

MARKS PUBLISHED FOR OPPOSITION

The following marks are published in compliance with section 12(a) of the Trademark Act of 1946. Applications for the registration of marks in more than one class have been filed as provided in section 30 of said act as amended by Public Law 772, 87th Congress, approved Oct. 9, 1962, 76 Stat. 769. Opposition under section 13 may be filed within thirty days of the date of this publication. See rules 2.101 to 2.105.

A separate fee of two hundred dollars for opposing each mark in each class must accompany the opposition.

SECTION 1.— INTERNATIONAL CLASSIFICATION

The short titles associated below with the international class numbers are terms designed merely for quick identification and are not an official part of the international classification. The full names of international classes are given in section 6.1 of the trademark rules of practice.

The designation "U.S. Cl." appearing in this section refers to the U.S. class in effect prior to Sep. 1, 1973 rather than the international class which applies to applications filed on or after that date. For adoption of international classification see notice in the OFFICIAL GAZETTE of Jun. 26, 1973 (911 O.G. TM 210).

Application in more than one class

SN 75-368,830. TVL BROADCASTING, INC., PROVIDENCE, RI. FILED 10-6-1997.

STC BROADCASTING

NO CLAIM IS MADE TO THE EXCLUSIVE RIGHT TO USE "BROADCASTING", APART FROM THE MARK AS SHOWN.

CLASS 35—ADVERTISING AND BUSINESS

FOR PROVIDING A WEBSITE OF INFORMATION FEATURING DATA ABOUT THE ACQUISITION, OPERATION, AND MANAGEMENT OF TELEVISION BROADCAST STATIONS (U.S. CLS. 100, 101 AND 102).
FIRST USE 3-0-1997; IN COMMERCE 3-0-1997.

CLASS 38—COMMUNICATION

FOR TELEVISION BROADCASTING SERVICES (U.S. CLS. 100, 101 AND 104).
FIRST USE 3-0-1997; IN COMMERCE 3-0-1997.
ALICE BENMAMAN, EXAMINING ATTORNEY

SN 75-383,532. AALBORG INDUSTRIES A/S, DK-9100 AALBORG, DENMARK, FILED 11-3-1997.

AALBORG INDUSTRIES

OWNER OF ERPN CMNTY TM OFC REG. NO. 458901, DATED 8-11-1998, EXPIRES 8-11-2008.
NO CLAIM IS MADE TO THE EXCLUSIVE RIGHT TO USE "INDUSTRIES", APART FROM THE MARK AS SHOWN.
SEC. 2(F) AS TO "AALBORG".

CLASS 9—ELECTRICAL AND SCIENTIFIC APPARATUS

FOR BOILER CONTROL APPARATUS, NAMELY, PROCESS CONTROLLERS; BOILER CONTROL INSTRUMENTS; GAS-FLUE CONTROLLERS AND COMPUTER PROGRAMS FOR GAS-FLUE ANALYSIS (U.S. CLS. 21, 23, 26, 36 AND 38).

CLASS 11—ENVIRONMENTAL CONTROL APPARATUS

FOR STEAM BOILERS; MARINE BOILERS; HOT WATER BOILERS; THERMAL OIL BOILERS; INDUSTRIAL BOILERS; BOILER PIPES; BOILER TUBES; BOILER FEED WATER INSTALLATIONS; BOILER FUEL FEED INSTALLATIONS; HEAT EXCHANGERS FOR OIL, WATER AND STEAM COOLING, HEATING AND EVAPORATION; FILTERS FOR BOILERS SOLD AS PART OF BOILER INSTALLATIONS; FLUE-GAS FILTERS SOLD AS PART OF BOILER INSTALLATIONS (U.S. CLS. 13, 21, 23, 31 AND 34).

CLASS 37—CONSTRUCTION AND REPAIR

FOR BOILER SERVICES, NAMELY, BUILDING, INSTALLATION, MAINTENANCE AND REPAIR (U.S. CLS. 100, 103 AND 106).
ROBIN CHOSID, EXAMINING ATTORNEY

SN 75-503,601. ILLUSION FACTORY, INC., THE, WOODLAND HILLS, CA. FILED 6-16-1998.

THE ILLUSION FACTORY

CLASS 35—ADVERTISING AND BUSINESS

FOR PRODUCTION OF TELEVISION COMMERCIALS AND TRAILERS; COPYRIGHT MANAGEMENT AND CONSULTATION (U.S. CLS. 100, 101 AND 102).
FIRST USE 0-0-1979; IN COMMERCE 11-0-1980.

CLASS 41—EDUCATION AND ENTERTAINMENT

FOR ENTERTAINMENT SERVICES, NAMELY, PRODUCTION OF LIVE ACTION FILMS, TELEVISION PROGRAMS, HOME VIDEOTAPES, MULTIMEDIA ENTERTAINMENT SOFTWARE; ENTERTAINMENT SERVICES, NAMELY, PREPARATION OF SPECIAL EFFECTS AND SCORING FOR THE TELEVISION, MOTION PICTURE FILM, AND VIDEO INDUSTRIES; MOTION PICTURE FILM PRODUCTION SERVICES (U.S. CLS. 100, 101 AND 107).
FIRST USE 0-0-1979; IN COMMERCE 11-0-1980.

CLASS 42—SCIENTIFIC, COMPUTER AND LEGAL SERVICES

FOR GRAPHIC ART DESIGN SERVICES; GRAPHIC ILLUSTRATION FOR OTHERS; GRAPHIC ART AND DESIGN SERVICES IN THE NATURE OF DIGITAL IMAGING, SPECIAL EFFECTS, PHOTOGRAPHY, ILLUSTRATION, AND TYPESETTING; GRAPHIC ART AND DESIGN SERVICES FOR CREATING BROCHURES, CATALOGS, ADVERTISEMENTS, POSTERS, AND PACKAGING DISPLAYS FOR CORPORATIONS AS WELL AS THE FILM, TELEVISION, AND VIDEO INDUSTRIES (U.S. CLS. 100 AND 101).

FIRST USE 0-0-1979; IN COMMERCE 11-0-1980.
TRACY CROSS, EXAMINING ATTORNEY

SN 75-524,993. 7 GRAND AND COMPANY LTD, DUBLIN 2, IRELAND, FILED 7-24-1998.

ARTICOLI

PRIORITY CLAIMED UNDER SEC. 44(D) ON ERP N CMNTY TM OFC APPLICATION NO. 820035, FILED 5-8-1998, REG. NO. 820035, DATED 10-18-2000, EXPIRES 5-8-2008.
OWNER OF BENELUX REG. NO. 200091, DATED 5-8-1998, EXPIRES 5-8-2008.

THE ENGLISH TRANSLATION OF "ARTICOLI" IS "ARTICLES".

CLASS 3—COSMETICS AND CLEANING PREPARATIONS

FOR (BASED ON INTENT TO USE) AFTERSHAVE LOTION, ANTIPERSPIRANT, NON-MEDICATED BATH SALTS, BEAUTY MASKS, BLUSHER, BUBBLE BATH, COLD CREAM, COLOGNE, DENTIFRICE, PERSONAL DEODORANT AND ANTIPERSPIRANT, DEPILATORIES, EMERY BOARDS, NAIL ENAMEL, EYE MAKEUP, EYE MAKEUP REMOVER, EYE SHADOW, EYEBROW PENCILS, ARTIFICIAL EYELASHES, EYELINERS, FACIAL SCRUBS, ARTIFICIAL FINGERNAILS, BATH GELS, NON-MEDICATED HAIR CARE PREPARATIONS, HAIR COLOR REMOVERS, HAIR CONDITIONERS, HAIR DRESSINGS FOR MEN, HAIR DYE, HAIR LIGHTENER, HAIR REMOVING CREAMS, HAIR RINSE, HAIR SPRAY, HAIR STRAIGHTENING PREPARATIONS, HAIR WAVING LOTIONS, HAND CLEANING PREPARATIONS, HAND-CREAM, LIP GLOSS, LIPSTICK, MAKEUP, FACIAL MAKEUP, FOUNDATION MAKEUP, MASCARA, MASSAGE OILS, MOUTHWASH, NAIL BUFFING PREPARATIONS, NAIL CARE PREPARATIONS, NAIL HARDENER, NAIL POLISH, NAIL POLISH BASE COAT, NAIL POLISH REMOVER, NAIL POLISH TOP COAT, NAIL STRENGTHENER, NIGHT CREAM, PAINT AND VARNISH STRIPPING OR REMOVING PREPARATIONS, PERFUMES, DENTURE POLISHES, BABY POWDER, FACE POWDER, ROUGE, SADDLE SOAP, HAIR SHAMPOOS, SHAVE CREAM, SHOWER GEL, SKIN CLARIFIER, SKIN CLEANING CREAM, SKIN EMOLLIENT, SKIN LIGHTENER, SKIN MOISTURIZER, SKIN TONER, DEODORANT SOAPS, TOILET SOAPS, LIQUID SOAPS, SPOT REMOVERS, SUNTAN LOTION, TALCUM POWDER, TOILET WATER, TOOTH GEL, TOOTH PASTE, VANISHING CREAM AND WRINKLE REMOVING SKIN CARE PREPARATIONS (U.S. CLS. 1, 4, 6, 50, 51 AND 52).

CLASS 9—ELECTRICAL AND SCIENTIFIC APPARATUS

FOR (BASED ON INTENT TO USE) SPECTACLES, PINCE-NEZ, EYEGLASSES FOR DIVING, CONTACT LENSES, SUN GLASSES, SPECTACLE CASES, AND STRING FOR SECURING GLASSES (U.S. CLS. 21, 23, 26, 36 AND 38).

CLASS 14—JEWELRY

FOR (BASED ON INTENT TO USE) ALARM CLOCKS, CHRONOMETERS, CLOCKS, HALL CLOCKS, PENDULUM CLOCKS, POCKET WATCHES, PRECIOUS STONES AND IMITATIONS THEREOF, TABLE CLOCKS, WALL CLOCKS, WATCHES AND WRIST WATCHES (U.S. CLS. 2, 27, 28 AND 50).

CLASS 18—LEATHER GOODS

FOR (BASED ON INTENT TO USE) ALL PURPOSE ATHLETIC BAGS, ATTACHE CASES, BABY BACK PACKS, CARRY-ON BAGS, CLUTCH BAGS, DUFFEL BAGS, SHOULDER BAGS, TOTE BAGS, GARMENT TRAVEL BAGS, BILLFOLDS, HAT BOXES FOR TRAVEL, HORSE BRIDLES, BRIEFCASES, WALKING CANES FOR NON-MEDICAL PURPOSES, CARD CASES FOR CALLING, BUSINESS AND CREDIT CARDS, KEY CASES, CLUTCH PURSES, COSMETIC CASES SOLD EMPTY, FUR PELTS, HAND BAGS, LUGGAGE, OVERNIGHT CASES MADE OF LEATHER, BACK PACKS, PASSPORT CASES, PASSPORT WALLETS, PLAYING CARD CASES MADE OF LEATHER, BRIEF CASE TYPE PORTFOLIOS, DRAWSTRING AND FELT POUCHES, RUCK-SACKS, SADDLES, SUITCASES, TOILETRY CASES SOLD EMPTY, TRUNKS FOR TRAVELING, PATIO AND BEACH UMBRELLAS, VALISES, VANITY CASES SOLD EMPTY AND WALKING STICKS (U.S. CLS. 1, 2, 3, 22 AND 41).

CLASS 25—CLOTHING

FOR (BASED ON INTENT TO USE) BATHING SUITS, BELTS, BLAZERS, BLOUSES, BONNETS, BREECHES, CAPTANS, CAPS, CARDIGANS, CASSOCKS, CHEMISETTES, CLOAKS, COATS, COLLARS MADE IN WHOLE OR PART OF FUR, FOULARDS, GILETS, GLOVES, GOWNS, HATS, HOSIERY, JACKETS, JEANS, JERSEYS, JUMPERS, LOUNGWEAR, MANTLES, NECKTIES, NIGHT-GOWNS, OVERALLS, OVERCOATS, PAJAMAS, PANTY-HOSE, PANTS, PELISSES, PETTICOATS, PULL-OVERS, RAINCOATS, ROBES, SCARVES, SHAWLS, SHIRTS, SHORTS, SKIRTS, SLACKS, SLIPPERS, SOCKS, STOCKINGS, STOLE, SUITS, SWEATERS, TAILLEURS, TIES, TIGHTS, TOPS, TRENCH COATS, TROUSERS, BATHING AND SWIM TRUNKS, T-SHIRTS, TUNICS, UNDERWEAR, VESTS, WAISTCOATS AND WIND RESISTANT JACKETS (U.S. CLS. 22 AND 39).

CLASS 35—ADVERTISING AND BUSINESS

FOR DIRECT MAIL ADVERTISING; ELECTRONIC BILLBOARD ADVERTISING; PREPARING AUDIO-VISUAL PRESENTATION FOR USE IN ADVERTISING; TELEVISION ADVERTISING AGENCIES; DISSEMINATION OF ADVERTISING MATTERS; ADVERTISING SERVICES, NAMELY PROVIDING ADVERTISING SPACE IN A PERIODICAL; ADVERTISING SLOGAN AND CARTOON CHARACTER LICENSING; RENTAL OF ADVERTISING SPACE; COOPERATIVE ADVERTISING AND MARKETING; MODELING FOR ADVERTISING OR SALES PROMOTION; ORGANIZING EXHIBITIONS FOR COMMERCIAL OR ADVERTISING PURPOSE, BUSINESS MANAGEMENT AND ADMINISTRATION OF CLOTHING, COSMETICS, PERFUMES AND ACCESSORIES SHOPS (U.S. CLS. 100, 101 AND 102).

CLASS 36—INSURANCE AND FINANCIAL

FOR FINANCIAL VALUATION OF REAL ESTATE AND RENTAL PROPERTY (U.S. CLS. 100, 101 AND 102).

CLASS 37—CONSTRUCTION AND REPAIR

FOR BUILDING CONSTRUCTION, REPAIR, AND INSTALLATION OF COMMERCIAL SPACE FOR RETAIL SALES (U.S. CLS. 100, 103 AND 106).

CLASS 42—SCIENTIFIC, COMPUTER AND LEGAL SERVICES

FOR RESTAURANT SERVICES, NAMELY PROVIDING FOOD AND DRINKS; MEDICAL, HYGIENIC, AND BEAUTY SERVICES, NAMELY BEAUTY SALONS, COMPUTER PROGRAMMING (U.S. CLS. 100 AND 101).
LESLIE RICHARDS, EXAMINING ATTORNEY

CLASS 42—SCIENTIFIC, COMPUTER AND LEGAL SERVICES

FOR EDUCATIONAL CONSULTING SERVICES FOR DEVELOPING AND TEACHING READING, WRITING, LISTENING AND COMMUNICATION SKILLS (U.S. CLS. 100 AND 101).
PAULA MAYS, EXAMINING ATTORNEY

SN 75-547,204. GINA GROUP PLC, THE, LONDON, UNITED KINGDOM, FILED 9-2-1998.

SN 75-839,438. ASTRAZENECA PLC, LONDON, W1Y 6LN, ENGLAND, FILED 11-3-1999.

GINA

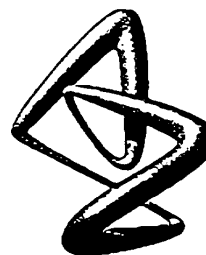
OWNER OF ERPN CMNTY TM OFC REG. NO. 000880096, DATED 7-17-1998, EXPIRES 7-17-2008.
OWNER OF U.S. REG. NO. 1,832,263.

PRIORITY CLAIMED UNDER SEC. 44(D) ON UNITED KINGDOM APPLICATION NO. 2,196,350, FILED 5-4-1999, REG. NO. 2196350, DATED 5-11-2001, EXPIRES 5-4-2009. SEC. 2(F).

CLASS 18—LEATHER GOODS

FOR HANDBAGS, EVENING BAGS, TRAVELING BAGS, PURSES, HOLDALLS, ATTACHE CASES, INCLUDING THE AFORESAID GOODS BEING MADE OF LEATHER, IMITATION LEATHER, SYNTHETIC MATERIALS, FABRIC, EMBROIDERED MATERIALS, BEADED MATERIALS, SILK, WOOLS, COTTON, LINEN; UMBRELLAS (U.S. CLS. 1, 2, 3, 22 AND 41).

CLASS 1—CHEMICALS

FOR HOUSE MARK FOR CHEMICALS USED IN THE PHARMACEUTICAL INDUSTRY, AGRICULTURE, HORTICULTURE AND FORESTRY; UNPROCESSED ARTIFICIAL RESINS, UNPROCESSED PLASTICS, CHEMICAL SUBSTANCES FOR PRESERVING FOODSTUFFS, TANNING SUBSTANCES, ADHESIVES USED IN INDUSTRY, NONE OF WHICH GOODS ARE USED IN THE PHOTO PROCESSING OR PHOTO INDUSTRY, AGROCHEMICALS AND SPECIALTY CHEMICALS FOR USE IN THE PHARMACEUTICAL INDUSTRIES (U.S. CLS. 1, 5, 6, 10, 26 AND 46).

CLASS 25—CLOTHING

FOR FOOTWEAR AND BELTS (U.S. CLS. 22 AND 39).
HENRY S. ZAK, EXAMINING ATTORNEY

CLASS 5—PHARMACEUTICALS

FOR HOUSE MARK FOR PHARMACEUTICALS IN THE FIELD OF HUMAN MEDICINE (U.S. CLS. 6, 18, 44, 46, 51 AND 52).

SN 75-777,025. ALPHASKILLS, INC., JEFFERSONVILLE, GA. FILED 8-16-1999.

READ WITH SARAH

NO CLAIM IS MADE TO THE EXCLUSIVE RIGHT TO USE "READ", APART FROM THE MARK AS SHOWN.

CLASS 10—MEDICAL APPARATUS

FOR HOUSE MARK FOR SURGICAL AND MEDICAL INSTRUMENTS (U.S. CLS. 26, 39 AND 44).

CLASS 16—PAPER GOODS AND PRINTED MATTER

FOR PRINTED CURRICULA, LESSON PLANS, TEACHING GUIDES, AND PRINTED TEXTS AND MATERIALS ON TEACHING READING, WRITING, LISTENING AND COMMUNICATION SKILLS (U.S. CLS. 2, 5, 22, 23, 29, 37, 38 AND 50).

CLASS 29—MEATS AND PROCESSED FOODS

FOR HOUSE MARK FOR PREPARED AND PROCESSED PROTEIN AND MYCO-PROTEIN FOR HUMAN CONSUMPTION (U.S. CL. 46).

CLASS 35—ADVERTISING AND BUSINESS

FOR BUSINESS MANAGEMENT CONSULTATION; BUSINESS ORGANIZATION CONSULTATION; BUSINESS ADMINISTRATION CONSULTATION; BUSINESS RESEARCH; IMPORT AND EXPORT AGENCIES; PROMOTING THE SPORTS COMPETITIONS AND CONCERTS OF OTHERS (U.S. CLS. 100, 101 AND 102).

CLASS 36—INSURANCE AND FINANCIAL

FOR FINANCIAL MANAGEMENT; FINANCIAL ANALYSIS AND CONSULTATION; REAL ESTATE MANAGEMENT (U.S. CLS. 100, 101 AND 102).

CLASS 39—TRANSPORTATION AND STORAGE

FOR STORAGE OF INDUSTRIAL CHEMICALS USED IN THE PHARMACEUTICAL INDUSTRY, AGRICULTURAL CHEMICALS AND PHARMACEUTICALS; TRANSPORT AND DELIVERY OF GOODS BY ROAD, RAIL, WATER AND AIR (U.S. CLS. 100 AND 105).

CLASS 41—EDUCATION AND ENTERTAINMENT

FOR ARRANGING AND CONDUCTING EDUCATIONAL CONFERENCE IN THE FIELD OF PHARMACEUTICALS; ARRANGING AND CONDUCTING SYMPOSIA IN THE FIELD OF PHARMACEUTICALS (U.S. CLS. 100, 101 AND 107).

CLASS 42—SCIENTIFIC, COMPUTER AND LEGAL SERVICES

FOR DIAGNOSTIC TESTING AND ANALYSIS OF PHARMACEUTICAL PRODUCTS; ADVISORY SERVICES RELATING TO HEALTHCARE; CONSULTANCY SERVICES RELATING TO HEALTHCARE; ALL RELATING TO PHARMACEUTICAL PRODUCTS (U.S. CLS. 100 AND 101).

DAVID H. STINE, EXAMINING ATTORNEY

SN 75-893,844. TERRANET LTD., BALZAN BZN 08, MALTA, FILED 1-8-2000.



PRIORITY CLAIMED UNDER SEC. 44(D) ON ERP CMNTY TM OFC APPLICATION NO. 1239136, FILED 7-13-1999, REG. NO. 01239136, DATED 1-18-2001, EXPIRES 7-13-2009.

OWNER OF ERP CMNTY TM OFC REG. NO. 001476597, DATED 1-31-2001, EXPIRES 1-31-2011.

THE COLOR(S) SKY BLUE, BLUE AND BLACK IS/ARE CLAIMED AS A FEATURE OF THE MARK.

THE COLORS SKY BLUE APPEARS IN THE TOP THIRD OF THE TERM SHORE, THE COLOR BLACK APPEARS IN THE MIDDLE OF THE WORD SHORE AND THE UNDERSCORE "E," AND THE COLOR BLUE APPEARS IN THE BOTTOM THIRD OF THE WORD SHORE.

CLASS 9—ELECTRICAL AND SCIENTIFIC APPARATUS

FOR COMPUTER EQUIPMENT AND APPARATUS, NAMELY, COMMUNICATION SERVERS USED TO FACILITATE THE TRANSMISSION, SECURITY, PROCESSING AND CLEARING OF DATA PERTAINING TO INTERNET, MOBILE AND DIGITAL BUSINESS TRANSACTIONS; NETWORK AND INTERNETWORK SYSTEMS USED TO FACILITATE THE TRANSMISSION, SECURITY, PROCESSING AND CLEARING OF DATA PERTAINING TO INTERNET, MOBILE AND DIGITAL BUSINESS TRANSACTIONS COMPRISED OF COMPUTER NETWORK HUBS, SWITCHES AND ROUTERS (U.S. CLS. 21, 23, 26, 36 AND 38).

CLASS 42—SCIENTIFIC, COMPUTER AND LEGAL SERVICES

FOR COMPUTER SERVICES, NAMELY, DEVELOPING, CREATING AND MAINTAINING WEBSITES AND ELECTRONIC SHOPPING CARTS FOR OTHERS FOR THE PURPOSE OF CONDUCTING ELECTRONIC COMMERCE AND INTERNET BASED TRANSACTIONS AND TECHNICAL SUPPORT SERVICES, NAMELY TROUBLESHOOTING OF COMPUTER HARDWARE AND SOFTWARE PROBLEMS RELATED THERETO (U.S. CLS. 100 AND 101).

FIRST USE 10-1-1999; IN COMMERCE 10-1-1999.

KELLY BOULTON, EXAMINING ATTORNEY

SN 75-943,581. GEODESIA LIMITED, LONDON, UNITED KINGDOM, FILED 3-14-2000.

GEODESIA

PRIORITY CLAIMED UNDER SEC. 44(D) ON ERP CMNTY TM OFC APPLICATION NO. 1499581, FILED 2-9-2000, REG. NO. 001499581, DATED 1-9-2004, EXPIRES 2-9-2010.

THE TERM GEODESIA IS A SPANISH OR ITALIAN WORD WHICH TRANSLATES INTO ENGLISH AS "GEODESY".

CLASS 35—ADVERTISING AND BUSINESS

FOR BUSINESS INVESTIGATION AND CONSULTATION SERVICES; BUSINESS AUDITING; MARKETING RESEARCH; CONDUCTING MARKETING STUDIES; ACCOUNTING SERVICES; TAXATION CONSULTATION; AUCTIONEERING; BUSINESS MANAGEMENT CONSULTATION AND BUSINESS CONSULTATION IN THE FIELDS OF INTELLECTUAL PROPERTY; SECRETARIAL SERVICES; PERSONNEL RECRUITMENT; COMMERCIAL INFORMATION AGENCY SERVICES; COMPUTERIZED ON-LINE RETAIL STORE SERVICES FEATURING BOOKS; DATABASE MANAGEMENT SERVICES; LOCUM SERVICES FOR OTHERS, NAMELY TEMPORARY EMPLOYEE AGENCIES; AND ALL THE AFORESAID SERVICES PROVIDED VIA THE INTERNET (U.S. CLS. 100, 101 AND 102).

CLASS 36—INSURANCE AND FINANCIAL

FOR RISK MANAGEMENT SERVICES; PROVIDING FINANCE INFORMATION RELATING TO INTELLECTUAL PROPERTY; FINANCIAL SERVICES, NAMELY VALUATION OF AN INTELLECTUAL PROPERTY; INSURANCE SERVICES; NAMELY UNDERWRITING INSURANCE POLICIES FOR INTELLECTUAL PROPERTY AND THE INFRINGEMENT THEREOF; RESOURCING OF VENTURE CAPITAL FOR OTHERS; AND ALL THE AFORESAID SERVICES PROVIDED BY THE INTERNET (U.S. CLS. 100, 101 AND 102).

CLASS 38—COMMUNICATION

FOR TELECOMMUNICATION SERVICES, NAMELY INTERNET SERVICE PROVISION; ELECTRONIC TRANSMISSION OF DATA; ELECTRONIC MAIL SERVICES; PROVIDING USER ACCESS TO THE INTERNET; PROVIDING TELECOMMUNICATION CONNECTIONS TO THE INTERNET OR DATABASE ON THE INTERNET (U.S. CLS. 100, 101 AND 104).

CLASS 41—EDUCATION AND ENTERTAINMENT

FOR EDUCATION AND TRAINING SERVICES, NAMELY TRAINING IN THE FIELD OF INTELLECTUAL PROPERTY AND THE USE AND OPERATION OF COMPUTERS; ARRANGING AND CONDUCTING CONFERENCES, SEMINARS AND WORKSHOPS IN THE FIELD OF INTELLECTUAL PROPERTY; LIBRARY SERVICES; AND ALL THE AFORESAID SERVICES PROVIDED BY THE INTERNET (U.S. CLS. 100, 101 AND 107).

CLASS 42—SCIENTIFIC, COMPUTER AND LEGAL SERVICES

FOR DATABASE DEVELOPMENT SERVICES; LEGAL SERVICES; LEGAL RESEARCH SERVICES; NEW PRODUCT RESEARCH AND DEVELOPMENT FOR OTHERS; EXPERT WITNESS SERVICES IN THE FIELD OF INTELLECTUAL PROPERTY; INTELLECTUAL PROPERTY LICENSING; DESIGNING AND IMPLEMENTING WEB PAGES ON THE INTERNET FOR OTHERS; SOFTWARE DESIGN SERVICES FOR OTHERS; COMPUTER PROGRAMMING FOR OTHERS; MAINTENANCE OF COMPUTER SOFTWARE; GRAPHIC ART DESIGN; LANGUAGE TRANSLATION SERVICES; HOSTING THE WEB SITES OF OTHERS ON A COMPUTER SERVER FOR A GLOBAL COMPUTER NETWORK; ELECTRONIC MAIL HOSTING SERVICES; NEWS AGENCIES, NAMELY GATHERING AND DISSIMINATION OF NEWS; AND ALL OF THE AFORESAID SERVICES PROVIDED BY THE INTERNET (U.S. CLS. 100 AND 101).

MARY BOAGNI, EXAMINING ATTORNEY

SN 75-979,308. BAKERS FOOTWEAR GROUP INC., ST. LOUIS, MO. FILED 3-12-1998.

BAKERS

NOVUS INC. CLAIMS THE EXCLUSIVE RIGHT TO USE THE MARK IN THE AREA COMPRISING THE COMMONWEALTH OF PUERTO RICO AND THE U.S. VIRGIN ISLANDS. BAKERS FOOTWEAR GROUP, INC. CLAIMS THE EXCLUSIVE RIGHT TO USE THE MARK IN THE AREA COMPRISING THE UNITED STATES, EXCLUDING THE COMMONWEALTH OF PUERTO RICO AND THE U.S. VIRGIN ISLANDS.

OWNER OF U.S. REG. NO. 719,778.

CLASS 3—COSMETICS AND CLEANING PREPARATIONS

FOR SHOE POLISHES, SHOE OILS, AND SHOE POLISH WITH A SPONGE APPLICATOR (U.S. CLS. 1, 4, 6, 50, 51 AND 52).

FIRST USE 12-31-1997; IN COMMERCE 12-31-1997.

CLASS 9—ELECTRICAL AND SCIENTIFIC APPARATUS

FOR SUNGLASSES (U.S. CLS. 21, 23, 26, 36 AND 38).
FIRST USE 12-31-1997; IN COMMERCE 12-31-1997.

CLASS 14—JEWELRY

FOR JEWELRY (U.S. CLS. 2, 27, 28 AND 50).
FIRST USE 12-31-1997; IN COMMERCE 12-31-1997.

CLASS 18—LEATHER GOODS

FOR WALLETS, BACKPACKS, AND HANDBAGS (U.S. CLS. 1, 2, 3, 22 AND 41).
FIRST USE 12-31-1997; IN COMMERCE 12-31-1997.

CLASS 21—HOUSEWARES AND GLASS

FOR SHOE BRUSHES AND SHOE SPONGES (U.S. CLS. 2, 13, 23, 29, 30, 33, 40 AND 50).
FIRST USE 12-31-1997; IN COMMERCE 12-31-1997.

CLASS 26—FANCY GOODS

FOR HAIR ORNAMENTS AND HAIR ACCESSORIES, NAMELY, SALON CLIPS, HAIRPINS, BARRETTES, HAIRSTICKS, COMBS, SNAP CLIPS, HAIRCLAWS, PONYTAIL HOLDERS, HAIR BANDS, AND HAIR BOWS (U.S. CLS. 37, 39, 40, 42 AND 50).

FIRST USE 12-31-1997; IN COMMERCE 12-31-1997.
KARLA PERKINS, EXAMINING ATTORNEY

SN 75-983,405. SHO-BOND CORPORATION, CHIYODA-KU, TOKYO, JAPAN, FILED 4-20-1998.

SHO-BOND

OWNER OF JAPAN REG. NO. 1702202, DATED 7-25-1984, EXPIRES 2-17-2014.

OWNER OF JAPAN REG. NO. 3006225, DATED 9-30-1994, EXPIRES 5-11-2014.

OWNER OF JAPAN REG. NO. 1452889, DATED 1-30-1981, EXPIRES 9-19-2010.

OWNER OF JAPAN REG. NO. 2472347, DATED 10-30-1992, EXPIRES 5-21-2012.

CLASS 6—METAL GOODS

FOR (BASED ON 44(E) FOREIGN REGISTRATION NUMBER 1702202) METAL EXPANSION JOINTS FOR BRIDGES (U.S. CLS. 2, 12, 13, 14, 23, 25 AND 50).

CLASS 19—NON-METALLIC BUILDING MATERIALS

FOR (BASED ON 44(E) FOREIGN REGISTRATION NUMBER 1452889) NON-METAL EXPANSION JOINT FOR BRIDGES (U.S. CLS. 1, 12, 33 AND 50).

CLASS 37—CONSTRUCTION AND REPAIR

FOR (BASED ON 44(E) FOREIGN REGISTRATION NUMBER 3006225) ERECTION OF STEEL STRUCTURES, GENERAL BUILDING CONSTRUCTION, HOUSING PAINTING AND ROAD PAVING (U.S. CLS. 100, 103 AND 106).

CLASS 42—SCIENTIFIC, COMPUTER AND LEGAL SERVICES

FOR (BASED ON 44(E) FOREIGN REGISTRATION NUMBER 2472347) INTERIOR DECORATING AND CIVIL ENGINEERING SERVICES (U.S. CLS. 100 AND 101).
CHARLES L. JENKINS, EXAMINING ATTORNEY

SN 76-189,221. FRNK TECHNOLOGY GROUP, SAN MATEO, CA. FILED 1-3-2001.

BONDAGE

SEC. 2(F).

CLASS 35—ADVERTISING AND BUSINESS

FOR PROMOTING GOODS AND SERVICES OF OTHERS BY DISSEMINATING ADVERTISEMENTS FOR OTHERS VIA LOCAL AND GLOBAL COMPUTER NETWORKS; CONDUCTING PUBLIC OPINION POLL SURVEYS FOR NON-BUSINESS, NON-MARKETING PURPOSES VIA A GLOBAL COMPUTER NETWORK WEBSITE (U.S. CLS. 100, 101 AND 102).

FIRST USE 7-8-1995; IN COMMERCE 4-1-1997.

CLASS 38—COMMUNICATION

FOR VIDEO AND MOVIE BROADCASTING SERVICES IN THE FIELD OF ADULT ENTERTAINMENT VIA A GLOBAL COMPUTER NETWORK (U.S. CLS. 100, 101 AND 104).

FIRST USE 7-8-1995; IN COMMERCE 4-1-1997.
ZHALEH DELANEY, EXAMINING ATTORNEY

SN 76-219,007. KAO KABUSHIKI KAISHA, TA KAO CORPORATION, CHUO-KU, TOKYO 103-8210, JAPAN, FILED 3-2-2001.

Oriena

THE MARK CONSISTS OF STANDARD CHARACTERS WITHOUT CLAIM TO ANY PARTICULAR FONT, STYLE, SIZE, OR COLOR.

OWNER OF JAPAN REG. NO. 4530707, DATED 12-21-2001, EXPIRES 12-21-2011.

CLASS 3—COSMETICS AND CLEANING PREPARATIONS

FOR COSMETICS, NAMELY, SKIN SOAP, SKIN CARE CREAM, SKIN MOISTURIZER, SKIN CARE LOTION, SKIN CARE MILK, FACE CARE LOTION, BEAUTY MASK, FACIAL MASSAGE LOTION, BODY MASSAGE LOTION, MAKE UP REMOVER, EAU DE COLOGNE (U.S. CLS. 1, 4, 6, 50, 51 AND 52).

CLASS 21—HOUSEWARES AND GLASS

FOR COSMETIC BRUSHES (U.S. CLS. 2, 13, 23, 29, 30, 33, 40 AND 50).

JEFFERY COWARD, EXAMINING ATTORNEY

SN 76-220,442. BIOCYTEX, 13010 MARSEILLE, FRANCE, FILED 3-6-2001.

CELLQUANT

OWNER OF FRANCE REG. NO. 99776429, DATED 2-19-1999, EXPIRES 2-19-2009.

CLASS 1—CHEMICALS

FOR DIAGNOSTIC REAGENTS INTENDED TO BE USED FOR CELLULAR ANALYSIS OF BLOOD BIOLOGICAL SAMPLE (U.S. CLS. 1, 5, 6, 10, 26 AND 46).

FIRST USE 11-0-1998; IN COMMERCE 4-0-1999.

CLASS 10—MEDICAL APPARATUS

FOR DIAGNOSTIC APPARATUS FOR THE CELLULAR ANALYSIS OF BLOOD BIOLOGICAL SAMPLE (U.S. CLS. 26, 39 AND 44).

FIRST USE 11-0-1998; IN COMMERCE 4-0-1999.

SCOTT OSCLICK, EXAMINING ATTORNEY

SN 76-224,395. DRAEGER'S SUPER MARKETS, PALO ALTO, CA. FILED 3-14-2001.

Draeger's Epicurean Classics

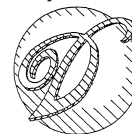

THE DRAWING IS LINED FOR THE COLORS WHITE ON THE WORDS, GREEN WITH ORANGE ON THE LETTER "D," AND GREEN WITH SHADOWS ON THE BALL BACKGROUND.

CLASS 29—MEATS AND PROCESSED FOODS

FOR PACKAGED FOODS, NAMELY— BROTHS, CHOWDERS, SOUPS, VEGETABLE, FISH AND BEEF STOCK, FRUIT, GARDEN AND VEGETABLE SALADS (U.S. CL. 46).

FIRST USE 12-31-1996; IN COMMERCE 12-31-1996.

CLASS 30—STAPLE FOODS

FOR BREAD, CROUTONS, DEMI-GLACE SAUCE, MARINADES, RAVIOLIS, SALAD DRESSINGS, SAUCES, VINAIGRETTES, VANILLA, AND VINEGAR (U.S. CL. 46).

FIRST USE 12-31-1996; IN COMMERCE 12-31-1996.

NELSON SNYDER, EXAMINING ATTORNEY

SN 76-230,736. TOKAI OPTICAL CO., LTD., AICHI-KEN 444-2192, JAPAN, FILED 3-27-2001.

TOKAI

PRIORITY CLAIMED UNDER SEC. 44(D) ON JAPAN APPLICATION NO. 2000-135280, FILED 12-15-2000, REG. NO. 4826128, DATED 12-17-2004, EXPIRES 12-17-2014.

OWNER OF U.S. REG. NO. 2,373,339.

CLASS 9—ELECTRICAL AND SCIENTIFIC APPARATUS

FOR OPTICAL FIBER CABLES; OPTICAL FILTERS; OPTICAL LENSES; OPTICAL MIRRORS; CONTACT LENSES; CONTAINERS FOR CONTACT SPECTACLE FRAMES; OPTICAL GLASSES (U.S. CLS. 21, 23, 26, 36 AND 38).

CLASS 40—MATERIAL TREATMENT

FOR PROCESSING AND TREATMENT OF CONTACT LENSES, EYEGLOSS LENSES, OPTICAL LENSES AND SPECTACLES; CUTTING, GRINDING AND POLISHING OF EYEGLOSS LENSES; EYEGLOSS LENS DYEING; EYEGLOSS LENS GROOVING; OPTICAL LENS GRINDING; PROCESSING AND TREATMENT OF GLASSES; PROCESSING AND TREATMENT OF METALS; PROCESSING AND TREATMENT OF ELECTRIC MATERIALS; PROCESSING AND TREATMENT OF ELECTRONIC COMPONENTS; PROCESSING AND TREATMENT OF CHEMICAL PRODUCTS; CUSTOM ASSEMBLING AND PROCESSING OF COMPUTER PERIPHERAL EQUIPMENT; THIN-FILM PROCESSING AND TREATMENT; SURFACE COATING PROCESSING AND TREATMENT; FILM COATING PROCESSING AND TREATMENT; RENTAL OF PROCESSING MACHINES FOR ADJUSTMENT OF SPECTACLES (U.S. CLS. 100, 103 AND 106).

STACY WAHLBERG, EXAMINING ATTORNEY

CLASS 16—PAPER GOODS AND PRINTED MATTER

FOR MAGAZINES ON THE SUBJECTS OF TRAVEL, RECREATIONAL ACTIVITIES, AUTOMOBILES, MUSIC, MOTION PICTURES, COMPUTERS AND COMPUTER SOFTWARE, COMPUTER NETWORKS, BOOKS AND COMIC BOOKS, COMPUTER GAMES AND VIDEO GAMES, OUTDOOR PURSUITS, SCIENCE, MARRIAGE, NEWLY-MARRIED LIFE, LOCAL GEOGRAPHIC AREAS, INFANT REARING, FASHION, BEAUTY, LAND, HOUSES, HOME IMPROVEMENT, GARDENING, APARTMENTS, LEARNING, EDUCATION, BUSINESS AND FINANCIAL SERVICES; MAGAZINES ON THE SUBJECTS OF QUALIFICATION AND LICENSING IN THE FIELDS OF TRAVEL, AUTOMOBILES, COMPUTERS, AND COMPUTER SOFTWARE, COMPUTER NETWORKS, SCIENCE, INFANT REARING, FASHION, BEAUTY, LAND, HOUSES, HOME IMPROVEMENT, GARDENING, APARTMENTS, BUSINESS, FINANCIAL SERVICES, AND LAW; COMIC MAGAZINES AND COMIC BOOKS; PLAYING CARDS; TRADING CARDS (U.S. CLS. 2, 5, 22, 23, 29, 37, 38 AND 50).

SN 76-248,999. RECRUIT CO., LTD., CHUO-KU, TOKYO, JAPAN, FILED 4-30-2001.

RECRUIT

PRIORITY CLAIMED UNDER SEC. 44(D) ON JAPAN APPLICATION NO. 2000-121190, FILED 11-8-2000, REG. NO. 4618940, DATED 11-8-2002, EXPIRES 11-8-2012.
THE ENTIRE MARK IS COLORED BLUE.

CLASS 9—ELECTRICAL AND SCIENTIFIC APPARATUS

FOR COMPUTER SOFTWARE AND COMPUTER SOFTWARE THAT MAY BE DOWNLOADED VIA COMPUTER NETWORKS FOR USE IN ELECTRONIC PUBLISHING, SENDING AND RECEIVING MESSAGES, DATA BASE MANAGEMENT, DECODING COMPRESSED DATA, IMAGE PROCESSING, REPRODUCING MUSIC DATA, COMPUTER GAMES, VIDEO GAMES, ELECTRONIC COMMERCE TO ALLOW USERS TO PERFORM ELECTRONIC BUSINESS TRANSACTIONS VIA A GLOBAL COMPUTER NETWORK, SEARCHING INFORMATION RELATING TO REAL ESTATE, AUTOMOBILES, TRAVEL, WEDDINGS, INFANT REARING, GOURMET AND FINANCIAL SERVICES, TRADING OF REAL ESTATE AND AUTOMOBILES, FINANCIAL TRANSACTIONS, NAMELY, COMPUTER COMMUNICATIONS SOFTWARE TO ALLOW CUSTOMERS TO ACCESS BANK ACCOUNT INFORMATION AND TRANSACT BANK BUSINESS, AND TO ACCESS SECURITIES COMPANY ACCOUNT INFORMATION AND TRANSACT SECURITIES BUSINESS, MAKING TRAVEL RESERVATIONS, MAKING RESERVATIONS FOR WEDDING CEREMONY FACILITIES AND FOR RESTAURANTS; EDUCATIONAL SOFTWARE FOR CHILDREN, EDUCATIONAL SOFTWARE FOR EMPLOYEES AND MANAGEMENT FOR SALES PRACTICE, MARKETING, FINANCE, LEGAL AFFAIRS, PERSONAL AFFAIRS, AND FOREIGN LANGUAGES, AND EDUCATIONAL SOFTWARE FEATURING INSTRUCTION IN TEACHING LANGUAGES; VIDEO GAME SOFTWARE; PRERECORDED AUDIO TAPES AND DISCS FEATURING MUSIC; PRERECORDED VIDEO TAPES AND DISCS FEATURING MUSIC, VOICE DRAMATIZATIONS, LIVE PERFORMANCES BY MUSICAL BANDS, ANIMATION, MOTION PICTURES FOR ENTERTAINMENT, NAMELY, ACTION MOVIES, COMEDIES, DRAMAS, AND ROMANCES, EMPLOYEE EDUCATIONAL INSTRUCTION AND MANAGEMENT EDUCATIONAL INSTRUCTION, INFORMATION IN THE FIELDS OF REAL ESTATE, AUTOMOBILES, EMPLOYMENT, TRAVEL, WEDDINGS, INFANT REARING, GOURMET AND FINANCIAL SERVICES (U.S. CLS. 21, 23, 26, 36 AND 38).

CLASS 35—ADVERTISING AND BUSINESS

FOR ADVERTISING FOR OTHERS, NAMELY, DIRECT MARKETING ADVERTISING, ADVERTISING IN MAGAZINES, NEWSPAPERS, SIGNBOARDS, AND TRANSPORTATION SYSTEMS, DISSEMINATION OF ADVERTISING FOR OTHERS VIA THE INTERNET, ADVERTISING AGENCY SERVICES; PROFESSIONAL BUSINESS CONSULTATION; PERSONNEL MANAGEMENT CONSULTATION, MARKET RESEARCH; COMMERCIAL INFORMATION AGENCIES; PROMOTING THE GOODS AND SERVICES OF OTHERS THROUGH THE DISTRIBUTION OF DISCOUNT CARDS, PLANNING OF SALES PROMOTION ACTIVITIES FOR OTHERS; AUCTIONEERING; PROVIDING INFORMATION ABOUT RESTAURANT FRANCHISING, NAMELY, OFFERING TECHNICAL ASSISTANCE IN THE ESTABLISHMENT AND/OR OPERATION OF RESTAURANTS (U.S. CLS. 100, 101 AND 102).

CLASS 36—INSURANCE AND FINANCIAL

FOR INFORMATION SERVICES RELATING TO FINANCE, NAMELY, FINANCIAL INFORMATION PROVIDED BY ELECTRONIC MEANS, FINANCIAL INFORMATION PROCESSING; PROVIDING INFORMATION IN THE FIELDS OF INSURANCE AND SECURITIES, NAMELY, PROVIDING INSURANCE PRODUCTS INFORMATION, INSURANCE QUOTES AND CLAIM ADJUSTMENT INFORMATION, AND SECURITIES PRODUCTS AND MARKET INFORMATION; REAL ESTATE INFORMATION SERVICES, NAMELY, REAL ESTATE LISTINGS; AUTOMOBILE APPRAISAL SERVICES (U.S. CLS. 100, 101 AND 102).

CLASS 38—COMMUNICATION

FOR COMMUNICATION BY FACSIMILE TRANSMISSION; COMMUNICATION BY COMPUTER TERMINALS, NAMELY, ELECTRONIC TRANSMISSION OF DATA AND DOCUMENTS VIA COMPUTER TERMINALS, FACSIMILE TRANSMISSION; VOICE MAIL; ELECTRONIC MAIL; PROVIDING ONLINE ELECTRONIC BULLETIN BOARDS FOR TRANSMISSION OF MESSAGES AMONG COMPUTER USERS CONCERNING TRAVEL, RECREATIONAL ACTIVITIES, AUTOMOBILES, MUSIC, MOTION PICTURES, COMPUTERS AND COMPUTER SOFTWARE, COMPUTER NETWORKS, BOOKS AND COMIC BOOKS, COMPUTER GAMES AND VIDEO GAMES, OUTDOOR PURSUITS, SCIENCE, MARRIAGE, NEWLY-MARRIED LIFE, LOCAL GEOGRAPHIC AREAS, INFANT REARING, FASHION, BEAUTY, LAND, HOUSES, HOME IMPROVEMENT, GARDENING, APARTMENTS, LEARNING, EDUCATION, BUSINESS AND FINANCIAL SERVICES; WIRELESS TELECOMMUNICATION SERVICES FOR ACCESS TO A GLOBAL COMPUTER NETWORK; TELEVISION BROADCASTING, RADIO BROADCASTING, AND SATELLITE BROADCASTING (U.S. CLS. 100, 101 AND 104).

CLASS 39—TRANSPORTATION AND STORAGE

FOR TRAVEL INFORMATION SERVICES; TRAVEL RESERVATIONS FOR TRANSPORTATION, ARRANGING OF TRAVEL TOURS, BOOKING OF SEATS FOR TRANSPORTATION; INFORMATION SERVICES RELATING TO CARGO TRANSPORTATION IN CONNECTION WITH MOVING FROM ONE ABODE OR LOCATION TO ANOTHER, AND TRANSPORTING ARCHITECTURAL STRUCTURES; BROKERAGE OF CARGO TRANSPORTATION IN CONNECTION WITH MOVING FROM ONE ABODE OR LOCATION TO ANOTHER, AND TRANSPORTING ARCHITECTURAL STRUCTURES (U.S. CLS. 100 AND 105).

CLASS 41—EDUCATION AND ENTERTAINMENT

FOR INSTRUCTIONAL AND TRAINING SERVICES IN THE FIELD OF MUSIC VERSIFICATION, COMPOSITION, AND ARRANGEMENT, AND PRODUCTION OF ANIMATION AND GAME PROGRAMS; INSTRUCTIONAL AND EDUCATIONAL SERVICES, NAMELY, CONDUCTING SEMINARS AND WORKSHOPS IN THE FIELD OF OBTAINING QUALIFICATION OR LICENSES FOR CAREER COUNSELING, TRAVEL, AUTOMOBILES, COMPUTERS, AND COMPUTER SOFTWARE, COMPUTER NETWORKS, SCIENCE, INFANT REARING, FASHION, BEAUTY, LAND, HOUSES, HOME IMPROVEMENT, GARDENING, APARTMENTS, BUSINESS, FINANCIAL SERVICES, AND LAW; PROVIDING INFORMATION ABOUT SCHOOLS; INFORMATION SERVICES RELATING TO CULTURE AND SCHOLARSHIP; ARRANGING AND CONDUCTING OF EXHIBITIONS FOR CULTURAL OR EDUCATIONAL PURPOSES; LIBRARY SERVICES VIA COMPUTER NETWORKS; ENTERTAINMENT IN THE NATURE OF FASHION SHOWS; PRODUCTION AND DISTRIBUTION OF MOVIES; PRESENTATION OF LIVE PERFORMANCES BY MUSICAL BANDS AND OF DRAMATIC PLAYS; PRODUCTION OF RADIO AND TELEVISION PROGRAMS; PRODUCTION OF PRERECORDED VIDEO TAPES AND DISCS FOR OTHERS; ORGANIZING SPORTS COMPETITIONS; INFORMATION SERVICES RELATING TO SPORTS; PROVIDING ONLINE COMPUTER GAMES; PROVIDING FACILITIES FOR MOVIES, PERFORMANCES OF THEATRICAL SHOWS, AND PLAYS AND MUSIC, OR EDUCATIONAL MEETINGS AND CONVENTIONS; RECORDING STUDIO AND MOVIE STUDIO SERVICES; PROVIDING SPORTS FACILITIES, NAMELY, GYMNASIUMS; PROVIDING FACILITIES FOR RECREATIONAL ACTIVITIES; BOOKING OF SEATS FOR THEATRICAL SHOWS AND CONCERTS; PRODUCTION OF SHOWS RELATING TO CARTOON, VIDEO, AND GAME CHARACTERS; PRODUCTION OF MATRICES FOR RECORDS; PUBLICATION OF BOOKS AND MAGAZINES; RENTAL OF PRERECORDED AUDIO TAPES AND DISCS AND VIDEO TAPES AND DISCS; RENTAL OF COMPUTER GAME PROGRAMS (U.S. CLS. 100, 101 AND 107).

CLASS 42—SCIENTIFIC, COMPUTER AND LEGAL SERVICES

FOR VOCATIONAL APTITUDE TESTING, VOCATIONAL GUIDANCE; PROVIDING HOTEL INFORMATION, MAKING HOTEL RESERVATIONS FOR OTHERS, PROVIDING INFORMATION ABOUT RESTAURANTS, MAKING RESTAURANT RESERVATIONS FOR OTHERS; PROVIDING ON-LINE COMPUTER DATABASES STORING NEWSPAPER AND MAGAZINE ARTICLES AND WHICH ENABLE USERS TO LOCATE SPECIFIC ARTICLES BY USE OF KEYWORDS; INFORMATION SERVICES RELATING TO WEDDING CEREMONY FACILITIES; PROVIDING A WIDE VARIETY OF INFORMATION OF GENERAL INTEREST VIA A GLOBAL COMPUTER NETWORK; PSYCHOLOGICAL CONSULTATION, HUMAN-RELATIONS COUNSELING SERVICES; RENTAL OF COMPUTER PROGRAMS STORED IN STORAGE MEDIA RELATING TO TRAVEL, RECREATIONAL ACTIVITIES, AUTOMOBILES, MUSIC, MOTION PICTURES, COMPUTERS AND COMPUTER SOFTWARE, COMPUTER NETWORKS, BOOKS, AND COMIC BOOKS, COMPUTER GAMES AND VIDEO GAMES, OUTDOOR PURSUITS, SCIENCE, MARRIAGE, NEWLY-MARRIED LIFE, LOCAL GEOGRAPHIC

AREAS, INFANT REARING, FASHION, BEAUTY, LAND, HOUSES, HOME IMPROVEMENT, GARDENING, APARTMENTS, LEARNING, EDUCATION, BUSINESS, AND FINANCIAL SERVICES; LEASING, NAMELY, PROVIDING TEMPORARY USE OF ONLINE NON-DOWNLOADABLE COMPUTER PROGRAMS RELATING TO TRAVEL, RECREATIONAL ACTIVITIES, AUTOMOBILES, MUSIC, MOTION PICTURES, COMPUTERS AND COMPUTER SOFTWARE, COMPUTER NETWORKS, BOOKS AND COMIC BOOKS, COMPUTER GAMES AND VIDEO GAMES, OUTDOOR PURSUITS, SCIENCE, MARRIAGE, NEWLY-MARRIED LIFE, LOCAL GEOGRAPHIC AREAS, INFANT REARING, FASHION, BEAUTY, LAND, HOUSES, HOME IMPROVEMENT, GARDENING, APARTMENTS, LEARNING, EDUCATION, BUSINESS, AND FINANCIAL SERVICES; DESIGN AND MAINTENANCE OF COMPUTER SOFTWARE PROGRAMS FOR OTHERS; PROVIDING SEARCH ENGINES FOR OBTAINING DATA ON A GLOBAL COMPUTER NETWORK; PROVIDING PROFILES OF, OR SUMMARIES OF INFORMATION IN, ELECTRONIC BULLETIN BOARDS OR WEB SITES OF OTHERS, TO ENABLE ANY INDIVIDUAL TO EASILY LOCATE PARTICULAR ELECTRONIC BULLETIN BOARDS OR WEB SITES CONTAINING INFORMATION MOST RELEVANT AND USEFUL TO SAID INDIVIDUAL FOR A PARTICULAR PURPOSE; COMPUTER SERVICES, NAMELY, CREATING AND MAINTAINING WEB SITES FOR OTHERS; HOSTING WEB SITES OF OTHERS ON A GLOBAL COMPUTER NETWORK; ARENA SERVICES, NAMELY, PROVIDING FACILITIES FOR SPORTS (U.S. CLS. 100 AND 101).

ELIZABETH J. WINTER, EXAMINING ATTORNEY

SN 76-259,605. LI & FUNG (B.V.I.) LIMITED, ROAD TOWN, TORTOLA, BR. VIRGIN ISLANDS, FILED 5-18-2001.

COLBY

PRIORITY CLAIMED UNDER SEC. 44(D) ON HONG KONG APPLICATION NO. 7819/2001, FILED 5-17-2001, REG. NO. 08427, DATED 5-17-2001, EXPIRES 5-17-2008.

PRIORITY CLAIMED UNDER SEC. 44(D) ON HONG KONG APPLICATION NO. 7818/2001, FILED 5-17-2001, REG. NO. 08428, DATED 5-17-2001, EXPIRES 5-17-2008.

THE NAME "COLBY" DOES NOT IDENTIFY A LIVING INDIVIDUAL.

CLASS 25—CLOTHING

FOR CLOTHING, NAMELY TOPS AND BOTTOMS, TANK TOPS, T-SHIRTS, SHIRTS, NECKTIES, ASCOTS, SWEATSHIRTS, SWEAT PANTS, SWEAT SUITS, ATHLETIC UNIFORMS, CARDIGANS, SWEATERS, JACKETS, SUITS, COATS, ANORAKS, JERSEYS, VESTS, PULLOVERS, PANTS, BLOUSES, LEGGINGS, SHORTS, SKIRTS, ROMPERS, TROUSERS, JUMPSUITS, OVERALLS, DRESSES, JUMPERS, BATHING SUITS, UNITARDS, LEOTARDS, TIGHTS, UNDERWEAR, SLEEP WEAR, NAMELY SLEEP SHIRTS, PAJAMAS, NIGHTGOWNS, ROBES, SLIPPERS, SOCKS, HOSIERY, BANDANNAS, SCARVES, MUFFLERS, HATS, CAPS, HEADBANDS, WRIST BANDS, GLOVES, BELTS, SUSPENDERS, RAINCOATS, GALOSHES; FOOTWEAR; HEAD WEAR (U.S. CLS. 22 AND 39).

CLASS 35—ADVERTISING AND BUSINESS

FOR (BASED ON USE) IMPORT AND EXPORT AGENCIES SERVICES (U.S. CLS. 100, 101 AND 102).

FIRST USE 0-0-1975; IN COMMERCE 0-0-1975.
DOUGLAS LEE, EXAMINING ATTORNEY

SN 76-286,769. ADVA AG OPTICAL NETWORKING, 98617 MEININGEN, FED REP GERMANY, FILED 7-17-2001.

FSP II

PRIORITY CLAIMED UNDER SEC. 44(D) ON ERPN CMNTY TM OFC APPLICATION NO. 002227080, FILED 5-22-2001, REG. NO. 002227080, DATED 3-10-2005, EXPIRES 5-22-2011.

CLASS 9—ELECTRICAL AND SCIENTIFIC APPARATUS

FOR APPARATUS FOR RECORDING, TRANSMITTING, OR REPRODUCING SOUND OR VIDEO; PASSIVE AND ACTIVE APPARATUS FOR FIBER OPTIC TECHNOLOGY, NAMELY, WAVELENGTH MULTIPLEXERS, WAVELENGTH DEMULTIPLEXERS, TIME-DIVISION MULTIPLEXERS, TIME-DIVISION DEMULTIPLEXERS, ADD/DROP-MULTIPLEXERS, REPEATERS, OPTICAL FIBER AMPLIFIERS, LASERS, LASER DIODES AND LEDS, AND OPTICAL DETECTOR DIODES; BLANK MAGNETIC DATA CARRIERS; BLANK OPTICAL DATA CARRIERS, BLANK MAGNETO-OPTICAL DATA CARRIERS; COMPUTERS; COMPUTER NETWORK SOFTWARE PARTICULARLY SOFTWARE FOR THE PLANNING, MAINTENANCE AND MANAGEMENT OF NETWORKS (U.S. CLS. 21, 23, 26, 36 AND 38).

CLASS 42—SCIENTIFIC, COMPUTER AND LEGAL SERVICES

FOR COMPUTER PROGRAMMING FOR OTHERS OF PROGRAMS FOR THE PLANNING, MAINTENANCE AND MANAGEMENT OF COMPUTER NETWORKS; COMPUTER CONSULTATION; COMPUTER SOFTWARE DESIGN AND CONSULTATION FOR OTHERS, NAMELY, DESIGNING SOFTWARE FOR SETTING UP DATA TRANSMISSION NETWORKS; SCIENTIFIC RESEARCH; INDUSTRIAL RESEARCH IN THE FIELDS OF OPTICS, FIBER OPTICS, OPTO-ELECTRONICS, AND ELECTRONICS (U.S. CLS. 100 AND 101).

CHRISIE B. KING, EXAMINING ATTORNEY

SN 76-291,897. IST INTERNATIONAL SECURITY TECHNOLOGY OY, FIN-00210, HELSINKI, FINLAND, FILED 7-30-2001.

VIVAGO

OWNER OF ERPN CMNTY TM OFC REG. NO. 002250900, DATED 8-21-2004, EXPIRES 6-8-2011.

CLASS 9—ELECTRICAL AND SCIENTIFIC APPARATUS

FOR PERSONAL PHYSIOLOGICAL ANALYZERS, NAMELY, WIRELESS MONITORS, COMPUTER HARDWARE AND SOFTWARE FOR ANALYZING HUMAN VITAL FUNCTIONS AND MOVEMENT (U.S. CLS. 21, 23, 26, 36 AND 38).

CLASS 10—MEDICAL APPARATUS

FOR MONITORS FOR RECORDING AND ANALYZING HUMAN VITAL FUNCTIONS, NAMELY HEART, BLOOD PRESSURE AND PULSE AND PROVIDING ALARM SIGNALS IN CONNECTION THEREWITH; MONITORS FOR DETECTING AND ANALYZING MOVEMENT AND PROVIDING ALARM SIGNALS WHEN INSUFFICIENT MOVEMENT IS RECORDED; MONITORS TO BE WORN DURING EXERCISE TO MONITOR HUMAN VITAL FUNCTIONS (U.S. CLS. 26, 39 AND 44).

CAROLINE WEIMER, EXAMINING ATTORNEY

SN 76-298,621. BRITISH BROADCASTING CORPORATION, THE, LONDON, W1A 1AA, UNITED KINGDOM, FILED 8-14-2001.

ACE LIGHTNING

OWNER OF UNITED KINGDOM REG. NO. 2271275, DATED 1-17-2003, EXPIRES 5-29-2011.

"ACE LIGHTENING" DOES NOT IDENTIFY A PARTICULAR LIVING INDIVIDUAL.

CLASS 3—COSMETICS AND CLEANING PREPARATIONS

FOR NON-MEDICATED TOILET PREPARATIONS, NAMELY, SOAPS, SHAMPOOS, AND TALCUM POWDER; PREPARATIONS FOR USE IN THE BATH AND SHOWER, NAMELY, BUBBLE BATHS, BATH FOAM, NON-MEDICATED BATH SALTS, BATH OIL AND SHOWER GEL; PREPARATIONS FOR THE HAIR, NAMELY, HAIR GEL, HAIR SPRAY, SHAMPOO, CONDITIONER, AND HAIR MOUSSE; PREPARATIONS FOR CLEANING THE TEETH, NAMELY TOOTHPASTE AND TOOTH GEL; PERFUMES; EAU DE COLOGNE; DEODORANTS FOR PERSONAL USE; ESSENTIAL OILS FOR PERSONAL USE; FOOD AND DRINK FLAVORING; TOILETRIES, NAMELY, BODY POWDER, CREAMS, SOAPS, BATH SALTS, BATH GELS, AND PERFUMES; NON-MEDICATED SKIN CARE PREPARATIONS; COSMETICS; COTTON WOOL FOR COSMETIC PURPOSES; MAKE-UP REMOVING PREPARATIONS; MOUTH WASHES; NAIL CARE PREPARATIONS; NAIL VARNISHES AND POLISHES; NAIL VARNISH REMOVING PREPARATIONS; DEPILATORIES; EMERY PAPER AND PUMICE STONES FOR PERSONAL USE; BEAUTY MASKS; PERFUMING SACHETS; SCENTED WOOD; SHOE CREAMS AND POLISHES; WINDSCREEN CLEANING PREPARATIONS (U.S. CLS. 1, 4, 6, 50, 51 AND 52).

CLASS 9—ELECTRICAL AND SCIENTIFIC APPARATUS

FOR SOUND, VIDEO AND DATA RECORDINGS AND CARRIERS, NAMELY, PRE-RECORDED AUDIO CASSETTE TAPES, VIDEO TAPES, DIGITAL VIDEO DISCS KNOWN AS DVD'S, COMPACT DISCS AND RECORDS ALL FEATURING INSTRUCTION, ENTERTAINMENT, EDUCATION AND INFORMATION RELATING TO RECREATIONAL ACTIVITIES AND TO ANIMATIONS, MUSIC, DRAMA, FILM, TELEVISION AND RADIO PROGRAMS INCLUDING CHILDREN'S TELEVISION AND RADIO PROGRAMS AND ON-LINE CONTENT, GAMES, LIVE CONCERTS AND EVENTS, FICTION, AND CARTOONS; PRE-RECORDED COMPUTER CARTRIDGES, DIGITAL AUDIO AND VIDEO COMPRESSION FILES, COMPACT DISCS, JPEGS RECORDED ON COMPACT DISCS AND COMPUTER MEMORY CARDS ALL FEATURING INSTRUCTION, ENTERTAINMENT, EDUCATION AND INFORMATION RELATING TO RECREATIONAL ACTIVITIES AND TO ANIMATIONS, MUSIC, DRAMA, FILM, TELEVISION AND RADIO PROGRAMS INCLUDING CHILDREN'S TELEVISION AND RADIO PROGRAMS AND ON-LINE CONTENT, GAMES, LIVE CONCERTS AND EVENTS, FICTION, AND CARTOONS; STILL AND MOVING IMAGES AND DATA IN COMPRESSED AND UNCOMPRESSED FORM

RECORDED ON AUDIO CASSETTE TAPES, VIDEO TAPES, DIGITAL VIDEO DISCS KNOWN AS DVD'S, COMPACT DISCS AND RECORDS ALL FEATURING INSTRUCTION, ENTERTAINMENT, EDUCATION AND INFORMATION RELATING TO RECREATIONAL ACTIVITIES AND TO ANIMATIONS, MUSIC, DRAMA, FILM, TELEVISION AND RADIO PROGRAMS INCLUDING CHILDREN'S TELEVISION AND RADIO PROGRAMS AND ON-LINE CONTENT, GAMES, LIVE CONCERTS AND EVENTS, FICTION, AND CARTOONS; DOWNLOADABLE ELECTRONIC PUBLICATIONS, NAMELY NEWSLETTERS, MAGAZINES, BULLETIN BOARDS FEATURING INSTRUCTION, ENTERTAINMENT, EDUCATION AND INFORMATION RELATING TO RECREATIONAL ACTIVITIES AND TO ANIMATIONS, MUSIC, DRAMA, FILM, TELEVISION AND RADIO PROGRAMS INCLUDING CHILDREN'S TELEVISION AND RADIO PROGRAMS AND ON-LINE CONTENT, GAMES, LIVE CONCERTS AND EVENTS, FICTION, AND CARTOONS; PRE-RECORDED MOTION PICTURE FILMS AND SOUND FILMS PREPARED FOR EXHIBITION FEATURING INSTRUCTION, ENTERTAINMENT, EDUCATION AND INFORMATION RELATING TO RECREATIONAL ACTIVITIES AND TO ANIMATIONS, MUSIC, DRAMA, FILM, TELEVISION AND RADIO PROGRAMS INCLUDING CHILDREN'S TELEVISION AND RADIO PROGRAMS AND ON-LINE CONTENT, GAMES, LIVE CONCERTS AND EVENTS, FICTION, AND CARTOONS; ANIMATED CARTOONS RECORDED ON DIGITAL MEDIA IN THE NATURE OF DVD'S, DOWNLOADABLE ONLINE CARTOONS; COMPUTER SOFTWARE, NAMELY, SOFTWARE FOR USE IN DELIVERING AND RECEIVING VIDEO ON DEMAND SERVICES AND TO FACILITATE STREAMING ACROSS THE INTERNET, DOWNLOADING AN AUDIO/VIDEO STREAM FROM A GLOBAL COMPUTER NETWORK, WORD PROCESSING, ORGANIZATION OF DATA AND ACCESSING THE INTERNET; DOWNLOADABLE ELECTRONIC PUBLICATIONS DOWNLOADED IN AUDIO AND VIDEO STREAMING FORM PROVIDED ON-LINE OR FROM THE INTERNET IN THE NATURE OF MAGAZINES, BOOKS, BROCHURES, PAMPHLETS, CATALOGS, AND PROGRAMS FEATURING INSTRUCTION, ENTERTAINMENT, EDUCATION AND INFORMATION RELATING TO RECREATIONAL ACTIVITIES AND TO ANIMATIONS, MUSIC, DRAMA, FILM, TELEVISION AND RADIO PROGRAMS INCLUDING CHILDREN'S TELEVISION AND RADIO PROGRAMS AND ON-LINE CONTENT, GAMES, LIVE CONCERTS AND EVENTS, FICTION, AND CARTOONS; COMPUTER AND VIDEO GAME PROGRAMS AND EQUIPMENT, NAMELY, COMPUTER GAME SOFTWARE, COMPUTER GAME TAPES, COMPUTER GAME DISCS, HAND HELD JOY STICK UNITS FOR PLAYING VIDEO GAMES, VIDEO GAME INTERACTIVE REMOTE CONTROL UNITS, AND VIDEO GAME INTERACTIVE CONTROL MATS; ELECTRONIC GAMES, NAMELY, VIDEO GAME MACHINES FOR USE WITH TELEVISIONS; INTERACTIVE COMPUTER GAME DISCS; MOUSE PADS; MULTIMEDIA SOFTWARE RECORDED ON CD-ROM'S ALL FEATURING INSTRUCTION, ENTERTAINMENT, EDUCATION AND INFORMATION RELATING TO RECREATIONAL ACTIVITIES AND TO ANIMATIONS, MUSIC, DRAMA, FILM, TELEVISION AND RADIO PROGRAMS INCLUDING CHILDREN'S TELEVISION AND RADIO PROGRAMS AND ON-LINE CONTENT, GAMES, LIVE CONCERTS AND EVENTS, FICTION, AND CARTOONS; ELECTRONICALLY, MAGNETICALLY AND OPTICALLY RECORDED DATA RECORDED ON OPTICAL DISCS FOR COMPUTERS ALL FEATURING INSTRUCTION, ENTERTAINMENT, EDUCATION AND INFORMATION RELATING TO RECREATIONAL ACTIVITIES AND TO ANIMATIONS, MUSIC, DRAMA, FILM, TELEVISION AND RADIO PROGRAMS INCLUDING CHILDREN'S TELEVISION AND RADIO PROGRAMS AND ON-LINE CONTENT, GAMES, LIVE CONCERTS AND EVENTS, FICTION, AND CARTOONS; SOUND, VIDEO AND DATA RECORDING AND REPRODUCING APPARATUS, NAMELY, AUDIO AND VIDEO TAPE RECORDERS; VIRTUAL REALITY GAMES SOFTWARE AND VIDEO GAME MACHINES FOR USE WITH TELEVISION AND COMPUTERS FOR PLAYING SOFTWARE; TELEVISION AND RADIO SIGNAL TRANSMITTERS AND RECEIVERS; MOBILE TELEPHONE FASCIA'S AND COVERS; DOWNLOADABLE AUDIO AND VIDEO FILES INCLUDING THOSE MADE AVAILABLE THROUGH TIME DELAY APPARATUS, ALL FEATURING INSTRUCTION, ENTERTAINMENT, EDUCATION AND INFORMATION RELATING TO RE-

CREATIONAL ACTIVITIES AND TO ANIMATIONS, MUSIC, DRAMA, FILM, TELEVISION AND RADIO PROGRAMS INCLUDING CHILDREN'S TELEVISION AND RADIO PROGRAMS AND ON-LINE CONTENT, GAMES, LIVE CONCERTS AND EVENTS, FICTION, AND CARTOONS; DOWNLOADABLE COMPUTER GAMES FOR USE WITH MOBILE PHONES; AND PARTS FOR ALL THE AFORESAID GOODS; AND NOVELTIES IN THE FORM OF SOUVENIRS, NAMELY, MAGNETS; BUT NONE OF THE ABOVE GOODS IN THE FIELDS OF HEALTH, FITNESS AND NUTRITION (U.S. CLS. 21, 23, 26, 36 AND 38).

CLASS 16—PAPER GOODS AND PRINTED MATTER

FOR PAPER, NAMELY, PRINTING PAPER, NOTE PAPER, WRITING PAPER, PAPER NAPKINS, PAPER PARTY HATS, PAPER PARTY BAGS, WRAPPING PAPER, GIFT BAGS, CARDBOARD BOXES; PRINTED MATTER AND PUBLICATIONS, NAMELY, PERIODICALS, MAGAZINES, INFORMATIONAL BROCHURES, BOOKS, BOOKLETS, PAMPHLETS, PRINTED GUIDES, CATALOGUES AND PROGRAMS, ALL IN THE FIELD OF INSTRUCTION, ENTERTAINMENT, EDUCATION AND INFORMATION RELATING TO RECREATIONAL ACTIVITIES AND TO ANIMATIONS, MUSIC, DRAMA, FILM, TELEVISION AND RADIO PROGRAMS INCLUDING CHILDREN'S TELEVISION AND RADIO PROGRAMS AND ON-LINE CONTENT, GAMES, LIVE CONCERTS AND EVENTS, FICTION, AND CARTOONS; PRINT CARTOONS, NAMELY, CARTOONS APPEARING IN NEWSPAPERS, COMIC BOOKS, CARTOON STRIPS IN MAGAZINES, PERIODICALS, BOOKLETS, MAGAZINES, POSTCARDS, BOOKS, AND OTHER PRINTED MEDIA; BOOK BINDING MATERIALS, NAMELY, BOOK BINDING, CARDBOARD BACKING FOR BINDING, COVERS FOR SCHOOL BOOKS, NOTEBOOKS, NOTEPADS, FOLDERS, PHOTOGRAPHS; STATIONERY; ADHESIVES FOR STATIONERY OR HOUSEHOLD PURPOSES; CHILDREN'S ART MATERIALS, NAMELY, EASELS AND DRAWING BOOKS; PAINT BRUSHES; TYPEWRITERS AND OFFICE REQUISITES, NAMELY, PENS, PENCIL HOLDERS, DESK CALENDARS, WRITING INSTRUMENTS, PENCILS AND CRAYONS, RING BINDERS, CLIP BOARDS, RUBBER BANDS; PENCIL SHARPENER; PLASTIC MATERIAL FOR PACKAGING, NAMELY BAGS AND BUBBLE PACKS; PLAYING CARDS; PRINTERS' TYPE; PRINTING BLOCKS; POSTERS; CARDS, NAMELY POSTCARDS; TRADING CARDS, GREETING CARDS AND NOTE CARDS; PRINTED CERTIFICATES, PRINTED INVITATIONS; CALENDARS; PHOTOGRAPH ALBUMS; PRINTS AND FRAMED PRINTS; PAPER AND PLASTIC CARRIER BAGS FOR MERCHANDISE; PAPER BAGS, GIFT BAGS; PAPER AND CARDBOARD GIFT BOXES; NOTE PADS; ADHESIVE BACKED PAPER FOR STATIONERY PURPOSES; STATIONERY PINS AND TACKS; DIARIES; COASTERS OF CARDBOARD OR PAPER; GIFT TAGS AND LUGGAGE TAGS OF PAPER AND CARDBOARD; ORNAMENTS OF PAPER, NAMELY HOLIDAY ORNAMENTS, CARDBOARD AND PAPER MACHE; STICKERS; IRON-ON AND PLASTIC TRANSFERS AND DECALCOMANIAS; RUBBER STAMPS; RING BINDERS; FOLDERS; PERSONAL ORGANIZERS; ADDRESS BOOKS; TELEPHONE BOOKS; NOTE BOOKS; PEN AND PENCIL CASES; PEN AND PENCIL BOXES; PEN AND PENCIL HOLDERS; DRAWING RULERS; ERASERS; DESK MATS; EMBROIDERY, SEWING AND KNITTING PATTERNS; POSTAGE STAMPS; BUT NONE OF THE ABOVE GOODS IN THE FIELDS OF HEALTH, FITNESS AND NUTRITION (U.S. CLS. 2, 5, 22, 23, 29, 37, 38 AND 50).

CLASS 25—CLOTHING

FOR CLOTHING, NAMELY SHOES, T-SHIRTS, BLOUSES, VESTS, PANTS, JEANS, SWEATPANTS, OVERALLS, SHORTS, SKIRTS, DRESSES, SWIMSUITS, JACKETS, COATS, SWEATERS, SWEATSHIRTS, ROBES, TIES, BELTS, GLOVES, MITTENS, PAJAMAS AND UNDERWEAR, SHIRTS, SLIPPERS, TOPS, SOCKS AND SCARVES; FOOTWEAR; HEADGEAR, NAMELY HATS, CAPS, BASEBALL CAPS, SKIING HATS, EARMUFFS, HEADBANDS, SUN VISORS (U.S. CLS. 22 AND 39).

CLASS 28—TOYS AND SPORTING GOODS

FOR TOYS, NAMELY, BOARD GAMES, ARCADE GAMES, KITES, CARD GAMES AND TRAVEL GAMES, AND PUZZLES; PARTY FAVORS IN THE NATURE OF NOISEMAKERS AND CHRISTMAS CRACKERS; DOLLS; SOFT SCULPTURE TOYS; TOY MUSICAL BOXES; TOY MUSICAL INSTRUMENTS; TOY MODELS, NAMELY, ACTION FIGURES, TOY FIGURINES, VEHICLES AND PLAYSETS THEREFOR; PLAY BALLS AND PLAY BALLOONS; TOY STAMPS; SWIM FLOATS FOR RECREATIONAL USE AND INFLATABLE TOYS FOR PLAY PURPOSES; COMPUTER GAMES APPARATUS, NAMELY, BATTERY POWERED COMPUTER GAME WITH LCD SCREEN WHICH FEATURES ANIMATION AND SOUND EFFECTS; ELECTRONIC AND VIDEO GAMES APPARATUS, NAMELY, A HAND HELD UNIT FOR PLAYING ELECTRONIC AND VIDEO GAMES; HAND HELD ELECTRONIC AND VIDEO GAMES; TABLE TOP GAMES, ELECTRONIC KEY CHAIN GAMES; ELECTRONIC AMUSEMENT APPARATUS NOT BEING AUTOMATIC, COUNTER OR COIN FED, NAMELY, AMUSEMENT PARK RIDES, MALL BASED AMUSEMENT PARK STYLE RIDES; VIRTUAL REALITY APPARATUS FOR AMUSEMENT AND ENTERTAINMENT PURPOSES, NAMELY, ARCADE GAMES AND RIDES, BUT NOT TOYS IN THE AREAS OF HEALTH, FITNESS AND NUTRITION (U.S. CLS. 22, 23, 38 AND 50).

CLASS 30—STAPLE FOODS

FOR COFFEE; TEA; COCOA; COCOA PRODUCTS, NAMELY, COCOA-MIXES, COCOA-BASED INGREDIENT IN CONFECTIONERY PRODUCTS; CHOCOLATE; CHOCOLATE-BASED PRODUCTS, NAMELY, CHOCOLATE CHIPS, CHOCOLATE FONDUE, CHOCOLATE POWDER, CHOCOLATE SYRUP, CHOCOLATE TOPPING, CHOCOLATE TRUFFLES, HOT CHOCOLATE, CHOCOLATE BARS, CHOCOLATE CANDY, CHOCOLATE MILK SYRUP; SUGAR; ARTIFICIAL COFFEE; FLOUR; PREPARATIONS MADE FROM CEREALS, NAMELY, CEREAL BASED SNACK FOODS, CEREAL BARS, INSTANT OATMEAL, OATMEAL, TOASTER PASTRIES, BREAKFAST CEREAL; BREAD; PASTRY; PASTRIES; CAKES; BISCUITS; CONFECTIONERY, NAMELY, CANDY, CHOCOLATES, SWEETS IN THE NATURE OF NOVELTY CANDY BARS, SOUR CANDY, GUMMY CANDY, CHEWING GUM, LOLLYPOPS, SUCKING CANDY, ICE CREAM AND FLAVORED ICES; HONEY; TREACLE; YEAST BAKING-POWDER; SALT; MUSTARD; VINEGAR; SAUCES; CONDIMENTS, NAMELY, KETCHUP, RELISH, MAYONNAISE, MUSTARD, BARBECUE SAUCE, SALSA, SALAD DRESSING, TARTAR SAUCE, HORSERADISH; AND PASTA (U.S. CL. 46).

CLASS 41—EDUCATION AND ENTERTAINMENT

FOR ENTERTAINMENT SERVICES, NAMELY, PROVIDING AN ON-GOING SERIES OF MOVIES, RADIO AND TELEVISION PROGRAMS, AND GAMES FEATURING CHILDREN'S ENTERTAINMENT, ACTION, ADVENTURE, AND ANIMATION; PRODUCTION, DISTRIBUTION AND SYNDICATION AND RENTAL OF TELEVISION AND RADIO PROGRAMS AND MOTION PICTURE FILMS ALL FEATURING MUSIC, GAMES, ENTERTAINMENT, INSTRUCTION AND EDUCATION; PRODUCTION AND RENTAL OF SOUND AND VIDEO RECORDINGS, INTERACTIVE COMPACT DISCS, DIGITAL VERSATILE DISCS KNOWN AS DVDS, DIGITAL VIDEO DISCS WITH READ/WRITE CAPABILITY KNOWN AS DVD-RWS AND OD-ROMS IN THE FIELD OF CHILDREN'S ENTERTAINMENT, ACTION, ADVENTURE, ANIMATION, AND GAMES; MUSIC PUBLISHING SERVICES, ELECTRONIC PUBLISHING SERVICES, NAMELY PUBLICATION OF TEXT AND GRAPHIC WORKS OF OTHERS ON CD, CD-ROM AND DVD FEATURING MUSIC, ENTERTAINMENT, INSTRUCTION AND EDUCATION IN THE FIELD OF ENTERTAINMENT; ON-LINE PUBLICATION OF BOOKS, MAGAZINES, AUDIO AND VIDEO WORKS FEATURING ENTERTAINMENT, EDUCATION AND INSTRUCTION; PROVIDING ONLINE PUBLICATIONS, NAMELY BOOKS, MAGAZINES, NEWSLETTERS, CATALOGUES, PROGRAMS AND GUIDES ABOUT ENTERTAINMENT IN THE FIELDS OF CHILDREN'S ENTERTAINMENT, ACTION, ADVENTURE, ANIMATION, AND GAMES; ORGANIZATION, PRODUCTION AND PRESENTATION OF EVENTS, NAMELY, LIVE SHOW PERFORMANCES FEATURING MUSIC, COSTUMED CHARACTERS AND THEATRICAL PRODUCTIONS, ALL FOR THE ENTERTAINMENT OF CHILDREN; PROVISION OF ENTERTAINMENT SERVICES, NAMELY, PROVIDING ON-LINE TELEVISION, RADIO, AUDIO AND VIDEO PROGRAMS AND GAMES FEATURING CHILDREN'S ENTERTAINMENT, ACTION, ADVENTURE, AND ANIMATION; PROVIDING INFORMATION ABOUT ENTERTAINMENT IN THE FIELDS OF CHILDREN'S ENTERTAINMENT, ACTION, ADVENTURE, ANIMATION, GAMES, CULTURE AND RECREATION VIA PDA, INTERACTIVE TELEVISION, BROADBAND AND A WEBSITE, BUT NONE OF THE ABOVE SERVICES IN THE FIELDS OF HEALTH, FITNESS AND NUTRITION (U.S. CLS. 100, 101 AND 107).

MARTHA FROMM, EXAMINING ATTORNEY

SN 76-301,066. FAIRMONT HOTELS & RESORTS (U.S.) INC., TORONTO, ONTARIO, CANADA, FILED 8-17-2001.

THE *Fairmont*
RESIDENCES

OWNER OF U.S. REG. NOS. 982,668, 983,000 AND OTHERS.

NO CLAIM IS MADE TO THE EXCLUSIVE RIGHT TO USE "RESIDENCES", APART FROM THE MARK AS SHOWN.

CLASS 36—INSURANCE AND FINANCIAL

FOR SERVICES RELATING TO APARTMENTS, NAMELY, LEASING OF APARTMENTS; REAL ESTATE SALES MANAGEMENT SERVICES FEATURING APARTMENTS; REAL ESTATE MANAGEMENT SERVICES, NAMELY, GRANTING AND MANAGING THE RIGHTS OF OTHERS TO USE REAL ESTATE PROPERTIES; VACATION REAL ESTATE TIME SHARING; REAL ESTATE TIME SHARING; MANAGEMENT OF APARTMENTS; AND GLOBAL COMPUTER SERVICES, NAMELY, PROVIDING INFORMATION ON APARTMENTS, REAL ESTATE TIME SHARING FACILITIES, AND LEASING OF APARTMENTS (U.S. CLS. 100, 101 AND 102).

CLASS 43—HOTEL AND RESTAURANT SERVICES

FOR MAKING RESERVATIONS AND BOOKINGS FOR TEMPORARY LODGING; AND MAKING RESERVATIONS FOR LONG-TERM AND SHORT-TERM STAYS IN APARTMENTS (U.S. CLS. 100 AND 101).

MITCHELL FRONT, EXAMINING ATTORNEY

SN 76-307,645. THE STATE HERMITAGE MUSEUM, 190000 ST. PETERSBURG, RUSSIAN FED., FILED 9-4-2001.

**ГОСУДАРСТВЕННЫЙ
ЭРМИТАЖ**

PRIORITY CLAIMED UNDER SEC. 44(D) ON ERPN CMNTY TM OFC APPLICATION NO. 2308971, FILED 7-20-2001, REG. NO. 002308971, DATED 9-17-2002, EXPIRES 7-20-2011.

NO CLAIM IS MADE TO THE EXCLUSIVE RIGHT TO USE THE NON-LATIN CHARACTERS THAT TRANSLITERATE TO MEAN STATE, APART FROM THE MARK AS SHOWN.

THE MARK CONSISTS OF SMALL CYRILLIC LETTERING SPELLING THE RUSSIAN WORD "STATE" ABOVE LARGE CYRILLIC LETTERING SPELLING THE RUSSIAN WORD "HERMITAGE". THE LARGE CYRILLIC LETTERING SPELLING THE RUSSIAN WORD "HERMITAGE" OVERLAYS A PARTIAL SINE CURVE.

THE RUSSIAN PHRASE IN THE MARK TRANSLATES TO THE ENGLISH PHRASE "STATE HERMITAGE", WHEREIN THE SMALL LETTERING IS THE WORD "STATE" AND THE LARGE LETTERING IS THE WORD "HERMITAGE".

THE NON-LATIN CHARACTERS IN THE MARK TRANSLITERATE TO "GOSUDARSTVENNIY ERMITAZH," AND THIS MEANS "STATE HERMITAGE" IN ENGLISH.

CLASS 9—ELECTRICAL AND SCIENTIFIC APPARATUS

FOR DATA CARRIERS AND RECORDING DISCS, NAMELY PRE-RECORDED COMPACT DISCS, FLOPPY DISCS, CD ROMS AND AUDIO AND VIDEO TAPES FEATURING MUSIC, VIDEO DOCUMENTARIES IN THE FIELD OF ART AND MULTIMEDIA PRESENTATIONS IN THE FIELD OF ART AND ART HISTORY; COMPUTER SOFTWARE FOR USE IN SHOWING INTERACTIVE TOURS OF MUSEUMS AND VARIOUS IMAGES AND INFORMATION RELATING TO THE MUSEUM'S COLLECTION IN THE FIELDS OF ART, HISTORY AND EDUCATION; BAROMETERS (U.S. CLS. 21, 23, 26, 36 AND 38).

CLASS 14—JEWELRY

FOR JEWELRY, REPLICAS AND REPRODUCTIONS OF REAL JEWELRY MADE OF PRECIOUS METALS AND THEIR ALLOYS AND SOUVENIR CUPS AND PICTURE FRAMES MADE OF PRECIOUS METALS; JEWELRY, REPLICAS AND REPRODUCTIONS OF JEWELRY IN PRECIOUS METALS OR COATED THEREWITH, JEWELRY MADE OF PRECIOUS STONES; HOROLOGICAL AND CHRONOMETRIC INSTRUMENTS, NAMELY, WATCHES AND CLOCKS (U.S. CLS. 2, 27, 28 AND 50).

CLASS 16—PAPER GOODS AND PRINTED MATTER

FOR PAPER, NAMELY, PRINTED PAPERS, NAMELY NEWSPAPERS, MAGAZINES, BROCHURES, POSTCARDS AND WRITING PAPER, CARDBOARD; DESK AND GIFT ITEMS MADE OF PAPER NAMELY BOOKMARKERS, CALENDARS, AGENDAS; PRINTED MATTER, NAMELY, PHOTO BOOKS, READING BOOKS AND HISTORY BOOKS; LEATHER BOOK COVERS; CATALOGUES IN THE FIELD OF ART; ARTISTS' MATERIALS, NAMELY, ART PAPER, CRAFT PAPER AND CREPE PAPER; CANVAS FOR PAINTING, CARD STOCK AND MOUNTING BOARD; PAINT BRUSHES; INSTRUCTIONAL AND TEACHING MATERIAL MANUALS IN THE FIELD OF ART AND ART HISTORY; DESK SETS; STATIONERY; BOOK MARKS MADE OF LEATHER AND IMITATIONS OF LEATHER (U.S. CLS. 2, 5, 22, 23, 29, 37, 38 AND 50).

CLASS 18—LEATHER GOODS

FOR LEATHER GOODS AND ACCESSORIES, NAMELY, BOXES, PURSES, WALLETS, KEY RINGS; ANIMAL SKINS AND HIDES; LUGGAGE TRUNKS AND TRAVELLING BAGS; UMBRELLAS, PARASOLS AND WALKING STICKS (U.S. CLS. 1, 2, 3, 22 AND 41).

CLASS 20—FURNITURE AND ARTICLES NOT OTHERWISE CLASSIFIED

FOR FURNITURE NAMELY TABLES, CHAIRS AND CHESTS; MIRRORS; PICTURE FRAMES; REPLICAS, REPRODUCTIONS OF FURNITURE NAMELY TABLES, CHAIRS AND CHESTS, SMALL BOXES MADE OF WOOD; PICTURE FRAMES, SMALL DECORATIVE GOODS NAMELY, BUSTS MADE OF CORK, REED, CANE, WICKER, HORN, BONE, IVORY, WHALE BONE, SHELL, AMBER, MOTHER-OF-PEARL, MEERSCHAUM AND SUBSTITUTES FOR ALL OF THESE MATERIALS, OR OF PLASTICS; CUSHIONS; LEATHER PICTURE FRAMES (U.S. CLS. 2, 13, 22, 25, 32 AND 50).

CLASS 21—HOUSEWARES AND GLASS

FOR HOUSEHOLD OR KITCHEN UTENSILS, NAMELY, POTS AND PANS AND CONTAINERS NOT OF PRECIOUS METAL; HAIR COMBS AND BRUSHES; BRUSH-MAKING MATERIALS NAMELY ANIMAL BRISTLES; ARTICLES FOR CLEANING PURPOSES, NAMELY, CLEANING CLOTHS AND STEEL WOOL; UN-WORKED OR SEMI-WORKED GLASS, NAMELY, GLASS REPRODUCTIONS OF ARTWORK AND DECORATIVE ITEMS OF GLASS, SCULPTURES OF GLASS, FIGURES OF GLASS, BOXES OF GLASS, BOWLS, AND DRAWER PULLS OF GLASS, PLATES, JUGS, VASES, BEVERAGE GLASSES, BEVERAGE AND DECORATIVE GLASSWARE; TABLETOP VASES, BOWLS, JUGS; PORCELAIN AND EARTHENWARE EGGS, DOOR KNOBS, SCULPTURES, VASES AND STATUES (U.S. CLS. 2, 13, 23, 29, 30, 33, 40 AND 50).

CLASS 24—FABRICS

FOR TEXTILES, NAMELY, BED LINENS, DUVET COVERS, VALENCES, PILLOW CASES; TABLE CLOTHS, NAPKINS AND TABLE RUNNERS; CURTAINS; COVERS FOR CUSHIONS; TAPESTRIES; PRINTED CANVAS REPRODUCTIONS AND REPLICAS OF TAPESTRIES AND ARTWORK; NON-PAPER TABLEMATS (U.S. CLS. 42 AND 50).

CLASS 25—CLOTHING

FOR CLOTHING, NAMELY, SCARVES, TIES, NECKWEAR, SHIRTS, T-SHIRTS, SWEAT SHIRTS, POLO SHIRTS, FLEECE SWEATERS, JUMPERS, CARDIGANS, WAISTCOATS, RAIN TROUSERS, COATS AND CAPES; SOCKS; FOOTWEAR, NAMELY, FELT SLIPPERS; HEADGEAR, NAMELY, CAPS AND HATS (U.S. CLS. 22 AND 39).

CLASS 30—STAPLE FOODS

FOR COFFEE; TEA; COCOA; SUGAR; CHICORY BASED COFFEE SUBSTITUTE; FLOUR; BISCUITS; CONFECTIONERY, NAMELY, CHOCOLATES, FUDGE AND SUGAR BASED CONFECTIONERY PRODUCTS; FLAVORED ICES; CONDIMENTS NAMELY KETCHUP, HOT SAUCE; HONEY; MUSTARD; VINEGAR; SAUCES; SPICES; ICE (U.S. CL. 46).

CLASS 41—EDUCATION AND ENTERTAINMENT

FOR MUSEUMS; ORGANIZATION OF EXHIBITIONS FOR CULTURAL OR EDUCATIONAL ACTIVITIES; PUBLISHING OF BOOKS AND CATALOGUES (U.S. CLS. 100, 101 AND 107).

JOHN LINCOSKI, EXAMINING ATTORNEY

SN 76-309,050. KISS TECHNOLOGY A/S, HORSHOLM, DENMARK, FILED 9-5-2001.

SN 76-346,247. FRAUNHOFER-GESELLSCHAFT ZUR FÖRDERUNG DER ANGEWANDTEN FORSCHUNG E.V., MÜNCHEN, FED REP GERMANY, FILED 12-7-2001.

COOL

PRIORITY CLAIMED UNDER SEC. 44(D) ON DENMARK APPLICATION NO. DK.VA2001009, FILED 3-5-2001, REG. NO. VR20011780, DATED 4-23-2001, EXPIRES 4-23-2011.

CLASS 9—ELECTRICAL AND SCIENTIFIC APPARATUS

FOR COMPUTER SOFTWARE FOR CONTROLLING DVD PLAYERS, DVD BURNERS, DVD RECORDERS, DVD REWRITERS, CD PLAYERS, CD BURNERS, CD RECORDERS, CD REWRITERS, MP3 PLAYERS, MP3 BURNERS, MP3 RECORDERS IN THE FIELD OF ENTERTAINMENT; ELECTRONIC APPARATUS, NAMELY, DVD PLAYERS, DVD BURNERS, DVD RECORDERS, DVD REWRITERS, CD PLAYERS, CD BURNERS, CD RECORDERS, CD REWRITERS, MP3 PLAYERS, MP3 BURNERS, MP3 RECORDERS (U.S. CLS. 21, 23, 26, 36 AND 38).

CLASS 42—SCIENTIFIC, COMPUTER AND LEGAL SERVICES

FOR PROVIDING TEMPORARY USE ON ON-LINE NON-DOWNLOADABLE SOFTWARE FOR CONTROLLING ELECTRONIC APPARATUS; LEASING ACCESS TIME TO WEBSITES FOR CONTROLLING ELECTRONIC APPARATUS (U.S. CLS. 100 AND 101).

CAROLYN CATALDO, EXAMINING ATTORNEY

SN 76-342,421. SIEMENS AKTIENGESELLSCHAFT, MÜNCHEN, FED REP GERMANY, FILED 11-28-2001.

SCCP

PRIORITY CLAIMED UNDER SEC. 44(D) ON FED REP GERMANY APPLICATION NO. 3013441164, FILED 6-5-2001, REG. NO. 30134411, DATED 3-24-2004, EXPIRES 6-30-2011.

CLASS 41—EDUCATION AND ENTERTAINMENT

FOR EDUCATIONAL SERVICES, NAMELY, THE ORGANIZATION, IMPLEMENTATION AND HOLDING OF SEMINARS, TRAINING COURSES, CONFERENCES, CONGRESSES, MEETINGS, SYMPOSIA, WORKSHOPS, COLLOQUIA AND LECTURES IN THE FIELD OF TELECOMMUNICATIONS (U.S. CLS. 100, 101 AND 107).

CLASS 42—SCIENTIFIC, COMPUTER AND LEGAL SERVICES

FOR PROVIDING AUTHENTICATION AND VERIFICATION OF DIGITAL SIGNATURES AND PROVIDING REAL TIME INFORMATION REGARDING THE VALIDITY OF DIGITAL CERTIFICATE AUTHORITIES (U.S. CLS. 100 AND 101).

CHRIS WELLS, EXAMINING ATTORNEY

OPENCAT

PRIORITY CLAIMED UNDER SEC. 44(D) ON FED REP GERMANY APPLICATION NO. 30135098.1/0, FILED 6-8-2001, REG. NO. 30135098, DATED 6-29-2001, EXPIRES 6-30-2011.

CLASS 9—ELECTRICAL AND SCIENTIFIC APPARATUS

FOR BLANK COMPUTER DATA CARRIERS, NAMELY, CD'S, DVD'S AND FLOPPY DISCS; COMPUTER HARDWARE; DISC DRIVES, NAMELY, CD-ROMS, SHARED COMPUTER NETWORK DISC DRIVES, REMOVABLE MEMORIES FOR RECORDING AND STORAGE OF DATA; AND BLANK RAM CHIPS (U.S. CLS. 21, 23, 26, 36 AND 38).

CLASS 35—ADVERTISING AND BUSINESS

FOR PROFESSIONAL BUSINESS CONSULTING SERVICES; ADVERTISING SERVICES, NAMELY, ONLINE ADVERTISING FOR OTHERS; E-COMMERCE SERVICES, NAMELY, COMPUTERIZED ONLINE ORDERING SERVICES PROVIDED FOR OTHERS IN THE FIELD OF GENERAL CONSUMER GOODS; PROVIDING ORDER FULFILLMENT SERVICES BY THE INTERNET ACCOMPANIED WITH RELATED ACCOUNT SETTLEMENTS AND STATEMENTS, PRESENTATIONS OF GOODS AND SERVICES FOR OTHERS; LICENSING OF COMPUTER SOFTWARE; PROVIDING HOME SHOPPING SERVICES IN THE FIELD OF CONSUMER GOODS AND BUSINESS GOODS BY MEANS OF TELEVISION; ELECTRONIC DATA PROCESSING CONSULTING SERVICES (U.S. CLS. 100, 101 AND 102).

CLASS 38—COMMUNICATION

FOR TELECOMMUNICATIONS GATEWAY SERVICES AND PROVIDING MULTIPLE USER COMPUTER ACCESS TO THE INTERNET (U.S. CLS. 100, 101 AND 104).

CLASS 41—EDUCATION AND ENTERTAINMENT

FOR EDUCATION AND ADVANCED TRAINING SERVICES IN THE FORM OF SEMINARS, WORKSHOPS, AND CLASSES IN THE FIELD OF INFORMATION TECHNOLOGY AND PROCESS INTEGRATION OF SUPPLIER AND BUYER, DATA HANDLING AND MAPPING, DESIGN AND MANAGEMENT OF COMMERCE PROCESSES AND SOLUTIONS (U.S. CLS. 100, 101 AND 107).

CLASS 42—SCIENTIFIC, COMPUTER AND LEGAL SERVICES

FOR SERVICES OF A CERTIFICATION AGENCY, NAMELY, TESTING, ANALYSIS, AND EVALUATION OF GOODS AND SERVICES OF OTHERS FOR PURPOSES OF CERTIFICATION; COMPUTER PROGRAMMING FOR OTHERS; TECHNICAL CONSULTING SERVICES IN THE FIELD OF TELECOMMUNICATIONS (U.S. CLS. 100 AND 101).

DAVID C. REIHNER, EXAMINING ATTORNEY

SN 76-351,496. GOODWILL INDUSTRIES INTERNATIONAL, INC., BETHESDA, MD. FILED 12-20-2001.

SN 76-351,497. GOODWILL INDUSTRIES INTERNATIONAL, INC., BETHESDA, MD. FILED 12-20-2001.



OWNER OF U.S. REG. NOS. 854,872, 1,592,248 AND OTHERS.

NO CLAIM IS MADE TO THE EXCLUSIVE RIGHT TO USE "INDUSTRIES INTERNATIONAL, INC.", APART FROM THE MARK AS SHOWN.

CLASS 35—ADVERTISING AND BUSINESS

FOR PROVIDING EMPLOYMENT PLACEMENT SERVICES FOR HANDICAPPED, DISABLED AND DISADVANTAGED PERSONS; PROVIDING TECHNICAL AID AND ASSISTANCE, BUSINESS MANAGEMENT AND CONSULTING SERVICES, EXECUTIVE RECRUITING SERVICES, AND DEVELOPING AND MAINTAINING OPERATIONAL STANDARDS FOR ORGANIZATIONS THAT PROVIDE REHABILITATION, TRAINING, EMPLOYMENT AND OPPORTUNITIES FOR PERSONAL GROWTH FOR HANDICAPPED, DISABLED AND DISADVANTAGED PERSONS (U.S. CLS. 100, 101 AND 102).

FIRST USE 4-19-2000; IN COMMERCE 4-19-2000.

CLASS 36—INSURANCE AND FINANCIAL

FOR PROVIDING FUND RAISING SERVICES TO BENEFIT HANDICAPPED, DISABLED AND DISADVANTAGED PERSONS; PROVIDING FINANCIAL MANAGEMENT SERVICES, AND FINANCIAL ADVICE TO ORGANIZATIONS THAT PROVIDE REHABILITATION, TRAINING, EMPLOYMENT AND OPPORTUNITIES FOR PERSONAL GROWTH FOR HANDICAPPED, DISABLED AND DISADVANTAGED PERSONS (U.S. CLS. 100, 101 AND 102).

FIRST USE 4-19-2000; IN COMMERCE 4-19-2000.

CLASS 41—EDUCATION AND ENTERTAINMENT

FOR PROVIDING VOCATIONAL TRAINING SERVICES FOR HANDICAPPED, DISABLED AND DISADVANTAGED PERSONS; PROVIDING COURSES AND SEMINARS TO TRAIN AND DEVELOP PERSONNEL FOR ORGANIZATIONS THAT PROVIDE REHABILITATION, TRAINING, EMPLOYMENT AND OPPORTUNITIES FOR PERSONAL GROWTH FOR HANDICAPPED, DISABLED AND DISADVANTAGED PERSONS (U.S. CLS. 100, 101 AND 107).

FIRST USE 4-19-2000; IN COMMERCE 4-19-2000.

CLASS 42—SCIENTIFIC, COMPUTER AND LEGAL SERVICES

FOR PROVIDING REHABILITATION SERVICES FOR HANDICAPPED, DISABLED AND DISADVANTAGED PERSONS; PROVIDING LEGISLATIVE AND REGULATORY LOBBYING SERVICES ON ISSUES OF IMPORTANCE TO HANDICAPPED, DISABLED AND DISADVANTAGED PERSONS; PROVIDING LEGAL SERVICES AND LEGAL ADVICE TO ORGANIZATIONS THAT AID HANDICAPPED, DISABLED AND DISADVANTAGED PERSONS; PROVIDING RESEARCH SERVICES IN THE FIELD OF REHABILITATION, TRAINING AND EMPLOYMENT OF HANDICAPPED, DISABLED AND DISADVANTAGED PERSONS; PROMOTING THE INTERESTS OF AND ENCOURAGING AND ASSISTING IN THE ESTABLISHMENT, DEVELOPMENT AND GROWTH OF ORGANIZATIONS THROUGHOUT THE WORLD DEDICATED TO PROVIDING REHABILITATION SERVICES, TRAINING, EMPLOYMENT AND OPPORTUNITIES FOR PERSONAL GROWTH FOR HANDICAPPED, DISABLED AND DISADVANTAGED PERSONS (U.S. CLS. 100 AND 101).

FIRST USE 4-19-2000; IN COMMERCE 4-19-2000.

VIVIAN MICZNIK FIRST, EXAMINING ATTORNEY



OWNER OF U.S. REG. NOS. 854,872, 1,592,248 AND OTHERS.

NO CLAIM IS MADE TO THE EXCLUSIVE RIGHT TO USE "INDUSTRIES INTERNATIONAL, INC.", APART FROM THE MARK AS SHOWN.

CLASS 35—ADVERTISING AND BUSINESS

FOR PROVIDING EMPLOYMENT PLACEMENT SERVICES FOR HANDICAPPED, DISABLED AND DISADVANTAGED PERSONS; PROVIDING TECHNICAL AID AND ASSISTANCE, BUSINESS MANAGEMENT AND CONSULTING SERVICES, EXECUTIVE RECRUITING SERVICES, AND DEVELOPING AND MAINTAINING OPERATIONAL STANDARDS FOR ORGANIZATIONS THAT PROVIDE REHABILITATION, TRAINING, EMPLOYMENT AND OPPORTUNITIES FOR PERSONAL GROWTH FOR HANDICAPPED, DISABLED AND DISADVANTAGED PERSONS (U.S. CLS. 100, 101 AND 102).

FIRST USE 4-19-2000; IN COMMERCE 4-19-2000.

CLASS 36—INSURANCE AND FINANCIAL

FOR PROVIDING FUND RAISING SERVICES TO BENEFIT HANDICAPPED, DISABLED AND DISADVANTAGED PERSONS; PROVIDING FINANCIAL MANAGEMENT SERVICES, AND FINANCIAL ADVICE TO ORGANIZATIONS THAT PROVIDE REHABILITATION, TRAINING, EMPLOYMENT AND OPPORTUNITIES FOR PERSONAL GROWTH FOR HANDICAPPED, DISABLED AND DISADVANTAGED PERSONS (U.S. CLS. 100, 101 AND 102).

FIRST USE 4-19-2000; IN COMMERCE 4-19-2000.

CLASS 41—EDUCATION AND ENTERTAINMENT

FOR PROVIDING VOCATIONAL TRAINING SERVICES FOR HANDICAPPED, DISABLED AND DISADVANTAGED PERSONS; PROVIDING COURSES AND SEMINARS TO TRAIN AND DEVELOP PERSONNEL FOR ORGANIZATIONS THAT PROVIDE REHABILITATION, TRAINING, EMPLOYMENT AND OPPORTUNITIES FOR PERSONAL GROWTH FOR HANDICAPPED, DISABLED AND DISADVANTAGED PERSONS (U.S. CLS. 100, 101 AND 107).

FIRST USE 4-19-2000; IN COMMERCE 4-19-2000.

CLASS 42—SCIENTIFIC, COMPUTER AND LEGAL SERVICES

FOR PROVIDING REHABILITATION SERVICES FOR HANDICAPPED, DISABLED AND DISADVANTAGED PERSONS; PROVIDING LEGISLATIVE AND REGULATORY LOBBYING SERVICES ON ISSUES OF IMPORTANCE TO HANDICAPPED, DISABLED AND DISADVANTAGED PERSONS; PROVIDING LEGAL SERVICES AND LEGAL ADVICE TO ORGANIZATIONS THAT AID HANDICAPPED, DISABLED AND DISADVANTAGED PERSONS; PROVIDING RESEARCH SERVICES IN THE FIELD OF REHABILITATION, TRAINING AND EMPLOYMENT OF HANDICAPPED, DISABLED AND DISADVANTAGED PERSONS; PROMOTING THE INTERESTS OF AND ENCOURAGING AND ASSISTING IN THE ESTABLISHMENT, DEVELOPMENT AND GROWTH OF ORGANIZATIONS THROUGHOUT THE WORLD DEDICATED TO PROVIDING REHABILITATION SERVICES, TRAINING, EMPLOYMENT AND OPPORTUNITIES FOR PERSONAL GROWTH FOR HANDICAPPED, DISABLED AND DISADVANTAGED PERSONS (U.S. CLS. 100 AND 101).

FIRST USE 4-19-2000; IN COMMERCE 4-19-2000.
VIVIAN MICZNIK FIRST, EXAMINING ATTORNEY

SN 76-351,902. DSM IP ASSETS B.V., TE HEERLEN, NETHERLANDS, FILED 12-21-2001.

UNLIMITED.DSM

PRIORITY CLAIMED UNDER SEC. 44(D) ON BENELUX APPLICATION NO. 0992260, FILED 6-25-2001, REG. NO. 0697855, DATED 6-25-2001, EXPIRES 6-25-2011.

CLASS 1—CHEMICALS

FOR PHOTOGRAPHIC CHEMICALS; CHROMATOGRAPHIC CHEMICALS; LITHOGRAPHIC CHEMICALS; CHEMICALS AND BIOCHEMICALS FOR USE IN THE MANUFACTURE OF FOOD AND BEVERAGES; ARTIFICIAL SWEETENERS; CHEMICALS AND BIOCHEMICALS FOR USE IN THE MANUFACTURE OF PHARMACEUTICALS; CHEMICALS AND BIOCHEMICALS FOR USE IN THE MANUFACTURE OF ANIMAL FEEDSTUFFS; CHEMICALS FOR USE IN THE MANUFACTURE OF FOOD FLAVORINGS AND FRAGRANCES; UNPROCESSED ARTIFICIAL RESINS FOR USE IN A WIDE VARIETY OF FIELDS; UNPROCESSED PLASTICS, NAMELY PLASTIC MOLDING COMPOUNDS FOR USE IN THE MANUFACTURE OF MOLDED PLASTIC ARTICLES; PLASTIC MOLDING COMPOUNDS FOR USE IN THE MANUFACTURE OF PLASTIC SHEETS AND FILMS; PLASTIC MOLDING COMPOUNDS FOR USE IN PLASTIC EXTRUSION OPERATIONS; MANURE; FIRE EXTINGUISHING COMPOSITIONS; TEMPERING CHEMICALS FOR USE IN METAL WORKING OR SOLDERING; SOLDERING CHEMICALS; SOLDERING FLUX; CHEMICALS FOR PRESERVING FOODSTUFFS AND BEVERAGES; TANNING AGENTS FOR USE IN THE MANUFACTURE OF LEATHER; AND ADHESIVES FOR GENERAL INDUSTRIAL USE (U.S. CLS. 1, 5, 6, 10, 26 AND 46).

CLASS 2—PAINTS

FOR EXTERIOR PAINTS; INTERIOR PAINTS; PAINT PRIMERS; PAINT SEALERS; PAINT THINNERS; PAINT FOR USE IN THE MANUFACTURE OF AUTOMOBILES; VARNISHES; LACQUERS IN THE NATURE OF A COATING; RUST PRESERVATIVES IN THE NATURE OF A COATING; WOOD PRESERVATIVES; COLORANTS FOR USE IN THE MANUFACTURE OF FOOD, BEVERAGES, PHARMACEUTICALS, COSMETICS, PRINTING INK; INDUSTRIAL COATINGS FOR METAL OBJECTS; RADIATION-CURABLE COATINGS IN THE NATURE OF PAINTS, VARNISHES AND LACQUERS FOR USE ON OPTICAL FIBERS AND OPTICAL MEDIA; AND RADIATION CURABLE INKS FOR USE ON OPTICAL FIBERS AND OPTICAL MEDIA (U.S. CLS. 6, 11 AND 16).

CLASS 3—COSMETICS AND CLEANING PREPARATIONS

FOR LAUNDRY BLEACH; LAUNDRY BLUEING; LAUNDRY DETERGENT; LAUNDRY PRE-SOAK; LAUNDRY SIZING; LAUNDRY STARCH; GENERAL PURPOSE CLEANING, POLISHING, AND ABRASIVE LIQUIDS AND POWDERS; SOAPS, NAMELY ANTI-BACTERIAL SOAP, DEODORANT SOAP; DETERGENT SOAP; DISINFECTANT SOAPS AND HAND SOAPS; PERFUMES; ESSENTIAL OILS FOR PERSONAL USE; ESSENTIAL OILS FOR FOOD FLAVORINGS; COSMETICS; HAIR LOTIONS; AND DENTIFRICES (U.S. CLS. 1, 4, 6, 50, 51 AND 52).

CLASS 4—LUBRICANTS AND FUELS

FOR NON-CHEMICAL GASOLINE AND MOTOR OIL ADDITIVES (U.S. CLS. 1, 6 AND 15).

CLASS 5—PHARMACEUTICALS

FOR PHARMACEUTICAL AND VETERINARY PREPARATIONS FOR THE TREATMENT OF INFECTIONS; VITAMIN PREPARATIONS; FOOD SUPPLEMENTS; FEED SUPPLEMENTS FOR LIVESTOCK, CATS, DOGS AND PETS; PREPARATIONS FOR DESTROYING VERMIN; FUNGICIDES FOR DOMESTIC USE; FUNGICIDES FOR AGRICULTURAL AND HORTICULTURAL USE; HERBICIDES FOR DOMESTIC USE; AND HERBICIDES FOR AGRICULTURAL AND HORTICULTURAL USE (U.S. CLS. 6, 18, 44, 46, 51 AND 52).

CLASS 17—RUBBER GOODS

FOR SYNTHETIC RUBBER IN THE FORM OF PELLETS, CRUMBS OR BALES FOR USE IN THE MANUFACTURE OF SHEETS, TUBES, PROFILES, HOSES, WEATHER STRIPS, SEALING MATERIALS, GASKETS, MUD FLAPS, CONNECTORS, FLOORING, WATER-PROOFING, PIPE WRAP, ACOUSTIC BACKING, TANK LINERS, CONVEYOR BELTS, MEAT TRAYS, TOOL GRIPS, STEP PADS, GROMMETS, NON-SLIP COVERINGS, GOLF CLUB AND RACKET GRIPS, BINDINGS AND PROTECTIVE EQUIPMENT; THERMOPLASTIC ELASTOMER RESINS IN PELLET FORM FOR USE IN FURTHER MANUFACTURE; SEMI-PROCESSED PLASTIC PRODUCTS IN THE FORM OF GRANULES, FIBERS, WIRES, BANDS, STRIPS, FILMS, SHEETS, PLATES, BOARDS, BARS, PROFILES, BLOCKS, RODS, HOSES, PIPES AND MEMBRANES FOR GENERAL MANUFACTURING USE; MICROPOROUS PLASTIC FILMS AND MEMBRANES FOR GENERAL MANUFACTURING USE; SYNTHETIC RESINS IN SEMI-FINISHED MOLDED FORM FOR GENERAL INDUSTRIAL USE; SEMI-FINISHED THERMOSETTING PLASTIC COMPOSITE MATERIAL IN THE FORM OF PROFILES, BOARDS, SHEETS, BLOCKS, RODS, POWDER, AND PELLETS FOR USE IN MANUFACTURING; AND FLEXIBLE PIPES, NOT OF METAL (U.S. CLS. 1, 5, 12, 13, 35 AND 50).

CLASS 19—NON-METALLIC BUILDING MATERIALS

FOR PLASTIC EXTRUSIONS, NAMELY, DECKING USED IN BUILDING CONSTRUCTION; AND GEOTEXTILES, NAMELY, EROSION CONTROL FABRIC AND SHEETING FOR USE IN CIVIL AND HYDRAULIC ENGINEERING (U.S. CLS. 1, 12, 33 AND 50).

CLASS 22—CORDAGE AND FIBERS

FOR ROPES; STRING; COMMERCIAL NETS; TENTS; TARPULINS NOT COVERS SPECIFICALLY DESIGN FOR VEHICLES; SAILS; SACKS AND BAGS FOR THE TRANSPORTATION OR STORAGE OF MATERIALS IN BULK; AND RAW FIBROUS TEXTILE MATERIALS (U.S. CLS. 1, 2, 7, 19, 22, 42 AND 50).

CLASS 23—YARNS AND THREADS

FOR YARNS AND THREADS (U.S. CL. 43).

CLASS 24—FABRICS

FOR FABRICS MADE OF PLASTIC FIBERS FOR USE IN THE MANUFACTURE OF SAILS, GEOTEXTILES AND PROTECTIVE CLOTHING; AND BALLISTIC RESISTANT FABRICS COMPRISED IN PART OF PLASTICS FOR USE IN THE PRODUCTION OF BULLET-RESISTANT CLOTHING AND ARMOR FOR CARS AND COCKPIT DOORS (U.S. CLS. 42 AND 50).

CLASS 29—MEATS AND PROCESSED FOODS

FOR PROTEIN FOR USE AS A FOOD ADDITIVE AND A FOOD FILLER INGREDIENT IN THE DAIRY INDUSTRY; RENNET; YOGURT; MEAT; FISH IN GENERAL FOR FOOD PURPOSES; POULTRY IN GENERAL; GAME; MEAT EXTRACT; PRESERVED, DRIED AND COOKED FRUITS AND VEGETABLES; JELLIES; JAMS; FRUIT SAUCES; EGGS; MILK; DAIRY PRODUCTS EXCLUDING ICE CREAM, ICE MILK AND FROZEN YOGURT; EDIBLE OILS; AND EDIBLE FATS (U.S. CL. 46).

CLASS 30—STAPLE FOODS

FOR COFFEE; TEA; COCOA; SUGAR; RICE; TAPIOCA; SAGO; COFFEE SUBSTITUTES; FLOUR; PREPARATIONS MADE FROM CEREALS, NAMELY, BREAKFAST CEREALS AND CEREAL-BASED SNACK FOODS; BREAD, PASTRY AND CONFECTIONERY, NAMELY, CAKES, PASTRIES, BUNS, BISCUITS AND COOKIES; ICE CREAM; HONEY; TREACLE; YEAST; BAKING POWDER; FOOD FLAVORINGS; SALT; MUSTARD; VINEGAR; HERB SAUCES; SPICES; AND ICE (U.S. CL. 46).

CLASS 31—NATURAL AGRICULTURAL PRODUCTS

FOR FOODSTUFFS FOR ANIMALS; ANIMAL FEED; ANIMAL FEED ADDITIVES FOR NON-NUTRITIONAL, NON-MEDICINAL PURPOSES FOR USE AS FLAVORING, INGREDIENT OR FILLER; RAW OATS SOLD ONLY AS AN INGREDIENT IN ANIMAL FEED; AND BEVERAGES FOR ANIMALS (U.S. CLS. 1 AND 46).

CLASS 32—LIGHT BEVERAGES

FOR BEER; AERATED FRUIT JUICES; CONCENTRATES, SYRUPS OR POWDERS USED IN THE PREPARATION OF SOFT DRINKS; ESSENCES NOT IN THE NATURE OF ESSENTIAL OILS FOR USE IN MAKING SOFT DRINKS; FRUIT DRINKS; FRUIT FLAVORED DRINKS; PREPARATIONS FOR MAKING FRUIT DRINKS; SYRUP FOR MAKING LEMONADE; AND SYRUPS FOR MAKING FRUIT DRINKS AND SOFT DRINKS (U.S. CLS. 45, 46 AND 48).

CLASS 42—SCIENTIFIC, COMPUTER AND LEGAL SERVICES

FOR RESEARCH AND DEVELOPMENT OF NEW CHEMICAL PROCESSES FOR OTHERS; DESIGN OF CHEMICAL PLANTS AND INSTALLATIONS FOR OTHERS; CONDUCTING TECHNICAL FEASIBILITY STUDIES; CONSULTING SERVICES IN THE FIELDS OF CHEMICAL PLANT EXPANSION AND CHEMICAL INSTALLATION EXPANSION; TECHNICAL CONSULTATION AND DRAFTING OF EXPERT REPORTS IN CONNECTION WITH CHEMICAL PLANTS AND CHEMICAL MANUFACTURING; ENGINEERING SERVICES; ENGINEERING CONSULTATION SERVICES; PHYSICIST SERVICES; PHYSICIST CONSULTATION SERVICES; LEGAL SERVICES; LEGAL CONSULTATION SERVICES, INCLUDING AREAS OF PATENT LAW, INTELLECTUAL PROPERTY LAW AND LICENSING LAW; CHEMIST SERVICES; CHEMIST CONSULTATION SERVICES; CHEMICAL LABORATORY SERVICES; CHEMICAL AND PHYSICAL ANALYSIS SERVICES; TECHNICAL SUPERVISION AND INSPECTION SERVICES IN

THE FIELDS OF CHEMICAL PLANTS AND INSTALLATIONS AND CHEMICAL MANUFACTURING; SCIENTIFIC REPORTING FOR OTHERS BY ENGINEERS, CHEMISTS AND LABORATORY TECHNICIANS; CHEMICAL RESEARCH; PROVIDING INFORMATION ON WORK ENVIRONMENT SAFETY MATTERS; TESTING, ANALYSIS AND EVALUATION OF THE GOODS AND SERVICES OF OTHERS FOR THE PURPOSE OF CERTIFICATION IN THE FIELDS OF CHEMICAL PLANTS AND INSTALLATIONS AND CHEMICAL MANUFACTURING; AND INTELLECTUAL PROPERTY CONSULTATION (U.S. CLS. 100 AND 101).

VERNA BETH RIRIE, EXAMINING ATTORNEY

SN 76-352,362. H. C. JOHNSON GROUP, INC., ROCKFORD, IL. FILED 12-26-2001.

JohnsonGroup

SEC. 2(F).

CLASS 35—ADVERTISING AND BUSINESS

FOR DOCUMENT COPYING AND PHOTOCOPYING SERVICES; WEB-BASED FULFILLMENT SERVICES PERFORMED FOR OTHERS, NAMELY, ON-LINE FULFILLMENT OF ORDERS FOR PROMOTIONAL LITERATURE AND PROMOTIONAL OR INCENTIVE GIFTS; AND BUSINESS CONSULTING (U.S. CLS. 100, 101 AND 102).

FIRST USE 1-1-1988; IN COMMERCE 1-1-1988.

CLASS 40—MATERIAL TREATMENT

FOR COMMERCIAL PRINTING SERVICES AND BINDERY SERVICES (U.S. CLS. 100, 103 AND 106).

FIRST USE 1-1-1998; IN COMMERCE 1-1-1998.

CLASS 42—SCIENTIFIC, COMPUTER AND LEGAL SERVICES

FOR GRAPHIC ART DESIGN AND COMPUTER GENERATED TYPOGRAPHIC SERVICES (U.S. CLS. 100 AND 101).

FIRST USE 1-1-1988; IN COMMERCE 1-1-1988.

ALICIA COLLINS, EXAMINING ATTORNEY

SN 76-368,793. TECAN TRADING AG, CH-8708 MANNE-DORF, SWITZERLAND, FILED 2-8-2002.

CDLAB**CLASS 9—ELECTRICAL AND SCIENTIFIC APPARATUS**

FOR SCIENTIFIC APPARATUS, NAMELY, AN INTEGRATED COMBINATION OF A MICROCENTRIFUGE AND MICROCENTRIFUGE ROTOR FOR MICROANALYSIS, MICROSYNTHESIS, PURIFICATION AND SAMPLE PREPARATION (U.S. CLS. 21, 23, 26, 36 AND 38).

CLASS 10—MEDICAL APPARATUS

FOR MEDICAL APPARATUS, NAMELY, AN INTEGRATED COMBINATION OF A MICROCENTRIFUGE AND MICROCENTRIFUGE ROTOR FOR MICROANALYSIS, MICROSYNTHESIS, PURIFICATION AND SAMPLE PREPARATION (U.S. CLS. 26, 39 AND 44).

RONALD AIKENS, EXAMINING ATTORNEY

SN 76-370,553. SPORT DIRECT B.V., 7418 EZ DEVENTER, NETHERLANDS, FILED 2-12-2002.

STANNO

PRIORITY CLAIMED UNDER SEC. 44(D) ON BENELUX APPLICATION NO. 1005262, FILED 2-12-2002, REG. NO. 0705894, DATED 2-12-2002, EXPIRES 2-12-2012.

CLASS 25—CLOTHING

FOR SPORTSWEAR, NAMELY, JOGGING SUITS, T-SHIRTS, SWEATSHIRTS, JERSEYS, TIGHTS, SHORTS, SOCKS, SPORTS UNDERWEAR, JACKETS, RAINWEAR, SWIM WEAR, TENNIS SHORTS, TENNIS DRESSES, TENNIS SKIRTS, GOLF SHIRTS, SWEATERS, PULL-OVERS, WARM-UP SUITS, TRAINING SUITS, SKI SUITS, JUMP SUITS, FLEECE SHIRTS AND SPORTS GLOVES; SPORTS SHOES, NAMELY, SOCCER SHOES, HIKING SHOES, TRACK AND FIELD TRAINING SHOES, RUNNING SHOES, INDOOR SHOES, BASKETBALL SHOES, TENNIS SHOES AND SLIPPERS; HEADGEAR, NAMELY, CAPS, SWIMMING CAPS AND HEADBANDS (U.S. CLS. 22 AND 39).

CLASS 28—TOYS AND SPORTING GOODS

FOR SPORTING ARTICLES, NAMELY, SPORTS BALLS OF ALL TYPES, WEIGHTS FOR EXERCISE AND FOR LIFTING, WEIGHT LIFTING BELTS, PROTECTIVE PADDING AND GUARDS FOR SOCCER, FOOTBALL, HOCKEY, RUGBY, SKATING, BASEBALL, SOFTBALL AND GOLF; BODY PROTECTORS OF ALL TYPES FOR THE PRACTICE OF SPORTS, GOLF BAGS, HEAD COVERS FOR GOLF CLUBS, GOLF TEES AND BALL MARKERS, HOCKEY STICKS, BASEBALL AND SOFTBALL BATS, MITTS AND GLOVES FOR THE PRACTICE OF SPORTS, NAMELY, SOCCER, FOOTBALL, HOCKEY, RUGBY, SKATING, BASEBALL, SOFTBALL AND GOLF; ICE SKATES, TENNIS RACKETS, SQUASH RACKETS AND BADMINTON RACKETS (U.S. CLS. 22, 23, 38 AND 50).

JASON TURNER, EXAMINING ATTORNEY

SN 76-376,625. ASA HYDRAULIK GESELLSCHAFT M.B.H., A-1210 VIENNA, AUSTRIA, FILED 2-22-2002.



PRIORITY CLAIMED UNDER SEC. 44(D) ON AUSTRIA APPLICATION NO. AM6412/2001, FILED 9-7-2001, REG. NO. 200191, DATED 10-31-2001, EXPIRES 10-31-2011.
OWNER OF U.S. REG. NO. 2,120,747.

CLASS 7—MACHINERY

FOR COOLING RADIATORS FOR MOTORS AND ENGINES; VEHICLE ENGINE PARTS, NAMELY, OIL COOLERS; MACHINE PARTS, NAMELY, OIL COOLERS; FANS FOR MOTORS AND ENGINES; HYDRAULIC PUMPS; PUMP CONTROL VALVES; SPARE PARTS FOR EACH OF THE FOREMENTIONED GOODS (U.S. CLS. 13, 19, 21, 23, 31, 34 AND 35).

CLASS 9—ELECTRICAL AND SCIENTIFIC APPARATUS

FOR ELECTRIC CONTROL SWITCHES; THERMOSTATS AND SPARE PARTS FOR EACH OF THE FOREMENTIONED GOODS (U.S. CLS. 21, 23, 26, 36 AND 38).

CLASS 17—RUBBER GOODS

FOR NON-METAL PIPE FITTINGS; NON-METAL PIPE COUPLINGS AND JOINTS (U.S. CLS. 1, 5, 12, 13, 35 AND 50).

KHANH LE, EXAMINING ATTORNEY

SN 76-379,942. TERANET ENTERPRISES LTD., TORONTO, ONTARIO, CANADA, FILED 3-7-2002.

PORTAS

PRIORITY CLAIMED UNDER SEC. 44(D) ON CANADA APPLICATION NO. 1129051, FILED 1-24-2002, REG. NO. TMA604676, DATED 3-10-2004, EXPIRES 3-10-2019.

CLASS 9—ELECTRICAL AND SCIENTIFIC APPARATUS

FOR FRAMEWORK FOR SOFTWARE, TOOLS, DATA, AND SERVICES FOR LAND REGISTRATION SYSTEMS AND OPERATIONS AND FRAMEWORK FOR INFORMATION REGISTRATION MANAGEMENT APPLICATIONS, NAMELY, COMPUTER SOFTWARE FOR COMPUTER SECURITY CERTIFICATION, ENCRYPTION SOFTWARE AND THE ORGANIZATION, REGISTRATION, MANAGEMENT AND DELIVERY OF INFORMATION (U.S. CLS. 21, 23, 26, 36 AND 38).

CLASS 16—PAPER GOODS AND PRINTED MATTER

FOR STATIONERY, NAMELY, CALENDARS, GREETING CARDS, ORDER FORMS, PRINTED FORMS, POSTERS, APPOINTMENT BOOKS, ALMANACS, ATLASES, PHOTOGRAPHS, PAPER BANNERS, PENS, PENCILS, MARKERS, AND NEWSLETTERS, PERIODICALS, MAGAZINES, BOOK REVIEWS, AND A SERIES OF BOOKS, ALL OF THE FOREGOING IN THE FIELD OF COMPUTER HARDWARE, SOFTWARE, COMPUTER NETWORKS, SOFTWARE APPLICATION SERVICE PROVISION, COMPUTER HOSTING, COMPUTER SECURITY, COMPUTER USER AUTHENTICATION, ONLINE TRANSACTIONS, LAND REGISTRATION SYSTEMS FOR COMPUTER SECURITY, CERTIFICATE AUTHORITY FOR COMPUTER SECURITY, AND REGISTRATION AUTHORITY FOR COMPUTER SECURITY (U.S. CLS. 2, 5, 22, 23, 29, 37, 38 AND 50).

CLASS 42—SCIENTIFIC, COMPUTER AND LEGAL SERVICES

FOR PROVISION OF SOFTWARE, DECISION SUPPORT TOOLS, TECHNOLOGY AND INTERNET SOLUTIONS FOR THE ORGANIZATION, REGISTRATION AND DELIVERY OF LAND RELATED INFORMATION, NAMELY, DESIGNING AND IMPLEMENTING COMPUTER SOFTWARE, DECISION SUPPORT TOOLS, DATA AND DATABASES USED FOR SEARCHING, RETRIEVING, ORGANIZING, PREPARING, COMPILING, SUBMITTING, REGISTERING, DELIVERING AND MANAGING INFORMATION, COMPUTER SOFTWARE INSTALLATION, INTEGRATION, AND DEPLOYMENT IN THE FIELD OF INFORMATION SECURITY, COMPUTER INFORMATION SECURITY IN THE NATURE OF PUBLIC KEY ENCRYPTION, AUTHENTICATION OF DIGITAL SIGNATURES, ISSUING DIGITAL ENCRYPTION KEYS AND/OR DIGITAL CERTIFICATES, ADMINISTRATION OF LISTS OF THOSE BLOCKED FROM USE, VERIFYING AND CONFIRMING THE AUTHENTICITY OF UTILIZED ENCRYPTION KEYS, AUTHORIZING COMPUTER NETWORK RESOURCES FOR COMPUTERS USERS AND SOFTWARE APPLICATIONS, AND THE CREATION OF DIGITAL CERTIFICATES; INFORMATION REGISTRATION MANAGEMENT APPLICATIONS AND TOOLS, NAMELY, PROVISION OF SOFTWARE, DECISION SUPPORT TOOLS, TECHNOLOGY AND INTERNET SOLUTIONS FOR THE ORGANIZATION, REGISTRATION, AND DELIVERY OF GEOGRAPHIC LAND RELATED, FINANCIAL, LEGAL AND HEALTH INFORMATION, NAMELY, DATABASE DEVELOPMENT AND MAINTENANCE SERVICES FROM DOCUMENTS RELATING TO GEOGRAPHIC, LAND RELATED, FINANCIAL, LEGAL AND HEALTH INFORMATION (U.S. CLS. 100 AND 101).

BRIAN PINO, EXAMINING ATTORNEY

CLASS 38—COMMUNICATION

FOR STREAMING OF AUDIO AND VISUAL RECORDINGS FEATURING MUSIC AND MUSIC BASED ENTERTAINMENT OVER A GLOBAL COMPUTER NETWORK (U.S. CLS. 100, 101 AND 104).

FIRST USE 2-1-2002; IN COMMERCE 2-1-2002.

CLASS 41—EDUCATION AND ENTERTAINMENT

FOR PROVIDING A WEBSITE ON A GLOBAL COMPUTER NETWORK FEATURING INFORMATION ON MUSICAL PERFORMERS, MUSICAL PERFORMANCES, MUSICAL PERFORMER APPEARANCES, SOUND AND VIDEO RECORDINGS, AND INTERVIEWS; ENTERTAINMENT SERVICES, NAMELY PROMOTING AND CONDUCTING ONLINE RADIO CONTESTS WHEREBY VOTERS CAST VOTES FOR PREFERRED MUSICAL PERFORMERS OR MUSICAL GROUPS (U.S. CLS. 100, 101 AND 107).

FIRST USE 2-1-2002; IN COMMERCE 2-1-2002.

SAMUEL E. SHARPER JR., EXAMINING ATTORNEY

SN 76-384,475. TECAN TRADING AG, CH-8708 MANNE-
DORF, SWITZERLAND, FILED 3-19-2002.

LABCD**CLASS 9—ELECTRICAL AND SCIENTIFIC APPARATUS**

FOR SCIENTIFIC APPARATUS, NAMELY, AN INTEGRATED COMBINATION OF A MICROCENTRIFUGE AND MICROCENTRIFUGE ROTOR FOR MICROANALYSIS, MICROSYNTHESIS, PURIFICATION AND SAMPLE PREPARATION (U.S. CLS. 21, 23, 26, 36 AND 38).

SN 76-394,499. VOTIVO, LTD., SEATTLE, WA. FILED 4-11-
2002.

CLASS 10—MEDICAL APPARATUS

FOR MEDICAL APPARATUS, NAMELY, AN INTEGRATED COMBINATION OF A MICROCENTRIFUGE AND MICROCENTRIFUGE ROTOR FOR MICROANALYSIS, MICROSYNTHESIS, PURIFICATION AND SAMPLE PREPARATION (U.S. CLS. 26, 39 AND 44).

RONALD AIKENS, EXAMINING ATTORNEY

NEWBURY HOLLY

NO CLAIM IS MADE TO THE EXCLUSIVE RIGHT TO USE "HOLLY", APART FROM THE MARK AS SHOWN.

SN 76-387,263. MCGATHY PROMOTIONS, INC., NEW
YORK, NY. FILED 3-25-2002.

ROCKSTAR2K

CLASS 3—COSMETICS AND CLEANING PREPARATIONS

FOR INCENSE (U.S. CLS. 1, 4, 6, 50, 51 AND 52).
FIRST USE 8-17-1998; IN COMMERCE 8-17-1998.

CLASS 35—ADVERTISING AND BUSINESS

FOR ON-LINE RETAIL STORE SERVICES FEATURING CLOTHING; PROMOTING THE GOODS AND SERVICES OF OTHERS BY PROVIDING A WEBSITE PROMOTING AND DEVELOPING MUSICAL TALENT (U.S. CLS. 100, 101 AND 102).

FIRST USE 2-1-2002; IN COMMERCE 2-1-2002.

CLASS 4—LUBRICANTS AND FUELS

FOR CANDLES, TAPERS (U.S. CLS. 1, 6 AND 15).
FIRST USE 8-17-1998; IN COMMERCE 8-17-1998.
ALEXANDER L. POWERS, EXAMINING ATTORNEY

SN 76-401,239. HERBIE HYDRANT, LLC, LEAWOOD, KS.
FILED 4-26-2002.

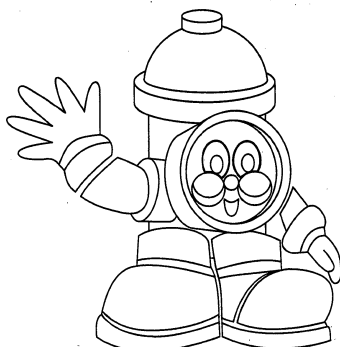

CLASS 9—ELECTRICAL AND SCIENTIFIC APPARATUS

FOR CHILDREN'S EMERGENCY SAFETY EQUIPMENT CONSISTING OF A FLASHING LIGHT, A FLASH LIGHT, ALARM AND TIMING DEVICE, ALL IN THE SHAPE OF A MINIATURE FIRE HYDRANT (U.S. CLS. 21, 23, 26, 36 AND 38).

FIRST USE 3-12-2002; IN COMMERCE 3-12-2002.

CLASS 14—JEWELRY

FOR CHILDREN'S CLOCK IN THE FORM OF A FIRE HYDRANT (U.S. CLS. 2, 27, 28 AND 50).

FIRST USE 4-12-2002; IN COMMERCE 4-12-2002.

CLASS 16—PAPER GOODS AND PRINTED MATTER

FOR PRINTED MATERIALS, NAMELY BOOKS, MAGAZINES, AND PAMPHLETS, ALL WHICH PROMOTE PUBLIC AWARENESS OF THE NEED FOR FIRE SAFETY AND SUPPORT THE EDUCATION OF THE PUBLIC, ESPECIALLY CHILDREN, WITH REGARD TO FIRE SAFETY (U.S. CLS. 2, 5, 22, 23, 29, 37, 38 AND 50).

FIRST USE 4-12-2002; IN COMMERCE 4-12-2002.

CLASS 35—ADVERTISING AND BUSINESS

FOR PROMOTING PUBLIC AWARENESS OF THE NEED FOR FIRE SAFETY AND OF THE NEED FOR EDUCATION OF THE PUBLIC, ESPECIALLY CHILDREN, WITH REGARD TO FIRE SAFETY BY PROVIDING INFORMATION IN THAT FIELD OF, BY MEANS OF A GLOBAL COMPUTER NETWORK (U.S. CLS. 100, 101 AND 102).

FIRST USE 3-12-2002; IN COMMERCE 3-12-2002.

LINDA MICKLEBURGH, EXAMINING ATTORNEY

SN 76-404,047. BEATE UHSE AKTIENGESELLSCHAFT, D-24941 FLENSBURG, FED REP GERMANY, FILED 5-7-2002.

BEATE UHSE

PRIORITY CLAIMED UNDER SEC. 44(D) ON FED REP GERMANY APPLICATION NO. 301721076, FILED 12-18-2001, REG. NO. 30172107, DATED 12-15-2001, EXPIRES 12-31-2011.

THE NAME IN THE MARK DOES NOT IDENTIFY A LIVING INDIVIDUAL.

CLASS 3—COSMETICS AND CLEANING PREPARATIONS

FOR BODY SOAPS, DEODORANT AND DISINFECTANT SOAPS; PERFUMERY, NAMELY, PERFUMES, COLOGNES AND ESSENTIAL OILS FOR PERSONAL USE; MASSAGE OILS; COSMETICS, HAIR LOTIONS; DENTIFRICES, DEODORANTS FOR PERSONAL USE, COSMETIC KITS PRIMARILY COMPOSED OF LIPSTICK, EYE SHADOW AND BLUSH; BATH SALTS, DEPILATORY PREPARATIONS, HAIR DYES, HAIR SHAMPOOS, FALSE NAILS, FALSE EYELASHES, LIPSTICKS, MAKE-UP, NAIL VARNISH, MAKE-UP PREPARATIONS (U.S. CLS. 1, 4, 6, 50, 51 AND 52).

CLASS 5—PHARMACEUTICALS

FOR PHARMACEUTICAL, SANITARY AND CHEMICAL PREPARATIONS FOR HEALTH CARE, NAMELY, PERSONAL LUBRICATION OILS, PERSONAL LUBRICATION CREAMS; CONTRACEPTIVES CREAMS AND SUPPOSITORIES, ORGASM CREAMS; PREPARATIONS FOR PHYSICAL INVIGORATION AND TO INCREASE POTENCY (U.S. CLS. 6, 18, 44, 46, 51 AND 52).

CLASS 10—MEDICAL APPARATUS

FOR HYGIENIC RUBBER GOODS, NAMELY, FINGER GUARDS AND GLOVES FOR MEDICAL PURPOSES, GLOVES FOR MASSAGE, CONDOMS; MECHANICAL CONTRACEPTIVES, NAMELY, DIAPHRAGMS, PESSARIES; EROTICIZING ARTICLES FOR DIRECT BODY APPLICATION, NAMELY, ELECTRIC AND NON ELECTRIC MASSAGE AND VIBROMASSAGE APPARATUS, VIBRATORS, FUNCTIONAL LIMITATIONS OF PARTS OF THE HUMAN BODY AND SEXUAL ORGANS; ERECTION-AND ORGASM-FACILITATING APPLIANCES, NAMELY; LOVE-BALLS, PENIS RINGS (U.S. CLS. 26, 39 AND 44).

CLASS 14—JEWELRY

FOR JEWELRY AND IMITATION JEWELRY, NAMELY AMULETS, PINS, BROOCHES, NECKLACES, TIE CLIPS, TIE PINS, CUFFLINKS, RINGS, BRACELETS, CHAINS, EARRINGS, HAT ORNAMENTS, KEY RINGS, MEDALLIONS, ORNAMENTAL PINS, PEARLS, SEMI-PRECIOUS STONES, SILVER ORNAMENTS, PASTE JEWELRY, TIE PINS, WATCH CHAINS; WATCHES, CHRONOGRAPHS (U.S. CLS. 2, 27, 28 AND 50).

CLASS 16—PAPER GOODS AND PRINTED MATTER

FOR PRINTED MATTER, NAMELY, BOOKS, CALENDARS, MAGAZINES, COMIC BOOKS, BOOKMARKERS, GREETING CARDS, NOTE BOOKS, PAMPHLETS, PICTURES, POSTCARDS, SONG BOOKS, TEAR-OFF CALENDARS, THE AFOREMENTIONED GOODS FOR EROTIC ENTERTAINMENT AND SEXUAL EDUCATION; PHOTOGRAPHS; PHOTO-ILLUSTRATED BOOKS IN THE FIELD OF EROTIC ENTERTAINMENT AND SEXUAL EDUCATION, INSTRUCTION AND TEACHING MATERIAL; STATIONARY (U.S. CLS. 2, 5, 22, 23, 29, 37, 38 AND 50).

CLASS 18—LEATHER GOODS

FOR GOODS MADE OF LEATHER AND IMITATIONS OF LEATHER; NAMELY, LEATHER STRAPS, LEATHER LEASHES; KEY CASES, POCKET WALLETS, PURSES; BAGS, NAMELY, BEACH BAGS, BAGS FOR CAMERAS, HANDBAGS, TRAVELING BAGS, TRUNKS AND TRAVELING BAGS, VANITY CASES SOLD EMPTY; TRAVELING SETS (LEATHERWEAR); UMBRELLAS, PARASOLS, WALKING STICKS; WHIPS, LEATHER STRAPS AND LEASHES (U.S. CLS. 1, 2, 3, 22 AND 41).

CLASS 25—CLOTHING

FOR CLOTHING, NAMELY, BATHING SUITS, BATHING TRUNKS, BATH ROBES, BATHING CAPS, BATH SANDALS, TEDDIES, BRASSIERES, BELTS, GLOVES, GIRDLES, UNDERWEAR, CORSELETS, DRESSING GOWNS, NIGHTDRESSES, PAJAMAS, SCARVES, LADIES' AND MEN'S UNDERWEAR, TIGHTS, STOCKING, GARTERS, STOCKING SUSPENDERS, APRONS; ASCOTS, BEACH CLOTHES, BEACH SHOES, CAMISOLES, COLLAR PROTECTORS, HEADBANDS, FROCKS, JACKETS, KNITWEAR, NECKTIES, PETTICOATS, PULL-OVERS, SANDALS, SARIS, SCARVES, SHIRTS, SHAWLS, SKIRTS, SLIPS, T-SHIRT, TIGHTS, WIMPLES; FACEMASKS AS CLOTHING; THE AFOREMENTIONED GOODS ALSO MADE OF OR USING LEATHER, LATEX, RUBBER; FOOTWEAR, NAMELY, LADIES' SHOES, LADIES' BOOTS, SLIPPERS; HEADWEAR (U.S. CLS. 22 AND 39).

CLASS 41—EDUCATION AND ENTERTAINMENT

FOR PRODUCTION OF TELEVISION AND RADIO PROGRAMS, AND PRODUCTION OF LIVE TELEVISION AND RADIO PROGRAMS; ENTERTAINMENT IN THE NATURE OF PRE-RECORDED SEX-ORIENTED MESSAGES AND LIVE CONVERSATIONS BY TELEPHONE (U.S. CLS. 100, 101 AND 107).

SOPHIA S. KIM, EXAMINING ATTORNEY

SN 76-414,537. CAMPUS COMPACT, PROVIDENCE, RI. FILED 5-31-2002.

CAMPUS COMPACT

NO CLAIM IS MADE TO THE EXCLUSIVE RIGHT TO USE "CAMPUS", APART FROM THE MARK AS SHOWN.

CLASS 14—JEWELRY

FOR LAPEL PINS (U.S. CLS. 2, 27, 28 AND 50). FIRST USE 4-30-2001; IN COMMERCE 4-30-2001.

CLASS 16—PAPER GOODS AND PRINTED MATTER

FOR PRINTED CURRICULUM GUIDES IN THE FIELD OF SERVICE LEARNING AND CIVIC ENGAGEMENT AND PRINTED MATERIALS NAMELY, PROGRAM GUIDES OF CAMPUS COMMUNITY SERVICE, SERVICE LEARNING AND CIVIC ENGAGEMENT PRACTICES (U.S. CLS. 2, 5, 22, 23, 29, 37, 38 AND 50). FIRST USE 6-30-2001; IN COMMERCE 6-30-2001.

CLASS 18—LEATHER GOODS

FOR TOTE BAGS (U.S. CLS. 1, 2, 3, 22 AND 41). FIRST USE 1-24-2002; IN COMMERCE 1-24-2002.

CLASS 25—CLOTHING

FOR CLOTHING, NAMELY SHIRTS, SWEATSHIRTS, JACKETS, HATS, TIES AND SCARVES (U.S. CLS. 22 AND 39).

FIRST USE 12-7-2000; IN COMMERCE 12-7-2000.

CLASS 41—EDUCATION AND ENTERTAINMENT

FOR EDUCATIONAL SERVICES, NAMELY, CONDUCTING WORKSHOPS FOR FACULTY, PRESIDENTS, CHIEF ACADEMIC OFFICERS, COMMUNITY SERVICE STAFF AND STUDENTS IN THE FIELD OF SERVICE-LEARNING AND CIVIC ENGAGEMENT, AND PROVIDING EDUCATIONAL MATERIALS IN THE NATURE OF TRAINING AND TECHNICAL ASSISTANCE MATERIALS THEREWITH (U.S. CLS. 100, 101 AND 107).

FIRST USE 3-31-2001; IN COMMERCE 3-31-2001.
BARNEY CHARLON, EXAMINING ATTORNEY

SN 76-415,400. B & B ISLAND DISTRIBUTING, LLC, HONOLULU, HI. FILED 5-31-2002.

HAWAIIAN BLEND

NO CLAIM IS MADE TO THE EXCLUSIVE RIGHT TO USE "BLEND", APART FROM THE MARK AS SHOWN.

CLASS 3—COSMETICS AND CLEANING PREPARATIONS

FOR SUN CARE PRODUCTS, NAMELY, SUN TAN OILS AND LOTIONS, SPF OIL AND LOTION SUN SCREENS, SPF LIP SCREENS, BROWNING LOTIONS, AFTER SUN LOTIONS (U.S. CLS. 1, 4, 6, 50, 51 AND 52). FIRST USE 1-1-2003; IN COMMERCE 1-1-2003.

CLASS 5—PHARMACEUTICALS

FOR SUN CARE PRODUCTS, NAMELY, BURN RELIEF GELS (U.S. CLS. 6, 18, 44, 46, 51 AND 52). FIRST USE 1-1-2003; IN COMMERCE 1-1-2003.
AISHA CLARKE, EXAMINING ATTORNEY

SN 76-437,166. INTEX RECREATION CORP., LONG BEACH, CA. FILED 8-2-2002.

THE WET SET

OWNER OF U.S. REG. NOS. 1,016,381, 2,563,581 AND OTHERS.

CLASS 7—MACHINERY

FOR POWER TOOLS USED TO CLEAN SWIMMING POOLS, NAMELY MACHINES FOR CLEANING SURFACES USING WATER PRESSURE (U.S. CLS. 13, 19, 21, 23, 31, 34 AND 35). FIRST USE 0-0-2000; IN COMMERCE 0-0-2000.

CLASS 8—HAND TOOLS

FOR HAND TOOLS USED TO CLEAN SWIMMING POOLS, NAMELY POOL LEAF SKIMMERS (U.S. CLS. 23, 28 AND 44). FIRST USE 0-0-2000; IN COMMERCE 0-0-2000.
WON TEAK OH, EXAMINING ATTORNEY

SN 76-439,266, TELEVISION FRANCAISE 1, 92100 BOULOGNE-BILLANCOURT, FRANCE, FILED 8-9-2002.

USHUAIA

OWNER OF FRANCE REG. NO. 99782334, DATED 3-22-1999, EXPIRES 3-22-2009.

CLASS 3—COSMETICS AND CLEANING PREPARATIONS

FOR SUBSTANCES FOR LAUNDRY USE, NAMELY, BLEACHES, DETERGENTS, FABRIC SOFTENERS, ANTI-STATIC DRYER SHEETS; ALL PURPOSE CLEANING PREPARATIONS; BUFFING COMPOUNDS FOR ALL PURPOSE HOUSEHOLD USE; FLOOR AND FURNITURE POLISH; BODY SOAPS, FACIAL SOAPS; PERFUMERY, ESSENTIAL OILS FOR PERSONAL USE; COSMETICS, NAMELY, LIPSTICKS, EYE SHADOWS, EYELINERS, ROUGE FOUNDATIONS, BLUSHES, MASCARA; HAIR STYLING PREPARATIONS; DENTIFRICE (U.S. CLS. 1, 4, 6, 50, 51 AND 52).

CLASS 9—ELECTRICAL AND SCIENTIFIC APPARATUS

FOR PHOTOGRAPHIC INSTRUMENTS, NAMELY, LENSES, LENS FILTERS, FLASHES, CAMERAS, CINEMATOGRAPHIC INSTRUMENTS, NAMELY, MOVIE CAMERA FILMS, OPTICAL INSTRUMENTS, NAMELY, TELESCOPES, MICROSCOPES, AND BINOCULARS; AUDIO AND VIDEO HARDWARE, NAMELY, MAGNETIC TAPE RECORDERS AND PLAYERS, LASER DISK PLAYERS, COMPACT DISK PLAYERS, PHONOGRAPHS, AMPLIFIERS, TUNERS, TELEVISIONS, VIDEO TAPE RECORDERS AND PLAYERS, MICROPHONES, SPEAKERS AND HEADPHONES; BLANK MAGNETIC COMPUTER DISCS, AND BLANK MAGNETIC TAPE CASSETTES; BLANK COMPACT DISCS, BLANK CASSETTE TAPES, AND BLANK DIGITAL AUDIO TAPES; COIN OPERATED VENDING MACHINES; COMPUTER HARDWARE, NAMELY, COMPUTERS, DISK DRIVES, HARD DRIVES, TAPE DRIVES, MICE, MONITORS, AND PRINTERS; CASH REGISTERS, CALCULATING MACHINES, DATA PROCESSING APPARATUS, NAMELY COUPLERS, READERS, SCANNERS AND COMPUTERS; FIRE EXTINGUISHING EQUIPMENT, NAMELY EXTINGUISHERS, BLANKETS, FIRE ENGINES, TRUCKS, FIRE-RESISTANT GLOVES, FIRE-RESISTANT HELMETS AND FIRE-RESISTANT JACKETS, DIVING GLOVES (U.S. CLS. 21, 23, 26, 36 AND 38).

CLASS 16—PAPER GOODS AND PRINTED MATTER

FOR CORRUGATED PAPERBOARD, ART PAPER AND WRITING PAPER, PAPERBOARD CONTAINERS, NAMELY, BOXES, BAGS; POSTER BOARD, NEWSPAPER FIBERS; PRINTED MATTER, NAMELY, NEWSPAPERS FOR GENERAL CIRCULATION, MAGAZINES AND JOURNALS FEATURING CURRENT EVENTS FOR GENERAL CIRCULATION; BRISTOL BOARD; PAINTING SURFACES MADE OF PAPERBOARD; PHOTOGRAPHS, TYPEWRITERS; PRINTERS' TYPE; PRINTING BLOCKS (U.S. CLS. 2, 5, 22, 23, 29, 37, 38 AND 50).

CLASS 25—CLOTHING

FOR FOOTWEAR, HEADWEAR, SHIRTS, BLOUSES, TROUSERS AND GLOVES, RIDING GLOVES (U.S. CLS. 22 AND 39).

CLASS 28—TOYS AND SPORTING GOODS

FOR DECORATIONS FOR CHRISTMAS TREES; BACKGAMMON GAMES, PLAY BALLOONS, SPORTS BALLS, PLAYGROUND BALLS, BASEBALL GLOVES, BASEBALL BATS, STATIONARY EXERCISE BICYCLES, BILLIARD TABLES, BOB-SLEIGHS, BODY-BUILDING APPARATUS, NAMELY WEIGHTS AND EXERCISE MACHINES, BOXING GLOVES, CHESS GAMES, CRICKET BAGS, DARTS, DOLLS, FENCING MASKS, FISH HOOKS, TABLES FOR INDOOR FOOTBALL, GOLF CLUBS, GOLF GLOVES, HOCKEY STICKS, HOCKEY GLOVES, ICE SKATES, MARIONETTES, PARLOR GAMES, TOY PISTOLS, TENNIS RACKETS, BADMINTON RACKETS, ROLLER SKATES, SKIS, SURF BOARDS, SURF SKIS, TEDDY BEARS, TENNIS NETS, PLAYING CARDS, AND TOY MASKS (U.S. CLS. 22, 23, 38 AND 50).

CLASS 35—ADVERTISING AND BUSINESS

FOR ADVERTISING AGENCY SERVICES; BUSINESS MANAGEMENT; SECRETARIAL SERVICES; FILING SERVICES; DISTRIBUTION OF PROSPECTUSES FOR OTHERS; BUSINESS INFORMATION AND CONSULTATION; COMPILATION OF INFORMATION INTO COMPUTER DATA BASES; ACCOUNTING; DOCUMENT REPRODUCTION; EMPLOYMENT AGENCIES; ORGANIZATION OF TRADE SHOW EXHIBITIONS FOR ARTISTS; ORGANIZATION OF EXHIBITIONS FOR CULTURAL OR EDUCATIONAL PURPOSES, NAMELY, PROMOTING TRAVEL, PROMOTING EDUCATION ABOUT TRAVEL, PROMOTING THE RESPECT OF NATURE AND THE ENVIRONMENT (U.S. CLS. 100, 101 AND 102).

CLASS 38—COMMUNICATION

FOR TELECOMMUNICATIONS, NAMELY CABLE, RADIO AND TELEVISION BROADCASTING SERVICES; CELLULAR TELEPHONE COMMUNICATIONS SERVICES, ELECTRONIC TRANSMISSION OF COMPUTER DATA BETWEEN COMPUTER TERMINALS, TELEGRAM TRANSMISSION, TELEPHONE COMMUNICATIONS SERVICES; TRANSMISSION OF MESSAGES AND IMAGES BY COMPUTER; ELECTRONIC MAIL SERVICES, FACSIMILE TRANSMISSION, ELECTRONIC STORE-AND-FORWARD MESSAGING SERVICES; RADIO AND TELEPHONIC PAGING SERVICES; RENTAL OF MESSAGE SENDING APPARATUS; AND TELEGRAPH SERVICES (U.S. CLS. 100, 101 AND 104).

CLASS 41—EDUCATION AND ENTERTAINMENT

FOR PUBLISHING FOR OTHERS OF BOOKS AND MAGAZINES; BOOK LENDING; TRAINING ANIMALS FOR OTHERS; RENTING OF FILMS, GRAMOPHONE RECORDINGS, CINEMA PROJECTORS AND THEATRICAL PROPS AND ACCESSORIES; ORGANIZATION OF EDUCATION OR ENTERTAINMENT COMPETITIONS, ORGANIZATION OF SPORTS COMPETITIONS, NAMELY COMPETITIONS IN FOOTBALL, SWIMMING, BASEBALL, HOCKEY AND SKIING, SCHEDULING OF PROGRAMS AND THE PUBLISHING OF INFORMATION ABOUT SCHEDULES FOR TELEVISION PROGRAMS; ENTERTAINMENT IN THE NATURE OF ONGOING TELEVISION PROGRAM SERIES IN THE FIELDS OF NEWS, ENTERTAINMENT, COMEDY, SPORTS AND VARIETY PROGRAMS; PRODUCTION OF TELEVISION PROGRAMS, RADIO PROGRAMS AND FILMS (U.S. CLS. 100, 101 AND 107).

DAVID C. REIHNER, EXAMINING ATTORNEY

SN 76-440,666. SURVALENT TECHNOLOGY CORPORATION, MISSISSAUGA, ONTARIO, CANADA, FILED 8-15-2002.

SURVALENT

PRIORITY CLAIMED UNDER SEC. 44(D) ON CANADA APPLICATION NO. 1.132,098, FILED 2-22-2002, REG. NO. TMA635443, DATED 3-16-2005, EXPIRES 3-16-2020.

CLASS 9—ELECTRICAL AND SCIENTIFIC APPARATUS

FOR SUPERVISORY CONTROL AND DATA ACQUISITIONS SYSTEM MASTER STATION COMPRISED OF COMPUTER HARDWARE, PROJECTION DISPLAYS, OPERATING SYSTEMS SOFTWARE AND APPLICATION SOFTWARE (U.S. CLS. 21, 23, 26, 36 AND 38).

FIRST USE 6-1-2002; IN COMMERCE 6-1-2002.

CLASS 42—SCIENTIFIC, COMPUTER AND LEGAL SERVICES

FOR DESIGN OF SUPERVISORY CONTROL AND DATA ACQUISITION SYSTEM MASTER STATIONS; MAINTENANCE OF COMPUTER SOFTWARE USED IN SUPERVISORY CONTROL AND DATA ACQUISITION SYSTEM MASTER STATIONS (U.S. CLS. 100 AND 101).

FIRST USE 6-1-2002; IN COMMERCE 6-1-2002.

CAROLYN CATALDO, EXAMINING ATTORNEY

SN 76-444,207. POSTEN AKTIEBOLAG, STOCKHOLM, SWEDEN, FILED 8-23-2002.

FROM2.COM

CLASS 9—ELECTRICAL AND SCIENTIFIC APPARATUS

FOR NAUTICAL, PHOTOGRAPHIC, CINEMATOGRAPHIC, OPTICAL, SURVEYING, WEIGHING, MEASURING, SIGNALING, LIFE-SAVING, AND TEACHING APPARATUS AND INSTRUMENTS, NAMELY COMPASSES, CAMERAS, SURVEYING EQUIPMENT, NAMELY STRING LINE POSITIONING COLLARS, STAKES AND STAKE PULLERS, LIFE PRESERVERS, SCALES, LASERS FOR MEASURING PURPOSES, SCIENTIFIC, ELECTRICAL, AND CHECKING, SUPERVISION, APPARATUS AND INSTRUMENTS INCLUDED IN THE CLASS AND NOT FOR MEDICAL PURPOSES, NAMELY OPTICAL INSTRUMENTS AND APPARATUS FOR MEASURING AND WEIGHING LETTERS OF GOODS AND READING OF ADDRESSES AND LABELS, NAMELY SCALES AND SCANNERS; PHOTOGRAPHIC INSTRUMENTS AND APPARATUS FOR MAKING PHOTOGRAPHS OF LETTERS AND GOODS AND FOR SUPERVISION, NAMELY DIGITAL CAMERAS AND FIBER OPTIC CAMERAS, TRACK AND TRADE INSTRUMENTS, NAMELY TRANSPONDERS AND GPR RECEIVERS, NAVIGATIONAL INSTRUMENTS AND APPARATUS FOR PLANNING THE LOGISTIC CHAINS AND NAVIGATING ROUTE, NAMELY ON-BOARD COMPUTERS FOR USE IN TRUCKS AND BOATS, ELECTRICAL AND CHECKING INSTRUMENTS AND APPARATUS FOR THE LETTER AND GOODS TRAFFIC, NAMELY COMPUTER MONITORS FOR DISPLAYING THE LOCATION AND POSITION OF A FLEET OF VEHICLES ON A MAP AND ELECTRONIC LETTER AND PACKAGING SCALES AND LASER COUNTERS FOR COUNTING MAIL AND PARCELS, SIGNALING AND LIFE SAVING INSTRUMENTS AND APPARATUS AGAINST THEFT AND ROBBERY, NAMELY ANTI-INTRUSION ALARMS AND AUTOMATIC TELEPHONE DIALERS FOR USE WITH HOME SECURITY SYSTEMS; PHONOGRAPHS, BLANK CD-ROM DISCS, RECORDING DISCS FEATURING MUSIC AND VIDEO GAMES; AUTOMATIC VENDING MACHINES AND MECHANISMS FOR COIN-OPERATED APPARATUS, CASH REG-

ISTERS, CALCULATING MACHINES, REGISTERED COMPUTER PROGRAMS FOR USE IN DATABASE MANAGEMENT, FOR USE AS A SPREADSHEET, FOR WORK PROCESSING, FOR ELECTRONIC IDENTIFICATION, CERTIFICATION, AUTHORIZATION OF BANK CUSTOMERS OVER A COMPUTER NETWORK AND FOR CERTIFYING PASSWORD AUTHENTICITY OF SUBSCRIPTION DATABASE USERS, FOR DATA PROGRAMMING COMPUTER SOFTWARE FOR USE IN PAYMENT SERVICES, NAMELY FOR MANAGEMENT OF A SUPPLY CHAIN, SOFTWARE FOR USE IN PAYMENT SERVICES, NAMELY FOR PREPARING BILLING STATEMENTS AND TRACKING PAYMENT DEADLINES; SOFTWARE FOR MESSAGING SERVICES DELIVERING INSTANT MESSAGES VIA WIRELESS NETWORKS AND SOFTWARE FOR DISPLAYING CONTACT AND ACCESSING ELECTRONIC TRANSACTIONS ON A WEBSITE, SOFTWARE FOR USE IN BOOKBINDING MACHINES AND DATA PROCESSING EQUIPMENT, NAMELY, DATA ELECTRONIC INTERCHANGE SYSTEMS BETWEEN COMPANIES AND BETWEEN COMPANIES AND CONSUMERS, AND BETWEEN CONSUMER AND CONSUMER FOR HYBRID MAIL SERVICES, AND FOR DATA PROCESSING AND COMPUTERS; AND FIRE-EXTINGUISHERS, FIRE PROTECTION APPARATUS, NAMELY FIRE ALARMS AND FIRE SPRINKLERS (U.S. CLS. 21, 23, 26, 36 AND 38).

CLASS 16—PAPER GOODS AND PRINTED MATTER

FOR GOODS MADE FROM PAPERS AND CARDBOARD, NAMELY STAMPS, LETTER PAPERS, CARDS, POSTCARDS, CARDBOARD BOXES, ENVELOPES, NOTEBOOKS, NOTEPAPERS, LABELS, GIFT WRAPPING PAPERS, BUSINESS CARDS, PAPER FOR OFFICE USE, NAMELY COPIER, COMPUTER AND FAX MACHINE PAPER; PRINTED MATTER, NAMELY EMPLOYEE NEWSPAPER REGARDING POSTAL SERVICES, CUSTOMER MAGAZINES REGARDING POSTAL SERVICES; BOOKBINDING MATERIAL FOR USE WITH BOOK BINDING MACHINES, NAMELY CARDBOARD BACKING; STATIONARY; ADHESIVES FOR STATIONARY OR HOUSEHOLD PURPOSES; ARTISTS' MATERIALS, NAMELY POSTCARDS, NOTEPAPERS, PAINTING PAPERS, STICKERS, LABELS, ADHESIVE TAPE; PAINTBRUSHES; ELECTRONIC TYPEWRITERS AND OFFICE REQUISITES, EXCEPT FURNITURE, NAMELY, PENS, PENCILS, ERASERS, PAINTBRUSHES, LETTER KNIVES; PRINTED INSTRUCTIONAL AND TEACHING MATERIAL FOR USE IN MESSAGING LOGISTICS, FINANCIAL, COMPUTER AND SOFTWARE AND ON-LINE SERVICES; PLASTIC SEALER FOR PACKAGING AND PLASTIC BAGS FOR MERCHANDISE PACKAGING; PRINTERS TYPE AND PRINTING BLOCKS (U.S. CLS. 2, 5, 22, 23, 29, 37, 38 AND 50).

CLASS 28—TOYS AND SPORTING GOODS

FOR PLAYING CARDS (U.S. CLS. 22, 23, 38 AND 50).

CLASS 35—ADVERTISING AND BUSINESS

FOR ADVERTISING SERVICES, NAMELY PROVIDING ADVERTISING SPACES IN PERIODICALS AND IN PREMISES, BANNERS AND ADS ON WEBSITES, ADVERTISING PRODUCTION, BUSINESS MANAGEMENT, BUSINESS ADMINISTRATION, AND OFFICE FUNCTIONS NAMELY BUSINESS CONSULTANCY WORK, MAIL SORTING, HANDLING AND RECEIVING, FACILITIES MANAGEMENT OF TECHNICAL OPERATIONS; TRANSPORTATION LOGISTICS SERVICES, NAMELY, PLANNING AND SCHEDULING SHIPMENTS FOR USERS OF TRANSPORTATION SERVICES (U.S. CLS. 100, 101 AND 102).

CLASS 36—INSURANCE AND FINANCIAL

FOR INSURANCE UNDERWRITING SERVICES IN THE FIELD OF LIFE INSURANCE, PENSION INSURANCE, CAPTIVE INSURANCE, UNDERWRITING EXTENDED WARRANTY INSURANCE CONTRACTS IN THE FIELD OF FINANCIAL AFFAIRS, NAMELY ADVICE CONCERNING INVESTMENTS, MONETARY AFFAIRS, NAMELY BANKING AND INVESTMENT SERVICES IN THE FIELD OF SECURITIES (U.S. CLS. 100, 101 AND 102).

CLASS 37—CONSTRUCTION AND REPAIR

FOR BUILDING CONSTRUCTION AND REPAIR, MAINTENANCE AND INSTALLATION OF COMPUTER RELATED APPARATUS, INSTRUMENTS, AND EQUIPMENT (U.S. CLS. 100, 103 AND 106).

CLASS 38—COMMUNICATION

FOR TELECOMMUNICATIONS, NAMELY, COMPUTER AIDED TRANSMISSION AND RECEPTION OF MESSAGES AND IMAGES, PROVIDING MULTIPLE-USER ACCESS TO A GLOBAL COMPUTER INFORMATION NETWORK (U.S. CLS. 100, 101 AND 104).

CLASS 39—TRANSPORTATION AND STORAGE

FOR TRANSPORT VIA CAR, VAN, TRUCK, LORRY, TRAIN, BOAT, AIRPLANE, HELICOPTER, BICYCLE, MOTORCYCLE; PICK-UP AND DELIVERY OF LETTERS AND PARCELS OF OTHERS VIA TRUCK, RAILROAD, BOAT AND AIRPLANE, CROSS DOCKING SERVICES FOR OTHERS; MAKING RESERVATIONS AND BOOKINGS FOR TRANSPORTATION; PROVIDING COMPUTER DATABASES IN THE FIELD OF POSTAL SERVICES (U.S. CLS. 100 AND 105).

CLASS 41—EDUCATION AND ENTERTAINMENT

FOR EDUCATIONAL SERVICES, NAMELY CONDUCTING CLASSES, SEMINARS, CONFERENCES, WORKSHOPS IN THE FIELD OF POSTAL SERVICES, PROVIDING TRAINING IN THE FIELD OF POSTAL AND INFORMATION SERVICES; ENTERTAINMENT SERVICES, ORGANIZING EXHIBITIONS FOR SPORTING AND CULTURAL PURPOSES, ELECTRONIC PUBLISHING SERVICES, NAMELY, PUBLICATION OF TEXT AND GRAPHIC WORKS OF OTHERS ON CD, DVD, ON-LINE, FEATURING ART AND BOOKS (U.S. CLS. 100, 101 AND 107).

CLASS 42—SCIENTIFIC, COMPUTER AND LEGAL SERVICES

FOR ENGINEERING SERVICES; RENTAL OF COMPUTERS; COMPUTER NETWORK SERVICES NAMELY, DESIGN OF COMPUTER NETWORKS AND COMPUTER PROGRAMS FOR OTHER FOR CONTROLLING AND EXECUTION OF TRANSPORTS BY WATER, LAND, OR AIR AS WELL AS STORAGE AND PACKAGING OF GOODS FOR OTHERS, COMPUTER NETWORK ENGINEERING SERVICES; COMPUTER PROGRAMMING FOR OTHERS; DEVELOPMENT AND CREATION OF COMPUTER PROGRAMS FOR OTHERS FOR DATA PROCESSING EQUIPMENT; UPDATING OF COMPUTER SOFTWARE FOR OTHERS, CONSULTANCY IN THE FIELD OF COMPUTER HARDWARE AND COMPUTER PROGRAMMING AND RENTAL OF COMPUTERS (U.S. CLS. 100 AND 101).

CAROLYN CATALDO, EXAMINING ATTORNEY

SN 76-444,208. POSTEN AKTIEBOLAG, STOCKHOLM, SWEDEN, FILED 8-23-2002.

FROM2

CLASS 9—ELECTRICAL AND SCIENTIFIC APPARATUS

FOR NAUTICAL, PHOTOGRAPHIC, CINEMATOGRAPHIC, OPTICAL, SURVEYING, WEIGHING, MEASURING, SIGNALING, LIFE-SAVING, AND TEACHING APPARATUS AND INSTRUMENTS, NAMELY COMPASSES, CAMERAS, SURVEYING EQUIPMENT, NAMELY STRING LINE POSITIONING COLLARS, STAKES AND STAKE PULLERS, LIFE PRESERVERS, SCALES, LASERS FOR MEASURING PURPOSES, SCIENTIFIC, ELECTRICAL, AND CHECKING, SUPERVISION, APPARATUS AND INSTRUMENTS INCLUDED IN THE CLASS AND NOT FOR MEDICAL PURPOSES, NAMELY OPTICAL INSTRUMENTS AND APPARATUS FOR MEASURING AND WEIGHING LETTERS OF GOODS AND READING OF ADDRESSES AND LABELS, NAMELY SCALES AND SCANNERS; PHOTOGRAPHIC INSTRUMENTS AND APPARATUS FOR MAKING PHOTOGRAPHS OF LETTERS AND GOODS AND FOR SUPERVISION, NAMELY DIGITAL CAMERAS AND FIBER OPTIC CAMERAS, TRACK AND TRADE INSTRUMENTS, NAMELY TRANSPONDERS AND GPR RECEIVERS, NAVIGATIONAL INSTRUMENTS AND APPARATUS FOR PLANNING THE LOGISTIC CHAINS AND NAVIGATING ROUTE, NAMELY ON-BOARD COMPUTERS FOR USE IN TRUCKS AND BOATS, ELECTRICAL AND CHECKING INSTRUMENTS AND APPARATUS FOR THE LETTER AND GOODS TRAFFIC, NAMELY COMPUTER MONITORS FOR DISPLAYING THE LOCATION AND POSITION OF A FLEET OF VEHICLES ON A MAP AND ELECTRONIC LETTER AND PACKAGING SCALES AND LASER COUNTERS FOR COUNTING MAIL AND PARCELS, SIGNALING AND LIFE SAVING INSTRUMENTS AND APPARATUS AGAINST THEFT AND ROBBERY, NAMELY ANTI-INTRUSION ALARMS AND AUTOMATIC TELEPHONE DIALERS FOR USE WITH HOME SECURITY SYSTEMS; PHONOGRAPHS, BLANK CD-ROM DISCS, RECORDING DISCS FEATURING MUSIC AND VIDEO GAMES; AUTOMATIC VENDING MACHINES AND MECHANISMS FOR COIN-OPERATED APPARATUS, CASH REGISTERS, CALCULATING MACHINES, REGISTERED COMPUTER PROGRAMS FOR USE IN DATABASE MANAGEMENT, FOR USE AS A SPREADSHEET, FOR WORK PROCESSING, FOR ELECTRONIC IDENTIFICATION, CERTIFICATION, AUTHORIZATION OF BANK CUSTOMERS OVER A COMPUTER NETWORK AND FOR CERTIFYING PASSWORD AUTHENTICITY OF SUBSCRIPTION DATABASE USERS, FOR DATA PROGRAMMING COMPUTER SOFTWARE FOR USE IN PAYMENT SERVICES, NAMELY FOR MANAGEMENT OF A SUPPLY CHAIN, SOFTWARE FOR USE IN PAYMENT SERVICES, NAMELY FOR PREPARING BILLING STATEMENTS AND TRACKING PAYMENT DEADLINES; SOFTWARE FOR MESSAGING SERVICES DELIVERING INSTANT MESSAGES VIA WIRELESS NETWORKS AND SOFTWARE FOR DISPLAYING CONTACT AND ACCESSING ELECTRONIC TRANSACTIONS ON A WEBSITE, SOFTWARE FOR USE IN BOOKBINDING MACHINES AND DATA PROCESSING EQUIPMENT, NAMELY, DATA ELECTRONIC INTERCHANGE SYSTEMS BETWEEN COMPANIES AND BETWEEN COMPANIES AND CONSUMERS, AND BETWEEN CONSUMER AND CONSUMER FOR HYBRID MAIL SERVICES, AND FOR DATA PROCESSING AND COMPUTERS; AND FIRE-EXTINGUISHERS, FIRE PROTECTION APPARATUS, NAMELY FIRE ALARMS AND FIRE SPRINKLERS (U.S. CLS. 21, 23, 26, 36 AND 38).

CLASS 16—PAPER GOODS AND PRINTED MATTER

FOR GOODS MADE FROM PAPERS AND CARDBOARD, NAMELY STAMPS, LETTER PAPERS, CARDS, POSTCARDS, CARDBOARD BOXES, ENVELOPES, NOTEBOOKS, NOTEPAPERS, LABELS, GIFT WRAPPING PAPERS, BUSINESS CARDS, PAPER FOR OFFICE USE, NAMELY COPIER, COMPUTER AND FAX MACHINE PAPER; PRINTED MATTER, NAMELY EMPLOYEE NEWSPAPER REGARDING POSTAL SERVICES, CUSTOMER MAGAZINES REGARDING POSTAL SERVICES; BOOKBINDING MATERIAL FOR USE WITH BOOK BINDING MACHINES, NAMELY CARDBOARD BACKING; STATIONARY; ADHESIVES FOR STATIONARY OR HOUSEHOLD PURPOSES; ARTISTS MATERIALS, NAMELY POSTCARDS, NOTEPAPERS, PAINTING PAPERS, STICKERS, LABELS, ADHESIVE TAPE; PAINTBRUSHES; ELECTRONIC TYPEWRITERS AND OFFICE REQUISITES, EXCEPT FURNITURE, NAMELY, PENS, PENCILS, ERASERS, PAINTBRUSHES, LETTER KNIVES; PRINTED INSTRUCTIONAL AND TEACHING MATERIAL FOR USE IN MESSAGING LOGISTICS, FINANCIAL, COMPUTER AND SOFTWARE AND ONLINE SERVICES; PLASTIC SEALER FOR PACKAGING AND PLASTIC BAGS FOR MERCHANDISE PACKAGING; PRINTERS TYPE AND PRINTING BLOCKS (U.S. CLS. 2, 5, 22, 23, 29, 37, 38 AND 50).

CLASS 28—TOYS AND SPORTING GOODS

FOR PLAYING CARDS (U.S. CLS. 22, 23, 38 AND 50).

CLASS 35—ADVERTISING AND BUSINESS

FOR ADVERTISING SERVICES, NAMELY PROVIDING ADVERTISING SPACES IN PERIODICALS AND IN PREMISES, BANNERS AND ADS ON WEBSITES, ADVERTISING PRODUCTION, BUSINESS MANAGEMENT, BUSINESS ADMINISTRATION, AND OFFICE FUNCTIONS NAMELY BUSINESS CONSULTANCY WORK, MAIL SORTING, HANDLING AND RECEIVING, FACILITIES MANAGEMENT OF TECHNICAL OPERATIONS; TRANSPORTATION LOGISTICS SERVICES, NAMELY, PLANNING AND SCHEDULING SHIPMENTS FOR USERS OF TRANSPORTATION SERVICES (U.S. CLS. 100, 101 AND 102).

CLASS 36—INSURANCE AND FINANCIAL

FOR INSURANCE UNDERWRITING SERVICES IN THE FIELD OF LIFE INSURANCE, PENSION INSURANCE, CAPTIVE INSURANCE, UNDERWRITING EXTENDED WARRANTY INSURANCE CONTRACTS IN THE FIELD OF FINANCIAL AFFAIRS, NAMELY ADVICE CONCERNING INVESTMENTS, MONETARY AFFAIRS, NAMELY BANKING AND INVESTMENT SERVICES IN THE FIELD OF SECURITIES (U.S. CLS. 100, 101 AND 102).

CLASS 37—CONSTRUCTION AND REPAIR

FOR BUILDING CONSTRUCTION AND REPAIR, MAINTENANCE AND INSTALLATION OF COMPUTER RELATED APPARATUS, INSTRUMENTS, AND EQUIPMENT (U.S. CLS. 100, 103 AND 106).

CLASS 38—COMMUNICATION

FOR TELECOMMUNICATIONS, NAMELY, COMPUTER AIDED TRANSMISSION AND RECEPTION OF MESSAGES AND IMAGES, PROVIDING MULTIPLE-USER ACCESS TO A GLOBAL COMPUTER INFORMATION NETWORK (U.S. CLS. 100, 101 AND 104).

CLASS 39—TRANSPORTATION AND STORAGE

FOR TRANSPORT VIA CAR, VAN, TRUCK, LORRY, TRAIN, BOAT, AIRPLANE, HELICOPTER, BICYCLE, MOTORCYCLE; PICK-UP AND DELIVERY OF LETTERS AND PARCELS OF OTHERS VIA TRUCK, RAILROAD, BOAT AND AIRPLANE, CROSS DOCKING SERVICES FOR OTHERS; MAKING RESERVATIONS AND BOOKINGS FOR TRANSPORTATION; PROVIDING COMPUTER DATABASES IN THE FIELD OF POSTAL SERVICES (U.S. CLS. 100 AND 105).

CLASS 41—EDUCATION AND ENTERTAINMENT

FOR EDUCATIONAL SERVICES, NAMELY CONDUCTING CLASSES, SEMINARS, CONFERENCES, WORKSHOPS IN THE FIELD OF POSTAL SERVICES, PROVIDING TRAINING IN THE FIELD OF POSTAL AND INFORMATION SERVICES; ENTERTAINMENT SERVICES, ORGANIZING EXHIBITIONS FOR SPORTING AND CULTURAL PURPOSES, ELECTRONIC PUBLISHING SERVICES, NAMELY, PUBLICATION OF TEXT AND GRAPHIC WORKS OF OTHERS ON CD, DVD, ON-LINE, FEATURING ART AND BOOKS (U.S. CLS. 100, 101 AND 107).

CLASS 42—SCIENTIFIC, COMPUTER AND LEGAL SERVICES

FOR ENGINEERING SERVICES; RENTAL OF COMPUTERS; COMPUTER NETWORK SERVICES NAMELY, DESIGN OF COMPUTER NETWORKS AND COMPUTER PROGRAMS FOR OTHER FOR CONTROLLING AND EXECUTION OF TRANSPORTS BY WATER, LAND, OR AIR AS WELL AS STORAGE AND PACKAGING OF GOODS FOR OTHERS, COMPUTER NETWORK ENGINEERING SERVICES; COMPUTER PROGRAMMING FOR OTHERS; DEVELOPMENT AND CREATION OF COMPUTER PROGRAMS FOR OTHERS FOR DATA PROCESSING EQUIPMENT; UPDATING OF COMPUTER SOFTWARE FOR OTHERS, CONSULTANCY IN THE FIELD OF COMPUTER HARDWARE AND COMPUTER PROGRAMMING AND RENTAL OF COMPUTERS (U.S. CLS. 100 AND 101).

CAROLYN CATALDO, EXAMINING ATTORNEY

SN 76-446,293. HOME MEDIA NETWORKS, EDINBURG, UNITED KINGDOM, FILED 8-30-2002.

SHOWSHIFTER

PRIORITY CLAIMED UNDER SEC. 44(D) ON ERPN CMNTY TM OFC APPLICATION NO. 002600708, FILED 3-1-2002, REG. NO. 002600708, DATED 8-27-2003, EXPIRES 3-1-2012.

CLASS 9—ELECTRICAL AND SCIENTIFIC APPARATUS

FOR COMPUTER SOFTWARE ADAPTED TO USE A REMOTE ENABLED INTERFACE TO ALLOW A PC TO FUNCTION AS A HOME ENTERTAINMENT CENTER, NAMELY COMPUTER SOFTWARE THAT RUNS ON PC PLATFORMS TO ALLOW A USER TO WATCH, RECORD AND PAUSE TELEVISION, PLAY DVDS, AND LISTEN TO MP3 MUSIC FILES; CUSTOMIZABLE SOFTWARE FOR ALLOWING A PC TO FUNCTION AS A HOME ENTERTAINMENT CENTER, NAMELY COMPUTER SOFTWARE ALLOWING A PC TO OPERATE AS A DIGITAL HARD DISK RECORDER OR DIGITAL VIDEO RECORDER THAT RUNS ON PC PLATFORMS TO ALLOW A USER TO WATCH, RECORD AND PAUSE TELEVISION, PLAY DVDS, AND LISTEN TO MP3 MUSIC FILES; SOFTWARE FOR CONNECTING DVDS, TELEVISION, COMPACT DISCS AND MP3S THROUGH A SINGLE INTERFACE; SOFTWARE FOR BROADCASTING, TIME SHIFTING, PAUSING AND RECORDING TELEVISION PROGRAMS; SEARCH ENGINE SOFTWARE TO ENABLE SEARCHING OF DATA; COMPUTER SOFTWARE FOR INTEGRATION OF TELEVISION, VIDEO, DVDS, CDS AND MP3S (U.S. CLS. 21, 23, 26, 36 AND 38).

CLASS 42—SCIENTIFIC, COMPUTER AND LEGAL SERVICES

FOR CREATION, DESIGN, DEVELOPMENT, INTEGRATION, CUSTOMIZATION AND RENTAL OF COMPUTER SOFTWARE AND COMPUTER HARDWARE; UPDATING AND UPGRADING COMPUTER SOFTWARE; INSTALLATION AND MAINTENANCE OF COMPUTER SOFTWARE; CUSTOM DESIGN OF COMPUTER SOFTWARE PACKAGES; COMPUTER SOFTWARE CONSULTANCY; AND PROVIDING COMPUTER SOFTWARE AND HARDWARE INFORMATION, AND COMPUTER SOFTWARE AND HARDWARE CONSULTATION (U.S. CLS. 100 AND 101).

BARBARA BROWN, EXAMINING ATTORNEY

SN 76-452,430. KERRY GROUP SERVICES LIMITED, TRALEE, CO. KERRY, IRELAND, FILED 9-17-2002.

DOREL

OWNER OF ERPN CMNTY TM OFC REG. NO. 002852176, DATED 1-8-2004, EXPIRES 9-18-2012.

CLASS 1—CHEMICALS

FOR CHEMICALS FOR USE IN THE MANUFACTURE OF AND PRESERVATION OF FOODS AND BEVERAGES; DOUGH RELAXERS, CONDITIONERS AND IMPROVERS; CHEMICAL PRODUCTS FOR USE IN THE BAKING INDUSTRY FOR THE MANUFACTURE OF BREAD, NAMELY, BREAD IMPROVERS; CHEMICALS USED IN THE MANUFACTURE OF FOOD AND BEVERAGE, NAMELY, HYDROLYSATES, PROTEIN HYDROLYSATES, HYDROLYSED PROTEINS, PEPTIDES, PEPTIDES, FOOD STABILISERS (U.S. CLS. 1, 5, 6, 10, 26 AND 46).

CLASS 30—STAPLE FOODS

FOR BREAD; WHEAT GLUTEN; BREAD IMPROVERS, NAMELY, INGREDIENTS AND ADDITIVES FOR PREPARING AND IMPROVING BAKERY PRODUCTS; BREAD IMPROVERS IN THE NATURE OF FOOD ADDITIVES FOR NON-NUTRITIONAL PURPOSES FOR USE AS FLAVORING OR FILLER; YEAST, YEAST EXTRACTS; WHEAT GLUTEN; YEAST FOR USE IN THE FOOD AND BEVERAGE INDUSTRIES (U.S. CL. 46).

LEIGH CAROLINE CASE, EXAMINING ATTORNEY

SN 76-458,678. SCOTTISH & NEWCASTLE PLC, EDINBURGH EH12 6HX, SCOTLAND, FILED 10-10-2002.

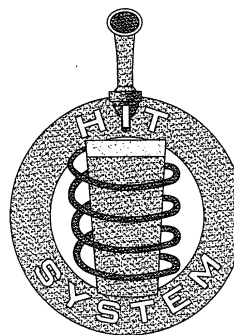

PRIORITY CLAIMED UNDER SEC. 44(D) ON ERPN CMNTY TM OFC APPLICATION NO. 2809713, FILED 8-12-2002, REG. NO. 2809713, DATED 10-20-2003, EXPIRES 8-12-2012.

NO CLAIM IS MADE TO THE EXCLUSIVE RIGHT TO USE SYSTEM, APART FROM THE MARK AS SHOWN.

THE STIPPLING IS FOR SHADING PURPOSES.

CLASS 6—METAL GOODS

FOR CANS OF METAL, OF ALUMINUM AND OF ALLOYS, SOLD EMPTY, ALL FOR ALCOHOLIC BEVERAGES AND WITH OR WITHOUT INSERTS INCORPORATING A MECHANISM FOR THE RELEASE AND/OR GENERATION OF GAS; METAL KEGS FOR ALCOHOLIC BEVERAGES (U.S. CLS. 2, 12, 13, 14, 23, 25 AND 50).

CLASS 8—HAND TOOLS

FOR HAND-OPERATED BEER VENT TAPS MADE OF METAL; HAND OPERATED TAPS FOR GENERATING, DISTRIBUTING AND DISPENSING GASSES INTO A LIQUID BEVERAGE (U.S. CLS. 23, 28 AND 44).

CLASS 11—ENVIRONMENTAL CONTROL APPARATUS

FOR GAS INJECTORS FOR GENERATING AND DISPENSING GASSES INTO LIQUID BEVERAGES; REFRIGERATED BEVERAGE DISPENSING GENERATING UNITS FEATURING GAS MIXING UNITS AND GAS INJECTORS (U.S. CLS. 13, 21, 23, 31 AND 34).

CLASS 32—LIGHT BEVERAGES

FOR BEER, ALE, BITTER TYPE, LAGER, STOUT, PORTER, SHANDY, AND MIXTURES COMPRISED OF THE AFORESAID GOODS; PREPARATIONS FOR MAKING ALCOHOLIC BEVERAGES (U.S. CLS. 45, 46 AND 48).

AMY GEARIN, EXAMINING ATTORNEY

SN 76-467,893. CJ CORP., SEOUL, REPUBLIC OF KOREA,
FILED 11-18-2002.

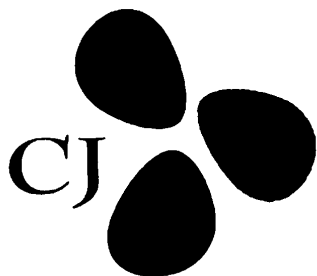

PRIORITY CLAIMED UNDER SEC. 44(D) ON REPUBLIC OF KOREA APPLICATION NO. 2002-0041181, FILED 9-6-2002, REG. NO. 0605405, DATED 1-10-2005, EXPIRES 1-10-2015.

THE MARK CONSISTS OF THREE COLORS, BLUE, ORANGE AND RED THAT ARE IN AN EGG-LIKE SHAPE, WHICH ARE LOCATED NEXT TO THE MARK CJ. THE UPPER LEFT EGG-LIKE SHAPE IS BLUE, THE MIDDLE RIGHT EGG-LIKE SHAPE IS ORANGE, AND THE LOWER LEFT EGG-LIKE SHAPE IS RED. COLOR IS CLAIMED AS A FEATURE OF THE MARK.

CLASS 29—MEATS AND PROCESSED FOODS

FOR VEGETABLE PASTES, NAMELY, RED PEPPER PASTES, AND SOYBEAN PASTES (U.S. CL. 46).

CLASS 30—STAPLE FOODS

FOR RICE, ALMOND PASTES, NOODLES, MALTED WHEAT FLOUR, MALT EXTRACT FOR FOOD, PUDDING, DUMPLINGS, SUGAR CUBES, RICE CAKES, SEASONING, NAMELY, MONO SODIUM GLUTAMATE, SAUCES, GARLIC POWDERS, SEASONING SALTS, GREEN TEAS, COFFEE-BASED BEVERAGES CONTAINING MILK, ICE, GRAVIES, FOOD SEASONING IN THE FORM OF A COMPOSITE CHEMICAL, WHEAT FLOURS FOR FOOD, VINEGARS, SUGARS, DEXTROSE SYRUPS, NUCLEIC ACID SEASONINGS (U.S. CL. 46).

INGRID C. EULIN, EXAMINING ATTORNEY

SN 76-467,899. CJ CORP., SEOUL, REPUBLIC OF KOREA,
FILED 11-18-2002.

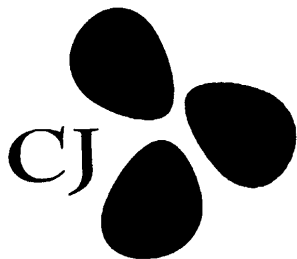

PRIORITY CLAIMED UNDER SEC. 44(D) ON REPUBLIC OF KOREA APPLICATION NO. 2002-0041182, FILED 9-6-2002, REG. NO. 0599136, DATED 11-11-2004, EXPIRES 11-11-2014.

THE MARK CONSISTS OF THREE COLORS, BLUE, ORANGE AND RED THAT ARE IN AN EGG-LIKE SHAPE, WHICH ARE LOCATED NEXT TO THE MARK CJ. THE UPPER LEFT EGG-LIKE SHAPE IS BLUE, THE MIDDLE RIGHT EGG-LIKE SHAPE IS ORANGE, AND THE LOWER LEFT EGG-LIKE SHAPE IS RED. COLOR IS CLAIMED AS A FEATURE OF THE MARK.

CLASS 29—MEATS AND PROCESSED FOODS

FOR PROCESSED COCONUT, NAMELY, COPRA; DRIED EDIBLE ALGAE, NAMELY, SEA TANGLES (U.S. CL. 46).

CLASS 31—NATURAL AGRICULTURAL PRODUCTS

FOR LIVE PLANTS AND TREES, NAMELY, RICE PLANTS, PERSIMMON TREES, BUSHES; FRESH POTATOES, SUGAR CANE, MALTS FOR BREWING, MALTS FOR DISTILLING, ANIMAL FEED, NAMELY, STRENGTHENING ANIMAL FORAGE, FODDER FOR PETS, BLENDED FODDER, NON-MEDICATED ADDITIVE FOR ANIMAL FODDER NOT FOR MEDICAL PURPOSES, SOYBEAN FODDER; AGRICULTURAL SEEDS, NAMELY, GRAIN SEEDS, RAW COCOA BEANS, FERTILE EGGS FOR HATCHING, LIVESTOCK, LIVE FISH FOR FOOD PURPOSES, NAMELY, LIVE SNAKEHEAD FISHES, LIVE INSECTS AND SILKWORMS FOR BAIT; RAW HOPS; AND UNPROCESSED, RAW ROUGH CORK (U.S. CLS. 1 AND 46).

INGRID C. EULIN, EXAMINING ATTORNEY

SN 76-470,230. PARTS,RX, INC., SAN CLEMENTE, CA,
FILED 11-25-2002.

PARTSRX

CLASS 9—ELECTRICAL AND SCIENTIFIC APPARATUS

FOR COMPUTER SOFTWARE IN THE ELECTRONIC COMPONENT FIELD, NAMELY, SOFTWARE PROVIDING AND UPDATING ELECTRONIC COMPONENT AVAILABILITY AND TRANSACTION INFORMATION (U.S. CLS. 21, 23, 26, 36 AND 38).

CLASS 36—INSURANCE AND FINANCIAL

FOR BROKERAGE OF ELECTRONIC COMPONENTS, NAMELY, PRICE AND QUANTITY NEGOTIATION AND PURCHASE EXECUTION (U.S. CLS. 100, 101 AND 102).

KATHLEEN M. VANSTON, EXAMINING ATTORNEY

SN 76-473,229. PIRELLI PNEUMATICI S.P.A., 20126 MILAN,
ITALY, FILED 12-2-2002.

MIRS

OWNER OF ITALY REG. NO. 00906891, DATED 9-10-2003,
EXPIRES 3-16-2010.

CLASS 12—VEHICLES

FOR TIRES; PNEUMATIC, SEMI-PNEUMATIC AND SOLID TIRES FOR VEHICLE WHEELS; WHEELS FOR VEHICLES, INNER TUBES, RIMS, STRUCTURAL AND REPLACEMENT PARTS AND FITTINGS FOR ALL THE AFORESAID GOODS (U.S. CLS. 19, 21, 23, 31, 35 AND 44).

CLASS 35—ADVERTISING AND BUSINESS

FOR BUSINESS MANAGEMENT AND BUSINESS PROMOTION VIA THE INTERNET AND TELEPHONE NETWORKS FOR THE DRIVERS AND FOR CAR PRODUCERS IN THE FIELD OF TIRES; MANAGING THE FULFILLMENT OF ORDERS FOR THE PRODUCTION OF TIRES; MANAGING THE FULFILLMENT OF ORDERS FOR THE INSTALLATION OF TIRES; DISTRIBUTORSHIP SERVICES IN THE FIELD OF TIRES VIA THE INTERNET; AND DISSEMINATION OF ADVERTISING MATTER (U.S. CLS. 100, 101 AND 102).

CLASS 40—MATERIAL TREATMENT

FOR MANUFACTURE OF TIRES IN THE FIELD OF LAND VEHICLES TO THE ORDER AND SPECIFICATION OF OTHERS (U.S. CLS. 100, 103 AND 106).
MATTHEW KLINE, EXAMINING ATTORNEY

CLASS 11—ENVIRONMENTAL CONTROL APPARATUS

FOR HEATING, VENTILATING AND AIR CONDITIONING UNITS AND PARTS, AND COMPONENTS THEREFOR; AND ENVIRONMENTAL CONTROL APPARATUS, NAMELY, FURNACES, HEAT PUMPS, COMPRESSORS AND CONDENSERS FOR AIR CONDITIONING UNITS AND WATER HEATERS, SPACE HEATERS, EVAPORATIVE COOLERS AND COILS, AIR HANDLERS, VENTILATORS, EXHAUST FANS, BURNERS, HEAT EXCHANGERS, ACCUMULATORS, FILTER DRIERS, AND SIGHT GLASSES ALL BEING STRUCTURAL PARTS OF AIR CONDITIONING, HEATING AND VENTILATING UNITS AND FURNACES; TEMPERATURE CONTROLLED LIQUID MIXING VALVES FOR AIR CONDITIONERS; PNEUMATIC TANKS AND STORAGE TANKS FOR HEATING, VENTILATING AND AIR CONDITIONING SYSTEMS (U.S. CLS. 13, 21, 23, 31 AND 34).

FIRST USE 12-1-1946; IN COMMERCE 12-1-1946.
PAUL F. GAST, EXAMINING ATTORNEY

SN 76-474,621. RHEEM MANUFACTURING COMPANY, NEW YORK, NY. FILED 11-26-2002.

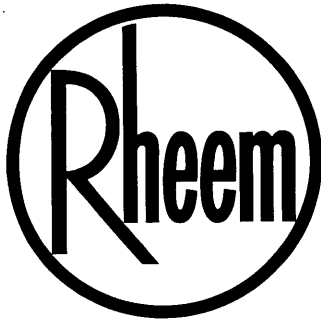

OWNER OF U.S. REG. NOS. 669,287 AND 671,120.
SEC. 2(F).

CLASS 6—METAL GOODS

FOR METAL GOODS, NAMELY, METAL DRUMS SOLD EMPTY, COMBINATION METAL-FIBER DRUMS, BASEMENT WATER TANKS (U.S. CLS. 2, 12, 13, 14, 23, 25 AND 50).

FIRST USE 12-1-1946; IN COMMERCE 12-1-1946.

CLASS 7—MACHINERY

FOR APPARATUS FOR HEATING, VENTILATING, AIR CONDITIONING UNITS, AND FURNACES, NAMELY, AIR COMPRESSORS AND ELECTRIC MOTORS FOR MACHINES (U.S. CLS. 13, 19, 21, 23, 31, 34 AND 35).

FIRST USE 12-1-1946; IN COMMERCE 12-1-1946.

CLASS 9—ELECTRICAL AND SCIENTIFIC APPARATUS

FOR THERMOSTATS; SUB-BASES, NAMELY, ELECTRICAL TRANSFORMERS AND RELAYS, ELECTRICAL CONTRACTORS, ELECTRICAL CONTROLLERS, ELECTRICAL SWITCHES, AND SOLENOID VALVES (U.S. CLS. 21, 23, 26, 36 AND 38).

FIRST USE 12-1-1946; IN COMMERCE 12-1-1946.

SN 76-478,168. STEAG AKTIENGESELLSCHAFT, 45128 ESSEN, FED REP GERMANY, FILED 12-10-2002.



PRIORITY CLAIMED UNDER SEC. 44(D) ON FED REP GERMANY APPLICATION NO. 30229249.7/3, FILED 6-14-2002, REG. NO. 30229249, DATED 8-9-2002, EXPIRES 6-30-2012.

NO CLAIM IS MADE TO THE EXCLUSIVE RIGHT TO USE "THE POWER COMPANY", APART FROM THE MARK AS SHOWN.

THE COLOR(S) BLUE AND BLACK IS/ARE CLAIMED AS A FEATURE OF THE MARK.

BLUE IS USED IN THE LETTERING OF THE WORD "STEAG". A LIGHTER SHADE OF BLUE IN THE SHAPE OF A SQUARE FORMS A PARTIAL BACKGROUND TO THE WORD "STEAG". THE WORDING "THE POWER COMPANY" IS IN BLACK.

CLASS 35—ADVERTISING AND BUSINESS

FOR BUSINESS MANAGEMENT; BUSINESS MANAGEMENT CONSULTATION IN THE FIELDS OF ENERGY TECHNOLOGY, ENERGY SUPPLY FOR ENERGY SUPPLY COMPANIES AND FOR ENERGY, ELECTRICITY AND PROCESS HEAT CONSUMING COMPANIES; BUSINESS AND INDUSTRIAL ADMINISTRATION MANAGEMENT OF POWER PLANTS; INDUSTRIAL ADMINISTRATION CONSULTING FOR POWER PLANT DISPOSAL AND RESIDUAL DISPOSAL IN WASTE INCINERATION PLANTS; PREPARATION OF TECHNICAL AND BUSINESS MANAGEMENT CERTIFICATES (U.S. CLS. 100, 101 AND 102).

CLASS 36—INSURANCE AND FINANCIAL

FOR INSURANCE UNDERWRITING FOR ENERGY COMPANIES; FINANCIAL ANALYSIS AND CONSULTATION FOR ENERGY COMPANIES (U.S. CLS. 100, 101 AND 102).

CLASS 37—CONSTRUCTION AND REPAIR

FOR INDUSTRIAL PLANT CONSTRUCTION IN THE FIELD OF ENERGY SUPPLY, ENVIRONMENTAL TECHNOLOGY, CLEAN ROOM TECHNOLOGY, AIR CONDITIONING, ENERGY AND HEAT ENGINEERING; INSTALLATION, ASSEMBLY, MAINTENANCE AND REPAIR OF MACHINES, INDUSTRIAL BUILDINGS, ENERGY SUPPLY PLANTS, CONTROL MEASURING, AND ELECTRO-TECHNICAL UNITS AND INDUSTRIAL PLANTS FOR ENERGY, POWER, LONG DISTANCE ENERGY, AND COMPRESSED AIR PRODUCTION AND SUPPLY, AIR CONDITIONING AND VENTILATION; BUILDING DEMOLITION, BUILDING SEALING SERVICES; COLLECTION OF TRASH, INDUSTRIAL AND COMMERCIAL SPECIALIZED TRASH, FROM SOLID, MUDDY AND LIQUID METALLIC AND METAL-CONTAINING INDUSTRIAL RESIDUE; SHUT-DOWN AND DISPOSAL OF NUCLEAR PLANTS; HAZARDOUS WASTE MANAGEMENT IN THE NATURE OF CLEAN-UP OF ABANDONED NUCLEAR SITES AND FLUE GAS CLEANING; CONSTRUCTION PLANNING (U.S. CLS. 100, 103 AND 106).

CLASS 38—COMMUNICATION

FOR TELECOMMUNICATIONS CONSULTING SERVICES FOR THE SPECIFIC NEEDS OF ENERGY SUPPLY COMPANIES (U.S. CLS. 100, 101 AND 104).

CLASS 39—TRANSPORTATION AND STORAGE

FOR DISTRIBUTION OF ENERGY, ELECTRICITY, GAS, HEATING, LONG-DISTANCE ENERGY, PRESSURIZED AIR AND WATER; TRANSMISSION OF GASES, LIQUID AND SOLID MATERIAL VIA PIPELINES (U.S. CLS. 100 AND 105).

CLASS 40—MATERIAL TREATMENT

FOR RECYCLING OF RESIDUALS FROM FOSSIL-FIRED POWER PLANTS; INCINERATION OF RESIDUALS FROM FOSSIL-FIRED POWER PLANTS (U.S. CLS. 100, 103 AND 106).

CLASS 41—EDUCATION AND ENTERTAINMENT

FOR TRAINING SERVICES IN THE FIELD OF POWER PLANT OPERATION, WASTE INCINERATION AND WATER PROCESSING (U.S. CLS. 100, 101 AND 107).

CLASS 42—SCIENTIFIC, COMPUTER AND LEGAL SERVICES

FOR ENGINEERING SERVICES; ARCHITECTURAL DESIGN SERVICES; CHEMIST SERVICES; PHYSICIST SERVICES; TECHNICAL CONSULTATION IN THE FIELD OF ENERGY PRODUCTION AND WASTE DISPOSAL; MATERIAL TESTING; PERFORMING CHEMICAL AND PHYSICAL ANALYSIS OF WASTE AND RESIDUALS OF WASTE-INCINERATION FACILITIES, POWER PLANTS AND/OR WATER TREATMENT FACILITIES; ASSISTING ENERGY COMPANIES IN ESTABLISHING PROGRAMS FOR DATA PROCESSING FOR ENERGY TECHNOLOGY AND ENERGY SUPPLY COMPANIES; TECHNICAL CONSULTING FOR POWER PLANT WASTE DISPOSAL AND RESIDUAL DISPOSAL IN WASTE-INCINERATION FACILITIES (U.S. CLS. 100 AND 101).

CLASS 45—PERSONAL SERVICES

FOR SECURITY SERVICES, NAMELY, MONITORING OF PERSONNEL, BUILDINGS AND VALUABLES; GUARD SERVICES FOR THE PROTECTION OF FACTORIES AND PERSONNEL (U.S. CLS. 100 AND 101).
DAWN FELDMAN, EXAMINING ATTORNEY

SN 76-478,365. INTEGRATED BIOMATERIAL & CELL TECHNOLOGIES S.R.L., 40128 BOLOGNA (BO), ITALY, FILED 12-26-2002.

SILCROTHANE

PRIORITY CLAIMED UNDER SEC. 44(D) ON ITALY APPLICATION NO. 001414, FILED 12-13-2002, REG. NO. 00921987, DATED 12-13-2002, EXPIRES 12-13-2012.

CLASS 1—CHEMICALS

FOR SILICONES AND SILICONE MATERIALS FOR USE IN THE MANUFACTURE OF VASCULAR AND CARDIO-VASCULAR PROSTHESIS, NAMELY, SILICONE MATERIALS COMPRISING POLYDIALKYL-SILOXANES AND POLYURETHANES (U.S. CLS. 1, 5, 6, 10, 26 AND 46).

CLASS 5—PHARMACEUTICALS

FOR PREPARATIONS FOR THE TREATMENT OF VASCULAR AND CARDIO-VASCULAR DISEASE COMPRISING POLYSILOXANES OR ORGANO-FUNCTIONAL POLYSILOXANES OR SILICONES OR SILICONE MATERIALS, NAMELY, SILICONE MATERIALS COMPRISING POLYDIALKYL-SILOXANES AND POLYURETHANES (U.S. CLS. 6, 18, 44, 46, 51 AND 52).

CLASS 10—MEDICAL APPARATUS

FOR MEDICAL STENTS AND ORTHOPEDIC PROSTHESIS, VASCULAR PROSTHESIS, CARDIO-VASCULAR PROSTHESIS, SURGICAL PROSTHESIS, NAMELY, VASCULAR PROSTHESIS AND CARDIO-VASCULAR PROSTHESIS FOR BIO-MEDICAL USE, MADE OF MATERIALS COMPRISED OF SILICONE OR MADE OF SILICONE MATERIALS COMPRISED OF POLYDIALKYL-SILOXANES AND POLYURETHANES; SILICONE AND SILICONE MATERIALS, NAMELY, SILICONE GEL SHEETING FOR TREATMENT OF SCARS (U.S. CLS. 26, 39 AND 44).

JOHN SCHUYLER YARD, EXAMINING ATTORNEY

SN 76-481,074. COSMECEUTIC SOLUTIONS PTY LTD, VICTORIA 3003, AUSTRALIA, FILED 1-8-2003.

RESERVOIR

PRIORITY CLAIMED UNDER SEC. 44(D) ON AUSTRALIA APPLICATION NO. 919438, FILED 7-10-2002, REG. NO. 919438, DATED 7-10-2002, EXPIRES 7-10-2012.

CLASS 3—COSMETICS AND CLEANING PREPARATIONS

FOR SOAPS, ESSENTIAL OILS FOR PERSONAL USE, COSMETICS, SKIN CLEANSING PREPARATIONS, CLEANSING MILK FOR TOILET PURPOSES, COSMETIC CREAMS, LOTIONS FOR COSMETIC PURPOSES, GELS FOR COSMETIC PURPOSES, OILS FOR COSMETIC PURPOSES, SPRAYS FOR TOPICAL APPLICATION FOR COSMETIC PURPOSES, SKIN CARE PREPARATIONS, COSMETIC PREPARATIONS FOR SLIMMING PURPOSES, PLANT EXTRACT COMPOSITES FOR COSMETIC PURPOSES, MOISTURIZERS, HAIR CARE PRODUCTS AND DENTIFRICES, COSMETIC KITS CONSISTING OF ONE OR MORE OF THE FOREGOING GOODS (U.S. CLS. 1, 4, 6, 50, 51 AND 52).

CLASS 5—PHARMACEUTICALS

FOR PHARMACEUTICALS PREPARATIONS FOR THE TREATMENT OF ACNE, AGE SPOTS, SCARS, BROKEN CAPILLARIES, FUNGAL INFECTIONS, ECZEMA AND PSORIASIS, TOPICAL VETERINARY PREPARATIONS FOR THE TREATMENT OF SKIN DISEASES, MEDICATED COMPOSITIONS FOR TOPICAL APPLICATIONS, NAMELY SOLUTIONS, LOTIONS, CREAMS, GELS, STICKS, SPRAYS, PADS, OINTMENTS, PASTES, MOUSSES, MOUTHWASHES AND AEROSOLS FOR THE TREATMENT OF ACNE, AGE SPOTS, SCARS, BROKEN CAPILLARIES, FUNGAL INFECTIONS, ECZEMA AND PSORIASIS, ANTIBACTERIAL PHARMACEUTICALS, ANTIVIRALS FOR MEDICAL USE, ACNE TREATMENT PREPARATIONS, MEDICATED SKIN PREPARATIONS FOR USE TREATING SKIN DISEASE, TOPICAL MEDICATED SKIN PREPARATIONS FOR USE IN TREATING SKIN SCARRING AND SKIN DAMAGE, PHARMACEUTICAL COMPOSITIONS FOR SPRAY APPLICATION TO THE SKIN, NAMELY SOLUTIONS, LOTIONS, CREAMS, GELS, STICKS, SPRAYS, PADS, OINTMENTS, PASTES, MOUSSES, MOUTHWASHES AND AEROSOLS FOR THE TREATMENT OF ACNE, AGE SPOTS, SCARS, BROKEN CAPILLARIES, FUNGAL INFECTIONS, ECZEMA AND PSORIASIS, PHARMACEUTICAL PREPARATIONS FOR TRANSDERMAL DELIVERY, NAMELY SOLUTIONS, LOTIONS, CREAMS, GELS, STICKS, SPRAYS, PADS, OINTMENTS, PASTES, MOUSSES, MOUTHWASHES AND AEROSOLS FOR THE TREATMENT OF WRINKLES, ACNE, AGE SPOTS, SCARS, BROKEN CAPILLARIES, FUNGAL INFECTIONS, ECZEMA AND PSORIASIS (U.S. CLS. 6, 18, 44, 46, 51 AND 52).

EDWARD NELSON, EXAMINING ATTORNEY

CLASS 6—METAL GOODS

FOR CONSTRUCTION MATERIALS MADE OF METAL FOR PANELS, CEILINGS AND PROFILES; PREFABRICATED COMPONENTS AND MODULES MADE OF METAL FOR CONSTRUCTION OF DRY PARTITION WALLS AND DISPLACEABLE WALLS; MATERIALS AND PARTS TO ASSEMBLE CEILINGS MADE OF METAL; PREFABRICATED SANITARY WALLS MADE OF METAL, SUPPORTING AND PANELING ELEMENTS FOR BATH AND SHOWER TUBS MADE OF METAL; PARTITION WALLS AND POCKETS MADE OF METAL; BATHROOM FURNITURE, SHELVES, PARTITION WALLS AND POCKETS MADE OF METAL; PLATFORMS AND BENCHES MADE OF METAL FOR SANITARY EQUIPMENT; METAL CONSTRUCTION COMPONENTS, NAMELY DISMOUNTABLE AND REMOUNTABLE CEILING ELEMENTS, TUBES AND ADAPTERS TO CREATE FREEZING AND AIR DISTRIBUTION CEILINGS; PARTS OF ALL AFOREMENTIONED GOODS; ASSEMBLY AND SUPPORTING FRAMEWORKS COMPRISING OF METAL AS WELL AS INSTALLATION MODULES FOR FIXING SANITARY EQUIPMENTS, NAMELY, DRAINS, COCKS, TRAPS, VALVES, SCREWS, SPOUTS; FITTING AND JUNCTION PARTS FOR SANITARY EQUIPMENT MADE OF METAL, NAMELY, METAL DRAINS, COCKS, TRAPS, VALVES, SCREWS, SPOUTS (U.S. CLS. 2, 12, 13, 14, 23, 25 AND 50).

CLASS 7—MACHINERY

FOR INDUSTRIAL AND DOMESTIC APPLIANCES, NAMELY, ELECTRIC GENERATORS; ELECTRIC FOAM APPLICATORS (U.S. CLS. 13, 19, 21, 23, 31, 34 AND 35).

CLASS 8—HAND TOOLS

FOR HAND-OPERATED TOOLS AND EQUIPMENT, NAMELY, MASTIC APPLICATORS, SPATULAS AND KNIVES FOR WORKING UP WITH AFOREMENTIONED MATERIALS (U.S. CLS. 23, 28 AND 44).

CLASS 11—ENVIRONMENTAL CONTROL APPARATUS

FOR INDUSTRIAL AND DOMESTIC ELECTRIC APPLIANCES, NAMELY, LIGHTING, HEATING, VAPOR GENERATING, COOKING, FREEZING, DRYING VENTILATION, AND WATER CIRCULATION APPLIANCES, AS WELL AS SANITARY EQUIPMENT NAMELY BATH TUBS, SHOWER TUBS, WASH BASINS, BIDETS, TOILET SEATS; FITTINGS FOR AFOREMENTIONED GOODS; PARTS OF ALL AFOREMENTIONED GOODS; FILTER IN PARTICULAR MADE OF CELLULAR PLASTICS, AND FIBRE MATERIALS FOR THE FILTRATION OF GASEOUS AND FLUID MEDIA FOR HOUSEHOLD AND INDUSTRIAL USE; ASSEMBLY AND SUPPORTING FRAMEWORKS COMPRISING PRIMARILY OF PLASTICS AND METAL AS WELL AS INSTALLATION MODULES FOR FIXING SANITARY EQUIPMENTS, NAMELY, DRAINS, COCKS, TRAPS, VALVES, SCREWS, SPOUTS; FITTINGS AND JUNCTION PARTS FOR SANITARY EQUIPMENT MADE OF METAL AND/OR PLASTICS, NAMELY, DRAINS, COCKS, TRAPS, VALVES, SCREWS, SPOUTS; PART OF ALL AFOREMENTIONED GOODS (U.S. CLS. 13, 21, 23, 31 AND 34).

CLASS 17—RUBBER GOODS

FOR RUBBER, POLYMER, ACRYL SEALANTS FOR BUILDING AND INDUSTRIAL USE; ADHESIVES AND PRESSURE SENSITIVE TAPES FOR COMMERCIAL/INDUSTRIAL USE/PURPOSES; SEALANT AND INSULATION MATERIAL, NAMELY, IMPREGNATED FOAM TAPES; PLASTIC SEALANT TAPES FOR GENERAL USE; PLASTICS, CELLULAR PLASTICS IN FORM OF PLATES AND MOLDED PARTS FOR COLD, HEAT, FIRE AND NOISE PROTECTION; INSULATION AND FIRE PROTECTION MATERIALS COMPRISING OF PLASTICS AND CELLULAR PLASTICS, METAL, GLASS, CERAMIC AND PLASTIC FIBRES AND METAL FOILS FOR MANUFACTURING OF COLD, FIRE PROTECTION, HEAT AND NOISE INSULATION FOR SHIPS, AIRCRAFTS AND VEHICLE CONSTRUCTION; INTER-

SN 76-481,530, ILLBRUCK BUILDING SYSTEMS GMBH, LEVERKUSEN, FED REP GERMANY, FILED 1-9-2003.



PRIORITY CLAIMED UNDER SEC. 44(D) ON FED REP GERMANY APPLICATION NO. 30234931.6, FILED 7-18-2002, REG. NO. 30234931, DATED 12-10-2002, EXPIRES 7-31-2012.

THE COLOR(S) GREEN, WHITE AND BLACK IS/ARE CLAIMED AS A FEATURE OF THE MARK.

THE MARK CONSISTS OF THE WORD "ILLBRUCK;" A BOX WHICH IS LIGHT GREEN; A CIRCLE INSIDE THE BOX THAT IS WHITE; A RECTANGLE INSIDE THE BOX THAT IS BLACK; AND A CIRCLE OUTSIDE THE BOX THAT IS LIGHT GREEN.

CLASS 1—CHEMICALS

FOR CHEMICAL MATERIALS FOR COMMERCIAL USE IN THE MANUFACTURE OF SEALANT AND INSULATION MATERIALS FOR COMMERCIAL PURPOSES (U.S. CLS. 1, 5, 6, 10, 26 AND 46).

CLASS 2—PAINTS

FOR PRIMER FOR SEALANT AND INSULATION MATERIALS; PARTS OF ALL AFOREMENTIONED GOODS (U.S. CLS. 6, 11 AND 16).

FOR FITTINGS WITH COMPONENTS MADE OF MINERAL MATERIALS, NAMELY, PLASTER PLATES COMBINED WITH SYNTHETICS AND/OR FOAM MATERIAL; PLASTER AND PLASTERBOARDS AND COMBINATIONS OF MINERAL AND PLASTIC CELLULAR MATERIAL; SEALANTS AND JOINT SEALANT PROFILES MADE OF PLASTICS FOR GENERAL USE; PARTS OF ALL AFOREMENTIONED GOODS; ASSEMBLY AND SUPPORTING FRAMEWORKS COMPRISING OF PLASTICS AS WELL AS INSTALLATION MODULES FOR FIXING SANITARY EQUIPMENTS, NAMELY, DRAINS, COCKS, TRAPS, VALVES, SCREWS, SPOUTS (U.S. CLS. 1, 5, 12, 13, 35 AND 50).

CLASS 19—NON-METALLIC BUILDING MATERIALS

FOR CONSTRUCTION MATERIALS MADE OF NON-METAL FOR CEILINGS AND PANELS AND FOR CEILINGS AND PROFILES; PREFABRICATED COMPONENTS AND MODULES MADE OF NON-METAL FOR CONSTRUCTION OF DRY PARTITION WALLS AND DISPLACEABLE WALLS; NON-METAL MATERIALS AND PARTS TO ASSEMBLE CEILINGS FOR USE IN CONSTRUCTION; PREFABRICATED SANITARY WALLS MADE OF NON-METAL; SUPPORTING AND PANELING ELEMENTS FOR BATH AND SHOWER TUBS MADE OF NON-METAL; PARTITION WALLS AND POCKETS MADE OF NON-METAL SANITARY EQUIPMENT; BATHROOM FURNITURE, SHELVES, PARTITION WALLS AND POCKETS MADE OF NON-METAL; PLATFORMS MADE OF NON-METAL AND PARTS FOR ALL AFOREMENTIONED GOODS; CONSTRUCTION MATERIALS NOT OF METAL IN FORM OF PLATES AND MOLDED PARTS TO CREATE FREEZING AND AIR DISTRIBUTION CEILINGS; PARTS OF ALL AFOREMENTIONED GOODS (U.S. CLS. 1, 12, 33 AND 50).

CLASS 35—ADVERTISING AND BUSINESS

FOR ADVERTISING AGENCY (U.S. CLS. 100, 101 AND 102).

CLASS 37—CONSTRUCTION AND REPAIR

FOR CONSULTATION AND ADVISING ON INSTALLATION OF LIGHTING EQUIPMENT AND CONTROL OF LIGHTING CONDITIONS (U.S. CLS. 100, 103 AND 106).

CLASS 42—SCIENTIFIC, COMPUTER AND LEGAL SERVICES

FOR TECHNICAL AND DESIGN CONSULTATION SERVICES IN THE FIELD OF DEVELOPMENT, APPLICATION AND USE OF BUILDING PRODUCTS, MATERIALS AND COMPONENTS; CONSULTATION SERVICES IN THE FIELD OF LIGHT CAPACITY CALCULATIONS; ACOUSTICAL MEASUREMENTS (U.S. CLS. 100 AND 101).

ZACHARY BELLO, EXAMINING ATTORNEY

SN 76-482,398. OUTOKUMPU OYJ, 02200 ESPOO, FINLAND, FILED 1-10-2003.

NORDIC GREEN PLUS

PRIORITY CLAIMED UNDER SEC. 44(D) ON FINLAND APPLICATION NO. T200203250, FILED 11-11-2002, REG. NO. 228183, DATED 8-29-2003, EXPIRES 8-29-2013.

CLASS 6—METAL GOODS

FOR COPPER SHEETS, PLATES, FOILS AND STRIPS (U.S. CLS. 2, 12, 13, 14, 23, 25 AND 50).

CLASS 40—MATERIAL TREATMENT

FOR TREATMENT OF COPPER OR ALLOYS BY OXIDATION (U.S. CLS. 100, 103 AND 106).
SUELLEN HICKEY, EXAMINING ATTORNEY

SN 76-483,390. IT'S THE HOW, L.L.C., DALLAS, TX. FILED 1-21-2003.

ITH

CLASS 16—PAPER GOODS AND PRINTED MATTER

FOR PUBLICATIONS AND TRAINING MATERIALS IN THE FORM OF BOOKS, CHARTS, WORKBOOK TEMPLATES, PERIODICALS, AND OUTLINES THAT RELATE TO PERSONAL AND PROFESSIONAL ACHIEVEMENTS (U.S. CLS. 2, 5, 22, 23, 29, 37, 38 AND 50).

FIRST USE 4-22-2000; IN COMMERCE 6-30-2000.

CLASS 35—ADVERTISING AND BUSINESS

FOR BUSINESS CONSULTING SERVICES (U.S. CLS. 100, 101 AND 102).

FIRST USE 4-22-2000; IN COMMERCE 6-30-2000.

LINDA MICKLEBURGH, EXAMINING ATTORNEY

SN 76-485,231. TRUMBULL SERVICES, L.L.C., WINDSOR, CT. FILED 1-24-2003.

SUBROSOURCE

CLASS 9—ELECTRICAL AND SCIENTIFIC APPARATUS

FOR SOFTWARE TO ASSIST IN DEBT AND TAX COLLECTION, AND CLAIM EVALUATION AND ANALYSIS, NAMELY IN REGARD TO THE EXERCISE OF SUBROGATION RIGHTS (U.S. CLS. 21, 23, 26, 36 AND 38).

FIRST USE 7-0-2002; IN COMMERCE 7-0-2002.

CLASS 36—INSURANCE AND FINANCIAL

FOR DEBT AND TAX COLLECTION SERVICES; INSURANCE CLAIM EVALUATION AND ANALYSIS SERVICES IN REGARD TO THE EXERCISE OF SUBROGATION RIGHTS (U.S. CLS. 100, 101 AND 102).

FIRST USE 7-0-2002; IN COMMERCE 7-0-2002.

TRACY CROSS, EXAMINING ATTORNEY

SN 76-489,840. TEXTILE MANAGEMENT ASSOCIATES, INC., DALTON, GA. FILED 2-12-2003.

THE NAME UNDER THE GAME

THE MARK CONSISTS OF STANDARD CHARACTERS WITHOUT CLAIM TO ANY PARTICULAR FONT, STYLE, SIZE, OR COLOR.

CLASS 19—NON-METALLIC BUILDING MATERIALS

FOR ATHLETIC FLOORING, NAMELY, NON-METAL MODULAR FLOORS AND NON-METAL SUSPENDED FLOORS USED FOR INDOOR AND OUTDOOR TRACKS; NON-METAL FLOORS, NAMELY, GYMNASIUM SURFACES, REHABILITATION SPORTS FLOORING, PARK AND RECREATION FLOORING, ICE FLOORING FOR HOCKEY FIELDS, SUSPENDED GYMNASIUM FLOORING, BADMINTON COURT FLOORING, HANDBALL COURT FLOORING, VOLLEYBALL FLOORING, SPEED SKATING FLOORING, ROLLER HOCKEY FLOORING LACROSSE FLOORING, PORTABLE FLOORING DESIGNED FOR RACING, MULTI-PURPOSE ATHLETIC RECREATIONAL FLOORING (U.S. CLS. 1, 12, 33 AND 50).
FIRST USE 2-3-2003; IN COMMERCE 2-3-2003.

CLASS 20—FURNITURE AND ARTICLES NOT OTHERWISE CLASSIFIED

FOR BENCHES AND BLEACHERS FOR STADIUMS AND ARENAS; PORTABLE SEATING NAMELY BENCHES AND BLEACHERS (U.S. CLS. 2, 13, 22, 25, 32 AND 50).
FIRST USE 2-3-2003; IN COMMERCE 2-3-2003.

CLASS 27—FLOOR COVERINGS

FOR ATHLETIC AND RECREATIONAL ARTIFICIAL AND SYNTHETIC TURF SURFACES, NAMELY, ARTIFICIAL AND SYNTHETIC TURF; PORTABLE ARTIFICIAL TURF SURFACES, NAMELY, ROLL-OUT SURFACES, ATHLETIC TRACKS, FOOTBALL FIELDS, RUNNING TRACKS, FIELD SURFACES, TENNIS COURTS AND TENNIS SURFACES, HOCKEY FLOORING SURFACES, BACKYARD GAME COURTS, AND SHOCK ABSORPTION SURFACES; CARPETING, RUGS, MATS AND MATTING FOR ATHLETIC AND RECREATIONAL SURFACES, NAMELY GYMNASIUM EXERCISE MATS; SHOCK ABSORBENT FLOOR PADS; SYNTHETIC TURF HYBRIDS FLOORING; GYMNASIUM EXERCISE CARPETS AND MATS (U.S. CLS. 19, 20, 37, 42 AND 50).
FIRST USE 2-3-2003; IN COMMERCE 2-3-2003.

CLASS 31—NATURAL AGRICULTURAL PRODUCTS

FOR NATURAL GRASS SURFACES AND NON-ARTIFICIAL TURF SYSTEMS COMPOSED OF NATURAL GRASS; STABILIZED GRASS (U.S. CLS. 1 AND 46).
FIRST USE 2-3-2003; IN COMMERCE 2-3-2003.
DORITT L. CARROLL, EXAMINING ATTORNEY

CLASS 35—ADVERTISING AND BUSINESS

FOR BUSINESS MANAGEMENT AND CONSULTATION IN THE FIELD OF DEVELOPMENT AND MARKETING OF HEALTHCARE SERVICES, MARKET RESEARCH AND ANALYSIS SERVICES, BUSINESS RESEARCH AND SURVEY SERVICES, PREPARATION OF BUSINESS AND MARKETING REPORTS, DEVELOPMENT OF MARKETING AND ADVERTISING PROGRAMS FOR OTHERS, AND BUSINESS MANAGEMENT SERVICES (U.S. CLS. 100, 101 AND 102).
FIRST USE 2-8-2000; IN COMMERCE 2-8-2000.

CLASS 41—EDUCATION AND ENTERTAINMENT

FOR EDUCATIONAL SERVICES, NAMELY CONFERENCES IN THE FIELD OF HEALTHCARE MARKETING AND BUSINESS MANAGEMENT (U.S. CLS. 100, 101 AND 107).
FIRST USE 2-26-2001; IN COMMERCE 2-26-2001.

CLASS 44—MEDICAL, BEAUTY AND AGRICULTURAL SERVICES

FOR HEALTHCARE SERVICES (U.S. CLS. 100 AND 101).
FIRST USE 2-8-2000; IN COMMERCE 2-8-2000.
GINA HAYES, EXAMINING ATTORNEY

SN 76-494,613. VACLAV HRBEK-BODY HF, CHODOV, CZECH REPUBLIC, FILED 3-4-2003.

TT SPORT TOWN

SN 76-491,893. MUSCULOSKELETAL MANAGEMENT SYSTEMS, LLC, CANONSBURG, PA. FILED 2-21-2003.

HUMAN MOTION INSTITUTE

OWNER OF U.S. REG. NOS. 2,574,102 AND 2,640,495.
NO CLAIM IS MADE TO THE EXCLUSIVE RIGHT TO USE "INSTITUTE", APART FROM THE MARK AS SHOWN.
SEC. 2(F).

NO CLAIM IS MADE TO THE EXCLUSIVE RIGHT TO USE SPORT, APART FROM THE MARK AS SHOWN.

CLASS 20—FURNITURE AND ARTICLES NOT OTHERWISE CLASSIFIED

FOR SLEEPING BAGS (U.S. CLS. 2, 13, 22, 25, 32 AND 50).

CLASS 28—TOYS AND SPORTING GOODS

FOR GYMNASTICS APPARATUS, EQUIPMENT FOR BADMINTON GAME PLAYING, BILLIARD GAME PLAYING, VOLLEYBALL GAME PLAYING (U.S. CLS. 22, 23, 38 AND 50).
MICHAEL KAZAZIAN, EXAMINING ATTORNEY

SN 76-494,897. CARROSSERIE STEVENS, 9160 LOKEREN, BELGIUM, FILED 3-6-2003.



PRIORITY CLAIMED UNDER SEC. 44(D) ON ERPN CMNTY TM OFC APPLICATION NO. 2998136, FILED 1-7-2003, REG. NO. 2998136, DATED 2-25-2004, EXPIRES 1-7-2013.

CLASS 7—MACHINERY

FOR MACHINES AND MACHINES TOOLS FOR MANUFACTURING PANELS (U.S. CLS. 13, 19, 21, 23, 31, 34 AND 35).

CLASS 19—NON-METALLIC BUILDING MATERIALS

FOR NON-METALLIC BUILDING MATERIALS, NAMELY, PANELS IN COMPOSITE MATERIAL WHICH CAN BE USED FOR MANUFACTURING FLOORS, WALLS AND CEILINGS FOR THE CONSTRUCTION OF HOUSES, AIRPLANES, VEHICLES AND FOR MANUFACTURING PALLETS, CONTAINERS, BULLET-PROOF WALLS, DECKS (OF SHIPS), TOWERS OF WINDMILLS AND WALLS OF COLD STORES (U.S. CLS. 1, 12, 33 AND 50).

JOHN DALIER, EXAMINING ATTORNEY

SN 76-497,239. WINDWARD PRINT STAR, INC., DBA ADPLEX.RHODES, HOUSTON, TX. FILED 3-14-2003.

ADPLEX•RHODES

THE MARK CONSISTS OF STANDARD CHARACTERS WITHOUT CLAIM TO ANY PARTICULAR FONT, STYLE, SIZE, OR COLOR.

CLASS 9—ELECTRICAL AND SCIENTIFIC APPARATUS

FOR COMPUTER SOFTWARE FOR MANAGEMENT OF MERCHANDISING AND ADVERTISING WORKFLOW IN THE FIELD OF RETAIL AND MERCHANDISING WORKFLOW SYSTEMS, MEDIA ASSET MANAGEMENT AND COLLABORATIVE WORKFLOW AND ONLINE ADVERTISING AND MARKETING TEMPLATING SYSTEMS (U.S. CLS. 21, 23, 26, 36 AND 38).

FIRST USE 12-6-2002; IN COMMERCE 12-6-2002.

CLASS 35—ADVERTISING AND BUSINESS

FOR ADVERTISING, NAMELY, PROVIDING ADVERTISING, MARKETING AND PROMOTIONAL SERVICES FOR OTHERS; BUSINESS CONSULTATION IN THE NATURE OF MARKETING TO TARGET CUSTOMERS; PROMOTING RETAIL AND CONSUMER BUSINESSES THROUGH THE DEVELOPMENT AND DISTRIBUTION OF PRINTED AND AUDIO PROMOTIONAL MATERIALS; DIRECT MAIL CONSULTATION SERVICES (U.S. CLS. 100, 101 AND 102).

FIRST USE 12-6-2002; IN COMMERCE 12-6-2002.

CLASS 42—SCIENTIFIC, COMPUTER AND LEGAL SERVICES

FOR PROVIDING TEMPORARY USE OF NON-DOWNLOADABLE COMPUTER SOFTWARE FOR MANAGEMENT OF MERCHANDISING AND ADVERTISING WORKFLOW IN THE FIELD OF RETAIL AND MERCHANDISING WORKFLOW SYSTEMS, MEDIA ASSET MANAGEMENT AND COLLABORATIVE WORKFLOW AND ONLINE ADVERTISING AND MARKETING TEMPLATING SYSTEMS (U.S. CLS. 100 AND 101).

FIRST USE 12-6-2002; IN COMMERCE 12-6-2002.
CAROLINE WOOD, EXAMINING ATTORNEY

SN 76-497,608. CITY OF HOPE, DUARTE, CA. FILED 3-17-2003.

WHERE THE POWER OF KNOWLEDGE SAVES LIVES

CLASS 16—PAPER GOODS AND PRINTED MATTER

FOR PROMOTIONAL PUBLICATIONS, NAMELY, PAMPHLETS, NEWSLETTERS, MAGAZINES, QUARTERLY PUBLICATIONS IN THE NATURE OF BULLETINS AND PERIODICALS IN THE FIELD OF MEDICAL RESEARCH, DISEASE PREVENTION AND TREATMENT; AND BROCHURES IN THE FIELD OF CHARITABLE FUNDRAISING SERVICES; COUPON BOOKS; BUSINESS CARDS; STATIONERY; ENVELOPES; STICKERS; AND WRITING INSTRUMENTS (U.S. CLS. 2, 5, 22, 23, 29, 37, 38 AND 50).

FIRST USE 10-1-1998; IN COMMERCE 10-1-1998.

CLASS 21—HOUSEWARES AND GLASS

FOR MUGS, PLASTIC COASTERS, AND PLASTIC WATER BOTTLES SOLD EMPTY (U.S. CLS. 2, 13, 23, 29, 30, 33, 40 AND 50).

FIRST USE 10-1-1998; IN COMMERCE 10-1-1998.

CLASS 25—CLOTHING

FOR CLOTHING, NAMELY, T-SHIRTS, SWEATSHIRTS, JOGGING SUITS, HATS, CAPS AND VISORS (U.S. CLS. 22 AND 39).

FIRST USE 10-1-1998; IN COMMERCE 10-1-1998.

CLASS 36—INSURANCE AND FINANCIAL

FOR CHARITABLE FUNDRAISING WALKS AND MARATHON RACES; BOWLING TOURNAMENTS; AND BASEBALL TOURNAMENTS (U.S. CLS. 100, 101 AND 102).

FIRST USE 10-1-1998; IN COMMERCE 10-1-1998.

CLASS 41—EDUCATION AND ENTERTAINMENT

FOR EDUCATIONAL SERVICES, NAMELY PROVIDING SEMINARS IN THE FIELD OF CANCER RESEARCH (U.S. CLS. 100, 101 AND 107).

FIRST USE 10-1-1998; IN COMMERCE 10-1-1998.

CLASS 42—SCIENTIFIC, COMPUTER AND LEGAL SERVICES

FOR PROVIDING MEDICAL INFORMATION RELATING TO ONGOING RESEARCH PROGRAMS AND STUDIES (U.S. CLS. 100 AND 101).

FIRST USE 10-1-1998; IN COMMERCE 10-1-1998.
BARNEY CHARLON, EXAMINING ATTORNEY

SN 76-503,730. CALIFORNIAMAN TRIATHLON, LLC, MEADOW VISTA, CA. FILED 4-3-2003.

CALIFORNIAMAN**CLASS 25—CLOTHING**

FOR APRONS, ASCOTS, ATHLETIC FOOTWEAR, ATHLETIC SHOES, ATHLETIC UNIFORMS, BANDANAS, BASEBALL CAPS, BATH SLIPPERS, BATHING CAPS, BATHING SUITS, BATHING CAPS, BATHING SUITS, BATHING TRUNKS, BATHROBES, BEACH COVER-UPS, BEACH SHOES, BEACHWEAR, BEANIES, BELTS, BERETS, BERMUDA SHORTS, BIKINIS, BLAZERS, BLOUSES, BODY SHAPERS, BODY SUITS, BOXER SHORTS, BRAS, BRASSIERES, BRIEFS, CAMP SHIRTS, CAPS, CARDIGANS, CHEFS HATS, CLOTHING, NAMELY WRAP-AROUNDS, COATS, COLLARS, CROP TOPS, CUFFS, DENIM JACKETS, EAR MUFFS, GOLF SHIRTS, GYM SHORTS, HALTER TOPS, HATS, HEAD BANDS, HEADWEAR, INFANTWEAR, JACKETS, JEANS, JOGGING SUITS, LEATHER JACKETS, LEG WARMERS, LEGGINGS, LIGHT-REFLECTING JACKETS, LINGERIE, LOUNGEWEAR, MOCK TURTLE-NECK SWEATERS, MONEY BELTS, MUFFLERS, NECK BANDS, NECKWEAR, NIGHT SHIRTS, PAJAMAS, PANTIES, PANTS, POLO SHIRTS, PONCHOS, PULLOVERS, RAIN JACKETS, SANDALS, SASHES, SCARVES, SHAWLS, SHIRTS, SHOES, SHORTS, SLEEP SHIRTS, SLEEPWEAR, SLIPPERS, SNEAKERS, SOCKS, SPORT COATS, SPORT SHIRTS, SUN VISORS, SWEAT BANDS, SWEAT PANTS, SWEAT SHIRTS, SWEAT SHORTS, SWEAT SUITS, SWIMSUITS, TANK TOPS, T-SHIRTS, VISORS, V-NECK SWEATERS, WIND RESISTANT JACKETS, WRIST BANDS, AND WRISTBANDS CONTAINING A COOLING SUBSTANCE TO COOL THE WEARER, DISTRIBUTED ONLY AT APPLICANT'S MULTI-SPORT ATHLETIC CONTESTS (U.S. CLS. 22 AND 39).

FIRST USE 1-1-2003; IN COMMERCE 1-1-2003.

CLASS 41—EDUCATION AND ENTERTAINMENT

FOR ENTERTAINMENT SERVICES, NAMELY PRESENTATION OF ATHLETIC CONTESTS FEATURING RUNNING, SWIMMING AND BIKING (U.S. CLS. 100, 101 AND 107).

FIRST USE 1-1-2003; IN COMMERCE 1-1-2003.
MARLENE BELL, EXAMINING ATTORNEY

SN 76-504,654. ASSOCIATION POUR LE DEVELOPPMENT ECONOMIQUE DE LA REGION LYONNAISE, LYON, FRANCE, FILED 4-8-2003.

ADERLY

OWNER OF FRANCE REG. NO. 023201388, DATED 12-24-2002, EXPIRES 12-24-2012.

CLASS 35—ADVERTISING AND BUSINESS

FOR ASSISTANCE IN RUNNING AND ORGANIZING INDUSTRIAL AND COMMERCIAL BUSINESSES, NAMELY, BUSINESS MANAGEMENT SERVICES FOR FEASIBILITY STUDIES, BUSINESS SITE LOCATION RESEARCH, REGULATORY CONSULTING, BUSINESS ORGANIZATION CONSULTATION, LOCATING SUPPLIERS OF OFFICE REQUISITES, EMPLOYEE RECRUITMENT, AND EMPLOYEE RELOCATION SERVICES; ADVERTISING SERVICES, NAMELY, PROMOTING THE SERVICES OF INDUSTRIAL, COMMERCIAL, AND RETAIL BUSINESSES BY RENDERING SALES PROMOTION ADVICE; BUSINESS RESEARCH AND CONSULTANCY; ANSWERING BUSINESS INQUIRIES AND PROVIDING BUSINESS INFORMATION CONCERNING GEOGRAPHIC REGIONS, BUSINESS DEVELOPMENT, AND BUSINESS PROJECTS; EMPLOYMENT AGENCIES AND PERSONAL RECRUITMENT SERVICES; PERSONAL MANAGEMENT CONSULTANCY; PUBLIC RELATIONS SERVICES; EMPLOYEE RELOCATION SERVICES (U.S. CLS. 100, 101 AND 102).

FIRST USE 1-0-1974; IN COMMERCE 1-0-1982.

CLASS 36—INSURANCE AND FINANCIAL

FOR FINANCIAL CONSULTING FOR BUSINESS (U.S. CLS. 100, 101 AND 102).

FIRST USE 0-0-1974; IN COMMERCE 1-0-1983.

CLASS 43—HOTEL AND RESTAURANT SERVICES

FOR ARRANGING HOUSING ACCOMMODATIONS FOR RELOCATED EMPLOYEES (U.S. CLS. 100 AND 101).

FIRST USE 1-0-1974; IN COMMERCE 1-0-1982.
KELLY BOULTON, EXAMINING ATTORNEY

SN 76-504,774. BIG CITY BREWING COMPANY LIMITED, KINGSTON 5, JAMAICA, FILED 4-7-2003.



PRIORITY CLAIMED UNDER SEC. 44(D) ON JAMAICA APPLICATION NO. 43532, FILED 2-11-2003, REG. NO. 43532, DATED 2-11-2003, EXPIRES 2-11-2010.

NO CLAIM IS MADE TO THE EXCLUSIVE RIGHT TO USE SHANDY, APART FROM THE MARK AS SHOWN.

CLASS 16—PAPER GOODS AND PRINTED MATTER

FOR LABELS; PAPER AND PRINTED MATTER, NAMELY BROCHURES, NEWSLETTERS, AND MAGAZINES IN THE FIELD OF ALCOHOLIC, MIXED AND NON-ALCOHOLIC BEVERAGES; PRINTED MATTER, NAMELY BANNERS, PRICE CARDS, TABLE TENTS, POSTERS, CALENDARS, CARDBOARD FLOOR DISPLAY UNITS FOR MERCHANDISING PRODUCTS, PAPER COASTERS, PAPER PENNANTS, AND BUMPER STICKERS (U.S. CLS. 2, 5, 22, 23, 29, 37, 38 AND 50).

CLASS 32—LIGHT BEVERAGES

FOR BEERS; MINERAL AND AERATED WATERS; FRUIT DRINKS AND FRUIT JUICES; SYRUP AND NON-ALCOHOLIC COCKTAIL MIXES FOR MAKING SHANDY (U.S. CLS. 45, 46 AND 48).

CLASS 33—WINES AND SPIRITS

FOR ALCOHOLIC BEVERAGES, NAMELY, ALCOHOLIC BEVERAGES PRODUCED FROM A BREWED MALT BASE WITH NATURAL FLAVORS; ALCOHOLIC COFFEE-BASED BEVERAGE; ALCOHOLIC MALT COOLERS; ALCOHOLIC PUNCH; ALCOHOLIC TEA-BASED BEVERAGE; PREPARED ALCOHOLIC COCKTAILS; APERITIFS WITH DISTILLED ALCOHOLIC LIQUOR BASE (U.S. CLS. 47 AND 49).

STEPHANIE DAVIS, EXAMINING ATTORNEY

SN 76-505,364. OASIS SILICONSYSTEMS HOLDING A.G., AUSTIN, TX. FILED 4-10-2003.

MEDIA LB

PRIORITY CLAIMED UNDER SEC. 44(D) ON FED REP GERMANY APPLICATION NO. 30309522.9/0, FILED 2-20-2003, REG. NO. 303095221, DATED 8-25-2003, EXPIRES 2-28-2013.

CLASS 9—ELECTRICAL AND SCIENTIFIC APPARATUS

FOR ELECTRONIC, ELECTRO-OPTICAL AND OPTICAL NETWORKS FOR DATA EXCHANGE, PARTICULARLY FOR ON-BOARD-ELECTRONICS OF VEHICLES; ELECTRONIC, ELECTRO-OPTICAL AND/OR OPTICAL COMPONENTS OF SAID NETWORKS, PARTICULARLY DATA LINES AND DATA BUS SYSTEMS, CONNECTORS AND INTERFACES, TRANSMITTERS AND RECEIVERS, TRANSCEIVERS, DIGITAL SIGNAL PROCESSORS, INTEGRATED CIRCUITS, MICROPROCESSORS, CONTROLLERS, A/D AND D/A CONVERTERS, AND DEVICES FOR PROVIDING VIRTUAL USER/SYSTEM INTERFACES; SOFTWARE, IN PARTICULAR FOR DATA EXCHANGE IN ELECTRONIC, ELECTRO-OPTICAL AND OPTICAL NETWORKS, FOR PROVIDING VIRTUAL INTERFACES, FOR MANAGING OF PHYSICAL INTERFACES, FOR EMULATING OF NETWORK DEVICES AND FOR PROVIDING VIRTUAL USER/SYSTEM INTERFACES; ELECTRONIC DEVICES FOR ENTERTAINMENT ELECTRONICS AND COMMUNICATION TECHNOLOGY, NAMELY, RADIOS, RADIO RECEIVERS, RADIO TUNERS, TV RECEIVERS, TV TUNERS, DRIVES, CD PLAYERS, CD RECORDERS, CD CHANGERS, DVD RECORDERS, DVD PLAYERS, DVD CHANGERS, COMPUTERS WITH INTERNET ACCESS, LAPTOP COMPUTERS WITH INTERNET ACCESS, NAVIGATION SYSTEMS, GLOBAL POSITIONING SYSTEMS (GPS), TELEMATIC DEVICES, SATELLITE RECEIVERS, LOUDSPEAKER SYSTEMS, AMPLIFIERS, A/D AND D/A CONVERTERS, DISPLAYS, TOUCH-SCREEN DISPLAYS, BUTTONS, SLIDERS, SPEECH RECOGNITION DEVICES, KEYS, KEYBOARDS, SCREENS, DIGITAL VIDEO BROADCAST (DVB), PERSONAL DIGITAL ASSISTANTS (PDA), TELEPHONES, MOBILE PHONES, SECURITY DEVICES, COCKPITS, MICROPHONES, LOUDSPEAKERS, HEADPHONES, VOICE ENTRIES AND OUTPUTS, AND GAME CONSOLES (U.S. CLS. 21, 23, 26, 36 AND 38).

CLASS 41—EDUCATION AND ENTERTAINMENT

FOR PROVIDING TRAINING AND CONDUCTING SEMINARS IN THE DESIGN AND USE OF PLASTIC OPTICAL FIBER NETWORKS IN AUTOMOBILES, NETWORKING, AUTOMOTIVE ELECTRONICS, COMMUNICATION TECHNOLOGY, AND AUDIO AND VIDEO APPLICATIONS (U.S. CLS. 100, 101 AND 107).

CLASS 42—SCIENTIFIC, COMPUTER AND LEGAL SERVICES

FOR COMPUTER SOFTWARE DESIGN AND CONSULTATION FOR OTHERS; DESIGN OF INTEGRATED CIRCUITS AND CHIP DEVELOPMENT FOR OTHERS; LICENSING NETWORK TECHNOLOGY FOR ELECTRONIC, ELECTRO-OPTICAL AND OPTICAL NETWORKS FOR DATA EXCHANGE (U.S. CLS. 100 AND 101).

ALLISON HOLTZ, EXAMINING ATTORNEY

SN 76-505,413. SEIKO INSTRUMENTS KABUSHIKI KAISHA, TA SEIKO INSTRUMENTS INC., CHIBA 261-8507, JAPAN, FILED 4-10-2003.

**Wrist Mount System**

PRIORITY CLAIMED UNDER SEC. 44(D) ON JAPAN APPLICATION NO. 2002-105907, FILED 12-16-2002, REG. NO. 4707437, DATED 9-5-2003, EXPIRES 9-5-2013.

NO CLAIM IS MADE TO THE EXCLUSIVE RIGHT TO USE WRIST MOUNT SYSTEM, APART FROM THE MARK AS SHOWN.

CLASS 9—ELECTRICAL AND SCIENTIFIC APPARATUS

FOR MEASURING OR TESTING MACHINES AND INSTRUMENTS, NAMELY, TEMPERATURE INDICATORS, ACCELERATION INDICATORS, MANOMETERS, ALTIMETERS, AND MAGNET-COMASSES; BATTERIES; ELECTRIC WIRE AND CABLES; PHOTOGRAPHIC APPARATUS AND INSTRUMENTS, NAMELY, CAMERAS; CINEMATOGRAPHIC APPARATUS AND INSTRUMENTS, NAMELY, SOUND RECORDING APPARATUS; SPECTACLES; GLASS TUBES FOR SCIENTIFIC PURPOSES; ELECTRIC COMMUNICATION APPARATUS AND INSTRUMENTS, NAMELY, TELEPHONES, TELEVISIONS, RADIOS, PORTABLE COMMUNICATION APPARATUS, REMOTE CONTROLLERS, SPEAKERS, MICROPHONES, AND CAMCORDERS; ELECTRONIC MACHINES AND INSTRUMENTS, NAMELY, COMPUTERS, WORD PROCESSORS AND DESKTOP ELECTRIC CALCULATORS AND PARTS AND FITTINGS THEREFOR; ELECTROLYSIS APPARATUS FOR ELECTROPLATING PURPOSES; ELECTRICAL CIRCUITS FOR USE IN AMUSEMENTS GAME MACHINES FOR REPRODUCING MUSIC, SPEECH, AND SPECIAL EFFECTS; ROTARY CONVERTERS; ELECTRIC FLAT IRONS; ELECTRICALLY HEATED HAIRCURLERS; ELECTRIC DOORBELLS; RAILWAY SAFETY LIGHTS AND SIGNAL BELLS; VEHICLE BREAKDOWN WARNING TRIANGLES; LUMINOUS OR MECHANICAL ROAD SIGNS; FIRE ALARMS; GLOVES FOR PROTECTION AGAINST ACCIDENTS; FIRE EXTINGUISHERS; FIRE HOSE NOZZLES; FIRE ENGINES; FIRE BOATS; ANTI-THEFT WARNING APPARATUS; PROTECTIVE HELMETS; FIREPROOF CLOTHING; DUST MASKS; GAS MASKS; ELECTRIC CIGAR LIGHTERS FOR AUTOMOBILES; ELECTRIC RESISTANCE WIRE; WELDING ELECTRODES; WELDING MASKS; SLIDE FILM MOUNTS; VENDING MACHINES; COIN-OPERATED GATES FOR CAR PARKS OR PARKING LOTS; CASH REGISTERS; CALCULATING SCALES; COIN COUNTING AND SORTING MACHINES; EVENT RECORDERS; PHOTO-COPYING MACHINES; MANUALLY OPERATED CALCULATORS; DRAWING OR DRAFTING MACHINES; TIME STAMPING MACHINES; TIME RECORDERS; ELECTRIC CALCULATORS; PUNCH CARD MACHINES; PUNCH CLOCK MACHINES; VOTING MACHINES; AUTOMATED BILLING MACHINES; WEIGHT BELTS FOR DIVING; AIR TANKS FOR USE IN SCUBA DIVING; REGULATORS FOR USE IN SCUBA DIVING; DOG WHISTLES; ELECTRIC AUTOMATIC DOOR OPENERS; METRONOMES (U.S. CLS. 21, 23, 26, 36 AND 38).

CLASS 14—JEWELRY

FOR PRECIOUS METALS, NUTCRACKERS OF PRECIOUS METAL, PEPPER POTS OF PRECIOUS METAL, SUGAR BOWLS OF PRECIOUS METAL, SALT SHAKERS OF PRECIOUS METAL, EGG CUPS OF PRECIOUS METAL, NAPKIN HOLDERS OF PRECIOUS METAL, NAPKIN RINGS OF PRECIOUS METAL, TRAYS OF PRECIOUS METAL, TOOTHPICK HOLDERS OF PRECIOUS METAL, FLOWER VASES AND BOWLS OF PRECIOUS METAL, BOXES OF PRECIOUS METAL FOR NEEDLES, JEWEL CASES OF PRECIOUS METAL, CANDLE EXTINGUISHERS AND CANDLESTICKS OF PRECIOUS METAL, PURSE SAND WALLETS OF PRECIOUS METAL, SHOE ORNAMENTS OF PRECIOUS METAL, POWDER COMPACTS OF PRECIOUS METAL, SMOKERS' ARTICLES OF PRECIOUS METAL, UNWROUGHT AND SEMI-WROUGHT PRECIOUS STONES AND THEIR IMITATIONS, CLOCKS AND WATCHES (U.S. CLS. 2, 27, 28 AND 50).

CLASS 28—TOYS AND SPORTING GOODS

FOR VIDEO GAME APPARATUS FOR PERSONAL USE, NAMELY, HAND HELD UNIT FOR PLAYING VIDEO GAMES AND STAND ALONE VIDEO GAME MACHINES (U.S. CLS. 22, 23, 38 AND 50).

CLASS 38—COMMUNICATION

FOR MOBILE TELEPHONE COMMUNICATION, COMMUNICATION BY COMPUTER TERMINALS, COMMUNICATION BY TELEPHONE FACSIMILE TRANSMISSION, PAGING SERVICES, RENTAL OF TELECOMMUNICATION EQUIPMENT INCLUDING TELEPHONES AND FACSIMILE APPARATUS (U.S. CLS. 100, 101 AND 104).

NORA BUCHANAN WILL, EXAMINING ATTORNEY

SN 76-510,392. UNITED ASSOCIATION OF JOURNEYMEN AND APPRENTICES OF THE PLUMBING AND PIPE FITTING INDUSTRY OF THE UNITED STATES AND CANADA, WASHINGTON, DC. FILED 4-29-2003.



NO CLAIM IS MADE TO THE EXCLUSIVE RIGHT TO USE SPRINKLERFITTERS STEAMFITTERS UNION PLUMBERS PIPEFITTERS SERVICE TECHNICIANS, APART FROM THE MARK AS SHOWN.

CLASS 35—ADVERTISING AND BUSINESS

FOR UNION ASSOCIATION SERVICES, NAMELY, PROMOTING THE INTERESTS OF PLUMBERS, PIPEFITTERS, SPRINKLERFITTERS, STEAMFITTERS AND SERVICE TECHNICIANS AND OTHER EMPLOYEES IN THE PLUMBING AND PIPEFITTING INDUSTRY (U.S. CLS. 100, 101 AND 102).

FIRST USE 8-6-2001; IN COMMERCE 8-6-2001.

CLASS 200—COLLECTIVE MEMBERSHIP

FOR COLLECTIVE MEMBERSHIP MARK INDICATING MEMBERSHIP IN A UNION OF PLUMBERS, PIPE FITTERS, SERVICE TECHNICIANS, SPRINKLERFITTERS, STEAMFITTERS.

FIRST USE 8-6-2001; IN COMMERCE 8-6-2001.

YSA DEJESUS, EXAMINING ATTORNEY

SN 76-511,698. RHEINMETALL DEFENCE ELECTRONICS GMBH, 28309 BREMEN, FED REP GERMANY, FILED 5-5-2003.

ASRAD

PRIORITY CLAIMED UNDER SEC. 44(D) ON FED REP GERMANY APPLICATION NO. 30254759.2/0, FILED 11-9-2002, REG. NO. 30254759, DATED 2-13-2003, EXPIRES 11-30-2012.

CLASS 9—ELECTRICAL AND SCIENTIFIC APPARATUS

FOR FIRING CONTROL SYSTEMS FOR THE AIR DEFENSE, ESSENTIALLY CONSISTING OF SENSORS FOR MONITORING THE AIR SPACE, DATA PROCESSORS, PICTURE COMPILERS, OPERATING CONSOLES WITH MONITORS AND OPERATOR CONTROL PANELS, INTERFACE UNITS FOR CONNECTING TO EFFECTORS; ELECTRONIC, ELECTRO-OPTICAL AND ELECTRO-MECHANICAL APPARATUS USED TO CONTROL FIRING OF ARMAMENTS; EQUIPMENT FOR TARGET ACQUISITION, TARGET TRACKING, TARGET SURVEY AND TARGET CLASSIFICATION, NAMELY COMPUTER HARDWARE AND SOFTWARE, SENSORS, DETECTORS, PROCESSORS, TRANSMITTERS, ANTENNAS, DISPLAY PROJECTORS AND DISPLAY SCREENS, SEEKERS, AND LASER GUIDANCE UNITS; RADAR, RADAR ANTENNAS; NAVIGATION EQUIPMENT, NAMELY VIDEO SOUNDERS, PLOTTERS, RADAR, GPS RECEIVERS, SONAR, GLOBAL POSITIONERS, RADIO RECEIVERS, ANTENNAS, DISPLAY MONITORS, AND COMPUTER HARDWARE AND OPERATING SOFTWARE FOR USE THEREWITH; PLATFORM STABILIZING SYSTEMS COMPOSED PRIMARILY OF GYROSCOPES; LASER RANGE FINDERS; THERMAL AND TV IMAGING SENSORS AND CAMERAS; OPTOELECTRONIC SENSORS FOR THE MEASUREMENT AND DETECTION OF OBJECTS; OPERATING AND DISPLAY CONSOLES AND HOUSINGS; DEVICES FOR THE INPUT AND OUTPUT OF DATA AND PROGRAMS, NAMELY MICROPROCESSORS, MODEMS, AND COMPUTER HARDWARE; BLANK MAGNETIC DATA CARRIERS; DATA AND COMPUTER PROGRAMS ON OPTIONAL TYPES OF STORAGE MEDIA FOR MILITARY AND GOVERNMENT USE, NAMELY, AIR DEFENSE, AIR TRAFFIC CONTROL, ELECTRONIC COUNTER MEASURES, ELECTRONIC SUPPORT MEASURES, AND IMAGE PROCESSING (U.S. CLS. 21, 23, 26, 36 AND 38).

CLASS 13—FIREARMS

FOR WEAPONS SYSTEMS, NAMELY ANTI-AIRCRAFT GUNS AND MISSILES, AND SIGHTING AND AIMING DEVICES, WEAPONS PLATFORMS OR PEDESTALS THEREFORE; ROCKET LAUNCHERS (U.S. CLS. 2 AND 9).

CLASS 41—EDUCATION AND ENTERTAINMENT

FOR CUSTOM WRITING OF INSTRUCTION MANUALS AND REPLACEMENT PARTS LISTS FOR OTHERS; CUSTOM WRITING OF MAINTENANCE SCHEDULES FOR OTHERS (U.S. CLS. 100, 101 AND 107).

CLASS 42—SCIENTIFIC, COMPUTER AND LEGAL SERVICES

FOR PROVIDING TECHNICAL SUPPORT FOR GOODS IN THE FIELDS OF WEAPONS SYSTEMS, DEFENSE SYSTEMS, INTELLIGENCE SYSTEMS AND SECURITY SYSTEMS VIA LIVE CONSULTATION, ON-LINE INSTRUCTION, AND TELEPHONE; STARTUP, REPAIR, UPDATING AND UPGRADING OF COMPUTER SOFTWARE AND COMPUTER PROGRAMS FOR THIRD PARTIES FOR A FEE (U.S. CLS. 100 AND 101).
ANDREW BENZMILLER, EXAMINING ATTORNEY

SN 76-513,126. UBS AG, CH-8001 ZÜRICH, SWITZERLAND,
FILED 5-9-2003.

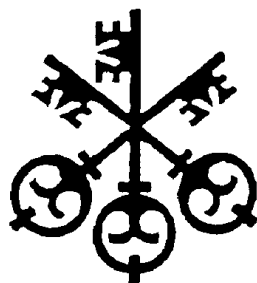

PRIORITY CLAIMED UNDER SEC. 44(D) ON SWITZERLAND APPLICATION NO. 09603/2002, FILED 11-11-2002, REG. NO. 509981, DATED 5-2-2003, EXPIRES 11-11-2012.

CLASS 3—COSMETICS AND CLEANING PREPARATIONS

FOR SOAPS; PERFUMERY, ETHEREAL OILS NAMELY BODY OIL, ESSENTIAL OILS FOR PERSONAL USE; COSMETICS; BEAUTY CARE PRODUCTS, NAMELY BODY AND FACE MOISTURIZING CREAMS, MASKS AND ANTI-AGING CREAMS; AND DENTIFRICES (U.S. CLS. 1, 4, 6, 50, 51 AND 52).

CLASS 6—METAL GOODS

FOR COMMON METALS AND THEIR ALLOYS FOR FURTHER MANUFACTURING (U.S. CLS. 2, 12, 13, 14, 23, 25 AND 50).

CLASS 7—MACHINERY

FOR HOUSEHOLD OR KITCHEN APPLIANCES NOT MADE OF OR COATED WITH PRECIOUS METALS, NAMELY, ELECTRIC FOOD BLENDERS AND ELECTRIC MIXERS; ELECTRIC SCISSORS (U.S. CLS. 13, 19, 21, 23, 31, 34 AND 35).

CLASS 8—HAND TOOLS

FOR HAND-OPERATED TOOLS AND IMPLEMENTS, NAMELY HAMMERS, WRENCHES, SCREWDRIVERS, CHOPPERS, SLICERS AND SHEARS; CUTLERY; FORKS AND SPOONS; AND SCISSORS (U.S. CLS. 23, 28 AND 44).

CLASS 9—ELECTRICAL AND SCIENTIFIC APPARATUS

FOR ELECTRONIC EQUIPMENT AND INSTRUMENTS, NAMELY CURRENCY CONVERTERS, AGENDAS, PAGERS AND PERSONAL ORGANIZERS; EQUIPMENT FOR THE RECORDING, STORING, PROCESSING, TRANSMISSION OR REPRODUCTION OF DATA, IN PARTICULAR OF SOUND, IMAGES OR TEXT, OF INFORMATION AND MESSAGES, NAMELY COMPUTER AND COMPUTER CABLES, DIGITAL AUDIO TAPE PLAYERS AND RECORDERS, DIGITAL VIDEO RECORDERS AND PLAYERS, DIGITAL CAMERAS AND DIGITAL CELLULAR PHONES; MAGNETIC RECORDING DEVICES, NAMELY TAPE DRIVES; TELECOMMUNICATIONS DEVICES AND INSTALLATIONS, NAMELY TELEPHONES, TELEPHONE SWITCHES, TELEPHONE ANSWERING MACHINES AND CALLER IDENTIFICATION BOXES; PRE-RECORDED OPTICAL, MAGNETIC AND ELECTRONIC DATA CARRIERS IN THE FIELD OF BANKING, INSURANCE AND FINANCIAL SERVICES; COMPUTER HARDWARE AND SOFTWARE IN THE FIELDS OF INVESTMENT BANKING, ON-LINE BANKING, INSURANCE AND FINANCIAL SERVICES, NAMELY FOR ACCESSING FINANCIAL AND ACCOUNT INFORMATION, DATABASE MANAGEMENT, FOR TRANSACTING BANK AND INVESTMENT BUSINESS AND FOR THE TRADING OF SECURITIES, CURRENCIES, OPTIONS, FOREIGN EXCHANGE, FUTURES, FUNDS AND COMMODITIES; DOWNLOADABLE ELECTRONIC PUBLICATIONS IN THE NATURE OF A MAGAZINE, NEWSLETTER AND REPORTS IN THE FIELDS OF BANKING, INSURANCE, INVESTMENTS AND FINANCIAL SERVICES (U.S. CLS. 21, 23, 26, 36 AND 38).

CLASS 11—ENVIRONMENTAL CONTROL APPARATUS

FOR WALL, TABLE AND DESK ELECTRIC LIGHT FITTINGS AND LAMPS; OIL LAMPS; HOUSEHOLD OR KITCHEN APPLIANCES, NOT MADE OF OR COATED WITH PRECIOUS METALS, NAMELY MICROWAVE OVENS FOR COOKING, ELECTRIC HAIR DRYERS AND ELECTRIC TOASTERS (U.S. CLS. 13, 21, 23, 31 AND 34).

CLASS 12—VEHICLES

FOR VEHICLES, NAMELY CARS, TRUCKS, MOTORCYCLES, ALL TERRAIN VEHICLES, AND MOTORIZED GOLF CARTS; APPARATUS FOR LOCOMOTION BY LAND, AIR, OR WATER, NAMELY CARS, TRUCKS, MOTORCYCLES, AIRPLANES, GLIDERS, ALL TERRAIN VEHICLES, BOATS AND MOTORIZED GOLF CARTS (U.S. CLS. 19, 21, 23, 31, 35 AND 44).

CLASS 14—JEWELRY

FOR PRECIOUS METALS AND THEIR ALLOYS AND GOODS MANUFACTURED FROM OR COATED WITH PRECIOUS METALS, NAMELY GOLD, SILVER AND PLATINUM BARS, CANDLE STICK HOLDERS, JEWELRY BOXES AND LETTER OPENERS; COINS, NAMELY MONETARY, NON-MONETARY AND COLLECTIBLE COINS; PRECIOUS METAL INGOTS; JEWELRY, PRECIOUS GEMSTONES; HOROLOGICAL AND CHRONOMETRICAL INSTRUMENTS, NAMELY CLOCKS, WATCHES, CHRONOMETERS; SMOKERS ARTICLES, NAMELY LIGHTERS OF PRECIOUS METALS AND CASES OF PRECIOUS METAL (U.S. CLS. 2, 27, 28 AND 50).

CLASS 15—MUSICAL INSTRUMENTS

FOR MUSICAL INSTRUMENTS (U.S. CLS. 2, 21 AND 36).

CLASS 16—PAPER GOODS AND PRINTED MATTER

FOR PRINTED PRODUCTS, NAMELY BROCHURES, MAGAZINES, NEWSPAPERS, REPORTS, CATALOGUES, LISTS, MANUALS, PAMPHLETS, LEAFLETS AND FLYERS IN THE FIELD OF BANKING, FINANCE, INVESTMENT AND INSURANCE; PRINTED INSTRUCTIONAL, EDUCATIONAL AND TEACHING MATERIALS, WRITING PAPER, COMPUTER PAPER AND STATIONERY, NAMELY FOR BANKING, FINANCE, INVESTMENT AND INSURANCE USES; JOURNALS AND PUBLICATIONS, NAMELY FINANCIAL MAGAZINES AND ACCOUNTING BOOKS; ADVERTISING MATERIALS, NAMELY POSTERS AND PAPER BANNERS; PRINTED INSTRUCTIONAL AND TEACHING MATERIAL IN THE FIELD OF BANKING, FINANCE, INVESTMENT AND INSURANCE; DESK, POCKET AND WALL CALENDARS; DATE BOOKS; PACKAGING MATERIAL, NAMELY PAPER, PAPER AND CARDBOARD BOXES AND PAPER AND PLASTIC BAGS; TABLE COVERS OF PAPER; ORNAMENTAL DESK SETS (U.S. CLS. 2, 5, 22, 23, 29, 37, 38 AND 50).

CLASS 18—LEATHER GOODS

FOR LEATHER AND IMITATION LEATHER SOLD IN BULK, AND GOODS MADE FROM THESE MATERIALS, NAMELY PURSES, WALLETS, KEY CHAINS, ALL PURPOSE SPORTS AND ATHLETIC BAGS AND AGENDA CASES; TRUNKS AND TRAVELING BAGS; UMBRELLAS, PARASOLS AND WALKING STICKS (U.S. CLS. 1, 2, 3, 22 AND 41).

CLASS 20—FURNITURE AND ARTICLES NOT OTHERWISE CLASSIFIED

FOR FURNITURE; MIRRORS AS FURNITURE; PICTURE FRAMES; GOODS MADE OF WOOD, CORK, REED, CANE, WICKER, WILLOW, HORN, BONE, IVORY, WHALEBONE, TORTOISESHELL, AMBER, MOTHER OF PEARL, MEERSCHAUM AND SUBSTITUTES FOR ALL THESE MATERIALS, OR OF PLASTIC, NAMELY FURNITURE, PICTURE FRAMES; ADVERTISING MATERIALS, NAMELY PLASTIC BANNERS (U.S. CLS. 2, 13, 22, 25, 32 AND 50).

CLASS 21—HOUSEWARES AND GLASS

FOR HOUSEHOLD OR KITCHEN UTENSILS NOT MADE OR COATED WITH PRECIOUS METALS NAMELY GRATERS, SPATULAS, DRINKING FLASKS, BARWARE, NAMELY WINE BUCKETS, CORKSCREWS, COCKTAIL SHAKERS, BOTTLE OPENERS, AND CONTAINERS NOT MADE OF OR COATED WITH PRECIOUS METALS; CLEANING COMBS AND SPONGES; BRUSHES, EXCLUDING PAINTBRUSHES, NAMELY FOR SHOES AND CLEANING—CLEANING MATERIALS, NAMELY RAGS AND STEEL WOOL; GLASSWARE, PORCELAIN AND EARTHENWARE, NAMELY EGGS, FIGURES AND BUSTS (U.S. CLS. 2, 13, 23, 29, 30, 33, 40 AND 50).

CLASS 24—FABRICS

FOR CLOTH TEXTILES FOR THE MANUFACTURE OF TEXTILE GOODS NAMELY PLACE MATS, NAPKINS AND SHOPPING BAGS; BED COVERS AND TABLE COVERS NOT OF PAPER; ADVERTISING MATERIALS, NAMELY CLOTH BANNERS (U.S. CLS. 42 AND 50).

CLASS 25—CLOTHING

FOR CLOTHING, NAMELY, SHIRTS, PANTS AND JACKETS; FOOTWEAR; HEADWEAR; HEADGEAR, NAMELY HATS, CAPS AND EAR MUFFS (U.S. CLS. 22 AND 39).

CLASS 27—FLOOR COVERINGS

FOR CARPETS, RUGS, DOOR AND BATH MATS; CARPET, RUG, DOOR AND BATH MATTING (U.S. CLS. 19, 20, 37, 42 AND 50).

CLASS 28—TOYS AND SPORTING GOODS

FOR GAMES AND PLAYTHINGS, NAMELY CARD GAMES, BOARD GAMES AND ACTION SKILL GAMES; GYMNASIAC APPARATUS AND SPORT ARTICLES, NAMELY GOLF BALLS, BASEBALLS, SOFTBALLS, RACQUETBALLS BALLS, TENNIS BALLS, BASKETBALLS, SQUASH BALLS, BASEBALL AND SOFTBALL BATS, BASKETBALL GOAL SETS, STREET HOCKEY GOAL SETS, ICE HOCKEY PUCKS, ICE HOCKEY STICKS AND SOCCER GOAL SETS; CHRISTMAS TREE DECORATIONS; PLAYING CARDS; VEHICLES AND APPARATUS OF LOCOMOTION BY LAND, NAMELY, NON-MOTORIZED GOLF CARTS; ORNAMENTAL DOLLS (U.S. CLS. 22, 23, 38 AND 50).

CLASS 30—STAPLE FOODS

FOR COFFEE, TEA, COCOA, SUGAR, RICE; BREAD; PASTRY AND CONFECTIONERY, NAMELY CAKES, PIES, COOKIES AND CANDIES; FLAVORED ICES; HONEY; AND SPICES (U.S. CL. 46).

CLASS 32—LIGHT BEVERAGES

FOR BEERS; MINERAL AND CARBONATED WATERS AND OTHER NON-ALCOHOLIC DRINKS, NAMELY DRINKING WATER, SODA WATER AND CARBONATED SOFT DRINKS, LOW CALORIE SOFT DRINKS AND FLAVORED SOFT DRINKS; FRUIT DRINKS AND FRUIT JUICES (U.S. CLS. 45, 46 AND 48).

CLASS 33—WINES AND SPIRITS

FOR ALCOHOLIC DRINKS, EXCLUDING BEERS, NAMELY WINES, SCOTCH, VODKA, GIN, RUM, WHISKEYS AND SCHNAPPS (U.S. CLS. 47 AND 49).

CLASS 34—SMOKERS' ARTICLES

FOR TOBACCO; SMOKERS' ARTICLES, NAMELY PIPES, LIGHTERS OF NON-PRECIOUS METALS, CASES OF NON-PRECIOUS METALS, CIGAR CUTTERS, CIGAR TUBES AND ASH RECEPTACLES; MATCHES (U.S. CLS. 2, 8, 9 AND 17).

CLASS 35—ADVERTISING AND BUSINESS

FOR ADVERTISING AGENCY SERVICES; PROCUREMENT, NAMELY PURCHASING ENERGY, SOURCES OF ENERGY AND ENERGY BY-PRODUCTS FOR OTHERS, AND CONSULTANCY SERVICES IN CONNECTION THEREWITH; PROCUREMENT OF LONG-TERM SUPPLY CONTRACTS FOR THIRD PARTIES IN CONNECTION WITH THE PROVISION OF ENERGY, SOURCES OF ENERGY, AND ENERGY BY-PRODUCTS FOR OTHERS; RENTAL OF ADVERTISING SPACE FOR THIRD PARTIES ON THE WORLD-WIDE COMPUTER NETWORKS OR IN CONVENTIONAL MEDIA; MARKET RESEARCH; MARKETING FOR OTHERS; TELEMARKETING; TELEPHONE ANSWERING SERVICES; PUBLIC RELATIONS; ORGANIZING TRADE AND INDUSTRIAL FAIRS; ORGANIZING AND CONDUCTING EXHIBITIONS IN THE FIELDS OF ENERGY, BUSINESS ADMINISTRATION, BANKING AND FINANCIAL MATTERS; PREPARATION OF BUSINESS MANAGEMENT INFORMATION ON A WIDE VARIETY OF TOPICS FOR TRADE AND INDUSTRY; PRODUCTION OF ECONOMIC FORECASTS; FINANCIAL ANALYSIS, NAMELY, ASSESSMENTS OF VALUE AND EFFICIENCY IN BUSINESS MATTERS; BUSINESS CONSULTANCY SERVICES IN THE FIELD OF THE MANAGEMENT OF PRICE RISKS; STAFF RECRUITMENT; OFFICE WORK, NAMELY SECRETARIAL AND CLERICAL SERVICES; ACCOUNTING, INTERNAL AND EXTERNAL BUSINESS AUDITING; BUSINESS MANAGEMENT; PROVISION OF BUSINESS MANAGEMENT INFORMATION VIA GLOBAL COMPUTER NETWORKS; CONSULTANCY SERVICES ON THE ORGANIZATION AND MANAGEMENT OF BUSINESSES; BUSINESS ADMINISTRATION; BUSINESS CONSULTANCY SERVICES ON THE CONDUCT OF COMMERCIAL TRANSACTIONS; PROCESSING OF STATISTICAL DATA; PROCESSING AND SYSTEMATIZING OF DATA IN COMPUTER DATABASES; COMPUTER DATABASE

MANAGEMENT; E-COMMERCE SERVICES, IN PARTICULAR PROVISION OF PRODUCT INFORMATION VIA WORLD-WIDE COMPUTER OR TELEMATIC NETWORKS FOR ADVERTISING AND SALES PURPOSES; COMPILATION AND SYSTEMATIZATION OF PUBLIC AND PRIVATE DATA IN DATABASES; INTERNET BASED RETAIL SERVICES FOR OTHERS, NAMELY COMPUTER HARDWARE AND SOFTWARE STORES VIA WORLD-WIDE COMPUTER NETWORKS; CONDUCT OF ART AUCTIONS; ON-LINE ORDERING SERVICE VIA COMPUTER SYSTEMS FOR TRADING IN ENERGY; PROCESSING AND SYSTEMATIZING OF DATA IN COMPUTER DATABASES IN THE FIELD OF TRADING IN OIL, GAS, ELECTRICITY AND OTHER ENERGY SOURCES; MANAGEMENT AND PROCESSING OF IMAGE, AUDIO AND TEXT FILES AND INFORMATION ABOUT ENERGY; MARKETING SERVICE FOR OTHERS IN THE FIELD OF TRADING IN ENERGY AND SOURCES OF ENERGY; PROMOTING THE GOODS OF OTHERS IN THE FIELD OF ENERGY AND SOURCES OF ENERGY AS WELL AS PETRO-CHEMICAL PRODUCTS THROUGH THE DISTRIBUTION OF PRINTED AND AUDIO MATERIALS AND PROVIDING HYPERTEXT LINKS TO THE WEB SITES OF OTHERS; CONSULTANCY SERVICES ON ENERGY CONSERVATION AND DEVELOPMENT OF COMPREHENSIVE ENERGY CONSERVATION PLANS FOR HOUSEHOLDS, BUSINESSES AND INDUSTRY; COLLECTION OF STATISTICAL DATA; COLLECTION OF DATA IN COMPUTER DATABASES IN THE FIELD OF TRADING IN OIL, GAS, ELECTRICITY AND OTHER ENERGY SOURCES (U.S. CLS. 100, 101 AND 102).

CLASS 36—INSURANCE AND FINANCIAL

FOR INSURANCE AFFAIRS, NAMELY INSURANCE BROKERAGE; INSURANCE CONSULTATION; INSURANCE UNDERWRITING FOR ALL TYPES OF INSURANCE; FINANCIAL AFFAIRS, NAMELY FINANCIAL MANAGEMENT AND FINANCIAL ANALYSIS AND CONSULTATION; BANKING; PROVISION OF FINANCIAL INFORMATION VIA COMPUTER SYSTEMS; ELECTRONIC BANKING SERVICES VIA A WORLD-WIDE COMPUTER NETWORK; INTERACTIVE ELECTRONIC PROVISION OF FINANCIAL SERVICES, NAMELY PROVIDING ON-LINE STORED VALUE ACCOUNTS IN AN ELECTRONIC ENVIRONMENT AND BANKING SERVICES VIA GLOBAL COMPUTER NETWORKS; STOCK EXCHANGE SERVICES INCLUDING TRADING IN SECURITIES, DERIVATIVES AND CURRENCIES; MONEY LENDING; BROKER AND CONSULTANCY SERVICES IN CONNECTION WITH INSURANCE, FINANCIAL, BANKING OR REAL ESTATE MATTERS AS WELL AS CURRENCY EXCHANGE AND TRADING MATTERS, AND AGENCY SERVICES IN CONNECTION WITH INSURANCE OR REAL ESTATE MATTERS AS WELL AS CURRENCY TRADING MATTERS; FINANCIAL CONSULTANCY SERVICES IN THE FIELD OF PAYMENT SYSTEMS; MANAGEMENT OF PROVIDENT FUNDS; FINANCIAL TRANSACTIONS, NAMELY INVESTMENT FUND TRANSFER AND TRANSACTIONS AND ELECTRONIC FUND TRANSFER; CONSULTANCY SERVICES IN THE FIELD OF FINANCIAL PLANNING AND FINANCIAL MANAGEMENT; SERVICES IN THE FIELD OF INVESTMENT AND RISK MANAGEMENT; ASSET MANAGEMENT; REAL ESTATE SERVICES, NAMELY REAL ESTATE ACQUISITION SERVICES, REAL ESTATE APPRAISAL, REAL ESTATE EQUITY SHARING, NAMELY, MANAGING AND ARRANGING FOR CO-OWNERSHIP OF REAL ESTATE, REAL ESTATE ESCROW SERVICES, REAL ESTATE INVESTMENT AND REAL ESTATE MANAGEMENT; FINANCIAL SERVICES FOR TRUSTS, NAMELY ESTATE TRUST MANAGEMENT, TRUST SERVICES, NAMELY, INVESTMENT AND TRUST COMPANY SERVICES, ESTATE PLANNING AND TRUSTEESHIP REPRESENTATIVES; EVALUATION OF FINANCIAL INVESTMENTS; BROKERAGE SERVICES IN CONNECTION WITH TRADING IN ENERGY, SOURCES OF ENERGY AND ENERGY BY-PRODUCTS; FINANCIAL SPONSORSHIP IN THE FIELDS OF CULTURAL ARTS, SPORTS AND ECONOMIC, LAW, TAX AND POLITICAL RESEARCH; INTERACTIVE ELECTRONIC CONDUCT OF FINANCIAL AND BANKING SERVICES VIA GLOBAL COMPUTER NETWORKS; CONSULTANCY SERVICES FOR ALL THE ABOVE-LISTED SERVICES (U.S. CLS. 100, 101 AND 102).

CLASS 37—CONSTRUCTION AND REPAIR

FOR BUILDING CONSTRUCTION; REPAIR OF BUILDINGS AND ROOFS; INSTALLATION OF OFFICE DIVIDERS, COMPUTER WORKSTATIONS AND ELECTRICAL SYSTEMS (U.S. CLS. 100, 103 AND 106).

CLASS 38—COMMUNICATION

FOR TELECOMMUNICATIONS, NAMELY LOCAL AND LONG DISTANCE TRANSMISSION OF VOICE, DATA AND GRAPHICS BY MEANS OF TELEPHONE, TELEGRAPHIC, CABLE, AND SATELLITE; TELECOMMUNICATIONS CONSULTANCY SERVICES IN THE FIELD OF PAYMENT SYSTEMS; TELEGRAM SERVICES; TRANSMISSION, DISSEMINATION AND MAILING OF DOCUMENTS, MESSAGES, DATA AND INFORMATION VIA COMPUTER NETWORKS AND OTHER ELECTRONIC OR DIGITAL COMMUNICATIONS NETWORKS; ELECTRONIC TRANSMISSION, INCLUDING ON-LINE TRANSMISSION OF FINANCIAL TRANSACTION DATA; TRANSMISSION OF BUSINESS INFORMATION VIA GLOBAL COMPUTER NETWORKS; TELETXT; VIDEOTEXT AND ELECTRONIC MAIL SERVICES; PROVISION OF MULTIPLE USER ACCESS TO THE GLOBAL COMPUTER NETWORKS, NAMELY THE INTERNET, DATABASES AND WEBSITES; PROVISION OF TELECOMMUNICATIONS CONNECTIONS TO A GLOBAL COMPUTER NETWORK FOR THE RECEIPT OF ORDERS FOR GOODS AND SERVICES BY ELECTRONIC DATA TRANSMISSION; ELECTRONIC MAIL SERVICES IN CONNECTION WITH A DATABASE, NAMELY THE RECEIPT OF MESSAGES OF ANY NATURE FROM DATABASE USERS AND FORWARDING SUCH MESSAGES TO OTHER DATABASE USERS; PROVISION OF MULTIPLE USER ACCESS VIA HYPER CONNECTIONS TO GLOBAL COMPUTER NETWORKS TO ACCESS DATA AND INFORMATION; AND CONSULTANCY SERVICES FOR ALL THE ABOVE-LISTED SERVICES (U.S. CLS. 100, 101 AND 104).

CLASS 39—TRANSPORTATION AND STORAGE

FOR STORAGE, TRANSPORT AND DISTRIBUTION OF ENERGY, OF SOURCES OF ENERGY AND OF ENERGY BY-PRODUCTS; DELIVERY SERVICES IN THE FIELD OF ENERGY, SOURCES OF ENERGY AND ENERGY BY-PRODUCTS; TRANSPORT OF MONEY AND VALUABLES VIA TRAINS, AIRPLANES, TRUCKS AND ARMORED VANS IN THE FIELDS OF FINANCIAL AND BANKING SERVICES; DELIVERY OF GOODS BY AIRPLANES, TRUCKS, TRAINS AND ARMORED VANS (U.S. CLS. 100 AND 105).

CLASS 40—MATERIAL TREATMENT

FOR TREATMENT OF MATERIALS, NAMELY METAL TREATMENT, APPLYING PROTECTIVE COATING TO WOOD AND METAL AND COTTON; TREATMENT, NAMELY, MOLD PREVENTION TREATMENT TO COTTON TEXTILES, FABRICS AND CLOTHING (U.S. CLS. 100, 103 AND 106).

CLASS 41—EDUCATION AND ENTERTAINMENT

FOR EDUCATION, NAMELY CONDUCTING CLASSES, SEMINARS AND CONFERENCES IN THE FIELD OF BANKING, INSURANCE, INVESTMENTS, MANAGEMENT AND FINANCIAL SERVICES; PROVISION OF TRAINING IN THE FIELD OF BANKING, INSURANCE, INVESTMENTS, MANAGEMENT AND FINANCIAL SERVICES; ORGANIZATION AND CONDUCT OF SEMINARS AND WORKSHOPS IN THE FIELD OF BANKING, INSURANCE, INVESTMENTS, MANAGEMENT AND FINANCIAL SERVICES; ORGANIZATION AND CONDUCT OF EXHIBITIONS FOR CULTURAL AND TRAINING PURPOSES; ENTERTAINMENT, NAMELY LIVE MUSIC PERFORMANCES, THEATRICAL PRODUCTIONS, LIVE COMEDIC PERFORMANCES, AND NOVELTY ACTS; ORGANIZING SPORTING AND CULTURAL ACTIVITIES (U.S. CLS. 100, 101 AND 107).

CLASS 42—SCIENTIFIC, COMPUTER AND LEGAL SERVICES

FOR LEGAL SERVICES, IN PARTICULAR IN RELATION TO THE ESTABLISHMENT AND MANAGEMENT OF BUSINESSES; SCIENTIFIC AND INDUSTRIAL PRODUCT RESEARCH; CREATION OF COMPUTER PROGRAMS FOR DATA PROCESSING FOR OTHERS; COMPUTER CONSULTANCY SERVICES; COMPUTER CONSULTANCY SERVICES IN THE FIELD OF PAYMENT SYSTEMS; PROGRAMMING OF WEBSITES FOR OTHERS; DESIGN OF DATABASES AND WEBSITES FOR OTHERS; RENTAL OF STORAGE SPACE FOR THE USE OF WEBSITES, NAMELY HOSTING THE WEBSITES OF OTHERS; COMPUTER CONSULTANCY SERVICES IN THE FIELD OF THE ELECTRONIC CONDUCT OF BUSINESS TRANSACTIONS AND OF DATA PROCESSING; INTELLECTUAL PROPERTY CONSULTATION REGARDING MANAGEMENT AND EVALUATION OF INTELLECTUAL PROPERTY RIGHTS; PROVISION OF INFORMATION ON THE SUBJECT OF COMPUTER SYSTEM DESIGN; COLLECTION OF STATISTICAL DATA; COLLECTION OF DATA IN COMPUTER DATABASES; COLLECTION OF DATA IN COMPUTER DATABASES IN THE FIELD OF TRADING IN OIL, GAS, ELECTRICITY AND OTHER ENERGY SOURCES; AND REAL ESTATE CLOSING SERVICES (U.S. CLS. 100 AND 101).

CLASS 43—HOTEL AND RESTAURANT SERVICES

FOR SERVICES FOR PROVIDING FOOD AND DRINK, NAMELY VIA RESTAURANTS AND CATERING SERVICES; PROVIDING TEMPORARY HOUSING ACCOMMODATION (U.S. CLS. 100 AND 101).

CLASS 44—MEDICAL, BEAUTY AND AGRICULTURAL SERVICES

FOR HEALTH SERVICES AND BEAUTY SALON CARE FOR HUMAN BEINGS (U.S. CLS. 100 AND 101).

CLASS 45—PERSONAL SERVICES

FOR SECURITY SERVICES FOR THE PROTECTION OF PROPERTY AND INDIVIDUALS, NAMELY MONITORING SECURITY SYSTEMS, MONITORING OF COMPUTER SYSTEMS FOR SECURITY PURPOSES, MONITORING OF BURGLAR, SECURITY AND FIRE ALARMS; SECURITY GUARD SERVICES (U.S. CLS. 100 AND 101).

KARANENDRA S. CHHINA, EXAMINING ATTORNEY

SN 76-514,181. NEX FLOW INTERNATIONAL, INC., KITCHENER, ONTARIO N2G 4G8, CANADA, FILED 5-14-2003.

NEX FLOW

PRIORITY CLAIMED UNDER SEC. 44(D) ON CANADA APPLICATION NO. 1176500, FILED 5-1-2003, REG. NO. 630648, DATED 1-20-2005, EXPIRES 1-20-2020.

CLASS 7—MACHINERY

FOR COMPRESSED AIR-OPERATED COMPONENTS FOR USE IN CONVEYING, NAMELY IN-LINE AIR VACUUM CONVEYORS FOR INDUSTRIAL APPLICATIONS (U.S. CLS. 13, 19, 21, 23, 31, 34 AND 35).

CLASS 11—ENVIRONMENTAL CONTROL APPARATUS

FOR COMPRESSED AIR-OPERATED COMPONENTS FOR USE IN INDUSTRIAL AND COMMERCIAL COOLING, BLOW-OFF AND VENTILATING, NAMELY AIR KNIVES, AIR AMPLIFIERS, VORTEX TUBES, CABINET COOLERS, TOOL COOLERS, NEEDLE CHILLERS, AIR IONIZES, AIR JETS AND AIR NOZZLES AND REPLACEMENT PARTS THEREFORE (U.S. CLS. 13, 21, 23, 31 AND 34).

ROBERT LAVACHE, EXAMINING ATTORNEY

SN 76-515,922. KOENIG & BAUER AKTIENGESELLSCHAFT, 97080 WURZBURG, FED REP GERMANY, FILED 5-21-2003.

RAPIDA

PRIORITY CLAIMED UNDER SEC. 44(D) ON FED REP GERMANY APPLICATION NO. 30257269.4/0, FILED 11-25-2002, REG. NO. 30257269, DATED 1-28-2003, EXPIRES 11-30-2012.

THE ENGLISH TRANSLATION OF "RAPIDA" IS "FAST".

CLASS 7—MACHINERY

FOR PRINTING PRESSES AND THEIR STRUCTURAL AND REPLACEMENT PARTS; GRAPHIC ARTS MACHINES AND THEIR STRUCTURAL AND REPLACEMENT PARTS; PRINT CONVERTING MACHINES AND THEIR STRUCTURAL AND REPLACEMENT PARTS; ACCESSORIES FOR PRINTING PRESSES, GRAPHIC ARTS MACHINES AND PRINT CONVERTING MACHINES, NAMELY, MECHANICAL TRANSPORT SYSTEMS COMPRISED OF CONVEYORS AND CONVEYOR BELTS, PRINTING COUPLES, INKING UNITS, DAMPENERS, POWER OPERATED FOLDING MACHINES, REELSTANDS (U.S. CLS. 13, 19, 21, 23, 31, 34 AND 35).

CLASS 9—ELECTRICAL AND SCIENTIFIC APPARATUS

FOR ELECTRONIC ACCESSORIES FOR PRINTING PRESSES, GRAPHIC ARTS MACHINES AND PRINT CONVERTING MACHINES, NAMELY, REGULATORS, CONTROLLERS AND MONITORS (U.S. CLS. 21, 23, 26, 36 AND 38).

ROBERT LAVACHE, EXAMINING ATTORNEY

SN 76-517,923. EDUCATIONAL IDEAS, INC., BREA, CA, FILED 5-29-2003.

EXPLORE**CLASS 9—ELECTRICAL AND SCIENTIFIC APPARATUS**

FOR PRE-RECORDED COMPACT DISCS, AND AUDIO CASSETTES, SOLD TO EDUCATORS AS PART OF A SET PRE-APPROVED FOR CLASSROOM USE IN TEACHING IN ACCORDANCE WITH STATE APPROVED CURRICULA, ALL FEATURING LANGUAGE PROFICIENCY TESTING AND INSTRUCTION IN LANGUAGE AND SPEECH (U.S. CLS. 21, 23, 26, 36 AND 38).

FIRST USE 0-0-1993; IN COMMERCE 0-0-1993.

CLASS 16—PAPER GOODS AND PRINTED MATTER

FOR PRINTED INSTRUCTIONAL, EDUCATIONAL AND TEACHING MATERIALS SOLD TO EDUCATORS AS A SET PRE-APPROVED FOR CLASSROOM USE IN TEACHING IN ACCORDANCE WITH STATE APPROVED CURRICULA, NAMELY, TEACHERS' MANUALS, STUDENT WORKBOOKS, PRINTED TESTS AND WALL CHARTS, ALL PERTAINING TO LANGUAGE PROFICIENCY TESTING AND INSTRUCTION IN LANGUAGES AND SPEECH (U.S. CLS. 2, 5, 22, 23, 29, 37, 38 AND 50).

FIRST USE 0-0-1993; IN COMMERCE 0-0-1993.
LINDA MICKLEBURGH, EXAMINING ATTORNEY

SN 76-524,643. ORIGIN PRODUCTS LTD, LONDON NW6 6RA, UNITED KINGDOM, FILED 6-23-2003.

POLLY POCKET

OWNER OF U.S. REG. NO. 2,112,633.
THE NAME POLLY POCKET IS THE NAME OF AN ANIMATED CARTOON CHARACTER AND DOES NOT IDENTIFY A LIVING INDIVIDUAL.

CLASS 35—ADVERTISING AND BUSINESS

FOR PROVIDING PRODUCTS INFORMATION VIA GLOBAL COMPUTER WEBSITE (U.S. CLS. 100, 101 AND 102).

CLASS 41—EDUCATION AND ENTERTAINMENT

FOR ENTERTAINMENT SERVICES, NAMELY, THE PRODUCTION OF ANIMATED TELEVISION SERIES; PROVIDING EDUCATIONAL AND ENTERTAINMENT SERVICES VIA GLOBAL COMPUTER WEBSITE FEATURING GAMES, PRODUCT TRIVIA AND ACTIVITIES INTENDED FOR CONSUMERS OF ALL AGES (U.S. CLS. 100, 101 AND 107).

MITCHELL FRONT, EXAMINING ATTORNEY

SN 76-529,540. MEMPHIS ZOO, INC., DBA MEMPHIS ZOOLOGICAL SOCIETY, MEMPHIS, TN. FILED 7-14-2003.

MEMPHIS ZOO

NO CLAIM IS MADE TO THE EXCLUSIVE RIGHT TO USE "ZOO", APART FROM THE MARK AS SHOWN.
SEC. 2(F).

CLASS 16—PAPER GOODS AND PRINTED MATTER

FOR PHOTO ALBUMS, SCRAP BOOKS, FICTION BOOKS, NATURE BOOKS, EDUCATIONAL BOOKS IN THE FIELDS OF ZOOLOGY, CONSERVATION AND WILDLIFE, SCIENTIFIC BOOKS, CHILDREN'S BOOKS, ADDRESS BOOKS, NOTE BOOKS, COLORING BOOKS, GREETING CARDS, NOTE CARDS, PICTURE POSTCARDS, TRADING CARDS, STATIONERY, ENVELOPES, PAPER PARTY HATS, PAPER GIFT WRAP AND BOWS, FABRIC AND PAPER GIFT BAGS, PAPER BAGS, PAPER TABLE LINENS, PAPER PARTY DECORATIONS, BULLETIN BOARDS, BUMPER STICKERS, NOTEBOOKS, NOTE PAPER, DECALS, FOLDERS, BINDERS, ART PRINTS, BOOK COVERS, BOOKENDS, BOOKMARKS, PENS AND PENCILS (U.S. CLS. 2, 5, 22, 23, 29, 37, 38 AND 50).

FIRST USE 12-31-1988; IN COMMERCE 12-31-1988.

CLASS 41—EDUCATION AND ENTERTAINMENT

FOR EDUCATIONAL AND ENTERTAINMENT SERVICES, NAMELY, ORGANIZING AND CONDUCTING EDUCATIONAL PROGRAMS, SEMINARS, LECTURES AND WORKSHOPS IN THE FIELD OF WILDLIFE, WILDLIFE CONSERVATION AND THE CONSERVATION OF ANIMAL HABITATS, PLANTS AND ANIMALS AND DISSEMINATING INFORMATION AND LITERATURE IN CONNECTION THEREWITH; EDUCATIONAL DEMONSTRATIONS; LIVED COSTUMED CHARACTER PERFORMANCES, AND CONDUCTING EDUCATIONAL EVENTS AND EXHIBITIONS PERTAINING TO PLANTS, ANIMALS, ANIMAL HABITATS, WILDLIFE AND WILDLIFE CONSERVATION THEMES (U.S. CLS. 100, 101 AND 107).

FIRST USE 2-28-1923; IN COMMERCE 2-28-1923.
ANN E. SAPPENFIELD, EXAMINING ATTORNEY

SN 76-529,611. LUTZ -JESCO AMERICA CORP., ROCHESTER, NY. FILED 7-11-2003.



THE LINING IN THE DRAWING DOES NOT SIGNIFY COLOR, BUT IS A FEATURE OF THE MARK.

CLASS 7—MACHINERY

FOR CHEMICAL FEED PUMPS AND DRY MATERIAL FEEDERS (U.S. CLS. 13, 19, 21, 23, 31, 34 AND 35).

FIRST USE 1-1-1990; IN COMMERCE 1-1-1990.

CLASS 9—ELECTRICAL AND SCIENTIFIC APPARATUS

FOR SOLENOID-, DIAPHRAGM-, PISTON-, AND MOTOR-DRIVEN DOSING AND METERING PUMPS; ELECTRONIC CONTROL SYSTEMS FOR SOLENOID-, DIAPHRAGM-, PISTON-, AND MOTOR-DRIVEN SOLENOID-, DIAPHRAGM-, PISTON- AND MOTOR-DRIVEN DOSING AND METERING PUMPS; MEASURING SYSTEMS FOR SOLENOID-, MOTOR-DRIVEN SOLENOID-, DIAPHRAGM-, PISTON- AND MOTOR-DRIVEN SOLENOID-DIAPHRAGM-, PISTON- AND MOTOR DRIVEN DOSING AND METERING PUMPS; AND ACCESSORIES FOR SOLENOID, MOTOR-DRIVEN, DOSING AND METERING PUMPS (U.S. CLS. 21, 23, 26, 36 AND 38).

FIRST USE 1-1-1990; IN COMMERCE 1-1-1990.
DAWN FELDMAN, EXAMINING ATTORNEY

SN 76-531,686. VIZM, INC., RESTON, VA. FILED 7-18-2003.

VIZM**CLASS 9—ELECTRICAL AND SCIENTIFIC APPARATUS**

FOR COMPUTER SOFTWARE USED TO TEACH VALUES, CHARACTER, GOAL SETTING, AND DECISION MAKING SKILLS; COMPUTER GAME DISKS; VIDEO TAPES, CDS AND DVDS IN THE FIELD OF EDUCATION, PARENTING, VALUES, CHARACTER, GOAL SETTING, AND DECISION MAKING (U.S. CLS. 21, 23, 26, 36 AND 38).

CLASS 16—PAPER GOODS AND PRINTED MATTER

FOR PUBLICATIONS, NAMELY, BOOKS, WORKBOOKS, NEWSLETTERS, VOCATIONAL GUIDES, MAGAZINES, JOURNALS, AND PAMPHLETS IN THE FIELD OF EDUCATION, PARENTING, VALUES, CHARACTER, GOAL SETTING, AND DECISION MAKING (U.S. CLS. 2, 5, 22, 23, 29, 37, 38 AND 50).

CLASS 28—TOYS AND SPORTING GOODS

FOR BOARD GAMES (U.S. CLS. 22, 23, 38 AND 50).

CLASS 41—EDUCATION AND ENTERTAINMENT

FOR EDUCATIONAL SERVICES, NAMELY, SEMINARS AND WORKSHOPS IN THE FIELD OF TEACHING METHODS, PARENTING, VALUES, CHARACTER, GOAL SETTING, AND DECISION MAKING; EDUCATIONAL SERVICES, NAMELY, SEMINARS AND WORKSHOPS IN THE FIELD OF TEACHING METHODS, PARENTING, VALUES, CHARACTER, GOAL SETTING, AND DECISION MAKING, SAID SEMINARS AND WORKSHOPS TO EMPLOY RADIO PROGRAMS, TELEVISION PROGRAMS, AND FILMS AS TEACHING AIDS; RADIO PROGRAMS AND ONGOING TELEVISION PROGRAMS IN THE FIELDS OF EDUCATION, PARENTING, VALUES, CHARACTER, GOAL SETTING, AND DECISION MAKING (U.S. CLS. 100, 101 AND 107).

CLASS 44—MEDICAL, BEAUTY AND AGRICULTURAL SERVICES

FOR PSYCHOLOGICAL COUNSELING IN THE FIELDS OF EDUCATION, PARENTING, VALUES, CHARACTER, GOAL SETTING, AND DECISION MAKING (U.S. CLS. 100 AND 101).
WILLIAM BRECKENFELD, EXAMINING ATTORNEY

CLASS 11—ENVIRONMENTAL CONTROL APPARATUS

FOR AIR CONDITIONING, HEATING, VENTILATING AND REFRIGERATION REPLACEMENT PARTS, NAMELY, ADAPTERS, AIR CLEANERS, AIR CONDITIONER COVERS, AIR FILTERS, COMPRESSORS AND ACCESSORIES THEREFORE, NAMELY, CONDENSATE PUMPS, CONDENSER PADS, FURNACE AND HEAT SEQUENCERS, EXPANSION VALVES, GAS VALVES, REFRIGERATION BALL VALVES, WATER HEATER VALVES, FURNACE IGNITERS, HUB PULLERS, HUMIDIFIERS, IGNITORS, OIL BURNERS, VENTERS, FANS, RAINSHIELDS, TROUBLE LIGHTS, PUMPS, MANIFOLDS, V-BELTS, VENTER BLOWERS, ALL FOR USE IN HEATING, VENTILATING, AIR CONDITIONING AND REFRIGERATION UNITS (U.S. CLS. 13, 21, 23, 31 AND 34).

FIRST USE 4-0-1986; IN COMMERCE 7-0-1986.
DARRYL SPRUILL, EXAMINING ATTORNEY

SN 76-532,984. YORK INTERNATIONAL CORPORATION, YORK, PA. FILED 7-29-2003.

SN 76-532,982. YORK INTERNATIONAL CORPORATION, YORK, PA. FILED 7-29-2003.



SOURCE 1

CLASS 7—MACHINERY

FOR REFRIGERATION COMPRESSORS AND ACCESSORIES, NAMELY, BEARING BRACKETS, BLOWER WHEELS, BUSHINGS, VENTER WHEELS, SLEEVE BEARINGS, REGULATORS, POWER GENERATORS, AND MOTORS (U.S. CLS. 13, 19, 21, 23, 31, 34 AND 35).
FIRST USE 4-0-1986; IN COMMERCE 7-0-1986.

CLASS 9—ELECTRICAL AND SCIENTIFIC APPARATUS

FOR ELECTRICAL COMPONENTS FOR USE IN AIR CONDITIONING, HEATING, VENTILATING, AND REFRIGERATION UNITS, NAMELY, AUXILIARY SWITCHES, ACTUATORS, CAPACITORS, CARBON DIOXIDE SENSORS, CARBON MONOXIDE ALARMS AND MONITORS, CONTACTORS, FLAME DETECTORS AND SENSORS, SMOKE ALARMS, COMBUSTION ANALYZERS, THERMOSTATS, THERMOCOUPLES, TIMERS, ELECTRICAL RELAYS, TRANSFORMERS, SOLENOID COILS, START DEVICES, LINE AND VOLTAGE MONITOR MODULES, LOGIC MODULES, IGNITION MODULES, PILOT MODULES, AND SOLENOID VALVES (U.S. CLS. 21, 23, 26, 36 AND 38).
FIRST USE 4-0-1986; IN COMMERCE 7-0-1986.

CLASS 7—MACHINERY

FOR REFRIGERATION COMPRESSORS AND ACCESSORIES, NAMELY, BEARING BRACKETS, BLOWER WHEELS, BUSHINGS, VENTER WHEELS, SLEEVE BEARINGS, REGULATORS, POWER GENERATORS, AND MOTORS (U.S. CLS. 13, 19, 21, 23, 31, 34 AND 35).
FIRST USE 4-0-1986; IN COMMERCE 7-0-1986.

CLASS 9—ELECTRICAL AND SCIENTIFIC APPARATUS

FOR ELECTRICAL COMPONENTS FOR USE IN AIR CONDITIONING, HEATING, VENTILATING, AND REFRIGERATION UNITS, NAMELY, AUXILIARY SWITCHES, ACTUATORS, CAPACITORS, CARBON DIOXIDE SENSORS, CARBON MONOXIDE ALARMS AND MONITORS, CONTACTORS, FLAME DETECTORS AND SENSORS, SMOKE ALARMS, COMBUSTION ANALYZERS, THERMOSTATS, THERMOCOUPLES, TIMERS, ELECTRICAL RELAYS, TRANSFORMERS, SOLENOID COILS, START DEVICES, LINE AND VOLTAGE MONITOR MODULES, LOGIC MODULES, IGNITION MODULES, PILOT MODULES, AND SOLENOID VALVES (U.S. CLS. 21, 23, 26, 36 AND 38).
FIRST USE 4-0-1986; IN COMMERCE 7-0-1986.

CLASS 11—ENVIRONMENTAL CONTROL APPARATUS

FOR AIR CONDITIONING, HEATING, VENTILATING AND REFRIGERATION REPLACEMENT PARTS, NAMELY, ADAPTERS, AIR CLEANERS, AIR CONDITIONER COVERS, AIR FILTERS, COMPRESSORS AND ACCESSORIES THEREFORE, NAMELY, CONDENSATE PUMPS, CONDENSER PADS, FURNACE AND HEAT SEQUENCERS, EXPANSION VALVES, GAS VALVES, REFRIGERATION BALL VALVES, WATER HEATER VALVES, FURNACE IGNITERS, HUB PULLERS, HUMIDIFIERS, IGNITORS, OIL BURNERS, VENTERS, FANS, RAINSHIELDS, TROUBLE LIGHTS, PUMPS, MANIFOLDS, V-BELTS, VENTER BLOWERS, ALL FOR USE IN HEATING, VENTILATING, AIR CONDITIONING AND REFRIGERATION UNITS (U.S. CLS. 13, 21, 23, 31 AND 34).

FIRST USE 4-0-1986; IN COMMERCE 7-0-1986.
DARRYL SPRUILL, EXAMINING ATTORNEY

CLASS 37—CONSTRUCTION AND REPAIR

FOR INSTALLING, MAINTENANCE, AND REPAIR OF SMART CARD SYSTEM EQUIPMENT; LEASING OF LAUNDRY, WASHING AND DRYING MACHINES (U.S. CLS. 100, 103 AND 106).

CAROL SPILS, EXAMINING ATTORNEY

SN 76-537,267. COINAMATIC CANADA INC., MISSISSAUGA, ONTARIO, CANADA, FILED 8-13-2003.

SN 76-537,283. KANZAKI KOKYUKOKI MFG. CO., LTD., HYOGO 661-0981, JAPAN, FILED 8-13-2003.

AMENITY FIRST

PRIORITY CLAIMED UNDER SEC. 44(D) ON CANADA APPLICATION NO. 1,177,345, FILED 5-20-2003, REG. NO. TMA616,016, DATED 7-29-2004, EXPIRES 7-29-2019.

OWNER OF U.S. REG. NOS. 1,624,692, 1,829,327 AND 2,712,602.

TUFF TORQ**CLASS 9—ELECTRICAL AND SCIENTIFIC APPARATUS**

FOR ENCODED MICROPROCESSOR SMART CARDS FOR PROVIDING ELECTRONIC PAYMENT SERVICES FOR GOODS AND SERVICES, ACCESS TO LAUNDRY ROOM EQUIPMENT, VENDING MACHINES, PARKING SYSTEMS, LIBRARY SERVICES, DRY CLEANING SERVICES AND MUNICIPAL SERVICES; MICROPROCESSOR SMART CARD SOFTWARE FOR USE TO OPERATE, MANAGE, ENABLE AND DISABLE TRANSACTIONS COMPLETED VIA SMART CARDS, TRACK DATA AND IMPLEMENT CHANGES IN THE OPERATION OF THE MICROPROCESSOR SMART CARD SYSTEM, AND AUTHENTICATE AND PROCESS PAYMENTS TO AND FROM OTHERS; POINT-OF-SALE COMPUTER TERMINALS AND COMPUTER KIOSKS CONSISTING OF A MICROPROCESSOR SMART CARD READER, TOUCH-SCREEN OR VIDEO DISPLAY MONITOR FOR PROCESSING ELECTRONIC DEBIT OR CREDIT TRANSACTIONS, PURCHASING GOODS AND SERVICES, VERIFYING CARDHOLDERS' ACCOUNT BALANCES, MAKING RESERVATIONS AND APPOINTMENTS, ORGANIZING MEETINGS AND EVENTS AND DISPLAYING ANNOUNCEMENTS; VENDING MACHINES (U.S. CLS. 21, 23, 26, 36 AND 38).

CLASS 7—MACHINERY

FOR BASED ON USE IN COMMERCE— TRANSMISSIONS FOR INDUSTRIAL AND AGRICULTURAL MACHINES; AND BASED ON INTENT TO USE—HYDRAULIC PUMPS AND VALVES THEREFOR FOR INDUSTRIAL MACHINES AND AGRICULTURAL MACHINES; ELECTRIC GENERATORS FOR INDUSTRIAL MACHINES, AGRICULTURAL MACHINES, AND MARINE VESSELS; TRANSMISSION PARTS FOR MARINE VESSELS NAMELY GEARS, HYDRAULIC PUMPS, HYDRAULIC MOTORS, AND VALVES THEREFOR; HYDRAULIC EQUIPMENT FOR INDUSTRIAL MACHINES AND AGRICULTURAL MACHINES, NAMELY VALVES, PUMPS AND HOUSING SUMPS COMBINED INTO SINGLE UNITS; TRANSMISSION PARTS FOR MARINE VESSELS NAMELY HYDRAULIC EQUIPMENT COMPRISED OF VALVES, PUMPS AND HOUSING SUMPS COMBINED INTO SINGLE UNITS; TRANSMISSIONS FOR WIND POWERED INDUSTRIAL MACHINES; TRANSMISSIONS FOR SEAGOING AND MARINE VESSELS; MARINE TRANSMISSION GEARS; HYDRAULIC PUMPS AND GENERATORS FOR LAND VEHICLES; ENGINE PARTS FOR LAND VEHICLES NAMELY HYDRAULIC EQUIPMENT COMPRISED OF VALVES PUMPS AND HOUSING SUMPS COMBINED INTO SINGLE UNITS (U.S. CLS. 13, 19, 21, 23, 31, 34 AND 35).

FIRST USE 0-0-1990; IN COMMERCE 0-0-1990.

CLASS 35—ADVERTISING AND BUSINESS

FOR VENDING MACHINE SERVICES FEATURING PRODUCTS AND FOOD ITEMS; RETAIL STORE SERVICES, FEATURING WASHING, DRYING AND LAUNDRY MACHINES (U.S. CLS. 100, 101 AND 102).

CLASS 12—VEHICLES

FOR BASED ON USE IN COMMERCE— TRANSMISSIONS FOR LAND VEHICLES; AND, BASED ON INTENT TO USE— PARTS OF TRANSMISSIONS FOR LAND VEHICLES, NAMELY, HYDRAULIC VALVES; STRUCTURAL PARTS FOR LAND VEHICLES AND MARINE VESSELS NAMELY HYDRAULIC EQUIPMENT COMPRISED OF VALVES, PUMPS AND HOUSING SUMPS COMBINED INTO SINGLE UNITS; TRANSMISSIONS PARTS FOR LAND VEHICLES NAMELY HYDRAULIC EQUIPMENT COMPRISED OF VALVES, PUMPS AND HOUSING SUMPS COMBINED INTO SINGLE UNITS (U.S. CLS. 19, 21, 23, 31, 35 AND 44).

FIRST USE 0-0-1990; IN COMMERCE 0-0-1990.
JAMES GRIFFIN, EXAMINING ATTORNEY

CLASS 36—INSURANCE AND FINANCIAL

FOR PROCESSING OF CREDIT, DEBIT CARD AND CASH PAYMENT TRANSACTIONS TO SMART CARDS; RECEIVING CREDIT AND DEBIT CARD AUTHORIZATIONS FROM FINANCIAL INSTITUTIONS; TRANSFER OF VALUE FROM CREDIT AND DEBIT CARDS AND TRANSFERRING VALUE TO AND FROM SMART CARDS (U.S. CLS. 100, 101 AND 102).

SN 76-538,146. INFORMATOUCH, LLC, ZEPHYR COVE, NV.
FILED 8-1-2003.



CLASS 35—ADVERTISING AND BUSINESS

FOR ON-LINE LOCAL BUSINESS DIRECTORIES FEATURING RESTAURANTS, SHOPS, LOCAL ATTRACTIONS AND TRANSPORTATION; PROVIDING ON-LINE DIRECTORY INFORMATION SERVICES ALSO FEATURING HYPERLINKS TO OTHER WEB SITES; PROMOTION OF THE GOODS AND SERVICES OF OTHERS THROUGH ELECTRONIC BILLBOARD ADVERTISING (U.S. CLS. 100, 101 AND 102).

FIRST USE 3-20-2002; IN COMMERCE 3-20-2002.

CLASS 37—CONSTRUCTION AND REPAIR

FOR INSTALLATION AND MAINTENANCE OF TOUCHSCREEN COMPUTER NETWORKS IN THE FIELD OF HOSPITALITY (U.S. CLS. 100, 103 AND 106).

FIRST USE 3-20-2002; IN COMMERCE 3-20-2002.

CLASS 38—COMMUNICATION

FOR PROVIDING A HIGH SPEED ACCESS TO AREA NETWORKS AND A GLOBAL COMPUTER INFORMATION NETWORK; PROVIDING TELECOMMUNICATIONS CONNECTIONS TO A GLOBAL COMPUTER NETWORK (U.S. CLS. 100, 101 AND 104).

FIRST USE 3-20-2002; IN COMMERCE 3-20-2002.

CLASS 41—EDUCATION AND ENTERTAINMENT

FOR ENTERTAINMENT IN THE NATURE OF VISUAL AND AUDIO PERFORMANCES, AND MUSICAL, VARIETY, NEWS AND COMEDY SHOWS AND MOVIES (U.S. CLS. 100, 101 AND 107).

FIRST USE 3-20-2002; IN COMMERCE 3-20-2002.
GEOFFREY FOSDICK, EXAMINING ATTORNEY

SN 76-538,306. ESSENCE OF LIFE LTD., TEL AVIV 64367, ISRAEL, FILED 8-18-2003.



PRIORITY CLAIMED UNDER SEC. 44(D) ON ISRAEL APPLICATION NO. 162812, FILED 2-16-2003, REG. NO. 162812, DATED 10-31-2003, EXPIRES 2-16-2010.

THE NON-LATIN CHARACTERS IN THE MARK ARE TRANSLITERATED "BO-U B'YAHAD" AND TRANSLATED IN ENGLISH MEAN "LET'S JOIN TOGETHER".

CLASS 9—ELECTRICAL AND SCIENTIFIC APPARATUS

FOR HAND-HELD COMPUTER GAMES (U.S. CLS. 21, 23, 26, 36 AND 38).

CLASS 28—TOYS AND SPORTING GOODS

FOR STUFFED DOLLS, DOLLS, DOLL PLAYSETS, STUFFED TOY ANIMALS, EDUCATIONAL TOYS NAMELY, CHILDREN'S ACTIVITY KITS UTILIZING INTERCHANGEABLE DESIGN STICKERS, PRE-CUT PLASTIC MATERIALS, CARDBOARD AND OTHER MATERIALS; GAMES, NAMELY, CARD GAMES, BOARD GAMES, GAMES IN BOOKLET FORMAT (U.S. CLS. 22, 23, 38 AND 50).

CHRIS WELLS, EXAMINING ATTORNEY

SN 76-539,035. OASIS SILICONSYSTEMS HOLDING A.G., AUSTIN, TX. FILED 8-20-2003.



PRIORITY CLAIMED UNDER SEC. 44(D) ON FED REP GERMANY APPLICATION NO. 30309522.9/0, FILED 2-20-2003, REG. NO. 30309522, DATED 8-25-2003, EXPIRES 2-28-2013.

CLASS 9—ELECTRICAL AND SCIENTIFIC APPARATUS

FOR ELECTRONIC, ELECTRO-OPTICAL AND OPTICAL NETWORKS FOR DATA EXCHANGE, PARTICULARLY FOR ON-BOARD-ELECTRONICS OF VEHICLES; ELECTRONIC, ELECTRO-OPTICAL AND/OR OPTICAL COMPONENTS OF SAID NETWORKS, PARTICULARLY DATA LINES AND DATA BUS SYSTEMS, CONNECTORS AND INTERFACES, TRANSMITTERS AND RECEIVERS, TRANSCIEVERS, DIGITAL SIGNAL PROCESSORS, INTEGRATED CIRCUITS, MICROPROCESSORS, CONTROLLERS, A/D AND D/A CONVERTERS, AND DEVICES FOR PROVIDING VIRTUAL USER/SYSTEM INTERFACES; SOFTWARE, IN PARTICULAR FOR DATA EXCHANGE IN ELECTRONIC, ELECTRO-OPTICAL AND OPTICAL NETWORKS, FOR PROVIDING VIRTUAL INTERFACES, FOR MANAGING OF PHYSICAL INTERFACES, FOR EMULATING OF NETWORK DEVICES AND FOR PROVIDING VIRTUAL USER/SYSTEM INTERFACES; ELECTRONIC DEVICES FOR ENTERTAINMENT ELECTRONICS AND COMMUNICATION TECHNOLOGY, NAMELY, RADIOS, RADIO RECEIVERS, RADIO TUNERS, TV RECEIVERS, TV TUNERS, DRIVES, CD PLAYERS, CD RECORDERS, CD CHANGERS, DVD RECORDERS, DVD PLAYERS, DVD CHANGERS, COMPUTERS WITH INTERNET ACCESS, LAPTOP COMPUTERS WITH INTERNET ACCESS, NAVIGATION SYSTEMS, GLOBAL POSITIONING SYSTEMS (GPS), TELEMATIC DEVICES, SATELLITE RECEIVERS, LOUDSPEAKER SYSTEMS, AMPLIFIERS, A/D AND D/A CONVERTERS, DISPLAYS, TOUCHSCREEN DISPLAYS, BUTTONS, SLIDERS, SPEECH RECOGNITION DEVICES, KEYS, KEYBOARDS, SCREENS, DIGITAL VIDEO BROADCAST (DVB), PERSONAL DIGITAL ASSISTANTS (PDA), TELEPHONES, MOBILE PHONES, SECURITY DEVICES, COCKPITS, MICROPHONES, LOUDSPEAKERS, HEADPHONES, VOICE ENTRIES AND OUTPUTS, AND GAME CONSOLES (U.S. CLS. 21, 23, 26, 36 AND 38).

CLASS 41—EDUCATION AND ENTERTAINMENT

FOR PROVIDING TRAINING AND CONDUCTING SEMINARS IN THE DESIGN AND USE OF PLASTIC OPTICAL FIBER NETWORKS IN AUTOMOBILES, NETWORKING, AUTOMOTIVE ELECTRONICS, COMMUNICATION TECHNOLOGY, AND AUDIO AND VIDEO APPLICATIONS (U.S. CLS. 100, 101 AND 107).

CLASS 42—SCIENTIFIC, COMPUTER AND LEGAL SERVICES

FOR SOFTWARE DESIGN AND CONSULTATION SERVICES FOR OTHERS; DESIGN OF INTEGRATED CIRCUITS AND CHIP DEVELOPMENT FOR OTHERS; LICENSING NETWORK TECHNOLOGY FOR ELECTRONIC, ELECTRO-OPTICAL AND OPTICAL NETWORKS FOR DATA EXCHANGE (U.S. CLS. 100 AND 101).
INGRID C. EULIN, EXAMINING ATTORNEY

SN 76-541,143. CARLISLE INTANGIBLE COMPANY, SYRACUSE, NY. FILED 8-18-2003.



OWNER OF U.S. REG. NOS. 1,087,761, 1,118,724 AND OTHERS.

CLASS 2—PAINTS

FOR PROTECTIVE COATINGS, NAMELY, POLYETHYLENE DECK COATINGS (U.S. CLS. 6, 11 AND 16).
FIRST USE 10-0-1994; IN COMMERCE 10-0-1994.

CLASS 17—RUBBER GOODS

FOR WATERPROOF MEMBRANE SHEETING (U.S. CLS. 1, 5, 12, 13, 35 AND 50).
FIRST USE 10-0-1994; IN COMMERCE 10-0-1994.

CLASS 19—NON-METALLIC BUILDING MATERIALS

FOR ROOFING UNDERLAYMENT AND RUBBERIZED ASPHALT (U.S. CLS. 1, 12, 33 AND 50).
FIRST USE 10-0-1994; IN COMMERCE 10-0-1994.
MARLENE BELL, EXAMINING ATTORNEY

SN 76-541,455. LENG-D'OR, S.A., 08755 CASTELLBISBAL, BARCELONA, SPAIN, FILED 9-2-2003.



PRIORITY CLAIMED UNDER SEC. 44(D) ON SPAIN APPLICATION NO. 2.551.067, FILED 7-17-2003, REG. NO. 2.551.067, DATED 7-17-2003, EXPIRES 7-17-2013.

CLASS 29—MEATS AND PROCESSED FOODS

FOR POTATO PRODUCTS, WITH OR WITHOUT FLAVORED MODIFIERS, NAMELY, POTATO CRISPS, POTATO-BASED SNACK FOODS AND POTATO CHIPS; AND FRENCH FRIED POTATOES (U.S. CL. 46).

CLASS 30—STAPLE FOODS

FOR POTATO PRODUCTS, WITH OR WITHOUT FLAVORED MODIFIERS, NAMELY, POTATO FLOUR; RICE-BASED OR CORN-BASED BREAKFAST CEREALS; RICE-BASED SNACK FOODS AND CORN BASED SNACK FOODS AND SALTED BISCUITS (U.S. CL. 46).
KENNETH D. BATTLE, EXAMINING ATTORNEY

SN 76-541,739. SPIN MASTER LIMITED, TORONTO, ONTARIO, CANADA, FILED 8-21-2003.

ROOM IN A BOX

PRIORITY CLAIMED UNDER SEC. 44(D) ON UNITED KINGDOM APPLICATION NO. 2338883, FILED 7-25-2003, REG. NO. 2,338,883, DATED 7-25-2003, EXPIRES 7-25-2013.

CLASS 20—FURNITURE AND ARTICLES NOT OTHERWISE CLASSIFIED

FOR ARTICLES OF FURNITURE; SLEEPING BAGS (U.S. CLS. 2, 13, 22, 25, 32 AND 50).

CLASS 24—FABRICS

FOR TEXTILES AND TEXTILE GOODS, NAMELY, HAND TOWELS OF TEXTILE, TEXTILE NAPKINS, TEXTILE PLACE MATS, TABLE LINEN, TABLE CLOTHS NOT OF PAPER, TEXTILE WALL HANGINGS, CURTAINS, BEDSPREADS, COMFORTERS, COVERS, BED SHEETS, DUVET COVERS, PILLOW COVERS, PILLOW CASES, PILLOW SHAMS, HAND TOWELS OF TEXTILE, BATH TOWELS (U.S. CLS. 42 AND 50).

CLASS 28—TOYS AND SPORTING GOODS

FOR GAMES, TOYS AND PLAYTHINGS, NAMELY, CHILDREN'S PLAY TENTS AND SLEEPING BED TENTS (U.S. CLS. 22, 23, 38 AND 50).
ANGELA M. MICHELI, EXAMINING ATTORNEY

SN 76-542,683. QUICKTREE, INC., SAN JOSE, CA. FILED 8-25-2003.

QUICKTREE**CLASS 9—ELECTRICAL AND SCIENTIFIC APPARATUS**

FOR COMPUTER HARDWARE: COMPUTER HARDWARE AND SOFTWARE FOR PROCESSING XML DATA AND OTHER DATA REPRESENTATIONS; COMPUTER CHIPS, INTEGRATED CIRCUITS (U.S. CLS. 21, 23, 26, 36 AND 38).

CLASS 42—SCIENTIFIC, COMPUTER AND LEGAL SERVICES

FOR INSTALLATION, MAINTENANCE, REPAIR AND UPDATING OF COMPUTER SOFTWARE; TECHNICAL SUPPORT SERVICES, NAMELY, TROUBLESHOOTING OF COMPUTER HARDWARE AND SOFTWARE PROBLEMS; COMPUTER PROGRAMMING SERVICES; CUSTOMIZATION OF COMPUTER HARDWARE AND SOFTWARE; COMPUTER AND COMPUTER SOFTWARE CONSULTING SERVICES; COMPUTER HARDWARE AND SOFTWARE DESIGN SERVICES (U.S. CLS. 100 AND 101).

MATTHEW PAPPAS, EXAMINING ATTORNEY

SN 76-542,968. GINO ROSSI S.A., SLUPSK, POLAND, FILED 9-2-2003.



gino rossi

PRIORITY CLAIMED UNDER SEC. 44(D) ON POLAND APPLICATION NO. Z-267475, FILED 7-16-2003, REG. NO. Z-267475, DATED 7-16-2003, EXPIRES 7-16-2013.

"GINO ROSSI" DOES NOT IDENTIFY A PARTICULAR LIVING INDIVIDUAL.

CLASS 18—LEATHER GOODS

FOR WALLETS; VALISES; TRUNKS; TRAVELLING BAGS; SUITCASES; SHOULDER BAGS; COIN PURSES; PORTMANTEAUS; BRIEFCASE-TYPE PORTFOLIOS; ANIMAL HIDES; WHIPS FOR ANIMALS; HANDBAGS; LEATHER SHOPPING BAGS; LEATHER LEASHES AND HARNESSSES FOR ANIMALS (U.S. CLS. 1, 2, 3, 22 AND 41).

FIRST USE 1-0-2002; IN COMMERCE 1-0-2002.

CLASS 25—CLOTHING

FOR LEATHER COATS; FOOTWEAR; LEATHER BELTS; LEATHER CLOTHING, NAMELY, SHIRTS, VESTS, JACKETS, COATS, PANTS, CAPS; FUR COATS; FUR JACKETS; FUR BELTS; FUR GLOVES; FUR HATS; LEATHER JACKETS; LEATHER COATS; CLOTHING MADE OF PLASTIC AND OF NATURAL MATERIALS, NAMELY, SHIRTS, VESTS, JACKETS, COATS, PANTS, VESTS, BELTS AND GLOVES; LEATHER CLOTHES, NAMELY, GLOVES, HATS, SHOES; LEATHER APPAREL, NAMELY, LEATHER TIES, BOW TIES, HATS, GLOVES AND STOLES (U.S. CLS. 22 AND 39).

FIRST USE 1-0-2002; IN COMMERCE 1-0-2002.

CLASS 26—FANCY GOODS

FOR HAIR BOWS; HAIR BUCKLES; HAIR ORNAMENTS; SHOE ORNAMENTS NOT OF PRECIOUS METAL; REINS FOR GUIDING CHILDREN; LEATHER LEASHES AND HARNESSSES FOR CHILDREN; SHOELACES (U.S. CLS. 37, 39, 40, 42 AND 50).

FIRST USE 1-0-2002; IN COMMERCE 1-0-2002.

ALICE SUE CARRUTHERS, EXAMINING ATTORNEY

SN 76-544,284. SCHUCO INTERNATIONAL KG, BIELEFELD, D-33609, FED REP GERMANY, FILED 9-12-2003.

SCHÜCO

PRIORITY CLAIMED UNDER SEC. 44(D) ON FED REP GERMANY APPLICATION NO. 30313541.7, FILED 3-15-2003, REG. NO. 30313541, DATED 9-4-2003, EXPIRES 3-31-2013.

OWNER OF U.S. REG. NOS. 1,954,010 AND 2,245,451.

CLASS 6—METAL GOODS

FOR BUILDING MATERIALS MADE OF METAL, NAMELY PROFILES, TUBES, PLATES, SHEETS AND FOILS FOR WINDOWS, DOORS, GATES, STAIRCASES, BALCONIES, FACADES, SKYLIGHTS; METAL BUILDING MATERIALS, NAMELY WINDOWS, DOORS, GATES, STAIRS, PARTITION WALLS, FACADES, BALCONIES, PREFABRICATED CONSERVATORIES, ROOFS, WINDOW, DOOR AND COLLECTOR FRAMES AND PREFABRICATED PARTS THEREFORE; METAL BUILDING MATERIALS, NAMELY SHUTTERS, WINDOWSILLS, RAIN-LEADING SHEETS AND PROFILES, MAILBOXES, FENCES, SCAFFOLDS; METAL HARDWARE, NAMELY NUTS AND SCREWS; METAL SEALS; METAL LOCKS AND PARTS THEREFOR FOR WINDOWS, DOORS AND GATES; TRANSPORTABLE METAL EXHIBITION STANDS, ALL OF THE FOREGOING GOODS MADE WHOLLY OF METAL OR SUBSTANTIALLY OF METAL IN COMBINATION WITH GLASS, WOOD OR PLASTIC (U.S. CLS. 2, 12, 13, 14, 23, 25 AND 50).

CLASS 7—MACHINERY

FOR POLISHING AND MOLDING MACHINES FOR WORKING METALS AND PLASTICS; MACHINE PARTS, NAMELY MACHINE FRAMES; DRIVING GEARS FOR WINDOWS AND DOORS; AND POWER TOOLS, NAMELY DRILLS; SAWING MACHINES, WELDING MACHINES FOR PLASTIC FRAMES, PUNCHING MACHINES, MILLING MACHINES (U.S. CLS. 13, 19, 21, 23, 31, 34 AND 35).

CLASS 8—HAND TOOLS

FOR HAND TOOLS, NAMELY DRILLS, SAWS, SCREW DRIVERS, HAND PUNCHING TOOL, SCISSORS, FOIL ROLL COATERS, KNIFES, AUGERS; PLANING BLADES FOR SHADING SYSTEMS (U.S. CLS. 23, 28 AND 44).

CLASS 9—ELECTRICAL AND SCIENTIFIC APPARATUS

FOR ELECTRONIC LOCKS FOR WINDOWS, DOORS AND GATES; SOLAR COLLECTORS AND FRAMES THEREFORE, SOLD AS A UNIT (U.S. CLS. 21, 23, 26, 36 AND 38).

CLASS 11—ENVIRONMENTAL CONTROL APPARATUS

FOR ELECTRIC LIGHTING FIXTURES, ELECTRIC HEATERS FOR COMMERCIAL USE, VENTILATORS FOR AIR CONDITIONERS, HEAT EXCHANGERS USING SOLAR ENERGY (U.S. CLS. 13, 21, 23, 31 AND 34).

CLASS 17—RUBBER GOODS

FOR PACKING MATERIAL FOR FORMING SEALS; ELECTRICAL INSULATING TAPE; NON-METAL SEALS OF PLASTIC, BRUSHES, AND TEXTILES OR COMBINATION THEREOF FOR GENERAL MANUFACTURING USE; POLYURETHANE FILM FOR FORMING SEALS; AND PLASTIC IN EXTRUDED FORM FOR GENERAL MANUFACTURING USE (U.S. CLS. 1, 5, 12, 13, 35 AND 50).

CLASS 19—NON-METALLIC BUILDING MATERIALS

FOR NON-METALLIC BUILDING MATERIALS, NAMELY PROFILES, TUBES; PLATES, SHEETS AND FOILS FOR WINDOWS, DOORS, GATES, BALCONIES, CONSERVATORIES, ROOFS; NON-METALLIC BUILDING MATERIALS, NAMELY WINDOWS, DOORS, GATES, STAIRS, PARTITION WALLS, BALCONIES, PREFABRICATED CONSERVATORIES, ROOFS, DOOR, WINDOW AND COLLECTOR FRAMES, FACINGS AND PREFABRICATED PARTS THEREFORE; NON-METAL BUILDING MATERIALS, NAMELY SHUTTERS, BALUSTRADES FOR STAIRS AND BALCONIES, WINDOW-SILLS, RAIN-LEADING PROFILES, FENCES, SCAFFOLDS, AND NON-METAL TRANSPORTABLE BUILDINGS, AND NON-METAL TRANSPORTABLE EXHIBITION STANDS, ALL OF THE FOREGOING GOODS WHOLLY NON-METALS OR SUBSTANTIALLY NON-METAL IN COMBINATION WITH METAL (U.S. CLS. 1, 12, 33 AND 50).

ELLEN B. AWRICH, EXAMINING ATTORNEY

SN 76-544,734. MENARD, INC., EAU CLAIRE, WI. FILED 9-15-2003.

EASY GRIP

NO CLAIM IS MADE TO THE EXCLUSIVE RIGHT TO USE GRIP, APART FROM THE MARK AS SHOWN.

CLASS 8—HAND TOOLS

FOR HAND TOOLS, NAMELY, RATCHETS AND WRENCHES (U.S. CLS. 23, 28 AND 44).
FIRST USE 10-0-2000; IN COMMERCE 10-0-2000.

CLASS 9—ELECTRICAL AND SCIENTIFIC APPARATUS

FOR TAPE MEASURES (U.S. CLS. 21, 23, 26, 36 AND 38).
FIRST USE 10-0-2000; IN COMMERCE 10-0-2000.
IRENE D. WILLIAMS, EXAMINING ATTORNEY

SN 76-544,735. MENARD, INC., EAU CLAIRE, WI. FILED 9-15-2003.

easy **GRIP**

NO CLAIM IS MADE TO THE EXCLUSIVE RIGHT TO USE GRIP, APART FROM THE MARK AS SHOWN.

CLASS 8—HAND TOOLS

FOR HAND TOOLS, NAMELY, RATCHETS AND WRENCHES (U.S. CLS. 23, 28 AND 44).
FIRST USE 10-0-2000; IN COMMERCE 10-0-2000.

CLASS 9—ELECTRICAL AND SCIENTIFIC APPARATUS

FOR TAPE MEASURES (U.S. CLS. 21, 23, 26, 36 AND 38).
FIRST USE 10-0-2000; IN COMMERCE 10-0-2000.
IRENE D. WILLIAMS, EXAMINING ATTORNEY

SN 76-545,266. WASHWORLD, INC., DEPERE, WI. FILED 9-8-2003.

WASHWORLD

CLASS 35—ADVERTISING AND BUSINESS

FOR RETAIL STORE SERVICES FEATURING VEHICLE WASH PARTS AND RELATED EQUIPMENT (U.S. CLS. 100, 101 AND 102).

FIRST USE 9-2-1998; IN COMMERCE 9-2-1998.

CLASS 40—MATERIAL TREATMENT

FOR CUSTOM CONSTRUCTION OF VEHICLE WASH SYSTEMS (U.S. CLS. 100, 103 AND 106).

FIRST USE 9-2-1998; IN COMMERCE 9-2-1998.

ANDREA SAUNDERS, EXAMINING ATTORNEY

SN 76-545,383. ALEXANDER, CHARLES E., RICHMOND, VA. FILED 9-2-2003.



THE COLOR(S) BLUE, BLACK, PINK, YELLOW AND WHITE IS/ARE CLAIMED AS A FEATURE OF THE MARK. THE COLORS BLUE APPEARS IN THE THINK WORD, JT'S BRAIN, JT ON HIS SHIRT, JT'S SHORTS AND SHOES; PINK APPEARS ON JT'S FACE, TONGUE, ARMS AND LEGS; YELLOW APPEARS ON JT'S BRAIN CELLS, SHIRT, SHORTS AND SHOES; BLACK APPEARS ON THE MARK LETTERING, BRAIN GLOW, JUST THINK WORD AND JT'S DRAWING; WHITE APPEARS IN JT'S EYES AND ON HIS HANDS.

CLASS 25—CLOTHING

FOR CLOTHING, NAMELY T-SHIRTS, HATS, FLEECE PULLOVER, COSTUMES, BOXER SHORTS, UNDERWEAR AND SLEEPWEAR (U.S. CLS. 22 AND 39).
FIRST USE 3-9-2003; IN COMMERCE 3-9-2003.

CLASS 41—EDUCATION AND ENTERTAINMENT

FOR ENTERTAINMENT SERVICES, NAMELY, PROVIDING A WEBSITE FOR CHILDREN AND EDUCATIONAL PURPOSES FEATURING PICTURES OF DIFFERENT SCENES WITH THE LETTERS JT HIDDEN WITHIN ALSO A SEGMENT FOR CHILDREN TO EXPRESS THEIR THOUGHTS (U.S. CLS. 100, 101 AND 107).

FIRST USE 3-9-2003; IN COMMERCE 3-9-2003.

CHERYL CLAYTON, EXAMINING ATTORNEY

SN 76-548,539. DAIMLERCHRYSLER AG, 70567 STUTTGART, FED REP GERMANY, FILED 10-2-2003.

SN 76-549,421. HIPPON, PARIS, FRANCE, FILED 9-15-2003.

G 350

PRIORITY CLAIMED UNDER SEC. 44(D) ON FED REP GERMANY APPLICATION NO. 30318381012, FILED 4-7-2003, REG. NO. 30318381, DATED 5-19-2003, EXPIRES 4-30-2013.

OWNER OF U.S. REG. NOS. 2,230,063, 2,788,529 AND OTHERS.

NO CLAIM IS MADE TO THE EXCLUSIVE RIGHT TO USE "350", APART FROM THE MARK AS SHOWN.

CLASS 12—VEHICLES

FOR AUTOMOBILES AND THEIR STRUCTURAL PARTS (U.S. CLS. 19, 21, 23, 31, 35 AND 44).

CLASS 28—TOYS AND SPORTING GOODS

FOR TOY MODEL VEHICLES (U.S. CLS. 22, 23, 38 AND 50).

ADA HAN, EXAMINING ATTORNEY

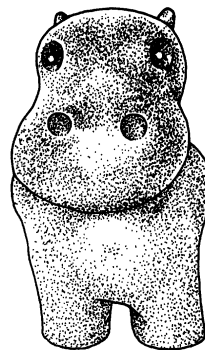

PRIORITY CLAIMED UNDER SEC. 44(D) ON FRANCE APPLICATION NO. 033215861, FILED 3-14-2003, REG. NO. 033215861, DATED 3-14-2003, EXPIRES 3-14-2013.

THE STIPPLING IS FOR SHADING PURPOSES.

THE MARK CONSISTS OF A STYLIZED HIPPOPOTAMUS.

CLASS 9—ELECTRICAL AND SCIENTIFIC APPARATUS

FOR APPARATUS FOR RECORDING, TRANSMITTING, REPRODUCING, STORING, MANIPULATING, BROADCASTING, EMITTING OR PICKING UP SOUND, IMAGES AND DATA, NAMELY BLANK AND PRE-RECORDED MAGNETIC COMPUTER TAPES AND VIDEOTAPES, ALL THE PRE-RECORDED MEDIA CONTAINING SOFTWARE USED FOR OPERATING CHAT-ROOMS AND ELECTRONIC MESSAGING ON THE INTERNET; BLANK VIDEODISCS AND PRE-RECORDED VIDEODISCS FEATURING SOFTWARE FOR OPERATING CHAT-ROOMS AND ELECTRONIC MESSAGING ON THE INTERNET; BLANK OPTICAL DISKS AND PRE-RECORDED OPTICAL DISKS FEATURING SOFTWARE FOR OPERATING CHAT-ROOMS AND ELECTRONIC MESSAGING ON THE INTERNET; BLANK DIGITAL DISCS AND PRE-RECORDED DIGITAL DISCS FEATURING SOFTWARE FOR OPERATING CHAT-ROOMS AND ELECTRONIC MESSAGING ON THE INTERNET; BLANK COMPACT DISCS AND PRE-RECORDED COMPACT DISCS ALL THE PRE-RECORDED MEDIA FEATURING SOFTWARE FOR OPERATING CHAT-ROOMS OR A PEER-TO-PEER EXCHANGE SYSTEM ON THE INTERNET; COMPUTER PERIPHERALS, NAMELY, COMPUTER INTERFACE BOARDS FOR THE TRANSMISSION OF MESSAGES; COMPUTER PROGRAMS CONTAINING COMMUNICATION PROTOCOLS AND APPLICATION PROGRAMS USED FOR THE TRANSMISSION AND EXCHANGE OF MESSAGES, COMMUNICATIONS AND DATA BETWEEN ON-LINE USERS WHOSE SUBJECT MATTER IS TO CHAT OR EXCHANGE KNOWLEDGE ON AN ELECTRONIC NETWORK; COMPUTER SOFTWARE CONTAINING DIRECTORIES OF CHAT ROOMS AND OF ON-LINE USERS OF SAID CHAT-ROOMS; COMPUTER SOFTWARE CONTAINING DIRECTORIES OF DATA ABOUT ON-LINE USERS AND ADDRESS BOOKS OF CONTACTS; EQUIPMENT FOR PROCESSING INFORMATION, NAMELY, DATA PROCESSORS AND COMPUTERS (U.S. CLS. 21, 23, 26, 36 AND 38).

SN 76-549,257. THE DRUTHERS SISTERS LLC, JACKSON, MS. FILED 10-6-2003.

DRUTHERS SISTERS

CLASS 16—PAPER GOODS AND PRINTED MATTER

FOR PAPER GOODS, NAMELY NAPKINS, COASTERS, STATIONERY, WRITING PAPER, ADDRESS BOOKS, PHOTO ALBUMS, SCRAPBOOKS, BLANK WRITING JOURNALS, WORKBOOKS DIRECTED TO VALUES ANALYSIS, NON-FICTION BOOKS ON THE SUBJECT OF VALUES ANALYSIS, GREETING CARDS, POST CARDS, CALENDARS, WRAPPING PAPER, SACKS AND BAGS (U.S. CLS. 2, 5, 22, 23, 29, 37, 38 AND 50).

CLASS 25—CLOTHING

FOR CLOTHING, NAMELY TEE SHIRTS, SHIRTS, JACKETS, PANTS, SOCKS, CAPS AND HATS (U.S. CLS. 22 AND 39).

DOMINIC J. FERRAIUOLO, EXAMINING ATTORNEY

CLASS 35—ADVERTISING AND BUSINESS

FOR ONLINE DISSEMINATION OF BUSINESS INFORMATION AND DATA AND ADVERTISING INFORMATION AND DATA IN THE FIELD OF ADVERTISEMENT AND BUSINESS MARKETING; COMPUTERIZED FILE UPDATING, NAMELY DATA PROCESSING SERVICES, COMPUTERIZED DATABASE MANAGEMENT IN THE FIELD OF BUSINESS; SUBSCRIPTION SERVICES, NAMELY, ARRANGING SUBSCRIPTIONS FOR OTHERS TO ONLINE ACCESS TO CHAT ROOMS; DOCUMENT REPRODUCTION; COMPUTERIZED DATABASE MANAGEMENT OF RICH DATA FILES; PROVIDING ONLINE E-MAIL ADDRESS DIRECTORY INFORMATION (U.S. CLS. 100, 101 AND 102).

CLASS 38—COMMUNICATION

FOR TELECOMMUNICATION, COMMUNICATION VIA COMPUTER TERMINALS AND NETWORKS, NAMELY ELECTRONIC TRANSMISSION OF MESSAGES AND DATA, E-MAIL, PROVIDING ON-LINE CHAT ROOMS FOR TRANSMISSION OF MESSAGES AMONG COMPUTER USERS CONCERNING GENERAL INTEREST INFORMATION FROM PEERS VIA A GLOBAL COMPUTER NETWORK AND PEER-TO-PEER WEB MESSAGING VIA COMPUTER TERMINALS AND NETWORKS; TRANSMISSION AND BROADCASTING OF DATA, SOUNDS, TEXTS, IMAGES AND MESSAGES BY ELECTRONIC MEANS, TELEMETRIC MEANS, HERTZ MEANS, OPTICAL MEANS, WIRE AND SATELLITES; ELECTRONIC MAIL SERVICES, NAMELY, BY ELECTRONIC TRANSMISSION OF DATA VIA AN INTERNET WEBSITE AND/OR AN ELECTRONIC NETWORK, NAMELY VIA COMPUTER TERMINALS AND NETWORKS; AUDIO AND VIDEO BROADCASTING FOR OTHERS OF ELECTRONIC ANIMATIONS, MESSAGES, NEWSLETTERS, ADVERTISING, DATA AND SUMMARIES, REQUESTS AND DATABASE CHARACTERISTICS AND CONTENTS VIA ELECTRONIC MEDIA, VIA NETWORK, AND VIA COMPUTER TERMINALS; ELECTRONIC TRANSMISSION OF NEWS VIA ELECTRONIC MEDIA, TELEMETRIC, HERTZ, OPTICAL, WIRE, SATELLITE NETWORKS, VIA COMPUTER TERMINALS AND NETWORKS; PROVIDING ONLINE CHAT-ROOMS AND PEER-TO-PEER WEB MESSAGING FOR TRANSMISSION OF MESSAGES AMONG COMPUTER USERS CONCERNING PERSONAL AND INTERACTIVE COMMUNICATIONS RELATED TO GENERAL INTEREST INFORMATION FROM PEERS VIA A GLOBAL COMPUTER NETWORK; PROVIDING AN ONLINE ELECTRONIC BULLETIN BOARD FOR THE TRANSMISSION OF MESSAGES AMONG COMPUTER USERS CONCERNING TOPICS OF GENERAL INTEREST (U.S. CLS. 100, 101 AND 104).

CLASS 42—SCIENTIFIC, COMPUTER AND LEGAL SERVICES

FOR INFORMATION SEARCHING, NAMELY DATA MINING SERVICE FOR INFORMATION RESEARCH INTO COMPUTER DATA FILES; PROVIDING SEARCH ENGINES FOR OBTAINING DATA ON A GLOBAL COMPUTER NETWORK (U.S. CLS. 100 AND 101).
DORITT L. CARROLL, EXAMINING ATTORNEY

SN 76-549,942. JAM INDUSTRIES LTD./LTÉE, QUEBEC, H9X 4B7, CANADA, FILED 10-8-2003.

FAST CONNECT

PRIORITY CLAIMED UNDER SEC. 44(D) ON CANADA APPLICATION NO. 1188325, FILED 8-25-2003, REG. NO. TMA636647, DATED 4-1-2005, EXPIRES 4-1-2015.

NO CLAIM IS MADE TO THE EXCLUSIVE RIGHT TO USE "CONNECT", APART FROM THE MARK AS SHOWN.

CLASS 9—ELECTRICAL AND SCIENTIFIC APPARATUS

FOR CAR AUDIO ACCESSORIES, NAMELY, ELECTRICAL WIRES, TERMINATED CONNECTING ELECTRICAL WIRES, ELECTRICAL CABLES, ELECTRICAL CONNECTORS, INSTALLATION KITS CONSISTING PRIMARILY OF INTERCONNECTED ELECTRICAL WIRING, ELECTRICAL WIRING HARNESES AND PLASTIC MOLDED PARTS FOR INSTALLATION OF CAR AUDIO SYSTEMS (U.S. CLS. 21, 23, 26, 36 AND 38).

CLASS 18—LEATHER GOODS

FOR HARNESES (U.S. CLS. 1, 2, 3, 22 AND 41).
KATHRYN COWARD, EXAMINING ATTORNEY

SN 76-550,471. ZIMMERMAN ASSOCIATES, INC., FAIRFAX, VA. FILED 10-9-2003.

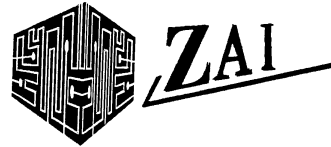

OWNER OF U.S. REG. NO. 2,095,251.

CLASS 35—ADVERTISING AND BUSINESS

FOR INFORMATION MANAGEMENT SERVICES IN THE FIELDS OF RECORDS MANAGEMENT AND FACILITIES MANAGEMENT; AND TECHNICAL SUPPORT AND CONSULTING SERVICES IN THE FIELDS OF RECORDS MANAGEMENT AND FACILITIES MANAGEMENT (U.S. CLS. 100, 101 AND 102).
FIRST USE 2-21-2003; IN COMMERCE 2-21-2003.

CLASS 42—SCIENTIFIC, COMPUTER AND LEGAL SERVICES

FOR RESEARCH IN THE FIELD OF ENGINEERING; DATABASE DEVELOPMENT SERVICES (U.S. CLS. 100 AND 101).
FIRST USE 2-21-2003; IN COMMERCE 2-21-2003.
CIMMERIAN COLEMAN, EXAMINING ATTORNEY

SN 76-550,472. ZIMMERMAN ASSOCIATES, INC., FAIRFAX, VA. FILED 10-9-2003.



OWNER OF U.S. REG. NO. 2,095,251.

CLASS 35—ADVERTISING AND BUSINESS

FOR INFORMATION MANAGEMENT SERVICES IN THE FIELDS OF RECORDS MANAGEMENT AND FACILITIES MANAGEMENT; AND TECHNICAL SUPPORT AND CONSULTING SERVICES IN THE FIELDS OF RECORDS MANAGEMENT AND FACILITIES MANAGEMENT (U.S. CLS. 100, 101 AND 102).
FIRST USE 2-21-2003; IN COMMERCE 2-21-2003.

CLASS 42—SCIENTIFIC, COMPUTER AND LEGAL SERVICES

FOR RESEARCH IN THE FIELD OF ENGINEERING; DATABASE DEVELOPMENT SERVICES (U.S. CLS. 100 AND 101).

FIRST USE 2-21-2003; IN COMMERCE 2-21-2003.
CIMMERIAN COLEMAN, EXAMINING ATTORNEY

SN 76-551,471. SUNPROS CO., LTD., TOKYO, 169-8588, JAPAN, FILED 9-25-2003.



NO CLAIM IS MADE TO THE EXCLUSIVE RIGHT TO USE "PROFESSIONAL DRIFT GRAND PRIX SERIES", APART FROM THE MARK AS SHOWN.

THE COLOR(S) ORANGE IS/ARE CLAIMED AS A FEATURE OF THE MARK.

THE BACKGROUND OF THE MARK IS ORANGE WITH THE WRITING IN BLACK. A WHITE FLAME OVERLAPS THE UPPER LEFT OF D1.

CLASS 9—ELECTRICAL AND SCIENTIFIC APPARATUS

FOR ARCADE VIDEO GAME MACHINES FOR USE WITH TELEVISIONS; ELECTRONIC MACHINES AND APPARATUS NAMELY, COMPUTERS AND COMPUTER GAME PROGRAMS, PARTS AND FITTINGS THEREFORE; CONSUMER VIDEO GAMES; ELECTRONIC CIRCUITS AND RECORDED PROGRAMS ON CD-ROMS FOR OPERATING HAND-HELD GAMES WITH LIQUID CRYSTAL DISPLAYS; RECORDED VIDEO DISCS AND VIDEO TAPES FEATURING AN AUTOMOBILE SALON, MOTOR SHOWS, AUTOMOBILE RACING AND EVENTS RELATED TO MOTOR SHOWS AND AUTO RACING; DOWNLOADABLE ELECTRONIC PUBLICATIONS IN THE NATURE OF NEWSLETTER IN THE FIELD OF AN AUTOMOBILE SALON, MOTOR SHOWS, AUTOMOBILE RACING EVENTS; DOWNLOADABLE MUSICAL SOUND RECORDINGS; DOWNLOADABLE VIDEO RECORDINGS FEATURING GAMES AND AUTOMOBILES (U.S. CLS. 21, 23, 26, 36 AND 38).

CLASS 16—PAPER GOODS AND PRINTED MATTER

FOR BOND PAPERS, PRINTING PAPERS, WRAPPING PAPERS, MILLBOARD, NAMELY STRONG HEAVY HARD PAPERBOARD SUITABLE FOR LINING BOOK COVERS, BOND, COPY AND CRAFT PROCESSED PAPER, PAPERBOARDS AND CARDBOARD; STATIONERY, PAPER STATIONERY NAMELY, PHOTOGRAPH, SCRAPBOOK AND STAMP ALBUMS, BUSINESS CARDS, AUTOMOBILE CARDS, BLANK NOTE CARDS, GAME CARDS, AND GREETING CARDS, SCORE-CARDS, SCORE-BOOKS, NOTEBOOKS, WRITING PADS, ENVELOPES, BUSINESS CARD PAPER, WRITING IMPLEMENTS NAMELY PENCILS, PENCIL POINT PROTECTORS, FELT WRITING PENS, MECHANICAL PENCILS, BALL-POINT PENS, FOUNTAIN PENS, SEALS IN THE FORM OF DECALS, AND SEALS FOR CONTAINERS, STICKERS, PRICE TAGS, NOTICE BILLS FOR ADVERTISING, NUMBERING STAMPS, AND LABELS; PRINTED MATTER NAMELY, CATALOGS IN THE FIELD OF AUTOMOBILES, CALENDARS, AUTOMOBILE, AUTOMOBILE EVENT AND GAME MAGAZINES, AUTOMOBILE, AUTOMOBILE EVENT AND GAME BOOKS, NEWSPAPERS FOR GENERAL CIRCULATION AND FOR UP-COMING AUTOMOBILE EVENTS, AUTOMOBILE, AUTOMOBILE EVENT AND GAME NEWSLETTERS, AND AUTOMOBILE, AUTOMOBILE EVENT AND GAME PAMPHLETS; PHOTOGRAPHS (U.S. CLS. 2, 5, 22, 23, 29, 37, 38 AND 50).

CLASS 28—TOYS AND SPORTING GOODS

FOR STAND ALONE ARCADE VIDEO GAME MACHINES (U.S. CLS. 22, 23, 38 AND 50).

CLASS 35—ADVERTISING AND BUSINESS

FOR PRODUCTION OF VIDEO, CD AND DVDS CONTAINING COMMERCIALS FOR ADVERTISING PURPOSES FOR OTHERS; ADVERTISING AND PUBLICITY FOR OTHERS (U.S. CLS. 100, 101 AND 102).

CLASS 41—EDUCATION AND ENTERTAINMENT

FOR PROVIDING ON LINE EDUCATIONAL AND ENTERTAINMENT ELECTRONIC PUBLICATIONS IN THE FIELD OF AUTOMOBILE RACING, AUTOMOBILE SHOWS; MOVIE THEATERS, MOVIE FILM PRODUCTION, OR MOVIE FILM DISTRIBUTION; EDUCATIONAL, CULTURAL, AMUSEMENT, AND SPORTS VIDEOTAPE FILM PRODUCTION; ORGANIZATION, MANAGEMENT OR ARRANGEMENT OF AUTORACES; PROVIDING AMUSEMENT FACILITIES; RENTAL OF IMAGE-RECORDED MAGNETIC TAPES; ORGANIZING, PLANNING, AND CONDUCTING COMPETITIONS BY USING CONSUMER VIDEO GAMES AND OTHER TOYS; PROVIDING AMUSEMENT ARCADE SERVICES; PRODUCTION OF RADIO OR TELEVISION PROGRAMS; DIRECTING RADIO OR TELEVISION PROGRAMS; OPERATION OF VIDEO EQUIPMENT OR AUDIO EQUIPMENT FOR PRODUCTION OF RADIO OR TELEVISION PROGRAMS; PROVIDING ONLINE MUSIC AND PICTURES FOR EDUCATIONAL AND ENTERTAINMENT PURPOSES; PROVIDING EDUCATIONAL AND ENTERTAINMENT VIDEO TAPE, CD AND DVD PRODUCTION (U.S. CLS. 100, 101 AND 107).

CLASS 42—SCIENTIFIC, COMPUTER AND LEGAL SERVICES

FOR TECHNICAL ADVICE RELATING TO PERFORMANCE, OPERATION, AND UTILIZATION OF COMPUTERS, AUTOMOBILES AND OTHER MACHINES THAT REQUIRE HIGH LEVELS OF PERSONAL KNOWLEDGE, SKILL OR EXPERIENCE OF THE OPERATORS TO MEET THE REQUIRED ACCURACY IN OPERATING THEM; RENTAL OF COMPUTERS; PROVIDING COMPUTER PROGRAMMING FOR OTHERS; DESIGNING, CREATING AND PROVIDING MAINTENANCE OF PROGRAMS FOR ARCADE VIDEO GAME MACHINES AND CONSUMER VIDEO GAMES; PROVIDING INFORMATION FOR DESIGNING, CREATING, AND PROVIDING MAINTENANCE FOR COMPUTER PROGRAMMING WHICH IS NECESSARY FOR PLAYING STREAMING CORRESPONDENCE INFORMATION ON COMPUTER; RENTAL OF COMPUTER PROGRAMS (U.S. CLS. 100 AND 101).

JOHN DWYER, EXAMINING ATTORNEY

SN 76-552,174. RENSSELAER POLYTECHNIC INSTITUTE, TROY, NY. FILED 10-17-2003.



NO CLAIM IS MADE TO THE EXCLUSIVE RIGHT TO USE "EXPERIMENTAL MEDIA & PERFORMING ARTS CENTER", APART FROM THE MARK AS SHOWN.

THE STIPLING IN THE DRAWING IS FOR SHADING PURPOSES ONLY.

CLASS 41—EDUCATION AND ENTERTAINMENT

FOR ENTERTAINMENT SERVICES, NAMELY, PRODUCTION AND PROVISION OF LIVE PERFORMANCES BY MUSICAL PERFORMERS, THEATRICAL PERFORMERS, OR DRAMATIC PERFORMERS; EDUCATIONAL SERVICES, NAMELY, PROVIDING SEMINARS AND WORKSHOPS FEATURING LECTURES, FILMS, PANEL DISCUSSIONS, AND READINGS, IN THE FIELD OF THE ARTS, WITH AND WITHOUT ELECTRONIC MEDIA, AND DISTRIBUTION OF COURSE MATERIALS THEREWITH; RADIO AND TELEVISION PROGRAMMING; ENTERTAINMENT SERVICES, NAMELY, PRODUCTION OF TELEVISION, MOTION PICTURE FILMS, MUSICAL PERFORMANCES, THEATRICAL PERFORMANCES, AND DRAMATIC PERFORMANCES INCLUDING PLAYS, OPERAS, AND DANCES (U.S. CLS. 100, 101 AND 107).

CLASS 42—SCIENTIFIC, COMPUTER AND LEGAL SERVICES

FOR RESEARCH SERVICES, NAMELY, DEVELOPING COMPUTERIZED HARDWARE AND SOFTWARE FOR PERFORMANCES AND MEDIA PRODUCTIONS (U.S. CLS. 100 AND 101).

DANIEL CAPSHAW, EXAMINING ATTORNEY

SN 76-554,790. GLOBALUXE, INC., MOORPARK, CA. FILED 10-10-2003.



Kindled Spirits

CLASS 3—COSMETICS AND CLEANING PREPARATIONS

FOR PREPARATIONS FOR BODY, HAIR AND SKIN CARE, NAMELY, PREPARATIONS IN THE FORM OF HAND SOAPS, DEODORANT SOAPS, ANTI-BACTERIAL SOAPS, BATH GELS, SHAVING GELS, BATH OILS, BODY OILS, NON-MEDICATED BATH SALTS, LIP BALMS, NON-MEDICATED SKIN BALMS, HAIR SHAMPOOS, HAIR CONDITIONERS, SKIN CONDITIONERS, SKIN LOTIONS, SKIN MOISTURIZERS, SKIN CLEANSERS, SKIN CREAMS, FACE CREAMS, HAND CREAMS, PERFUME AND COLOGNE, AND PET SHAMPOOS AND DEODORIZING SKIN POWDERS, HOUSEHOLD CLEANING PREPARATIONS, NAMELY, LIQUID COUNTER CLEANING SOLUTIONS, GENERAL PURPOSE CLEANING ABRASIVE POWDERS, LIQUID FLOOR AND SURFACE CLEANING SOLUTIONS, DISPOSABLE WIPES IMPREGNATED WITH CHEMICALS OR COMPOUNDS FOR COUNTER AND FLOOR SURFACE CLEANING, LIQUID CLEANER FOR GLASS SURFACES, AUTOMATIC DISHWASHING DETERGENTS AND DISHWASHING DETERGENTS, LAUNDRY DETERGENTS, FABRIC SOFTENERS, STAIN REMOVERS, AND OTHER SCENTED AND/OR AROMA PRODUCTS NAMELY POTPOURRI (U.S. CLS. 1, 4, 6, 50, 51 AND 52).

FIRST USE 8-25-2003; IN COMMERCE 8-25-2003.

CLASS 4—LUBRICANTS AND FUELS

FOR CANDLES (U.S. CLS. 1, 6 AND 15).
FIRST USE 8-25-2003; IN COMMERCE 8-25-2003.
BILL DAWE, EXAMINING ATTORNEY

SN 76-555,291. PICSEL (RESEARCH) LIMITED, G51 4BP
GLASGOW, UNITED KINGDOM, FILED 10-28-2003.

E-PAGE**CLASS 9—ELECTRICAL AND SCIENTIFIC APPARATUS**

FOR DATA PROCESSORS; MICROPROCESSORS; COMPUTER DEVICES, NAMELY, PERSONAL COMPUTERS, COMPUTER GAME CONSOLES; HAND HELD COMPUTER DEVICES, NAMELY, PERSONAL DIGITAL ASSISTANTS, COMPUTER GAME TERMINALS, HAND HELD INDUSTRIAL TERMINALS, HAND HELD TABLET COMPUTERS FOR WEB BROWSING AND HAND HELD COMPUTERS; COMPUTER PERIPHERAL DEVICES; COMPUTER PRINTERS; MOBILE PHONES; ELECTRONIC COMMUNICATION DEVICES, NAMELY, PAGERS, EMAIL COMPUTER TERMINALS, TELEPHONE SETS WITH SCREENS AND FAX MACHINES; CABLE TELEVISION APPARATUS AND INSTRUMENTS, NAMELY, CABLE TELEVISION DECODERS; DIGITAL PROJECTORS, NAMELY, MULTIMEDIA PROJECTORS, CONFERENCE ROOM PROJECTORS, HOME THEATRE PROJECTORS, VIDEO PROJECTORS AND DIGITAL PHOTOGRAPH PROJECTORS; DIGITAL CAMERAS; COMPUTER MEMORIES, NAMELY, ROM CARDS, CARTRIDGES AND DISCS, COMPUTER MEMORY CARDS CONTAINING CHIPS; COMPUTER CHIPS; DATA STORAGE DEVICES FOR THE RECORDATION OF COMPUTER PROGRAMS, NAMELY DISCS AND CD ROMS; COMPUTER SOFTWARE FOR USE IN BROWSING, MESSAGING, IMAGE VIEWING, INFORMATION RETRIEVAL, NAVIGATION SYSTEMS AND GAMES; COMPUTER GRAPHICS SOFTWARE; GRAPHICAL USER INTERFACE SOFTWARE; DIGITAL DOCUMENT PROCESSING COMPUTER SOFTWARE (U.S. CLS. 21, 23, 26, 36 AND 38).

CLASS 42—SCIENTIFIC, COMPUTER AND LEGAL SERVICES

FOR LICENSING OF INTELLECTUAL PROPERTY RELATING TO DATA PROCESSING SYSTEMS, MICROPROCESSORS, COMPUTER DEVICE, HAND HELD COMPUTER DEVICES, COMPUTER PERIPHERAL DEVICES, PRINTERS, MOBILE PHONES, ELECTRONIC COMMUNICATION DEVICES, CABLE TELEVISION APPARATUS AND INSTRUMENTS INCLUDING CABLE TELEVISION DECODERS, DIGITAL PROJECTORS, DIGITAL CAMERAS, READ ONLY MEMORIES (ROMS), ROM CARDS, CARTRIDGES AND DISCS, COMPUTER CARDS CONTAINING CHIPS, COMPUTER CHIPS, DATA STORAGE DEVICES FOR THE RECORDAL OF COMPUTER PROGRAMS, COMPUTER PROGRAMS, COMPUTER PROGRAMS FOR PRODUCING COMPUTER GRAPHICS, GRAPHICAL USER INTERFACE SOFTWARE AND DIGITAL DOCUMENT PROCESSING COMPUTER SOFTWARE; DESIGN OF DATA PROCESSING SYSTEMS FOR COMPUTER GRAPHICS AND DIGITAL PROCESSING (U.S. CLS. 100 AND 101).

YONG KIM, EXAMINING ATTORNEY

SN 76-555,588. POWER PLAY INTERNATIONAL, INC.,
COMMERCE TOWNSHIP, MI. FILED 10-31-2003.

MR. AND MRS. HOCKEY

THE MARK CONSISTS OF STANDARD CHARACTERS WITHOUT CLAIM TO ANY PARTICULAR FONT, STYLE, SIZE, OR COLOR.

OWNER OF U.S. REG. NOS. 1,890,150 AND 2,718,629.
NO CLAIM IS MADE TO THE EXCLUSIVE RIGHT TO USE HOCKEY, APART FROM THE MARK AS SHOWN.

CLASS 36—INSURANCE AND FINANCIAL

FOR CONDUCTING CHARITABLE FUND RAISING EXHIBITIONS AND PROMOTIONS IN CONNECTION WITH THE SPORT OF HOCKEY (U.S. CLS. 100, 101 AND 102).

FIRST USE 0-0-1993; IN COMMERCE 0-0-1993.

CLASS 41—EDUCATION AND ENTERTAINMENT

FOR ARRANGING AND CONDUCTING EDUCATIONAL AND HISTORICAL LECTURES AND PRESENTATIONS; AND ARRANGING AND CONDUCTING PERSONAL APPEARANCES OF CELEBRITIES, ALL CONNECTION WITH THE SPORT OF HOCKEY (U.S. CLS. 100, 101 AND 107).

FIRST USE 0-0-1993; IN COMMERCE 0-0-1993.
CURTIS FRENCH, EXAMINING ATTORNEY

CLASS 7—MACHINERY

FOR ELECTRODIALYSIS MACHINES FOR DESALTING OF ACID AND/OR ALKALI, CONCENTRATION OF ACID AND/OR ALKALI, CONCENTRATION OF METAL SALT, PREPARATION OF ACID AND/OR ALKALI FROM SALTS, AND/OR PREPARATION OF ORGANIC ACID FROM SALTS OF ORGANIC ACID; ELECTRODIALYSIS MACHINES FOR ELECTRICAL REMOVAL OF HEAVY METALS PRESENT IN SOIL; ELECTRODIALYSIS MACHINES FOR PREPARATION OF SALT BY CONCENTRATION OF SEAWATER, CONTROL OF ACIDITY OF FRUIT JUICE, PREPARATION OF SALT-REDUCED SOY SAUCE, DESALTING AND PURIFICATION OF AQUEOUS SOLUTION OF AMINO ACIDS, TREATMENT OF DAIRY PRODUCTS, AND/OR DESALTING OF WHEY; DIFFUSION DIALYSIS MACHINES FOR RECOVERY OF ACID OR ALKALI; CHEMICAL PROCESSING MACHINES AND APPARATUS FOR EXTRACTING, FILTERING, SEPARATING, GRINDING, MIXING, AGITATING AND/OR MAKING CHEMICALS FOR INDUSTRIAL AND COMMERCIAL USE FOR USE IN THE CHEMICAL INDUSTRIES; MACHINES AND APPARATUS FOR FILTERING, SEPARATING, DRYING AND MIXING OF INGREDIENTS IN FOOD AND BEVERAGES FOR USE IN FOOD OR BEVERAGE PROCESSING, USED FOR THE PURPOSES OF DEMINERALIZATION OF CHEESE WHEY, ORGANIC ACIDS, AMINO ACIDS, NATURAL EXTRACT, POLYSACCHARIDE OR BETAINE, DESALINATION OF SOY SAUCE, STABILIZATION OF WINE, DEMINERALIZATION AND DEACIDIFICATION OF FRUIT JUICE, AND/OR DEMINERALIZATION AND PURIFICATION OF PHARMACEUTICAL INTERMEDIATE AND/OR MOLLASSES; MACHINES AND APPARATUS FOR USE IN FOOD OR BEVERAGE PROCESSING; ELECTRODEPOSITION PAINTING MACHINES AND APPARATUS COMPRISING OF AN ION EXCHANGE MEMBRANE USED FOR PAINTING AUTOMOBILE BODY, CONSTRUCTION MATERIALS AND HOME ELECTRIC APPLIANCES WITH AN EPOXY RESIN-BASED OR ACRYLIC RESIN-BASED PAINTING; PAINTING MACHINES AND APPARATUS USED FOR FORMING AN EPOXY RESIN-BASED OR ACRYLIC RESIN-BASED PAINTING LAYER ON AUTOMOBILE BODY OR ALUMINUM SASH (U.S. CLS. 13, 19, 21, 23, 31, 34 AND 35).

SN 76-556,692. ASTOM CO., LTD., TOKYO, JAPAN, FILED 11-3-2003.

 The logo for ASTOM features the word "ASTOM" in a bold, sans-serif font. The letters "A", "S", "T", and "M" are blue, while the letter "O" is green. The "O" is stylized with a heart shape cut out of its center.

OWNER OF JAPAN REG. NO. 4756686, DATED 3-19-2004, EXPIRES 3-19-2014.

THE COLOR(S) BLUE AND GREEN IS/ARE CLAIMED AS A FEATURE OF THE MARK.

THE MARK CONSISTS OF THE WORD "ASTOM" APPEARING IN GREEN AND BLUE. THE LETTERS "A", "S", "T" AND "M" APPEAR IN THE COLOR BLUE. THE LOWER PORTION/HALF OF THE LETTER "O" APPEARS IN THE COLOR BLUE AND THE UPPER/HALF PORTION OF THE LETTER "O" APPEARS IN THE COLOR GREEN.

CLASS 1—CHEMICALS

FOR ION EXCHANGE RESIN MEMBRANES; ION EXCHANGE RESINS; CHEMICAL PREPARATIONS USED FOR REGENERATION OF ION EXCHANGER (U.S. CLS. 1, 5, 6, 10, 26 AND 46).

CLASS 9—ELECTRICAL AND SCIENTIFIC APPARATUS

FOR ELECTROLYSERS; ELECTROPLATING APPARATUS; ELECTRODES COMPRISING ION EXCHANGE MEMBRANE FOR USE IN ELECTRODEPOSITION PAINTING; ELECTRODES USED FOR FORMING AN EPOXY RESIN-BASED OR ACRYLIC RESIN-BASED PAINTING LAYER ON AUTOMOBILE BODY OR ALUMINUM SASH (U.S. CLS. 21, 23, 26, 36 AND 38).

CHRISTOPHER BUONGIORNO, EXAMINING ATTORNEY

SN 76-556,754. POMWONDERFUL LLC, LOS ANGELES, CA. FILED 10-22-2003.

 The logo for POMEGRANATE features the word "POMEGRANATE" in a bold, sans-serif font. The letter "O" is replaced by a heart shape.

NO CLAIM IS MADE TO THE EXCLUSIVE RIGHT TO USE "POMEGRANATE", APART FROM THE MARK AS SHOWN.

THE MARK CONTAINS A HEART DESIGN IN PLACE OF THE LETTER "O" IN THE WORD "POMEGRANATE".

CLASS 31—NATURAL AGRICULTURAL PRODUCTS

FOR FRESH FRUITS (U.S. CLS. 1 AND 46).

CLASS 32—LIGHT BEVERAGES

FOR FRUIT JUICES AND FRUIT JUICE CONCENTRATES (U.S. CLS. 45, 46 AND 48).
KATHRYN COWARD, EXAMINING ATTORNEY

SN 76-557,881. ACADEMIE SCIENTIFIQUE DE BEAUTE, S.A., 92704 COLOMBES CEDEX, FRANCE, FILED 11-5-2003.

ACADAYSPA

THE MARK CONSISTS OF STANDARD CHARACTERS WITHOUT CLAIM TO ANY PARTICULAR FONT, STYLE, SIZE, OR COLOR.

PRIORITY CLAIMED UNDER SEC. 44(D) ON FRANCE APPLICATION NO. 033227023, FILED 5-23-2003, REG. NO. 033227023, DATED 5-23-2003, EXPIRES 5-23-2013.

CLASS 3—COSMETICS AND CLEANING PREPARATIONS

FOR SOAPS; PERFUMERY; ESSENTIAL OILS FOR PERSONAL USE; COSMETICS; HAIR LOTION; PRODUCTS FOR THE FACE AND FOR THE BODY, NAMELY, BODY AND FACIAL MASKS, FACIAL AND BODY SCRUB, CREAMS AND MILKS; NON-MEDICATED BATH SALTS; COSMETICS DERIVED FROM SEAWEED; TOOTHPASTE; AND ANTIPERSPIRANTS (U.S. CLS. 1, 4, 6, 50, 51 AND 52).

CLASS 5—PHARMACEUTICALS

FOR DIETARY PRODUCTS, NAMELY SUPPLEMENTS; HERBAL MUD PACKS FOR THERAPEUTIC PURPOSES (U.S. CLS. 6, 18, 44, 46, 51 AND 52).

JOHN GARTNER, EXAMINING ATTORNEY

SN 76-558,044. SCOTT PAPER LIMITED, MISSISSAUGA, ONTARIO, CANADA, FILED 11-7-2003.

THE ULTIMATE WASHROOM

THE MARK CONSISTS OF STANDARD CHARACTERS WITHOUT CLAIM TO ANY PARTICULAR FONT, STYLE, SIZE, OR COLOR.

PRIORITY CLAIMED UNDER SEC. 44(D) ON CANADA APPLICATION NO. 1195993, FILED 11-6-2003, REG. NO. TMA634185, DATED 3-3-2005, EXPIRES 3-3-2020.

CLASS 3—COSMETICS AND CLEANING PREPARATIONS

FOR HAND CARE PRODUCTS, NAMELY, ANTIBACTERIAL SOAPS AND LOTIONS; ANTISEPTIC SOAPS (U.S. CLS. 1, 4, 6, 50, 51 AND 52).

CLASS 5—PHARMACEUTICALS

FOR AIR FRESHENERS; ANTISEPTIC LOTIONS (U.S. CLS. 6, 18, 44, 46, 51 AND 52).

CLASS 16—PAPER GOODS AND PRINTED MATTER

FOR PAPER PRODUCTS, NAMELY, BATHROOM TISSUE, FACIAL TISSUE, NAPKINS, PAPER TOWELS, AND PAPER WIPES NOT IMPREGNATED WITH CHEMICALS OR COMPOUNDS (U.S. CLS. 2, 5, 22, 23, 29, 37, 38 AND 50).

MICHELE SWAIN, EXAMINING ATTORNEY

SN 76-558,067. ATLAS DATABASE SOFTWARE CORP., CALABASAS, CA. FILED 11-7-2003.

ATLAS

THE MARK CONSISTS OF STANDARD CHARACTERS WITHOUT CLAIM TO ANY PARTICULAR FONT, STYLE, SIZE, OR COLOR.

CLASS 9—ELECTRICAL AND SCIENTIFIC APPARATUS

FOR COMPUTER SOFTWARE AND MANUALS THEREFORE FOR USE IN CONNECTION WITH MEDICAL RECORDS, PATIENT INFORMATION, CLINICAL HISTORIES, CLINICAL TASK WORKFLOW, RADIOLOGY AND LABORATORY TEST ORDERING RESULTS REPORTING, AND PROVIDING REMOTE ACCESS TO THE FOREGOING BETWEEN USERS (U.S. CLS. 21, 23, 26, 36 AND 38).

FIRST USE 10-0-1989; IN COMMERCE 10-0-1989.

CLASS 42—SCIENTIFIC, COMPUTER AND LEGAL SERVICES

FOR APPLICATION SERVICE PROVIDER FEATURING SOFTWARE FOR USE IN CONNECTION WITH MEDICAL RECORDS, PATIENT INFORMATION, CLINICAL HISTORIES, CLINICAL TASK WORKFLOW, RADIOLOGY AND LABORATORY TEST ORDERING AND RESULTS REPORTING, AND PROVIDING REMOTE ACCESS TO THE FOREGOING BETWEEN USERS; COMPUTER SOFTWARE CONSULTATION, DESIGN FOR OTHERS AND DEVELOPMENT (U.S. CLS. 100 AND 101).

FIRST USE 10-0-1989; IN COMMERCE 10-0-1989.
KELLY BOULTON, EXAMINING ATTORNEY

SN 76-558,496. SUNPROS CO., LTD., TOKYO 169-8588, JAPAN, FILED 11-10-2003.



NO CLAIM IS MADE TO THE EXCLUSIVE RIGHT TO USE "PROFESSIONAL DRIFT GRAND PRIX SERIES", APART FROM THE MARK AS SHOWN.

THE COLOR(S) ORANGE IS/ARE CLAIMED AS A FEATURE OF THE MARK.

THE BACKGROUND OF THE MARK IS ORANGE AND THE WRITING IS IN BLACK. A WHITE FLAME OVERLAPS THE UPPER LEFT OF D1.

CLASS 9—ELECTRICAL AND SCIENTIFIC APPARATUS

FOR COMPUTER GAME SOFTWARE AND FIRMWARE; COMPUTER SOFTWARE FEATURING AUTO RACING GAMES; VIDEO GAME INTERACTIVE HAND HELD REMOTE CONTROLS FOR PLAYING ELECTRONIC GAMES; COMPUTER PROGRAMS FOR GAMES (U.S. CLS. 21, 23, 26, 36 AND 38).

CLASS 28—TOYS AND SPORTING GOODS

FOR GAME MACHINES NAMELY STAND ALONG VIDEO OUTPUT, STAND ALONE VIDEO; HAND HELD UNIT FOR PLAY ELECTRONIC GAMES; BODY-TRAINING APPARATUS, NAMELY EXERCISE MACHINES; BUILDING GAMES FEATURING TOY BUILDING PARTS; DISCUSSES; DOLLS; FAIRGROUND APPARATUS, NAMELY AMUSEMENT PARK RIDES; GAMES, NAMELY BOARD GAMES, ACTION SKILL GAMES, AUTO RACING GAMES; GOLF BAGS, WITH OR WITHOUT WHEELS; GLOVES FOR GAMES, NAMELY GOLF; AUTO RACING, AUTO DRIVING; GOLF CLUBS; GOLF GLOVES; JIGSAW PUZZLES; PLAYING CARDS; RADIO-CONTROLLED TOY VEHICLES; SCALE MODEL VEHICLES; TOY BOXES, NOT BEING FURNITURE; TOY BUILDING BLOCKS; TOYS DESIGNED TO BE ATTACHED TO CAR SEATS, STROLLERS, CRIBS, HIGH CHAIRS; TOY FIGURES; TOY MOBILES; TOY MODEL CARS; TOY MODEL HOBBY CRAFT KITS; TOY MODEL CAR KITS; TOY MODEL VEHICLES AND RELATED ACCESSORIES SOLD AS UNITS; TOY VEHICLES; TOY VEHICLES AND ACCESSORIES THEREFORE; TOY VEHICLES WITH TRANSFORMING PARTS (U.S. CLS. 22, 23, 38 AND 50).

KAREN BRACEY, EXAMINING ATTORNEY

SN 76-558,899. MERITUULEN RAUTA OY, 02270 ESPOO, FINLAND, FILED 11-10-2003.

NEPTUNUS TRANSMISSION

THE MARK CONSISTS OF STANDARD CHARACTERS WITHOUT CLAIM TO ANY PARTICULAR FONT, STYLE, SIZE, OR COLOR.

PRIORITY CLAIMED UNDER SEC. 44(D) ON FINLAND APPLICATION NO. T200301176, FILED 5-9-2003, REG. NO. 229505, DATED 1-30-2004, EXPIRES 1-30-2014.

NO CLAIM IS MADE TO THE EXCLUSIVE RIGHT TO USE "TRANSMISSION", APART FROM THE MARK AS SHOWN.

THE ENGLISH TRANSLATION OF THE TERM NEPTUNUS IN THE MARK IS "NEPTUNE".

CLASS 7—MACHINERY

FOR PLANETARY TRANSMISSION GEARS FOR MACHINES (U.S. CLS. 13, 19, 21, 23, 31, 34 AND 35).

CLASS 12—VEHICLES

FOR TRANSMISSION MECHANISMS FOR LAND VEHICLES, NAMELY PLANETARY GEARS (U.S. CLS. 19, 21, 23, 31, 35 AND 44).

SCOTT BALDWIN, EXAMINING ATTORNEY

SN 76-559,489. CHEMISCHE FABRIK BUDENHEIM KG, D-55257 BUDENHEIM, FED REP GERMANY, FILED 11-12-2003.

BUDAL

THE MARK CONSISTS OF STANDARD CHARACTERS WITHOUT CLAIM TO ANY PARTICULAR FONT, STYLE, SIZE, OR COLOR.

OWNER OF FED REP GERMANY REG. NO. 30252144, DATED 10-7-2003, EXPIRES 10-7-2013.

THE MARK IS PRESENTED IN STANDARD CHARACTER FORMAT WITHOUT CLAIM TO ANY PARTICULAR FONT STYLE, SIZE, OR COLOR.

CLASS 1—CHEMICALS

FOR CHEMICAL SUBSTANCES FOR PRESERVING FOODSTUFFS; CHEMICAL COMPOSITIONS FOR USE IN THE PRODUCTION OF FOOD PRODUCTS, NAMELY, FOR PREVENTING BLOOD COAGULATION AND FOR SOFTENING MEAT FIBRES; CHEMICALS USED IN PHOTOGRAPHY; WATER SOFTENING CHEMICAL PREPARATION; CHEMICALS, NAMELY WATER SOFTENING AGENTS AND ANTI-INCRUSTANTS; CHEMICALS, NAMELY ION EXCHANGERS; CHEMICALS FOR USE IN THE MANUFACTURE OF FOOD, COSMETIC, TOILETRIES AND PERSONAL CARE PRODUCTS, NAMELY, EMULSIFYING AGENTS; FIRE EXTINGUISHING COMPOSITIONS; TEXTILE IMPREGNATING CHEMICALS, PAPER IMPREGNATING CHEMICALS; CHEMICAL FLAME PROTECTION SUBSTANCES; CHEMICALS FOR INDUSTRIAL USE, NAMELY AUXILIARY AGENTS FOR ELECTROPLATING, FOR THE CERAMICS AND GLASS INDUSTRY, AND FOR THE SURFACE TREATMENT OF METALS; CHEMICAL PRODUCTS FOR THE MANUFACTURE OF METAL JOINTS BY SOLDERING AND WELDING, NAMELY WELDING FLUXES AND FLUXING AGENTS; PHOSPHORIC SALTS; FERTILIZERS FOR AGRICULTURAL USE; FERTILIZERS FOR DOMESTIC USE; PLANT NUTRIENT SALTS; CHEMICALS FOR USE IN THE FINISHING AND TANNING OF LEATHER; MELTING SALTS FOR CHEESE; CHEMICAL ADDITIVES FOR USE IN THE MANUFACTURE OF CONDENSED MILK; EMULSIFYING AGENTS FOR EDIBLE FATS AND OILS; CHEMICAL ADDITIVES FOR DIETETIC FOODSTUFFS AND FOR FOODSTUFFS FOR ANIMALS; LEAVENING AGENTS INCLUDING BAKING POWDER; BAKING AGENTS; CHEMICAL PRODUCTS FOR MINERAL ENRICHMENT, AS ANTI-CAKING AGENTS, FOR TREATMENT OF POTATOES AND VEGETABLES AS WELL AS FOR TREATMENT OF EGGS; CHEMICAL ADDITIVES FOR THE PREPARATION OF DAIRY PRODUCTS, DESSERTS AND DRINKS, FOR NOODLES AND OTHER DOUGH PRODUCTS (U.S. CLS. 1, 5, 6, 10, 26 AND 46).

CLASS 5—PHARMACEUTICALS

FOR MEDICATED SPA BATH SALTS AND MEDICATED BATH SALTS (U.S. CLS. 6, 18, 44, 46, 51 AND 52).

CLASS 30—STAPLE FOODS

FOR FOOD LEAVENING AGENTS, INCLUDING BAKING POWDER; BAKING AGENTS, NAMELY BAKERY MIXES (U.S. CL. 46).

CLASS 31—NATURAL AGRICULTURAL PRODUCTS

FOR FOODSTUFFS FOR ANIMALS (U.S. CLS. 1 AND 46).
MICHAEL HALL, EXAMINING ATTORNEY

SN 76-559,543. SOMMERS, CORRIE, PHILLIPS RANCH, CA. FILED 10-27-2003.

CLASS 7—MACHINERY

FOR BONDING MACHINES FOR SEMICONDUCTOR DEVICES, MICROELECTRONIC DEVICES AND COMPONENTS (U.S. CLS. 13, 19, 21, 23, 31, 34 AND 35).

CLASS 9—ELECTRICAL AND SCIENTIFIC APPARATUS

FOR ELECTRICAL BONDING MACHINES FOR ELECTRICALLY CONNECTING METAL OR OTHER CONDUCTIVE ELEMENTS; SEMICONDUCTOR DEVICES, MICROCOMPUTERS AND INTEGRATED CIRCUITS AND COMPONENTS FOR THE FOREGOING (U.S. CLS. 21, 23, 26, 36 AND 38).
ELIZABETH HUGHITT, EXAMINING ATTORNEY

RUDEGAL

SN 76-559,867. AUTOTESTER, INC., DALLAS, TX. FILED 11-14-2003.

CLASS 25—CLOTHING

FOR CLOTHING, NAMELY, T-SHIRTS, SWEAT-SHIRTS AND UNDERWEAR (U.S. CLS. 22 AND 39).
FIRST USE 2-1-1995; IN COMMERCE 2-1-1995.

CLASS 41—EDUCATION AND ENTERTAINMENT

FOR PROVIDING NEWS IN THE NATURE OF CURRENT EVENTS REPORTING IN THE GENRE OF REGGAE MUSIC, RADIO ENTERTAINMENT SERVICES, NAMELY, RADIO PROGRAMS FEATURING PERFORMANCES BY RADIO PERSONALITIES, AND VIDEO JOCKEYS FOR SPECIAL EVENTS IN THE REGGAE GENRE (U.S. CLS. 100, 101 AND 107).
FIRST USE 2-1-1995; IN COMMERCE 2-1-1995.

TINA L. SNAPP, EXAMINING ATTORNEY

AUTOTESTER ONE

SN 76-559,758. ORTHODYNE ELECTRONICS CORPORATION, IRVINE, CA. FILED 11-17-2003.

Power Ribbon

THE MARK CONSISTS OF STANDARD CHARACTERS WITHOUT CLAIM TO ANY PARTICULAR FONT, STYLE, SIZE, OR COLOR.

NO CLAIM IS MADE TO THE EXCLUSIVE RIGHT TO USE "RIBBON", APART FROM THE MARK AS SHOWN.

CLASS 6—METAL GOODS

FOR METAL AND COMPOSITE METAL BONDING MATERIALS, SUCH AS ALUMINUM, COPPER, NICKEL, GOLD, SILVER, PALLADIUM, OR PLATINUM AND CLAD MATERIALS FROM AT LEAST TWO OF THE FOREGOING BONDING MATERIALS IN RIBBON, TAPE, OR STRIP FORM. FOR USE IN SEMICONDUCTOR DEVICES, MICROELECTRONIC DEVICES AND COMPONENTS, AND BONDING MACHINES (U.S. CLS. 2, 12, 13, 14, 23, 25 AND 50).

THE MARK CONSISTS OF STANDARD CHARACTERS WITHOUT CLAIM TO ANY PARTICULAR FONT, STYLE, SIZE, OR COLOR.

OWNER OF U.S. REG. NOS. 1,845,361, 2,382,540 AND 2,665,007.

NO CLAIM IS MADE TO THE EXCLUSIVE RIGHT TO USE "AUTOTESTER", APART FROM THE MARK AS SHOWN.

CLASS 9—ELECTRICAL AND SCIENTIFIC APPARATUS

FOR COMPUTER PROGRAMS FOR TESTING COMPUTER APPLICATION PROGRAMS WHICH CAN RECORD, EDIT, PLAY BACK AND ANALYZE TESTING SESSIONS RUNNING LOCALLY OR ON A REMOTE HOST COMPUTER (U.S. CLS. 21, 23, 26, 36 AND 38).
FIRST USE 8-0-2001; IN COMMERCE 8-0-2001.

CLASS 35—ADVERTISING AND BUSINESS

FOR BUSINESS SERVICES, NAMELY, COMPUTERIZED AND CENTRAL FILE MANAGEMENT AND BUSINESS FILE MANAGEMENT (U.S. CLS. 100, 101 AND 102).

FIRST USE 8-0-2001; IN COMMERCE 8-0-2001.
HOWARD SMIGA, EXAMINING ATTORNEY

SN 76-560,042. CREATIVE SECURITY CONCEPTS, INC.,
SAN JOSE, CA. FILED 11-14-2003.

SN 76-560,409. ORDER OF SAINT BENEDICT, COLLEGE-
VILLE, MN. FILED 10-24-2003.



NO CLAIM IS MADE TO THE EXCLUSIVE RIGHT TO USE "SECURITY" AND "INC.", APART FROM THE MARK AS SHOWN.

THE MARK CONSISTS OF STYLIZED LETTERING; A STYLIZED COMPUTER MONITOR WITH A PADLOCK ON THE SCREEN, THE LETTERS CSC ARE ON THE PADLOCK, ALL OF THIS IS INSIDE A SHADED TRIANGLE - THE STYLIZED LETTERING IS ON EACH SIDE OF THE TRIANGLE.

CLASS 41—EDUCATION AND ENTERTAINMENT

FOR EDUCATIONAL SERVICES, NAMELY, CONDUCTING SEMINARS AND TRAINING IN THE FIELDS OF EXECUTIVE SECURITY AND BODYGUARD SERVICES; EDUCATIONAL SERVICES, NAMELY, CONDUCTING SEMINARS AND TRAINING IN THE FIELDS OF PHYSICAL ASSET PROTECTION AND SECURITY GUARD SERVICES; EDUCATIONAL SERVICES, NAMELY, CONDUCTING SEMINARS AND TRAINING IN THE FIELDS OF INTELLECTUAL PROPERTY PROTECTION AND SECURITY OF CORPORATE TRADE SECRETS, INVENTIONS, AND TECHNOLOGY; EDUCATIONAL SERVICES, NAMELY, CONDUCTING SEMINARS AND TRAINING IN THE FIELDS OF GENERAL PRIVATE AND PRE-EMPLOYMENT INVESTIGATIONS (U.S. CLS. 100, 101 AND 107).

FIRST USE 3-5-1999; IN COMMERCE 11-2-2000.

CLASS 42—SCIENTIFIC, COMPUTER AND LEGAL SERVICES

FOR ENVIRONMENTAL DESIGN OF BUILDINGS FOR CRIME PROTECTION PURPOSES; DESIGN AND DEVELOPMENT OF NETWORK SECURITY FOR OTHERS (U.S. CLS. 100 AND 101).

FIRST USE 3-5-1999; IN COMMERCE 11-2-2000.

CLASS 45—PERSONAL SERVICES

FOR MONITORING OF COMPUTER NETWORKS AND INFORMATION SYSTEMS FOR SECURITY PURPOSES (U.S. CLS. 100 AND 101).

FIRST USE 3-5-1999; IN COMMERCE 11-2-2000.
GRETTA YAO, EXAMINING ATTORNEY



THE MARK CONSISTS OF THE CAPITALIZED LETTERS "SBU" WITH THE NUMBER "1" APPEARING WITHIN THE LETTER "U".

CLASS 25—CLOTHING

FOR CLOTHING, NAMELY, SWEATSHIRTS, SWEAT-PANTS, T-SHIRTS, TANK TOPS, POLO SHIRTS, RUGBY SHIRTS, SPORT SHIRTS, TURTLENECKS, JERSEYS, SWEATERS, BLAZERS, TIES, SHORTS, JEANS, PANTS, VESTS, JACKETS, COATS, WIND RESISTANT JACKETS AND PANTS, WARMUP SUITS, GLOVES, MITTENS, HATS, CAPS, VISORS, SCARVES, ATHLETIC UNIFORMS, SOCKS, HOSIERY, LEOTARDS, APRONS, WRIST BANDS, BATHING SUITS, BATHING TRUNKS, BATHROBES, INFANT WEAR, CLOTH BIBS, GOLF SHIRTS, NIGHT SHIRTS, SLEEPWEAR, AND BOXER SHORTS (U.S. CLS. 22 AND 39).

FIRST USE 9-1-1992; IN COMMERCE 9-1-1992.

CLASS 41—EDUCATION AND ENTERTAINMENT

FOR EDUCATIONAL SERVICES, NAMELY, PROVIDING COLLEGE LEVEL ATHLETIC PROGRAMS AND EVENTS, INFORMATION REGARDING SUCH PROGRAMS AND EVENTS, STUDENT AND ALUMNI ACTIVITIES AND ORGANIZATIONS, AND ATHLETIC SUPPORTING ORGANIZATIONS AND CLUBS; ENTERTAINMENT SERVICES, NAMELY ATHLETIC AND SPORTING CONTESTS, EVENTS AND GAMES (U.S. CLS. 100, 101 AND 107).

FIRST USE 9-1-1992; IN COMMERCE 9-1-1992.

ESTHER BELENKER, EXAMINING ATTORNEY

SN 76-561,573. CONSTELLATION ENERGY GROUP, INC.,
BALTIMORE, MD. FILED 11-25-2003.

MARKETWATCH

THE MARK CONSISTS OF STANDARD CHARACTERS WITHOUT CLAIM TO ANY PARTICULAR FONT, STYLE, SIZE, OR COLOR.

CLASS 35—ADVERTISING AND BUSINESS

FOR PROVIDING A SERVICE THAT ALLOWS CUSTOMERS TO PURCHASE ENERGY, NAMELY, ELECTRICITY, NATURAL GAS AND RENEWABLE ENERGY, AT A PRICE DETERMINED BY THE CUSTOMER. (U.S. CLS. 100, 101 AND 102).

CLASS 36—INSURANCE AND FINANCIAL

FOR BROKERAGE OF ELECTRICITY, NATURAL GAS AND RENEWABLE ENERGY TO INDUSTRIAL AND COMMERCIAL CUSTOMERS. (U.S. CLS. 100, 101 AND 102).

CLASS 39—TRANSPORTATION AND STORAGE

FOR DISTRIBUTION OF ENERGY, NAMELY, ELECTRICITY, NATURAL GAS AND RENEWABLE ENERGY FROM WIND, BIOMASS, LANDFILL GAS, SOLAR AND HYDROGEN; UTILITY SERVICES, NAMELY, PROVIDING ELECTRICITY, NATURAL GAS AND RENEWABLE ENERGY TO INDUSTRIAL AND COMMERCIAL CUSTOMERS (U.S. CLS. 100 AND 105).

CLASS 40—MATERIAL TREATMENT

FOR PRODUCTION OF ENERGY, NAMELY, ELECTRICITY, NATURAL GAS AND RENEWABLE ENERGY FROM WIND, BIOMASS, LANDFILL GAS AND HYDROGEN (U.S. CLS. 100, 103 AND 106).
MATTHEW PAPPAS, EXAMINING ATTORNEY

SN 76-561,708. KABUSHIKI KAISHA TANITA, TOKYO, JAPAN, FILED 11-25-2003.



PRIORITY CLAIMED UNDER SEC. 44(D) ON JAPAN APPLICATION NO. 2003-060195, FILED 7-17-2003, REG. NO. 4753359, DATED 3-5-2004, EXPIRES 3-5-2014.

CLASS 9—ELECTRICAL AND SCIENTIFIC APPARATUS

FOR BODY WEIGHT SCALES WITH BODY FAT ANALYZERS, BODY WEIGHT SCALES WITH BODY COMPOSITION ANALYZERS, BODY WEIGHT SCALES, BABY SCALES, KITCHEN SCALES, BATHROOM SCALES, INDUSTRIAL SCALES, SCALES FOR COMMERCIAL USE, PEDOMETERS, ELECTRONIC APPARATUS AND INSTRUMENTS FOR ANALYZING WATER QUALITY, NAMELY WATER QUALITY ANALYZERS, SKIN CONDITION ANALYZERS NOT FOR MEDICAL USE, ELECTRONIC APPARATUS AND INSTRUMENTS FOR MEASURING THE QUANTITY OF CHEMICALS CAUSING BAD SMELL AND OTHER CHEMICALS IN AIR, NAMELY, AIR ANALYZERS, ELECTRONIC APPARATUS FOR MEASURING THE QUANTITY OF CHEMICALS CAUSING BODY ODORS, NAMELY, BODY ODORS ANALYZERS, ELECTRICAL COMMUNICATION MACHINES AND INSTRUMENTS, NAMELY, TELEPHONES, PAGERS, TELEVISIONS, RADIOS, COMMUNICATION DEVICES FOR RECEIVING MEASURING DATA FROM BODY COMPOSITION ANALYZERS, BODY FAT ANALYZERS, SPHYGMOMANOMETERS, PEDOMETERS, ETC; AND STORING, PROCESSING AND TRANSMITTING SUCH DATA TO PERSONAL COMPUTERS AND OTHER COMPUTERS, ELECTRONIC DIARIES, PERSONAL DIGITAL ASSISTANTS, DIGITAL VIDEO AND AUDIO RECORDERS AND PLAYERS, AND CELLULAR TELEPHONES, COMPUTERS, COMPUTER PERIPHERAL DEVICES, ELECTRONIC CIRCUIT BOARDS AND CHIPS, INTEGRATED CIRCUITS, ELECTRONIC CIRCUITS ON WHICH COMPUTER PROGRAMS ARE RECORDED FOR USE IN BREATH ANALYZERS, BODY WEIGHT SCALES WITH BODY FAT ANALYZERS, BODY WEIGHT SCALES WITH BODY COMPOSITION ANALYZERS, AND OTHER SCALES, PEDOMETERS, WATER ANALYZERS, SKIN ANALYZERS, AIR ANALYZERS, ODOR ANALYZERS AND METRONOMES, DOWNLOADABLE COMPUTER PROGRAMS AND COMPUTER PROGRAMS RECORDED ON COMPUTER MEDIA FOR USE IN MANAGING PERSONAL DATA FOR HEALTH AND MEDICAL CARE, FOR PROVIDING HEALTH AND MEDICAL ADVICE, AND FOR OPERATING BREATH ANALYZERS, BODY WEIGHT SCALES WITH BODY FAT ANALYZERS, BODY WEIGHT SCALES WITH BODY COMPOSITION ANALYZERS, AND OTHER SCALES, PEDOMETERS, WATER ANALYZERS, SKIN ANALYZERS, AIR ANALYZERS, ODOR ANALYZERS AND METRONOMES, ELECTRONIC CIRCUITS AND CD-ROMS ON WHICH COMPUTER GAME PROGRAMS ARE RECORDED, PRE-RECORDED VIDEODISCS AND VIDEOTAPES FEATURING HEALTH, BODY COMPOSITION, WEIGHT LOSS, WEIGHT MANAGEMENT, AIR, ODOR AND BREATH ANALYSIS, BEAUTY, MEDICINE AND NUTRITION, VIDEO GAMES MACHINES ADAPTED FOR USE WITH TELEVISION RECEIVERS ONLY, METRONOMES, ELECTRONIC CIRCUITS AND CD-ROMS ON WHICH PROGRAMS FOR PORTABLE GAMES WITH LIQUID CRYSTAL DISPLAYS ARE RECORDED, NAMELY, COMPUTER GAME SOFTWARE, DOWNLOADABLE ELECTRONIC PUBLICATIONS AND ELECTRONIC PUBLICATIONS RECORDED ON COMPUTER MEDIA ON THE SUBJECT OF HEALTH, BODY COMPOSITION, WEIGHT LOSS, WEIGHT MANAGEMENT, AIR, ODOR AND BREATH ANALYSIS, BEAUTY MEDICINE AND NUTRITION (U.S. CLS. 21, 23, 26, 36 AND 38).

SN 76-561,574. CONSTELLATION ENERGY GROUP, INC., BALTIMORE, MD. FILED 11-25-2003.

MARKETWATCH PLUS

THE MARK CONSISTS OF STANDARD CHARACTERS WITHOUT CLAIM TO ANY PARTICULAR FONT, STYLE, SIZE, OR COLOR.

CLASS 35—ADVERTISING AND BUSINESS

FOR PROVIDING A SERVICE THAT ALLOWS CUSTOMERS TO PURCHASE ENERGY, NAMELY, ELECTRICITY, NATURAL GAS AND RENEWABLE ENERGY, AT A PRICE DETERMINED BY THE CUSTOMER. (U.S. CLS. 100, 101 AND 102).

CLASS 36—INSURANCE AND FINANCIAL

FOR BROKERAGE OF ELECTRICITY, NATURAL GAS AND RENEWABLE ENERGY TO INDUSTRIAL AND COMMERCIAL CUSTOMERS. (U.S. CLS. 100, 101 AND 102).

CLASS 39—TRANSPORTATION AND STORAGE

FOR DISTRIBUTION OF ENERGY, NAMELY, ELECTRICITY, NATURAL GAS AND RENEWABLE ENERGY FROM WIND, BIOMASS, LANDFILL GAS, SOLAR AND HYDROGEN; UTILITY SERVICES, NAMELY, PROVIDING ELECTRICITY, NATURAL GAS AND RENEWABLE ENERGY TO INDUSTRIAL AND COMMERCIAL CUSTOMERS (U.S. CLS. 100 AND 105).

CLASS 40—MATERIAL TREATMENT

FOR PRODUCTION OF ENERGY, NAMELY, ELECTRICITY, NATURAL GAS AND RENEWABLE ENERGY FROM WIND, BIOMASS, LANDFILL GAS AND HYDROGEN (U.S. CLS. 100, 103 AND 106).
MATTHEW PAPPAS, EXAMINING ATTORNEY

CLASS 10—MEDICAL APPARATUS

FOR CONTRACEPTIVES, NAMELY, DIAPHRAGMS FOR CONTRACEPTION AND CONDOMS, PULSE RATE MONITORS FOR MEASURING A PERSON'S PULSE, CLINICAL THERMOMETERS FOR MEDICAL USE, BONE DENSITOMETERS BEING BONE MINERAL DENSITY MEASURING APPARATUS, BODY FAT ANALYZERS FOR MEDICAL USE, BODY COMPOSITION ANALYZERS FOR MEDICAL USE, BIOELECTRICAL IMPEDANCE ANALYZERS, SPHYGMOMANOMETERS, ELECTRICAL MASSAGE DEVICES FOR DOMESTIC USE; ALCOHOL BREATH TESTING UNITS, ELECTRONIC BREATH ANALYZERS (U.S. CLS. 26, 39 AND 44).

JAMES GRIFFIN, EXAMINING ATTORNEY

SN 76-561,711. KABUSHIKI KAISHA TANITA, TOKYO, JAPAN, FILED 11-25-2003.

InnerScan

PRIORITY CLAIMED UNDER SEC. 44(D) ON JAPAN APPLICATION NO. 2003-060197, FILED 7-17-2003, REG. NO. 4753361, DATED 3-5-2004, EXPIRES 3-5-2014.

CLASS 9—ELECTRICAL AND SCIENTIFIC APPARATUS

FOR BODY WEIGHT SCALES WITH BODY FAT ANALYZERS, BODY WEIGHT SCALES WITH BODY COMPOSITION ANALYZERS, BODY WEIGHT SCALES, BABY SCALES, KITCHEN SCALES, BATHROOM SCALES, INDUSTRIAL SCALES, SCALES FOR COMMERCIAL USE, PEDOMETERS, ELECTRONIC APPARATUS AND INSTRUMENTS FOR ANALYZING WATER QUALITY, NAMELY WATER QUALITY ANALYZERS, SKIN CONDITION ANALYZERS NOT FOR MEDICAL USE, ELECTRONIC APPARATUS AND INSTRUMENTS FOR MEASURING THE QUANTITY OF CHEMICALS CAUSING BAD SMELL AND OTHER CHEMICALS IN AIR, NAMELY, AIR ANALYZERS, ELECTRONIC APPARATUS FOR MEASURING THE QUANTITY OF CHEMICALS CAUSING BODY ODORS, NAMELY, BODY ODORS ANALYZERS, ELECTRICAL COMMUNICATION MACHINES AND INSTRUMENTS, NAMELY, TELEPHONES, PAGERS, TELEVISIONS, RADIOS, COMMUNICATION DEVICES FOR RECEIVING MEASURING DATA FROM BODY COMPOSITION ANALYZERS, BODY FAT ANALYZERS, SPHYGMOMANOMETERS, PEDOMETERS, ETC; AND STORING, PROCESSING AND TRANSMITTING SUCH DATA TO PERSONAL COMPUTERS AND OTHER COMPUTERS, ELECTRONIC DIARIES, PERSONAL DIGITAL ASSISTANTS, DIGITAL VIDEO AND AUDIO RECORDERS AND PLAYERS, AND CELLULAR TELEPHONES, COMPUTERS, COMPUTER PERIPHERAL DEVICES, ELECTRONIC CIRCUIT BOARDS AND CHIPS, INTEGRATED CIRCUITS, ELECTRONIC CIRCUITS ON WHICH COMPUTER PROGRAMS ARE RECORDED FOR USE IN BREATH ANALYZERS, BODY WEIGHT SCALES WITH BODY FAT ANALYZERS, BODY WEIGHT SCALES WITH BODY COMPOSITION ANALYZERS, AND OTHER SCALES, PEDOMETERS, WATER ANALYZERS, SKIN ANALYZERS, AIR ANALYZERS, ODOR ANALYZERS AND METRONOMES, DOWNLOADABLE COMPUTER PROGRAMS AND COMPUTER PROGRAMS RECORDED ON COMPUTER MEDIA FOR USE IN MANAGING PERSONAL DATA FOR HEALTH AND MEDICAL CARE, FOR PROVIDING HEALTH AND MEDICAL ADVICE, AND FOR OPERATING BREATH ANALYZERS, BODY WEIGHT SCALES WITH BODY FAT ANALYZERS, BODY WEIGHT SCALES WITH BODY COMPOSITION ANALYZERS, AND OTHER SCALES, PEDOMETERS, WATER ANALYZERS, SKIN ANALYZERS, AIR ANALYZERS, ODOR ANALYZERS AND METRONOMES, ELECTRONIC CIRCUITS AND CD-ROMS ON WHICH COMPUTER GAME PROGRAMS ARE RECORDED, PRE-RECORDED VIDEODISCS AND VIDEOTAPES FEATURING HEALTH, BODY COMPOSITION,

WEIGHT LOSS, WEIGHT MANAGEMENT, AIR, ODOR AND BREATH ANALYSIS, BEAUTY, MEDICINE AND NUTRITION, VIDEO GAMES MACHINES ADAPTED FOR USE WITH TELEVISION RECEIVERS ONLY, METRONOMES, ELECTRONIC CIRCUITS AND CD-ROMS ON WHICH PROGRAMS FOR PORTABLE GAMES WITH LIQUID CRYSTAL DISPLAYS ARE RECORDED, NAMELY, COMPUTER GAME SOFTWARE, DOWNLOADABLE ELECTRONIC PUBLICATIONS AND ELECTRONIC PUBLICATIONS RECORDED ON COMPUTER MEDIA ON THE SUBJECT OF HEALTH, BODY COMPOSITION, WEIGHT LOSS, WEIGHT MANAGEMENT, AIR, ODOR AND BREATH ANALYSIS, BEAUTY MEDICINE AND NUTRITION (U.S. CLS. 21, 23, 26, 36 AND 38).

CLASS 10—MEDICAL APPARATUS

FOR CONTRACEPTIVES, NAMELY, DIAPHRAGMS FOR CONTRACEPTION AND CONDOMS, PULSE RATE MONITORS FOR MEASURING A PERSON'S PULSE, CLINICAL THERMOMETERS FOR MEDICAL USE, BONE DENSITOMETERS BEING BONE MINERAL DENSITY MEASURING APPARATUS, BODY FAT ANALYZERS FOR MEDICAL USE, BODY COMPOSITION ANALYZERS FOR MEDICAL USE, BIOELECTRICAL IMPEDANCE ANALYZERS, SPHYGMOMANOMETERS, ELECTRICAL MASSAGE DEVICES FOR DOMESTIC USE; ALCOHOL BREATH TESTING UNITS, ELECTRONIC BREATH ANALYZERS (U.S. CLS. 26, 39 AND 44).

JAMES GRIFFIN, EXAMINING ATTORNEY

SN 76-561,933. EAST WEST RESORT DEVELOPMENT V, L.P., L.L.L.P., TRUCKEE, CA. FILED 11-26-2003.

GRAY'S CROSSING

THE MARK CONSISTS OF STANDARD CHARACTERS WITHOUT CLAIM TO ANY PARTICULAR FONT, STYLE, SIZE, OR COLOR.

CLASS 36—INSURANCE AND FINANCIAL

FOR REAL ESTATE LEASING, BROKERAGE, LISTING, MANAGEMENT AND TIME-SHARING SERVICES (U.S. CLS. 100, 101 AND 102).

FIRST USE 10-0-2002; IN COMMERCE 10-0-2002.

CLASS 37—CONSTRUCTION AND REPAIR

FOR REAL ESTATE LAND DEVELOPMENT SERVICES, NAMELY, PLANNING AND LAYING OUT RESIDENTIAL COMMUNITIES (U.S. CLS. 100, 103 AND 106).

FIRST USE 10-0-2002; IN COMMERCE 10-0-2002.

CLASS 41—EDUCATION AND ENTERTAINMENT

FOR PROVIDING ENTERTAINMENT AND RECREATIONAL SERVICES, NAMELY, HIKING, SKIING, GOLF, PERSONAL FITNESS, SWIMMING, HORSEBACK RIDING, TENNIS, OUTDOOR NATURE HIKES, FISHING, BOATING, CAMPING, SNOWSHOEING, BIKING, RUNNING AND PHYSICAL FITNESS INSTRUCTION FOR RESORT LODGING ATTENDEES (U.S. CLS. 100, 101 AND 107).

FIRST USE 10-0-2002; IN COMMERCE 10-0-2002.
EDWARD NELSON, EXAMINING ATTORNEY

SN 76-562,267. TRADEMARK MEDICAL, L.L.C., ST. LOUIS, MO. FILED 11-28-2003.

HYDROSAFE

THE MARK CONSISTS OF STANDARD CHARACTERS WITHOUT CLAIM TO ANY PARTICULAR FONT, STYLE, SIZE, OR COLOR.

CLASS 5—PHARMACEUTICALS

FOR BANDAGES FOR SKIN WOUNDS, MOLE SKIN FOR USE AS A MEDICAL BANDAGE, AND SURGICAL BANDAGES, ALL FOR ANIMALS (U.S. CLS. 6, 18, 44, 46, 51 AND 52).

CLASS 10—MEDICAL APPARATUS

FOR BANDAGES FOR ANATOMICAL JOINTS, COMPRESSION BANDAGES, ELASTIC BANDAGES, AND ORTHOPEDIC SUPPORT BANDAGES, ALL FOR ANIMALS (U.S. CLS. 26, 39 AND 44).

BRENDAN REGAN, EXAMINING ATTORNEY

SN 76-562,560. T.M.C. COMPANY, LIMITED, TOYONAKA, OSAKA, 561-0842, JAPAN, FILED 12-2-2003.

BATTLE DRIFT

THE MARK CONSISTS OF STANDARD CHARACTERS WITHOUT CLAIM TO ANY PARTICULAR FONT, STYLE, SIZE, OR COLOR.

NO CLAIM IS MADE TO THE EXCLUSIVE RIGHT TO USE "DRIFT", APART FROM THE MARK AS SHOWN.

CLASS 9—ELECTRICAL AND SCIENTIFIC APPARATUS

FOR GOGGLES FOR AUTOMOBILE RACING; HELMETS FOR AUTOMOBILE RACING; SUNGLASSES (U.S. CLS. 21, 23, 26, 36 AND 38).

CLASS 12—VEHICLES

FOR AUTOMOBILES AND PARTS AND FITTINGS THEREFOR, NAMELY, CLUTCHES; ARMS FOR AUTOMOBILES, NAMELY, SUSPENSION UPPER ARMS, SUSPENSION LOWER ARMS, STABILIZER, TRAILING ARMS, AXLES, RADIUS-RODS, LATERAL-RODS, TENSION RODS AND KNUCKLE ARMS; DAMPER SYSTEM FOR AUTOMOBILES, NAMELY, STRAIGHT AND TAPER TYPE SPRINGS, CYLINDERS, PILLOW UPPER MOUNTS AND HELPER COIL SPRINGS; SUSPENSION PARTS FOR AUTOMOBILES, NAMELY, COIL SPRINGS, LEAF SPRINGS AND SUSPENSION RUBBERS; TORSION BARS FOR AUTOMOBILES; SHOCK ABSORBER FOR AUTOMOBILES; BRAKE PADS FOR AUTOMOBILES; STRUT TOWER BARS FOR AUTOMOBILES; LSD, NAMELY LIMITED SLIP DIFFERENTIAL FOR AUTOMOBILES; BUSHES FOR AUTOMOBILES, NAMELY, RUBBER BUSHES, POLYURETHANE BUSHES, MUFFLER BUSHES; NON-ELECTRIC MOTORS AND THEIR PARTS FOR LAND VEHICLES, NAMELY, INTERNAL COMBUSTION ENGINES, JET ENGINES AND TURBINES (U.S. CLS. 19, 21, 23, 31, 35 AND 44).

CLASS 16—PAPER GOODS AND PRINTED MATTER

FOR BANNERS OF PAPER, FLAGS OF PAPER; CARDBOARD; STATIONERY AND STUDY GUIDES, PHOTOGRAPHS (U.S. CLS. 2, 5, 22, 23, 29, 37, 38 AND 50).

CLASS 25—CLOTHING

FOR BANDANNAS; BELTS; BLOUSON; BOOTS FOR SPORTS; CAP PEAKS; CLOTHING OF IMITATION LEATHER, NAMELY BLOUSON AND GLOVES; CLOTHING OF LEATHER, NAMELY, BLOUSON AND GLOVES; COVERALLS; FOOTWEAR; GLOVES FOR AUTOMOBILE RACING; GLOVES FOR DRIVING VEHICLE; GLOVES; HEAD GEAR, NAMELY HATS AND CAPS; HEADBANDS; HOODS; JACKETS; JERSEYS; JUMPERS; KNITWEAR, NAMELY SWEATER, HEADWEAR AND SOCKS; MOTORIST'S CLOTHING, NAMELY, RACING SUITS AND RACING GLOVES; NECKERCHIEFS; NECKTIES; PARKAS; RACING PANTS; RACING SUITS; SHIRT FRONTS; SHOES AND BOOTS FOR AUTOMOBILE RACING; SLIPPERS; SPORTS JERSEYS; SPORTS SHOES; STOCKINGS; SUITS; SUN VISORS; SWEAT SHIRT AND SWEAT PANTS; SWEATERS; TEE-SHIRTS; UNIFORMS; VESTS; VISORS; WAISTCOATS; WORK WEAR, NAMELY, OVERALLS AND MECHANIC GLOVES (U.S. CLS. 22 AND 39).

CLASS 41—EDUCATION AND ENTERTAINMENT

FOR ENTERTAINMENT SERVICES, NAMELY, AUTOMOTIVE DRIFTING AND RACING EVENTS (U.S. CLS. 100, 101 AND 107).

CLASS 42—SCIENTIFIC, COMPUTER AND LEGAL SERVICES

FOR COMPUTER SOFTWARE DESIGN FOR OTHERS; COMPUTER PROGRAMMING FOR OTHERS; MAINTENANCE OF COMPUTER SOFTWARE; TECHNOLOGY CONSULTATION, NAMELY, INTRODUCTION AND EXPLANATION OF PERFORMANCE AND OPERATION IN THE FIELD OF COMPUTERS AND AUTOMOBILES; COMPUTER RENTAL; DESIGN, PROGRAMMING AND MAINTENANCE OF SOFTWARE FOR THE ARCADE AND CONSUMER VIDEO GAME MACHINES OF OTHERS (U.S. CLS. 100 AND 101).

MICHAEL KEATING, EXAMINING ATTORNEY

SN 76-563,752. FLEETPRIDE, INC., THE WOODLANDS, TX. FILED 12-8-2003.

POWERPRODUCTS
THE HEAVY DUTY CONNECTION

NO CLAIM IS MADE TO THE EXCLUSIVE RIGHT TO USE "HEAVY DUTY", APART FROM THE MARK AS SHOWN.

SEC. 2(F) AS TO "POWER PRODUCTS".

CLASS 9—ELECTRICAL AND SCIENTIFIC APPARATUS

FOR HEAVY DUTY TRUCK AND TRAILER PARTS, NAMELY ELECTRICAL COMPONENTS COMPRISED OF CONNECTORS, COILED ELECTRICAL CABLES, BATTERY TERMINALS, TRAILER CABLE, PRIMARY WIRE, BATTERY CABLE, CIRCUIT BREAKERS, BACK-UP ALARMS AND SWITCHES (U.S. CLS. 21, 23, 26, 36 AND 38).

FIRST USE 12-20-1988; IN COMMERCE 12-20-1988.

CLASS 12—VEHICLES

FOR HEAVY DUTY TRUCK AND TRAILER PARTS, NAMELY, BRAKES; BRAKE LININGS; BRAKE HARDWARE COMPONENTS FOR HEAVY DUTY TRUCKS AND TRAILERS, NAMELY, ROTORS, DRUMS AND LOADED CALIPERS, BRAKE CYLINDER REPAIR KITS, SOLD AS A UNIT; CAM SHAFTS AND SLACK ADJUSTERS; POWERTRAIN SYSTEMS COMPRISED OF CLUTCHES, CLUTCH BRAKES, TORQUE CONVERTERS, DRIVE LINES, UNIVERSAL JOINTS, POWER TAKEOFFS, TRANSMISSION AND POWER DIVIDERS; WHEEL ATTACHMENTS COMPRISED OF OIL CAPS, CAP NUTS, AND STUDS; AIR BRAKE SYSTEMS COMPRISED OF VALVES, AIR BRAKE TUBINGS, RESERVOIRS, AIR BRAKE HOSES, AND AIR BRAKE HOSE ASSEMBLIES; AND DASH FANS (U.S. CLS. 19, 21, 23, 31, 35 AND 44).

FIRST USE 12-20-1988; IN COMMERCE 12-20-1988.

MARY BOAGNI, EXAMINING ATTORNEY

SN 76-564,995. RADIOCHICK, LLC, NEW YORK, NY. FILED 12-1-2003.



OWNER OF U.S. REG. NOS. 2,455,110, 2,556,730 AND 2,751,278.

NO CLAIM IS MADE TO THE EXCLUSIVE RIGHT TO USE "RADIO" IN INTERNATIONAL CLASS 41, APART FROM THE MARK AS SHOWN.

THE STYLIZED WORDS "THE RADIO CHICK" APPEAR IN YELLOW COLOR WITH THE EDGES (TO THE LEFT) OF THE LETTERS IN WHITE COLOR

CLASS 25—CLOTHING

FOR CLOTHING, NAMELY, LINGERIE, CAPS (U.S. CLS. 22 AND 39).
FIRST USE 12-0-1999; IN COMMERCE 12-0-2003.

CLASS 41—EDUCATION AND ENTERTAINMENT

FOR ENTERTAINMENT SERVICES IN THE NATURE OF ON-GOING TELEVISION, ONLINE OR WEBSITE PROGRAM IN THE FIELDS OF VARIETY, TALK, NEWS COMMENTARY, AND COMEDY (U.S. CLS. 100, 101 AND 107).

FIRST USE 10-0-1999; IN COMMERCE 10-0-1999.
CAROLINE WOOD, EXAMINING ATTORNEY

SN 76-565,066. SYNAPSE MARKETING CONSULTANTS LTD., BURLINGTON, ONTARIO, CANADA, FILED 12-1-2003.

AXIOM REAL TIME METRICS

THE MARK CONSISTS OF STANDARD CHARACTERS WITHOUT CLAIM TO ANY PARTICULAR FONT, STYLE, SIZE, OR COLOR.

PRIORITY CLAIMED UNDER SEC. 44(D) ON CANADA APPLICATION NO. 1191015, FILED 9-16-2003, REG. NO. TMA625238, DATED 11-10-2004, EXPIRES 11-10-2019.

NO CLAIM IS MADE TO THE EXCLUSIVE RIGHT TO USE "REAL TIME METRICS", APART FROM THE MARK AS SHOWN.

CLASS 9—ELECTRICAL AND SCIENTIFIC APPARATUS

FOR COMPUTER SOFTWARE TO COLLECT, MANAGE, ANALYSE AND REPORT DATA FOR PHARMACEUTICAL STUDIES AND OTHER STUDIES IN THE FIELD OF MEDICAL RESEARCH AND TREATMENT (U.S. CLS. 21, 23, 26, 36 AND 38).

CLASS 42—SCIENTIFIC, COMPUTER AND LEGAL SERVICES

FOR CONSULTING SERVICES IN THE FIELD OF MEDICAL RESEARCH AND TREATMENT RESPECTING ELECTRONIC DATA CAPTURE (U.S. CLS. 100 AND 101).

ALICE BENMAMAN, EXAMINING ATTORNEY

SN 76-565,950. CONTINENTAL TEVES AG & CO. OHG, D-60488 FRANKFURT, FED REP GERMANY, FILED 12-18-2003.

AUTOSAR

PRIORITY CLAIMED UNDER SEC. 44(D) ON FED REP GERMANY APPLICATION NO. 30337806.9/1, FILED 7-25-2003, REG. NO. 30337806, DATED 10-14-2003, EXPIRES 10-14-2013.

CLASS 9—ELECTRICAL AND SCIENTIFIC APPARATUS

FOR SCIENTIFIC APPARATUSES, NAMELY, GLASS TUBES; SURVEYING APPARATUS, NAMELY, SURVEYING CHAINS; PHOTOGRAPHIC APPARATUSES, NAMELY PHOTOGRAPHIC CAMERA; FILM, NAMELY, CINEMATOGRAPHIC FILM; OPTICAL INSTRUMENTS, NAMELY, OPTICAL FILTERS; WEIGHING APPARATUSES, NAMELY, SCALE; MEASURING APPARATUS, NAMELY, BEVELS; SIGNAL INSTRUMENTS, NAMELY SIGNAL BELLS; CONTROL INSTRUMENTS, NAMELY, CRUISE CONTROLS FOR MOTOR VEHICLES; RESCUE AND INSTRUCTIONAL APPARATUSES, NAMELY, RING BUOYS FOR USE IN WATER RESCUE; APPARATUSES FOR GUIDANCE, NAMELY, SATELLITE NAVIGATIONAL SYSTEM, NAMELY, A GLOBAL POSITIONING SYSTEM (GPS); SWITCHING APPARATUSES, NAMELY, ELECTRIC SWITCHES; CONVERTING APPARATUSES, NAMELY, APPARATUS FOR CONVERTING ELECTRONIC RADIATION TO ELECTRICAL ENERGY, NAMELY PHOTOVOLTAIC SOLAR MODULES; STORING APPARATUSES, NAMELY, PLASTIC AND CARDBOARD CASES FOR STORING RECORD ALBUMS; APPARATUSES FOR CONTROLLING AND REGULATING ELECTRICITY, NAMELY, ELECTRIC SWITCHES, ELECTRIC REGULATORS AND ELECTRIC CONTROL UNITS FOR CONTROLLING ELECTRICAL ENERGY BETWEEN MOTORS, BATTERIES, TRANSMISSION AND BRAKES IN LAND VEHICLES; DEVICES FOR RECORDING, TRANSMITTING AND PLAYING BACK OF SOUND AND PICTURE, NAMELY, DIGITAL VIDEO RECORDERS; MAGNETIC RECORDING DEVICES, NAMELY, MAGNETIC TAPE RECORDERS; VINYL RECORDS, NAMELY, PHONOGRAPH RECORDS FEATURING MUSICAL RECORDINGS; CALCULATORS; DATA PROCESSING EQUIPMENT, NAMELY, COMPUTER CHIPS; COMPUTERS, COMPUTER HARDWARE; APPARATUSES AND INSTRUMENTS FOR SCIENTIFIC RESEARCH IN LABORATORIES, NAMELY, SENSING AND SIGNALING DEVICES FOR MEASUREMENT AND QUALITY CONTROL OF MATERIALS PROCESSING BY LASER; MEASURING INSTRUMENT, NAMELY GONIOMETERS; COMPUTER PROGRAMS AND SOFTWARE FOR USE IN NETWORKING THE FUNCTIONS OF SEPARATE PARTS OF MOTOR VEHICLES TO CREATE A COORDINATED SYSTEM; ALL OF THE AFOREMENTIONED GOODS FOR USE IN THE FIELD OF VEHICLE TECHNOLOGY (U.S. CLS. 21, 23, 26, 36 AND 38).

CLASS 12—VEHICLES

FOR VEHICLES, NAMELY, AUTOMOBILES; STRUCTURAL PARTS FOR LAND VEHICLES, NAMELY, WHEELS; APPARATUSES FOR CONVEYING ON LAND, THE AIR OR THE WATER, NAMELY BOATS, AUTOMOBILES, AIRCRAFT; DEVICES FOR SUPPLYING POWER TO LAND VEHICLES, NAMELY, GAS PEDALS; APPARATUSES AND INSTRUMENTS FOR STEERING VEHICLES, NAMELY, STEERING WHEELS; STEERING UNITS FOR LAND VEHICLES AND PARTS THEREOF (U.S. CLS. 19, 21, 23, 31, 35 AND 44).

CLASS 42—SCIENTIFIC, COMPUTER AND LEGAL SERVICES

FOR ENGINEERING; SCIENTIFIC RESEARCH; DESIGN OF NEW PRODUCTS FOR OTHERS; INDUSTRIAL ANALYSIS, NAMELY, ANALYSIS OF VEHICLE TECHNOLOGY; COMPUTER SOFTWARE DESIGN FOR OTHERS; COMPUTER SOFTWARE DEVELOPMENT; LEGAL SERVICES, NAMELY, LEGAL CONSULTATION AND REPRESENTATION; ENGINEERING SERVICES, NAMELY, PROVIDING EVALUATIONS, ESTIMATES, EXAMINATIONS AND EXPERT OPINIONS; ALL THE AFOREMENTIONED SERVICES IN THE FIELD OF VEHICLE TECHNOLOGY (U.S. CLS. 100 AND 101).
EVELYN BRADLEY, EXAMINING ATTORNEY

SN 76-566,638. WORLD RESOURCES INSTITUTE, WASHINGTON, DC. FILED 12-22-2003.

THE ACCESS INITIATIVE

THE MARK CONSISTS OF STANDARD CHARACTERS WITHOUT CLAIM TO ANY PARTICULAR FONT, STYLE, SIZE, OR COLOR.

CLASS 9—ELECTRICAL AND SCIENTIFIC APPARATUS

FOR PUBLICATIONS, NAMELY, BOOKS ON CD ROM IN THE FIELD OF ENVIRONMENTAL AND GOVERNANCE ISSUES (U.S. CLS. 21, 23, 26, 36 AND 38).
FIRST USE 8-0-2002; IN COMMERCE 8-0-2002.

CLASS 16—PAPER GOODS AND PRINTED MATTER

FOR PUBLICATIONS, NAMELY, BOOKS IN PRINT IN THE FIELD OF ENVIRONMENTAL AND GOVERNANCE ISSUES (U.S. CLS. 2, 5, 22, 23, 29, 37, 38 AND 50).
FIRST USE 8-0-2002; IN COMMERCE 8-0-2002.

CLASS 42—SCIENTIFIC, COMPUTER AND LEGAL SERVICES

FOR CONSULTATION AND RESEARCH SERVICES IN THE FIELD OF ENVIRONMENTAL AND GOVERNANCE DECISION MAKING (U.S. CLS. 100 AND 101).
FIRST USE 1-0-2001; IN COMMERCE 2-0-2001.
ANDREA SAUNDERS, EXAMINING ATTORNEY

SN 76-567,294. NATIONAL INFORMATION SOLUTIONS COOPERATIVE, INC., ST. PETERS, MO. FILED 12-29-2003.



OWNER OF U.S. REG. NO. 2,472,557.

CLASS 9—ELECTRICAL AND SCIENTIFIC APPARATUS

FOR COMPUTER SOFTWARE, NAMELY AN INTEGRATED ENTERPRISE SYSTEM HAVING BILLING MODULES, ACCOUNTING MODULES AND ENGINEERING MODULES USED BY RURAL ELECTRIC AND TELECOMMUNICATIONS COOPERATIVES AND TRAINING MANUALS SOLD AS A UNIT THEREWITH (U.S. CLS. 21, 23, 26, 36 AND 38).
FIRST USE 7-31-2000; IN COMMERCE 7-31-2000.

CLASS 35—ADVERTISING AND BUSINESS

FOR BUSINESS SERVICES, NAMELY AUTOMATED MAILROOM SERVICES, NAMELY, THE PRINTING AND MAILING OF BILLS AND OTHER CONSUMER RELATED DOCUMENTS, AS WELL AS THE RECEIVING AND PROCESSING OF REMITTED PAYMENTS AND COOPERATIVES NOT IN THE FIELD OF ADVERTISING AGENCY AND PUBLIC RELATIONS SERVICES; DATA CENTER SERVICES NAMELY, THE STORAGE, PROCESSING, MAINTENANCE AND MANAGEMENT OF DATA, FOR RURAL TELECOMMUNICATIONS COOPERATIVES; CONSOLIDATION PAYMENT AND ANALYSIS OF UTILITY BILLS FOR OTHERS; MANAGEMENT CONSULTING FOR RURAL TELECOMMUNICATIONS COOPERATIVES NOT IN THE FIELD OF ADVERTISING AGENCY AND PUBLIC RELATIONS SERVICES (U.S. CLS. 100, 101 AND 102).

FIRST USE 7-31-2000; IN COMMERCE 7-31-2000.

CLASS 37—CONSTRUCTION AND REPAIR

FOR INSTALLATION OF COMPUTER HARDWARE FOR RURAL ELECTRIC AND TELECOMMUNICATIONS COOPERATIVES NOT IN THE FIELD OF ADVERTISING AGENCY AND PUBLIC RELATIONS SERVICES (U.S. CLS. 100, 103 AND 106).

FIRST USE 7-31-2000; IN COMMERCE 7-31-2000.

CLASS 41—EDUCATION AND ENTERTAINMENT

FOR TRAINING IN THE FIELD OF COMPUTER HARDWARE AND SOFTWARE SUPPORT NOT IN THE FIELD OF ADVERTISING AGENCY AND PUBLIC RELATIONS SERVICES (U.S. CLS. 100, 101 AND 107).

FIRST USE 7-31-2000; IN COMMERCE 7-31-2000.

CLASS 42—SCIENTIFIC, COMPUTER AND LEGAL SERVICES

FOR TECHNICAL SUPPORT SERVICES, NAMELY HARDWARE AND SOFTWARE SUPPORT IN THE NATURE OF TROUBLESHOOTING OF COMPUTER HARDWARE AND SOFTWARE PROBLEMS, NETWORK ANALYSIS, VIRTUAL PRIVATE NETWORKS, WIDE AREA AND LOCAL AREA NETWORK SOLUTIONS FOR RURAL ELECTRIC AND TELECOMMUNICATIONS COOPERATIVES NOT IN THE FIELD OF ADVERTISING AGENCY AND PUBLIC RELATIONS SERVICES; APPLICATION SERVICE PROVIDER (ASP) SERVICES, NAMELY, THE STORAGE, PROCESSING, MAINTENANCE AND MANAGEMENT OF DATA FOR RURAL ELECTRIC COOPERATIVES NOT IN THE FIELD OF ADVERTISING AGENCY AND PUBLIC RELATIONS SERVICES; COMPUTER SERVICES, NAMELY CUSTOM COMPUTER PROGRAMMING FOR BILLING, ACCOUNTING, AND/OR ENGINEERING MODULES AND APPLICATIONS, AND TO INTEGRATE AND INTERFACE WITH THIRD PARTY SOFTWARE, FOR RURAL ELECTRIC AND TELECOMMUNICATIONS COOPERATIVES NOT IN THE FIELD OF ADVERTISING AGENCY AND PUBLIC RELATIONS SERVICES; COMPUTER SERVICES, NAMELY, SELECTION AND INTEGRATION OF HARDWARE AND SELECTION, INTEGRATION AND INSTALLATION OF SOFTWARE FOR RURAL ELECTRIC COOPERATIVES NOT IN THE FIELD OF ADVERTISING AGENCY AND PUBLIC RELATIONS SERVICES (U.S. CLS. 100 AND 101).

FIRST USE 7-31-2000; IN COMMERCE 7-31-2000.
AISHA CLARKE, EXAMINING ATTORNEY

SN 76-568,175. KITTY HAWK KITES, INC., KILL DEVIL HILLS, NC. FILED 1-5-2004.



NO CLAIM IS MADE TO THE EXCLUSIVE RIGHT TO USE KITES AND OUTER BANKS, NC. AND 1903 AND 2003, APART FROM THE MARK AS SHOWN.

CLASS 25—CLOTHING

FOR CLOTHING, NAMELY, SHIRTS, T-SHIRTS, SHORTS, PANTS, SWEATSHIRTS, CAPS, SWEATERS AND JACKETS (U.S. CLS. 22 AND 39).

FIRST USE 0-0-1997; IN COMMERCE 0-0-1997.

CLASS 35—ADVERTISING AND BUSINESS

FOR RETAIL STORE SERVICES IN THE AREA OF APPAREL, GIFTS, KAYAKS, SAILBOATS, INLINE SKATES, KITES, MAGNETS, MUGS, GLASSES, USED BICYCLES, STICKERS, KEY CHAINS, PENS, LAPEL PINS, PUZZLES, PLAYING CARDS, COASTERS, GLIDERS, MODEL PLANES, TOYS, WINDSOCKS, TOWELS, BAGS, FLAGS, BOTTLE OPENERS; AND FOR WHOLESALE DISTRIBUTORSHIPS FEATURING CLOTHING (U.S. CLS. 100, 101 AND 102).

FIRST USE 0-0-1997; IN COMMERCE 0-0-1997.

JANICE L. MCMORROW, EXAMINING ATTORNEY

SN 76-568,315. VIZREA CORPORATION, BELLEVUE, WA. FILED 12-12-2003.

VIZREA

THE MARK CONSISTS OF STANDARD CHARACTERS WITHOUT CLAIM TO ANY PARTICULAR FONT, STYLE, SIZE, OR COLOR.

CLASS 9—ELECTRICAL AND SCIENTIFIC APPARATUS

FOR COMPUTER HARDWARE AND SOFTWARE FOR USE IN RECORDING, TRANSMITTING, RECEIVING AND PLAYING MULTIMEDIA CONTENT, INCLUDING AUDIO AND VIDEO; IMAGE CAPTURE DEVICES, NAMELY, CAMERAS, DIGITAL CAMERAS, VIDEO CAMERAS, AND CAMERAS AND VIDEO CAMERAS BUILT INTO MOBILE DEVICES SUCH AS PERSONAL DIGITAL ASSISTANTS AND MOBILE PHONES; COMPUTER HARDWARE AND SOFTWARE FOR CONNECTING AND TRANSMITTING INFORMATION BETWEEN AND AMONG COMPUTERS, MOBILE DEVICES AND OTHER KINDS OF WIRELESS DEVICES; COMPUTER HARDWARE AND SOFTWARE FOR CONNECTING TO THE INTERNET; COMPUTER SECURITY SOFTWARE FOR ENSURING PRIVACY AND SAFE ACCESS TO THE INTERNET AND ONLINE SERVICES; ENCRYPTION HARDWARE AND SOFTWARE; BLANK SMART CARDS; ELECTRONIC BUSINESS CARDS, NAMELY, PRERECORDED CDS AND DVDS FEATURING BUSINESS CARD INFORMATION; COMPUTER SOFTWARE FOR REAL-TIME COMMUNICATION IN THE NATURE OF CHAT AND INSTANT MESSAGING, SOFTWARE FOR SENDING, RECEIVING AND DISPLAYING EMAILS, AND SOFTWARE FOR SENDING, RECEIVING, AND DISPLAYING ELECTRONIC SYNDICATION FEEDS AND SHORT MESSAGE SERVICE (SMS) MESSAGES; COMMUNICATIONS SOFTWARE, NAMELY, SOFTWARE FOR CONNECTING COMPUTER NETWORK USERS AND GLOBAL COMPUTER NETWORKS; COMPUTER SOFTWARE FOR MONITORING PERSONAL CAMERAS AND IMAGE CAPTURE DEVICES; OPERATING SOFTWARE, NAMELY, LAN OPERATING SOFTWARE, USB OPERATING SOFTWARE, OPERATING SOFTWARE FOR MOBILE DEVICES, NAMELY, PERSONAL DIGITAL ASSISTANTS AND MOBILE PHONES, PORTABLE DIGITAL MUSIC PLAYERS, PORTABLE DIGITAL MOVIE PLAYERS, PORTABLE DIGITAL MEDIA PLAYERS, DIGITAL CAMERAS AND VIDEO CAMERAS; COMPUTER HARDWARE; COMPUTER PERIPHERALS; ELECTRONIC DEVICES, NAMELY, RADIOS, TELEVISIONS, PERSONAL DIGITAL ASSISTANTS, TELEPHONES, AUDIO RECORDERS, AUDIO PLAYERS, VIDEO RECORDERS, VIDEO PLAYERS, MP3 PLAYERS AND OTHER PORTABLE DIGITAL MUSIC PLAYERS, CELLULAR PHONES, DIGITAL VIDEO RECORDERS, DIGITAL MEDIA PLAYERS; COMPUTER SOFTWARE FOR CREATING, DEVELOPING AND MAINTAINING WEB SITES, COMPUTER E-COMMERCE SOFTWARE TO ALLOW USERS TO PERFORM ELECTRONIC BUSINESS TRANSACTIONS VIA A GLOBAL COMPUTER NETWORK (U.S. CLS. 21, 23, 26, 36 AND 38).

CLASS 35—ADVERTISING AND BUSINESS

FOR BUSINESS SERVICES, NAMELY, BUSINESS MANAGEMENT, BUSINESS MARKETING, BUSINESS NETWORKING, BUSINESS PLANNING, BUSINESS RESEARCH, E-COMMERCE SERVICES, NAMELY, INTEGRATED TRACKING AND MANAGEMENT OF COMMERCIAL TRANSACTIONS ON A GLOBAL COMPUTER NETWORK; NEGOTIATION, MEDIATION AND SETTLEMENT OF COMMERCIAL TRANSACTIONS FOR THIRD PARTIES; PROMOTING THE GOODS AND SERVICES OF OTHERS THROUGH ON-LINE ADVERTISING (U.S. CLS. 100, 101 AND 102).

CLASS 38—COMMUNICATION

FOR COMMUNICATION SERVICES VIA THE INTERNET, WIRELESS AND MOBILE DEVICES, NAMELY, PROVIDING MULTIPLE USER DIAL-UP AND DEDICATED ACCESS TO THE INTERNET; STREAMING OF AUDIO AND VIDEO MATERIAL ON THE INTERNET AND TO AND FROM WIRELESS AND MOBILE DEVICES; ELECTRONIC TRANSMISSION OF DATA, DOCUMENTS AND APPLICATIONS BETWEEN COMPUTERS AND WIRELESS AND MOBILE DEVICES; MOBILE TELEPHONE COMMUNICATION, MOBILE RADIO COMMUNICATION, DATA COMMUNICATION BY EMAIL, SHORT MESSAGE SERVICE (SMS), SYNDICATION FEEDS, AND INSTANT MESSAGING; PROVIDING ON-LINE CHAT ROOMS FOR TRANSMISSION OF MESSAGES AMONG COMPUTER USERS ON A WIDE

VARIETY OF SUBJECTS OF GENERAL INTEREST; WIRELESS BROADBAND COMMUNICATION; WIRELESS COMMUNICATIONS SERVICES, NAMELY, TRANSMISSION OF GRAPHICS AND AUDIO TO MOBILE TELEPHONES, PERSONAL DIGITAL ASSISTANTS, PORTABLE DIGITAL MEDIA PLAYERS, PORTABLE DIGITAL MOVIE PLAYERS, PORTABLE DIGITAL MUSIC PLAYERS, DIGITAL CAMERAS AND VIDEO CAMERAS, VIDEO RECORDERS, DIGITAL VIDEO RECORDERS AND VIDEO PLAYERS; WEB MESSAGING SERVICES; WEB CONFERENCING SERVICES (U.S. CLS. 100, 101 AND 104).

CLASS 41—EDUCATION AND ENTERTAINMENT

FOR PROVIDING ON-LINE INFORMATION AND NEWS IN THE FIELD OF ENTERTAINMENT, NAMELY, PROVIDING ON-LINE REVIEWS AND NEWS RELATING TO MOVIES, BOOKS, MUSIC AND COMPUTER GAMES; PROVIDING A WEBSITE FEATURING NON-DOWNLOADABLE PUBLICATIONS, NAMELY A SERIES OF FICTION BOOKS AND A SERIES OF NONFICTION BOOKS IN THE FIELDS OF ART, SCIENCE, MUSIC, SPORTS, COMPUTERS AND TECHNOLOGY, POP CULTURE, AND BIOGRAPHIES; PROVIDING A WEBSITE FEATURING MULTIMEDIA MATERIALS, NAMELY, COMPUTER GAMES, MOVIES, PRERECORDED MUSIC, AND INFORMATION IN THE FIELD OF NEWS, COMPUTER GAMES, BOOKS, MOVIES AND MUSIC, AND COMMENTARY AND ARTICLES ABOUT EVENTS, PERSONALITIES, COMPUTER GAMES, BOOKS, MOVIES, AND MUSIC, ALL ON-LINE VIA A GLOBAL COMPUTER NETWORK; PROVIDING ONLINE NEWS IN THE NATURE OF CURRENT EVENT REPORTING; PROVIDING A WEBSITE FEATURING MULTIMEDIA MATERIALS, NAMELY, MOVIES, MUSIC AND COMPUTER GAMES, A SERIES OF NONDOWNLOADABLE ELECTRONIC FICTION BOOKS, AND A SERIES OF NONDOWNLOADABLE ELECTRONIC NONFICTION BOOKS IN THE FIELDS OF ART, SCIENCE, MUSIC, SPORTS, COMPUTERS AND TECHNOLOGY, POP CULTURE AND BIOGRAPHIES, THAT MAY BE ACCESSED VIA USERS OF THE INTERNET, AND BY USERS OF MOBILE PHONES, PORTABLE DIGITAL MUSIC PLAYERS, PORTABLE DIGITAL VIDEO PLAYERS, PORTABLE DIGITAL MEDIA PLAYERS, PERSONAL DIGITAL ASSISTANTS, DIGITAL VIDEO RECORDERS AND SIMILAR DIGITAL ENTERTAINMENT DEVICES (U.S. CLS. 100, 101 AND 107).

AMY ALFIERI, EXAMINING ATTORNEY

SN 76-568,316. VIZREA CORPORATION, BELLEVUE, WA.
FILED 12-12-2003.

STREAMLINING YOUR DIGITAL WORLD

THE MARK CONSISTS OF STANDARD CHARACTERS WITHOUT CLAIM TO ANY PARTICULAR FONT, STYLE, SIZE, OR COLOR.

CLASS 9—ELECTRICAL AND SCIENTIFIC APPARATUS

FOR COMPUTER HARDWARE AND SOFTWARE FOR USE IN RECORDING, TRANSMITTING, RECEIVING AND PLAYING MULTIMEDIA CONTENT, INCLUDING AUDIO AND VIDEO; IMAGE CAPTURE DEVICES, NAMELY, CAMERAS, DIGITAL CAMERAS, VIDEO CAMERAS, AND CAMERAS AND VIDEO CAMERAS BUILT INTO MOBILE DEVICES SUCH AS PERSONAL DIGITAL ASSISTANTS AND MOBILE PHONES; COMPUTER HARDWARE AND SOFTWARE FOR CONNECTING AND TRANSMITTING INFORMATION BETWEEN AND AMONG COMPUTERS, MOBILE DEVICES AND OTHER KINDS OF WIRELESS DEVICES; COMPUTER HARDWARE AND SOFTWARE FOR CONNECTING TO THE INTERNET; COMPUTER SECURITY SOFTWARE FOR ENSURING PRIVACY AND SAFE ACCESS TO THE INTERNET AND ONLINE SERVICES; ENCRYPTION HARDWARE AND SOFTWARE; BLANK SMART CARDS; ELECTRONIC BUSINESS CARDS, NAMELY, PRERECORDED CDS AND DVDS FEATURING BUSINESS CARD INFORMATION; COMPUTER SOFTWARE FOR REAL-TIME COMMUNICATION IN THE NATURE OF CHAT AND INSTANT MESSAGING, SOFTWARE FOR SENDING, RECEIVING AND DISPLAYING EMAILS, AND SOFTWARE FOR SENDING, RECEIVING, AND DISPLAYING ELECTRONIC SYNDICATION FEEDS AND SHORT MESSAGE SERVICE (SMS) MESSAGES; COMMUNICATIONS SOFTWARE, NAMELY, SOFTWARE FOR CONNECTING COMPUTER NETWORK USERS AND GLOBAL COMPUTER NETWORKS; COMPUTER SOFTWARE FOR MONITORING PERSONAL CAMERAS AND IMAGE CAPTURE DEVICES; OPERATING SOFTWARE, NAMELY, LAN OPERATING SOFTWARE, USB OPERATING SOFTWARE, OPERATING SOFTWARE FOR MOBILE DEVICES, NAMELY, PERSONAL DIGITAL ASSISTANTS AND MOBILE PHONES, PORTABLE DIGITAL MUSIC PLAYERS, PORTABLE DIGITAL MOVIE PLAYERS, PORTABLE DIGITAL MEDIA PLAYERS, DIGITAL CAMERAS AND VIDEO CAMERAS; COMPUTER HARDWARE; COMPUTER PERIPHERALS; ELECTRONIC DEVICES, NAMELY, RADIOS, TELEVISIONS, PERSONAL DIGITAL ASSISTANTS, TELEPHONES, AUDIO RECORDERS, AUDIO PLAYERS, VIDEO RECORDERS, VIDEO PLAYERS, MP3 PLAYERS AND OTHER PORTABLE DIGITAL MUSIC PLAYERS, CELLULAR PHONES, DIGITAL VIDEO RECORDERS, DIGITAL MEDIA PLAYERS; COMPUTER SOFTWARE FOR CREATING, DEVELOPING AND MAINTAINING WEB SITES, COMPUTER E-COMMERCE SOFTWARE TO ALLOW USERS TO PERFORM ELECTRONIC BUSINESS TRANSACTIONS VIA A GLOBAL COMPUTER NETWORK (U.S. CLS. 21, 23, 26, 36 AND 38).

CLASS 35—ADVERTISING AND BUSINESS

FOR BUSINESS SERVICES, NAMELY, BUSINESS MANAGEMENT, BUSINESS MARKETING, BUSINESS NETWORKING, BUSINESS PLANNING, BUSINESS RESEARCH, E-COMMERCE SERVICES, NAMELY, INTEGRATED TRACKING AND MANAGEMENT OF COMMERCIAL TRANSACTIONS ON A GLOBAL COMPUTER NETWORK; NEGOTIATION, MEDIATION AND SETTLEMENT OF COMMERCIAL TRANSACTIONS FOR THIRD PARTIES; PROMOTING THE GOODS AND SERVICES OF OTHERS THROUGH ON-LINE ADVERTISING (U.S. CLS. 100, 101 AND 102).

CLASS 38—COMMUNICATION

FOR COMMUNICATION SERVICES VIA THE INTERNET, WIRELESS AND MOBILE DEVICES, NAMELY, PROVIDING MULTIPLE USER DIAL-UP AND DEDICATED ACCESS TO THE INTERNET; STREAMING OF AUDIO AND VIDEO MATERIAL ON THE INTERNET AND TO AND FROM WIRELESS AND MOBILE DEVICES; ELECTRONIC TRANSMISSION OF DATA, DOCUMENTS AND APPLICATIONS BETWEEN COMPUTERS AND WIRELESS AND MOBILE DEVICES; MOBILE TELEPHONE COMMUNICATION, MOBILE RADIO COMMUNICATION, DATA COMMUNICATION BY EMAIL, SHORT MESSAGE SERVICE (SMS), SYNDICATION FEEDS, AND INSTANT MESSAGING; PROVIDING ON-LINE CHAT ROOMS FOR TRANSMISSION OF MESSAGES AMONG COMPUTER USERS ON A WIDE

VARIETY OF SUBJECTS OF GENERAL INTEREST; WIRELESS BROADBAND COMMUNICATION; WIRELESS COMMUNICATIONS SERVICES, NAMELY, TRANSMISSION OF GRAPHICS AND AUDIO TO MOBILE TELEPHONES, PERSONAL DIGITAL ASSISTANTS, PORTABLE DIGITAL MEDIA PLAYERS, PORTABLE DIGITAL MOVIE PLAYERS, PORTABLE DIGITAL MUSIC PLAYERS, DIGITAL CAMERAS AND VIDEO CAMERAS, VIDEO RECORDERS, DIGITAL VIDEO RECORDERS AND VIDEO PLAYERS; WEB MESSAGING SERVICES; WEB CONFERENCING SERVICES (U.S. CLS. 100, 101 AND 104).

CLASS 41—EDUCATION AND ENTERTAINMENT

FOR PROVIDING ON-LINE INFORMATION AND NEWS IN THE FIELD OF ENTERTAINMENT, NAMELY, PROVIDING ON-LINE REVIEWS AND NEWS RELATING TO MOVIES, BOOKS, MUSIC AND COMPUTER GAMES; PROVIDING A WEBSITE FEATURING NON-DOWNLOADABLE PUBLICATIONS, NAMELY A SERIES OF FICTION BOOKS AND A SERIES OF NONFICTION BOOKS IN THE FIELDS OF ART, SCIENCE, MUSIC, SPORTS, COMPUTERS AND TECHNOLOGY, POP CULTURE, AND BIOGRAPHIES; PROVIDING A WEBSITE FEATURING MULTIMEDIA MATERIALS, NAMELY, COMPUTER GAMES, MOVIES, PRERECORDED MUSIC, AND INFORMATION IN THE FIELD OF NEWS, COMPUTER GAMES, BOOKS, MOVIES AND MUSIC, AND COMMENTARY AND ARTICLES ABOUT EVENTS, PERSONALITIES, COMPUTER GAMES, BOOKS, MOVIES, AND MUSIC, ALL ON-LINE VIA A GLOBAL COMPUTER NETWORK; PROVIDING ONLINE NEWS IN THE NATURE OF CURRENT EVENT REPORTING; PROVIDING A WEBSITE FEATURING MULTIMEDIA MATERIALS, NAMELY, MOVIES, MUSIC AND COMPUTER GAMES, A SERIES OF NONDOWNLOADABLE ELECTRONIC FICTION BOOKS, AND A SERIES OF NONDOWNLOADABLE ELECTRONIC NONFICTION BOOKS IN THE FIELDS OF ART, SCIENCE, MUSIC, SPORTS, COMPUTERS AND TECHNOLOGY, POP CULTURE AND BIOGRAPHIES, THAT MAY BE ACCESSED VIA USERS OF THE INTERNET, AND BY USERS OF MOBILE PHONES, PORTABLE DIGITAL MUSIC PLAYERS, PORTABLE DIGITAL VIDEO PLAYERS, PORTABLE DIGITAL MEDIA PLAYERS, PERSONAL DIGITAL ASSISTANTS, DIGITAL VIDEO RECORDERS AND SIMILAR DIGITAL ENTERTAINMENT DEVICES (U.S. CLS. 100, 101 AND 107).

AMY ALFIERI, EXAMINING ATTORNEY

SN 76-568,918. INTERNATIONAL PENTECOSTAL HOLINESS CHURCH, INC., BETHANY, OK. FILED 1-6-2004.

FAITH CAFE

THE MARK CONSISTS OF STANDARD CHARACTERS WITHOUT CLAIM TO ANY PARTICULAR FONT, STYLE, SIZE, OR COLOR.

NO CLAIM IS MADE TO THE EXCLUSIVE RIGHT TO USE "FAITH", APART FROM THE MARK AS SHOWN.

CLASS 38—COMMUNICATION

FOR TELEVISION BROADCASTING (U.S. CLS. 100, 101 AND 104).

FIRST USE 10-0-2003; IN COMMERCE 10-0-2003.

CLASS 41—EDUCATION AND ENTERTAINMENT

FOR ENTERTAINMENT IN THE NATURE OF ONGOING TELEVISION PROGRAMS IN THE FIELD OF COMEDY, VARIETY, MUSICALS, LITERARY DISCUSSIONS, RELIGIOUS DIALOGUE, AND TALK SHOWS (U.S. CLS. 100, 101 AND 107).

FIRST USE 10-0-2003; IN COMMERCE 10-0-2003.
NELSON SNYDER, EXAMINING ATTORNEY

SN 76-570,875. CESAR & CLAUDIA CASTELLANOS MINISTRIES, INC., N. MIAMI, FL. FILED 1-14-2004.

**CLASS 9—ELECTRICAL AND SCIENTIFIC APPARATUS**

FOR VIDEOS AND CASSETTES PROVIDING INFORMATION IN THE FIELD OF READING SKILLS AND GENERAL EDUCATION (U.S. CLS. 21, 23, 26, 36 AND 38).

FIRST USE 0-0-1998; IN COMMERCE 0-0-1998.

CLASS 16—PAPER GOODS AND PRINTED MATTER

FOR PRINTED, INSTRUCTIONAL, AND EDUCATIONAL TEACHING MATERIALS IN THE FIELDS OF READING SKILLS AND GENERAL EDUCATION (U.S. CLS. 2, 5, 22, 23, 29, 37, 38 AND 50).

FIRST USE 0-0-1998; IN COMMERCE 0-0-1998.

CLASS 41—EDUCATION AND ENTERTAINMENT

FOR TEACHING AND EDUCATIONAL SERVICES, NAMELY CONDUCTING CLASSES, SEMINARS AND WORKSHOPS IN THE FIELDS OF READING SKILLS AND GENERAL EDUCATION (U.S. CLS. 100, 101 AND 107).

FIRST USE 0-0-1998; IN COMMERCE 0-0-1998.
BARBARA BROWN, EXAMINING ATTORNEY

SN 76-570,094. MATCH.COM, L.P., RICHARDSON, TX. FILED 1-15-2004.

MATCHTRAVEL

THE MARK CONSISTS OF STANDARD CHARACTERS WITHOUT CLAIM TO ANY PARTICULAR FONT, STYLE, SIZE, OR COLOR.

OWNER OF U.S. REG. NOS. 224,989, 2,640,223 AND OTHERS.

SN 76-571,738. MEDICAL COMPONENTS, INC., HARLEYSVILLE, PA. FILED 1-23-2004.

CLASS 39—TRANSPORTATION AND STORAGE

FOR ORGANIZING AND ARRANGING TRIPS, CRUISES AND VACATIONS FOR OTHERS (U.S. CLS. 100 AND 105).

FIRST USE 7-2-2002; IN COMMERCE 7-2-2002.

CLASS 41—EDUCATION AND ENTERTAINMENT

FOR ENTERTAINMENT SERVICES, NAMELY, ORGANIZING AND ARRANGING SOCIAL EVENTS FOR OTHERS (U.S. CLS. 100, 101 AND 107).

FIRST USE 7-2-2002; IN COMMERCE 7-2-2002.

CLASS 45—PERSONAL SERVICES

FOR SOCIAL INTRODUCTION AGENCIES, NAMELY, PROVIDING SOCIAL INTRODUCTION AND DATE-ARRANGING SERVICES FOR OTHERS (U.S. CLS. 100 AND 101).

FIRST USE 7-2-2002; IN COMMERCE 7-2-2002.
STEVEN JACKSON, EXAMINING ATTORNEY

MAG⁺IC

CLASS 5—PHARMACEUTICALS

FOR SURGICAL AND CLINICAL DRESSINGS AND SLEEVES, MATERIALS FOR DRESSINGS, NAMELY, BANDAGES FOR DRESSINGS, WOUND DRESSINGS, AND GAUZE FOR DRESSINGS, SANITARY PREPARATIONS FOR MEDICAL PURPOSES, ANTIBACTERIAL ADHESIVE BANDAGES AND DRESSINGS (U.S. CLS. 6, 18, 44, 46, 51 AND 52).

FIRST USE 2-9-2005; IN COMMERCE 2-9-2005.

CLASS 10—MEDICAL APPARATUS

FOR MEDICAL INSTRUMENTS, NAMELY CATHETERS AND CATHETER KITS CONSISTING OF CATHETERS, MEDICAL GUIDE WIRE BULB INTRODUCERS AND MEDICAL GUIDE WIRES, CATHETER INTRODUCERS, INTRODUCER SHEATHS AND DILATORS, HYPODERMIC NEEDLES, AND CAPS FOR MEDICAL OR SURGICAL PURPOSES (U.S. CLS. 26, 39 AND 44).

FIRST USE 2-9-2005; IN COMMERCE 2-9-2005.
ASMAT KHAN, EXAMINING ATTORNEY

SN 76-573,209. CMEDIA CORPORATION, HERNDON, VA.
FILED 1-30-2004.

CMEDIA

CLASS 9—ELECTRICAL AND SCIENTIFIC APPARATUS

FOR COMPUTER HARDWARE; GENERAL USE COMPUTER SOFTWARE FOR INTAKE, STORAGE, MANAGEMENT, DELIVERY, DISTRIBUTION, SEARCHING, RETRIEVAL, DISPLAY, AND ORGANIZATION OF AUDIO AND VIDEO IMAGES (U.S. CLS. 21, 23, 26, 36 AND 38).

FIRST USE 11-0-2002; IN COMMERCE 11-0-2002.

CLASS 42—SCIENTIFIC, COMPUTER AND LEGAL SERVICES

FOR INTEGRATION OF COMPUTER SYSTEMS AND NETWORKS; ENGINEERING SERVICES; MAINTENANCE, INSTALLATION AND UPGRADING OF COMPUTER SOFTWARE; TECHNICAL SUPPORT SERVICES, NAMELY, TROUBLESHOOTING OF COMPUTER SOFTWARE PROBLEMS (U.S. CLS. 100 AND 101).

FIRST USE 11-0-2002; IN COMMERCE 11-0-2002.
SUELLEN HICKEY, EXAMINING ATTORNEY

SN 76-572,806. SCREENVUE, INC., LOS ANGELES, CA.
FILED 1-20-2004.



SCREENVUE

SN 76-574,288. SAMMY CORPORATION, TOSHIMA-KU,
TOKYO 170-8436, JAPAN, FILED 2-6-2004.

KENJU

THE DRAWING PROVIDED IS IN BLACK AND WHITE BECAUSE COLOR IS NOT CLAIMED AS A FEATURE OF THE MARK. ALL SHADING HAS BEEN SHOWN WITH DOTS. THE DOTS ARE FOR SHADING PURPOSES ONLY, IS NOT A FEATURE OF THE MARK, AND IS NOT INTENDED TO SHOW COLOR.

CLASS 9—ELECTRICAL AND SCIENTIFIC APPARATUS

FOR DVDS AND CD-ROMS CONTAINING VIDEO CLIPS FEATURING RELIGIOUS TOPICS, AND INSTRUCTIONAL MATERIALS REGARDING THE CONTENTS OF THE RECORDINGS SOLD AS A UNIT THEREWITH (U.S. CLS. 21, 23, 26, 36 AND 38).

FIRST USE 5-15-2003; IN COMMERCE 5-15-2003.

CLASS 35—ADVERTISING AND BUSINESS

FOR COMPILATION SERVICE, NAMELY, COMPILATION OF DVDS AND CD-ROMS FEATURING RELIGIOUS TOPICS, AND INSTRUCTIONAL MATERIALS REGARDING THE CONTENTS OF THE RECORDINGS DISTRIBUTED AS A UNIT THEREWITH (U.S. CLS. 100, 101 AND 102).

FIRST USE 5-15-2003; IN COMMERCE 5-15-2003.
BARBARA A. GOLD, EXAMINING ATTORNEY

THE ENGLISH TRANSLATION OF THE JAPANESE WORDING "KENJU" IN THE MARK IS "HANDGUN".

CLASS 9—ELECTRICAL AND SCIENTIFIC APPARATUS

FOR COMPUTER GAME PROGRAMS STORED ON ELECTRONIC CIRCUIT CARDS, MAGNETIC DISCS, OPTICAL DISCS, CD-ROM, DVD-ROM, AND MAGNETIC TAPES; VIDEO GAME PROGRAMS FOR BUSINESS USE STORED ON ELECTRONIC CIRCUIT CARDS, MAGNETIC DISCS, OPTICAL DISCS, CD-ROM, DVD-ROM, AND MAGNETIC TAPES; VIDEO GAME PROGRAMS FOR HOME USE STORED ON ELECTRONIC CIRCUIT CARDS, MAGNETIC DISCS, OPTICAL DISCS, CD-ROM, DVD-ROM, AND MAGNETIC TAPES; VIDEO GAME OUTPUT MACHINES FOR USE WITH TELEVISIONS FOR HOME USE; VENDING MACHINES; ELECTRONIC CIRCUIT CARDS, CD-ROM AND DVD-ROM HAVING AN AUTOMATIC PLAYING PROGRAM FOR ELECTRONIC MUSICAL INSTRUMENTS; VIDEO GAME INTERACTIVE REMOTE CONTROLS FOR PLAYING ELECTRONIC GAMES AND BATTERY-POWERED COMPUTER GAME WITH LCD SCREEN WHICH FEATURES ANIMATION AND SOUND EFFECTS; VIDEO GAME PROGRAMS FOR USE WITH PORTABLE, BATTERY POWERED COMPUTER GAME WITH LCD DISPLAY (U.S. CLS. 21, 23, 26, 36 AND 38).

CLASS 28—TOYS AND SPORTING GOODS

FOR COIN OPERATED VIDEO GAME MACHINES FOR BUSINESS USE; MAGNETIC CARD OPERATED VIDEO GAME MACHINES FOR BUSINESS USE; AUTOMATIC AND COIN-OPERATED ARCADE GAME MACHINES; BALLS FOR GAMES; SMALL BALLS FOR GAMES; COUNTERS FOR GAMES; GAME EQUIPMENT, NAMELY, GAME TABLES, GAME WHEELS, GAME CARDS, AND GAME MATERIALS; AUTOMATIC GAMES OTHER THAN THOSE ADAPTED FOR USE WITH TELEVISION RECEIVERS ONLY; APPARATUS FOR ELECTRONIC GAMES OTHER THAN THOSE ADAPTED FOR USE WITH TELEVISION RECEIVERS ONLY; MOBILE TOYS, SCALE MODEL VEHICLES; PARLOR GAMES; PLAYING BALLS; PLAYING CARDS; RADIO-CONTROLLED TOY VEHICLES; PORTABLE GAME MACHINES WITH LIQUID CRYSTAL DISPLAY HAVING A FUNCTION OF TRANSMITTING OR RECEIVING SIGNALS (U.S. CLS. 22, 23, 38 AND 50).

DAWN FELDMAN, EXAMINING ATTORNEY

SN 76-574,465. YOKEMICK, DIANE I., GREENVILLE, SC. FILED 2-9-2004.

WEDDING INVITATIONS AND MORE

NO CLAIM IS MADE TO THE EXCLUSIVE RIGHT TO USE "WEDDING INVITATIONS", APART FROM THE MARK AS SHOWN.

CLASS 37—CONSTRUCTION AND REPAIR

FOR CONSULTATION SERVICES IN THE FIELD OF PRESERVATION OF WEDDING DRESSES (U.S. CLS. 100, 103 AND 106).

FIRST USE 11-30-2000; IN COMMERCE 11-30-2000.

CLASS 41—EDUCATION AND ENTERTAINMENT

FOR CONSULTING SERVICES PERTAINING TO WEDDING INVITATIONS, WEDDING PROGRAMS, WEDDING ACCESSORIES, WEDDING FAVORS AND CALLIGRAPHY SERVICES (U.S. CLS. 100, 101 AND 107).

FIRST USE 11-30-2000; IN COMMERCE 11-30-2000.

LESLEY LAMOTHE, EXAMINING ATTORNEY

SN 76-574,815. IMPEX INC., IRVING, TX. FILED 2-6-2004.



THE MARK CONSISTS OF A SQUARE ENCAPSULATING THE WORDINGS "SAGUARO WEST" WITH THE OUTLINE OF A MOUNTAIN AND THE OUTLINE OF THE MOUNTAIN'S CORRESPONDING REFLECTION IN THE BACKGROUND.

CLASS 18—LEATHER GOODS

FOR LEATHER GOODS AND IMITATION LEATHER GOODS FOR MEN, WOMEN, AND CHILDREN, NAMELY, BACKPACKS, BILLFOLDS, BOOTS, BRIEF CASES, COIN PURSES, HANDBAGS, SATCHELS, AND WAIST PACKS (U.S. CLS. 1, 2, 3, 22 AND 41).

FIRST USE 5-1-1995; IN COMMERCE 5-1-1995.

CLASS 25—CLOTHING

FOR MEN'S, WOMEN'S, AND CHILDREN'S CLOTHING, NAMELY, BELTS, BIB OVERALLS, BLAZERS, BLOUSES, BOOTS, BUTTON DOWN SHIRTS, CAPS, CASUAL DRESSES, CASUAL PANTS, COATS, CREW-NECK SHIRTS, DRESSES, DUNGAREES, GLOVES, GOLF SHIRTS, HATS, HAT BANDS, HOODED SHIRTS, JACKETS, JEANS, JUMP SUITS, KNIT SHIRTS, LONG-SLEEVED SHIRTS, OVERALLS, OVER COATS, POLO SHIRTS, PULLOVERS, SHORTS, SKIRTS, SLACKS, SOCKS, SWEAT SHIRTS, SWEATERS, SWEAT SHORTS, TANK TOPS, TROUSERS, T-SHIRTS, VESTS, WORK PANTS, AND WORK SHIRTS; BELTS, LEATHER BLAZERS, LEATHER BLOUSES, LEATHER COATS, LEATHER DRESSES, LEATHER GLOVES, LEATHER JACKETS, LEATHER OVER COATS, LEATHER PANTS, LEATHER SHIRTS, LEATHER SKIRTS, LEATHER VESTS, AND LEATHER HAT BANDS (U.S. CLS. 22 AND 39).

FIRST USE 5-1-1995; IN COMMERCE 5-1-1995.

ZACHARY BELLO, EXAMINING ATTORNEY

SN 76-574,816. IMPEX INC., IRVING, TX. FILED 2-6-2004.



CLASS 18—LEATHER GOODS

FOR LEATHER GOODS AND IMITATION LEATHER GOODS FOR MEN, WOMEN, AND CHILDREN, NAMELY, BACKPACKS, BILLFOLDS, BOOTS, BRIEF CASES, COIN PURSES, HANDBAGS, SATCHELS, AND WAIST PACKS (U.S. CLS. 1, 2, 3, 22 AND 41).

FIRST USE 5-1-1995; IN COMMERCE 5-1-1995.

CLASS 25—CLOTHING

FOR MEN'S, WOMEN'S, AND CHILDREN'S CLOTHING, NAMELY, BELTS, BIB OVERALLS, BLAZERS, BLOUSES, BOOTS, BUTTON DOWN SHIRTS, CAPS, CASUAL DRESSES, CASUAL PANTS, COATS, CREW-NECK SHIRTS, DRESSES, DUNGAREES, GLOVES, GOLF SHIRTS, HATS, HAT BANDS, HOODED SHIRTS, JACKETS, JEANS, JUMP SUITS, KNIT SHIRTS, LONG-SLEEVED SHIRTS, OVERALLS, OVER COATS, POLO SHIRTS, PULLOVERS, SHORTS, SKIRTS, SLACKS, SOCKS, SWEAT SHIRTS, SWEATERS, SWEAT SHORTS, TANK TOPS, TROUSERS, T-SHIRTS, VESTS, WORK PANTS, AND WORK SHIRTS; BELTS, LEATHER BLAZERS, LEATHER BLOUSES, LEATHER COATS, LEATHER DRESSES, LEATHER GLOVES, LEATHER JACKETS, LEATHER OVER COATS, LEATHER PANTS, LEATHER SHIRTS, LEATHER SKIRTS, LEATHER VESTS, AND LEATHER HAT BANDS (U.S. CLS. 22 AND 39).

FIRST USE 5-1-1995; IN COMMERCE 5-1-1995.

ZACHARY BELLO, EXAMINING ATTORNEY

SN 76-574,871. UNITED STATES OLYMPIC COMMITTEE,
COLORADO SPRINGS, CO. FILED 2-10-2004.

199 CULTURES. 5 BOROUGHES. 1 DREAM.

THE MARK CONSISTS OF STANDARD CHARACTERS WITHOUT CLAIM TO ANY PARTICULAR FONT, STYLE, SIZE, OR COLOR.

CLASS 14—JEWELRY

FOR ORNAMENTAL LAPEL PINS, CLOCKS, WATCHES, AND JEWELRY (U.S. CLS. 2, 27, 28 AND 50).

CLASS 16—PAPER GOODS AND PRINTED MATTER

FOR NEWSLETTERS AND BROCHURES CONCERNING A SPORTS ORGANIZATION AND ELITE-LEVEL SPORT COMPETITIONS; POSTERS; STATIONERY, NOTE PAPER, NOTECARDS AND ENVELOPES; NOTE PADS; CALENDARS; TRADING CARDS; PENS, PENCILS AND PEN AND PENCIL SETS; NOTEBOOKS AND BINDERS; DIARIES AND PERSONAL JOURNALS; BOOK MARKS; PAPER CLIP HOLDERS; PAPER WEIGHTS; PAPER BANNERS, DECALS AND WINDSHIELD DECAL STRIPS; AND PAPER NAPKINS (U.S. CLS. 2, 5, 22, 23, 29, 37, 38 AND 50).

CLASS 25—CLOTHING

FOR CLOTHING, NAMELY, HATS, CAPS, T-SHIRTS, TANK TOPS, SWEATSHIRTS, HOODED SWEATSHIRTS, POLOS, GOLF KNIT TOPS, FLEECE JACKETS, SWEAT PANTS, SHORTS, INFANT BODYSUITS, SOCKS, FOOTWEAR, SCARVES, JERSEYS, DRESSES, SKIRTS, GLOVES (U.S. CLS. 22 AND 39).

CLASS 41—EDUCATION AND ENTERTAINMENT

FOR ORGANIZING AND CONDUCTING ELITE LEVEL SPORTS AND ATHLETIC COMPETITIONS AND DEMONSTRATIONS; ORGANIZING CULTURAL EVENTS, NAMELY, MUSICAL, THEATRICAL AND DANCE EXHIBITIONS, ART EXHIBITIONS AND CRAFT EXHIBITIONS; ENTERTAINMENT SERVICES, NAMELY, PROVIDING RADIO AND TELEVISION PROGRAMS FEATURING ELITE LEVEL ATHLETIC EVENTS (U.S. CLS. 100, 101 AND 107).

JEFFERY COWARD, EXAMINING ATTORNEY

SN 76-574,873. UNITED STATES OLYMPIC COMMITTEE,
COLORADO SPRINGS, CO. FILED 2-10-2004.

LET THE DREAMS BEGIN

THE MARK CONSISTS OF STANDARD CHARACTERS WITHOUT CLAIM TO ANY PARTICULAR FONT, STYLE, SIZE, OR COLOR.

CLASS 9—ELECTRICAL AND SCIENTIFIC APPARATUS

FOR VIDEOTAPES, AUDIO TAPES, CASSETTE TAPES, DVDS AND CD-ROMS FEATURING INFORMATION ABOUT A SPORTS ORGANIZATION AND ELITE-LEVEL SPORTS COMPETITION; MAGNETS; SUNGLASSES AND SWIM GOGGLES (U.S. CLS. 21, 23, 26, 36 AND 38).

CLASS 14—JEWELRY

FOR ORNAMENTAL LAPEL PINS, CLOCKS, WATCHES, AND JEWELRY (U.S. CLS. 2, 27, 28 AND 50).

CLASS 16—PAPER GOODS AND PRINTED MATTER

FOR NEWSLETTERS AND BROCHURES CONCERNING A SPORTS ORGANIZATION AND ELITE-LEVEL SPORT COMPETITIONS; POSTERS; STATIONERY, NOTE PAPER, NOTECARDS AND ENVELOPES; NOTE PADS; CALENDARS; TRADING CARDS; PENS, PENCILS AND PEN AND PENCIL SETS; NOTEBOOKS AND BINDERS; DIARIES AND PERSONAL JOURNALS; BOOK MARKS; PAPER CLIP HOLDERS; PAPER WEIGHTS; PAPER BANNERS, DECALS AND WINDSHIELD DECAL STRIPS; AND PAPER NAPKINS (U.S. CLS. 2, 5, 22, 23, 29, 37, 38 AND 50).

CLASS 18—LEATHER GOODS

FOR LUGGAGE, SPORTS BAGS, DUFFEL BAGS, GARMENT BAGS, BACKPACKS, BRIEF CASES, FANNY PACKS, HANDBAGS, LUGGAGE TAGS, AND UMBRELLAS (U.S. CLS. 1, 2, 3, 22 AND 41).

CLASS 20—FURNITURE AND ARTICLES NOT OTHERWISE CLASSIFIED

FOR PICTURE FRAMES, HAND-HELD MIRRORS AND FURNITURE MIRRORS (U.S. CLS. 2, 13, 22, 25, 32 AND 50).

CLASS 21—HOUSEWARES AND GLASS

FOR CUPS, MUGS, DRINKING GLASSES, SHOT GLASSES, STEINS, AND WATER BOTTLES, SOLD EMPTY (U.S. CLS. 2, 13, 23, 29, 30, 33, 40 AND 50).

CLASS 24—FABRICS

FOR CLOTH PENNANTS, THROW BLANKETS AND TOWELS (U.S. CLS. 42 AND 50).

CLASS 25—CLOTHING

FOR CLOTHING, NAMELY, HATS, CAPS, T-SHIRTS, TANK TOPS, SWEATSHIRTS, HOODED SWEATSHIRTS, POLOS, GOLF KNIT TOPS, FLEECE JACKETS, SWEAT PANTS, SHORTS, INFANT BODYSUITS, SOCKS, FOOTWEAR, SCARVES, JERSEYS, DRESSES, SKIRTS, GLOVES AND BICYCLING GLOVES (U.S. CLS. 22 AND 39).

CLASS 28—TOYS AND SPORTING GOODS

FOR PLUSH TOYS, DOLLS, SPORT BALLS, BASKETBALLS, BASEBALLS, SOCCER BALLS, PLAYING CARDS, CHRISTMAS TREE ORNAMENTS, AND SPORTING EQUIPMENT, NAMELY, GYMNASTIC APPARATUS, SWIM FINS, ARCHERY ARROWS, BOXING GLOVES, BASEBALL GLOVES, BASEBALL BATS, FENCING MASKS, KNEE PADS FOR ATHLETIC USE, JUMP ROPES, BASKETBALL NETS, VOLLEYBALL NETS, TABLE TENNIS NETS, TENNIS RACKETS, AND WEIGHTS FOR WEIGHTLIFTING COMPETITIONS (U.S. CLS. 22, 23, 38 AND 50).

CLASS 35—ADVERTISING AND BUSINESS

FOR PROMOTING PARTICIPATION WITH AND SELECTION FOR THE UNITED STATES TEAM FOR AN INTERNATIONAL ATHLETIC EVENT; PROMOTING THE GOODS AND SERVICES OF OTHERS BY ARRANGING FOR SPONSORSHIP AND LICENSING WITH REGARD TO ATHLETIC EVENTS (U.S. CLS. 100, 101 AND 102).

CLASS 41—EDUCATION AND ENTERTAINMENT

FOR ORGANIZING AND CONDUCTING ELITE LEVEL SPORTS AND ATHLETIC COMPETITIONS AND DEMONSTRATIONS; ORGANIZING CULTURAL EVENTS, NAMELY, MUSICAL, THEATRICAL AND DANCE EXHIBITIONS, ART EXHIBITIONS AND CRAFT EXHIBITIONS; ENTERTAINMENT SERVICES, NAMELY, PROVIDING RADIO AND TELEVISION PROGRAMS FEATURING ELITE LEVEL ATHLETIC EVENTS (U.S. CLS. 100, 101 AND 107).

JEFFERY COWARD, EXAMINING ATTORNEY

SN 76-575,826. HOME SAFETY COUNCIL, WILKESBORO, NC. FILED 2-17-2004.



SN 76-575,222. SRC HOLDINGS CORPORATION, SPRINGFIELD, MO. FILED 2-12-2004.

SRC

NO CLAIM IS MADE TO THE EXCLUSIVE RIGHT TO USE HOME SAFETY, APART FROM THE MARK AS SHOWN.

SEC. 2(F) AS TO COUNCIL.

CLASS 9—ELECTRICAL AND SCIENTIFIC APPARATUS

FOR PRERECORDED VIDEOTAPES PROMOTING HOME SAFETY AWARENESS AND INJURY PREVENTION (U.S. CLS. 21, 23, 26, 36 AND 38).

FIRST USE 2-1-2004; IN COMMERCE 2-1-2004.

CLASS 16—PAPER GOODS AND PRINTED MATTER

FOR PRINTED PUBLICATIONS, NAMELY, BROCHURES, PAMPHLETS, NEWSLETTERS AND POSTERS IN THE AREA OF HOME SAFETY AWARENESS AND INJURY PREVENTION (U.S. CLS. 2, 5, 22, 23, 29, 37, 38 AND 50).

FIRST USE 2-1-2004; IN COMMERCE 2-1-2004.

CLASS 36—INSURANCE AND FINANCIAL

FOR CHARITABLE FUND RAISING (U.S. CLS. 100, 101 AND 102).

FIRST USE 2-1-2004; IN COMMERCE 2-1-2004.

CLASS 41—EDUCATION AND ENTERTAINMENT

FOR EDUCATIONAL SERVICES, NAMELY, CONDUCTING WORKSHOPS, SEMINARS AND CLASSES TO PROMOTE HOME SAFETY AWARENESS AND INJURY PREVENTION (U.S. CLS. 100, 101 AND 107).

FIRST USE 2-1-2004; IN COMMERCE 2-1-2004.

STEVEN JACKSON, EXAMINING ATTORNEY

THE MARK CONSISTS OF STANDARD CHARACTERS WITHOUT CLAIM TO ANY PARTICULAR FONT, STYLE, SIZE, OR COLOR.

OWNER OF U.S. REG. NOS. 1,524,164, 1,524,385 AND OTHERS.

CLASS 7—MACHINERY

FOR REMANUFACTURED PARTS FOR ENGINES AND TRANSMISSIONS OF AGRICULTURAL LAND VEHICLES, HEAVY-DUTY TRUCKS, AND AUTOMOTIVE VEHICLES, NAMELY, CYLINDER HEADS, CRANKSHAFTS, CAMSHAFTS, CONNECTING RODS, CRANKCASES, WATER PUMPS, OIL COOLERS, OIL PUMPS, ROTATING ASSEMBLIES AND TORQUE AMPLIFIERS (U.S. CLS. 13, 19, 21, 23, 31, 34 AND 35).

FIRST USE 9-0-1986; IN COMMERCE 9-0-1986.

CLASS 12—VEHICLES

FOR REMANUFACTURED ENGINES, TRANSMISSIONS, TORQUE CONVERTERS AND BRAKE SHOES FOR AGRICULTURAL LAND VEHICLES, HEAVY-DUTY TRUCKS, AND AUTOMOTIVE VEHICLES (U.S. CLS. 19, 21, 23, 31, 35 AND 44).

FIRST USE 9-0-1986; IN COMMERCE 9-0-1986.

RONALD MCMORROW, EXAMINING ATTORNEY

SN 76-576,282. NATIONAL STOCK EXCHANGE, CHICAGO, IL. FILED 2-12-2004.

NATIONAL STOCK EXCHANGE

NO CLAIM IS MADE TO THE EXCLUSIVE RIGHT TO USE "STOCK EXCHANGE", APART FROM THE MARK AS SHOWN.

SEC. 2(F).

CLASS 36—INSURANCE AND FINANCIAL

FOR OPERATING A STOCK EXCHANGE, NAMELY, PROVIDING A FINANCIAL MARKET FOR THE TRADING AND AUCTIONING OF SECURITIES; PROVIDING STOCK EXCHANGE PRICE QUOTATIONS AND RELATED INFORMATION; PROVIDING FULLY AUTOMATED SECURITIES BROKERAGE SERVICES (U.S. CLS. 100, 101 AND 102).
FIRST USE 11-7-2003; IN COMMERCE 11-7-2003.

SN 76-576,692. DAIMLERCHRYSLER AG, 70567 STUTTGART, FED REP GERMANY, FILED 2-23-2004.

GL 500

CLASS 38—COMMUNICATION

FOR ELECTRONIC TRANSMISSION OF DATA, MESSAGES AND DOCUMENTS TO BUYERS, SELLERS AND BROKERS OF SECURITIES, ALL OF THE FOREGOING NOT IN THE FIELD OF SPORTS INFORMATION SERVICES (U.S. CLS. 100, 101 AND 104).
FIRST USE 11-7-2003; IN COMMERCE 11-7-2003.
TONJA GASKINS, EXAMINING ATTORNEY

THE MARK CONSISTS OF STANDARD CHARACTERS WITHOUT CLAIM TO ANY PARTICULAR FONT, STYLE, SIZE, OR COLOR.

PRIORITY CLAIMED UNDER SEC. 44(D) ON FED REP GERMANY APPLICATION NO. 30345467.9/1, FILED 9-3-2003, REG. NO. 30345467, DATED 10-20-2003, EXPIRES 9-3-2013.

NO CLAIM IS MADE TO THE EXCLUSIVE RIGHT TO USE "500", APART FROM THE MARK AS SHOWN.

CLASS 12—VEHICLES

FOR AUTOMOBILES AND THEIR STRUCTURAL PARTS (U.S. CLS. 19, 21, 23, 31, 35 AND 44).

CLASS 28—TOYS AND SPORTING GOODS

FOR TOY MODEL VEHICLES (U.S. CLS. 22, 23, 38 AND 50).

CLASS 37—CONSTRUCTION AND REPAIR

FOR REPAIR AND MAINTENANCE OF VEHICLES (U.S. CLS. 100, 103 AND 106).
CAROLINE WOOD, EXAMINING ATTORNEY

SN 76-576,691. DAIMLERCHRYSLER AG, 70567 STUTTGART, FED REP GERMANY, FILED 2-23-2004.

GL 450

SN 76-576,693. DAIMLERCHRYSLER AG, 70567 STUTTGART, FED REP GERMANY, FILED 2-23-2004.

GL 550

THE MARK CONSISTS OF STANDARD CHARACTERS WITHOUT CLAIM TO ANY PARTICULAR FONT, STYLE, SIZE, OR COLOR.

PRIORITY CLAIMED UNDER SEC. 44(D) ON FED REP GERMANY APPLICATION NO. 30345466.0/1, FILED 9-3-2003, REG. NO. 3034566, DATED 10-20-2003, EXPIRES 10-20-2013.

NO CLAIM IS MADE TO THE EXCLUSIVE RIGHT TO USE "450", APART FROM THE MARK AS SHOWN.

THE MARK CONSISTS OF STANDARD CHARACTERS WITHOUT CLAIM TO ANY PARTICULAR FONT, STYLE, SIZE, OR COLOR.

PRIORITY CLAIMED UNDER SEC. 44(D) ON FED REP GERMANY APPLICATION NO. 30345468.7/1, FILED 9-3-2003, REG. NO. 30345468, DATED 10-20-2003, EXPIRES 9-3-2013.

NO CLAIM IS MADE TO THE EXCLUSIVE RIGHT TO USE "550", APART FROM THE MARK AS SHOWN.

CLASS 12—VEHICLES

FOR AUTOMOBILES AND THEIR STRUCTURAL PARTS (U.S. CLS. 19, 21, 23, 31, 35 AND 44).

CLASS 12—VEHICLES

FOR AUTOMOBILES AND THEIR STRUCTURAL PARTS (U.S. CLS. 19, 21, 23, 31, 35 AND 44).

CLASS 28—TOYS AND SPORTING GOODS

FOR TOY MODEL VEHICLES (U.S. CLS. 22, 23, 38 AND 50).

CLASS 28—TOYS AND SPORTING GOODS

FOR TOY MODEL VEHICLES (U.S. CLS. 22, 23, 38 AND 50).

CLASS 37—CONSTRUCTION AND REPAIR

FOR REPAIR AND MAINTENANCE OF VEHICLES (U.S. CLS. 100, 103 AND 106).
CAROLINE WOOD, EXAMINING ATTORNEY

CLASS 37—CONSTRUCTION AND REPAIR

FOR REPAIR AND MAINTENANCE OF VEHICLES (U.S. CLS. 100, 103 AND 106).
CAROLINE WOOD, EXAMINING ATTORNEY

SN 76-576,694. DAIMLERCHRYSLER AG, 70567 STUTT-GART, FED REP GERMANY, FILED 2-23-2004.

SN 76-576,806. IVY CLASSIC INDUSTRIES, INC., NEW ROCHELLE, NY. FILED 2-19-2004.

GL 350



THE MARK CONSISTS OF STANDARD CHARACTERS WITHOUT CLAIM TO ANY PARTICULAR FONT, STYLE, SIZE, OR COLOR.

PRIORITY CLAIMED UNDER SEC. 44(D) ON FED REP GERMANY APPLICATION NO. 30345464.4/1, FILED 9-3-2003, REG. NO. 30345464, DATED 10-20-2003, EXPIRES 9-3-2013.

NO CLAIM IS MADE TO THE EXCLUSIVE RIGHT TO USE "350", APART FROM THE MARK AS SHOWN.

CLASS 12—VEHICLES

FOR AUTOMOBILES AND THEIR STRUCTURAL PARTS (U.S. CLS. 19, 21, 23, 31, 35 AND 44).

CLASS 28—TOYS AND SPORTING GOODS

FOR TOY MODEL VEHICLES (U.S. CLS. 22, 23, 38 AND 50).

CLASS 37—CONSTRUCTION AND REPAIR

FOR REPAIR AND MAINTENANCE OF VEHICLES (U.S. CLS. 100, 103 AND 106).

CAROLINE WOOD, EXAMINING ATTORNEY

CLASS 7—MACHINERY

FOR ABRASIVE PRODUCTS, NAMELY, ABRASIVE SHEETS, SANDING BELTS, SANDING DISCS, FLAP DISCS, DRUM SANDERS, ROLLS AND GRINDING WHEELS FOR POWER OPERATED SANDERS (U.S. CLS. 13, 19, 21, 23, 31, 34 AND 35).

FIRST USE 1-1-2004; IN COMMERCE 1-1-2004.

CLASS 8—HAND TOOLS

FOR ABRASIVE PRODUCTS, NAMELY, ABRASIVE SHEETS, SANDING BELTS, SANDING DISCS, FLAP DISCS, DRUM SANDERS, ROLLS AND GRINDING WHEELS FOR HAND OPERATED SANDERS (U.S. CLS. 23, 28 AND 44).

FIRST USE 1-1-2004; IN COMMERCE 1-1-2004.

MIDGE BUTLER, EXAMINING ATTORNEY

SN 76-576,697. DAIMLERCHRYSLER AG, 70567 STUTT-GART, FED REP GERMANY, FILED 2-23-2004.

SN 76-578,468. DAIMLERCHRYSLER AG, 70567 STUTT-GART, FED REP GERMANY, FILED 3-1-2004.

GL 280

GL-CLASS

THE MARK CONSISTS OF STANDARD CHARACTERS WITHOUT CLAIM TO ANY PARTICULAR FONT, STYLE, SIZE, OR COLOR.

PRIORITY CLAIMED UNDER SEC. 44(D) ON FED REP GERMANY APPLICATION NO. 30345462.8/1, FILED 9-3-2003, REG. NO. 30345462, DATED 10-6-2003, EXPIRES 9-3-2013.

NO CLAIM IS MADE TO THE EXCLUSIVE RIGHT TO USE "280", APART FROM THE MARK AS SHOWN.

CLASS 12—VEHICLES

FOR AUTOMOBILES AND THEIR STRUCTURAL PARTS (U.S. CLS. 19, 21, 23, 31, 35 AND 44).

CLASS 28—TOYS AND SPORTING GOODS

FOR TOY MODEL VEHICLES (U.S. CLS. 22, 23, 38 AND 50).

CLASS 37—CONSTRUCTION AND REPAIR

FOR REPAIR AND MAINTENANCE OF VEHICLES (U.S. CLS. 100, 103 AND 106).

CAROLINE WOOD, EXAMINING ATTORNEY

THE MARK CONSISTS OF STANDARD CHARACTERS WITHOUT CLAIM TO ANY PARTICULAR FONT, STYLE, SIZE, OR COLOR.

PRIORITY CLAIMED UNDER SEC. 44(D) ON FED REP GERMANY APPLICATION NO. 30345459.8/1, FILED 9-3-2003, REG. NO. 30345459, DATED 10-6-2003, EXPIRES 10-6-2013.

CLASS 12—VEHICLES

FOR AUTOMOBILES AND THEIR STRUCTURAL PARTS (U.S. CLS. 19, 21, 23, 31, 35 AND 44).

CLASS 28—TOYS AND SPORTING GOODS

FOR TOY MODEL VEHICLES (U.S. CLS. 22, 23, 38 AND 50).

CLASS 37—CONSTRUCTION AND REPAIR

FOR REPAIR AND MAINTENANCE OF MOTOR VEHICLES (U.S. CLS. 100, 103 AND 106).

CAROLINE WOOD, EXAMINING ATTORNEY

SN 76-578,891. STANLEY ASSOCIATES, INC., ALEXANDRIA, VA. FILED 3-3-2004.

STANLEY

THE MARK CONSISTS OF STANDARD CHARACTERS WITHOUT CLAIM TO ANY PARTICULAR FONT, STYLE, SIZE, OR COLOR.

CLASS 37—CONSTRUCTION AND REPAIR

FOR COMPUTER HARDWARE INSTALLATION SERVICES (U.S. CLS. 100, 103 AND 106).
FIRST USE 0-0-1985; IN COMMERCE 0-0-1985.

CLASS 38—COMMUNICATION

FOR TELEPHONY SERVICES VIA THE INTERNET (U.S. CLS. 100, 101 AND 104).
FIRST USE 11-18-1996; IN COMMERCE 11-18-1996.

CLASS 41—EDUCATION AND ENTERTAINMENT

FOR EDUCATIONAL SERVICES, NAMELY TRAINING WORKSHOPS AND SEMINARS IN THE FIELD OF SOFTWARE DEVELOPMENT (U.S. CLS. 100, 101 AND 107).
FIRST USE 0-0-1988; IN COMMERCE 0-0-1988.

CLASS 42—SCIENTIFIC, COMPUTER AND LEGAL SERVICES

FOR INFORMATION TECHNOLOGY SERVICES, NAMELY NETWORK SYSTEMS DESIGN, DEVELOPMENT, TEST AND EVALUATION; NETWORK ENGINEERING, MANAGEMENT AND TECHNICAL SUPPORT NAMELY TROUBLESHOOTING OF COMPUTER HARDWARE AND SOFTWARE; ENTERPRISE ARCHITECTURE SERVICES; AND REMOTE HOSTING OF NETWORKS, INSTALLATION OF COMPUTER SOFTWARE (U.S. CLS. 100 AND 101).
FIRST USE 0-0-1985; IN COMMERCE 0-0-1985.

CLASS 45—PERSONAL SERVICES

FOR NETWORK SECURITY SERVICES, NAMELY ASSESSMENT, IMPLEMENTATION AND MONITORING OF COMPUTER NETWORKS AND SYSTEMS FOR SECURITY PURPOSES (U.S. CLS. 100 AND 101).
FIRST USE 11-18-1996; IN COMMERCE 11-18-1996.
HOWARD B. LEVINE, EXAMINING ATTORNEY

SN 76-579,066. ISEE SYSTEMS, INC., LEBANON, NH. FILED 3-4-2004.



NO CLAIM IS MADE TO THE EXCLUSIVE RIGHT TO USE "SYSTEMS", APART FROM THE MARK AS SHOWN.

CLASS 9—ELECTRICAL AND SCIENTIFIC APPARATUS

FOR COMPUTER SOFTWARE FOR EDUCATION, NAMELY, MODEL BUILDING IN LIFE, PHYSICAL AND SOCIAL SCIENCES AND MATHEMATICS, AND MODEL BUILDING, SIMULATION AND BUSINESS ANALYZING AND PROBLEM SOLVING FOR USE IN THE FIELDS OF BUSINESS ADMINISTRATION, MANAGEMENT, MANUFACTURING, RESEARCH AND DEVELOPMENT, RETAIL/WHOLESALE, MARKETING/SALES, ENGINEERING, REENGINEERING, TOTAL QUALITY MANAGEMENT, TOTAL QUALITY ASSURANCE, PROCESS ANALYSIS AND IMPROVEMENT, FINANCIAL ANALYSIS, STRATEGIC BUSINESS PLANNING, HUMAN RESOURCES, TRANSPORTATION, ORGANIZATIONAL DEVELOPMENT, CONSULTING AND BUSINESS FORECASTING; MICROCOMPUTER PROGRAMS AND PROGRAM MANUALS ALL SOLD AS A UNIT FOR USE IN THE FIELDS OF BUSINESS AND EDUCATION (U.S. CLS. 21, 23, 26, 36 AND 38).

CLASS 41—EDUCATION AND ENTERTAINMENT

FOR TRAINING AND EDUCATION SERVICES, NAMELY, PROVIDING WORKSHOPS AND SEMINARS DESIGNED TO EQUIP BUSINESSES AND EDUCATORS WITH A FRAMEWORK, LANGUAGE, METHOD AND TOOLS FOR IMPROVING THE PERFORMANCE OF A BUSINESS ORGANIZATION AND LEARNING EXPERIENCE OF TEACHERS/STUDENTS (U.S. CLS. 100, 101 AND 107).

HENRY S. ZAK, EXAMINING ATTORNEY

SN 76-580,055. M G K GROUP INC., NEW YORK, NY. FILED 3-9-2004.

MONTIQUE

THE MARK CONSISTS OF STANDARD CHARACTERS WITHOUT CLAIM TO ANY PARTICULAR FONT, STYLE, SIZE, OR COLOR.

CLASS 18—LEATHER GOODS

FOR HANDBAGS, TOTE BAGS, COSMETIC CASES SOLD EMPTY, UMBRELLAS (U.S. CLS. 1, 2, 3, 22 AND 41).
FIRST USE 12-0-2004; IN COMMERCE 12-0-2004.

CLASS 21—HOUSEWARES AND GLASS

FOR BOWLS AND COASTERS, NOT OF PAPER AND NOT BEING OF LINEN (U.S. CLS. 2, 13, 23, 29, 30, 33, 40 AND 50).
FIRST USE 12-0-2004; IN COMMERCE 12-0-2004.

CLASS 24—FABRICS

FOR PLACEMATS NOT BEING PAPER AND NOT BEING TABLE LINEN (U.S. CLS. 42 AND 50).
FIRST USE 12-0-2004; IN COMMERCE 12-0-2004.
CHRISIE B. KING, EXAMINING ATTORNEY

SN 76-580,924. SUSANNE COUSINS, LOS ANGELES, CA.
FILED 3-15-2004.

SUSS

SEC. 2(F).

CLASS 23—YARNS AND THREADS

FOR YARNS FOR KNITTING (U.S. CL. 43).
FIRST USE 3-0-1995; IN COMMERCE 3-0-1995.

CLASS 35—ADVERTISING AND BUSINESS

FOR RETAIL STORES AND ONLINE RETAIL SERVICES FEATURING KNITTING MERCHANDISE (U.S. CLS. 100, 101 AND 102).
FIRST USE 3-0-1995; IN COMMERCE 3-0-1995.
SAMUEL E. SHARPER JR., EXAMINING ATTORNEY

SN 76-581,317. SHERWOOD EQUITIES, INC., NEW YORK, NY. FILED 1-26-2004.

SHERWOOD EQUITIES

THE MARK CONSISTS OF STANDARD CHARACTERS WITHOUT CLAIM TO ANY PARTICULAR FONT, STYLE, SIZE, OR COLOR.
NO CLAIM IS MADE TO THE EXCLUSIVE RIGHT TO USE EQUITIES, APART FROM THE MARK AS SHOWN.

CLASS 36—INSURANCE AND FINANCIAL

FOR REAL ESTATE MANAGEMENT, LEASING OF REAL ESTATE, REAL ESTATE PROCUREMENT FOR OTHERS; REAL ESTATE BROKERAGE (U.S. CLS. 100, 101 AND 102).
FIRST USE 7-25-1972; IN COMMERCE 7-25-1972.

CLASS 37—CONSTRUCTION AND REPAIR

FOR REAL ESTATE DEVELOPMENT (U.S. CLS. 100, 103 AND 106).
FIRST USE 7-25-1972; IN COMMERCE 7-25-1972.
STACY WAHLBERG, EXAMINING ATTORNEY

SN 76-581,852. ODOM'S TENNESSEE PRIDE SAUSAGE, INC., MADISON, TN. FILED 3-18-2004.

TENNESSEE PRIDE

OWNER OF U.S. REG. NOS. 887,577, 2,653,431 AND OTHERS.
SEC. 2(F) TENNESSEE.

CLASS 29—MEATS AND PROCESSED FOODS

FOR FRESH SAUSAGE ROLLS, LINKS AND PATTIES; FRESH SOUSE; FULLY COOKED SAUSAGE LINKS AND PATTIES; SAUSAGE BALL APPETIZERS (U.S. CL. 46).
FIRST USE 0-0-1943; IN COMMERCE 0-0-1943.

CLASS 30—STAPLE FOODS

FOR FROZEN BREAKFAST SANDWICHES; FROZEN APPETIZERS, NAMELY, SAUSAGE HOT DOG SANDWICHES, WRAPS AND SWIRLS; AND GRAVY (U.S. CL. 46).
FIRST USE 0-0-1943; IN COMMERCE 0-0-1943.
WILLIAM BRECKENFELD, EXAMINING ATTORNEY

SN 76-582,205. NUT HUT, THE, CARLSBAD, CA. FILED 3-18-2004.

OLD WORLD TREATS

THE MARK CONSISTS OF STANDARD CHARACTERS WITHOUT CLAIM TO ANY PARTICULAR FONT, STYLE, SIZE, OR COLOR.
NO CLAIM IS MADE TO THE EXCLUSIVE RIGHT TO USE "TREATS", APART FROM THE MARK AS SHOWN.

CLASS 29—MEATS AND PROCESSED FOODS

FOR CANDIED NUTS; SNACK MIX CONSISTING PRIMARILY OF PROCESSED NUTS (U.S. CL. 46).
FIRST USE 12-1-2001; IN COMMERCE 12-1-2001.

CLASS 30—STAPLE FOODS

FOR CHOCOLATE COVERED NUTS; SNACK MIX CONSISTING PRIMARILY OF CANDIED NUTS (U.S. CL. 46).
FIRST USE 12-1-2001; IN COMMERCE 12-1-2001.
DAVID ELTON, EXAMINING ATTORNEY

SN 76-582,289. PDI-PHARMA (INTERNATIONAL), INC., RICHMOND HILL, ONTARIO, CANADA, FILED 3-18-2004.

PDI

THE MARK CONSISTS OF STANDARD CHARACTERS WITHOUT CLAIM TO ANY PARTICULAR FONT, STYLE, SIZE, OR COLOR.

CLASS 35—ADVERTISING AND BUSINESS

FOR BUSINESS PLANNING, BUSINESS CONSULTATION, AND BUSINESS MANAGEMENT FOR THE PHARMACEUTICAL INDUSTRY, BUSINESS LIAISON SERVICES, NAMELY ACTING AS A LIAISON BETWEEN THE PHARMACEUTICAL INDUSTRY AND REGULATORY AGENCIES (U.S. CLS. 100, 101 AND 102).
FIRST USE 8-28-2000; IN COMMERCE 8-28-2000.

CLASS 42—SCIENTIFIC, COMPUTER AND LEGAL SERVICES

FOR REVIEWING STANDARDS AND PRACTICES TO ASSURE COMPLIANCE WITH PHARMACEUTICAL LAWS AND REGULATIONS; PREPARING PHARMACEUTICAL COMPLIANCE REPORTS FOR THE PHARMACEUTICAL INDUSTRY (U.S. CLS. 100 AND 101).

FIRST USE 8-28-2000; IN COMMERCE 8-28-2000.
LEIGH CAROLINE CASE, EXAMINING ATTORNEY

SN 76-582,915. FRESH INTELLECTUAL PROPERTIES, INC., WILMINGTON, DE. FILED 3-15-2004.

FLOWER COUNTRY

THE MARK CONSISTS OF STANDARD CHARACTERS WITHOUT CLAIM TO ANY PARTICULAR FONT, STYLE, SIZE, OR COLOR.

OWNER OF U.S. REG. NO. 2,402,317.

NO CLAIM IS MADE TO THE EXCLUSIVE RIGHT TO USE FLOWER, APART FROM THE MARK AS SHOWN.

CLASS 31—NATURAL AGRICULTURAL PRODUCTS

FOR FRESH CUT AND DRIED FLOWERS, FLORAL BOUQUETS AND ARRANGEMENTS, LIVE FLOWER WREATHS, LIVING PLANTS, AND LIVE TREES (U.S. CLS. 1 AND 46).

CLASS 35—ADVERTISING AND BUSINESS

FOR RETAIL STORE SERVICES, MAIL ORDER AND CATALOG SERVICES, TELEPHONE-, INTERACTIVE TELEVISION-, AND ONLINE-ACCESSED RETAIL STORE SERVICES FEATURING ARTIFICIAL, FRESH CUT AND DRIED FLOWERS, FLORAL BOUQUETS AND ARRANGEMENTS, PLANTS, TREES, GIFTS, GIFT BASKETS, GOURMET FOODS, POPCORN, PRODUCE, CANDY, CHOCOLATE, BAKERY ITEMS, HOME FURNISHINGS, HOME DECORATING ITEMS AND ACCESSORIES, KITCHENWARE AND ACCESSORIES, COLLECTIBLES, STATIONARY ITEMS AND ACCESSORIES, AROMATHERAPY GIFT BASKETS, CANDLES AND CANDLE ACCESSORIES, JEWELRY, WATCHES, GAMES, TOYS, PLUSH TOYS AND ANIMALS, BOOKS, PRERECORDED AUDIO AND VIDEO TAPES, CASSETTES AND DISKS, PICTURE FRAMES, PHOTO ALBUMS AND GENERAL MERCHANDISE (U.S. CLS. 100, 101 AND 102).

TRACY CROSS, EXAMINING ATTORNEY

SN 76-583,181. METRO INDUSTRIES, INC., WILKES-BARRE, PA. FILED 3-23-2004.

WE PUT LAB SPACE TO WORK

THE MARK CONSISTS OF STANDARD CHARACTERS WITHOUT CLAIM TO ANY PARTICULAR FONT, STYLE, SIZE, OR COLOR.

OWNER OF U.S. REG. NO. 1,810,054.

CLASS 12—VEHICLES

FOR NON-MOTORIZED LAB CARTS (U.S. CLS. 19, 21, 23, 31, 35 AND 44).

FIRST USE 8-0-2003; IN COMMERCE 8-0-2003.

CLASS 20—FURNITURE AND ARTICLES NOT OTHERWISE CLASSIFIED

FOR SHELVES, SHELVING SYSTEMS AND PARTS THEREFOR; CABINETS AND FURNITURE (U.S. CLS. 2, 13, 22, 25, 32 AND 50).

FIRST USE 8-0-2003; IN COMMERCE 8-0-2003.
MONTIA G. PRESSEY, EXAMINING ATTORNEY

SN 76-583,645. DAIMLERCHRYSLER AG, 70567 STUTTGART, FED REP GERMANY, FILED 3-29-2004.

C 63

THE MARK CONSISTS OF STANDARD CHARACTERS WITHOUT CLAIM TO ANY PARTICULAR FONT, STYLE, SIZE, OR COLOR.

PRIORITY CLAIMED UNDER SEC. 44(D) ON FED REP GERMANY APPLICATION NO. 30365840.1/1. FILED 12-11-2003, REG. NO. 30365840, DATED 2-9-2004, EXPIRES 2-28-2014.

NO CLAIM IS MADE TO THE EXCLUSIVE RIGHT TO USE "63", APART FROM THE MARK AS SHOWN.

CLASS 12—VEHICLES

FOR AUTOMOBILES AND STRUCTURAL PARTS THEREFOR (U.S. CLS. 19, 21, 23, 31, 35 AND 44).

CLASS 28—TOYS AND SPORTING GOODS

FOR TOY MODEL MOTOR VEHICLES (U.S. CLS. 22, 23, 38 AND 50).

JOSETTE BEVERLY, EXAMINING ATTORNEY

SN 76-583,751. A CHEERFUL GIVER, INC., ELMER, NJ. FILED 3-29-2004.



OWNER OF U.S. REG. NO. 2,156,264.

NO CLAIM IS MADE TO THE EXCLUSIVE RIGHT TO USE PSALM 103, APART FROM THE MARK AS SHOWN. THE STIPPLING IS A FEATURE OF THE MARK.

CLASS 4—LUBRICANTS AND FUELS

FOR CANDLES (U.S. CLS. 1, 6 AND 15).

FIRST USE 5-5-1995; IN COMMERCE 5-5-1995.

CLASS 16—PAPER GOODS AND PRINTED MATTER

FOR NOTE CARDS AND STATIONERY (U.S. CLS. 2, 5, 22, 23, 29, 37, 38 AND 50).
FIRST USE 5-5-1995; IN COMMERCE 5-5-1995.
KAREN K. BUSH, EXAMINING ATTORNEY

SN 76-584,072. TV GUIDE MAGAZINE GROUP, INC., LOS ANGELES, CA. FILED 3-30-2004.

I-GUIDE

THE MARK CONSISTS OF STANDARD CHARACTERS WITHOUT CLAIM TO ANY PARTICULAR FONT, STYLE, SIZE, OR COLOR.
OWNER OF U.S. REG. NOS. 650,942, 2,833,591 AND OTHERS.

CLASS 35—ADVERTISING AND BUSINESS

FOR ADVERTISING SERVICES, NAMELY, PROMOTING THE GOODS AND SERVICES OF OTHERS BY PREPARING AND PLACING INFORMATIONAL AND PROMOTIONAL ADVERTISEMENTS VIA BROADCAST, CABLE, SATELLITE AND ON-LINE ELECTRONIC COMMUNICATIONS NETWORKS (U.S. CLS. 100, 101 AND 102).

CLASS 38—COMMUNICATION

FOR COMMUNICATIONS SERVICES, NAMELY, THE TRANSMISSION AND DELIVERY OF PROMOTIONAL, INFORMATIONAL, AND INTERACTIVE TELEVISION PROGRAMMING SERVICES VIA BROADCAST, CABLE, SATELLITE AND ON-LINE ELECTRONIC COMMUNICATIONS NETWORKS (U.S. CLS. 100, 101 AND 104).

CLASS 41—EDUCATION AND ENTERTAINMENT

FOR ENTERTAINMENT SERVICES, NAMELY, THE PRODUCTION AND DISTRIBUTION OF PROMOTIONAL, INFORMATIONAL, AND INTERACTIVE TELEVISION PROGRAMMING SERVICES VIA BROADCAST, CABLE, SATELLITE AND ON-LINE ELECTRONIC COMMUNICATIONS NETWORKS (U.S. CLS. 100, 101 AND 107).

MARGERY A. TIERNEY, EXAMINING ATTORNEY

SN 76-584,330. WEDDINGCHANNEL.COM, INC., LOS ANGELES, CA. FILED 4-1-2004.

WEDDINGBELLS STYLE

THE MARK CONSISTS OF STANDARD CHARACTERS WITHOUT CLAIM TO ANY PARTICULAR FONT, STYLE, SIZE, OR COLOR.

CLASS 16—PAPER GOODS AND PRINTED MATTER

FOR PUBLICATIONS, NAMELY, BOOKS, MAGAZINES, AND NEWSLETTERS IN THE FIELDS OF WEDDINGS AND WEDDING PLANNING (U.S. CLS. 2, 5, 22, 23, 29, 37, 38 AND 50).

CLASS 41—EDUCATION AND ENTERTAINMENT

FOR ONLINE PUBLICATIONS, NAMELY, ONLINE BOOKS, MAGAZINES, AND NEWSLETTERS IN THE FIELDS OF WEDDINGS AND WEDDING PLANNING; ONLINE COMPUTER SERVICES, NAMELY, PROVIDING INFORMATION IN THE FIELDS OF WEDDINGS AND WEDDING PLANNING VIA THE INTERNET (U.S. CLS. 100, 101 AND 107).
RUSS HERMAN, EXAMINING ATTORNEY

SN 76-584,569. WEBLOYALTY.COM, INC., NORWALK, CT. FILED 4-2-2004.

WEBLOYALTY

THE MARK CONSISTS OF STANDARD CHARACTERS WITHOUT CLAIM TO ANY PARTICULAR FONT, STYLE, SIZE, OR COLOR.

CLASS 35—ADVERTISING AND BUSINESS

FOR CONSULTING SERVICES IN THE FIELD OF ADVERTISING AND MARKETING, NAMELY ADVERTISING AND MARKETING ANALYSIS FOR OTHERS VIA GLOBAL COMPUTER NETWORK FOR ENHANCING THE POTENTIAL FOR WEB SITE TRAFFIC, FUTURE SALES, REGISTRATIONS, DOWNLOADS, REPORT VISITS AND REPEAT SALES; PROMOTING THE GOODS AND SERVICES OF OTHERS BY MEANS OF A PREFERRED CUSTOMER PROGRAM, ADVERTISING THE GOODS AND SERVICES OF OTHERS THROUGH DISCOUNTS PROVIDED ON SHOPPING, DINING, AMUSEMENT ATTRACTION TICKETS, MOVIE TICKETS, HOTEL RESERVATIONS, VACATION CONDOMINIUMS, CAR RENTALS, AIRLINE TICKETS SOLD THROUGH THE INTERNET AND DIRECT SALES METHODS; MONITORING CONSUMER CREDIT REPORTS AND PROVIDING AN ALERT AS TO ANY CHANGES THEREIN (U.S. CLS. 100, 101 AND 102).
FIRST USE 1-2-2004; IN COMMERCE 1-2-2004.

CLASS 36—INSURANCE AND FINANCIAL

FOR GUARANTEED DELIVERY SERVICES OF OTHERS, NAMELY, INSURANCE UNDERWRITING IN THE FIELD OF THEFT AND LOSS OF DELIVERY PACKAGES (U.S. CLS. 100, 101 AND 102).
FIRST USE 1-2-2004; IN COMMERCE 1-2-2004.

CLASS 37—CONSTRUCTION AND REPAIR

FOR EMERGENCY ROADSIDE SERVICES (U.S. CLS. 100, 103 AND 106).
FIRST USE 1-2-2004; IN COMMERCE 1-2-2004.

CLASS 45—PERSONAL SERVICES

FOR FRAUD DETECTION SERVICES IN THE FIELD OF CREDIT CARD TRANSACTIONS (U.S. CLS. 100 AND 101).
FIRST USE 1-2-2004; IN COMMERCE 1-2-2004.
MARK SPARACINO, EXAMINING ATTORNEY

SN 76-584,711. MANGILAO GOLF CLUB, MANGILAO, GUAM, FILED 4-5-2004.

MANGILAO GOLF CLUB

THE MARK CONSISTS OF STANDARD CHARACTERS WITHOUT CLAIM TO ANY PARTICULAR FONT, STYLE, SIZE, OR COLOR.

OWNER OF U.S. REG. NOS. 1,846,739, 1,847,105 AND OTHERS.

NO CLAIM IS MADE TO THE EXCLUSIVE RIGHT TO USE "GOLF CLUB", APART FROM THE MARK AS SHOWN.

SEC. 2(F).

CLASS 35—ADVERTISING AND BUSINESS

FOR RETAIL STORE SERVICES FEATURING CLOTHING AND GOLF EQUIPMENT AND SUPPLIES (U.S. CLS. 100, 101 AND 102).

FIRST USE 4-26-1992; IN COMMERCE 4-26-1992.

CLASS 41—EDUCATION AND ENTERTAINMENT

FOR GOLF CLUB SERVICES (U.S. CLS. 100, 101 AND 107).

FIRST USE 4-26-1992; IN COMMERCE 4-26-1992.

CLASS 43—HOTEL AND RESTAURANT SERVICES

FOR RESTAURANT SERVICES (U.S. CLS. 100 AND 101).

FIRST USE 4-26-1992; IN COMMERCE 4-26-1992.

STEVEN JACKSON, EXAMINING ATTORNEY

SN 76-584,964. SMART DOCUMENT SOLUTIONS, LLC, ALPHARETTA, GA. FILED 4-2-2004.

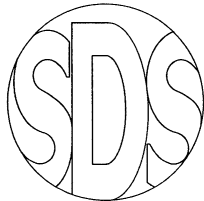

**SMART DOCUMENT
SOLUTIONS**

NO CLAIM IS MADE TO THE EXCLUSIVE RIGHT TO USE "DOCUMENT SOLUTIONS", APART FROM THE MARK AS SHOWN.

CLASS 9—ELECTRICAL AND SCIENTIFIC APPARATUS

FOR COMPUTER SOFTWARE FOR USE IN CONNECTION WITH— ELECTRONIC DOCUMENT STORAGE AND MANAGEMENT, ELECTRONIC TRACKING OF RELEASE OF INFORMATION REQUESTS, PROVIDING NOTIFICATION TO INFORMATION REQUESTORS REGARDING STATUS OF DOCUMENT REQUESTS, SCANNING AND TRANSMISSION OF DOCUMENTS ELECTRONICALLY, ACCOUNTING TO PATIENTS CONCERNING DISCLOSURE OF THEIR HEALTH INFORMATION (U.S. CLS. 21, 23, 26, 36 AND 38).

FIRST USE 10-18-2003; IN COMMERCE 10-18-2003.

CLASS 35—ADVERTISING AND BUSINESS

FOR RECORDS MANAGEMENT SERVICES, NAMELY, PROVIDING REPRODUCTION, MANAGEMENT, INDEXING AND RETRIEVAL OF DOCUMENTS VIA AN ELECTRONIC DOCUMENT SYSTEM FOR OTHERS; INFORMATION MANAGEMENT SERVICES, NAMELY TRACKING DOCUMENTS OVER COMPUTER NETWORKS FOR OTHERS; MANAGEMENT OF PHYSICAL DOCUMENTS FOR OTHERS, NAMELY, ARRANGING FOR PICKUP, DELIVERY, STORAGE, AND TRANSPORTATION OF PHYSICAL DOCUMENTS VIA GROUND AND AIR CARRIERS (U.S. CLS. 100, 101 AND 102).

FIRST USE 10-18-2003; IN COMMERCE 10-18-2003.

CLASS 38—COMMUNICATION

FOR ELECTRONIC DOCUMENT DELIVERY SERVICES (U.S. CLS. 100, 101 AND 104).

FIRST USE 10-18-2003; IN COMMERCE 10-18-2003.

CLASS 39—TRANSPORTATION AND STORAGE

FOR ELECTRONIC DOCUMENT STORAGE SERVICES ALLOWING ELECTRONIC RETRIEVAL BY OTHERS; TRANSPORTATION AND DELIVERY OF PHYSICAL DOCUMENTS FOR OTHERS (U.S. CLS. 100 AND 105).

FIRST USE 10-18-2003; IN COMMERCE 10-18-2003.

CLASS 40—MATERIAL TREATMENT

FOR DOCUMENT DATA TRANSFER AND PHYSICAL CONVERSION SERVICES FROM ONE MEDIUM TO ANOTHER (U.S. CLS. 100, 103 AND 106).

FIRST USE 10-18-2003; IN COMMERCE 10-18-2003.

CLASS 42—SCIENTIFIC, COMPUTER AND LEGAL SERVICES

FOR PROVIDING TEMPORARY USE OF NON-DOWNLOADABLE COMPUTER SOFTWARE FOR TRACKING RECORDS AND DOCUMENTS OVER COMPUTER NETWORKS, INTRANETS AND THE INTERNET (U.S. CLS. 100 AND 101).

FIRST USE 10-18-2003; IN COMMERCE 10-18-2003.

JENNIFER CHICOSKI, EXAMINING ATTORNEY

SN 76-585,029. RETTER, DANIEL, NEW YORK, NY. FILED 4-5-2004.

JUST GRATITUDE NOT ATTITUDE

THE MARK CONSISTS OF STANDARD CHARACTERS WITHOUT CLAIM TO ANY PARTICULAR FONT, STYLE, SIZE, OR COLOR.

CLASS 35—ADVERTISING AND BUSINESS

FOR TRAVEL MANAGEMENT; INSURANCE CLAIMS AUDITING SERVICES (U.S. CLS. 100, 101 AND 102).

CLASS 36—INSURANCE AND FINANCIAL

FOR INSURANCE BROKERAGE SERVICES, NAMELY, PROVIDING HOMEOWNERS, LIFE, AUTOMOBILE, DENTAL AND HEALTH INSURANCE; FINANCING SERVICES; BANKING; INVESTMENT BANKING SERVICES; MONEY LENDING (U.S. CLS. 100, 101 AND 102).

CLASS 39—TRANSPORTATION AND STORAGE

FOR TRANSPORTATION OF PASSENGERS AND/OR GOODS BY AUTOMOBILE, SHIP AND RAIL; AIRLINE TRANSPORTATION SERVICES (U.S. CLS. 100 AND 105).

CLASS 43—HOTEL AND RESTAURANT SERVICES

FOR PROVIDING TEMPORARY ACCOMMODATIONS; HOTELS; HOSTELS; HOTEL SERVICES; HOSTELRY SERVICES (U.S. CLS. 100 AND 101).
JAMES A. RAUEN, EXAMINING ATTORNEY

SN 76-585,592. MEDIA MIGRATION SERVICES, INC., BELLINGHAM, WA. FILED 4-5-2004.



NO CLAIM IS MADE TO THE EXCLUSIVE RIGHT TO USE "MEDIA MIGRATION SERVICES INC", APART FROM THE MARK AS SHOWN.

CLASS 39—TRANSPORTATION AND STORAGE

FOR DATA CENTER SERVICES MOVING SERVICES, NAMELY, THE PHYSICAL MOVEMENT OF HARDWARE AND DATA MEDIA SERVICING MIDRANGE SERVERS AND MAINFRAME OPERATIONS (U.S. CLS. 100 AND 105).

FIRST USE 6-1-2003; IN COMMERCE 6-1-2003.

CLASS 42—SCIENTIFIC, COMPUTER AND LEGAL SERVICES

FOR DATA CENTER SERVICES, NAMELY, THE NON-PHYSICAL CONVERSION OF MEDIA SERVICING MIDRANGE SERVERS AND MAINFRAME OPERATIONS (U.S. CLS. 100 AND 101).

FIRST USE 6-1-2003; IN COMMERCE 6-1-2003.
LESLEY LAMOTHE, EXAMINING ATTORNEY

SN 76-585,255. OUTOKUMPU OYJ, 02200 ESPOO, FINLAND, FILED 4-6-2004.

CIRCORED

THE MARK CONSISTS OF STANDARD CHARACTERS WITHOUT CLAIM TO ANY PARTICULAR FONT, STYLE, SIZE, OR COLOR.

CLASS 6—METAL GOODS

FOR DIRECTLY REDUCED IRON FOR USE IN GENERAL MANUFACTURING OF STEEL (U.S. CLS. 2, 12, 13, 14, 23, 25 AND 50).

CLASS 37—CONSTRUCTION AND REPAIR

FOR CONSTRUCTION OF INDUSTRIAL PLANTS (U.S. CLS. 100, 103 AND 106).

CLASS 42—SCIENTIFIC, COMPUTER AND LEGAL SERVICES

FOR ENGINEERING SERVICES, TECHNICAL CONSULTING IN THE FIELD OF ENGINEERING; ARCHITECTURAL DESIGN FOR OTHERS OF INDUSTRIAL PLANTS; DEVELOPMENT OF PROCESSES FOR THE REDUCTION OF FINE ORES, USING COAL PRIMARILY, ACCORDING TO THE CIRCULATING FLUIDIZED BED PRINCIPLE (U.S. CLS. 100 AND 101).
STEVEN JACKSON, EXAMINING ATTORNEY

SN 76-585,703. COOK, KYLE, DALLAS, TX. FILED 4-7-2004.

THE NEW LEFT

THE MARK CONSISTS OF STANDARD CHARACTERS WITHOUT CLAIM TO ANY PARTICULAR FONT, STYLE, SIZE, OR COLOR.

CLASS 9—ELECTRICAL AND SCIENTIFIC APPARATUS

FOR MUSICAL SOUND RECORDINGS AND MUSICAL VIDEO RECORDINGS (U.S. CLS. 21, 23, 26, 36 AND 38).

FIRST USE 1-1-2000; IN COMMERCE 1-1-2000.

CLASS 25—CLOTHING

FOR T-SHIRTS; HATS (U.S. CLS. 22 AND 39).
FIRST USE 1-1-2000; IN COMMERCE 1-1-2000.
VIVIAN MICZNIK FIRST, EXAMINING ATTORNEY

SN 76-585,776. BOARD OF REGENTS OF THE UNIVERSITY OF OKLAHOMA, THE, NORMAN, OK. FILED 4-8-2004.

SN 76-585,867. PLANTER TECHNOLOGY, INC., MORGAN HILL, CA. FILED 4-7-2004.

GROWING UP STRONG

CLASS 16—PAPER GOODS AND PRINTED MATTER

FOR PRINTED INSTRUCTIONAL, EDUCATIONAL, AND TEACHING MANUALS AND MATERIALS FOR EARLY CHILDHOOD EDUCATIONAL FACILITIES (U.S. CLS. 2, 5, 22, 23, 29, 37, 38 AND 50).

FIRST USE 8-29-1986; IN COMMERCE 8-29-1986.

CLASS 28—TOYS AND SPORTING GOODS

FOR DOLLS (U.S. CLS. 22, 23, 38 AND 50).

FIRST USE 8-29-1986; IN COMMERCE 8-29-1986.

STANLEY I. OSBORNE, EXAMINING ATTORNEY

SN 76-585,820. PROSISA INTERNATIONAL LLC, 750-8^o ANDAR, SAO PAULO SP, BRAZIL, FILED 4-8-2004.

SMARTEPAD

THE MARK CONSISTS OF STANDARD CHARACTERS WITHOUT CLAIM TO ANY PARTICULAR FONT, STYLE, SIZE, OR COLOR.

CLASS 9—ELECTRICAL AND SCIENTIFIC APPARATUS

FOR COMPUTER HARDWARE AND SOFTWARE PROGRAMS FOR PROVIDING ACCESS TO A GLOBAL COMPUTER NETWORK, FEATURING POINT AND CLICK ACCESS TO AND CONTROL OF USER-CUSTOMIZED CONTENT, SUCH AS PROGRAMMABLE OR NONPROGRAMMABLE COMPUTER MOUSE OR COMPUTER PERIPHERAL DEVICE, NOT INCLUDING FOR USE IN CAPTURING HANDWRITTEN INFORMATION AND TRANSMITTING IT TO COMPUTER DEVICES SUCH AS PERSONAL DIGITAL ASSISTANTS (U.S. CLS. 21, 23, 26, 36 AND 38).

CLASS 35—ADVERTISING AND BUSINESS

FOR DISPLAYING AND DISSEMINATION OF ADVERTISEMENTS FOR OTHERS VIA A GLOBAL COMPUTER NETWORK OR THE INTERNET; PROMOTING THE GOODS AND SERVICES OF OTHERS BY PLACING ADVERTISEMENTS AND MARKETING MATERIALS FOR OTHERS IN ELECTRONIC PUBLICATIONS ACCESSED THROUGH A GLOBAL COMPUTER NETWORK OR THE INTERNET, BY PROVIDING HYPERTEXT LINKS TO WEB SITES OF OTHERS VIA A GLOBAL COMPUTER NETWORK OR THE INTERNET, BY PROVIDING A WEB SITE AT WHICH USERS CAN LINK TO ADVERTISER WEB PAGES VIA A GLOBAL COMPUTER NETWORK OR THE INTERNET (U.S. CLS. 100, 101 AND 102).

CHRISTOPHER ADKINS, EXAMINING ATTORNEY

TOURNESOL

THE ENGLISH TRANSLATION OF THE MARK "TOURNESOL" IS "SUNFLOWER".

CLASS 20—FURNITURE AND ARTICLES NOT OTHERWISE CLASSIFIED

FOR OUTDOOR SITE FINISHING NAMELY, BENCHES, TABLES, AND OTHER OUTDOOR FURNITURE (U.S. CLS. 2, 13, 22, 25, 32 AND 50).

CLASS 21—HOUSEWARES AND GLASS

FOR OUTDOOR SITE FINISHINGS NAMELY PLANTER, ASH CANS, AND TRASH CANS (U.S. CLS. 2, 13, 23, 29, 30, 33, 40 AND 50).

HENRY S. ZAK, EXAMINING ATTORNEY

SN 76-585,955. WITRON LOGISTIK + INFORMATIK GMBH, D-92711 PARKSTEIN, FED REP GERMANY, FILED 4-9-2004.

CPMS

THE MARK CONSISTS OF STANDARD CHARACTERS WITHOUT CLAIM TO ANY PARTICULAR FONT, STYLE, SIZE, OR COLOR.

OWNER OF FED REP GERMANY REG. NO. 39917928, DATED 6-21-1999, EXPIRES 3-31-2009.

CLASS 9—ELECTRICAL AND SCIENTIFIC APPARATUS

FOR COMPUTER SOFTWARE IN THE FIELD OF BUSINESS MANAGEMENT SYSTEMS, NAMELY, SOFTWARE FOR INTEGRATING THE PLANNING, MANUFACTURING, SALES AND MARKETING FACETS OF A BUSINESS ENTERPRISE, FOR USE IN THE CORRUGATED PACKAGING INDUSTRY (U.S. CLS. 21, 23, 26, 36 AND 38).

FIRST USE 5-0-1999; IN COMMERCE 5-0-1999.

CLASS 35—ADVERTISING AND BUSINESS

FOR BUSINESS MANAGEMENT CONSULTATION, NAMELY, CONSULTATION ON RUNNING AN ELECTRONIC DATA PROCESSING BUSINESS; COLLECTING AND PROCESSING DATA FOR OTHERS (U.S. CLS. 100, 101 AND 102).

FIRST USE 5-0-1999; IN COMMERCE 5-0-1999.

CLASS 42—SCIENTIFIC, COMPUTER AND LEGAL SERVICES

FOR COMPUTER SOFTWARE DEVELOPMENT, MAINTENANCE, AND UPDATING FOR OTHERS INCLUDING THAT OF PROGRAMS FOR ELECTRONIC DATA PROCESSING AND DATABASES; TECHNICAL CONSULTATION IN THE FIELD OF CORRUGATED PACKAGING; ENGINEERING SERVICES IN THE FIELD OF ELECTRONIC DATA PROCESSING (U.S. CLS. 100 AND 101).

FIRST USE 5-0-1999; IN COMMERCE 5-0-1999.
CAROLINE WOOD, EXAMINING ATTORNEY

CLASS 44—MEDICAL, BEAUTY AND AGRICULTURAL SERVICES

FOR VERBAL THERAPY AND COUNSELING SERVICES IN THE FIELDS OF SPIRITUAL, MENTAL AND EMOTIONAL HEALTH, NAMELY COUNSELING FOR ANXIETY, DEPRESSION, GRIEF, TRAUMA AND MARITAL PROBLEMS, AND LIFE TRANSITION COUNSELING INCLUDING MARRIAGE, FAMILY AND CAREER ISSUES (U.S. CLS. 100 AND 101).

JOHN DALIER, EXAMINING ATTORNEY

SN 76-586,163. AMERICAN AUTO ACCESSORIES INCORPORATION, CORONA, NY. FILED 4-12-2004.

NETAMI

THE MARK CONSISTS OF STANDARD CHARACTERS WITHOUT CLAIM TO ANY PARTICULAR FONT, STYLE, SIZE, OR COLOR.

CLASS 7—MACHINERY

FOR AUTOMOBILE MUFFLERS. (U.S. CLS. 13, 19, 21, 23, 31, 34 AND 35).

CLASS 12—VEHICLES

FOR AUTOMOBILE PARTS AND ACCESSORIES, NAMELY, CAR SEATS AND SUSPENSION SYSTEMS (U.S. CLS. 19, 21, 23, 31, 35 AND 44).

SCOTT OSICK, EXAMINING ATTORNEY

SN 76-586,370. STERRY, PATRICIA, CHELTENHAM, GLOUCESTERSHIRE, GL50 4AF, UNITED KINGDOM, FILED 4-7-2004.

BLOCK CLEARANCE

THE MARK CONSISTS OF STANDARD CHARACTERS WITHOUT CLAIM TO ANY PARTICULAR FONT, STYLE, SIZE, OR COLOR.

PRIORITY CLAIMED UNDER SEC. 44(D) ON UNITED KINGDOM APPLICATION NO. 2345786, FILED 10-13-2003, REG. NO. 2345786, DATED 7-9-2004, EXPIRES 10-13-2013.

CLASS 41—EDUCATION AND ENTERTAINMENT

FOR EDUCATIONAL SERVICES, NAMELY CONDUCTING CLASSES, SEMINARS, CONFERENCES, WORKSHOPS AND DISTANCE LEARNING PROGRAMS, AND DISTRIBUTING COURSE MATERIALS IN CONNECTION WITH SUCH EDUCATIONAL SERVICES, ALL IN THE FIELD OF VERBAL THERAPY AND COUNSELING SERVICES RELATED TO SPIRITUAL, MENTAL AND EMOTIONAL HEALTH (U.S. CLS. 100, 101 AND 107).

SN 76-586,519. GENTLE GIANT STUDIOS, INC., BURBANK, CA. FILED 4-12-2004.

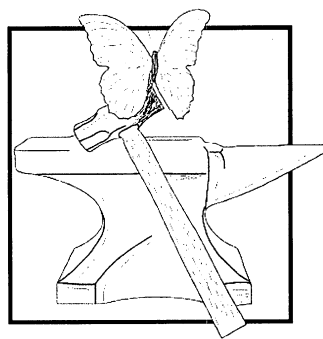

THE STIPPLING IS A FEATURE OF THE MARK.
THE MARK CONSISTS OF A BUTTERFLY, HAMMER AND ANVIL IN STYLIZED FORM.

CLASS 6—METAL GOODS

FOR COLLECTIBLE STATUES, MINI-BUSTS AND FIGURINES MADE OF COMMON METAL (U.S. CLS. 2, 12, 13, 14, 23, 25 AND 50).

FIRST USE 6-30-2002; IN COMMERCE 6-30-2002.

CLASS 14—JEWELRY

FOR COLLECTIBLE STATUES, MINI-BUSTS AND FIGURINES MADE OF PRECIOUS METAL (U.S. CLS. 2, 27, 28 AND 50).

FIRST USE 6-30-2002; IN COMMERCE 6-30-2002.

CLASS 20—FURNITURE AND ARTICLES NOT OTHERWISE CLASSIFIED

FOR COLLECTIBLE STATUES, MINI-BUSTS AND FIGURINES MADE OF PLASTIC AND POLYSTONE (U.S. CLS. 2, 13, 22, 25, 32 AND 50).

FIRST USE 6-30-2002; IN COMMERCE 6-30-2002.

CLASS 28—TOYS AND SPORTING GOODS

FOR TOY FIGURINES (U.S. CLS. 22, 23, 38 AND 50).

FIRST USE 6-30-2002; IN COMMERCE 6-30-2002.

CLASS 40—MATERIAL TREATMENT

FOR PROTOTYPE FABRICATION OF NEW PRODUCTS FOR OTHERS IN THE FIELD OF THREE-DIMENSIONAL STATUES, MINI-BUSTS, FIGURINES AND OTHER THREE-DIMENSIONAL PRODUCTS INCORPORATING LICENSED ARTWORK; ELECTRONIC SCANNING OF THREE-DIMENSIONAL OBJECTS FOR OTHERS (U.S. CLS. 100, 103 AND 106).

FIRST USE 12-31-1996; IN COMMERCE 12-31-1996.

CLASS 42—SCIENTIFIC, COMPUTER AND LEGAL SERVICES

FOR DESIGN SERVICES FOR OTHERS IN THE FIELD OF THREE-DIMENSIONAL STATUES, MINI-BUSTS, FIGURINES AND OTHER THREE-DIMENSIONAL PRODUCTS (U.S. CLS. 100 AND 101).

FIRST USE 12-31-1996; IN COMMERCE 12-31-1996.
MATTHEW PAPPAS, EXAMINING ATTORNEY

SN 76-587,367. MASTER PAINTERS INSTITUTE, INC., BUMABY, BRITISH COLUMBIA V5C 3T6, CANADA, FILED 4-15-2004.

**CLASS 9—ELECTRICAL AND SCIENTIFIC APPARATUS**

FOR ELECTRONIC PUBLICATIONS PROVIDED IN CD-ROM FORMAT, NAMELY, BOOKS, MANUALS AND OTHER WRITTEN WORKS, NAMELY, HANDBOOKS, INFORMATION BULLETINS, PAMPHLETS AND LEAFLETS REGARDING PAINTING, WALL COVERING AND SPECIFICATION STANDARDS, RELATING TO PAINTING AND WALL COVERING (U.S. CLS. 21, 23, 26, 36 AND 38).

FIRST USE 2-0-1997; IN COMMERCE 2-0-1997.

CLASS 16—PAPER GOODS AND PRINTED MATTER

FOR BOOKS, MANUALS AND OTHER WRITTEN WORKS, NAMELY, HANDBOOKS, INFORMATION BULLETINS, PAMPHLETS, AND LEAFLETS REGARDING PAINTING, WALL COVERING AND SPECIFICATION STANDARDS RELATING TO PAINTING AND WALL COVERING (U.S. CLS. 2, 5, 22, 23, 29, 37, 38 AND 50).

FIRST USE 2-0-1997; IN COMMERCE 2-0-1997.

CLASS 41—EDUCATION AND ENTERTAINMENT

FOR EDUCATIONAL SERVICES, NAMELY CONDUCTING CLASSES, WORKSHOPS, SEMINARS AND CONFERENCES IN CONNECTION WITH PAINTING, WALL COVERING, AND SPECIFICATION STANDARDS RELATING TO PAINTING AND WALL COVERING (U.S. CLS. 100, 101 AND 107).

FIRST USE 2-0-1997; IN COMMERCE 2-0-1997.

RONALD MCMORROW, EXAMINING ATTORNEY

SN 76-586,520. GENTLE GIANT STUDIOS, INC., BURBANK, CA. FILED 4-12-2004.

GENTLE GIANT

THE MARK CONSISTS OF STANDARD CHARACTERS WITHOUT CLAIM TO ANY PARTICULAR FONT, STYLE, SIZE, OR COLOR.

CLASS 6—METAL GOODS

FOR COLLECTIBLE STATUES, MINI-BUSTS AND FIGURINES MADE OF COMMON METAL (U.S. CLS. 2, 12, 13, 14, 23, 25 AND 50).

FIRST USE 6-30-2002; IN COMMERCE 6-30-2002.

CLASS 14—JEWELRY

FOR COLLECTIBLE STATUES, MINI-BUSTS AND FIGURINES MADE OF PRECIOUS METAL (U.S. CLS. 2, 27, 28 AND 50).

FIRST USE 6-30-2002; IN COMMERCE 6-30-2002.

CLASS 20—FURNITURE AND ARTICLES NOT OTHERWISE CLASSIFIED

FOR COLLECTIBLE STATUES, MINI-BUSTS AND FIGURINES MADE OF PLASTIC AND POLYSTONE (U.S. CLS. 2, 13, 22, 25, 32 AND 50).

FIRST USE 6-30-2002; IN COMMERCE 6-30-2002.

CLASS 28—TOYS AND SPORTING GOODS

FOR TOY FIGURINES (U.S. CLS. 22, 23, 38 AND 50).
FIRST USE 6-30-2002; IN COMMERCE 6-30-2002.

CLASS 40—MATERIAL TREATMENT

FOR PROTOTYPE FABRICATION OF NEW PRODUCTS FOR OTHERS IN THE FIELD OF THREE-DIMENSIONAL STATUES, MINI-BUSTS, FIGURINES AND OTHER THREE-DIMENSIONAL PRODUCTS INCORPORATING LICENSED ARTWORK; ELECTRONIC SCANNING OF THREE-DIMENSIONAL OBJECTS FOR OTHERS (U.S. CLS. 100, 103 AND 106).

FIRST USE 12-31-1996; IN COMMERCE 12-31-1996.

CLASS 42—SCIENTIFIC, COMPUTER AND LEGAL SERVICES

FOR DESIGN SERVICES FOR OTHERS IN THE FIELD OF THREE-DIMENSIONAL STATUES, MINI-BUSTS, FIGURINES AND OTHER THREE-DIMENSIONAL PRODUCTS (U.S. CLS. 100 AND 101).

FIRST USE 12-31-1996; IN COMMERCE 12-31-1996.
MATTHEW PAPPAS, EXAMINING ATTORNEY

SN 76-587,563. BRIGGS & STRATTON POWER PRODUCTS GROUP, LLC, JEFFERSON, WI. FILED 4-20-2004.



NO CLAIM IS MADE TO THE EXCLUSIVE RIGHT TO USE "ALL WHEEL STEER", APART FROM THE MARK AS SHOWN.

CLASS 7—MACHINERY

FOR RIDING LAWNMOWERS (U.S. CLS. 13, 19, 21, 23, 31, 34 AND 35).
FIRST USE 4-1-2004; IN COMMERCE 4-1-2004.

SN 76-587,756. NYPRO INC., CLINTON, MA. FILED 4-21-2004.

CLASS 12—VEHICLES

FOR LAWN AND GARDEN TRACTORS (U.S. CLS. 19, 21, 23, 31, 35 AND 44).
FIRST USE 4-1-2004; IN COMMERCE 4-1-2004.
BARBARA BROWN, EXAMINING ATTORNEY

NYPROMOLD INC.

THE MARK CONSISTS OF STANDARD CHARACTERS WITHOUT CLAIM TO ANY PARTICULAR FONT, STYLE, SIZE, OR COLOR.

OWNER OF U.S. REG. NO. 1,960,337.

NO CLAIM IS MADE TO THE EXCLUSIVE RIGHT TO USE "INC.", APART FROM THE MARK AS SHOWN.

SN 76-587,723. PREMIUMWEAR, INC., MINNETONKA, MN. FILED 4-19-2004.

CLASS 6—METAL GOODS

FOR METAL MOLDS FOR MOLDING PLASTICS (U.S. CLS. 2, 12, 13, 14, 23, 25 AND 50).
FIRST USE 1-4-1988; IN COMMERCE 1-4-1988.

CLASS 40—MATERIAL TREATMENT

FOR CUSTOM MANUFACTURE OF MOLDS FOR USE IN INDUSTRY (U.S. CLS. 100, 103 AND 106).
FIRST USE 1-4-1988; IN COMMERCE 1-4-1988.
KATHERINE STOIDES, EXAMINING ATTORNEY

PAGE & TUTTLE

THE MARK CONSISTS OF STANDARD CHARACTERS WITHOUT CLAIM TO ANY PARTICULAR FONT, STYLE, SIZE, OR COLOR.

OWNER OF U.S. REG. NO. 2,208,753.

SN 76-587,757. NYPRO INC., CLINTON, MA. FILED 4-21-2004.

CLASS 18—LEATHER GOODS

FOR LUGGAGE AND TRAVEL BAGS FOR ALL PURPOSES, BACKPACKS (U.S. CLS. 1, 2, 3, 22 AND 41).
FIRST USE 1-31-2001; IN COMMERCE 1-31-2001.

CLASS 21—HOUSEWARES AND GLASS

FOR INSULATED COOLERS (U.S. CLS. 2, 13, 23, 29, 30, 33, 40 AND 50).
FIRST USE 1-31-2001; IN COMMERCE 1-31-2001.

CLASS 24—FABRICS

FOR BLANKETS OF WOOL AND FLEECE, GOLF TOWELS (U.S. CLS. 42 AND 50).
FIRST USE 1-31-2004; IN COMMERCE 1-31-2004.

CLASS 35—ADVERTISING AND BUSINESS

FOR ONLINE ORDERING AND MAILING ORDER CATALOG SERVICES FEATURING LUGGAGE, TRADITIONAL AND TRAVEL BAGS FOR ALL PURPOSES, BACKPACKS; INSULATED COOLERS, BLANKETS OF WOOL AND FLEECE, APPAREL, HATS, DOWN VESTS, GOLF TOWELS AND GOLF ACCESSORIES, GOLF HARDWARE (U.S. CLS. 100, 101 AND 102).
FIRST USE 1-31-2004; IN COMMERCE 1-31-2004.

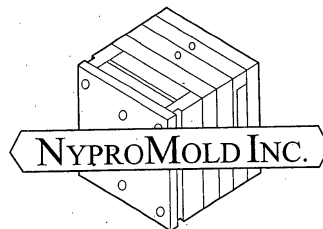

OWNER OF U.S. REG. NO. 1,960,337.

NO CLAIM IS MADE TO THE EXCLUSIVE RIGHT TO USE "INC.", APART FROM THE MARK AS SHOWN.

CLASS 6—METAL GOODS

FOR METAL MOLDS FOR MOLDING PLASTICS (U.S. CLS. 2, 12, 13, 14, 23, 25 AND 50).
FIRST USE 1-4-1988; IN COMMERCE 1-4-1988.

CLASS 40—MATERIAL TREATMENT

FOR PERSONALIZED EMBROIDERY SERVICES (U.S. CLS. 100, 103 AND 106).
FIRST USE 1-31-1998; IN COMMERCE 1-31-1998.
REGINA DRUMMOND, EXAMINING ATTORNEY

CLASS 40—MATERIAL TREATMENT

FOR CUSTOM MANUFACTURE OF MOLDS FOR USE IN INDUSTRY (U.S. CLS. 100, 103 AND 106).
FIRST USE 1-4-1988; IN COMMERCE 1-4-1988.
KATHERINE STOIDES, EXAMINING ATTORNEY

SN 76-588,035. NATURE VISION, INC., BRAINERD, MN. FILED 4-22-2004.

SN 76-588,560. GEOSAT SOLUTIONS, INC., HOLLYWOOD, FL. FILED 4-26-2004.

NATURE VISION, INC.

THE MARK CONSISTS OF STANDARD CHARACTERS WITHOUT CLAIM TO ANY PARTICULAR FONT, STYLE, SIZE, OR COLOR.

NO CLAIM IS MADE TO THE EXCLUSIVE RIGHT TO USE "VISION, INC.", APART FROM THE MARK AS SHOWN.

CLASS 9—ELECTRICAL AND SCIENTIFIC APPARATUS

FOR VIDEO VIEWING SYSTEMS COMPRISING A VIDEO CAMERA, MONITOR, BATTERY, CABLING AND ACCESSORIES THEREFORE, NAMELY CAMERA SUPPORTS, BATTERY CHARGERS, STEERING FINS, SCREEN MAGNIFIERS, BALLAST WEIGHTS AND CABLES; CAMERAS, NAMELY VIDEO CAMERAS, 35 MM CAMERAS AND PHOTOGRAPHIC CAMERAS; UNDERWATER VIDEO CAMERAS; VIDEO MONITORS; MOTORIZED VIDEO CAMERA CABLE CONTROLS; CAMERA BATTERIES; CAMERA SUPPORTS; AND CAMERA CASES (U.S. CLS. 21, 23, 26, 36 AND 38).
FIRST USE 2-5-1998; IN COMMERCE 2-5-1998.

CLASS 28—TOYS AND SPORTING GOODS

FOR FISHING RODS AND REELS (U.S. CLS. 22, 23, 38 AND 50).
FIRST USE 2-5-1998; IN COMMERCE 2-5-1998.
KARANENDRA S. CHHINA, EXAMINING ATTORNEY

SN 76-588,256. DIVEMAR INC., GREELY, ONTARIO, CANADA, FILED 4-22-2004.

DIVEX

THE MARK CONSISTS OF STANDARD CHARACTERS WITHOUT CLAIM TO ANY PARTICULAR FONT, STYLE, SIZE, OR COLOR.

PRIORITY CLAIMED UNDER SEC. 44(D) ON CANADA APPLICATION NO. 1212278, FILED 4-5-2004, REG. NO. TMA637,180, DATED 4-12-2005, EXPIRES 4-12-2020.

CLASS 9—ELECTRICAL AND SCIENTIFIC APPARATUS

FOR SNORKELING AND SCUBA MASKS, MASK STRAPS, DIVING REGULATORS, BUOYANCY COMPENSATORS, PRESSURE AND DEPTH GAUGES AND CAMERAS (U.S. CLS. 21, 23, 26, 36 AND 38).

CLASS 25—CLOTHING

FOR VESTS, WET SUITS, DRY SUITS, DRY SUIT UNDERWEAR AND SWIMWEAR (U.S. CLS. 22 AND 39).
DAVID ELTON, EXAMINING ATTORNEY

MADISON

THE MARK CONSISTS OF STANDARD CHARACTERS WITHOUT CLAIM TO ANY PARTICULAR FONT, STYLE, SIZE, OR COLOR.

CLASS 9—ELECTRICAL AND SCIENTIFIC APPARATUS

FOR DIRECT BROADCAST SATELLITE RECEPTION SYSTEMS COMPRISED PRIMARILY OF SATELLITE DISH ANTENNAS, SIGNAL FEED LINES, SATELLITE DIRECTION-FINDERS, SIGNAL STRENGTH METERS, AMPLIFIERS, DOWN-CONVERTERS, DEMODULATORS, RECEIVERS, BUT ALSO CONTAINING RELATED MOUNTING HARDWARE FOR TEMPORARY AND PERMANENT INSTALLATION; ASSET TRACKING DEVICES NAMELY GLOBAL POSITIONING SYSTEM (GPS) CONSISTING OF COMPUTERS, COMPUTER SOFTWARE, TRANSMITTERS, RECEIVERS, AND NETWORK INTERFACE DEVICES; NETWORK CONNECTOR, NAMELY MULTIPLE ANALOG DIGITAL INPUT SENSOR OUTPUT NETWORK INTERFACES (U.S. CLS. 21, 23, 26, 36 AND 38).
FIRST USE 10-10-2002; IN COMMERCE 10-10-2002.

CLASS 35—ADVERTISING AND BUSINESS

FOR MONITORING AND TRACKING SEA VESSELS AND THEIR GEOGRAPHIC LOCATIONS AT SEA AND WHILE BEING TRANSPORTED OVER LAND (U.S. CLS. 100, 101 AND 102).
FIRST USE 10-10-2002; IN COMMERCE 10-10-2002.
JOHN DALIER, EXAMINING ATTORNEY

SN 76-588,654. KABUSHIKI KAISHA SONY COMPUTER ENTERTAINMENT, TA SONY COMPUTER ENTERTAINMENT INC., TOKYO, 107-0062, JAPAN, FILED 4-23-2004.



OWNER OF JAPAN REG. NO. 4762588, DATED 4-9-2004, EXPIRES 4-9-2014.

CLASS 9—ELECTRICAL AND SCIENTIFIC APPARATUS

FOR CD PLAYERS; AUDIO-VIDEO COMPACT DISCS FEATURING MUSIC ENTERTAINMENT FILMS, ANIMATION AND COMPUTER GAMES; CONSUMER VIDEO GAME MACHINES ADAPTED FOR USE WITH TELEVISION RECEIVERS ONLY; CONTROLLERS, JOY-STICKS, MEMORY CARDS, VOLUME CONTROLLERS AND MICE FOR CONSUMER VIDEO GAME MACHINES ADAPTED FOR USE WITH TELEVISION RECEIVERS ONLY; DVD PLAYER; COMPUTER SOFTWARE FEATURING DOWNLOADABLE IMAGE AND CHARACTER DATA OF MAGAZINES, BOOKS, NEWSPAPERS, MAPS, PICTURES AND DRAWINGS; DOWNLOADABLE SOUND RECORDINGS FEATURING MUSIC; DOWNLOADABLE VIDEO RECORDINGS FEATURING IMAGES OF VIDEO GAMES; ELECTRONIC INTEGRATED CIRCUITS, CD-ROMS AND OTHER MEMORY MEDIUM RECORDED PROGRAMS, NAMELY COMPUTER GAME PROGRAMS, FOR HAND-HELD GAMES WITH LIQUID CRYSTAL DISPLAYS; ELECTRONIC PUBLICATIONS, NAMELY MANUALS FOR VIDEO GAMES AND MAGAZINES FOR VIDEO GAMES RECORDED ON COMPUTER MEDIA; COMPUTER PROGRAMS FOR ARCADE VIDEO GAME MACHINES; COMPUTER PROGRAMS FOR CONSUMER VIDEO GAMES; RECORDED DVD-ROM FEATURING MUSICAL ENTERTAINMENT FILMS, ANIMATION AND COMPUTER GAMES; RECORDED VIDEO DISCS AND TAPES FEATURING MUSICAL ENTERTAINMENT FILMS, ANIMATION AND COMPUTER GAMES; SOUND RECORDED MAGNETIC CARDS, SHEETS AND TAPES; SOUND RECORDED OPTICAL DISCS FEATURING MUSIC AND SPECIAL EFFECTS (U.S. CLS. 21, 23, 26, 36 AND 38).

CLASS 28—TOYS AND SPORTING GOODS

FOR HAND-HELD GAMES WITH LIQUID CRYSTAL DISPLAYS INCLUDING EXCLUSIVE EARPHONES CONNECTED AND USED FOR HAND-HELD GAMES WITH LIQUID CRYSTAL DISPLAYS AND OTHER ACCESSORIES; POCKET-SIZED ELECTRONIC GAMES, NAMELY HAND-HELD UNIT FOR PLAYING ELECTRONIC GAMES (U.S. CLS. 22, 23, 38 AND 50).

SUE LAWRENCE, EXAMINING ATTORNEY

SN 76-588,702. BLUEGRASS EQUINE PRODUCTS, INC., LEXINGTON, KY. FILED 4-26-2004.



NO CLAIM IS MADE TO THE EXCLUSIVE RIGHT TO USE "EQUINE PRODUCTS, INC.", APART FROM THE MARK AS SHOWN.

CLASS 5—PHARMACEUTICALS

FOR EQUINE PRODUCTS, NAMELY, FEED ADDITIVE FOR USE AS A NUTRITIONAL SUPPLEMENT (U.S. CLS. 6, 18, 44, 46, 51 AND 52).

FIRST USE 6-30-2002; IN COMMERCE 6-30-2002.

CLASS 18—LEATHER GOODS

FOR EQUINE PRODUCTS, NAMELY, EQUINE SLIPPERS (U.S. CLS. 1, 2, 3, 22 AND 41).

FIRST USE 7-16-1998; IN COMMERCE 7-16-1998.

DAVID MURRAY, EXAMINING ATTORNEY

SN 76-588,971. VERISIGN, INC., DULLES, VA. FILED 4-27-2004.

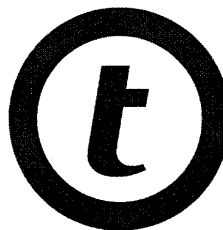
**CLASS 9—ELECTRICAL AND SCIENTIFIC APPARATUS**

FOR COMPUTER SOFTWARE IN THE FIELD OF CRYPTOGRAPHIC NETWORK SECURITY AND DATA SECURITY FUNCTIONS; COMPUTER SOFTWARE FOR INTEGRATION OF INFORMATION LOGIC AND DATA BETWEEN COMPUTER NETWORKS; COMPUTER SOFTWARE FOR AUTOMATING A PROCESS FOR AUTHENTICATION OF IDENTITY USING EXISTING DATABASES IN CONNECTION WITH THE ISSUANCE AND MANAGEMENT OF DIGITAL CERTIFICATES USED FOR AUTHENTICATION OR ENCRYPTION OF DIGITAL COMMUNICATIONS, OR AUTHENTICATION OF A DIGITAL SIGNATURE IN AN ELECTRONIC TRANSACTION OR COMMUNICATION, OVER THE INTERNET AND OTHER COMPUTER NETWORKS; COMPUTER SOFTWARE, NAMELY ENCRYPTION SOFTWARE TO ENABLE SECURE TRANSMISSION OF DIGITAL INFORMATION, NAMELY, CONFIDENTIAL, FINANCIAL AND CREDIT CARD INFORMATION OVER THE INTERNET AS WELL AS OVER OTHER MODES OF COMMUNICATION BETWEEN COMPUTING DEVICES; COMPUTER SOFTWARE TO INTEGRATE MANAGED SECURITY SERVICES, NAMELY PUBLIC KEY INFRASTRUCTURE (PKI) SERVICES, DIGITAL CERTIFICATE ISSUANCE, VERIFICATION, AND MANAGEMENT, AND ENTERPRISE SOFTWARE INTEGRATION, WITH EXISTING COMMUNICATIONS NETWORKS, SOFTWARE, AND SERVICES, DOWNLOADABLE ELECTRONIC PUBLICATIONS IN THE NATURE OF A NEWSLETTER IN THE FIELD OF INFORMATION TECHNOLOGY (U.S. CLS. 21, 23, 26, 36 AND 38).

CLASS 36—INSURANCE AND FINANCIAL

FOR FINANCIAL SERVICES, NAMELY PROVIDING FINANCIAL TRANSACTION PROCESSING SERVICES BY ELECTRONIC MEANS VIA THE INTERNET AND OTHER COMPUTER NETWORKS IN THE FIELD OF ELECTRONIC FUND TRANSFER AND PAYMENT PROCESSING SERVICES; FINANCIAL MANAGEMENT SERVICES FOR ELECTRONIC DELIVERY, PROCESSING AND TRANSFER OF FUNDS, PAYMENTS, FINANCIAL TRANSACTIONS AND FINANCIAL INFORMATION VIA THE INTERNET AND OTHER COMPUTER NETWORKS (U.S. CLS. 100, 101 AND 102).

CLASS 42—SCIENTIFIC, COMPUTER AND LEGAL SERVICES

FOR PROVIDING AUTHENTICATION OF IDENTITY; ISSUANCE AND MANAGEMENT OF DIGITAL CERTIFICATES FOR AUTHENTICATION OR ENCRYPTION OF A DIGITAL COMMUNICATION, OR AUTHENTICATION OF A DIGITAL SIGNATURE IN AN ELECTRONIC TRANSACTION OR COMMUNICATION, OVER THE INTERNET AND OTHER COMPUTER NETWORK AND PROVIDING TECHNICAL AND CUSTOMER SUPPORT IN CONNECTION THEREWITH; COMPUTER RELATED SERVICES, NAMELY, MANAGED COMPUTER NETWORK AND INTERNET SECURITY SERVICES, NAMELY, PUBLIC KEY INFRASTRUCTURE ("PKI") VERIFICATION, AUTHENTICATION, DISTRIBUTION AND MANAGEMENT, DIGITAL CERTIFICATE ISSUANCE, VERIFICATION AND MANAGEMENT, AND ENTERPRISE SOFTWARE INTEGRATION (U.S. CLS. 100 AND 101).

KEVON CHISOLM, EXAMINING ATTORNEY

CLASS 42—SCIENTIFIC, COMPUTER AND LEGAL SERVICES

FOR PROVIDING AUTHENTICATION OF IDENTITY; ISSUANCE AND MANAGEMENT OF DIGITAL CERTIFICATES FOR AUTHENTICATION OR ENCRYPTION OF A DIGITAL COMMUNICATION, OR AUTHENTICATION OF A DIGITAL SIGNATURE IN AN ELECTRONIC TRANSACTION OR COMMUNICATION, OVER THE INTERNET AND OTHER COMPUTER NETWORK AND PROVIDING TECHNICAL AND CUSTOMER SUPPORT IN CONNECTION THEREWITH; COMPUTER RELATED SERVICES, NAMELY, MANAGED COMPUTER NETWORK AND INTERNET SECURITY SERVICES, NAMELY, PUBLIC KEY INFRASTRUCTURE ("PKI") VERIFICATION, AUTHENTICATION, DISTRIBUTION AND MANAGEMENT, DIGITAL CERTIFICATE ISSUANCE, VERIFICATION AND MANAGEMENT, AND ENTERPRISE SOFTWARE INTEGRATION (U.S. CLS. 100 AND 101).

KEVON CHISOLM, EXAMINING ATTORNEY

SN 76-588,972. VERISIGN, INC., DULLES, VA. FILED 4-27-2004.

thawte

CLASS 9—ELECTRICAL AND SCIENTIFIC APPARATUS

FOR COMPUTER SOFTWARE IN THE FIELD OF CRYPTOGRAPHIC NETWORK SECURITY AND DATA SECURITY FUNCTIONS; COMPUTER SOFTWARE FOR INTEGRATION OF INFORMATION LOGIC AND DATA BETWEEN COMPUTER NETWORKS; COMPUTER SOFTWARE FOR AUTOMATING A PROCESS FOR AUTHENTICATION OF IDENTITY USING EXISTING DATABASES IN CONNECTION WITH THE ISSUANCE AND MANAGEMENT OF DIGITAL CERTIFICATES USED FOR AUTHENTICATION OR ENCRYPTION OF DIGITAL COMMUNICATIONS, OR AUTHENTICATION OF A DIGITAL SIGNATURE IN AN ELECTRONIC TRANSACTION OR COMMUNICATION, OVER THE INTERNET AND OTHER COMPUTER NETWORKS; COMPUTER SOFTWARE, NAMELY ENCRYPTION SOFTWARE TO ENABLE SECURE TRANSMISSION OF DIGITAL INFORMATION, NAMELY, CONFIDENTIAL, FINANCIAL AND CREDIT CARD INFORMATION OVER THE INTERNET AS WELL AS OVER OTHER MODES OF COMMUNICATION BETWEEN COMPUTING DEVICES; COMPUTER SOFTWARE TO INTEGRATE MANAGED SECURITY SERVICES, NAMELY PUBLIC KEY INFRASTRUCTURE (PKI) SERVICES, DIGITAL CERTIFICATE ISSUANCE, VERIFICATION, AND MANAGEMENT, AND ENTERPRISE SOFTWARE INTEGRATION, WITH EXISTING COMMUNICATIONS NETWORKS, SOFTWARE, AND SERVICES, DOWNLOADABLE ELECTRONIC PUBLICATIONS IN THE NATURE OF A NEWSLETTER IN THE FIELD OF INFORMATION TECHNOLOGY (U.S. CLS. 21, 23, 26, 36 AND 38).

CLASS 36—INSURANCE AND FINANCIAL

FOR FINANCIAL SERVICES, NAMELY PROVIDING FINANCIAL TRANSACTION PROCESSING SERVICES BY ELECTRONIC MEANS VIA THE INTERNET AND OTHER COMPUTER NETWORKS IN THE FIELD OF ELECTRONIC FUND TRANSFER AND PAYMENT PROCESSING SERVICES; FINANCIAL MANAGEMENT SERVICES FOR ELECTRONIC DELIVERY, PROCESSING AND TRANSFER OF FUNDS, PAYMENTS, FINANCIAL TRANSACTIONS AND FINANCIAL INFORMATION VIA THE INTERNET AND OTHER COMPUTER NETWORKS (U.S. CLS. 100, 101 AND 102).

SN 76-589,148. WALKSTYLES, INC., LAGUNA HILLS, CA. FILED 4-28-2004.

WEWHOWALK

THE MARK CONSISTS OF STANDARD CHARACTERS WITHOUT CLAIM TO ANY PARTICULAR FONT, STYLE, SIZE, OR COLOR.

CLASS 9—ELECTRICAL AND SCIENTIFIC APPARATUS

FOR Pedometer (U.S. CLS. 21, 23, 26, 36 AND 38).

CLASS 16—PAPER GOODS AND PRINTED MATTER

FOR PAMPHLETS AND BROCHURES ABOUT LIFESTYLE PRODUCTS IN THE NATURE OF CLOTHING, EXERCISE EQUIPMENT AND RELATED ACCESSORIES, HEALTH AND FITNESS NEWS, HEALTH AND FITNESS EVENTS AND ACTIVITIES; AND JOURNALS AND DIARIES, NAMELY, BOOKS FOR RECORDING PERSONAL INFORMATION REGARDING FITNESS ACTIVITY (U.S. CLS. 2, 5, 22, 23, 29, 37, 38 AND 50).

CLASS 18—LEATHER GOODS

FOR Fanny packs and backpacks (U.S. CLS. 1, 2, 3, 22 AND 41).

CLASS 21—HOUSEWARES AND GLASS

FOR BOTTLES, SOLD EMPTY (U.S. CLS. 2, 13, 23, 29, 30, 33, 40 AND 50).

CLASS 25—CLOTHING

FOR CLOTHING, NAMELY, TANK TOPS, SHIRTS, SWEATSHIRTS, JACKETS, SHORTS, PANTS, SHOES, CAPS, VISORS, SOCKS, HEAD BANDS AND WRIST BANDS (U.S. CLS. 22 AND 39).

CLASS 41—EDUCATION AND ENTERTAINMENT

FOR PROVIDING INFORMATION IN THE FIELD OF FITNESS NEWS, FITNESS CLOTHING, EXERCISE EQUIPMENT AND RELATED ACCESSORIES AND FITNESS EVENTS AND ACTIVITIES VIA THE INTERNET (U.S. CLS. 100, 101 AND 107).

LINDA E. BLOHM, EXAMINING ATTORNEY

SN 76-589,215. SELECTIVE INSURANCE GROUP, INC., BRANCHVILLE, NJ. FILED 4-23-2004.

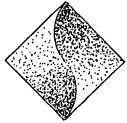

SELECTIVE

OWNER OF U.S. REG. NOS. 1,824,614, 2,436,942 AND OTHERS.

THE STIPPLING IS FOR SHADING PURPOSES ONLY.

CLASS 35—ADVERTISING AND BUSINESS

FOR HUMAN RESOURCES SERVICES, NAMELY, HUMAN RESOURCES MANAGEMENT, AND SERVING AS A HUMAN RESOURCES DEPARTMENT FOR OTHERS; ADMINISTRATION OF BUSINESS PAYROLL FOR OTHERS (U.S. CLS. 100, 101 AND 102).

FIRST USE 3-15-2000; IN COMMERCE 3-15-2000.

CLASS 36—INSURANCE AND FINANCIAL

FOR INSURANCE UNDERWRITING IN THE FIELD OF PROPERTY AND CASUALTY INSURANCE, HEALTH INSURANCE, AND FLOOD INSURANCE; INSURANCE CLAIMS PROCESSING AND MANAGEMENT; AND RISK MANAGEMENT SERVICES (U.S. CLS. 100, 101 AND 102).

FIRST USE 3-15-2000; IN COMMERCE 3-15-2000.

CLASS 42—SCIENTIFIC, COMPUTER AND LEGAL SERVICES

FOR PROVIDING TEMPORARY USE OF NON-DOWNLOADABLE SOFTWARE FOR USE BY INSURANCE AGENTS FOR INSURANCE BROKERAGE IN THE FIELDS OF PERSONAL AUTOMOBILE, HOMOWNERS, DWELLING, FIRE AND PERSONAL CATASTROPHE LIABILITY INSURANCE (U.S. CLS. 100 AND 101).

FIRST USE 3-15-2000; IN COMMERCE 3-15-2000.
DARRYL SPRUILL, EXAMINING ATTORNEY

SN 76-590,930. LANIER WORLDWIDE, INC., ATLANTA, GA. FILED 5-7-2004.

LANIER

THE MARK CONSISTS OF STANDARD CHARACTERS WITHOUT CLAIM TO ANY PARTICULAR FONT, STYLE, SIZE, OR COLOR.

OWNER OF U.S. REG. NOS. 988,938, 1,621,822 AND 2,237,858.
SEC. 2(F).

CLASS 1—CHEMICALS

FOR DEVELOPER FOR PHOTOCOPY AND FACSIMILE MACHINES (U.S. CLS. 1, 5, 6, 10, 26 AND 46).
FIRST USE 7-11-1989; IN COMMERCE 7-11-1989.

CLASS 2—PAINTS

FOR TONER FOR PHOTOCOPY AND FACSIMILE MACHINES (U.S. CLS. 6, 11 AND 16).
FIRST USE 7-11-1989; IN COMMERCE 7-11-1989.

CLASS 9—ELECTRICAL AND SCIENTIFIC APPARATUS

FOR ELECTRONIC BUSINESS EQUIPMENT, NAMELY PHOTOCOPIERS, DIGITAL DUPLICATORS, FACSIMILE MACHINES, MULTI-FUNCTION FACSIMILE MACHINES, LASER PRINTERS, DOCUMENT FEEDERS AND SORTERS, COMPUTERS, APPARATUS FOR DIGITIZING AND PROJECTING GRAPHIC IMAGES, SCANNERS, DIGITAL DUPLICATORS THAT ALSO HAVE PRINT, SCAN AND FAX CAPABILITIES; AND SOFTWARE FOR DOCUMENT MANAGEMENT, DOCUMENT DISTRIBUTION, AND PRODUCTION WORKFLOW (U.S. CLS. 21, 23, 26, 36 AND 38).
FIRST USE 7-11-1989; IN COMMERCE 7-11-1989.

CLASS 16—PAPER GOODS AND PRINTED MATTER

FOR PAPER, COATED AND UNCOATED, FOR PHOTOCOPY AND FACSIMILE MACHINES (U.S. CLS. 2, 5, 22, 23, 29, 37, 38 AND 50).
FIRST USE 7-11-1989; IN COMMERCE 7-11-1989.

CLASS 35—ADVERTISING AND BUSINESS

FOR CONSULTATION AND SUPPORT SERVICES IN THE FIELD OF DOCUMENT MANAGEMENT AND DOCUMENT REPRODUCTION; DOCUMENT MANAGEMENT, NAMELY DOCUMENT INDEXING FOR OTHERS; DOCUMENT REPRODUCTION; FACILITY MANAGEMENT SERVICES, NAMELY COPY AND MAILROOM OUTSOURCING (U.S. CLS. 100, 101 AND 102).

FIRST USE 1-1-1997; IN COMMERCE 1-1-1997.
MICHAEL HALL, EXAMINING ATTORNEY

SN 76-591,050. DIC ENTERTAINMENT CORP., BURBANK, CA. FILED 5-7-2004.

**CLASS 3—COSMETICS AND CLEANING PREPARATIONS**

FOR BATH OILS, BUBBLE BATH, BATH GEL, SOAP, TOOTHPASTE, NON-MEDICATED LIP BALM, LIP GLOSS, SHAMPOO, PERFUME, COLOGNE, BODY LOTION, LIPSTICK, POWDER BLUSH, EYE SHADOW, MASCARA, EYE LINER, LIQUID MAKEUP, ROUGE, PRE-MOISTENED COSMETIC WIPES, NAIL POLISH, BODY GLITTER (U.S. CLS. 1, 4, 6, 50, 51 AND 52).

CLASS 6—METAL GOODS

FOR METAL KEY RINGS, METAL DECORATIVE BOXES (U.S. CLS. 2, 12, 13, 14, 23, 25 AND 50).

CLASS 14—JEWELRY

FOR JEWELRY ITEMS, NAMELY, NECKLACES, LOCKETS, RINGS, BRACELETS, CHARMS, ANKLE BRACELETS, WATCHES, COSTUME JEWELRY, EAR CLIPS, AND EARRINGS, JEWELRY WORN ON THE BODY BY MEANS OF PIERCING, JEWELRY MAKING BEAD KITS, COMPRISED OF BEADS, NEEDLES, CLASPS AND CORDING, CLOCKS (U.S. CLS. 2, 27, 28 AND 50).

CLASS 18—LEATHER GOODS

FOR BACKPACKS, TOTE BAGS, BEACH BAGS, GYM BAGS, DUFFEL BAGS, OVERNIGHT BAGS, PURSES, COIN PURSES, WALLETS, HANDBAGS, KEY CASES, LUGGAGE, SUITCASES, UMBRELLAS, FANNY PACKS, WAIST PACKS, LIPSTICK HOLDERS, PURSES, COSMETIC CASES SOLD EMPTY, LUGGAGE TRUNKS, HAT BOXES (U.S. CLS. 1, 2, 3, 22 AND 41).

CLASS 26—FANCY GOODS

FOR HAIR ACCESSORIES, NAMELY, HAIR CLIPS, BARRETTES, HAIR BANDS AND PONYTAIL HOLDERS, RIBBONS AND BOWS FOR GIFT WRAPPING, SHOE LACES, ORNAMENTAL NOVELTY PINS AND BUTTONS (U.S. CLS. 37, 39, 40, 42 AND 50).

SEAN DWYER, EXAMINING ATTORNEY

SN 76-591,131. CHENG SHIN RUBBER USA, INC., SUWANEE, GA. FILED 5-10-2004.



OWNER OF U.S. REG. NOS. 1,702,477, 2,782,049 AND OTHERS.

CLASS 9—ELECTRICAL AND SCIENTIFIC APPARATUS

FOR LUMINOUS NON-METAL MARQUEE SIGNS FOR USE BY RETAIL STORES (U.S. CLS. 21, 23, 26, 36 AND 38).

FIRST USE 1-1-2001; IN COMMERCE 1-1-2001.

CLASS 12—VEHICLES

FOR TIRES; INNER TUBES FOR BICYCLE TIRES AND FOR VEHICLE TIRES (U.S. CLS. 19, 21, 23, 31, 35 AND 44).

FIRST USE 1-1-1997; IN COMMERCE 1-1-1997.

CLASS 14—JEWELRY

FOR CLOCKS (U.S. CLS. 2, 27, 28 AND 50).
FIRST USE 1-1-2001; IN COMMERCE 1-1-2001.

CLASS 16—PAPER GOODS AND PRINTED MATTER

FOR DECALS, PAPER BANNERS; BOOKLETS IN THE FIELD OF BICYCLES, VEHICLE TIRES AND RELATED PRODUCTS, BROCHURES IN THE FIELD OF BICYCLES, VEHICLE TIRES AND RELATED PRODUCTS (U.S. CLS. 2, 5, 22, 23, 29, 37, 38 AND 50).

FIRST USE 1-1-1997; IN COMMERCE 1-1-1997.

CLASS 21—HOUSEWARES AND GLASS

FOR MUGS, SPORTS WATER BOTTLES SOLD EMPTY (U.S. CLS. 2, 13, 23, 29, 30, 33, 40 AND 50).
FIRST USE 1-1-2000; IN COMMERCE 1-1-2000.

CLASS 25—CLOTHING

FOR CLOTHING, NAMELY, BASEBALL-STYLE CAPS, SHIRTS, JACKETS, AND JERSEYS, SOLD THROUGH AUTHORIZED TIRE DISTRIBUTORS (U.S. CLS. 22 AND 39).

FIRST USE 1-1-1996; IN COMMERCE 1-1-1996.
MELISSA SHELLA, EXAMINING ATTORNEY

SN 76-591,277. AMERIKLEEN CORPORATION, HENDERSON, NV. FILED 5-10-2004.

**CLASS 3—COSMETICS AND CLEANING PREPARATIONS**

FOR CLEANING LIQUID FOR PEDICURE SPAS, HAIR SALONS AND BARBERSHOPS, HOSPITALS, EXERCISE FACILITIES, MANICURE SALONS AND HYDROTHERAPY SPAS (U.S. CLS. 1, 4, 6, 50, 51 AND 52).

FIRST USE 7-27-2003; IN COMMERCE 7-27-2003.

CLASS 5—PHARMACEUTICALS

FOR DISINFECTANTS FOR HYGIENIC PURPOSES, NAMELY, DISINFECTANT LIQUID FOR PEDICURE SPAS, HAIR SALONS AND BARBER SHOPS, HOSPITALS, EXERCISE FACILITIES, MANICURE SALONS AND HYDROTHERAPY SPAS (U.S. CLS. 6, 18, 44, 46, 51 AND 52).

FIRST USE 7-27-2003; IN COMMERCE 7-27-2003.
JOHN DWYER, EXAMINING ATTORNEY

SN 76-591,442. LOWEN CORPORATION, DBA LOWEN COLOR GRAPHICS, HUTCHINSON, KS. FILED 5-10-2004.

SIGNS THAT MEAN BUSINESS

THE MARK CONSISTS OF STANDARD CHARACTERS WITHOUT CLAIM TO ANY PARTICULAR FONT, STYLE, SIZE, OR COLOR.

NO CLAIM IS MADE TO THE EXCLUSIVE RIGHT TO USE "SIGNS", APART FROM THE MARK AS SHOWN.

CLASS 16—PAPER GOODS AND PRINTED MATTER

FOR CATALOGS IN THE FIELD OF SIGNS, DECALS, VEHICLE GRAPHICS AND BANNERS (U.S. CLS. 2, 5, 22, 23, 29, 37, 38 AND 50).

FIRST USE 4-0-2003; IN COMMERCE 4-0-2003.

CLASS 35—ADVERTISING AND BUSINESS

FOR RETAIL STORE SERVICES, MAIL ORDER CATALOG SERVICES AND COMPUTERIZED ON-LINE ORDERING SERVICES, ALL FEATURING SIGNS, DECALS, VEHICLE GRAPHICS AND BANNERS (U.S. CLS. 100, 101 AND 102).

FIRST USE 4-0-2003; IN COMMERCE 4-0-2003.
RON FAIRBANKS, EXAMINING ATTORNEY

SN 76-591,596. GENERAL CONFERENCE CORPORATION OF SEVENTH-DAY ADVENTISTS, SILVER SPRING, MD. FILED 5-11-2004.

ADVENTIST NEWSLINE

THE MARK CONSISTS OF STANDARD CHARACTERS WITHOUT CLAIM TO ANY PARTICULAR FONT, STYLE, SIZE, OR COLOR.

OWNER OF U.S. REG. NOS. 1,176,153, 1,944,937 AND 2,651,619.

NO CLAIM IS MADE TO THE EXCLUSIVE RIGHT TO USE NEWSLINE, APART FROM THE MARK AS SHOWN. SEC. 2(F) ADVENTIST.

CLASS 38—COMMUNICATION

FOR TELEVISION BROADCASTING SERVICES (U.S. CLS. 100, 101 AND 104).

FIRST USE 9-6-2002; IN COMMERCE 9-6-2002.

CLASS 41—EDUCATION AND ENTERTAINMENT

FOR PRODUCTION AND DISTRIBUTION OF INTERNET PROGRAMS FOR OTHERS IN THE NATURE OF CURRENT NEWS PROGRAMS (U.S. CLS. 100, 101 AND 107).

FIRST USE 9-6-2002; IN COMMERCE 9-6-2002.
ZHALEH DELANEY, EXAMINING ATTORNEY

SN 76-591,667. DUNHAM, KATHLEEN, SEBASTOPOL, CA. FILED 5-11-2004.

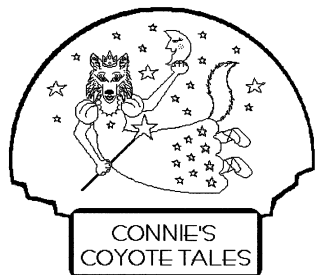

CONNIE'S DOES NOT IDENTIFY A LIVING INDIVIDUAL.

IT IS A PICTURE OF A COYOTE IN A LONG DRESS CARRYING A WAND WITH A STAR. A MOON AND STARS ARE IN THE BACK-GROUND. UNDERNEATH THE PICTURE ARE THE WORDS, CONNIE'S COYOTE TALES.

CLASS 9—ELECTRICAL AND SCIENTIFIC APPARATUS

FOR REFRIGERATOR MAGNETS THAT ARE EDUCATIONAL IN NATURE AND INSTRUCTIONAL MANUALS SOLD AS A UNIT (U.S. CLS. 21, 23, 26, 36 AND 38).

CLASS 16—PAPER GOODS AND PRINTED MATTER

FOR EDUCATIONAL WORKBOOKS FOR CHILDREN IN THE FIELD OF CHILD THERAPY (U.S. CLS. 2, 5, 22, 23, 29, 37, 38 AND 50).

STEVEN JACKSON, EXAMINING ATTORNEY

SN 76-591,767. ROYER, MARILYNN J., HAMMOND, IN. FILED 5-10-2004.

JUST PRAY

THE MARK CONSISTS OF STANDARD CHARACTERS WITHOUT CLAIM TO ANY PARTICULAR FONT, STYLE, SIZE, OR COLOR.

CLASS 16—PAPER GOODS AND PRINTED MATTER

FOR PRINTED MATTER, NAMELY BUMPER STICKERS, DECALS (U.S. CLS. 2, 5, 22, 23, 29, 37, 38 AND 50).
FIRST USE 1-19-2004; IN COMMERCE 1-19-2004.

CLASS 25—CLOTHING

FOR CLOTHING, NAMELY SHIRTS, SWEATSHIRTS, T-SHIRTS, POLO SHIRTS, GOLF SHIRTS, SWEATERS; HEADWEAR, NAMELY CAPS, HATS, SUNVISORS, HEADBANDS (U.S. CLS. 22 AND 39).

FIRST USE 1-19-2004; IN COMMERCE 1-19-2004.
LOURDES AYALA, EXAMINING ATTORNEY

SN 76-592,089. EXTRACTIS SWITZERLAND SA, ECUBLENS, SWITZERLAND, FILED 5-13-2004.

extractis

THE MARK CONSISTS OF STANDARD CHARACTERS WITHOUT CLAIM TO ANY PARTICULAR FONT, STYLE, SIZE, OR COLOR.

OWNER OF SWITZERLAND REG. NO. 515822, DATED 11-4-2003, EXPIRES 2-7-2013.

CLASS 7—MACHINERY

FOR EXTRACTING MACHINES FOR THE EXTRACTION OF OIL FROM OIL BEARING PLANT AND ANIMAL MATERIAL (U.S. CLS. 13, 19, 21, 23, 31, 34 AND 35).

CLASS 40—MATERIAL TREATMENT

FOR TREATMENT OF MATERIAL NAMELY TREATMENT OF OIL BEARING PLANT AND ANIMAL MATERIALS FOR THE EXTRACTION OF OIL; CUSTOM MANUFACTURING OF OIL FROM OIL BEARING PLANT AND ANIMAL MATERIAL (U.S. CLS. 100, 103 AND 106).

TRACY FLETCHER, EXAMINING ATTORNEY

SN 76-592,130. HARBOR PAYMENTS, INC., ATLANTA, GA.
FILED 5-13-2004.

BILLING HARBOR

THE MARK CONSISTS OF STANDARD CHARACTERS WITHOUT CLAIM TO ANY PARTICULAR FONT, STYLE, SIZE, OR COLOR.

NO CLAIM IS MADE TO THE EXCLUSIVE RIGHT TO USE BILLING, APART FROM THE MARK AS SHOWN.

CLASS 35—ADVERTISING AND BUSINESS

FOR INVOICING SERVICES; BILLING SERVICES; BILLING MANAGEMENT SERVICES (U.S. CLS. 100, 101 AND 102).

FIRST USE 9-5-2003; IN COMMERCE 9-5-2003.

CLASS 36—INSURANCE AND FINANCIAL

FOR BILL PAYMENT SERVICES; ELECTRONIC PROCESSING OF INSURANCE CLAIMS AND PAYMENT DATA (U.S. CLS. 100, 101 AND 102).

FIRST USE 5-13-2004; IN COMMERCE 5-13-2004.

CLASS 42—SCIENTIFIC, COMPUTER AND LEGAL SERVICES

FOR PROVIDING TEMPORARY USE OF NON-DOWNLOADABLE COMPUTER SOFTWARE FOR PREPARING INVOICES OVER COMPUTER NETWORKS, INTRANETS AND THE INTERNET (U.S. CLS. 100 AND 101).

FIRST USE 5-13-2004; IN COMMERCE 5-13-2004.

JOHN KELLY, EXAMINING ATTORNEY

SN 76-592,136. HARBOR PAYMENTS, INC., ATLANTA, GA.
FILED 5-13-2004.

HARBOR PAYMENTS

THE MARK CONSISTS OF STANDARD CHARACTERS WITHOUT CLAIM TO ANY PARTICULAR FONT, STYLE, SIZE, OR COLOR.

NO CLAIM IS MADE TO THE EXCLUSIVE RIGHT TO USE PAYMENTS, APART FROM THE MARK AS SHOWN.

CLASS 35—ADVERTISING AND BUSINESS

FOR INVOICING SERVICES; BILLING SERVICES; BILLING MANAGEMENT SERVICES (U.S. CLS. 100, 101 AND 102).

FIRST USE 9-5-2003; IN COMMERCE 9-5-2003.

CLASS 36—INSURANCE AND FINANCIAL

FOR BILL PAYMENT SERVICES; ELECTRONIC PROCESSING OF INSURANCE CLAIMS AND PAYMENT DATA (U.S. CLS. 100, 101 AND 102).

FIRST USE 5-13-2004; IN COMMERCE 5-13-2004.

CLASS 42—SCIENTIFIC, COMPUTER AND LEGAL SERVICES

FOR PROVIDING TEMPORARY USE OF NON-DOWNLOADABLE COMPUTER SOFTWARE FOR PREPARING INVOICES OVER COMPUTER NETWORKS, INTRANETS AND THE INTERNET (U.S. CLS. 100 AND 101).

FIRST USE 5-13-2004; IN COMMERCE 5-13-2004.

JOHN KELLY, EXAMINING ATTORNEY

SN 76-592,138. HARBOR PAYMENTS, INC., ATLANTA, GA.
FILED 5-13-2004.

PAYMENT HARBOR

THE MARK CONSISTS OF STANDARD CHARACTERS WITHOUT CLAIM TO ANY PARTICULAR FONT, STYLE, SIZE, OR COLOR.

NO CLAIM IS MADE TO THE EXCLUSIVE RIGHT TO USE PAYMENT, APART FROM THE MARK AS SHOWN.

CLASS 35—ADVERTISING AND BUSINESS

FOR INVOICING SERVICES; BILLING SERVICES; BILLING MANAGEMENT SERVICES (U.S. CLS. 100, 101 AND 102).

FIRST USE 9-5-2003; IN COMMERCE 9-5-2003.

CLASS 36—INSURANCE AND FINANCIAL

FOR BILL PAYMENT SERVICES; ELECTRONIC PROCESSING OF INSURANCE CLAIMS AND PAYMENT DATA (U.S. CLS. 100, 101 AND 102).

FIRST USE 5-13-2004; IN COMMERCE 5-13-2004.

CLASS 42—SCIENTIFIC, COMPUTER AND LEGAL SERVICES

FOR PROVIDING TEMPORARY USE OF NON-DOWNLOADABLE COMPUTER SOFTWARE FOR PREPARING INVOICES OVER COMPUTER NETWORKS, INTRANETS AND THE INTERNET (U.S. CLS. 100 AND 101).

FIRST USE 5-13-2004; IN COMMERCE 5-13-2004.

JOHN KELLY, EXAMINING ATTORNEY

SN 76-592,140. HARBOR PAYMENTS, INC., ATLANTA, GA.
FILED 5-13-2004.

INVOICE HARBOR

THE MARK CONSISTS OF STANDARD CHARACTERS WITHOUT CLAIM TO ANY PARTICULAR FONT, STYLE, SIZE, OR COLOR.

NO CLAIM IS MADE TO THE EXCLUSIVE RIGHT TO USE INVOICE, APART FROM THE MARK AS SHOWN.

CLASS 35—ADVERTISING AND BUSINESS

FOR INVOICING SERVICES; BILLING SERVICES; BILLING MANAGEMENT SERVICES (U.S. CLS. 100, 101 AND 102).

FIRST USE 9-5-2003; IN COMMERCE 9-5-2003.

CLASS 36—INSURANCE AND FINANCIAL

FOR BILL PAYMENT SERVICES; ELECTRONIC PROCESSING OF INSURANCE CLAIMS AND PAYMENT DATA (U.S. CLS. 100, 101 AND 102).

FIRST USE 5-13-2004; IN COMMERCE 5-13-2004.

CLASS 42—SCIENTIFIC, COMPUTER AND LEGAL SERVICES

FOR PROVIDING TEMPORARY USE OF NON-DOWNLOADABLE COMPUTER SOFTWARE FOR PREPARING INVOICES OVER COMPUTER NETWORKS, INTRANETS AND THE INTERNET (U.S. CLS. 100 AND 101).

FIRST USE 5-13-2004; IN COMMERCE 5-13-2004.

JOHN KELLY, EXAMINING ATTORNEY

SN 76-592,213. SANDY CLOUGH STUDIO, LLC, MARIETTA, GA. FILED 5-14-2004.

SANDY CLOUGH

THE MARK CONSISTS OF STANDARD CHARACTERS WITHOUT CLAIM TO ANY PARTICULAR FONT, STYLE, SIZE, OR COLOR.

THE NAME SANDY CLOUGH IDENTIFIES A LIVING INDIVIDUAL WHOSE CONSENT IS OF RECORD.

CLASS 16—PAPER GOODS AND PRINTED MATTER

FOR PRINTED MATTER, NAMELY, ART PRINTS, GIFT BOOKS, NOTE CARDS, AND NEWSLETTERS IN THE FIELD OF PROMOTING ART AND FRIENDSHIP AND NETWORKING AMONG WOMEN (U.S. CLS. 2, 5, 22, 23, 29, 37, 38 AND 50).

FIRST USE 0-0-1979; IN COMMERCE 0-0-1979.

CLASS 21—HOUSEWARES AND GLASS

FOR TEA SETS, PLATES, BOWLS, CANISTER SETS, COOKIE JARS, SUGAR BOWLS NOT OF PRECIOUS METALS, CREAMER PITCHERS, CANDLE HOLDERS NOT OF PRECIOUS METAL (U.S. CLS. 2, 13, 23, 29, 30, 33, 40 AND 50).

FIRST USE 6-0-2002; IN COMMERCE 6-0-2002.

CLASS 30—STAPLE FOODS

FOR TEA (U.S. CL. 46).

FIRST USE 6-0-2002; IN COMMERCE 6-0-2002.

GINA HAYES, EXAMINING ATTORNEY

SN 76-592,341. CHURCHILL YACHT PARTNERS, LLC, MINNEAPOLIS, MN. FILED 5-17-2004.

CHURCHILL YACHT PARTNERS

THE MARK CONSISTS OF STANDARD CHARACTERS WITHOUT CLAIM TO ANY PARTICULAR FONT, STYLE, SIZE, OR COLOR.

NO CLAIM IS MADE TO THE EXCLUSIVE RIGHT TO USE "YACHT PARTNERS", APART FROM THE MARK AS SHOWN.

CLASS 35—ADVERTISING AND BUSINESS

FOR PERSONNEL MANAGEMENT IN THE FIELD OF YACHT CREWS (U.S. CLS. 100, 101 AND 102).

FIRST USE 6-1-2004; IN COMMERCE 6-1-2004.

CLASS 36—INSURANCE AND FINANCIAL

FOR YACHT BROKERAGE SERVICES (U.S. CLS. 100, 101 AND 102).

FIRST USE 6-1-2004; IN COMMERCE 6-1-2004.

CLASS 37—CONSTRUCTION AND REPAIR

FOR CONSULTING SERVICES RELATING TO YACHT CONSTRUCTION (U.S. CLS. 100, 103 AND 106).

FIRST USE 6-1-2004; IN COMMERCE 6-1-2004.

CLASS 39—TRANSPORTATION AND STORAGE

FOR YACHT CHARTERING SERVICES (U.S. CLS. 100 AND 105).

FIRST USE 6-1-2004; IN COMMERCE 6-1-2004.

STEVEN R. FOSTER, EXAMINING ATTORNEY

SN 76-592,445. DOLLAR TREE STORES, INC., CHESAPEAKE, VA. FILED 5-17-2004.

CHRISTMAS HOUSE

THE MARK CONSISTS OF STANDARD CHARACTERS WITHOUT CLAIM TO ANY PARTICULAR FONT, STYLE, SIZE, OR COLOR.

NO CLAIM IS MADE TO THE EXCLUSIVE RIGHT TO USE CHRISTMAS, APART FROM THE MARK AS SHOWN.

CLASS 16—PAPER GOODS AND PRINTED MATTER

FOR PAPER GOODS, NAMELY CHRISTMAS GIFT WRAP, CHRISTMAS GIFT BAGS, CHRISTMAS GIFT BOXES, CHRISTMAS GIFT WRAP BOWS AND CHRISTMAS PARTY GOODS IN THE NATURE OF PAPER NAPKINS; PRINTED MATTER IN THE NATURE OF CHRISTMAS CARDS (U.S. CLS. 2, 5, 22, 23, 29, 37, 38 AND 50).

FIRST USE 3-6-1996; IN COMMERCE 3-6-1996.

CLASS 20—FURNITURE AND ARTICLES NOT OTHERWISE CLASSIFIED

FOR CHRISTMAS FIGURINES OF POLYRESIN AND WOOD (U.S. CLS. 2, 13, 22, 25, 32 AND 50).
FIRST USE 3-6-1996; IN COMMERCE 3-6-1996.

CLASS 28—TOYS AND SPORTING GOODS

FOR CHRISTMAS DECORATIONS, NAMELY TREE ORNAMENTS, ARTIFICIAL CHRISTMAS GARLAND, AND MODELED PLASTIC FIGURINES (U.S. CLS. 22, 23, 38 AND 50).
FIRST USE 3-6-1996; IN COMMERCE 3-6-1996.
BRIDGETT SMITH, EXAMINING ATTORNEY

SN 76-593,116. DESA IP, LLC, MIAMI, FL. FILED 5-19-2004.

THE NEW NAME IN FLAME

THE MARK CONSISTS OF STANDARD CHARACTERS WITHOUT CLAIM TO ANY PARTICULAR FONT, STYLE, SIZE, OR COLOR.

CLASS 4—LUBRICANTS AND FUELS

FOR ARTIFICIAL GAS LOGS AND EMBERS (U.S. CLS. 1, 6 AND 15).

CLASS 11—ENVIRONMENTAL CONTROL APPARATUS

FOR WOOD AND GAS BURNING FIREPLACES, FIREPLACE INSERTS, NAMELY, METAL BOXES FOR WOOD BURNING FIREPLACES, AND METAL BOXES AND GAS BURNER SYSTEMS COMPRISED OF GAS CONTROLS, MANIFOLDS, BURNERS, ARTIFICIAL LOGS AND/OR ARTIFICIAL GLOWING MEDIA FOR GAS BURNING FIREPLACES (U.S. CLS. 13, 21, 23, 31 AND 34).
CHRISTOPHER BUONGIORNO, EXAMINING ATTORNEY

SN 76-593,376. MARCH MADNESS ATHLETIC ASSOCIATION LLC, BLOOMINGTON, IL. FILED 5-21-2004.

MARCH MADNESS

THE MARK CONSISTS OF STANDARD CHARACTERS WITHOUT CLAIM TO ANY PARTICULAR FONT, STYLE, SIZE, OR COLOR.

OWNER OF U.S. REG. NOS. 1,571,340, 2,485,443 AND OTHERS.

CLASS 9—ELECTRICAL AND SCIENTIFIC APPARATUS

FOR COMPUTER GAME SOFTWARE AND RELATED INSTRUCTIONAL MANUALS AND GUIDES SOLD AS A UNIT (U.S. CLS. 21, 23, 26, 36 AND 38).
FIRST USE 3-0-1996; IN COMMERCE 3-0-1996.

CLASS 38—COMMUNICATION

FOR TELECOMMUNICATIONS SERVICES; NAMELY THE TRANSMISSION OF VOICE, DATA, IMAGES, AUDIO, VIDEO AND INFORMATION VIA LOCAL AND LONG DISTANCE TELEPHONE, SATELLITE AND GLOBAL COMPUTER NETWORKS; LEASING TELECOMMUNICATIONS EQUIPMENT, COMPONENTS, SYSTEMS AND SUPPLIES; ELECTRONIC MAIL SERVICES; TELEPHONE VOICE MESSAGING SERVICES; PROVIDING MULTIPLE-USER ACCESS TO GLOBAL COMPUTER NETWORKS TO TRANSMIT, RECEIVE AND OTHERWISE ACCESS AND USE INFORMATION OF GENERAL INTEREST TO CONSUMERS; WEB CASTING OF ATHLETIC GAMES, TOURNAMENTS, EXHIBITIONS, AND EVENTS VIA THE INTERNET (U.S. CLS. 100, 101 AND 104).
FIRST USE 3-0-2001; IN COMMERCE 3-0-2001.

CLASS 41—EDUCATION AND ENTERTAINMENT

FOR PROVIDING SPORTS INFORMATION VIA THE INTERNET (U.S. CLS. 100, 101 AND 107).
FIRST USE 3-0-1995; IN COMMERCE 3-0-1995.
VIVIAN MICZNIK FIRST, EXAMINING ATTORNEY

SN 76-594,008. JOHNSON, JIMMIE, BIRMINGHAM, MI. FILED 5-26-2004.



NO CLAIM IS MADE TO THE EXCLUSIVE RIGHT TO USE RACING, APART FROM THE MARK AS SHOWN.

THE NAME "JIMMIE JOHNSON" IDENTIFIES A LIVING INDIVIDUAL WHOSE CONSENT IS OF RECORD.

THE COLOR(S) BLACK, RED AND GRAY IS/ARE CLAIMED AS A FEATURE OF THE MARK.

THE WORDS JIMMIE JOHNSON AND THE RACING FLAG ARE IN BLACK. THE WORD RACING IS IN RED. ALL OF THE FOREGOING ARE OUTLINED IN GRAY AND THERE ARE TWO GRAY HORIZONTAL LINES.

CLASS 25—CLOTHING

FOR SHIRTS, T-SHIRTS, CAPS, HATS, VISORS, AND BANDANNAS (U.S. CLS. 22 AND 39).

CLASS 41—EDUCATION AND ENTERTAINMENT

FOR ENTERTAINMENT IN THE NATURE OF PROFESSIONAL RACE CAR DRIVING SERVICES (U.S. CLS. 100, 101 AND 107).
MELVIN AXILBUND, EXAMINING ATTORNEY

SN 76-594,015. T. R. Z. CORPORATION, ELYRIA, OH. FILED 5-26-2004.

MASTER PIZZA

THE MARK CONSISTS OF STANDARD CHARACTERS WITHOUT CLAIM TO ANY PARTICULAR FONT, STYLE, SIZE, OR COLOR.

NO CLAIM IS MADE TO THE EXCLUSIVE RIGHT TO USE "PIZZA", APART FROM THE MARK AS SHOWN.

CLASS 29—MEATS AND PROCESSED FOODS

FOR MOZZARELLA STICKS, ONION RINGS, BREADED MUSHROOMS, RIBS, HOT WINGS, CHICKEN FINGERS, POTATO CHIPS, GARDEN SALAD, AND ANTIPASTO SALAD (U.S. CL. 46).

FIRST USE 12-0-1994; IN COMMERCE 12-0-1994.

CLASS 30—STAPLE FOODS

FOR PASTA, PIZZA, CHICKEN SANDWICHES, BLT SANDWICHES, HAMBURGER SANDWICHES, SUB SANDWICHES, FRENCH BREAD, GARLIC BREAD, BREAD STICKS, AND BROWNIES (U.S. CL. 46).

FIRST USE 2-0-1968; IN COMMERCE 2-0-1968.

CLASS 43—HOTEL AND RESTAURANT SERVICES

FOR RESTAURANT AND CARRYOUT FOOD SERVICES FEATURING PASTA, PIZZA, CHICKEN SANDWICHES, BLT SANDWICHES, HAMBURGER SANDWICHES, SUB SANDWICHES, FRENCH BREAD, GARLIC BREAD, BREAD STICKS, BROWNIES, MOZZARELLA STICKS, ONION RINGS, BREADED MUSHROOMS, RIBS, HOT WINGS, CHICKEN FINGERS, POTATO CHIPS, GARDEN SALAD, AND ANTIPASTO SALAD (U.S. CLS. 100 AND 101).

FIRST USE 2-0-1968; IN COMMERCE 2-0-1968.

ALICE SUE CARRUTHERS, EXAMINING ATTORNEY

SN 76-594,084. GRANTHAM, POOLE, RANDALL, REITANO, ARRINGTON & CUNNINGHAM, PLLC, JACKSON, MS. FILED 5-26-2004.

WE SEE YOU THROUGH

THE MARK CONSISTS OF STANDARD CHARACTERS WITHOUT CLAIM TO ANY PARTICULAR FONT, STYLE, SIZE, OR COLOR.

CLASS 35—ADVERTISING AND BUSINESS

FOR PROVIDING ACCOUNTING, ACCOUNT AUDITING, TAX PLANNING TAX RETURN PREPARATION, PROVIDING EMPLOYEE RECRUITMENT; PROVIDING MEDICAL OFFICE SUPPORT STAFF SERVICES; AND PROVIDING CONSULTING SERVICES IN THE FIELD OF BUSINESS OPERATIONS AND MANAGEMENT (U.S. CLS. 100, 101 AND 102).

FIRST USE 3-2-2004; IN COMMERCE 3-2-2004.

CLASS 36—INSURANCE AND FINANCIAL

FOR PERSONAL FINANCIAL AND ESTATE PLANNING SERVICES; PROVIDING FINANCIAL VALUATION AND COST SEGREGATION SERVICES; ADMINISTRATION OF EMPLOYEE PENSION AND PROFIT SHARING PLANS; ADMINISTRATION OF EMPLOYEE BENEFIT PLANS (U.S. CLS. 100, 101 AND 102).

FIRST USE 3-2-2004; IN COMMERCE 3-2-2004.

CLASS 42—SCIENTIFIC, COMPUTER AND LEGAL SERVICES

FOR TECHNICAL SUPPORT SERVICES, NAMELY, TROUBLESHOOTING OF COMPUTER HARDWARE AND SOFTWARE PROBLEMS; AND PROVIDING EXPERT WITNESS SERVICES IN THE FIELD OF BUSINESS OPERATIONS AND BUSINESS ECONOMIC DAMAGES CALCULATIONS FOR CONTRACT DISPUTES, BUSINESS INTERRUPTIONS, PERSONAL INJURY AND WRONGFUL DEATH (U.S. CLS. 100 AND 101).

FIRST USE 3-2-2004; IN COMMERCE 3-2-2004.

MARK T. MULLEN, EXAMINING ATTORNEY

SN 76-594,277. H-CAP, LTD., GEORGE TOWN, GRAND CAYMAN, CAYMAN ISLANDS, FILED 5-25-2004.

EVERCRETE

THE MARK CONSISTS OF STANDARD CHARACTERS WITHOUT CLAIM TO ANY PARTICULAR FONT, STYLE, SIZE, OR COLOR.

OWNER OF U.S. REG. NO. 397,748.

CLASS 1—CHEMICALS

FOR CHEMICAL ADDITIVES FOR PROTECTING OR SEALING CONCRETE; CONCRETE PRESERVATIVES; CHEMICAL PRODUCTS FOR USE IN THE MANUFACTURE, PREPARATION AND TREATMENT OF CONCRETE; CHEMICAL COMPOSITIONS FOR HARDENING, WEATHERPROOFING AND WATERPROOFING CONCRETE; PRESERVATIVES FOR TILES, MASONRY, CEMENT, WOOD OR BRICKWORK; CHEMICAL COMPOSITIONS AND GELS FOR SEALING, WATERPROOFING, HARDENING AND PRESERVING WOOD OR CONCRETE (U.S. CLS. 1, 5, 6, 10, 26 AND 46).

FIRST USE 11-8-1980; IN COMMERCE 11-8-1980.

CLASS 2—PAINTS

FOR OILS FOR USE AS PROTECTIVE COATINGS FOR CONCRETE; OILS FOR USE AS CONCRETE PRESERVATIVES; OILS FOR USE AS PROTECTIVE COATINGS FOR WOOD; OILS FOR USE AS WOOD PRESERVATIVES; CONCRETE SEALING AGENTS; WOOD SEALING AGENTS; COMPOSITIONS FOR PRESERVING CONCRETE (U.S. CLS. 6, 11 AND 16).

FIRST USE 11-8-1980; IN COMMERCE 11-8-1980.

SHARI SHEFFIELD, EXAMINING ATTORNEY

SN 76-594,512. MENZEL, CRYSTAL MAUREEN, LIVINGSTON, NJ. FILED 5-27-2004.

SN 76-594,974. AEC, INC., GRIMES, IA. FILED 6-1-2004.

MENZEL VIOLINS

N-V

NO CLAIM IS MADE TO THE EXCLUSIVE RIGHT TO USE "VIOLINS", APART FROM THE MARK AS SHOWN. SEC. 2(F).

CLASS 35—ADVERTISING AND BUSINESS

FOR RETAIL STORES FEATURING STRINGED MUSICAL INSTRUMENTS (U.S. CLS. 100, 101 AND 102).
FIRST USE 5-21-1994; IN COMMERCE 5-21-1994.

CLASS 37—CONSTRUCTION AND REPAIR

FOR REPAIR OF MUSICAL INSTRUMENTS, NAMELY, VIOLINS, VIOLAS, CELLOS, AND BASSES (U.S. CLS. 100, 103 AND 106).
FIRST USE 5-21-1994; IN COMMERCE 5-21-1994.
JIM RINGLE, EXAMINING ATTORNEY

THE MARK CONSISTS OF STANDARD CHARACTERS WITHOUT CLAIM TO ANY PARTICULAR FONT, STYLE, SIZE, OR COLOR.

CLASS 7—MACHINERY

FOR PARTS FOR MOTORS AND ENGINES FOR USE IN ALL-TERRAIN VEHICLES, MOTORCYCLES AND OTHER LAND VEHICLES, NAMELY, ENGINE CASES, ENGINE HEADS, AIR CLEANER SUPPORT BRACKET KIT CONSISTING PRIMARILY OF AIR CLEANER, AIR CLEANER COVER AND AIR FILTER, IGNITION, IGNITION SWITCH, KICK STARTERS, OIL FILTER MOUNT, OIL TANK MOUNT, SPARK PLUG IGNITION WIRES, CONTACT POINTS COVER, SPARK PLUGS, STARTER BOOT, STARTER, STARTER BUTTON, STARTER RELAY PLUG, THROTTLE CABLE, THROTTLE GRIP SET, THROTTLE HOUSING, CARBURETOR, DISTRIBUTOR KIT CONSISTING PRIMARILY OF DISTRIBUTOR CAP, DISTRIBUTOR CAM AND ROTOR, EXHAUST BRACKET, EXHAUST FLANGE KIT CONSISTING PRIMARILY OF EXHAUST PIPES, PULLEY, SPROCKET PULLEY AND PARTS FOR FUEL INJECTION SYSTEMS, NAMELY, FUEL VALVES (U.S. CLS. 13, 19, 21, 23, 31, 34 AND 35).

SN 76-594,861. TECHNO-PIEUX INC., QUEBEC, CANADA, FILED 6-1-2004.

techno METAL POST



PRIORITY CLAIMED UNDER SEC. 44(D) ON CANADA APPLICATION NO. 1218092, FILED 5-26-2004, REG. NO. TMA638884, DATED 5-3-2005, EXPIRES 5-3-2020.
OWNER OF U.S. REG. NO. 2,880,694.

NO CLAIM IS MADE TO THE EXCLUSIVE RIGHT TO USE "METAL POST", APART FROM THE MARK AS SHOWN.

CLASS 6—METAL GOODS

FOR FOUNDATIONS, PILLARS, FOUNDATION POSTS, FOUNDATION STAKES AND FOUNDATION PILES ALL MADE OF METAL (U.S. CLS. 2, 12, 13, 14, 23, 25 AND 50).

CLASS 9—ELECTRICAL AND SCIENTIFIC APPARATUS

FOR METERS TO DETERMINE THE LOAD BEARING CAPACITY OF FOUNDATIONS, FOOTINGS AND PILING (U.S. CLS. 21, 23, 26, 36 AND 38).

CLASS 42—SCIENTIFIC, COMPUTER AND LEGAL SERVICES

FOR ENGINEERING SERVICES IN THE DESIGN OF FOUNDATIONS AND PERFORMANCE OF TESTS FOR FOUNDATIONS (U.S. CLS. 100 AND 101).
KAREN BRACEY, EXAMINING ATTORNEY

CLASS 12—VEHICLES

FOR MOTORCYCLES, ALL-TERRAIN VEHICLES, MOTORCYCLE PARTS, AND ALL-TERRAIN VEHICLE PARTS, NAMELY, ENGINES AND MOTORS, COUPLINGS, AXLE COVERS, AXLE SPACERS, BATTERY CUSHIONS, BATTERY STRAPS, BELT GUARDS, BRAKE CALIPERS, BRAKE HANGERS, BRAKE LINES, BRAKE PADS, BRAKE ROTORS, CABLE COVERS, CHARGING SYSTEMS, CLUTCHES, CLUTCH CABLES, CLUTCH CABLE COVERS, CLUTCH PUSHRODS, CLUTCH SHELLS, DISC ROTOR VENTS, DRIVE BELTS, FENDER PAINT SAVERS, FORK STOPS, FORK TUBES, FORK TUBE LUGS, FUEL TANKS, HANDLE BAR CONTROL KITS CONSISTING PRIMARILY OF HANDLE BAR CONTROLS, HANDLE BAR DAMPENERS, HANDLE BAR RISERS, HANDLE BARS AND HANDLE GRIPS, HEADLIGHT MOUNTING BLOCKS, HORN WITH COVERS, IDLE CABLES, INNER PRIMARY COVERS, INVERTED FRONT ENDS, JUMPER HARNESSES, KEY SWITCH COVERS, KICK STANDS, KICKER ARMS, LICENSE PLATE FRAMES, MINI HORNS, REARVIEW MIRRORS, MOTOR MOUNT SPACERS, PRIMARY DRIVE SYSTEMS, NAMELY, INNER PRIMARY COVERS, OUTER PRIMARY COVERS, PRIMARY COVERS, PRIMARY DRIVES AND PRIMARY SPACERS, ROTOR SPACERS, RUBBER ISOLATORS, SHIFTER RODS, SHOCK ABSORBER KITS CONSISTING PRIMARILY OF SHOCKS, SWINGARM BUMPER, TRIPLE TREES, TURN SIGNAL MOUNTS, UPPER LEG BUSHINGS, VAPOR VALVES, VOLTAGE REGULATOR MOUNT, TRANSMISSIONS, TRANSMISSION CASES, AND TRANSMISSION COMPONENTS, NAMELY, HYDRAULIC ACTUATORS (U.S. CLS. 19, 21, 23, 31, 35 AND 44).
JULIE WATSON, EXAMINING ATTORNEY

SN 76-595,141. NIPRO CORPORATION, OSAKA, OSAKA, JAPAN, FILED 5-27-2004.

NIPRO

OWNER OF U.S. REG. NO. 1,441,070.

CLASS 5—PHARMACEUTICALS

FOR (BASED ON INTENT TO USE) MEDICAL DIAGNOSTIC TEST STRIPS FOR CHECKING A GLUCOSE LEVEL IN BLOOD (U.S. CLS. 6, 18, 44, 46, 51 AND 52).

CLASS 10—MEDICAL APPARATUS

FOR (BASED ON USE IN COMMERCE) DIABETES MANAGEMENT PRODUCTS FOR DIABETES MONITORING TREATMENT, NAMELY DRUG INFUSION PUMPS; (BASED ON INTENT TO USE) DIABETES MANAGEMENT PRODUCTS FOR DIABETES MONITORING TREATMENT, NAMELY GLUCOSE MONITORS (U.S. CLS. 26, 39 AND 44).

FIRST USE 8-8-2002; IN COMMERCE 8-8-2002.

CLASS 35—ADVERTISING AND BUSINESS

FOR (BASED ON INTENT TO USE) RETAIL STORES FEATURING MEDICAL SUPPLIES; RETAIL PHARMACY SERVICES (U.S. CLS. 100, 101 AND 102).

CLASS 44—MEDICAL, BEAUTY AND AGRICULTURAL SERVICES

FOR (BASED ON INTENT TO USE) MEDICAL COUNSELING FOR DIABETES DISEASE MANAGEMENT AND TREATMENT STRATEGIES PROVIDED VIA THE INTERNET (U.S. CLS. 100 AND 101).

ELISSA GARBER KON, EXAMINING ATTORNEY

SN 76-595,268. CONTINENTAL TEVES AG & CO. OHG, D-60488 FRANKFURT, FED REP GERMANY, FILED 6-3-2004.

ARP

THE MARK CONSISTS OF STANDARD CHARACTERS WITHOUT CLAIM TO ANY PARTICULAR FONT, STYLE, SIZE, OR COLOR.

PRIORITY CLAIMED UNDER SEC. 44(D) ON FED REP GERMANY APPLICATION NO. 30407138.2/1, FILED 2-10-2004, REG. NO. 30407138, DATED 3-22-2004, EXPIRES 2-28-2014.

CLASS 9—ELECTRICAL AND SCIENTIFIC APPARATUS

FOR ELECTRIC AND ELECTRONIC CONTROL AND REGULATING UNITS FOR DRIVES, BRAKES, SUSPENSION AND DAMPING, FOR INCORPORATION INTO LAND MOTOR VEHICLES FOR ROLLOVER PROTECTION (U.S. CLS. 21, 23, 26, 36 AND 38).

CLASS 12—VEHICLES

FOR LAND MOTOR VEHICLE COMPONENTS, NAMELY, STRUCTURAL PARTS USED TO PROVIDE ANTI-ROLLOVER PROTECTION (U.S. CLS. 19, 21, 23, 31, 35 AND 44).

ALICE SUE CARRUTHERS, EXAMINING ATTORNEY

SN 76-595,723. TWO FAT CHILE CATS, INC., NAPLES, FL. FILED 6-4-2004.



THE COLOR(S) GREEN, BLACK, BROWNISH ORANGE, LIGHT ORANGE, RED, DARK RED, AND YELLOW IS/ARE CLAIMED AS A FEATURE OF THE MARK.

THE INITIAL LETTERS "T", "F" AND "C" OF TWO FAT CHILE CATS ARE GREEN. THE OTHER LETTERS IN TWO FAT CHILE CATS ARE BLACK. THE FAT CAT ON THE LEFT IS BROWNISH ORANGE. THE TALL SKINNY CAT ON THE RIGHT IS LIGHT ORANGE. THE PEPPERS IN THE MARK ARE DARK RED. THE COLORS OF THE SPIRAL BACKGROUND ARE RED AND YELLOW.

CLASS 29—MEATS AND PROCESSED FOODS

FOR PREPARED FOOD PRODUCTS; NAMELY, JELLIES, JAMS (U.S. CL. 46).

CLASS 30—STAPLE FOODS

FOR SAUCES AND SEASONINGS (U.S. CL. 46).

BRIAN NEVILLE, EXAMINING ATTORNEY

SN 76-595,803. IRIE RADIO, INC., OCEAN CITY, MD. FILED 6-7-2004.

YOUR ENTERTAINMENT CONNECTION

THE MARK CONSISTS OF STANDARD CHARACTERS WITHOUT CLAIM TO ANY PARTICULAR FONT, STYLE, SIZE, OR COLOR.

CLASS 38—COMMUNICATION

FOR RADIO PROGRAM BROADCASTING (U.S. CLS. 100, 101 AND 104).

FIRST USE 11-22-2002; IN COMMERCE 11-22-2002.

CLASS 41—EDUCATION AND ENTERTAINMENT

FOR RADIO PROGRAMMING; ENTERTAINMENT SERVICES, NAMELY, PROVIDING A RADIO PROGRAM IN THE FIELD OF LIVE ENTERTAINMENT INFORMATION (U.S. CLS. 100, 101 AND 107).

FIRST USE 11-22-2002; IN COMMERCE 11-22-2002.

AMY GEARIN, EXAMINING ATTORNEY

SN 76-596,090. THE BOARD OF REGENTS OF THE UNIVERSITY SYSTEM OF GEORGIA, ATLANTA, GA. FILED 6-8-2004.

THE UNIVERSITY OF GEORGIA

THE MARK CONSISTS OF STANDARD CHARACTERS WITHOUT CLAIM TO ANY PARTICULAR FONT, STYLE, SIZE, OR COLOR.

NO CLAIM IS MADE TO THE EXCLUSIVE RIGHT TO USE UNIVERSITY, APART FROM THE MARK AS SHOWN. SEC. 2(F).

CLASS 6—METAL GOODS

FOR METAL KEY CHAINS (U.S. CLS. 2, 12, 13, 14, 23, 25 AND 50).
FIRST USE 0-0-1988; IN COMMERCE 0-0-1988.

CLASS 14—JEWELRY

FOR JEWELRY, NAMELY LAPEL PINS AND RINGS (U.S. CLS. 2, 27, 28 AND 50).
FIRST USE 6-0-1938; IN COMMERCE 6-0-1938.

CLASS 16—PAPER GOODS AND PRINTED MATTER

FOR FOLDERS, DECALS, NOTEBOOKS, NOTE PAPER, PAPER WEIGHTS (U.S. CLS. 2, 5, 22, 23, 29, 37, 38 AND 50).
FIRST USE 1-0-1900; IN COMMERCE 1-0-1900.

CLASS 21—HOUSEWARES AND GLASS

FOR DRINKING GLASSES AND MUGS (U.S. CLS. 2, 13, 23, 29, 30, 33, 40 AND 50).
FIRST USE 1-0-1900; IN COMMERCE 1-0-1900.

CLASS 25—CLOTHING

FOR CAPS, HATS, T-SHIRTS, SWEATSHIRTS AND SCARVES (U.S. CLS. 22 AND 39).
FIRST USE 1-0-1900; IN COMMERCE 1-0-1900.

CLASS 41—EDUCATION AND ENTERTAINMENT

FOR EDUCATIONAL SERVICES, NAMELY PROVIDING COURSES OF STUDY AT THE UNIVERSITY LEVEL (U.S. CLS. 100, 101 AND 107).
FIRST USE 0-0-1785; IN COMMERCE 0-0-1785.
AISHA CLARKE, EXAMINING ATTORNEY

SN 76-596,278. ENCANA GAS STORAGE INC., WILMINGTON, DE. FILED 5-24-2004.

LNG HIGHWAY

THE MARK CONSISTS OF STANDARD CHARACTERS WITHOUT CLAIM TO ANY PARTICULAR FONT, STYLE, SIZE, OR COLOR.

NO CLAIM IS MADE TO THE EXCLUSIVE RIGHT TO USE "LNG", APART FROM THE MARK AS SHOWN.

CLASS 35—ADVERTISING AND BUSINESS

FOR MARKETING CONSULTING SERVICES IN THE AREA OF COORDINATED INFRASTRUCTURE DEVELOPMENT OF PIPELINES, LIQUID NATURAL GAS, AND NATURAL GAS STORAGE FOR OTHERS; ADVERTISING AND PROMOTION SERVICES AND RELATED CONSULTING (U.S. CLS. 100, 101 AND 102).
FIRST USE 7-30-2003; IN COMMERCE 7-30-2003.

CLASS 37—CONSTRUCTION AND REPAIR

FOR CONSULTING SERVICES IN THE AREA OF THE INTERCONNECTION AND DEVELOPMENT OF PIPELINE, LIQUID NATURAL GAS, AND NATURAL GAS STORAGE INFRASTRUCTURE (U.S. CLS. 100, 103 AND 106).
FIRST USE 7-30-2003; IN COMMERCE 7-30-2003.

JIM RINGLE, EXAMINING ATTORNEY

SN 76-597,519. TUWAY MOBILE COMMUNICATIONS, INC., BETHLEHEM, PA. FILED 6-14-2004.



NO CLAIM IS MADE TO THE EXCLUSIVE RIGHT TO USE "TWO WAY COMMUNICATIONS", APART FROM THE MARK AS SHOWN.

CLASS 38—COMMUNICATION

FOR TELECOMMUNICATIONS GATEWAY, ACCESS, WIRELESS BROADBAND, VOICE OVER INTERNET PROTOCOL (VOIP), ISDN, CALL PROCESSING, AND VOICE LOGGING SERVICES (U.S. CLS. 100, 101 AND 104).
FIRST USE 4-1-2004; IN COMMERCE 4-1-2004.

CLASS 42—SCIENTIFIC, COMPUTER AND LEGAL SERVICES

FOR DESIGNING AND IMPLEMENTING LEADING-EDGE TELECOMMUNICATIONS SYSTEMS FEATURING FIXED DATA TRANSPORT, TWO-WAY RADIO AND INFRASTRUCTURE, AND MOBILE DATA TRANSMISSION (U.S. CLS. 100 AND 101).
FIRST USE 4-1-2004; IN COMMERCE 4-1-2004.

MICHAEL KAZAZIAN, EXAMINING ATTORNEY

SN 76-597,635. BAHAMAS BILLFISH CHAMPIONSHIP, INC., HOLLYWOOD, FL. FILED 6-16-2004.

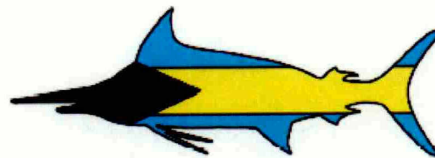

THE COLOR(S) BLACK, YELLOW AND BLUE ARE CLAIMED AS A FEATURE OF THE MARK.

THE MARK CONSISTS OF A FISH IN THE COLORS BLACK, YELLOW AND BLUE.

CLASS 18—LEATHER GOODS

FOR ALL-PURPOSE CARRYING BAGS, DUFFEL BAGS, LUGGAGE, AND LUGGAGE TAGS (U.S. CLS. 1, 2, 3, 22 AND 41).

FIRST USE 4-0-1997; IN COMMERCE 4-0-1997.

CLASS 21—HOUSEWARES AND GLASS

FOR BEVERAGE GLASSWARE AND PLASTIC COATED COASTERS (U.S. CLS. 2, 13, 23, 29, 30, 33, 40 AND 50).

FIRST USE 4-0-1997; IN COMMERCE 4-0-1997.

CLASS 24—FABRICS

FOR TOWELS AND FABRIC FLAGS (U.S. CLS. 42 AND 50).

FIRST USE 4-0-1997; IN COMMERCE 4-0-1997.

CLASS 25—CLOTHING

FOR CLOTHING, NAMELY, SHIRTS, JACKETS, PULLOVERS, HATS, AND VISORS (U.S. CLS. 22 AND 39).

FIRST USE 4-0-1997; IN COMMERCE 4-0-1997.

CLASS 41—EDUCATION AND ENTERTAINMENT

FOR ARRANGING AND CONDUCTING FISHING TOURNAMENTS AND CONTESTS (U.S. CLS. 100, 101 AND 107).

FIRST USE 4-0-1997; IN COMMERCE 4-0-1997.

DOMINIC J. FERRAIUOLO, EXAMINING ATTORNEY

SN 76-598,135. EDUCATION THROUGH MUSIC, INC., NEW YORK, NY. FILED 6-18-2004.

ETM

THE MARK CONSISTS OF STANDARD CHARACTERS WITHOUT CLAIM TO ANY PARTICULAR FONT, STYLE, SIZE, OR COLOR.

CLASS 16—PAPER GOODS AND PRINTED MATTER

FOR PUBLICATIONS AND PRINTED MATERIALS, NAMELY, BOOKS, NEWSLETTERS, PRINTED TEACHING MATERIALS, WORKBOOKS, INSTRUCTION MANUALS, TEACHERS' MANUALS, COLORING BOOKS, ACTIVITY BOOKS, SONG BOOKS AND PRINTED CURRICULUM IN THE FIELD OF MUSIC AND EDUCATION FOR CHILDREN (U.S. CLS. 2, 5, 22, 23, 29, 37, 38 AND 50).

FIRST USE 0-0-1997; IN COMMERCE 0-0-1999.

CLASS 36—INSURANCE AND FINANCIAL

FOR CHARITABLE FUND RAISING SERVICES, NAMELY, RAISING FUNDS FOR THE DEVELOPMENT AND DISSEMINATION OF PROGRAMS AND ACADEMIC CURRICULUM INTEGRATED WITH MUSIC AND OTHER FINE ARTS FOR THE PURPOSE OF STIMULATING AND ENHANCING ACADEMIC PERFORMANCE IN CHILDREN (U.S. CLS. 100, 101 AND 102).

FIRST USE 0-0-1992; IN COMMERCE 0-0-1992.

CLASS 41—EDUCATION AND ENTERTAINMENT

FOR EDUCATIONAL SERVICES, NAMELY, THE DEVELOPMENT AND DISSEMINATION OF PROGRAMS AND ACADEMIC CURRICULUM INTEGRATED WITH MUSIC AND OTHER FINE ARTS FOR THE PURPOSE OF STIMULATING AND ENHANCING ACADEMIC PERFORMANCE IN CHILDREN (U.S. CLS. 100, 101 AND 107).

FIRST USE 0-0-1992; IN COMMERCE 0-0-1999.

TRACY FLETCHER, EXAMINING ATTORNEY

SN 76-598,180. PURE ENTERTAINMENT, INC., FT. LAUDERDALE, FL. FILED 6-18-2004.

PURE RECORDS

NO CLAIM IS MADE TO THE EXCLUSIVE RIGHT TO USE "RECORDS", APART FROM THE MARK AS SHOWN.

CLASS 9—ELECTRICAL AND SCIENTIFIC APPARATUS

FOR SOUND RECORDINGS, VIDEO RECORDINGS, PRERECORDED COMPACT DISCS, PRERECORDED PHONOGRAPH RECORDS, PRERECORDED VIDEO TAPES, VIDEO DISCS AND DVDS ALL FEATURING MUSICAL COMPOSITIONS AND MUSICAL PERFORMANCES (U.S. CLS. 21, 23, 26, 36 AND 38).

FIRST USE 6-3-2005; IN COMMERCE 6-3-2005.

CLASS 41—EDUCATION AND ENTERTAINMENT

FOR RECORD PRODUCTION; RECORD MASTER PRODUCTION; MUSIC PRODUCTION; AUDIO RECORDING AND PRODUCTION; VIDEOTAPE PRODUCTION; ENTERTAINMENT SERVICES, NAMELY, PRODUCING MUSICAL AUDIO AND VIDEO RECORDINGS; ENTERTAINMENT IN THE NATURE OF A LIVE MUSICAL ARTIST, MUSICAL BAND AND MUSICAL GROUP; ENTERTAINMENT IN THE NATURE OF LIVE PERFORMANCES BY A MUSICAL ARTIST, MUSICAL BAND AND MUSICAL GROUP; ENTERTAINMENT IN THE NATURE OF VISUAL AND AUDIO PERFORMANCES BY A MUSICAL ARTIST, MUSICAL BAND AND MUSICAL GROUP; ENTERTAINMENT, NAMELY, LIVE MUSIC CONCERTS; ENTERTAINMENT, NAMELY, PERSONAL APPEARANCES BY A MUSICAL ARTIST, MUSICAL BAND AND MUSICAL GROUP; ENTERTAINMENT SERVICES, NAMELY, PROVIDING A WEB SITE FEATURING MUSICAL PERFORMANCES, MUSICAL VIDEOS, RELATED FILM CLIPS, PHOTOGRAPHS, AND OTHER MULTIMEDIA MATERIALS; ENTERTAINMENT SERVICES, NAMELY, PROVIDING PRERECORDED MUSIC, INFORMATION IN THE FIELD OF MUSIC, COMMENTARY AND ARTICLES ABOUT MUSIC, ALL ONLINE VIA A GLOBAL COMPUTER NETWORK (U.S. CLS. 100, 101 AND 107).

FIRST USE 9-0-2004; IN COMMERCE 9-0-2004.

WILLIAM BRECKENFELD, EXAMINING ATTORNEY

SN 76-598,273. STRATEGIC SWITCH AND AUDIO LLC, UNIT B SCHAUMBURG, IL. FILED 6-21-2004.

STRATEGIC SWITCH & AUDIO

THE MARK CONSISTS OF STANDARD CHARACTERS WITHOUT CLAIM TO ANY PARTICULAR FONT, STYLE, SIZE, OR COLOR.

NO CLAIM IS MADE TO THE EXCLUSIVE RIGHT TO USE SWITCH & AUDIO, APART FROM THE MARK AS SHOWN.

CLASS 9—ELECTRICAL AND SCIENTIFIC APPARATUS

FOR ELECTRONIC COMPONENTS, NAMELY, SWITCHES, SPEAKERS, BUZZERS AND SOUND GENERATORS (U.S. CLS. 21, 23, 26, 36 AND 38).
FIRST USE 9-15-2002; IN COMMERCE 9-15-2002.

CLASS 35—ADVERTISING AND BUSINESS

FOR DISTRIBUTORSHIP SERVICES IN THE FIELD OF ELECTRONIC COMPONENTS, NAMELY, SWITCHES, SPEAKERS, BUZZERS, SOUND GENERATORS AND BATTERIES (U.S. CLS. 100, 101 AND 102).
FIRST USE 9-3-2002; IN COMMERCE 9-3-2002.
SUSAN LESLIE DUBOIS, EXAMINING ATTORNEY

CLASS 25—CLOTHING

FOR CLOTHING FOR MEN, WOMEN AND CHILDREN, NAMELY; T-SHIRTS, SHIRTS, DORM SHIRTS, BLOUSES, SWEATERS, CARDIGANS, TURTLENECKS, VESTS, WIND SHIRTS, SWEAT SHIRTS, TANK TOPS, JERSEYS, BASEBALL SHIRTS, GOLF SHIRTS, JOGGING SHIRTS, SKIRTS, SHORTS, GYM SHORTS, BOXERS, TENNIS SHIRTS, JEANS, PANTS, SWEAT PANTS, WARM-UP SUITS, JACKETS, RUNNING SUITS, RAIN WEAR, SLEEP WEAR, ROBES, SWIM WEAR, SNOWBOARD PANTS, SNOWBOARD JACKETS, SKATEBOARD PANTS, SKATEBOARD SHORTS, BELTS, BANDANNAS, NECKBANDS, WRISTBANDS, SUSPENDERS, BEACH WEAR, CAPS, HATS, BEANIES, HEADBANDS, SWEATBANDS, EAR MUFFS, VISORS AND SUNVISORS (U.S. CLS. 22 AND 39).
FIRST USE 3-1-2003; IN COMMERCE 3-1-2004.

CLASS 40—MATERIAL TREATMENT

FOR APPLYING FINISHES SUCH AS SCREEN PRINTING, EMBROIDERY, HEAT APPLIED APPLICATIONS AND PAD PRINTING TO CLOTHING, MUGS, BLANKETS, BRIEFCASES, BACKPACKS, DUFFEL BAGS, GOLF BALLS, PENS, TOWELS AND KEY CHAINS (U.S. CLS. 100, 103 AND 106).
FIRST USE 3-1-2003; IN COMMERCE 3-1-2004.
LEIGH CAROLINE CASE, EXAMINING ATTORNEY

SN 76-598,513. MITCHELLACE, INC., PORTSMOUTH, OH.
FILED 6-18-2004.



CLASS 22—CORDAGE AND FIBERS

FOR LANYARDS FOR HOLDING EYEGLASSES, BADGES, KEYS, IDENTIFICATION CARDS, WHISTLES, WATER BOTTLES, AND EVENT PASSES (U.S. CLS. 1, 2, 7, 19, 22, 42 AND 50).
FIRST USE 12-1-2003; IN COMMERCE 12-1-2003.

CLASS 26—FANCY GOODS

FOR SHOE LACES (U.S. CLS. 37, 39, 40, 42 AND 50).
FIRST USE 12-1-2003; IN COMMERCE 12-1-2003.
KELLEY WELLS, EXAMINING ATTORNEY

SN 76-598,752. TROY GROUP, INC., SANTA ANA, CA.
FILED 6-21-2004.

TROY LASER INDELIBLE SOLUTION

THE MARK CONSISTS OF STANDARD CHARACTERS WITHOUT CLAIM TO ANY PARTICULAR FONT, STYLE, SIZE, OR COLOR.
OWNER OF U.S. REG. NOS. 1,322,989 AND 1,996,706.
NO CLAIM IS MADE TO THE EXCLUSIVE RIGHT TO USE "LASER INDELIBLE SOLUTION" AS TO CLASS 2, APART FROM THE MARK AS SHOWN.

CLASS 2—PAINTS

FOR TONER FOR COPIERS AND PRINTERS (U.S. CLS. 6, 11 AND 16).

CLASS 16—PAPER GOODS AND PRINTED MATTER

FOR PAPER PRODUCTS, NAMELY COPIER AND PRINTER PAPER (U.S. CLS. 2, 5, 22, 23, 29, 37, 38 AND 50).
CATHERINE CAIN, EXAMINING ATTORNEY

SN 76-598,535. RITSCHARD BROS., INC., ARGYLE, WI.
FILED 6-22-2004.

THUNDER BRIDGE TRADING CO.

THE MARK CONSISTS OF STANDARD CHARACTERS WITHOUT CLAIM TO ANY PARTICULAR FONT, STYLE, SIZE, OR COLOR.
NO CLAIM IS MADE TO THE EXCLUSIVE RIGHT TO USE TRADING CO., APART FROM THE MARK AS SHOWN.

SN 76-598,754. LAFAYETTE VENETIAN BLIND, INC., WEST LAFAYETTE, IN. FILED 6-21-2004.

Louver Mover

THE MARK CONSISTS OF STANDARD CHARACTERS WITHOUT CLAIM TO ANY PARTICULAR FONT, STYLE, SIZE, OR COLOR.

CLASS 19—NON-METALLIC BUILDING MATERIALS

FOR NON-METAL SHUTTERS AND PARTS OF SHUTTERS, NAMELY, LOUVERS AND COMPONENTS FOR LOUVER AND SHUTTER ASSEMBLIES, NAMELY, GEAR ACTUATORS FOR OPENING AND CLOSING ALL LOUVERS IN UNISON, SOLD AS A UNIT THEREWITH (U.S. CLS. 1, 12, 33 AND 50).

FIRST USE 11-15-1993; IN COMMERCE 11-15-1993.

CLASS 20—FURNITURE AND ARTICLES NOT OTHERWISE CLASSIFIED

FOR WINDOW BLINDS; INTERIOR WINDOW SHUTTERS; AND PARTS OF INTERIOR WINDOW SHUTTERS, NAMELY, LOUVERS (U.S. CLS. 2, 13, 22, 25, 32 AND 50).

FIRST USE 11-15-1993; IN COMMERCE 11-15-1993.
CATHERINE CAIN, EXAMINING ATTORNEY

SN 76-599,009. NAMCO LTD., TOKYO, JAPAN, FILED 6-24-2004.

TALES OF SYMPHONIA

THE MARK CONSISTS OF STANDARD CHARACTERS WITHOUT CLAIM TO ANY PARTICULAR FONT, STYLE, SIZE, OR COLOR.

CLASS 9—ELECTRICAL AND SCIENTIFIC APPARATUS

FOR VIDEO GAME CARTRIDGES AND COMPUTER GAME PROGRAMS (U.S. CLS. 21, 23, 26, 36 AND 38).

CLASS 28—TOYS AND SPORTING GOODS

FOR COIN-OPERATED AMUSEMENT GAME MACHINES (U.S. CLS. 22, 23, 38 AND 50).
RONALD MCMORROW, EXAMINING ATTORNEY

SN 76-599,010. NAMCO LTD., TOKYO, JAPAN, FILED 6-24-2004.

THE NIGHTMARE OF DRUAGA

THE MARK CONSISTS OF STANDARD CHARACTERS WITHOUT CLAIM TO ANY PARTICULAR FONT, STYLE, SIZE, OR COLOR.

PRIORITY CLAIMED UNDER SEC. 44(D) ON JAPAN APPLICATION NO. 2003-115960, FILED 12-26-2003.

CLASS 9—ELECTRICAL AND SCIENTIFIC APPARATUS

FOR VIDEO GAME CARTRIDGES AND COMPUTER GAME PROGRAMS (U.S. CLS. 21, 23, 26, 36 AND 38).

CLASS 28—TOYS AND SPORTING GOODS

FOR COIN-OPERATED AMUSEMENT GAME MACHINES (U.S. CLS. 22, 23, 38 AND 50).
RONALD MCMORROW, EXAMINING ATTORNEY

SN 76-599,065. OLDEMARK LLC, BURLINGTON, VT. FILED 6-22-2004.



OWNER OF U.S. REG. NOS. 935,109, 2,777,699 AND OTHERS.

NO CLAIM IS MADE TO THE EXCLUSIVE RIGHT TO USE "KIDS", APART FROM THE MARK AS SHOWN. THE NAME WENDY APPEARING IN THE MARK IDENTIFIES A LIVING INDIVIDUAL WHOSE CONSENT IS OF RECORD.

CLASS 36—INSURANCE AND FINANCIAL

FOR CHARITABLE FUNDRAISING (U.S. CLS. 100, 101 AND 102).

FIRST USE 4-1-2004; IN COMMERCE 4-1-2004.

CLASS 45—PERSONAL SERVICES

FOR ADOPTION AND CHILD PLACEMENT SERVICES (U.S. CLS. 100 AND 101).

FIRST USE 4-1-2004; IN COMMERCE 4-1-2004.
RENEE MCCRAY, EXAMINING ATTORNEY

SN 76-599,704. CTM CREATIVE TILE MARKETING, INC., FORT LAUDERDALE, FL. FILED 6-28-2004.



NO CLAIM IS MADE TO THE EXCLUSIVE RIGHT TO USE "CASA", APART FROM THE MARK AS SHOWN.

THE ENGLISH TRANSLATION OF THE SPANISH WORD "CASA" IS "HOUSE".

CLASS 19—NON-METALLIC BUILDING MATERIALS

FOR NATURAL STONES, STONE MOSAICS, CERAMIC AND PORCELAIN TILES (U.S. CLS. 1, 12, 33 AND 50).

CLASS 21—HOUSEWARES AND GLASS

FOR GLASS AND CERAMIC MOSAICS NOT FOR BUILDING (U.S. CLS. 2, 13, 23, 29, 30, 33, 40 AND 50).

CLASS 35—ADVERTISING AND BUSINESS

FOR RETAIL STORE SERVICES AND WHOLESALE DISTRIBUTORSHIP SERVICES FEATURING CERAMIC AND PORCELAIN TILES, NATURAL STONE AND MOSAICS CONSISTING OF STONE, GLASS, AND CERAMIC (U.S. CLS. 100, 101 AND 102).

BILL DAWE, EXAMINING ATTORNEY

SN 76-600,011. STIKLEY ENTERPRISES, INC., HOUSTON, TX. FILED 6-28-2004.

SN 76-600,391. RITO MINTS, LTD., TROIS-RIVIERES, QUEBEC, CANADA, FILED 6-29-2004.



NO CLAIM IS MADE TO THE EXCLUSIVE RIGHT TO USE "PRODUCTIONS", APART FROM THE MARK AS SHOWN.

THE ENGLISH TRANSLATION OF THE WORD "TIERRA" IN THE MARK IS "EARTH".

CLASS 35—ADVERTISING AND BUSINESS

FOR GENERAL BUSINESS CONSULTATION SERVICES, PREPARING CUSTOM ADVERTISEMENTS IN THE FORM OF PRINT MEDIA FOR OTHERS, ADVERTISING SERVICES, NAMELY CREATING CORPORATE AND BRAND IDENTITY THROUGH PRINT MEDIA FOR OTHERS (U.S. CLS. 100, 101 AND 102).
FIRST USE 6-2-2004; IN COMMERCE 6-2-2004.

CLASS 38—COMMUNICATION

FOR STREAMING OF AUDIO AND VIDEO CONTENT ON THE INTERNET (U.S. CLS. 100, 101 AND 104).
FIRST USE 6-2-2004; IN COMMERCE 6-2-2004.

CLASS 40—MATERIAL TREATMENT

FOR DESKTOP PUBLISHING FOR OTHERS (U.S. CLS. 100, 103 AND 106).
FIRST USE 6-2-2004; IN COMMERCE 6-2-2004.

CLASS 41—EDUCATION AND ENTERTAINMENT

FOR AUDIO RECORDING AND PRODUCTION, NAMELY, AUDIO TAPE EDITING, MIXING AND MASTERING, VIDEOTAPE RECORDING AND EDITING, MUSIC PUBLISHING (U.S. CLS. 100, 101 AND 107).
FIRST USE 6-2-2004; IN COMMERCE 6-2-2004.

CLASS 42—SCIENTIFIC, COMPUTER AND LEGAL SERVICES

FOR COMPUTER SERVICES, NAMELY DESIGN OF NETWORK WEB PAGES FOR OTHERS, HOSTING OF DIGITAL CONTENT ON THE INTERNET, LICENSING OF INTELLECTUAL PROPERTY, GRAPHIC PRINT MEDIA ILLUSTRATION SERVICES FOR OTHERS (U.S. CLS. 100 AND 101).
FIRST USE 6-2-2004; IN COMMERCE 6-2-2004.
BRENDAN REGAN, EXAMINING ATTORNEY

RITO

THE MARK CONSISTS OF STANDARD CHARACTERS WITHOUT CLAIM TO ANY PARTICULAR FONT, STYLE, SIZE, OR COLOR.

"RITO" MEANS "RITE" OR "RITUAL" IN SPANISH.

CLASS 30—STAPLE FOODS

FOR CONFECTIONARY, NAMELY, CANDY (U.S. CL. 46).
FIRST USE 0-0-1957; IN COMMERCE 0-0-1998.

CLASS 40—MATERIAL TREATMENT

FOR CUSTOM MANUFACTURING TO THE ORDER AND SPECIFICATION OF OTHERS OF CANDY AND CANDY PACKAGING (U.S. CLS. 100, 103 AND 106).
FIRST USE 0-0-1957; IN COMMERCE 0-0-1995.
DAVID C. REIHNER, EXAMINING ATTORNEY

SN 76-600,400. ALOE LABORATORIES, INC., HARLINGEN, TX. FILED 6-29-2004.

ALOELABS

THE MARK CONSISTS OF STANDARD CHARACTERS WITHOUT CLAIM TO ANY PARTICULAR FONT, STYLE, SIZE, OR COLOR.

OWNER OF U.S. REG. NO. 1,384,934.

CLASS 3—COSMETICS AND CLEANING PREPARATIONS

FOR TOPICAL ALOE VERA GEL, ALOE VERA MOISTURIZING LOTION AND CREAM, ALOE VERA AFTER SUN LOTION, SUNSCREEN LOTION, AGE SPOT CONTROL CREAM; HAIR TONIC; AND MOUTHWASH (U.S. CLS. 1, 4, 6, 50, 51 AND 52).
FIRST USE 2-1-2001; IN COMMERCE 2-1-2001.

CLASS 5—PHARMACEUTICALS

FOR ALOE VERA PLANT POWDER CAPSULES AS A HERBAL SUPPLEMENT, MEDICATED TOPICAL CREAM AND FIRST AID JELLY FOR RELIEF OF MINOR BUMS, RASHES, CUTS, INSECT BITES AND BLEMISHES (U.S. CLS. 6, 18, 44, 46, 51 AND 52).
FIRST USE 2-1-2001; IN COMMERCE 2-1-2001.
CHRISTOPHER BUONGIORNO, EXAMINING ATTORNEY

SN 76-600,512. LYMPHOMA RESEARCH FOUNDATION,
NEW YORK, NY. FILED 7-2-2004.

PRACTICE-A-THON ON A GRAND SCALE FOR LYMPHOMA

NO CLAIM IS MADE TO THE EXCLUSIVE RIGHT TO USE "LYMPHOMA", APART FROM THE MARK AS SHOWN.

CLASS 35—ADVERTISING AND BUSINESS

FOR PROMOTING PUBLIC AWARENESS OF THE NEED FOR RESEARCH AND TREATMENT IN THE FIELD OF LYMPHOMA (U.S. CLS. 100, 101 AND 102).
FIRST USE 4-12-2004; IN COMMERCE 4-12-2004.

CLASS 36—INSURANCE AND FINANCIAL

FOR CHARITABLE FUNDRAISING IN THE FIELD OF LYMPHOMA EFFECTED THROUGH ORGANIZING AND CONDUCTING MUSICAL PROGRAMS AND EVENTS (U.S. CLS. 100, 101 AND 102).
FIRST USE 4-12-2004; IN COMMERCE 4-12-2004.
HOWARD SMIGA, EXAMINING ATTORNEY

CLASS 9—ELECTRICAL AND SCIENTIFIC APPARATUS

FOR COMPUTER SOFTWARE FOR PROGRAMMING COMPUTER CONTROLLED MACHINES; COMPUTER SOFTWARE FOR MANUFACTURERS OF PRODUCTS INCLUDING CABINETRY, FURNITURE, AND FIXTURES, FOR THE CUTTING, FORMING AND MANUFACTURE OF CABINETRY, FURNITURE, AND FIXTURES; AND COMPUTER NUMERICAL CONTROL SYSTEMS COMPRISED OF A MICROPROCESSOR-BASED CENTRAL PROCESSING UNIT, RANDOM-ACCESS MEMORY, INPUT/OUTPUT BUSES FOR INPUTTING DATA TO AND RETRIEVING DATA THEREFROM, KEYBOARD AND MANUAL HAND HELD DATA INPUTTING DEVICES, NAMELY, HAND-HELD KEYPADS, CATHODE RAY TUBE FOR THE DISPLAYING OF DATA, FLEXIBLE DISK MEMORY STORAGE, HARD DISK MEMORY STORAGE SYSTEM COMPRISED OF COMPUTER HARDWARE, OPERATING SOFTWARE, AND HARD DISK DRIVE, FUNCTION-SPECIFIC ELECTRICAL SWITCHES FOR INPUTTING SIGNALS TO SAID CENTRAL PROCESSING UNIT, SERVO MOTOR CONTROL SYSTEMS COMPRISED OF COMPUTER HARDWARE, OPERATING SOFTWARE AND ELECTRONIC SERVO MOTOR CONTROLLERS FOR CONTROLLING CENTRAL PROCESSING UNIT FOR MACHINE TOOL AND AUTOMATION APPLICATIONS, AND RELATED SOFTWARE PROGRAMS FOR PROVIDING TO SAID CENTRAL PROCESSING UNIT INDIVIDUAL WORKPIECE PROCESSING INSTRUCTIONS, NAMELY AS CUT-PATHS, AND DOCUMENTATION SOLD AS A UNIT (U.S. CLS. 21, 23, 26, 36 AND 38).
FIRST USE 1-31-1989; IN COMMERCE 1-31-1989.

CLASS 35—ADVERTISING AND BUSINESS

FOR COMPUTERIZED ON-LINE ORDERING SERVICES IN THE FIELD OF CABINETRY DESIGN AND FABRICATION (U.S. CLS. 100, 101 AND 102).
FIRST USE 8-2-2001; IN COMMERCE 8-2-2001.
MELVIN AXILBUND, EXAMINING ATTORNEY

SN 76-601,256. BURROUGHS & CHAPIN COMPANY, INC.,
MYRTLE BEACH, SC. FILED 7-7-2004.

OUR NAME MEANS A GREAT DEAL

THE MARK CONSISTS OF STANDARD CHARACTERS WITHOUT CLAIM TO ANY PARTICULAR FONT, STYLE, SIZE, OR COLOR.

CLASS 41—EDUCATION AND ENTERTAINMENT

FOR ENTERTAINMENT SERVICES, NAMELY, PROVIDING FACILITIES FOR RECREATIONAL ACTIVITIES, NAMELY, GOLF, TENNIS, SWIMMING, BIKING; AND PROVIDING ENTERTAINMENT ATTRACTIONS, NAMELY, GOLF COURSES, DRIVING RANGES, TENNIS COURTS, SWIMMING POOLS, BIKE PATHS, CINEMAS, RESTAURANTS, AND MUSIC VENUES FEATURING LIVE MUSIC (U.S. CLS. 100, 101 AND 107).
FIRST USE 1-1-2003; IN COMMERCE 1-1-2003.

CLASS 43—HOTEL AND RESTAURANT SERVICES

FOR VACATION PLANNING SERVICES FOR TRIPS TO MYRTLE BEACH, NAMELY, TRAVEL AGENCY SERVICES, NAMELY, MAKING RESERVATIONS AND BOOKINGS FOR TEMPORARY LODGING (U.S. CLS. 100 AND 101).
FIRST USE 1-1-2003; IN COMMERCE 1-1-2003.
BILL DAWE, EXAMINING ATTORNEY

SN 76-600,886. THERMWOOD CORPORATION, DALE, IN.
FILED 7-7-2004.

THERMWOOD

THE MARK CONSISTS OF STANDARD CHARACTERS WITHOUT CLAIM TO ANY PARTICULAR FONT, STYLE, SIZE, OR COLOR.

CLASS 7—MACHINERY

FOR MACHINES AND MACHINE TOOLS FOR THE CUTTING AND FORMING OF MATERIALS, NAMELY MILLING MACHINES AND METAL AND WOOD WORKING MACHINES AND MACHINE CENTERS (U.S. CLS. 13, 19, 21, 23, 31, 34 AND 35).
FIRST USE 9-7-1976; IN COMMERCE 9-7-1976.

SN 76-601,587. STEELE, JEFFREY, FRANKLIN, TN. FILED 7-12-2004.

SN 76-602,571. GOLD COAST PROFESSIONAL SCHOOLS, INC., TAMARAC, FL. FILED 7-16-2004.

3 RING CIRCUS

THE MARK CONSISTS OF STANDARD CHARACTERS WITHOUT CLAIM TO ANY PARTICULAR FONT, STYLE, SIZE, OR COLOR.

CLASS 9—ELECTRICAL AND SCIENTIFIC APPARATUS

FOR MUSICAL SOUND RECORDINGS (U.S. CLS. 21, 23, 26, 36 AND 38).
FIRST USE 12-1-2002; IN COMMERCE 12-1-2002.

CLASS 41—EDUCATION AND ENTERTAINMENT

FOR MUSIC PUBLISHING SERVICES (U.S. CLS. 100, 101 AND 107).
FIRST USE 12-1-2002; IN COMMERCE 12-1-2002.
MICHAEL TANNER, EXAMINING ATTORNEY

SN 76-601,652. METHOD123 LIMITED, AUCKLAND, NEW ZEALAND, FILED 7-12-2004.

METHOD123

THE MARK CONSISTS OF STANDARD CHARACTERS WITHOUT CLAIM TO ANY PARTICULAR FONT, STYLE, SIZE, OR COLOR.

PRIORITY CLAIMED UNDER SEC. 44(D) ON NEW ZEALAND APPLICATION NO. 710160, FILED 3-26-2004, REG. NO. (210)710160, DATED 9-30-2004, EXPIRES 3-26-2014.

CLASS 16—PAPER GOODS AND PRINTED MATTER

FOR PRINTED PRODUCTS, NAMELY NEWSLETTERS AND PUBLICATIONS ON THE SUBJECT OF BUSINESS MANAGEMENT; DRAFTING, DRAWING AND MARKING TEMPLATES; PRINTED VISUALS IN THE NATURE OF PROMOTIONAL MATERIALS (U.S. CLS. 2, 5, 22, 23, 29, 37, 38 AND 50).

CLASS 35—ADVERTISING AND BUSINESS

FOR BUSINESS MANAGEMENT SERVICES; BUSINESS MANAGEMENT CONSULTANCY AS WELL AS DEVELOPMENT OF PROCESSES FOR THE ANALYSIS AND THE IMPLEMENTATION OF STRATEGY PLANS AND MANAGEMENT PROJECTS PROVIDED ONLINE (U.S. CLS. 100, 101 AND 102).

ANNE E. GUSTASON, EXAMINING ATTORNEY



CLASS 9—ELECTRICAL AND SCIENTIFIC APPARATUS

FOR PRE-RECORDED EDUCATIONAL CD'S AND TAPES IN THE FIELDS OF MORTGAGE, APPRAISAL, COMMUNITY ASSOCIATION MANAGEMENT, CONSTRUCTION, INSURANCE, MATHEMATICS, AND REAL ESTATE (U.S. CLS. 21, 23, 26, 36 AND 38).
FIRST USE 6-1-1970; IN COMMERCE 6-1-1970.

CLASS 16—PAPER GOODS AND PRINTED MATTER

FOR PRINTED INSTRUCTIONAL, EDUCATIONAL, AND TEACHING MATERIALS IN THE AREAS OF APPRAISAL, COMMUNITY ASSOCIATION MANAGERS, CONSTRUCTION, INSURANCE, MATHEMATICS, MORTGAGES, AND REAL ESTATE (U.S. CLS. 2, 5, 22, 23, 29, 37, 38 AND 50).
FIRST USE 6-1-1970; IN COMMERCE 6-1-1970.

CLASS 41—EDUCATION AND ENTERTAINMENT

FOR EDUCATIONAL SERVICES NAMELY, CONDUCTING CLASSES, SEMINARS, WORKSHOPS IN THE FIELDS OF MORTGAGE BROKERAGE, REAL ESTATE, INSURANCE, COMMUNITY ASSOCIATION MANAGEMENT, MATHEMATICS, CONSTRUCTION, AND APPRAISAL (U.S. CLS. 100, 101 AND 107).
FIRST USE 6-1-1970; IN COMMERCE 6-1-1970.
LESLEY LAMOTHE, EXAMINING ATTORNEY

SN 76-603,103. THE JEWISH THEOLOGICAL SEMINARY OF AMERICA, NEW YORK, NY. FILED 7-19-2004.



THE MARK CONSISTS OF THE DESIGN OF A BUSH WHOSE LEAVES ARE REPRESENTED BY FLAMES.

CLASS 9—ELECTRICAL AND SCIENTIFIC APPARATUS

FOR PRERECORDED AUDIO AND VIDEO TAPES, DVDS AND CDS RELATING TO JUDAICA AND JEWISH LIFE, HISTORY AND CULTURE (U.S. CLS. 21, 23, 26, 36 AND 38).

FIRST USE 7-0-1986; IN COMMERCE 7-0-1986.

CLASS 16—PAPER GOODS AND PRINTED MATTER

FOR PRINTED PUBLICATIONS, NAMELY, BOOKS, NEWSLETTERS, CATALOGUES, BROCHURES AND PAMPHLETS RELATING TO JUDAICA, JEWISH LIFE, HISTORY, CULTURE AND ISSUES, EDUCATION, LIBRARIES AND LIBRARY SERVICES, RESEARCH, TEACHING AND COMMUNITY EDUCATION PROGRAMS, SUMMER CAMPS (U.S. CLS. 2, 5, 22, 23, 29, 37, 38 AND 50).

FIRST USE 7-0-1986; IN COMMERCE 7-0-1986.

CLASS 41—EDUCATION AND ENTERTAINMENT

FOR EDUCATION AND ENTERTAINMENT SERVICES, NAMELY, PROVIDING COURSES OF INSTRUCTION AT THE PRIMARY, SECONDARY, COLLEGE, GRADUATE AND PROFESSIONAL LEVELS IN THE FIELDS OF JUDAICA, JEWISH STUDIES, MUSIC, HISTORY, RELIGION, PHILOSOPHY, LANGUAGE, LITERATURE; TEACHING AND COMMUNITY EDUCATION PROGRAMS, NAMELY, CONDUCTING SEMINARS, WORKSHOPS, AND CONFERENCES IN THE FIELDS OF JUDAICA AND JEWISH STUDIES; LIBRARIES AND EDUCATIONAL RESEARCH; PRODUCTION AND DISTRIBUTION OF RADIO AND TELEVISION PROGRAMS FOR OTHERS, RELATING TO JUDAISM AND JEWISH STUDIES (U.S. CLS. 100, 101 AND 107).

FIRST USE 7-0-1986; IN COMMERCE 7-0-1986.
CHARLES JOYNER, EXAMINING ATTORNEY

SN 76-603,541. THE NASDAQ STOCK MARKET, INC., NEW YORK, NY. FILED 7-21-2004.

NASDAQ MARKET CENTER

THE MARK CONSISTS OF STANDARD CHARACTERS WITHOUT CLAIM TO ANY PARTICULAR FONT, STYLE, SIZE, OR COLOR.

OWNER OF U.S. REG. NOS. 922,973, 2,156,078 AND OTHERS.

NO CLAIM IS MADE TO THE EXCLUSIVE RIGHT TO USE "MARKET CENTER", APART FROM THE MARK AS SHOWN.

CLASS 36—INSURANCE AND FINANCIAL

FOR FINANCIAL SERVICES, NAMELY, PROVIDING FINANCIAL INFORMATION IN THE NATURE OF MARKET QUOTATIONS AND ORDERS FOR SECURITIES; PROVIDING AN ON-LINE COMPUTER DATABASE FEATURING REAL-TIME FINANCIAL INVESTMENT INFORMATION; FINANCIAL BROKERAGE SERVICES, NAMELY, AGGREGATING AND EXECUTING FINANCIAL INSTRUMENTS MARKET ORDERS VIA ELECTRONIC NETWORKS (U.S. CLS. 100, 101 AND 102).

FIRST USE 3-15-2004; IN COMMERCE 3-15-2004.

CLASS 38—COMMUNICATION

FOR ELECTRONIC TRANSMISSION OF FINANCIAL INSTRUMENTS MARKET QUOTATIONS AND ORDERS; COMMUNICATIONS NETWORKS FOR COLLECTION, PROCESSING, DISTRIBUTION AND TRANSMISSION OF FINANCIAL INSTRUMENTS MARKET INFORMATION VIA COMPUTER TERMINALS (U.S. CLS. 100, 101 AND 104).

FIRST USE 3-15-2004; IN COMMERCE 3-15-2004.
ELLEN PERKINS, EXAMINING ATTORNEY

SN 76-603,779. BRANDYWINE SENIOR CARE, INC., MT. LAUREL, NJ. FILED 7-23-2004.

BRANDYWINE ASSISTED LIVING

THE MARK CONSISTS OF STANDARD CHARACTERS WITHOUT CLAIM TO ANY PARTICULAR FONT, STYLE, SIZE, OR COLOR.

NO CLAIM IS MADE TO THE EXCLUSIVE RIGHT TO USE "ASSISTED LIVING", APART FROM THE MARK AS SHOWN.

CLASS 43—HOTEL AND RESTAURANT SERVICES

FOR PROVIDING ASSISTED LIVING AND CONGREGATE LIVING FACILITIES, NAMELY RESPITE CARE AND ELDER CARE DAY CARE SERVICES; HOME CARE AND ADULT CARE IN THE NATURE OF FOOD PREPARATION (U.S. CLS. 100 AND 101).

FIRST USE 8-19-1998; IN COMMERCE 8-19-1998.

CLASS 44—MEDICAL, BEAUTY AND AGRICULTURAL SERVICES

FOR NURSING HOMES (U.S. CLS. 100 AND 101).
FIRST USE 8-19-1998; IN COMMERCE 8-19-1998.
BILL DAWE, EXAMINING ATTORNEY

SN 76-603,962. CLEAR IMPACT, LLC, CORTE MADERA, CA. FILED 7-26-2004.

CLEAR IMPACT

THE MARK CONSISTS OF STANDARD CHARACTERS WITHOUT CLAIM TO ANY PARTICULAR FONT, STYLE, SIZE, OR COLOR.

CLASS 35—ADVERTISING AND BUSINESS

FOR BUSINESS MANAGEMENT CONSULTING; BUSINESS MANAGEMENT CONSULTING, NAMELY PERSONAL AND FIRM BRAND DEVELOPMENT (U.S. CLS. 100, 101 AND 102).

FIRST USE 8-1-2004; IN COMMERCE 8-1-2004.

CLASS 41—EDUCATION AND ENTERTAINMENT

FOR PROFESSIONAL EXECUTIVE COACHING SERVICES IN THE FIELD OF BUSINESS DEVELOPMENT, MARKETING AND STRATEGIC BUSINESS PLANNING, CLIENT RESEARCH, TEAM AND LEADERSHIP DEVELOPMENT, AND EMPLOYEE MANAGEMENT AND RETENTION (U.S. CLS. 100, 101 AND 107).

FIRST USE 8-1-2004; IN COMMERCE 8-1-2004.
MARK SPARACINO, EXAMINING ATTORNEY

SN 76-604,182. ELECTRONIC RETAILING ASSOCIATION, ARLINGTON, VA. FILED 7-27-2004.

THE GLOBAL SOURCE FOR MARKETING...ON TV, ONLINE, ON RADIO

THE MARK CONSISTS OF STANDARD CHARACTERS WITHOUT CLAIM TO ANY PARTICULAR FONT, STYLE, SIZE, OR COLOR.

CLASS 9—ELECTRICAL AND SCIENTIFIC APPARATUS

FOR DOWNLOADABLE ELECTRONIC PUBLICATIONS IN THE NATURE OF MAGAZINES AND NEWSLETTERS IN THE FIELD OF DIRECT RESPONSE MARKETING AND RETAILING (U.S. CLS. 21, 23, 26, 36 AND 38).

FIRST USE 1-0-2005; IN COMMERCE 1-0-2005.

CLASS 16—PAPER GOODS AND PRINTED MATTER

FOR MAGAZINES IN THE FIELD OF DIRECT RESPONSE MARKETING AND RETAILING (U.S. CLS. 2, 5, 22, 23, 29, 37, 38 AND 50).

FIRST USE 9-0-2004; IN COMMERCE 9-0-2004.
MICHAEL KEATING, EXAMINING ATTORNEY

SN 76-604,974. SMITH ABRASIVES, INC., HOT SPRINGS, AR. FILED 8-2-2004.

Smith's
SINCE 1886

NO CLAIM IS MADE TO THE EXCLUSIVE RIGHT TO USE "SINCE 1886", APART FROM THE MARK AS SHOWN. SEC. 2(F).

CLASS 8—HAND TOOLS

FOR MANUAL SHARPENERS FOR KNIVES, SCISSORS, AND TOOLS (U.S. CLS. 23, 28 AND 44).

FIRST USE 0-0-1960; IN COMMERCE 0-0-1960.

CLASS 9—ELECTRICAL AND SCIENTIFIC APPARATUS

FOR CROSS HAIR ILLUMINATOR FOR OPTICAL GUN SIGHTS (U.S. CLS. 21, 23, 26, 36 AND 38).

FIRST USE 0-0-2000; IN COMMERCE 0-0-2000.
SUSAN HAYASH, EXAMINING ATTORNEY

SN 76-605,054. CHICAGO COSMETOLOGISTS ASSOCIATION, INC., CHICAGO, IL. FILED 7-30-2004.

aaee / American Association
for Esthetics Education

NO CLAIM IS MADE TO THE EXCLUSIVE RIGHT TO USE AMERICAN ASSOCIATION FOR ESTHETICS EDUCATION, APART FROM THE MARK AS SHOWN.

CLASS 35—ADVERTISING AND BUSINESS

FOR ASSOCIATION SERVICES, NAMELY, PROMOTING THE INTERESTS OF COSMETOLOGISTS (U.S. CLS. 100, 101 AND 102).

FIRST USE 5-22-2004; IN COMMERCE 5-22-2004.

CLASS 41—EDUCATION AND ENTERTAINMENT

FOR EDUCATIONAL SERVICES, NAMELY CONDUCTING WORKSHOPS, SEMINARS AND CLASSES IN THE FIELD OF COSMETOLOGY (U.S. CLS. 100, 101 AND 107).

FIRST USE 5-16-2005; IN COMMERCE 5-16-2005.
APRIL L. RADEMACHER, EXAMINING ATTORNEY

SN 76-605,458. GOOD FOOD, INC., HONEY BROOK, PA. FILED 8-4-2004.

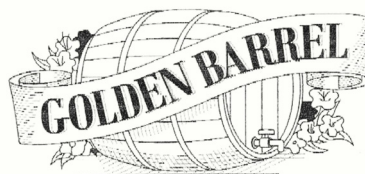

OWNER OF U.S. REG. NOS. 1,205,627, 1,642,931 AND OTHERS.

THE MARK CONSISTS OF A FANCIFUL DEPICTION OF A BARREL WITH FLOWERS AND A RIBBON.

CLASS 29—MEATS AND PROCESSED FOODS

FOR EDIBLE OILS (U.S. CL. 46).

FIRST USE 7-1-2003; IN COMMERCE 7-3-2003.

CLASS 30—STAPLE FOODS

FOR TABLE SYRUP; MAPLE SYRUP; CORN SYRUP; LIGHT CORN SYRUP; PANCAKE SYRUP; LIGHT PANCAKE SYRUP; PANCAKE AND WAFFLE SYRUP; SORGHUM SYRUP; MOLASSES; CAKE AND PIE MIX; AND SUGAR (U.S. CL. 46).

FIRST USE 7-1-2003; IN COMMERCE 7-3-2003.
ANNE E. GUSTASON, EXAMINING ATTORNEY

SN 76-605,667. WAKEFERN FOOD CORP., ELIZABETH, NJ.
FILED 8-5-2004.

SN 76-605,715. THE REGENTS OF THE UNIVERSITY OF
MICHIGAN, ANN ARBOR, MI. FILED 8-5-2004.



OWNER OF U.S. REG. NOS. 1,867,239, 2,467,334 AND OTHERS.

NO CLAIM IS MADE TO THE EXCLUSIVE RIGHT TO USE "UNIVERSITY", APART FROM THE MARK AS SHOWN.

THE MARK CONSISTS OF THE WORD MARK SHOPRITE UNIVERSITY, AND THE LETTERS SRU IN BLACK AND WHITE WITHIN A RECTANGLE.

CLASS 16—PAPER GOODS AND PRINTED MATTER

FOR EDUCATIONAL MATERIALS, NAMELY, TRAINING MANUALS AND WORKBOOKS IN THE FIELDS OF PROJECT MANAGEMENT, CUSTOMER SERVICE, CAREER DEVELOPMENT, TIME MANAGEMENT, COMMUNICATIONS, LEADERSHIP, DIVERSITY, WRITING AND GRAMMAR, LABOR RELATIONS, COMPUTERS, SOFTWARE, BUSINESS MANAGEMENT, HUMAN RESOURCES AND MARKETING; BROCHURES AND BOOKS IN THE FIELDS OF PROJECT MANAGEMENT, CUSTOMER SERVICE, CAREER DEVELOPMENT, TIME MANAGEMENT, COMMUNICATIONS, LEADERSHIP, DIVERSITY, WRITING AND GRAMMAR, LABOR RELATIONS, COMPUTERS, SOFTWARE, BUSINESS MANAGEMENT, HUMAN RESOURCES AND MARKETING (U.S. CLS. 2, 5, 22, 23, 29, 37, 38 AND 50).

FIRST USE 2-0-1996; IN COMMERCE 2-0-1996.

CLASS 41—EDUCATION AND ENTERTAINMENT

FOR EDUCATIONAL SERVICES, NAMELY, CONDUCTING CLASSES, SEMINARS, CONFERENCES AND WORKSHOPS IN THE FIELDS OF PROJECT MANAGEMENT, CUSTOMER SERVICE, CAREER DEVELOPMENT, TIME MANAGEMENT, COMMUNICATIONS, LEADERSHIP, DIVERSITY, WRITING AND GRAMMAR, LABOR RELATIONS, COMPUTERS, SOFTWARE, BUSINESS MANAGEMENT, HUMAN RESOURCES AND MARKETING (U.S. CLS. 100, 101 AND 107).

FIRST USE 2-0-1996; IN COMMERCE 2-0-1996.

JANICE L. MCMORROW, EXAMINING ATTORNEY



CLASS 9—ELECTRICAL AND SCIENTIFIC APPARATUS

FOR COMPUTER SOFTWARE AND COMPUTER SOFTWARE DEVELOPMENT TOOLS THAT SUPPORT COLLABORATION ACROSS NETWORKS BETWEEN TEAMS OF USERS, AND THAT PROVIDES ONLINE SUPPORT FOR TRADITIONAL AND DISTANCE TEACHING AND LEARNING (U.S. CLS. 21, 23, 26, 36 AND 38).

CLASS 42—SCIENTIFIC, COMPUTER AND LEGAL SERVICES

FOR COMPUTER SOFTWARE DEVELOPMENT FOR EDUCATIONAL COMPUTER SOFTWARE AND ASSOCIATED OPEN SOURCE TOOLS; APPLICATION SERVICE PROVIDER FEATURING THE USE OF EDUCATIONAL COMPUTER SOFTWARE AND ASSOCIATED OPEN SOURCE TOOLS (U.S. CLS. 100 AND 101).

MELISSA VALLILLO, EXAMINING ATTORNEY

SN 76-606,048. ALLIANCE FOR TELECOMMUNICATIONS INDUSTRY SOLUTIONS, INC., WASHINGTON, DC.
FILED 8-9-2004.

ATIS

THE MARK CONSISTS OF STANDARD CHARACTERS WITHOUT CLAIM TO ANY PARTICULAR FONT, STYLE, SIZE, OR COLOR.

CLASS 16—PAPER GOODS AND PRINTED MATTER

FOR NEWSLETTERS, PRINTED STANDARDS, PRINTED REPORTS, PRINTED GUIDELINES AND PRINTED SPECIFICATIONS, ALL IN THE FIELD OF TELECOMMUNICATIONS AND INFORMATION TECHNOLOGY (U.S. CLS. 2, 5, 22, 23, 29, 37, 38 AND 50).

FIRST USE 0-0-1993; IN COMMERCE 0-0-1993.

CLASS 42—SCIENTIFIC, COMPUTER AND LEGAL SERVICES

FOR TECHNICAL RESEARCH IN THE FIELD OF TELECOMMUNICATIONS, NAMELY DEVELOPMENT AND DISSEMINATION OF TECHNICAL AND OPERATIONAL STANDARDS AND REQUIREMENTS APPLICABLE TO TELECOMMUNICATIONS AND INFORMATION TECHNOLOGY (U.S. CLS. 100 AND 101).

FIRST USE 10-0-1993; IN COMMERCE 10-0-1993.

CHERYL CLAYTON, EXAMINING ATTORNEY

SN 76-606,049. ALLIANCE FOR TELECOMMUNICATIONS INDUSTRY SOLUTIONS, INC., WASHINGTON, DC. FILED 8-9-2004.

SN 76-606,259. EDELBRÖCK CORPORATION, TORRANCE, CA. FILED 8-9-2004.



CLASS 16—PAPER GOODS AND PRINTED MATTER

FOR NEWSLETTERS, PRINTED STANDARDS, PRINTED REPORTS, PRINTED GUIDELINES AND PRINTED SPECIFICATIONS, ALL IN THE FIELD OF TELECOMMUNICATIONS AND INFORMATION TECHNOLOGY (U.S. CLS. 2, 5, 22, 23, 29, 37, 38 AND 50).
FIRST USE 0-0-1993; IN COMMERCE 0-0-1993.

CLASS 42—SCIENTIFIC, COMPUTER AND LEGAL SERVICES

FOR TECHNICAL RESEARCH IN THE FIELD OF TELECOMMUNICATIONS, NAMELY DEVELOPMENT AND DISSEMINATION OF TECHNICAL AND OPERATIONAL STANDARDS AND REQUIREMENTS APPLICABLE TO TELECOMMUNICATIONS AND INFORMATION TECHNOLOGY (U.S. CLS. 100 AND 101).
FIRST USE 10-0-1993; IN COMMERCE 10-0-1993.
CHERYL CLAYTON, EXAMINING ATTORNEY

SN 76-606,160. EIGHT MILE CHOPPERS, LLC, WARREN, MI. FILED 8-10-2004.



NO CLAIM IS MADE TO THE EXCLUSIVE RIGHT TO USE "EIGHT MILE CHOPPERS DETROIT", APART FROM THE MARK AS SHOWN.

CLASS 25—CLOTHING

FOR CLOTHING, NAMELY, SHIRTS, HATS, SHORTS, PANTS AND JACKETS (U.S. CLS. 22 AND 39).
FIRST USE 8-0-2003; IN COMMERCE 8-0-2003.

CLASS 35—ADVERTISING AND BUSINESS

FOR DEALERSHIP IN THE FIELD OF MOTORCYCLES (U.S. CLS. 100, 101 AND 102).
FIRST USE 8-0-2003; IN COMMERCE 8-0-2003.
SUSAN STIGLITZ, EXAMINING ATTORNEY



OWNER OF U.S. REG. NO. 2,315,630.

CLASS 6—METAL GOODS

FOR AUTOMOTIVE AFTER MARKET ACCESSORIES, NAMELY, METAL HOSE FITTINGS AND CLAMPS, WOVEN METAL FUEL, OIL, BRAKE AND RADIATOR LINES; HOSE SLEEVING KITS CONSISTING OF WOVEN METAL SLEEVING AND METAL END FITTINGS; OIL LINE KITS CONSISTING OF WOVEN METAL HOSES WITH ATTACHED METAL END FITTINGS (U.S. CLS. 2, 12, 13, 14, 23, 25 AND 50).
FIRST USE 1-0-1985; IN COMMERCE 1-0-1985.

CLASS 12—VEHICLES

FOR AUTOMOTIVE AFTER MARKET ACCESSORIES, NAMELY BRAKE ADAPTER FITTINGS, BRAKE LINE CLAMPS, BRAKE LINES, BRAKE ROTORS AND AUTOMOTIVE, TRUCK AND MOTORCYCLE BRAKE HOSES (U.S. CLS. 19, 21, 23, 31, 35 AND 44).
FIRST USE 1-0-1985; IN COMMERCE 1-0-1985.
SCOTT OSLICK, EXAMINING ATTORNEY

SN 76-606,300. EARTHDATA HOLDINGS, INC., FREDERICK, MD. FILED 8-10-2004.

EarthData

THE MARK CONSISTS OF STANDARD CHARACTERS WITHOUT CLAIM TO ANY PARTICULAR FONT, STYLE, SIZE, OR COLOR.

OWNER OF U.S. REG. NOS. 2,194,401, 2,194,402 AND 2,320,698.
SEC. 2(F).

CLASS 39—TRANSPORTATION AND STORAGE

FOR STORAGE OF ELECTRONIC MEDIA, NAMELY, IMAGES, TEXT AND AUDIO DATA; STORAGE SERVICES FOR ARCHIVING DATABASES, IMAGES AND OTHER ELECTRONIC DATA (U.S. CLS. 100 AND 105).
FIRST USE 1-1-1998; IN COMMERCE 1-1-1998.

CLASS 40—MATERIAL TREATMENT

FOR ELECTRONIC IMAGING, SCANNING, DIGITIZING, ALTERATION OF HARD COPY MAPS AND PHOTOGRAPHS USING HIGH RESOLUTION SCANNERS IN TWO-DIMENSIONS AND SUPPLYING SCANNED DATA IN BOTH RASTER AND VECTOR FORM IN THREE DIMENSION PHOTOGRAPHIC MAPPING IMAGES; COMPLETE FILM DEVELOPMENT PHOTOGRAPHIC SERVICES; FILM RECORDING OF VECTOR AND RASTER DIGITAL DATA SETS ONTO FILM AND PAPER MEDIA (U.S. CLS. 100, 103 AND 106).
FIRST USE 1-1-1998; IN COMMERCE 1-1-1998.

CLASS 42—SCIENTIFIC, COMPUTER AND LEGAL SERVICES

FOR STEREO PHOTOGRAMMETRIC MAPPING IN ANALYTICAL HARD COPY FORM AND DIGITAL SOFT COPY FORM; CLOSE RANGE MAPPING USING PHOTOGRAMMETRY IN ANALYTICAL HARD COPY AND DIGITAL SOFT COPY FORM; DESIGN MULTILAYERED GEOGRAPHIC INFORMATION SYSTEMS, DESIGNING SOFTWARE FOR INTEGRATION OF HIGH RESOLUTION SATELLITE IMAGERY, DIGITAL AND HELICOPTER SENSOR IMAGERY AND GROUND SENSOR IMAGERY IN ALL FORMATS; DESIGNING APPLICATION SOFTWARE AND HARDWARE FOR HIGH RESOLUTION SATELLITE IMAGERY, DIGITAL AIRCRAFT AND HELICOPTER SENSOR, DESIGNING SOFTWARE TO FACILITATE HIGH RESOLUTION MAPPING IMAGERY WITH MULTILAYERED GEOGRAPHIC INFORMATION SYSTEMS; AIRBORNE VIDEOGRAPHY SERVICES; CONSULTING SERVICES ON DESIGN, BUILDING AND IMPLEMENTATION OF GEOGRAPHIC INFORMATION SYSTEMS; CONSULTING SERVICES IN THE FIELD OF DESIGN, SELECTION, IMPLEMENTATION AND USE OF COMPUTER HARDWARE AND SOFTWARE SYSTEMS FOR OTHERS; COMPUTER SOFTWARE DESIGN FOR OTHERS; IMAGE PROCESSING SOFTWARE DESIGN; DESIGN, DEVELOPMENT AND IMPLEMENTATION OF SOFTWARE; TECHNICAL CONSULTANCY REGARDING THE FIELD OF GEOSPATIAL IMAGING AND REMOTE SENSING; MAPPING (U.S. CLS. 100 AND 101).
FIRST USE 1-1-1998; IN COMMERCE 1-1-1998.
DAWN HAN, EXAMINING ATTORNEY

SN 76-606,479, MIKE-COURY, MARION, CORONA, CA.
FILED 8-11-2004.



1

THE MARK CONSISTS OF A HEART WITH CROSSED ARMS AND THE WORDS I LIKE ME! PRINTED INSIDE THE HEART.

CLASS 9—ELECTRICAL AND SCIENTIFIC APPARATUS

FOR SOUND RECORDINGS FEATURING STORIES FOR CHILDREN; MUSICAL SOUND RECORDINGS; PRE-RECORDED COMPACT DISCS FEATURING SOUND RECORDINGS FEATURING STORIES FOR CHILDREN; PRE-RECORDED COMPACT DISCS FEATURING MUSICAL SOUND RECORDINGS; PHONOGRAPH RECORDS FEATURING SOUND RECORDINGS FEATURING STORIES FOR CHILDREN; PHONOGRAPH RECORDS FEATURING MUSICAL SOUND RECORDINGS; PRE-RECORDED AUDIO TAPES FEATURING SOUND RECORDINGS FEATURING STORIES FOR CHILDREN; PRE-RECORDED AUDIO TAPES FEATURING MUSICAL SOUND RECORDINGS (U.S. CLS. 21, 23, 26, 36 AND 38).
FIRST USE 1-1-1981; IN COMMERCE 1-1-1982.

CLASS 16—PAPER GOODS AND PRINTED MATTER

FOR PRINTED MATTER, NAMELY, COLORING BOOKS FOR CHILDREN, WORKBOOKS FOR CHILDREN, AND CHILDRENS' STORYBOOKS (U.S. CLS. 2, 5, 22, 23, 29, 37, 38 AND 50).
FIRST USE 1-1-1982; IN COMMERCE 1-0-1986.

CLASS 25—CLOTHING

FOR CLOTHING, NAMELY, T-SHIRTS, SWEATSHIRTS, HATS AND CAPS (U.S. CLS. 22 AND 39).
FIRST USE 1-1-1978; IN COMMERCE 1-1-1980.

CLASS 28—TOYS AND SPORTING GOODS

FOR TOYS, NAMELY, STUFFED DOLLS AND ANIMALS, STUFFED TOY ANIMALS AND PLUSH TOYS (U.S. CLS. 22, 23, 38 AND 50).
FIRST USE 1-1-1982; IN COMMERCE 1-1-1986.

CLASS 41—EDUCATION AND ENTERTAINMENT

FOR EDUCATIONAL SERVICES, NAMELY, SELF ESTEEM SEMINARS AND PROGRAMS FOR CHILDREN (U.S. CLS. 100, 101 AND 107).
FIRST USE 4-1-1972; IN COMMERCE 1-1-1976.
SUELLEN HICKEY, EXAMINING ATTORNEY

SN 76-606,486, KNOWLEDGE LEARNING CORPORATION,
GOLDEN, CO. FILED 8-11-2004.

MEDALLION SCHOOL PARTNERSHIPS

THE MARK CONSISTS OF STANDARD CHARACTERS WITHOUT CLAIM TO ANY PARTICULAR FONT, STYLE, SIZE, OR COLOR.

OWNER OF U.S. REG. NO. 2,300,403.
NO CLAIM IS MADE TO THE EXCLUSIVE RIGHT TO USE "SCHOOL PARTNERSHIPS", APART FROM THE MARK AS SHOWN.

CLASS 41—EDUCATION AND ENTERTAINMENT

FOR EDUCATIONAL SERVICES, NAMELY, PROVIDING COURSES OF INSTRUCTION AT THE KINDERGARTEN AND THE ELEMENTARY AND MIDDLE SCHOOL LEVELS (U.S. CLS. 100, 101 AND 107).
FIRST USE 3-30-1998; IN COMMERCE 3-30-1998.

CLASS 43—HOTEL AND RESTAURANT SERVICES

FOR CHILD CARE SERVICES AND BEFORE AND AFTER SCHOOL EXTENDED DAY CARE SERVICES (U.S. CLS. 100 AND 101).

FIRST USE 3-30-1998; IN COMMERCE 3-30-1998.
SCOTT OSLICK, EXAMINING ATTORNEY

SN 76-607,892. WEEKS, KERMIT, POLK CITY, FL. FILED 8-20-2004.

WE ARE THE PAST, WE ARE THE PRESENT, WE ARE THE FUTURE

THE MARK CONSISTS OF STANDARD CHARACTERS WITHOUT CLAIM TO ANY PARTICULAR FONT, STYLE, SIZE, OR COLOR.

CLASS 35—ADVERTISING AND BUSINESS

FOR RETAIL CLOTHING STORE SERVICES, RETAIL FOOD STORE SERVICES, RETAIL TOY STORE SERVICES, RETAIL CRAFT STORE SERVICES, RETAIL BOOK STORE SERVICES, RETAIL STORES IN THE AREA OF GIFT ITEMS AND SOUVENIRS (U.S. CLS. 100, 101 AND 102).

SN 76-607,318. WEST TEXAS PEPPER TRADERS, INC., ABILENE, TX. FILED 8-12-2004.

WEST TEXAS PEPPER TRADERS



NO CLAIM IS MADE TO THE EXCLUSIVE RIGHT TO USE WEST TEXAS PEPPER TRADERS, APART FROM THE MARK AS SHOWN.

CLASS 41—EDUCATION AND ENTERTAINMENT

FOR ENTERTAINMENT SERVICES IN THE NATURE OF MOTION PICTURE FILM PRODUCTION, PRESENTATION OF LIVE SHOW PERFORMANCES FEATURING ANIMATRONICS, HOLOGRAPHICS AND LIVE STAGE PERFORMANCES; AMUSEMENT AND EDUCATIONAL SERVICES IN THE NATURE OF AMUSEMENT PARK AND THEME PARK SERVICES, MUSEUMS; ENTERTAINMENT SERVICES IN THE NATURE PROVIDING RIDES IN HOT AIR BALLOONS, HELICOPTERS AND AIRPLANES (U.S. CLS. 100, 101 AND 107).

MIDGE BUTLER, EXAMINING ATTORNEY

CLASS 29—MEATS AND PROCESSED FOODS

FOR PROCESSED PEPPERS (U.S. CL. 46).
FIRST USE 1-20-2003; IN COMMERCE 1-20-2003.

SN 76-608,062. NAMCO LTD., TOKYO, JAPAN, FILED 8-20-2004.

CLASS 30—STAPLE FOODS

FOR MARINADE AND SPICES (U.S. CL. 46).
FIRST USE 1-20-2003; IN COMMERCE 1-20-2003.
RON FAIRBANKS, EXAMINING ATTORNEY

TEKEN'S NINA WILLIAMS IN:

THE MARK CONSISTS OF STANDARD CHARACTERS WITHOUT CLAIM TO ANY PARTICULAR FONT, STYLE, SIZE, OR COLOR.

OWNER OF U.S. REG. NOS. 2,079,670 AND 2,712,081.

"NINA WILLIAMS" DOES NOT IDENTIFY A LIVING INDIVIDUAL.

SN 76-607,858. INSCI CORPORATION, WESTBOROUGH, MA. FILED 8-20-2004.

CLEARSTORY

THE MARK CONSISTS OF STANDARD CHARACTERS WITHOUT CLAIM TO ANY PARTICULAR FONT, STYLE, SIZE, OR COLOR.

CLASS 9—ELECTRICAL AND SCIENTIFIC APPARATUS

FOR VIDEO GAME CARTRIDGES; COMPUTER GAME PROGRAMS (U.S. CLS. 21, 23, 26, 36 AND 38).

CLASS 9—ELECTRICAL AND SCIENTIFIC APPARATUS

FOR COMPUTERS SOFTWARE FOR BUSINESS MANAGEMENT, PERSONNEL MANAGEMENT, BUSINESS COMMUNICATIONS, ENTERPRISE RESOURCE PLANNING, MEDIA MANAGEMENT AND DATA MANAGEMENT (U.S. CLS. 21, 23, 26, 36 AND 38).

CLASS 28—TOYS AND SPORTING GOODS

FOR COIN-OPERATED AMUSEMENT GAME MACHINES (U.S. CLS. 22, 23, 38 AND 50).

MATTHEW PAPPAS, EXAMINING ATTORNEY

SN 76-608,063. NAMCO LTD., TOKYO, JAPAN, FILED 8-20-2004.

TAIKO: DRUM MASTER

THE MARK CONSISTS OF STANDARD CHARACTERS WITHOUT CLAIM TO ANY PARTICULAR FONT, STYLE, SIZE, OR COLOR.

THE ENGLISH TRANSLATION OF THE FOREIGN WORDING IN THE MARK IS "DRUM".

CLASS 42—SCIENTIFIC, COMPUTER AND LEGAL SERVICES

FOR CONSULTING SERVICES IN THE FIELD OF COMPUTER SOFTWARE (U.S. CLS. 100 AND 101).
MATTHEW PAPPAS, EXAMINING ATTORNEY

CLASS 9—ELECTRICAL AND SCIENTIFIC APPARATUS

FOR VIDEO GAME CARTRIDGES; COMPUTER GAME PROGRAMS (U.S. CLS. 21, 23, 26, 36 AND 38).

CLASS 28—TOYS AND SPORTING GOODS

FOR COIN-OPERATED AMUSEMENT GAME MACHINES (U.S. CLS. 22, 23, 38 AND 50).
MATTHEW PAPPAS, EXAMINING ATTORNEY

SN 76-608,228. AMERICAN TECHNICAL CERAMICS CORPORATION, HUNTINGTON STATION, NY. FILED 8-23-2004.

AMERICAN TECHNICAL CERAMICS

THE MARK CONSISTS OF STANDARD CHARACTERS WITHOUT CLAIM TO ANY PARTICULAR FONT, STYLE, SIZE, OR COLOR.

OWNER OF U.S. REG. NO. 1,355,000.

NO CLAIM IS MADE TO THE EXCLUSIVE RIGHT TO USE "TECHNICAL CERAMICS", APART FROM THE MARK AS SHOWN.
SEC. 2(F).

CLASS 9—ELECTRICAL AND SCIENTIFIC APPARATUS

FOR ELECTRONIC COMPONENTS, NAMELY CAPACITORS, MULTI LAYERED CAPACITORS, SINGLE LAYERED CAPACITORS, RESISTORS, INDUCTORS, THIN-FILM CIRCUITRY AND THIN-FILM SUBSTRATES (U.S. CLS. 21, 23, 26, 36 AND 38).

FIRST USE 12-15-1965; IN COMMERCE 4-18-1969.

CLASS 42—SCIENTIFIC, COMPUTER AND LEGAL SERVICES

FOR PROVIDING ON-LINE COMPUTER SERVICES, NAMELY OFFERING INFORMATION REGARDING CAPACITORS AND THIN-FILM ELECTRONIC COMPONENTS IN THE NATURE OF DESIGN GUIDANCE VIA A GLOBAL COMPUTER NETWORK (U.S. CLS. 100 AND 101).

FIRST USE 8-18-1997; IN COMMERCE 8-18-1997.
RICHARD WHITE, EXAMINING ATTORNEY

SN 76-608,627. SANTAROSSA MOSAIC & TILE CO., INC., INDIANAPOLIS, IN. FILED 8-23-2004.

MAKE YOUR HOME A WORK OF ART

THE MARK CONSISTS OF STANDARD CHARACTERS WITHOUT CLAIM TO ANY PARTICULAR FONT, STYLE, SIZE, OR COLOR.

CLASS 37—CONSTRUCTION AND REPAIR

FOR INSTALLATION OF FLOORING, NAMELY, CERAMIC TILE, STONE, GRANITE, QUARRY TILE, MARBLE, TERRAZZO, CARPET, VINYL AND WOOD; INSTALLATION OF MARBLE AND GRANITE FOR USE IN COUNTERTOPS, FLOORING AND OTHER HOUSEHOLD STRUCTURES AND FIXTURES (U.S. CLS. 100, 103 AND 106).

FIRST USE 6-1-2004; IN COMMERCE 6-1-2004.

CLASS 40—MATERIAL TREATMENT

FOR CUSTOM FABRICATION OF MARBLE AND GRANITE FOR USE IN COUNTERTOPS, FLOORING AND OTHER HOUSEHOLD STRUCTURES AND FIXTURES (U.S. CLS. 100, 103 AND 106).

FIRST USE 6-1-2004; IN COMMERCE 6-1-2004.
STEVEN R. FOSTER, EXAMINING ATTORNEY

SN 76-608,864. DEFLECTO CORPORATION, INDIANAPOLIS, IN. FILED 8-24-2004.

DEFLECT-O

THE MARK CONSISTS OF STANDARD CHARACTERS WITHOUT CLAIM TO ANY PARTICULAR FONT, STYLE, SIZE, OR COLOR.

OWNER OF U.S. REG. NOS. 781,754, 1,020,535 AND 1,021,453.

CLASS 11—ENVIRONMENTAL CONTROL APPARATUS

FOR CONNECTOR CONDUIT FOR COUPLING TOGETHER A CLOTHES DRYER EXHAUST OUTLET AND A LENGTH OF FLEXIBLE DUCTING; DRYER VENT KITS COMPRISING A CLOTHES DRYER EXHAUST VENT, AN EXTERIOR BIRD AND RODENT EXCLUSION SCREEN, A FLEXIBLE EXHAUST DUCT, AND CLAMPS THEREFOR; HEATING AND AIR CONDITIONING SYSTEM EXTENSION KITS AND DUCT EXTENSION KITS COMPRISING DUCT HOSE, A REGISTER, A WINGED BOOT, DUCT TAPE AND A FLANGED CONNECTOR; EXTENSION SLEEVE SOLD AS A COMPONENT PART OF AN AIR DEFLECTOR AND REGISTER DEFLECTORS; FLEXIBLE VENTING EQUIPMENT, NAMELY PLASTIC, METALLIC, ALUMINUM AND FIBERGLASS DUCTING HOSE FOR USE IN CLOTHES DRYER VENTING, ATTIC VENTING, BATHROOM, STOVE AND RANGE VENTING AND FOR AIR MOVEMENT IN HEATING AND AIR CONDITIONING DUCT SYSTEMS; HEATING AND COOLING APPARATUS INCLUDING AIR CIRCULATION DEVICES NAMELY FANS AND VENTS, DRYER EXHAUST VENTS; PARTS AND ACCESSORIES IN THIS CLASS FOR THE AFORESAID GOODS (U.S. CLS. 13, 21, 23, 31 AND 34).

FIRST USE 12-31-1968; IN COMMERCE 12-31-1968.

CLASS 16—PAPER GOODS AND PRINTED MATTER

FOR DESK TOP LITERATURE RACKS FOR STORAGE AND DISPLAY OF PRINTED MATERIAL ADAPTABLE FOR WALL MOUNTING; DESK AND OFFICE ACCESSORIES, NAMELY, DESK PADS, FRONT LOADABLE LETTER TRAYS, FRONT LOADABLE LEGAL TRAYS, SIDE LOADABLE LETTER TRAYS, SIDE LOADABLE LETTER TRAYS, PENCIL CUPS, BUSINESS CARD HOLDERS, PLANNER STANDS IN THE FORM OF DISPLAYS, MEMO HOLDERS, SLATE BOARDS FOR WRITING, CLIP BOARDS FOR STATIONERY USE, PAPER SORTERS, PAPER CLIP HOLDERS, BOOKENDS, MAGAZINE FILE HOLDERS, HANGING FILE FOLDER AND DATA BINDER HOLDERS; STACKABLE DESK-TOP FILING DRAWERS CONTAINED IN A UNIT BODY (U.S. CLS. 2, 5, 22, 23, 29, 37, 38 AND 50).

FIRST USE 12-31-1968; IN COMMERCE 12-31-1968.

CLASS 20—FURNITURE AND ARTICLES NOT OTHERWISE CLASSIFIED

FOR DESK AND OFFICE ACCESSORIES, NAMELY DESK TOP SHELVES FOR HOLDING BOOKS, PLANNERS, ETC; LITERATURE RACKS FOR STORAGE AND DISPLAY OF PRINTED MATERIAL, DISPLAY BOARDS, DISPLAY STANDS, PICTURE FRAMES, STORAGE RACKS, MAGAZINE RACKS, SHELVES, CONTAINERS NOT OF METAL FOR COMMERCIAL USE; FURNITURE, PARTS AND FITTINGS FOR ALL THE AFORESAID GOODS; NON-METAL CLAMPS, HOOKS, FURNITURE DOORS FOR CABINETS, HINGES, VENT COVERS; PLASTIC FILING POCKETS OR CONTAINERS FOR GENERAL USE; WALL-MOUNTED, GENERAL PURPOSE RECEPTACLES FOR HOLDING ARTICLES AND TRANSPARENT PLASTIC BOARDS, NAMELY FRAMES AND SIGN HOLDERS, FOR THE PURPOSE OF MOUNTING FOR DISPLAY PHOTOGRAPHS, GRAPHICS AND OTHER DOCUMENTS (U.S. CLS. 2, 13, 22, 25, 32 AND 50).

FIRST USE 12-31-1968; IN COMMERCE 12-31-1968.
ANNE FARRELL, EXAMINING ATTORNEY

CLASS 16—PAPER GOODS AND PRINTED MATTER

FOR BUMPER STICKERS; ANNOUNCEMENT CARDS; PAPER NAME BADGES; PAPER BAGS; PENS; BALL-POINT PENS; PENCILS; PAPER BANNERS; BOOK COVERS; CALENDARS; CREDIT CARDS WITHOUT MAGNETIC ENCODING; DATE BOOKS; DESK ACCESSORIES, NAMELY DESK CALENDARS, DESK PAD AND DESK TOP PLANNERS; DIARIES; GRAPHIC ART REPRODUCTIONS; MEMBERSHIP CARDS WITHOUT MAGNETIC CODING; POSTERS (U.S. CLS. 2, 5, 22, 23, 29, 37, 38 AND 50).

CLASS 25—CLOTHING

FOR MEN'S WOMEN'S AND CHILDREN'S CLOTHING, NAMELY, SHIRTS; TEE-SHIRTS; POLO SHIRTS; BLOUSES; HATS; PANTS; TROUSERS; SKIRTS; SUITS; JACKETS; SPORT JACKETS; LEATHER JACKETS; JEAN JACKETS; GLOVES AND SWEATERS (U.S. CLS. 22 AND 39).

DOMINIC J. FERRAIUOLO, EXAMINING ATTORNEY

SN 76-609,009, FOGLIA, ROBERT, WEST PATERSON, NJ.
FILED 8-27-2004.

JAMAICAN = ICAN

SN 76-609,013, FOGLIA, ROBERT, WEST PATERSON, NJ.
FILED 8-27-2004.

CLASS 16—PAPER GOODS AND PRINTED MATTER

FOR BUMPER STICKERS; ANNOUNCEMENT CARDS; PAPER NAME BADGES; PAPER BAGS; PENS; BALL-POINT PENS; PENCILS; PAPER BANNERS; BOOK COVERS; CALENDARS; CREDIT CARDS WITHOUT MAGNETIC ENCODING; DATE BOOKS; DESK ACCESSORIES, NAMELY DESK CALENDARS, DESK PAD AND DESK TOP PLANNERS; DIARIES; GRAPHIC ART REPRODUCTIONS; MEMBERSHIP CARDS WITHOUT MAGNETIC CODING; POSTERS (U.S. CLS. 2, 5, 22, 23, 29, 37, 38 AND 50).

CLASS 25—CLOTHING

FOR MEN'S WOMEN'S AND CHILDREN'S CLOTHING, NAMELY, SHIRTS; TEE-SHIRTS; POLO SHIRTS; BLOUSES; HATS; PANTS; TROUSERS; SKIRTS; SUITS; JACKETS; SPORT JACKETS; LEATHER JACKETS; JEAN JACKETS; GLOVES AND SWEATERS (U.S. CLS. 22 AND 39).

DOMINIC J. FERRAIUOLO, EXAMINING ATTORNEY

AFRICAN = ICAN

CLASS 16—PAPER GOODS AND PRINTED MATTER

FOR BUMPER STICKERS; ANNOUNCEMENT CARDS; PAPER NAME BADGES; PAPER BAGS; PENS; BALL-POINT PENS; PENCILS; PAPER BANNERS; BOOK COVERS; CALENDARS; CREDIT CARDS WITHOUT MAGNETIC ENCODING; DATE BOOKS; DESK ACCESSORIES, NAMELY DESK CALENDARS, DESK PAD AND DESK TOP PLANNERS; DIARIES; GRAPHIC ART REPRODUCTIONS; MEMBERSHIP CARDS WITHOUT MAGNETIC CODING; POSTERS (U.S. CLS. 2, 5, 22, 23, 29, 37, 38 AND 50).

CLASS 25—CLOTHING

FOR MEN'S WOMEN'S AND CHILDREN'S CLOTHING, NAMELY, SHIRTS; TEE-SHIRTS; POLO SHIRTS; BLOUSES; HATS; PANTS; TROUSERS; SKIRTS; SUITS; JACKETS; SPORT JACKETS; LEATHER JACKETS; JEAN JACKETS; GLOVES AND SWEATERS (U.S. CLS. 22 AND 39).

DOMINIC J. FERRAIUOLO, EXAMINING ATTORNEY

SN 76-609,012, FOGLIA, ROBERT, WEST PATERSON, NJ.
FILED 8-27-2004.

PUERTORICAN = ICAN

NO CLAIM IS MADE TO THE EXCLUSIVE RIGHT TO USE "WEAR", APART FROM THE MARK AS SHOWN.

SN 76-609,634. GERHARTZ & ASSOCIATES, INC., ORLANDO, FL. FILED 8-30-2004.

SN 76-609,997. ROTELMANN GMBH & CO., 58791 WERDOHL, FED REP GERMANY, FILED 8-31-2004.



CLASS 35—ADVERTISING AND BUSINESS

FOR RETAIL STORE SERVICES, WHOLESALE DISTRIBUTORSHIPS, WHOLESALE STORES, AND COMPUTERIZED ON-LINE RETAIL STORES FEATURING GEOGRAPHIC PRODUCTS AND SERVICES, NAMELY CUSTOM MAPS, PRE-PREPARED STANDARD MAPS, GEOGRAPHIC REPORTS, AND MAPPING SOFTWARE; BUSINESS CONSULTATION IN THE FIELD OF MAPPING (U.S. CLS. 100, 101 AND 102).

FIRST USE 1-1-2003; IN COMMERCE 5-1-2004.

CLASS 42—SCIENTIFIC, COMPUTER AND LEGAL SERVICES

FOR SCIENTIFIC GEOGRAPHIC ANALYSIS; PROVIDING TEMPORARY USE OF ON-LINE NON-DOWNLOADABLE SOFTWARE FOR USE IN MAPPING VIA A GLOBAL COMPUTER NETWORK (U.S. CLS. 100 AND 101).

FIRST USE 1-1-2003; IN COMMERCE 5-1-2004.
TARAH HARDY, EXAMINING ATTORNEY

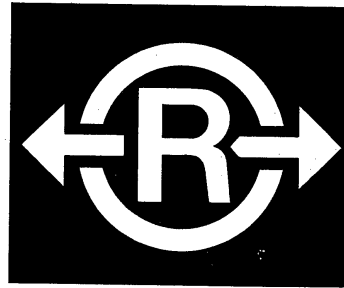

SN 76-609,900. LEISURE BOY, LLC, OCONOMOWOC, WI. FILED 9-2-2004.

LEISURE BOY

THE MARK CONSISTS OF STANDARD CHARACTERS WITHOUT CLAIM TO ANY PARTICULAR FONT, STYLE, SIZE, OR COLOR.

NO CLAIM IS MADE TO THE EXCLUSIVE RIGHT TO USE BOY, APART FROM THE MARK AS SHOWN.

CLASS 16—PAPER GOODS AND PRINTED MATTER

FOR POSTERS, PICTURES (U.S. CLS. 2, 5, 22, 23, 29, 37, 38 AND 50).

CLASS 25—CLOTHING

FOR CLOTHING, NAMELY, T-SHIRTS, SHIRTS, SHORTS AND HATS (U.S. CLS. 22 AND 39).

CLASS 34—SMOKERS' ARTICLES

FOR CIGARS (U.S. CLS. 2, 8, 9 AND 17).
WILLIAM BRECKENFELD, EXAMINING ATTORNEY

CLASS 6—METAL GOODS

FOR VALVES AND SLIDE VALVES FOR SHUT-OFF AND ON CONTROL OF LIQUID FLOWS, ALL PRODUCTS MADE OF METAL (U.S. CLS. 2, 12, 13, 14, 23, 25 AND 50).

FIRST USE 12-0-1980; IN COMMERCE 7-0-1985.

CLASS 7—MACHINERY

FOR FITTINGS FOR HYDRAULIC EQUIPMENT, IN PARTICULAR VALVES, ALL GOODS AS MACHINE PARTS (U.S. CLS. 13, 19, 21, 23, 31, 34 AND 35).

FIRST USE 12-0-1980; IN COMMERCE 7-0-1985.

CLASS 11—ENVIRONMENTAL CONTROL APPARATUS

FOR PLUMBING FITTINGS, NAMELY, VALVES, BALL VALVES; MULTIWAY BALL VALVES; BALL VALVE COMBINATIONS, COMPACT ACCUMULATOR BLOCKS, ACCUMULATOR CONNECTION BLOCKS (U.S. CLS. 13, 21, 23, 31 AND 34).

FIRST USE 12-0-1980; IN COMMERCE 7-0-1985.
JOSETTE BEVERLY, EXAMINING ATTORNEY

SN 76-610,404. TRL GROUP, INC., NORWALK, CT. FILED 9-2-2004.



CLASS 35—ADVERTISING AND BUSINESS

FOR ADMINISTRATION OF A DISCOUNT CONSUMER MEMBERSHIP PROGRAM FOR ENABLING PARTICIPANTS TO OBTAIN DISCOUNTS, SAVINGS AND REBATES ON CONSUMER MERCHANDISE, FOOD AND DINING, TRAVEL AND LODGING, GIFTS, HEALTHCARE SERVICES AND PRODUCTS, FITNESS AND EXERCISE PRODUCTS AND SERVICES, PERSONAL FINANCE PRODUCTS AND SERVICES, MAGAZINES AND NEWSPAPERS, HOME IMPROVEMENT PRODUCTS AND SERVICES, GASOLINE AND OTHER AUTOMOTIVE PRODUCTS AND SERVICES, AND MOVIES, RECREATION AND OTHER LEISURE AND ENTERTAINMENT ACTIVITIES THROUGH USE OF A DISCOUNT MEMBERSHIP CARD, PROVIDING ON-LINE CUSTOMER PRODUCT GUIDES, REVIEWS AND COMPARISONS; PROVIDING CONSUMER HOTLINE SERVICES FOR PRODUCT QUESTIONS AND COMPARISONS (U.S. CLS. 100, 101 AND 102).
FIRST USE 8-0-2003; IN COMMERCE 8-0-2003.

CLASS 36—INSURANCE AND FINANCIAL

FOR PROVIDING MEMBERS WITH INFORMATION ABOUT, ACCESS TO AND SAVINGS ON CREDIT REPORTS AND OTHER FINANCIAL INFORMATION ON THEMSELVES AND THEIR FAMILIES (U.S. CLS. 100, 101 AND 102).
FIRST USE 8-0-2003; IN COMMERCE 8-0-2003.

CLASS 37—CONSTRUCTION AND REPAIR

FOR PROVIDING TECHNICAL MECHANIC INFORMATION IN THE AUTOMOTIVE FIELD, BY TELEPHONE (U.S. CLS. 100, 103 AND 106).
FIRST USE 8-0-2003; IN COMMERCE 8-0-2003.
GRETTA YAO, EXAMINING ATTORNEY

SN 76-610,593. DILLARD'S, INC., LITTLE ROCK, AR. FILED 9-9-2004.



THE MARK CONSISTS OF STANDARD CHARACTERS WITHOUT CLAIM TO ANY PARTICULAR FONT, STYLE, SIZE, OR COLOR.
THE NAME "J VINCENT" DOES NOT IDENTIFY ANY PARTICULAR LIVING INDIVIDUAL.

CLASS 18—LEATHER GOODS

FOR HANDBAGS (U.S. CLS. 1, 2, 3, 22 AND 41).

CLASS 25—CLOTHING

FOR WOMEN'S SPORTSWEAR, NAMELY SHIRTS, PANTS, BLOUSES, SWEATERS, SKIRTS, BLAZERS, JACKETS, DRESSES AND TOPS; BELTS; SHOES (U.S. CLS. 22 AND 39).
SKYE YOUNG, EXAMINING ATTORNEY

SN 76-610,748. IDEATE, INC., SAN FRANCISCO, CA. FILED 9-10-2004.



THE MARK CONSISTS OF STANDARD CHARACTERS WITHOUT CLAIM TO ANY PARTICULAR FONT, STYLE, SIZE, OR COLOR.

CLASS 35—ADVERTISING AND BUSINESS

FOR RETAIL SERVICES BY DIRECT SOLICITATION OF SALES AGENTS IN THE FIELD OF COMPUTER HARDWARE AND SOFTWARE (U.S. CLS. 100, 101 AND 102).
FIRST USE 8-6-2004; IN COMMERCE 8-6-2004.

CLASS 42—SCIENTIFIC, COMPUTER AND LEGAL SERVICES

FOR CONSULTING SERVICES IN THE FIELD OF DESIGN, SELECTION, IMPLEMENTATION AND USE OF COMPUTER HARDWARE AND SOFTWARE SYSTEMS FOR OTHERS AND COMPUTER SOFTWARE DEVELOPMENT (U.S. CLS. 100 AND 101).
FIRST USE 8-6-2004; IN COMMERCE 8-6-2004.
TEJBIR SINGH, EXAMINING ATTORNEY

SN 76-610,862. SOLNICK, ESME, LONDON NW3 7PN, UNITED KINGDOM, AND SOLNICK, ALISON SUE TERESA, LONDON NW2 3XH, UNITED KINGDOM, AND BARNETT, JENNIFER SARAH GAY, BRENTWOOD, CA, AND SOLNICK, GILLIAN BARBARA, LONDON NW6 7AA, UNITED KINGDOM, AND SOLNICK, TIM ALAN GENE, LONDON NW3 2JA, UNITED KINGDOM, FILED 9-10-2004.



THE MARK CONSISTS OF STANDARD CHARACTERS WITHOUT CLAIM TO ANY PARTICULAR FONT, STYLE, SIZE, OR COLOR.
THE ENGLISH TRANSLATION OF "IDEE FIXE" IS "FIXATION".

CLASS 6—METAL GOODS

FOR GENERAL PURPOSE METAL STORAGE CONTAINERS (U.S. CLS. 2, 12, 13, 14, 23, 25 AND 50).
FIRST USE 0-0-2003; IN COMMERCE 0-0-2003.

CLASS 16—PAPER GOODS AND PRINTED MATTER

FOR NOTE CARDS SOLD INDIVIDUALLY AND IN BOXED SETS (U.S. CLS. 2, 5, 22, 23, 29, 37, 38 AND 50).
FIRST USE 0-0-1995; IN COMMERCE 0-0-1995.
ROBERT LAVACHE, EXAMINING ATTORNEY

SN 76-611,586. BIBLE BROADCASTING NETWORK, INC., CHARLOTTE, NC. FILED 9-10-2004.



SN 76-610,896. MISTLETOE TECHNOLOGIES, INC., CUPERTINO, CA. FILED 9-7-2004.

APPLIANCE CORE

NO CLAIM IS MADE TO THE EXCLUSIVE RIGHT TO USE "APPLIANCE", APART FROM THE MARK AS SHOWN.

NO CLAIM IS MADE TO THE EXCLUSIVE RIGHT TO USE "INTERNATIONAL", APART FROM THE MARK AS SHOWN.

CLASS 9—ELECTRICAL AND SCIENTIFIC APPARATUS

FOR COMPUTERS, COMPUTER HARDWARE, COMPUTER CHIPS, COMPUTER SOFTWARE FOR USE IN OPERATING AND MAINTAINING COMPUTER SYSTEMS (U.S. CLS. 21, 23, 26, 36 AND 38).

CLASS 38—COMMUNICATION

FOR RADIO BROADCASTING (U.S. CLS. 100, 101 AND 104).
FIRST USE 0-0-1974; IN COMMERCE 0-0-1974.

CLASS 40—MATERIAL TREATMENT

FOR CUSTOM MANUFACTURE OF COMPUTER CHIPS FOR OTHERS (U.S. CLS. 100, 103 AND 106).

CLASS 41—EDUCATION AND ENTERTAINMENT

FOR ENTERTAINMENT SERVICES, NAMELY, PROVIDING A RADIO PROGRAM IN THE FIELD OF RELIGION VIA A GLOBAL COMPUTER NETWORK (U.S. CLS. 100, 101 AND 107).
FIRST USE 0-0-1974; IN COMMERCE 0-0-1974.
WINSTON FOLMAR, EXAMINING ATTORNEY

CLASS 42—SCIENTIFIC, COMPUTER AND LEGAL SERVICES

FOR DESIGN OF COMPUTER CHIPS; COMPUTER SOFTWARE DEVELOPMENT; COMPUTER SOFTWARE DESIGN (U.S. CLS. 100 AND 101).
LESLEY LAMOTHE, EXAMINING ATTORNEY

SN 76-611,650. IPG TECHNOLOGIES INC., COLUMBIA, SC. FILED 9-16-2004.

SN 76-611,477. HAMCO, INC., GONZALES, LA. FILED 9-9-2004.

SPIT HAPPENS

THE MARK CONSISTS OF STANDARD CHARACTERS WITHOUT CLAIM TO ANY PARTICULAR FONT, STYLE, SIZE, OR COLOR.
OWNER OF U.S. REG. NO. 1,815,972.



NO CLAIM IS MADE TO THE EXCLUSIVE RIGHT TO USE "TAPE", APART FROM THE MARK AS SHOWN.

CLASS 10—MEDICAL APPARATUS

FOR BABY BOTTLES (U.S. CLS. 26, 39 AND 44).

CLASS 16—PAPER GOODS AND PRINTED MATTER

FOR NATURAL RUBBER ADHESIVE CARTON SEALING TAPE FOR HOUSEHOLD PURPOSES (U.S. CLS. 2, 5, 22, 23, 29, 37, 38 AND 50).
FIRST USE 12-12-2003; IN COMMERCE 12-12-2003.

CLASS 21—HOUSEWARES AND GLASS

FOR DRINKING CUPS (U.S. CLS. 2, 13, 23, 29, 30, 33, 40 AND 50).

CLASS 17—RUBBER GOODS

FOR NATURAL RUBBER ADHESIVE CARTON SEALING TAPE FOR INDUSTRIAL PURPOSES (U.S. CLS. 1, 5, 12, 13, 35 AND 50).
FIRST USE 12-12-2003; IN COMMERCE 12-12-2003.
RAMONA ORTIGA, EXAMINING ATTORNEY

CLASS 25—CLOTHING

FOR BABY CLOTHING, NAMELY, ONE PIECE GARMENT FOR INFANTS AND TODDLERS (U.S. CLS. 22 AND 39).
ANN E. SAPPENFIELD, EXAMINING ATTORNEY

SN 76-611,703. H2OUTFITTERS, ORR'S ISLAND, ME. FILED 9-13-2004.

H2OUTFITTERS

THE MARK CONSISTS OF STANDARD CHARACTERS WITHOUT CLAIM TO ANY PARTICULAR FONT, STYLE, SIZE, OR COLOR.

CLASS 39—TRANSPORTATION AND STORAGE

FOR ORGANIZATION AND PLANNING OF CANOE AND KAYAK TRIPS (U.S. CLS. 100 AND 105).
FIRST USE 1-15-1984; IN COMMERCE 1-15-1984.

CLASS 41—EDUCATION AND ENTERTAINMENT

FOR INSTRUCTIONAL SERVICES IN CANOEING AND KAYAKING (U.S. CLS. 100, 101 AND 107).
FIRST USE 1-15-1984; IN COMMERCE 1-15-1984.
ROBERT LORENZO, EXAMINING ATTORNEY

SN 76-611,999. FRANKLIN MEDIA NETWORKS, LLC, TARPON SPRINGS, FL. FILED 9-17-2004.

KICSFLIX

THE MARK CONSISTS OF STANDARD CHARACTERS WITHOUT CLAIM TO ANY PARTICULAR FONT, STYLE, SIZE, OR COLOR.

CLASS 9—ELECTRICAL AND SCIENTIFIC APPARATUS

FOR PRE-RECORDED CD'S, AUDIO TAPES, VIDEO TAPES, LASER DISKS AND DVD'S FEATURING ANIMATED CHILDREN'S STORIES WITH EDUCATIONAL CONTENT (U.S. CLS. 21, 23, 26, 36 AND 38).
FIRST USE 8-25-2004; IN COMMERCE 8-25-2004.

CLASS 16—PAPER GOODS AND PRINTED MATTER

FOR CHILDREN'S BOOKS, INSTRUCTIONAL AND TEACHING MATERIALS, NAMELY BOOKS, PAMPHLETS AND COMICS FEATURING CHILDREN'S STORIES WITH EDUCATIONAL CONTENT (U.S. CLS. 2, 5, 22, 23, 29, 37, 38 AND 50).
FIRST USE 8-25-2004; IN COMMERCE 8-25-2004.
SUSAN HAYASH, EXAMINING ATTORNEY

SN 76-612,062. RED OR DEAD LIMITED, LONDON W1U 3PH, UNITED KINGDOM, FILED 9-14-2004.

RED OR DEAD

THE MARK CONSISTS OF STANDARD CHARACTERS WITHOUT CLAIM TO ANY PARTICULAR FONT, STYLE, SIZE, OR COLOR.

OWNER OF UNITED KINGDOM REG. NO. 2111673, DATED 8-18-1997, EXPIRES 10-2-2006.

CLASS 3—COSMETICS AND CLEANING PREPARATIONS

FOR SOAPS, SHAMPOOS, PERFUMES, ESSENTIAL OILS FOR PERSONAL USE, COSMETICS, HAIR LOTIONS, DEPILATORIES, SKIN LOTIONS, SKIN TREATMENTS IN THE NATURE OF NON-MEDICATED SKIN CARE PREPARATIONS, TOILETRIES (U.S. CLS. 1, 4, 6, 50, 51 AND 52).

CLASS 9—ELECTRICAL AND SCIENTIFIC APPARATUS

FOR SPECTACLES, SPECTACLE FRAMES, SPECTACLE CASES, SUNGLASSES, SUNGLASS FRAMES, SUNGLASS CASES; PARTS AND FITTINGS FOR ALL THE AFORESAID GOODS (U.S. CLS. 21, 23, 26, 36 AND 38).

CLASS 14—JEWELRY

FOR WATCHES, WATCHSTRAPS, CLOCKS, JEWELRY, MEDALS, BADGES OF PRECIOUS METAL, BUCKLES OF PRECIOUS METAL, TIE CLIPS, TIE PINS (U.S. CLS. 2, 27, 28 AND 50).

CLASS 18—LEATHER GOODS

FOR BAGS, NAMELY, HANDBAGS, PURSES, RUCKSACKS, BACKPACKS, KNAPSACKS, SATCHELS, BRIEFCASE-TYPE PORTFOLIOS, ATTACHE CASES, WALLETS, BRIEFCASES, TRUNKS, SUITCASES, TRAVELLING BAGS (U.S. CLS. 1, 2, 3, 22 AND 41).
KIMBERLY PERRY, EXAMINING ATTORNEY

SN 76-612,210. DEGUSSA AG, DUESSELDORF, FED REP GERMANY, FILED 9-15-2004.

PLANIPRON

THE MARK CONSISTS OF STANDARD CHARACTERS WITHOUT CLAIM TO ANY PARTICULAR FONT, STYLE, SIZE, OR COLOR.

OWNER OF FED REP GERMANY REG. NO. 30411521, DATED 4-5-2004, EXPIRES 4-5-2014.

CLASS 1—CHEMICALS

FOR CHEMICALS FOR USE IN THE MANUFACTURE OF A BROAD VARIETY OF GOODS; MANURES; FIRE EXTINGUISHING COMPOSITIONS; CHEMICAL SUBSTANCES FOR PRESERVING FOODSTUFFS; ADHESIVES USED IN INDUSTRY (U.S. CLS. 1, 5, 6, 10, 26 AND 46).

CLASS 5—PHARMACEUTICALS

FOR PHARMACEUTICAL PREPARATIONS FOR THE TREATMENT OF SKIN IRRITATIONS; VETERINARY PREPARATIONS FOR THE TREATMENT OF SKIN IRRITATIONS; PREPARATIONS FOR DESTROYING VERMIN; FUNGICIDES, HERBICIDES (U.S. CLS. 6, 18, 44, 46, 51 AND 52).

EDWARD NELSON, EXAMINING ATTORNEY

SN 76-612,310. AMERICAN GASTROENTEROLOGICAL ASSOCIATION, BETHESDA, MD. FILED 9-21-2004.

SN 76-613,615. FULL THROTTLE FILMS, INC., GLENDALE, CA. FILED 9-23-2004.

DIGESTIVE DISEASES SELF-EDUCATION PROGRAM

THE MARK CONSISTS OF STANDARD CHARACTERS WITHOUT CLAIM TO ANY PARTICULAR FONT, STYLE, SIZE, OR COLOR.

OWNER OF U.S. REG. NO. 2,270,042.
NO CLAIM IS MADE TO THE EXCLUSIVE RIGHT TO USE "PROGRAM", APART FROM THE MARK AS SHOWN. SEC. 2(F).

VER

CLASS 9—ELECTRICAL AND SCIENTIFIC APPARATUS

FOR PRE-RECORDED CD-ROMS FEATURING EDUCATIONAL INFORMATION IN THE FIELDS OF GASTROENTEROLOGY AND HEPATOLOGY (U.S. CLS. 21, 23, 26, 36 AND 38).

FIRST USE 5-0-1998; IN COMMERCE 5-0-1998.

CLASS 41—EDUCATION AND ENTERTAINMENT

FOR EDUCATIONAL SERVICES, NAMELY THE OFFERING OF AN INTERACTIVE MULTIMEDIA PROGRAM FEATURING INFORMATION IN THE FIELDS OF GASTROENTEROLOGY AND HEPATOLOGY (U.S. CLS. 100, 101 AND 107).

FIRST USE 12-0-1997; IN COMMERCE 12-0-1997.
TRACY WHITAKER-BOWN, EXAMINING ATTORNEY

THE MARK CONSISTS OF STANDARD CHARACTERS WITHOUT CLAIM TO ANY PARTICULAR FONT, STYLE, SIZE, OR COLOR.

CLASS 38—COMMUNICATION

FOR RENTAL OF EQUIPMENT, NAMELY, BROADCAST EQUIPMENT (U.S. CLS. 100, 101 AND 104).

FIRST USE 9-0-1990; IN COMMERCE 9-0-1990.

CLASS 41—EDUCATION AND ENTERTAINMENT

FOR RENTAL OF EQUIPMENT, NAMELY, AUDIO, VIDEO, AND CAMERA EQUIPMENT (U.S. CLS. 100, 101 AND 107).

FIRST USE 9-0-1990; IN COMMERCE 9-0-1990.
JENNIFER KRISP, EXAMINING ATTORNEY

SN 76-613,044. BOUGAINVILLEA GROWERS INTERNATIONAL, LLC, BOYTON BEACH, FL. FILED 9-20-2004.

SN 76-613,933. THE RETROFIT COMPANIES, INC., OWATONNA, MN. FILED 9-24-2004.

BGI

THE RETROFIT COMPANIES

THE MARK CONSISTS OF STANDARD CHARACTERS WITHOUT CLAIM TO ANY PARTICULAR FONT, STYLE, SIZE, OR COLOR.

NO CLAIM IS MADE TO THE EXCLUSIVE RIGHT TO USE "COMPANIES", APART FROM THE MARK AS SHOWN. SEC. 2(F).

THE MARK CONSISTS OF STANDARD CHARACTERS WITHOUT CLAIM TO ANY PARTICULAR FONT, STYLE, SIZE, OR COLOR.

CLASS 1—CHEMICALS

FOR FERTILIZER (U.S. CLS. 1, 5, 6, 10, 26 AND 46).
FIRST USE 3-0-1998; IN COMMERCE 3-0-1998.

CLASS 31—NATURAL AGRICULTURAL PRODUCTS

FOR LIVE FLOWERING PLANTS (U.S. CLS. 1 AND 46).
FIRST USE 1-0-1998; IN COMMERCE 1-0-1998.
JIM RINGLE, EXAMINING ATTORNEY

CLASS 37—CONSTRUCTION AND REPAIR

FOR PIPE AND WIRE ELECTRICAL CONTRACTOR SERVICES; INSTALLATION OF ENERGY EFFICIENT LIGHTING (U.S. CLS. 100, 103 AND 106).

FIRST USE 12-17-1997; IN COMMERCE 12-17-1997.

CLASS 40—MATERIAL TREATMENT

FOR RECYCLING OF ELECTRICAL, LIGHTING AND RELATED WASTE, INCLUDING FLUORESCENT LAMPS, PCB BALLASTS, MERCURY DEVICES OR DEBRIS, BATTERIES, ELECTRONIC SCRAP AND OTHER HAZARDOUS MATERIALS (U.S. CLS. 100, 103 AND 106).

FIRST USE 12-17-1997; IN COMMERCE 12-17-1997.
DAWN HAN, EXAMINING ATTORNEY

SN 76-614,567. CASEY TREES ENDOWMENT FUND, WASHINGTON, DC. FILED 10-4-2004.

SN 76-614,641. GARTH FISHER SKIN CARE, LLC, BEVERLY HILLS, CA. FILED 10-6-2004.



CLASS 35—ADVERTISING AND BUSINESS

FOR CHARITABLE SERVICES, NAMELY, ORGANIZING AND CONDUCTING VOLUNTEER PROGRAMS AND COMMUNITY SERVICE PROJECTS IN THE NATURE OF TREE PLANTING PROGRAMS IN URBAN COMMUNITIES (U.S. CLS. 100, 101 AND 102).

FIRST USE 7-0-2003; IN COMMERCE 7-0-2003.

CLASS 41—EDUCATION AND ENTERTAINMENT

FOR EDUCATIONAL AND TRAINING SERVICES, NAMELY, CONDUCTING CLASSES, SEMINARS AND WORKSHOPS IN THE FIELD OF TREE MAINTENANCE, URBAN AND COMMUNITY TREE-PLANTING (U.S. CLS. 100, 101 AND 107).

FIRST USE 7-0-2003; IN COMMERCE 7-0-2003.
BARBARA A. GOLD, EXAMINING ATTORNEY

SN 76-614,572. CASEY TREES ENDOWMENT FUND, WASHINGTON, DC. FILED 10-4-2004.

CASEY TREES

THE MARK CONSISTS OF STANDARD CHARACTERS WITHOUT CLAIM TO ANY PARTICULAR FONT, STYLE, SIZE, OR COLOR.

NO CLAIM IS MADE TO THE EXCLUSIVE RIGHT TO USE TREES, APART FROM THE MARK AS SHOWN.

CLASS 41—EDUCATION AND ENTERTAINMENT

FOR EDUCATIONAL AND TRAINING SERVICES, NAMELY, CONDUCTING CLASSES, SEMINARS AND WORKSHOPS IN THE FIELD OF TREE MAINTENANCE, URBAN AND COMMUNITY TREE-PLANTING (U.S. CLS. 100, 101 AND 107).

FIRST USE 7-0-2003; IN COMMERCE 7-0-2003.

CLASS 44—MEDICAL, BEAUTY AND AGRICULTURAL SERVICES

FOR CONDUCTING TREE PLANTING PROGRAMS IN URBAN COMMUNITIES (U.S. CLS. 100 AND 101).

FIRST USE 7-0-2003; IN COMMERCE 7-0-2003.
MICHELE SWAIN, EXAMINING ATTORNEY

CLINICARE

THE MARK CONSISTS OF STANDARD CHARACTERS WITHOUT CLAIM TO ANY PARTICULAR FONT, STYLE, SIZE, OR COLOR.

CLASS 3—COSMETICS AND CLEANING PREPARATIONS

FOR NON-MEDICATED SKIN CARE PRODUCTS, NAMELY, FACIAL CLEANSERS, SCRUBS, EXFOLIATOR CREAMS AND LOTIONS, MASQUES, PEELS, MOISTURIZING CREAMS, LOTIONS AND SERUMS, HYDRATORS, CREAMS, GELS, SUN TANNING LOTION, SUNSCREEN, SELF-TANNING AND SUN-CARE PREPARATIONS, SPOT AND PIGMENT LIGHTENING GELS, ANTI-AGING CREAMS, LOTIONS AND SERUMS, NON-MEDICATED ACNE PRODUCTS, MAKE-UP REMOVERS; HAIR CARE PRODUCTS, NAMELY, SHAMPOO, CONDITIONER AND STYLING PRODUCTS; COSMETICS, NAMELY, LIQUID FOUNDATION, FACE POWDER, EYE SHADOW, MASCARA, EYEBROW PENCIL, LIPSTICK, LIP GLOSS, BLUSHER, LIP PENCIL, EYELINER; FRAGRANCES, NAMELY, PERFUME, EAU DE TOILETTE, EAU DE COLOGNE (U.S. CLS. 1, 4, 6, 50, 51 AND 52).

CLASS 5—PHARMACEUTICALS

FOR MEDICATED LOTIONS, CREAMS AND CLEANSERS FOR THE TREATMENT OF ACNE (U.S. CLS. 6, 18, 44, 46, 51 AND 52).

PATRICIA EVANKO, EXAMINING ATTORNEY

SN 76-614,861. LODIS CORPORATION, LOS ANGELES, CA. FILED 10-4-2004.

LODIS

THE MARK CONSISTS OF STANDARD CHARACTERS WITHOUT CLAIM TO ANY PARTICULAR FONT, STYLE, SIZE, OR COLOR.

CLASS 16—PAPER GOODS AND PRINTED MATTER

FOR CHECK BOOK HOLDERS, TELEPHONE AND ADDRESS BOOKS, APPOINTMENT BOOKS AND AGENDAS, PEN/PENCIL HOLDERS, AGENDA WITH DIARY AND LEGAL TRAY, NOTE PAPER HOLDERS, AND LEGAL PAD HOLDERS (U.S. CLS. 2, 5, 22, 23, 29, 37, 38 AND 50).

FIRST USE 2-0-1968; IN COMMERCE 2-0-1968.

CLASS 18—LEATHER GOODS

FOR BILLFOLDS, WALLETS, CREDIT CARD CASES, CALLING CARD CASES, KEY CASES, PASSPORT CASES, FRENCH PURSES, CONTINENTAL PURSES, CLUTCHES, COIN PURSES, HANDBAGS AND PURSES, SHOULDER BAGS, COSMETIC CASES SOLD EMPTY, TOILET CASES SOLD EMPTY, LUGGAGE TAGS, BRIEFCASE-TYPE PORTFOLIOS, ATTACHE CASES, AND OVERNIGHT CASES (U.S. CLS. 1, 2, 3, 22 AND 41).

FIRST USE 2-0-1968; IN COMMERCE 2-0-1968.

CHRISTOPHER ADKINS, EXAMINING ATTORNEY

CLASS 41—EDUCATION AND ENTERTAINMENT

FOR EDUCATIONAL SERVICES, NAMELY, CONDUCTING CLASSES, SEMINARS, AND CONFERENCES FOR PROFESSIONALS IN THE FIELDS OF FINANCIAL SERVICES, INSURANCE, AND CHARITABLE GIVING AND FUNDRAISING, BY MEANS OF LIVE, ONLINE, AUDIO, AND VIDEO PRESENTATIONS; OFFERING AND ADMINISTERING EXAMINATIONS FOR PROFESSIONALS IN THE FIELDS OF FINANCIAL SERVICES, INSURANCE, AND CHARITABLE GIVING AND FUNDRAISING ON COMPUTER TERMINALS (U.S. CLS. 100, 101 AND 107).

CURTIS FRENCH, EXAMINING ATTORNEY

SN 76-614,946. THE AMERICAN COLLEGE, BRYN MAWR, PA. FILED 10-6-2004.

SN 76-614,959. ASCENT GROUP, L.L.C., ALPINE, UT. FILED 10-4-2004.

THE AMERICAN COLLEGE OF FINANCIAL SERVICES

THE WORK ITSELF

THE MARK CONSISTS OF STANDARD CHARACTERS WITHOUT CLAIM TO ANY PARTICULAR FONT, STYLE, SIZE, OR COLOR.

OWNER OF U.S. REG. NOS. 1,114,023, 1,131,051 AND 1,636,031.

NO CLAIM IS MADE TO THE EXCLUSIVE RIGHT TO USE FINANCIAL SERVICES, APART FROM THE MARK AS SHOWN.

SEC. 2(F) "THE AMERICAN COLLEGE".

THE MARK CONSISTS OF STANDARD CHARACTERS WITHOUT CLAIM TO ANY PARTICULAR FONT, STYLE, SIZE, OR COLOR.

CLASS 9—ELECTRICAL AND SCIENTIFIC APPARATUS

FOR COMPUTER SOFTWARE FOR INSTRUCTION IN THE FIELDS OF FINANCIAL SERVICES, INSURANCE, AND CHARITABLE GIVING AND FUNDRAISING; PRE-RECORDED EDUCATIONAL AUDIO AND VIDEO CASSETTES AND DISCS IN THE FIELDS OF FINANCIAL SERVICES, INSURANCE, AND CHARITABLE GIVING AND FUNDRAISING (U.S. CLS. 21, 23, 26, 36 AND 38).

CLASS 14—JEWELRY

FOR JEWELRY, NAMELY, TIE CHAINS, TIE TACKS, TIE BARS, KEY CHAINS MADE OF OR COATED WITH PRECIOUS METALS, KEY PINS, NECK CHAINS, NECKLACES, BRACELETS, STICK PINS, BROOCHES, RINGS, AND CUFF LINKS (U.S. CLS. 2, 27, 28 AND 50).

CLASS 16—PAPER GOODS AND PRINTED MATTER

FOR EDUCATIONAL PUBLICATIONS IN THE FIELDS OF FINANCIAL SERVICES, INSURANCE, AND CHARITABLE GIVING AND FUNDRAISING, NAMELY BOOKS, PAMPHLETS, JOURNALS, NEWSLETTERS, PRINTED COURSE STUDY GUIDES, TEXTBOOKS, PRINTED LISTENING GUIDES FOR AUDIO CASSETTES AND DISCS, PRINTED VIEWING GUIDES FOR VIDEO CASSETTES AND DISCS, AND PRINTED USER GUIDES FOR COMPUTER SOFTWARE (U.S. CLS. 2, 5, 22, 23, 29, 37, 38 AND 50).

CLASS 25—CLOTHING

FOR CLOTHING, NAMELY, SHIRTS, JACKETS, SWEATSHIRTS, SWEATPANTS, SHORTS, HATS (U.S. CLS. 22 AND 39).

CLASS 16—PAPER GOODS AND PRINTED MATTER

FOR PRINTED BOOKLETS, BOOKS, BROCHURES, DIAGRAMS, QUESTIONNAIRES, WORKSHEETS, AND TEACHING GUIDES USED IN THE FIELD OF BUSINESS EDUCATION, SPECIFICALLY FOR USE IN TRAINING AND EXECUTIVE CONSULTING IN THE AREAS OF BUSINESS STRATEGY, PERFORMANCE ASSESSMENT, PERFORMANCE MANAGEMENT AND EXECUTION, LEADERSHIP, MANAGEMENT, TEAM DEVELOPMENT, AND COMMUNICATION SKILLS (U.S. CLS. 2, 5, 22, 23, 29, 37, 38 AND 50).

FIRST USE 8-0-2003; IN COMMERCE 8-0-2003.

CLASS 35—ADVERTISING AND BUSINESS

FOR BUSINESS MANAGEMENT AND CONSULTING SERVICES, NAMELY, DEVELOPING AND IMPLEMENTING BUSINESS STRATEGY; ALIGNING AND INTEGRATING HUMAN RESOURCES WITH CORPORATE STRATEGY (U.S. CLS. 100, 101 AND 102).

FIRST USE 8-0-2003; IN COMMERCE 8-0-2003.

CLASS 41—EDUCATION AND ENTERTAINMENT

FOR EDUCATIONAL AND INSTRUCTIONAL SERVICES, NAMELY CONDUCTING BUSINESS EDUCATION SEMINARS AND WORKSHOPS IN THE FIELDS OF BUSINESS STRATEGY, PERFORMANCE ASSESSMENT, PERFORMANCE MANAGEMENT AND EXECUTION, LEADERSHIP, MANAGEMENT, TEAM DEVELOPMENT, AND COMMUNICATION SKILLS (U.S. CLS. 100, 101 AND 107).

FIRST USE 8-0-2003; IN COMMERCE 8-0-2003.

ANGELA M. MICHELI, EXAMINING ATTORNEY

SN 76-615,030. AMERICAN KIDNEY FUND, INC., ROCKVILLE, MD. FILED 10-6-2004.

SN 76-615,091. CHANEL, INC., NEW YORK, NY. FILED 10-8-2004.

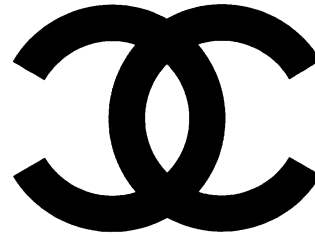

NO CLAIM IS MADE TO THE EXCLUSIVE RIGHT TO USE "MINORITY INTERVENTION AND KIDNEY EDUCATION" AND "PROGRAM", APART FROM THE MARK AS SHOWN.

THE MARK CONSISTS OF THE WORD "MIKE" WITH A STYLIZED LETTER "I" AND THE PHRASE, "MINORITY INTERVENTION AND KIDNEY EDUCATION A PROGRAM OF THE AMERICAN KIDNEY FUND".
SEC. 2(F) AS TO "AMERICAN KIDNEY FUND".

OWNER OF U.S. REG. NOS. 195,359, 1,734,822 AND OTHERS.
THE MARK IS COMPROMISED OF INTERLOCKING C'S.

CLASS 9—ELECTRICAL AND SCIENTIFIC APPARATUS

FOR MOBILE PHONE STRAPS, EYEGLASS FRAMES, SUNGLASSES (U.S. CLS. 21, 23, 26, 36 AND 38).
FIRST USE 9-1-2004; IN COMMERCE 9-1-2004.

CLASS 36—INSURANCE AND FINANCIAL

FOR CHARITABLE FUND RAISING SERVICES (U.S. CLS. 100, 101 AND 102).
FIRST USE 8-30-2003; IN COMMERCE 8-30-2003.

CLASS 25—CLOTHING

FOR GLOVES, SWIMWEAR (U.S. CLS. 22 AND 39).
FIRST USE 7-1-2003; IN COMMERCE 7-1-2003.

CLASS 44—MEDICAL, BEAUTY AND AGRICULTURAL SERVICES

FOR CHARITABLE SERVICES, NAMELY, PROVIDING MEDICAL AND HEALTHCARE INFORMATION AND STRATEGIES CONCERNING THE PREVENTION OF KIDNEY DISEASE AMONG AFRICAN-AMERICAN, HISPANIC, NATIVE- AMERICAN, AND ASIAN-AMERICAN COMMUNITIES (U.S. CLS. 100 AND 101).
FIRST USE 8-30-2003; IN COMMERCE 8-30-2003.
KIMBERLY PERRY, EXAMINING ATTORNEY

CLASS 26—FANCY GOODS

FOR HAIR ACCESSORIES NAMELY BARRETTES AND PONY-TAIL HOLDERS (U.S. CLS. 37, 39, 40, 42 AND 50).
FIRST USE 9-1-2004; IN COMMERCE 9-1-2004.
KIMBERLY PERRY, EXAMINING ATTORNEY

SN 76-615,062. THE HARTZ MOUNTAIN CORPORATION, SECAUCUS, NJ. FILED 10-8-2004.

SN 76-615,304. LORAC COSMETICS, INC., CHATSWORTH, CA. FILED 10-12-2004.



OWNER OF U.S. REG. NO. 2,307,035.
NO CLAIM IS MADE TO THE EXCLUSIVE RIGHT TO USE DENTAL CHEWS, APART FROM THE MARK AS SHOWN.

THE MARK CONSISTS OF STANDARD CHARACTERS WITHOUT CLAIM TO ANY PARTICULAR FONT, STYLE, SIZE, OR COLOR.
OWNER OF U.S. REG. NO. 1,852,838.

CLASS 18—LEATHER GOODS

FOR PET ACCESSORIES, NAMELY RAWHIDE DOG CHEWS, DOG LEASHES AND PET COLLARS (U.S. CLS. 1, 2, 3, 22 AND 41).
FIRST USE 9-20-2002; IN COMMERCE 9-20-2002.

CLASS 3—COSMETICS AND CLEANING PREPARATIONS

FOR COSMETICS AND MAKE-UP, NAMELY, LIPSTICK, LIP GLOSS, LIP POLISH, EYE SHADOW, EYE LINER, MASCARA, BROW WAX, LIP PENCILS, EYE PENCILS, FACE POWDER, CONCEALER, FOUNDATION MAKE-UP, BLUSH; SKIN CARE PRODUCTS, NAMELY, MOISTURIZER, TONER, FACIAL WASH (U.S. CLS. 1, 4, 6, 50, 51 AND 52).
FIRST USE 9-30-1993; IN COMMERCE 9-30-1993.

CLASS 31—NATURAL AGRICULTURAL PRODUCTS

FOR PET FOOD, PET BISCUITS, AND EDIBLE PET TREATS AND SNACKS (U.S. CLS. 1 AND 46).
FIRST USE 9-20-2002; IN COMMERCE 9-20-2002.
TARAH HARDY, EXAMINING ATTORNEY

CLASS 21—HOUSEWARES AND GLASS

FOR MAKE-UP BRUSHES (U.S. CLS. 2, 13, 23, 29, 30, 33, 40 AND 50).
FIRST USE 0-0-1995; IN COMMERCE 0-0-1995.
RAMONA ORTIGA, EXAMINING ATTORNEY

SN 76-615,673. NEW CREATIVE ENTERPRISES, INC., MILFORD, OH. FILED 10-7-2004.

NEW CREATIVE

THE MARK CONSISTS OF STANDARD CHARACTERS WITHOUT CLAIM TO ANY PARTICULAR FONT, STYLE, SIZE, OR COLOR.

CLASS 11—ENVIRONMENTAL CONTROL APPARATUS

FOR CANDLE LANTERNS AND LAMPS (U.S. CLS. 13, 21, 23, 31 AND 34).
FIRST USE 1-0-1995; IN COMMERCE 5-0-1995.

CLASS 18—LEATHER GOODS

FOR CANVAS TOTE BAGS (U.S. CLS. 1, 2, 3, 22 AND 41).
FIRST USE 1-0-1995; IN COMMERCE 5-0-1995.

CLASS 19—NON-METALLIC BUILDING MATERIALS

FOR DECORATIVE GARDEN STONES (U.S. CLS. 1, 12, 33 AND 50).
FIRST USE 1-0-1999; IN COMMERCE 5-0-1999.

CLASS 20—FURNITURE AND ARTICLES NOT OTHERWISE CLASSIFIED

FOR FURNITURE ITEMS MADE OF WOOD AND METAL AND A COMBINATION OF WOOD AND METAL, NAMELY, TABLES, FURNITURE CHESTS, CHAIRS, BAKERS RACKS, MIRRORS, AND STOOLS; LAWN ORNAMENTS MADE OF WOOD; PICTURE FRAMES; FIREPLACE SCREENS MADE OF WOOD; WALL SHELVES; WIND CHIMES (U.S. CLS. 2, 13, 22, 25, 32 AND 50).
FIRST USE 5-0-1997; IN COMMERCE 9-0-1997.

CLASS 21—HOUSEWARES AND GLASS

FOR BIRD HOUSES; COASTERS MADE OF WOOD AND CORK; BIRDFEEDERS; SERVING TRAYS NOT OF PRECIOUS METAL, NAMELY, WOODEN SERVING TRAYS; CANDLE ACCESSORIES, NOT OF PRECIOUS METAL, NAMELY, CANDLE HOLDERS, CANDLE JARS, CANDLE VOTIVES, AND CANDLE RINGS MADE OF POLYRESIN, GLASS OR CERAMIC; BASKETS MADE OF WOOD AND CERAMIC; HOLDERS FOR FLOWERS AND PLANTS MADE OF POLYRESIN; CERAMIC FLOWER POTS; CANDLES ACCESSORIES NOT OF PRECIOUS METAL, NAMELY, PEDESTAL FOR CANDLES MADE OF METAL, METAL CANDLE HOLDERS, METAL CANDLE VOTIVES, AND CANDLE RINGS MADE OF METAL; CANDLE ACCESSORIES MADE OF WOOD, NAMELY, WOODEN CANDLE BOXES AND WOODEN CANDLE RINGS; PLANTERS MADE OF WOOD (U.S. CLS. 2, 13, 23, 29, 30, 33, 40 AND 50).
FIRST USE 1-0-1984; IN COMMERCE 5-0-1984.

CLASS 24—FABRICS

FOR CLOTH FLAGS; LAWN ORNAMENTS MADE OF NYLON, NAMELY, CLOTH BANNERS (U.S. CLS. 42 AND 50).
FIRST USE 6-0-1994; IN COMMERCE 9-0-1994.

CLASS 26—FANCY GOODS

FOR ARTIFICIAL FLOWER ARRANGEMENTS AND ARTIFICIAL FOLIAGES (U.S. CLS. 37, 39, 40, 42 AND 50).
FIRST USE 1-0-1979; IN COMMERCE 1-0-1979.

CLASS 28—TOYS AND SPORTING GOODS

FOR CLOTH WIND SOCKS AND STREAMERS FOR DECORATIVE PURPOSES; SNOW GLOBES (U.S. CLS. 22, 23, 38 AND 50).
FIRST USE 6-0-1994; IN COMMERCE 9-0-1994.
CURTIS FRENCH, EXAMINING ATTORNEY

SN 76-615,856. NETJETS, INC., WOODBRIDGE, NJ. FILED 10-8-2004.

LIFESTYLES PORTFOLIO

THE MARK CONSISTS OF STANDARD CHARACTERS WITHOUT CLAIM TO ANY PARTICULAR FONT, STYLE, SIZE, OR COLOR.

OWNER OF U.S. REG. NOS. 1,545,644, 2,671,376 AND 2,767,835.
NO CLAIM IS MADE TO THE EXCLUSIVE RIGHT TO USE PORTFOLIO, APART FROM THE MARK AS SHOWN.

CLASS 16—PAPER GOODS AND PRINTED MATTER

FOR MAGAZINES AND BROCHURES PROMOTING THE GOODS AND SERVICES OF THIRD PARTIES (U.S. CLS. 2, 5, 22, 23, 29, 37, 38 AND 50).
FIRST USE 4-1-2004; IN COMMERCE 4-1-2004.

CLASS 35—ADVERTISING AND BUSINESS

FOR PROMOTING THE PRODUCTS OF OTHERS THROUGH DISTRIBUTION OF THE PRODUCTS ON PROPRIETARY AIRCRAFT AND THROUGH PROVIDING ADVERTISING SPACE IN MAGAZINES AND BROCHURES (U.S. CLS. 100, 101 AND 102).
FIRST USE 4-1-2004; IN COMMERCE 4-1-2004.
ANGELA M. MICHELI, EXAMINING ATTORNEY

SN 76-615,859. NETJETS, INC., WOODBRIDGE, NJ. FILED 10-8-2004.

NETJETS LIFESTYLES

THE MARK CONSISTS OF STANDARD CHARACTERS WITHOUT CLAIM TO ANY PARTICULAR FONT, STYLE, SIZE, OR COLOR.

OWNER OF U.S. REG. NOS. 1,545,644, 2,671,376 AND 2,767,835.

CLASS 16—PAPER GOODS AND PRINTED MATTER

FOR MAGAZINES AND BROCHURES PROMOTING THE GOODS AND SERVICES OF THIRD PARTIES (U.S. CLS. 2, 5, 22, 23, 29, 37, 38 AND 50).
FIRST USE 4-1-2004; IN COMMERCE 4-1-2004.

CLASS 35—ADVERTISING AND BUSINESS

FOR PROMOTING THE PRODUCTS OF OTHERS THROUGH DISTRIBUTION OF THE PRODUCTS ON PROPRIETARY AIRCRAFT AND THROUGH PROVIDING ADVERTISING SPACE IN MAGAZINES AND BROCHURES (U.S. CLS. 100, 101 AND 102).

FIRST USE 4-1-2004; IN COMMERCE 4-1-2004.
ANGELA M. MICHELI, EXAMINING ATTORNEY

SN 76-615,865. NETJETS, INC., WOODBRIDGE, NJ. FILED 10-8-2004.

NETJETS LIFESTYLES PORTFOLIO

THE MARK CONSISTS OF STANDARD CHARACTERS WITHOUT CLAIM TO ANY PARTICULAR FONT, STYLE, SIZE, OR COLOR.

OWNER OF U.S. REG. NOS. 1,545,644, 2,671,376 AND 2,767,835.

NO CLAIM IS MADE TO THE EXCLUSIVE RIGHT TO USE PORTFOLIO, APART FROM THE MARK AS SHOWN.

SN 76-615,863. UNIVERSITY OF NORTH CAROLINA AT CHAPEL HILL, THE, CHAPEL HILL, NC. FILED 10-8-2004.

**CLASS 16—PAPER GOODS AND PRINTED MATTER**

FOR MAGAZINES AND BROCHURES PROMOTING THE GOODS AND SERVICES OF THIRD PARTIES (U.S. CLS. 2, 5, 22, 23, 29, 37, 38 AND 50).

FIRST USE 4-1-2004; IN COMMERCE 4-1-2004.

CLASS 35—ADVERTISING AND BUSINESS

FOR PROMOTING THE PRODUCTS OF OTHERS THROUGH DISTRIBUTION OF THE PRODUCTS ON PROPRIETARY AIRCRAFT AND THROUGH PROVIDING ADVERTISING SPACE IN MAGAZINES AND BROCHURES (U.S. CLS. 100, 101 AND 102).

FIRST USE 4-1-2004; IN COMMERCE 4-1-2004.
ANGELA M. MICHELI, EXAMINING ATTORNEY

OWNER OF U.S. REG. NO. 1,255,593.

SN 76-616,442. CHILDREN'S HOSPITAL OF PHILADELPHIA, THE, PHILADELPHIA, PA. FILED 10-15-2004.

CLASS 16—PAPER GOODS AND PRINTED MATTER

FOR BUSINESS CARDS, STATIONERY, ENVELOPES, NOTE CARDS, NOTE PADS AND DECALS (U.S. CLS. 2, 5, 22, 23, 29, 37, 38 AND 50).

FIRST USE 2-0-2004; IN COMMERCE 2-0-2004.

**CLASS 21—HOUSEWARES AND GLASS**

FOR DRINKING GLASSES AND MUGS (U.S. CLS. 2, 13, 23, 29, 30, 33, 40 AND 50).

FIRST USE 4-0-2004; IN COMMERCE 4-0-2004.

NO CLAIM IS MADE TO THE EXCLUSIVE RIGHT TO USE "CHILDREN'S HOSPITAL", APART FROM THE MARK AS SHOWN.

SEC. 2(F) AS TO "THE CHILDREN'S HOSPITAL OF PHILADELPHIA A PEDIATRIC HEALTHCARE NETWORK".

CLASS 25—CLOTHING

FOR T-SHIRTS, SWEAT SHIRTS, POLO SHIRTS AND INFANT WEAR (U.S. CLS. 22 AND 39).

FIRST USE 4-0-2004; IN COMMERCE 4-0-2004.

CLASS 42—SCIENTIFIC, COMPUTER AND LEGAL SERVICES

FOR MEDICAL RESEARCH (U.S. CLS. 100 AND 101).
FIRST USE 4-30-1999; IN COMMERCE 7-31-1999.

CLASS 41—EDUCATION AND ENTERTAINMENT

FOR EDUCATIONAL AND ENTERTAINMENT SERVICES, NAMELY, PROVIDING COURSES OF INSTRUCTION AT THE UNIVERSITY LEVEL; EDUCATIONAL RESEARCH; ARRANGING AND CONDUCTING ATHLETIC EVENTS AND TOURNAMENTS, EXHIBITIONS, CONFERENCES, LIVE PERFORMANCES AND FESTIVALS (U.S. CLS. 100, 101 AND 107).

FIRST USE 4-0-2004; IN COMMERCE 4-0-2004.
ANGELA M. MICHELI, EXAMINING ATTORNEY

CLASS 44—MEDICAL, BEAUTY AND AGRICULTURAL SERVICES

FOR HOSPITAL SERVICES, MEDICAL SERVICES, MEDICAL TESTING; PROVIDING HEALTH AND MEDICAL INFORMATION; MEDICAL COUNSELING SERVICES (U.S. CLS. 100 AND 101).

FIRST USE 4-30-1999; IN COMMERCE 7-31-1999.
TARAH HARDY, EXAMINING ATTORNEY

SN 76-616,449. SPALDING UNIVERSITY, INC., LOUISVILLE, KY. FILED 10-15-2004.



NO CLAIM IS MADE TO THE EXCLUSIVE RIGHT TO USE UNIVERSITY, 1814 AND LOUISVILLE KENTUCKY, APART FROM THE MARK AS SHOWN.

CLASS 14—JEWELRY

FOR JEWELRY (U.S. CLS. 2, 27, 28 AND 50).
FIRST USE 0-0-1984; IN COMMERCE 0-0-1984.

CLASS 41—EDUCATION AND ENTERTAINMENT

FOR EDUCATION SERVICES, NAMELY PROVIDING COURSES OF INSTRUCTION AT THE UNIVERSITY LEVEL AND DISTRIBUTING COURSE MATERIAL IN CONNECTION THEREWITH; ARRANGING AND CONDUCTING EDUCATIONAL CONFERENCES; EDUCATIONAL RESEARCH; AND ENTERTAINMENT SERVICES, NAMELY, ARRANGING AND CONDUCTING ATHLETIC EVENTS, ART SHOWS, AND LIVE PERFORMANCES OF THEATRE, MUSIC, DANCE AND THE LIKE (U.S. CLS. 100, 101 AND 107).

FIRST USE 0-0-1984; IN COMMERCE 0-0-1984.
TARAH HARDY, EXAMINING ATTORNEY

SN 76-616,507. EARLFIELD INC., PELHAM, NY. FILED 10-18-2004.



THE COLOR(S) BLUE, WHITE AND ORANGE IS/ARE CLAIMED AS A FEATURE OF THE MARK.

THE MARK CONSISTS OF THE COMBINED WORDS "GOTRAVEL" WITH ICONS BENEATH THE LITERAL ELEMENT REPRESENTING A CAMERA, A COLLECTION OF PEOPLE, AND A BEACH SCENE, RESPECTIVELY. THE COLOR BLUE IS IN THE WORD "GO" AND IN THE BACKGROUND OF THE CAMERA AND BEACH SCENE ICONS. THE COLOR WHITE IS IN THE WORD "TRAVEL" AND IN THE REPRESENTATION OF THE CAMERA, THE BEACH, SCENE, AND IN THE BACKGROUND OF THE COLLECTION OF PEOPLE. THE COLOR ORANGE SURROUNDS THE LITERAL ELEMENT AND THE ICONS.

CLASS 35—ADVERTISING AND BUSINESS

FOR COOPERATIVE ADVERTISING AND MARKETING IN THE FIELD OF RESERVATIONS AND BOOKINGS OF AIR TRAVEL, TRAVEL TOURS, HOTELS, TRANSPORTATION AND INSURANCE (U.S. CLS. 100, 101 AND 102).

FIRST USE 7-7-2004; IN COMMERCE 7-7-2004.

CLASS 39—TRANSPORTATION AND STORAGE

FOR TRANSPORTATION RESERVATION SERVICES, NAMELY, RESERVATIONS AND BOOKINGS OF AIR TRAVEL, TRAVEL TOURS, HOTELS AND TRANSPORTATION; PROVIDING A COMPUTER DATABASE BY MEANS OF A GLOBAL COMPUTER NETWORK IN THE FIELDS OF TRAVEL AND TOURISM (U.S. CLS. 100 AND 105).

FIRST USE 7-7-2004; IN COMMERCE 7-7-2004.

CLASS 43—HOTEL AND RESTAURANT SERVICES

FOR PROVIDING A COMPUTER DATABASE BY MEANS OF A GLOBAL COMPUTER NETWORK IN THE FIELD OF HOSPITALITY (U.S. CLS. 100 AND 101).
FIRST USE 7-7-2004; IN COMMERCE 7-7-2004.

INGA ERVIN, EXAMINING ATTORNEY

SN 76-616,508. SCHOLASTIC INC., NEW YORK, NY. FILED 10-18-2004.

THE SPY FIVE

THE MARK CONSISTS OF STANDARD CHARACTERS WITHOUT CLAIM TO ANY PARTICULAR FONT, STYLE, SIZE, OR COLOR.

CLASS 28—TOYS AND SPORTING GOODS

FOR KIT COMPOSED OF CHILDREN'S BOOKS AND TOY SPY GADGETS, NAMELY TOY ALARMS, TOY KEY CARDS DISGUISED AS KEY RINGS, TOY CAMERAS, TOY MONOCULARS, EDIBLE PAPER AND EDIBLE INK PENS, ALL SOLD TOGETHER AS A UNIT (U.S. CLS. 22, 23, 38 AND 50).

FIRST USE 9-1-2004; IN COMMERCE 9-1-2004.

CLASS 35—ADVERTISING AND BUSINESS

FOR MAIL ORDER BOOK CLUB SERVICES FEATURING BOOKS AND TOYS FOR CHILDREN (U.S. CLS. 100, 101 AND 102).

FIRST USE 9-1-2004; IN COMMERCE 9-1-2004.

NAKWAMA ANKRAH, EXAMINING ATTORNEY

SN 76-616,567. ENCOMPASS GROUP, LLC, MCDONOUGH, GA. FILED 10-19-2004.

THE PILLOW FACTORY

THE MARK CONSISTS OF STANDARD CHARACTERS WITHOUT CLAIM TO ANY PARTICULAR FONT, STYLE, SIZE, OR COLOR.

OWNER OF U.S. REG. NO. 2,415,004.

NO CLAIM IS MADE TO THE EXCLUSIVE RIGHT TO USE "PILLOW", APART FROM THE MARK AS SHOWN.

CLASS 20—FURNITURE AND ARTICLES NOT OTHERWISE CLASSIFIED

FOR PILLOWS, NAMELY HOUSEHOLD BED PILLOWS, BED PILLOWS AND PATIENT POSITIONERS FOR USE IN MEDICAL FACILITIES, INSTITUTIONAL AND HOSPITALITY MARKET BED PILLOWS, AND TRANSPORTATION MARKET PILLOWS (U.S. CLS. 2, 13, 22, 25, 32 AND 50).

FIRST USE 0-0-1983; IN COMMERCE 0-0-1983.

CLASS 24—FABRICS

FOR PILLOW CASES AND BED SHEETS, MATTRESS PADS AND COMFORTERS (U.S. CLS. 42 AND 50).

FIRST USE 0-0-1983; IN COMMERCE 0-0-1983.
ANNE E. GUSTASON, EXAMINING ATTORNEY

SN 76-616,820. LAMSON AND GOODNOW, LLC, SHELBURNE FALLS, MA. FILED 10-19-2004.

HOTSPOT

THE MARK CONSISTS OF STANDARD CHARACTERS WITHOUT CLAIM TO ANY PARTICULAR FONT, STYLE, SIZE, OR COLOR.

CLASS 21—HOUSEWARES AND GLASS

FOR SILICONE KITCHEN UTENSILS, NAMELY TRIVETS, COASTERS AND CUTTING BOARDS (U.S. CLS. 2, 13, 23, 29, 30, 33, 40 AND 50).

FIRST USE 1-1-2002; IN COMMERCE 1-1-2002.

SN 76-616,587. ORCHARD HOUSE LICENSING COMPANY, ROXBURY, CT. FILED 10-18-2004.

CLASS 24—FABRICS

FOR SILICONE POTHOLDERS (U.S. CLS. 42 AND 50).
FIRST USE 1-1-2002; IN COMMERCE 1-1-2002.
MITCHELL FRONT, EXAMINING ATTORNEY



SN 76-616,821. THE CITY OF NEW YORK, BROOKLYN, NY. FILED 10-19-2004.

FDNY

THE MARK CONSISTS OF STANDARD CHARACTERS WITHOUT CLAIM TO ANY PARTICULAR FONT, STYLE, SIZE, OR COLOR.

OWNER OF U.S. REG. NO. 2,606,740.

OWNER OF U.S. REG. NOS. 1,356,557, 2,311,928 AND OTHERS.

CLASS 16—PAPER GOODS AND PRINTED MATTER

FOR CHILDREN'S BOOKS, ACTIVITY BOOKS, POSTERS, STICKERS, PRINTED CHARTS, TRADING CARDS, POST CARDS (U.S. CLS. 2, 5, 22, 23, 29, 37, 38 AND 50).

FIRST USE 0-0-1997; IN COMMERCE 0-0-1997.

CLASS 41—EDUCATION AND ENTERTAINMENT

FOR CHILDREN'S ENTERTAINMENT AND EDUCATIONAL SERVICES, NAMELY, PROVIDING A WEB SITE FEATURING MUSIC, MUSICAL VIDEOS, VIDEOS, STORIES, AUDIOS, ANIMATED MOTION PICTURE FILMS, AND OTHER INTERACTIVE COMPONENTS AND MULTIMEDIA MATERIALS; PROVIDING INCENTIVES TO CHILDREN TO ENCOURAGE READING (U.S. CLS. 100, 101 AND 107).

FIRST USE 0-0-1997; IN COMMERCE 0-0-1997.
DOMINIC J. FERRAIUOLO, EXAMINING ATTORNEY

CLASS 6—METAL GOODS

FOR METAL KEY CHAINS, METAL KEY RINGS, METAL HOLIDAY ORNAMENTS (U.S. CLS. 2, 12, 13, 14, 23, 25 AND 50).

FIRST USE 1-1-1898; IN COMMERCE 2-0-1999.

CLASS 9—ELECTRICAL AND SCIENTIFIC APPARATUS

FOR THERMOMETERS NOT FOR MEDICAL USE, MOUSE PADS, DECORATIVE REFRIGERATOR MAGNETS, CHILDREN'S MUSICAL SOUND AND VIDEO RECORDINGS, COMPACT DISC HOLDERS; CHILDREN'S EDUCATIONAL SOFTWARE, VIDEO TAPES FEATURING PUBLIC SAFETY AND HEALTH INFORMATION (U.S. CLS. 21, 23, 26, 36 AND 38).

FIRST USE 1-1-1898; IN COMMERCE 10-0-2000.

CLASS 11—ENVIRONMENTAL CONTROL APPARATUS

FOR FLASHLIGHTS AND PEN LIGHTS (U.S. CLS. 13, 21, 23, 31 AND 34).

FIRST USE 1-1-1898; IN COMMERCE 10-0-2000.

CLASS 14—JEWELRY

FOR LAPEL PINS, COSTUME JEWELRY, CUFF LINKS, PENDANTS, TIE CLIPS AND TIE PINS (U.S. CLS. 2, 27, 28 AND 50).

FIRST USE 1-1-1898; IN COMMERCE 10-0-2000.

CLASS 16—PAPER GOODS AND PRINTED MATTER

FOR CALENDARS, NOTEPADS, PENS, PENCILS, PENCIL BOXES, STICKERS, BUMPER STICKERS, DECALS, BOOKS, MAGAZINES AND BROCHURES FEATURING INFORMATION ON FIRE SAFETY (U.S. CLS. 2, 5, 22, 23, 29, 37, 38 AND 50).

FIRST USE 1-1-1898; IN COMMERCE 0-0-1996.

CLASS 18—LEATHER GOODS

FOR ALL-PURPOSE SPORTS BAGS, UMBRELLAS (U.S. CLS. 1, 2, 3, 22 AND 41).

FIRST USE 1-1-1898; IN COMMERCE 10-0-2000.

CLASS 20—FURNITURE AND ARTICLES NOT OTHERWISE CLASSIFIED

FOR PLASTIC AND FOAM KEY CHAINS AND KEY CHAIN TAGS, CUSHIONS, PLASTIC FIGURINES AND PICTURE FRAMES (U.S. CLS. 2, 13, 22, 25, 32 AND 50).

FIRST USE 1-1-1898; IN COMMERCE 2-0-1999.

CLASS 21—HOUSEWARES AND GLASS

FOR MUGS, LUNCH BOXES, THERMAL INSULATED CONTAINERS FOR FOOD OR BEVERAGE, DRINKING GLASSES, COMMEMORATIVE PLATES, DECORATIVE PLATES, SOUVENIR PLATES AND PLASTIC COASTERS (U.S. CLS. 2, 13, 23, 29, 30, 33, 40 AND 50).

FIRST USE 1-1-1898; IN COMMERCE 10-0-2000.

CLASS 24—FABRICS

FOR BLANKET THROWS (U.S. CLS. 42 AND 50).

FIRST USE 1-1-1898; IN COMMERCE 10-0-2000.

CLASS 26—FANCY GOODS

FOR CLOTH PATCHES FOR CLOTHING (U.S. CLS. 37, 39, 40, 42 AND 50).

FIRST USE 1-1-1898; IN COMMERCE 10-0-2000.

CLASS 28—TOYS AND SPORTING GOODS

FOR TOY MODEL CARS, TOY FIRE HELMETS, STUFFED TOY ANIMALS, TOY DOLLS AND ACCESSORIES THEREFORE, ARTICULATED TOY FIGURINES, TOY BANKS, CHRISTMAS TREE ORNAMENTS, SNOW GLOBES, TOY VEHICLES, JIGSAW PUZZLES AND PLAYING CARDS (U.S. CLS. 22, 23, 38 AND 50).

FIRST USE 1-1-1898; IN COMMERCE 2-0-1999.

MITCHELL FRONT, EXAMINING ATTORNEY

SN 76-616,991. HEALTH CARE AND RETIREMENT CORPORATION OF AMERICA, TOLEDO, OH. FILED 10-21-2004.

HCR

THE MARK CONSISTS OF STANDARD CHARACTERS WITHOUT CLAIM TO ANY PARTICULAR FONT, STYLE, SIZE, OR COLOR.

OWNER OF U.S. REG. NOS. 1,222,842, 1,793,002 AND 1,823,278.

CLASS 41—EDUCATION AND ENTERTAINMENT

FOR EDUCATIONAL SERVICES; NAMELY, CONDUCTING CLASSES, SEMINARS, AND WORKSHOPS FOR HEALTH CARE TRAINING (U.S. CLS. 100, 101 AND 107).

FIRST USE 4-0-1982; IN COMMERCE 4-0-1982.

CLASS 44—MEDICAL, BEAUTY AND AGRICULTURAL SERVICES

FOR HEALTH CARE; PHYSICAL AND OCCUPATIONAL REHABILITATION; TRANSITIONAL HEALTH CARE; NURSING HOME CARE; HOME HEALTH AND HOSPICE CARE (U.S. CLS. 100 AND 101).

FIRST USE 4-0-1982; IN COMMERCE 4-0-1982.

MICHAEL WEBSTER, EXAMINING ATTORNEY

SN 76-617,020. FINGER PRINCE, INC., MEDIA, PA. FILED 10-18-2004.

PETER NERO

THE MARK CONSISTS OF STANDARD CHARACTERS WITHOUT CLAIM TO ANY PARTICULAR FONT, STYLE, SIZE, OR COLOR.

PETER NERO IDENTIFIES A LIVING INDIVIDUAL WHOSE CONSENT IS OF RECORD.

CLASS 9—ELECTRICAL AND SCIENTIFIC APPARATUS

FOR SERIES OF AUDIO AND SOUND RECORDINGS FEATURING MUSIC; A SERIES OF PRERECORDED DIGITAL AUDIO TAPE, RECORDS, AND COMPACT DISCS FEATURING MUSIC (U.S. CLS. 21, 23, 26, 36 AND 38).

FIRST USE 4-1-1961; IN COMMERCE 4-1-1961.

CLASS 41—EDUCATION AND ENTERTAINMENT

FOR ENTERTAINMENT SERVICE IN THE NATURE OF VISUAL AND AUDIO PERFORMANCE, NAMELY, MUSICAL PERFORMANCE; ENTERTAINMENT SERVICES IN THE NATURE OF MUSICAL AND ORCHESTRA PERFORMANCES; ENTERTAINMENT SERVICES, NAMELY, PRODUCTION OF MUSICAL AND ORCHESTRA PERFORMANCES (U.S. CLS. 100, 101 AND 107).

FIRST USE 6-0-1961; IN COMMERCE 6-0-1961.

NAAKWAMA ANKRAH, EXAMINING ATTORNEY

SN 76-617,484. GEORGE WEISS ASSOCIATES, INC., HARTFORD, CT. FILED 10-25-2004.

SN 76-617,815. ADVANCE MAGAZINE PUBLISHERS INC., NEW YORK, NY. FILED 10-26-2004.

WEISSVIEW

THE MARK CONSISTS OF STANDARD CHARACTERS WITHOUT CLAIM TO ANY PARTICULAR FONT, STYLE, SIZE, OR COLOR.

CLASS 36—INSURANCE AND FINANCIAL

FOR INVESTMENT MANAGEMENT SERVICES, NAMELY, PROVIDING ONLINE DATABASES FEATURING SECURITIES INFORMATION, PORTFOLIO ACCOUNTING, MANAGEMENT AND TRADING IN SECURITIES (U.S. CLS. 100, 101 AND 102).
FIRST USE 10-1-2004; IN COMMERCE 10-1-2004.

CLASS 42—SCIENTIFIC, COMPUTER AND LEGAL SERVICES

FOR PROVIDING TEMPORARY USE OF ONLINE NON-DOWN LOADABLE SOFTWARE FOR PORTFOLIO ACCOUNTING, MANAGEMENT AND TRADING IN SECURITIES (U.S. CLS. 100 AND 101).
FIRST USE 10-1-2004; IN COMMERCE 10-1-2004.
ESTHER BELENKER, EXAMINING ATTORNEY

SN 76-617,747. PHONAK HOLDING AG, CH-8712 STAEFA, SWITZERLAND, FILED 10-26-2004.

CROSLink

PRIORITY CLAIMED UNDER SEC. 44(D) ON SWITZERLAND APPLICATION NO. 29542004, FILED 8-30-2004, REG. NO. 525843, DATED 9-16-2004, EXPIRES 8-30-2014.

CLASS 9—ELECTRICAL AND SCIENTIFIC APPARATUS

FOR WIRELESS TRANSMITTERS AND RECEIVERS, IN PARTICULAR FOR USE IN CONNECTION WITH HEARING AIDS FOR THE DEAF (U.S. CLS. 21, 23, 26, 36 AND 38).

CLASS 10—MEDICAL APPARATUS

FOR HEARING AIDS FOR THE DEAF AND PARTS THEREOF (U.S. CLS. 26, 39 AND 44).
GLENN CLARK, EXAMINING ATTORNEY

COLOR MAKES A DIFFERENCE

THE MARK CONSISTS OF STANDARD CHARACTERS WITHOUT CLAIM TO ANY PARTICULAR FONT, STYLE, SIZE, OR COLOR.

CLASS 36—INSURANCE AND FINANCIAL

FOR CHARITABLE FUND RAISING (U.S. CLS. 100, 101 AND 102).
FIRST USE 3-14-2002; IN COMMERCE 3-14-2002.

CLASS 41—EDUCATION AND ENTERTAINMENT

FOR EDUCATIONAL SERVICES IN THE NATURE OF SEMINARS AND PANEL DISCUSSIONS FEATURING HOME DECORATION AND HOME DESIGN (U.S. CLS. 100, 101 AND 107).
FIRST USE 3-14-2002; IN COMMERCE 3-14-2002.
KEVIN DINALLO, EXAMINING ATTORNEY

SN 76-617,927. TOM'S OF MAINE, INC., KENNEBUNK, ME. FILED 10-21-2004.

BRING NATURE HOME

THE MARK CONSISTS OF STANDARD CHARACTERS WITHOUT CLAIM TO ANY PARTICULAR FONT, STYLE, SIZE, OR COLOR.

CLASS 35—ADVERTISING AND BUSINESS

FOR PROMOTING PUBLIC AWARENESS OF THE BENEFITS OF USING NATURAL INGREDIENTS (U.S. CLS. 100, 101 AND 102).
FIRST USE 9-1-2004; IN COMMERCE 9-1-2004.

CLASS 44—MEDICAL, BEAUTY AND AGRICULTURAL SERVICES

FOR PROVIDING INFORMATION IN THE FIELDS OF GARDENING AND HERBAL MEDICINE (U.S. CLS. 100 AND 101).
FIRST USE 9-1-2004; IN COMMERCE 9-1-2004.
KAREN K. BUSH, EXAMINING ATTORNEY

SN 76-618,267. YALE UNIVERSITY, NEW HAVEN, CT.
FILED 10-27-2004.

SN 76-619,501. NORTHWEST LICENSING, LLC, DOWNERS
GROVE, IL. FILED 11-5-2004.

YALE MEDICAL GROUP

THE MARK CONSISTS OF STANDARD CHARACTERS WITHOUT CLAIM TO ANY PARTICULAR FONT, STYLE, SIZE, OR COLOR.

OWNER OF U.S. REG. NOS. 1,391,543, 2,271,288 AND OTHERS.

NO CLAIM IS MADE TO THE EXCLUSIVE RIGHT TO USE MEDICAL GROUP, APART FROM THE MARK AS SHOWN.

CLASS 35—ADVERTISING AND BUSINESS

FOR PROMOTING PUBLIC AWARENESS OF PUBLIC HEALTH ISSUES (U.S. CLS. 100, 101 AND 102).
FIRST USE 4-0-2001; IN COMMERCE 4-0-2001.

CLASS 44—MEDICAL, BEAUTY AND AGRICULTURAL SERVICES

FOR MEDICAL SERVICES; MEDICAL CLINICS; PROVIDING HEALTH CARE SERVICES; TECHNICAL CONSULTATION AND RESEARCH IN THE FIELDS OF HEALTH, PHARMACEUTICALS, BIOLOGY AND MEDICINE (U.S. CLS. 100 AND 101).
FIRST USE 4-0-2001; IN COMMERCE 4-0-2001.

TRACY WHITAKER-BOWN, EXAMINING ATTORNEY

SN 76-619,400. DAILY NEWS, L.P., NEW YORK, NY. FILED
11-4-2004.

SCRATCH N' MATCH

THE MARK CONSISTS OF STANDARD CHARACTERS WITHOUT CLAIM TO ANY PARTICULAR FONT, STYLE, SIZE, OR COLOR.
SEC. 2(F).

CLASS 28—TOYS AND SPORTING GOODS

FOR PROMOTIONAL GAME CARDS (U.S. CLS. 22, 23, 38 AND 50).
FIRST USE 9-17-1995; IN COMMERCE 9-17-1995.

CLASS 41—EDUCATION AND ENTERTAINMENT

FOR ENTERTAINMENT SERVICES, NAMELY, CONDUCTING CONTESTS IN NEWSPAPERS (U.S. CLS. 100, 101 AND 107).
FIRST USE 9-17-1995; IN COMMERCE 9-17-1995.
HENRY S. ZAK, EXAMINING ATTORNEY

CHICAGO PIZZA AUTHORITY

THE MARK CONSISTS OF STANDARD CHARACTERS WITHOUT CLAIM TO ANY PARTICULAR FONT, STYLE, SIZE, OR COLOR.

NO CLAIM IS MADE TO THE EXCLUSIVE RIGHT TO USE CHICAGO PIZZA, APART FROM THE MARK AS SHOWN.

CLASS 39—TRANSPORTATION AND STORAGE

FOR FOOD AND PIZZA DELIVERY (U.S. CLS. 100 AND 105).
FIRST USE 12-31-1984; IN COMMERCE 12-31-1984.

CLASS 43—HOTEL AND RESTAURANT SERVICES

FOR CARRY OUT RESTAURANTS (U.S. CLS. 100 AND 101).
FIRST USE 12-31-1984; IN COMMERCE 12-31-1984.
RUSS HERMAN, EXAMINING ATTORNEY

SN 76-619,720. DEGUSSA AG, 40474 DUESSELDORF, FED
REP GERMANY, FILED 11-8-2004.

catMETium

THE MARK CONSISTS OF STANDARD CHARACTERS WITHOUT CLAIM TO ANY PARTICULAR FONT, STYLE, SIZE, OR COLOR.

OWNER OF FED REP GERMANY REG. NO. 30358153,
DATED 6-1-2004, EXPIRES 11-30-2013.

CLASS 1—CHEMICALS

FOR CHEMICALS FOR USE IN THE MANUFACTURE IN A WIDE VARIETY OF GOODS; CATALYSTS FOR USE IN THE MANUFACTURE OF INDUSTRIAL CHEMICALS AS FINE CHEMICALS AND INGREDIENTS FOR PHARMACEUTICALS; CHEMICAL CATALYSTS FOR USE IN THE MANUFACTURE OF A WIDE VARIETY OF GOODS IN THE CHEMICAL AND PHARMACEUTICAL INDUSTRY (U.S. CLS. 1, 5, 6, 10, 26 AND 46).

CLASS 35—ADVERTISING AND BUSINESS

FOR PROVIDING OF SALES AND PURCHASING BUSINESS INFORMATION ABOUT CHEMICAL PRODUCTS VIA THE INTERNET (U.S. CLS. 100, 101 AND 102).

CLASS 42—SCIENTIFIC, COMPUTER AND LEGAL SERVICES

FOR SCIENTIFIC RESEARCH; DEVELOPMENT OF NEW TECHNOLOGY FOR OTHERS IN THE FIELD OF CHEMICALS; TECHNOLOGY CONSULTATION AND RESEARCH IN THE FIELD OF CHEMICALS; RESEARCH IN THE FIELD OF CHEMICAL CATALYSTS; RESEARCH IN THE FIELD OF CHEMICALS; RESEARCH IN THE FIELD OF CATALYSTS; RESEARCH AND DEVELOPMENT FOR NEW PRODUCTS FOR OTHERS; INDUSTRIAL CHEMICAL ANALYSIS (U.S. CLS. 100 AND 101).

REBECCA GAN, EXAMINING ATTORNEY

SN 76-620,486. ULTIMATE STAKES GOLF TOUR, LLC, GOLDEN, CO. FILED 11-15-2004.

ULTIMATE STAKES GOLF TOUR

SN 76-620,026. NOVA SOUTHEASTERN UNIVERSITY, INC., FORT LAUDERDALE, FL. FILED 11-10-2004.

NOVA SOUTHEASTERN UNIVERSITY

THE MARK CONSISTS OF STANDARD CHARACTERS WITHOUT CLAIM TO ANY PARTICULAR FONT, STYLE, SIZE, OR COLOR.

OWNER OF U.S. REG. NOS. 1,916,926 AND 1,924,170.

NO CLAIM IS MADE TO THE EXCLUSIVE RIGHT TO USE "UNIVERSITY", APART FROM THE MARK AS SHOWN.

CLASS 41—EDUCATION AND ENTERTAINMENT

FOR ON-SITE EDUCATIONAL SERVICES AT THE PRE-K TO 12TH GRADE LEVELS, AND ON-SITE AND ON-LINE EDUCATIONAL SERVICES AT THE UNIVERSITY LEVEL; COMMUNITY OUTREACH SERVICES AT THE UNIVERSITY LEVEL, NAMELY, ONE-ON-ONE AND GROUP READING TUTORIAL PROGRAMS AND ARITHMETIC TUTORIAL LEARNING PROGRAMS (U.S. CLS. 100, 101 AND 107).

FIRST USE 0-0-1994; IN COMMERCE 0-0-1994.

CLASS 42—SCIENTIFIC, COMPUTER AND LEGAL SERVICES

FOR BASIC, CLINICAL, AND APPLIED RESEARCH SERVICES AT THE UNIVERSITY LEVEL IN THE FIELDS OF EDUCATION, BUSINESS, LAW, OCEANOGRAPHY, COMPUTER AND INFORMATION SCIENCES, MEDICINE, DENTISTRY, OPTOMETRY, AUDIOLOGY, PHARMACY, NURSING, ALLIED HEALTH, PSYCHOLOGY, CHILD DEVELOPMENT, FAMILY THERAPY, CONFLICT RESOLUTION, CRIMINAL JUSTICE, HUMANITIES, SOCIAL SCIENCES, BIOMEDICINE, AND BIOMATERIALS; COMMUNITY OUTREACH SERVICES AT THE UNIVERSITY LEVEL, NAMELY, CONFLICT RESOLUTION SERVICES IN LEGAL AND NON-LEGAL SETTINGS AND LEGAL SERVICES (U.S. CLS. 100 AND 101).

FIRST USE 0-0-1994; IN COMMERCE 0-0-1994.

CLASS 44—MEDICAL, BEAUTY AND AGRICULTURAL SERVICES

FOR OUT-PATIENT CLINICS AND TREATMENT, TESTING, AND ASSESSMENT PROGRAMS IN THE FIELDS OF MEDICINE, DENTISTRY, OPTOMETRY, AUDIOLOGY, PHARMACY, NURSING, ALLIED HEALTH, PSYCHOLOGY, AND FAMILY THERAPY (U.S. CLS. 100 AND 101).

FIRST USE 0-0-1994; IN COMMERCE 0-0-1994.
ROBIN CHOSID, EXAMINING ATTORNEY

THE MARK CONSISTS OF STANDARD CHARACTERS WITHOUT CLAIM TO ANY PARTICULAR FONT, STYLE, SIZE, OR COLOR.

NO CLAIM IS MADE TO THE EXCLUSIVE RIGHT TO USE "GOLF TOUR", APART FROM THE MARK AS SHOWN.

CLASS 25—CLOTHING

FOR CLOTHING FOR MEN, WOMEN AND CHILDREN NAMELY T-SHIRTS, SHIRTS, BLOUSES, SWEATERS, CARDIGANS, TURTLENECKS, VESTS, SWEAT SHIRTS, TANK TOPS, JERSEYS, BASEBALL SHIRTS, GOLF SHIRTS, JOGGING SHIRTS, SKIRTS, SHORTS, GYM SHORTS, TENNIS SHORTS, JEANS, PANTS, WORK PANTS, TROUSERS, SLACKS, TUNICS, DRESSES, JUMPERS, SUITS, SUN SUITS, COVER-ALLS, OVERALLS, SWEATSHIRTS, SWEAT PANTS, SWEAT SUITS, WARM-UP SUITS, JACKETS, BLAZERS, GLOVES, MITTENS, SCARVES, COATS, SHAWLS, GOLF JACKETS, GOLF PANTS, PARKAS, CAPES, PONCHOS, RUNNING SUITS, SMOCKS, JUMP SUITS, RAIN WEAR, UNDERWEAR, LINGERIE, HOSIERY, SOCKS, TIGHTS, LEGGINGS, LEG WARMERS, NECK WEAR NAMELY NECK TIES, SLEEPWEAR, ROBES, DRESSING GOWNS, SWIMWEAR, INFANTWEAR, SNOWBOARD PANTS AND SNOWBOARD JACKETS, BELTS, BANDANNAS, NECKBANDS, WRISTBANDS, SUSPENDERS, BEACH WEAR, SHOES, SNEAKERS, ATHLETIC SHOES, BOOTS, SANDALS, GOLFING FOOTWEAR, SLIPPERS AND BOOTIES, CAPS, HATS, BEANIES, HEADBANDS, SWEATBANDS, BANDANAS, EAR MUFFS, VISORS AND SUN VISORS (U.S. CLS. 22 AND 39).

FIRST USE 10-5-2004; IN COMMERCE 10-5-2004.

CLASS 41—EDUCATION AND ENTERTAINMENT

FOR ENTERTAINMENT IN THE NATURE OF TELEvised SPORTS SHOWS, NAMELY, COMPETITIONS AND TOURNAMENTS IN THE FIELD OF GOLF; ORGANIZING AND CONDUCTING GOLF EXHIBITIONS, COMPETITIONS AND TOURNAMENTS; ENTERTAINMENT, NAMELY, PRODUCTION OF ON-GOING TELEVISION AND CABLE TELEVISION PROGRAMS RELATING TO GOLF; ENTERTAINMENT IN THE NATURE OF THE GOLFERS GAMBLING ON THE OUTCOME OF THEIR EVENTS AND TOURNAMENTS; EDUCATION SERVICES, NAMELY, CONDUCTING INSTRUCTIONAL PROGRAMS IN THE FIELD OF GOLF; ENTERTAINMENT SERVICES, NAMELY, PROVIDING AN ON-LINE GOLF COMPUTER GAME; PROVIDING INFORMATION IN THE FIELD OF GOLF AND PROVIDING GENERAL INTEREST ENTERTAINMENT INFORMATION VIA WEBSITES ON THE INTERNET; PROVIDING GOLF AND SPORTING INFORMATION VIA WIRELESS AND MOBILE DEVICES (U.S. CLS. 100, 101 AND 107).

FIRST USE 10-5-2004; IN COMMERCE 10-5-2004.
JOHN GARTNER, EXAMINING ATTORNEY

SN 76-621,336. ALABANZA CORPORATION, BALTIMORE, MD. FILED 11-15-2004.

SN 76-623,520. TOFASCO OF AMERICA, INC., LA VERNE, CA. FILED 12-7-2004.

ALAGUARD

THE MARK CONSISTS OF STANDARD CHARACTERS WITHOUT CLAIM TO ANY PARTICULAR FONT, STYLE, SIZE, OR COLOR.

OWNER OF U.S. REG. NOS. 2,607,693 AND 2,715,545.

CLASS 42—SCIENTIFIC, COMPUTER AND LEGAL SERVICES

FOR COMPUTER CONSULTATION SERVICES IN THE FIELD OF COMPUTER SYSTEM SECURITY; COMPUTER SUPPORT SERVICES, NAMELY, MONITORING THE NETWORKS AND SERVERS OF OTHERS FOR TECHNICAL SYSTEM SECURITY PURPOSES (U.S. CLS. 100 AND 101).

FIRST USE 3-1-2003; IN COMMERCE 3-1-2003.

CLASS 45—PERSONAL SERVICES

FOR REMOTE MONITORING OF COMPUTER SYSTEMS OF OTHERS FOR SECURITY PURPOSES (U.S. CLS. 100 AND 101).

FIRST USE 3-1-2003; IN COMMERCE 3-1-2003.

MARY ROSSMAN, EXAMINING ATTORNEY

SN 76-623,109. VENTAS, INC., LOUISVILLE, KY. FILED 12-3-2004.

CUSTOM CAPITAL TAILORED FOR GROWTH.

THE MARK CONSISTS OF STANDARD CHARACTERS WITHOUT CLAIM TO ANY PARTICULAR FONT, STYLE, SIZE, OR COLOR.

NO CLAIM IS MADE TO THE EXCLUSIVE RIGHT TO USE "CAPITAL", APART FROM THE MARK AS SHOWN.

CLASS 16—PAPER GOODS AND PRINTED MATTER

FOR PRINTED MATTER, NAMELY, BROCHURES, BOOKLETS, GUIDEBOOKS, NOTEBOOKS, WORKBOOKS AND OUTLINES IN THE FIELD OF REAL ESTATE INVESTMENT TRUST (U.S. CLS. 2, 5, 22, 23, 29, 37, 38 AND 50).

FIRST USE 9-1-2003; IN COMMERCE 9-1-2003.

CLASS 36—INSURANCE AND FINANCIAL

FOR REAL ESTATE SERVICES, NAMELY, REAL ESTATE INVESTMENT, ACQUISITION AND MANAGEMENT SERVICES, REAL ESTATE INVESTMENT TRUST SERVICES; REAL ESTATE ADMINISTRATION, NAMELY, REAL ESTATE FINANCING AND LEASING SERVICES; REAL ESTATE FUND MANAGEMENT SERVICES (U.S. CLS. 100, 101 AND 102).

FIRST USE 9-1-2003; IN COMMERCE 9-1-2003.

DAVID ELTON, EXAMINING ATTORNEY

PIT PASS

THE MARK CONSISTS OF STANDARD CHARACTERS WITHOUT CLAIM TO ANY PARTICULAR FONT, STYLE, SIZE, OR COLOR.

CLASS 20—FURNITURE AND ARTICLES NOT OTHERWISE CLASSIFIED

FOR OUTDOOR FURNITURE (U.S. CLS. 2, 13, 22, 25, 32 AND 50).

CLASS 21—HOUSEWARES AND GLASS

FOR INSULATED FOOD AND DRINK CONTAINERS, NAMELY COOLERS AND JUGS NOT MADE OF METAL (U.S. CLS. 2, 13, 23, 29, 30, 33, 40 AND 50).

CLASS 22—CORDAGE AND FIBERS

FOR OUTDOOR CANOPIES (U.S. CLS. 1, 2, 7, 19, 22, 42 AND 50).

STEVEN JACKSON, EXAMINING ATTORNEY

SN 76-624,223. ANSCHUTZ ENTERTAINMENT GROUP, INC., LOS ANGELES, CA. FILED 12-9-2004.

GIVING THE WORLD REASON TO CHEER

THE MARK CONSISTS OF STANDARD CHARACTERS WITHOUT CLAIM TO ANY PARTICULAR FONT, STYLE, SIZE, OR COLOR.

CLASS 35—ADVERTISING AND BUSINESS

FOR PROMOTING SPORTS AND ENTERTAINMENT EVENTS OF OTHERS; PROMOTING THE GOODS AND SERVICES OF OTHERS BY ARRANGING FOR SPONSORS TO AFFILIATE THEIR GOODS AND SERVICES WITH SPORTS TEAMS, ENTERTAINERS OR SPORTS AND ENTERTAINMENT FACILITIES; AND MANAGEMENT OF SPORTS AND ENTERTAINMENT FACILITIES OR ARENAS (U.S. CLS. 100, 101 AND 102).

FIRST USE 7-0-2004; IN COMMERCE 7-0-2004.

CLASS 37—CONSTRUCTION AND REPAIR

FOR REAL ESTATE DEVELOPMENT SERVICES (U.S. CLS. 100, 103 AND 106).

FIRST USE 7-0-2004; IN COMMERCE 7-0-2004.

CLASS 41—EDUCATION AND ENTERTAINMENT

FOR PROVIDING FACILITIES FOR SPORTS AND ENTERTAINMENT EVENTS; OPERATING SPORTS AND ENTERTAINMENT FACILITIES OR ARENAS; ENTERTAINMENT SERVICES, NAMELY, CONDUCTING ICE HOCKEY GAMES, BASKETBALL GAMES, TENNIS MATCHES, SOCCER GAMES, AND A WIDE RANGE OF ATHLETIC, RECREATIONAL, ARTISTIC, MUSICAL AND THEATRICAL ACTIVITIES, NAMELY, DANCE PERFORMANCES, ICE COMPETITIONS, CYCLING EVENTS, ICE SHOWS, BOXING MATCHES, TRACK AND FIELD EVENTS, VARIETY SHOWS, CIRCUS EVENTS, AND THEATRE PRODUCTIONS; CONCERT ENTERTAINMENT, NAMELY, LIVE MUSIC; PROVIDING SPORTS TRAINING FACILITIES; THE PRODUCTION OR CO-PRODUCTION OF SPORTS AND ENTERTAINMENT EVENTS, CONCERTS, CONVENTIONS AND EXHIBITIONS, FOR PUBLIC EXHIBITION, VIEWING AND FOR RADIO, TELEVISION AND PAY-PER-VIEW TELEVISION BROADCAST; AND BOOKING OF CONCERTS, ATHLETIC, ARTISTIC, THEATRICAL AND OTHER ENTERTAINMENT EVENTS (U.S. CLS. 100, 101 AND 107).

FIRST USE 7-0-2004; IN COMMERCE 7-0-2004.
STEPHANIE DAVIS, EXAMINING ATTORNEY

SN 76-625,359. ROSALIND FRANKLIN UNIVERSITY OF MEDICINE AND SCIENCE, NORTH CHICAGO, IL. FILED 12-21-2004.

ROSALIND FRANKLIN UNIVERSITY OF MEDICINE AND SCIENCE

THE MARK CONSISTS OF STANDARD CHARACTERS WITHOUT CLAIM TO ANY PARTICULAR FONT, STYLE, SIZE, OR COLOR.

NO CLAIM IS MADE TO THE EXCLUSIVE RIGHT TO USE "UNIVERSITY OF MEDICINE AND SCIENCE", APART FROM THE MARK AS SHOWN.

CLASS 41—EDUCATION AND ENTERTAINMENT

FOR EDUCATIONAL SERVICES, NAMELY, CONDUCTING UNDERGRADUATE, GRADUATE, POST-GRADUATE, AND PATIENT EDUCATION CLASSES, SEMINARS, AND WORKSHOPS IN THE FIELDS OF MEDICINE, NUTRITION, PATHOLOGY, PHYSICAL THERAPY, PODIATRY, PHYSICIAN ASSISTANCE, CLINICAL LABORATORY SCIENCES, AND BASIC BIOMEDICAL SCIENCES (U.S. CLS. 100, 101 AND 107).

FIRST USE 3-1-2004; IN COMMERCE 3-1-2004.

CLASS 42—SCIENTIFIC, COMPUTER AND LEGAL SERVICES

FOR RESEARCH SERVICES IN THE FIELDS OF MEDICINE, NUTRITION, PATHOLOGY, PHYSICAL THERAPY, PODIATRY, PHYSICIAN ASSISTANCE, CLINICAL LABORATORY SCIENCES, AND BASIC BIOMEDICAL SCIENCES (U.S. CLS. 100 AND 101).

FIRST USE 3-1-2004; IN COMMERCE 3-1-2004.

CLASS 44—MEDICAL, BEAUTY AND AGRICULTURAL SERVICES

FOR DIETARY AND NUTRITIONAL GUIDANCE; FOOD NUTRITION CONSULTATION; HEALTH CARE; MAINTAINING FILES AND RECORDS CONCERNING THE MEDICAL CONDITION OF INDIVIDUALS; MEDICAL CLINICS; MEDICAL CONSULTATIONS; MEDICAL EVALUATION SERVICES; MEDICAL IMAGING SERVICES; MEDICAL SERVICES; MEDICAL TESTING; NURSING CARE; NUTRITION COUNSELING; PHYSICAL THERAPY; PHYSICIAN'S SERVICES; PROVIDING HEALTH INFORMATION; PROVIDING MEDICAL INFORMATION; SURGERY; AND X-RAY TECHNICIAN SERVICES (U.S. CLS. 100 AND 101).

FIRST USE 3-1-2004; IN COMMERCE 3-1-2004.
ANN LINNEHAN, EXAMINING ATTORNEY

SN 76-625,813. CCI THERMAL TECHNOLOGIES INC., EDMONTON, ALBERTA, CANADA, FILED 12-27-2004.

CALORITECH

THE MARK CONSISTS OF STANDARD CHARACTERS WITHOUT CLAIM TO ANY PARTICULAR FONT, STYLE, SIZE, OR COLOR.

CLASS 9—ELECTRICAL AND SCIENTIFIC APPARATUS

FOR ELECTRICAL HEATING EQUIPMENT, NAMELY, ELECTRONIC TEMPERATURE CONTROLS, THERMOSTATS, AND CONTROL PANELS FOR COMMERCIAL AND INDUSTRIAL USE (U.S. CLS. 21, 23, 26, 36 AND 38).

FIRST USE 1-0-1987; IN COMMERCE 1-0-1987.

CLASS 40—MATERIAL TREATMENT

FOR CUSTOM FABRICATION OF ELECTRIC HEATING ELEMENTS (U.S. CLS. 100, 103 AND 106).

FIRST USE 1-0-1987; IN COMMERCE 1-0-1987.

CLASS 42—SCIENTIFIC, COMPUTER AND LEGAL SERVICES

FOR CUSTOM DESIGN OF ELECTRIC RESISTANCE HEATING EQUIPMENT (U.S. CLS. 100 AND 101).

FIRST USE 1-0-1987; IN COMMERCE 1-0-1987.

H. M. FISHER, EXAMINING ATTORNEY

SN 76-625,835. PROTECT-A-BUB USA, LLC, NEW YORK, NY. FILED 12-27-2004.

PROTECT-A-BUB WORLD WIDE

THE MARK CONSISTS OF STANDARD CHARACTERS WITHOUT CLAIM TO ANY PARTICULAR FONT, STYLE, SIZE, OR COLOR.

NO CLAIM IS MADE TO THE EXCLUSIVE RIGHT TO USE "WORLDWIDE", APART FROM THE MARK AS SHOWN.

CLASS 12—VEHICLES

FOR SUNSHADES AND RAINCOVERS ATTACHABLE TO STROLLERS, CAR SEATS AND BABY CARRIAGES (U.S. CLS. 19, 21, 23, 31, 35 AND 44).

FIRST USE 10-0-1996; IN COMMERCE 10-0-2003.

CLASS 24—FABRICS

FOR SWADDLING BLANKETS (U.S. CLS. 42 AND 50).
FIRST USE 12-0-2004; IN COMMERCE 12-0-2004.

CLASS 25—CLOTHING

FOR INFANT AND CHILDREN'S SWIMSUITS (U.S. CLS. 22 AND 39).

FIRST USE 6-0-2004; IN COMMERCE 6-0-2004.
TANYA AMOS, EXAMINING ATTORNEY

SN 76-625,892. DINERS CLUB INTERNATIONAL LTD., CHICAGO, IL. FILED 12-27-2004.

GLOBAL VISION

THE MARK CONSISTS OF STANDARD CHARACTERS WITHOUT CLAIM TO ANY PARTICULAR FONT, STYLE, SIZE, OR COLOR.

CLASS 35—ADVERTISING AND BUSINESS

FOR CORPORATE TRAVEL AND EXPENSE REPORTING AND MANAGEMENT SERVICES (U.S. CLS. 100, 101 AND 102).

FIRST USE 4-17-1995; IN COMMERCE 6-1-1995.

CLASS 36—INSURANCE AND FINANCIAL

FOR CREDIT CARD SERVICES (U.S. CLS. 100, 101 AND 102).

FIRST USE 4-17-1995; IN COMMERCE 6-1-1995.
ANN LINNEHAN, EXAMINING ATTORNEY

SN 76-626,140. AUBURN UNIVERSITY, AUBURN UNIVERSITY, AL. FILED 12-27-2004.

AUBURN COMMONS

THE MARK CONSISTS OF STANDARD CHARACTERS WITHOUT CLAIM TO ANY PARTICULAR FONT, STYLE, SIZE, OR COLOR.

OWNER OF U.S. REG. NOS. 2,040,157, 2,381,222 AND OTHERS.

CLASS 16—PAPER GOODS AND PRINTED MATTER

FOR NEWSLETTER FOR UNIVERSITY GRADUATES, ALUMNI, AND SUPPORTERS (U.S. CLS. 2, 5, 22, 23, 29, 37, 38 AND 50).

FIRST USE 12-0-2002; IN COMMERCE 12-0-2002.

CLASS 41—EDUCATION AND ENTERTAINMENT

FOR PROVIDING AN ONLINE ELECTRONIC NEWSLETTER FOR UNIVERSITY GRADUATES, ALUMNI, AND SUPPORTERS (U.S. CLS. 100, 101 AND 107).

FIRST USE 12-0-2002; IN COMMERCE 12-0-2002.
ALLISON HOLTZ, EXAMINING ATTORNEY

SN 76-626,207. CODISCOS INTERNATIONAL CORPORATION, PANAMA CITY, PANAMA, FILED 12-23-2004.

KING BONGO

THE MARK CONSISTS OF STANDARD CHARACTERS WITHOUT CLAIM TO ANY PARTICULAR FONT, STYLE, SIZE, OR COLOR.

CLASS 9—ELECTRICAL AND SCIENTIFIC APPARATUS

FOR PHONOGRAPH RECORDS, CD'S, AUDIO TAPES, VIDEO TAPE AND DVD'S FEATURING MUSICAL PERFORMANCES (U.S. CLS. 21, 23, 26, 36 AND 38).

CLASS 41—EDUCATION AND ENTERTAINMENT

FOR ENTERTAINMENT SERVICES IN THE NATURE OF LIVE AND PRE-RECORDED PERFORMANCES BY A MUSICAL GROUP; AUDIO AND VIDEO RECORDING, PRODUCTION AND CONSULTING SERVICES (U.S. CLS. 100, 101 AND 107).

TARAH HARDY, EXAMINING ATTORNEY

SN 76-626,208. CONAGRA BRANDS, INC., OMAHA, NE. FILED 12-23-2004.

HEALTHY CHOICE & DESIGN

THE MARK CONSISTS OF STANDARD CHARACTERS WITHOUT CLAIM TO ANY PARTICULAR FONT, STYLE, SIZE, OR COLOR.

OWNER OF U.S. REG. NOS. 1,528,468, 1,722,202 AND OTHERS.

CLASS 29—MEATS AND PROCESSED FOODS

FOR COTTAGE CHEESE, DAIRY PRODUCTS, EXCLUDING ICE CREAM, MILK AND FROZEN YOGURT (U.S. CL. 46).

CLASS 30—STAPLE FOODS

FOR FROZEN YOGURT (U.S. CL. 46).
TARAH HARDY, EXAMINING ATTORNEY

SN 76-626,228. MOLECULAR IMPRINTS, INC., AUSTIN, TX.
FILED 12-27-2004.

SN 76-642,487. COMFORCE CORPORATION, WOODBURY,
NY. FILED 7-8-2005.

IMPRIIO

COMFORCE

THE MARK CONSISTS OF STANDARD CHARACTERS WITHOUT CLAIM TO ANY PARTICULAR FONT, STYLE, SIZE, OR COLOR.

CLASS 9—ELECTRICAL AND SCIENTIFIC APPARATUS

FOR USB FLASH MEMORY DEVICES THAT STORE COMPUTER-READABLE INFORMATION (U.S. CLS. 21, 23, 26, 36 AND 38).
FIRST USE 2-0-2002; IN COMMERCE 6-0-2002.

CLASS 16—PAPER GOODS AND PRINTED MATTER

FOR WRITING INSTRUMENTS THAT CREATE OPTICALLY CONTRASTING REGIONS ON SUBSTRATES (U.S. CLS. 2, 5, 22, 23, 29, 37, 38 AND 50).
FIRST USE 2-0-2002; IN COMMERCE 6-0-2002.
BARBARA A. GOLD, EXAMINING ATTORNEY

CLASS 35—ADVERTISING AND BUSINESS

FOR JOB PLACEMENT SERVICES FOR TEMPORARY AND PERMANENT EMPLOYEES (U.S. CLS. 100, 101 AND 102).
FIRST USE 9-15-1995; IN COMMERCE 9-15-1995.

CLASS 38—COMMUNICATION

FOR TELECOMMUNICATIONS CONSULTATION SERVICES (U.S. CLS. 100, 101 AND 104).
FIRST USE 9-15-1995; IN COMMERCE 9-15-1995.

CLASS 42—SCIENTIFIC, COMPUTER AND LEGAL SERVICES

FOR COMPUTER CONSULTATION SERVICES (U.S. CLS. 100 AND 101).
FIRST USE 9-15-1995; IN COMMERCE 9-15-1995.
DANIEL CAPSHAW, EXAMINING ATTORNEY

SN 76-626,438. THE LUMBY COMPANY, CHAPEL HILL, NC.
FILED 12-28-2004.

SN 76-977,337. REID SUPPLY COMPANY, MUSKEGON, MI.
FILED 10-18-2002.

LUMBY

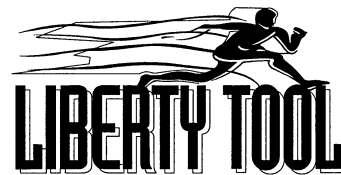

THE MARK CONSISTS OF STANDARD CHARACTERS WITHOUT CLAIM TO ANY PARTICULAR FONT, STYLE, SIZE, OR COLOR.

CLASS 16—PAPER GOODS AND PRINTED MATTER

FOR PAPER GOODS, NAMELY, CALENDARS, OCCASION CARDS, GREETING CARDS, STATIONERY AND POSTERS (U.S. CLS. 2, 5, 22, 23, 29, 37, 38 AND 50).

CLASS 21—HOUSEWARES AND GLASS

FOR POTTERY AND CERAMIC DISHWARE, NAMELY, DISHES, CUPS AND MUGS (U.S. CLS. 2, 13, 23, 29, 30, 33, 40 AND 50).

CLASS 25—CLOTHING

FOR CLOTHING, NAMELY, SHIRTS, SWEATSHIRTS AND HATS (U.S. CLS. 22 AND 39).
TANYA AMOS, EXAMINING ATTORNEY

CLASS 7—MACHINERY

FOR MACHINE TOOL PARTS AND ACCESSORIES, NAMELY, AIR GUNS, BEARINGS, BUSHINGS, CRANKS, PLUNGERS, PUNCHES, AND SHAFT COUPLINGS (U.S. CLS. 13, 19, 21, 23, 31, 34 AND 35).

CLASS 11—ENVIRONMENTAL CONTROL APPARATUS

FOR FLASHLIGHTS, BENDABLE ELECTRIC LIGHTING FIXTURES, BENDABLE FLASHLIGHTS, AND ELECTRIC LAMPS FOR LIGHTING WORK AREAS (U.S. CLS. 13, 21, 23, 31 AND 34).

CLASS 17—RUBBER GOODS

FOR HOSES FOR PNEUMATIC TOOLS; PLASTIC ADJUSTABLE COOLANT HOSES FOR USE WITH INDUSTRIAL MACHINERY (U.S. CLS. 1, 5, 12, 13, 35 AND 50).
JOHN SCHUYLER YARD, EXAMINING ATTORNEY

SN 76-977,431. SIMPSON FINANCIAL, INC., NEW BRAUNFELS, TX. FILED 11-12-2002.



OWNER OF U.S. REG. NO. 1,243,427.
SEC. 2(F).

CLASS 9—ELECTRICAL AND SCIENTIFIC APPARATUS

FOR FIRE CONTROL APPAREL AND FIRE PROTECTIVE CLOTHING FOR THE MOTOR SPORTS RACING INDUSTRY, NAMELY, UNDERWEAR SHIRTS AND DRAWERS, PANTS, SHIRTS, JACKETS, SUITS, SOCKS, SHOES, BOOTS, SAFETY HELMETS, GOGGLES, CAPS AND HATS; SAFETY EQUIPMENT, NAMELY, ABSORBING PADDING AND LINERS FOR HELMETS; FUELER APRONS; PROTECTIVE GLOVES; PROTECTIVE SLEEVES; HEATSHIELD PIT GLOVES; AND HELMET BAGS (U.S. CLS. 21, 23, 26, 36 AND 38).

FIRST USE 0-0-1988; IN COMMERCE 0-0-1988.

CLASS 12—VEHICLES

FOR MOTOR VEHICLE PARTS AND ACCESSORIES FOR THE MOTOR SPORTS RACING INDUSTRY, NAMELY, DRIVER RESTRAINT HARNESSSES, NECK SUPPORT YOKES AND HARNESS PADS, WEBBING BELTS FOR HARNESSSES, ANTI-FRICTION BELTS, ANTI-SUBMARINE BELTS, ROLL BARS, WINDOW NETS, FUEL CELLS AND FILL VALVES AND FUEL LINE FITTINGS THEREFOR, TRANSMISSION EXPLOSION SHIELD BLANKET, DRAG CHUTES AND CHUTE PACKS; VEHICLE TOW STRAPS AND WHEEL TIE DOWNS; CHILD VEHICLE SAFETY SEATS AND BOOSTER SEATS (U.S. CLS. 19, 21, 23, 31, 35 AND 44).

FIRST USE 0-0-1988; IN COMMERCE 0-0-1988.
JAMES A. RAUEN, EXAMINING ATTORNEY

SN 76-977,443. SIMPSON FINANCIAL, INC., NEW BRAUNFELS, TX. FILED 11-12-2002.



OWNER OF U.S. REG. NOS. 1,243,426, 1,243,427 AND 1,263,417.
SEC. 2(F).

CLASS 9—ELECTRICAL AND SCIENTIFIC APPARATUS

FOR FIRE CONTROL APPAREL AND FIRE PROTECTIVE CLOTHING FOR THE MOTOR SPORTS RACING INDUSTRY, NAMELY— UNDERWEAR SHIRTS AND DRAWERS, PANTS, SHIRTS, JACKETS, SUITS, SOCKS, SHOES, BOOTS, SAFETY HELMETS, GOGGLES, CAPS AND HATS; SAFETY EQUIPMENT, NAMELY— ABSORBING PADDING AND LINES FOR HELMETS; FUELER APRONS; PROTECTIVE GLOVES; PROTECTIVE SLEEVES; AND HEATSHIELD PIT GLOVES; AND HELMET BAGS (U.S. CLS. 21, 23, 26, 36 AND 38).

FIRST USE 12-31-1977; IN COMMERCE 12-31-1977.

CLASS 12—VEHICLES

FOR DRIVER RESTRAINT HARNESSSES, NECK SUPPORT YOKES AND HARNESS PADS, WEBBING BELTS FOR HARNESSSES, ANTI-FRICTION BELTS, ANTI-SUBMARINE BELTS, ROLL BARS, WINDOW NETS, FUEL CELLS AND FILL VALVES AND FUEL LINE FITTINGS THEREFOR, TRANSMISSION EXPLOSION SHIELD BLANKET, DRAG CHUTES AND CHUTE PACKS, VEHICLE TOW STRAPS AND WHEEL TIE DOWNS, CHILD VEHICLE SAFETY SEATS AND BOOSTER SEATS (U.S. CLS. 19, 21, 23, 31, 35 AND 44).

FIRST USE 12-31-1977; IN COMMERCE 12-31-1977.
TRACY CROSS, EXAMINING ATTORNEY

SN 76-977,611. PIKE NURSERIES, INC., NORCROSS, GA. FILED 8-25-2003.

EARTH HELPER

OWNER OF U.S. REG. NO. 1,784,333.
SEC. 2(F) AS TO "EARTH".

CLASS 1—CHEMICALS

FOR POTTING SOIL; PLANTING SOIL; GROWING MEDIA FOR PLANTS, NAMELY, PLANTING MIX AND CONTAINER MIX (U.S. CLS. 1, 5, 6, 10, 26 AND 46).

FIRST USE 0-0-1993; IN COMMERCE 0-0-1993.

CLASS 31—NATURAL AGRICULTURAL PRODUCTS

FOR RAW BARK NUGGETS (U.S. CLS. 1 AND 46).
FIRST USE 0-0-1993; IN COMMERCE 0-0-1993.
TONI HICKEY, EXAMINING ATTORNEY

SN 78-021,529. DEFINITY HEALTH CORPORATION, MINNEAPOLIS, MN. FILED 8-16-2000.

DEFINITY

OWNER OF U.S. REG. NO. 2,765,560.
NO CLAIM IS MADE TO THE EXCLUSIVE RIGHT TO USE "HEALTH", APART FROM THE MARK AS SHOWN.

CLASS 36—INSURANCE AND FINANCIAL

FOR PROVIDING ONLINE HEALTH CARE PLAN AND BENEFIT INFORMATION FEATURING BENEFIT ACCOUNT INFORMATION, DESCRIPTIONS OF VARIOUS HEALTH CARE PLANS AND BENEFITS AND COMMUNITY SPECIFIC PROVIDER EVALUATION. (U.S. CLS. 100, 101 AND 102).

CLASS 44—MEDICAL, BEAUTY AND AGRICULTURAL SERVICES

FOR PROVIDING INFORMATION VIA THE INTERNET IN THE FIELD OF HEALTH AND HEALTH CARE, NAMELY, PROVIDING ANSWERS TO CONSUMERS HEALTH CARE NEEDS AND PERSONAL HEALTH INFORMATION. (U.S. CLS. 100 AND 101).
MICHAEL ENGEL, EXAMINING ATTORNEY

SN 78-089,912. SANOFI-SYNTHELABO, PARIS, FRANCE,
FILED 10-24-2001.

OPEN YOUR EYES TO SLEEP

OWNER OF FRANCE REG. NO. 013128306, DATED 10-24-2001, EXPIRES 10-24-2011.

CLASS 9—ELECTRICAL AND SCIENTIFIC APPARATUS

FOR PRE-RECORDED, AUDIO AND VIDEO CASSETTES FEATURING MEDICAL INFORMATION; COMPUTER SOFTWARE FOR CREATING, STORING AND MAINTAINING DATA REGARDING MEDICAL MARKET SURVEYS REALIZED WITH PATIENTS AND FOR CREATING, STORING AND MAINTAINING PATIENT MEDICAL HISTORIES FOR USE IN THE MEDICAL FIELD (U.S. CLS. 21, 23, 26, 36 AND 38).

CLASS 16—PAPER GOODS AND PRINTED MATTER

FOR POSTERS, POSTCARDS, HEADED NOTEPAPERS, NOTEPAPERS, CARDBOARD BOXES, SEALING WAX, BAGS OF PAPER OR PLASTICS FOR PACKAGING, ENVELOPES, LABELS; PRINTED PUBLICATION NAMEDLY NEWSPAPERS, MAGAZINES, PAMPHLETS AND BOOKS FEATURING MEDICAL INFORMATION; PRINTED INSTRUCTIONAL, EDUCATIONAL AND TEACHING MATERIALS IN THE MEDICAL FIELD (U.S. CLS. 2, 5, 22, 23, 29, 37, 38 AND 50).

CLASS 41—EDUCATION AND ENTERTAINMENT

FOR ARRANGING AND CONDUCTING OF SEMINARS, CONFERENCES, AND CONGRESSES IN THE MEDICAL FIELD; PUBLISHING OF MAGAZINES, BOOKS, AND GUIDES IN THE MEDICAL FIELD (U.S. CLS. 100, 101 AND 107).

CLASS 42—SCIENTIFIC, COMPUTER AND LEGAL SERVICES

FOR MEDICAL RESEARCH SERVICES, NAMEDLY PROVIDING OF MEDICAL DOCUMENTATION AND LABORATORY EQUIPMENT TO EVALUATE AND ANALYZE PATIENTS' SLEEP DISORDERS; ARRANGING AND CONDUCTING RESEARCH GROUPS IN THE MEDICAL FIELD; CONSULTATION AND MEDICAL INFORMATION SERVICES FOR GENERAL PUBLIC, DOCTORS AND MEDICAL STAFF (U.S. CLS. 100 AND 101).

SUELLEN HICKEY, EXAMINING ATTORNEY

SN 78-123,264. ISIXSIGMA LLC, RIDGEFIELD, CT. FILED 4-22-2002.

ISIXSIGMA

CLASS 9—ELECTRICAL AND SCIENTIFIC APPARATUS

FOR DOWNLOADABLE ELECTRONIC PUBLICATIONS IN THE NATURE OF MAGAZINES AND "E-BOOKS" IN THE FIELD OF BUSINESS MANAGEMENT AND QUALITY (U.S. CLS. 21, 23, 26, 36 AND 38).
FIRST USE 3-2-2000; IN COMMERCE 3-2-2000.

CLASS 35—ADVERTISING AND BUSINESS

FOR PROVIDING AN ONLINE COMPUTER DATABASE IN THE FIELD OF BUSINESS MANAGEMENT AND QUALITY (U.S. CLS. 100, 101 AND 102).
FIRST USE 3-2-2000; IN COMMERCE 3-2-2000.

CLASS 38—COMMUNICATION

FOR PROVIDING AN ONLINE BULLETIN BOARD FOR THE TRANSMISSION OF MESSAGES AMONG COMPUTER USERS CONCERNING BUSINESS MANAGEMENT AND QUALITY (U.S. CLS. 100, 101 AND 104).
FIRST USE 3-2-2000; IN COMMERCE 3-2-2000.

CLASS 41—EDUCATION AND ENTERTAINMENT

FOR PROVIDING A NON-DOWNLOADABLE ONLINE MAGAZINE IN THE FIELD OF BUSINESS MANAGEMENT AND QUALITY (U.S. CLS. 100, 101 AND 107).
FIRST USE 3-2-2000; IN COMMERCE 3-2-2000.
KAREN BRACEY, EXAMINING ATTORNEY

SN 78-135,552. SENSYS MEDICAL, INC., CHANDLER, AZ.
FILED 6-13-2002.

SENSYS

CLASS 9—ELECTRICAL AND SCIENTIFIC APPARATUS

FOR OPTICAL MEASUREMENT EQUIPMENT, NAMEDLY APPARATUS FOR NONINVASIVE ANALYTE CONCENTRATION DETERMINATION; SOFTWARE FOR OPERATING MEDICAL DIAGNOSTIC AND MONITORING APPARATUS, NAMEDLY APPARATUS FOR NONINVASIVE ANALYTE CONCENTRATION DETERMINATION (U.S. CLS. 21, 23, 26, 36 AND 38).

CLASS 10—MEDICAL APPARATUS

FOR MEDICAL DIAGNOSTIC AND MONITORING APPARATUS, NAMEDLY APPARATUS FOR NONINVASIVE ANALYTE CONCENTRATION DETERMINATION (U.S. CLS. 26, 39 AND 44).

CLASS 42—SCIENTIFIC, COMPUTER AND LEGAL SERVICES

FOR SCIENTIFIC AND INDUSTRIAL RESEARCH FOR MEDICAL PURPOSES, NAMEDLY SCIENTIFIC AND INDUSTRIAL RESEARCH IN THE USE OF NEAR-INFRARED RADIATION FOR THE NONINVASIVE DETERMINATION OF ANALYTE CONCENTRATIONS (U.S. CLS. 100 AND 101).
LAURIEL DALIER, EXAMINING ATTORNEY

SN 78-143,575. YOUNG, CLARK & ASSOCIATES (YCA),
SNELLVILLE, GA. FILED 7-12-2002.

PROJECT SUCCESS FIRSTSTEP PROCESS

NO CLAIM IS MADE TO THE EXCLUSIVE RIGHT TO USE "PROJECT" AND "PROCESS", APART FROM THE MARK AS SHOWN.

CLASS 35—ADVERTISING AND BUSINESS

FOR PROJECT CONSULTING SERVICES FOR LARGE INDUSTRIAL AND MANUFACTURING COMPANIES FOR PLANNING AND DELIVERING PROJECTS ON TIME AND ON BUDGET INVOLVING THE FACILITATION AND MENTORING OF PROJECT TEAMS RESPONSIBLE FOR THE PLANNING AND CONTROL OF PROJECTS, NAMELY, PRODUCT DEVELOPMENT AND INTRODUCTION, REENGINEERING AND CORE PROCESS REDESIGN, FACILITY START-UP AND EQUIPMENT INSTALLATION, MAJOR MAINTENANCE, MERGERS AND ACQUISITIONS, INFORMATION TECHNOLOGY DEVELOPMENT AND IMPLEMENTATION, MARKETING PROGRAM DEVELOPMENT AND IMPLEMENTATION, AND DEVELOPMENT AND IMPLEMENTATION OF INFRASTRUCTURE SUPPORTING THE APPLICATION OF MANAGEMENT OF SUCH PROJECTS WITHIN SUCH ORGANIZATION (U.S. CLS. 100, 101 AND 102).

CLASS 41—EDUCATION AND ENTERTAINMENT

FOR CUSTOMIZED TRAINING PROGRAMS FOR TEACHING METHODOLOGIES AND TECHNIQUES OF PROJECT MANAGEMENT AND USE OF PROJECT MANAGEMENT SOFTWARE (U.S. CLS. 100, 101 AND 107).

MICHELE SWAIN, EXAMINING ATTORNEY

SN 78-144,817. SPACE CANNON VH S.R.L., 15043 FUBINE (AL), ITALY, FILED 7-17-2002.

SPACE CANNON VH

PRIORITY CLAIMED UNDER SEC. 44(D) ON ITALY APPLICATION NO. T02001C00094, FILED 3-28-2002, REG. NO. 00873781, DATED 9-4-2002, EXPIRES 3-28-2012.

CLASS 11—ENVIRONMENTAL CONTROL APPARATUS

FOR (BASED ON USE IN COMMERCE) HIGH INTENSITY SEARCH LIGHTS, LAMPS, COLOR FILTERS FOR USE IN LIGHTING INSTRUMENTS, LASER LIGHT PROJECTORS, LIGHT PROJECTORS, AND PARTS AND FITTINGS FOR ALL THE AFORESAID GOODS (U.S. CLS. 13, 21, 23, 31 AND 34).

FIRST USE 0-0-1994; IN COMMERCE 0-0-1994.

CLASS 37—CONSTRUCTION AND REPAIR

FOR CONSTRUCTION, REPAIR, INSTALLATION AND MAINTENANCE SERVICES IN THE FIELD OF LIGHTING ELECTRIC POWER AND ELECTRONICS (U.S. CLS. 100, 103 AND 106).

PAULA MAYS, EXAMINING ATTORNEY

SN 78-145,867. THALES, PARIS, FRANCE, FILED 7-19-2002.

THALES

OWNER OF FRANCE REG. NO. 306292600, DATED 11-7-2000, EXPIRES 11-7-2010.

CLASS 9—ELECTRICAL AND SCIENTIFIC APPARATUS

FOR ELECTROMAGNETIC AND MICROELECTRONIC EQUIPMENT, NAMELY, ELECTROMAGNETIC LENS, ELECTROMAGNETIC RELAY, ELECTROMAGNETIC UNIT, INDUCTORS, CAPACITORS, CHIPS, CIRCUITS; RADIO-ELECTRIC, ELECTROTECHNICAL AND ELECTROSTATIC EQUIPMENT, NAMELY, RADIO-ELECTRIC TRANSMITTERS, RECEIVER, MODULATORS, CONDUCTORS, DEFLECTORS, LENS, SHIELDS; IDENTIFICATION, DETECTION, TESTING, MAPPING EQUIPMENT, NAMELY, LASERS, SCANNERS, BEACONS, CONTROLLERS, DETECTORS, TESTERS, CARTOGRAPHERS; TEST AND MEASUREMENT EQUIPMENT, TELEMETRY APPARATUS AND EQUIPMENT, NAMELY, TESTING STATION OR TESTING STAND, TRANSDUCER, TRANSFORMER, TRANSMITTER, MEASURING PICK-UP, LEADS, AMPLIFIER, CONTROLLER, TELEMETERS, LASERS; ELECTRONIC APPARATUS FOR FINANCIAL, BANKING AND COMMERCIAL TRANSACTIONS, FOR THE PROCESSING OF TRANSPORT TICKETS, ADMITTANCE CONTROL, NAMELY, ELECTRONIC DOOR OPENERS, ELECTRONIC FENCES OR GATES, ELECTRONIC GATE OPERATORS, ELECTRONIC PURSES, ELECTRONIC OR MAGNETIC OR OPTIC CARD READERS, ENCODERS, WRITERS, PRINTERS, CONTROLLERS; AUTOMATIC TURNSTILES; COMPUTER TERMINALS FOR MANAGEMENT SYSTEMS, POINT OF SALE COMPUTER TERMINALS; ELECTROMECHANICAL AND ELECTRONIC EQUIPMENT FOR THE PROCESSING OF COINS, TOKENS, BANK NOTES, MAGNETIC STRIPE CARDS OR SMART CARDS, CHECKS, PAPER TITLES, PRINTED FORMS, NAMELY, BAR CODE READERS, MAGNETIC OR OPTICAL CODED CARDS, CHECK MARKING MACHINES FOR PREVENTING FRAUD, TICKET OR BADGE OR LABEL PUNCHERS, COMPUTER TICKET PRINTERS, POINT OF SALE DISPLAYS, COIN OR CHECK ELECTRONIC SORTERS, LASER PRINTERS, MAGNETIC CARD ENCODERS, MAGNETIC CARD READERS, BANK AUTOMAT, BANK TERMINALS, COIN-CHECKER, BILL VALIDATOR; ELECTRIC OR ELECTRONIC SENSORS FOR CAMERAS, LASERS, RADARS, TEMPERATURE, PRESSURE, ALTITUDE, PHOTO-SENSORS, PHOTOELECTRIC SENSORS, OPTOELECTRONIC COMPONENTS, PROXIMITY AND ULTRASONIC PROXIMITY SENSORS, LIMIT AND SAFETY SWITCHES, CONNECTION SYSTEMS, ENCODERS; DETECTORS, NAMELY, RADON DETECTORS, LASER OR RADAR SPEED DETECTORS, X-RAY DETECTORS, INFRARED DETECTORS, READERS OF ACCESS CODES OR RECORDED MEMORY CARDS, MICROPROCESSORS; RECORDED MEMORY CARDS, ELECTRONIC IDENTIFICATION CARDS, SMART CARDS, NAMELY, MAGNETICALLY ENCODED TELEPHONE CARDS WITH CREDITS IN UNITS; MAGNETICALLY ENCODED CREDIT CARDS, MAGNETICALLY ENCODED DEBIT CARDS, MAGNETICALLY ENCODED CARDS FOR ELECTRONIC GAMES DESIGNED TO BE USED WITH TELEPHONE RECEIVERS, AUTOMATIC AND MECHANICAL DISPENSERS FOR PRE-PAYMENT, NAMELY, AUTOMATIC CHANGE MACHINES, AUTOMATIC CARD AND TOKEN DISPENSING MACHINES; GUIDANCE AND NAVIGATION SYSTEMS COMPRISING AN INERTIAL MEASURING UNIT, OPTICAL NAVIGATION SUBSYSTEM, COMMAND MODULE COMPUTER FOR USE IN SPACE PROGRAM, FLIGHT CONTROL SYSTEM, GUIDED MUNITIONS, PROJECTILE TRAJECTORY; RADIO TRANSMITTERS (U.S. CLS. 21, 23, 26, 36 AND 38).

CLASS 13—FIREARMS

FOR FIREARMS; AMMUNITION AND PROJECTILES; EXPLOSIVES; FIREWORKS; FUSES; WEAPONS SYSTEMS, COMPRISING BALLISTIC OR GUIDED MISSILES, PROPELLED WEAPONS, AND WEAPON DECOYS (U.S. CLS. 2 AND 9).

CLASS 28—TOYS AND SPORTING GOODS

FOR COIN-OPERATED VIDEO GAMES; RADIO-CONTROLLED VEHICLES (U.S. CLS. 22, 23, 38 AND 50).

CLASS 38—COMMUNICATION

FOR TELECOMMUNICATIONS SERVICES, NAMELY, IMAGE, SOUND AND DATA TRANSMISSION BY MOBILE RADIO, RADIO-TELEPHONE, TELEGRAM, SATELLITE, TELECOMMUNICATION NETWORK, MICROWAVE CHANNELS, COMMUNICATION SERVICES VIA TELECOMPUTERIZED AND DIGITAL MEDIA, NAMELY, VIA VIDEOPHONE, VISIOPHONE AND VIDEO CONFERENCING; INFORMATION TRANSMISSION VIA TELEMATICS OR SATELLITE; ELECTRONIC TRANSMISSION OF MESSAGES VIA CABLE NETWORKS; TELEX AND TELEGRAM COMMUNICATION SERVICES; RADIOTELEPHONE OR TELECOMMUNICATIONS CALL TRANSFER SERVICES; DATA TRANSMISSION SERVICES IN PARTICULAR HIGH-SPEED PACKET TRANSMISSION FOR PUBLIC NETWORK OPERATIONS AND ENTERPRISES; ELECTRONIC TRANSMISSION OF COMPUTERIZED DOCUMENTS VIA COMPUTER TERMINALS OR ONLINE DOCUMENT TRANSMISSION AND DELIVERY VIA A GLOBAL COMPUTER NETWORK; ELECTRONIC MAIL, ELECTRONIC MESSAGING AND ELECTRONIC INFORMATION TRANSMISSION SERVICES ALL VIA GLOBAL COMMUNICATION OR PRIVATE ACCESS NETWORKS; TRANSMISSION BY SATELLITE OR MICROWAVE CHANNELS; COMPUTER AIDED TRANSMISSION OF DATA, SOUND AND IMAGES; MOBILE RADIOTELEPHONE COMMUNICATION SERVICES; SECURE DATA TRANSMISSION SERVICES IN PARTICULAR WITH ACCESS CODES; COMMUNICATIONS BY COMPUTER TERMINALS; TELECOMMUNICATION SERVICES, NAMELY PERSONAL COMMUNICATION SERVICES IN THE NATURE OF MOBILE RADIOTELEPHONE, FACSIMILE, COMPUTER, AND VIDEO CONFERENCING COMMUNICATIONS; PROVIDING TELECOMMUNICATIONS CONNECTIONS TO A RADIO TELEPHONE NETWORK BY SUBSCRIPTION; PROVIDING TELECOMMUNICATIONS CONNECTIONS TO A GLOBAL COMPUTER NETWORK; OFFERING TECHNICAL ADVICE AND CONSULTATION IN THE FIELD OF TELECOMMUNICATIONS; TECHNICAL ADVICE AND CONSULTATION IN THE FIELD OF TELECOMMUNICATIONS (U.S. CLS. 100, 101 AND 104).

CLASS 42—SCIENTIFIC, COMPUTER AND LEGAL SERVICES

FOR DESIGN OF COMPUTER AND TELECOMMUNICATION SYSTEMS FOR OTHERS; DESIGN AND DEVELOPMENT OF HIGH-SPEED EQUIPMENT FOR PUBLIC NETWORK OPERATORS AND ENTERPRISES; APPLICATIONS ENGINEERING SERVICES USING MAJOR COMPUTER SYSTEMS AND FACILITIES; TECHNICAL SUPPORT, NAMELY, MONITORING OF COMPUTER, TELECOMMUNICATIONS AND DATA TRANSMISSION NETWORK SYSTEMS; OFFERING TECHNICAL ADVICE AND CONSULTATION IN THE FIELD OF INFORMATION TECHNOLOGY; CUSTOM DESIGN AND ENGINEERING OF TELECOMMUNICATION NETWORKS AND COMPUTER SYSTEMS (U.S. CLS. 100 AND 101).

CLASS 45—PERSONAL SERVICES

FOR CONSULTING SERVICES IN THE FIELD OF ELECTRONIC SECURITY (U.S. CLS. 100 AND 101).
SHARON MEIER, EXAMINING ATTORNEY

CLASS 35—ADVERTISING AND BUSINESS

FOR ADVERTISING SERVICES, NAMELY, CREATING CORPORATE LOGOS FOR OTHERS; ADVERTISING SERVICES, NAMELY, CREATING CORPORATE AND BRAND IDENTITY FOR OTHERS; PREPARATION OF CUSTOM ADVERTISEMENTS AND CUSTOM PROMOTIONAL PRODUCTS FOR OTHERS; PREPARING AUDIO-VISUAL PRESENTATIONS FOR USE IN ADVERTISING; PREPARING PROMOTIONAL AND MERCHANDISING MATERIAL FOR OTHERS (U.S. CLS. 100, 101 AND 102).

FIRST USE 7-15-2001; IN COMMERCE 11-15-2001.

CLASS 40—MATERIAL TREATMENT

FOR DIGITAL COMPRESSION OF IMAGES AND VIDEO FOR THE INTERNET, CD ROMS, AND DVD ROMS, AND ANY OTHER PORTABLE STORAGE MEDIA; DIGITAL ENHANCEMENT OF PHOTOGRAPHS; DIGITAL IMAGE CORRECTION SERVICES OF VIDEOS; DIGITAL IMAGING SERVICES; DIGITAL RESTORATION AND/OR ENHANCEMENT OF PHOTOGRAPHS; DUPLICATION OF TAPE RECORDINGS; DUPLICATION OF VIDEO CASSETTES; DUPLICATION OF VIDEO TAPES; ELECTRONIC DIGITIZING OF PHOTOGRAPHS INTO A COMPUTER READABLE MEDIA; COLOR SEPARATION SERVICES; PHOTOCOMPOSITION SERVICES; PHOTOGRAPHIC COMPUTER IMAGING; PHOTOGRAPHIC ENLARGING; PHOTOGRAPHIC PRINTING; PHOTOGRAPHIC RESTORATION; PHOTOGRAPHIC RETOUCHING; VIDEO EDITING; VIDEO TAPE EDITING (U.S. CLS. 100, 103 AND 106).

FIRST USE 7-15-2001; IN COMMERCE 11-15-2001.

CLASS 41—EDUCATION AND ENTERTAINMENT

FOR AUDIO RECORDING AND PRODUCTION; COMPOSITION OF MUSIC FOR OTHERS; MUSIC PRODUCTION SERVICES; PHOTOGRAPHY SERVICES; RECORD PRODUCTION; SPECIAL EFFECTS ANIMATION SERVICES FOR FILM AND VIDEO; VIDEOTAPE PRODUCTION; DVD PRODUCTION; VIDEOTAPING (U.S. CLS. 100, 101 AND 107).

FIRST USE 7-15-2001; IN COMMERCE 11-15-2001.

CLASS 42—SCIENTIFIC, COMPUTER AND LEGAL SERVICES

FOR COMMERCIAL ART DESIGN; COMPUTER GRAPHICS SERVICES; COMPUTER PROGRAMMING FOR OTHERS; COMPUTER PROJECT MANAGEMENT SERVICES; COMPUTER SERVICES, NAMELY, CREATING AND MAINTAINING WEB SITES FOR OTHERS; COMPUTER SERVICES, NAMELY, DESIGNING AND IMPLEMENTING NETWORK WEB PAGES FOR OTHERS; COMPUTER SERVICES, NAMELY, DESIGNING AND IMPLEMENTING WEB SITES FOR OTHERS; DATABASE DEVELOPMENT SERVICES; DISPLAYING THE WEB SITES AND IMAGES OF OTHERS ON A COMPUTER SERVER; COMPUTER CODE CONVERSION FOR OTHERS; COMPUTER CONSULTATION; GRAPHIC ILLUSTRATION SERVICES FOR OTHERS; TECHNICAL WRITING FOR OTHERS (U.S. CLS. 100 AND 101).

FIRST USE 7-15-2001; IN COMMERCE 11-15-2001.

IRENE D. WILLIAMS, EXAMINING ATTORNEY

SN 78-150,078. INOVIZ LLC, FORT LEE, NJ. FILED 8-1-2002.



NO CLAIM IS MADE TO THE EXCLUSIVE RIGHT TO USE "CONVERGING MEDIA", APART FROM THE MARK AS SHOWN.

SN 78-154,475. SOFTPRO SOFTWARE PROFESSIONAL GMBH & CO. KG, 71034 BOEBLINGEN, FED REP GERMANY, FILED 8-15-2002.

SIGNWARE

OWNER OF ERPNTM CMNTY TM OFC REG. NO. 2827970, DATED 1-5-2004, EXPIRES 8-26-2012.

CLASS 9—ELECTRICAL AND SCIENTIFIC APPARATUS

FOR COMPUTER SOFTWARE FOR ELECTRONIC STORING, COMPARING, RECOGNIZING, VISUALIZING AND PROCESSING OF HANDWRITTEN SIGNATURES (U.S. CLS. 21, 23, 26, 36 AND 38).

CLASS 42—SCIENTIFIC, COMPUTER AND LEGAL SERVICES

FOR DEVELOPMENT AND MAINTENANCE OF COMPUTER PROGRAMS FOR DATA PROCESSING; TECHNICAL CONSULTANCY IN THE FIELD OF DATA PROCESSING; SERVICES OF A COMPUTER SCIENTIST, NAMELY COMPUTER CONSULTATION, COMPUTER SOFTWARE DESIGN DEVELOPMENT FOR OTHERS (U.S. CLS. 100 AND 101).

BRETT J. GOLDEN, EXAMINING ATTORNEY

SN 78-166,557. AUTOWEB.COM, INC., DBA AUTOMOTIVE INFORMATION CENTER (AIC), IRVINE, CA. FILED 9-20-2002.

AUTOPORTRAITS**CLASS 35—ADVERTISING AND BUSINESS**

FOR PROVIDING AN ON-LINE WEB SITE FOR CONSUMER AND PROFESSIONALS FEATURING AUTOMOBILE AND MOTOR VEHICLE CONSUMER INFORMATION, NAMELY SELECTION, AVAILABILITY, PRICING, QUOTATIONS, COMPARISONS, SALES, WARRANTIES, REPAIR AND MAINTENANCE, PARTS, CUSTOMIZATION AND SERVICES INFORMATION; PROVIDING AUTOMOTIVE AND VEHICULAR CONSUMER AND PRODUCT INFORMATION VIA A GLOBAL COMPUTER NETWORK RELATING TO VEHICLES FOR SALE, SPECIFICATION AND PERFORMANCE REVIEWS OF VEHICLES, VALUATION OF VEHICLES, AVAILABILITY OF VEHICLE PARTS AND ACCESSORIES, DEALERS, MANUFACTURERS, AUTOMOTIVE SERVICES AND SERVICE PROVIDERS, AS WELL AS TRADE INFORMATION ABOUT GENERAL INDUSTRY NEWS; PROVIDING ADVERTISING, MARKETING AND PROMOTION SERVICES TO OTHERS, NAMELY THE DISSEMINATION OF ADVERTISING FOR OTHERS, PROMOTING THE GOODS AND SERVICES OF OTHERS THROUGH THE DISTRIBUTION OF ONLINE ADVERTISEMENTS, PROVIDING A WEBSITE WHEREIN USERS CAN LINK TO THE WEBSITES OF THE MERCHANTS AND PROVIDING PRINT, RADIO AND TELEVISION ADVERTISING, INCENTIVE AWARDS, AND CROSS-PROMOTION AND REFERRAL PROGRAMS; E-COMMERCE SERVICES, NAMELY PROVIDING ON-LINE RETAIL STORE SERVICES IN THE FIELD OF AUTOMOBILES AND MOTOR VEHICLES; AUTOMOBILE AND MOTOR VEHICLE DEALERSHIPS REFERRAL SERVICES PROVIDED LOCALLY, REMOTELY AND OVER THE INTERNET AND VIA COMPUTER AND DATA COMMUNICATIONS NETWORKS (U.S. CLS. 100, 101 AND 102).

SN 78-157,654. CORPORATE RISK MANAGEMENT, INC., WESTMONT, IL. FILED 8-26-2002.

CLASS 42—SCIENTIFIC, COMPUTER AND LEGAL SERVICES

FOR COMPUTER SERVICES, NAMELY, PROVIDING SEARCH ENGINES FOR OBTAINING DATA ON A GLOBAL COMPUTER NETWORK; COMPUTER SERVICES, NAMELY PROVIDING SEARCH ENGINES FOR OBTAINING DATA ON A COMPUTER NETWORK, NAMELY, AND PROVIDING TEMPORARY USE OF NON-DOWNLOADABLE SEARCH ENGINE SOFTWARE FOR USE IN SEARCHING DATABASES FEATURING INFORMATION, CATALOGUES, PHOTOGRAPHS, SPECIFICATIONS, PRICING, REVIEWS, DEALERS, RETAILERS, WHOLESALERS, DISTRIBUTORS AND SERVICE PROVIDERS IN THE FIELDS OF AUTOMOBILES AND MOTOR VEHICLES, AND AUTOMOBILE AND MOTOR VEHICLE ACCESSORIES; COMPUTER SOFTWARE DESIGN FOR OTHERS; COMPUTER CONSULTATION; MAINTENANCE OF COMPUTER SOFTWARE; MAINTENANCE AND UPDATING OF COMPUTER SOFTWARE AND COMPUTER SERVICES, NAMELY, CREATING, MAINTAINING AND HOSTING WEB SITES FOR A GLOBAL COMPUTER NETWORK FOR THE PURPOSE OF ADVERTISING AUTOMOBILES AND OTHER VEHICLES FOR SALE OR LEASE, PROVIDING AUTOMOTIVE-RELATED SERVICES AND PROVIDING GENERAL INFORMATION AND SPECIFICATIONS ABOUT AUTOMOBILES AND OTHER VEHICLES, AND PARTS, ACCESSORIES AND SERVICES FOR AUTOMOBILES AND OTHER VEHICLES; PROVIDING ELECTRONIC AND COMPUTER BASED PRODUCT RESEARCH IN THE FIELD OF AUTOMOBILES AND MOTOR VEHICLES (U.S. CLS. 100 AND 101).

DOMINIC J. FERRAIUOLO, EXAMINING ATTORNEY

CRM**CLASS 36—INSURANCE AND FINANCIAL**

FOR INSURANCE BROKERAGE, ADMINISTRATION OF EMPLOYEE BENEFIT PLANS, AND RISK MANAGEMENT SERVICES (U.S. CLS. 100, 101 AND 102).

FIRST USE 1-1-1979; IN COMMERCE 1-1-1979.

CLASS 42—SCIENTIFIC, COMPUTER AND LEGAL SERVICES

FOR LITIGATION SUPPORT SERVICES FOR INSURANCE-RELATED CASES AND ISSUES (U.S. CLS. 100 AND 101).

FIRST USE 1-1-1979; IN COMMERCE 1-1-1979.

ALICE SUE CARRUTHERS, EXAMINING ATTORNEY

SN 78-167,298. GORDANO LIMITED, CLEVEDON, NORTH SOMERSET, UNITED KINGDOM, FILED 9-24-2002.

SN 78-170,406. SALTROCK SURFWEAR LIMITED, NORTH DEVON EX33 2DX, UNITED KINGDOM, FILED 10-2-2002.

gordano



OWNER OF UNITED KINGDOM REG. NO. 2309311, DATED 8-29-2002, EXPIRES 8-29-2012.

CLASS 18—LEATHER GOODS

FOR ARTICLES MADE OF LEATHER OR OF IMITATION LEATHER NAMELY ALL-PURPOSE CARRYING BAGS, BRIEFCASES AND RUCKSACKS; UMBRELLAS AND PARASOLS AND COVERS FOR UMBRELLAS AND PARASOLS (U.S. CLS. 1, 2, 3, 22 AND 41).

CLASS 25—CLOTHING

FOR ARTICLES OF CLOTHING, NAMELY FOOTWEAR, HATS, CAPS, BATHING SUITS, BATHING TRUNKS, WATER SOCKS, SPORT SHIRTS, SHIRTS, SWEAT SHIRTS, SWEAT SHORTS, SHORTS, SWEAT SUITS, SWEATERS, SWEATSOCKS, T-SHIRTS, WIND SHIRTS, PANTS, SWEAT PANTS, BELTS, TROUSERS, DRESSES, WETSUITS, ALL FOR USE IN RELATION TO WATER SPORTS OR BEACH SPORTS (U.S. CLS. 22 AND 39).

DOMINIC J. FERRAIUOLO, EXAMINING ATTORNEY

PRIORITY CLAIMED UNDER SEC. 44(D) ON UNITED KINGDOM APPLICATION NO. 002814531, FILED 8-16-2002, REG. NO. 002814531, DATED 2-23-2004, EXPIRES 8-16-2012.

CLASS 9—ELECTRICAL AND SCIENTIFIC APPARATUS

FOR BLANK MAGNETIC DATA CARRIERS, BLANK DISCS FOR COMPUTERS; DATA PROCESSORS; COMPUTERS, COMPUTER HARDWARE; COMPUTER SOFTWARE, NAMELY FOR MESSAGING AND E-MAIL SYSTEMS; COMPUTER PROGRAMS, NAMELY FOR MESSAGING AND E-MAIL SYSTEMS; COMPUTER SOFTWARE FOR USE IN ELECTRONIC MAIL, CALENDAR AND SCHEDULING, DIRECT MAIL; AND COMPUTER PROGRAMS FOR PROVIDING ENHANCED ELECTRONIC MAIL AND MESSAGING CAPABILITIES, NAMELY SECURING MESSAGING AND E-MAIL SYSTEMS (U.S. CLS. 21, 23, 26, 36 AND 38).

CLASS 38—COMMUNICATION

FOR TELECOMMUNICATION SERVICES, NAMELY E-MAIL AND MESSAGING SYSTEMS VIA COMPUTER; COMMUNICATION SERVICES, NAMELY E-MAIL AND MESSAGING SYSTEMS VIA COMPUTER; DELIVERY OF MESSAGES BY ELECTRONIC TRANSMISSION; ALL THESE SERVICES ALSO AVAILABLE ON-LINE FROM A COMPUTER DATABASE AND/OR THE INTERNET (U.S. CLS. 100, 101 AND 104).

CLASS 42—SCIENTIFIC, COMPUTER AND LEGAL SERVICES

FOR DESIGN AND DEVELOPMENT OF COMPUTER SOFTWARE FOR OTHERS; PROVISION OF ADVICE AND TECHNICAL ASSISTANCE IN SETTING UP COMPUTERS AND LINKS PROVIDED OVER THE COMPUTER RELATING TO E-MAIL AND MESSAGING SYSTEMS; COMPUTER PROGRAMMING FOR OTHERS; COMPUTER CONSULTANCY AND TECHNICAL SUPPORT, NAMELY TROUBLE SHOOTING PROBLEMS OF SOFTWARE AND HARDWARE USED FOR E-MAIL AND MESSAGING SYSTEMS; ALL THESE SERVICES ALSO AVAILABLE ON-LINE FROM A COMPUTER DATABASE AND/OR THE INTERNET (U.S. CLS. 100 AND 101).

KARLA PERKINS, EXAMINING ATTORNEY

SN 78-170,942. APAMA (UK) LIMITED, CAMBRIDGE, ENGLAND, FILED 10-4-2002.

APAMA

OWNER OF UNITED KINGDOM REG. NO. 2297101, DATED 9-20-2002, EXPIRES 4-4-2012.

CLASS 9—ELECTRICAL AND SCIENTIFIC APPARATUS

FOR COMPUTER SOFTWARE FOR USE IN INFORMATION MANAGEMENT, DATA ANALYSIS, DATA MINING, REPORTING, QUERYING AND DECISION SUPPORT; COMPUTER HARDWARE; COMPUTER PERIPHERALS; PRERECORDED MAGNETIC TAPES AND DISCS CONTAINING COMPUTER SOFTWARE FOR ANALYSIS AND BUSINESS INTELLIGENCE; PRERECORDED CDS CONTAINING COMPUTER SOFTWARE FOR DATA ANALYSIS AND BUSINESS INTELLIGENCE; CD ROMS CONTAINING COMPUTER SOFTWARE FOR MONITORING, STORING, RECORDING PROCESSING AND REPRODUCTION OF REAL-TIME DATA (U.S. CLS. 21, 23, 26, 36 AND 38).

CLASS 42—SCIENTIFIC, COMPUTER AND LEGAL SERVICES

FOR COMPUTER SOFTWARE CONSULTATION; COMPUTER SYSTEMS ANALYSIS; COMPUTER SOFTWARE DEVELOPMENT AND DESIGN; MAINTENANCE OF COMPUTER SOFTWARE; UPDATING OF COMPUTER SOFTWARE FOR OTHERS (U.S. CLS. 100 AND 101). MARIA-VICTORIA SUAREZ, EXAMINING ATTORNEY

SN 78-199,061. J. C. KELLEY, L.L.C., DBA PRISTINE SYSTEMS, HOUSTON, TX. FILED 12-31-2002.



NO CLAIM IS MADE TO THE EXCLUSIVE RIGHT TO USE "SYSTEMS", APART FROM THE MARK AS SHOWN. THE LINING IS FOR SHADING PURPOSES AND DOES NOT INDICATE COLOR.

SN 78-182,172. MY HOME LLC, NEW YORK, NY. FILED 11-6-2002.



NO CLAIM IS MADE TO THE EXCLUSIVE RIGHT TO USE "HOME RENOVATION", APART FROM THE MARK AS SHOWN.

CLASS 35—ADVERTISING AND BUSINESS

FOR (BASED ON INTENT TO USE) PROCUREMENT, NAMELY, PURCHASING CONSTRUCTION MATERIALS FOR OTHERS (U.S. CLS. 100, 101 AND 102).

CLASS 35—ADVERTISING AND BUSINESS

FOR FRANCHISING, NAMELY OFFERING TECHNICAL ASSISTANCE IN THE ESTABLISHMENT AND OPERATION OF COMMERCIAL AND RESIDENTIAL JANITORIAL SERVICES (U.S. CLS. 100, 101 AND 102). FIRST USE 8-19-2002; IN COMMERCE 9-1-2002.

CLASS 37—CONSTRUCTION AND REPAIR

FOR (BASED ON USE IN COMMERCE) HOME RENOVATION AND GENERAL CONSTRUCTION PROJECT MANAGEMENT SERVICES FOR OTHERS, NAMELY, HOUSE DEMOLITION, PAINTING, PLUMBING AND ELECTRICAL SUBCONTRACTING SERVICES (U.S. CLS. 100, 103 AND 106).

FIRST USE 11-1-2001; IN COMMERCE 11-1-2001. KELLY BOULTON, EXAMINING ATTORNEY

CLASS 37—CONSTRUCTION AND REPAIR

FOR JANITORIAL SERVICES FOR RESIDENTIAL AND COMMERCIAL CUSTOMERS, NAMELY OFFICE BUILDING AND CORPORATE CUSTOMERS, RESTAURANT AND FOOD SERVICE CUSTOMERS, MEDICAL AND HEALTH CARE CUSTOMERS, BANKING AND FINANCIAL CUSTOMERS, AIRLINE AND AIRPORT CUSTOMERS, HOSPITALITY AND FITNESS CLUB CUSTOMERS AND OTHER COMMERCIAL ESTABLISHMENTS (U.S. CLS. 100, 103 AND 106).

FIRST USE 8-19-2002; IN COMMERCE 9-1-2002. BARBARA GAYNOR, EXAMINING ATTORNEY

SN 78-199,803. R&B HOLDINGS, LLC, BOSTON, MA. FILED 1-3-2003.

ZOINKS!

SN 78-185,166. OUTOKUMPU OYJ, ESPOO, FINLAND, FILED 11-14-2002.

NORDIC GREEN

PRIORITY CLAIMED UNDER SEC. 44(D) ON FINLAND APPLICATION NO. T200201493, FILED 5-17-2002, REG. NO. 226697, DATED 3-14-2003, EXPIRES 3-14-2013.

PRIORITY CLAIMED UNDER SEC. 44(D) ON FINLAND APPLICATION NO. T200201493, FILED 5-17-2002, REG. NO. 226697, DATED 3-14-2003, EXPIRES 3-14-2013.

CLASS 6—METAL GOODS

FOR COPPER SHEETS, PLATES, FOILS AND STRIPS (U.S. CLS. 2, 12, 13, 14, 23, 25 AND 50).

THE MARK CONSISTS OF STANDARD CHARACTERS WITHOUT CLAIM TO ANY PARTICULAR FONT, STYLE, SIZE, OR COLOR.

CLASS 25—CLOTHING

FOR CLOTHING, NAMELY, ATHLETIC UNIFORMS, BABY BIBS NOT OF PAPER, BANDANAS, BASEBALL CAPS, BIB OVERALLS, BOXER BRIEFS, BRIEFS, CAPS, COVERALLS, FLEECE PULLOVERS, GYM SHORTS, HAT BANDS, HATS, HEAD BANDS, HOODS, INFANTWEAR, JERSEYS, PAJAMAS, POLO SHIRTS, SHIRTS, SHORTS, SWEAT SHIRTS, SWEAT PANTS, PANTS, AND T-SHIRTS (U.S. CLS. 22 AND 39).

FIRST USE 9-28-2001; IN COMMERCE 9-28-2001.

CLASS 40—MATERIAL TREATMENT

FOR TREATMENT OF COPPER OR ALLOYS BY OXIDATION (U.S. CLS. 100, 103 AND 106). SUELLEN HICKEY, EXAMINING ATTORNEY

CLASS 35—ADVERTISING AND BUSINESS

FOR RETAIL TOY STORE SERVICES FEATURING TOYS, GAMES, BOOKS, PUZZLES, CLOTHING, VIDEOS AND MUSIC (U.S. CLS. 100, 101 AND 102).

FIRST USE 1-3-2003; IN COMMERCE 1-3-2003. RON FAIRBANKS, EXAMINING ATTORNEY

SN 78-200,154. SPEDIAN LTD, GLASGOW, UNITED KINGDOM, FILED 1-6-2003.

SPEDIAN

PRIORITY CLAIMED UNDER SEC. 44(D) ON UNITED KINGDOM APPLICATION NO. 2304487, FILED 7-5-2002, REG. NO. 2304487, DATED 4-2-2004, EXPIRES 7-5-2012.

CLASS 20—FURNITURE AND ARTICLES NOT OTHERWISE CLASSIFIED

FOR PLASTIC VEHICLE MOUNTED DISPLAY PANELS (U.S. CLS. 2, 13, 22, 25, 32 AND 50).

CLASS 35—ADVERTISING AND BUSINESS

FOR ADVERTISING SERVICES, NAMELY, PROVIDING ADVERTISING SPACE ON GOODS CARRYING VEHICLES; RENTAL OF ADVERTISING SPACE; ADVISORY SERVICES RELATING TO ADVERTISING, NAMELY, CREATING CORPORATE AND BRAND IDENTITIES FOR OTHERS; ADVERTISING SERVICES INCORPORATING GRAPHIC ILLUSTRATIONS; ELECTRONIC BILLBOARD ADVERTISING; PREPARING AND PLACING ADVERTISEMENTS ON BILLBOARDS; RENTAL OF SIGNS FOR ADVERTISING PURPOSES; RENTAL OF ADVERTISING BILLBOARDS; AND RENTAL OF ADVERTISING SPACE ON DATA CARRYING VEHICLES (U.S. CLS. 100, 101 AND 102).

TRICIA SONNEBORN, EXAMINING ATTORNEY

SN 78-200,932. VICTORY SCHOOLS, INC., NEW YORK, NY. FILED 1-7-2003.



Victory Schools

NO CLAIM IS MADE TO THE EXCLUSIVE RIGHT TO USE "SCHOOLS", APART FROM THE MARK AS SHOWN.

THE COLOR(S) BLUE AND ORANGE IS/ARE CLAIMED AS A FEATURE OF THE MARK.

THE COLOR BLUE APPEARS IN THE LEFT HALF OF THE SHIELD, THE RIGHT HALF OF THE OPEN BOOK IN THE SHIELD'S CENTER AND THE WORDS "VICTORY SCHOOLS." THE COLOR ORANGE APPEARS IN THE RIGHT HALF OF THE SHIELD, THE LEFT HALF OF THE OPEN BOOK IN ITS CENTER.

THE MARK CONSISTS OF A FIGURE OF A SHIELD WITH A FIGURE OF AN OPEN BOOK IN THE MIDDLE OF THE SHIELD.

CLASS 35—ADVERTISING AND BUSINESS

FOR BUSINESS MANAGEMENT CONSULTATION FOR PUBLIC AND PRIVATE SCHOOLS, SCHOOL DISTRICTS, DEPARTMENTS OF EDUCATION AND CHARTER SCHOOLS, REGARDING PAYROLL ADMINISTRATION; HUMAN RESOURCES; FINANCE AND BUDGETING; VENDOR MANAGEMENT; AND STUDENT RECRUITMENT AND ENROLLMENT (U.S. CLS. 100, 101 AND 102).

FIRST USE 3-9-1999; IN COMMERCE 3-9-1999.

CLASS 41—EDUCATION AND ENTERTAINMENT

FOR EDUCATIONAL CONSULTING SERVICES TO PUBLIC AND PRIVATE SCHOOLS, SCHOOL DISTRICTS, DEPARTMENTS OF EDUCATION AND CHARTER SCHOOLS REGARDING CURRICULA MATERIALS; STUDENT TESTING AND EVALUATION; TEACHER TRAINING AND INSTRUCTIONAL METHODOLOGIES; CREATION OF PROPRIETARY CURRICULA; AND MONITORING STUDENT AND TEACHER PROGRESS IN RELATION TO EDUCATIONAL PROGRAM GOALS (U.S. CLS. 100, 101 AND 107).

FIRST USE 3-9-1999; IN COMMERCE 3-9-1999.

JILL C. ALT, EXAMINING ATTORNEY

SN 78-203,684. DOYON UNIVERSAL SERVICES, LLC, ANCHORAGE, AK. FILED 1-15-2003.



NO CLAIM IS MADE TO THE EXCLUSIVE RIGHT TO USE "UNIVERSAL SERVICES", APART FROM THE MARK AS SHOWN.

CLASS 37—CONSTRUCTION AND REPAIR

FOR FACILITY MAINTENANCE SERVICES, NAMELY, CLEANING AND GENERAL HOUSEKEEPING SERVICES IN INDUSTRIAL FACILITIES AND COMMERCIAL BUILDINGS, JANITORIAL SERVICES, AND INSTALLATION, MAINTENANCE, REPAIR AND REPLACEMENT OF AIR CONDITIONING, HEATING, PLUMBING, ELECTRICAL, WATER AND WASTE WATER TREATMENT SYSTEMS (U.S. CLS. 100, 103 AND 106).

FIRST USE 7-0-1999; IN COMMERCE 7-0-1999.

CLASS 43—HOTEL AND RESTAURANT SERVICES

FOR CATERING SERVICES (U.S. CLS. 100 AND 101).

FIRST USE 7-0-1999; IN COMMERCE 7-0-1999.

CLASS 45—PERSONAL SERVICES

FOR SECURITY SERVICES, NAMELY, PROVIDING SECURITY GUARD SERVICES FOR INDUSTRIAL AND COMMERCIAL LOCATIONS (U.S. CLS. 100 AND 101).

FIRST USE 7-0-1999; IN COMMERCE 7-0-1999.

INGA ERVIN, EXAMINING ATTORNEY

SN 78-204,636. ALTINYILDIZ MENSUCAT VE KONFEKSIYON FABRIKALARI ANONIM SIRKETI, ISTANBUL, TURKEY, FILED 1-17-2003.



NO CLAIM IS MADE TO THE EXCLUSIVE RIGHT TO USE "FABRIKA", APART FROM THE MARK AS SHOWN. THE ENGLISH TRANSLATION OF FABRIKA IS "FACTORY." THE ENGLISH TRANSLATION OF ALTINYILDIZ IS "GOLDEN STAR."

CLASS 18—LEATHER GOODS

FOR LEATHER AND IMITATIONS OF LEATHER, AND GOODS MADE OF THESE MATERIALS, NAMELY, PROCESSED AND UNPROCESSED LEATHER SOLD IN BULK; LEATHER USED IN THE FURTHER MANUFACTURE OF CLOTHING, FURNISHING, BOOKBINDING, SHOEMAKING AND SADDLERY; ANIMAL SKINS AND HIDES; BAGS, NAMELY LEATHER BAGS FOR MERCHANDISE PACKAGING, ALL PURPOSE SPORT BAGS, RUCKSACKS, VALISES, FANNY PACKS, SUITCASES, BRIEF CASES, CLUTCHES, BAGS FOR CLIMBERS, DRAWSTRING POUCHES, SCHOOL BAGS, TRUNKS, TRAVELING TRUNKS, LEATHER ENVELOPES FOR MERCHANDISE PACKAGING, PURSES; UMBRELLAS, PARASOLS AND WALKING STICKS; WHIPS, HARNESS AND SADDLERY; SADDLEBAGS (U.S. CLS. 1, 2, 3, 22 AND 41).

CLASS 24—FABRICS

FOR WOVEN AND NON-WOVEN TEXTILE FABRICS AND TEXTILES AND TEXTILE GOODS, NAMELY, TEXTILE FABRICS FOR USE IN THE MANUFACTURE OF CLOTHING; TEXTILE FABRICS FOR THE MANUFACTURE OF HOUSE FURNISHINGS; TEXTILE FABRICS FOR USE IN THE MANUFACTURE OF FURNISHINGS FOR HOME, INDUSTRIAL AND COMMERCIAL USE; UPHOLSTERY FABRICS; FABRICS FOR CURTAINS; FIBERGLASS FABRICS FOR TEXTILE USE; TEXTILE LININGS FOR GARMENTS; TEXTILE FABRICS FOR THE MANUFACTURE OF WATER FILTERS; CURTAINS; CURTAINS OF TEXTILE OR PLASTIC; SHOWER CURTAINS; HOUSEHOLD APPLIANCE COVERS; TABLE CLOTHS NOT OF PAPER INCLUDING PLASTIC TABLE CLOTHS; BED LINEN, TABLE LINENS; BED COVERS, NAMELY BEDSPREADS; DUST RUFFLES; SHEETS, AFGHANS, PILLOW CASES, UNFITTED COVERS FOR SOFAS, UNFITTED COVERS FOR COFFEE TABLE; NAPKINS OF TEXTILE; FIBER BED COVERS, NAMELY, BEDSPREADS, EIDERDOWNS; BLANKETS; WOOLEN BLANKETS; WASHCLOTHS; WASHING MITTS; HAND AND FACE TOWELS; BATH TOWELS; KITCHEN TOWELS; WALL HANGINGS OF TEXTILE; HANDKERCHIEFS OF TEXTILE; NAPKINS OF CLOTH FOR REMOVING MAKE-UP; CLOTH FLAGS, BANNERS, STREAMERS, AND LABELS (U.S. CLS. 42 AND 50).

CLASS 25—CLOTHING

FOR CLOTHING, NAMELY, COATS, TOP COATS, OVERCOATS, RAIN COATS, JACKETS, ANORAKS, CAPES, PONCHOS, BOMBER JACKETS, DENIM JACKETS, BLAZERS, FUR-TRIMMED COATS AND VESTS, CLOTHING OF LEARNER AND CLOTHING OF IMITATIONS OF LEATHER, NAMELY, VESTS, WAIST-COATS, SUITS, TAIL COATS AND DINNER JACKETS, EVENING DRESSES, BLOUSES AND TUNICS, SWEATERS, CARDIGANS, SKIRTS, DRESSES, PANTS, SUSPENDERS, JEANS, GOLF SHORTS, SLACKS WITH STRAP UNDER FOOT, OVERALLS AND DUNGAREES, SHORTS, SHIRTS, T-SHIRTS, SWEATSHIRTS, SWEATPANTS, UNIFORMS, ATHLETIC UNIFORMS, MILITARY UNIFORMS, UNDERWEAR, BOXER SHORTS, PETTY-

PANTS, LONG AND SHORT UNDERPANTS, PANTIES, SHORT SLEEVED VESTS AND LONG SLEEVED VESTS, BRAS, CORSETS, BODYSUITS, BUSTIERS, GARTERS, TIGHTS, UNDERSKIRTS, APRONS, HALLOWEEN COSTUMES, INFANT AND BABY WEAR, CLOTH BABY BIBS, CLOTH DIAPERS, BATHROBES, BEACHWEAR, BATHING SUITS AND BIKINIS; NIGHTWEAR, NAMELY, PAJAMAS, NIGHT DRESSES, MORNING GOWN, DRESSING GOWN; LEISURE WEAR AND SPORTS WEAR, NAMELY, GYMNASTIC BODY SUITS, GYMNASTIC SHOES, TRACK SUITS, SHORTS AND TIGHTS, SKIWEAR; HEADGEAR, NAMELY, HATS, CAPS, KNIT HATS, RAIN HATS, BANDANAS, HEADBANDS, SCARVES; MUFFLERS, NECK SCARVES, SHAWLS, TIES, BELTS, GLOVES, MITTENS; FOOTWEAR, NAMELY, SHOES, SNEAKERS, GYMNASTIC SHOES, WRESTLING BOOTS, BOOTS, RAIN BOOTS, SKI BOOTS, SLIPPERS, SANDALS, SHOE SOLES AND HEELS, SOCKS, PANTYHOSE (U.S. CLS. 22 AND 39).

CLASS 35—ADVERTISING AND BUSINESS

FOR ADVERTISING AGENCIES; BUSINESS MANAGEMENT; ADMINISTRATION OF BUSINESS PAYROLL FOR OTHERS; ON-LINE TRADING SERVICES IN WHICH SELLER POSTS PRODUCTS TO BE AUCTIONED AND BIDDING IS DONE VIA THE INTERNET; AUCTION SERVICES; ADVERTISING SERVICES, NAMELY PROVIDING ADVERTISING SPACE IN A PERIODICAL; MAIL ORDER SERVICES FEATURING CLOTHING, WOVEN AND NON-WOVEN TEXTILE FABRICS AND TEXTILE AND TEXTILE GOODS, AND LEATHER AND IMITATION LEATHER AND GOODS MADE OF THESE MATERIALS; RETAIL STORE SERVICES FEATURING CLOTHING, WOVEN AND NON-WOVEN TEXTILE FABRICS AND TEXTILE AND TEXTILE GOODS, AND LEATHER AND IMITATION LEATHER AND GOODS MADE OF THESE MATERIALS; PROMOTING THE SERVICES OF MANUFACTURERS OF CLOTHING, WOVEN AND NON-WOVEN TEXTILE FABRICS AND TEXTILE AND TEXTILE GOODS, AND LEATHER AND IMITATION LEATHER AND GOODS MADE OF THESE MATERIALS BY RENDERING SALES PROMOTION ADVICE; BUSINESS INFORMATION FOR CLOTHING, WOVEN AND NON-WOVEN TEXTILE FABRICS AND TEXTILE AND TEXTILE GOODS, AND LEATHER AND IMITATION LEATHER AND GOODS MADE OF THESE MATERIALS; RETAIL DEPARTMENT STORES; RETAIL ON-LINE DEPARTMENT STORES, RETAIL CONVENIENCE STORES; RETAIL ON-LINE CONVENIENCE STORES; COMPUTERIZED ON-LINE ORDERING FEATURING GENERAL MERCHANDISE AND GENERAL CONSUMER GOODS; PROVIDING AN ON-LINE COMMERCIAL INFORMATION DIRECTORY; PROVIDING A SEARCHABLE DATABASE IN THE FIELD OF BUSINESS INFORMATION FOR CLOTHING, WOVEN AND NON-WOVEN TEXTILE FABRICS AND TEXTILE AND TEXTILE GOODS, AND LEATHER AND IMITATION LEATHER AND GOODS MADE OF THESE MATERIALS AVAILABLE VIA A GLOBAL COMPUTER NETWORK; DISSEMINATION OF ADVERTISING FOR OTHERS VIA AN ON-LINE ELECTRONIC COMMUNICATIONS NETWORK; PROVIDING A SEARCHABLE ON-LINE DATABASE FEATURING DIRECTORIES OF THE GOODS AND SERVICES OF OTHERS IN THE FIELDS OF FINANCES, INSURANCE, BANKING REAL ESTATE AND VEHICLES; SHOPPER'S GUIDE INFORMATION, NAMELY, PROVIDING A SEARCHABLE ON-LINE ADVERTISING GUIDE FEATURING THE GOODS AND SERVICES OF OTHER ON-LINE VENDORS; COMPUTERIZED DATABASE MANAGEMENT SERVICES; COMPUTER SERVICES, NAMELY, PROVIDING DIRECTORIES FOR TELEPHONE NUMBERS, BUSINESS ADDRESSES, ELECTRONIC MAIL ADDRESSES, NETWORK HOME PAGE ADDRESSES, ADDRESSES AND TELEPHONE NUMBER OF PEOPLE, PLACES AND ORGANIZATIONS; PROVIDING AN INTERACTIVE DATABASE FEATURING AUTOMATICALLY UPDATING ADDRESS BOOK, PERSONAL PLANNER, DATA REMINDER AND ALUMNI AND PROFESSIONAL GROUP LINKS ALL VIA A GLOBAL COMPUTER NETWORK (U.S. CLS. 100, 101 AND 102).

KELLY BOULTON, EXAMINING ATTORNEY

SN 78-206,076. REED MIDEM, PARIS, FRANCE, FILED 1-22-2003.

MIP ASSET

PRIORITY CLAIMED UNDER SEC. 44(D) ON FRANCE APPLICATION NO. 023175904, FILED 7-23-2002, REG. NO. 023175904, DATED 7-23-2002, EXPIRES 7-23-2012.

CLASS 35—ADVERTISING AND BUSINESS

FOR ARRANGING AND CONDUCTING TRADESHOW EXHIBITIONS FOR COMMERCIAL OR ADVERTISING PURPOSES IN THE FIELDS OF FINANCE, BANKING, INSURANCE, MULTIMEDIA, AS WELL AS IN THE FIELD OF PRODUCTION, MARKETING AND SELLING OF MOTION PICTURE FILMS AND TELEVISION PROGRAMS; ORGANIZING EXHIBITIONS, EVENTS AND NEWSGROUPS, INCLUDING OVER THE INTERNET, FOR COMMERCIAL OR ADVERTISING PURPOSES IN THE FIELDS OF FINANCE, BANKING, INSURANCE, MULTIMEDIA, AS WELL AS IN THE FIELD OF PRODUCTION, MARKETING AND SELLING OF MOTION PICTURE FILMS AND TELEVISION PROGRAMS; ADVERTISING AGENCIES; CONDUCTING PUBLIC OPINION POLLS; PROVIDING STATISTICAL INFORMATION; PROVIDING RADIO AND TELEVISION ADVERTISING FOR OTHERS; DISSEMINATION OF ADVERTISING MATTER; PUBLIC RELATIONS (U.S. CLS. 100, 101 AND 102).

CLASS 36—INSURANCE AND FINANCIAL

FOR INSURANCE AGENCIES; INSURANCE BROKERAGE; FINANCIAL PLANNING; FINANCIAL MANAGEMENT; MONETARY EXCHANGE; REAL ESTATE BROKERAGE; REAL ESTATE MANAGEMENT (U.S. CLS. 100, 101 AND 102).

CLASS 41—EDUCATION AND ENTERTAINMENT

FOR CULTURAL AND EDUCATIONAL SERVICES, NAMELY, ARRANGING AND CONDUCTING, INCLUDING OVER THE INTERNET, OF COLLOQUIUMS, SEMINARS, SYMPOSIUMS, CONFERENCES AND CONGRESSES, ALL IN THE FIELDS OF FINANCE, BANKING, INSURANCE, MULTIMEDIA, AS WELL AS IN THE FIELD OF PRODUCTION, MARKETING AND SELLING OF MOTION PICTURE FILMS AND TELEVISION PROGRAMS; PUBLICATION, INCLUDING OVER THE INTERNET, OF BOOKS, TEXTS, PAMPHLETS, MAGAZINES AND MUSIC (U.S. CLS. 100, 101 AND 107).
MICHAEL SOUDERS, EXAMINING ATTORNEY

SN 78-208,517. MARS FAMILY ENTERPRISES, INC., MARINETTE, WI. FILED 1-29-2003.

RENISANT

CLASS 35—ADVERTISING AND BUSINESS

FOR BUSINESS MANAGEMENT AND CONSULTING SERVICES, NAMELY, PROVIDING ASSISTANCE TO INDIVIDUALS AND ORGANIZATIONS WITH PROBLEM SOLVING, CRITICAL THINKING SKILLS, STRATEGY FORMULATION, STRATEGY IMPLEMENTATION AND NETWORKING SERVICES, INCLUDING THE ASSEMBLY AND SUPERVISION OF PROFESSIONAL AND BUSINESS ADVISORS (U.S. CLS. 100, 101 AND 102).
FIRST USE 10-18-2002; IN COMMERCE 10-18-2002.

CLASS 41—EDUCATION AND ENTERTAINMENT

FOR PERSONAL CONSULTING SERVICES, NAMELY, CAREER COUNSELING (U.S. CLS. 100, 101 AND 107).
FIRST USE 10-18-2002; IN COMMERCE 10-18-2002.
IRENE D. WILLIAMS, EXAMINING ATTORNEY

SN 78-215,738. SALTROCK SURFWEAR LIMITED, NORTH DEVON EX33 2DX, UNITED KINGDOM, FILED 2-17-2003.



PRIORITY CLAIMED UNDER SEC. 44(D) ON UNITED KINGDOM APPLICATION NO. 2309127, FILED 8-28-2002, REG. NO. 2309127, DATED 8-28-2002, EXPIRES 8-28-2012.

THE MARK CONSISTS OF A DESIGN OF A HEAD-SHAPED TOP OF THE DESIGN WITH THE APPEARANCE OF FLAMES PROTRUDING FROM THE HEAD, AND TWO "U" SHAPED OVAL DESIGNS UNDERNEATH THE FLAMING HEAD.

CLASS 18—LEATHER GOODS

FOR ARTICLES MADE OF LEATHER OR IMITATION LEATHER, NAMELY, RUCKSACKS, HANDBAGS, OVERNIGHT CASES, SUITCASES; UMBRELLAS AND PARASOLS AND COVERS FOR UMBRELLAS AND PARASOLS (U.S. CLS. 1, 2, 3, 22 AND 41).

CLASS 25—CLOTHING

FOR ARTICLES OF CLOTHING, NAMELY FOOTWEAR, HATS, CAPS, BATHING CAPS, BATHING SUITS, BATHING TRUNKS, WATER SOCKS, SPORT SHIRTS, SHIRTS, SWEAT SHIRTS, SWEAT SHORTS, SHORTS, SWEAT SUITS, SWEATERS, SWEATSOCKS, T-SHIRTS, WIND SHIRTS, WINDSHIRTS, PANTS, SWEAT PANTS, BELTS, TROUSERS, DRESSES, WETSUITS, ALL FOR USE IN RELATION TO WATER SPORTS OR BEACH SPORTS (U.S. CLS. 22 AND 39).
WILLIAM P. SHANAHAN, EXAMINING ATTORNEY

SN 78-215,982. ROTTER, MARTIN J., GLENSIDE, PA. FILED 2-18-2003.

GEORGIA WEB

CLASS 19—NON-METALLIC BUILDING MATERIALS

FOR NON METAL RIDGE VENTS FOR METAL, SHINGLE AND TILE ROOFS (U.S. CLS. 1, 12, 33 AND 50).

CLASS 24—FABRICS

FOR NON-WOVEN MESH FABRIC COMPRISED OF RANDOMLY SPACED FILAMENTS AND A BINDER FOR CONVERSION INTO A VARIETY OF INDUSTRIAL AND COMMERCIAL GOODS (U.S. CLS. 42 AND 50).

GIANCARLO CASTRO, EXAMINING ATTORNEY

SN 78-219,665, DEUTSCHE TELEKOM AG, BONN, FED REP GERMANY, FILED 2-27-2003.

Cash & Go

THE MARK CONSISTS OF STANDARD CHARACTERS WITHOUT CLAIM TO ANY PARTICULAR FONT, STYLE, SIZE, OR COLOR.

PRIORITY CLAIMED UNDER SEC. 44(D) ON FED REP GERMANY APPLICATION NO. 30242610.8, FILED 9-2-2002, REG. NO. 30242610, DATED 1-10-2005, EXPIRES 9-30-2012.

CLASS 9—ELECTRICAL AND SCIENTIFIC APPARATUS

FOR ELECTRIC, ELECTRONIC, OPTICAL, MEASURING, SIGNALING, CONTROLLING AND TEACHING APPARATUS AND INSTRUMENTS, ALL FOR USE WITH TELECOMMUNICATIONS, NAMELY, BLANK MAGNETIC DATA CARRIERS AND BLANK OPTICAL DATA CARRIERS, DATA PROCESSORS AND COMPUTERS, NAMELY, MICROCOMPUTERS, MINICOMPUTERS, COMPUTER CENTRAL PROCESSORS, COMPUTER MONITORS, COMPUTER KEYBOARDS, COMPUTER TERMINALS, COMPUTER INTERFACE BOARDS, COMPUTER MEMORIES, COMPUTER LASER PRINTERS, COMPUTER IMPACT PRINTERS, COMPUTER DOT MATRIX PRINTERS, COMPUTER OPERATING SYSTEMS, COMPUTERS AND INSTRUCTIONAL MANUALS SOLD AS A UNIT, COMPUTER INTERFACE APPARATUS, NAMELY, COMPUTER MODEMS, COMPUTER MOUSE AND MOUSE PAD, COMPUTER PERIPHERALS AND PARTS THEREOF; COMPUTER PROGRAMS AND DATABASES FOR USE IN OPERATING TELECOMMUNICATIONS AND BUSINESS MANAGEMENT SYSTEMS AND RELATED INSTRUCTION MANUALS SOLD AS A UNIT; COMPUTER PROGRAMS, NAMELY, FINANCIAL ACCOUNTING SYSTEM SOFTWARE, SOFTWARE USED FOR THE PROVISION OF ONLINE INFORMATION SERVICES, NETWORK MANAGEMENT SOFTWARE, COMPUTER PROXY SOFTWARE FOR USE WITH OTHER SOFTWARE PROGRAMS, COMPUTER PROGRAMS AND SOFTWARE FOR CONTROLLING ACCESS AND ALARM MONITORING OF HOMES, APARTMENTS, BUILDINGS AND OTHER PROPERTIES, BILLING ANALYSIS SOFTWARE, AND SOFTWARE FOR NETWORK ACCESS CONTROL AND FOR CREATING AND MAINTAINING FIREWALLS; COMPUTER PROGRAMS FOR ACCESSING A GLOBAL COMPUTER NETWORK AND INTERACTIVE COMPUTER COMMUNICATIONS NETWORK; OPTICAL CABLES, OPTIC FILTERS, OPTICAL SCANNERS, OPTICAL CHARACTER READERS, BLANK OPTICAL DISCS, OPTICAL FIBERS, OPTICAL GLASS FOR SIGNAL TRANSMISSION, ELECTRONIC AND OPTICAL COMMUNICATIONS INSTRUMENTS AND COMPONENTS, NAMELY, OPTIC TRANSMITTERS, OPTIC RECEIVERS FOR TELEPHONE, AUDIO, VIDEO; CABLE FOR OPTICAL SIGNAL PROCESSING, OPTIC SWITCHES, OPTICAL ATTENUATORS, OPTICAL AMPLIFIERS, OPTICAL CHARACTER RECOGNITION APPARATUS, AND PARTS THEREOF; AUDIO, VIDEO AND DATA COMMUNICATIONS SYSTEMS, NAMELY, DIGITAL AND ANALOGUE SIGNAL TRANSMITTERS, RECEIVERS AND CONVERTERS, RADIO AND TELEPHONE TRANSMITTERS, RECEIVERS AND SERVERS, ANSWERING MACHINES, TELECOMMUNICATION TRANSMISSION, RECEIVING AND STORAGE APPARATUS, NAMELY, TELECOMMUNICATIONS TRANS-

MITTING SETS, DATA TRANSMITTERS, FACSIMILE MACHINES, ELECTRONIC MAIL APPARATUS FOR ELECTRONIC EXCHANGE OF DATA IMAGES AND MESSAGES, REMOTE CONTROLS AND SET-TOP UNITS FOR TELEVISION, CINEMATOGRAPHIC TELEVISION AND AMUSEMENT EQUIPMENT, NAMELY, SIGNAL DECODERS, ELECTRICAL WIRE, ELECTRICAL WIRE CONNECTORS, INTEGRATED CIRCUITS, PRINTED CIRCUITS, ELECTRIC CIRCUITS, CIRCUIT BREAKERS, PRINTED CIRCUIT BOARDS, ELECTRIC CIRCUIT BOARDS, CIRCUIT CONNECTORS, ELECTRICAL CONTROLLERS, ELECTRICAL CONVERTERS, ELECTRICAL FUSES, ELECTRIC LUMINESCENT DISPLAY PANELS, ELECTRICAL SWITCH PLATES, ELECTRIC PLUGS, ANTENNAS, ELECTRICAL CABLES, COMPUTER CABLES, COMPUTER CHIPS, SILICON CHIPS, CHRONOGRAPHS FOR USE AS SPECIALIZED TIME RECORDING APPARATUS, ELECTRIC COILS, COMPUTER BUFFERS, BLANK COMPUTER DISCS, BLANK COMPUTER FLOPPY DISKS, COMPUTER HARD DISCS, ELECTRICAL CONDUCTORS, ACOUSTIC CONDUITS, ELECTRICAL CONDUITS, FIBER OPTIC CONDUITS AND PARTS THEREOF; COMPACT DISC PLAYERS, AUDIO AND VIDEO TAPE RECORDERS, AUDIO AND VIDEO TAPE PLAYERS, AUDIO AND VIDEO CASSETTE RECORDERS, AUDIO AND VIDEO CASSETTE PLAYERS, BLANK AUDIO AND VIDEO TAPES, CASSETTES, AND DISCS; AUDIO AND VIDEO TAPES, CASSETTES, DISCS AND MICROFICHE FEATURING INFORMATION CONCERNING TELECOMMUNICATIONS, AND CONCERNING PERSONAL AND BUSINESS MANAGEMENT SYSTEMS; AUDIO AND VIDEO RECORDINGS IN THE FIELD OF TELECOMMUNICATIONS, INFORMATION TECHNOLOGY; TELEVISION AND TELEVISION PERIPHERAL EQUIPMENT, NAMELY CAMERAS, SET BOXES, REMOTE CONTROL UNITS FOR INTERACTIVE AND NON-INTERACTIVE USE; COMPUTER MEMORY, COMPUTER PERIPHERALS AND MODEMS; VIDEO MONITORS, AUTOMATIC VENDING MACHINES AND TIMING MECHANISMS THEREFOR AND PARTS THEREOF; MACHINE READABLE, MAGNETICALLY ENCODED CARDS, NAMELY, PREPAID TELEPHONE CALLING CARDS AND CREDIT CARDS; BLANK SMART CARDS; DATA PROCESSORS AND READERS, WORD PROCESSORS, MAGNETIC CODED CARD READERS, MAGNETIC CODED CARDS, NAMELY, FIDELITY CARDS, ELECTRONIC ENCRYPTION UNITS, LASERS NOT FOR MEDICAL USE, LIGHT EMITTING DIODES, LIGHT EMITTING DIODE DISPLAYS, MICROPROCESSORS, BLANK MAGNETIC DATA CARRIERS, DEMAGNETIZERS FOR MAGNETIC TAPES, AND PARTS THEREOF; COMPUTER, DATA AND VIDEO NETWORKING AND CONFERENCING EQUIPMENT, NAMELY, TELECONFERENCING EQUIPMENT AND AUDIOVISUAL TEACHING EQUIPMENT IN THE NATURE OF OVERHEAD FILM, PHOTOGRAPHIC AND SLIDE PROJECTORS, PROJECTION SCREENS, COMPUTER BASED INFORMATION DISPLAY EQUIPMENT, NAMELY, COMPUTERS WHICH DISPLAY INFORMATION ON AN OVERHEAD SCREEN, INTERCOMS; TELEPHONES, TELEPHONE ANSWERING MACHINES, TELEPHONE TRANSMITTERS, TELEPHONE NETWORKS, TELEPHONE WIRES, TELEPRINTERS, TELETYPEWRITERS, AND PARTS THEREOF, NAMELY, CALLER IDENTIFICATION BOXES, DIALING ASSEMBLIES, TELEPHONE UNITS, AUDIO OPERATED RELAYS, AUDIO OPERATED RELAYS, AUDIO/VIDEO SIGNAL AND OPTICAL FILTERS, PROTECTORS AND AUTOMATIC SIGNALING AND CONTROL EQUIPMENT, TELEMETERS, WIRELESS AND CELLULAR TELEPHONES, RADIO PAGERS, PORTABLE COMPUTERS, FACSIMILE TRANSMITTERS AND RECEIVERS, WIRELESS FAX MACHINES, PERSONAL COMMUNICATIONS EQUIPMENT, NAMELY, PERSONAL DIGITAL ASSISTANTS, CALCULATORS AND RELATED PERIPHERALS; SATELLITE PROCESSORS, SATELLITES AND SATELLITE COMMUNICATION EARTH STATIONS BOTH STATIONARY AND MOVEABLE; AUDIO AND VIDEO RECORDINGS IN THE FIELD OF NEWS, SPORTS, ENTERTAINMENT, CULTURE, BUSINESS AND FINANCE, WEATHER AND TRAVEL; PRERECORDED COMPACT DISCS, AUDIO CASSETTE TAPES, VIDEO CASSETTE TAPES, DIGITAL AUDIO TAPES AND DIGITAL VIDEO DISCS FEATURING MUSICAL, VARIETY, NEWS AND COMEDY SHOWS; COMPUTER GAME PROGRAMS FOR CHILDREN AND ADULTS; VIDEO AND COMPUTER GAME CARTRIDGES (U.S. CLS. 21, 23, 26, 36 AND 38).

CLASS 16—PAPER GOODS AND PRINTED MATTER

FOR PRINTED MATTER, NAMELY, TELEPHONE DIRECTORIES, BOOKS, NEWSLETTERS, PAMPHLETS, BROCHURES, MAGAZINES AND PAPERBACKS ALL IN THE FIELD OF TELECOMMUNICATIONS, PRINTED AND STAMPED PLASTIC AND CARDBOARD GREETING, BLANK, NOTE, AND INDEX CARDS; NOTE PAPER AND ENVELOPES, RUBBER STAMPS AND IMPRESSION STAMPS, NAME TAGS AND LABELS MADE FROM PAPER OR CARDBOARD, NOTEBOOKS, DIARIES, NOTE PAPERS, NOTE PADS, ADDRESS BOOKS, FOLDERS FOR LETTERS AND LOOSE PAPERS, CLEAR HOLE REINFORCEMENTS, STUDENT CALENDARS, STAMP ALBUMS AND PHOTO-ALBUMS; PAPER WEIGHTS, LETTER OPENERS, BLOTTING PADS; DESK TRAYS, DESK STANDS AND HOLDERS FOR HOLDING STATIONERY AND OFFICE IMPLEMENTS; PRINTED INSTRUCTIONAL AND TEACHING MATERIALS ALL IN THE FIELDS OF TELECOMMUNICATIONS, INFORMATION TECHNOLOGY, SAFETY, NEWS, SPORTS, ENTERTAINMENT, CULTURE, BUSINESS AND FINANCE, WEATHER AND TRAVEL; STATIONERY, DRAWING RULERS, ERASERS, STAPLERS, STAPLES, PAPER CLIPS, BOOK MARKERS, CUTOUT SAMPLES AND STENCILS; SCRATCH PICTURES, PAPER, NAMELY, BOND PAPER AND ART PAPER, PVC STICKERS, GIFT WRAP PAPER; BLACKBOARDS, CHALK STICKS, ADHESIVES FOR STATIONERY OR HOUSEHOLD PURPOSES; DRAWING AND PAINTING MATERIALS, NAMELY, PENCILS, DRAWING PENCILS, PENS, DRAWING PENS, PAINT TRAYS, PAINTING SETS FOR ARTISTS, PAINTING SETS FOR CHILDREN, CRAFT PAINT KITS, AND PENCIL CASES; NON-MAGNETICALLY ENCODED, PREPAID TELEPHONE CALLING CARDS (U.S. CLS. 2, 5, 22, 23, 29, 37, 38 AND 50).

CLASS 35—ADVERTISING AND BUSINESS

FOR ADVERTISING SERVICES, NAMELY, PREPARING AND PLACING ADVERTISEMENTS FOR OTHERS PROMOTING THE GOODS AND SERVICES OF OTHERS THROUGH PRINTED ADVERTISING, PRINTED DIRECTORIES, THROUGH ENCODED MEDIA, THROUGH THE DISSEMINATION OF PROMOTIONAL MATERIALS, THROUGH DIRECT MAIL ADVERTISING, THROUGH ELECTRONIC BILLBOARD ADVERTISING, PREPARING AUDIO-VISUAL PRESENTATIONS FOR USE IN ADVERTISING; BUSINESS SERVICES, NAMELY, BUSINESS APPRAISALS, BUSINESS AUDITING, PROVIDING BUSINESS INFORMATION, NAMELY, PREPARING BUSINESS REPORTS AND CONDUCTING BUSINESS RESEARCH, ANALYSIS AND SURVEYS, BUSINESS MANAGEMENT PLANNING, BUSINESS MANAGEMENT CONSULTATION, BUSINESS MANAGEMENT SUPERVISION, CONDUCTING BUSINESS NETWORKING FOR OTHERS; BUSINESS MANAGEMENT AND CONSULTING SERVICES EXCLUDING AGRICULTURAL BUSINESS MANAGEMENT AND CONSULTING SERVICES; BUSINESS INFORMATION SERVICES IN THE FIELD OF TELECOMMUNICATIONS, ADVERTISING, INFORMATION TECHNOLOGY, AND MARKETING; RENTAL OF AUTOMATIC VENDING MACHINES; ORGANIZING AND CONDUCTING JOB FAIRS; RENTAL OF DATA PROCESSING EQUIPMENT (U.S. CLS. 100, 101 AND 102).

CLASS 36—INSURANCE AND FINANCIAL

FOR FINANCIAL SERVICES, NAMELY, CLEARING OF SECURE FINANCIAL TRANSACTIONS THROUGH ONLINE SERVICES; FINANCIAL ANALYSIS AND CONSULTATION, PROVIDING FINANCIAL INFORMATION, ISSUANCE OF SECURITIES, COMMERCIAL LENDING SERVICES, FINANCIAL PORTFOLIO MANAGEMENT, DISCOUNT BROKERAGE SERVICES, STOCK BROKERAGE, SECURITY BROKERAGE, BUSINESS BROKERAGE, BUSINESS VENTURE SERVICES IN THE NATURE OF VENTURE CAPITAL FUNDING SERVICES TO EMERGING AND START-UP COMPANIES, SECURITIES CONSULTING AND SAFE KEEPING, BROKERAGE OF PRODUCTIVE INVESTMENTS AND FUNDS; FINANCIAL SPONSORSHIP OF SPORTS, EDUCATIONAL

AND ENTERTAINMENT PROGRAMS AND EVENTS; REAL ESTATE SERVICES, NAMELY BROKERAGE, MANAGEMENT, LEASING, APPRAISAL OF REAL PROPERTY; CUSTOMS BROKERAGE FOR THIRD PARTIES; TELEPHONE CALLING CARD SERVICES; ELECTRONIC COMMERCE SERVICES, NAMELY, ELECTRONIC DEBIT AND CREDIT CARD PROCESSING SERVICES, FUNDS TRANSFER AND PAYMENT PROCESSING SERVICES; PROVIDING INFORMATION VIA THE TELEPHONE AND THE GLOBAL COMMUNICATIONS INFORMATION NETWORK IN THE FIELD OF FINANCE (U.S. CLS. 100, 101 AND 102).

CLASS 38—COMMUNICATION

FOR CONSULTING SERVICES IN THE FIELD OF TELECOMMUNICATION, TELECOMMUNICATIONS AND INFORMATION TECHNOLOGY SERVICES, NAMELY, ELECTRIC, DIGITAL, CELLULAR AND WIRELESS TRANSMISSION OF VOICE, DATA, INFORMATION, IMAGES, SIGNALS AND MESSAGES AND TRANSMISSION OF VOICE, DATA, IMAGES, AUDIO, VIDEO AND INFORMATION VIA TELEPHONE, TELEVISION AND GLOBAL COMMUNICATIONS INFORMATION NETWORKS; PROVIDING TELECOMMUNICATIONS CONNECTIONS OVER A GLOBAL COMMUNICATIONS INFORMATION NETWORK, ELECTRONIC MAIL, VOICE MAIL AND MESSAGING SERVICES, NAMELY, THE RECORDING AND STORAGE AND SUBSEQUENT TRANSMISSION OF VOICE MESSAGES BY TELEPHONE; RENTAL OF TELECOMMUNICATIONS EQUIPMENT, NAMELY, EQUIPMENT FOR ELECTRONIC ACCESS TO GLOBAL TELECOMMUNICATIONS NETWORK, EQUIPMENT FOR TRANSMITTING, RECEIVING, RECORDING AND MONITORING VOICE, DATA, INFORMATION, IMAGES, SIGNALS, MESSAGES, COMPRISED OF DATA AND WORD PROCESSORS, AND TELECOMMUNICATIONS HARDWARE AND SOFTWARE AND COMPONENTS AND PERIPHERALS THEREOF FOR USE IN THE TELECOMMUNICATIONS INDUSTRY, AND RENTAL OF EQUIPMENT FOR TRANSMITTING, RECEIVING, RECORDING AND MONITORING COMPUTER PROGRAMS FOR USE IN OPERATING AND ACCESSING TELECOMMUNICATIONS SYSTEMS; AUDIO AND VIDEO BROADCASTING FEATURING ENTERTAINMENT IN THE NATURE OF LIVE VISUAL AND AUDIO PERFORMANCES, AND MUSICAL, VARIETY, NEWS AND COMEDY SHOWS; PROVIDING MULTIPLE-USER DIAL-UP AND DEDICATED ACCESS TO THE INTERNET; PERSONAL COMMUNICATIONS SERVICES; PAGER SERVICES; ELECTRONIC MAIL SERVICES; TRANSMISSION AND BROADCAST OF AUDIO AND VIDEO PROGRAMMING; PROVIDING MULTIPLE-USER ACCESS TO A GLOBAL COMMUNICATION INFORMATION NETWORK; LEASING TELECOMMUNICATIONS EQUIPMENT, COMPONENTS, SYSTEMS AND SUPPLIES (U.S. CLS. 100, 101 AND 104).

CLASS 42—SCIENTIFIC, COMPUTER AND LEGAL SERVICES

FOR COMPUTER PROGRAMMING SERVICES FOR OTHERS; RENTAL OF SOFTWARE FOR ONLINE ACCESS; RENTAL OF HARDWARE, NAMELY, COMPUTERS AND COMPONENTS, FOR ONLINE ACCESS; WEB PAGE HOSTING SERVICES FOR OTHERS ON AN INTERNET COMPUTER SERVER; COMPUTER SERVICES, NAMELY, CREATING INDEXES OF INFORMATION AVAILABLE ON COMPUTER NETWORKS; DESIGN SERVICES FOR OTHERS IN THE FIELD OF INFORMATION TECHNOLOGY, COMPUTER PROGRAMMING, TELECOMMUNICATIONS AND GLOBAL COMMUNICATION NETWORKS; CONSULTING SERVICES IN THE FIELD OF INFORMATION TECHNOLOGY AND COMPUTER PROGRAMMING; INSTALLATION, MAINTENANCE AND REPAIR OF COMPUTER SOFTWARE (U.S. CLS. 100 AND 101).

LOURDES AYALA, EXAMINING ATTORNEY

SN 78-220,144. MULTIPLICAS CASA DE BOLSA, C.A., CARACAS, VENEZUELA, FILED 2-28-2003.

SN 78-231,111. TILLATE GMBH, ADLISWIL, SWITZERLAND, FILED 3-28-2003.



OWNER OF VENEZUELA REG. NO. 096556, DATED 2-27-2002, EXPIRES 2-27-2012.

NO CLAIM IS MADE TO THE EXCLUSIVE RIGHT TO USE "CASA DE BOLSA", APART FROM THE MARK AS SHOWN.

THE FOREIGN WORDING IN THE MARK TRANSLATES INTO ENGLISH AS MULTIPLY STOCK BROKERAGE HOUSE.

CLASS 35—ADVERTISING AND BUSINESS

FOR BUSINESS CONSULTING (U.S. CLS. 100, 101 AND 102).

CLASS 36—INSURANCE AND FINANCIAL

FOR INVESTMENT BROKERAGE AND INVESTMENT ADVISORY SERVICES, FINANCIAL ADVISORY AND INVESTMENT BROKERAGE SERVICES, FINANCIAL AND REAL ESTATE INVESTMENT CONSULTING SERVICES (U.S. CLS. 100, 101 AND 102).

ESTHER A. BORSUK, EXAMINING ATTORNEY

SN 78-224,092. ALL SEASONS MUSHROOM FARMS INC., LANGLEY, BRITISH COLUMBIA, CANADA, FILED 3-11-2003.



PRIORITY CLAIMED UNDER SEC. 44(D) ON CANADA APPLICATION NO. 1153642, FILED 9-23-2002, REG. NO. TMA631054, DATED 1-25-2005, EXPIRES 1-25-2020.

NO CLAIM IS MADE TO THE EXCLUSIVE RIGHT TO USE "MUSHROOMS", APART FROM THE MARK AS SHOWN.

CLASS 31—NATURAL AGRICULTURAL PRODUCTS

FOR FRESH MUSHROOMS (U.S. CLS. 1 AND 46). FIRST USE 3-0-2001; IN COMMERCE 11-0-2001.

CLASS 35—ADVERTISING AND BUSINESS

FOR WHOLESALE AND RETAIL STORE SERVICES FOR GENERAL COMMERCE AND THE FOOD INDUSTRY FEATURING MUSHROOMS (U.S. CLS. 100, 101 AND 102).

FIRST USE 3-0-2001; IN COMMERCE 11-0-2001. ROBIN CHOSID, EXAMINING ATTORNEY



OWNER OF SWITZERLAND REG. NO. 493133, DATED 1-22-2002, EXPIRES 1-22-2012.

CLASS 35—ADVERTISING AND BUSINESS

FOR ADVERTISING SERVICES PROVIDED VIA COMPUTER AND TELECOMMUNICATION NETWORKS, SUCH AS THE INTERNET, NAMELY DISSEMINATION OF ADVERTISING FOR OTHERS, DIRECT MARKETING ADVERTISING BY E-MAIL, AND PROMOTING THE GOODS AND SERVICES OF OTHERS BY DISTRIBUTING PROMOTIONAL MATERIAL IN THE FIELD OF CONCERTS, MUSICALS, THEATRICAL SHOWS, AND ENTERTAINMENT EVENTS, BARS, RESTAURANTS, AND HOTELS; BUSINESS MANAGEMENT AND SECRETARIAL SERVICES IN THE FIELD OF SPECIAL EVENTS RELATED TO GASTRONOMY AND CONCERTS, MUSICALS, THEATRICAL SHOWS, ENTERTAINMENT EVENTS, BARS, RESTAURANTS, AND HOTELS (U.S. CLS. 100, 101 AND 102).

CLASS 38—COMMUNICATION

FOR MAKING CHAT ROOMS AVAILABLE TO OTHERS FOR THE TRANSMISSION OF MESSAGES BETWEEN COMPUTERS IN THE FIELD OF SPECIAL EVENTS PLANNING, AND GASTRONOMY (U.S. CLS. 100, 101 AND 104).

CLASS 39—TRANSPORTATION AND STORAGE

FOR LEASING AND MAINTAINING STORAGE FOR WEB HOSTING CONCERNING CONTENTS FOR EVENTS AND GASTRONOMY, NAMELY STORAGE SERVICES FOR ARCHIVING DATABASES, IMAGES AND OTHER ELECTRONIC DATA (U.S. CLS. 100 AND 105).

CLASS 41—EDUCATION AND ENTERTAINMENT

FOR TRAINING IN THE USE OF COMPUTER TELECOMMUNICATION NETWORKS AND THE INTERNET; EDUCATION SERVICES, NAMELY CONDUCTING SEMINARS, CONFERENCES, WORKSHOPS IN THE FIELD OF SPECIAL EVENTS PLANNING AND GASTRONOMY; ORGANIZING COMMUNITY CULTURAL EVENTS; PRODUCTION OF VIDEO AND AUDIO CASSETTES FOR SPECIAL EVENTS; PROVIDING A WEBSITE FEATURING INFORMATION ON EVENT PLANNING IN THE FIELD OF GASTRONOMY (U.S. CLS. 100, 101 AND 107).

CLASS 42—SCIENTIFIC, COMPUTER AND LEGAL SERVICES

FOR DEVELOPMENT AND MAINTENANCE OF THIRD PARTY WEBSITES; CONSULTING IN THE FIELD OF ONLINE REGISTRATIONS OF DOMAIN-NAMES FOR EVENTS AND GASTRONOMY; HOSTING OF DIGITAL CONTENT ON THE INTERNET IN THE FIELD OF SPECIAL EVENTS PLANNING AND GASTRONOMY (U.S. CLS. 100 AND 101).

CLASS 43—HOTEL AND RESTAURANT SERVICES

FOR PROVIDING INFORMATION, NAMELY DISSEMINATING INFORMATION IN THE FIELD OF BARS, RESTAURANTS, AND HOTELS (U.S. CLS. 100 AND 101).
AMY ALFIERI, EXAMINING ATTORNEY

SN 78-231,569. BUSINESS WIRE, SAN FRANCISCO, CA. FILED 3-28-2003.



OWNER OF U.S. REG. NOS. 1,131,770 AND 1,440,566.
THE LINING IS A FEATURE OF THE MARK AND DOES NOT INDICATE COLOR.
SEC. 2(F) AS TO "BUSINESS WIRE".

CLASS 9—ELECTRICAL AND SCIENTIFIC APPARATUS

FOR DOWNLOADABLE NEWSLETTERS, PRESS RELEASES, AND NEWS RELEASES FEATURING A WIDE VARIETY OF TOPICS OF GENERAL INTEREST (U.S. CLS. 21, 23, 26, 36 AND 38).
FIRST USE 3-1-2000; IN COMMERCE 3-1-2000.

CLASS 16—PAPER GOODS AND PRINTED MATTER

FOR PRINTED MATTER IN THE FORM OF NEWSLETTERS, PRESS RELEASES AND NEWS RELEASES (U.S. CLS. 2, 5, 22, 23, 29, 37, 38 AND 50).
FIRST USE 3-1-2000; IN COMMERCE 3-1-2000.

CLASS 38—COMMUNICATION

FOR ELECTRONIC TRANSMISSION OF MESSAGES AND IMAGES, DATA AND DOCUMENTS, VIA COMPUTER TERMINALS, THE INTERNET, SATELLITE AND WIRELESS TRANSMISSION; ELECTRONIC MAIL; FACSIMILE TRANSMISSIONS (U.S. CLS. 100, 101 AND 104).
FIRST USE 3-1-2000; IN COMMERCE 3-1-2000.

CLASS 41—EDUCATION AND ENTERTAINMENT

FOR PUBLICATION OF NEWSLETTERS, NEW RELEASES AND PRESS RELEASES; NEWS AND PRESS RELEASE WIRE SERVICES (U.S. CLS. 100, 101 AND 107).
FIRST USE 3-1-2000; IN COMMERCE 3-1-2000.
ANNE MADDEN, EXAMINING ATTORNEY

SN 78-231,935. OMGEO LLC, NEW YORK, NY. FILED 3-31-2003.

SHAPING STP

NO CLAIM IS MADE TO THE EXCLUSIVE RIGHT TO USE "STP", APART FROM THE MARK AS SHOWN.

CLASS 9—ELECTRICAL AND SCIENTIFIC APPARATUS

FOR COMPUTER SOFTWARE FOR FINANCIAL TRANSACTIONS IN THE FIELDS OF SECURITIES TRADE PROCESSING AND TRADE MANAGEMENT (U.S. CLS. 21, 23, 26, 36 AND 38).

CLASS 36—INSURANCE AND FINANCIAL

FOR PROVIDING FINANCIAL INFORMATION RELATING TO THE FINANCING OF STOCKS, BONDS AND OTHER FINANCIAL INSTRUMENTS, FINANCIAL INVESTMENT RESEARCH, FINANCIAL REPORTING AND PROVIDING FINANCIAL CONSULTING AND ADVISORY SERVICES; COMPUTERIZED TRADE MANAGEMENT SERVICES, NAMELY, THE PROCESSING AND ROUTING OF INFORMATION ON THE TRADING OF SECURITIES AND RELATED INFORMATION (U.S. CLS. 100, 101 AND 102).
DAVID C. REIHNER, EXAMINING ATTORNEY

SN 78-233,011. TERRY STORE-AGE S.P.A., MILANO, ITALY, FILED 4-2-2003.



OWNER OF U.S. REG. NO. 2,060,602.

CLASS 20—FURNITURE AND ARTICLES NOT OTHERWISE CLASSIFIED

FOR CONTAINERS MADE OF PLASTIC MATERIAL, NAMELY, STORAGE UNITS, TOOL BOXES; TOOL CASES, ORGANIZER BOXES; FITTED MULTIPLE CHEST OF DRAWERS; FURNITURE MADE FROM PLASTIC MATERIAL, NAMELY, SHELVING UNITS, CABINETS WITH DRAWERS, CABINETS WITH DOORS, TOOL RACKS; FITTED FURNITURE MADE FROM PLASTIC MATERIAL (U.S. CLS. 2, 13, 22, 25, 32 AND 50).
FIRST USE 4-1-2003; IN COMMERCE 4-1-2003.

CLASS 21—HOUSEWARES AND GLASS

FOR CONTAINERS FOR HOUSEHOLD OR KITCHEN USE NOT OF PRECIOUS METAL, NAMELY, ALL PURPOSE PORTABLE HOUSEHOLD CONTAINERS; HOUSEHOLD AND KITCHEN UTENSILS, NAMELY, BASTING SPOONS, BOTTLE OPENERS, SCRUBBING BRUSHES, BRUSHES FOR BASTING MEAT, CAKE SERVERS, COOKIE CUTTERS, CORK SCREWS, CORN COB HOLDERS, FUNNELS, GARLIC PRESSES, GRATERS, ROLLING PINS, SPATULAS, TURNERS, WHISKS, KITCHEN LADLES, MIXING SPOONS, SERVING SPOONS, STRAINERS, SCOOPS, POT AND PAN SCRAPERS (U.S. CLS. 2, 13, 23, 29, 30, 33, 40 AND 50).
FIRST USE 4-1-2003; IN COMMERCE 4-1-2003.
PAULA MAHONEY, EXAMINING ATTORNEY

SN 78-239,643. SPYDER ACTIVE SPORTS, INC., BOULDER, CO. FILED 4-18-2003.

LEGION

OWNER OF U.S. REG. NO. 2,815,283.

CLASS 18—LEATHER GOODS

FOR HIP PACKS, BACKPACKS, TRAVEL BAGS, AND WALLETS (U.S. CLS. 1, 2, 3, 22 AND 41).

CLASS 25—CLOTHING

FOR T-SHIRTS, SWEAT SHIRTS, BUTTON SHIRTS, SWEATERS, FLEECE JACKETS, OUTERWEAR JACKETS, COTTON JACKETS, DENIM PANTS, COTTON PANTS, OUTERWEAR IN THE NATURE OF PANTS, SKIRTS, MEN'S AND WOMEN'S SWIMWEAR, SOCKS, SHOES, FOOTWEAR, GLOVES, MITTENS, NECK GAITERS, ONE-PIECE OUTERWEAR SKI SUITS, TIGHTS, UNDERWEAR, LONG UNDERWEAR, CAPS, HATS AND BELTS (U.S. CLS. 22 AND 39).

ZHALEH DELANEY, EXAMINING ATTORNEY

SN 78-242,944. MARKETWATCH.COM, INC., SAN FRANCISCO, CA. FILED 4-28-2003.

WORLD BUSINESS NEWS ALLIANCE

NO CLAIM IS MADE TO THE EXCLUSIVE RIGHT TO USE "WORLD BUSINESS NEWS", APART FROM THE MARK AS SHOWN.

CLASS 35—ADVERTISING AND BUSINESS

FOR PROVIDING INFORMATION IN THE FIELDS OF BUSINESS AND COMMERCE OVER THE INTERNET, GLOBAL COMPUTER NETWORKS AND GLOBAL COMMUNICATION NETWORKS; PROVIDING AN ON-LINE DATABASE IN THE FIELD OF BUSINESS AND COMMERCE. (U.S. CLS. 100, 101 AND 102).

CLASS 36—INSURANCE AND FINANCIAL

FOR PROVIDING INFORMATION IN THE FIELD OF INVESTMENT AND FINANCE VIA THE INTERNET, COMPUTER NETWORKS AND GLOBAL COMMUNICATION NETWORKS; PROVIDING AN ON-LINE COMPUTER DATABASE IN THE FIELD OF INVESTMENT AND FINANCE. (U.S. CLS. 100, 101 AND 102).

CLASS 41—EDUCATION AND ENTERTAINMENT

FOR NEWS AGENCY AND NEWS REPORTING SERVICES, NAMELY, GATHERING, REPORTING AND DISSEMINATING NEWS; PROVIDING INFORMATION IN THE FIELDS OF GENERAL NEWS AND GENERAL INTEREST OVER THE INTERNET, GLOBAL COMPUTER NETWORKS AND GLOBAL COMMUNICATION NETWORKS (U.S. CLS. 100, 101 AND 107).

GINA HAYES, EXAMINING ATTORNEY

SN 78-241,845. FOODSAFE SYSTEMS, INC., SOUTH SAN FRANCISCO, CA. FILED 4-24-2003.



NO CLAIM IS MADE TO THE EXCLUSIVE RIGHT TO USE "SYSTEMS, INC"., APART FROM THE MARK AS SHOWN.

CLASS 41—EDUCATION AND ENTERTAINMENT

FOR EDUCATIONAL SERVICES IN THE FIELD OF FOOD SAFETY AND SANITATION, AND COMPLIANCE WITH FOOD SAFETY LAWS AND REGULATIONS, NAMELY, CONDUCTING TRAINING IN THE FIELD OF FOOD SAFETY AND SANITATION (U.S. CLS. 100, 101 AND 107).

FIRST USE 9-1-1999; IN COMMERCE 9-1-1999.

CLASS 42—SCIENTIFIC, COMPUTER AND LEGAL SERVICES

FOR CONSULTATION IN THE FIELD OF FOOD SAFETY AND SANITATION, AND COMPLIANCE WITH FOOD SAFETY LAWS AND REGULATIONS; DEVELOPMENT OF FOOD SAFETY, QUALITY ASSURANCE AND QUALITY CONTROL PROGRAMS FOR OTHERS; QUALITY CONTROL FOR OTHERS; PROVIDING QUALITY ASSURANCES IN THE FIELD OF FOOD SAFETY, NAMELY, TECHNICAL SUPERVISION AND INSPECTION (U.S. CLS. 100 AND 101).

FIRST USE 9-1-1999; IN COMMERCE 9-1-1999.
BRIAN PINO, EXAMINING ATTORNEY

SN 78-244,580. SYSTINET CORPORATION, CAMBRIDGE, MA. FILED 5-1-2003.

SYSTINET**CLASS 9—ELECTRICAL AND SCIENTIFIC APPARATUS**

FOR COMPUTER SOFTWARE FOR BUILDING, DEPLOYING, SECURING AND MANAGING THE COMMUNICATIONS AND INTERACTIONS BETWEEN TWO OR MORE COMPUTERS, COMPUTER SERVERS, AND/OR OTHER COMPUTING DEVICES THAT CONNECT TO A NETWORK (U.S. CLS. 21, 23, 26, 36 AND 38).

FIRST USE 11-0-2001; IN COMMERCE 11-0-2001.

CLASS 42—SCIENTIFIC, COMPUTER AND LEGAL SERVICES

FOR COMPUTER SERVICES, NAMELY DEPLOYING, MANAGING, PROGRAMMING, AND DESIGNING THE COMMUNICATIONS AND INTERACTIONS BETWEEN TWO OR MORE COMPUTERS, COMPUTER SERVERS, AND/OR OTHER COMPUTING DEVICES THAT CONNECT TO A NETWORK (U.S. CLS. 100 AND 101).

FIRST USE 11-0-2001; IN COMMERCE 11-0-2001.
ANDREW BENZMILLER, EXAMINING ATTORNEY

SN 78-248,944. LETTUCE ENTERTAIN YOU ENTERPRISES, INC., CHICAGO, IL. FILED 5-13-2003.

WOW BAO HOT ASIAN BUNS

NO CLAIM IS MADE TO THE EXCLUSIVE RIGHT TO USE "BAO HOT ASIAN BUNS", APART FROM THE MARK AS SHOWN.
THE ENGLISH TRANSLATION OF THE WORD "BAO" IN THE MARK IS "BUNS".

CLASS 30—STAPLE FOODS

FOR BUNS (U.S. CL. 46).

CLASS 43—HOTEL AND RESTAURANT SERVICES

FOR RESTAURANT SERVICES (U.S. CLS. 100 AND 101).
SUSAN LESLIE DUBOIS, EXAMINING ATTORNEY

CLASS 43—HOTEL AND RESTAURANT SERVICES

FOR (BASED ON INTENT TO USE)— INFORMATION SERVICES, NAMELY THE PROVISION OF INFORMATION, VIA AN ON-LINE COMMUNICATION NETWORK, RELATING TO FOOD, COOKING, AND MENU PLANNING (U.S. CLS. 100 AND 101).

SUE LAWRENCE, EXAMINING ATTORNEY

SN 78-251,114. SOLIOS ENVIRONNEMENT, SAINT-GERMAIN-EN-LAYE, FRANCE, FILED 5-16-2003.

SOLIOS

PRIORITY CLAIMED UNDER SEC. 44(D) ON FRANCE APPLICATION NO. 023195014, FILED 11-20-2002, REG. NO. 023195014, DATED 11-20-2002, EXPIRES 11-20-2012.

SN 78-248,991. SYM, WILLIAM MICHAEL, BUDERIM, QUEENSLAND, AUSTRALIA, AND SYM, ANNETTE EVE, BUDERIM, QUEENSLAND, AUSTRALIA, FILED 5-13-2003.

SYMPLY TOO GOOD TO BE TRUE

PRIORITY CLAIMED UNDER SEC. 44(D) ON AUSTRALIA APPLICATION NO. 941837, FILED 1-30-2003, REG. NO. 941837, DATED 1-30-2003, EXPIRES 1-30-2013.

OWNER OF AUSTRALIA REG. NO. 743312, DATED 9-8-1997, EXPIRES 9-8-2007.

CLASS 9—ELECTRICAL AND SCIENTIFIC APPARATUS

FOR (BASED ON INTENT TO USE)— DEVICES FOR RECORDING, TRANSMISSION, AND REPRODUCTION OF SOUND AND/OR IMAGES, NAMELY AUDIOVISUAL DEVICES IN THE NATURE OF PRE-RECORDED CINEMATOGRAPHIC FILM, AUDIO TAPES, AND PHONOGRAPH RECORDS, ALL FEATURING INFORMATION ON FOOD, COOKING, MENU PLANNERS; WEIGHT-LOSS PROGRAMS, AND MOTIVATIONAL SPEAKING; (BASED ON 44(D) PRIORITY APPLICATION/44(E))— CD'S, DVD'S, AND PRE-RECORDED VIDEO TAPES, ALL FEATURING INFORMATION ON FOOD, COOKING, MENU PLANNERS, WEIGHT-LOSS PROGRAMS, AND MOTIVATIONAL SPEAKING; COMPUTER PROGRAMS USED TO CREATE WEIGHT-LOSS PROGRAMS AND MENU PLANNERS IN THE FIELD OF HEALTH AND GENERAL WELLBEING (U.S. CLS. 21, 23, 26, 36 AND 38).

CLASS 16—PAPER GOODS AND PRINTED MATTER

FOR (BASED ON INTENT TO USE)— PRINTED MATTER, NAMELY DECALS, PAPER LABELS, NOTEBOOKS, STATIONERY, BOOKLETS, BOOKS, LEAFLETS, AND MAGAZINES, ALL FEATURING INFORMATION ON FOOD, COOKING, MENU PLANNERS, WEIGHT-LOSS PROGRAMS, AND MOTIVATIONAL SPEAKING; POSTERS; (BASED ON 44(E))— LOW-FAT COOKBOOKS (U.S. CLS. 2, 5, 22, 23, 29, 37, 38 AND 50).

CLASS 7—MACHINERY

FOR MACHINES FOR INDUSTRY, BUILDINGS AND PUBLIC WORKS, NAMELY, BREAKERS, CRUSHERS, VIBRATING SCREENS, CLASSIFIERS FOR SEPARATING METALS, BALL MILLS, MIXING MACHINES, NAMELY, PREHEATED SCREWS; APPARATUS FOR TRANSPORT OF MATERIALS, NAMELY, LIFTING CONVEYORS BELTS, SCREW CONVEYORS, AEROSLIDES, PNEUMATIC CONVEYORS, SOLID DIVERSIFIERS OF GAS FLOW; MACHINES AND EQUIPMENT USED FOR THE TREATMENT OF AIR AND GASES, OF DUST, DRY OR SEMI-DRY, AND THE RECOVERY OF HEAT, NAMELY, STATIC AND MECHANICAL DUST EXTRACTORS, GAS-SCRUBBING APPARATUS, FABRIC PRECIPITATOR COLLECTORS, LOW-PRESSURE JET BAG FILTERS, FABRIC GAS FILTERS; MACHINES FOR METALLURGY AND THE PRODUCTION OF STEEL, ALUMINUM, CEMENT; MACHINES FOR PREPARATION OF SCRAPS AND SLAGS FOR THEIR RECYCLING; METAL CASTING MACHINES; VIBRO-COMPACTOR FOR THE MANUFACTURE OF ANODES, PUSHER/SQUEEZER OF ANODES (U.S. CLS. 13, 19, 21, 23, 31, 34 AND 35).

CLASS 11—ENVIRONMENTAL CONTROL APPARATUS

FOR EQUIPMENT FOR PREPARATION, PREHEATING, MIXING, COMPACTING, AND COOLING OF MATERIALS NECESSARY FOR ALUMINUM AND ANODE PRODUCTION, NAMELY, MELTING AND HOLDING FURNACES, COIL AND FOIL ANNEALING FURNACES, SLAB REHEATING FURNACES, ALUMINUM PROBES FOR USE IN FURNACES, INDUSTRIAL OVENS, INDUSTRIAL KILNS FOR DECOATING AND DECONTAMINATING METALS, INDUSTRIAL WASTE INCINERATORS, EVAPORATIVE COOLING TOWERS, METAL QUENCHING TANKS; INDUSTRIAL POLLUTION CONTROL SYSTEMS FOR PITCH FUME TREATMENT FOR AIR AND GASES PRODUCED BY ALUMINUM AND CEMENT PRODUCTION AND WASTE INCINERATION CONSISTING OF DRY SCRUBBERS, FILTERS, PRECIPITATORS, EVAPORATING TOWERS, HEAT EXCHANGERS, AND VENTURI SCRUBBERS AND REACTORS; PARTS AND FITTINGS FOR ALL THE AFORESAID GOODS (U.S. CLS. 13, 21, 23, 31 AND 34).

CLASS 37—CONSTRUCTION AND REPAIR

FOR CONSTRUCTION OF FACTORIES AND INSTALLATIONS USING THE MECHANICAL TECHNIQUES, THERMICS, AERODYNAMICS; CONSTRUCTION FACTORIES FOR PRODUCTION OF ANODES FOR THE METALLURGY OF ALUMINUM BY FRAGMENTATION, SORTING, PROPORTIONING, MIXTURES, PRESSING, VIBRATION, COOKING; CONSTRUCTION OF TREATMENT PLANT FOR THE WASTE, TRANSPORT, SORTING, MIXING AND RECYCLING OF THE METALLURGY, ALUMINUM AND METALS; INSTALLATION OF FURNACES OF OVER-COATING, DECONTAMINATION, SMELTERS AND TREATMENT OF SCRAPS AND SLAGS; INSTALLATION OF THE EQUIPMENT WORKING IN OR WITH THIS THERMAL EQUIPMENT; CONSTRUCTION CONSULTATION, CONSULTATION IN BUILDING CONSTRUCTION SUPERVISION; BUILDING RESTORATION, NAMELY, RESTORATION OF FACTORIES AND INSTALLATIONS BY REPAIR OR REPLACEMENT OF THE EQUIPMENT DAMAGED, USED OR DESTROYED TO ALLOW THE MAINTENANCE OF THE INDUSTRIAL PERFORMANCES (U.S. CLS. 100, 103 AND 106).

CLASS 42—SCIENTIFIC, COMPUTER AND LEGAL SERVICES

FOR DESIGN OF APPLICATION SOFTWARE FOR MANAGING FACTORIES AND INSTALLATIONS OF OTHERS; TECHNOLOGICAL SERVICES, NAMELY, RESEARCH AND DEVELOPMENT FOR OTHERS IN THE FIELD OF CHEMISTRY, METALLURGY, PHYSICS, ELECTRICITY, ELECTRONICS, ENGINEERING, DATA PROCESSING, OPTICAL, TEXTILE, PAPER, MEDICINE, BIOLOGY, AGRICULTURE, AND GEOLOGY; INDUSTRIAL RESEARCH FOR OTHERS (U.S. CLS. 100 AND 101).

MICHELE SWAIN, EXAMINING ATTORNEY

CLASS 39—TRANSPORTATION AND STORAGE

FOR AIR TRANSPORTATION OF PASSENGERS, FREIGHT AND MAIL; TRAVEL AGENCY SERVICES, NAMELY, MAKING AIR, SEA, AND LAND TRANSPORTATION RESERVATIONS; ARRANGING TRAVEL TOURS AND CRUISES FOR OTHERS; AIR TRANSPORTATION SERVICES FEATURING A BONUS PROGRAM FOR FREQUENT AIR TRAVELERS; PROVIDING TIMETABLE INFORMATION FOR TRAVELERS VIA A GLOBAL COMPUTER NETWORK, NAMELY, PROVIDING FLIGHT ARRIVAL AND DEPARTURE INFORMATION; CARGO HANDLING SERVICES; WAREHOUSE STORAGE AND FREIGHT FORWARDING SERVICES (U.S. CLS. 100 AND 105).

FIRST USE 6-1-2000; IN COMMERCE 6-1-2000.

CLASS 41—EDUCATION AND ENTERTAINMENT

FOR TRAINING OF FLIGHT PERSONNEL EMPLOYED BY THIRD PARTIES; TRAINING OF GROUND PERSONNEL IN THE FIELD OF AIR TRANSPORTATION (U.S. CLS. 100, 101 AND 107).

FIRST USE 6-1-2000; IN COMMERCE 6-7-2001.

MARY BOAGNI, EXAMINING ATTORNEY

SN 78-263,273. GLSEN, NEW YORK, NY. FILED 6-17-2003.

DAY OF SILENCE

SN 78-261,009. FINNAIR OYJ, 01053 FINNAIR, FINLAND, FILED 6-11-2003.



PRIORITY CLAIMED UNDER SEC. 44(D) ON FINLAND APPLICATION NO. T200300403, FILED 2-13-2003, REG. NO. 228895, DATED 11-14-2003, EXPIRES 11-14-2013.

OWNER OF U.S. REG. NOS. 1,624,090 AND 2,150,686.

THE STIPPLING IN THE DRAWING IS FOR SHADING PURPOSES ONLY.

THE MARK CONSISTS OF IN PART A STYLIZED LETTER F WHICH FORMS PART OF AN AIRPLANE.

CLASS 35—ADVERTISING AND BUSINESS

FOR PROVIDING ON-LINE PRICE QUOTATIONS FOR GOODS AND SERVICES TO TRAVELERS (U.S. CLS. 100, 101 AND 102).

FIRST USE 6-1-2000; IN COMMERCE 6-1-2000.

CLASS 37—CONSTRUCTION AND REPAIR

FOR AIRCRAFT AND FLIGHT SIMULATOR REPAIR, RENOVATION, MODERNIZATION AND MAINTENANCE SERVICES (U.S. CLS. 100, 103 AND 106).

FIRST USE 6-1-2000; IN COMMERCE 9-30-2000.

CLASS 35—ADVERTISING AND BUSINESS

FOR PROMOTING PUBLIC AWARENESS REGARDING THE HARASSMENT OF PEOPLE ON THE BASIS OF SEXUAL ORIENTATION OR GENDER IDENTITY/EXPRESSION (U.S. CLS. 100, 101 AND 102).

FIRST USE 1-1-1996; IN COMMERCE 1-1-1996.

CLASS 41—EDUCATION AND ENTERTAINMENT

FOR CONDUCTING WORKSHOPS AND SEMINARS RELATING TO THE HARASSMENT OF PEOPLE ON THE BASIS OF SEXUAL ORIENTATION OR GENDER IDENTITY/EXPRESSION (U.S. CLS. 100, 101 AND 107).

FIRST USE 1-1-1996; IN COMMERCE 1-1-1996.

MIDGE BUTLER, EXAMINING ATTORNEY

SN 78-264,936. HAAS, GARY L., MELBOURNE, FL. FILED 6-20-2003.

SINGLES ADVOCATE

NO CLAIM IS MADE TO THE EXCLUSIVE RIGHT TO USE "SINGLES", APART FROM THE MARK AS SHOWN.

CLASS 9—ELECTRICAL AND SCIENTIFIC APPARATUS

FOR ONLINE DOWNLOADABLE NEWSLETTERS, PAMPHLETS AND MAGAZINES BY ADVERTISER SPONSORS, TO SINGLES CONCERNING UPCOMING EVENTS, NAMELY, PARTIES, SPORTING EVENTS, ENTERTAINMENT EVENTS, INCLUDING MUSIC CONCERTS, CONTESTS, FESTIVALS, LOCAL AND NON-LOCAL TRIPS, TOURS, TRAVELING AND EXCURSIONS; ONLINE DOWNLOADABLE NEWSLETTER, PAMPHLETS AND MAGAZINES ON ARTICLES DISTRIBUTED OVER THE WORLDWIDE WEB ON SINGLES' ACTIVITIES AND ARTICLES OF GENERAL INTEREST TO SINGLES; ONLINE DOWNLOADABLE NEWSLETTER, PAMPHLETS AND MAGAZINES ON LISTS DISTRIBUTED OVER THE WORLDWIDE WEB TO SINGLES CONCERNING SINGLES CLUBS, GROUPS AND ORGANIZATIONS; CONSUMER COUPONS FOR PRODUCTS AND SERVICES TO SINGLES IN SELECTED GEOGRAPHIC REGIONS, DOWNLOADABLE FROM THE WORLDWIDE WEB (U.S. CLS. 21, 23, 26, 36 AND 38).

FIRST USE 1-24-2003; IN COMMERCE 1-24-2003.

CLASS 35—ADVERTISING AND BUSINESS

FOR ON-LINE ADVERTISING SERVICES FOR SINGLES, NAMELY, PROVIDING BUSINESS INFORMATION LISTINGS AND CLASSIFIED ADS FOR PRODUCTS AND SERVICES TO SINGLES IN SELECTED GEOGRAPHIC REGIONS ON THE WORLDWIDE WEB (U.S. CLS. 100, 101 AND 102).

FIRST USE 1-24-2003; IN COMMERCE 1-24-2003.
SCOTT OSCLICK, EXAMINING ATTORNEY

SN 78-265,513, CHILDRE, DOC, BOULDER CREEK, CA.
FILED 6-21-2003.

INTUI-TECHNOLOGY

OWNER OF U.S. REG. NO. 1,716,705.

CLASS 9—ELECTRICAL AND SCIENTIFIC APPARATUS

FOR COMPUTER HARDWARE AND SOFTWARE FOR PROVIDING REAL TIME ANALYSIS AND VISUAL DISPLAY OF CHANGING HEART RHYTHMS, EMOTIONAL APTITUDE, AND NERVOUS SYSTEM BALANCE, NAMELY APPARATUS EMPLOYING SENSORS FOR MEASURING PHYSIOLOGICAL/EMOTIONAL STATE AND PROVIDING AUDIBLE AND/OR VISUAL INDICATION OF PHYSIOLOGICAL/EMOTIONAL STATE FOR THE PURPOSE OF IMPROVING PERFORMANCE, ACHIEVING EMOTIONAL BALANCE AND REDUCING STRESS; FREQUENCY TRANSMISSION DEVICES, NAMELY, CORDLESS, WIRELESS, VIDEO OR SATELLITE TELEPHONES, PDAS AND COMPUTERS; COMBINATION CELLULAR TELEPHONES AND WRIST WATCHES, COMBINATION PAGERS AND WRIST WATCHES; VIDEO GAMES, NAMELY, VIDEO GAME SOFTWARE, FOR PROVIDING REAL TIME ANALYSIS AND VISUAL DISPLAY OF CHANGING HEART RHYTHMS, EMOTIONAL APTITUDE, AND NERVOUS SYSTEM BALANCE, EMPLOYING SENSORS FOR MEASURING PHYSIOLOGICAL/EMOTIONAL STATE AND PROVIDING AUDIBLE AND/OR VISUAL INDICATION OF PHYSIOLOGICAL/EMOTIONAL STATE FOR THE PURPOSE OF IMPROVING PERFORMANCE, ACHIEVING EMOTIONAL BALANCE AND REDUCING STRESS (U.S. CLS. 21, 23, 26, 36 AND 38).

FIRST USE 5-3-1999; IN COMMERCE 5-3-1999.

CLASS 14—JEWELRY

FOR SPORTS WATCHES PROVIDING REAL TIME ANALYSIS AND VISUAL DISPLAY OF HEART RHYTHMS AND EMOTIONAL BALANCE (U.S. CLS. 2, 27, 28 AND 50).

FIRST USE 5-3-1999; IN COMMERCE 5-3-1999.

CLASS 42—SCIENTIFIC, COMPUTER AND LEGAL SERVICES

FOR TECHNOLOGY CONSULTING AND RESEARCH AND DEVELOPMENT SERVICES, NAMELY CONSULTING, RESEARCH AND DEVELOPMENT OF METHODS, DEVICES AND SYSTEMS FOR DETECTION, IMAGING, MONITORING, DIAGNOSIS, DISCOVERY, ALTERATION, THERAPY AND MODULATION RELATING TO THE THEORETICAL OR PRACTICAL ASPECTS OF COMPLEX BRANCHES OF HUMAN PERFORMANCE AND EFFORT (U.S. CLS. 100 AND 101).

FIRST USE 5-3-1999; IN COMMERCE 5-3-1999.

RICHARD WHITE, EXAMINING ATTORNEY

SN 78-265,676. RAMOS, PEDRO R., MIAMI, FL. FILED 6-23-2003.



NO CLAIM IS MADE TO THE EXCLUSIVE RIGHT TO USE "SPICES", APART FROM THE MARK AS SHOWN.

CLASS 29—MEATS AND PROCESSED FOODS

FOR ORANGE BUTTER AND PEANUT-BASED SNACK FOODS (U.S. CL. 46).

FIRST USE 1-5-1999; IN COMMERCE 1-5-1999.

CLASS 30—STAPLE FOODS

FOR CREOLE SAUCE, NAMELY, MOJO CRIOLLO, PROCESSED HERBS, AND SPICES, NAMELY, ANISE SEED, ANNATO PASTE, BAY LEAVES, CHAMOMILE, FLOWERS, CINNAMON STICKS, CORIANDER SEED, CRUSHED RED PEPPER, CURRY POWDER, DION DION, EUCALYPTUS, FLAXSEED, GROUND ANNATO SEED, GROUND BAY LEAVES, GROUND BLACK PEPPER, GROUND CINNAMON, GROUND CUMIN, GROUND NUTMEG, GROUND OREGANO, GROUND WHITE PEPPER, LINDEN FLOWERS, MARJORAM, SESAME SEED, PAPRIKA, PARSLEY, PEPPERMINT, ROSEMARY, SAGE, STAR ANISE; WHOLE ALL SPICE, WHOLE ANNATO SEED, WHOLE BLACK PEPPER, WHOLE CLOVES, WHOLE CUMIN, WHOLE MEXICAN OREGANO, WHOLE NUTMEG, AND WHOLE OREGANO; BITTER ORANGE MARINATING SAUCE, AND EDIBLE CAKE DECORATIONS (U.S. CL. 46).

FIRST USE 1-5-1999; IN COMMERCE 1-5-1999.

CLASS 32—LIGHT BEVERAGES

FOR LEMON JUICE (U.S. CLS. 45, 46 AND 48).

FIRST USE 1-5-1999; IN COMMERCE 1-5-1999.

CLASS 33—WINES AND SPIRITS

FOR COOKING WINE (U.S. CLS. 47 AND 49).
FIRST USE 1-5-1999; IN COMMERCE 1-5-1999.
DEZMONA MIZELLE, EXAMINING ATTORNEY

SN 78-269,209. BURNDEN HOLDINGS (UK) LIMITED,
BOLTON, UNITED KINGDOM, FILED 7-1-2003.

CELSIUS
PERFORMANCE GLASS

SN 78-266,233. PACE, TIMOTHY V., DAYTONA BEACH, FL.
AND PACE, CELIA S., DAYTONA BEACH, FL. FILED 6-
24-2003.

BIG SHARK**CLASS 25—CLOTHING**

FOR CLOTHING, NAMELY, T-SHIRTS, SHOES, HATS,
SANDALS, SWIMWEAR, SWEATSHIRTS, JACKETS AND
VISORS (U.S. CLS. 22 AND 39).
FIRST USE 12-27-2004; IN COMMERCE 12-27-2004.

PRIORITY CLAIMED UNDER SEC. 44(D) ON ERP
CMNTY TM OFC APPLICATION NO. 3092161, FILED 3-10-
2003, REG. NO. 3092161, DATED 8-24-2004, EXPIRES 3-10-
2013.

NO CLAIM IS MADE TO THE EXCLUSIVE RIGHT TO
USE "PERFORMANCE GLASS", APART FROM THE MARK
AS SHOWN.

THE MARK CONSISTS OF THE WORDING 'CELSIUS'
APPEARING IN STYLIZED LETTERS ABOVE A GRAPHIC
REPRESENTATION OF A LINE AND HAVING THE WORDING
'PERFORMANCE GLASS' IN STYLIZED LETTERING
APPEARING UNDER THE LINE.

CLASS 35—ADVERTISING AND BUSINESS

FOR RETAIL STORE SERVICES FEATURING CLOTH-
ING, SOUVENIRS AND JEWELRY (U.S. CLS. 100, 101
AND 102).
FIRST USE 9-0-2003; IN COMMERCE 9-0-2003.
KELLEY WELLS, EXAMINING ATTORNEY

CLASS 6—METAL GOODS

FOR METAL GLAZING UNITS AND METAL DOUBLE
GLAZING UNITS, NAMELY, METAL WINDOW UNITS
AND METAL WALL UNITS CONSISTING OF METAL
FRAMES AND GLASS SOLD AS A UNIT; PARTS AND
FITTINGS THE AFORESAID GOODS (U.S. CLS. 2, 12, 13,
14, 23, 25 AND 50).

**CLASS 19—NON-METALLIC BUILDING MA-
TERIALS**

FOR WINDOW GLASS; GLASS PANELS; GLASS
PANES; INSULATED GLASS; INSULATED GLASS;
SAFETY GLASS; NON-METALLIC GLAZING UNITS
AND NON-METALLIC DOUBLE GLAZING UNITS,
NAMELY, NON-METALLIC WINDOW UNITS AND
NON-METALLIC WALL UNITS CONSISTING OF NON-
METALLIC FRAMES AND GLASS SOLD AS A UNIT;
PARTS AND FITTINGS FOR THE AFORESAID GOODS
(U.S. CLS. 1, 12, 33 AND 50).

JOANNA DUKOVIC, EXAMINING ATTORNEY

SN 78-267,870. HILCONA AKTIENGESELLSCHAFT,
SCHAAN, LIECHTENSTEIN, FILED 6-27-2003.

HILCONA

OWNER OF LIECHTENSTEIN REG. NO. 3498, DATED 2-7-
1972, EXPIRES 1-8-2012.
OWNER OF U.S. REG. NO. 2,178,085.

CLASS 29—MEATS AND PROCESSED FOODS

FOR MEAT, FISH, POULTRY AND GAME; MEAT
EXTRACTS; PRESERVED, DRIED AND COOKED
FRUITS AND VEGETABLES; JELLIES, JAMS; EGGS,
MILK, CHOCOLATE MILK, BUTTER, CHEESE, EGG-
NOG, MARGARINE, DAIRY BASED WHIPPED TOP-
PINGS, CREAM, WHIPPING CREAM, YOGURT;
EDIBLE OILS AND FATS; AND FRUITS PRESERVES
(U.S. CL. 46).

SN 78-269,468. PRINCESS CRUISE LINES, LTD., SANTA
CLARITA, CA. FILED 7-1-2003.

**PRINCESS
SCHOLARSHIP@SEA
PROGRAM**

OWNER OF U.S. REG. NOS. 895,711, 1,361,054 AND
OTHERS.

NO CLAIM IS MADE TO THE EXCLUSIVE RIGHT TO
USE "SCHOLARSHIP AT SEA PROGRAM", APART FROM
THE MARK AS SHOWN.

CLASS 30—STAPLE FOODS

FOR COFFEE, TEA, COCOA, SUGAR, RICE, TAPIO-
CA, SAGO, FLOUR, PROCESSED CEREAL GRAINS
AND BREAKFAST CEREALS, BREAD, PASTRY, FRO-
ZEN CONFECTIONS AND CANDY, FLAVORED ICES;
HONEY, TREACLE; YEAST, BAKING POWDER; SALT,
MUSTARD; VINEGAR, SAUCES EXCLUDING FRUIT
SAUCES; SPICES; ICE, ICE CREAM, ICE MILK, FROZEN
YOGURT AND FROZEN CUSTARD, MAYONNAISE
AND SALAD DRESSING (U.S. CL. 46).
LAURA KOVAISKY, EXAMINING ATTORNEY

**CLASS 39—TRANSPORTATION AND STO-
RAGE**

FOR CRUISE SHIP SERVICES (U.S. CLS. 100 AND 105).
FIRST USE 1-3-2003; IN COMMERCE 1-3-2003.

CLASS 41—EDUCATION AND ENTERTAINMENT

FOR EDUCATION AND ENTERTAINMENT SERVICES, NAMELY, CONDUCTING CLASSES, ENRICHMENT COURSES AND DEMONSTRATIONS ON BOARD CRUISE SHIPS, IN THE FIELDS OF PHOTOGRAPHY, COMPUTER TECHNOLOGY, CULINARY ARTS, VISUAL ARTS AND CREATIVE ARTS (U.S. CLS. 100, 101 AND 107).

FIRST USE 1-3-2003; IN COMMERCE 1-3-2003.
BARBARA GAYNOR, EXAMINING ATTORNEY

SN 78-269,843. QINETIQ LIMITED, LONDON, UNITED KINGDOM, FILED 7-2-2003.

STRATEC

PRIORITY CLAIMED UNDER SEC. 44(D) ON ERPNTY TM OFC APPLICATION NO. 003024817, FILED 1-28-2003, REG. NO. 003024817, DATED 10-20-2004, EXPIRES 1-28-2013.

CLASS 9—ELECTRICAL AND SCIENTIFIC APPARATUS

FOR PROTECTIVE HELMETS (U.S. CLS. 21, 23, 26, 36 AND 38).

CLASS 17—RUBBER GOODS

FOR POLYMERS, FOAMED POLYMERS, AND REINFORCED POLYMERS, FOR USE IN MANUFACTURING (U.S. CLS. 1, 5, 12, 13, 35 AND 50).

CLASS 40—MATERIAL TREATMENT

FOR MOULDING POLYMERS, FOAMED POLYMERS, AND REINFORCED POLYMERS (U.S. CLS. 100, 103 AND 106).

ALICE SUE CARRUTHERS, EXAMINING ATTORNEY

SN 78-270,824. KABUSHIKI KAISHA KOBE SEIKO SHO, TA KOBE STEEL, LTD., HYOGO, JAPAN, FILED 7-7-2003.

KOBELCO ECO-SOLUTIONS

OWNER OF U.S. REG. NOS. 1,252,176, 2,698,157 AND OTHERS.

CLASS 7—MACHINERY

FOR METAL CUTTING MACHINES; METAL STRIP ROLLING MACHINES; DIRT REDUCTION MACHINES, NAMELY, WATER CLEANING SYSTEMS FOR REMOVING DIRT AND SALT OF SEA WATER FROM WATER SEPARATORS, AND VACUUM CLEANING SYSTEMS FOR REMOVING DIRT AND DUST FROM WASTE DISPOSAL MACHINES, COMPRISED OF FILTERS; CONTINUOUS METAL CASTING MACHINES; ROLLING MILLS AND ROLLERS FOR ROLLING MILLS; METAL EXTRUDING MACHINES; PRESS MACHINES, NAMELY, INDUSTRIAL MACHINE PRESSES; EXTRUSION PRESS MACHINES; FORGING PRESSES; UPSETTER, NAMELY AN INDUSTRIAL MACHINE FORGING UNIT WITH MECHANICAL PRESSES; HOT AND COLD ISOSTATIC PRESS MACHINES; WIRE DRAWING MACHINES; MAGNETIC STIRRING MACHINES; MINERAL PROCESSING MACHINES, NAMELY CRUSHING MACHINES, GRINDING MILL MACHINES, VIBRATING SCREEN SEPARATORS, FEEDING MACHINES, PRESSURE CONTAINER VESSELS, HEAT EXCHANGERS, VAPORIZING MACHINES, GAS SEPARATION MACHINES, REFORMER TUBES, REPLACEMENT VALVES, COMPRESSORS AND GAS EXPANDERS; PUMPS, NAMELY, CENTRIFUGAL PUMPS, RECIPROCATING PUMPS, ROTARY PUMPS, AXIAL FLOW PUMPS, AND MIXED FLOW PUMPS; GAS TURBINE GENERATORS, ROTOR SHAFTS AND TURBINE BLADES; RUBBER PROCESSING EQUIPMENT, NAMELY, TIRE CURING MACHINES, TIRE UNIFORMITY MACHINES, TIRE TESTING MACHINES, AND TIRE SHAPING MACHINES; PLASTIC PROCESSING EQUIPMENT, NAMELY, PALLETIZING MACHINES AND BEAD WINDING MACHINES; FOUNDRY MACHINES, NAMELY, DIE CASTING MACHINES; CONCRETE MIXING MACHINES; MIXING MACHINES FOR SYNTHESIZING RUBBER AND PLASTIC FOR TIRES; EXTRUDING MACHINES FOR RUBBER FOR TIRES AND PLASTIC, NAMELY, INJECTION MOLDING MACHINES; GILT COATING MACHINES; PLASMA ETCHING MACHINES; SPRAY PAINTING INDUSTRIAL ROBOT; WELDING INDUSTRIAL ROBOT; MATERIAL HANDLING ROBOT, NAMELY, PALLETIZING ROBOT; MASTER-SLAVE MANIPULATOR MACHINES FOR ROBOTS; ELECTRIC WELDING MACHINES; HYDRAULIC EXCAVATORS; ELECTRIC MINING SHOVELS AND PARTS THEREOF, NAMELY, DRAG LINES; FLOATING CRANE MACHINES; PILE DRIVERS; BUCKET WHEEL EXCAVATORS; CRANES; WHEEL LOADERS; CONTINUOUS UNLOAD CONVEYORS; DRILLS, NAMELY, HAND-HELD ELECTRIC DRILLS; PRESSURE CRYSTALLIZATION MACHINES FOR NUCLEAR WASTE STORAGE; WEAVING MACHINES; MUNICIPAL REFUSE SHREDDING EQUIPMENT, NAMELY, PAPER AND WOOD SHREDDING MACHINES; ROUGH TERRAIN CRANES; NOISE INSULATION EQUIPMENT AND NOISE LEVEL MEASURING AND ANALYTICAL UNITS, FOR REDUCING NOISE FROM INDUSTRIAL MACHINES, ROAD WORK CONSTRUCTION MACHINES AND TUNNEL WORK CONSTRUCTION MACHINES, COMPRISED OF ACOUSTICAL METAL AND PLASTER, AND REPLACEMENT PARTS THEREFOR; ELECTRIC WELDING MACHINES COMPRISING NOZZLE, CARRIAGE AND ELECTRODES; ARC ION PLATING MACHINES; AND PORTABLE ELECTRICALLY IGNITED CUTTING TORCHES (U.S. CLS. 13, 19, 21, 23, 31, 34 AND 35).

CLASS 9—ELECTRICAL AND SCIENTIFIC APPARATUS

FOR WELDING ELECTRODES; ELECTRODE WIRE FOR WELDING; ELECTRICAL TRANSFORMERS FOR USE WITH ELECTRIC WELDING MACHINES; COMPUTER SYSTEMS COMPRISED OF COMPUTERS, INTEGRATED CIRCUITS AND ELECTRIC CIRCUIT BOARDS, FOR USE WITH WELDING MACHINES, MACHINE TOOLS, RUBBER PROCESSING EQUIPMENT, WASTE AND SEWAGE TREATMENT EQUIPMENT, MINERAL PROCESSING EQUIPMENT, AND PLASTIC PROCESSING EQUIPMENT; REAL-TIME COMPUTER OPERATING SYSTEMS FOR USE WITH WELDING MACHINES, MACHINE TOOLS, RUBBER PROCESSING EQUIPMENT, WASTE AND SEWAGE TREATMENT, MINERAL PROCESSING EQUIPMENT, AND PLASTIC PROCESSING EQUIPMENT; MONITORING SYSTEM, NAMELY, COMPUTER SOFTWARE AND

RELATED COMPUTER COMPONENTS FOR MONITORING WELDING MACHINES, MACHINE TOOLS, RUBBER PROCESSING EQUIPMENT, WASTE AND SEWAGE TREATMENT EQUIPMENT, MINERAL PROCESSING EQUIPMENT, AND PLASTIC PROCESSING EQUIPMENT; TELEMETERS; ELECTRONIC SURFACE INSPECTION MACHINES; ELECTRONIC CONTROL EQUIPMENT, NAMELY, COMPUTERS FOR CONTROLLING WASTE AND SEWAGE TREATMENT EQUIPMENT AND AIR-GAS PRODUCTION EQUIPMENT; ELECTRONIC SCIENTIFIC MEASURING AND CHECKING EQUIPMENT, NAMELY, ALTIMETERS, OSCILLOSCOPES, VOLTMETERS, HYGROSTATS, THERMOSTATS, GLASS INSTRUMENTS FOR EXPERIMENTAL USE, NAMELY SPECTROGRAPHS AND MICROSCOPES, AND PORCELAIN INSTRUMENTS FOR EXPERIMENTAL USE, NAMELY STILLS FOR LABORATORY EXPERIMENTS; AND ELECTROSTATIC COATING MACHINES (U.S. CLS. 21, 23, 26, 36 AND 38).

CLASS 11—ENVIRONMENTAL CONTROL APPARATUS

FOR SODIUM OXIDE AND NITROGEN OXIDE REMOVAL MACHINES, NAMELY, DESALINATION MACHINES, DISINFECTANT APPARATUS, AND DISTILLATION APPARATUS; INCINERATORS; INDUSTRIAL FURNACES; FURNACE BOILERS; WATER AND AIR POLLUTION CONTROL EQUIPMENT, NAMELY, REVERSE OSMOSIS EQUIPMENT, CAVITATORS, AIR WASHERS, HEATING APPARATUS, SUSPENSION PREHEATERS, COOLING APPARATUS, DRYING APPARATUS, AND LIQUEFIERS; CRYOGENIC EQUIPMENT SOLD AS A UNIT, NAMELY, CRYOGENIC REFRIGERATORS, STORAGE TANKS, PUMPS, TEMPERATURE MEASURING UNITS, EVAPORATORS, CONDENSERS, HEAT EXCHANGERS, AND PUMP CHILLERS, FOR INDUSTRIAL USE; FILTERS FOR WATER AND AIR CLEANING MACHINERY; ROTARY KILNS; DESALINATION UNITS; APPARATUS FOR USE IN FERMENTATION INSTALLATIONS; INDUCTION UNITS, NAMELY, HEATERS; EVAPORATORS AND EVAPORATIVE COOLING TOWERS FOR USE WITH FURNACES, LIQUIDS AND WATER; WASTE AND SEWAGE TREATMENT EQUIPMENT, NAMELY, FILTERS, AGITATORS, DRYERS, ABSORBERS, ABSORPTION COLLECTORS AND DISSOLVERS; AND SOLID WASTE TREATMENT EQUIPMENT, NAMELY, LIQUEFIERS (U.S. CLS. 13, 21, 23, 31 AND 34).

CLASS 37—CONSTRUCTION AND REPAIR

FOR INSTALLATION, MAINTENANCE AND REPAIR OF APPARATUS AND INSTRUMENTS FOR SCIENTIFIC MEASURING AND CHECKING, NAMELY ALTIMETERS, OSCILLOSCOPES, VOLTMETERS, HYGROSTATS, THERMOSTATS, GLASS INSTRUMENTS FOR EXPERIMENTAL USE, NAMELY SPECTROGRAPHS AND MICROSCOPES, AND PORCELAIN INSTRUMENTS FOR EXPERIMENTAL USE, NAMELY, STILLS FOR LABORATORY EXPERIMENTS; INSTALLATION, MAINTENANCE AND REPAIR OF EQUIPMENT FOR USE WITH WASTE AND SEWAGE TREATMENT, STEAM AND ELECTRIC HEATING, STEAM GENERATION, REFRIGERATION, DRYING, VENTILATING, WATER SUPPLY AND SANITARY WASTE PROCESSING; INSTALLATION, MAINTENANCE AND REPAIR OF COMPUTER HARDWARE; INSTALLATION, MAINTENANCE AND REPAIR OF INDUSTRIAL MACHINES AND MACHINE TOOLS, AND OF THE CONTROLS, MOTORS AND COMPRESSORS FOR SAID EQUIPMENT; INSTALLATION, MAINTENANCE AND REPAIR OF CONSTRUCTION EQUIPMENT, NAMELY, EXCAVATORS AND COMPRESSORS; BUILDING CONSTRUCTION SERVICES; AND RENTAL OF CONSTRUCTION EQUIPMENT (U.S. CLS. 100, 103 AND 106).
GENE MACIOL, EXAMINING ATTORNEY

SN 78-271,226. BRYANT RUBBER CORP., HARBOR CITY, CA. FILED 7-7-2003.

SPAPS

CLASS 17—RUBBER GOODS

FOR INGREDIENTS FOR MOLDING PRODUCTS, NAMELY MOLDABLE SILICONE RUBBER FOR OVERMOLDING ONTO PLASTICS TO PRODUCE PLASTIC AND RUBBER COMPOSITES WITH NO ADHESION TO METAL MOLD SURFACES; PLASTIC AND RUBBER COMPOSITES FOR USE AS VALVE SEALS, GASKETS, AND DIAPHRAGMS FOR USE IN INDUSTRIAL, MEDICAL AND CONSUMER PRODUCTS (U.S. CLS. 1, 5, 12, 13, 35 AND 50).

CLASS 20—FURNITURE AND ARTICLES NOT OTHERWISE CLASSIFIED

FOR MOLDED PRODUCTS, NAMELY NON-METAL HANDLES FOR USE IN HAND TOOLS, UTENSILS, SURGICAL INSTRUMENTS, MEDICAL DEVICES, AND NON-METAL HANDLES FOR USE IN CONSUMER PRODUCTS, NAMELY, BRUSHES FOR CLEANING TEETH, COOKING UTENSILS, KITCHEN UTENSILS, COOKING PANS AND BOWLS, PLUMBING REPAIR TOOLS, LUGGAGE, INDUSTRIAL CARRYING CASES (U.S. CLS. 2, 13, 22, 25, 32 AND 50).

GENE MACIOL, EXAMINING ATTORNEY

SN 78-271,515. ARES TRADING, S.A., VAUMARCUS 2028, SWITZERLAND, FILED 7-8-2003.

KLIRACT

OWNER OF SWITZERLAND REG. NO. 514469, DATED 9-25-2003, EXPIRES 10-9-2013.

CLASS 5—PHARMACEUTICALS

FOR PHARMACEUTICAL PREPARATIONS, NAMELY, PREPARATIONS FOR THE TREATMENT OF IMMUNOLOGICAL DISEASES AND DISORDERS, INFLAMMATORY DISEASES AND DISORDERS, ONCOLOGICAL DISEASES AND DISORDERS, AND GASTROENTEROLOGIC DISEASES AND DISORDERS (U.S. CLS. 6, 18, 44, 46, 51 AND 52).

CLASS 44—MEDICAL, BEAUTY AND AGRICULTURAL SERVICES

FOR MEDICAL SERVICES, PROVIDING MEDICAL INFORMATION, MEDICAL COUNSELING; PROVIDING MEDICAL INFORMATION BY MEANS OF THE INTERNET AND MEDICAL COUNSELING PROVIDED BY MEANS OF THE INTERNET (U.S. CLS. 100 AND 101).
MICHAEL ENGEL, EXAMINING ATTORNEY

SN 78-271,668. WINKORP AG, 8006 ZÜRICH, SWITZERLAND, FILED 7-8-2003.

WINKORP

PRIORITY CLAIMED UNDER SEC. 44(D) ON SWITZERLAND APPLICATION NO. 00837/2003, FILED 2-10-2003, REG. NO. 513217, DATED 2-10-2003, EXPIRES 2-10-2013.

CLASS 35—ADVERTISING AND BUSINESS

FOR SERVICES PROVIDED BY A CREATIVE AGENCY, NAMELY, ADVERTISING AGENCY SERVICES, PUBLIC RELATIONS SERVICES, BUSINESS MARKETING SERVICES, CREATING CORPORATE AND BRAND IDENTITIES FOR OTHERS, CONDUCTING MARKETING STUDIES AND PERFORMING MARKET RESEARCH; RETAIL STORE SERVICES AND ELECTRONIC RETAILING SERVICES VIA COMPUTER FEATURING HOME ACCESSORIES, BOOKS, FASHION AND GIFTS (U.S. CLS. 100, 101 AND 102).

CLASS 41—EDUCATION AND ENTERTAINMENT

FOR PUBLICATION OF PERIODICALS AND BOOKS (U.S. CLS. 100, 101 AND 107).

CLASS 42—SCIENTIFIC, COMPUTER AND LEGAL SERVICES

FOR DESIGNING WEBSITES FOR OTHERS; INDUSTRIAL DESIGN; INTERIOR DECORATING, INCLUDING ROOM DESIGN; ARCHITECTURAL DESIGN (U.S. CLS. 100 AND 101).

NICHOLAS ALTREE, EXAMINING ATTORNEY

SN 78-273,731, KONAMI COMPUTER ENTERTAINMENT STUDIOS, INC., TOKYO, JAPAN, FILED 7-14-2003.

TRY! STOPWATCH**CLASS 9—ELECTRICAL AND SCIENTIFIC APPARATUS**

FOR DOWNLOADABLE GAME PROGRAMS FOR MOBILE TELEPHONES (U.S. CLS. 21, 23, 26, 36 AND 38).

CLASS 41—EDUCATION AND ENTERTAINMENT

FOR GAME SERVICES PROVIDED BY MEANS OF COMMUNICATIONS BY COMPUTER TERMINALS OR MOBILE TELEPHONES (U.S. CLS. 100, 101 AND 107).

RONALD AIKENS, EXAMINING ATTORNEY

SN 78-274,732, CIVITAS GROUP, WASHINGTON, DC, FILED 7-16-2003.

CIVITAS GROUP

NO CLAIM IS MADE TO THE EXCLUSIVE RIGHT TO USE GROUP, APART FROM THE MARK AS SHOWN.

CLASS 35—ADVERTISING AND BUSINESS

FOR BUSINESS CONSULTING SERVICES; BUSINESS MANAGEMENT CONSULTING SERVICES IN THE FIELD OF MARKET ANALYSIS, MARKET DEMAND ANALYSIS, INTERNATIONAL AND DOMESTIC GOVERNMENT PROCUREMENT, AND CRITICAL INFRASTRUCTURE PROTECTION, NAMELY, PROTECTION OF HIGH VALUE MANUFACTURING FACILITIES, ROADWAYS AND RAILWAYS, POWER GRIDS AND TELECOMMUNICATIONS GRIDS THROUGH THE INTEGRATION OF EXISTING AND NEW SECURITY NETWORKS AMONG DIFFERENT TARGETS AND DIFFERENT PROTECTIVE SYSTEMS; GOVERNMENT RELATIONS AND ADVOCACY, NAMELY, HELPING COMPANIES AND OTHER BUSINESS VENTURES WITH PROCUREMENT STRATEGY, IDENTIFICATION, SELECTION, AND PROMOTION OF TECHNOLOGICAL STANDARDS, AND THE ADMINISTRATION AND MANAGEMENT OF RESEARCHING GRANTS AND INVESTMENTS FOR RESEARCH AND DEVELOPMENT PURPOSES; LOBBYING SERVICES, NAMELY, PROMOTING THE INTERESTS OF MANUFACTURERS, INFORMATION TECHNOLOGY SERVICE PROVIDERS, COMPANIES WITH EMERGING TECHNOLOGIES, AND COMPANIES IN OTHER REGULATED INDUSTRIES IN THE FIELDS OF GOVERNMENT PROCUREMENT, REGULATION, ADOPTION OF STANDARDS, LEGISLATION, AND CRITICAL INFRASTRUCTURE PROTECTION, NAMELY, PROTECTION OF HIGH VALUE MANUFACTURING FACILITIES, ROADWAYS AND RAILWAYS, POWER GRIDS AND TELECOMMUNICATIONS GRIDS THROUGH THE INTEGRATION OF EXISTING AND NEW SECURITY NETWORKS AMONG DIFFERENT TARGETS AND DIFFERENT PROTECTIVE SYSTEMS; AND PROVIDING STRATEGIC BUSINESS ADVICE AND DUE DILIGENCE SERVICES IN CONNECTION WITH MERGERS AND ACQUISITIONS, INVESTMENTS IN COMPANIES, AND INVESTMENTS IN TECHNOLOGIES TO COMPANIES AND OTHER BUSINESS VENTURES (U.S. CLS. 100, 101 AND 102).

CLASS 36—INSURANCE AND FINANCIAL

FOR HELPING COMPANIES AND OTHER BUSINESS VENTURES OBTAIN GRANTS AND INVESTMENTS FOR RESEARCH AND DEVELOPMENT PURPOSES BY DEVELOPING GRANT STRATEGIES, GRANT WRITING AND SEARCHING FOR GRANT SOURCES AND STRATEGIC PARTNERS (U.S. CLS. 100, 101 AND 102).

MARLENE BELL, EXAMINING ATTORNEY

SN 78-277,837, MANAGED DATA ACCESS, LLC, MIAMI, FL, FILED 7-23-2003.

**CLASS 38—COMMUNICATION**

FOR DATA ACCESS SERVICES, NAMELY, PROVIDING A HIGH SPEED ACCESS TO AREA NETWORKS AND A GLOBAL COMPUTER INFORMATION NETWORK; CORPORATE DIGITAL MEDIA DELIVERY BY ELECTRONIC TRANSMISSION; ENTERPRISE TEXT AND NUMERIC WIRELESS DIGITAL MESSAGING SERVICES; INTEGRATED RICH MEDIA CONTENT DELIVERY OF MESSAGES BY ELECTRONIC TRANSMISSION; PROVIDING ON-LINE CHAT ROOMS FOR VIRTUAL COMMUNITIES FOR THE TRANSMISSION OF MESSAGES AMONG COMPUTER USERS CONCERNING BUSINESS RELATED DATA AND INFORMATION (U.S. CLS. 100, 101 AND 104).

FIRST USE 4-1-2003; IN COMMERCE 4-1-2003.

CLASS 39—TRANSPORTATION AND STORAGE

FOR STORAGE SERVICES, NAMELY, STORAGE OF ELECTRONIC MEDIA, NAMELY, IMAGES, TEXT AND AUDIO DATA, AND PROVIDING INDEPENDENT STORAGE CONSULTANCY SERVICES IN CONNECTION THEREWITH (U.S. CLS. 100 AND 105).

FIRST USE 4-1-2003; IN COMMERCE 4-1-2003.
JOSETTE BEVERLY, EXAMINING ATTORNEY

CLASS 28—TOYS AND SPORTING GOODS

FOR CHILDREN'S TOYS WITH INSTRUCTIONAL PURPOSES, NAMELY, MULTIPLE ACTIVITY TOYS, POPUP TOYS, PUZZLES, INFANT TOYS AND BOARD GAMES ALL FOR USE IN CONJUNCTION WITH LEARNING, BEHAVIORAL DEVELOPMENT, COGNITIVE DEVELOPMENT, SOCIAL DEVELOPMENT, EMOTIONAL DEVELOPMENT, LANGUAGE DEVELOPMENT AND BRAIN DEVELOPMENT (U.S. CLS. 22, 23, 38 AND 50).

SN 78-278,780. FANZY PRODUCTS LLC, BOCA RATON, FL.
FILED 7-25-2003.

LEAD HEADS**CLASS 16—PAPER GOODS AND PRINTED MATTER**

FOR CLOTHING STENCILS, CARTOON STRIPS, DECORATIVE PENCIL- OR PEN-TOP ORNAMENTS, ERASERS, STATIONERY, POSTERS, TEMPORARY TATTOOS (U.S. CLS. 2, 5, 22, 23, 29, 37, 38 AND 50).

CLASS 28—TOYS AND SPORTING GOODS

FOR TOYS, NAMELY, TOY FIGURES AND BOARD GAMES (U.S. CLS. 22, 23, 38 AND 50).

CLASS 41—EDUCATION AND ENTERTAINMENT

FOR ENTERTAINMENT SERVICES, NAMELY, A TELEVISION CARTOON SERIES; AND LIVE PERFORMANCES BY A MUSICAL BAND (U.S. CLS. 100, 101 AND 107).

MATTHEW KLINE, EXAMINING ATTORNEY

CLASS 36—INSURANCE AND FINANCIAL

FOR CHARITABLE FUND RAISING IN THE AREAS OF RESEARCH, STUDY AND EDUCATION IN THE FIELDS OF LEARNING, BEHAVIORAL DEVELOPMENT, COGNITIVE DEVELOPMENT, SOCIAL DEVELOPMENT, EMOTIONAL DEVELOPMENT, LANGUAGE DEVELOPMENT AND BRAIN DEVELOPMENT (U.S. CLS. 100, 101 AND 102).

CLASS 41—EDUCATION AND ENTERTAINMENT

FOR EDUCATIONAL SERVICES, NAMELY, PROVIDING SEMINARS, WORKSHOPS AND CONFERENCES IN THE FIELDS OF LEARNING, BEHAVIORAL DEVELOPMENT, COGNITIVE DEVELOPMENT, SOCIAL DEVELOPMENT, EMOTIONAL DEVELOPMENT, LANGUAGE DEVELOPMENT AND BRAIN DEVELOPMENT, AND PROVIDING DAYCARE TRAINING, PRESCHOOL TRAINING, EDUCATIONAL TRAINING, LANGUAGE TRAINING AND TEACHER TRAINING RELATED THERETO (U.S. CLS. 100, 101 AND 107).

SN 78-279,788. UNIVERSITY OF WASHINGTON, SEATTLE, WA. FILED 7-28-2003.

ILABS**CLASS 9—ELECTRICAL AND SCIENTIFIC APPARATUS**

FOR VIDEO TAPES, AUDIO TAPES, COMPACT DISCS, EDUCATIONAL SOFTWARE PROGRAM FOR INSTRUCTIONAL PURPOSES AND VIDEO GAME DISCS, SOFTWARE, TAPES, VIDEO CARTRIDGES, AND AUDIO CARTRIDGES IN THE FIELDS OF LEARNING, BEHAVIORAL DEVELOPMENT, COGNITIVE DEVELOPMENT, SOCIAL DEVELOPMENT, EMOTIONAL DEVELOPMENT, LANGUAGE DEVELOPMENT AND BRAIN DEVELOPMENT (U.S. CLS. 21, 23, 26, 36 AND 38).

CLASS 16—PAPER GOODS AND PRINTED MATTER

FOR MAGAZINES, NEWSLETTERS, BOOKS, AND OTHER PRINTED MATTER, NAMELY, LESSONS, INSTRUCTIONAL GUIDES, REPORTS, ARTICLES, PAMPHLETS, BROCHURES, AND CURRICULA IN THE FIELDS OF LEARNING, BEHAVIORAL DEVELOPMENT, COGNITIVE DEVELOPMENT, SOCIAL DEVELOPMENT, EMOTIONAL DEVELOPMENT, LANGUAGE DEVELOPMENT AND BRAIN DEVELOPMENT (U.S. CLS. 2, 5, 22, 23, 29, 37, 38 AND 50).

CLASS 42—SCIENTIFIC, COMPUTER AND LEGAL SERVICES

FOR TECHNICAL CONSULTING SERVICES IN THE FIELDS OF LEARNING, BEHAVIORAL DEVELOPMENT, COGNITIVE DEVELOPMENT, SOCIAL DEVELOPMENT, EMOTIONAL DEVELOPMENT, LANGUAGE DEVELOPMENT AND BRAIN DEVELOPMENT (U.S. CLS. 100 AND 101).

KARANENDRA S. CHHINA, EXAMINING ATTORNEY

SN 78-279,950. MAUI SKIMMERS, LIMITED LIABILITY COMPANY, KIHAI, HI. FILED 7-28-2003.



NO CLAIM IS MADE TO THE EXCLUSIVE RIGHT TO USE "MAUI SKIMMERS", "HIGH PERFORMANCE SKIMBOARD DESIGNS", AND "THE DEPICTION OF THE ISLAND MAUI", APART FROM THE MARK AS SHOWN.

COLORS ARE A FEATURE OF THE MARK. COLORS, SUCH AS GREEN OR RED APPEAR AS THE PRIMARY COLOR TO DEPICT THE ISLAND OF MAUI AND FOR THE LETTERING STATING MAUI SKIMMERS ON THE TOP OF THE MARK. BLACK IS USED AS THE FILLER COLOR BETWEEN THE IMAGE OF THE ISLAND OF MAUI UP TO THE INTERIOR EDGES OF THE TRIANGLE, FOR THE LETTERING ON HIGH PERFORMANCE SKIMBOARD DESIGNS, AND FOR THE LINES OUTLINING THE MARK.

TRIANGULAR SHAPED DESIGN WITH A DEPICTION OF THE ISLAND OF MAUI INSIDE THE TRIANGLE, AND THE WORDS MAUI SKIMMERS ALONG THE TOP OF THE TRIANGLE, THE WORDS HIGH PERFORMANCE ALONG THE LEFT EDGE OF THE TRIANGLE, AND THE WORDS SKIMBOARD DESIGNS ALONG THE RIGHT EDGE OF THE TRIANGLE.

CLASS 25—CLOTHING

FOR CLOTHING, NAMELY SURF WEAR, SWIM WEAR, T-SHIRTS, SWEAT SHIRTS, SHORTS, SHIRTS, HATS, TOPS, DRESSES, BEACH WEAR, SWIM TRUNKS, BATHING SUITS, WET SUITS, SPORT SHIRTS, WRAP AROUNDS, CAPS, BELTS, PANTS, BEACH COVER UPS, BEACH SHOES, RASH GUARDS, AND SWEAT PANTS (U.S. CLS. 22 AND 39).

FIRST USE 1-1-1987; IN COMMERCE 1-1-1987.

CLASS 28—TOYS AND SPORTING GOODS

FOR SKIMBOARDS, SURFBOARDS, SAILBOARDS, WAKE BOARDS, BODY BOARDS, SURFBOARD FINS, SURFBOARD LEASHES AND WAX, SURF FINS, FINS FOR BODY BOARDS, LEASHES USED IN CONJUNCTION WITH SURFING, KITE SURFING BOARDS, AND PADDLE BOARDS (U.S. CLS. 22, 23, 38 AND 50).

FIRST USE 1-1-1987; IN COMMERCE 1-1-1987.
DARRYL SPRUILL, EXAMINING ATTORNEY

SN 78-281,242. DOGS IN HATS, LLC, GRAND HAVEN, MI. FILED 7-31-2003.



DOGS IN HATS
CHILDREN'S PUBLISHING COMPANY

NO CLAIM IS MADE TO THE EXCLUSIVE RIGHT TO USE "CHILDREN'S PUBLISHING COMPANY", APART FROM THE MARK AS SHOWN.

THE MARK CONSISTS OF LOGO AND WORDS.

CLASS 16—PAPER GOODS AND PRINTED MATTER

FOR CHILDREN'S BOOKS, COLORING BOOKS, EDUCATIONAL PRODUCTS, NAMELY, WORKBOOKS, FLASHCARDS, STORYBOOKS, ACTIVITY BOOKS (U.S. CLS. 2, 5, 22, 23, 29, 37, 38 AND 50).

FIRST USE 3-7-2003; IN COMMERCE 6-4-2003.

CLASS 28—TOYS AND SPORTING GOODS

FOR GAME CARDS (U.S. CLS. 22, 23, 38 AND 50).

FIRST USE 5-7-2003; IN COMMERCE 6-4-2003.

NAKWAMA ANKRAH, EXAMINING ATTORNEY

SN 78-283,085. GUTTER KING INTERNATIONAL, INC., COCOA, FL. FILED 8-5-2003.

THE KING OF SEAMLESS GUTTERS

OWNER OF U.S. REG. NO. 2,023,836.

NO CLAIM IS MADE TO THE EXCLUSIVE RIGHT TO USE "SEAMLESS GUTTERS", APART FROM THE MARK AS SHOWN.

CLASS 6—METAL GOODS

FOR SEAMLESS FACIA METAL GUTTERS FOR BUILDING STRUCTURES (U.S. CLS. 2, 12, 13, 14, 23, 25 AND 50).

FIRST USE 1-15-1994; IN COMMERCE 1-15-1994.

CLASS 19—NON-METALLIC BUILDING MATERIALS

FOR SEAMLESS NON-METAL GUTTERS FOR BUILDING STRUCTURES (U.S. CLS. 1, 12, 33 AND 50).

FIRST USE 1-15-1994; IN COMMERCE 1-15-1994.

JASON TURNER, EXAMINING ATTORNEY

SN 78-285,220. G & G DISTRIBUTION INC., DBA RYAN'S PET SUPPLIES, PHOENIX, AZ. FILED 8-8-2003.

VALUE GROOM

NO CLAIM IS MADE TO THE EXCLUSIVE RIGHT TO USE "GROOM", APART FROM THE MARK AS SHOWN.

CLASS 3—COSMETICS AND CLEANING PREPARATIONS

FOR NON-MEDICATED GROOMING PREPARATIONS FOR DOGS, NAMELY, EAR POWDERS AND EAR CLEANERS FOR HELPING EARS STAY DRY AND ODOR FREE, SHAMPOOS, CONDITIONERS, COLOGNES AND TANGLE REMOVERS, AND ALL-IN-ONE CLEANSER, LUBRICANT AND COOLANT COMPOSITIONS FOR ELECTRONIC CLIPPER BLADES (U.S. CLS. 1, 4, 6, 50, 51 AND 52).

CLASS 5—PHARMACEUTICALS

FOR STYPTIC POWDER FOR ANIMALS; MEDICATED GROOMING PREPARATIONS FOR DOGS, NAMELY, EAR POWDERS AND EAR CLEANERS FOR HELPING EARS STAY DRY AND ODOR FREE, SHAMPOOS, CONDITIONERS, COLOGNES AND TANGLE REMOVERS (U.S. CLS. 6, 18, 44, 46, 51 AND 52).

CLASS 8—HAND TOOLS

FOR PET SUPPLIES, NAMELY, KITS FOR CLEANING ELECTRONIC CLIPPERS, NAMELY, BRUSHES, A STORAGE POUCH AND A SCREWDRIVER AND NUTDRIVER TOOL SET; THUMB AND FINGER RESTS FOR USE WITH GROOMING CLIPPERS; HAND-OPERATED SHEARS (U.S. CLS. 23, 28 AND 44).

SN 78-291,375. AUTOWEB.COM, INC., DBA AUTOMOTIVE INFORMATION CENTER (AIC), IRVINE, CA. FILED 8-22-2003.

CLASS 10—MEDICAL APPARATUS

FOR HEMOSTATS (U.S. CLS. 26, 39 AND 44).
JERI J. FICKES, EXAMINING ATTORNEY

AUTOSPECS

SN 78-287,530. QWEST COMMUNICATIONS INTERNATIONAL INC., DENVER, CO. FILED 8-14-2003.



OWNER OF U.S. REG. NO. 2,646,655.
NO CLAIM IS MADE TO THE EXCLUSIVE RIGHT TO USE "CENTER OMAHA", APART FROM THE MARK AS SHOWN.

CLASS 35—ADVERTISING AND BUSINESS

FOR ARRANGING AND CONDUCTING CONFERENCES AND EXHIBITIONS FOR BUSINESS PURPOSES. (U.S. CLS. 100, 101 AND 102).

CLASS 41—EDUCATION AND ENTERTAINMENT

FOR CONDUCTING SPORTS AND ENTERTAINMENT EVENTS IN THE NATURE OF LIVE CONCERTS, PUBLIC COMEDY PERFORMANCES, PUBLIC SPEAKING PERFORMANCES, PUBLIC DANCE PERFORMANCES, PUBLIC SKATING PERFORMANCES AND RACES, PUBLIC SKATEBOARDING PERFORMANCES AND RACES, PUBLIC DRAMA PERFORMANCES, PUBLIC LIVE MUSICAL PERFORMANCES, RODEOS, HOCKEY GAMES, BASKETBALL GAMES, LACROSSE GAMES, SWIMMING RACES, WRESTLING MATCHES, TRUCK RACES, BICYCLE RACES, MOTOCROSS RACES, MOTORCYCLE RACES, EXTREME SPORTS, CHILDREN'S SHOWS, ART SHOWS, FAMILY SHOWS, AND CIRCUSES FOR PUBLIC EXHIBITION AND RADIO AND TELEVISION BROADCAST. (U.S. CLS. 100, 101 AND 107).

ANDREA SAUNDERS, EXAMINING ATTORNEY

CLASS 35—ADVERTISING AND BUSINESS

FOR PROVIDING AN ONLINE WEB SITE FOR CONSUMER AND PROFESSIONALS FEATURING AUTOMOBILE AND MOTOR VEHICLE CONSUMER INFORMATION, NAMELY SELECTION, AVAILABILITY, PRICING, QUOTATIONS, COMPARISONS, SALES, WARRANTIES, REPAIR AND MAINTENANCE, PARTS, CUSTOMIZATION AND SERVICES INFORMATION; PROVIDING AUTOMOTIVE AND VEHICULAR CONSUMER AND PRODUCT INFORMATION VIA A GLOBAL COMPUTER NETWORK RELATING TO VEHICLES FOR SALE, SPECIFICATION AND PERFORMANCE REVIEWS OF VEHICLES, VALUATION OF VEHICLES, AVAILABILITY OF VEHICLE PARTS AND ACCESSORIES, DEALERS, MANUFACTURERS, AUTOMOTIVE SERVICES AND SERVICE PROVIDERS, AS WELL AS TRADE INFORMATION ABOUT GENERAL INDUSTRY NEWS; PROVIDING ADVERTISING, MARKETING AND PROMOTION SERVICES TO OTHERS, NAMELY THE DISSEMINATION OF ADVERTISING FOR OTHERS, PROMOTING THE GOODS AND SERVICES OF OTHERS THROUGH THE DISTRIBUTION OF ONLINE ADVERTISEMENTS, PROVIDING A WEBSITE WHEREIN USERS CAN LINK TO THE WEBSITES OF THE MERCHANTS AND PROVIDING PRINT, RADIO AND TELEVISION ADVERTISING, INCENTIVE AWARDS, AND CROSS-PROMOTION AND REFERRAL PROGRAMS; E-COMMERCE SERVICES, NAMELY PROVIDING ONLINE RETAIL STORE SERVICES IN THE FIELD OF AUTOMOBILES AND MOTOR VEHICLES; AUTOMOBILE AND MOTOR VEHICLE DEALERSHIPS REFERRAL SERVICES PROVIDED LOCALLY, REMOTELY AND OVER THE INTERNET AND VIA COMPUTER AND DATA COMMUNICATIONS NETWORKS (U.S. CLS. 100, 101 AND 102).

FIRST USE 12-1-2000; IN COMMERCE 12-1-2000.

CLASS 42—SCIENTIFIC, COMPUTER AND LEGAL SERVICES

FOR COMPUTER SERVICES, NAMELY PROVIDING SEARCH ENGINES FOR OBTAINING DATA ON LOCAL AREA, WIDE AREA AND ENTERPRISE COMPUTER NETWORKS; PROVIDING TEMPORARY USE OF NON-DOWNLOADABLE SEARCH ENGINE SOFTWARE FOR USE IN SEARCHING DATABASES FEATURING INFORMATION, CATALOGUES, PHOTOGRAPHS, SPECIFICATIONS, PRICING, REVIEWS, DEALERS, RETAILERS, WHOLESALERS, DISTRIBUTORS AND SERVICE PROVIDERS IN THE FIELDS OF AUTOMOBILES AND MOTOR VEHICLES, AND AUTOMOBILE AND MOTOR VEHICLE ACCESSORIES; COMPUTER SOFTWARE DESIGN FOR OTHERS; COMPUTER CONSULTATION; MAINTENANCE OF COMPUTER SOFTWARE; MAINTENANCE AND UPDATING OF COMPUTER SOFTWARE; AND COMPUTER SERVICES, NAMELY CREATING, MAINTAINING AND HOSTING WEB SITES OF OTHERS FOR A GLOBAL COMPUTER NETWORK FOR THE PURPOSE OF ADVERTISING AUTOMOBILES AND OTHER VEHICLES FOR SALE OR LEASE; PROVIDING ELECTRONIC AND COMPUTER BASED PRODUCT RESEARCH IN THE FIELD OF AUTOMOBILES AND MOTOR VEHICLES (U.S. CLS. 100 AND 101).

FIRST USE 12-1-2000; IN COMMERCE 12-1-2000.
MICHAEL WEBSTER, EXAMINING ATTORNEY

SN 78-292,463. STONE MANAGEMENT GROUP, INC.,
LONG BEACH, CA. FILED 8-26-2003.

SN 78-293,752. VSP TECHNOLOGIES, INC., OSSINING, NY.
FILED 8-28-2003.

HOMEGRANITE

CLASS 19—NON-METALLIC BUILDING MATERIALS

FOR NATURAL STONES FOR HOME USES, NAMELY, GRANITE; FLOORING, NAMELY, GRANITE TILE FLOORS (U.S. CLS. 1, 12, 33 AND 50).

FIRST USE 8-28-2003; IN COMMERCE 8-28-2003.

CLASS 20—FURNITURE AND ARTICLES NOT OTHERWISE CLASSIFIED

FOR GRANITE FURNITURE, PARTS, NAMELY, KITCHEN COUNTERTOPS AND FURNITURE TOPS, BATHROOM VANITIES MADE OF GRANITE (U.S. CLS. 2, 13, 22, 25, 32 AND 50).

FIRST USE 8-28-2003; IN COMMERCE 8-28-2003.
JOHN DWYER, EXAMINING ATTORNEY

SN 78-293,281. RESTAT, LLC, GERMANTOWN, WI. FILED 8-28-2003.

REPORTAL

CLASS 35—ADVERTISING AND BUSINESS

FOR PROVIDING A SECURE WEBSITE ALLOWING PRESCRIPTION DRUG USERS TO REVIEW PRESCRIPTION INFORMATION ON INCENTIVES TO PROMOTE GENERIC AND FORMULARY DRUG UTILIZATION (U.S. CLS. 100, 101 AND 102).

FIRST USE 1-1-2003; IN COMMERCE 5-1-2003.

CLASS 36—INSURANCE AND FINANCIAL

FOR PROVIDING A SECURE WEBSITE ALLOWING PRESCRIPTION DRUG USERS TO REVIEW PRESCRIPTION INFORMATION ON-LINE, NAMELY, INFORMATION REGARDING PAYMENT COORDINATION WITH PRIMARY OR SECONDARY CARRIERS (U.S. CLS. 100, 101 AND 102).

FIRST USE 1-1-2003; IN COMMERCE 5-1-2003.

CLASS 44—MEDICAL, BEAUTY AND AGRICULTURAL SERVICES

FOR PROVIDING A SECURE WEBSITE ALLOWING PRESCRIPTION DRUG USERS TO REVIEW PRESCRIPTION INFORMATION ON-LINE INCLUDING, DRUG SELECTION AND UTILIZATION; AUTHORIZATION FOR DRUG UTILIZATION, AND FORMULARY OVERRIDES (U.S. CLS. 100 AND 101).

FIRST USE 1-1-2003; IN COMMERCE 5-1-2003.
JOHN LINCOSKI, EXAMINING ATTORNEY

ZYTREL

CLASS 3—COSMETICS AND CLEANING PREPARATIONS

FOR COMPONENT OF PERSONAL CARE PRODUCTS, NAMELY BODY CREAMS, SKIN CREAMS, COLD CREAMS, EYE CREAMS IN THE FORM OF LOTIONS AND GELS AND OINTMENTS; COMPONENT OF PERSONAL CLEANSING PRODUCTS, NAMELY HAND AND BODY SOAPS AND PREMOISTENED COSMETIC WIPES AND BABY LOTIONS; COMPONENT OF HOUSEHOLD CLEANSING PRODUCTS, NAMELY DISINFECTANT SOAPS, LAUNDRY SOAPS, SOAPS FOR HOUSEHOLD USE AND ALL PURPOSE CLEANER SPRAYS AND DISPOSABLE WIPES IMPREGNATED WITH CHEMICALS OR COMPOUNDS FOR HOUSEHOLD USE AND CARPET CLEANER SPRAYS IN SPRAY BOTTLES; COMPONENT OF INSTITUTIONAL CLEANSING PRODUCTS, NAMELY AUTOMATIC DISHWASHING DETERGENTS, GERMICIDAL DETERGENTS, TOILET BOWL DETERGENTS, DETERGENTS PREPARED FROM PETROLEUM, AND DISINFECTANT SOAPS AND DISPOSABLE WIPES IMPREGNATED WITH CHEMICALS OR COMPOUNDS FOR INSTITUTIONAL KITCHEN USE AND CARPET CLEANER SPRAYS IN SPRAY BOTTLES (U.S. CLS. 1, 4, 6, 50, 51 AND 52).

CLASS 5—PHARMACEUTICALS

FOR COMPONENT OF PERSONAL CARE ANTISEPTIC AND ANTIMICROBIAL PRODUCTS, NAMELY ANTIBACTERIAL ALCOHOL SKIN SANITIZER GELS AND MEDICATED SKIN LOTIONS, MEDICATED SKIN BODY CREAMS, MEDICATED SKIN CREAMS, AND ANTIBIOTIC OINTMENTS; COMPONENT OF ANTIMICROBIAL PERSONAL CLEANSING PRODUCTS, NAMELY MEDICATED HAND AND BODY SOAPS AND PREMOISTENED MEDICATED WIPES AND MEDICATED BABY LOTIONS FOR DIAPER RASH (U.S. CLS. 6, 18, 44, 46, 51 AND 52).

TANYA AMOS, EXAMINING ATTORNEY

SN 78-294,088. BHP STEEL LIMITED, MELBOURNE 3000,
AUSTRALIA, FILED 8-29-2003.

BLUESCOPE STEEL

PRIORITY CLAIMED UNDER SEC. 44(D) ON AUSTRALIA APPLICATION NO. 962463, FILED 7-18-2003, REG. NO. 962463, DATED 7-18-2003, EXPIRES 7-18-2013.

NO CLAIM IS MADE TO THE EXCLUSIVE RIGHT TO USE STEEL, APART FROM THE MARK AS SHOWN.

CLASS 6—METAL GOODS

FOR COMMON METALS AND THEIR ALLOYS, NAMELY, COMMON METALS IN THE FORM OF COILS, STRIPS OR SHEETS; PRECOATED METAL IN THE FORM OF SHEETS, COILS AND STRIPS FOR FURTHER MANUFACTURE, BUILDING AND CONSTRUCTION; PRECOATED METAL BUILDING MATERIALS, NAMELY, COATED SHEET METAL FOR ROOFING AND WALLS; PREPAINTED METAL IN THE FORM OF SHEETS, COILS AND STRIPS FOR FURTHER MANUFACTURE, BUILDING AND CONSTRUCTION; PREPAINTED METAL BUILDING MATERIALS, NAMELY, PAINTED SHEET METAL FOR ROOFING AND WALLS; STEEL METAL IN THE FORM OF SHEETS, COILS, STRIPS, PLATES, BARS, RODS, SLABS AND INGOTS; METAL ROOF AND WALL CLADDING, METAL CEILING BATTENS, METAL ROOF TRUSSES, METAL STRUCTURAL DECKING, METAL FORM WORK AND REINFORCING MATERIALS FOR BUILDING, NAMELY, RODS, PLATES AND BARS; METAL WIRE MESH; STEEL IN EXPANDED METAL FORM; METAL RAINWATER PRODUCTS, NAMELY, FASCIAS, GUTTERING, RIDGECAPPING, DOWNPIPES AND METAL RAINWATER TANKS; METAL BUILDING FRAMES, FRAMING SECTIONS AND PARTS THEREFOR FOR HOUSES AND COMMERCIAL BUILDINGS; TRANSPORTABLE BUILDINGS OF METAL; METAL FENCING MATERIALS, NAMELY, POSTS AND PANELS; PIPES AND TUBES OF METAL; METAL FASTENERS, NAMELY, BRACKETS, CLIPS AND CLAMPS; PLASTIC COATED WIRE (U.S. CLS. 2, 12, 13, 14, 23, 25 AND 50).

CLASS 19—NON-METALLIC BUILDING MATERIALS

FOR NON-METAL BUILDING MATERIALS, NAMELY, WOOD BALUSTRADING, CONCRETE BALUSTRADING, STONE BALUSTRADING, WOOD BEAMS, CONCRETE BEAMS, STONE BEAMS, WOOD BUILDING PANELS, CONCRETE BUILDING PANELS, STONE BUILDING PANELS, NONMETAL CEILING PANELS, CLADDING FOR BUILDING, WOOD FACINGS FOR BUILDING, CONCRETE FACINGS FOR BUILDING, STONE FACINGS FOR BUILDING, FLASHING FOR BUILDING, FRAMEWORK FOR BUILDING, GIRDERS, GUTTERS, HIPS FOR ROOFING; JOISTS, LININGS FOR BUILDING, LINTELS, MOULDINGS FOR BUILDING AND FOR CORNICES, PARTITIONS, ROOF COVERINGS, ROOF FLASHING, ROOFING, WALL CLADDINGS, WALL TILES FOR BUILDING, WINDOW FRAMES; RIGID PIPES NOT OF METAL FOR BUILDING; MESH, NAMELY, NON-METAL FENCING; NON-METAL ROOF AND WALL SHEETS AND PANELS; NON-METALLIC POSTS (U.S. CLS. 1, 12, 33 AND 50).

CLASS 35—ADVERTISING AND BUSINESS

FOR BUSINESS MANAGEMENT; COMMERCIAL OR INDUSTRIAL MANAGEMENT ASSISTANCE; COST-PRICE ANALYSIS; COMPUTERIZED DATABASE FILE MANAGEMENT, NAMELY, COMPILATION AND SYSTEMIZATION OF INFORMATION INTO COMPUTER DATABASES; PURCHASING AGENTS, NAMELY, ARRANGING EXCHANGES BETWEEN BUYERS AND SELLERS; EXPORTING SERVICES, NAMELY, PURCHASING AND EXPORTING GOODS FOR OTHERS; IMPORT-EXPORT AGENCIES; PROMOTING THE GOODS AND SERVICES OF OTHERS BY MEANS OF DISTRIBUTION OF PRINTED MATTER, RADIO PROMOTIONS AND COMMERCIALS, TELEVISION PROMOTION AND COMMERCIALS, INTERNET ADVERTISING AND PROVIDING AN INTERNET WEBSITE FEATURING GOODS AND SERVICES OF OTHERS; PROMOTING

THE SALE OF METAL AND NONMETAL GOODS OF OTHERS TO BUYERS IN A RETAIL AND WHOLESALE SETTING; ONLINE RETAIL STORE AND WHOLESALE DISTRIBUTION SERVICES FEATURING METAL IN THE FORM OF SHEETS, COILS AND STRIPS, METAL AND NON-METAL BUILDING MATERIALS, METAL BUILDINGS, INCLUDING TRANSPORTABLE BUILDINGS AND PRE-ENGINEERED BUILDINGS, METAL RAINWATER PRODUCTS AND METAL FENCING MATERIALS; DATA PROCESSING SERVICES; MANAGEMENT OF INTELLECTUAL PROPERTY (U.S. CLS. 100, 101 AND 102).

CLASS 37—CONSTRUCTION AND REPAIR

FOR BUILDING CONSTRUCTION AND REPAIR SERVICES; BUILDING PROJECT MANAGEMENT, NAMELY, BUILDING CONSTRUCTION SUPERVISION (U.S. CLS. 100, 103 AND 106).

CLASS 38—COMMUNICATION

FOR COMMUNICATIONS SERVICES VIA COMPUTER TERMINALS, COMPUTER NETWORKS AND FIBRE OPTIC NETWORKS, NAMELY, COMPUTER AIDED TRANSMISSION OF MESSAGES AND IMAGES, ELECTRONIC MAIL, ELECTRONIC TRANSMISSION OF MESSAGES AND DATA COMMUNICATIONS; PROVISION OF ELECTRONIC COMMUNICATIONS FACILITIES; E-MAIL FORWARDING; DELIVERY OF MESSAGES BY ELECTRONIC TRANSMISSION; TELECOMMUNICATIONS SERVICES, NAMELY, INTERNET EXCHANGE POINT WHERE INTERNET SERVICE PROVIDERS CONNECT WITH EACH OTHER TO EXCHANGE INTERNET TRAFFIC (U.S. CLS. 100, 101 AND 104).

CLASS 39—TRANSPORTATION AND STORAGE

FOR TRANSPORT OF GOODS BY ROAD VEHICLES, RAILWAY, AIR AND MARINE; PACKAGING ARTICLES FOR TRANSPORTATION; AND STORAGE OF GOODS IN GENERAL; DISTRIBUTION OF METAL IN THE FORM OF SHEETS, COILS AND STRIPS, METAL AND NON-METAL BUILDING MATERIALS, METAL BUILDINGS INCLUDING TRANSPORTABLE BUILDINGS AND PRE-ENGINEERED BUILDINGS, METAL RAINWATER PRODUCTS AND METAL FENCING MATERIALS; STORAGE AND RETRIEVAL SERVICES FOR ARCHIVING DATABASES, IMAGES AND OTHER ELECTRONIC DATA; ELECTRONIC MESSAGE STORAGE (U.S. CLS. 100 AND 105).

CLASS 40—MATERIAL TREATMENT

FOR MECHANICAL SERVICES FOR THE TREATMENT OR TRANSFORMATION OF SUBSTANCES, NAMELY, ORGANIC AND INORGANIC TREATMENT AND COATING OF METAL SURFACES AND COATED METAL SURFACES, INCLUDING PASSIVATION, PRE-TREATMENT AND ROLL-FORMING OF METAL SURFACES; APPLICATION OF PROTECTIVE METAL COATINGS; POLISHING, ABRADING AND CUFFING OF METAL; METAL GALVANIZATION AND CHROMING SERVICES (U.S. CLS. 100, 103 AND 106).

CLASS 42—SCIENTIFIC, COMPUTER AND LEGAL SERVICES

FOR ENGINEERING SERVICES, INCLUDING ENGINEERING DESIGN, ENGINEERING SURVEYING, ENGINEERING DRAWING AND CONSTRUCTION ENGINEERING; ENGINEERING CONSULTING; SCIENTIFIC RESEARCH; TECHNICAL RESEARCH, NAMELY, METALLURGICAL AND CHEMICAL ANALYSIS, TESTING AND RESEARCH; CONSTRUCTION DRAFTING; INDUSTRIAL DESIGN; TECHNICAL CONSULTATION AND RESEARCH IN THE FIELD OF METAL PRODUCTS AND BUILDING MATERIALS; MATERIALS TESTING; CHEMICAL RESEARCH; CHEMISTRY CONSULTATION SERVICES; COMPUTER PROGRAMMING FOR OTHERS; DEVELOPMENT, DESIGN, UPDATING, MODIFYING AND MAINTENANCE OF COMPUTER SOFTWARE FOR OTHERS; RENTAL OF COMPUTER SOFTWARE AND HARDWARE; COMPUTER SOFTWARE AND HARDWARE CONSULTATION; LICENSING OF INTELLECTUAL PROPERTY (U.S. CLS. 100 AND 101).

THEODORE MCBRIDE, EXAMINING ATTORNEY

SN 78-294,146. CUISINE CONCEPTS, LLC, EDINA, MN. FILED 8-29-2003.

GUAC ROCKS**CLASS 29—MEATS AND PROCESSED FOODS**

FOR GUACAMOLE DIPS (U.S. CL. 46).
FIRST USE 5-0-1999; IN COMMERCE 8-0-1999.

CLASS 43—HOTEL AND RESTAURANT SERVICES

FOR RESTAURANT SERVICES (U.S. CLS. 100 AND 101).
FIRST USE 5-0-1999; IN COMMERCE 8-0-1999.
FRED MANDIR, EXAMINING ATTORNEY

SN 78-296,984. ALAN BROWN ENERGY RESOURCES 1988 LIMITED, HAMILTON, NEW ZEALAND, FILED 9-6-2003.

GASMATE

PRIORITY CLAIMED UNDER SEC. 44(D) ON NEW ZEALAND APPLICATION NO. 700942, FILED 9-4-2003, REG. NO. 700942, DATED 6-8-2004, EXPIRES 6-8-2014.

CLASS 11—ENVIRONMENTAL CONTROL APPARATUS

FOR BARBECUES, COOKERS, NAMELY, OVENS AND GAS HEATING APPLIANCES FOR COOKING; GRILLS, NAMELY, GAS APPLIANCES FOR GRILLING FOOD; ROTISSERIES, GAS TOASTERS, GAS BURNERS FOR DOMESTIC USE; LIGHTING APPARATUS, NAMELY, GAS LAMPS, GAS BURNERS FOR LAMPS; FLARES; HEATING APPARATUS, NAMELY, GAS RADIATORS FOR HEATING BUILDINGS, GAS POWERED HEATERS FOR OUTDOORS; OUTDOOR GAS POWERED BRAZERS; GAS REGULATORS AND GAS REGULATOR VALVES; SPARK IGNITERS FOR GAS APPLIANCES (U.S. CLS. 13, 21, 23, 31 AND 34).

CLASS 21—HOUSEWARES AND GLASS

FOR COOKING AND BARBECUE UTENSILS, NAMELY SPATULAS, BARBECUE TONGS, BARBECUE AND SERVING FORKS, BASTING AND SERVING SPOONS, GRILLS AND NON-ELECTRIC GRIDDLES; SAUCEPANS, POTS AND FRY PANS; BRUSHES FOR CLEANING BARBECUES, COOKERS AND COOKING UTENSILS; NON-ELECTRIC DEEP FRYERS; NON-ELECTRIC KETTLES; DISH COVERS, PLATES, BOWLS, CUPS, MUGS (U.S. CLS. 2, 13, 23, 29, 30, 33, 40 AND 50).
APRIL L. RADEMACHER, EXAMINING ATTORNEY

SN 78-298,740. TRIMACO, LLC, DURHAM, NC. FILED 9-10-2003.

TRIMACO**CLASS 8—HAND TOOLS**

FOR CAULKING GUNS (U.S. CLS. 23, 28 AND 44).

SN 78-294,116. BLOOMBERG L.P., NEW YORK, NY. FILED 8-29-2003.

READ. WHEREVER YOU ARE.**CLASS 16—PAPER GOODS AND PRINTED MATTER**

FOR PUBLICATIONS, NAMELY, REPORTS, DIRECTORIES, BROCHURES, LEAFLETS, NEWSLETTERS, BOOKLETS, PAMPHLETS, POST CARDS, FLYERS, MAGAZINE SUPPLEMENTS TO NEWSPAPERS, MAGAZINES AND TRADE AND PROFESSIONAL BOOKS IN THE FIELDS OF NEWS, BUSINESS, FINANCE, CURRENT EVENTS, ENTERTAINMENT, SPORTS, HUMAN INTEREST STORIES, SECURITIES, SECURITIES MARKETS AND THE ENERGY AND ASPHALT INDUSTRIES (U.S. CLS. 2, 5, 22, 23, 29, 37, 38 AND 50).

FIRST USE 4-2-2003; IN COMMERCE 4-2-2003.

CLASS 41—EDUCATION AND ENTERTAINMENT

FOR NEWS AGENCIES AND NEWS REPORTING SERVICES, NAMELY, GATHERING AND DISSEMINATION OF NEWS BY COMPUTER; COMPUTER SERVICES, NAMELY, PROVIDING ON-LINE PUBLICATIONS IN THE NATURE OF REPORTS, DIRECTORIES, BROCHURES, REFERENCE MATERIALS, LEAFLETS, NEWSLETTERS, NEWSPAPERS, BOOKLETS, PAMPHLETS, POST CARDS, FLYERS, MAGAZINE SUPPLEMENTS TO NEWSPAPERS, MAGAZINES AND TRADE AND PROFESSIONAL BOOKS IN THE FIELDS OF NEWS, BUSINESS, FINANCE, CURRENT EVENTS, ENTERTAINMENT, SPORTS, HUMAN INTEREST STORIES, SECURITIES, SECURITIES MARKETS AND THE ENERGY AND ASPHALT INDUSTRIES (U.S. CLS. 100, 101 AND 107).

FIRST USE 4-2-2003; IN COMMERCE 4-2-2003.
CHERYL STEPLIGHT, EXAMINING ATTORNEY

CLASS 9—ELECTRICAL AND SCIENTIFIC APPARATUS

FOR PROTECTIVE WORK GLOVES; SAFETY GOGGLES; DUST MASKS AND PROTECTIVE MASKS (U.S. CLS. 21, 23, 26, 36 AND 38).

CLASS 16—PAPER GOODS AND PRINTED MATTER

FOR PAPER PRODUCTS, NAMELY, CONTRACTOR PAPER; PAPER DROP CLOTHS; KRAFT PAPER; CONSTRUCTION PAPER; BUTCHER PAPER; AND BANNER TAPES IN THE NATURE OF PRINTED PAPER SIGNS; PAINTING SUNDRIES, NAMELY, STAINING PADS, STAINING CLOTH APPLICATORS, DISPOSABLE WIPES NOT IMPREGNATED WITH CHEMICALS; PAINT TRAYS, PAINT TRAY LINERS, PAINT ROLLER FRAMES, SPONGES FOR PAINTING; RAGS USED AS PAINT OR STAIN APPLICATORS (U.S. CLS. 2, 5, 22, 23, 29, 37, 38 AND 50).

CLASS 17—RUBBER GOODS

FOR PLASTIC DROP CLOTHS; MASKING TAPE (U.S. CLS. 1, 5, 12, 13, 35 AND 50).

CLASS 21—HOUSEWARES AND GLASS

FOR RAGS FOR CLEANING, DISPOSABLE GLOVES FOR GENERAL USE, SPONGES FOR HOUSEHOLD PURPOSES, PAINT STRAINERS, PAPER TOWER DISPENSERS, BUCKETS, PAILS, CORNER GUARDS, AND WIRE BRUSHES, NOT BEING MACHINE PARTS (U.S. CLS. 2, 13, 23, 29, 30, 33, 40 AND 50).

CLASS 22—CORDAGE AND FIBERS

FOR CANVAS DROP CLOTHS (U.S. CLS. 1, 2, 7, 19, 22, 42 AND 50).

CLASS 24—FABRICS

FOR TACK CLOTHS USED TO PREPARE SURFACES FOR PAINTING, SHOP TOWELS, PAINTERS' TOWELS AND CHEESE CLOTH (U.S. CLS. 42 AND 50).

CLASS 25—CLOTHING

FOR PAINTER'S APPAREL, NAMELY, OVERALLS, COVERALLS, SHOE AND BOOT GUARDS, SPRAY SOCKS, PAINTERS' MITTS, SPRAY HOODS, GLOVES, APRONS, SHIRTS, PAINTER PANTS AND SHORTS, VESTS, HATS, AND PAINTERS' JACKETS (U.S. CLS. 22 AND 39).

PAULA MAHONEY, EXAMINING ATTORNEY

SN 78-299,149, KABUSHIKI KAISHA SQUARE ENIX, TA SQUARE ENIX CO., LTD., TOKYO, JAPAN, FILED 9-11-2003.

STAR OCEAN

OWNER OF U.S. REG. NO. 2,434,644.

CLASS 9—ELECTRICAL AND SCIENTIFIC APPARATUS

FOR COMPUTER GAME SOFTWARE; VIDEO GAME SOFTWARE; SOUND RECORDINGS IN THE FORM OF OPTICAL DISCS, MAGNETIC DISCS AND OTHER STORAGE MEDIA FEATURING MUSIC AND/OR ENTERTAINMENT; AUDIO VISUAL RECORDINGS IN THE FORM OF OPTICAL DISCS AND OTHER STORAGE MEDIA FEATURING MUSIC, ANIMATION AND/OR ENTERTAINMENT; PRERECORDED COMPACT DISCS FEATURING MUSIC; PRERECORDED DIGITAL VIDEO DISCS FEATURING MUSIC, ANIMATION AND/OR ENTERTAINMENT; PRERECORDED VIDEO CASSETTES FEATURING MUSIC, ANIMATION AND/OR ENTERTAINMENT; DECORATIVE MAGNETS; MOUSE PADS; STRAPS FOR CELLULAR PHONES; SUNGLASSES; MEMORY CARDS; MEMORY CARD CASES; CD CASES; KEYBOARDS; JOYSTICKS; VIDEO GAME CONTROLLERS; DOWNLOADABLE COMPUTER GRAPHICS; DOWNLOADABLE ANIMATION; DOWNLOADABLE MUSIC; DOWNLOADABLE ELECTRONIC PUBLICATIONS IN THE FIELD OF VIDEO GAMES; ELECTRONIC PUBLICATIONS RECORDED ON COMPUTER MEDIA, IN THE FIELD OF VIDEO GAMES (U.S. CLS. 21, 23, 26, 36 AND 38).

CLASS 16—PAPER GOODS AND PRINTED MATTER

FOR COMPUTER GAME STRATEGY GUIDEBOOKS; VIDEO GAME STRATEGY GUIDEBOOKS; SERIES OF BOOKS FEATURING FICTIONAL STORIES; COMPUTER GRAPHIC ART BOOKS; MUSICAL SCORE BOOKS; COMIC BOOKS; MAGAZINES FEATURING COMPUTER GAMES AND VIDEO GAMES; POSTERS; STICKERS; PAPER BANNERS; CALENDARS; POSTCARDS; TRADING CARDS; PHOTOGRAPHS; PHOTOGRAPH STANDS; STATIONERY (U.S. CLS. 2, 5, 22, 23, 29, 37, 38 AND 50).

THEODORE MCBRIDE, EXAMINING ATTORNEY

SN 78-299,850, ALPHA 6 DISTRIBUTIONS, LLC, PORT WASHINGTON, NY, FILED 9-12-2003.

ALLYANCE**CLASS 25—CLOTHING**

FOR MEN'S, WOMEN'S AND CHILDREN'S CLOTHING AND APPAREL, NAMELY, SKI JACKETS, ONE-PIECE SKI SUITS, SKI PANTS; SWEATERS, HATS, SHORTS, PANTS, T-SHIRTS, KNIT SHIRTS, INSULATED BOMBER JACKETS, PARKAS, UNFILLED SHELL JACKETS, DOWN-FILLED JACKETS, INSULATED PANTS AND SHELL PANTS; NAMELY, DOWN-FILLED JACKETS AND POLYESTER-FILLED JACKETS; SKIWEAR, NAMELY, BOOTS, GLOVES AND HEADWEAR; INCLEMENT WEATHER AND SKI APPAREL, NAMELY, JACKETS, PANTS, BIB OVERALLS AND SHIRTS; SHORTS; SWIMWEAR (U.S. CLS. 22 AND 39).

FIRST USE 1-0-2004; IN COMMERCE 1-0-2004.

CLASS 28—TOYS AND SPORTING GOODS

FOR SURFBOARD BAGS, SNOWBOARD BAGS (U.S. CLS. 22, 23, 38 AND 50).

FIRST USE 1-0-2004; IN COMMERCE 1-0-2004.
SOPHIA S. KIM, EXAMINING ATTORNEY

SN 78-300,080. CORE FLOW LTD., YOQNEAM ILIT, ISRAEL,
FILED 9-14-2003.

COREFLOW

PRIORITY CLAIMED UNDER SEC. 44(D) ON ISRAEL
APPLICATION NO. 163328, FILED 3-17-2003, REG. NO.
163328, DATED 3-3-2004, EXPIRES 3-17-2010.

PRIORITY CLAIMED UNDER SEC. 44(D) ON ISRAEL
APPLICATION NO. 163329, FILED 3-17-2003, REG. NO.
163329, DATED 3-3-2004, EXPIRES 3-17-2010.

CLASS 7—MACHINERY

FOR LIFTING AND GRIPPING MACHINES AND PARTS AND FITTINGS THEREOF FOR INDUSTRIAL USE, NAMELY, ASSEMBLY, MANUFACTURING, INSPECTION AND MONITORING OF PRODUCTION PROCESSES IN THE SEMICONDUCTOR, PRINTING, FLAT PANEL DISPLAY, COMPUTER HARDWARE AND PRINTED CIRCUIT BOARD INDUSTRIES; VACUUM OPERATED MACHINES AND PARTS AND FITTINGS THEREOF FOR INDUSTRIAL USE, NAMELY, ASSEMBLY, MANUFACTURING, INSPECTION AND MONITORING OF PRODUCTION PROCESSES IN THE SEMICONDUCTOR, PRINTING, FLAT PANEL DISPLAY, COMPUTER HARDWARE AND PRINTED CIRCUIT BOARD INDUSTRIES; SEMICONDUCTOR WAFER PROCESSING MACHINES AND PARTS AND FITTINGS THEREOF FOR INDUSTRIAL USE; SEMICONDUCTOR WAFER PROCESSING MACHINES AND PARTS AND FITTINGS THEREOF FOR ASSEMBLY, MANUFACTURE, INSPECTION AND MONITORING PRODUCTION PROCESSES OF PRINTED CIRCUIT BOARDS, SEMICONDUCTORS, FLAT PANEL DISPLAYS AND WAFERS; VACUUM CLAMPING CHUCKS FOR INDUSTRIAL USE, NAMELY, ASSEMBLY, MANUFACTURING, INSPECTION AND MONITORING OF PRODUCTION PROCESSES IN THE SEMICONDUCTOR, PRINTING, FLAT PANEL DISPLAYS, COMPUTER HARDWARE AND PRINTED CIRCUIT BOARD INDUSTRIES; WAFER CHUCKS FOR INDUSTRIAL USE, NAMELY, ASSEMBLY, MANUFACTURING, INSPECTION AND MONITORING OF PRODUCTION PROCESSES IN THE SEMICONDUCTOR, PRINTING, FLAT PANEL DISPLAY, COMPUTER HARDWARE AND PRINTED CIRCUIT BOARD INDUSTRIES; VACUUM WAFER CHUCK WITH ADAPTIVE PADS FOR INDUSTRIAL USE, NAMELY, ASSEMBLY, MANUFACTURING, INSPECTION AND MONITORING OF PRODUCTION PROCESSES IN THE SEMICONDUCTOR, PRINTING, FLAT PANEL DISPLAY, COMPUTER HARDWARE AND PRINTED CIRCUIT BOARD INDUSTRIES (U.S. CLS. 13, 19, 21, 23, 31, 34 AND 35).

CLASS 9—ELECTRICAL AND SCIENTIFIC APPARATUS

FOR SILICON WAFERS, SEMICONDUCTOR WAFERS, GLASS SUBSTRATES FOR LIQUID-CRYSTAL DISPLAY, GLASS SUBSTRATE FOR FLAT DISPLAY, FLAT PANEL DISPLAYS, FLAT PANEL DISPLAY GLASS SUBSTRATES (U.S. CLS. 21, 23, 26, 36 AND 38).
ELIZABETH PIGNATELLO, EXAMINING ATTORNEY

SN 78-300,357. FORMULA IMPRESSIONS CORP., ST. LOUIS,
MO. FILED 9-15-2003.

BOWLINGSHIRT.COM

SEC. 2(F).

CLASS 25—CLOTHING

FOR T-SHIRTS, SKIRTS, JACKETS, SWEATERS, SHOES (U.S. CLS. 22 AND 39).
FIRST USE 12-31-1995; IN COMMERCE 12-31-1998.

CLASS 35—ADVERTISING AND BUSINESS

FOR ON-LINE RETAIL STORE SERVICES FEATURING T-SHIRTS, SKIRTS, JACKETS, SWEATERS, SHOES, TOWELS, SUNGLASSES, CLOTHING PATCHES, BOWLING BALLS, BOWLING BALL BAGS, PURSES, GLASSWARE, MUGS, DRINK SHAKERS, GAMES, BOOKS, MUSIC MEMORABILIA, ASH TRAYS, PAPER WEIGHTS, LAMPS, PICTURE FRAMES, CANDLES, CIGARETTE LIGHTERS, NOVELTY STREET SIGNS (U.S. CLS. 100, 101 AND 102).

FIRST USE 12-31-1997; IN COMMERCE 12-31-1998.
VIVIAN MICZNIK FIRST, EXAMINING ATTORNEY

SN 78-300,586. KABUSHIKI KAISHA AUTOBACS SEVEN,
DBA AUTOBACS SEVEN CO., LTD., TOKYO, JAPAN,
FILED 9-15-2003.

SUPERAUTOBACS

OWNER OF U.S. REG. NOS. 1,212,899, 2,227,628 AND
2,464,267.

CLASS 2—PAINTS

FOR MINERAL-BASED AND NON-MINERAL BASED ANTI-RUST GREASES (U.S. CLS. 6, 11 AND 16).

CLASS 4—LUBRICANTS AND FUELS

FOR LEATHER PRESERVING OIL AND GREASE; NON-FUEL MINERAL OILS FOR INDUSTRIAL PURPOSES; MINERAL-BASED AND NON-MINERAL BASED GREASES FOR INDUSTRIAL MACHINES; NON-MINERAL BASED OILS FOR INDUSTRIAL PURPOSES THAT ARE NOT FOR FUEL USE; SOLID FUELS, NAMELY, JELLED ALCOHOL; LIQUID FUELS FOR USE IN MOTOR VEHICLES, NAMELY, GASOLINE, DIESEL; GASEOUS FUELS, NAMELY, PROPANE; SOLID LUBRICANTS FOR INDUSTRIAL MACHINERY (U.S. CLS. 1, 6 AND 15).

CLASS 7—MACHINERY

FOR UNLOADING TIPPLES NAMELY, MACHINES FOR TILTING RAILWAY FREIGHT CARS IN ORDER TO UNLOAD FREIGHT CAR CONTENTS (U.S. CLS. 13, 19, 21, 23, 31, 34 AND 35).

CLASS 9—ELECTRICAL AND SCIENTIFIC APPARATUS

FOR TELECOMMUNICATION MACHINES AND APPARATUS, NAMELY TELEVISION RECEIVERS, TELEVISION SETS, TELEVISION TRANSMITTERS, RADIO RECEIVERS; RADIO TRANSMITTERS; RADIOS FOR LAND VEHICLES; RADIO BEACON MACHINES AND APPARATUS, NAMELY, EMERGENCY RADIO SIGNAL TRANSMITTERS; ELECTRIC NAVIGATIONAL INSTRUMENTS, NAMELY, RADIO DIRECTION FINDERS; RADAR MACHINES AND APPARATUS; AUDIO FREQUENCY MACHINES AND APPARATUS, NAMELY, AUDIO FREQUENCY METERS AND CONVERTERS; PUBLIC-ADDRESS SYSTEMS AND INSTRUMENTS; COMPACT DISC PLAYERS; TAPE RECORDERS; ELECTRIC PHONOGRAPHS; RECORD PLAYERS; SOUND RECORDING APPARATUS AND INSTRUMENTS; VIDEO CAMERAS; VIDEODISC PLAYERS; VIDEOTAPE RECORDERS; AERIAL ANTENNAS; LOUDSPEAKERS; BLANK MAGNETIC TAPES FOR TAPE RECORDERS; BLANK VIDEO TAPES; CLEANING APPARATUS FOR PHONOGRAPH RECORDS; ELECTRONIC MACHINES, APPARATUS AND THEIR PARTS, NAMELY MAGNETIC OBJECT DETECTORS; VEHICLE BREAKDOWN WARNING TRIANGLES; ANTI-THEFT WARNING APPARATUS, NAMELY, BURGLAR ALARMS; ELECTRIC CIGAR AND CIGARETTE LIGHTERS FOR AUTOMOBILES; GASOLINE STATION EQUIPMENT, NAMELY TIRE PRESSURE GAUGES WITH WARNING LIGHTS TO INDICATE A DECREASE IN TIRE PRESSURE (U.S. CLS. 21, 23, 26, 36 AND 38).

CLASS 12—VEHICLES

FOR AUTOMOBILES AND THEIR STRUCTURAL PARTS AND MOTORS THEREFOR; AUTOMOBILE ACCESSORIES, NAMELY, AUTOMOBILE SEAT CUSHIONS; TWO-WHEELED MOTOR VEHICLES, NAMELY, BICYCLES, MOTORCYCLES, MOPEDS AND MOTORIZED SCOOTERS AND STRUCTURAL PARTS THEREFOR; BICYCLES AND BICYCLE PARTS, NAMELY BRAKES, CHAINS, HANDLE BARS; MOBILE RAILS CAR MOVERS FOR PUSHING AND PULLING MINE CARS; ROAD LOCOMOTIVES, NAMELY, TRACTION ENGINES; TORQUE CONVERTERS FOR LAND VEHICLES, NAMELY, NON-ELECTRIC PRIME MOVERS; AXLE BEARINGS AND WHEEL BEARINGS FOR LAND VEHICLES; POWER TRANSMISSIONS AND DRIVE GEARS FOR LAND VEHICLES; AC OR DC MOTORS FOR LAND VEHICLES; ADHESIVE RUBBER PATCHES FOR REPAIRING TUBES OR TIRES; ANTI-THEFT ALARMS FOR VEHICLES; MOTOR VEHICLE ALARM SYSTEMS, NAMELY, TIRE AIR PRESSURE DECREASE ALARM EQUIPMENT (U.S. CLS. 19, 21, 23, 31, 35 AND 44).

CLASS 17—RUBBER GOODS

FOR PLASTIC FILM FOR INDUSTRIAL AND COMMERCIAL PACKING USE, NAMELY, PLASTIC FILM FOR PROTECTING THE BODY OF AN AUTOMOBILE IN TRANSIT (U.S. CLS. 1, 5, 12, 13, 35 AND 50).

CLASS 24—FABRICS

FOR OILCLOTH (U.S. CLS. 42 AND 50).

CLASS 35—ADVERTISING AND BUSINESS

FOR ADVERTISING AGENCIES AND PUBLICITY AGENTS; MARKETING RESEARCH; PROVIDING INFORMATION, ANALYSIS AND GUIDANCE ON BUSINESS MANAGEMENT; RETAIL STORE SERVICES FEATURING ACCESSORIES FOR AUTOMOBILES; ALL ABOVE-MENTIONED SERVICES IN THE FIELD OF AUTOMOTIVE INDUSTRY (U.S. CLS. 100, 101 AND 102).

CLASS 36—INSURANCE AND FINANCIAL

FOR PROVIDING INFORMATION, ANALYSIS AND GUIDANCE ON COMMODITY EXCHANGE (U.S. CLS. 100, 101 AND 102).

CLASS 37—CONSTRUCTION AND REPAIR

FOR CAR WASHING; AUTOMOBILE SERVICE STATION SERVICES; REPAIR OF BICYCLES; REPAIR AND MAINTENANCE OF AUTOMOBILES, TWO-WHEELED MOTOR VEHICLES, GASOLINE STATION EQUIPMENT, NAMELY METERED GASOLINE PUMPS; RENTAL OF CAR-WASHING APPARATUS (U.S. CLS. 100, 103 AND 106).

NELSON SNYDER, EXAMINING ATTORNEY

SN 78-300,591. KABUSHIKI KAISHA AUTOBACS SEVEN, DBA AUTOBACS SEVEN CO., LTD., TOKYO, JAPAN, FILED 9-15-2003.



OWNER OF U.S. REG. NOS. 1,212,899, 2,227,628 AND 2,464,267.

NO CLAIM IS MADE TO THE EXCLUSIVE RIGHT TO USE "CAR", APART FROM THE MARK AS SHOWN.

CLASS 2—PAINTS

FOR MINERAL-BASED AND NON-MINERAL BASED ANTI-RUST GREASES (U.S. CLS. 6, 11 AND 16).

CLASS 4—LUBRICANTS AND FUELS

FOR LEATHER PRESERVING OIL AND GREASE; NON-FUEL MINERAL OILS FOR INDUSTRIAL PURPOSES; MINERAL-BASED AND NON-MINERAL BASED GREASES FOR INDUSTRIAL MACHINES; NON-MINERAL BASED OILS FOR INDUSTRIAL PURPOSES THAT ARE NOT FOR FUEL USE; SOLID FUELS, NAMELY, JELLED ALCOHOL; LIQUID FUELS FOR USE IN MOTOR VEHICLES, NAMELY, GASOLINE, DIESEL; GASEOUS FUELS, NAMELY, PROPANE; SOLID LUBRICANTS FOR INDUSTRIAL MACHINERY (U.S. CLS. 1, 6 AND 15).

CLASS 7—MACHINERY

FOR UNLOADING TIPPLES NAMELY, MACHINES FOR TILTING RAILWAY FREIGHT CARS IN ORDER TO UNLOAD FREIGHT CAR CONTENTS (U.S. CLS. 13, 19, 21, 23, 31, 34 AND 35).

CLASS 9—ELECTRICAL AND SCIENTIFIC APPARATUS

FOR TELECOMMUNICATION MACHINES AND APPARATUS, NAMELY TELEVISION RECEIVERS, TELEVISION SETS, TELEVISION TRANSMITTERS, RADIO RECEIVERS; RADIO TRANSMITTERS; RADIOS FOR LAND VEHICLES; RADIO BEACON MACHINES AND APPARATUS, NAMELY, EMERGENCY RADIO SIGNAL TRANSMITTERS; ELECTRIC NAVIGATIONAL INSTRUMENTS, NAMELY, RADIO DIRECTION FINDERS; RADAR MACHINES AND APPARATUS; AUDIO FREQUENCY MACHINES AND APPARATUS, NAMELY, AUDIO FREQUENCY METERS AND CONVERTERS; PUBLIC-ADDRESS SYSTEMS AND INSTRUMENTS; COMPACT DISC PLAYERS; TAPE RECORDERS; ELECTRIC PHONOGRAPHS; RECORD PLAYERS; SOUND RECORDING APPARATUS AND INSTRUMENTS; VIDEO CAMERAS; VIDEODISC PLAYERS; VIDEOTAPE RECORDERS; AERIAL ANTENNAS; LOUDSPEAKERS; BLANK MAGNETIC TAPES FOR TAPE RECORDERS; BLANK VIDEO TAPES; CLEANING APPARATUS FOR PHONOGRAPH RECORDS; ELECTRONIC MACHINES, APPARATUS AND THEIR PARTS, NAMELY MAGNETIC OBJECT DETECTORS; VEHICLE BREAKDOWN WARNING TRIANGLES; ANTI-THEFT WARNING APPARATUS, NAMELY, BURGLAR ALARMS; ELECTRIC CIGAR AND CIGARETTE LIGHTERS FOR AUTOMOBILES; GASOLINE STATION EQUIPMENT, NAMELY TIRE PRESSURE GAUGES WITH WARNING LIGHTS TO INDICATE A DECREASE IN TIRE PRESSURE (U.S. CLS. 21, 23, 26, 36 AND 38).

CLASS 12—VEHICLES

FOR AUTOMOBILES AND THEIR STRUCTURAL PARTS AND MOTORS THEREFOR; AUTOMOBILE ACCESSORIES, NAMELY, AUTOMOBILE SEAT CUSHIONS; TWO-WHEELED MOTOR VEHICLES, NAMELY, BICYCLES, MOTORCYCLES, MOPEDS AND MOTORIZED SCOOTERS AND STRUCTURAL PARTS THEREFOR; BICYCLES AND BICYCLE PARTS, NAMELY BRAKES, CHAINS, HANDLE BARS; MOBILE RAILS CAR MOVERS FOR PUSHING AND PULLING MINE CARS; ROAD LOCOMOTIVES, NAMELY, TRACTION ENGINES; TORQUE CONVERTERS FOR LAND VEHICLES, NAMELY, NON-ELECTRIC PRIME MOVERS; AXLE BEARINGS AND WHEEL BEARINGS FOR LAND VEHICLES; POWER TRANSMISSIONS AND DRIVE GEARS FOR LAND VEHICLES; AC OR DC MOTORS FOR LAND VEHICLES; ADHESIVE RUBBER PATCHES FOR REPAIRING TUBES OR TIRES; ANTI-THEFT ALARMS FOR VEHICLES; MOTOR VEHICLE ALARM SYSTEMS, NAMELY, TIRE AIR PRESSURE DECREASE ALARM EQUIPMENT (U.S. CLS. 19, 21, 23, 31, 35 AND 44).

CLASS 17—RUBBER GOODS

FOR PLASTIC FILM FOR INDUSTRIAL AND COMMERCIAL PACKING USE, NAMELY, PLASTIC FILM FOR PROTECTING THE BODY OF AN AUTOMOBILE IN TRANSIT (U.S. CLS. 1, 5, 12, 13, 35 AND 50).

CLASS 24—FABRICS

FOR OILCLOTH (U.S. CLS. 42 AND 50).

CLASS 35—ADVERTISING AND BUSINESS

FOR ADVERTISING AGENCIES AND PUBLICITY AGENTS; MARKETING RESEARCH; PROVIDING INFORMATION, ANALYSIS AND GUIDANCE ON BUSINESS MANAGEMENT; RETAIL STORE SERVICES FEATURING ACCESSORIES FOR AUTOMOBILES; ALL ABOVE-MENTIONED SERVICES IN THE FIELD OF AUTOMOTIVE INDUSTRY (U.S. CLS. 100, 101 AND 102).

CLASS 36—INSURANCE AND FINANCIAL

FOR PROVIDING INFORMATION, ANALYSIS AND GUIDANCE ON COMMODITY EXCHANGE (U.S. CLS. 100, 101 AND 102).

CLASS 37—CONSTRUCTION AND REPAIR

FOR CAR WASHING; AUTOMOBILE SERVICE STATION SERVICES; REPAIR OF BICYCLES; REPAIR AND MAINTENANCE OF AUTOMOBILES, TWO-WHEELED MOTOR VEHICLES, GASOLINE STATION EQUIPMENT, NAMELY METERED GASOLINE PUMPS; RENTAL OF CAR-WASHING APPARATUS (U.S. CLS. 100, 103 AND 106).

NELSON SNYDER, EXAMINING ATTORNEY

SN 78-301,358. TILSIT EDITIONS, VILLEJUST, FRANCE, FILED 9-17-2003.

TILSIT

OWNER OF FRANCE REG. NO. 033216502, DATED 3-21-2003, EXPIRES 3-21-2013.

CLASS 16—PAPER GOODS AND PRINTED MATTER

FOR STATIONERY PRODUCTS, NAMELY, BUSINESS CARDS; GREETING CARDS; LOOSE-LEAF FILES, NAMELY FILE FOLDERS; FILE CARDS; FILE SORTERS; LETTER FILES; ADHESIVE FOR STATIONERY OR HOUSEHOLD PURPOSES; POSTERS; STAPLES; DESK PADS; WRITING PADS; CALENDARS; ENVELOPES; NOTEBOOKS; WRITING SUPPLIES, NAMELY WRITING INSTRUMENTS, WRITING INK, WRITING PAPER, WRITING TABLETS; SHEETS NAMELY PAPER SHEETS FOR WRITING; PRINTS; MAGAZINES, BOOKS, EDUCATIONAL BOOKS, AND REVIEWS IN THE FIELD OF GAMES (U.S. CLS. 2, 5, 22, 23, 29, 37, 38 AND 50).

CLASS 28—TOYS AND SPORTING GOODS

FOR GAMES NAMELY BOARD AND PARLOUR GAMES; JIGSAW PUZZLES, PLAYING CARDS, COLLECTIBLE CARD GAMES, TAROT CARD GAMES; TACTICAL AND STRATEGICAL GAMES NAMELY TRIVIA GAMES, ROLE PLAYING GAMES, COLLECTIBLE MINIATURE BOARD GAMES (U.S. CLS. 22, 23, 38 AND 50).

CLASS 41—EDUCATION AND ENTERTAINMENT

FOR PUBLICATION OF BOOKS, REVIEWS AND MAGAZINES, TEXT BOOK PUBLISHING OTHER THAN ADVERTISING AND PROMOTIONAL TEXTS (U.S. CLS. 100, 101 AND 107).

KELLY BOULTON, EXAMINING ATTORNEY

SN 78-302,885. FUDGEN, WENDELL, SAN LEANDRO, CA, FILED 9-19-2003.

STATUE OF RESPONSIBILITY

NO CLAIM IS MADE TO THE EXCLUSIVE RIGHT TO USE "STATUE", APART FROM THE MARK AS SHOWN.

CLASS 6—METAL GOODS

FOR STATUES OF NON-PRECIOUS METAL (U.S. CLS. 2, 12, 13, 14, 23, 25 AND 50).

CLASS 14—JEWELRY

FOR STATUES OF PRECIOUS METALS (U.S. CLS. 2, 27, 28 AND 50).

CLASS 19—NON-METALLIC BUILDING MATERIALS

FOR STATUES OF STONE, CONCRETE OR MARBLE (U.S. CLS. 1, 12, 33 AND 50).

CLASS 20—FURNITURE AND ARTICLES NOT OTHERWISE CLASSIFIED

FOR STATUES OF BONE, IVORY, PLASTER, PLASTIC, WAX OR WOOD (U.S. CLS. 2, 13, 22, 25, 32 AND 50).

CLASS 21—HOUSEWARES AND GLASS

FOR STATUES OF CHINA, CRYSTAL, EARTHENWARE, GLASS, PORCELAIN OR TERRA COTTA (U.S. CLS. 2, 13, 23, 29, 30, 33, 40 AND 50).

MATTHEW KLINE, EXAMINING ATTORNEY

CLASS 36—INSURANCE AND FINANCIAL

FOR CHARITABLE FUNDRAISING SERVICES FOR PROMOTING RESEARCH, EDUCATION AND OTHER ACTIVITIES RELATING TO CARDIOVASCULAR HEALTH, FITNESS AND NUTRITION, AND/OR THE PREVENTION OR REDUCTION OF CARDIOVASCULAR DISEASE AND STROKE; CHARITABLE FUNDRAISING IN THE FIELD OF CARDIOVASCULAR HEALTH IN THE NATURE OF MEMORIAL DONATIONS; CHARITABLE FUNDRAISING SERVICES IN CONNECTION WITH CARDIOVASCULAR HEALTH AWARENESS (U.S. CLS. 100, 101 AND 102).

CLASS 38—COMMUNICATION

FOR OPERATING AN INTERNET WEB SITE PROVIDING CHAT ROOMS AND BULLETIN BOARDS FOR THE TRANSMISSION OF MESSAGES, AND ONLINE CONFERENCING SERVICES, ALL IN THE FIELD OF CARDIOVASCULAR DISEASE AND HEALTH (U.S. CLS. 100, 101 AND 104).

CLASS 41—EDUCATION AND ENTERTAINMENT

FOR EDUCATION SERVICES, NAMELY, CONDUCTING SEMINARS IN CONNECTION WITH WOMEN'S RISK OF CARDIOVASCULAR DISEASE AND ITS PREVENTION; CONTINUING EDUCATION FOR HEALTHCARE PROFESSIONALS, PATIENT EDUCATION PROGRAMS; AND CONDUCTING PUBLIC PARTICIPATION EVENTS, ALL TO PROMOTE AWARENESS OF CARDIOVASCULAR HEALTH, FITNESS AND NUTRITION (U.S. CLS. 100, 101 AND 107).

CLASS 44—MEDICAL, BEAUTY AND AGRICULTURAL SERVICES

FOR CONDUCTING SCREENINGS FOR CARDIOVASCULAR DISEASE RISK FACTORS; PROVIDING INTERACTIVE ONLINE RESOURCE INFORMATION AND MATERIALS VIA A GLOBAL COMPUTER NETWORK RELATING TO CARDIOVASCULAR HEALTH, FITNESS, AND NUTRITION, AND/OR THE PREVENTION OR REDUCTION OF CARDIOVASCULAR DISEASE AND STROKE; OPERATING AN INTERNET WEBSITE PROVIDING INFORMATION IN THE FIELD OF CARDIOVASCULAR DISEASE AND HEALTH THAT MAY BE DOWNLOADED TO DVD'S, PDA'S, PERSONAL COMPUTERS, AND/OR PRINT (U.S. CLS. 100 AND 101).

GWEN STOKOLS, EXAMINING ATTORNEY

SN 78-302,957. AMERICAN HEART ASSOCIATION, INC., DALLAS, TX. FILED 9-19-2003.

GO RED FOR WOMEN**CLASS 14—JEWELRY**

FOR JEWELRY, NAMELY, PINS, CHARMS, PENDANTS, CUFF LINKS, AND MEDALLIONS (U.S. CLS. 2, 27, 28 AND 50).

CLASS 16—PAPER GOODS AND PRINTED MATTER

FOR PRINTED AND ELECTRONIC MEDIA EDUCATIONAL MATERIALS, NAMELY, BOOKS, PAMPHLETS, BROCHURES, AND BOOKLETS, POSTERS, WALLET CARDS, AND BOOK MARKS RELATING TO PREVENTION OF CARDIOVASCULAR DISEASE IN WOMEN; AND KITS COMPRISING POSTERS, ABRIDGED/DIGEST VERSION OF TREATMENT GUIDELINES, PERSONALIZED APPOINTMENT REMINDER CARDS, PATIENT EDUCATION BOOKLETS, INTERNET ACCESS AND DOWNLOADING INSTRUCTIONS, PINS, BROCHURES, WALLET CARDS AND BOOKMARKS, RELATING TO PREVENTION OF CARDIOVASCULAR DISEASE IN WOMEN (U.S. CLS. 2, 5, 22, 23, 29, 37, 38 AND 50).

CLASS 35—ADVERTISING AND BUSINESS

FOR PROMOTING PUBLIC AWARENESS TO EDUCATE WOMEN REGARDING THE RISK AND PREVENTION OF CARDIOVASCULAR DISEASE, BY MEANS OF CONDUCTING PUBLIC RELATIONS/MEDIA CAMPAIGNS CONSISTING OF AUDIO AND VIDEO NEWS RELEASES, MORNING TALK SHOWS, CELEBRITY SPOKESPERSON, SATELLITE MEDIA TOURS, DESK SIDE INTERVIEWS, ADVERTISING, CONDUCTING LOBBYING AND ADVOCACY PROGRAMS RELATING TO CARDIOVASCULAR HEALTH AND DISEASE AND ITS RISKS AND PREVENTION; CONDUCTING SURVEYS OF WOMEN RELATING TO CARDIOVASCULAR HEALTH AND CARDIOVASCULAR DISEASE (U.S. CLS. 100, 101 AND 102).

SN 78-304,574. VITERRA ENERGY SERVICES GMBH & CO. KG, ESSEN, FED REP GERMANY, FILED 9-24-2003.

ISTA

OWNER OF FED REP GERMANY REG. NO. 1000148, DATED 4-1-1980, EXPIRES 4-30-2009.
OWNER OF U.S. REG. NO. 1,138,633.

CLASS 35—ADVERTISING AND BUSINESS

FOR RECORDATION OF CONSUMPTION VALUE AND BILLING OF HEAT, COLD AND WARM WATER COSTS, AND OTHER HOUSEHOLD INCIDENTAL COSTS, NAMELY, UTILITY BILL MANAGEMENT SERVICES, CONSISTING OF TRACKING, REPORTING, ANALYZING AND DELIVERING ENERGY INFORMATION IN THE FORM OF UTILITY BILLS AND UTILITY METER DATA RATE SCHEDULES (U.S. CLS. 100, 101 AND 102).

CLASS 36—INSURANCE AND FINANCIAL

FOR INSTALLMENT PURCHASE, NAMELY, LEASE-PURCHASE FINANCING OF EQUIPMENT, SPECIFICALLY, WATER FILTERS, PROPORTIONING EQUIPMENT FOR WATER TREATMENT AND SOFTENING OF WATER, WATER METERS, HEATING COST DISTRIBUTORS, WARM WATER COST DISTRIBUTORS, HEAT METERS, HEATING THERMOSTATS, THERMOSTAT VALVES, ACTUATORS FOR WATER VALVES, AND HEAT METERS (U.S. CLS. 100, 101 AND 102).

SN 78-306,266. QUANTA CAPITAL HOLDINGS LTD., HAMILTON, BERMUDA, FILED 9-26-2003.

CLASS 37—CONSTRUCTION AND REPAIR

FOR MAINTENANCE OF HEAT METERS, WARM AND COLD WATER METERS; MAINTENANCE OF THE EQUIPMENT FOR COMMERCIAL USE, SPECIFICALLY, WATER FILTERS, PROPORTIONING EQUIPMENT FOR WATER TREATMENT AND SOFTENING OF WATER, WATER METERS, HEATING COST DISTRIBUTORS, WARM WATER COST DISTRIBUTORS, HEAT METERS, HEATING THERMOSTATS, THERMOSTAT VALVES, AND ACTUATORS FOR WATER VALVES, HEAT METERS (U.S. CLS. 100, 103 AND 106).

CLASS 36—INSURANCE AND FINANCIAL

FOR INSURANCE AND REINSURANCE UNDERWRITING SERVICES FOR ALL TYPES OF INSURANCE; RISK MANAGEMENT, ASSESSMENT, ANALYSIS AND CONSULTING SERVICES; ENVIRONMENTAL FINANCIAL RISK CONSULTING AND ASSESSMENT; ENVIRONMENTAL INFORMATION MANAGEMENT SERVICES, NAMELY, COLLECTING, COMPILING, MONITORING, MANAGING, ANALYZING, DISTRIBUTING AND REPORTING INFORMATION RELATED TO AND TO ASSIST WITH ENVIRONMENTAL FINANCIAL RISK MANAGEMENT (U.S. CLS. 100, 101 AND 102).

CLASS 39—TRANSPORTATION AND STORAGE

FOR LEASING OF UTILITY-PROVIDING SERVICES RELATED EQUIPMENT, NAMELY, WATER FILTERS, PROPORTIONING EQUIPMENT FOR WATER TREATMENT AND SOFTENING OF WATER, WATER METERS, HEATING COST DISTRIBUTORS, WARM WATER COST DISTRIBUTORS, HEAT METERS, HEATING THERMOSTATS, THERMOSTAT VALVES, AND ACTUATORS FOR WATER VALVES AND HEAT METERS (U.S. CLS. 100 AND 105).

CLASS 40—MATERIAL TREATMENT

FOR ENVIRONMENTAL REMEDIATION CONSULTING SERVICES; ENVIRONMENTAL REMEDIATION ASSESSMENT SERVICES; AND ENVIRONMENTAL INFORMATION MANAGEMENT SERVICES, NAMELY, COLLECTING, COMPILING, MONITORING, MANAGING, ANALYZING, DISTRIBUTING AND REPORTING INFORMATION RELATED TO AND TO ASSIST WITH ENVIRONMENTAL REMEDIATION (U.S. CLS. 100, 103 AND 106).

CLASS 42—SCIENTIFIC, COMPUTER AND LEGAL SERVICES

FOR ENVIRONMENTAL COMPLIANCE CONSULTING SERVICES; ENVIRONMENTAL COMPLIANCE ASSESSMENT SERVICES; ENVIRONMENTAL ENGINEERING SERVICES; ENVIRONMENTAL INFORMATION MANAGEMENT SERVICES, NAMELY, COLLECTING, COMPILING, MONITORING, MANAGING, ANALYZING, DISTRIBUTING AND REPORTING INFORMATION RELATED TO AND TO ASSIST WITH ENVIRONMENTAL COMPLIANCE AND PROJECT MANAGEMENT (U.S. CLS. 100 AND 101).
JERI J. FICKES, EXAMINING ATTORNEY

CLASS 40—MATERIAL TREATMENT

FOR LEASING OF PROPORTIONING EQUIPMENT FOR WATER TREATMENT AND SOFTENING OF WATER, NAMELY, PUMPS, VALVES, METERS, FILTERS; PROCESSING OF SOFTWARE FOR OTHERS, NAMELY, INSERTING SOFTWARE PROTECTION PROGRAMS AND SECURITY PROGRAMS ONTO MAGNETIC MEDIA (U.S. CLS. 100, 103 AND 106).

SN 78-306,320. JASMIN DESIGNS, LLC, NEW YORK, NY. FILED 9-26-2003.

HAVE A GODDESS DAY**CLASS 18—LEATHER GOODS**

FOR HANDBAGS, BACKPACKS, AND SHOE BAGS FOR TRAVEL (U.S. CLS. 1, 2, 3, 22 AND 41).

CLASS 42—SCIENTIFIC, COMPUTER AND LEGAL SERVICES

FOR DEVELOPMENT AND PROCESSING OF SOFTWARE FOR OTHERS, PROCESSING OF SOFTWARE FOR OTHERS, NAMELY, INSTALLATION, CUSTOMIZATION AND UPDATING (U.S. CLS. 100 AND 101).
RUDY R. SINGLETON, EXAMINING ATTORNEY

CLASS 25—CLOTHING

FOR T-SHIRTS, DRESSES, SKIRTS, PANTS, TOPS, SCARVES, AND BELTS (U.S. CLS. 22 AND 39).
JANICE L. MCMORROW, EXAMINING ATTORNEY

SN 78-307,456. PROMETHEAN LIMITED, LANCASHIRE, UNITED KINGDOM, FILED 9-30-2003.

PROMETHEAN

PRIORITY CLAIMED UNDER SEC. 44(D) ON UNITED KINGDOM APPLICATION NO. 2340264, FILED 8-11-2003, REG. NO. 2340264, DATED 8-11-2003, EXPIRES 8-11-2010.

CLASS 9—ELECTRICAL AND SCIENTIFIC APPARATUS

FOR ELECTRONIC APPARATUS AND INSTRUMENTS FOR USE IN TEACHING, AND PERSONAL COMPUTING EQUIPMENT FOR USE THEREWITH, NAMELY, COMPUTERS, KEYBOARDS, INTERACTIVE ELECTRONIC WHITEBOARDS AND ASSOCIATED ELECTRONIC PENS AND PADS AND HANDHELD TRANSMITTERS AND RECEIVERS OF DATA; DISPLAY APPARATUS AND LIGHT PROJECTORS, NAMELY, SLIDE PROJECTORS; PROJECTION AND DISPLAY SCREENS, AND VIDEO MONITORS; ELECTRONIC GRAPHIC TABLETS AND KEYPADS; COMPUTER SOFTWARE RECORDED ON ELECTRONIC DATA CARRIERS, AND COMPUTER SOFTWARE DOWNLOADABLE FROM ON-LINE DATABASES, ALL SUCH SOFTWARE FOR USE IN TEACHING, TRAINING, AND EDUCATION COMPRISING A GENERIC SOFTWARE TOOLSET FOR DEVELOPMENT AND INTERACTIVE PRESENTATION OF LESSONS AND LECTURES; ELECTRONIC ENCRYPTION UNITS; WIRELESS COMPUTER PERIPHERALS AND WIRELESS TELEPHONES; CHILDREN'S EDUCATIONAL SOFTWARE; AUDIO TAPE, DIGITAL VIDEO AND EVENT RECORDERS; DATA PROCESSORS; DISC STORAGE CONTAINERS; BLANK INTEGRATED CIRCUIT CARDS FOR RECORDING, TRANSMITTING AND REPRODUCING SOUND AND IMAGES IN MOBILE TELEPHONE SERVICES; AUDIO, STEREO AND VIDEO RECEIVERS; SIGNAL PROCESSORS; RADIO AND TELEPHONE TRANSMITTERS; HANDHELD WIRELESS RECEIVERS AND TRANSMITTERS; CHILDREN'S EDUCATIONAL INTERACTIVE MULTIMEDIA SOFTWARE; LIGHT EMITTING DIODE DISPLAYS; FLAT PANEL DISPLAY SCREENS; LIQUID CRYSTAL DISPLAYS; COMPUTER HARDWARE; COMPUTERS; COMPUTER PERIPHERALS; COMPUTER KEYPADS; COMPUTER OPERATING PROGRAMS (U.S. CLS. 21, 23, 26, 36 AND 38).

CLASS 16—PAPER GOODS AND PRINTED MATTER

FOR PRINTED MATTER, NAMELY, PUBLICATIONS, NAMELY, NEWSLETTERS, MAGAZINES, AND JOURNALS IN THE FIELDS OF TEACHING, TRAINING AND EDUCATION PARTICULARLY THROUGH INTERACTIVE TECHNOLOGIES AND THEIR USE; BOOKS IN THE FIELDS OF TEACHING, TRAINING AND EDUCATION PARTICULARLY THROUGH INTERACTIVE TECHNOLOGIES AND THEIR USE; BROCHURES ABOUT EDUCATION METHODS AND TECHNOLOGIES AND THEIR USE; MANUALS RELATING TO INTERACTIVE TEACHING APPARATUS AND ITS USE; COMPUTER MANUALS RELATING TO COMPUTER HARDWARE, SOFTWARE AND FIRMWARE FOR USE IN TEACHING, TRAINING AND EDUCATION COMPRISING A GENERIC SOFTWARE TOOLSET FOR DEVELOPMENT AND INTERACTIVE PRESENTATION OF LESSONS AND LECTURES, AND ITS USE; BOOKLETS IN THE FIELDS OF TEACHING, TRAINING AND EDUCATION PARTICULARLY THROUGH INTERACTIVE TECHNOLOGIES; PAMPHLETS IN THE FIELDS OF TEACHING, TRAINING AND EDUCATION PARTICULARLY THROUGH INTERACTIVE TECHNOLOGIES AND THEIR USE; PRINTED INSTRUCTIONAL AND TEACHING MATERIALS IN RELATION TO BUSINESS, SCHOOL, LEARNING AND ACADEMIC SUBJECTS TAUGHT THROUGH INTERACTIVE MEANS; STATIONERY (U.S. CLS. 2, 5, 22, 23, 29, 37, 38 AND 50).

CLASS 41—EDUCATION AND ENTERTAINMENT

FOR RENTAL AND HIRE OF EDUCATIONAL APPARATUS AND EQUIPMENT, NAMELY, VIDEO PROJECTION APPARATUS AND ACCESSORIES; WHITEBOARDS; HAND-HELD APPARATUS FOR USE IN RELATION TO WHITEBOARDS; PROJECTION AND DISPLAY SCREENS; ELECTRONIC TABLETS AND KEYPADS; ELECTRONIC PENS AND PADS, AND PERSONAL COMPUTING EQUIPMENT FOR USE THEREWITH; CONDUCTING EDUCATIONAL DEMONSTRATION SERVICES, ARRANGING AND CONDUCTING SEMINARS AND WORKSHOPS IN RELATION TO EDUCATIONAL APPARATUS AND EQUIPMENT AND THEIR USE; CONSULTING SERVICES IN THE FIELDS OF TEACHING AND MULTI-MEDIA (U.S. CLS. 100, 101 AND 107).

JENNIFER CHICOSKI, EXAMINING ATTORNEY

SN 78-310,830. KABUSHIKI KAISHA SQUARE ENIX, TA SQUARE ENIX CO., LTD., TOKYO, JAPAN, FILED 10-8-2003.

DRAGON QUEST

CLASS 9—ELECTRICAL AND SCIENTIFIC APPARATUS

FOR COMPUTER GAME SOFTWARE; VIDEO GAME SOFTWARE; SOUND RECORDINGS IN THE FORM OF OPTICAL DISCS, MAGNETIC DISCS AND TAPES AND SEMICONDUCTOR ROMS FEATURING MUSIC AND/OR MUSICAL ENTERTAINMENT; AUDIOVISUAL RECORDINGS IN THE FORM OF OPTICAL DISCS, MAGNETIC DISCS AND TAPES AND SEMICONDUCTOR ROMS FEATURING MUSIC, ANIMATION AND/OR ENTERTAINMENT; PRERECORDED COMPACT DISCS FEATURING MUSIC; PRERECORDED DIGITAL VIDEO DISCS FEATURING MUSIC, ANIMATION AND/OR ENTERTAINMENT; PRERECORDED VIDEO CASSETTES FEATURING MUSIC, ANIMATION AND/OR ENTERTAINMENT; DECORATIVE MAGNETS; MOUSE PADS; STRAPS FOR CELLULAR PHONES; SUNGLASSES; MEMORY CARDS; MEMORY CARD CASES; CD CASES; COMPUTER KEYBOARDS; COMPUTER AND VIDEO GAME JOYSTICKS; VIDEO GAME CONTROLLERS; DOWNLOADABLE COMPUTER GRAPHICS SOFTWARE, NAMELY DOWNLOADABLE WALLPAPERS OR DOWNLOADABLE SCREEN SAVERS FOR THE SCREENS OF COMPUTER DISPLAYS OR MOBILE PHONE DISPLAYS; DOWNLOADABLE COMPUTER GRAPHIC SOFTWARE CONTAINING DOWNLOADABLE ANIMATED ACTIVE WALLPAPERS OR DOWNLOADABLE ANIMATED SCREEN SAVERS FOR THE SCREENS OF COMPUTER DISPLAYS OR MOBILE PHONE DISPLAYS; DOWNLOADABLE VIDEO RECORDINGS FEATURING CARTOON CHARACTERS AND/OR VIDEO GAME CHARACTERS; DOWNLOADABLE MUSICAL AND SOUND RECORDINGS; DOWNLOADABLE GAME PROGRAMS; DOWNLOADABLE ELECTRONIC PUBLICATIONS IN THE FIELD OF COMPUTER GAMES, VIDEO GAMES AND GENERAL ENTERTAINMENT; ELECTRONIC PUBLICATIONS RECORDED ON COMPUTER MEDIA, IN THE FIELD OF COMPUTER GAMES, VIDEO GAMES AND GENERAL ENTERTAINMENT (U.S. CLS. 21, 23, 26, 36 AND 38).

CLASS 16—PAPER GOODS AND PRINTED MATTER

FOR COMPUTER GAME STRATEGY GUIDE BOOKS; VIDEO GAME STRATEGY GUIDEBOOKS; SERIES OF BOOKS FEATURING FICTIONAL AND/OR FANTASY STORIES; SONG BOOKS; MUSICAL SCORE BOOKS; COMIC BOOKS; MAGAZINES FEATURING VIDEO GAMES; POSTERS; STICKERS; PAPER BANNERS; CALENDARS; POSTCARDS; PENS; PENCILS; PENCIL CAPS; PEN CASES; DRAWING RULERS; RUBBER STAMPS; NOTEBOOKS; COLLECTORS' CARDS; TRADING CARDS; PHOTOGRAPHS (U.S. CLS. 2, 5, 22, 23, 29, 37, 38 AND 50).

CLASS 28—TOYS AND SPORTING GOODS

FOR DOLLS; TOY FIGURES; STUFFED TOYS; INFLATABLE TOYS; TOY VEHICLES; TOY GUNS; TOY SWORDS; PLAYING CARDS; CARD GAMES; BOARD GAMES; JIGSAW PUZZLES; HAND-HELD VIDEO GAME UNITS (U.S. CLS. 22, 23, 38 AND 50).

CLASS 41—EDUCATION AND ENTERTAINMENT

FOR PROVIDING ON-LINE COMPUTER GAMES AND/OR ON-LINE VIDEO GAMES; PROVIDING INFORMATION ON COMPUTER GAME STRATEGIES AND VIDEO GAME STRATEGIES VIA COMPUTER NETWORKS AND/OR GLOBAL COMMUNICATION NETWORKS; PROVIDING INFORMATION ON ENTERTAINMENT IN THE FIELD OF COMPUTER GAMES, VIDEO GAMES, CARD GAMES, CARTOON ANIMATION, COMICS, NOVELS AND MAGAZINES; PROVIDING ON-LINE NON-DOWNLOADABLE COMICS; PROVIDING ON-LINE NON-DOWNLOADABLE MAGAZINES IN THE FIELD OF COMPUTER GAMES, VIDEO GAMES, CARTOONS AND GENERAL ENTERTAINMENT (U.S. CLS. 100, 101 AND 107).

THEODORE MCBRIDE, EXAMINING ATTORNEY

SN 78-312,300. GUARANTY TRUST COMPANY, CHICAGO, IL. FILED 10-10-2003.



ATG TRUST
C O M P A N Y

NO CLAIM IS MADE TO THE EXCLUSIVE RIGHT TO USE TRUST COMPANY, APART FROM THE MARK AS SHOWN.

CLASS 36—INSURANCE AND FINANCIAL

FOR CORPORATE AND PERSONAL TRUST AND ESTATE SERVICES, NAMELY, TRUST MANAGEMENT AND PROBATE BOND ISSUANCE, STARKER TRUST INTERMEDIARY SERVICES, LAND TRUST SERVICES AND ASSET CUSTODY SERVICES, PROVIDED THROUGH ATTORNEYS TO THEIR CLIENTS (U.S. CLS. 100, 101 AND 102).

CLASS 41—EDUCATION AND ENTERTAINMENT

FOR PUBLICATION OF NEWSLETTERS FOR ATTORNEYS CONCERNING TRUST AND ESTATE PLANNING; CONDUCTING SEMINARS FOR ATTORNEYS CONCERNING TRUST AND ESTATE PLANNING (U.S. CLS. 100, 101 AND 107).

ANDREA SAUNDERS, EXAMINING ATTORNEY

SN 78-313,377. YELLOWBRIX, INC., ALEXANDRIA, VA. FILED 10-14-2003.

**CLASS 35—ADVERTISING AND BUSINESS**

FOR DATA MANAGEMENT AND CONTENT SYNDICATION SERVICES, NAMELY, PROVIDING FOR THE AGGREGATION AND PRESENTATION OF PERSONALIZED INFORMATION FROM INTERNAL AND EXTERNAL SOURCES; PROVIDING NEWS, INFORMATION AND DATA IN THE FIELDS OF BUSINESS, POLITICS AND GOVERNMENT VIA A GLOBAL COMPUTER NETWORK; ANALYSIS, MAPPING, COMPARISON, CORRELATION, CATEGORIZATION AND DISTRIBUTION OF ONLINE CONTENT AND INFORMATION IN THE FOREGOING FIELDS FOR OTHERS THROUGH WEB SITES (U.S. CLS. 100, 101 AND 102).

FIRST USE 1-28-2003; IN COMMERCE 1-28-2003.

CLASS 36—INSURANCE AND FINANCIAL

FOR PROVIDING NEWS, INFORMATION AND DATA IN THE FIELDS OF FINANCE, FINANCIAL PLANNING, FINANCIAL RESEARCH, INVESTING, STOCK QUOTES, SECURITIES, SECURITIES MARKETS, ECONOMIES, BANKRUPTCY AND REAL ESTATE VIA A GLOBAL COMPUTER NETWORK; ANALYSIS, MAPPING, COMPARISON, CORRELATION, CATEGORIZATION AND DISTRIBUTION OF ONLINE CONTENT AND INFORMATION IN THE FOREGOING FIELDS FOR OTHERS THROUGH WEB SITES (U.S. CLS. 100, 101 AND 102).

FIRST USE 1-28-2003; IN COMMERCE 1-28-2003.

CLASS 41—EDUCATION AND ENTERTAINMENT

FOR PROVIDING NEWS, INFORMATION AND DATA IN THE FIELDS OF SPORTS, ENTERTAINMENT, EDUCATION, CULTURE, ART, MUSIC, MOVIES, THEATRE, BOOKS, GAMING, CURRENT NATIONAL AND INTERNATIONAL EVENTS, AND HISTORY VIA A GLOBAL COMPUTER NETWORK; PROVIDING DOCUMENTS AND ARTICLES IN THE FIELDS OF BUSINESS, POLITICS, GOVERNMENT, FINANCE, FINANCIAL PLANNING, FINANCIAL RESEARCH, INVESTING, STOCK QUOTES, SECURITIES, SECURITIES MARKETS, ECONOMICS, BANKRUPTCY, REAL ESTATE, HOME IMPROVEMENT, AUTOMOTIVE MAINTENANCE AND REPAIR, SPORTS, ENTERTAINMENT, EDUCATION, CULTURE, ART, MUSIC, MOVIES, THEATRE, BOOKS, GAMING, CURRENT NATIONAL AND INTERNATIONAL EVENTS, HISTORY, WEATHER, LAW, ENVIRONMENT, SCIENCE, TECHNOLOGY, COMPUTERS, COMPUTER SOFTWARE, DEFENSE, SECURITY AND FASHION VIA A GLOBAL COMPUTER NETWORK; ANALYSIS, MAPPING, COMPARISON, CORRELATION, CATEGORIZATION AND DISTRIBUTION OF ONLINE CONTENT AND INFORMATION IN THE FOREGOING FIELDS FOR OTHERS THROUGH WEB SITES (U.S. CLS. 100, 101 AND 107).

FIRST USE 1-28-2003; IN COMMERCE 1-28-2003.

CLASS 42—SCIENTIFIC, COMPUTER AND LEGAL SERVICES

FOR PROVIDING NEWS, INFORMATION AND DATA IN THE FIELDS OF WEATHER, LAW, ENVIRONMENT, SCIENCE, TECHNOLOGY, COMPUTERS AND COMPUTER SOFTWARE VIA A GLOBAL COMPUTER NETWORK; ANALYSIS, MAPPING, COMPARISON, CORRELATION, CATEGORIZATION AND DISTRIBUTION OF ONLINE CONTENT AND INFORMATION IN THE FOREGOING FIELDS FOR OTHERS THROUGH WEB SITES (U.S. CLS. 100 AND 101).

FIRST USE 1-28-2003; IN COMMERCE 1-28-2003.
RON FAIRBANKS, EXAMINING ATTORNEY

SN 78-313,985. LASER REGISTRATION, INC., WASHINGTON, DC. FILED 10-15-2003.



PRIORITY CLAIMED UNDER SEC. 44(D) ON CANADA APPLICATION NO. 1192220, FILED 10-10-2003.

NO CLAIM IS MADE TO THE EXCLUSIVE RIGHT TO USE "REGISTRATION.COM", APART FROM THE MARK AS SHOWN.

CLASS 35—ADVERTISING AND BUSINESS

FOR PROVIDING ON-LINE COMPUTER SERVICES TO PARTICIPANTS AND ORGANIZERS OF CONVENTIONS, CONFERENCES, TRADE SHOWS AND SEMINARS, NAMELY, THE REGISTRATION OF PARTICIPANTS AND ORGANIZERS OF SUCH CONVENTIONS, CONFERENCES, TRADE SHOWS AND SEMINARS (U.S. CLS. 100, 101 AND 102).

FIRST USE 1-5-2000; IN COMMERCE 1-5-2000.

SN 78-313,983. COMPANY OF MILITARY HISTORIANS, RUTLAND, MA. FILED 10-15-2003.

**CLASS 43—HOTEL AND RESTAURANT SERVICES**

FOR PROVIDING ON-LINE COMPUTER SERVICES TO PARTICIPANTS AND ORGANIZERS OF CONVENTIONS, CONFERENCES, TRADE SHOWS AND SEMINARS, NAMELY, THE HOTEL RESERVATIONS OF PARTICIPANTS AND ORGANIZERS OF SUCH CONVENTIONS, CONFERENCES, TRADE SHOWS AND SEMINARS (U.S. CLS. 100 AND 101).

FIRST USE 1-5-2000; IN COMMERCE 1-5-2000.

FLORENTINA BLANDU, EXAMINING ATTORNEY

SN 78-318,732. SUZUKEN CO., LTD., NAGOYA, JAPAN, FILED 10-27-2003.

LIFECORDER**CLASS 9—ELECTRICAL AND SCIENTIFIC APPARATUS**

FOR PEDOMETERS, INCLUDING PEDOMETERS FOR USE IN MEASURING AND DISPLAYING STEP COUNT, PHYSICAL ACTIVITY INTENSITY, CALORIE EXPENDITURE, AND EXERCISE TIME; ELECTRONIC PHYSICAL ACTIVITY MONITOR FOR NON-MEDICAL USE; NON-MEDICAL PHYSICAL ACTIVITY MONITOR AND COMBINATION PEDOMETER FOR USE IN MEASURING AND DISPLAYING STEP COUNT, PHYSICAL ACTIVITY INTENSITY, CALORIE EXPENDITURE, AND EXERCISE TIME (U.S. CLS. 21, 23, 26, 36 AND 38).

CLASS 10—MEDICAL APPARATUS

FOR ACTIVITY MONITOR WITH CALORIE EXPENDITURE, NAMELY, HEART ACTIVITY MONITOR WITH CALORIE EXPENDITURE TO BE WORN DURING PHYSICAL EXERCISE; MEDICAL ACTIVITY MONITOR WITH CALORIE EXPENDITURE FOR USE IN MEASURING AND DISPLAYING MUSCULAR ACTIVITY; PHYSICAL ACTIVITY MONITOR FOR MEDICAL USE, NAMELY FOR USE IN MEASURING AND DISPLAYING STEP COUNT, ACTIVITY INTENSITY, CALORIE EXPENDITURE, AND EXERCISE TIME (U.S. CLS. 26, 39 AND 44).

ZHALEH DELANEY, EXAMINING ATTORNEY

NO CLAIM IS MADE TO THE EXCLUSIVE RIGHT TO USE MILITARY HISTORIANS, APART FROM THE MARK AS SHOWN.

CLASS 16—PAPER GOODS AND PRINTED MATTER

FOR PUBLICATIONS, NAMELY JOURNALS IN THE FIELD OF HISTORY (U.S. CLS. 2, 5, 22, 23, 29, 37, 38 AND 50).

FIRST USE 0-0-1994; IN COMMERCE 0-0-1994.

CLASS 41—EDUCATION AND ENTERTAINMENT

FOR EDUCATIONAL SERVICES, NAMELY, ORGANIZING, PLANNING, HOSTING, AND CONDUCTING SEMINARS, LECTURES, SPEECHES, TOURS, AND FIELD TRIPS IN THE FIELD OF HISTORY (U.S. CLS. 100, 101 AND 107).

FIRST USE 0-0-1964; IN COMMERCE 0-0-1964.
HENRY S. ZAK, EXAMINING ATTORNEY

SN 78-319,007. PORTWISE AB, STOCKHOLM, SWEDEN,
FILED 10-27-2003.

SN 78-319,229. KIRKLAND, KEVIN B., ST. GEORGE, UT.
FILED 10-27-2003.

PORTWISE

OWNER OF ERPN CMNTY TM OFC REG. NO. 003092566,
DATED 2-14-2005, EXPIRES 3-12-2013.

CLASS 9—ELECTRICAL AND SCIENTIFIC APPARATUS

FOR COMPUTERS AND COMPUTER PERIPHERALS; COMPUTER SOFTWARE FOR USE IN CONNECTION WITH IT SECURITY, NAMELY BY ENABLING SECURE ACCESS, AUTHENTICATION AND AUTHORIZATION; COMPUTER PROGRAMS FOR USE IN CONNECTION WITH IT SECURITY, NAMELY BY ENABLING SECURE ACCESS, AUTHENTICATION AND AUTHORIZATION; COMPUTER HARDWARE; BLANK MAGNETIC AND OPTICAL DATA CARRIERS (U.S. CLS. 21, 23, 26, 36 AND 38).

CLASS 42—SCIENTIFIC, COMPUTER AND LEGAL SERVICES

FOR COMPUTER CONSULTANCY SERVICES; SUPPORT SERVICES FOR COMPUTER PROGRAMS, NAMELY, TROUBLESHOOTING OF SOFTWARE PROBLEMS; COMPUTER PROGRAMMING SERVICES; DEVELOPMENT AND UPDATING OF COMPUTER PROGRAMS (U.S. CLS. 100 AND 101).
JENNIFER KRISP, EXAMINING ATTORNEY

SN 78-319,097. I3ARCHIVE, INC., PHILADELPHIA, PA.
FILED 10-27-2003.



NO CLAIM IS MADE TO THE EXCLUSIVE RIGHT TO USE "NATIONAL DIGITAL MAMMOGRAPHY ARCHIVE", APART FROM THE MARK AS SHOWN.

CLASS 9—ELECTRICAL AND SCIENTIFIC APPARATUS

FOR COMPUTER PROGRAMS FOR STORAGE, RETRIEVAL AND DISTRIBUTION OF BREAST IMAGES FOR CLINICAL AND RESEARCH PURPOSES (U.S. CLS. 21, 23, 26, 36 AND 38).
FIRST USE 12-30-2001; IN COMMERCE 12-30-2001.

CLASS 39—TRANSPORTATION AND STORAGE

FOR ELECTRONIC STORAGE OF DATA RELATING TO MEDICAL IMAGING (U.S. CLS. 100 AND 105).
FIRST USE 12-30-2001; IN COMMERCE 12-30-2001.
JIM RINGLE, EXAMINING ATTORNEY

TRIONYX

CLASS 5—PHARMACEUTICALS

FOR DIETARY SUPPLEMENTS (U.S. CLS. 6, 18, 44, 46, 51 AND 52).

CLASS 44—MEDICAL, BEAUTY AND AGRICULTURAL SERVICES

FOR WEIGHT REDUCTION DIET PLANNING AND SUPERVISION (U.S. CLS. 100 AND 101).
SUSAN STIGLITZ, EXAMINING ATTORNEY

SN 78-320,404. PAISH, REGINALD W., BADMINTON, UNITED KINGDOM, FILED 10-29-2003.

KARRIPOT

PRIORITY CLAIMED UNDER SEC. 44(D) ON ERPN CMNTY TM OFC APPLICATION NO. 003150133, FILED 4-30-2003, REG. NO. 003150133, DATED 12-7-2004, EXPIRES 4-30-2013.

CLASS 6—METAL GOODS

FOR METAL CLIPS; HOOKS OF METAL; METAL HANDLES FOR CARRYING POTS AND CONTAINERS; PEGS OF METAL; PIPES OF METAL; POT HOOKS OF METAL; STEEL PIPES; STEEL TUBES; METAL SUPPORTS FOR PLANT GROWTH AND PARTS AND FITTINGS FOR ALL THE AFORESAID GOODS (U.S. CLS. 2, 12, 13, 14, 23, 25 AND 50).

CLASS 8—HAND TOOLS

FOR HAND TOOLS FOR THE GARDEN, NAMELY TROWELS, SPADES AND FORKS; LIFTING HAND JACKS AND PARTS AND FITTINGS FOR ALL THE AFORESAID GOODS (U.S. CLS. 23, 28 AND 44).

CLASS 20—FURNITURE AND ARTICLES NOT OTHERWISE CLASSIFIED

FOR NON METAL POT HOOKS; SUPPORTS FOR PLANT GROWTH, NAMELY PERGOLAS, TRELLISES AND ARBORS (U.S. CLS. 2, 13, 22, 25, 32 AND 50).

CLASS 21—HOUSEWARES AND GLASS

FOR FLOWER POTS; POTS; POTTERY; NAMELY POTS AND CONTAINERS FOR USE WITH PLANTS AND FLOWERS; AND PARTS AND FITTINGS FOR ALL THE AFORESAID GOODS (U.S. CLS. 2, 13, 23, 29, 30, 33, 40 AND 50).
JEFF DEFORD, EXAMINING ATTORNEY

SN 78-320,452. GENESIS TODAY, INC, WOODLAND HILLS, CA. FILED 10-29-2003.

SN 78-320,695. SAMSONITE CORPORATION, DENVER, CO. FILED 10-30-2003.



THE MARK CONSISTS OF STANDARD CHARACTERS WITHOUT CLAIM TO ANY PARTICULAR FONT, STYLE, SIZE, OR COLOR.

OWNER OF U.S. REG. NO. 2,930,502.
NO CLAIM IS MADE TO THE EXCLUSIVE RIGHT TO USE "NONI", APART FROM THE MARK AS SHOWN.

CLASS 5—PHARMACEUTICALS

FOR (BASED ON INTENT TO USE) APPETITE SUPPRESSANTS, CALCIUM SUPPLEMENTS, CENTRAL NERVOUS SYSTEMS STIMULANTS, CHOLESTEROL REDUCERS, DIET CAPSULES, DIET PILLS, DIETARY DRINK MIX FOR USE AS A MEAL REPLACEMENT, DIETARY FOOD SUPPLEMENTS, DIETARY SUPPLEMENTS, FOOD FOR DIABETES, FOOD SUPPLEMENTS, NAMELY ANTI-OXIDANTS, GINSENG FOR MEDICAL USE, HERB TEAS FOR MEDICINAL PURPOSES, HERBAL SUPPLEMENTS, HERBAL TEAS FOR MEDICINAL PURPOSES, HOMEOPATHIC SUPPLEMENTS, LAXATIVES, MEAL REPLACEMENT AND DIETARY SUPPLEMENT DRINK MIXES, MEAL REPLACEMENT AND DIETARY SUPPLEMENT DRINKS, MEAL REPLACEMENT POWDERS, MINERAL SUPPLEMENTS, NUTRACEUTICALS FOR THE TREATMENT OF FATIGUE, DEPRESSION, NUTRACEUTICALS FOR THE USES AS A DIETARY SUPPLEMENT, NUTRITIONAL DRINK MIX FOR USES AS A MEAL REPLACEMENT, NUTRITIONAL SUPPLEMENTS, NUTRITIONALLY FORTIFIED WATER, NUTRITIONALLY FORTIFIED BEVERAGES, SOY PROTEIN FOR USES AS A NUTRITIONAL INGREDIENT IN VARIOUS POWDERED AND READY-TO-DRINK BEVERAGES, VITAMIN AND MINERAL SUPPLEMENTS, VITAMIN DROPS, VITAMIN SUPPLEMENTS, VITAMINS (U.S. CLS. 6, 18, 44, 46, 51 AND 52).

CLASS 29—MEATS AND PROCESSED FOODS

FOR CANDIED FRUIT, CANDIED FRUIT SNACKS, CANDIED NUTS, DRIED FRUITS, FRUIT AND SOY BASED SNACK FOOD, FRUIT CHIPS, FRUIT CONSERVES, FRUIT LEATHERS, FRUIT PASTE, FRUIT PECTIN, FRUIT PEELS, FRUIT PRESERVES, FRUIT PULPS, FRUIT RINDS, FRUIT SALADS, APPLESAUCE AND CRANBERRY SAUCE, FRUIT-BASED SNACK FOODS, SOY PROTEIN FOR USES AS A FOOD ADDITIVE, PROTEIN BASED, NUTRIENT-DENSE SNACK BARS, SNACK MIX CONSISTING PRIMARILY OF PROCESSED FRUITS, PROCESSED NUTS ARID/OR RAISINS (U.S. CL. 46).

FIRST USE 11-15-2003; IN COMMERCE 11-15-2003.

CLASS 30—STAPLE FOODS

FOR (BASED ON INTENT TO USE) BREAKFAST CEREALS, CANDY, CANDY BARS, CHOCOLATE-BASED READY-TO-EAT FOOD BARS, GRANOLA, GRANOLA-BASED SNACK BARS, HERB TEA FOR FOOD PURPOSES, OATMEAL, PANCAKE MIXES, READY TO EAT, CEREAL DERIVED FOOD BARS, ROLLED OATS, YEAST (U.S. CL. 46).

MICHELLE S. WISEMAN, EXAMINING ATTORNEY

EZ GO

CLASS 9—ELECTRICAL AND SCIENTIFIC APPARATUS

FOR GARMENT STEAMERS; ELECTRICAL CONVERTERS OR ADAPTER PLUGS; STEAM IRONS (U.S. CLS. 21, 23, 26, 36 AND 38).

CLASS 16—PAPER GOODS AND PRINTED MATTER

FOR PASSPORT HOLDERS (U.S. CLS. 2, 5, 22, 23, 29, 37, 38 AND 50).

CLASS 18—LEATHER GOODS

FOR COSMETIC BAGS/ORGANIZERS SOLD EMPTY; TOILETRY CASES SOLD EMPTY; LUGGAGE STRAPS; LUGGAGE TAGS; LUGGAGE STRAP SHOULDER PROTECTORS; FOLDABLE TRAVEL UMBRELLAS (U.S. CLS. 1, 2, 3, 22 AND 41).

CLASS 25—CLOTHING

FOR FABRIC MONEY BELTS - WAIST, NECK, AND HOLSTER STYLES (U.S. CLS. 22 AND 39).
CYNTHIA SLOAN, EXAMINING ATTORNEY

SN 78-321,591. HEWLETT-PACKARD DEVELOPMENT COMPANY, L.P., HOUSTON, TX. FILED 10-31-2003.

MUSIC ZONE

NO CLAIM IS MADE TO THE EXCLUSIVE RIGHT TO USE "MUSIC", APART FROM THE MARK AS SHOWN.

CLASS 9—ELECTRICAL AND SCIENTIFIC APPARATUS

FOR COMPUTERS; COMPUTER HARDWARE; COMPUTER PERIPHERALS; PORTABLE MEDIA PLAYERS; TELEPHONES; CELLULAR TELEPHONES; PERSONAL DIGITAL ASSISTANTS; CAMERAS; AUDIO AND VIDEO EQUIPMENT, NAMELY, RADIOS, RECEIVERS, CASSETTE TAPE PLAYERS AND RECORDERS, SPEAKERS, MICROPHONES, HEADPHONES, VIDEO RECORDERS AND PLAYERS, CD AND DVD RECORDERS AND PLAYERS, MINI DISC PLAYERS, MP3 PLAYERS, AND TELEVISIONS; COMPUTER SOFTWARE FOR DOWNLOADING, TRANSMITTING, RECEIVING, EDITING, EXTRACTING, ENCODING, DECODING, PLAYING AND STORING AUDIO, VIDEO AND MULTIMEDIA FILES; PRE-RECORDED AUDIO, VIDEO AND/OR COMPUTER DATA NAMELY, CDS, DVDS, MINIDISKS, MAGNETO-OPTICAL DISKS FEATURING MUSIC AND MUSICAL VIDEOS; DOWNLOADABLE AUDIO AND VIDEO FILES FEATURING MUSIC AND MUSICAL VIDEO (U.S. CLS. 21, 23, 26, 36 AND 38).

CLASS 35—ADVERTISING AND BUSINESS

FOR ONLINE RETAIL STORE SERVICES FEATURING DOWNLOADABLE MUSIC. (U.S. CLS. 100, 101 AND 102).

CLASS 38—COMMUNICATION

FOR TELECOMMUNICATIONS, NAMELY, SUBSCRIPTION BROADCASTING OF MUSIC AND MUSICAL VIDEO VIA CABLE, SATELLITE OR THE INTERNET; STREAMING OF AUDIO AND VIDEO FILES VIA COMPUTER AND OTHER COMMUNICATIONS NETWORKS; AUDIO-ON-DEMAND AND VIDEO-ON-DEMAND TRANSMISSION SERVICES; WEBCASTING SERVICES; MUSIC DOWNLOADING SERVICES, NAMELY, TRANSMITTING STREAMED SOUND AND AUDIO-VISUAL RECORDINGS VIA THE INTERNET (U.S. CLS. 100, 101 AND 104).

CLASS 41—EDUCATION AND ENTERTAINMENT

FOR INTERNET RADIO SERVICES, NAMELY, PROVIDING A RADIO PROGRAM IN THE FIELD OF MUSIC AND MUSICAL BASED ENTERTAINMENT; PROVIDING A WEBSITE FEATURING INFORMATION ON AUDIO AND VIDEO RECORDINGS, MUSICAL ARTISTS AND MUSICAL BASED ENTERTAINMENT; PROVIDING ONLINE MUSIC AND MUSICAL VIDEO ENTERTAINMENT BY SUBSCRIPTION (U.S. CLS. 100, 101 AND 107).

PRISCILLA MILTON, EXAMINING ATTORNEY

SN 78-322,270. UNICITY PROPERTIES, INC., OREM, UT. FILED 11-3-2003.

UNICITY MAKE LIFE
BETTER

THE MARK CONSISTS OF STANDARD CHARACTERS WITHOUT CLAIM TO ANY PARTICULAR FONT, STYLE, SIZE, OR COLOR.

CLASS 3—COSMETICS AND CLEANING PREPARATIONS

FOR COSMETICS, NAMELY, SOAPS, PERFUMES, ESSENTIAL OILS FOR PERSONAL USE: SKIN, BODY AND HAIR LOTIONS, BODY AND FACIAL MASKS; PERFUME OILS; BODY AND FACIAL SCRUBS, SKIN AND EYE GEL, SHAMPOOS, CONDITIONERS AND HAIR SPRAY (U.S. CLS. 1, 4, 6, 50, 51 AND 52).

CLASS 5—PHARMACEUTICALS

FOR MEDICATED HAIR LOTIONS; PHARMACEUTICAL, VETERINARY AND SANITARY SUBSTANCES, NAMELY, INFANTS' AND INVALIDS' FOODS, HERBAL TEAS FOR MEDICINAL PURPOSES, DIURETIC PREPARATIONS, WOUND DRESSINGS, BURN DRESSINGS, PREPARATIONS FOR TREATING COLDS, POLLEN FOR USE AS A DIETARY SUPPLEMENT, DIETARY SUPPLEMENTS, NUTRITIONAL SUPPLEMENTS, AND VITAMIN AND MINERAL SUPPLEMENTS (U.S. CLS. 6, 18, 44, 46, 51 AND 52).

CLASS 35—ADVERTISING AND BUSINESS

FOR FRANCHISING, NAMELY, OFFERING TECHNICAL ASSISTANCE IN CONNECTION WITH THE ESTABLISHMENT AND OPERATION OF PERSON TO PERSON WHOLESALE AND RETAIL MERCHANDISING OF VARIOUS GOODS, NAMELY, NUTRITIONAL AND DIETARY SUPPLEMENTS, PERSONAL CARE PRODUCTS SUCH AS SHAMPOO, CONDITIONER, AND COSMETICS (U.S. CLS. 100, 101 AND 102).

ASMAT KHAN, EXAMINING ATTORNEY

SN 78-323,507. MILACRON INDUSTRIAL PRODUCTS INC., LIVONIA, MI. FILED 11-5-2003.

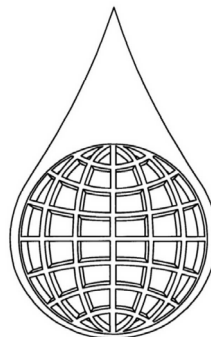

THE MARK CONSISTS OF BLACK AND WHITE DRAWING.

CLASS 1—CHEMICALS

FOR INDUSTRIAL FLUIDS, NAMELY COOLANTS, CHEMICAL PREPARATIONS FOR USE AS CORROSION INHIBITORS FOR USE IN GENERAL MACHINING AND METALWORKING (U.S. CLS. 1, 5, 6, 10, 26 AND 46). FIRST USE 10-6-2003; IN COMMERCE 10-6-2003.

CLASS 3—COSMETICS AND CLEANING PREPARATIONS

FOR INDUSTRIAL FLUIDS, NAMELY, CHEMICAL CLEANERS USED IN THE MACHINING AND METALWORKING INDUSTRIES (U.S. CLS. 1, 4, 6, 50, 51 AND 52).

FIRST USE 4-13-2005; IN COMMERCE 4-13-2005.

CLASS 4—LUBRICANTS AND FUELS

FOR INDUSTRIAL FLUIDS, NAMELY LUBRICANTS USED IN MANUFACTURING (U.S. CLS. 1, 6 AND 15). FIRST USE 10-6-2003; IN COMMERCE 10-6-2003. DARRYL SPRUILL, EXAMINING ATTORNEY

SN 78-323,819. BOVIBANK AS, ÅS, NORWAY, FILED 11-6-2003.



PRIORITY CLAIMED UNDER SEC. 44(D) ON NORWAY APPLICATION NO. 200310194, FILED 10-31-2003, REG. NO. 224901, DATED 11-18-2004, EXPIRES 11-18-2014.

THE MARK CONSISTS OF THE STYLIZED WORD "BOVIBANK" BELOW A GRAPHIC IMAGE OF A STYLIZED HUMAN CHROMOSOME ABOVE A REVERSED S.

CLASS 1—CHEMICALS

FOR PROTEINS IN THE USE OF BIOMARKERS, NAMELY, PROTEIN ARRAYS AND NUCLEOTIDE ARRAYS FOR SCIENTIFIC AND MEDICAL RESEARCH (U.S. CLS. 1, 5, 6, 10, 26 AND 46).

SN 78-324,833. MCWILSON, WALTER W., MURRIETA, CA. FILED 11-7-2003.

CLASS 5—PHARMACEUTICALS

FOR VETERINARY PREPARATIONS, NAMELY, PAIN RELIEF MEDICATION; PRODUCTS FOR THE ANIMAL LIVESTOCK BREEDING MARKET, NAMELY ANIMAL SEMEN; SEMEN FOR ARTIFICIAL INSEMINATION OF ANIMAL LIVESTOCK; GENETIC RADIO-ISOTOPE MARKERS FOR DIAGNOSTIC USE IN ANIMAL LIVESTOCK BREEDING; OVULATION TEST KITS FOR USE IN ANIMAL LIVESTOCK BREEDING; PREPARATIONS FOR DETECTING MUTATION IN PRION GENES FOR VETERINARY PURPOSES; PHARMACEUTICAL PREPARATIONS FOR THE VETERINARY MARKET FOR USE IN THE PREVENTION OF OSTEOPOROSIS; CHEMOTHERAPEUTICS FOR THE VETERINARY MARKET; DIAGNOSTIC PREPARATIONS FOR MEDICAL AND VETERINARY USE; THERAPEUTIC PRODUCTS FOR THE HUMAN PHARMACEUTICAL MARKET, NAMELY, PHARMACEUTICAL PREPARATIONS, CONSISTING OF DRUG DELIVERY SYSTEM COMPRISING POLYMER-BASED ORAL TABLETS FOR THE CONTINUOUS RELEASE OF A WIDE VARIETY OF THERAPEUTIC AGENTS; THERAPEUTICS FOR THE ANIMAL LIVESTOCK MARKET, NAMELY RUBBING COMPOUND FOR THERAPEUTIC USE ON LIVESTOCK; CHEMICAL PREPARATIONS AND REAGENTS FOR VETERINARY RESEARCH AND VETERINARY BREEDING USE; ANIMAL FEED PROTEIN ADDITIVE FOR USE AS A NUTRITIONAL SUPPLEMENT (U.S. CLS. 6, 18, 44, 46, 51 AND 52).

CLASS 31—NATURAL AGRICULTURAL PRODUCTS

FOR FOODSTUFFS FOR ANIMALS; NON-MEDICATED ADDITIVES FOR ANIMAL FEED; FEED COMPONENTS FOR ANIMALS, NAMELY, ANIMAL FEED ADDITIVES FOR NON-NUTRITIONAL PURPOSES FOR USE AS FLAVOURING, INGREDIENT OR FILLER (U.S. CLS. 1 AND 46).

CLASS 42—SCIENTIFIC, COMPUTER AND LEGAL SERVICES

FOR TECHNOLOGY SERVICES FOR THE VETERINARIAN MARKET, NAMELY, COMPUTER HARDWARE AND SOFTWARE CONSULTATION FOR VETERINARIANS, AND COMPUTER PROGRAMMING IN THE MEDICAL FIELD FOR VETERINARIANS; TECHNOLOGY SERVICE FOR PROGENY PROGRAMS, NAMELY, PROVIDING TEMPORARY USE OF ON-LINE NON-DOWNLOADABLE SOFTWARE FOR USE IN DATABASE MANAGEMENT IN THE FIELD OF BREEDING, TRACEABILITY TESTING AND TRACKING ANIMALS; AND TESTING PHARMACEUTICALS, COSMETICS OR FOODSTUFF; SERVICES TO THE HUMAN PHARMACEUTICALS MARKET, NAMELY, PHARMACEUTICAL RESEARCH AND DEVELOPMENT OF PHARMACEUTICALS FOR HUMANS (U.S. CLS. 100 AND 101).

CLASS 44—MEDICAL, BEAUTY AND AGRICULTURAL SERVICES

FOR MEDICAL SERVICES, VETERINARY SERVICES (U.S. CLS. 100 AND 101).
NELSON SNYDER, EXAMINING ATTORNEY

AMARI R.U.M.

THE MARK CONSISTS OF STANDARD CHARACTERS WITHOUT CLAIM TO ANY PARTICULAR FONT, STYLE, SIZE, OR COLOR.

CLASS 9—ELECTRICAL AND SCIENTIFIC APPARATUS

FOR MUSICAL SOUND RECORDINGS (U.S. CLS. 21, 23, 26, 36 AND 38).
FIRST USE 11-5-2003; IN COMMERCE 11-5-2003.

CLASS 41—EDUCATION AND ENTERTAINMENT

FOR LIVE PERFORMANCES BY A MUSICAL GROUP (U.S. CLS. 100, 101 AND 107).
FIRST USE 6-1-2003; IN COMMERCE 11-5-2003.
PATRICIA EVANKO, EXAMINING ATTORNEY

SN 78-325,744. DELORENZI, PATRICIA D., KANSAS CITY, MO. FILED 11-10-2003.

BABY BURKE SPECIALTIES

THE MARK CONSISTS OF STANDARD CHARACTERS WITHOUT CLAIM TO ANY PARTICULAR FONT, STYLE, SIZE, OR COLOR.

NO CLAIM IS MADE TO THE EXCLUSIVE RIGHT TO USE "SPECIALTIES", APART FROM THE MARK AS SHOWN.

BABY BURKE IDENTIFIES A PARTICULAR LIVING INDIVIDUAL WHOSE CONSENT IS OF RECORD.

CLASS 14—JEWELRY

FOR JEWELRY (U.S. CLS. 2, 27, 28 AND 50).
FIRST USE 10-15-2003; IN COMMERCE 10-15-2003.

CLASS 16—PAPER GOODS AND PRINTED MATTER

FOR PAPER GOODS AND PRINTED MATTER, NAMELY, NOTE CARDS, GREETING CARDS AND INVITATION CARDS (U.S. CLS. 2, 5, 22, 23, 29, 37, 38 AND 50).

FIRST USE 11-1-2003; IN COMMERCE 11-1-2003.
SOPHIA S. KIM, EXAMINING ATTORNEY

SN 78-325,758. DOC HAAS, LLC, DBA XTREME BRANDS,
GREENVILLE, SC. FILED 11-10-2003.

SMOKIN' JOE'S RACING

THE MARK CONSISTS OF STANDARD CHARACTERS WITHOUT CLAIM TO ANY PARTICULAR FONT, STYLE, SIZE, OR COLOR.

NO CLAIM IS MADE TO THE EXCLUSIVE RIGHT TO USE "RACING", APART FROM THE MARK AS SHOWN.

THE NAME(S), PORTRAIT(S), AND/OR SIGNATURE(S) SHOWN IN THE MARK DOES NOT IDENTIFY A PARTICULAR LIVING INDIVIDUAL.

CLASS 25—CLOTHING

FOR CLOTHING, NAMELY, T-SHIRTS, THERMAL SHIRTS, JACKETS, SWEATSHIRTS; GARMENTS MADE OF FLEECE AND OTHER FABRICS, NAMELY, SWEATERS, VESTS, SWEATSHIRTS, GLOVES AND BEANIES; BANDANAS, SHORTS, SWIM TRUNKS AND UNDERGARMENTS (U.S. CLS. 22 AND 39).

FIRST USE 1-1-1992; IN COMMERCE 2-26-1993.

CLASS 41—EDUCATION AND ENTERTAINMENT

FOR ENTERTAINMENT SERVICES, NAMELY, SPONSORING MOTORIZED AND VEHICULAR RACING EVENTS, MOTORCROSS EVENTS, AND MARINE RACING EVENTS (U.S. CLS. 100, 101 AND 107).

FIRST USE 1-2-1993; IN COMMERCE 2-1-2002.

SOPHIA S. KIM, EXAMINING ATTORNEY

SN 78-325,760. DOC HAAS, LLC, DBA XTREME BRANDS,
GREENVILLE, SC. FILED 11-10-2003.

JOE THIRSTY

THE MARK CONSISTS OF STANDARD CHARACTERS WITHOUT CLAIM TO ANY PARTICULAR FONT, STYLE, SIZE, OR COLOR.

THE NAME JOE DOES NOT IDENTIFY A LIVING INDIVIDUAL.

CLASS 16—PAPER GOODS AND PRINTED MATTER

FOR DECALS AND PAPER TOWELS (U.S. CLS. 2, 5, 22, 23, 29, 37, 38 AND 50).

FIRST USE 8-1-1998; IN COMMERCE 8-1-1998.

CLASS 21—HOUSEWARES AND GLASS

FOR MULTI-PURPOSE CLEANING, POLISHING AND DRYING TOOLS, NAMELY, CLOTHS COMPRISED OF COTTON FIBERS, LEATHER HIDES, CHAMOIS, SPONGES, SQUEEGEES, GLOVE-LIKE HAND MITTS OF FABRIC; HOUSEHOLD CONTAINERS, NAMELY, CUPS, MUGS AND GLASSES; NON-WOVEN CLOTHS FOR CLEANSING VARIOUS SURFACES (U.S. CLS. 2, 13, 23, 29, 30, 33, 40 AND 50).

FIRST USE 2-1-1992; IN COMMERCE 2-26-2000.

CLASS 24—FABRICS

FOR SPORTS TOWELS (U.S. CLS. 42 AND 50).

FIRST USE 1-1-1992; IN COMMERCE 2-26-2000.

CLASS 25—CLOTHING

FOR CLOTHING, NAMELY, T-SHIRTS, THERMAL SHIRTS, JACKETS, SWEATSHIRTS; GARMENTS MADE OF FLEECE AND OTHER FABRICS, NAMELY, SWEATERS, VESTS, SWEATSHIRTS, GLOVES AND BEANIES; BANDANAS, SHORTS, SWIM TRUNKS, UNDERGARMENTS (U.S. CLS. 22 AND 39).

FIRST USE 1-1-1992; IN COMMERCE 2-26-1993.

SOPHIA S. KIM, EXAMINING ATTORNEY

SN 78-325,824. DIAMOND BASEBALL COMPANY, INC.,
DBA DIAMOND SPORTS CO., INC., CYPRESS, CA. FILED
11-10-2003.

AUTHENTIC DIAMOND COLLECTION

THE MARK CONSISTS OF STANDARD CHARACTERS WITHOUT CLAIM TO ANY PARTICULAR FONT, STYLE, SIZE, OR COLOR.

OWNER OF U.S. REG. NOS. 1,961,637 AND 2,045,819.

NO CLAIM IS MADE TO THE EXCLUSIVE RIGHT TO USE "AUTHENTIC" AND "COLLECTION", APART FROM THE MARK AS SHOWN.

CLASS 9—ELECTRICAL AND SCIENTIFIC APPARATUS

FOR BATTING HELMETS, REPLACEMENT WIRE GUARDS AND STRAPS FOR BATTING HELMETS (U.S. CLS. 21, 23, 26, 36 AND 38).

CLASS 18—LEATHER GOODS

FOR TRAVEL BAGS OF LEATHER AND IMITATIONS OF LEATHER, TOTE BAGS (U.S. CLS. 1, 2, 3, 22 AND 41).

CLASS 25—CLOTHING

FOR ATHLETIC APPAREL AND CLOTHING, NAMELY, UNDERSHIRTS, UNDERSHORTS, SHIRTS, VESTS, COMPRESSION VESTS, COMPRESSION SHIRTS, SLIDING SHORTS, COMPRESSION SHORTS AND CAPS (U.S. CLS. 22 AND 39).

CLASS 28—TOYS AND SPORTING GOODS

FOR SPORTING GOODS, NAMELY, BASEBALLS, SOFTBALLS, PITCHING MACHINE BALLS, CATCHER'S MASKS, WRIST PROTECTIVE GUARDS FOR ATHLETIC USE, HAND PROTECTIVE GUARDS FOR ATHLETIC USE, THROAT PROTECTIVE GUARDS FOR ATHLETIC USE, BATTING GLOVES, MITTS, FACE MASKS, REPLACEMENT FACE MASK PADS, BODY AND CHEST PROTECTIVE GUARDS FOR ATHLETIC USE, UMPIRE BODY AND CHEST PROTECTIVE GUARDS FOR ATHLETIC USE, LEG AND SHIN PROTECTIVE GUARDS FOR ATHLETIC USE, UMPIRE BALL-STRIKE INDICATORS, BASEBALL PLATE BRUSHES, BAGS USED SPECIFICALLY BY UMPIRES FOR CARRYING SPORTS BALLS, ATHLETIC EQUIPMENT BAGS AND TOTE BAGS SPECIFICALLY DESIGNED FOR CARRYING SPORTS EQUIPMENT, BUCKETS DESIGNED FOR CARRYING SPORTS BALLS, FOOTBALL SHOULDER PADS, FOOTBALL SHOULDER AND ARM BRACES, FOOTBALL THIGH GUARDS (U.S. CLS. 22, 23, 38 AND 50).
SOPHIA S. KIM, EXAMINING ATTORNEY

SN 78-327,040. DIAGEO BRANDS B.V., AMSTERDAM, NETHERLANDS, FILED 11-12-2003.

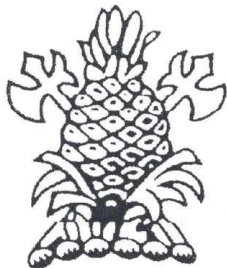

PRIORITY CLAIMED UNDER SEC. 44(D) ON ERP N CMNTY TM OFC APPLICATION NO. 003297975, FILED 8-6-2003, REG. NO. 003297975, DATED 2-7-2005, EXPIRES 8-6-2013.

THE MARK CONSISTS OF A DESIGN OF A PINEAPPLE AND TWO AXES SITTING ON TOP OF LEAVES ON A BASE.

CLASS 21—HOUSEWARES AND GLASS

FOR HOUSEHOLD OR KITCHEN UTENSILS NOT OF PRECIOUS METAL OR COATED THEREWITH, NAMELY BOWLS, DRINKING GLASSES, BEVERAGE GLASSWARE, GLASS BOWLS, GLASS DISHES; PORCELAIN AND EARTHENWARE MUGS, DISHES AND BOWLS; TUMBLERS IN THE NATURE OF DRINKING VESSELS, BEER MUGS, MUGS, ICE BUCKETS, ICE CUBE TRAYS, ICE TONGS, PLASTIC COASTERS, COASTERS NOT OF PAPER AND NOT BEING TABLE LINEN, BOTTLE OPENERS; BUCKETS, CANDLE-HOLDERS NOT OF PRECIOUS METAL; PORTABLE COOLERS, CUPS; FOAM DRINK HOLDERS, COCKTAIL SHAKERS, COCKTAIL STIRRERS, COCKTAIL STICKS, JUGS, TANKARDS, DECANTERS, NONE OF THE AFORESAID BEING OF PRECIOUS METAL (U.S. CLS. 2, 13, 23, 29, 30, 33, 40 AND 50).

CLASS 33—WINES AND SPIRITS

FOR ALCOHOLIC BEVERAGES, NAMELY, DISTILLED SPIRITS (U.S. CLS. 47 AND 49).
JASON TURNER, EXAMINING ATTORNEY

SN 78-327,761. COINCIDE MEDIA, LLC, NEW ORLEANS, LA. FILED 11-13-2003.

LOW CARB ENERGY

THE MARK CONSISTS OF STANDARD CHARACTERS WITHOUT CLAIM TO ANY PARTICULAR FONT, STYLE, SIZE, OR COLOR.

NO CLAIM IS MADE TO THE EXCLUSIVE RIGHT TO USE "LOW CARB", APART FROM THE MARK AS SHOWN.

CLASS 16—PAPER GOODS AND PRINTED MATTER

FOR PUBLICATIONS, NAMELY BOOKS, MAGAZINES, CALENDARS; NOTEBOOKS, FORMS; GREETING CARDS, STATIONERY; CATALOGUES, MANUALS, BROCHURES, PAMPHLETS, GUIDES, AND NEWSLETTERS IN THE FIELD OF FERTILITY, CONCEPTION, PREGNANCY AND PARENTHOOD AND ISSUES OF INTEREST FOR WOMEN AND FAMILIES IN THE AREAS OF HEALTH, BABIES, BOOKS, FOOD, MONEY, RELATIONSHIPS, HOBBIES; SHOPPING, TRAVEL AND WORKING FROM HOME (U.S. CLS. 2, 5, 22, 23, 29, 37, 38 AND 50).

CLASS 41—EDUCATION AND ENTERTAINMENT

FOR ON-LINE NON-DOWNLOADABLE ELECTRONIC PUBLICATIONS AND MAGAZINE SERVICES FOCUSING ON PARENTING, PREGNANCY, ISSUES AND NEWS PERTAINING TO VARIOUS LOCALITIES, FOOD, COOKING, HOUSEKEEPING, DECORATING, ENTERTAINING, WEDDINGS, CRAFTS, HOLIDAY PLANNING, CELEBRATIONS, HOME CARE, RECIPES; CUISINE, HOMEMAKING, EVENT PLANNING, DOMESTIC ARTS, CULTURE, IDEAS; BOOKS AND BOOK REVIEWS, MUSIC; MULTIMEDIA, POLITICS, AND CONVERSATION, ACCESSIBLE VIA GLOBAL OR NON-GLOBAL COMPUTER NETWORKS (U.S. CLS. 100, 101 AND 107).

GRETTA YAO, EXAMINING ATTORNEY

SN 78-327,771. CREATIVE SECURITY CONCEPTS, INC., SAN JOSE, CA. FILED S.R. 11-13-2003; AM. P.R. 4-13-2005.

CREATIVE SECURITY CONCEPTS

THE MARK CONSISTS OF STANDARD CHARACTERS WITHOUT CLAIM TO ANY PARTICULAR FONT, STYLE, SIZE, OR COLOR.

NO CLAIM IS MADE TO THE EXCLUSIVE RIGHT TO USE "SECURITY", APART FROM THE MARK AS SHOWN.

CLASS 41—EDUCATION AND ENTERTAINMENT

FOR EDUCATIONAL SERVICES, NAMELY, CONDUCTING SEMINARS AND TRAINING IN THE FIELDS OF EXECUTIVE SECURITY AND BODYGUARD SERVICES; EDUCATIONAL SERVICES, NAMELY, CONDUCTING SEMINARS AND TRAINING IN THE FIELDS OF PHYSICAL ASSET PROTECTION AND SECURITY GUARD SERVICES; EDUCATIONAL SERVICES, NAMELY, CONDUCTING SEMINARS AND TRAINING IN THE FIELDS OF INTELLECTUAL PROPERTY PROTECTION AND SECURITY OF CORPORATE TRADE SECRETS, INVENTIONS, AND TECHNOLOGY; EDUCATIONAL SERVICES, NAMELY, CONDUCTING SEMINARS AND TRAINING IN THE FIELDS OF GENERAL PRIVATE AND PRE-EMPLOYMENT INVESTIGATION (U.S. CLS. 100, 101 AND 107).

FIRST USE 3-5-1999; IN COMMERCE 11-2-2000.

CLASS 42—SCIENTIFIC, COMPUTER AND LEGAL SERVICES

FOR ENVIRONMENTAL DESIGN OF BUILDINGS FOR CRIME PROTECTION PURPOSES; DESIGN AND DEVELOPMENT OF NETWORK SECURITY FOR OTHERS (U.S. CLS. 100 AND 101).

FIRST USE 3-5-1999; IN COMMERCE 11-2-2000.

CLASS 45—PERSONAL SERVICES

FOR MONITORING OF COMPUTER NETWORKS AND INFORMATION SYSTEMS FOR SECURITY PURPOSES (U.S. CLS. 100 AND 101).

FIRST USE 3-5-1999; IN COMMERCE 11-2-2000.

GRETTA YAO, EXAMINING ATTORNEY

SN 78-328,737, TC LICENSE, LTD, HUMMELSTOWN, PA. FILED 11-17-2003.

TAGTELLER

THE MARK CONSISTS OF STANDARD CHARACTERS WITHOUT CLAIM TO ANY PARTICULAR FONT, STYLE, SIZE, OR COLOR.

CLASS 9—ELECTRICAL AND SCIENTIFIC APPARATUS

FOR AUTOMATED SELF SERVICE MACHINES FOR DISPENSING RADIO FREQUENCY IDENTIFICATION TRANSPONDERS FOR MOBILE PAYMENT SYSTEMS (U.S. CLS. 21, 23, 26, 36 AND 38).

FIRST USE 11-4-2003; IN COMMERCE 11-4-2003.

CLASS 35—ADVERTISING AND BUSINESS

FOR BUSINESS MANAGEMENT CONSULTATION SERVICES FOR COLLECTING, TRACKING, REPORTING AND ANALYZING INFORMATION IN THE FIELD OF ELECTRONIC MOBILE PAYMENTS (U.S. CLS. 100, 101 AND 102).

CLASS 36—INSURANCE AND FINANCIAL

FOR ELECTRONIC TOLL COLLECTION SERVICES (U.S. CLS. 100, 101 AND 102).

DAWN HAN, EXAMINING ATTORNEY

SN 78-329,030, FUJITSU NETWORK COMMUNICATIONS, INC., RICHARDSON, TX. FILED 11-17-2003.

NetMIGRATION

THE MARK CONSISTS OF STANDARD CHARACTERS WITHOUT CLAIM TO ANY PARTICULAR FONT, STYLE, SIZE, OR COLOR.

CLASS 37—CONSTRUCTION AND REPAIR

FOR INSTALLATION AND MAINTENANCE OF COMPUTER HARDWARE UPGRADES TO VOICE, DATA AND VIDEO TELECOMMUNICATIONS NETWORKS (U.S. CLS. 100, 103 AND 106).

FIRST USE 9-8-2003; IN COMMERCE 9-8-2003.

CLASS 42—SCIENTIFIC, COMPUTER AND LEGAL SERVICES

FOR INSTALLATION OF TELECOMMUNICATIONS NETWORKS SOFTWARE; TECHNICAL CONSULTATION SERVICES, PROVIDED BY MEANS OF A WORLD WIDE COMPUTER NETWORK, E-MAIL, VOICE MAIL, TELEPHONE AND CELLULAR TELEPHONE AND FACSIMILE TRANSMISSION, NAMELY, TROUBLESHOOTING OF UPGRADES TO VOICE, DATA AND VIDEO TELECOMMUNICATIONS NETWORK HARDWARE AND SOFTWARE (U.S. CLS. 100 AND 101).

FIRST USE 9-8-2003; IN COMMERCE 9-8-2003.

BRIAN PINO, EXAMINING ATTORNEY

SN 78-329,840, TOOTSIE ROLL BRANDS LLC, CHICAGO, IL. FILED 11-19-2003.

TOOTSIE ROLL POP

THE MARK CONSISTS OF STANDARD CHARACTERS WITHOUT CLAIM TO ANY PARTICULAR FONT, STYLE, SIZE, OR COLOR.

CLASS 3—COSMETICS AND CLEANING PREPARATIONS

FOR COSMETICS, NON-MEDICATED LIP BALM, LIP GLOSS, SKIN SOAP, BATH FOAM, NAIL POLISH, AND BODY LOTION (U.S. CLS. 1, 4, 6, 50, 51 AND 52).

FIRST USE 10-0-2002; IN COMMERCE 10-0-2002.

CLASS 14—JEWELRY

FOR JEWELRY, WATCHES, BRACELETS, NECKLACES AND RINGS (U.S. CLS. 2, 27, 28 AND 50).
FIRST USE 6-0-2003; IN COMMERCE 6-0-2003.

CLASS 16—PAPER GOODS AND PRINTED MATTER

FOR STATIONERY BOX SETS, STICKERS, NOTEBOOKS, DIARIES, PENCILS, ERASERS, NON-GRADUATED RULERS, ADDRESS BOOKS, SELF ADHESIVE PAPER, GIFT TAGS, GREETING CARDS, FOLDERS, BLANK JOURNALS, PENS, SCENTED MARKERS, AND SCRATCH AND SNIFF STICKERS (U.S. CLS. 2, 5, 22, 23, 29, 37, 38 AND 50).

FIRST USE 6-0-2003; IN COMMERCE 6-0-2003.

CLASS 20—FURNITURE AND ARTICLES NOT OTHERWISE CLASSIFIED

FOR PICTURE FRAMES, NON-METAL AND NON-LEATHER KEY CHAINS (U.S. CLS. 2, 13, 22, 25, 32 AND 50).

FIRST USE 6-0-2003; IN COMMERCE 6-0-2003.

CLASS 25—CLOTHING

FOR UNDERWEAR, BRAS, CAMISOLES, PANTS, SHIRTS, SWEATSHIRTS, JERSEYS, HEADBANDS, STOCKINGS, SOCKS, FOOTWEAR, SHORTS, BELTS, PAJAMAS (U.S. CLS. 22 AND 39).

FIRST USE 6-0-2003; IN COMMERCE 6-0-2003.
KIMBERLY FRYE, EXAMINING ATTORNEY

SN 78-330,379, CHEVRON PHILLIPS CHEMICAL COMPANY LP, THE WOODLANDS, TX. FILED 11-19-2003.

ADVANCING FORMULAS FOR LIFE

THE MARK CONSISTS OF STANDARD CHARACTERS WITHOUT CLAIM TO ANY PARTICULAR FONT, STYLE, SIZE, OR COLOR.

CLASS 1—CHEMICALS

FOR AROMATIC CHEMICALS, NAMELY, STYRENE, TOLUENE, BENZENE, PARAXYLENE, ORTHOXYLENE, CYCLOHEXANE, DIETHYLBENZENE, MIXED XYLENES, FOR USE IN THE MANUFACTURE OF AUTOMOTIVE PARTS, EXPLOSIVES, COSMETICS, ARTIFICIAL SWEETENERS, DETERGENTS, FABRIC COATINGS, OCTANE ENHANCER, PAINTS AND PRINTING INKS, POLYURETHANE FOAM, SOLVENTS, ADHESIVES, TIRES, CARS, BOATS, COMPUTERS, VIDEO GAMES, COATINGS, ASPHALT, FLOOR WAX, KITCHEN COUNTERTOPS, FILM, MEDICAL EQUIPMENT, CD JEWEL CASES, FOOD CONTAINERS AND PACKAGING, TONER, SYNTHETIC RUBBER, PAINTS, CLOTHING, PLASTIC BOTTLES; OLEFINS, SUCH AS PROPYLENE, PYROLYSIS OIL, PYROLYSIS GASOLINE, ETHYLENE, DICYCLOPENTADIENE, HEAVY AROMATIC DISTILLATE, RESIN OIL, ISOPRENE FEEDSTOCK, FOR USE IN THE MANUFACTURE OF CONSUMER PRODUCTS; CHEMICAL ADDITIVES FOR USE WITH INTERNAL COMBUSTION ENGINE FUELS; OCTANE BOOSTER CHEMICAL FUEL ADDITIVE; FUEL INJECTION CHEMICAL CLEANER ADDITIVES; CHEMICAL ENGINE TREATMENTS AND ADDITIVES FOR ENGINE OILS, GASOLINE AND DIESEL FUELS, TRANSMISSION FLUIDS; CHEMICAL ODORANT TO BE ADDED TO NATURAL GAS, LIQUEFIED PETROLEUM GAS, AND OTHER COMBUSTIBLE GASES TO WARN THE CONSUMER OF LEAKS IN GAS LINES

AND COOKING AND HEATING APPLIANCES; DEFLOCCULANT FOR USE IN DRILLING MUDS; MINERAL FLOTATION AGENTS FOR USE IN THE MINING AND FERTILIZER INDUSTRIES; MINING CHEMICALS; CHEMICAL ADDITIVES FOR OIL WELL DRILLING FLUIDS, CHEMICAL DRILLING FLUID MODIFIERS, AND DRILLING MUD; CHEMICAL EXTENDERS FOR CLAYS USED IN DRILLING MUDS; CHEMICAL POWDER AND LIQUID CEMENT ADDITIVE FOR CEMENT FLUID LOSS CONTROL; FIREFIGHTING TRAINING FLUIDS IN THE NATURE OF FIRE EXTINGUISHING COMPOSITIONS; MERCAPTANS FOR USE IN THE MANUFACTURE OF FLAVORS AND FRAGRANCES, AGRICULTURAL INTERMEDIATES, BIOCIDES, CATALYST SULFIDING AND PYROLYSIS FURNACE ADDITIVES, LPG ODORANTS, ADDITIVES, MODIFIERS AND SOLVENTS, AND IN METALWORKING AND METAL PROCESSING; NEOHEXENE FOR USE IN THE MANUFACTURE OF FRAGRANCES, HEALTH, BEAUTY, AND PHARMACEUTICAL PRODUCTS; OLEFIN POLYMERS FOR USE IN PLASTIC MOLDING, EXTRUSION, FILM FORMING AND BLENDING OPERATIONS; OLEFINIC CHEMICALS FOR USE IN THE MANUFACTURE OF COMMODITY AND SPECIALTY CHEMICALS, SYNTHETIC RUBBER, PLASTICS, ADHESIVES, INKS, DYES, SOLVENTS, ANTISEPTIC, INSECTICIDE, AND FUEL OIL; ORGANOSULFUR CHEMICAL COMPOUNDS FOR USE IN THE MANUFACTURE AGRICULTURAL PRODUCTS, BIOCIDES, CLEANING PRODUCTS, HEALTH AND PHARMACEUTICAL PRODUCTS, ACID CATALYSTS, ADHESIVES, FUEL ADDITIVES, CATALYST PRESULFIDING PRODUCTS, LUBRICANT ADDITIVES, AND IN AROMATIC EXTRACTION, NATURAL GAS TREATMENT, CHEMICAL MANUFACTURING AND EXTRACTION, LEATHER AND TEXTILE PROCESSING, AND METALWORKING AND METAL PROCESSING; OXYGEN SCAVENGING RESINS AND POLYMERS FOR USE IN THE MANUFACTURE OF PACKAGING FOR OXYGEN SENSITIVE PRODUCTS; PETROCHEMICALS FOR USE IN THE MANUFACTURE OF PLASTICS, FUELS, COMMODITY AND SPECIALTY CHEMICALS; PLASTIC MOLDING COMPOUNDS FOR USE IN PLASTIC EXTRUSION OPERATIONS AND THE MANUFACTURE OF MOLDED PLASTIC ARTICLES, PLASTIC SHEETS AND FILMS, AUTOMOTIVE PARTS, RESINS; PROPYLENE FOR USE IN THE MANUFACTURE OF PROPYLENE OXIDE, ACRYLIC ACID, ALCOHOLS, ISOPROPANOL, POLYPROPYLENE; STYRENE FOR USE IN THE MANUFACTURE OF PLASTICS AND CHEMICALS; CRYSTAL POLYSTYRENE FOR USE IN THE MANUFACTURE OF INJECTION MOLDED MEDICAL CONTAINERS, CD JEWEL BOXES, CONTAINERS, DESK ORGANIZERS, AUDIO CASSETTES, HOUSEWARES, CUTLERY, INJECTION MOLDED DRINK CUPS, MEDICAL DEVICES, THICK WALL INJECTION MOLDED GLASSES, CLAM-SHELL CONTAINERS, COLOR CONCENTRATES, FLOPPY DISKETTES, DISPLAYS AND RETAIL PRODUCT SHELVING, CONTAINERS AND LIDS, PACKAGING, DAIRY CONTAINERS, PRINTED TOYS, DRINK CUPS, LIDS, PORTION CONTAINERS, DISHWARE; STYRENE-BUTADIENE COPOLYMER FOR USE IN MANUFACTURE OF FOOD SERVICE PACKAGING, RIGID PACKAGING, BLISTER PACKAGING, CONSUMER DISPLAYS, CUPS AND LIDS, HEAT SHRINK FILM, INDUSTRIAL FILMS, TAMPER EVIDENT PACKAGING, MEDICAL PACKAGING, APPLIANCES, HANGERS, TOYS, FLEXIBLE PACKAGING; SULFUR CONTAINING THERMOPLASTIC AND ENGINEERING RESINS FOR INDUSTRIAL USE AS A MOLDING COMPOUND, AN EXTRUSION COMPOUND, A BLENDING COMPOUND; POLYETHYLENE FOR THE MANUFACTURE OF CAPS, HOUSEWARES, FLEXIBLE PACKAGING, LAMINATION, INDUSTRIAL PACKAGING, CLOSURES, THIN WALL MOLDING, LINERS, BOARD COATING, LIQUID FOOD BOTTLES, PERSONAL CARE PRODUCTS, FOOD AND RETAIL PACKAGING, HEAVY DUTY PACKAGING, PIPE, TOYS, CARTS, RECREATIONAL PARTS, INDUSTRIAL WASTE CONTAINERS, TANKS, MARINE EQUIPMENT, PAILS, CRATES, LARGE CONTAINERS, CONDUIT, PHARMACEUTICAL PRODUCTS, HOUSEHOLD INDUSTRIAL CHEMICALS, COATING, HIGH GLOSS PACKAGING, BLOWN FILM PRODUCTS, FLEXIBLE BLOW MOLDED PRODUCTS, FILM, GEOMEMBRANE, SHEETS, AUTOMOTIVE INTERIORS, AUTOMOTIVE EXTERIORS, BUMPER FACIAS, INSTRUMENT PANELS, DOOR PANELS, HEAD LAMP HOUSINGS, ELECTRICAL HOUSINGS, BRACKETS, UNDERHOOD COMPONENTS, RESIN FOR COMPOUND-

ING, YARN, NONWOVEN FABRICS, HOSPITAL WARE, MULTIFILAMENT FIBER, WOVEN PRODUCTS, ROPE, CORDAGE, SPICE BOTTLES, TOILETRY BOTTLES, COSMETIC BOTTLES, ANTIFREEZE RESERVOIRS, ENGINE COOLANT RESERVOIRS, PALLETS, BINS, BULK CONTAINERS, RETURNABLE PACKAGING; POLYPHENYLENE SULFIDE RESINS AND ALLOYS FOR THE MANUFACTURE OF HVAC APPLIANCES, HOUSEHOLD APPLIANCES, BUSINESS MACHINES, LIGHTING APPLIANCES, FUEL/INDUCTION SYSTEMS, ELECTRICAL SYSTEMS, COOLANT SYSTEMS, POWER-TRAIN/TRANSMISSION SYSTEMS, BRAKE SYSTEMS, AUTOMOTIVE LIGHTING, BOBBINS, PACKAGING, SWITCHES/RELAYS, OIL FIELD EQUIPMENT, PUMPS, VALVES, COATINGS; THERMOPLASTICS FOR USE IN THE MANUFACTURE OF CONSUMER PRODUCTS; SYNTHETIC RESINOUS COPOLYMERS OF BUTADIENE AND STYRENE FOR PACKAGING, CONSUMER PRODUCTS, MEDICAL, CHEMICAL AND POLYMER INDUSTRIES; POLYMERS AND SYNTHETIC RESINS USED FOR ABSORBING OXYGEN (U.S. CLS. 1, 5, 6, 10, 26 AND 46).

SN 78-330,727. SOZO INTERNATIONAL, INC., LOUISVILLE, KY. FILED 11-20-2003.

SOZO

CLASS 3—COSMETICS AND CLEANING PREPARATIONS

FOR SURFACTANT CLEANING PREPARATIONS FOR INDUSTRIAL USE IN REMOVING HYDROCARBON AND PARTICULATE TAR, SCALE, PARAFFIN AND ASPHALTIC DEPOSITS; DRY CLEANING FLUIDS (U.S. CLS. 1, 4, 6, 50, 51 AND 52).

CLASS 4—LUBRICANTS AND FUELS

FOR FUEL FOR MOTOR VEHICLES, NAMELY, GASOLINE, DIESEL, RACING FUELS, REFERENCE FUELS, PERFORMANCE FUELS, TEST FUELS, EMISSION CERTIFICATION FUELS, FUEL BLENDSTOCKS, SPECIALTY FUELS; DIESEL FUEL, FUEL OIL, GASOLINE, NON-CHEMICAL GASOLINE ADDITIVES, NON-CHEMICAL ENGINE TREATMENTS AND ADDITIVES FOR ENGINE OILS, GASOLINE AND DIESEL FUELS, TRANSMISSION FLUIDS AND COOLING SYSTEMS; BENZENE FUEL; HYDROCARBONS FOR USE IN CLEANING, CHEMICAL MANUFACTURING AND EXTRACTION, WATER TREATMENT, HEALTH AND PHARMACEUTICAL PRODUCTS, FLAVORS, FRAGRANCES; NORMAL ALPHA OLEFINS FOR USE IN THE MANUFACTURE OF PERSONAL CARE PRODUCTS, PVC LUBRICANTS, ASA, ALKYL SILANES, METAL ALKYL, CANDLES, POUR POINT DEPRESSANTS, LUBE OIL ADDITIVES, MERCAPTANS, EPOXIDES, LUBE OIL ADDITIVES, ALKYL AROMATICS, DRILLING FLUIDS, MALEIC ANHYDRIDE COPOLYMERS, AOS, ADMA, METAL WORKING FLUIDS, DI/POLY-HALIDES, FLAVORS AND FRAGRANCES, POLYETHYLENE COMONOMERS, DETERGENT ALCOHOLS, POLYALPHAOLEFINS, POLYOL ESTERS, PLASTICIZER ALOCHOLS; POLYALPHAOLEFINS FOR USE IN LUBRICANTS, GREASES AND FLUIDS; NAPHTHAS FOR USE AS SOLVENTS OR THINNERS IN PAINTS, VARNISHES, AND PAINTERS' MATERIALS WHICH ARE SOLUBLE IN LIQUID HYDROCARBONS; SYNTHETIC INDUSTRIAL LUBRICANTS (U.S. CLS. 1, 6 AND 15).

CLASS 17—RUBBER GOODS

FOR EXTRUDED PLASTIC FOR USE IN MANUFACTURING PLASTIC PIPE FOR CONVEYING NATURAL GAS; PLASTIC IN THE FORM OF BARS, BLOCKS, PELLETS, RODS, SHEETS AND TUBES FOR MANUFACTURING AND GENERAL INDUSTRIAL USE; PLASTIC PIPE FITTINGS; POLYETHYLENE PIPE (U.S. CLS. 1, 5, 12, 13, 35 AND 50).

CLASS 40—MATERIAL TREATMENT

FOR CUSTOM MANUFACTURE OF POLYMER AND RESIN-BASED PACKAGING FOR USE IN OXYGEN SENSITIVE APPLICATIONS; CUSTOM MANUFACTURE OF CHEMICALS AND CHEMICAL FORMULATIONS (U.S. CLS. 100, 103 AND 106).

BARNEY CHARLON, EXAMINING ATTORNEY

THE MARK CONSISTS OF STANDARD CHARACTERS WITHOUT CLAIM TO ANY PARTICULAR FONT, STYLE, SIZE, OR COLOR.

THE TERM "SOZO" IS A GREEK WORD MEANING TO MAKE WELL, HEAL, TO RESCUE FROM DANGER OR TO SAVE.

CLASS 36—INSURANCE AND FINANCIAL

FOR CHARITABLE FUNDRAISING (U.S. CLS. 100, 101 AND 102).

FIRST USE 11-1-2002; IN COMMERCE 11-1-2002.

CLASS 37—CONSTRUCTION AND REPAIR

FOR CHARITABLE SERVICES, NAMELY THE CONSTRUCTION AND REPAIR OF BUILDINGS FOR UNDERDEVELOPED COUNTRIES AND OTHERS IN NEED (U.S. CLS. 100, 103 AND 106).

FIRST USE 11-1-2002; IN COMMERCE 11-1-2002.

CLASS 41—EDUCATION AND ENTERTAINMENT

FOR PROVIDING TRAINING IN THE FIELDS OF HEALTH CARE, EDUCATION, LEADERSHIP AND ECONOMIC DEVELOPMENT AND DISTRIBUTING WRITTEN MATERIALS IN CONNECTION THEREWITH; PROVIDING INSTRUCTION IN THE FIELDS OF GENERAL HEALTH CARE, PREVENTIVE HEALTHCARE, DENTAL CARE, NUTRITION, CHILD DEVELOPMENT, LITERACY, LANGUAGE SKILLS, GENERAL EDUCATION, LEADERSHIP, GENERAL BUSINESS SKILLS AND ECONOMIC DEVELOPMENT AND DISTRIBUTING WRITTEN MATERIALS IN CONNECTION THEREWITH, ALL IN CONNECTION WITH MISSION WORK TO UNDERDEVELOPED OR IMPOVERISHED COMMUNITIES (U.S. CLS. 100, 101 AND 107).

FIRST USE 11-1-2002; IN COMMERCE 11-1-2002.

CLASS 44—MEDICAL, BEAUTY AND AGRICULTURAL SERVICES

FOR PROVIDING MEDICAL SERVICES TO UNDERDEVELOPED COUNTRIES AND OTHERS IN NEED (U.S. CLS. 100 AND 101).

FIRST USE 11-1-2002; IN COMMERCE 11-1-2002.

SCOTT BALDWIN, EXAMINING ATTORNEY

SN 78-330,820. EMPOWER WORKS LIMITED, CHENNAI, INDIA, FILED 11-20-2003.

SN 78-332,706. PETSUNITED, LLC, HAZLETON, PA. FILED 11-25-2003.



THE MARK CONSISTS OF A BUTTERFLY DESIGN

CLASS 9—ELECTRICAL AND SCIENTIFIC APPARATUS

FOR COMPUTER SOFTWARE AND DOWNLOADABLE SOFTWARE THAT FACILITATES RECRUITING, TRAINING, MANPOWER AND RESOURCE PLANNING; COMPUTER SOFTWARE AND DOWNLOADABLE SOFTWARE THAT COMPUTES PAYROLL AND PREPARES COMPANY DIRECTORIES, ALL IN THE FIELDS OF HUMAN RESOURCES, HUMAN CAPITAL MANAGEMENT, WORK-FORCE MANAGEMENT, EMPLOYEE RELATIONS MANAGEMENT, EMPLOYEE-PROCESS AUTOMATION, EMPLOYEE SELF-SERVICE AND SELF-ADMINISTRATION, BUSINESS INTELLIGENCE AND ANALYTICS, EMPLOYEE EDUCATION AND TRAINING, CORPORATE TRAINING, GOALS AND PERFORMANCE MANAGEMENT, CORPORATE AND INDIVIDUAL PERFORMANCE MAXIMIZATION (U.S. CLS. 21, 23, 26, 36 AND 38).

FIRST USE 10-15-2003; IN COMMERCE 10-15-2003.

CLASS 42—SCIENTIFIC, COMPUTER AND LEGAL SERVICES

FOR SOFTWARE SERVICES, NAMELY COMPUTER SOFTWARE CONSULTATION, COMPUTER SOFTWARE DESIGN FOR OTHERS, COMPUTER SOFTWARE DEVELOPMENT, INSTALLATION OF COMPUTER SOFTWARE, MAINTENANCE AND REPAIR OF COMPUTER SOFTWARE, ASP APPLICATION SERVICE PROVIDER FEATURING SOFTWARE THAT FACILITATES RECRUITING, TRAINING, MANPOWER AND RESOURCE PLANNING, COMPUTER SOFTWARE AND DOWNLOADABLE SOFTWARE THAT COMPUTES PAYROLL AND PREPARES COMPANY DIRECTORIES; TECHNICAL SUPPORT SERVICES, NAMELY, TROUBLESHOOTING OF COMPUTER SOFTWARE PROBLEMS, UPDATING OF SOFTWARE FOR OTHERS (U.S. CLS. 100 AND 101).

FIRST USE 10-15-2003; IN COMMERCE 10-15-2003.
SOPHIA S. KIM, EXAMINING ATTORNEY

THERAPET

THE MARK CONSISTS OF STANDARD CHARACTERS WITHOUT CLAIM TO ANY PARTICULAR FONT, STYLE, SIZE, OR COLOR.

OWNER OF U.S. REG. NOS. 1,354,918 AND 2,036,972.

CLASS 3—COSMETICS AND CLEANING PREPARATIONS

FOR PET SUPPLIES, NAMELY, NON-MEDICATED GROOMING SUPPLIES FOR CATS AND DOGS IN THE NATURE OF SHAMPOOS, CONDITIONERS, DEGREASERS AND SPRAYS TO DRY COATS QUICKLY (U.S. CLS. 1, 4, 6, 50, 51 AND 52).

FIRST USE 7-2-1984; IN COMMERCE 7-2-1984.

CLASS 5—PHARMACEUTICALS

FOR NON-PRESCRIPTION MEDICAMENTS FOR CATS AND DOGS IN THE NATURE OF DIETARY SUPPLEMENTS (U.S. CLS. 6, 18, 44, 46, 51 AND 52).

FIRST USE 7-2-1984; IN COMMERCE 7-2-1984.

CLASS 16—PAPER GOODS AND PRINTED MATTER

FOR TRAINING AIDS FOR CATS AND DOGS IN THE NATURE OF DISPOSABLE HOUSEBREAKING PADS (U.S. CLS. 2, 5, 22, 23, 29, 37, 38 AND 50).

FIRST USE 7-2-1984; IN COMMERCE 7-2-1984.

CLASS 18—LEATHER GOODS

FOR CLOTHING FOR CATS AND DOGS; RESTRAINING AIDS FOR CATS AND DOGS IN THE NATURE OF LEASHES, COLLARS, HARNESSES AND TRAINING LEADS (U.S. CLS. 1, 2, 3, 22 AND 41).

FIRST USE 7-2-1984; IN COMMERCE 7-2-1984.

CLASS 20—FURNITURE AND ARTICLES NOT OTHERWISE CLASSIFIED

FOR PORTABLE BEDS FOR CATS AND DOGS, GROOMING TABLES FOR CATS AND DOGS (U.S. CLS. 2, 13, 22, 25, 32 AND 50).

FIRST USE 7-2-1984; IN COMMERCE 7-2-1984.

CLASS 21—HOUSEWARES AND GLASS

FOR PET FEEDING DISHES FOR CATS AND DOGS (U.S. CLS. 2, 13, 23, 29, 30, 33, 40 AND 50).

FIRST USE 7-2-1984; IN COMMERCE 7-2-1984.
BRIDGETT SMITH, EXAMINING ATTORNEY

SN 78-333,598. BODY MAKEOVER SYSTEM, INC., SANTA MONICA, CA. FILED 11-26-2003.

6 WEEK BODY MAKEOVER

THE MARK CONSISTS OF STANDARD CHARACTERS WITHOUT CLAIM TO ANY PARTICULAR FONT, STYLE, SIZE, OR COLOR.

OWNER OF U.S. REG. NO. 2,179,743.
NO CLAIM IS MADE TO THE EXCLUSIVE RIGHT TO USE "BODY MAKEOVER", APART FROM THE MARK AS SHOWN.
SEC. 2(F).

CLASS 41—EDUCATION AND ENTERTAINMENT

FOR PHYSICAL FITNESS CONSULTATION SERVICES (U.S. CLS. 100, 101 AND 107).
FIRST USE 7-0-1985; IN COMMERCE 7-0-1985.

CLASS 44—MEDICAL, BEAUTY AND AGRICULTURAL SERVICES

FOR WEIGHT REDUCTION DIET PLANNING AND SUPERVISION (U.S. CLS. 100 AND 101).
FIRST USE 7-0-1985; IN COMMERCE 7-0-1985.
KATHLEEN M. VANSTON, EXAMINING ATTORNEY

SN 78-335,254. KUMAL DAL MILLS, DELHI, INDIA, FILED 12-2-2003.



NO CLAIM IS MADE TO THE EXCLUSIVE RIGHT TO USE "BHOG", APART FROM THE MARK AS SHOWN.

THE COLORS WHITE, RED AND GOLD ARE CLAIMED AS A FEATURE OF THE MARK.

THE COLORS APPEAR AS THE LETTERS FOR SHAKTI BHOG IN WHITE, SURROUNDED BY A DESIGN ELEMENT IN RED OUTLINED IN GOLD.

THE FOREIGN WORDING IN THE MARK TRANSLATES INTO ENGLISH AS POWER OFFERING.

CLASS 29—MEATS AND PROCESSED FOODS

FOR MEAT, FISH, POULTRY AND GAME, MEAT EXTRACTS; PRESERVED DRIED AND COOKED FRUITS AND VEGETABLES, JELLIES, JAMS; EGGS, MILK, AND CHEESE; EDIBLE OILS AND FATS; FRUIT PRESERVES, PICKLES (U.S. CL. 46).
FIRST USE 4-0-2003; IN COMMERCE 4-0-2003.

CLASS 30—STAPLE FOODS

FOR COFFEE, TEA, COCOA, SUGAR, CHOCOLATE, TAPIOCA, SAGO, COFFEE SUBSTITUTES, FLOUR, GRAM FLOUR, PORRIDGE, PROCESSED CEREALS, PULSES, BREAD, BISCUITS, CAKES, PASTRIES, CONFECTIONARY; HONEY, TREACLE, YEAST, BAKING POWDER, SALT, MUSTARD, PEPPER, VINEGAR, SAUCES, SPICES; CANDY; POPPADUMS (U.S. CL. 46).
FIRST USE 4-0-2003; IN COMMERCE 4-0-2003.
CATHERINE FAINT, EXAMINING ATTORNEY

SN 78-335,704. PARKER MERIDIAN, MARIETTA, GA. FILED 12-3-2003.

WE BRING SERVICES TO YOU

THE MARK CONSISTS OF STANDARD CHARACTERS WITHOUT CLAIM TO ANY PARTICULAR FONT, STYLE, SIZE, OR COLOR.

CLASS 35—ADVERTISING AND BUSINESS

FOR VEHICLE FLEET MANAGEMENT SERVICES; BUSINESS CONSULTATION SERVICES, NAMELY, DEVELOPMENT AND STRUCTURING OF FINANCIAL SERVICE BUSINESS OPERATIONS FOR OTHERS (U.S. CLS. 100, 101 AND 102).
FIRST USE 11-26-2002; IN COMMERCE 11-26-2002.

CLASS 36—INSURANCE AND FINANCIAL

FOR INSURANCE BROKERAGE; INVESTMENT BROKERAGE; BROKERAGE IN THE FIELD OF BANKING, NAMELY, MORTGAGE BROKERAGE; INSURANCE BROKERAGE IN THE FIELDS OF DENTAL INSURANCE AND HOME PROTECTION INSURANCE; REAL ESTATE APPRAISALS; AUTOMOBILE BROKERAGE; INSURANCE BROKERAGE SERVICES; CREDIT AGENCY IN THE FIELDS OF CONSUMER AND COMMERCIAL CREDIT; CREDIT CARD SERVICES; REAL ESTATE LOAN FINANCING SERVICES; BANKING SERVICES; ASSET BASED AND PRIVATE LABEL FINANCING SERVICES; FINANCIAL ANALYSIS AND CONSULTATION; FINANCIAL ASSET MANAGEMENT FOR OTHERS; INSURANCE AND RE-INSURANCE SERVICES, NAMELY, UNDERWRITING SERVICES FOR ALL TYPES OF INSURANCE; EQUITY INVESTMENTS SERVICES; INSURANCE UNDERWRITING SERVICES IN THE FIELD OF BONDS; FINANCIAL GUARANTEE ASSURANCE UNDERWRITING SERVICES; PERSONAL LOAN FINANCING SERVICES; COMMERCIAL REAL ESTATE AGENCY SERVICES; MUTUAL FUND INVESTMENT; PRIVATE EQUITY AND DEBT INVESTMENT; JOINT VENTURE FINANCING; LEASE-PURCHASE FINANCING; LEASING AND RENTAL OF MOBILE AND MODULAR BUILDINGS; CONSULTATION SERVICES RELATING TO THE FOREGOING SERVICES (U.S. CLS. 100, 101 AND 102).
FIRST USE 11-26-2002; IN COMMERCE 11-26-2002.

CLASS 37—CONSTRUCTION AND REPAIR

FOR CARPET CLEANING SERVICES (U.S. CLS. 100, 103 AND 106).
FIRST USE 11-26-2002; IN COMMERCE 11-26-2002.
TRACY FLETCHER, EXAMINING ATTORNEY

SN 78-336,127. THE H. D. LEE COMPANY, INC., WILMINGTON, DE. FILED 12-4-2003.

SN 78-338,597. PUMPKIN BABES, INC., SAN FRANCISCO, CA. FILED 12-9-2003.

ONE DAY, ONE CAUSE, ONE CURE.

THE MARK CONSISTS OF STANDARD CHARACTERS WITHOUT CLAIM TO ANY PARTICULAR FONT, STYLE, SIZE, OR COLOR.

CLASS 25—CLOTHING

FOR CLOTHING, NAMELY T-SHIRTS (U.S. CLS. 22 AND 39).
FIRST USE 10-10-2003; IN COMMERCE 10-10-2003.

CLASS 36—INSURANCE AND FINANCIAL

FOR CHARITABLE FUNDRAISING SERVICES FOR THE PREVENTION AND CURE OF BREAST CANCER (U.S. CLS. 100, 101 AND 102).
FIRST USE 10-8-1999; IN COMMERCE 10-8-1999.
CHRISTOPHER ADKINS, EXAMINING ATTORNEY

PUMPKIN

SN 78-337,416. GO FRESH EXPRESS, INC., PORT CHARLOTTE, FL. FILED 12-6-2003.

Go Fresh Express

THE MARK CONSISTS OF STANDARD CHARACTERS WITHOUT CLAIM TO ANY PARTICULAR FONT, STYLE, SIZE, OR COLOR.

THE MARK CONSISTS OF STANDARD CHARACTERS WITHOUT CLAIM TO ANY PARTICULAR FONT, STYLE, SIZE, OR COLOR.

NO CLAIM IS MADE TO THE EXCLUSIVE RIGHT TO USE "EXPRESS", APART FROM THE MARK AS SHOWN.

CLASS 35—ADVERTISING AND BUSINESS

FOR TRANSPORTATION LOGISTICS SERVICES, NAMELY, ARRANGING THE TRANSPORTATION OF GOODS FOR OTHERS (U.S. CLS. 100, 101 AND 102).
FIRST USE 4-8-2002; IN COMMERCE 10-1-2002.

CLASS 39—TRANSPORTATION AND STORAGE

FOR TRANSPORTATION OF GOODS BY TRUCK; LOGISTICS AND REVERSE LOGISTICS SERVICES, NAMELY, TRANSPORTATION AND DELIVERY OF PACKAGES AND FREIGHT FOR OTHERS BY TRUCK (U.S. CLS. 100 AND 105).
FIRST USE 4-8-2002; IN COMMERCE 10-1-2002.
ANDREA SAUNDERS, EXAMINING ATTORNEY

CLASS 25—CLOTHING

FOR CLOTHING, NAMELY, BABY T-SHIRTS, PANTS, SWEATERS, DRESSES, SOCKS, HATS, BODYSUITS, JACKETS, SWEATSHIRTS, ROMPERS, SHOES, LAYETTES, ONE-PIECE INFANT UNDERWEAR, ROMPERS, BODYSUITS, HATS, HEADBANDS, SCARVES, BOOTIES, SOCKS, MITTENS, BURP CLOTHES, NAMELY, SHIRTS, PANTS, T-SHIRTS AND COVERALLS; CHILDREN'S T-SHIRTS, PANTS, SWEATERS, DRESSES, SKIRTS, BODYSUITS, JACKETS, SWEATSHIRTS, SWEAT PANTS, HATS, HEADBANDS, TIGHTS, SCARVES, SHOES, BELTS (U.S. CLS. 22 AND 39).
FIRST USE 2-1-2003; IN COMMERCE 2-1-2003.

CLASS 35—ADVERTISING AND BUSINESS

FOR RETAIL STORE SERVICES FEATURING BABY AND CHILDREN'S CLOTHES, NAMELY, T-SHIRTS, PANTS, SWEATERS, DRESSES, SOCKS, HATS, BODYSUITS, JACKETS, SWEATSHIRTS, ROMPERS, SHOES, LAYETTE; BABY AND CHILDREN'S ACCESSORIES, NAMELY, HATS, HEADBANDS, SUN GLASSES, TIGHTS, SCARVES, HAIR CLIPS, SHOES, BELTS, TOYS, DIAPER BAGS, GIFT CARDS, PLUSH TOYS (U.S. CLS. 100, 101 AND 102).
FIRST USE 2-1-2003; IN COMMERCE 2-1-2003.
TONI HICKEY, EXAMINING ATTORNEY

SN 78-339,911. STEFAM HOLDINGS LIMITED, ROAD TOWN, TORTOLA, BR.VIRGIN ISLANDS, FILED 12-12-2003.

ZAKANAKA

THE MARK CONSISTS OF STANDARD CHARACTERS WITHOUT CLAIM TO ANY PARTICULAR FONT, STYLE, SIZE, OR COLOR.

PRIORITY CLAIMED UNDER SEC. 44(D) ON SOUTH AFRICA APPLICATION NO. 2003/09698, FILED 6-12-2003, REG. NO. 2003/09698, DATED 3-16-2004, EXPIRES 3-16-2014.

PRIORITY CLAIMED UNDER SEC. 44(D) ON SOUTH AFRICA APPLICATION NO. 2003/09693, FILED 6-12-2003, REG. NO. 2003/09693, DATED 3-16-2004, EXPIRES 3-16-2014.

PRIORITY CLAIMED UNDER SEC. 44(D) ON SOUTH AFRICA APPLICATION NO. 2003/09692, FILED 6-12-2003, REG. NO. 2003/09692, DATED 3-16-2004, EXPIRES 3-16-2014.

CLASS 14—JEWELRY

FOR AMULETS; BRACELETS; BROOCHES; WATCH AND JEWELRY CHAINS; JEWELRY CHARMS; MEDALLIONS; NAPKIN HOLDERS AND NAPKIN RINGS OF PRECIOUS METAL; NECKLACES; JEWELRY ORNAMENTS; PLATED JEWELRY; JEWELRY MADE FROM PLATINUM; RINGS OF PRECIOUS METAL; SALAD BOWLS OF PRECIOUS METAL; SALT CELLARS OF PRECIOUS METALS; SEMI-PRECIOUS STONES; SILVER ORNAMENTS; SILVER PLATED PLATES AND DISHES; STATUES MADE OF PRECIOUS METALS; STATUETTES MADE OF PRECIOUS METALS; SUGAR BOWLS MADE OF PRECIOUS METALS; TANKARDS MADE OF PRECIOUS METALS; TRAYS MADE OF PRECIOUS METAL FOR HOUSEHOLD PURPOSES; URNS OF PRECIOUS METALS; VASES OF PRECIOUS METAL (U.S. CLS. 2, 27, 28 AND 50).

CLASS 20—FURNITURE AND ARTICLES NOT OTHERWISE CLASSIFIED

FOR ANIMAL HORNS; BENCHES; BOXES OF WOOD OR PLASTIC; CABINETS; CHAIRS; CUSHIONS; DECK CHAIRS; EASY CHAIRS; FURNITURE; UNWORKED OR SEMI-WORKED HORN; UNWORKED OR SEMI-WORKED IVORY; JEWELRY CASES NOT OF PRECIOUS METAL; REMOVABLE MATS FOR SINKS; SEATS; STOOLS; TABLES; TRESTLE TABLES; AND UNWORKED OR PARTLY WORKED YELLOW AMBER (U.S. CLS. 2, 13, 22, 25, 32 AND 50).

CLASS 35—ADVERTISING AND BUSINESS

FOR ONLINE RETAIL ORDERING SERVICES AND RETAIL STORE SERVICES FEATURING THE FOLLOWING GOODS—AMULETS; BRACELETS; BROOCHES; WATCH AND JEWELRY CHAINS; JEWELRY CHARMS; MEDALLIONS; NAPKIN HOLDERS AND NAPKIN RINGS; NECKLACES; JEWELRY ORNAMENTS; PLATED JEWELRY; ARTICLES PLATED WITH PRECIOUS METAL; JEWELRY MADE FROM PLATINUM; RINGS OF PRECIOUS METAL; SALAD BOWLS OF PRECIOUS METAL; SALT CELLARS OF PRECIOUS METALS; SEMI-PRECIOUS STONES; SILVER ORNAMENTS; SILVER PLATED PLATES AND DISHES; STATUES MADE OF PRECIOUS METALS; STATUETTES MADE OF PRECIOUS METALS; SUGAR BOWLS MADE OF PRECIOUS METALS; TANKARDS MADE OF PRECIOUS METALS; TRAYS MADE OF PRECIOUS METAL FOR HOUSEHOLD PURPOSES; URNS OF PRECIOUS METALS; VASES OF PRECIOUS METAL; ANIMAL HORNS; BENCHES; BOXES OF WOOD OR PLASTIC; CABINET WORK; CHAIRS; CUSHIONS; DECK CHAIRS; EASY CHAIRS; FURNITURE; UNWORKED OR SEMI-WORKED HORN; UNWORKED OR SEMI-WORKED IVORY; JEWELRY CASES NOT OF PRECIOUS METAL; REMOVABLE MATS FOR SINKS; SEATS; STOOLS; TABLES; TRESTLES; AND YELLOW AMBER (U.S. CLS. 100, 101 AND 102).

NORA BUCHANAN WILL, EXAMINING ATTORNEY

SN 78-340,000. CREDIT AGRICOLE SA, 75015 PARIS, FRANCE, FILED 12-12-2003.

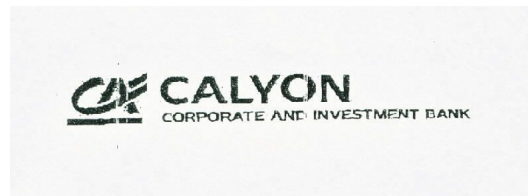

PRIORITY CLAIMED UNDER SEC. 44(D) ON FRANCE APPLICATION NO. 033256986, FILED 11-14-2003, REG. NO. 03/3256986, DATED 11-14-2003, EXPIRES 11-14-2013.

NO CLAIM IS MADE TO THE EXCLUSIVE RIGHT TO USE "CORPORATE AND INVESTMENT BANK", APART FROM THE MARK AS SHOWN.

THE MARK CONSISTS OF THE WORDS CALYON CORPORATE AND INVESTMENT BANK IN SPECIAL FORM WITH THE LETTERS CA IN FANCIFUL FORM AND AN ARBITRARY DESIGN.

CLASS 9—ELECTRICAL AND SCIENTIFIC APPARATUS

FOR MAGNETIC CARDS, DEBIT CARDS, CREDIT CARDS (U.S. CLS. 21, 23, 26, 36 AND 38).

CLASS 16—PAPER GOODS AND PRINTED MATTER

FOR PRINTED MATTER, NAMELY, NEWSLETTERS, PERIODICALS AND BOOKS IN THE FIELD OF FINANCE, FINANCIAL ANALYSIS AND FINANCIAL RESEARCH REPORTS (U.S. CLS. 2, 5, 22, 23, 29, 37, 38 AND 50).

CLASS 35—ADVERTISING AND BUSINESS

FOR PROVIDING ADVICE REGARDING BUSINESS ORGANIZATION AND MANAGEMENT; BUSINESS MANAGEMENT AND CONSULTATION (U.S. CLS. 100, 101 AND 102).

CLASS 36—INSURANCE AND FINANCIAL

FOR INSURANCE SERVICES, NAMELY, ASSURANCE UNDERWRITING SERVICES, FINANCIAL GUARANTEE SERVICES FOR THE PURPOSES OF CREDIT ENHANCEMENT WITH RESPECT TO BONDS, NOTES, OR OTHER FORMS OF INDEBTEDNESS, AND ASSET BACKED STRUCTURED FINANCE, MUNICIPAL AND GOVERNMENT PROJECT FINANCE AND CORPORATE OBLIGATIONS; FINANCIAL AND BANKING AFFAIRS IN THE FIELDS OF ASSET SECURITIZATION, CAPITAL INVESTMENT, INVESTMENT BANKING, ASSET MANAGEMENT, FINANCIAL APPRAISALS, CURRENCY TRADE AND TRANSFER, TRADING IN EQUITIES, EQUITY DERIVATIVES AND EQUITY OPTIONS, SECURITIES BROKERAGE AND CONSULTING SERVICES RELATING THERETO; REAL ESTATE AFFAIRS, NAMELY, REAL ESTATE INVESTMENT, ADVISORY AND PROPERTY MANAGEMENT SERVICES AND CONSULTING SERVICES RELATING THERETO; ISSUE OF TRAVELLERS' CHECKS AND LETTERS OF CREDIT; ISSUE OF SECURITIES; ISSUE OF CREDIT CARDS AND DEBIT CARDS; FINANCIAL ANALYSIS; FINANCIAL APPRAISALS; COMMERCIAL BANKING; TAX PAYMENT PROCESSING; LENDING FUNDS; FINANCIAL INFORMATION PROVIDED BY ELECTRONIC MEANS; FINANCIAL SERVICES, NAMELY, INVESTMENT FUND TRANSFER AND TRANSACTION SERVICES; CAPITAL INVESTMENT CONSULTATION; CAPITAL MANAGEMENT; SERVICES OF FUND MANAGEMENT; ACTUARIAL SERVICES; CREDIT AGENCIES; SAFE-DEPOSIT SERVICES; CHECK VERIFICATION; ELECTRONIC FUNDS TRANSFERS; ONLINE DATABASE IN THE FIELD OF BANKING AND FINANCE (U.S. CLS. 100, 101 AND 102).

CLASS 38—COMMUNICATION

FOR TELECOMMUNICATIONS, COMMUNICATIONS SERVICES, NAMELY COMMUNICATIONS BY COMPUTERS, BY TELEPHONE, BY INTERNET-TYPE NETWORK; INFORMATION TRANSMISSIONS BY MEANS OF INTERNET ACCESS CODES, OF INTERNET-TYPE NETWORKS, OF TELEMATIC ONLINE DATA CHANNELS OR COMPUTER TERMINALS, ELECTRONIC TRANSMISSION OF DATA, OF IMAGES, OF DOCUMENTS VIA COMPUTER TERMINALS OR TRANSMISSION SYSTEMS, NAMELY, WAVES, SATELLITES, INTERNET NETWORK; INFORMATION TRANSMISSION SERVICES BY MEANS OF VIDEO COMMUNICATION; TELECOMMUNICATIONS AND ELECTRONIC MAIL SERVICES FOR ONLINE SERVICES (U.S. CLS. 100, 101 AND 104).

KAREN K. BUSH, EXAMINING ATTORNEY

SN 78-340,395. MCWEENEY, GERALD, CO LEITRIM, IRELAND, FILED 12-12-2003.

THE POOR SCHOLAR

THE MARK CONSISTS OF STANDARD CHARACTERS WITHOUT CLAIM TO ANY PARTICULAR FONT, STYLE, SIZE, OR COLOR.

CLASS 16—PAPER GOODS AND PRINTED MATTER

FOR PAPER, CARDBOARD AND PRINTED GOODS, NAMELY, PHOTOGRAPH ALBUMS, SCRAPBOOK ALBUMS, MEMORY ALBUMS, BRAG BOOK ALBUMS, BINDERS, BUMPER STICKERS, CARDBOARD CONTAINERS, EMBROIDERY DESIGN PATTERNS, POSTCARDS, ADDRESS BOOKS, ANNOUNCEMENT CARDS, APPOINTMENT BOOKS, AUTOGRAPH BOOKS, PAPER BANNERS, CLIPBOARDS, LAP BOARDS FOR READING AND WRITING, BOOK COVERS, NOTEBOOKS, CARDBOARD BOXES, PAPER BOXES, PENCIL BOXES, STATIONERY BOXES, CALENDAR DESK PADS, GIFT CARDS, PEN CASES, PENCIL CASES, COASTERS MADE OF PAPER, DAILY PLANNERS, DECALS, PAPER PARTY DECORATIONS, DESK PADS, DESK SETS, DIARIES, METALLIC GIFT WRAP, PAPER GIFT WRAP BOWS, GIFT WRAPPING PAPER, PAPER GIFT WRAPPING RIBBONS, GLOBES, GREETING CARDS, PAPER PARTY HATS, SHIPPING LABELS, PRINTED PAPER LABELS, PAPER NAPKINS, NOTE PADS, WRITING PADS, TOILET PAPER, PAPER PENNANTS, PEN AND PENCIL HOLDERS; STATIONERY; AND TRAVEL BOOKS (U.S. CLS. 2, 5, 22, 23, 29, 37, 38 AND 50).

CLASS 18—LEATHER GOODS

FOR BACKPACKS, FANNY PACKS, KEY CASES, UMBRELLAS; BAGS, NAMELY, BOOK BAGS, DUFFEL BAGS, SCHOOLBOOK BAGS, OVERNIGHT BAGS AND ALL PURPOSE SPORTS BAGS (U.S. CLS. 1, 2, 3, 22 AND 41).

CLASS 20—FURNITURE AND ARTICLES NOT OTHERWISE CLASSIFIED

FOR LEATHER KEY FOBS, NON-METAL KEY CHAINS, KEY FOBS NOT OF METAL, NON-METAL KEY HOLDERS, NON-METAL KEY RINGS, NON-METAL NAMEPLATES, SIDEBOARDS; PLASTIC GOODS, NAMELY, GIFT PACKAGE DECORATIONS MADE OF PLASTIC, PLASTIC FLAGS, PLASTIC KEY CHAIN TAGS, PLASTIC NOVELTY LICENSE PLATES AND PLASTIC SIGNBOARDS (U.S. CLS. 2, 13, 22, 25, 32 AND 50).

CLASS 21—HOUSEWARES AND GLASS

FOR HOUSEHOLD AND KITCHEN ITEMS, NAMELY, BEVERAGE GLASSWARE, COASTERS NOT OF PAPER AND NOT BEING TABLE LINENS, STAINED GLASS FOR DECORATION, BEVERAGE WARE, BOTTLE OPENERS, COMMEMORATIVE PLATES, CUPS, DRINKING GLASSES, FLASKS, JUGS, MUGS, PAPER PLATES, PITCHERS, PLATES, SWIZZLE STICKS, PLASTIC CUPS AND PLASTIC PLATES (U.S. CLS. 2, 13, 23, 29, 30, 33, 40 AND 50).

CLASS 25—CLOTHING

FOR CLOTHING, NAMELY, BEACH WEAR, SURF WEAR, SKI WEAR, FOUL WEATHER GEAR, TENNIS WEAR, LOUNGE WEAR, RAINWEAR, BOTTOMS, SHIRTS, TOPS, JERSEYS, T-SHIRTS, BLOUSES, SWEATSHIRTS, PULLOVERS, SWEATERS, VESTS, CARDIGANS, DRESSES, PANTS, SLACKS, SHORTS, SKIRTS, TROUSERS, SWEAT PANTS, COATS, JACKETS, JUMPERS, OVERALLS, SWIM WEAR, COVER-UPS, ROBES, APRONS, PAJAMAS, SLEEP WEAR, LINGERIE, UNDERCLOTHING, SCARVES, SUSPENDERS, NECKERCHIEFS, GLOVES, MITTENS, WRISTBANDS, MUFFLERS, MUFFS AND NECKTIES; HEAD WEAR AND FOOTWEAR (U.S. CLS. 22 AND 39).

CLASS 28—TOYS AND SPORTING GOODS

FOR PLAYING CARDS; CARDBOARD TOYS, NAMELY, CHILDREN'S MULTIPLE ACTIVITY TOYS, BENDABLE TOYS, TOY VEHICLES, COLLECTABLE TOY FIGURINES, POP UP TOYS (U.S. CLS. 22, 23, 38 AND 50).

CLASS 33—WINES AND SPIRITS

FOR ALCOHOLIC BEVERAGES, NAMELY, WINE, WINE COOLERS, SANGRIA AND CHAMPAGNE (U.S. CLS. 47 AND 49).

SONYA STEPHENS, EXAMINING ATTORNEY

SN 78-340,840. LF, LLC, WILMINGTON, DE. FILED 12-15-2003.

LOWE'S

THE MARK CONSISTS OF STANDARD CHARACTERS WITHOUT CLAIM TO ANY PARTICULAR FONT, STYLE, SIZE, OR COLOR.

OWNER OF U.S. REG. NOS. 987,667, 1,931,270 AND OTHERS.

SEC. 2(F).

CLASS 16—PAPER GOODS AND PRINTED MATTER

FOR BOOKS AND MAGAZINES FEATURING IDEAS, METHODS AND INSTRUCTIONS RELATING TO HOME IMPROVEMENT, CONSTRUCTION, DECORATING, GARDENING, LANDSCAPING AND RELATED ACTIVITIES (U.S. CLS. 2, 5, 22, 23, 29, 37, 38 AND 50).

FIRST USE 0-0-1965; IN COMMERCE 0-0-1965.

CLASS 35—ADVERTISING AND BUSINESS

FOR RETAIL OUTLET STORE SERVICES FEATURING A VARIETY OF APPLIANCES, BUILDING MATERIALS, LIGHTING AND ELECTRICAL SUPPLIES, PLUMBING SUPPLIES, ROOFING MATERIALS, HOME FURNISHINGS, HOME IMPROVEMENT ITEMS, TOOLS, OUTDOOR POWER EQUIPMENT, HOME SAFETY AND SECURITY ITEMS, AND LANDSCAPING MATERIALS; BUSINESS CONSULTATION SERVICES FOR BUILDING MATERIALS, LIGHTING AND ELECTRICAL SUPPLIES, PLUMBING SUPPLIES, ROOFING MATERIALS, HOME FURNISHINGS, HOME IMPROVEMENT, HOME SAFETY AND SECURITY; BRIDAL REGISTRY SERVICES; RETAIL FLORAL STORE SERVICES; PROMOTING PUBLIC AWARENESS OF HOME SAFETY AND HOME PROTECTION PROCEDURES AND PRODUCTS AND DISTRIBUTING WRITTEN MATERIALS IN CONNECTION THEREWITH (U.S. CLS. 100, 101 AND 102).

FIRST USE 12-31-1946; IN COMMERCE 12-31-1946.

CLASS 36—INSURANCE AND FINANCIAL

FOR PROVIDING EXTENDED WARRANTIES ON APPLIANCES AND HOME IMPROVEMENT PRODUCTS; CREDIT CARD SERVICES; CHARITABLE FUNDRAISING (U.S. CLS. 100, 101 AND 102).

FIRST USE 0-0-1965; IN COMMERCE 0-0-1965.

CLASS 37—CONSTRUCTION AND REPAIR

FOR INSTALLATION, REPAIR AND REMODELING SERVICES SPECIALIZING IN APPLIANCES, BUILDING MATERIALS, LIGHTING AND ELECTRICAL SUPPLIES, PLUMBING SUPPLIES, ROOFING MATERIALS, HOME FURNISHINGS, HOME IMPROVEMENT ITEMS, HOME SAFETY AND SECURITY ITEMS, LANDSCAPING MATERIALS; RENTAL OF CONSTRUCTION EQUIPMENT AND TOOLS; PAINT MIXING SERVICES; COMPUTER PAINT MATCHING SERVICES (U.S. CLS. 100, 103 AND 106).

FIRST USE 5-20-1975; IN COMMERCE 5-20-1975.

CLASS 40—MATERIAL TREATMENT

FOR PROVIDING CUSTOM CUTTING OF LUMBER, ROPE, CHAIN, MINI BLINDS AND ROPE; CUSTOM PIPE THREADING SERVICES (U.S. CLS. 100, 103 AND 106).

FIRST USE 0-0-1966; IN COMMERCE 0-0-1966.

CLASS 41—EDUCATION AND ENTERTAINMENT

FOR EDUCATIONAL SERVICES, NAMELY, CONDUCTING CLINICS AND WORKSHOPS RELATING TO THE INSTALLATION AND REPAIR OF APPLIANCES, BUILDING MATERIALS, LIGHTING AND ELECTRICAL SUPPLIES, PLUMBING SUPPLIES, ROOFING MATERIALS, HOME FURNISHINGS, HOME IMPROVEMENT ITEMS, HOME SAFETY AND SECURITY ITEMS, AND LANDSCAPING (U.S. CLS. 100, 101 AND 107).

FIRST USE 11-8-1990; IN COMMERCE 11-8-1990.

CLASS 42—SCIENTIFIC, COMPUTER AND LEGAL SERVICES

FOR DESIGN AND/OR DESIGN CONSULTATION SERVICES FOR BUILDING MATERIALS, LIGHTING AND ELECTRICAL SUPPLIES, PLUMBING SUPPLIES, ROOFING MATERIALS, HOME FURNISHINGS, HOME IMPROVEMENT, HOME SAFETY AND SECURITY (U.S. CLS. 100 AND 101).

FIRST USE 0-0-1965; IN COMMERCE 0-0-1965.

CLASS 44—MEDICAL, BEAUTY AND AGRICULTURAL SERVICES

FOR CONSULTATION AND DESIGN SERVICES FOR LANDSCAPING AND LANDSCAPE GARDENING (U.S. CLS. 100 AND 101).

FIRST USE 0-0-1966; IN COMMERCE 0-0-1966.
ZACHARY BELLO, EXAMINING ATTORNEY

SN 78-342,244. HOME INSTEAD, INC., OMAHA, NE. FILED 12-17-2003.

SN 78-342,437. BROOMHAM, ROBERT KENNETH, BALLINA, AUSTRALIA, AND LISTER, TROY ERNEST, BALLINA, AUSTRALIA, AND ELLIS, RODNEY GRAEME, BALLINA, AUSTRALIA, FILED 12-17-2003.



CLASS 36—INSURANCE AND FINANCIAL

FOR CHARITABLE FUNDRAISING FOR PROVIDING FINANCIAL SUPPORT FOR ACTIVITIES DESIGNED TO IMPROVE THE QUALITY OF LIFE FOR THE ELDERLY (U.S. CLS. 100, 101 AND 102).

FIRST USE 8-1-2003; IN COMMERCE 8-1-2003.

CLASS 37—CONSTRUCTION AND REPAIR

FOR HOUSE CLEANING FOR THE ELDERLY (U.S. CLS. 100, 103 AND 106).

FIRST USE 7-15-1994; IN COMMERCE 7-15-1994.

CLASS 39—TRANSPORTATION AND STORAGE

FOR TRANSPORTATION OF ELDERLY PASSENGERS BY CAR OR VAN (U.S. CLS. 100 AND 105).

FIRST USE 7-15-1994; IN COMMERCE 7-15-1994.

CLASS 43—HOTEL AND RESTAURANT SERVICES

FOR MEAL PLANNING AND PREPARATION FOR THE ELDERLY (U.S. CLS. 100 AND 101).

FIRST USE 7-15-1994; IN COMMERCE 7-15-1994.

CLASS 45—PERSONAL SERVICES

FOR PERSONAL CARE ASSISTANCE WITH ACTIVITIES OF DAILY LIVING, SUCH AS COMPANIONSHIP, BATHING, GROOMING, MEDICATION REMINDERS, PERSONAL MOBILITY, AND RUNNING ERRANDS FOR THE ELDERLY (U.S. CLS. 100 AND 101).

FIRST USE 7-15-1994; IN COMMERCE 7-15-1994.
STEVEN R. FINE, EXAMINING ATTORNEY

HANDI GHANDI

THE MARK CONSISTS OF STANDARD CHARACTERS WITHOUT CLAIM TO ANY PARTICULAR FONT, STYLE, SIZE, OR COLOR.

PRIORITY CLAIMED UNDER SEC. 44(D) ON AUSTRALIA APPLICATION NO. 959661, FILED 6-30-2003, REG. NO. 959661, DATED 6-30-2003, EXPIRES 6-30-2013.

CLASS 29—MEATS AND PROCESSED FOODS

FOR PREPARED MEALS CONSISTING PRIMARILY OF MEAT, FISH, POULTRY OR VEGETABLES; MEAT, FISH AND POULTRY PRODUCTS, NAMELY, BEEF, LAMB, PORK, CHICKEN AND SEAFOOD CURRIES AND SOUPS; COOKED FRUIT, NAMELY, CHUTNEYS AND LASSI-BASED PASSIONFRUIT, MANGO, STRAWBERRY AND BANANA YOGURTS; COOKED VEGETABLES (U.S. CL. 46).

CLASS 35—ADVERTISING AND BUSINESS

FOR FRANCHISING OF RESTAURANT SERVICES (U.S. CLS. 100, 101 AND 102).

CLASS 43—HOTEL AND RESTAURANT SERVICES

FOR PROVISION OF CAFÉ, CAFETERIA, CANTEEN, CATERING, RESTAURANT, BUFFET RESTAURANT, FAST FOOD RESTAURANT AND BISTRO SERVICES; TAKE-OUT RESTAURANT SERVICES, NAMELY, PREPARING FOOD AND DRINKS FOR EAT-IN OR TAKE-AWAY (U.S. CLS. 100 AND 101).

SUSAN HAYASH, EXAMINING ATTORNEY

SN 78-342,450. 1-800-BAR NONE, A FINANCIAL CORPORATION, INC., PLEASANTON, CA. FILED 12-17-2003.

BAR NONE

THE MARK CONSISTS OF STANDARD CHARACTERS WITHOUT CLAIM TO ANY PARTICULAR FONT, STYLE, SIZE, OR COLOR.

OWNER OF U.S. REG. NO. 2,711,164.

CLASS 35—ADVERTISING AND BUSINESS

FOR BUSINESS MARKETING SERVICES, NAMELY PROVIDING LEAD GENERATION SERVICES FOR AUTOMOBILE DEALERSHIPS AND PROVIDING AN INTERNET WEBSITE CONTAINING INFORMATION ON AUTOMOBILE PURCHASE LEADS FOR USE BY AUTOMOBILE DEALERS; ADVERTISING SERVICES, NAMELY DISSEMINATING ADVERTISING MATERIALS FOR OTHERS IN THE FIELD OF CONSUMER FINANCE, AND THE ADMINISTRATION OF ADVERTISING PROGRAMS FOR AUTOMOBILE DEALERSHIPS, OPERATING CUSTOMER CALL CENTERS FOR THE GENERATION OF SALES LEADS TO AUTOMOBILE DEALERSHIPS; BUSINESS CONSULTATION SERVICES FOR AUTOMOBILE DEALERSHIPS, NAMELY ANALYZING AND REPORTING ON DEALERSHIP BUSINESS ACTIVITY; OPERATION OF TELEPHONE CALL CENTERS TO ANSWER CALLS GENERATED BY ADVERTISEMENTS AND THE REFERRAL OF BUYERS TO VENDORS IN THE AUTOMOBILE INDUSTRY (U.S. CLS. 100, 101 AND 102).

FIRST USE 2-0-1997; IN COMMERCE 2-0-1997.

CLASS 36—INSURANCE AND FINANCIAL

FOR PROVIDING CONSUMER FINANCING INFORMATION TO AUTOMOBILE DEALERS; CONSUMER FINANCING SERVICES IN THE FIELD OF AUTOMOBILE LOANS; CONSUMER FINANCING SERVICES AND INSURANCE SERVICES, NAMELY PROVIDING INFORMATION ABOUT AUTOMOBILE INSURANCE BROKERS TO CONSUMERS; AUTOMOBILE INSURANCE BROKERAGE SERVICES; CONSUMER INSURANCE SERVICES, NAMELY INSURANCE BROKERAGE SERVICES IN THE FIELD OF AUTOMOBILE INSURANCE; CREDIT INQUIRY AND CONSULTATION IN THE AUTOMOTIVE DEALERSHIP AND SALES FIELD (U.S. CLS. 100, 101 AND 102).

FIRST USE 2-0-1997; IN COMMERCE 2-0-1997.

ALICIA COLLINS, EXAMINING ATTORNEY

SN 78-342,804. OAKLEY, INC., FOOTHILL RANCH, CA. FILED 12-18-2003.



OWNER OF U.S. REG. NOS. 1,356,297, 2,875,361 AND OTHERS.

THE MARK CONSISTS OF THE WORD OAKLEY SURROUNDED BY AN OVAL.
SEC. 2(F).

CLASS 9—ELECTRICAL AND SCIENTIFIC APPARATUS

FOR PROTECTIVE EYEWEAR, NAMELY SPECTACLES, PRESCRIPTION EYEWEAR, ANTI-GLARE GLASSES AND SUNGLASSES AND THEIR PARTS AND ACCESSORIES, NAMELY REPLACEMENT LENSES, FRAMES, EARSTEMS, AND NOSE PIECES; CASES SPECIALLY ADAPTED FOR SPECTACLES AND SUNGLASSES AND THEIR PARTS AND ACCESSORIES (U.S. CLS. 21, 23, 26, 36 AND 38).

FIRST USE 5-22-2002; IN COMMERCE 5-22-2002.

CLASS 25—CLOTHING

FOR CLOTHING, NAMELY, T-SHIRTS, BEACHWEAR, BLOUSES, SPORTS SHIRTS, JERSEYS, SWIMWEAR, SWIMTRUNKS, SHORTS, UNDERWEAR, SHIRTS, PANTS, RACING PANTS, SKI AND SNOWBOARD PANTS AND JACKETS, JEANS, VESTS, JACKETS, WETSUITS, SWEATERS, PULLOVERS, COATS, SWEATPANTS, HEADWEAR, NAMELY, HATS, CAPS, VISORS AND FOOTWEAR, NAMELY WETSUIT BOOTIES, SHOES, SANDALS, ATHLETIC FOOTWEAR, ALL PURPOSE SPORTS FOOTWEAR, THONGS AND BOOTS (U.S. CLS. 22 AND 39).

FIRST USE 7-11-2002; IN COMMERCE 7-11-2002.

MARK T. MULLEN, EXAMINING ATTORNEY

SN 78-343,029. GENERAL ELECTRIC COMPANY, SCHEMECTADY, NY. FILED 12-18-2003.

GE

THE MARK CONSISTS OF STANDARD CHARACTERS WITHOUT CLAIM TO ANY PARTICULAR FONT, STYLE, SIZE, OR COLOR.

OWNER OF U.S. REG. NOS. 871,259, 1,020,378 AND 1,197,111.

CLASS 6—METAL GOODS

FOR METAL SEALS (U.S. CLS. 2, 12, 13, 14, 23, 25 AND 50).

CLASS 7—MACHINERY

FOR AXIAL AND CENTRIFUGAL COMPRESSORS; RECIPROCATING COMPRESSORS; SCREW AND VANE COMPRESSORS; ROTARY, VACUUM, ELECTRIC, SUBMERSIBLE AND CENTRIFUGAL PUMPS; TURBO EXPANDERS, NAMELY, COMPRESSORS; CNG REFUELING MACHINES FOR LAND VEHICLES AND INDUSTRIAL EQUIPMENT AND ACCESSORIES AND PARTS FOR ALL THE FOREGOING NAMELY, PUMPS, VALVES, FUEL FILTERS, FILTER CASINGS, DISTRIBUTOR ROTORS, BLADES, BEARINGS AND MECHANICAL SEALS; GAS TURBINES; STEAM TURBINES; STEAM CONDENSERS (U.S. CLS. 13, 19, 21, 23, 31, 34 AND 35).

CLASS 9—ELECTRICAL AND SCIENTIFIC APPARATUS

FOR FUEL PUMPS FOR SERVICE STATIONS FOR FUELING AIRPLANE ENGINES; FUEL DISTRIBUTION EQUIPMENT, NAMELY, METERED FUEL PUMPS, ELECTRICAL FUEL LEVEL GAUGES, CONTROL VALVES FOR REGULATING THE FLOW OF GASES AND LIQUIDS AND FUEL LINES; AUTOMATED FUEL STATION MANAGEMENT SYSTEMS COMPRISING COMPUTER OPERATING SOFTWARE, METERED FUEL PUMPS, RATE CONTROL PANELS, FUEL LINES AND DISPENSING NOZZLES FOR FUELING LAND AND MARINE VEHICLES AND AIRCRAFT; GAS METERS (U.S. CLS. 21, 23, 26, 36 AND 38).

CLASS 11—ENVIRONMENTAL CONTROL APPARATUS

FOR HEAT EXCHANGERS; CHEMICAL HEAVY WALL REACTORS AND NUCLEAR REACTORS AND ACCESSORIES AND COMPONENT PARTS THEREOF NAMELY, HEAT PUMPS, STEAM VALVES AND VALVES FOR REGULATING THE FLOW OF GASES AND LIQUIDS (U.S. CLS. 13, 21, 23, 31 AND 34).

CLASS 37—CONSTRUCTION AND REPAIR

FOR INSTALLATION, MAINTENANCE AND REPAIR SERVICES FOR COMPRESSORS AND PUMPS, NAMELY MACHINES, TURBO EXPANDERS, FUEL PUMPS AND FUEL DISTRIBUTION EQUIPMENT, CNG REFUELING EQUIPMENT, GAS TURBINES, STEAM TURBINES, AIR COOLED HEAT EXCHANGERS, STEAM CONDENSERS, HEAVY WALL REACTORS AND TUBULAR REACTORS; OIL AND GAS PIPELINE MAINTENANCE AND REPAIR SERVICES; DRILLING AND PUMPING OF OIL AND GAS; DRILLING FOR CRUDE OIL; OIL WELL CASING, TUBING AND DRILL PIPE INSTALLATION; RENTAL OF OIL AND GAS WELL DRILLING TOOLS (U.S. CLS. 100, 103 AND 106).

CLASS 39—TRANSPORTATION AND STORAGE

FOR TRANSMISSION OF OIL OR GAS THROUGH PIPELINES (U.S. CLS. 100 AND 105).

CLASS 40—MATERIAL TREATMENT

FOR OIL PRODUCTION SERVICES; GAS PRODUCTION SERVICES; OIL AND GAS WELL TREATMENT SERVICES; OIL AND GAS REFINING SERVICES (U.S. CLS. 100, 103 AND 106).

CLASS 42—SCIENTIFIC, COMPUTER AND LEGAL SERVICES

FOR ENGINEERING SERVICES; TECHNICAL CONSULTATION AND RESEARCH SERVICES IN THE OIL AND GAS INDUSTRIES; OIL AND GAS EXPLORATION SERVICES; GEOPHYSICAL EXPLORATION FOR THE OIL AND GAS INDUSTRIES; ANALYSIS OF OIL AND GAS FIELDS; OIL AND GAS PROSPECTING, NAMELY WELL LOGGING AND TESTING; OIL AND GAS WELL TESTING; OIL AND GAS PIPELINE INSPECTION; REMOTE MONITORING AND DIAGNOSTIC SERVICES FOR COMPRESSORS AND PUMPS, NAMELY MACHINES, TURBO EXPANDERS, FUEL PUMPS AND FUEL DISTRIBUTION EQUIPMENT, CNG REFUELING EQUIPMENT, GAS TURBINES, STEAM TURBINES, AIR COOLED HEAT EXCHANGERS, STEAM CONDENSERS, HEAVY WALL REACTORS AND TUBULAR REACTORS (U.S. CLS. 100 AND 101).

ANDREA SAUNDERS, EXAMINING ATTORNEY

SN 78-343,263. FUNDACION DEL MUSEO GUGGENHEIM BILBAO, BILBAO, SPAIN, FILED 12-19-2003.

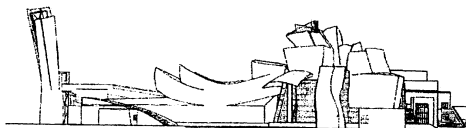

OWNER OF SPAIN REG. NO. 2756153, DATED 2-26-2004, EXPIRES 6-26-2012.

THE LINING SHOWN IN THE DRAWING IS A FEATURE OF THE MARK.

CLASS 21—HOUSEWARES AND GLASS

FOR CUPS, DRINKING GLASSES AND PLATES OF POTTERY, CRYSTAL AND PORCELAIN (U.S. CLS. 2, 13, 23, 29, 30, 33, 40 AND 50).

CLASS 25—CLOTHING

FOR SHIRTS AND T-SHIRTS (U.S. CLS. 22 AND 39).
YSA DEJESUS, EXAMINING ATTORNEY

SN 78-343,326. GENERAL ELECTRIC COMPANY, SCHE-NECTADY, NY. FILED 12-19-2003.



OWNER OF U.S. REG. NOS. 871,259, 1,197,111 AND OTHERS.

CLASS 6—METAL GOODS

FOR METAL SEALS (U.S. CLS. 2, 12, 13, 14, 23, 25 AND 50).

CLASS 7—MACHINERY

FOR AXIAL AND CENTRIFUGAL COMPRESSORS; RECIPROCATING COMPRESSORS; SCREW AND VANE COMPRESSORS; ROTARY, VACUUM, ELECTRIC, SUBMERSIBLE AND CENTRIFUGAL PUMPS; TURBOEXPANDERS, NAMELY, AIR AND ELECTRIC COMPRESSORS; CNG REFUELING MACHINES FOR LAND VEHICLES AND INDUSTRIAL EQUIPMENT AND ACCESSORIES AND PARTS FOR ALL THE FOREGOING NAMELY, PUMPS, VALVES, FUEL FILTERS, FILTER CASINGS, DISTRIBUTOR ROTORS, BLADES, BEARINGS AND MECHANICAL SEALS; GAS TURBINES, STEAM TURBINES; STEAM CONDENSERS (U.S. CLS. 13, 19, 21, 23, 31, 34 AND 35).

CLASS 9—ELECTRICAL AND SCIENTIFIC APPARATUS

FOR FUEL PUMPS FOR SERVICE STATIONS FOR FUELING AIRPLANE ENGINES; FUEL DISTRIBUTION EQUIPMENT, NAMELY, METERED FUEL PUMPS, ELECTRICAL FUEL LEVEL GAUGES, CONTROL VALVES FOR REGULATING THE FLOW OF GASES AND FUEL LINES; AUTOMATED FUEL STATION MANAGEMENT SYSTEMS COMPRISING COMPUTER OPERATING SOFTWARE, METERED FUEL PUMPS, RATE CONTROL PANELS, FUEL LINES AND DISPENSING NOZZLES FOR FUELING LAND AND MARINE VEHICLES AND MARINE VEHICLES AND AIRCRAFT; GAS METERS (U.S. CLS. 21, 23, 26, 36 AND 38).

CLASS 11—ENVIRONMENTAL CONTROL APPARATUS

FOR HEAT EXCHANGERS; CHEMICAL HEAVY WALL REACTORS AND NUCLEAR REACTORS AND ACCESSORIES AND COMPONENT PARTS THEREOF, NAMELY, HEAT PUMPS, STEAM VALVES AND VALVES FOR REGULATING THE FLOW OF GASES AND LIQUIDS (U.S. CLS. 13, 21, 23, 31 AND 34).

CLASS 37—CONSTRUCTION AND REPAIR

FOR INSTALLATION, MAINTENANCE AND REPAIR SERVICES FOR COMPRESSORS, PUMPS, NAMELY, MACHINES, TURBOEXPANDERS, FUEL PUMPS AND FUEL DISTRIBUTION EQUIPMENT, CNG REFUELING EQUIPMENT, GAS TURBINES, STEAM TURBINES, AIR COOLED HEAT-EXCHANGERS, STEAM CONDENSERS, HEAVY WALL REACTORS AND TUBULAR REACTORS; OIL AND GAS MAINTENANCE AND REPAIR SERVICES; DRILLING AND PUMPING OF OIL AND GAS; DRILLING FOR CRUDE OIL; OIL WELL CASING, TUBING AND DRILL PIPE INSTALLATION; RENTAL OF OIL AND GAS WELL DRILLING TOOLS (U.S. CLS. 100, 103 AND 106).

CLASS 39—TRANSPORTATION AND STORAGE

FOR TRANSMISSION OF OIL OR GAS THROUGH PIPELINES (U.S. CLS. 100 AND 105).

CLASS 40—MATERIAL TREATMENT

FOR OIL PRODUCTION SERVICES; GAS PRODUCTION SERVICES; OIL AND GAS WELL TREATMENT SERVICES; OIL AND GAS REFINING SERVICES (U.S. CLS. 100, 103 AND 106).

CLASS 42—SCIENTIFIC, COMPUTER AND LEGAL SERVICES

FOR ENGINEERING SERVICES; TECHNICAL CONSULTATION AND RESEARCH SERVICES IN THE OIL AND GAS INDUSTRIES; OIL AND GAS EXPLORATION SERVICES; GEOPHYSICAL EXPLORATION FOR THE OIL AND GAS INDUSTRIES; ANALYSIS OF OIL AND GAS FIELDS; OIL AND GAS PROSPECTING, NAMELY, WELL LOGGING AND TESTING; OIL AND GAS WELL TESTING; OIL AND GAS PIPELINE INSPECTION; REMOTE MONITORING AND DIAGNOSTIC SERVICES FOR COMPRESSORS, PUMPS, TURBOEXPANDERS, FUEL PUMPS AND FUEL DISTRIBUTION EQUIPMENT, CNG REFUELING EQUIPMENT, GAS TURBINES, STEAM TURBINES, AIR COOLED HEAT EXCHANGERS, STEAM CONDENSERS, HEAVY WALL REACTORS AND TUBULAR REACTORS (U.S. CLS. 100 AND 101).

ANDREA SAUNDERS, EXAMINING ATTORNEY

CLASS 35—ADVERTISING AND BUSINESS

FOR BUSINESS CONSULTING SERVICES RELATING TO THE DEVELOPMENT AND DESIGN OF SUPPLY CHAIN SOLUTIONS (U.S. CLS. 100, 101 AND 102).
FIRST USE 9-1-2003; IN COMMERCE 10-1-2003.

CLASS 42—SCIENTIFIC, COMPUTER AND LEGAL SERVICES

FOR COMPUTER SERVICES, NAMELY, INTEGRATING THE OPERATION AND FUNCTIONALITY OF COMPUTERS THAT CONTROL RADIO FREQUENCY IDENTIFICATION DEVICE - RFID - TECHNOLOGY SYSTEMS, WAREHOUSE MANAGEMENT, AND DISTRIBUTION SYSTEMS (U.S. CLS. 100 AND 101).
FIRST USE 9-1-2003; IN COMMERCE 10-1-2003.
GRETTA YAO, EXAMINING ATTORNEY

SN 78-344,971. SEDERMA SA, LE PERRY-ENYVELINES, FRANCE, FILED 12-23-2003.

SEDERMA

SN 78-344,563. XTERPRISE INCORPORATED, DALLAS, TX, FILED 12-22-2003.



THE MARK CONSISTS OF A STYLIZED LETTER X IN A BOX.

THE MARK CONSISTS OF STANDARD CHARACTERS WITHOUT CLAIM TO ANY PARTICULAR FONT, STYLE, SIZE, OR COLOR.

OWNER OF ERPN CMNTY TM OFC REG. NO. CTM00238787, DATED 1-31-2003, EXPIRES 9-20-2011.

CLASS 1—CHEMICALS

FOR CHEMICALS FOR USE IN THE MANUFACTURE OF COSMETICS, PHARMACEUTICALS, AND VETERINARY PREPARATIONS (U.S. CLS. 1, 5, 6, 10, 26 AND 46).

CLASS 3—COSMETICS AND CLEANING PREPARATIONS

FOR PERFUMES; EAU DE TOILETTE; BATH AND SHOWER GELS; NONMEDICATED BATH AND SHOWER SALTS; TOILET SOAPS; PERSONAL DEODORANTS; COSMETICS AND CREAMS, MILKS, LOTIONS, GELS AND POWDERS FOR FACE, BODY AND HANDS; SUN BLOCK AND SUN TAN PREPARATIONS AND SUN-TANNING AND AFTER-SUN MILKS, GELS AND OILS; MAKE-UP; GELS, SHAMPOOS, MOUSSES AND CONDITIONERS FOR HAIR DRESSING AND HAIR CARE; HAIR SPRAY; HAIR COLOR, HAIR BLEACH AND HAIR WAVING AND HAIR SETTING PREPARATIONS; ESSENTIAL OILS FOR PERSONAL USE; DENTIFRICES (U.S. CLS. 1, 4, 6, 50, 51 AND 52).

CLASS 5—PHARMACEUTICALS

FOR PHARMACEUTICAL PREPARATIONS FOR TREATING HAIR LOSS, FOR HAIR REGROWTH, FOR TREATING ACNE, AND MEDICATED SKIN CARE PREPARATIONS; VETERINARY PREPARATIONS FOR PROVIDING PAIN RELIEF, ANTISEPTICS, BALMS AND SKIN CARE ALL FOR ANIMALS; SANITARY PREPARATIONS FOR MEDICINE AND PERSONAL HYGIENE, NAMELY, SANITIZERS FOR HOSPITAL AND PERSONAL USE, AND FEMININE HYGIENE CLEANSING TOWELETTES, SANITARY NAPKINS AND DOUCHES; DIETETIC SUBSTANCES ADAPTED FOR MEDICAL USE NAMELY NUTRITIONAL SUPPLEMENTS; MEDICAL PLASTERS; MATERIALS FOR DRESSINGS, NAMELY, WOUND DRESSINGS, BURN DRESSINGS AND SURGICAL DRESSINGS; DISINFECTANTS FOR MEDICAL OR SANITARY PURPOSES OTHER THAN SOAP, NAMELY, DISINFECTANTS FOR MEDICAL INSTRUMENTS AND ALL-PURPOSE DISINFECTANTS (U.S. CLS. 6, 18, 44, 46, 51 AND 52).

JOHN DWYER, EXAMINING ATTORNEY

CLASS 5—PHARMACEUTICALS

FOR MEDICAL TREATMENT COMPONENTS PRE-PACKAGED IN STERILE MEDICAL KITS COMPRISED OF AT LEAST ONE COMPONENT SELECTED FROM THE FOLLOWING GROUPS— SURGICAL CLOTHS, SURGICAL DRESSINGS, SURGICAL TISSUES, NAMELY, PRE-MOISTENED MEDICATED TISSUES, ABSORBENT PADS, CLOTHS, TOWELS AND NAPKINS FOR MEDICAL USE, WADDING FOR MEDICAL USE, MEDICAL SWABS, MEDICAL COMPRESSES, TISSUES AND CLOTHS IMPREGNATED WITH ANTISEPTICS, WADDING AND COTTON SWABS FOR MEDICAL USE, SCAPULARS FOR SURGICAL PURPOSES, ADHESIVE TAPES, BANDS AND PLASTERS FOR MEDICAL USE (U.S. CLS. 6, 18, 44, 46, 51 AND 52).

SN 78-345,074. HEALTH ALLIANCE PLAN OF MICHIGAN, DETROIT, MI. FILED 12-23-2003.



OWNER OF U.S. REG. NO. 1,813,203.
THE COLOR(S) VIOLET IS/ARE CLAIMED AS A FEATURE OF THE MARK.
THE COLOR VIOLET APPEARS IN THE CHECKMARK DESIGN.
THE MARK CONSISTS OF CHECK MARK LOGO.

CLASS 36—INSURANCE AND FINANCIAL

FOR ADMINISTRATION OF THIRD PARTY PREFERRED PROVIDER ORGANIZATIONS AND HEALTH MAINTENANCE ORGANIZATIONS IN THE FIELD OF HEALTH CARE (U.S. CLS. 100, 101 AND 102).

CLASS 44—MEDICAL, BEAUTY AND AGRICULTURAL SERVICES

FOR HEALTH CARE SERVICES IN THE NATURE OF A HEALTH MAINTENANCE ORGANIZATION AND PREFERRED PROVIDER ORGANIZATION (U.S. CLS. 100 AND 101).

DEZMONA MIZELLE, EXAMINING ATTORNEY

CLASS 10—MEDICAL APPARATUS

FOR PRE-PACKAGED STERILE MEDICAL PROCEDURE KITS COMPRISING AT LEAST ONE OF THE FOLLOWING— SYRINGES, HOLLOW MEDICAL NEEDLES, SCALPELS, STITCH CUTTERS, FORCEPS, SCISSORS, TROCARS, CLAMPS, NEEDLE GUARDS, SAMPLING PORTS, EVACUATED PHIALS, KIDNEY DISHES, BOWLS, SPECULUMS, EXAMINATION SPATULAS, SUTURE NEEDLES, LAVAGE AND ENEMA APPARATUS, FOR USE IN ONE OF THE FOLLOWING SPECIFIC MEDICAL PROCEDURES— DIALYSIS, SUTURE EMPLACEMENT, SUTURE REMOVAL, PROSTHETIC EMPLACEMENT, WOUND DRESSING, EXAMINATION OF BODY CAVITIES TREATMENT, TREATMENT OF DISORDERS OF BODY CAVITIES, BURN TREATMENT, ULCER AND BED-SORE TREATMENT, LAPAROSCOPY, ASPIRATION OF BODY FLUIDS, SAMPLING OF BODY FLUIDS, INFUSION OF LIQUID INTO THE BODY, EMPLACEMENT OF SUBCUTANEOUS PELLETS; MEDICAL DEVICES PRE-PACKAGED IN STERILE MEDICAL PROCEDURE KITS COMPRISED OF AT LEAST ONE MEDICAL DEVICE SELECTED FROM THE FOLLOWING GROUP— SYRINGES, HOLLOW MEDICAL NEEDLES, SCALPELS, STITCH CUTTERS, FORCEPS, SCISSORS, TROCARS, CLAMPS, NEEDLE GUARDS, SAMPLING PORTS, EVACUATED PHIALS, KIDNEY DISHES, BOWLS, SPECULUMS, EXAMINATION SPATULAS, SUTURE NEEDLES, LAVAGE AND ENEMA APPARATUS (U.S. CLS. 26, 39 AND 44).

ALEX KEAM, EXAMINING ATTORNEY

SN 78-345,238. NOBLE HOUSE GROUP PTY LTD, Fyshwick, AUSTRALIA, FILED 12-23-2003.



NO CLAIM IS MADE TO THE EXCLUSIVE RIGHT TO USE "CLINICAL" AND THE REPRESENTATION OF THE CROSS, APART FROM THE MARK AS SHOWN.

THE MARK CONSISTS OF A CROSS DESIGN IS NOT DISPLAYED IN THE COLOR RED OR A COLORABLE IMITATION THEREOF.

SN 78-346,986. TERRA VERDE ARCHITECTS, LLC, BOULDER, CO. FILED 12-31-2003.



NO CLAIM IS MADE TO THE EXCLUSIVE RIGHT TO USE "ARCHITECTS", APART FROM THE MARK AS SHOWN.

THE COLORS FOREST GREEN AND GRAY ARE CLAIMED AS A FEATURE OF THE MARK.

THE MARK CONSISTS OF THE WORDING TERRA VERDE ARCHITECTS IN FOREST GREEN AND A PICTURE OF A GRAY ROCK SITS ABOVE THE WORDS TERRA VERDE ARCHITECTS, WITH A SHADOW APPEARING UNDER THE ROCK.

THE ENGLISH TRANSLATION OF TERRA VERDE IS GREEN EARTH.

CLASS 37—CONSTRUCTION AND REPAIR

FOR PLANNING AND LAYING-OUT OF RESIDENTIAL AND INSTITUTIONAL COMMUNITIES (U.S. CLS. 100, 103 AND 106).

FIRST USE 8-1-1996; IN COMMERCE 8-1-1996.

CLASS 42—SCIENTIFIC, COMPUTER AND LEGAL SERVICES

FOR ARCHITECTURAL AND INTERIOR DESIGN SERVICES (U.S. CLS. 100 AND 101).

FIRST USE 8-1-1996; IN COMMERCE 8-1-1996, KIMBERLY FRYE, EXAMINING ATTORNEY

SN 78-347,149. CHORTEK & GOTTSCHALK, LLP, WAUKESHA, WI. FILED 12-31-2003.



NO CLAIM IS MADE TO THE EXCLUSIVE RIGHT TO USE LLP CPAS AND BUSINESS ADVISORS, APART FROM THE MARK AS SHOWN.

CLASS 35—ADVERTISING AND BUSINESS

FOR ACCOUNTING, BUSINESS AUDITING, TAX PREPARATION AND BUSINESS ADVICE (U.S. CLS. 100, 101 AND 102).

FIRST USE 6-1-2003; IN COMMERCE 7-1-2003.

CLASS 42—SCIENTIFIC, COMPUTER AND LEGAL SERVICES

FOR TECHNOLOGY CONSULTING WITH BUSINESS CLIENTS, NAMELY, IN THE FIELD OF SELECTION AND IMPLEMENTATION OF COMPUTER SOFTWARE AND HARDWARE (U.S. CLS. 100 AND 101).

FIRST USE 6-1-2003; IN COMMERCE 7-1-2003. BARNEY CHARLON, EXAMINING ATTORNEY

SN 78-347,444. AGRAWAL, CHRISTOPHER K., CHESTERFIELD, MO. FILED 1-2-2004.

Potential Search

THE MARK CONSISTS OF STANDARD CHARACTERS WITHOUT CLAIM TO ANY PARTICULAR FONT, STYLE, SIZE, OR COLOR.

NO CLAIM IS MADE TO THE EXCLUSIVE RIGHT TO USE SEARCH, APART FROM THE MARK AS SHOWN.

CLASS 35—ADVERTISING AND BUSINESS

FOR COPYING OF DOCUMENTS FOR OTHERS, NAMELY, FILE WRAPPER COPYING AND PATENT COPYING. (U.S. CLS. 100, 101 AND 102).

FIRST USE 8-20-2002; IN COMMERCE 9-1-2002.

CLASS 42—SCIENTIFIC, COMPUTER AND LEGAL SERVICES

FOR PATENT AND TRADEMARK INTELLECTUAL PROPERTY SUPPORT SERVICES, NAMELY, PATENT, TRADEMARK AND COPYRIGHT SEARCHING, AND PUBLIC DOCUMENT FILING SERVICES. (U.S. CLS. 100 AND 101).

FIRST USE 8-20-2002; IN COMMERCE 9-1-2002. TRACY CROSS, EXAMINING ATTORNEY

SN 78-348,007. DIAMONDBACK TACTICAL, LLLP, PEORIA, AZ. FILED 1-5-2004.



THE MARK CONSISTS OF THE WORD BATTLELAB SUPERIMPOSED ON A STYLIZED BULLSEYE.

CLASS 9—ELECTRICAL AND SCIENTIFIC APPARATUS

FOR PROTECTIVE VESTS FOR THE PROTECTION AGAINST BALLISTIC PENETRATION AND PROTECTIVE HELMET COVERS, BOTH MADE OF NYLON AND FOR USE IN THE FIELDS OF MILITARY AND LAW ENFORCEMENT ACTIVITIES (U.S. CLS. 21, 23, 26, 36 AND 38).

SN 78-348,273. TELEPHONICS CORPORATION, FARMINGDALE, NY. FILED 1-6-2004.

TRULINK

CLASS 10—MEDICAL APPARATUS

FOR MEDICAL KITS PRIMARILY COMPRISED OF RESUSCITATION BAGS AND MASKS, RESPIRATORS FOR ARTIFICIAL RESPIRATION, TRAUMA DEVICES AND SUPPLIES, NAMELY, TRACH SHEARS, ANGIO-CATHS, CHEST SEALS, AND BURNSHEETS, MEDICAL SUPPLIES AND INSTRUMENTS, NAMELY, FORCEPS, MEDICAL TUBES, SCISSORS, SYRINGES, AND SPONGES, SPLINTS, MEDICAL TAPES AND BAGS, SAFETY PINS, TWEEZERS, WRAPS, BLANKETS, SURGICAL SUPPLIES AND INSTRUMENTS, NAMELY, MEDICAL MASKS, SCALPELS, RAZORS, SURGICAL THREAD, AND MIRRORS FOR SURGEONS, BLOOD PRESSURE MEASURING APPARATUS AND CATHETERS, FIRST AID SUPPLIES FOR THE CARE AND TREATMENT OF WOUNDS, NAMELY, MEDICAL GLOVES, GAUZE, DISINFECTANT WIPES MADE OF FABRIC OR PAPER, CREAMS AND OINTMENTS FOR MEDICAL USE, MEDICATIONS AND PAIN RELIEVERS, LARYNGOSCOPE SETS, STETHOSCOPES, ICE PACKS, THERMOMETERS, PHARMACEUTICAL PREPARATIONS AND SOLUTIONS FOR TREATING WOUNDS ASSOCIATED WITH BIOLOGICAL AND CHEMICAL WARFARE, PHARMACEUTICAL PREPARATIONS THAT AID IN THE COAGULATION OF BLOOD, BANDAGES, TOURNIQUETS, AND MEDICAL GLOVES ALL FOR USE IN THE FIELDS OF MILITARY AND LAW ENFORCEMENT ACTIVITIES, ALL SOLD TOGETHER AS A UNIT (U.S. CLS. 26, 39 AND 44).

THE MARK CONSISTS OF STANDARD CHARACTERS WITHOUT CLAIM TO ANY PARTICULAR FONT, STYLE, SIZE, OR COLOR.

CLASS 9—ELECTRICAL AND SCIENTIFIC APPARATUS

FOR RADIO COMMUNICATION SYSTEMS CONSISTING OF RADIO TRANSMITTERS AND RECEIVERS, FILTERS FOR RADIO INTERFERENCE SUPPRESSION, COMMUNICATIONS SOFTWARE FOR COMMUNICATING WITH USERS OF HAND HELD RADIOS (U.S. CLS. 21, 23, 26, 36 AND 38).

CLASS 42—SCIENTIFIC, COMPUTER AND LEGAL SERVICES

FOR ENGINEERING SERVICES; DESIGN SERVICES FOR OTHERS OF WIRELESS RADIO COMMUNICATION EQUIPMENT (U.S. CLS. 100 AND 101).
TANYA AMOS, EXAMINING ATTORNEY

CLASS 13—FIREARMS

FOR NYLON HOLSTER COVERS; GUN, SHELLS AND CARTRIDGE BELTS; POUCHES FOR HOLDING ARMS, AMMUNITION, AND MAGAZINES FOR WEAPONS, ALL FOR USE IN THE FIELDS OF MILITARY AND LAW ENFORCEMENT ACTIVITIES (U.S. CLS. 2 AND 9).

SN 78-348,543. INTELLIDOT CORPORATION, SAN MARCOS, CA. FILED 1-6-2004.

intelliDOT

CLASS 18—LEATHER GOODS

FOR BACKPACKS, KNAPSACKS, FANNY PACKS, TOOL POUCHES SOLD EMPTY FOR HOLDING RADIOS, FLASHLIGHTS AND OTHER UTILITIES FOR OUTDOOR SURVIVAL AND EXTENDED HIKES AND MISSIONS, AND WATERPROOF DUFFEL BAGS, ALL FOR USE IN THE FIELDS OF MILITARY AND LAW ENFORCEMENT ACTIVITIES (U.S. CLS. 1, 2, 3, 22 AND 41).

CLASS 25—CLOTHING

FOR CLOTHING, NAMELY, VESTS AND BELTS FOR USE IN THE FIELDS OF MILITARY AND LAW ENFORCEMENT ACTIVITIES (U.S. CLS. 22 AND 39).
AMY GEARIN, EXAMINING ATTORNEY

THE MARK CONSISTS OF THE WORD INTELLIDOT WITH A STYLIZED "O", THE "O" BEING DIVIDED INTO 3 PARTS BY 3 COMMA-SHAPED SWIRLS RESEMBLING THE PROPELLER OF A PLANE, AND HAVING TWO DOTS APPEARING IN THE UPPER LEFT THIRD OF THE CENTER OF THE "O" AND ONE DOT APPEARING IN EACH OF THE OTHER TWO THIRDS OF THE "O".

CLASS 9—ELECTRICAL AND SCIENTIFIC APPARATUS

FOR WIRELESS ELECTRO-OPTICAL DEVICES FOR READING, SCANNING, PROCESSING, VIEWING, RECEIVING, TRANSMITTING, FORWARDING, SORTING AND STORING DATA ENCODED IN PRINTED SYMBOLS, NAMELY, WIRELESS OPTICAL READERS AND HAND SCANNERS, AND OPERATING SOFTWARE THEREFORE; SOFTWARE FOR PERSONAL COMPUTERS, NAMELY, SOFTWARE FOR CODING DATA IN THE FORM OF ONE OR TWO DIMENSIONAL OPTICALLY READABLE SYMBOLS, AND FOR VIEWING, RECEIVING, TRANSMITTING, FORWARDING, SORTING, AND STORING SAID CODED DATA; SOFTWARE FOR PERSONAL COMPUTERS, NAMELY, SOFTWARE FOR COMMUNICATING CODED DATA WITH A SERVER; SOFTWARE FOR SERVERS, NAMELY, SOFTWARE FOR CODING DATA IN THE FORM OF ONE OR TWO DIMENSIONAL OPTICALLY READABLE SYMBOLS, AND FOR VIEWING, RECEIVING, TRANSMITTING, FORWARDING, SORTING, AND STORING SAID CODED DATA; SOFTWARE FOR SERVERS, NAMELY, SOFTWARE FOR COMMUNICATING CODED DATA WITH A PERSONAL COMPUTER; SOFTWARE FOR INTERNET SERVERS, NAMELY, SOFTWARE FOR DELIVERING INFORMATION OVER A GLOBAL COMPUTER NETWORK OR SOFTWARE FOR DIRECTING SERVERS TO HANDLE INFORMATION; UNIVERSAL SERIAL BUS DEVICES, NAMELY, UNIVERSAL SERIAL BUS RECEIVERS, AND OPERATING SOFTWARE THEREFORE; COMPUTER MICE AND OPERATING SOFTWARE THEREFORE; SCANNERS AND OPERATING SOFTWARE THEREFORE; PRINTERS AND OPERATING SOFTWARE FOR SAID PRINTERS, AND FOR PRINTING CODED DATA IN THE FORM OF ONE OR TWO DIMENSIONAL OPTICALLY READABLE SYMBOLS ON MEDIA TO CREATE PRINTED MEDIA, FOR LINKING SAID PRINTED MEDIA TO ELECTRONIC INFORMATION RELATED TO SAID PRINTED MEDIA, AND FOR GENERATING, LOGGING, FORWARDING AND MANAGING SUCH INFORMATION (U.S. CLS. 21, 23, 26, 36 AND 38).

CLASS 16—PAPER GOODS AND PRINTED MATTER

FOR BLANK, PARTIALLY PRINTED, AND PRINTED CODING LABELS AND RIBBONS, SIMILAR TO BAR CODE LABELS BUT WHICH CAN FEATURE ONE OR TWO DIMENSIONAL OPTICALLY READABLE SYMBOLS IN ADDITION TO OR INSTEAD OF BARS, WHICH ARE DESIGNED TO BE READ BY WIRELESS OPTICAL READERS AND HAND SCANNERS (U.S. CLS. 2, 5, 22, 23, 29, 37, 38 AND 50).

CLASS 35—ADVERTISING AND BUSINESS

FOR CREATING AND PROVIDING CODED DEVICES FOR OTHERS, SAID CODED DEVICES FOR PROVIDING INFORMATION ABOUT SAID OTHERS, ADVERTISEMENTS OF SAID OTHERS, THE BUSINESS OF SAID OTHERS, THE PRODUCTS OF SAID OTHERS, OR THE SERVICES OF SAID OTHERS (U.S. CLS. 100, 101 AND 102).

CLASS 38—COMMUNICATION

FOR PROVIDING CONNECTIONS TO A GLOBAL COMPUTER NETWORK SERVER FOR TRANSMITTING AND RECEIVING CODED DATA (U.S. CLS. 100, 101 AND 104).

CLASS 42—SCIENTIFIC, COMPUTER AND LEGAL SERVICES

FOR CUSTOM DESIGN FOR OTHERS IN THE FIELD OF DATA CODING DEVICES, NAMELY, WIRELESS OPTICAL READERS, HAND SCANNERS, OPERATING SOFTWARE THEREFORE, AND SOFTWARE FOR CODING DATA IN THE FORM OF ONE OR TWO DIMENSIONAL OPTICALLY READABLE SYMBOLS, AND VIEWING, RECEIVING, TRANSMITTING, FORWARDING, SORTING, AND STORING SAID CODED DATA (U.S. CLS. 100 AND 101).

TRACY WHITAKER-BOWN, EXAMINING ATTORNEY

SN 78-349,339. LERNCO, INC., WILMINGTON, DE. FILED 1-8-2004.

NEW YORK & COMPANY

THE MARK CONSISTS OF STANDARD CHARACTERS WITHOUT CLAIM TO ANY PARTICULAR FONT, STYLE, SIZE, OR COLOR.

OWNER OF U.S. REG. NOS. 2,076,151, 2,629,986 AND OTHERS.

NO CLAIM IS MADE TO THE EXCLUSIVE RIGHT TO USE "COMPANY", APART FROM THE MARK AS SHOWN. SEC. 2(F).

CLASS 9—ELECTRICAL AND SCIENTIFIC APPARATUS

FOR SUNGLASSES (U.S. CLS. 21, 23, 26, 36 AND 38). FIRST USE 11-1-1997; IN COMMERCE 11-1-1997.

CLASS 14—JEWELRY

FOR JEWELRY, ORNAMENTAL PINS AND WATCHES (U.S. CLS. 2, 27, 28 AND 50). FIRST USE 11-1-1997; IN COMMERCE 11-1-1997.

CLASS 18—LEATHER GOODS

FOR COIN PURSES, DAY PLANNER BOOKS, LIPSTICK CASES SOLD EMPTY, MAKE-UP BAGS SOLD EMPTY, MAKE-UP MIRROR CASES SOLD EMPTY AND WALLETTS (U.S. CLS. 1, 2, 3, 22 AND 41). FIRST USE 11-1-1997; IN COMMERCE 11-1-1997.

CLASS 20—FURNITURE AND ARTICLES NOT OTHERWISE CLASSIFIED

FOR NON-LEATHER AND NON-METAL KEY CHAINS AND PICTURE FRAMES (U.S. CLS. 2, 13, 22, 25, 32 AND 50).

FIRST USE 8-1-2003; IN COMMERCE 8-1-2003.

CLASS 25—CLOTHING

FOR BELTS, FLIP FLOPS, GLOVES, HATS, HOSIERY, MUFFLERS, PAREOS, PONCHOS, SCARVES AND SOCKS (U.S. CLS. 22 AND 39).

FIRST USE 11-1-1997; IN COMMERCE 11-1-1997.

CLASS 26—FANCY GOODS

FOR BARRETTES, HAIR BANDS, HAIR CLIPS, HAIR ORNAMENTS, HAIR PINS AND PONYTAIL HOLDERS (U.S. CLS. 37, 39, 40, 42 AND 50).

FIRST USE 11-1-1997; IN COMMERCE 11-1-1997.

MARIA-VICTORIA SUAREZ, EXAMINING ATTORNEY

SN 78-351,281. LASERFRONT TECHNOLOGIES KABUSHIKI KAISHA, KANAGAWA-KEN, JAPAN, FILED 1-13-2004.

CLASS 42—SCIENTIFIC, COMPUTER AND LEGAL SERVICES

FOR PRODUCT DEVELOPMENT CONSULTATION IN THE FIELD OF LASER BASED SYSTEM SOLUTIONS; COMPUTER PROGRAMMING FOR LASERS FOR OTHERS (U.S. CLS. 100 AND 101).
MICHAEL SOUDERS, EXAMINING ATTORNEY

LASERFRONT

SN 78-351,513. STEVENS, LISA A., KENMORE, WA. FILED 1-13-2004.

THE MARK CONSISTS OF STANDARD CHARACTERS WITHOUT CLAIM TO ANY PARTICULAR FONT, STYLE, SIZE, OR COLOR.

CLASS 7—MACHINERY

FOR LASER PROCESSING MACHINES, NAMELY LASER MACHINES FOR TRIMMING, SCRIBING, CUTTING, WELDING, DRILLING, SURFACE TREATMENT, MATERIAL DEPOSITION, REMOVING, MARKING, SOLDERING, MELTING, SINTERING, REPAIRING, ANNEALING, AND/OR CLEANING; LASER TESTING MACHINES FOR ELECTRIC DISCHARGE (U.S. CLS. 13, 19, 21, 23, 31, 34 AND 35).

CLASS 9—ELECTRICAL AND SCIENTIFIC APPARATUS

FOR LASERS NOT FOR MEDICAL USE, AND PARTS THEREFOR; LASER OSCILLATORS; SWITCH UNITS FOR LASER OSCILLATORS; PROTECTIVE GLASSES FOR YAG LASER; ELECTRICAL CONTROLLERS FOR LASER PROCESSING MACHINES; OPTICAL SCANNERS FOR LASER MACHINING UNITS; OPTICAL LENSES, OPTICAL MIRRORS, AND OPTICAL READERS, USED IN COMBINATION AS AN OPTICAL SYSTEM FOR LASER MACHINING UNITS; FIBER OPTICS, OPTICAL LENSES, AND OPTICAL MIRRORS USED IN COMBINATION AS AN OPTICAL SYSTEM FOR LASER MACHINING UNITS; LASER DIODES FOR LASER OSCILLATORS (U.S. CLS. 21, 23, 26, 36 AND 38).

CLASS 10—MEDICAL APPARATUS

FOR LASERS FOR MEDICAL USE, AND PARTS THEREFOR (U.S. CLS. 26, 39 AND 44).

CLASS 11—ENVIRONMENTAL CONTROL APPARATUS

FOR LAMPS AS LASER COMPONENTS, NAMELY, PUMPING EXCITATION LAMPS FOR LASER OSCILLATORS (U.S. CLS. 13, 21, 23, 31 AND 34).

CLASS 37—CONSTRUCTION AND REPAIR

FOR INSTALLATION, CONSTRUCTION, REPAIR, MAINTENANCE AND SERVICING OF LASER APPARATUS (U.S. CLS. 100, 103 AND 106).

CLASS 40—MATERIAL TREATMENT

FOR CUSTOM MANUFACTURING OF LASERS AND LASER SYSTEMS FOR OTHERS; CONSULTING IN THE FIELD OF LASER MANUFACTURING (U.S. CLS. 100, 103 AND 106).

CHATDOLLARS

THE MARK CONSISTS OF STANDARD CHARACTERS WITHOUT CLAIM TO ANY PARTICULAR FONT, STYLE, SIZE, OR COLOR.

CLASS 35—ADVERTISING AND BUSINESS

FOR PROMOTING THE GOODS AND SERVICES OF OTHERS BY ARRANGING FOR SPONSORS TO AFFILIATE THEIR COMPUTER WEBSITES WITH THE WEBSITES OF OTHERS OFFERING THE GOODS AND SERVICES (U.S. CLS. 100, 101 AND 102).
FIRST USE 5-0-2003; IN COMMERCE 5-0-2003.

CLASS 38—COMMUNICATION

FOR ELECTRONIC TELEPHONE MESSAGING SERVICES; COMPUTERIZED ONLINE CHAT ROOMS FOR THE TRANSMISSION OF MESSAGES AMONG COMPUTER USERS CONCERNING DATING AND PERSONAL RELATIONSHIPS; PROVIDING TELEPHONE CONFERENCING SERVICES; TELEPHONE CONFERENCING SERVICES IN THE NATURE OF COMBINATION AUDIO AND VIDEO CONFERENCING; TELEPHONE COMMUNICATION SERVICES IN THE NATURE OF ELECTRONIC MESSAGING, NAMELY, THE RECORDING, STORAGE AND SUBSEQUENT TRANSMISSION OF PERSONAL MESSAGES; ELECTRONIC TRANSMISSION OF DATA AND DOCUMENTS VIA COMPUTER (U.S. CLS. 100, 101 AND 104).
FIRST USE 5-0-2003; IN COMMERCE 5-0-2003.

CLASS 45—PERSONAL SERVICES

FOR MATCHMAKING AND COMPUTER DATING SERVICES VIA THE INTERNET (U.S. CLS. 100 AND 101).
FIRST USE 5-0-2003; IN COMMERCE 5-0-2003.
DAVID C. REIHNER, EXAMINING ATTORNEY

SN 78-352,542. THE ESCORIAL COMPANY LIMITED, HAREWOOD, CHRISTCHURCH, NEW ZEALAND, FILED 1-15-2004.

SAXMERE

THE MARK CONSISTS OF STANDARD CHARACTERS WITHOUT CLAIM TO ANY PARTICULAR FONT, STYLE, SIZE, OR COLOR.

OWNER OF NEW ZEALAND REG. NO. 266557, DATED 10-21-1997, EXPIRES 9-3-2013.

OWNER OF NEW ZEALAND REG. NO. 658681, DATED 12-12-2002, EXPIRES 6-11-2012.

CLASS 22—CORDAGE AND FIBERS

FOR RAW FIBROUS TEXTILE MATERIALS; ANIMAL FIBERS AND SHEEP FIBER, NAMELY, FLEECE AND WOOL; WOOL FLOCKS, WOOL PACKS, WOOL TOPS, SHORN WOOL; RAW, TREATED, COMBED OR CARDED WOOL (U.S. CLS. 1, 2, 7, 19, 22, 42 AND 50).

CLASS 25—CLOTHING

FOR ARTICLES OF CLOTHING, NAMELY, SHIRTS, PANTS, SKIRTS, JACKETS, COATS, HATS, BELTS, BERETS, BLOUSES, CARDIGANS, GLOVES, GOWNS, HOSIERY, JERSEYS, JUMPERS, JUMPSUITS, LINGERIE, MUFLERS, PAJAMAS, SCARVES, SASHES, SARONGS, SHAWLS, SHOES, SHORTS, SOCKS, SUITS, SWEATERS, T-SHIRTS, TROUSERS, UNDERGARMENTS; HEADWEAR; FOOTWEAR (U.S. CLS. 22 AND 39).

GRETTA YAO, EXAMINING ATTORNEY

SN 78-352,616. BRET ACHTENHAGEN'S SEASONAL SERVICES, LTD., EAGLE, WI. FILED 1-15-2004.



NO CLAIM IS MADE TO THE EXCLUSIVE RIGHT TO USE SEASONAL SERVICES, LTD., APART FROM THE MARK AS SHOWN.

THE MARK CONSISTS OF THE TWO WORDS "SEASONAL" AND "SERVICES." "SEASONAL" IS SITUATED ABOVE "SERVICES," AND THE MARK HAS THE TWO WORDS SHARING THE SAME FIRST LETTER "S". THE "S" IS STYLIZED IN THE SHAPE OF A CURVY LEAF. THE LETTERS "LTD" FOLLOW THE WORD "SERVICES" AND APPEAR IN A SMALLER FONT.

CLASS 37—CONSTRUCTION AND REPAIR

FOR IRRIGATION SYSTEM INSTALLATION, RETAINING WALL INSTALLATION, BRICK AND STONE WALKWAY INSTALLATION, LANDSCAPE GRADING, AND PARKING LOT AND WALKWAY SNOW REMOVAL (U.S. CLS. 100, 103 AND 106).

FIRST USE 3-13-1995; IN COMMERCE 3-13-1995.

CLASS 42—SCIENTIFIC, COMPUTER AND LEGAL SERVICES

FOR LANDSCAPE LIGHTING DESIGN (U.S. CLS. 100 AND 101).

FIRST USE 3-13-1995; IN COMMERCE 3-13-1995.

CLASS 44—MEDICAL, BEAUTY AND AGRICULTURAL SERVICES

FOR LANDSCAPE GARDENING DESIGN FOR OTHERS, HORTICULTURAL SERVICES; LANDSCAPE GARDENING; LAWN CARE; LAWN MOWING; PLANT CARE; PLANT AND TREE NURSERIES; SPREADING OF FERTILIZERS AND OTHER AGRICULTURAL CHEMICALS; WEED KILLING; LAWN SEEDING AND SODDING; AND LAWN AERATION (U.S. CLS. 100 AND 101).

FIRST USE 3-13-1995; IN COMMERCE 3-13-1995.

MARY BOAGNI, EXAMINING ATTORNEY

SN 78-353,537. UAL LOYALTY SERVICES, INC., CHICAGO, IL. FILED 1-19-2004.

AWARD ACCELERATOR

THE MARK CONSISTS OF STANDARD CHARACTERS WITHOUT CLAIM TO ANY PARTICULAR FONT, STYLE, SIZE, OR COLOR.

NO CLAIM IS MADE TO THE EXCLUSIVE RIGHT TO USE "AWARD", APART FROM THE MARK AS SHOWN.

CLASS 35—ADVERTISING AND BUSINESS

FOR PROMOTING THE GOODS AND SERVICES OF OTHERS ON-LINE BY MANAGING FREQUENT FLIER MILES, CONVERTING FREQUENT FLIER MILES INTO A CURRENCY AND REDEEMING SUCH FREQUENT FLIER MILES VIA A CURRENCY (U.S. CLS. 100, 101 AND 102).

CLASS 39—TRANSPORTATION AND STORAGE

FOR AIR TRANSPORTATION SERVICES FEATURING ON-LINE FREQUENT FLIER BONUS PROGRAM FEATURING ON-LINE SERVICE FOR CALCULATING FREQUENT FLIER MILES (U.S. CLS. 100 AND 105).

STEVEN JACKSON, EXAMINING ATTORNEY

SN 78-355,227. LEXINGTON MANAGEMENT CORPORATION, DALLAS, TX. FILED 1-21-2004.

**GENARES WORLDWIDE
RESERVATION
SERVICES**

THE MARK CONSISTS OF STANDARD CHARACTERS WITHOUT CLAIM TO ANY PARTICULAR FONT, STYLE, SIZE, OR COLOR.

NO CLAIM IS MADE TO THE EXCLUSIVE RIGHT TO USE "WORLDWIDE RESERVATION SERVICES", APART FROM THE MARK AS SHOWN.

CLASS 39—TRANSPORTATION AND STORAGE

FOR TRAVEL SERVICES, NAMELY; RENTAL OF CARS AND RENTAL CAR RESERVATIONS; ARRANGING OF CRUISES (U.S. CLS. 100 AND 105).

CLASS 41—EDUCATION AND ENTERTAINMENT

FOR MAKING RESERVATIONS FOR GOLF COURSES AND TEE TIMES (U.S. CLS. 100, 101 AND 107).

CLASS 43—HOTEL AND RESTAURANT SERVICES

FOR MAKING HOTEL RESERVATIONS FOR OTHERS AND RESERVATION OF CONVENTION SPACE FOR OTHERS (U.S. CLS. 100 AND 101).

CLASS 44—MEDICAL, BEAUTY AND AGRICULTURAL SERVICES

FOR MAKING SPA RESERVATIONS FOR OTHERS (U.S. CLS. 100 AND 101).
ELLEN PERKINS, EXAMINING ATTORNEY

SN 78-355,974. KINGSTON BRASS INC., CHINO, CA. FILED 1-22-2004.



CLASS 11—ENVIRONMENTAL CONTROL APPARATUS

FOR FAUCETS, BATH TUBS, TOILETS (U.S. CLS. 13, 21, 23, 31 AND 34).
FIRST USE 12-1-2003; IN COMMERCE 12-1-2003.

CLASS 20—FURNITURE AND ARTICLES NOT OTHERWISE CLASSIFIED

FOR NON-METAL GARMENT HOOKS, ROBE HOOKS; GLASS SHELVES (U.S. CLS. 2, 13, 22, 25, 32 AND 50).
FIRST USE 12-1-2003; IN COMMERCE 12-1-2003.

CLASS 21—HOUSEWARES AND GLASS

FOR TOWEL BARS; TOWEL RINGS; SOAP DISH; TOOTH BRUSH/TUMBLER HOLDERS; TOILET PAPER HOLDERS (U.S. CLS. 2, 13, 23, 29, 30, 33, 40 AND 50).
FIRST USE 12-1-2003; IN COMMERCE 12-1-2003.
ZACHARY BELLO, EXAMINING ATTORNEY

SN 78-356,604. SPECTRUM WATER COOLERS, INC., JESSUP, MD. FILED 1-23-2004.

ALWAYS ONN

THE MARK CONSISTS OF STANDARD CHARACTERS WITHOUT CLAIM TO ANY PARTICULAR FONT, STYLE, SIZE, OR COLOR.

CLASS 9—ELECTRICAL AND SCIENTIFIC APPARATUS

FOR VIDEO SCREENS FOR DISPLAYING INFORMATION AND ADVERTISING WIRELESSLY (U.S. CLS. 21, 23, 26, 36 AND 38).

CLASS 38—COMMUNICATION

FOR DELIVERY OF MESSAGES BY ELECTRONIC TRANSMISSION, NAMELY WIRELESSLY DELIVERING INFORMATION AND ADVERTISING TO A VIDEO SCREEN ON A PRIVATE NETWORK AND, SPECIFICALLY, NOT TRANSMITTED THROUGH RADIO AND TELEVISION BROADCASTING (U.S. CLS. 100, 101 AND 104).
KATHRYN COWARD, EXAMINING ATTORNEY

SN 78-358,624. GREATER HARTFORD PHYSICAL THERAPY, P.C., HARTFORD, CT. FILED 1-28-2004.

SN 78-358,734. MADISON HOLDINGS, INC., SEATTLE, WA. FILED 1-28-2004.



LIVE FIT

NO CLAIM IS MADE TO THE EXCLUSIVE RIGHT TO USE "LINE" IN CLASS 25 ONLY, APART FROM THE MARK AS SHOWN.

THE COLORS GREEN, BLACK AND WHITE ARE CLAIMED AS A FEATURE OF THE MARK.

THE MARK CONSISTS OF A CIRCLE WITH A GREEN BAND, AND WHITE INTERIOR, WITH THE WORDING, SHINJUKU LINE IN BLACK.

CLASS 25—CLOTHING

FOR (BASED ON INTENT TO USE) CLOTHING, NAMELY T-SHIRTS (U.S. CLS. 22 AND 39).

CLASS 43—HOTEL AND RESTAURANT SERVICES

FOR RESTAURANT SERVICES (U.S. CLS. 100 AND 101).

FIRST USE 8-20-2003; IN COMMERCE 8-20-2003.
ODESSA BIBBINS, EXAMINING ATTORNEY

SN 78-360,034. INTERO HOLDINGS, INC., DENVER, CO. FILED 1-30-2004.

THE MARK CONSISTS OF STANDARD CHARACTERS WITHOUT CLAIM TO ANY PARTICULAR FONT, STYLE, SIZE, OR COLOR.

CLASS 25—CLOTHING

FOR CLOTHING, NAMELY, SHIRTS, HATS, SWEATERS, SHORTS, JACKETS, SNEAKERS, SWEAT SHIRTS, SWEAT PANTS, SWEAT SHORTS, AND SWEAT SUITS (U.S. CLS. 22 AND 39).

FIRST USE 4-0-1998; IN COMMERCE 4-0-1998.

CLASS 28—TOYS AND SPORTING GOODS

FOR SPORTING GOODS, NAMELY, FLYING DISCS, GOLF BALLS AND EXERCISE BALLS (U.S. CLS. 22, 23, 38 AND 50).

FIRST USE 9-0-2003; IN COMMERCE 9-0-2003.

CLASS 44—MEDICAL, BEAUTY AND AGRICULTURAL SERVICES

FOR PHYSICAL THERAPY SERVICES (U.S. CLS. 100 AND 101).

FIRST USE 4-0-1998; IN COMMERCE 4-0-1998.
JOHN DWYER, EXAMINING ATTORNEY



OWNER OF U.S. REG. NO. 2,764,317.

NO CLAIM IS MADE TO THE EXCLUSIVE RIGHT TO USE "COMMERCIAL", APART FROM THE MARK AS SHOWN.

THE MARK CONSISTS OF A 3-DIMENSIONAL DESIGN OF A COLUMN AND COLUMN CAP PRECEDING THE WORDS INTERO COMMERCIAL. THE WORD INTERO IS ALL CAPITALIZED AND IN SERIF FONT, AND THE WORD COMMERCIAL IS LOCATED DIRECTLY BELOW THE WORD INTERO, IN A SMALLER ARIAL FONT.

CLASS 36—INSURANCE AND FINANCIAL

FOR FINANCIAL, REAL ESTATE, AND TITLE INSURANCE SERVICES, NAMELY, MORTGAGE LENDING, MORTGAGE BANKING AND ESCROW SERVICES (U.S. CLS. 100, 101 AND 102).

FIRST USE 9-1-2002; IN COMMERCE 9-1-2002.

CLASS 42—SCIENTIFIC, COMPUTER AND LEGAL SERVICES

FOR REAL ESTATE CLOSING SERVICES (U.S. CLS. 100 AND 101).

FIRST USE 9-1-2002; IN COMMERCE 9-1-2002.

WILLIAM P. SHANAHAN, EXAMINING ATTORNEY

SN 78-362,364. KRAKOWSKI, KIMBERLY E., ALEXANDRIA, VA. FILED 2-4-2004.

FANBANDS

THE MARK CONSISTS OF STANDARD CHARACTERS WITHOUT CLAIM TO ANY PARTICULAR FONT, STYLE, SIZE, OR COLOR.

CLASS 20—FURNITURE AND ARTICLES NOT OTHERWISE CLASSIFIED

FOR DECORATIVE ORNAMENTS MADE FROM PLASTIC AND WOOD THAT ATTACH AND HANG FROM CEILING FANS (U.S. CLS. 2, 13, 22, 25, 32 AND 50).

CLASS 24—FABRICS

FOR DECORATIVE ORNAMENTS MADE FROM CLOTH AND TEXTILES THAT ATTACH AND HANG FROM CEILING FANS (U.S. CLS. 42 AND 50).

ALLISON SCHRODY, EXAMINING ATTORNEY

PORTFOLIO

SN 78-360,573. JDA SOFTWARE GROUP, INC., SCOTTSDALE, AZ. FILED 1-31-2004.

SN 78-362,985. SONIC BRANDING SOLUTIONS LLC, NEW YORK, NY. FILED 2-5-2004.

THE MARK CONSISTS OF STANDARD CHARACTERS WITHOUT CLAIM TO ANY PARTICULAR FONT, STYLE, SIZE, OR COLOR.

OWNER OF U.S. REG. NO. 2,554,095.

CLASS 9—ELECTRICAL AND SCIENTIFIC APPARATUS

FOR COMPUTER SOFTWARE FOR USE IN THE RETAIL INDUSTRY, NAMELY, FOR FINANCIAL ANALYSIS, MANAGING AND REPORTING BUSINESS DATA, VERIFYING PRICES, ORDERING STOCK, AND OPERATING POINT-OF-SALE FUNCTIONS; COMPUTER SOFTWARE USED TO ACCESS AND TRANSMIT RETAILER MERCHANDISING DATA VIA A GLOBAL COMPUTER NETWORK (U.S. CLS. 21, 23, 26, 36 AND 38).

CLASS 42—SCIENTIFIC, COMPUTER AND LEGAL SERVICES

FOR COMPUTER SOFTWARE DESIGN AND CONSULTING SERVICES NAMELY, COMPUTER NETWORK CONFIGURATION, IMPLEMENTATION, MAINTENANCE, AND TROUBLESHOOTING FOR SOFTWARE USED IN THE RETAIL INDUSTRY (U.S. CLS. 100 AND 101).

SHARI SHEFFIELD, EXAMINING ATTORNEY

CELEBRITONES

THE MARK CONSISTS OF STANDARD CHARACTERS WITHOUT CLAIM TO ANY PARTICULAR FONT, STYLE, SIZE, OR COLOR.

CLASS 9—ELECTRICAL AND SCIENTIFIC APPARATUS

FOR ENCODED SMART CARDS, NAMELY PREPAID SMART CARDS FOR MOBILE TELEPHONES; PROVIDING DOWNLOADABLE RING TONES OR AUDIO FILES VIA WIRELESS NETWORKS OR THE INTERNET FOR USE WITH COMPUTERS, MOBILE TELEPHONES, PDAS OR OTHER WIRELESS DEVICES (U.S. CLS. 21, 23, 26, 36 AND 38).

CLASS 42—SCIENTIFIC, COMPUTER AND LEGAL SERVICES

FOR COMPUTER SERVICES, NAMELY, PROVIDING TEMPORARY USE OF NON-DOWNLOADABLE RING TONES OR AUDIO FILES VIA WIRELESS NETWORKS OR THE INTERNET FOR USE WITH COMPUTERS, MOBILE TELEPHONES, PDAS OR OTHER WIRELESS DEVICES (U.S. CLS. 100 AND 101).

RENEE MCCRAY, EXAMINING ATTORNEY

SN 78-363,415. COOPER TECHNOLOGIES COMPANY, HOUSTON, TX. FILED 2-5-2004.

CLASS 35—ADVERTISING AND BUSINESS

FOR RETAIL STORE SERVICES IN THE FIELD OF DURABLE MEDICAL EQUIPMENT AND PHARMACEUTICALS; RETAIL PHARMACY SERVICES (U.S. CLS. 100, 101 AND 102).

CLASS 44—MEDICAL, BEAUTY AND AGRICULTURAL SERVICES

FOR DISPENSING OF PHARMACEUTICALS TO INSTITUTIONS; HOME HEALTH CARE SERVICES IN THE NATURE OF HOME INTRAVENOUS THERAPY (U.S. CLS. 100 AND 101).

TONJA GASKINS, EXAMINING ATTORNEY

TRUVOLT

SN 78-365,306. CES COMPUTER SOLUTIONS, INC., PLAINVIEW, NY. FILED 2-10-2004.

THE MARK CONSISTS OF STANDARD CHARACTERS WITHOUT CLAIM TO ANY PARTICULAR FONT, STYLE, SIZE, OR COLOR.

CLASS 9—ELECTRICAL AND SCIENTIFIC APPARATUS

FOR REMOTE TRANSFORMERS FOR HALOGEN LOAD LIGHTS (U.S. CLS. 21, 23, 26, 36 AND 38).

CLASS 11—ENVIRONMENTAL CONTROL APPARATUS

FOR ELECTRICAL LIGHTING PRODUCTS, NAMELY, LOW VOLTAGE TRACK FIXTURES AND SYSTEMS COMPRISED OF INTEGRAL AND REMOTE TRANSFORMERS FOR HALOGEN LOAD LIGHTS; LOW VOLTAGE TRACK CABLE RIBBON AND RAIL FIXTURES AND FITTINGS; DECORATIVE, AND RECESSED ELECTRIC LIGHTING FIXTURES; AND LOW VOLTAGE SURFACE MOUNTED DOWNLIGHTS (U.S. CLS. 13, 21, 23, 31 AND 34).

GINA FINK, EXAMINING ATTORNEY

SN 78-364,564. NEIGHBORCARE HOLDINGS, INC., DOVER, DE. FILED 2-9-2004.

 NeighborCare EZBill

OWNER OF U.S. REG. NOS. 1,654,004 AND 2,245,401.
THE MARK CONSISTS OF A STYLIZED VERSION OF THE LETTER "R," THE LETTER "X" AND A STYLIZED RENDERING OF A PERSON WITH THE WORDS NEIGHBORCARE EZBILL TO THE RIGHT.

ADJUDICATOR

THE MARK CONSISTS OF STANDARD CHARACTERS WITHOUT CLAIM TO ANY PARTICULAR FONT, STYLE, SIZE, OR COLOR.

CLASS 9—ELECTRICAL AND SCIENTIFIC APPARATUS

FOR COMPUTER SOFTWARE FOR USE IN COMPUTERS TO IDENTIFY, ANALYZE AND RESTRUCTURE OR REPLACE UNSUCCESSFUL COMPUTER TRANSACTIONS OR OTHER COMPUTER SOFTWARE (U.S. CLS. 21, 23, 26, 36 AND 38).

FIRST USE 1-8-1989; IN COMMERCE 1-8-1989.

CLASS 42—SCIENTIFIC, COMPUTER AND LEGAL SERVICES

FOR APPLICATION SERVICE PROVIDER SERVICES FEATURING COMPUTER SOFTWARE THAT IDENTIFIES, ANALYZES AND RESTRUCTURES OR REPLACES UNSUCCESSFUL COMPUTER TRANSACTIONS OF OTHER COMPUTER SOFTWARE (U.S. CLS. 100 AND 101).

FIRST USE 1-8-1989; IN COMMERCE 1-8-1989.
WON TEAK OH, EXAMINING ATTORNEY

SN 78-365,979. LAGOON TRADING COMPANY LTD., LONDON, UNITED KINGDOM, FILED 2-11-2004.

LAGOON

THE MARK CONSISTS OF STANDARD CHARACTERS WITHOUT CLAIM TO ANY PARTICULAR FONT, STYLE, SIZE, OR COLOR.

CLASS 16—PAPER GOODS AND PRINTED MATTER

FOR BOOKS FEATURING GAMES, PUZZLES, QUIZZES, HUMOR, TRIVIA, GARDENING, OR WEBSITES; COOK BOOKS; GIFT BOOKS; GLOW-IN-THE-DARK DECALS (U.S. CLS. 2, 5, 22, 23, 29, 37, 38 AND 50).
FIRST USE 1-1-1997; IN COMMERCE 1-1-1997.

CLASS 28—TOYS AND SPORTING GOODS

FOR GAMES AND PLAYTHINGS, NAMELY, PUZZLES, MAZE GAMES, BOARD GAMES, PARLOR GAMES, PARTY GAMES, CARD GAMES, TABLE GAMES, DICE GAMES, TRIVIA GAMES, MAGIC TRICKS, SCIENCE EXPERIMENT AND ACTIVITY KITS, KITS FOR MAKING KITES, TOY ROCKETS, TOY BOATS, TOY HOT AIR BALLOONS, AND TOY AIRPLANES; HOBBY CRAFT KITS TO MAKE BEADED JEWELRY, BRAIDED ACCESSORIES, HAIR ACCESSORIES, MOSAIC ART, PAINTED GLASS ART, STAMP ART, AND TOYS AND PLAYTHINGS; PRINTED SETS OF CARDS FEATURING HUMOROUS TOPICS AND GAMES (U.S. CLS. 22, 23, 38 AND 50).

FIRST USE 1-1-1997; IN COMMERCE 1-1-1997.
JIM RINGLE, EXAMINING ATTORNEY

SN 78-365,992. LAGOON TRADING COMPANY LTD., LONDON, UNITED KINGDOM, FILED 2-11-2004.

LONCRINE BROXTON

THE MARK CONSISTS OF STANDARD CHARACTERS WITHOUT CLAIM TO ANY PARTICULAR FONT, STYLE, SIZE, OR COLOR.

CLASS 16—PAPER GOODS AND PRINTED MATTER

FOR PENS, RUBBER STAMPS (U.S. CLS. 2, 5, 22, 23, 29, 37, 38 AND 50).
FIRST USE 1-1-1999; IN COMMERCE 1-1-1999.

CLASS 28—TOYS AND SPORTING GOODS

FOR GAMES AND PLAYTHINGS, NAMELY, MAZE GAMES, THREE-DIMENSIONAL PUZZLE GAMES, HANDHELD GAMES OF SKILL AND DEXTERITY NAMELY GAMES COMPRISING A WIRE WAND THAT IS GUIDED OVER A WIRE FRAME, GAMES COMPRISING A CLEAR, WATER-FILLED CONTAINER CONTAINING BALLS, RINGS OR OTHER OBJECTS, AND GAMES COMPRISING A CLEAR PLASTIC CONTAINER CONTAINING BALLS WHICH PASS THROUGH HOLES, JUGGLING BALLS, KITES, TOY CONSTRUCTION KITS, CARD GAMES; EXECUTIVE DESKTOP TOYS, NAMELY, MARBLE RUN TOYS, MAGNETIC SCULPTURE TOYS, NOVELTY DICE TOYS; EXECUTIVE RELAXATION AND AMUSEMENT DEVICES, NAMELY, METAL BALLS SUSPENDED FROM RACKS, MAGNETIZED DESKTOP NOVELTY DEVICE COMPRISED OF METAL PARTS WHICH MAY BE MOLDED INTO A VARIETY OF SHAPES BY THE USER (U.S. CLS. 22, 23, 38 AND 50).

FIRST USE 1-1-1999; IN COMMERCE 1-1-1999.
JIM RINGLE, EXAMINING ATTORNEY

SN 78-367,195. LINC PREFERRED GROUP, INC., COOKEVILLE, TN. FILED 2-12-2004.

The logo for LINC edge features the word "LINC" in a large, bold, black sans-serif font. Below it, the word "edge" is written in a smaller, white, lowercase sans-serif font, positioned on a black, downward-pointing triangular shape that tapers to the right.

CLASS 35—ADVERTISING AND BUSINESS

FOR BUSINESS MANAGEMENT CONSULTATION IN THE FIELD OF TRANSPORTATION AND FREIGHT SERVICES, NAMELY, SELECTION, IMPLEMENTATION AND INTEGRATION OF TECHNICAL SOLUTIONS IN THE FIELD OF TRANSPORTATION AND FREIGHT SERVICES; FLEET MANAGEMENT FOR THE TRANSPORTATION AND FREIGHT INDUSTRIES; BUYING CLUBS IN THE FIELD OF TRANSPORTATION AND FREIGHT SERVICES FOR OBTAINING ECONOMIC ADVANTAGES IN THE NATURE OF NEGOTIATION AND ARRANGEMENT OF LEVERAGED BUYING DISCOUNTS THROUGH THE SUPPLY CHAIN; PREPARING PERSONALIZED BUSINESS REPORTS IN THE FIELD OF TRANSPORTATION AND FREIGHT SERVICES; OPERATIONAL ANALYSES AND IMPROVEMENT INITIATIVES IN THE FIELD OF TRANSPORTATION AND FREIGHT SERVICES; ARRANGING PAYROLL PREPARATION FOR OTHERS IN THE FIELD OF TRANSPORTATION AND FREIGHT SERVICES; ADVERTISING HEALTH AND LIFE INSURANCE AS WELL AS TRACKING AND MONITORING INSURANCE COMPLIANCE FOR HEALTH AND LIFE INSURANCE; ACCOUNTS RECEIVABLE SERVICES IN THE FIELD OF TRANSPORTATION AND FREIGHT SERVICES; PROVIDING SUPPLIER PARTNERS IN THE FIELD OF TRANSPORTATION AND FREIGHT SERVICES; DRIVER RECRUITMENT SERVICES IN THE FIELD OF TRANSPORTATION AND FREIGHT SERVICES (U.S. CLS. 100, 101 AND 102).

FIRST USE 3-15-2004; IN COMMERCE 3-15-2004.

CLASS 41—EDUCATION AND ENTERTAINMENT

FOR EDUCATIONAL AND TRAINING SERVICES, NAMELY OFFERING CLASSES AND WORKSHOPS IN THE FIELD OF TRANSPORTATION AND FREIGHT SERVICES (U.S. CLS. 100, 101 AND 107).

FIRST USE 3-15-2004; IN COMMERCE 3-15-2004.
CIMMERIAN COLEMAN, EXAMINING ATTORNEY

SN 78-368,050. POCLAIN HYDRAULICS, VERBERIE, FRANCE, FILED 2-13-2004.



OWNER OF FRANCE REG. NO. 003237121, DATED 6-12-2003, EXPIRES 6-12-2013.

THE COLOR(S) BLUE IS/ARE CLAIMED AS A FEATURE OF THE MARK.

THE MARK CONSISTS OF THE LETTERS PH, AND THE TERMS POCLAIN HYDRAULICS APPEARING HORIZONTALLY THROUGH THE MIDDLE OF THE LETTERS PH, THE LETTERS AND TERMS ALL APPEARING IN BLUE.

CLASS 7—MACHINERY

FOR HYDRAULIC AND HYDROSTATIC SYSTEMS, EQUIPMENT AND COMPONENTS FOR MACHINES, NAMELY, HYDROSTATIC MOTORS, HYDRAULIC TURBINES, HYDRAULIC JACKS, HYDRAULIC PUMPS, REGULATION, CONTROL, SAFETY AND BRAKING VALVES FOR HYDRAULIC SYSTEMS; HYDROSTATIC TRANSMISSION SYSTEMS FOR MACHINES (U.S. CLS. 13, 19, 21, 23, 31, 34 AND 35).

CLASS 9—ELECTRICAL AND SCIENTIFIC APPARATUS

FOR ELECTRONIC APPARATUS, NAMELY, COMPUTERS AND ELECTRONIC CONTROL UNITS FOR CONTROLLING HYDRAULIC AND HYDROSTATIC TRANSMISSION SYSTEMS; EMBEDDED MANAGEMENT SOFTWARE PROGRAMS FOR HYDRAULIC AND HYDROSTATIC TRANSMISSION SYSTEMS; SOFTWARE PROGRAMS FOR SETTING PARAMETERS OF EMBEDDED MANAGEMENT SOFTWARE PROGRAMS FOR HYDRAULIC AND HYDROSTATIC TRANSMISSION SYSTEMS (U.S. CLS. 21, 23, 26, 36 AND 38).

CLASS 12—VEHICLES

FOR HYDROSTATIC TRANSMISSIONS FOR LAND VEHICLES; HYDRAULIC CONTROLS FOR HYDROSTATIC TRANSMISSIONS FOR LAND VEHICLES; HYDRAULIC COMPONENTS FOR LAND VEHICLES, NAMELY, HYDRAULIC MOTORS, HYDRAULIC PUMPS, HYDRAULIC VALVES, HYDRAULIC JACKS; HYDRAULIC CIRCUITS FOR LAND VEHICLES; HYDRAULIC POWER STEERING GEAR FOR VEHICLES LAND VEHICLES (U.S. CLS. 19, 21, 23, 31, 35 AND 44).

CLASS 37—CONSTRUCTION AND REPAIR

FOR INSTALLATION, MAINTENANCE AND REPAIR OF HYDRAULIC MACHINES; REPAIRING AND MAINTAINING HYDROSTATIC TRANSMISSIONS OF VEHICLES AND HYDRAULIC COMPONENTS, NAMELY, HYDRAULIC MOTORS, HYDRAULIC PUMPS, HYDRAULIC TURBINES, HYDRAULIC JACKS, HYDRAULIC CONTROLS FOR MACHINES AND MOTORS AND HYDRAULIC SYSTEMS AND HYDRAULIC EQUIPMENT; INSTALLATION, MAINTENANCE AND REPAIR OF ELECTRONIC APPARATUS FOR CONTROLLING VEHICLE HYDRAULIC AND HYDROSTATIC TRANSMISSION SYSTEMS (U.S. CLS. 100, 103 AND 106).

CLASS 42—SCIENTIFIC, COMPUTER AND LEGAL SERVICES

FOR MATERIAL TESTING; TECHNICAL DRAFTING; ENGINEERING SERVICES IN THE FIELD OF HYDRAULIC AND HYDROSTATIC SYSTEMS AND COMPONENTS; CONDUCTING TECHNICAL PROJECT FEASIBILITY STUDIES; DESIGNING AND MAINTAINING SOFTWARE PROGRAMS IN THE FIELD OF HYDRAULIC COMPONENTS, HYDRAULIC AND HYDROSTATIC TRANSMISSION SYSTEMS; TECHNICAL CONSULTING AND TECHNICAL DESIGNING OF HYDRAULIC COMPONENTS AND OF HYDRAULIC AND HYDROSTATIC TRANSMISSION SYSTEMS (U.S. CLS. 100 AND 101).

DAVID ELTON, EXAMINING ATTORNEY

SN 78-368,482. MEDABOLIX FITNESS AND WEIGHTLOSS, LLC, CHARLESTON, WV. AND MEDABOLIX INC., CHARLESTON, WV. FILED 2-16-2004.



THE COLOR(S) VIOLET-BLUE AND PEA GREEN IS/ARE CLAIMED AS A FEATURE OF THE MARK.

THE COLOR VIOLET-BLUE APPEARS IN THE WORDING AND THE UPPER PORTION OF THE DESIGN ELEMENT, AND THE COLOR PEA GREEN APPEARS IN THE DOT OVER THE LETTER "I" AND THE LOWER PORTION OF THE DESIGN ELEMENT.

CLASS 41—EDUCATION AND ENTERTAINMENT

FOR FITNESS PLANNING AND SUPERVISION, NAMELY, PROVIDING FITNESS EXERCISE FACILITIES AND FITNESS CONSULTATION AND INSTRUCTION (U.S. CLS. 100, 101 AND 107).

FIRST USE 1-31-2004; IN COMMERCE 1-31-2004.

CLASS 44—MEDICAL, BEAUTY AND AGRICULTURAL SERVICES

FOR WEIGHT LOSS PLANNING AND SUPERVISION AND HEALTH INFORMATION (U.S. CLS. 100 AND 101).

FIRST USE 1-1-2004; IN COMMERCE 1-1-2004.
GISELLE AGOSTO, EXAMINING ATTORNEY

SN 78-368,869. WHITLAM LABEL COMPANY, CENTER LINE, MI. FILED 2-17-2004.

SN 78-369,760. LES INDUSTRIES TROVAC LIMITÉE, BLAINVILLE, QUÉBEC, CANADA, FILED 2-18-2004.

M VAC



THE MARK CONSISTS OF STANDARD CHARACTERS WITHOUT CLAIM TO ANY PARTICULAR FONT, STYLE, SIZE, OR COLOR.

PRIORITY CLAIMED UNDER SEC. 44(D) ON CANADA APPLICATION NO. 1197680, FILED 11-27-2003, REG. NO. TMA628917, DATED 12-22-2004, EXPIRES 12-22-2019.

NO CLAIM IS MADE TO THE EXCLUSIVE RIGHT TO USE "VAC", APART FROM THE MARK AS SHOWN.

CLASS 9—ELECTRICAL AND SCIENTIFIC APPARATUS

FOR RADIO-FREQUENCY IDENTIFICATION (RFID) LABELS FOR USE IN TRACKING MERCHANDISE (U.S. CLS. 21, 23, 26, 36 AND 38).

CLASS 16—PAPER GOODS AND PRINTED MATTER

FOR PAPER LABELS, NAMELY, BLANK OR PARTIALLY PRINTED PAPER LABELS, PRINTED PAPER LABELS, LAMINATED PAPER LABELS, PRESSURE-SENSITIVE LABELS, HEAT TRANSFER LABELS, REFLECTIVE LABELS, IN-MOLD LABELS, PRINTED BAR CODE LABELS FOR INFORMATION RETRIEVAL AND FOR IDENTIFYING, TRACKING, RECORDING AND MONITORING OBJECTS TO WHICH THEY ARE APPLIED; BAR CODE RIBBONS, THERMAL TRANSFER INK RIBBONS, LABEL PRINTING MACHINE RIBBONS, DECALS, IRON-ON AND PLASTIC TRANSFERS, BUMPER STICKERS, ADDRESS PLATES, ADHESIVE LABEL DISPENSERS FOR HOUSEHOLD OR STATIONERY USE, ADHESIVE LABEL APPLICATORS FOR HOUSEHOLD OR STATIONERY USE, PAPER STATIONERY INSERTS, PAPER TAGS, PAPER HANG TAGS (U.S. CLS. 2, 5, 22, 23, 29, 37, 38 AND 50).

FIRST USE 0-0-1972; IN COMMERCE 0-0-1972.

CLASS 20—FURNITURE AND ARTICLES NOT OTHERWISE CLASSIFIED

FOR PLASTIC LABELS, NAMELY, PRESSURE-SENSITIVE LABELS, DECORATIVE LABELS, LAMINATED LABELS, REFLECTIVE LABELS, IN-MOLD LABELS, HEAT TRANSFER LABELS (U.S. CLS. 2, 13, 22, 25, 32 AND 50).

NICHOLAS ALTREE, EXAMINING ATTORNEY

CLASS 7—MACHINERY

FOR CENTRAL CLEANING SYSTEMS, COMPRISED OF A CENTRAL VACUUM UNIT AND CONNECT CONDUITS AND CLEANING NOZZLES AND PARTS THEREFOR; CENTRAL CLEANING SYSTEM ATTACHMENTS, NAMELY, HANDLES, HOSES, WANDS, BRUSHES, POWERHEADS (U.S. CLS. 13, 19, 21, 23, 31, 34 AND 35).

CLASS 37—CONSTRUCTION AND REPAIR

FOR SERVICES OF INSTALLATION, MAINTENANCE AND REPAIR OF CENTRAL CLEANING AND VACUUM SYSTEMS (U.S. CLS. 100, 103 AND 106).

SCOTT BALDWIN, EXAMINING ATTORNEY

SN 78-370,617. EPRODUCTION SOLUTIONS, INC., KINGWOOD, TX. FILED 2-19-2004.

EPRODUCTION SOLUTIONS

THE MARK CONSISTS OF STANDARD CHARACTERS WITHOUT CLAIM TO ANY PARTICULAR FONT, STYLE, SIZE, OR COLOR.

CLASS 9—ELECTRICAL AND SCIENTIFIC APPARATUS

FOR PRODUCTION OPTIMIZATION SOLUTIONS CONSISTING OF WELL-SITE COMPUTER HARDWARE, NAMELY, CONTROLLERS, METERS, DRIVES, DOWNHOLE SENSORS, GAUGES, MOTHERBOARD AND APPLICATION CONFIGURATIONS, WIRELESS EQUIPMENT, NAMELY RADIO, CELLULAR, AND SATELLITE COMMUNICATION SYSTEMS AND WELL-HEAD AND SUBSEA CONTROL SYSTEMS COMPRISING OF POWER UNITS, CONTROL PANELS, REELERS, HOSES, AND SHEAVES; DESKTOP ANALYSIS SOFTWARE, NAMELY HARDWARE CONFIGURATION AND PRODUCT OPTIMIZATION SOFTWARE FOR ANALYZING MEASUREMENT DATA AND FACTORS IN PRODUCTION OPTIMIZATION, INTELLIGENT FIBER OPTICS USED TO REMOTELY MONITOR THE CONDITIONS OF DOWNHOLE OIL AND GAS WELLS; AND COMMUNICATION SYSTEMS COMPRISING RADIOS, CELLULAR TELEPHONES AND SATELLITE RECEIVERS FOR ONSHORE AND OFFSHORE OIL AND GAS WELL PRODUCTION OPERATIONS (U.S. CLS. 21, 23, 26, 36 AND 38).

FIRST USE 4-1-2001; IN COMMERCE 4-1-2001.

CLASS 35—ADVERTISING AND BUSINESS

FOR PROVIDING PERSONNEL FOR THE CONSULTATION AND DESIGN OF COMPUTER HARDWARE, DESKTOP ANALYSIS SOFTWARE AND COMMUNICATION SYSTEMS FOR OTHERS TO INCREASE PRODUCTION AND/OR LOWER OPERATIONAL COSTS FOR USE IN ONSHORE AND OFFSHORE OIL AND GAS PRODUCTION FIELDS AND PIPELINE MONITORING OPERATIONS (U.S. CLS. 100, 101 AND 102).

FIRST USE 4-1-2001; IN COMMERCE 4-1-2001.

CLASS 42—SCIENTIFIC, COMPUTER AND LEGAL SERVICES

FOR PRODUCTION OPTIMIZATION SERVICES, NAMELY CONSULTATION AND DESIGN OF COMPUTER HARDWARE, DESKTOP ANALYSIS SOFTWARE AND COMMUNICATION SYSTEMS FOR OTHERS TO INCREASE PRODUCTION AND/OR LOWER OPERATIONAL COSTS FOR USE IN ONSHORE AND OFFSHORE OIL AND GAS PRODUCTION FIELDS AND PIPELINE MONITORING OPERATIONS (U.S. CLS. 100 AND 101).

FIRST USE 4-1-2001; IN COMMERCE 4-1-2001.
MICHELE SWAIN, EXAMINING ATTORNEY

SN 78-370,630. HOMEGOODS, INC., FRAMINGHAM, MA.
FILED 2-19-2004.

STAR OF WONDER

THE MARK CONSISTS OF STANDARD CHARACTERS WITHOUT CLAIM TO ANY PARTICULAR FONT, STYLE, SIZE, OR COLOR.

CLASS 4—LUBRICANTS AND FUELS

FOR NOVELTY CHRISTMAS CANDLES (U.S. CLS. 1, 6 AND 15).

FIRST USE 8-1-2003; IN COMMERCE 8-1-2003.

CLASS 16—PAPER GOODS AND PRINTED MATTER

FOR GIFT WRAPPING PAPER AND CARDBOARD PHOTO STORAGE BOXES (U.S. CLS. 2, 5, 22, 23, 29, 37, 38 AND 50).

FIRST USE 8-1-2003; IN COMMERCE 8-1-2003.

CLASS 20—FURNITURE AND ARTICLES NOT OTHERWISE CLASSIFIED

FOR PICTURE FRAMES (U.S. CLS. 2, 13, 22, 25, 32 AND 50).

FIRST USE 8-1-2003; IN COMMERCE 8-1-2003.

CLASS 24—FABRICS

FOR TABLE LINENS, NAMELY, DECORATIVE TABLECLOTHS, TABLE RUNNERS, PLACE MATS, AND NAPKINS, NOT MADE OF PAPER; TABLE LINENS, NAMELY, MANTLE SCARVES (U.S. CLS. 42 AND 50).

FIRST USE 8-1-2003; IN COMMERCE 8-1-2003.

CLASS 28—TOYS AND SPORTING GOODS

FOR CHRISTMAS TREE ORNAMENTS, EXCEPT CONFECTIONERY OR ILLUMINATION ARTICLES; CHRISTMAS STOCKINGS; CHRISTMAS TREE SKIRTS; HOBBY CRAFT KITS FOR MAKING CUT-OUT WOOD SIGNS AND METAL OR WOOD DECORATIVE ACCESSORIES FOR THE HOME (U.S. CLS. 22, 23, 38 AND 50).

FIRST USE 8-1-2003; IN COMMERCE 8-1-2003.

MICHELE SWAIN, EXAMINING ATTORNEY

SN 78-370,977. LABELLARTE, MICHAEL, CHICAGO, IL.
FILED 2-19-2004.

Outsider

THE MARK CONSISTS OF STANDARD CHARACTERS WITHOUT CLAIM TO ANY PARTICULAR FONT, STYLE, SIZE, OR COLOR.

CLASS 35—ADVERTISING AND BUSINESS

FOR PREPARING AUDIO-VISUAL PRESENTATIONS OF CREATIVE IMAGES, SOUND AND TEXT, AND ANY COMBINATION THEREOF, IN ELECTRONIC, PHOTOGRAPHIC, PRINT-BASED, FILM-BASED AND ARTISTIC MEDIUMS, BASED IN PRINCIPLES OF FLEXIBLE AND CREATIVE WORK SPACE ORGANIZATION, FOR USE IN ADVERTISING, SOLICITATION AND PERSUASIVE COMMUNICATION (U.S. CLS. 100, 101 AND 102).

FIRST USE 10-18-2000; IN COMMERCE 10-19-2000.

CLASS 41—EDUCATION AND ENTERTAINMENT

FOR EDITING SERVICES, NAMELY, WRITTEN TEXT EDITING, VIDEO EDITING, FILM EDITING, AND AUDIO EDITING, OF CREATIVE IMAGES, SOUND AND TEXT, AND ANY COMBINATION THEREOF, IN ELECTRONIC, PHOTOGRAPHIC, PRINT-BASED, FILM-BASED AND ARTISTIC MEDIUMS, BASED IN PRINCIPLES OF FLEXIBLE AND CREATIVE WORK SPACE ORGANIZATION, FOR USE IN ADVERTISING AND PERSUASIVE COMMUNICATION; POST-PRODUCTION SERVICES, NAMELY, VIDEOTAPE PRODUCTION, MULTIMEDIA ENTERTAINMENT SOFTWARE PRODUCTION AND SOFTWARE PRODUCTION SERVICES, OF CREATIVE IMAGES, SOUND AND TEXT, AND ANY COMBINATION THEREOF, IN ELECTRONIC, PHOTOGRAPHIC, PRINT-BASED, FILM-BASED AND ARTISTIC MEDIUMS, BASED IN PRINCIPLES OF FLEXIBLE AND CREATIVE WORK SPACE ORGANIZATION, FOR USE IN ADVERTISING, SOLICITATION AND PERSUASIVE COMMUNICATION (U.S. CLS. 100, 101 AND 107).
FIRST USE 10-18-2000; IN COMMERCE 10-18-2000.

CLASS 42—SCIENTIFIC, COMPUTER AND LEGAL SERVICES

FOR GRAPHIC ART DESIGN OF CREATIVE IMAGES, SOUND AND TEXT, AND ANY COMBINATION THEREOF, IN ELECTRONIC, PHOTOGRAPHIC, PRINT-BASED, FILM-BASED AND ARTISTIC MEDIUMS, BASED ON PRINCIPLES OF FLEXIBLE AND CREATIVE WORK SPACE ORGANIZATION, FOR USE IN ADVERTISING AND PERSUASIVE COMMUNICATION; CONSULTING SERVICES IN THE FIELD OF ALL ASPECTS OF HARDWARE AND SOFTWARE IMPLEMENTATION FOR OTHERS IN THE AREAS OF ADVERTISING, SOLICITATION AND PERSUASIVE COMMUNICATION (U.S. CLS. 100 AND 101).
FIRST USE 10-18-2000; IN COMMERCE 10-18-2000.
KATHY DE JONGE, EXAMINING ATTORNEY

SN 78-371,299. RISOEN, MARCELLA BOSSE, LOS GATOS, CA. FILED 2-20-2004.

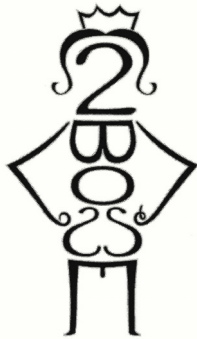
**CLASS 16—PAPER GOODS AND PRINTED MATTER**

FOR STATIONARY, AND NOTEPADS (U.S. CLS. 2, 5, 22, 23, 29, 37, 38 AND 50).
FIRST USE 4-22-1979; IN COMMERCE 4-22-2002.

CLASS 25—CLOTHING

FOR SHIRTS, UNDERWEAR, PANTS (U.S. CLS. 22 AND 39).
FIRST USE 2-12-2004; IN COMMERCE 2-12-2004.
GIANCARLO CASTRO, EXAMINING ATTORNEY

SN 78-372,083. NATURAL LANDS TRUST, INC., MEDIA, PA. FILED 2-23-2004.

SMARTCONSERVATION

THE MARK CONSISTS OF STANDARD CHARACTERS WITHOUT CLAIM TO ANY PARTICULAR FONT, STYLE, SIZE, OR COLOR.
SEC. 2(F).

CLASS 9—ELECTRICAL AND SCIENTIFIC APPARATUS

FOR COMPUTER SOFTWARE FOR ASSESSING AND COMPARING PRIORITIES FOR LAND CONSERVANCIES WHERE MAPS MAY BE AVAILABLE FOR DOWNLOAD FROM THE GLOBAL COMPUTER NETWORK (U.S. CLS. 21, 23, 26, 36 AND 38).
FIRST USE 3-0-2000; IN COMMERCE 3-0-2000.

CLASS 42—SCIENTIFIC, COMPUTER AND LEGAL SERVICES

FOR PROVIDING INFORMATION IN THE FIELD OF LAND CONSERVATION VIA A GLOBAL COMPUTER NETWORK; ECOLOGICAL SURVEYS, NAMELY, COMPLETING SURVEYS AND ASSESSMENTS OF POTENTIAL LAND CONSERVATION AREAS FOR OTHERS; TECHNOLOGY CONSULTATION IN THE FIELD OF ECOLOGY, NAMELY ASSESSING AND PRIORITIZING POTENTIAL AREAS FOR LAND CONSERVATION (U.S. CLS. 100 AND 101).
FIRST USE 3-0-2000; IN COMMERCE 3-0-2000.
GEORGIA CARTY, EXAMINING ATTORNEY

SN 78-373,708. BEAUFORT SOLUTIONS INC., ST. JOHN'S, NEW FOUNDLAND, CANADA, FILED 2-25-2004.



PRIORITY CLAIMED UNDER SEC. 44(D) ON CANADA APPLICATION NO. 1189060, FILED 8-29-2003, REG. NO. TMA633485, DATED 2-22-2005, EXPIRES 2-22-2020.

NO CLAIM IS MADE TO THE EXCLUSIVE RIGHT TO USE SOLUTIONS, APART FROM THE MARK AS SHOWN. THE MARK CONSISTS OF THE NAME BEAUFORT SOLUTIONS AND A DUAL SHADED CURVE DESIGN.

CLASS 9—ELECTRICAL AND SCIENTIFIC APPARATUS

FOR COMPUTER SOFTWARE FOR EDITING, MANIPULATION, PRINTING, STORAGE, AND TRANSMISSION OF DIGITAL IMAGES; SOFTWARE FOR THE REMOTE MONITORING OF DIGITAL IMAGE SYSTEMS; COMPUTER SOFTWARE FOR EDITING, MANIPULATION, PRINTING, STORAGE, AND TRANSMISSION OF DIGITAL IMAGES; SOFTWARE FOR THE REMOTE MONITORING OF DIGITAL IMAGE SYSTEMS (U.S. CLS. 21, 23, 26, 36 AND 38).

CLASS 42—SCIENTIFIC, COMPUTER AND LEGAL SERVICES

FOR CUSTOMIZATION, IMPLEMENTATION AND MAINTENANCE OF SOFTWARE FOR EDITING, MANIPULATION, PRINTING, STORAGE AND TRANSMISSION OF DIGITAL IMAGES; CONSULTING SERVICES IN THE FIELD OF SOFTWARE FOR EDITING, MANIPULATION, PRINTING, STORAGE AND TRANSMISSION OF DIGITAL IMAGES; WEB SITE DESIGN DEVELOPMENT AND HOSTING FOR OTHERS; TECHNICAL SUPPORT SERVICES, NAMELY TROUBLESHOOTING OF COMPUTER HARDWARE AND SOFTWARE PROBLEMS; POINT OF SALE INTEGRATION OF COMPUTER SYSTEMS AND NETWORKS; REMOTE MONITORING OF DIGITAL IMAGE SYSTEMS (U.S. CLS. 100 AND 101).

BRIAN NEVILLE, EXAMINING ATTORNEY

SN 78-374,712. MITSUI CHEMICALS, INC., AKA MITSUI KAGAKU KABUSHIKI KAISHA, MINATO-KU, TOKYO, JAPAN, FILED 2-26-2004.

FILFINE

THE MARK CONSISTS OF STANDARD CHARACTERS WITHOUT CLAIM TO ANY PARTICULAR FONT, STYLE, SIZE, OR COLOR.

PRIORITY CLAIMED UNDER SEC. 44(D) ON JAPAN APPLICATION NO. 2004-17,047, FILED 2-25-2004, REG. NO. 4809696, DATED 10-15-2004, EXPIRES 10-15-2014.

SN 78-374,431. DONALDSON COMPANY, INC., MINNEAPOLIS, MN. FILED 2-26-2004.

POWERCORE

CLASS 9—ELECTRICAL AND SCIENTIFIC APPARATUS

FOR OPTICAL FILTERS FOR PLASMA DISPLAY PANEL, LIQUID CRYSTAL DISPLAY PANEL, AND LIGHT EMITTING DIODE DISPLAY PANEL (U.S. CLS. 21, 23, 26, 36 AND 38).

CLASS 17—RUBBER GOODS

FOR PLASTIC FILMS FOR USE IN FURTHER MANUFACTURE OF ELECTRICAL AND ELECTRONIC PRODUCTS, PLASTIC IN SHEET FORM FOR GENERAL MANUFACTURING USE (U.S. CLS. 1, 5, 12, 13, 35 AND 50).

CURTIS FRENCH, EXAMINING ATTORNEY

SN 78-374,794. ARES TRADING S.A., CH-1170 AUBONNE, SWITZERLAND, FILED 2-26-2004.

THE MARK CONSISTS OF STANDARD CHARACTERS WITHOUT CLAIM TO ANY PARTICULAR FONT, STYLE, SIZE, OR COLOR.

OWNER OF U.S. REG. NO. 2,442,899.

**CLASS 7—MACHINERY**

FOR AIR INTAKE SYSTEMS, NAMELY, AIR CLEANERS AND FILTERS FOR CLEANING AIR FOR ENGINES; VEHICULAR AIR FILTER PRODUCTS, NAMELY FILTERS AND FILTER HOUSINGS; AIR INTAKE FILTERS FOR STATIONARY GAS TURBINES (U.S. CLS. 13, 19, 21, 23, 31, 34 AND 35).

FIRST USE 7-5-2000; IN COMMERCE 7-5-2000.

PRIORITY CLAIMED UNDER SEC. 44(D) ON SWITZERLAND APPLICATION NO. 005912004, FILED 2-17-2004, REG. NO. 520640, DATED 4-20-2004, EXPIRES 2-17-2014.

OWNER OF U.S. REG. NOS. 1,666,397, 2,059,423 AND OTHERS.

NO CLAIM IS MADE TO THE EXCLUSIVE RIGHT TO USE "REPRODUCTIVE HEALTH", APART FROM THE MARK AS SHOWN.

THE STIPLING IN THE DRAWING IS FOR SHADING PURPOSES ONLY AND IS NOT CLAIMED AS A FEATURE OF THE MARK.

CLASS 11—ENVIRONMENTAL CONTROL APPARATUS

FOR AIR FILTERS FOR USE IN COMMERCIAL AND INDUSTRIAL FILTER UNITS; AIR FILTERS FOR INDUSTRIAL INSTALLATIONS, NAMELY, FILTERS AND REPLACEMENT FILTERS FOR DUST COLLECTORS (U.S. CLS. 13, 21, 23, 31 AND 34).

FIRST USE 7-5-2000; IN COMMERCE 7-5-2000.

ANGELA M. MICHELI, EXAMINING ATTORNEY

CLASS 5—PHARMACEUTICALS

FOR PHARMACEUTICAL PREPARATIONS FOR USE IN THE TREATMENT OF INFERTILITY; DRUGS IN THE FIELD OF REPRODUCTIVE HEALTH (U.S. CLS. 6, 18, 44, 46, 51 AND 52).

CLASS 44—MEDICAL, BEAUTY AND AGRICULTURAL SERVICES

FOR MEDICAL SERVICES, PROVIDING MEDICAL INFORMATION SERVICES, NAMELY, PROVIDING INFORMATION RELATED TO THE TREATMENT OF INFERTILITY (U.S. CLS. 100 AND 101).

SEAN DWYER, EXAMINING ATTORNEY

CLASS 42—SCIENTIFIC, COMPUTER AND LEGAL SERVICES

FOR DESIGN/PROGRAMMING/MAINTENANCE OF COMPUTER PROGRAMS FOR CLASSIFYING INFORMATION FROM SCENES OF BROADCAST TELEVISION PROGRAMS; DESIGN/PROGRAMMING/MAINTENANCE OF COMPUTER PROGRAMS FOR PROVIDING NOTICE OF INFORMATION FROM SCENES OF BROADCAST TELEVISION PROGRAMS; DESIGN/PROGRAMMING/MAINTENANCE OF COMPUTER PROGRAMS FOR TRANSMITTING INFORMATION FROM SCENES OF BROADCAST TELEVISION PROGRAMS; DESIGN/PROGRAMMING/MAINTENANCE OF COMPUTER PROGRAMS FOR SENDING/RECEIVING MESSAGES OF SCENES OF BROADCAST TELEVISION PROGRAMS; DESIGN/PROGRAMMING/MAINTENANCE OF COMPUTER PROGRAMS FOR PLAYING AND RECORDING BROADCAST TELEVISION PROGRAMS IN ACCORDANCE WITH THE RECEIVED MESSAGES (U.S. CLS. 100 AND 101).

KAREN K. BUSH, EXAMINING ATTORNEY

SN 78-375.116. KABUSHIKI KAISHA ACCESS, TA ACCESS CO., LTD., CHIYODA-KU, TOKYO, JAPAN, FILED 2-27-2004.

SN 78-376.172. MEVACCEL, LLC, WRIGHT CITY, MO. FILED 3-1-2004.

PUSH-OnTV

MevAccel

THE MARK CONSISTS OF STANDARD CHARACTERS WITHOUT CLAIM TO ANY PARTICULAR FONT, STYLE, SIZE, OR COLOR.

THE MARK CONSISTS OF STANDARD CHARACTERS WITHOUT CLAIM TO ANY PARTICULAR FONT, STYLE, SIZE, OR COLOR.

CLASS 9—ELECTRICAL AND SCIENTIFIC APPARATUS

FOR COMPUTER PROGRAMS FOR CLASSIFYING INFORMATION FROM SCENES OF BROADCAST TELEVISION PROGRAMS; COMPUTER PROGRAMS FOR PROVIDING NOTICE OF INFORMATION FROM SCENES OF BROADCAST TELEVISION PROGRAMS; COMPUTER PROGRAMS FOR TRANSMITTING INFORMATION FROM SCENES OF BROADCAST TELEVISION PROGRAMS; COMPUTER PROGRAMS FOR SENDING/RECEIVING MESSAGES OF SCENES OF BROADCAST TELEVISION PROGRAMS; COMPUTER PROGRAMS FOR PLAYING AND RECORDING BROADCAST TELEVISION PROGRAMS IN ACCORDANCE WITH THE RECEIVED MESSAGES; PORTABLE TELEPHONES, NAMELY, CELLULAR PHONES; TELEVISIONS; VIDEO-DISC PLAYERS; DVD PLAYERS; PDA; STB; VEHICLE NAVIGATION SYSTEMS IN THE NATURE OF ON-BOARD COMPUTERS; HAND-HELD COMPUTERS (U.S. CLS. 21, 23, 26, 36 AND 38).

CLASS 35—ADVERTISING AND BUSINESS

FOR DISTRIBUTORSHIP SERVICES IN THE FIELD OF NEW AND REFURBISHED PARTS AND COMPONENTS TO MEDICAL FACILITIES WITH LINEAR ACCELERATORS USED IN RADIATION/ONCOLOGY TREATMENT (U.S. CLS. 100, 101 AND 102).

FIRST USE 3-1-2003; IN COMMERCE 3-1-2003.

CLASS 35—ADVERTISING AND BUSINESS

FOR ADVERTISING BROADCAST TELEVISION PROGRAMS OF OTHERS BY BROADCAST MEDIA OR VIA THE INTERNET; PROVISION OF INFORMATION RELATING TO ADVERTISING (U.S. CLS. 100, 101 AND 102).

CLASS 37—CONSTRUCTION AND REPAIR

FOR PROVIDE ON-SITE REPAIRS SERVICE TO MEDICAL FACILITIES WITH LINEAR ACCELERATORS USED IN RADIOLOGY/ONCOLOGY TREATMENT (U.S. CLS. 100, 103 AND 106).

FIRST USE 3-1-2003; IN COMMERCE 3-1-2003.

C. DIONNE CLYBURN, EXAMINING ATTORNEY

CLASS 38—COMMUNICATION

FOR PROVISION OF INFORMATION RELATING TO BROADCASTING OF SCENES OF TELEVISION PROGRAMS; PROVISION OF INFORMATION RELATING TO BROADCASTING OF TELEVISION PROGRAMS VIA DATA TRANSMISSIONS (U.S. CLS. 100, 101 AND 104).

SN 78-376,389. INSTACOTE, INC., ERIE, MI. FILED 3-1-2004.

SN 78-376,557. SPORTSCHANNEL NEW ENGLAND L.P., BURLINGTON, MA. FILED 3-1-2004.

INSTACOTE

THE MARK CONSISTS OF STANDARD CHARACTERS WITHOUT CLAIM TO ANY PARTICULAR FONT, STYLE, SIZE, OR COLOR.

CLASS 1—CHEMICALS

FOR COATINGS IN THE NATURE OF CHEMICALS FOR THE CONTAINMENT AND TREATMENT OF HAZARDOUS OR RADIOLOGICAL MATERIALS (U.S. CLS. 1, 5, 6, 10, 26 AND 46).

FIRST USE 10-1-1991; IN COMMERCE 10-1-1991.

CLASS 20—FURNITURE AND ARTICLES NOT OTHERWISE CLASSIFIED

FOR CUSTOM PLASTIC SHIPPING AND STORAGE CONTAINERS COMPOSED PRIMARILY OF A FILM OR SUBSTRATE BASE COATED WITH A SPRAYABLE POLYMER (U.S. CLS. 2, 13, 22, 25, 32 AND 50).

FIRST USE 10-1-1991; IN COMMERCE 10-1-1991.
MITCHELL FRONT, EXAMINING ATTORNEY

SN 78-376,404. JOHNNY CUBA ENTERPRISES, INC., MIAMI, FL. FILED 3-1-2004.



THE MARK DOES NOT PERTAIN TO OR IDENTIFY A LIVING INDIVIDUAL.

THE COLORS BLUE, ORANGE, YELLOW, GREY, AND GREEN ARE CLAIMED AS A FEATURE OF THE MARK.

THE COLOR BLUE CONSTITUTES THE BACKGROUND OF THE OVAL IN THE MARK, GREEN IS ON THE TOP OF THE PALM TREE AND ON THE ISLAND, ORANGE CONSTITUTES THE SUN, THE RECTANGULAR BACKGROUND, AND IS THE DOMINANT COLOR IN THE LETTERING WITH YELLOW OUTLINING, AND GRAY FORMS THE TREE TRUNK.

CLASS 30—STAPLE FOODS

FOR COFFEE (U.S. CL. 46).

CLASS 43—HOTEL AND RESTAURANT SERVICES

FOR RESTAURANT SERVICES (U.S. CLS. 100 AND 101).

DAVID C. REIHNER, EXAMINING ATTORNEY

TOMMY POINTS

THE MARK CONSISTS OF STANDARD CHARACTERS WITHOUT CLAIM TO ANY PARTICULAR FONT, STYLE, SIZE, OR COLOR.

THE NAME(S), PORTRAIT(S), AND/OR SIGNATURE(S) SHOWN IN THE MARK DOES NOT IDENTIFY A PARTICULAR LIVING INDIVIDUAL.

CLASS 16—PAPER GOODS AND PRINTED MATTER

FOR PAPER PRODUCTS AND STATIONERY ITEMS, NAMELY, DECALS, BUMPER STICKERS, TEMPORARY TATTOOS, PENS, PENCILS, POSTERS, HEAT TRANSFERS IRON-ONS AND WALL CALENDARS. (U.S. CLS. 2, 5, 22, 23, 29, 37, 38 AND 50).

CLASS 21—HOUSEWARES AND GLASS

FOR COLLECTOR CUPS, MUGS, PLATES (U.S. CLS. 2, 13, 23, 29, 30, 33, 40 AND 50).

CLASS 25—CLOTHING

FOR CLOTHING, NAMELY, T-SHIRTS, HATS, SWEATSHIRTS (U.S. CLS. 22 AND 39).

CLASS 26—FANCY GOODS

FOR NOVELTY PINS. (U.S. CLS. 37, 39, 40, 42 AND 50).

CLASS 41—EDUCATION AND ENTERTAINMENT

FOR ENTERTAINMENT SERVICES, NAMELY, ONGOING TELEVISION AND RADIO PROGRAMS IN THE FIELD OF SPORTS; AND CONDUCTING SPORTS CONTESTS. (U.S. CLS. 100, 101 AND 107).

MICHAEL ENGEL, EXAMINING ATTORNEY

SN 78-376,633. LONGS DRUG STORES CALIFORNIA, INC., WALNUT CREEK, CA. FILED 3-1-2004.

WALNUT GROVE MARKET

THE MARK CONSISTS OF STANDARD CHARACTERS WITHOUT CLAIM TO ANY PARTICULAR FONT, STYLE, SIZE, OR COLOR.

NO CLAIM IS MADE TO THE EXCLUSIVE RIGHT TO USE "MARKET", APART FROM THE MARK AS SHOWN.

CLASS 1—CHEMICALS

FOR ARTIFICIAL SWEETENERS (U.S. CLS. 1, 5, 6, 10, 26 AND 46).

CLASS 29—MEATS AND PROCESSED FOODS

FOR PROCESSED FOODSTUFFS, NAMELY, CANNED FRUITS AND VEGETABLES, HEAT PACKED MUSHROOMS, ORANGES, WATER CHESTNUTS, ARTICHOKE HEARTS, TOMATO PASTE, WHOLE PEELED TOMATOES, PACKAGED AND CANNED NUTS, DEHYDRATED FRUIT SNACKS, CHICKEN AND BEEF BROTH, BEEF JERKY, PROCESSED NUTS (U.S. CL. 46).

CLASS 30—STAPLE FOODS

FOR STAPLE FOODS, NAMELY, TOMATO SAUCE, GROUND COFFEE, WHOLE BEAN COFFEE, POPPED KETTLE CORN, POPPED POPCORN, NATURAL SWEETENERS, COOKIES, VINEGAR, PRETZELS (U.S. CL. 46).

CLASS 32—LIGHT BEVERAGES

FOR FRUIT JUICE; BOTTLED WATER (U.S. CLS. 45, 46 AND 48).

DAVID MURRAY, EXAMINING ATTORNEY

SN 78-377,042. DEMCO, INC., MADISON, WI. FILED 3-2-2004.

DEMCO LIBRARY INTERIORS

THE MARK CONSISTS OF STANDARD CHARACTERS WITHOUT CLAIM TO ANY PARTICULAR FONT, STYLE, SIZE, OR COLOR.

OWNER OF U.S. REG. NOS. 2,453,303, 2,721,302 AND OTHERS.

NO CLAIM IS MADE TO THE EXCLUSIVE RIGHT TO USE "LIBRARY INTERIORS", APART FROM THE MARK AS SHOWN.

CLASS 35—ADVERTISING AND BUSINESS

FOR DISTRIBUTORSHIPS IN THE FIELD OF FURNITURE; RETAIL DISTRIBUTORSHIP SERVICES FEATURING FURNITURE; AND PROCUREMENT, NAMELY, PURCHASING FURNITURE FOR OTHERS (U.S. CLS. 100, 101 AND 102).

FIRST USE 8-31-2003; IN COMMERCE 8-31-2003.

CLASS 37—CONSTRUCTION AND REPAIR

FOR INSTALLATION OF LIBRARY AND MEDIA DESIGN CENTER EQUIPMENT AND FURNISHINGS (U.S. CLS. 100, 103 AND 106).

FIRST USE 8-31-2003; IN COMMERCE 8-31-2003.

CLASS 42—SCIENTIFIC, COMPUTER AND LEGAL SERVICES

FOR INTERIOR DESIGN CONSULTATION IN THE FIELD OF LIBRARY AND MEDIA CENTER DESIGN, EQUIPMENT, AND FURNISHINGS (U.S. CLS. 100 AND 101).

FIRST USE 8-31-2003; IN COMMERCE 8-31-2003.
ALLISON HOLTZ, EXAMINING ATTORNEY

SN 78-378,288. POPULAR, INC., SAN JUAN, PUERTO RICO, FILED 3-4-2004.

Evertec Solutions

THE MARK CONSISTS OF STANDARD CHARACTERS WITHOUT CLAIM TO ANY PARTICULAR FONT, STYLE, SIZE, OR COLOR.

CLASS 35—ADVERTISING AND BUSINESS

FOR DATA MANAGEMENT AND PROCESSING SERVICES, BUSINESS MANAGEMENT SERVICES AND BUSINESS RESEARCH SERVICES (U.S. CLS. 100, 101 AND 102).

CLASS 36—INSURANCE AND FINANCIAL

FOR CHECK PROCESSING AND MONEY TRANSFER SERVICES (U.S. CLS. 100, 101 AND 102).

JERI J. FICKES, EXAMINING ATTORNEY

SN 78-378,873. AUSTIN POWDER COMPANY, CLEVELAND, OH. FILED 3-4-2004.



OWNER OF U.S. REG. NOS. 308,311 AND 2,511,886.

THE MARK CONSISTS OF TWO CONCENTRIC DIAMONDS, WITH THE WORD "AUSTIN" WITHIN THE CENTRAL DIAMOND AND THE WORDS "USED IN 1833 & EVER SINCE" IN THE SPACE BETWEEN THE TWO DIAMONDS.

CLASS 13—FIREARMS

FOR BLASTING PRODUCTS, NAMELY, BULK AND PACKAGED EXPLOSIVES, DETONATORS FOR EXPLOSIVES, DETONATING CORD, AND DETONATOR CONNECTING BLOCKS (U.S. CLS. 2 AND 9).

FIRST USE 5-1-1910; IN COMMERCE 5-1-1910.

CLASS 37—CONSTRUCTION AND REPAIR

FOR PROVIDING SITE DESIGN AND ASSESSMENT, EVALUATION, AND BLASTING MANAGEMENT SERVICES FOR EXPLOSIVE BLAST SITES (U.S. CLS. 100, 103 AND 106).

FIRST USE 0-0-1970; IN COMMERCE 0-0-1970.
ANDREA SAUNDERS, EXAMINING ATTORNEY

SN 78-379,177. TMX DARLOWS LIMITED, COLCHESTER
ESSEX, UNITED KINGDOM, FILED 3-5-2004.

DARLOWS

THE MARK CONSISTS OF STANDARD CHARACTERS WITHOUT CLAIM TO ANY PARTICULAR FONT, STYLE, SIZE, OR COLOR.

CLASS 36—INSURANCE AND FINANCIAL

FOR FINANCIAL SERVICES, NAMELY, MORTGAGE BANKING, MORTGAGE BROKERAGE, MORTGAGE LENDING AND MORTGAGE PROCUREMENT FOR OTHERS; INSURANCE SERVICES, NAMELY, INSURANCE ADMINISTRATION, INSURANCE AGENCIES, AND INSURANCE BROKERAGE; REAL ESTATE AGENCY SERVICES AND LEASING OF REAL ESTATE; FINANCIAL VALUATION OF PERSONAL PROPERTY AND REAL ESTATE (U.S. CLS. 100, 101 AND 102).

CLASS 42—SCIENTIFIC, COMPUTER AND LEGAL SERVICES

FOR LAND SURVEYING (U.S. CLS. 100 AND 101).
SHARON MEIER, EXAMINING ATTORNEY

CLASS 35—ADVERTISING AND BUSINESS

FOR PUBLIC RELATIONS SERVICES; CREATING, DEVELOPING AND IMPLEMENTING PROMOTIONAL CAMPAIGNS FOR BUSINESS AND PROMOTING THE GOODS AND SERVICES OF OTHERS THROUGH SPECIAL EVENTS IN THE NATURE OF PROMOTIONAL CONTESTS; ADVERTISING AND MARKETING SERVICES; PROMOTING THE SALE OF GOODS AND SERVICES OF OTHERS THROUGH THE DISTRIBUTION OF PRINTED MATERIAL; BUSINESS MANAGEMENT SERVICES; PUBLICITY SERVICES; MARKET RESEARCH AND MARKET ANALYSIS; RESEARCH AND INFORMATION SERVICES RELATING TO BUSINESS AND ADVERTISING; CONDUCTING MARKETING STUDIES; COMPILATION AND ANALYSIS OF BUSINESS STATISTICAL INFORMATION; BUSINESS ADMINISTRATION CONSULTANCY; AGENCIES FOR ADVERTISING SPACE; AGENCY REPRESENTATION, NAMELY, TALENT AGENCIES FOR ACTORS, MUSICIANS AND CELEBRITIES; PRODUCTION AND DISTRIBUTION OF RADIO AND TELEVISION COMMERCIALS (U.S. CLS. 100, 101 AND 102).

CLASS 41—EDUCATION AND ENTERTAINMENT

FOR ORGANIZING, PROMOTING AND CONDUCTING LIVE EVENTS OF OTHERS; ORGANIZING EXHIBITIONS FOR ENTERTAINMENT OR EDUCATIONAL PURPOSES; PRODUCTION AND DISTRIBUTION OF TELEVISION PROGRAMS, RADIO SHOWS AND MOTION PICTURE FILMS; TELEVISION PROGRAMMING SERVICES; PRESENTATION OF MUSICAL PERFORMANCES AND ENTERTAINMENT IN THE NATURE OF THEATER PRODUCTIONS (U.S. CLS. 100, 101 AND 107).

CLASS 42—SCIENTIFIC, COMPUTER AND LEGAL SERVICES

FOR COMMERCIAL ART DESIGN SERVICES; COMPUTER SERVICES, NAMELY, DESIGNING AND IMPLEMENTING WEB SITES FOR OTHERS; PRODUCT DESIGN AND DEVELOPMENT; VIDEO AND PHOTOGRAPHIC EDITING SERVICES; ART STUDIO SERVICES, NAMELY, GRAPHIC ART DESIGN; INDUSTRIAL DESIGN SERVICES; DESIGN OF PACKAGING FOR OTHERS AND PROVIDING INFORMATION AND CONSULTATION SERVICES RELATED TO THE ALL THE AFOREMENTIONED (U.S. CLS. 100 AND 101).
YSA DEJESUS, EXAMINING ATTORNEY

SN 78-379,459. FREUD COMMUNICATIONS LIMITED,
LONDON, UNITED KINGDOM, FILED 3-5-2004.

FREUD COMMUNICATIONS

THE MARK CONSISTS OF STANDARD CHARACTERS WITHOUT CLAIM TO ANY PARTICULAR FONT, STYLE, SIZE, OR COLOR.

PRIORITY CLAIMED UNDER SEC. 44(D) ON UNITED KINGDOM APPLICATION NO. 2355767, FILED 2-13-2004, REG. NO. 2355767, DATED 2-13-2004, EXPIRES 2-13-2014.

NO CLAIM IS MADE TO THE EXCLUSIVE RIGHT TO USE "COMMUNICATIONS", APART FROM THE MARK AS SHOWN.

SN 78-379,603. OCEAN RHYTHMS, LLC, OXNARD, CA,
FILED 3-5-2004.

OCEAN RHYTHMS

THE MARK CONSISTS OF STANDARD CHARACTERS WITHOUT CLAIM TO ANY PARTICULAR FONT, STYLE, SIZE, OR COLOR.

CLASS 6—METAL GOODS

FOR SURF SCULPTURE OF METAL (U.S. CLS. 2, 12, 13, 14, 23, 25 AND 50).
FIRST USE 4-1-2003; IN COMMERCE 4-1-2003.

CLASS 20—FURNITURE AND ARTICLES NOT OTHERWISE CLASSIFIED

FOR SURF SCULPTURE OF BONE, IVORY, PLASTER, PLASTIC, WAX, AND WOOD (U.S. CLS. 2, 13, 22, 25, 32 AND 50).

FIRST USE 4-1-2003; IN COMMERCE 4-1-2003.

CLASS 42—SCIENTIFIC, COMPUTER AND LEGAL SERVICES

FOR GRAPHIC ART, COMMERCIAL, INDUSTRIAL AND ARCHITECTURAL DESIGN (U.S. CLS. 100 AND 101).

FIRST USE 4-1-2003; IN COMMERCE 4-1-2003.
ANGELA M. MICHELI, EXAMINING ATTORNEY

SN 78-379,609. ANGLES BEAUTYCARE GROUP, INC., SAN DIEGO, CA. FILED 3-5-2004.

HAI ELITE

THE MARK CONSISTS OF STANDARD CHARACTERS WITHOUT CLAIM TO ANY PARTICULAR FONT, STYLE, SIZE, OR COLOR.

OWNER OF U.S. REG. NO. 2,518,282.

CLASS 9—ELECTRICAL AND SCIENTIFIC APPARATUS

FOR HAIR STYLING TOOLS, NAMELY, ELECTRIC FLAT IRONS AND ELECTRIC CURLING IRONS (U.S. CLS. 21, 23, 26, 36 AND 38).

CLASS 11—ENVIRONMENTAL CONTROL APPARATUS

FOR HAND HELD ELECTRIC HAIR DRYERS (U.S. CLS. 13, 21, 23, 31 AND 34).
JOHN GARTNER, EXAMINING ATTORNEY

SN 78-380,068. OCTEL STARREON LLC, LITTLETON, CO. FILED 3-8-2004.

LEGAL DIESEL

THE MARK CONSISTS OF STANDARD CHARACTERS WITHOUT CLAIM TO ANY PARTICULAR FONT, STYLE, SIZE, OR COLOR.

NO CLAIM IS MADE TO THE EXCLUSIVE RIGHT TO USE DIESEL, APART FROM THE MARK AS SHOWN.

CLASS 1—CHEMICALS

FOR CHEMICAL ADDITIVES FOR DIESEL FUEL SOLD IN BULK TO THE OIL INDUSTRY AND TO HEAVY DUTY TRANSPORTATION FLEETS (U.S. CLS. 1, 5, 6, 10, 26 AND 46).

CLASS 4—LUBRICANTS AND FUELS

FOR NON-CHEMICAL ADDITIVES FOR DIESEL FUEL SOLD IN BULK TO THE OIL INDUSTRY AND TO HEAVY DUTY TRANSPORTATION FLEETS (U.S. CLS. 1, 6 AND 15).

BARBARA GAYNOR, EXAMINING ATTORNEY

SN 78-380,126. UNITED IN MEMORY MEMORIAL QUILT, INC., LONG BEACH, CA. FILED 3-8-2004.

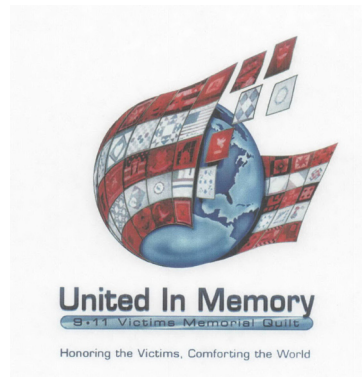

NO CLAIM IS MADE TO THE EXCLUSIVE RIGHT TO USE 9.11 VICTIMS MEMORIAL QUILT, APART FROM THE MARK AS SHOWN.

THE COLOR(S) RED, WHITE, BLUE AND GRAY IS/ARE CLAIMED AS A FEATURE OF THE MARK.

THE COLORS RED, WHITE AND GRAY APPEAR IN THE WRAP-AROUND QUILT SQUARES, AND THE COLOR BLUE APPEARS ON THE GLOBE, IN ALL OF THE WORDING IN THE MARK AND THE BACKGROUND TO THE WORDS 9.11 VICTIMS MEMORIAL QUILT.

THE MARK CONSISTS OF WORDS AND GLOBE DESIGN.

CLASS 25—CLOTHING

FOR T-SHIRTS (U.S. CLS. 22 AND 39).
FIRST USE 10-27-2001; IN COMMERCE 10-27-2001.

CLASS 36—INSURANCE AND FINANCIAL

FOR MEMORIAL FUND RAISING SERVICES (U.S. CLS. 100, 101 AND 102).
FIRST USE 10-27-2001; IN COMMERCE 10-27-2001.

CLASS 41—EDUCATION AND ENTERTAINMENT

FOR ARRANGING AND CONDUCTING EXHIBITIONS AS A MEMORIAL FOR 9-11 VICTIMS (U.S. CLS. 100, 101 AND 107).
FIRST USE 10-27-2001; IN COMMERCE 10-27-2001.
WILLIAM BRECKENFELD, EXAMINING ATTORNEY

SN 78-380,934. GOOD NEWS PUBLISHERS, WHEATON, IL.
FILED 3-9-2004.

English Standard Version

THE MARK CONSISTS OF STANDARD CHARACTERS WITHOUT CLAIM TO ANY PARTICULAR FONT, STYLE, SIZE, OR COLOR.
SEC. 2(F).

CLASS 9—ELECTRICAL AND SCIENTIFIC APPARATUS

FOR PRE-RECORDED COMPACT DISCS AND AUDIO CASSETTES OF THE BIBLE AND BOOKS FEATURING CHRISTIAN RELIGIOUS CONTENT (U.S. CLS. 21, 23, 26, 36 AND 38).
FIRST USE 11-0-2003; IN COMMERCE 11-0-2003.

CLASS 16—PAPER GOODS AND PRINTED MATTER

FOR PRINTED MATTER, NAMELY BIBLES AND BOOKS FEATURING CHRISTIAN RELIGIOUS CONTENT (U.S. CLS. 2, 5, 22, 23, 29, 37, 38 AND 50).
FIRST USE 9-0-2001; IN COMMERCE 9-0-2001.
MARIA-VICTORIA SUAREZ, EXAMINING ATTORNEY

SN 78-380,951. MOVINGSTATION LLC, CHICAGO, IL.
FILED 3-9-2004.

MOVING MADE EASY

THE MARK CONSISTS OF STANDARD CHARACTERS WITHOUT CLAIM TO ANY PARTICULAR FONT, STYLE, SIZE, OR COLOR.

CLASS 35—ADVERTISING AND BUSINESS

FOR COMPREHENSIVE RELOCATION MANAGEMENT SERVICES FOR CONSUMERS AND EMPLOYEE RELOCATION MANAGEMENT SERVICES FOR BUSINESSES, NAMELY, REAL ESTATE SALES MANAGEMENT, ARRANGING AUCTION SALES AND MANAGING MOVE IN CALENDARS, NAMELY, COORDINATING THE TIMING OF CUSTOMER AND EMPLOYEE RELOCATIONS WITH RELOCATION SERVICE PROVIDERS; ADMINISTRATION, BILLING, AND RECONCILIATION OF ACCOUNTS ON BEHALF OF OTHERS; CONSULTATION SERVICES IN THE FIELD OF RELOCATION PROVIDED BY PERSONAL RELOCATION MANAGERS (U.S. CLS. 100, 101 AND 102).
FIRST USE 7-0-2002; IN COMMERCE 7-0-2002.

CLASS 42—SCIENTIFIC, COMPUTER AND LEGAL SERVICES

FOR PROVIDING TEMPORARY USE OF ONLINE NON-DOWNLOADABLE SOFTWARE USED FOR TRACKING EXPENSES, COSTS AND FINANCING OF RELOCATIONS; REAL ESTATE CLOSING SERVICES (U.S. CLS. 100 AND 101).
FIRST USE 7-0-2002; IN COMMERCE 7-0-2002.
SUE LAWRENCE, EXAMINING ATTORNEY

SN 78-381,104. STAPLES THE OFFICE SUPERSTORE, LLC, FRAMINGHAM, MA. FILED 3-9-2004.

SIMPLY

THE MARK CONSISTS OF STANDARD CHARACTERS WITHOUT CLAIM TO ANY PARTICULAR FONT, STYLE, SIZE, OR COLOR.

CLASS 9—ELECTRICAL AND SCIENTIFIC APPARATUS

FOR COMPUTER HARDWARE, COMPUTER PRINTERS, COMPUTER PERIPHERALS, COMPUTER ACCESSORIES, NAMELY, DISK BOXES, MONITOR STANDS, KEYBOARDS, PRINTER CABLES, SPEAKERS AND MODEMS, BLANK COMPUTER DISKS, COMPUTER MICE, COMPUTER SOFTWARE FOR USE IN SPREADSHEETS, DATABASE MANAGEMENT, WORD PROCESSING; TELEPHONES, FACSIMILE MACHINES, AND DIGITAL CAMERAS (U.S. CLS. 21, 23, 26, 36 AND 38).

CLASS 20—FURNITURE AND ARTICLES NOT OTHERWISE CLASSIFIED

FOR COMPUTER FURNITURE (U.S. CLS. 2, 13, 22, 25, 32 AND 50).
MICHAEL WEBSTER, EXAMINING ATTORNEY

SN 78-381.107. STAPLES THE OFFICE SUPERSTORE LLC,
FRAMINGHAM, MA. FILED 3-9-2004.

SIMPLY

THE MARK CONSISTS OF STANDARD CHARACTERS
WITHOUT CLAIM TO ANY PARTICULAR FONT, STYLE,
SIZE, OR COLOR.

CLASS 2—PAINTS

FOR INK JET INK AND TONER FOR COMPUTER
PRINTERS (U.S. CLS. 6, 11 AND 16).

CLASS 16—PAPER GOODS AND PRINTED MATTER

FOR PAPER, PADS OF LEGAL PAPER, LOOSE LEAF
PAPER, AND WRITING PAPER, FILE FOLDERS, FILE
BOXES FOR STORAGE OF BUSINESS AND PERSONAL
RECORDS, PENS, PENCILS, PAPER CLIPS, PAPER
STAPLES, APPOINTMENT BOOKS, OFFICE DESK AC-
CESSORIES, NAMELY, DESK FILE TRAYS, PAPER
STAPLERS, PENCIL SHARPENERS, AND ADHESIVE
TAPE DISPENSERS FOR HOUSEHOLD AND STATION-
ERY USE (U.S. CLS. 2, 5, 22, 23, 29, 37, 38 AND 50).
MICHAEL WEBSTER, EXAMINING ATTORNEY

SN 78-381.570. BECKMAN COULTER, INC., FULLERTON,
CA. FILED 3-10-2004.

SCATTER PAK

THE MARK CONSISTS OF STANDARD CHARACTERS
WITHOUT CLAIM TO ANY PARTICULAR FONT, STYLE,
SIZE, OR COLOR.

NO CLAIM IS MADE TO THE EXCLUSIVE RIGHT TO
USE "PAK", APART FROM THE MARK AS SHOWN.

CLASS 1—CHEMICALS

FOR DIAGNOSTIC REAGENTS FOR SCIENTIFIC OR
RESEARCH USE (U.S. CLS. 1, 5, 6, 10, 26 AND 46).
FIRST USE 8-22-1989; IN COMMERCE 8-22-1989.

CLASS 5—PHARMACEUTICALS

FOR LABORATORY LYSING REAGENT FOR MEDI-
CAL DIAGNOSTIC OR CLINICAL USE (U.S. CLS. 6, 18,
44, 46, 51 AND 52).

FIRST USE 8-22-1989; IN COMMERCE 8-22-1989.
SCOTT BALDWIN, EXAMINING ATTORNEY

SN 78-381.754. 2008305 ONTARIO LIMITED, TORONTO,
ONTARIO, CANADA, FILED 3-10-2004.

SAM THE RECORD MAN

THE MARK CONSISTS OF STANDARD CHARACTERS
WITHOUT CLAIM TO ANY PARTICULAR FONT, STYLE,
SIZE, OR COLOR.

OWNER OF CANADA REG. NO. 167589, DATED 1-23-1970,
RENEWED AS REG. NO. 167589, DATED 1-23-2000, EXPIRES
1-23-2010.

OWNER OF U.S. REG. NOS. 1,510,719 AND 2,131,551.

CLASS 9—ELECTRICAL AND SCIENTIFIC APPARATUS

FOR SOUND REPRODUCTION EQUIPMENT AND
ACCESSORIES THEREFOR, NAMELY PHONOGRAPH
RECORDS, PRE-RECORDED AND BLANK MAGNETIC
TAPES, CARRYING CASES FOR RECORDS AND
TAPES, CLEANER FOR RECORDS AND TAPES, RE-
CORD NEEDLES, RECORD CARTRIDGES, PLASTIC
JACKETS FOR RECORDS (U.S. CLS. 21, 23, 26, 36 AND
38).

CLASS 35—ADVERTISING AND BUSINESS

FOR RETAIL STORE SERVICES FEATURING SOUND
REPRODUCTION EQUIPMENT AND ACCESSORIES
THEREFOR; TICKET AGENCY SERVICES FOR THEA-
TRICAL, CONCERT AND SPORTING EVENTS (U.S.
CLS. 100, 101 AND 102).

RON FAIRBANKS, EXAMINING ATTORNEY

SN 78-382.065. SPEETH, LAUREN MAVIS, WOODSIDE, CA.
FILED 3-10-2004.

The logo for 'elfenworks' is written in a cursive, lowercase font. To the right of the text is a stylized butterfly with its wings spread, and several small stars are scattered above and around the butterfly.

CLASS 35—ADVERTISING AND BUSINESS

FOR ADVERTISING SERVICES, NAMELY PREPAR-
ING ADVERTISEMENTS AND CUSTOM PROMOTI-
ONAL MATERIALS FOR OTHERS, NAMELY,
BANNER ADS, POSTERS, AND FLIERS; PROMOTING
THE CONCERTS AND FILMS OF OTHERS AND PUBLIC
RELATION SERVICES. (U.S. CLS. 100, 101 AND 102).

CLASS 41—EDUCATION AND ENTERTAINMENT

FOR COMMERCIAL ART DESIGN SERVICES; GRAPHIC ART DESIGN SERVICES; PRODUCTION SERVICES IN THE FIELDS OF MOTION PICTURES AND MUSIC; ARTWORK DESIGN FOR CD'S, DVD'S, WEBSITES, AND PRINTED SHEET MUSIC. (U.S. CLS. 100, 101 AND 107).

GEORGIA CARTY, EXAMINING ATTORNEY

SN 78-382,790. STEP TWO, S.A., ZARAGOZA, SPAIN, FILED 3-11-2004.



SN 78-382,577. COUNTY MATERIALS CORPORATION, MARATHON, WI. FILED 3-11-2004.

COUNTY MATERIALS CORPORATION

PRIORITY CLAIMED UNDER SEC. 44(D) ON SPAIN APPLICATION NO. 2581246, FILED 2-17-2004, REG. NO. 2581246, DATED 7-9-2004, EXPIRES 7-9-2014.

THE COLOR(S) BLUE IS/ARE CLAIMED AS A FEATURE OF THE MARK.

THE CIRCLES APPEAR IN THE COLOR BLUE; THE WORDING IS WHITE

THE MARK CONSISTS OF STYLIZED WORDING ITS-IMAGICAL, WHICH APPEARS INSIDE OF 2 OVERLAPPING CIRCLES, TOGETHER WITH A 3RD CIRCLE. THE CIRCLES APPEAR IN THE COLOR BLUE; THE WORDING IS WHITE.

CLASS 16—PAPER GOODS AND PRINTED MATTER

FOR PAPER, NAMELY ART PAPER AND WRITING PAPER; PAPER GOODS, NAMELY GIFT BAGS, GIFT WRAPPING PAPER, PARTY DECORATIONS RIBBONS; PRINTED MATTER, NAMELY STORY BOOKS, NOTE BOOKS, ATLAS, PHOTOGRAPH ALBUMS, PICTURE-CARD ALBUM, BABY BOOKS, CHILDREN'S ACTIVITY BOOKS, COLORING BOOKS, PICTURE BOOKS, SONG BOOKS; MAGAZINES IN THE FIELD OF TOYS; MOUNTED AND UNMOUNTED PHOTOGRAPHS AND PHOTOGRAPHIC PRINTS; ADHESIVE TAPES FOR STATIONERY OR HOUSEHOLD PURPOSES; ARTIST'S MATERIALS, NAMELY, PAINT, PAINTING SETS FOR CHILDREN, STENCILS, PENS, DRAWING BOARDS, DRAWING BRUSHES, DRAWING INSTRUMENTS, DRAWING PENCILS, RULERS, SQUARES AND DRAWING TRIANGLES, AQUARELLES, ARTS AND CRAFT PAINT KITS; DECALCOMANIAS; STICKERS; MODELING MATERIALS AND COMPOUNDS FOR USE BY CHILDREN; INKING PADS; SEALS IN THE FORM OF STAMPS; GREETING CARDS; CROSSWORD PUZZLES; PAPER, NAMELY ART PAPER AND WRITING PAPER; PAPER GOODS, NAMELY GIFT BAGS, GIFT WRAPPING PAPER, PARTY DECORATIONS RIBBONS; PRINTED MATTER, NAMELY STORY BOOKS, NOTE BOOKS, ATLAS, PHOTOGRAPH ALBUMS, PICTURE-CARD ALBUM, BABY BOOKS, CHILDREN'S ACTIVITY BOOKS, COLORING BOOKS, PICTURE BOOKS, SONG BOOKS; MAGAZINES IN THE FIELD OF TOYS; MOUNTED AND UNMOUNTED PHOTOGRAPHS AND PHOTOGRAPHIC PRINTS; ADHESIVE TAPES FOR STATIONERY OR HOUSEHOLD PURPOSES; ARTIST'S MATERIALS, NAMELY, PAINT, PAINTING SETS FOR CHILDREN, STENCILS, PENS, DRAWING BOARDS, DRAWING BRUSHES, DRAWING INSTRUMENTS, DRAWING PENCILS, RULERS, SQUARES AND DRAWING TRIANGLES, AQUARELLES, ARTS AND CRAFT PAINT KITS; DECALCOMANIAS; STICKERS; MODELING MATERIALS AND COMPOUNDS FOR USE BY CHILDREN; INKING PADS; SEALS IN THE FORM OF STAMPS; GREETING CARDS; CROSSWORD PUZZLES (U.S. CLS. 2, 5, 22, 23, 29, 37, 38 AND 50).

THE MARK CONSISTS OF STANDARD CHARACTERS WITHOUT CLAIM TO ANY PARTICULAR FONT, STYLE, SIZE, OR COLOR.

OWNER OF U.S. REG. NOS. 2,140,329, 2,340,647 AND OTHERS.

NO CLAIM IS MADE TO THE EXCLUSIVE RIGHT TO USE MATERIALS CORPORATION, APART FROM THE MARK AS SHOWN.

CLASS 19—NON-METALLIC BUILDING MATERIALS

FOR CONCRETE MASONRY UNITS, NAMELY DECORATIVE MASONRY BLOCKS, CONCRETE BLOCK, THERMAL BLOCK, SOUND ABSORBING BLOCK, RETAINING WALL UNITS, INTERLOCKING PAVERS; CONCRETE PIPE; HOLLOWCORE PLANKS, CONCRETE PRESTRESS GIRDERS; SPECIALTY CONCRETE PRODUCTS, NAMELY PRECAST CULVERTS, PRECAST HIGHWAY BARRIERS, PRECAST COLUMNS AND BEAMS, PRECAST CATCH BASINS, PRECAST MANHOLES (U.S. CLS. 1, 12, 33 AND 50).

FIRST USE 10-0-2003; IN COMMERCE 1-0-2004.

CLASS 35—ADVERTISING AND BUSINESS

FOR RETAIL STORE SERVICES AND WHOLESALE DISTRIBUTORSHIP SERVICES IN THE FIELD OF AGGREGATES, BRICK CONSTRUCTION PRODUCTS, LANDSCAPING PRODUCTS, READY-MIX SUPPLIES AND STEEL PRODUCTS (U.S. CLS. 100, 101 AND 102).

FIRST USE 10-0-2003; IN COMMERCE 1-0-2004.

WILLIAM VERHOSEK, EXAMINING ATTORNEY

CLASS 28—TOYS AND SPORTING GOODS

FOR GAMES AND PLAYTHINGS, NAMELY CHESS GAMES, DOMINOES, PUZZLES, CHECKERS GAMES, QUILTS, BACKGAMMON GAMES, BALLS, SWIMMING POOLS, TOY CARS, TOY WATERCRAFT, TOY AIRCRAFT, SCALE MODEL CARS, SCALE MODEL WATERCRAFT, SCALE MODEL AIRCRAFT, DOLLS, TOY MASKS, ROCKING HORSES, DOLLS ROOMS, DOLLS CLOTHES, DOLLS HOUSES, MARIONETTES, DOLLS FEEDING BOTTLES, SCALE MODEL VEHICLES, MARBLES FOR GAMES, WOODEN TRAIN SET, TOY TELEPHONE, TOY SHOP SET, TOY ROBOT, SKILL ACTIVITY TOYS FOR CHILDREN AND BABIES, BATTING GLOVES, TOY KITCHEN SET, SLIDES, SPRING BOARDS, GYMNASTICS AND SPORTING ARTICLES, NAMELY SWINGS, PARLOR GAMES, RATTLES, TABLE FOR TABLE TENNIS, BOWLING GAMES; GAMES AND PLAYTHINGS, NAMELY CHESS GAMES, DOMINOES, PUZZLES, CHECKERS GAMES, QUILTS, BACKGAMMON GAMES, BALLS, SWIMMING POOLS, TOY CARS, TOY WATERCRAFT, TOY AIRCRAFT, SCALE MODEL CARS, SCALE MODEL WATERCRAFT, SCALE MODEL AIRCRAFT, DOLLS, TOY MASKS, ROCKING HORSES, DOLLS ROOMS, DOLLS CLOTHES, DOLLS HOUSES, MARIONETTES, DOLLS FEEDING BOTTLES, SCALE MODEL VEHICLES, MARBLES FOR GAMES, WOODEN TRAIN SET, TOY TELEPHONE, TOY SHOP SET, TOY ROBOT, SKILL ACTIVITY TOYS FOR CHILDREN AND BABIES, BATTING GLOVES, TOY KITCHEN SET, SLIDES, SPRING BOARDS, GYMNASTICS AND SPORTING ARTICLES, NAMELY SWINGS, PARLOR GAMES, RATTLES, TABLE FOR TABLE TENNIS, BOWLING GAMES (U.S. CLS. 22, 23, 38 AND 50).

SN 78-383,009. AEROFLEX INCORPORATED, PLAINVIEW, NY. FILED 3-12-2004.

AEROFLEX

THE MARK CONSISTS OF STANDARD CHARACTERS WITHOUT CLAIM TO ANY PARTICULAR FONT, STYLE, SIZE, OR COLOR.
OWNER OF U.S. REG. NO. 825,714.

CLASS 35—ADVERTISING AND BUSINESS

FOR RETAIL STORE SERVICES IN THE FIELD OF GAME AND PLAYTHINGS; ELECTRONIC RETAILING SERVICES VIA COMPUTER FEATURING GAMES AND PLAYTHINGS; PREPARING AND PLACING ADVERTISEMENTS FOR OTHERS; BUSINESS MANAGEMENT PLANNING AND CONSULTATION; FRANCHISING, NAMELY, OFFERING TECHNICAL ASSISTANCE IN THE ESTABLISHMENT AND/OR OPERATION OF GAMES AND PLAYTHINGS STORES; EXPORT AND IMPORT AGENCIES; CONDUCTING BUSINESS AND MARKET RESEARCH SURVEYS; RETAIL STORE SERVICES IN THE FIELD OF GAME AND PLAYTHINGS; ELECTRONIC RETAILING SERVICES VIA COMPUTER FEATURING GAMES AND PLAYTHINGS; PREPARING AND PLACING ADVERTISEMENTS FOR OTHERS; BUSINESS MANAGEMENT PLANNING AND CONSULTATION; FRANCHISING, NAMELY, OFFERING TECHNICAL ASSISTANCE IN THE ESTABLISHMENT AND/OR OPERATION OF GAMES AND PLAYTHINGS STORES; EXPORT AND IMPORT AGENCIES; CONDUCTING BUSINESS AND MARKET RESEARCH SURVEYS (U.S. CLS. 100, 101 AND 102).

DOMINIC J. FERRAIUOLO, EXAMINING ATTORNEY

CLASS 7—MACHINERY

FOR DC TORQUE MOTORS, BRUSHLESS DC TORQUE MOTORS, AND BRUSHLESS DC MOTORS NOT USED FOR LAND VEHICLES (U.S. CLS. 13, 19, 21, 23, 31, 34 AND 35).

FIRST USE 7-1-1963; IN COMMERCE 7-1-1963.

CLASS 9—ELECTRICAL AND SCIENTIFIC APPARATUS

FOR RADIO FREQUENCY, RADAR, MICROWAVE, AND SATELLITE TEST AND MEASUREMENT EQUIPMENT, SYSTEMS, MODULES AND COMPUTER FIRMWARE ASSOCIATED THEREWITH, NAMELY, SIGNAL GENERATORS, A FULL LINE OF MANUAL AND AUTOMATIC RADIO FREQUENCY PARAMETRIC AND PROTOCOL LEVEL TEST EQUIPMENT, A FULL LINE OF AVIONIC COMMUNICATION AND AVIONIC NAVIGATION SYSTEMS TEST EQUIPMENT, AND SYNTHETIC TEST SYSTEMS COMPRISING MODIFIABLE CONFIGURATIONS OF RADIO FREQUENCY, RADAR, AND MICROWAVE TEST AND MEASUREMENT MODULES AND UNIT UNDER TESTING INTERFACES THAT ARE CONTROLLED WITH PROGRAMMABLE SOFTWARE AND INTEGRATED THROUGH A VARIETY OF HIGH-SPEED COMMUNICATIONS BUSES (U.S. CLS. 21, 23, 26, 36 AND 38).

FIRST USE 6-1-1963; IN COMMERCE 6-1-1963.
SUE LAWRENCE, EXAMINING ATTORNEY

SN 78-383,351. WINSHAPE CENTRE, INC., MOUNT BERRY, GA. FILED 3-12-2004.

SN 78-383,457. BSH HOME APPLIANCES CORPORATION, HUNTINGTON BEACH, CA. FILED 3-12-2004.

WINSHAPE

tempSensor

THE MARK CONSISTS OF STANDARD CHARACTERS WITHOUT CLAIM TO ANY PARTICULAR FONT, STYLE, SIZE, OR COLOR.

OWNER OF U.S. REG. NOS. 1,790,780, 2,245,767 AND OTHERS.

CLASS 36—INSURANCE AND FINANCIAL

FOR HOUSING AGENCY; PROVIDING EDUCATIONAL SCHOLARSHIPS (U.S. CLS. 100, 101 AND 102). FIRST USE 3-0-1984; IN COMMERCE 3-0-1984.

CLASS 39—TRANSPORTATION AND STORAGE

FOR CHARITABLE SERVICES IN THE NATURE OF ARRANGING AND CONDUCTING HORSEBACK RIDING, BIKING, ROPES COURSES, ROCK CLIMBING, AND CAMPING EXPEDITIONS FEATURING OBSTACLE COURSES AND OUTDOOR EXERCISE ACTIVITIES FOR THE PURPOSE OF TEACHING TEAM AND TRUST BUILDING (U.S. CLS. 100 AND 105).

FIRST USE 7-16-1984; IN COMMERCE 7-16-1984.

CLASS 41—EDUCATION AND ENTERTAINMENT

FOR CHARITABLE SERVICES, NAMELY, PROVIDING CLASSES, SEMINARS, WORKSHOPS, AND LECTURES IN THE FIELDS OF MARRIAGE ENRICHMENT AND MARRIAGE COUNSELING, AND EDUCATIONAL COMMUNITY OUTREACH PROGRAMS IN THE NATURE OF WORKSHOPS AND CLASSES IN THE FIELDS OF MARRIAGE ENRICHMENT AND MARRIAGE COUNSELING; PROVIDING RECREATIONAL CAMP SERVICES; EDUCATIONAL SERVICES IN THE NATURE OF CONDUCTING WORKSHOPS AND TRAINING IN THE FIELD OF TEAMBUILDING (U.S. CLS. 100, 101 AND 107).

FIRST USE 7-16-1984; IN COMMERCE 7-16-1984.

CLASS 43—HOTEL AND RESTAURANT SERVICES

FOR PROVIDING TEMPORARY HOUSING ACCOMMODATIONS (U.S. CLS. 100 AND 101).

FIRST USE 6-0-1985; IN COMMERCE 6-0-1985.

CLASS 45—PERSONAL SERVICES

FOR PROVIDING FOSTER CARE (U.S. CLS. 100 AND 101).

FIRST USE 8-0-1987; IN COMMERCE 8-0-1987. DAVID TAYLOR, EXAMINING ATTORNEY

THE MARK CONSISTS OF STANDARD CHARACTERS WITHOUT CLAIM TO ANY PARTICULAR FONT, STYLE, SIZE, OR COLOR.

CLASS 7—MACHINERY

FOR ELECTRIC MACHINES AND APPLIANCES FOR TREATING LAUNDRY AND CLOTHING, NAMELY, WASHING MACHINES (U.S. CLS. 13, 19, 21, 23, 31, 34 AND 35).

CLASS 11—ENVIRONMENTAL CONTROL APPARATUS

FOR HEATING AND COOKING DEVICES, NAMELY, RANGES; DRYERS, NAMELY LAUNDRY DRYERS, SPIN DRYERS, TUMBLE LAUNDRY DRYERS (U.S. CLS. 13, 21, 23, 31 AND 34).

RONALD AIKENS, EXAMINING ATTORNEY

SN 78-384,538. JEFF HANSON MANAGEMENT AND PROMOTIONS, INC., ORLANDO, FL. FILED 3-15-2004.

JHMP

THE MARK CONSISTS OF STANDARD CHARACTERS WITHOUT CLAIM TO ANY PARTICULAR FONT, STYLE, SIZE, OR COLOR.

CLASS 35—ADVERTISING AND BUSINESS

FOR MANAGEMENT IN THE ENTERTAINMENT INDUSTRY, NAMELY MANAGING PERFORMING ARTISTS, MANAGING TECHNICAL SUPPORT PERSONNEL FOR LIVE AND RECORDED PERFORMANCES OF RECORDING ARTISTS, AND PROMOTING MUSIC ARTISTS AND CONCERTS OF OTHERS; ANALYSIS, EVALUATION, CREATION, ESTABLISHMENT AND MAINTENANCE OF THE BRANDS OF OTHERS; AND MUSIC PUBLICITY SERVICES (U.S. CLS. 100, 101 AND 102).

FIRST USE 10-0-1997; IN COMMERCE 10-0-1997.

CLASS 41—EDUCATION AND ENTERTAINMENT

FOR PRODUCTION AND ORGANIZATION OF LIVE ENTERTAINMENT EVENTS, NAMELY CONCERTS, CONCERT TOURS, FESTIVALS AND INDUSTRY SHOWCASES IN THE MUSIC FIELD; AND THE PRODUCTION OF MOTION PICTURES, TELEVISION PROGRAMS AND SOUND RECORDINGS (U.S. CLS. 100, 101 AND 107).

FIRST USE 10-0-1997; IN COMMERCE 10-0-1997.
JERI J. FICKES, EXAMINING ATTORNEY

SN 78-385,729, SCHOLAR BALLER I.M.A.G.E., LLC, MESA, AZ. FILED 3-17-2004.



THE MARK CONSISTS OF DESIGN OF A WOMAN SITTING AT A DESK WRITING.

CLASS 25—CLOTHING

FOR APPAREL, NAMELY, SHIRTS; JACKETS; SWEATERS; SHORTS; PANTS; ATHLETIC WEAR NAMELY, RUNNING SHORTS, SWEATPANTS, ATHLETIC SOCKS, T-SHIRTS AND SWEATSHIRTS; HATS; VISORS; OUTERWEAR NAMELY, FLEECE JACKETS, FLEECE PULL-OVERS, RAIN JACKETS AND TOPS, WIND JACKETS AND PANTS; FOOTWEAR; SOCKS AND UNDERGARMENTS (U.S. CLS. 22 AND 39).

SN 78-385,094, CONSTANZA AGROINDUSTRIAL, S.A., LA VEGA, DOMINICAN REP, FILED 3-16-2004.



CLASS 41—EDUCATION AND ENTERTAINMENT

FOR EDUCATIONAL SERVICES, NAMELY, CONDUCTING CLASSES, SEMINARS, CONFERENCES AND WORKSHOPS IN THE FIELD OF ACADEMIC ACHIEVEMENT, ATHLETICS AND PHYSICAL EDUCATION (U.S. CLS. 100, 101 AND 107).

BARBARA GAYNOR, EXAMINING ATTORNEY

SN 78-386,895, MACROTECH POLYSEAL, INC., SALT LAKE CITY, UT. FILED 3-18-2004.

NO CLAIM IS MADE TO THE EXCLUSIVE RIGHT TO USE "CONSTANZA", APART FROM THE MARK AS SHOWN.

CLASS 29—MEATS AND PROCESSED FOODS

FOR TOMATO PASTE AND GARLIC PASTE (U.S. CL. 46).

FIRST USE 7-30-1985; IN COMMERCE 12-31-2000.

CLASS 30—STAPLE FOODS

FOR CONDIMENTS, NAMELY, SEASONINGS IN LIQUID FORM; SPICES IN GENERAL, ENGLISH SAUCE, SPICY SAUCE (U.S. CL. 46).

FIRST USE 7-30-1985; IN COMMERCE 12-31-2000.
DAWN HAN, EXAMINING ATTORNEY



THE MARK CONSISTS OF STANDARD CHARACTERS WITHOUT CLAIM TO ANY PARTICULAR FONT, STYLE, SIZE, OR COLOR.

CLASS 7—MACHINERY

FOR MACHINE PARTS, NAMELY, WEAR RINGS, GUIDE BEARINGS, AND PISTON RINGS (U.S. CLS. 13, 19, 21, 23, 31, 34 AND 35).

FIRST USE 1-0-1995; IN COMMERCE 1-0-1995.

CLASS 17—RUBBER GOODS

FOR POLYMERIC SEALS, NAMELY, ROD SEALS, PISTON SEALS, BUFFER SEALS, MANIFOLD SEALS, AND ROD WIPERS FOR HYDRAULIC AND PNEUMATIC APPLICATIONS (U.S. CLS. 1, 5, 12, 13, 35 AND 50).

FIRST USE 1-0-1995; IN COMMERCE 1-0-1995.
PRISCILLA MILTON, EXAMINING ATTORNEY

SN 78-387,851. KALLEH, INC., TEHRAN, IRAN, FILED 3-19-2004.



PRIORITY CLAIMED UNDER SEC. 44(D) ON FED REP GERMANY APPLICATION NO. 30405733, FILED 2-3-2004, REG. NO. 30405733, DATED 6-16-2004, EXPIRES 2-28-2014.

NO CLAIM IS MADE TO THE EXCLUSIVE RIGHT TO USE "KALLEH", APART FROM THE MARK AS SHOWN. THE COLOR(S) RED, GREEN AND WHITE IS/ARE CLAIMED AS A FEATURE OF THE MARK.

THE MARK CONSISTS OF THE WORD KALLEH IN WHITE CENTERED IN A RED OVAL WITH GREEN SHADING OUTSIDE OPPOSITE PORTIONS OF THE OVAL.

THE ENGLISH TRANSLATION OF THE WORD KALLEH IS "COW'S NIPPLES, COW'S TEATS, CATTLE RANCH, PASTRY, GRAZING, AND MEADOW".

SN 78-387,834. RAUCH INDUSTRIES, INC., GASTONIA, NC. FILED 3-19-2004.

CLASS 29—MEATS AND PROCESSED FOODS

FOR MILK AND MILK PRODUCTS, NAMELY, PASTEURIZED MILK, UHT MILK, FLAVORED MILK, MILK POWDER, BUTTER, HALF-AND-HALF, SWEET, SOUR AND WHIPPED CREAMS, WHEY PROTEIN, YOGURT; PROCESSED, HARD, SEMI-HARD, AND SOFT CHEESES; MEAT, POULTRY, FISH, AND GAME, INCLUDING PROCESSED MEAT, DRIED MEAT, SALAMI, SAUSAGES, DELICATESSEN MEAT AND MEAT EXTRACTS; FRUIT PRESERVES; FOOD PRODUCTS, NAMELY PICKLED VEGETABLES; FRUIT SAUCES, NAMELY, APPLE SAUCE AND CRANBERRY SAUCE; LEMON JUICE; AND PROCESSED OLIVES (U.S. CL. 46).

CLASS 30—STAPLE FOODS

FOR COFFEE, TEA, COCOA, SUGAR, RICE, TAPIOCA, SAGO, ARTIFICIAL COFFEE; FLOUR AND PREPARATIONS MADE FROM CEREALS, NAMELY, PROCESSED CEREALS, BREAKFAST CEREALS, CEREAL-BASED SNACK FOOD, READY TO EAT, CEREAL-DERIVED FOOD BARS; BREAD, PASTRY AND CANDY, FLAVORED ICES; HONEY, TREACLE; YEAST, BAKING POWDER; SALT; MUSTARD; VINEGAR, SAUCES; SPICES; FLAVORED, SWEETENED GELATIN DESERTS; RELISH; PICKLE RELISH; PICKLED GINGER; ICE, ICE CREAMS AND PUDDINGS (U.S. CL. 46).

CLASS 31—NATURAL AGRICULTURAL PRODUCTS

FOR AGRICULTURAL, HORTICULTURAL AND FORESTRY PRODUCTS IN THE NATURE OF UNPROCESSED SEEDS AND GRAINS FOR HUMAN CONSUMPTION, SEEDS FOR PLANTING, AND AGRICULTURAL GRAINS FOR PLANTING; LIVE ANIMALS; FRESH FRUITS AND VEGETABLES; AGRICULTURAL AND HORTICULTURAL SEEDS, NATURAL LIVING PLANTS AND FLOWERS; FOODSTUFFS FOR ANIMALS, MALT FOR BREWING AND DISTILLING (U.S. CLS. 1 AND 46).

CLASS 32—LIGHT BEVERAGES

FOR BEERS; MINERAL AND AERATED WATERS AND OTHER NON-ALCOHOLIC DRINKS, NAMELY, CARBONATED BEVERAGES; FRUIT DRINKS AND FRUIT JUICES; SYRUPS AND OTHER PREPARATIONS FOR MAKING BEVERAGES, NAMELY NON-ALCOHOLIC FRUIT EXTRACTS AND SYRUPS FOR BEVERAGES (U.S. CLS. 45, 46 AND 48).

BARNEY CHARLON, EXAMINING ATTORNEY

OK!

THE MARK CONSISTS OF STANDARD CHARACTERS WITHOUT CLAIM TO ANY PARTICULAR FONT, STYLE, SIZE, OR COLOR.

OWNER OF U.S. REG. NO. 2,212,466.

CLASS 28—TOYS AND SPORTING GOODS

FOR EGG DECORATING KITS; EASTER BASKET STUFFERS, NAMELY, TOY PLASTIC EGGS AND PLUSH TOYS (U.S. CLS. 22, 23, 38 AND 50).

CLASS 30—STAPLE FOODS

FOR EASTER BASKET STUFFERS, NAMELY CANDY (U.S. CL. 46).

GLENN CLARK, EXAMINING ATTORNEY

SN 78-388,427. ESQUEL ENTERPRISES LIMITED, WAN-CHAI, HONG KONG, FILED 3-22-2004.

SN 78-388,859. EXPRESS, LLC, COLUMBUS, OH. FILED 3-23-2004.

ANYWEAR FOR ROUND-THE-CLOCK FRESHNESS

THE MARK CONSISTS OF STANDARD CHARACTERS WITHOUT CLAIM TO ANY PARTICULAR FONT, STYLE, SIZE, OR COLOR.

OWNER OF HONG KONG REG. NO. 300151460, DATED 2-3-2004, EXPIRES 2-2-2014.

CLASS 24—FABRICS

FOR COMFORTERS, BED SHEETS, SHAMS, PILLOW SHAMS (U.S. CLS. 42 AND 50).

CLASS 25—CLOTHING

FOR TOPS, BLOUSES, SHIRTS, SPORT SHIRTS, BOXER BRIEFS, BOXER SHORTS, UNDERWEAR, PAJAMAS, SKIRTS, LOUNGEWEAR, DRESSES, ROBES, PANTS AND SHORTS (U.S. CLS. 22 AND 39).

BARBARA A. GOLD, EXAMINING ATTORNEY

SN 78-388,724. VISIONQUEST INDUSTRIES, INC., DBA VQ ORTHOCARE, IRVINE, CA. FILED 3-22-2004.



CLASS 10—MEDICAL APPARATUS

FOR MEDICAL EQUIPMENT AND SUPPLIES, NAMELY, ELECTROMEDICAL NERVE, BONE, AND MUSCLE STIMULATORS; ORTHOPEDIC BRACES; AND DURABLE MEDICAL EQUIPMENT AND SUPPLIES, NAMELY CONTINUOUS PASSIVE MOTION DEVICES, COLD/HEAT THERAPY DEVICES, TRACTION DEVICES, CRUTCHES AND EXERCISE KITS (U.S. CLS. 26, 39 AND 44).

CLASS 35—ADVERTISING AND BUSINESS

FOR DISTRIBUTORSHIP SERVICES IN THE FIELD OF MEDICAL EQUIPMENT AND DURABLE MEDICAL EQUIPMENT AND SUPPLIES (U.S. CLS. 100, 101 AND 102).

BARBARA A. LOUGHRAN, EXAMINING ATTORNEY

X2DL

THE MARK CONSISTS OF STANDARD CHARACTERS WITHOUT CLAIM TO ANY PARTICULAR FONT, STYLE, SIZE, OR COLOR.

CLASS 25—CLOTHING

FOR CLOTHING, NAMELY, BATHROBES, BEACH COVER-UPS, BELTS, BLAZERS, BLOUSES, BODY SUITS, BOOTS, BOXER SHORTS, BRAS, BUSTIERS, CAMISOLES, CAPS, COATS, DRESSES, GARTER BELTS, GIRDLES, GLOVES, GOWNS, HALTER TOPS, HATS, HEADBANDS, JACKETS, JEANS, JOGGING SUITS, KNIT SHIRTS, KNIT TOPS, LEOTARDS, LINGERIE, MITTENS, NEGLIGEEES, NIGHT GOWNS, NIGHT SHIRTS, PAJAMAS, PANTIES, PANTS, PANTYHOSE, SANDALS, SARONGS, SCARVES, SHIRTS, SHOES, SHORTS, SKIRTS, SLACKS, SLIPPERS, SLIPS, SNEAKERS, SOCKS, STOCKINGS, SUITS, SWEAT PANTS, SWEAT SHIRTS, SWEAT SHORTS, SWEAT SUITS, SWEATERS, SWIMSUITS, T-SHIRTS, TANK TOPS, TEDDIES, TIES, TIGHTS, UNDERPANTS, UNDERSHIRTS, UNDERWEAR AND VESTS SOLD ONLY IN SPECIALTY RETAIL STORES AND THROUGH SPECIALTY MAIL ORDER CATALOGS (U.S. CLS. 22 AND 39).

CLASS 35—ADVERTISING AND BUSINESS

FOR RETAIL STORE SERVICES, MAIL ORDER CATALOG SERVICES AND ON-LINE RETAIL STORE SERVICES FEATURING CLOTHING (U.S. CLS. 100, 101 AND 102).

REBECCA GILBERT, EXAMINING ATTORNEY

SN 78-388,962. ELITEAXIS, L.L.C., PHOENIX, AZ. FILED 3-23-2004.



THE MARK CONSISTS OF A STYLIZED LETTER "E".

CLASS 39—TRANSPORTATION AND STORAGE

SN 78-392,523. PETROLEOS MEXICANOS, MEXICO D.F., MEXICO, FILED 3-29-2004.

FOR TRAVEL AGENCY SERVICES, NAMELY, DEVELOPING, ARRANGING, AND MAKING RESERVATIONS FOR THE TRANSPORTATION ASPECT OF ENTERTAINMENT AND SPORTS PACKAGES FOR INDIVIDUALS AND GROUPS (U.S. CLS. 100 AND 105).
FIRST USE 8-12-2003; IN COMMERCE 8-12-2003.

CLASS 41—EDUCATION AND ENTERTAINMENT

FOR TRAVEL AGENCY SERVICES, NAMELY, DEVELOPING, ARRANGING, AND MAKING RESERVATIONS FOR THE EVENT-TICKETS ASPECT OF ENTERTAINMENT AND SPORTS PACKAGES FOR INDIVIDUALS AND GROUPS (U.S. CLS. 100, 101 AND 107).
FIRST USE 8-12-2003; IN COMMERCE 8-12-2003.

CLASS 43—HOTEL AND RESTAURANT SERVICES

FOR TRAVEL AGENCY SERVICES, NAMELY, DEVELOPING, ARRANGING, AND MAKING RESERVATIONS FOR THE TEMPORARY-LODGING ASPECT OF ENTERTAINMENT AND SPORTS PACKAGES FOR INDIVIDUALS AND GROUPS (U.S. CLS. 100 AND 101).
FIRST USE 8-12-2003; IN COMMERCE 8-12-2003.
EDWARD NELSON, EXAMINING ATTORNEY

PEMEX

THE MARK CONSISTS OF STANDARD CHARACTERS WITHOUT CLAIM TO ANY PARTICULAR FONT, STYLE, SIZE, OR COLOR.

CLASS 4—LUBRICANTS AND FUELS

FOR CRUDE OIL AND REFINED PETROLEUM PRODUCTS, NAMELY FUELS AND INDUSTRIAL OILS, GREASES, AND LUBRICANTS (U.S. CLS. 1, 6 AND 15).

SN 78-389,375. BIOMERIEUX, MARCY L'ETOILE, FRANCE, FILED 3-23-2004.

CLASS 35—ADVERTISING AND BUSINESS

FOR ADVERTISING, MANAGEMENT OF BUSINESS AFFAIRS AND COMMERCIAL FUNCTIONS OF AN INDUSTRIAL OR COMMERCIAL ENTERPRISE REGARDING SERVICES RELATED TO THE OIL INDUSTRY AND CRUDE-OIL AND REFINED PETROLEUM PRODUCTS (U.S. CLS. 100, 101 AND 102).

LIGHTSCAN**CLASS 40—MATERIAL TREATMENT**

FOR OIL REFINING (U.S. CLS. 100, 103 AND 106).
SHARI SHEFFIELD, EXAMINING ATTORNEY

THE MARK CONSISTS OF STANDARD CHARACTERS WITHOUT CLAIM TO ANY PARTICULAR FONT, STYLE, SIZE, OR COLOR.

PRIORITY CLAIMED UNDER SEC. 44(D) ON FRANCE APPLICATION NO. 033250611, FILED 10-10-2003, REG. NO. 033250611, DATED 10-10-2003, EXPIRES 10-10-2013.

SN 78-392,640. OMNICOM HOLDINGS INC., SAN FRANCISCO, CA. FILED 3-29-2004.

CLASS 9—ELECTRICAL AND SCIENTIFIC APPARATUS

FOR APPARATUS, NAMELY, NUCLEIC ACID ANALYZERS, FOR DETECTING MICROORGANISMS, BACTERIA, YEAST, NOT FOR MEDICAL USE; APPARATUS, NAMELY, NUCLEIC ACID ANALYZERS, FOR ANALYZING BIOLOGICAL SAMPLES (U.S. CLS. 21, 23, 26, 36 AND 38).

USM&P**CLASS 10—MEDICAL APPARATUS**

FOR APPARATUS, NAMELY, NUCLEIC ACID ANALYZERS, FOR MEDICAL USE FOR DETECTING MICROORGANISMS, BACTERIA, YEASTS, VIRUSES; APPARATUS, NAMELY, NUCLEIC ACID ANALYZERS, FOR MEDICAL USE FOR ANALYZING BIOLOGICAL SAMPLES (U.S. CLS. 26, 39 AND 44).
STANLEY I. OSBORNE, EXAMINING ATTORNEY

THE MARK CONSISTS OF STANDARD CHARACTERS WITHOUT CLAIM TO ANY PARTICULAR FONT, STYLE, SIZE, OR COLOR.

CLASS 35—ADVERTISING AND BUSINESS

FOR DIRECT MARKETING ADVERTISING SERVICES FOR OTHERS; PROMOTING THE SALE OF GOODS AND SERVICES OF OTHERS THROUGH THE DISTRIBUTION OF PRINTED MATERIAL AND PROMOTIONAL CONTESTS; ADVERTISING AGENCY SERVICES; PUBLIC RELATIONS SERVICES; MARKET RESEARCH; BUSINESS MARKETING CONSULTING IN THE FIELD OF BRAND DEVELOPMENT AND BRAND MANAGEMENT (U.S. CLS. 100, 101 AND 102).
FIRST USE 12-20-1990; IN COMMERCE 12-20-1990.

CLASS 41—EDUCATION AND ENTERTAINMENT

FOR SPECIAL EVENT PLANNING SERVICES (U.S. CLS. 100, 101 AND 107).
FIRST USE 12-20-2000; IN COMMERCE 12-20-2000.
DAVID ELTON, EXAMINING ATTORNEY

CLASS 41—EDUCATION AND ENTERTAINMENT

FOR EDUCATIONAL SERVICES, NAMELY, SEMINARS ON THE SUBJECT OF INVESTMENT BANKING, BUSINESS RESEARCH, ASSET MANAGEMENT SERVICES, INVESTMENT CONSULTATION, AND FINANCIAL MATTERS FOR THE FINANCIAL COMMUNITY (U.S. CLS. 100, 101 AND 107).
FIRST USE 7-12-2004; IN COMMERCE 7-12-2004.
IRENE D. WILLIAMS, EXAMINING ATTORNEY

SN 78-393,132. TRELLION TECHNOLOGIES, INC., SAN DIEGO, CA. FILED 3-30-2004.

SN 78-392,671. ADAMS HARKNESS FINANCIAL GROUP, INC., BOSTON, MA. FILED 3-29-2004.

**TAG DIGITAL MEDIA**

THE MARK CONSISTS OF STANDARD CHARACTERS WITHOUT CLAIM TO ANY PARTICULAR FONT, STYLE, SIZE, OR COLOR.

NO CLAIM IS MADE TO THE EXCLUSIVE RIGHT TO USE DIGITAL MEDIA, APART FROM THE MARK AS SHOWN.

CLASS 9—ELECTRICAL AND SCIENTIFIC APPARATUS

FOR PRERECORDED CD-AUDIO, CDS, DVDS AND DVDROMS CONTAINING PRODUCT USE AND ADVERTISING INFORMATION USED AS RETAIL MERCHANDISE INSERTS, PRODUCT MERCHANDISE ATTACHMENTS, DIRECT MAIL INSERTS, MAGAZINE AND NEWSPAPER INSERTS AND AS EVENT PROMOTIONAL ITEMS FOR USE BY OTHERS (U.S. CLS. 21, 23, 26, 36 AND 38).
FIRST USE 4-30-2003; IN COMMERCE 9-30-2003.

OWNER OF U.S. REG. NO. 2,508,856.

CLASS 16—PAPER GOODS AND PRINTED MATTER

FOR PRINTED MATERIALS, NAMELY, FINANCIAL RESEARCH REPORTS (U.S. CLS. 2, 5, 22, 23, 29, 37, 38 AND 50).
FIRST USE 7-12-2004; IN COMMERCE 7-12-2004.

CLASS 35—ADVERTISING AND BUSINESS

FOR BUSINESS RESEARCH (U.S. CLS. 100, 101 AND 102).
FIRST USE 7-12-2004; IN COMMERCE 7-12-2004.

CLASS 36—INSURANCE AND FINANCIAL

FOR FINANCIAL SERVICES IN THE NATURE OF FINANCIAL ANALYSIS AND OPINIONS, ASSET MANAGEMENT SERVICES, INVESTMENT CONSULTATION SERVICES, INVESTMENT BROKERAGE SERVICES (U.S. CLS. 100, 101 AND 102).
FIRST USE 7-12-2004; IN COMMERCE 7-12-2004.

CLASS 35—ADVERTISING AND BUSINESS

FOR BUSINESS CONSULTING SERVICES IN RELATION TO PRODUCT DISTRIBUTION AND LOGISTICS SERVICES; INTERACTIVE MULTIMEDIA CREATIVE SERVICES, NAMELY MARKETING SERVICES IN THE NATURE OF THE CREATION OF INTERACTIVE MULTIMEDIA MARKETING TOOLS FOR OTHERS; CONSUMER RESEARCH; MERCHANDISE PACKAGING FOR USE IN DIRECT MAIL ADVERTISING; PROMOTIONAL MARKETING SERVICES FEATURING A CONSUMER REWARDS SWEEPSTAKES; MARKETING AND ADVERTISING SERVICES ALL FOR OTHERS; ORDER FULFILLMENT SERVICES (U.S. CLS. 100, 101 AND 102).
FIRST USE 12-31-2002; IN COMMERCE 12-31-2002.

CLASS 39—TRANSPORTATION AND STORAGE

FOR PACKAGING ARTICLES FOR TRANSPORTATION IN THE FIELD OF DIRECT MAIL (U.S. CLS. 100 AND 105).
FIRST USE 12-31-2002; IN COMMERCE 12-31-2002.

CLASS 40—MATERIAL TREATMENT

FOR DUPLICATION OF CD-AUDIO, CDS, DVDS AND DVDROMS FOR OTHERS (U.S. CLS. 100, 103 AND 106).
FIRST USE 12-31-2002; IN COMMERCE 12-31-2002.

CLASS 42—SCIENTIFIC, COMPUTER AND LEGAL SERVICES

FOR DESIGN OF INTERACTIVE WEBSITES FOR OTHERS FOR ADVERTISING PURPOSES; GRAPHIC ART DESIGN; PACKAGING DESIGN FOR OTHERS; DATA MINING SERVICES FOR OTHERS (U.S. CLS. 100 AND 101).

FIRST USE 12-31-2002; IN COMMERCE 12-31-2002.
REBECCA GILBERT, EXAMINING ATTORNEY

SN 78-393,149. SEAVER MARKETING GROUP, INC., LA MESA, CA. FILED 3-30-2004.

CLASS 41—EDUCATION AND ENTERTAINMENT

FOR EDUCATION AND TRAINING SERVICES, NAMELY ORGANIZING WORKSHOPS IN THE FIELD OF MEASURING CORROSION RATES IN REFINERY CRUDE DISTILLATION UNITS (U.S. CLS. 100, 101 AND 107).

CLASS 42—SCIENTIFIC, COMPUTER AND LEGAL SERVICES

FOR ADVISORY AND CONSULTING SERVICES, NAMELY PREDICTING CORROSION RATES IN REFINERY CRUDE DISTILLING UNITS PROCESSING CERTAIN CRUDE OILS AND CRUDE OIL BLENDS (U.S. CLS. 100 AND 101).

STANLEY I. OSBORNE, EXAMINING ATTORNEY

ADchievement Award

SN 78-393,578. WINCUBIC.COM, INC., HONOLULU, HI. FILED 3-30-2004.

THE MARK CONSISTS OF STANDARD CHARACTERS WITHOUT CLAIM TO ANY PARTICULAR FONT, STYLE, SIZE, OR COLOR.

NO CLAIM IS MADE TO THE EXCLUSIVE RIGHT TO USE AWARD, APART FROM THE MARK AS SHOWN.

CLASS 16—PAPER GOODS AND PRINTED MATTER

FOR PRINTED AWARD CERTIFICATE FOR ADVERTISING EXCELLENCE IN SPORTS (U.S. CLS. 2, 5, 22, 23, 29, 37, 38 AND 50).

FIRST USE 9-0-2003; IN COMMERCE 1-0-2004.

CLASS 35—ADVERTISING AND BUSINESS

FOR PROMOTING THE SALE OF GOODS AND SERVICES OF OTHERS THROUGH THE DISTRIBUTION OF PRINTED MATERIAL AND PROMOTIONAL CONTESTS RELATED TO SPORTS MARKETING (U.S. CLS. 100, 101 AND 102).

FIRST USE 9-0-2003; IN COMMERCE 1-0-2004.
KIMBERLY PERRY, EXAMINING ATTORNEY

SN 78-393,440. SHELL TRADEMARK MANAGEMENT B.V., THE HAGUE, NETHERLANDS, FILED 3-30-2004.

SULTAN

THE MARK CONSISTS OF STANDARD CHARACTERS WITHOUT CLAIM TO ANY PARTICULAR FONT, STYLE, SIZE, OR COLOR.

OWNER OF BENELUX REG. NO. 0741609, DATED 10-13-2003, EXPIRES 10-13-2013.

Aloha Street

THE MARK CONSISTS OF STANDARD CHARACTERS WITHOUT CLAIM TO ANY PARTICULAR FONT, STYLE, SIZE, OR COLOR.

CLASS 16—PAPER GOODS AND PRINTED MATTER

FOR FREE MAGAZINE DESCRIBING AND PROMOTING HAWAII EVENTS, NAMELY ENTERTAINMENT AND CULTURAL ATTRACTIONS AND LOCAL DESTINATIONS OF INTEREST TO TOURISTS VISITING HAWAII FROM JAPAN AND FEATURING EDITORIALS, CULTURAL AND TRANSPORTATION INFORMATION, SHOPPING AND RESTAURANT GUIDES AND MAPS, AND ADVERTISEMENTS AND COUPONS FOR THE GOODS AND SERVICES OF OTHERS (U.S. CLS. 2, 5, 22, 23, 29, 37, 38 AND 50).

FIRST USE 0-0-1981; IN COMMERCE 10-1-1981.

CLASS 35—ADVERTISING AND BUSINESS

FOR PROMOTION OF GOODS AND SERVICES OF OTHERS BY PROVIDING ADVERTISING SPACE FOR PICTURE AND TEXT ADVERTISEMENTS IN PRINT AND ON-LINE PUBLICATIONS AND BY DISSEMINATING COUPONS REDEEMABLE BY READERS FOR ADVERTISER'S GOODS AND SERVICES; PROVIDING ASSISTANCE IN CREATING OF ADVERTISING MATERIAL IN THE NATURE OF CREATING FEATURE ARTICLES HIGHLIGHTING ADVERTISERS' PRODUCTS AND SERVICES; COOPERATIVE MARKETING IN THE NATURE OF PARTICIPATING IN ARRANGEMENTS WITH ADVERTISERS FEATURING AWARD OF PRIZES TO READERS AND ON-LINE SITE FANS WHO EARN POINTS FOR SUBMITTING COMMENTS AND REVIEWS OF ADVERTISERS' GOODS AND SERVICES (U.S. CLS. 100, 101 AND 102).

FIRST USE 0-0-1981; IN COMMERCE 0-0-1981.

CLASS 41—EDUCATION AND ENTERTAINMENT

FOR PUBLICATION OF PERIODIC JAPANESE LANGUAGE PRINT AND ELECTRONIC MAGAZINES FEATURING HAWAII ENTERTAINMENT AND CULTURAL ATTRACTIONS, INFORMATION GUIDES, SERVICES LISTINGS AND DIRECTORIES HELPFUL TO JAPANESE NATIONALS RESIDING, VACATIONING, OR PLANNING TO VACATION, IN HAWAII; NAMELY LISTINGS OF POPULAR NEIGHBOR ISLAND DESTINATIONS, INTERVIEWS, NEW BOOK RELEASES, RESTAURANT REVIEWS, PROFESSIONAL SERVICE DIRECTORIES, AND INCLUDING ADVERTISEMENTS FOR THE GOODS AND SERVICES OF OTHERS (U.S. CLS. 100, 101 AND 107).

FIRST USE 10-1-1981; IN COMMERCE 10-1-1981.
RENEE MCCRAY, EXAMINING ATTORNEY

SN 78-394,001. CIENA CORPORATION, LINTHICUM, MD.
FILED 3-31-2004.

CIENA

THE MARK CONSISTS OF STANDARD CHARACTERS WITHOUT CLAIM TO ANY PARTICULAR FONT, STYLE, SIZE, OR COLOR.

OWNER OF U.S. REG. NO. 2,070,330.

SN 78-393,813. NORMAN LOVE CONFECTIONS, INC., FORT MYERS, FL. FILED 3-31-2004.

**NORMAN LOVE
CONFECTIONS**

THE MARK CONSISTS OF STANDARD CHARACTERS WITHOUT CLAIM TO ANY PARTICULAR FONT, STYLE, SIZE, OR COLOR.

NO CLAIM IS MADE TO THE EXCLUSIVE RIGHT TO USE "CONFECTIONS", APART FROM THE MARK AS SHOWN.

THE NAME NORMAN LOVE IDENTIFIES A LIVING INDIVIDUAL WHOSE CONSENT IS OF RECORD.

CLASS 9—ELECTRICAL AND SCIENTIFIC APPARATUS

FOR TELECOMMUNICATION AND DATA NETWORKING EQUIPMENT, NETWORKING HARDWARE, NAMELY, DEVICES FOR TRANSPORTING, SWITCHING, AND AGGREGATING VOICE, DATA AND VIDEO COMMUNICATIONS ACROSS MULTIPLE NETWORK INFRASTRUCTURES AND COMMUNICATIONS PROTOCOLS, OPTICAL NETWORK PRODUCTS, NAMELY SWITCHES, ADD/DROP MULTIPLEXERS, AMPLIFIERS, OPTICAL TRANSPORTERS, OPTOELECTRONIC TRANSCEIVERS, COMMUNICATIONS HUBS, OPTICAL WAVEGUIDES AND REGENERATORS, TELECOMMUNICATIONS NETWORK HARDWARE AND SOFTWARE FOR INTERCONNECTING, MANAGING, CONTROLLING AND OPERATING CORE, ENTERPRISE, METROPOLITAN, LOCAL AND WIDE AREA NETWORKS; OPTICAL TRANSPORT HARDWARE AND COMPUTER SOFTWARE PLATFORMS FOR USE IN THE TRANSMISSION AND ROUTING OF INTERNET, VOICE, VIDEO AND DATA COMMUNICATIONS; OPTICAL NETWORK COMPUTER OPERATING SYSTEMS; OPTICAL LINK MANAGEMENT SOFTWARE APPLICATION SUITES FOR USE IN THE TRANSMISSION AND ROUTING OF INTERNET, VOICE, VIDEO AND DATA COMMUNICATIONS; AND INSTRUCTIONAL MANUALS SOLD IN CONNECTION WITH THE FOREGOING (U.S. CLS. 21, 23, 26, 36 AND 38).

FIRST USE 6-30-1996; IN COMMERCE 6-30-1996.

CLASS 30—STAPLE FOODS

FOR CANDY AND CHOCOLATES; HAND-CRAFTED CANDY AND CHOCOLATES; BAKERY DESSERTS; DESSERT MOUSSE; DESSERT PUDDINGS; PASTRIES; CAKES; BROWNIES; COOKIES; CANDY AND CHOCOLATES, NAMELY CREAMS AND NOUGATS; BOXED CANDIES AND CHOCOLATES; INDIVIDUAL DESSERT AND SPECIALTY CAKES; AND CANDY AND CHOCOLATE BARS (U.S. CL. 46).

FIRST USE 5-31-2004; IN COMMERCE 5-31-2004.

CLASS 37—CONSTRUCTION AND REPAIR

FOR INSTALLATION, MAINTENANCE AND REPAIR OF TELECOMMUNICATIONS EQUIPMENT AND NETWORK SYSTEMS (U.S. CLS. 100, 103 AND 106).

FIRST USE 1-1-1998; IN COMMERCE 1-1-1998.

CLASS 35—ADVERTISING AND BUSINESS

FOR WHOLESALE AND RETAIL STORE SERVICES FEATURING CANDY, CHOCOLATES, CAKES, BAKERY DESSERTS, BROWNIES, COOKIES, BOXED CANDIES AND CHOCOLATES, PASTRIES, AND GIFT BASKETS FILLED WITH ALL OF THE FOREGOING; AND ONLINE RETAIL STORE SERVICES FEATURING CANDY, CHOCOLATES, CAKES, BAKERY DESSERTS, BROWNIES, COOKIES, BOXED CANDIES AND CHOCOLATES, PASTRIES AND GIFT BASKETS FILLED WITH ALL OF THE FOREGOING (U.S. CLS. 100, 101 AND 102).

FIRST USE 5-31-2004; IN COMMERCE 5-31-2004.
JAMES A. RAUEN, EXAMINING ATTORNEY

CLASS 38—COMMUNICATION

FOR CONSULTING SERVICES IN THE FIELD OF TELECOMMUNICATION NETWORKS (U.S. CLS. 100, 101 AND 104).

FIRST USE 1-1-1998; IN COMMERCE 1-1-1998.

CLASS 41—EDUCATION AND ENTERTAINMENT

FOR COMPUTER TRAINING AND CONDUCTING COURSES, CLASSES, SEMINARS AND WORKSHOPS FOR USING, MAINTAINING, MONITORING, AND CONTROLLING SOFTWARE AND HARDWARE IN THE FIELD OF TELECOMMUNICATIONS SYSTEMS (U.S. CLS. 100, 101 AND 107).

FIRST USE 12-1-1996; IN COMMERCE 12-1-1996.

CLASS 42—SCIENTIFIC, COMPUTER AND LEGAL SERVICES

FOR ENGINEERING SERVICES, CONSULTING SERVICES IN THE FIELD OF DATA STORAGE, TECHNICAL AND SUPPORT SERVICES IN THE FIELD OF NETWORK ARCHITECTURE PLANNING, ANALYSIS, AND DESIGN SERVICES FOR OTHERS; TESTING OF TELECOMMUNICATION EQUIPMENT; UPDATING OF COMPUTER SOFTWARE FOR INTERCONNECTING, MANAGING, CONTROLLING AND OPERATING CORE, ENTERPRISE, METROPOLITAN, LOCAL AND WIDE AREA NETWORKS (U.S. CLS. 100 AND 101).

FIRST USE 1-1-1998; IN COMMERCE 1-1-1998.
SHAUNIA WALLACE, EXAMINING ATTORNEY

SN 78-394,435. MEDRECON, LTD., HOUSTON, TX. FILED 3-31-2004.

MEDICAL RESEARCH CONSULTANTS

THE MARK CONSISTS OF STANDARD CHARACTERS WITHOUT CLAIM TO ANY PARTICULAR FONT, STYLE, SIZE, OR COLOR.

NO CLAIM IS MADE TO THE EXCLUSIVE RIGHT TO USE "CONSULTANTS", APART FROM THE MARK AS SHOWN.
SEC. 2(F).

CLASS 35—ADVERTISING AND BUSINESS

FOR RECORDS MANAGEMENT SERVICES, NAMELY, DOCUMENT RETRIEVAL AND INDEXING FOR OTHERS; COSTS ASSESSMENT SERVICES; COST ANALYSES; BUSINESS MANAGEMENT CONSULTING WITH RELATION TO EXPERT WITNESS PERSONNEL (U.S. CLS. 100, 101 AND 102).

FIRST USE 12-1-1983; IN COMMERCE 12-1-1983.

SN 78-394,178. KEELING, KIM, DBA BOOTY FARMS, SUTHERLAND, NE. AND KEELING, SHARI, DBA BOOTY FARMS, SUTHERLAND, NE. FILED 3-31-2004.

CLASS 42—SCIENTIFIC, COMPUTER AND LEGAL SERVICES

FOR LITIGATION SUPPORT SERVICES, NAMELY, MEDICAL RECORDS AND DOCUMENT RETRIEVAL, REVIEW, ANALYSIS AND SUMMARIZATION BY PROFESSIONAL NURSING STAFF; LITIGATION CONSULTANCY, NAMELY, ASSESSING IMPORTANT ELEMENTS IN A CASE TO ASSIST CLIENTS IN ACCURATELY PRIORITIZING LITIGATION ACTIVITIES AND THE VALUE AND COST OF THE INTENDED LITIGATIONS (U.S. CLS. 100 AND 101).

FIRST USE 12-1-1983; IN COMMERCE 12-1-1983.
STEVEN R. FINE, EXAMINING ATTORNEY

BOOTY FARMS CHARACTER SEASONING CO.

SN 78-394,536. 3NINE AB, NACKA STRAND, SWEDEN, FILED 4-1-2004.



THE MARK CONSISTS OF STANDARD CHARACTERS WITHOUT CLAIM TO ANY PARTICULAR FONT, STYLE, SIZE, OR COLOR.

NO CLAIM IS MADE TO THE EXCLUSIVE RIGHT TO USE "SEASONING CO.", APART FROM THE MARK AS SHOWN.

CLASS 29—MEATS AND PROCESSED FOODS

FOR PICKLED OKRA, JERKY, SAUSAGES, AND DRIED MEAT PRODUCTS (U.S. CL. 46).

CLASS 30—STAPLE FOODS

FOR SPICES, SEASONINGS, BLENDED SPICES AND SEASONINGS, CORNMEAL AND CORNFLOUR SPICE MIXES, POPCORN, SALSA, BARBEQUE SAUCE, HOT SAUCE, AND RELISH (U.S. CL. 46).

G. MAYERSCHOFF, EXAMINING ATTORNEY

OWNER OF SWEDEN REG. NO. 365987, DATED 3-12-2004, EXPIRES 3-12-2014.

CLASS 7—MACHINERY

FOR INDUSTRIAL ENGINEERING AND MANUFACTURING EQUIPMENT, NAMELY, GAS SEPARATORS (U.S. CLS. 13, 19, 21, 23, 31, 34 AND 35).

CLASS 11—ENVIRONMENTAL CONTROL APPARATUS

FOR INDUSTRIAL ENGINEERING AND MANUFACTURING EQUIPMENT, NAMELY, AIR CLEANERS (U.S. CLS. 13, 21, 23, 31 AND 34).

MICHAEL HALL, EXAMINING ATTORNEY

SN 78-394,815. MUZUNAMI SEIKI CO., LTD., GIFU-KEN, JAPAN, FILED 4-1-2004.

SN 78-394,571. WIN-WIN AG, BELP, SWITZERLAND, FILED 4-1-2004.



PRIORITY CLAIMED UNDER SEC. 44(D) ON SWITZERLAND APPLICATION NO. 00617/2004, FILED 2-19-2004, REG. NO. 520438, DATED 4-13-2004, EXPIRES 2-19-2014.

THE COLOR(S) BLUE, YELLOW AND ORANGE IS/ARE CLAIMED AS A FEATURE OF THE MARK.

THE MARK DEPICTS A YELLOW AND ORANGE SUN SETTING BEHIND A BLUE BRIDGE DESIGN AGAINST A BLUE BACKGROUND WITH DARKER BLUE CURVED LINES LEADING INTO THE BRIDGE.

CLASS 35—ADVERTISING AND BUSINESS

FOR ADVERTISING SERVICES; MANAGEMENT CONSULTATION IN THE FIELD OF BUSINESS; BUSINESS ENTERPRISE ADMINISTRATION; OFFICE WORK; BUSINESS MANAGEMENT AND BUSINESS SUPPORT OF ENTERPRISES; BUSINESS ORGANIZATION AND MANAGEMENT CONSULTATION; MARKET SURVEY AND MARKET RESEARCH; ORGANIZATION OF COMMERCIAL FAIRS AND EXHIBITIONS FOR BUSINESS, ECONOMIC AND ADVERTISING PURPOSES (U.S. CLS. 100, 101 AND 102).

CLASS 41—EDUCATION AND ENTERTAINMENT

FOR EDUCATION SERVICES, NAMELY, ORGANIZATION AND EXECUTION OF SEMINARS, WORKSHOPS, COLLOQUIA, CONFERENCES, CONGRESSES AND SYMPOSIA IN THE FIELD OF BUSINESS AND HEALTH MANAGEMENT; TRAINING, NAMELY, TRAINING IN THE FIELD OF BUSINESS AND HEALTH MANAGEMENT; CULTURAL ACTIVITIES, NAMELY, LIVE MUSICAL PERFORMANCES AND THEATRICAL PRODUCTIONS (U.S. CLS. 100, 101 AND 107).

KATHY DE JONGE, EXAMINING ATTORNEY

BICOR

THE MARK CONSISTS OF STANDARD CHARACTERS WITHOUT CLAIM TO ANY PARTICULAR FONT, STYLE, SIZE, OR COLOR.

OWNER OF U.S. REG. NO. 1,751,862.

CLASS 2—PAINTS

FOR PRINTING INKS; MIMEOGRAPH INKS; FILLED INK CARTRIDGES (U.S. CLS. 6, 11 AND 16).

CLASS 7—MACHINERY

FOR PRINTING MACHINES AND PARTS THEREFOR; DIGITAL PRINTING MACHINES, INCLUDING DIGITAL MIMEOGRAPHING PRINTING MACHINES AND PARTS THEREFOR (U.S. CLS. 13, 19, 21, 23, 31, 34 AND 35).

CLASS 9—ELECTRICAL AND SCIENTIFIC APPARATUS

FOR COMPUTER COMPATIBLE DIGITAL PRINTING MACHINES AND THEIR PARTS AND ACCESSORIES, NAMELY, COLOR CYLINDERS, OPTICAL SCANNERS, THERMAL HEADS, PRINTER DRIVER SOFTWARE; PERIPHERALS FOR DIGITAL PRINTING MACHINES, NAMELY, SCANNERS; PRE-RECORDED VIDEO DISCS AND VIDEOTAPES FEATURING INSTRUCTION MANUALS FOR DIGITAL PRINTING MACHINES; DUPLICATORS FOR PHOTOGRAPHS AND DOCUMENTS; DIGITAL DUPLICATORS (U.S. CLS. 21, 23, 26, 36 AND 38).

CLASS 16—PAPER GOODS AND PRINTED MATTER

FOR MASTERS BEING A LAMINATION OF POLYESTER FILM AND PAPER FOR USE IN DIGITAL PRINTING MACHINES; DUPLICATING INKS; ROTARY DUPLICATORS (U.S. CLS. 2, 5, 22, 23, 29, 37, 38 AND 50).

MATTHEW PAPPAS, EXAMINING ATTORNEY

SN 78-394,936. DS WATERS OF AMERICA, LP, ATLANTA, GA. FILED 4-1-2004.

CLASS 42—SCIENTIFIC, COMPUTER AND LEGAL SERVICES

FOR MOBILE CUSTOM PICTURE AND LIGHTING DESIGN SERVICES (U.S. CLS. 100 AND 101).
FIRST USE 7-31-2004; IN COMMERCE 7-31-2004.
HENRY S. ZAK, EXAMINING ATTORNEY

**PURELY REFRESHING.
PERSONALLY
DELIVERED. EVERY
TWO WEEKS.**

THE MARK CONSISTS OF STANDARD CHARACTERS WITHOUT CLAIM TO ANY PARTICULAR FONT, STYLE, SIZE, OR COLOR.

CLASS 16—PAPER GOODS AND PRINTED MATTER

FOR PENS (U.S. CLS. 2, 5, 22, 23, 29, 37, 38 AND 50).

CLASS 21—HOUSEWARES AND GLASS

FOR MUGS (U.S. CLS. 2, 13, 23, 29, 30, 33, 40 AND 50).

CLASS 25—CLOTHING

FOR CLOTHING, NAMELY SHIRTS AND HATS. (U.S. CLS. 22 AND 39).

CLASS 32—LIGHT BEVERAGES

FOR BOTTLED WATER (U.S. CLS. 45, 46 AND 48).

CLASS 39—TRANSPORTATION AND STORAGE

FOR HOME AND OFFICE DELIVERY OF BOTTLED WATER PRODUCTS (U.S. CLS. 100 AND 105).
NAAKWAMA ANKRAH, EXAMINING ATTORNEY

SN 78-395,020. PANCREATIC CANCER ACTION NETWORK, INC., EL SEGUNDO, CA. FILED 4-1-2004.



THE MARK CONSISTS OF FOUR STYLIZED PEOPLE IN A ROW.

CLASS 35—ADVERTISING AND BUSINESS

FOR ASSOCIATION SERVICES, NAMELY, PROMOTING THE PUBLIC INTEREST AND AWARENESS IN PANCREATIC CANCER RESEARCH AND EDUCATION AND FOR PANCREATIC CANCER RESEARCH SERVICES (U.S. CLS. 100, 101 AND 102).
FIRST USE 7-1-2003; IN COMMERCE 7-1-2003.

CLASS 36—INSURANCE AND FINANCIAL

FOR CHARITABLE FUNDRAISING SERVICES RELATING TO PANCREATIC CANCER (U.S. CLS. 100, 101 AND 102).
FIRST USE 7-1-2003; IN COMMERCE 7-1-2003.

CLASS 41—EDUCATION AND ENTERTAINMENT

FOR EDUCATIONAL SERVICES, NAMELY, CONDUCTING COURSES ON TOPICS RELATED TO PANCREATIC CANCER AND DISTRIBUTING EDUCATIONAL MATERIALS IN CONNECTION THEREWITH (U.S. CLS. 100, 101 AND 107).
FIRST USE 7-1-2003; IN COMMERCE 7-1-2003.
SUSAN STIGLITZ, EXAMINING ATTORNEY

SN 78-394,988. BALLOU, GREGORY ALAN, SANTA BARBARA, CA. FILED 4-1-2004.

FRAMEMOBILE

THE MARK CONSISTS OF STANDARD CHARACTERS WITHOUT CLAIM TO ANY PARTICULAR FONT, STYLE, SIZE, OR COLOR.

CLASS 40—MATERIAL TREATMENT

FOR MOBILE CUSTOM PICTURE FRAMING SERVICES (U.S. CLS. 100, 103 AND 106).
FIRST USE 7-31-2004; IN COMMERCE 7-31-2004.

SN 78-395,779. THE GEORGE LUCAS EDUCATIONAL FOUNDATION, SAN RAFAEL, CA. FILED 4-2-2004.

SN 78-395,883. OOMA, INC., SAN FRANCISCO, CA. FILED 4-2-2004.



OOMA

NO CLAIM IS MADE TO THE EXCLUSIVE RIGHT TO USE "EDUCATIONAL FOUNDATION", APART FROM THE MARK AS SHOWN.

THE NAME GEORGE LUCAS IDENTIFIES A LIVING INDIVIDUAL WHOSE CONSENT IS OF RECORD.

THE COLOR(S) RED, GOLD AND BLUE IS/ARE CLAIMED AS A FEATURE OF THE MARK.

THE MARK CONSISTS OF THE WORDS THE GEORGE LUCAS EDUCATIONAL FOUNDATION THAT FORM A CIRCLE AROUND A HAND THAT IS RED AND GOLD WITH BLUE AND BLACK DOTTED LINES GOING THROUGH THE FINGERS OF THE HAND.

CLASS 9—ELECTRICAL AND SCIENTIFIC APPARATUS

FOR CD-ROMS, VIDEOTAPES AND DVDS CONCERNING TOPICS RELATED TO EDUCATION (U.S. CLS. 21, 23, 26, 36 AND 38).

FIRST USE 7-0-2003; IN COMMERCE 7-0-2003.

CLASS 16—PAPER GOODS AND PRINTED MATTER

FOR PRINTED MATERIALS, NAMELY BOOKS, BROCHURES, NEWSLETTERS, MAGAZINES, GUIDES, WORKBOOKS, FORMS, PAMPHLETS AND MONOGRAPHS CONCERNING TOPICS RELATED TO EDUCATION (U.S. CLS. 2, 5, 22, 23, 29, 37, 38 AND 50).

FIRST USE 11-0-1993; IN COMMERCE 11-0-1993.

CLASS 41—EDUCATION AND ENTERTAINMENT

FOR EDUCATIONAL SERVICES, NAMELY SEMINARS, CLASSES, WORKSHOPS AND CONFERENCES CONCERNING TOPICS RELATED TO EDUCATION AND THE DISTRIBUTION OF COURSE MATERIALS IN CONNECTION THEREWITH; ENTERTAINMENT SERVICES, NAMELY RADIO PROGRAMMING CONCERNING TOPICS RELATED TO EDUCATION; PROVIDING A WEBSITE CONCERNING TOPICS RELATED TO EDUCATION; DISSEMINATION OF EDUCATIONAL MATERIALS OF OTHERS CONCERNING TOPICS RELATED TO EDUCATION (U.S. CLS. 100, 101 AND 107).

FIRST USE 9-12-2002; IN COMMERCE 9-12-2002.
MARK SPARACINO, EXAMINING ATTORNEY

THE MARK CONSISTS OF STANDARD CHARACTERS WITHOUT CLAIM TO ANY PARTICULAR FONT, STYLE, SIZE, OR COLOR.

CLASS 9—ELECTRICAL AND SCIENTIFIC APPARATUS

FOR RESIDENTIAL GATEWAYS; COMPUTER NETWORKING HARDWARE; COMPUTER NETWORK HUBS, SWITCHES AND ROUTERS; TELEPHONE, AUDIO AND VIDEO RECEIVERS AND TRANSMITTERS; COMPUTER TELEPHONY SOFTWARE; COMPUTER SOFTWARE FOR PROVIDING VOICEMAIL, INSTANT MESSAGING AND VIDEO COMMUNICATION SERVICES IN THE FIELD OF TELECOMMUNICATIONS; COMPUTER SOFTWARE FOR PROVIDING TRANSMISSION AND EXCHANGE OF VOICE, VIDEO, DATA, IMAGES AND GRAPHICS IN THE FIELD OF TELECOMMUNICATIONS; COMPUTER HARDWARE (U.S. CLS. 21, 23, 26, 36 AND 38).

CLASS 38—COMMUNICATION

FOR TELEPHONE COMMUNICATION SERVICES; LOCAL AND LONG DISTANCE TELEPHONE SERVICES; INTERNET TELEPHONY SERVICES; VOICE MESSAGING SERVICES; TELEPHONE CONFERENCING SERVICES; NETWORK CONFERENCING SERVICES; TRANSMISSION AND EXCHANGE OF VOICE, VIDEO, DATA, IMAGES AND GRAPHICS VIA COMPUTER AND COMMUNICATIONS NETWORKS (U.S. CLS. 100, 101 AND 104).

JIM RINGLE, EXAMINING ATTORNEY

SN 78-396,654. TIRE MART, INC., ST. LOUIS, MO. FILED 4-5-2004.

TEAR IT UP

THE MARK CONSISTS OF STANDARD CHARACTERS WITHOUT CLAIM TO ANY PARTICULAR FONT, STYLE, SIZE, OR COLOR.

OWNER OF U.S. REG. NOS. 2,116,707, 2,240,919 AND 2,898,209.

CLASS 6—METAL GOODS

FOR METAL KEY CHAINS; METAL KEY TAGS; METAL KEY RINGS; METAL KEY FOBs; METAL LICENSE PLATES; AND METAL MONEY CLIPS (U.S. CLS. 2, 12, 13, 14, 23, 25 AND 50).

CLASS 9—ELECTRICAL AND SCIENTIFIC APPARATUS

FOR SUNGLASSES; EYEGLASSES; GOGGLES FOR SPORTS; SAFETY GOGGLES; EYEGLASS CASES; RADIOS; CD PLAYERS; TELEVISIONS; EYEGLASS CHAINS AND CORDS; DECORATIVE MAGNETS; AND COMPUTER GAME PROGRAMS; PROTECTIVE HELMETS FOR USE IN SKATEBOARDING, SNOWBOARDING, BIKING, AND MOTORSPORTS (U.S. CLS. 21, 23, 26, 36 AND 38).

CLASS 12—VEHICLES

FOR TIRES FOR MOTOR VEHICLES; TIRE COVERS; WHEEL COVERS; CONVERTIBLE SOFT TOPS FOR 4-WHEEL DRIVE, OPEN TOP, UTILITY AND MOTOR VEHICLES; LICENSE PLATE FRAMES, FASTENERS, AND HOLDERS; FITTED COVERS FOR VEHICLES; AUTOMOBILE SEAT CUSHIONS; WINDSHIELD SUNSHADES; CUP HOLDERS FOR USE IN VEHICLES; TRUCK BED LINERS; MUD FLAPS; AND NON-MOTORIZED SCOOTERS (U.S. CLS. 19, 21, 23, 31, 35 AND 44).

CLASS 14—JEWELRY

FOR JEWELRY, NAMELY WATCHES, BRACELETS, EARRINGS, NECKLACES, AND ANKLETS; CLOCKS; CLOCKS INCORPORATING RADIOS; MONEY CLIPS MADE OF PRECIOUS METAL; BELT BUCKLES OF PRECIOUS METAL; PINS BEING JEWELRY; WATCH WINDING BUTTONS; AND BROOCHES (U.S. CLS. 2, 27, 28 AND 50).

CLASS 16—PAPER GOODS AND PRINTED MATTER

FOR BUMPER STICKERS; ADHESIVE DECALS; ORNAMENTAL STICKERS; PRINTED MATTER, NAMELY NEWSPAPERS, NEWSLETTERS, MAGAZINES, PERIODICALS, AND BROCHURES, ALL IN THE FIELD OF MOTOR SPORTS; PRINTED MATTER, NAMELY, CALENDARS, ANNOUNCEMENT CARDS, POSTERS, AND GREETING CARDS; PHOTOGRAPHS; PHOTO ALBUMS; STATIONERY; PENS; PENCILS; ADDRESS LABELS; BOOK BINDINGS; ART PICTURES; ART PRINTS; PAPER BANNERS; FILE FOLDERS; CRAYONS; PERSONAL ORGANIZERS; AND PAPER BAGS (U.S. CLS. 2, 5, 22, 23, 29, 37, 38 AND 50).

CLASS 18—LEATHER GOODS

FOR LUGGAGE; SPORTS BAGS; TRAVEL BAGS; FANNY PACKS; DUFFLE BAGS; BACKPACKS; DOG COLLARS; PET LEASHES; LEATHER KEY CHAINS; LEATHER KEY RINGS; UMBRELLAS; AND WALLETS (U.S. CLS. 1, 2, 3, 22 AND 41).

CLASS 20—FURNITURE AND ARTICLES NOT OTHERWISE CLASSIFIED

FOR PICTURE FRAMES; NON-METAL MONEY CLIPS; CHAIRS; TABLES; SEAT CUSHIONS; MIRRORS; SLEEPING BAGS; NON-METAL KEY RINGS; NON-METAL AND NON-LEATHER KEY CHAINS; PLASTIC PENNANTS; AND TOY BOXES IN THE NATURE OF FURNITURE (U.S. CLS. 2, 13, 22, 25, 32 AND 50).

CLASS 21—HOUSEWARES AND GLASS

FOR PORTABLE COOLERS; MUGS; CUPS; DRINKING GLASSES; TRASH CANS; PITCHERS; BEVERAGE DECANTERS; PAPER CUPS; PAPER PLATES; SQUEEZE BOTTLES SOLD EMPTY; AND LUNCH BOXES (U.S. CLS. 2, 13, 23, 29, 30, 33, 40 AND 50).

CLASS 24—FABRICS

FOR GOLF TOWELS; BATH TOWELS; BEACH TOWELS; HAND TOWELS; BED BLANKETS; AND BED LINENS (U.S. CLS. 42 AND 50).

CLASS 25—CLOTHING

FOR SHIRTS; T-SHIRTS; SHORTS; PANTS; SWEATSHIRTS; SWEATPANTS; HATS; VISORS; CAPS; BANDANAS; HEADBANDS; SHOES; BELTS; TANK TOPS; SWIM TRUNKS; BATHING SUITS; SWIM SUITS; DRESSES; SKIRTS; BLOUSES; TUBE TOPS; GLOVES; MEN'S AND WOMEN'S UNDERWEAR; WRIST BANDS; AND FOOTWEAR, NAMELY SHOES, THONGS, SANDALS, SNOWBOARD BOOTS, SKI BOOTS, AND SOCKS; AND BICYCLING GLOVES (U.S. CLS. 22 AND 39).

CLASS 26—FANCY GOODS

FOR CLOTH PATCHES FOR CLOTHING; FABRIC APPLIQUES; EMBROIDERED CLOTH PATCHES FOR CLOTHING; SHOE LACES; BELT BUCKLES NOT OF PRECIOUS METAL; HAIR ACCESSORIES, NAMELY HAIR BANDS, HAIR BOWS, HAIR BUCKLES, HAIR ORNAMENTS, HAIR PINS, HAIR RIBBONS, AND BARRETTES; AND ORNAMENTAL NOVELTY BUTTONS (U.S. CLS. 37, 39, 40, 42 AND 50).

CLASS 28—TOYS AND SPORTING GOODS

FOR TOYS AND GAMES, NAMELY RUBBER ACTION BALLS, ACTION FIGURES AND ACCESSORIES THEREFOR; ACTION SKILL GAMES; MECHANICAL AND ELECTRIC ACTION TOYS; ACTION-TYPE TARGET GAMES; PAPER AIRPLANES; SCALE MODEL AIRPLANES; TOY AIRPLANES; STUFFED TOY ANIMALS; ANKLE AND WRIST WEIGHTS FOR EXERCISE; AERODYNAMIC DISKS FOR USE IN PLAYING CATCHING GAMES; ARM GUARDS FOR ATHLETIC USE; TOY ARMOR; ATHLETIC TAPE; BABY RATTLES; BACKBOARDS FOR BASKETBALL; BACKGAMMON GAME SETS; BALLOONS; CRAFT SETS FOR DECORATING BALLOONS; BASEBALLS; BASKETBALLS; BILLIARD BALLS; BOWLING BALLS; FOOTBALLS; GOLF BALLS; GOLF CLUBS; GOLF TEE MARKERS; GOLF CLUB HEADS; GOLF CLUB SHAFTS; GOLF CLUB HEAD COVERS; GOLF TEES; GOLF BAGS; HAND BALLS; NET BALLS; PLAYGROUND BALLS; RACKET BALLS; SOCCER BALLS; SPORTS BALLS; SQUASH BALLS; TABLE TENNIS BALLS; TENNIS BALLS; TETHER BALLS; VOLLEYBALLS; TOY BANKS; BARBELLS; BASEBALL BATS; BATTING GLOVES; BASEBALL GLOVES; BASEBALL MITTS; BATH AND BATHTUB TOYS; INFLATABLE BATH TOYS; TWIRLING BATONS; SOFTBALL BATS; BEAN BAGS; STUFFED TOY BEARS; TEDDY BEARS; CHRISTMAS TREE ORNAMENT BELLS; BILLIARD BRIDGES; BILLIARD BUMPERS;

BILLIARD CHALK; BILLIARD CUE RACKS; BILLIARD CUES; BILLIARD CUSHIONS; BILLIARD GAME PLAYING EQUIPMENT; BILLIARD NETS; BILLIARD TABLES; BILLIARD TALLY BALLS; BILLIARD TIPS; BILLIARD TRIANGLES; BINGO CARDS; BINGO GAME PLAYING EQUIPMENT; TOY BUILDING BLOCKS; TOY CONSTRUCTION BLOCKS; BOARD GAMES; EQUIPMENT SOLD AS A UNIT FOR PLAYING BOARD GAMES; BODY BOARDS; FINS FOR BODY BOARDS; LEASHES FOR BODY BOARDS; RESTRAINT STRAPS FOR BODY BOARDS; ROLE PLAYING GAME EQUIPMENT IN THE NATURE OF GAME BOOK MANUALS; BOWLING BALL COVERS; BOWLING DEFLECTORS; BOWLING PINS; MUSIC BOX TOYS; BOXES IN THE NATURE OF TOYS; BUBBLE MAKING WAND AND SOLUTION SETS; TOY CAP PISTOLS; CAPS FOR TOY PISTOLS; CARD GAMES; EQUIPMENT SOLD AS A UNIT FOR PLAYING CARD GAMES; POOL CUE CASES; CASES FOR ACTION FIGURES; CASES FOR PLAY ACCESSORIES; CASES FOR TOY STRUCTURES; CASES FOR TOY VEHICLES; POOL CUE CEMENT; FLOATING RECREATIONAL LOUNGE CHAIRS; CHECKER SETS; CHESS SETS; GAMING EQUIPMENT CHIPS; ARTIFICIAL CHRISTMAS GARLANDS; CHRISTMAS TREE DECORATIONS; CHRISTMAS TREE ORNAMENTS; CHRISTMAS TREE SKIRTS; CHRISTMAS TREE STAND COVERS; CHRISTMAS TREE STANDS; ARTIFICIAL CHRISTMAS TREES; ARTIFICIAL CHRISTMAS WREATHS; PLAYGROUND EQUIPMENT CLIMBING UNITS; ACTION OR PLAY FIGURE CLOTHING; DOLL CLOTHING; CHILDREN'S PLAY COSMETICS; COSTUME MASKS; DOLL COSTUMES; PARTY FAVORS IN THE NATURE OF CRACKERS OR NOISEMAKERS; POOL CUES; PORTABLE SUPPORT STRUCTURES FOR DANCE AND OTHER EXERCISES; DART BOARD CASES; DART BOARDS; DART CARRYING CASES; DART FLIGHTS; ELECTRONIC DART GAMES; DART POINT SHARPENERS; DART POINTS; DART SHAFTS; DART STEMS; DICE; FLYING DISCS; DOG TOYS; DOLL ACCESSORIES; DOLL CASES; DOLL HOUSE FURNISHINGS; DOLLS; BEAN BAG DOLLS; PAPER DOLLS; PORCELAIN DOLLS; RAG DOLLS; SOFT SCULPTURE DOLLS; DOLL PLAY SETS; DOMINOES; DUMBBELL SETS; DUMBBELLS; EASTER EGG COLORING KITS; EGG DECORATING KITS; ELECTRONIC GAME EQUIPMENT WITH A WATCH FUNCTION; HAND HELD UNIT FOR PLAYING ELECTRONIC GAMES; EXERCISE BARS; STATIONARY EXERCISE BICYCLES; MANUALLY OPERATED EXERCISE EQUIPMENT; EXERCISE WEIGHTS; PARTY FAVORS IN THE NATURE OF SMALL TOYS; PLAY FIGURES; FIREARM TARGETS; SWIM FLOATS FOR RECREATIONAL USE; KICK BOARD FLOTATION DEVICES FOR RECREATIONAL USE; STAND ALONE VIDEO OUTPUT GAME MACHINES; PROMOTIONAL GAME MATERIALS; GAME TABLES; GAMING WHEELS; EQUIPMENT SOLD AS A UNIT FOR PLAYING ACTION TYPE TARGET GAMES; HAND HELD UNIT FOR PLAYING VIDEO GAMES; MANIPULATIVE GAMES; PARLOR GAMES; PINBALL-TYPE GAMES; ROLE PLAYING GAMES; GAMING TABLES; GOALKEEPERS' GLOVES; GOLF GLOVES; HANDBALL GLOVES; HOCKEY GLOVES; KARATE GLOVES; SOFTBALL GLOVES; SWIMMING GLOVES; WATERSKI GLOVES; TOY ZIP GUNS; INFANT ACTION CRIB TOYS; JIGSAW PUZZLES; JUMP ROPES; KITE HANDLES; KITE LINES; KITE PARTS; KITE REELS; KITE STRING; KITE TAILS; KITES; MAGIC TRICKS; MANIPULATIVE PUZZLES; MARBLES; MARIONETTE PUPPETS; PAPER FACE MASKS; CRIB MOBILES; TOY MOBILES; MOBILES FOR CHILDREN; TOY MODEL TRAIN SETS; TOY MODEL VEHICLES AND RELATED ACCESSORIES SOLD AS UNITS; ELECTRONICALLY OPERATED TOY MOTOR VEHICLES; MOUTH GUARDS AS ATHLETIC EQUIPMENT; MUSICAL TOYS; TOY NOISEMAKERS; PADDLE BALL GAMES; PADDLES FOR USE IN PADDLE BALL GAMES; TABLE TENNIS PADDLES; COIN AND NON-COIN OPERATED PINBALL MACHINES; PINBALL-TYPE GAMES; PLUSH TOYS; SOFT SCULPTURE PLUSH TOYS; POOL BRIDGES; POOL BUMPERS; POOL CHALK HOLDERS; POOL CUE CHALK; POOL CUE CLAMPS; POOL CUE RACKS; POOL CUE TIPS; POOL CUSHIONS; POOL TALLY BALLS; PUPPETS; CUBE-TYPE THREE-DIMENSIONAL PUZZLES; INFANT'S RATTLES; TOY RECORD PLAYERS; RIDE-ON TOYS; INFLATABLE RIDE-ON TOYS; TRACTORS AND SLEDS FOR USE IN DOWNHILL AMUSEMENT RIDES; RING GAMES, NAMELY, QUILTS; ROCKING HORSES; ROLLER SKATES; SKIPPING ROPES; FLYING SAUCERS; TOY SCOOTERS; SOFT

SCULPTURE TOYS; SKATEBOARDS; ICE SKATES; SLING SHOTS; TOY SPINNING TOPS; STUFFED TOYS; SURFBOARDS; WATER WING SWIM AIDS FOR RECREATIONAL USE; SWIM BOARDS FOR RECREATIONAL USE; TOY SWORDS; TABLE TENNIS NETS; TABLE TENNIS POST SETS; TABLE TENNIS RACKETS; TABLE TENNIS TABLES; TENNIS UPRIGHTS; SAFETY PADDING FOR VOLLEYBALL AND TENNIS UPRIGHTS; TOY ACTION FIGURES AND ACCESSORIES; TOY FIGURES; TOY GLIDERS; TOY VEHICLES; BABY MULTIPLE ACTIVITY TOYS; CHILDREN'S MULTIPLE ACTIVITY TOYS; NON-RIDING TRANSPORTATION TOYS; SQUEEZABLE SQUEAKING TOYS; WATER SQUIRTING TOYS; WIND-UP WALKING TOYS; WIND-UP TOYS; PLAY WANDS; SKATEBOARDS; SKIS; SNOWBOARDS; SURF BOARD LEASHES; KNEEPADS FOR ATHLETIC USE; ELBOWPADS FOR ATHLETIC USE; AND YO-YOS (U.S. CLS. 22, 23, 38 AND 50).
YONG KIM, EXAMINING ATTORNEY

SN 78-396,718. CREO INC., BURNABY, B.C., CANADA,
FILED 4-5-2004.

TRACELESS

THE MARK CONSISTS OF STANDARD CHARACTERS WITHOUT CLAIM TO ANY PARTICULAR FONT, STYLE, SIZE, OR COLOR.

CLASS 1—CHEMICALS

FOR CHEMICAL MARKERS, NAMELY TAGGENTS (U.S. CLS. 1, 5, 6, 10, 26 AND 46).

CLASS 9—ELECTRICAL AND SCIENTIFIC APPARATUS

FOR COMPUTER HARDWARE AND SOFTWARE FOR DETECTING, ACQUIRING, MANIPULATING, STORING AND VERIFYING DATA (U.S. CLS. 21, 23, 26, 36 AND 38).

ODESSA BIBBINS, EXAMINING ATTORNEY

SN 78-396,874. ABELOW, DANIEL, LONGWOOD, FL. FILED 4-6-2004.

CLASS 43—HOTEL AND RESTAURANT SERVICES

FOR CHARITABLE SERVICES, NAMELY, DISTRIBUTION OF FOOD RELIEF PACKAGES TO POOR OR LOW-INCOME HOUSEHOLDS (U.S. CLS. 100 AND 101).
FIRST USE 9-1-2000; IN COMMERCE 9-1-2000.
DANIEL BRODY, EXAMINING ATTORNEY

On-The-Spot

SN 78-397,121. KNAPE & VOGT MANUFACTURING COMPANY, GRAND RAPIDS, MI. FILED 4-6-2004.

THE MARK CONSISTS OF STANDARD CHARACTERS WITHOUT CLAIM TO ANY PARTICULAR FONT, STYLE, SIZE, OR COLOR.

CLASS 35—ADVERTISING AND BUSINESS

FOR LICENSING OF SOFTWARE PRODUCTS EXTERNAL TO OR EMBEDDED IN DIGITAL AND PHYSICAL PRODUCTS, AND/OR SOFTWARE FOR INFORMATION CONTENT ALLOWING USERS AND VENDORS TO AUTHOR, REVIEW, DOWNLOAD, ORGANIZE AND ASSEMBLE MULTIPLE SOURCES OF DIGITAL CONTENT INTO COMPILATIONS FOR DISTRIBUTION TO THESE AND SUBSEQUENT USERS FOR USE, CUSTOM MODIFICATION AND REDISTRIBUTION TO OTHERS (U.S. CLS. 100, 101 AND 102).

CLASS 42—SCIENTIFIC, COMPUTER AND LEGAL SERVICES

FOR CONSULTING SERVICES THROUGH ON-SITE VISITS, TELECOMMUNICATIONS, PUBLISHED MATERIALS AND ONLINE INTERACTIVE EXCHANGES WITH BUSINESS, ACADEMIC, GOVERNMENT, CHARITABLE AND CONSUMER CLIENTS IN THE FIELDS OF COMPUTER TECHNOLOGY, PROPRIETARY METHODOLOGY AND PROCESSES FOR DEVELOPING AND CONFIGURING OF COMPUTER TECHNOLOGIES AND SOFTWARE THAT MAY BE EXTERNAL TO OR EMBEDDED WITHIN OTHER PRODUCTS AND SERVICES (U.S. CLS. 100 AND 101).

MELVIN AXILBUND, EXAMINING ATTORNEY

KNAPE & VOGT

THE MARK CONSISTS OF STANDARD CHARACTERS WITHOUT CLAIM TO ANY PARTICULAR FONT, STYLE, SIZE, OR COLOR.

CLASS 6—METAL GOODS

FOR STORE FIXTURE HARDWARE, NAMELY, METAL STANDARDS AND METAL BRACKETS; DRAWER HARDWARE AND STRUCTURES, NAMELY, TRACKS, SLIDES, ROLLERS, CATCHERS, LOCKS AND PULLS, ALL OF METAL; DOOR AND GATE HARDWARE AND STRUCTURES, NAMELY, HINGES, SHEAVES, LOCKS, PULLS, LATCHES, SLIDING DOOR TRACKS, AND FIXTURES, ALL OF METAL; SHELVING HARDWARE AND STRUCTURES, NAMELY, STANDARDS, BRACKETS, SUPPORTS AND SHELVES, ALL OF METAL; GLASS AND MIRROR FITTINGS, NAMELY, SLIPS, CLAMPS, CORNER BRACKETS, CHANNELS, TICKET AND LABEL HOLDERS, ALL OF METAL; METAL STORAGE AND RECYCLING BINS; CLOSET AND SHOWCASE HARDWARE, NAMELY, RODS, TUBING, CLOTHING CARRIERS, HAND ROD FLANGES, END CAPS, SUPPORTS AND SHELVES, ALL OF METAL (U.S. CLS. 2, 12, 13, 14, 23, 25 AND 50).

FIRST USE 0-0-1909; IN COMMERCE 0-0-1909.

SN 78-396,885. THE JEWISH RELIEF AGENCY, BALA CYNWYD, PA. FILED 4-6-2004.



NO CLAIM IS MADE TO THE EXCLUSIVE RIGHT TO USE "JEWISH RELIEF AGENCY", APART FROM THE MARK AS SHOWN.

CLASS 9—ELECTRICAL AND SCIENTIFIC APPARATUS

FOR COMPUTER ACCESSORIES AND SUPPORT APPARATUS, NAMELY, ADJUSTABLE KEYBOARD TRAY SUPPORTS, ADJUSTABLE MOUSE SUPPORTS, ADJUSTABLE COMPUTER MONITOR SUPPORTS AND COMPUTER PROCESSOR UNIT (CPU) SUPPORT HOLDERS (U.S. CLS. 21, 23, 26, 36 AND 38).

FIRST USE 0-0-1996; IN COMMERCE 0-0-1996.

CLASS 35—ADVERTISING AND BUSINESS

FOR CHARITABLE SERVICES, NAMELY, ORGANIZING AND CONDUCTING VOLUNTEER PROGRAMS AND COMMUNITY SERVICE PROJECTS; VOLUNTEER RECRUITMENT SERVICES (U.S. CLS. 100, 101 AND 102).
FIRST USE 9-1-2000; IN COMMERCE 9-1-2000.

CLASS 11—ENVIRONMENTAL CONTROL APPARATUS

FOR APPARATUS FOR LIGHTING, NAMELY, DESK LAMPS, DESK LIGHTS AND TASK LIGHTS (U.S. CLS. 13, 21, 23, 31 AND 34).

FIRST USE 0-0-1999; IN COMMERCE 0-0-1999.

CLASS 20—FURNITURE AND ARTICLES NOT OTHERWISE CLASSIFIED

FOR FURNITURE; CABINETS; ENTERTAINMENT CENTERS; NON-METAL SLIDING DOORS AND MOUNTING AND SUPPORTING HARDWARE SOLD AS A KIT THEREWITH; ADJUSTABLE TABLES AND ADJUSTABLE FOOTRESTS FOR OFFICE WORKSPACES; NON-METAL STORAGE AND RECYCLING PRODUCTS, NAMELY, PLASTIC STORAGE AND RECYCLING BINS, DIVIDERS FOR DRAWERS, NAMELY, DOUBLE-TIERED CUTLERY TRAYS, HALF-TOP CUTLERY TRAYS, TABLEWARE TRAYS, UTILITY TRAYS, SPICE DRAWER INSERTS, PLASTIC DRAWER LINING MATERIAL FOR BREAD DRAWERS; SPECIALITY STORAGE PRODUCTS, NAMELY, STAIR STEP SHELVES; BATH STORAGE PRODUCTS, NAMELY, ROLL-OUT HAMPERS, TILT-OUT HAMPERS, PLASTIC BIN ROLL-OUT HAMPERS, GROOMING STORAGE RACKS, COSMETIC DRAWER INSERTS, AND MAGAZINE RACKS; SHELVING, NAMELY, BUILT-IN SHELVES AND WALL-MOUNTED SHELVES; ADJUSTABLE COMPUTER WORKSTATIONS, NAMELY, ADJUSTABLE WORK SURFACES, TABLES AND FOOTRESTS; COMPUTER FURNITURE, NAMELY COMPUTER PLATFORMS, TRAYS, AND ADJUSTABLE TABLES; ROLL-OUTS; WOOD TRAY DIVIDERS AND WOOD CABINERY ROLL OUTS; METAL DIVIDERS FOR DRAWERS; METAL WIRE TRAY DIVIDERS AND ROLL-OUTS (U.S. CLS. 2, 13, 22, 25, 32 AND 50).

FIRST USE 0-0-1970; IN COMMERCE 0-0-1970.

CLASS 21—HOUSEWARES AND GLASS

FOR KITCHEN AND BATH ACCESSORIES, NAMELY, LAZY SUSANS, SINGLE AND DOOR-MOUNTED WASTEBASKETS, PLASTIC AND STAINLESS STEEL TRAYS, TOWEL BARS, SINGLE MOUNTED AND WALL-MOUNTED WINE RACKS AND BATH STORAGE PRODUCTS, NAMELY, SLIDE-OUT WASTEBASKETS, DOOR-MOUNTED WASTE BINS, AND TOILET PAPER HOLDERS; PORTABLE PLASTIC CONTAINERS FOR STORING HOUSEHOLD AND KITCHEN GOODS (U.S. CLS. 2, 13, 23, 29, 30, 33, 40 AND 50).

FIRST USE 0-0-1988; IN COMMERCE 0-0-1988.
STEVEN R. FINE, EXAMINING ATTORNEY

SN 78-397,553. SOUTH CONE, INC., SAN DIEGO, CA. FILED 4-7-2004.

PLANET REEF

THE MARK CONSISTS OF STANDARD CHARACTERS WITHOUT CLAIM TO ANY PARTICULAR FONT, STYLE, SIZE, OR COLOR.

OWNER OF U.S. REG. NOS. 2,280,009, 2,291,470 AND OTHERS.

CLASS 25—CLOTHING

FOR HEADWEAR; FOOTWEAR; CLOTHING, NAMELY SHORTS, WALKSHORTS, BOARDSHORTS, BOXERS, PANTS, JEANS, SWIMMING TRUNKS, BATHING SUITS, BIKINIS, SKIRTS, SARONGS, SHIRTS, BLOUSES, T-SHIRTS, JACKETS, FLEECEES, MUSCLETEES, SWEATSHIRTS, AND SOCKS (U.S. CLS. 22 AND 39).

CLASS 41—EDUCATION AND ENTERTAINMENT

FOR ARRANGING AND CONDUCTING FESTIVALS AND EXHIBITIONS FEATURING OUTDOOR SPORTING EVENTS AND SURFING CONTESTS (U.S. CLS. 100, 101 AND 107).

KIMBERLY FRYE, EXAMINING ATTORNEY

SN 78-397,645. ALFER ALUMINIUM GESELLSCHAFT MBH, WUTOSCHINGEN, FED REP GERMANY, FILED 4-7-2004.

cabelino

THE MARK CONSISTS OF STANDARD CHARACTERS WITHOUT CLAIM TO ANY PARTICULAR FONT, STYLE, SIZE, OR COLOR.

OWNER OF ERPN CMNTY TM OFC REG. NO. 30442558, DATED 7-31-2004, EXPIRES 7-31-2014.

CLASS 6—METAL GOODS

FOR BUILDING MATERIALS AND ROLLED AND Poured BUILDING MATERIALS OF METAL, NAMELY—PIPES AND TUBES; WIRES; SCREWS; PROFILED PIPES AND TUBES; PROFILED RAILS; PROFILED PIECES; CONSOLES; HOOKS; SLABS; LADDERS AND STAB-LADDERS; FRAMES; RODS; SCREW RODS; FRAMES; FRAME PIECES; PROFILED FLAT RAILS AND BARS; PROFILED ANGLE RAILS AND BARS AS WELL AS ASSEMBLY PROFILES FROM METAL FOR COVERINGS, EDGINGS AND CONNECTIONS AT WALL AND FLOOR COVERINGS AND STAIRS; CABLE CONDUITS; CABLE CLAMPS; FIXING CLIPS; METALLIC FRAME BARS FOR USE AS CABLE DUCTS, WITH CAST, DRY MORTARLESS CONSTRUCTION, FOR TILING, FOR BANDING, FOR HIDING THE TRANSITION OF VARIOUS FLOORING MATERIALS; ALL THE ABOVE GOODS OF METAL (U.S. CLS. 2, 12, 13, 14, 23, 25 AND 50).

CLASS 9—ELECTRICAL AND SCIENTIFIC APPARATUS

FOR CABLE CONDUITS, NAMELY, CHANNELS FOR ELECTRIC CABLES; CURRENT BARS; ANNUNCIATORS; POWER OUTLETS, POWER OUTLET COVERS; PLASTIC CABLE CONDUITS FOR ELECTRICAL USE (U.S. CLS. 21, 23, 26, 36 AND 38).

CLASS 11—ENVIRONMENTAL CONTROL APPARATUS

FOR SHINERS, NAMELY, ELECTRIC LUMINAIRES, AND LAMPS (U.S. CLS. 13, 21, 23, 31 AND 34).

CLASS 19—NON-METALLIC BUILDING MATERIALS

FOR PLASTIC BUILDING MATERIALS, NAMELY, RAILS; SLABS; RODS, FRAMES; FRAME PIECES; PROFILED FLAT RAILS AND BARS; AS WELL AS ASSEMBLY PROFILES FOR COVERINGS, EDGINGS AND CONNECTIONS AT WALL AND FLOOR COVERINGS AND STAIRS; WOOD FRAMES, FRAME BARS, FRAME PIECES FOR THE USE IN CONSTRUCTION, WITH CAST, DRY MORTARLESS CONSTRUCTION, FOR FILING, FOR BANDING, FOR HIDING THE TRANSITION OF VARIOUS FLOORING MATERIALS; COMBINED WOODEN AND ALUMINUM FRAMES, FRAME BARS, FRAME PIECES FOR THE USE IN CONSTRUCTION, WITH CAST, DRY MORTARLESS CONSTRUCTION, FOR TILING, FOR BANDING, FOR HIDING THE TRANSITION OF VARIOUS FLOORING MATERIALS (U.S. CLS. 1, 12, 33 AND 50).

CLASS 20—FURNITURE AND ARTICLES NOT OTHERWISE CLASSIFIED

FOR SHELVES; PLASTIC FRAME BARS FOR USE AS CABLE DUCTS; PLASTIC FIXING CLIPS FOR CABLE AND PIPES; NON METALLIC CABLE CLIPS (U.S. CLS. 2, 13, 22, 25, 32 AND 50).

GRETTA YAO, EXAMINING ATTORNEY

SN 78-398,194. THE LEONARD BERNSTEIN OFFICE, INC., NEW YORK, NY. FILED 4-7-2004.

WEST SIDE STORY

THE MARK CONSISTS OF STANDARD CHARACTERS WITHOUT CLAIM TO ANY PARTICULAR FONT, STYLE, SIZE, OR COLOR.

OWNER OF U.S. REG. NOS. 2,374,613, 2,380,730 AND 2,397,038.

CLASS 35—ADVERTISING AND BUSINESS

FOR ONLINE RETAIL STORE SERVICES FEATURING CLOTHING, PRINTED MATTER, AUDIO AND VIDEO CASSETTES, COMPACT DISCS, DIGITAL VIDEO DISCS, GLASSWARE, PAPER GOODS AND TOTE BAGS (U.S. CLS. 100, 101 AND 102).

FIRST USE 5-0-2001; IN COMMERCE 5-0-2001.

CLASS 38—COMMUNICATION

FOR PROVIDING ONLINE ELECTRONIC BULLETIN BOARDS FOR TRANSMISSION OF MESSAGES AMONG COMPUTER USERS CONCERNING IN CONNECTION WITH THEATRICAL PRODUCTIONS, FILM, MUSICAL COMPOSITIONS, PERFORMANCES, SOFTWARE, ARTICLES AND EDITORIALS (U.S. CLS. 100, 101 AND 104).

FIRST USE 5-0-2001; IN COMMERCE 5-0-2001.

CLASS 41—EDUCATION AND ENTERTAINMENT

FOR PROVIDING ONLINE DATABASES OF THEATRICAL PRODUCTIONS AND HISTORICAL ENTERTAINMENT INFORMATION AND LYRICS FROM THEATRICAL AND MOTION PICTURE PERFORMANCES (U.S. CLS. 100, 101 AND 107).

FIRST USE 5-0-2001; IN COMMERCE 5-0-2001.

CLASS 42—SCIENTIFIC, COMPUTER AND LEGAL SERVICES

FOR LEGAL SERVICES, NAMELY, PROVIDING LICENSING SERVICES IN CONNECTION WITH INTELLECTUAL PROPERTY, NAMELY, THEATRICAL PRODUCTIONS AND TRADEMARKS (U.S. CLS. 100 AND 101).

FIRST USE 5-0-2001; IN COMMERCE 5-0-2001.

JASON TURNER, EXAMINING ATTORNEY

SN 78-398,323. AGUERRE, SANTIAGO, LA JOLLA, CA. FILED 4-7-2004.

LIQUID NATION

THE MARK CONSISTS OF STANDARD CHARACTERS WITHOUT CLAIM TO ANY PARTICULAR FONT, STYLE, SIZE, OR COLOR.

CLASS 25—CLOTHING

FOR MEN'S AND WOMEN'S AND CHILDREN'S CLOTHING, NAMELY, T-SHIRTS, SWEATSHIRTS, TANK TOPS, JACKETS, PULLOVERS, SKIRTS, PANTS, SWEAT PANTS, SHORTS, SWIMSUITS; HEADWEAR, NAMELY, HATS AND CAPS (U.S. CLS. 22 AND 39).

CLASS 41—EDUCATION AND ENTERTAINMENT

FOR ENTERTAINMENT SERVICES, NAMELY ORGANIZING AND CONDUCTING EVENTS, PARTIES AND FESTIVALS IN THE FIELD OF SURFING. (U.S. CLS. 100, 101 AND 107).

WILLIAM BRECKENFELD, EXAMINING ATTORNEY

SN 78-398,492. FIREBAUGH, DOUG, BIRMINGHAM, MI. FILED 4-8-2004.

GOD POWERED

THE MARK CONSISTS OF STANDARD CHARACTERS WITHOUT CLAIM TO ANY PARTICULAR FONT, STYLE, SIZE, OR COLOR.

CLASS 9—ELECTRICAL AND SCIENTIFIC APPARATUS

FOR AUDIO TAPES AND CDS FEATURING PRE-RECORDED MUSIC AND SPEECHES (U.S. CLS. 21, 23, 26, 36 AND 38).

CLASS 16—PAPER GOODS AND PRINTED MATTER

FOR SERIES OF BOOKS AND NEWSLETTERS IN THE FIELD OF RELIGION (U.S. CLS. 2, 5, 22, 23, 29, 37, 38 AND 50).

WILLIAM BRECKENFELD, EXAMINING ATTORNEY

SN 78-398,896. ADAMS CREATIVE PRODUCTS, INC., PHILADELPHIA, PA. FILED 4-8-2004.

SN 78-398,798. CAUDALIE USA, INC., RICHARDSON, TX. FILED 4-8-2004.

W

Caudalie
Vinothérapie

THE MARK CONSISTS OF STANDARD CHARACTERS WITHOUT CLAIM TO ANY PARTICULAR FONT, STYLE, SIZE, OR COLOR.

CLASS 2—PAINTS

FOR ARTISTS' SUPPLIES, NAMELY, ARTISTS' PAINTS, ARTISTS' OIL PAINTS, ARTISTS' ACRYLIC PAINTS, AND ARTISTS' PAINT GELS, COLOR PIGMENTS, GUM TURPENTINE, VARNISH, GESSO PAINT THINNERS AND THICKENERS, WATER COLOR PAINTS, GUM TURPENTINE SUBSTITUTE USED WITH ARTISTS' OIL PAINTS AND OTHER ARTISTS' PAINTS AS A PAINT THINNER (U.S. CLS. 6, 11 AND 16).

FIRST USE 0-0-1962; IN COMMERCE 0-0-1962.

THE MARK CONSISTS OF STANDARD CHARACTERS WITHOUT CLAIM TO ANY PARTICULAR FONT, STYLE, SIZE, OR COLOR.

OWNER OF U.S. REG. NO. 2,258,400.

CLASS 3—COSMETICS AND CLEANING PREPARATIONS

FOR GRAPE-SEED-BASED SKIN CARE PREPARATIONS FOR USE IN COSMETICS (U.S. CLS. 1, 4, 6, 50, 51 AND 52).

FIRST USE 12-17-1998; IN COMMERCE 12-17-1998.

CLASS 44—MEDICAL, BEAUTY AND AGRICULTURAL SERVICES

FOR SPA SERVICES USING GRAPE-BASED PRODUCTS (U.S. CLS. 100 AND 101).

FIRST USE 12-17-1998; IN COMMERCE 12-17-1998.
AMY GEARIN, EXAMINING ATTORNEY

CLASS 16—PAPER GOODS AND PRINTED MATTER

FOR ARTISTS' SUPPLIES, NAMELY, BRUSHES, PANELS OF CANVAS FOR DRAWING AND PAINTING, PAPER FOR DRAWING AND PAINTING, PAPER FOR TRANSFERRING PATTERNS, PALETTES FOR PAINTING, CHALKS, CHARCOAL PENCILS, CHARCOAL STICKS, PENS, ERASERS, EASELS, PRINTED INSTRUCTIONAL MATERIALS AND BOOKS IN THE FIELD OF ART, DRAWING INKS, ART MATERIAL SETS COMPOSED PRIMARILY OF BRUSHES, PENCILS, CHARCOAL STICKS, ART PAPER, PENCIL SHARPENERS, WATERCOLOR AND OIL PAINTS, AND PLASTIC FILM FOR TRANSFER OF INDICIA ONTO OTHER SURFACES, SOLD AS A UNIT (U.S. CLS. 2, 5, 22, 23, 29, 37, 38 AND 50).

FIRST USE 0-0-1962; IN COMMERCE 0-0-1962.
TRACY CROSS, EXAMINING ATTORNEY

SN 78-398,933. GENETIC SAVINGS & CLONE, INC., SAUSALITO, CA. FILED 4-8-2004.

CLASS 42—SCIENTIFIC, COMPUTER AND LEGAL SERVICES

FOR ARCHITECTURAL DESIGN SERVICES; DRAFTING SERVICES; PLANNING OF BUILDINGS AND INFRASTRUCTURE SYSTEMS FOR BUILDINGS (U.S. CLS. 100 AND 101).

FIRST USE 1-1-1985; IN COMMERCE 1-1-1985.
MONIQUE MILLER, EXAMINING ATTORNEY

PETBANK

SN 78-399,463. EDUCATIONAL ADVENTURES, LLC, CHARLOTTE, NC. FILED 4-9-2004.



THE MARK CONSISTS OF STANDARD CHARACTERS WITHOUT CLAIM TO ANY PARTICULAR FONT, STYLE, SIZE, OR COLOR.

CLASS 42—SCIENTIFIC, COMPUTER AND LEGAL SERVICES

FOR RESEARCH AND DEVELOPMENT SERVICES IN THE FIELDS OF GENETICS, BIOLOGICAL AND ANIMAL CLONING, AND GENE MANIPULATION AND GENE THERAPY; ANIMAL AND BIOLOGICAL CLONING SERVICES. (U.S. CLS. 100 AND 101).

CLASS 44—MEDICAL, BEAUTY AND AGRICULTURAL SERVICES

FOR GENE BANK SERVICES, IN THE NATURE OF GENE HARVESTING, PRESERVATION AND STORAGE SERVICES; CATTERY SERVICES IN THE NATURE OF BREEDING CATS. (U.S. CLS. 100 AND 101).

APRIL L. RADEMACHER, EXAMINING ATTORNEY

THE COLOR(S) ORANGE, PURPLE, TAN, BLUE AND YELLOW AND GREY IS/ARE CLAIMED AS A FEATURE OF THE MARK.

THE PURPLE DOG AND TAN CAT APPEAR IN AN ORANGE CIRCLE, THE INVERTED TRIANGLE IS YELLOW AND THE LETTERING IS BLUE.

CLASS 22—CORDAGE AND FIBERS

FOR BED TENTS (U.S. CLS. 1, 2, 7, 19, 22, 42 AND 50).

CLASS 24—FABRICS

FOR HOUSEHOLD LINENS, BED SPREADS, QUILTS, BED SHEETS, PILLOW CASES, PILLOW SHAMS, DUVETS, DUST RUFFLES, BATH TOWELS, WASH MITTS, BEACH TOWELS AND WASH CLOTHS, TABLE CLOTHS NOT OF PAPER; TEXTILE WALL HANGINGS; AND FABRIC FOR THE MANUFACTURE OF CLOTHING AND CRAFTS (U.S. CLS. 42 AND 50).

NORA BUCHANAN WILL, EXAMINING ATTORNEY

SN 78-399,305. ROSENFELD, ENRIQUE NORTEN, NEW YORK, NY. FILED 4-9-2004.

TEN ARQUITECTOS

SN 78-399,597. ERRAND SERVICES BIZ, INC., LAFAYETTE, CO. FILED 4-9-2004.

THE MARK CONSISTS OF STANDARD CHARACTERS WITHOUT CLAIM TO ANY PARTICULAR FONT, STYLE, SIZE, OR COLOR.

NO CLAIM IS MADE TO THE EXCLUSIVE RIGHT TO USE "ARQUITECTOS", APART FROM THE MARK AS SHOWN.

THE ENGLISH TRANSLATION OF THE SPANISH WORD "ARQUITECTOS" IN THE MARK IS "ARCHITECTS".

CLASS 37—CONSTRUCTION AND REPAIR

FOR CONSTRUCTION PLANNING (U.S. CLS. 100, 103 AND 106).

FIRST USE 1-1-1985; IN COMMERCE 1-1-1985.



NO CLAIM IS MADE TO THE EXCLUSIVE RIGHT TO USE SERVICES, APART FROM THE MARK AS SHOWN.

THE MARK CONSISTS OF A LOWER CASE "E" INSIDE A THREE DIMENSIONAL SPHERE AND A CIRCULAR SHADOW BELOW THE SPHERE, AND THE STYLIZED LETTERS "SERVICES".

CLASS 44—MEDICAL, BEAUTY AND AGRICULTURAL SERVICES

FOR PET SITTING SERVICES (U.S. CLS. 100 AND 101).
FIRST USE 12-15-2003; IN COMMERCE 12-15-2003.

CLASS 45—PERSONAL SERVICES

FOR RUNNING ERRANDS FOR OTHERS, MAKING REQUESTED PERSONAL ARRANGEMENTS AND RESERVATIONS FOR OTHERS, PERSONAL SHOPPING FOR OTHERS AND HOUSE SITTING (U.S. CLS. 100 AND 101).

FIRST USE 12-15-2003; IN COMMERCE 12-15-2003.
MICHELE SWAIN, EXAMINING ATTORNEY

SN 78-399,822. MORRIS, PETER, CHICAGO, IL. FILED 4-10-2004.

**THE BUSINESS
SHRINK**

THE MARK CONSISTS OF STANDARD CHARACTERS WITHOUT CLAIM TO ANY PARTICULAR FONT, STYLE, SIZE, OR COLOR.

NO CLAIM IS MADE TO THE EXCLUSIVE RIGHT TO USE "BUSINESS", APART FROM THE MARK AS SHOWN.

CLASS 16—PAPER GOODS AND PRINTED MATTER

FOR PRINTED MATTER AND PRINTED PUBLICATIONS, NAMELY, BOOKS, BOOKLETS, CATALOGS, GUIDES, INSTRUCTIONAL AND TEACHING MATERIALS, PERIODICALS, NEWSLETTERS, JOURNALS, MAGAZINES, SECTIONS OF MAGAZINES, MAGAZINES AND NEWSPAPER COLUMNS, INFORMATION FACT SHEETS, BROCHURES AND PAMPHLETS, ALL IN THE FIELD OF BUSINESS AND BUSINESS STRATEGIES (U.S. CLS. 2, 5, 22, 23, 29, 37, 38 AND 50).

CLASS 35—ADVERTISING AND BUSINESS

FOR COMPUTER SERVICES, NAMELY, PROVIDING INFORMATION VIA AN INTERNET WEB SITE FEATURING INFORMATION ON THE SUBJECT MATTER OF APPLICANT'S RADIO PROGRAMS AND EDUCATIONAL SERVICES, NAMELY, BUSINESS AND BUSINESS STRATEGIES, SYSTEMS, ETHICS AND ANALYSIS (U.S. CLS. 100, 101 AND 102).

CLASS 41—EDUCATION AND ENTERTAINMENT

FOR EDUCATIONAL SERVICES, NAMELY, CONDUCTING CLASSES, SEMINARS, CONFERENCES, WORKSHOPS, INTERNET SESSIONS IN THE FIELDS OF BUSINESS AND BUSINESS STRATEGIES, SYSTEMS, ETHICS AND ANALYSIS (U.S. CLS. 100, 101 AND 107).
MATTHEW KLINE, EXAMINING ATTORNEY

SN 78-400,173. JOSEPH W. TENHAGEN GEMSTONES, INC., MIAMI, FL. FILED 4-12-2004.

**TGL UNIVERSAL
BRILLIANCE GRADE**

THE MARK CONSISTS OF STANDARD CHARACTERS WITHOUT CLAIM TO ANY PARTICULAR FONT, STYLE, SIZE, OR COLOR.

NO CLAIM IS MADE TO THE EXCLUSIVE RIGHT TO USE "UNIVERSAL BRILLIANCE GRADE", APART FROM THE MARK AS SHOWN.

CLASS 36—INSURANCE AND FINANCIAL

FOR APPRAISING DIAMONDS AND GEMSTONES' QUALITY CHARACTERISTIC, AND REPORTING ON THE APPRAISAL OF DIAMONDS' AND GEMSTONES' QUALITY CHARACTERISTICS (U.S. CLS. 100, 101 AND 102).

FIRST USE 8-4-2000; IN COMMERCE 8-4-2000.

CLASS 42—SCIENTIFIC, COMPUTER AND LEGAL SERVICES

FOR GEMOLOGICAL SERVICES, NAMELY, GRADING, ANALYZING, TESTING OF DIAMONDS AND GEMSTONES FOR QUALITY CHARACTERISTICS, AND REPORTING ON THE GRADING, ANALYZING, TESTING OF DIAMONDS' AND GEMSTONES' QUALITY CHARACTERISTICS (U.S. CLS. 100 AND 101).

FIRST USE 8-4-2000; IN COMMERCE 8-4-2000.

JOHN DALIER, EXAMINING ATTORNEY

SN 78-400,364. US SOUTHWEST, L.L.C., BULLHEAD CITY, AZ. FILED 4-12-2004.

US SOUTHWEST

THE COLOR(S) VIOLET, BLUE, RED, WHITE, YELLOW, PURPLE, GREEN & PINK IS/ARE CLAIMED AS A FEATURE OF THE MARK.

THE LETTERING IS VIOLET WITH WHITE BORDERS. THE BACKGROUND IS A BAR OF COLOR BANDS STARTING WITH A PINK BAND AT THE TOP, FOLLOWED BY A BLUE BAND, A YELLOW BAND, A RED BAND, A PURPLE BAND, A RED BAND, AND AT THE BOTTOM, A GREEN BAND.

THE MARK CONSISTS OF "US" IN HELVETICA COMPRESSED, INLINE EFFECT AND BOLD; "SOUTHWEST" IN HELVETICA, INLINE EFFECT, BOLD.

SEC. 2(F).

CLASS 36—INSURANCE AND FINANCIAL

FOR REAL ESTATE AGENCIES; REAL ESTATE MANAGEMENT (U.S. CLS. 100, 101 AND 102).

FIRST USE 10-15-1998; IN COMMERCE 1-1-1999.

CLASS 37—CONSTRUCTION AND REPAIR

FOR REAL ESTATE DEVELOPMENT; LAND DEVELOPMENT SERVICES, NAMELY, PLANNING AND LAYING OUT OF RESIDENTIAL AND COMMERCIAL COMMUNITY CONSTRUCTION; CUSTOM CONSTRUCTION OF HOUSES (U.S. CLS. 100, 103 AND 106).

FIRST USE 10-15-1998; IN COMMERCE 1-1-1999.
GEOFFREY FOSDICK, EXAMINING ATTORNEY

SN 78-400,844. CAROLINE K MORGAN PTY LIMITED, NORTH FITZROY VICTORIA 3068, AUSTRALIA, FILED 4-13-2004.

CAROLINE K MORGAN

THE MARK CONSISTS OF STANDARD CHARACTERS WITHOUT CLAIM TO ANY PARTICULAR FONT, STYLE, SIZE, OR COLOR.

PRIORITY CLAIMED UNDER SEC. 44(D) ON AUSTRALIA APPLICATION NO. 994119, FILED 3-17-2004, REG. NO. 994119, DATED 3-17-2004, EXPIRES 3-17-2014.

THE MARK CAROLINE K MORGAN DOES NOT IDENTIFY A LIVING INDIVIDUAL.

CLASS 18—LEATHER GOODS

FOR LEATHER AND IMITATION LEATHER BAGS; LUGGAGE, TRAVELING BAGS, BACKPACKS, TOTE BAGS, CARRYALLS, BUMBAGS, HANDBAGS, PURSES, COIN AND CHANGE PURSES (U.S. CLS. 1, 2, 3, 22 AND 41).

CLASS 25—CLOTHING

FOR FOOTWEAR; HEADWEAR; SHIRTS; BLOUSES; SINGLET; TEE-SHIRTS; TOPS; VESTS; CARDIGANS; SWEATERS; JUMPERS; WAISTCOATS; JACKETS; COATS; OVERCOATS; RAINCOATS; SHAWLS; WRAPS; GOWNS; ROBES; DRESSES; SKIRTS; PANTS; TROUSERS; JEANS; SHORTS; SUITS; SWIMWEAR; SOCKS; STOCKINGS; HOSIERY; SCARVES; GLOVES; MITTENS; BELTS (U.S. CLS. 22 AND 39).

IRA J. GOODSaid, EXAMINING ATTORNEY

SN 78-401,120. CHARLES SCHWAB & CO., INC., SAN FRANCISCO, CA. FILED 4-13-2004.

**SCHWAB TRADER CT
PRO**

THE MARK CONSISTS OF STANDARD CHARACTERS WITHOUT CLAIM TO ANY PARTICULAR FONT, STYLE, SIZE, OR COLOR.

NO CLAIM IS MADE TO THE EXCLUSIVE RIGHT TO USE TRADER OR PRO, APART FROM THE MARK AS SHOWN.

THE TERM "SCHWAB" DOES REFER TO THE SURNAME OF A PARTICULAR LIVING INDIVIDUAL, CHARLES SCHWAB.

SEC. 2(F) AS TO "SCHWAB".

CLASS 9—ELECTRICAL AND SCIENTIFIC APPARATUS

FOR DOWNLOADABLE SOFTWARE FOR USE BY INVESTORS IN THE TRADING AND ANALYSIS OF INVESTMENTS, FINANCES AND FINANCIAL PLANNING, VIA A GLOBAL COMPUTER NETWORK, NAMELY, SOFTWARE FOR ELECTRONIC TRADING IN ALL FORMS OF SECURITIES, NAMELY, STOCKS, BONDS, MUTUAL FUNDS, MONEY MARKET FUNDS, CURRENCIES, COMMODITIES, FUTURES, OPTIONS, INDICES OF ANY OF THEM, AND ANY OTHER INVESTMENT VEHICLES; DOWNLOADABLE SOFTWARE FOR USE IN PROVIDING FINANCIAL AND INVESTMENT INFORMATION, FINANCIAL AND INVESTMENT NEWS, AND FINANCIAL AND INVESTMENT RESEARCH; DOWNLOADABLE SOFTWARE FOR USE IN MAINTAINING FINANCIAL AND INVESTMENT DATABASES (U.S. CLS. 21, 23, 26, 36 AND 38).

CLASS 35—ADVERTISING AND BUSINESS

FOR PROVIDING INFORMATION AND ANALYSIS IN THE FIELDS OF ECONOMICS AND BUSINESS, NAMELY, INDUSTRY AND SECTOR REPORTS AND FORECASTS, ECONOMIC REPORTS AND FORECASTS (U.S. CLS. 100, 101 AND 102).

CLASS 36—INSURANCE AND FINANCIAL

FOR INVESTMENT BROKERAGE SERVICES AND SECURITIES INVESTMENT SERVICES PROVIDED ELECTRONICALLY AND VIA THE INTERNET, NAMELY, ELECTRONIC TRADING FOR OTHERS IN SECURITIES, STOCKS, BONDS, MUTUAL FUNDS, MONEY MARKET FUNDS, COMMODITIES, FUTURES, OPTIONS, CURRENCIES, INDICES OF ANY OF THEM, AND ANY OTHER INVESTMENT VEHICLES; BROKERAGE SERVICES AND INVESTMENT SERVICES, NAMELY, TRADING IN SECURITIES, STOCKS, BONDS, MUTUAL FUNDS, MONEY MARKET FUNDS, COMMODITIES, FUTURES, OPTIONS, CURRENCIES, AND INDICES OF ANY OF THEM; PROVIDING FINANCIAL AND INVESTMENT INFORMATION, FINANCIAL AND INVESTMENT NEWS, FINANCIAL AND INVESTMENT RESEARCH SERVICES, FINANCIAL AND INVESTMENT INFORMATION, NAMELY, PROVIDING REAL-TIME, STREAMING NASDAQ LEVEL II QUOTES, ADVANCED TECHNICAL CHARTING, MARKET CHARTS, WATCH LISTS AND ALERTS, STOCK SCREENER, AND TRADE EXECUTION INFORMATION, PROVIDING AN ON-LINE COMPUTER DATABASE IN THE FIELD OF FINANCE AND FINANCIAL INVESTMENT ALL FOR USE BY INVESTORS IN THE TRADING AND ANALYSIS OF INVESTMENTS, FINANCES, AND FINANCIAL PLANNING VIA THE INTERNET OR VIA OTHER MEANS; FINANCIAL PORTFOLIO MANAGEMENT SERVICES PROVIDED VIA ELECTRONIC COMMUNICATION NETWORKS; SECURITIES BROKERAGE ACCOUNT SERVICES INCLUDING AN INTEREST BEARING FEATURE FOR CASH BETWEEN INVESTMENTS, ACCESS TO CASH, AND MARGIN LOANS; CREDIT CARD AND DEBIT CARD SERVICES; CASH MANAGEMENT ACCOUNT SERVICES; BILL PAYMENT SERVICES AND ELECTRONIC FUND TRANSFER SERVICES; FINANCIAL ANALYSIS IN THE FIELDS OF INVESTING, FINANCE, STOCK SCREENING, AND MARKET TRENDS; FINANCIAL PLANNING AND FINANCIAL CONSULTATION, NAMELY, FINANCIAL DECISION MAKING SERVICES; FINANCIAL ANALYSIS, NAMELY, MONITORING INVESTMENT VALUE AND PERFORMANCE OF INVESTMENTS, ANALYZING INVESTMENT PERFORMANCE, EVALUATING ASSET ALLOCATION, RISK TOLERANCE, FINANCIAL ALTERNATIVE PLANS AND INVESTMENT TIME FRAMES; PROVIDING INFORMATION AND ANALYSIS IN THE FIELDS OF FINANCE, FINANCIAL INVESTMENT, FINANCIAL PLANNING, AND FINANCIAL INVESTMENT STRATEGY; PROVIDING INVESTMENT RESEARCH; PROVIDING AN INTERACTIVE ONLINE COMPUTER DATABASE IN THE FIELD OF FINANCIAL PORTFOLIO MANAGEMENT, FINANCIAL INVESTING, FINANCE, FINANCIAL PLANNING, FINANCIAL NEWS, AND FINANCIAL INFORMATION; PROVIDING INFORMATION IN THE FIELDS OF FINANCIAL INVESTMENT ACCOUNT INFORMATION AND FINANCIAL RESEARCH VIA ONLINE AND ELECTRONIC

MEANS; PROVISION OF NEWS, INFORMATION, RESEARCH, AND ANALYSIS IN THE FIELDS OF FINANCIAL INVESTING, FINANCE, AND FINANCIAL PLANNING VIA ELECTRONIC COMMUNICATION NETWORKS (U.S. CLS. 100, 101 AND 102).

SN 78-402,455. BATHCO, INC., WILMINGTON, DE. FILED 4-15-2004.

CLASS 38—COMMUNICATION

FOR PROVIDING ON-LINE CHAT ROOMS FOR TRANSMISSION OF MESSAGES AMONG COMPUTER USERS CONCERNING THE TRADING AND ANALYSIS OF INVESTMENTS, FINANCES AND FINANCIAL PLANNING, SECURITIES, NAMELY, STOCKS, BONDS, MUTUAL FUNDS, MONEY MARKET FUNDS, CURRENCIES, COMMODITIES, FUTURES, OPTIONS, INDICES OF ANY OF THEM, AND ANY OTHER INVESTMENT VEHICLES; PROVIDING ON-LINE CHAT ROOMS FOR TRANSMISSION OF MESSAGES AMONG COMPUTER USERS CONCERNING FINANCIAL AND INVESTMENT INFORMATION, FINANCIAL AND INVESTMENT NEWS, AND FINANCIAL AND INVESTMENT RESEARCH; PROVIDING ACCESS TO ELECTRONIC SITES FEATURING REAL-TIME, STREAMING NASDAQ LEVEL II QUOTES, ADVANCED TECHNICAL CHARTING, MARKET CHARTS, WATCH LISTS AND ALERTS, STOCK SCREENERS, AND TRADE EXECUTION INFORMATION (U.S. CLS. 100, 101 AND 104).

CLASS 41—EDUCATION AND ENTERTAINMENT

FOR EDUCATION SERVICES, NAMELY, PROVIDING TRAINING SESSIONS FOR INVESTORS IN THE FIELD OF TRADING IN ALL FORMS OF SECURITIES, NAMELY, STOCKS, BONDS, MUTUAL FUNDS, MONEY MARKET FUNDS, CURRENCIES, COMMODITIES, FUTURES, OPTIONS, INDICES OF ANY OF THEM, AND ANY OTHER INVESTMENT VEHICLES; EDUCATION SERVICES, NAMELY, PROVIDING TRAINING SESSIONS FOR INVESTORS IN THE FIELD OF FINANCIAL AND INVESTMENT INFORMATION, FINANCIAL AND INVESTMENT NEWS, AND FINANCIAL AND INVESTMENT RESEARCH; EDUCATION SERVICES, NAMELY, PROVIDING TRAINING SESSIONS FOR INVESTORS IN THE FIELD OF THE TRADING AND ANALYSIS OF INVESTMENTS, FINANCES AND FINANCIAL PLANNING (U.S. CLS. 100, 101 AND 107).

CLASS 42—SCIENTIFIC, COMPUTER AND LEGAL SERVICES

FOR PROVIDING TEMPORARY USE OF NON-DOWNLOADABLE SOFTWARE FOR USE BY INVESTORS IN THE TRADING AND ANALYSIS OF INVESTMENTS, FINANCES AND FINANCIAL PLANNING, VIA A GLOBAL COMPUTER NETWORK, NAMELY, SOFTWARE FOR ELECTRONIC TRADING IN ALL FORMS OF SECURITIES, NAMELY, STOCKS, BONDS, MUTUAL FUNDS, MONEY MARKET FUNDS, CURRENCIES, COMMODITIES, FUTURES, OPTIONS, INDICES OF ANY OF THEM, AND ANY OTHER INVESTMENT VEHICLES; PROVIDING TEMPORARY USE OF NON-DOWNLOADABLE SOFTWARE FOR PROVIDING FINANCIAL AND INVESTMENT INFORMATION, FINANCIAL AND INVESTMENT NEWS, AND FINANCIAL AND INVESTMENT RESEARCH; PROVIDING TEMPORARY USE OF NON-DOWNLOADABLE SOFTWARE WHICH ALLOWS USERS TO SEARCH FOR FINANCIAL AND INVESTMENT INFORMATION, FINANCIAL AND INVESTMENT NEWS, AND FINANCIAL AND INVESTMENT RESEARCH; PROVIDING TEMPORARY USE OF NON-DOWNLOADABLE SOFTWARE FOR USE IN MAINTAINING FINANCIAL AND INVESTMENT DATABASES (U.S. CLS. 100 AND 101).

EVELYN BRADLEY, EXAMINING ATTORNEY

B&BW

THE MARK CONSISTS OF STANDARD CHARACTERS WITHOUT CLAIM TO ANY PARTICULAR FONT, STYLE, SIZE, OR COLOR.

CLASS 3—COSMETICS AND CLEANING PREPARATIONS

FOR PERSONAL CARE PRODUCTS, NAMELY, AFTER SHAVE, AFTER SHAVE BALM, AGE SPOT LIGHTENING CREAMS, ANTIPERSPIRANT, ASTRINGENT FOR THE FACE, ASTRINGENT FOR THE SKIN, BATH BEADS, BATH CREAM, BATH BEADS, NAMELY, BATH CUBES AND BATH FIZZIES, BATH FOAM, BATH MILK, BATH OIL, BATH SALTS, BLEMISH CORRECTOR SKIN CREAM, BLEMISH SKIN CREAM STICK, BODY BALM, BODY SOAP BAR, BODY BUTTER BODY CREAM, BODY ESSENCE, NAMELY, FRAGRANT BODY SPRAY, BODY GEL, BODY GLITTER, BODY LOTION, BODY LUSTER, NAMELY, SHIMMERING BODY LOTION, BODY MASK, BODY OIL, BODY PAINT, BODY POWDER, BODY SCRUB, BODY SMOOTHER, BODY SOAP, BODY SPLASH, BODY WASH, BUBBLE BATH, BUFFING BAR, COLOGNE, CREAM BODY WASH, CREAM CLEANSER, CUTICLE CREAM, CUTICLE CREAM STICK, CUTICLE OIL PEN, DEODORANT, ESSENTIAL OILS FOR PERSONAL USE, EXFOLIATOR FOR THE FEET, NAMELY, EXFOLIATING SKIN CREAM AND SKIN SCRUB FOR THE FEET, EYE SUNSCREEN BLOCK, EYE CREAM, EYE GEL, EYE MASK, FACE BALM, FACE BLOCK, FACE CLEANSER, FACE CREAM, FACE GEL, FACE LOTION, FACE MASK, FACE MIST, NAMELY, FRAGRANT FACE SPRAYS, FACE MOISTURIZER, FACE POLISHER, FACE POWDER, FACE SCRUB, FACE SOAP, FACE WASH, FIRING LOTION TREATMENT, FOAM BATH, FOOT CREAM, FOOT LOTION, FOOT POWDER, FOOT SCRUB, FOOT SOAK, FOOT SPRAY, GEL FACE WASH, GLYCERIN SOAP, HAIR CONDITIONER, HAIR DETANGLER, HAIR DYE, HAIR GEL, HAIR GLITTER, HAIR INHIBITOR LOTION, HAIR MASCARA, HAIR POMADE, HAIR RECONSTRUCTING CREAM, HAIR REMOVING CREAM, HAIR REPAIR, HAIR RINSE, HAIR SHAMPOO, HAIR SHINE SERUM, HAIR SPRAY, HAIR STRAIGHTENING SHAMPOO, HAIR STYLING MOUSSE, HAND BALM, HAND CLEANSING SPRAY, HAND CREAM, HAND EXFOLIATOR, NAMELY EXFOLIATING HAND SKIN CREAM, HAND LOTION, HAND RENEWER LOTION, HAND SOAP, HAND WASH, LEG BRONZER LOTION AND CREAM, LEG REFRESHER SPRAY, ANTI-WRINKLE CREAM, NAMELY, LINE PREVENTION CONCENTRATE, LINE PREVENTION SERUM, LINE REDUCING CONCENTRATE, LINE REDUCING SERUM, LIP BALM, LIP BLOCK, LIP GLOSS, LIP PAINT, LIP PROTECTOR NON-MEDICATED CREAM, LIP SHINE, LIP TINT, MASSAGE CREAM, MASSAGE LOTION, MASSAGE OIL, MOOD ENHANCING MASSAGE OINTMENT, MOOD ENHANCING MIST, NAMELY, FRAGRANT SPRAY OR SPLASH, MOOD ENHANCING SKIN CREAM, NAIL CREAM, NAIL POLISH, NAIL POLISH REMOVER, NAIL STENCILS, NIGHT EYE CREAM, NIGHT NOURISHING SKIN CREAM, OIL BLOTTING SHEETS FOR THE SKIN, OIL BODY SPRAY, NON-MEDICATED MUSCLE RUB,

PERFUME, PERFUME OILS, PILLOW MIST, NAMELY, FRAGRANT LINEN SPRAY, POST-SUNTANNING LOTION FOR THE BODY, POTPOURRI, POWDER FOR THE FEET, PRE-SUNTANNING LOTION FOR THE BODY, PULSE POINT SKIN CREAM AND SKIN OIL, PUMICE STONES FOR PERSONAL USE, REFILLS FOR ELECTRIC ROOM FRAGRANCE DISPENSERS, ROOM FRAGRANCE SPRAY, SACHETS, SALT BODY SCRUB, SEA SALT EXFOLIATOR, NAMELY, SEA SALT EXFOLIATING BODY SCRUB, SELF TANNING PREPARATION, NAMELY SELF TANNING CREAMS AND LOTIONS, SHAVING CREAM, SHEA BUTTER HAND CREAM, SHEA BUTTER CREAM TREATMENT STICK, SHOWER CREAM, SHOWER FOAM, SHOWER GEL, SHOWER SCRUB, SKIN BRONZING CREAM, NON-MEDICATED SKIN CLEANSING WIPES, SKIN CREAM, SKIN EXFOLIATING CREAM AND SCRUB, SKIN LOTION, SKIN MATTIFIER POWDER AND LOTION, SKIN MOISTURIZER, SKIN POLISHER, SKIN SCRUB, SKIN SERUM, SKIN SMOOTHING OIL, SOAP, STYLING HAIR FOAM, SUGAR BODY SCRUB, SUN SCREEN, SUNBLOCK FOR THE BODY, SUNBLOCK FOR THE FACE, SUNLESS TANNING CREAM, SUNLESS TANNING LOTION FOR THE BODY, SUNLESS TANNING LOTION FOR THE FACE, SUNTAN LOTION FOR THE BODY, SUNTAN LOTION FOR THE FACE, TALCUM POWDER, NON-MEDICATED VAPOR OINTMENT CREAM (U.S. CLS. 1, 4, 6, 50, 51 AND 52).

CLASS 4—LUBRICANTS AND FUELS

FOR CANDLES (U.S. CLS. 1, 6 AND 15).

CLASS 16—PAPER GOODS AND PRINTED MATTER

FOR CARDBOARD GIFT BOXES, PAPER GIFT BOXES, FABRIC GIFT BAGS, PAPER GIFT BAGS, GIFT WRAPPING PAPER (U.S. CLS. 2, 5, 22, 23, 29, 37, 38 AND 50).

CLASS 18—LEATHER GOODS

FOR COSMETIC BAGS SOLD EMPTY, TOILETRY CASES SOLD EMPTY, TRAVEL BAGS, LUGGAGE (U.S. CLS. 1, 2, 3, 22 AND 41).

CLASS 35—ADVERTISING AND BUSINESS

FOR RETAIL STORE SERVICES IN THE FIELD OF PERSONAL CARE PRODUCTS AND HOME FRAGRANCE PRODUCTS AND ACCESSORIES (U.S. CLS. 100, 101 AND 102).

ANN LINNEHAN, EXAMINING ATTORNEY

SN 78-402,520. MY GRANDMA AND ME PUBLISHERS LLC, ST. JOHNS, MI. FILED 4-15-2004.



MY GRANDMA AND ME
PUBLISHERS

NO CLAIM IS MADE TO THE EXCLUSIVE RIGHT TO USE PUBLISHERS, APART FROM THE MARK AS SHOWN.

CLASS 16—PAPER GOODS AND PRINTED MATTER

FOR BOOK AND A SERIES OF BOOKS FEATURING CHILDREN'S STORIES (U.S. CLS. 2, 5, 22, 23, 29, 37, 38 AND 50).

FIRST USE 2-9-2004; IN COMMERCE 2-18-2004.

CLASS 41—EDUCATION AND ENTERTAINMENT

FOR PUBLICATION OF CHILDREN'S BOOKS (U.S. CLS. 100, 101 AND 107).

FIRST USE 2-9-2004; IN COMMERCE 2-18-2004.

CHRISTOPHER BUONGIORNO, EXAMINING ATTORNEY

SN 78-402,561. NATIONAL MUSEUM OF FUNERAL HISTORY, HOUSTON, TX. FILED 4-15-2004.

EVERY DAY ABOVE GROUND IS A GOOD ONE

THE MARK CONSISTS OF STANDARD CHARACTERS WITHOUT CLAIM TO ANY PARTICULAR FONT, STYLE, SIZE, OR COLOR.

OWNER OF U.S. REG. NO. 2,427,997.

CLASS 35—ADVERTISING AND BUSINESS

FOR ASSOCIATION SERVICES, NAMELY, PROMOTING THE INTERESTS OF THE DEATH CARE INDUSTRY IN THE FIELDS OF FUNERAL PRACTICES, BURIAL PRACTICES, MORTUARY PRACTICES, EMBALMING PRACTICES, CREMATION PRACTICES, CEMETERY PRACTICES INCLUDING LANDSCAPING AND GARDENING, AND THE PRACTICE OF TRANSPORTING HUMAN REMAINS (U.S. CLS. 100, 101 AND 102).

CLASS 36—INSURANCE AND FINANCIAL

FOR CHARITABLE FUND RAISING SERVICES; MEMORIAL FUND RAISING SERVICES (U.S. CLS. 100, 101 AND 102).

ANNE FARRELL, EXAMINING ATTORNEY

SN 78-402,782. MOCHAJUMBIE'S ISLAND COFFEE, INC., TEMPE, AZ. FILED 4-15-2004.



NO CLAIM IS MADE TO THE EXCLUSIVE RIGHT TO USE "ISLAND COFFEE", APART FROM THE MARK AS SHOWN.

THE FOREIGN WORDING IN THE MARK TRANSLATES INTO ENGLISH AS A "SPIRIT" OR "GHOST".

CLASS 30—STAPLE FOODS

FOR COFFEE, COFFEE BEANS AND BEVERAGES MADE OUT OF COFFEE (U.S. CL. 46).

CLASS 43—HOTEL AND RESTAURANT SERVICES

FOR RESTAURANT SERVICES (U.S. CLS. 100 AND 101).
JASON LOTT, EXAMINING ATTORNEY

SN 78-403,068. MEMCORP, INC., WESTON, FL. FILED 4-16-2004.



THE COLOR(S) BLUE, BLACK AND WHITE IS/ARE CLAIMED AS A FEATURE OF THE MARK.

THE MARK CONSISTS OF THE WHITE LETTER "V" IN A CIRCLE WITH BLUE BACKGROUND ABOVE THE "V" AND BLACK BACKGROUND BELOW THE "V" AND THE LETTERS "EXTRA" IN BLUE.

CLASS 7—MACHINERY

FOR ELECTRIC FOOD BLENDERS (U.S. CLS. 13, 19, 21, 23, 31, 34 AND 35).

CLASS 9—ELECTRICAL AND SCIENTIFIC APPARATUS

FOR TELEVISIONS, DVD PLAYERS, VIDEO CAMERAS, RADIOS, KARAOKE MACHINES, AUDIO SPEAKERS, TELEPHONES AND ELECTRIC IRONS (U.S. CLS. 21, 23, 26, 36 AND 38).

CLASS 11—ENVIRONMENTAL CONTROL APPARATUS

FOR HAIR DRYERS, ELECTRIC TOASTERS, ELECTRIC TOASTER OVENS AND MICROWAVE OVENS FOR COOKING (U.S. CLS. 13, 21, 23, 31 AND 34).
MARK RADEMACHER, EXAMINING ATTORNEY

SN 78-403,107. MCCAIN FOODS USA, INC., OAK BROOK, IL. FILED 4-16-2004.

GOLDEN CRISP

THE MARK CONSISTS OF STANDARD CHARACTERS WITHOUT CLAIM TO ANY PARTICULAR FONT, STYLE, SIZE, OR COLOR.

OWNER OF U.S. REG. NO. 1,425,849.
SEC. 2(F).

CLASS 29—MEATS AND PROCESSED FOODS

FOR PREPARED APPETIZERS CONSISTING PRIMARILY OF CHEESE, PROCESSED FRUITS AND VEGETABLES (U.S. CL. 46).

FIRST USE 1-0-1992; IN COMMERCE 1-0-1992.

CLASS 30—STAPLE FOODS

FOR FRENCH TOAST (U.S. CL. 46).

FIRST USE 1-0-1992; IN COMMERCE 1-0-1992.
RENEE MCCRAY, EXAMINING ATTORNEY

SN 78-403,227. BENCHMARK PERFORMANCE GROUP, INC., HOUSTON, TX. FILED 4-16-2004.

**NO LIMITS - KNOW
HOW**

THE MARK CONSISTS OF STANDARD CHARACTERS WITHOUT CLAIM TO ANY PARTICULAR FONT, STYLE, SIZE, OR COLOR.

CLASS 35—ADVERTISING AND BUSINESS

FOR DISTRIBUTORSHIP SERVICES FEATURING COMMODITY AND SPECIALTY CHEMICALS AND COMPOUNDS FOR OILFIELD AND INDUSTRIAL USES AND APPLICATIONS (U.S. CLS. 100, 101 AND 102).

FIRST USE 7-0-1996; IN COMMERCE 7-0-1996.

CLASS 39—TRANSPORTATION AND STORAGE

FOR WAREHOUSING SERVICES, NAMELY, STORAGE, DISTRIBUTION, PICKUP AND PACKING FOR SHIPMENT OF COMMODITY AND SPECIALTY CHEMICALS AND COMPOUNDS FOR OILFIELD AND INDUSTRIAL USE AND APPLICATION FOR OTHERS (U.S. CLS. 100 AND 105).

FIRST USE 7-0-1996; IN COMMERCE 7-0-1996.

CLASS 40—MATERIAL TREATMENT

FOR MANUFACTURE OF COMMODITY AND SPECIALTY CHEMICALS AND COMPOUNDS FOR OILFIELD AND INDUSTRIAL USES AND APPLICATIONS TO THE ORDER OR SPECIFICATION OF OTHERS (U.S. CLS. 100, 103 AND 106).

FIRST USE 7-0-1996; IN COMMERCE 7-0-1996.

MICHELLE S. WISEMAN, EXAMINING ATTORNEY

SN 78-404,576. LABRADOR RETRIEVER CO., LTD., TOKYO, JAPAN, FILED 4-20-2004.

SN 78-404,578. LABRADOR RETRIEVER CO., LTD., TOKYO, JAPAN, FILED 4-20-2004.

LABRA POP

THE MARK CONSISTS OF STANDARD CHARACTERS WITHOUT CLAIM TO ANY PARTICULAR FONT, STYLE, SIZE, OR COLOR.

PRIORITY CLAIMED UNDER SEC. 44(D) ON JAPAN APPLICATION NO. 2004-33879, FILED 4-9-2004, REG. NO. 4841280, DATED 2-25-2005, EXPIRES 2-25-2015.

CLASS 18—LEATHER GOODS

FOR TRAVELING BAGS OF LEATHER AND IMITATION LEATHER, ALL PURPOSE SPORTS BAGS, ATHLETIC BAGS, GARMENT BAGS FOR TRAVEL, VALISES, BRIEFCASES, POUCHES OF LEATHER AND IMITATION LEATHER, DRAWSTRING POUCHES, GOLF SHOE BAGS FOR TRAVEL AND CARRYING CASES, BACKPACKS, HANDBAGS, SHOULDER BAGS, SHOPPING BAGS OF LEATHER AND IMITATION LEATHER, TOTE BAGS, BEACH BAGS, SCHOOL SATCHELS, PURSES, WALLETS, BUSINESS CARD CASES, CREDIT CARD CASES, CLOTHING FOR PETS; PET ACCESSORIES, NAMELY, LEADS AND COLLARS, HARNESSSES FOR ANIMALS; UMBRELLAS, PARASOLS (U.S. CLS. 1, 2, 3, 22 AND 41).

CLASS 20—FURNITURE AND ARTICLES NOT OTHERWISE CLASSIFIED

FOR NON-METAL COMMUTATION TICKET HOLDERS (U.S. CLS. 2, 13, 22, 25, 32 AND 50).

CLASS 25—CLOTHING

FOR SHIRTS, TEE-SHIRTS, POLO SHIRTS, BLOUSES, TANK TOPS, CAMISOLES, SWEATSHIRTS, PULL-OVERS, VESTS, SWEATERS, CARDIGANS, JACKETS, DRESSES, PARKAS, COATS, PANTS, SWEATPANTS, OVERALLS, ROMPERS, CREEPERS, TROUSERS, SHORTS, SKIRTS, UNDERWEAR, PAJAMAS, SOCKS, BABY BIBS NOT OF PAPER, APRONS, MUFFLERS, BANDANNAS, GLOVES; HATS, CAPS, SUN VISORS; BELTS; SNEAKERS, SANDALS, SLIPPERS (U.S. CLS. 22 AND 39).

ANDREW RHIM, EXAMINING ATTORNEY

LABRA PUPPY

THE MARK CONSISTS OF STANDARD CHARACTERS WITHOUT CLAIM TO ANY PARTICULAR FONT, STYLE, SIZE, OR COLOR.

PRIORITY CLAIMED UNDER SEC. 44(D) ON JAPAN APPLICATION NO. 2004-33878, FILED 4-9-2004, REG. NO. 4841279, DATED 2-25-2005, EXPIRES 2-25-2015.

NO CLAIM IS MADE TO THE EXCLUSIVE RIGHT TO USE "PUPPY" AS TO "CLOTHING FOR PETS; PET ACCESSORIES, NAMELY, LEADS AND COLLARS, HARNESSSES FOR ANIMALS", APART FROM THE MARK AS SHOWN.

CLASS 18—LEATHER GOODS

FOR TRAVELING BAGS OF LEATHER AND IMITATION LEATHER, ALL PURPOSE SPORTS BAGS, ATHLETIC BAGS, GARMENT BAGS FOR TRAVEL, VALISES, BRIEFCASES, POUCHES OF LEATHER AND IMITATION LEATHER, DRAWSTRING POUCHES, GOLF SHOE BAGS FOR TRAVEL AND CARRYING CASES, BACKPACKS, HANDBAGS, SHOULDER BAGS, SHOPPING BAGS OF LEATHER AND IMITATION LEATHER, TOTE BAGS, BEACH BAGS, SCHOOL SATCHELS, PURSES, WALLETS, BUSINESS CARD CASES, CREDIT CARD CASES; CLOTHING FOR PETS; PET ACCESSORIES, NAMELY, LEADS AND COLLARS, HARNESSSES FOR ANIMALS; UMBRELLAS, PARASOLS (U.S. CLS. 1, 2, 3, 22 AND 41).

CLASS 20—FURNITURE AND ARTICLES NOT OTHERWISE CLASSIFIED

FOR NON-METAL COMMUTATION TICKET HOLDERS (U.S. CLS. 2, 13, 22, 25, 32 AND 50).

CLASS 25—CLOTHING

FOR SHIRTS, TEE-SHIRTS, POLO SHIRTS, BLOUSES, TANK TOPS, CAMISOLES, SWEATSHIRTS, PULL-OVERS, VESTS, SWEATERS, CARDIGANS, JACKETS, DRESSES, PARKAS, COATS, PANTS, SWEATPANTS, OVERALLS, ROMPERS, CREEPERS, TROUSERS, SHORTS, SKIRTS, UNDERWEAR, PAJAMAS, SOCKS, BABY BIBS NOT OF PAPER, APRONS, MUFFLERS, BANDANNAS, GLOVES; HATS, CAPS, SUN VISORS; BELTS; SNEAKERS, SANDALS, SLIPPERS (U.S. CLS. 22 AND 39).

ANDREW RHIM, EXAMINING ATTORNEY

SN 78-404,938. CHAMPION COMMUNICATIONS, GREENVILLE, SC. FILED 4-20-2004.

SN 78-405,191. HANDMARK, INC., KANSAS CITY, MO. FILED 4-20-2004.

CONNECT WITH THE BEST

THE MARK CONSISTS OF STANDARD CHARACTERS WITHOUT CLAIM TO ANY PARTICULAR FONT, STYLE, SIZE, OR COLOR.

CLASS 35—ADVERTISING AND BUSINESS

FOR BUSINESS CONSULTATION, BUSINESS MANAGEMENT, ADVERTISING AND MARKETING SERVICES, AND DISTRIBUTION OF ADVERTISING MATERIALS IN THE FIELD OF TELECOMMUNICATIONS (U.S. CLS. 100, 101 AND 102).

FIRST USE 6-1-2004; IN COMMERCE 6-1-2004.

CLASS 38—COMMUNICATION

FOR TELECOMMUNICATIONS SERVICES, NAMELY PROVIDING TELECOMMUNICATION SERVICES FOR VOICE COMMUNICATIONS OVER THE INTERNET, LOCAL AND LONG DISTANCE WIRED TELEPHONE SERVICES, LOCAL AND LONG DISTANCE WIRELESS TELEPHONE SERVICES, DIGITAL SUBSCRIBER LINE (DSL) SERVICES AND INTERNET SERVICE PROVIDER (ISP) DIAL-UP SERVICES, NAMELY PROVIDING MULTIPLE USER ACCESS TO A GLOBAL COMPUTER NETWORK (U.S. CLS. 100, 101 AND 104).

FIRST USE 6-1-2004; IN COMMERCE 6-1-2004.
TARAH HARDY, EXAMINING ATTORNEY

SN 78-404,958. CREATABLE MEDIA LIMITED, SYDNEY, AUSTRALIA, FILED 4-20-2004.



OWNER OF AUSTRALIA REG. NO. 902334, DATED 2-6-2002, EXPIRES 2-6-2012.

OWNER OF AUSTRALIA REG. NO. 902332, DATED 2-6-2002, EXPIRES 2-6-2012.

NO CLAIM IS MADE TO THE EXCLUSIVE RIGHT TO USE "MEDIA", APART FROM THE MARK AS SHOWN.

THE MARK CONSISTS OF THE WORDS "CREATABLE" AND "MEDIA" WITH A FANCIFULLY RENDERED EYEBALL BETWEEN THEM.

CLASS 20—FURNITURE AND ARTICLES NOT OTHERWISE CLASSIFIED

FOR FURNITURE, INCLUDING TABLES AND DETACHABLE TABLE TOPS (U.S. CLS. 2, 13, 22, 25, 32 AND 50).

CLASS 35—ADVERTISING AND BUSINESS

FOR ADVERTISING SERVICES, INCLUDING ADVERTISING USING PRINT MEDIA DISPLAYED ON FURNITURE (U.S. CLS. 100, 101 AND 102).

CATHERINE CAIN, EXAMINING ATTORNEY

HANDMARK

THE MARK CONSISTS OF STANDARD CHARACTERS WITHOUT CLAIM TO ANY PARTICULAR FONT, STYLE, SIZE, OR COLOR.

OWNER OF U.S. REG. NO. 2,672,872.

CLASS 9—ELECTRICAL AND SCIENTIFIC APPARATUS

FOR COMPUTER SOFTWARE FOR WIRELESS AGGREGATION AND CONTENT DELIVERY; COMPUTER SOFTWARE AND DOWNLOADABLE COMPUTER SOFTWARE FOR MOBILE TELEPHONES AND WIRELESS COMMUNICATION APPARATUS FOR PRODUCTIVITY APPLICATIONS, FINANCIAL APPLICATIONS, EDUCATIONAL APPLICATIONS, DATABASE MANAGEMENT AND TRAVEL; COMPUTER GAME SOFTWARE AND DOWNLOADABLE COMPUTER GAME SOFTWARE FOR MOBILE TELEPHONES AND WIRELESS COMMUNICATION APPARATUS; ELECTRONIC PUBLICATIONS, NAMELY, BOOKS, SHORT STORIES, MAGAZINES, MANUALS, ARTICLES, FEATURES, REPORTS, RESPONSES, AUDIO FILES AND IMAGES FEATURING REFERENCE INFORMATION, EDUCATIONAL MATERIALS, FICTION, NON-FICTION, HUMOR, CURRENT EVENTS, NEWS, SPORTS, PERSONAL INTEREST, WEATHER, DIRECTIONS, MAPS, SCHEDULES, REVIEWS AND RATINGS AND GAMES RECORDED ON PRE-RECORDED FLASH MEMORY CARDS AND MEMORY STICKS (U.S. CLS. 21, 23, 26, 36 AND 38).

FIRST USE 11-20-2000; IN COMMERCE 1-3-2001.

CLASS 35—ADVERTISING AND BUSINESS

FOR ON-LINE RETAIL STORE SERVICES FEATURING COMPUTER SOFTWARE AND ELECTRONIC PUBLICATIONS FOR MOBILE TELEPHONES AND WIRELESS COMMUNICATION APPARATUS (U.S. CLS. 100, 101 AND 102).

FIRST USE 11-20-2000; IN COMMERCE 11-20-2000.

CLASS 38—COMMUNICATION

FOR WIRELESS ELECTRONIC TRANSMISSION OF MESSAGES AND DATA; WIRELESS TRANSMISSION OF ELECTRONIC CONTENT IN THE NATURE OF MESSAGES, SOUNDS AND IMAGES, PHOTOGRAPHS, DOCUMENTS, TEXT AND OTHER DATA TO MOBILE TELEPHONES AND WIRELESS COMMUNICATION APPARATUS (U.S. CLS. 100, 101 AND 104).

FIRST USE 1-1-2004; IN COMMERCE 3-22-2004.

SKYE YOUNG, EXAMINING ATTORNEY

SN 78-405,362. WARLOW, GREG, B., LOS ANGELES, CA. FILED 4-21-2004.

SN 78-405,578. ADVANCE MANUFACTURING GROUP U.S.A., INC., SOUTH SAN FRANCISCO, CA. FILED 4-21-2004.

HEROES IN THE HOT ZONE

CLASS 9—ELECTRICAL AND SCIENTIFIC APPARATUS

FOR PRE-RECORDED AUDIO TAPES, VIDEO TAPES, CASSETTES, DISCS FEATURING MUSIC, STAGE-SHOWS, DANCE AND THEATRICAL PRODUCTIONS (U.S. CLS. 21, 23, 26, 36 AND 38).

CLASS 16—PAPER GOODS AND PRINTED MATTER

FOR BOOKS, POSTERS, CALENDERS, PHOTOGRAPHS, ALL FEATURING MUSIC, THEATER, DANCE, ENTERTAINMENT, ARTS, PERSONALITIES AND PERFORMERS (U.S. CLS. 2, 5, 22, 23, 29, 37, 38 AND 50).

CLASS 25—CLOTHING

FOR T-SHIRTS, SWEATSHIRTS, SWEATPANTS, SHORTS, PANTS, NECKTIES, UNDERWEAR, FOOTWEAR, HEADWEAR (U.S. CLS. 22 AND 39).

CLASS 41—EDUCATION AND ENTERTAINMENT

FOR MUSICALS AND DANCE PERFORMANCES, LIVE STAGE SHOWS, PRESENTATION OF PRE-RECORDED STAGE SHOWS BEFORE LIVE AUDIENCE, MUSICAL REVIEWS AND THEATRICAL PRODUCTIONS (U.S. CLS. 100, 101 AND 107).

RICHARD WHITE, EXAMINING ATTORNEY

SN 78-405,512. BD&K FOODS, INC., AUBURN, AL. FILED 4-21-2004.



NO CLAIM IS MADE TO THE EXCLUSIVE RIGHT TO USE "VEGGIES" OR "TO GO", APART FROM THE MARK AS SHOWN.

THE MARK CONSISTS OF THE WRITING IN THE MARK IS SLANTED TO THE RIGHT. THE WORD VEGGIES IS WRITTEN IN WHITE WITH GREEN BACKGROUND.

CLASS 29—MEATS AND PROCESSED FOODS

FOR READY TO EAT PRE-PACKAGED FOOD COMBINATIONS CONSISTING PRIMARILY OF SOUTHERN-STYLE VEGETABLES (U.S. CL. 46).

FIRST USE 3-31-2004; IN COMMERCE 3-31-2004.

CLASS 43—HOTEL AND RESTAURANT SERVICES

FOR RESTAURANT SERVICES (U.S. CLS. 100 AND 101).

FIRST USE 1-1-2000; IN COMMERCE 1-1-2000.

ARETHA SOMERVILLE, EXAMINING ATTORNEY

OBX RACING SPORTS

THE MARK CONSISTS OF STANDARD CHARACTERS WITHOUT CLAIM TO ANY PARTICULAR FONT, STYLE, SIZE, OR COLOR.

NO CLAIM IS MADE TO THE EXCLUSIVE RIGHT TO USE "RACING SPORTS", APART FROM THE MARK AS SHOWN.

CLASS 7—MACHINERY

FOR PULLEYS BEING PART OF MACHINES; VEHICLE AIR INTAKE MANIFOLDS; AUTOMOTIVE INTAKE MANIFOLDS, CAM SPROCKETS, AUTOMOBILE EXHAUST SYSTEMS COMPRISED PRIMARILY OF PIPES, MUFFLERS AND TIPS; HEADERS AS PART OF VEHICLE EXHAUST SYSTEM; ENGINE MUFFLER TIPS; AIR AND OIL FILTERS FOR MOTORS AND ENGINES; AUTOMOTIVE ENGINE FUEL REGULATORS AND FUEL RAILS; VALVE COVERS FOR AUTOMOBILE ENGINES; SPARK PLUG IGNITION WIRE (U.S. CLS. 13, 19, 21, 23, 31, 34 AND 35).

FIRST USE 11-0-1996; IN COMMERCE 11-0-1996.

CLASS 9—ELECTRICAL AND SCIENTIFIC APPARATUS

FOR SPEEDOMETERS, TACHOMETERS, VOLTAGE METERS AND PRESSURE GAUGES FOR VEHICLES (U.S. CLS. 21, 23, 26, 36 AND 38).

FIRST USE 11-0-1996; IN COMMERCE 11-0-1996.

CLASS 11—ENVIRONMENTAL CONTROL APPARATUS

FOR LIGHT BULBS, FOG LIGHTS AND LAMPS FOR VEHICLES; LAMP AND LIGHT BULB COVERS (U.S. CLS. 13, 21, 23, 31 AND 34).

FIRST USE 11-0-1996; IN COMMERCE 11-0-1996.

CLASS 12—VEHICLES

FOR AUTOMOBILE PARTS AND ACCESSORIES, NAMELY WHEELS; RIMS; VEHICLE WHEEL LUG NUTS; STRUCTURAL BRACES FOR AUTOMOBILES; AUTOMOBILE HOOD PINS; STRUCTURAL AUTOMOBILE TOW AND TIE BARS; LAND VEHICLE PARTS, NAMELY TRANSMISSION SHIFTERS; GAS RESERVOIR TANKS FOR LAND VEHICLES; CAR SEATS, SAFETY RAILS AND SEAT BELTS; EMERGENCY BRAKE HANDLES AND BOOTS FOR AUTOMOBILES; INTERIOR ACCESSORIES, NAMELY, PEDAL COVERS; FLOOR PLATES; REAR AND SIDE VIEW MIRRORS; SHIFT KNOBS AND BOOTS; STEERING WHEELS; BODY KITS COMPRISED PRIMARILY OF FENDERS; AUTOMOBILE GRILLS, FRONT, SIDE AND REAR BODY KITS COMPRISED PRIMARILY OF REAR SPOILERS, HOODS, AIR SCOOPS; PILLAR TRIM, TRUNK LID TRIM, INTERIOR TRIM, LICENSE PLATE FRAMES, FUEL CAP COVERS, WINDSHIELD WIPERS AND WASHER NOZZLES; SUSPENSION COILS, SHOCKS AND CAMBERS (U.S. CLS. 19, 21, 23, 31, 35 AND 44).

FIRST USE 11-0-1996; IN COMMERCE 11-0-1996.

CLASS 35—ADVERTISING AND BUSINESS

FOR WHOLESALE STORES FEATURING AFTER-MARKET AUTO PARTS AND ACCESSORIES (U.S. CLS. 100, 101 AND 102).

FIRST USE 11-0-1996; IN COMMERCE 11-0-1996.

HOWARD B. LEVINE, EXAMINING ATTORNEY

SN 78-405,965. PROFESSIONAL SECURITY ALLIANCE, INC., DBA PSA SECURITY NETWORK, DENVER, CO. FILED 4-21-2004.

PSA SECURITY NETWORK

THE MARK CONSISTS OF STANDARD CHARACTERS WITHOUT CLAIM TO ANY PARTICULAR FONT, STYLE, SIZE, OR COLOR.

OWNER OF U.S. REG. NOS. 1,551,296, 2,412,655 AND OTHERS.
SEC. 2(F).

CLASS 9—ELECTRICAL AND SCIENTIFIC APPARATUS

FOR ONLINE PUBLICATIONS, NAMELY, DOWNLOADABLE NEWSLETTERS REGARDING TOPICS OF INTEREST IN THE ELECTRONIC SECURITY INDUSTRY (U.S. CLS. 21, 23, 26, 36 AND 38).

FIRST USE 5-30-1988; IN COMMERCE 5-30-1988.

CLASS 35—ADVERTISING AND BUSINESS

FOR FACILITATING BUSINESS TO BUSINESS TRANSACTIONS BETWEEN DEALERS AND MANUFACTURERS OF ELECTRONIC SECURITY SYSTEMS, FIRE PROTECTION SYSTEMS, ACCESS CONTROL SYSTEMS, AND LIFE SAFETY SYSTEMS; AND COOPERATIVE MARKETING AND LOGISTICS MANAGEMENT CONCERNING THE SYSTEMS THROUGH MEMBERSHIP IN A COOPERATIVE ORGANIZATION (U.S. CLS. 100, 101 AND 102).

FIRST USE 5-30-1988; IN COMMERCE 5-30-1988.

CLASS 41—EDUCATION AND ENTERTAINMENT

FOR TRAINING SERVICES, NAMELY, PROVIDING TRAINING IN THE FIELD OF ELECTRONIC SECURITY SYSTEMS AND COMPONENTS OF THE SYSTEMS (U.S. CLS. 100, 101 AND 107).

FIRST USE 5-30-1988; IN COMMERCE 5-30-1988.
BRENDAN REGAN, EXAMINING ATTORNEY

SN 78-406,684. FACTOR 5, LLC, SAN RAFAEL, CA. FILED 4-22-2004.

THORNADO

THE MARK CONSISTS OF STANDARD CHARACTERS WITHOUT CLAIM TO ANY PARTICULAR FONT, STYLE, SIZE, OR COLOR.

CLASS 9—ELECTRICAL AND SCIENTIFIC APPARATUS

FOR COMPUTER GAME SOFTWARE; INTERACTIVE MULTIMEDIA COMPUTER GAME PROGRAMS; INTERACTIVE VIDEO GAME PROGRAMS; VIDEO GAME SOFTWARE AND VIDEO GAME MACHINES FOR USE WITH PERSONAL COMPUTERS AND TELEVISIONS; COMPUTER AND VIDEO GAME TAPES, DISCS, CASSETTES, AND CARTRIDGES; COMPUTER AND VIDEO GAME ACCESSORIES, NAMELY, COMPUTER JOY STICKS AND JOYPADS, COMPUTER MOUSE AND MOUSE PADS, COMPUTER PERIPHERALS, PRERECORDED AUDIO AND VIDEO TAPES, LASER DISCS, DVD DISCS, VIDEO DISCS, COMPACT DISCS, AND CD-ROMS FEATURING VIDEO GAMES; AND MANUALS SUPPLIED THEREWITH (U.S. CLS. 21, 23, 26, 36 AND 38).

CLASS 28—TOYS AND SPORTING GOODS

FOR VIDEO OUTPUT GAMES; NAMELY, STAND ALONE VIDEO OUTPUT GAME MACHINES; STAND ALONE VIDEO GAME MACHINES; ELECTRONIC EDUCATIONAL GAME MACHINES FOR CHILDREN AND ADULTS; HAND HELD UNITS FOR PLAYING VIDEO GAMES; HAND HELD UNITS FOR PLAYING ELECTRONIC GAMES AND MANUALS SUPPLIED AS A UNIT (U.S. CLS. 22, 23, 38 AND 50).

INGRID C. EULIN, EXAMINING ATTORNEY

SN 78-407,065. SIERRA SYSTEMS GROUP INC., VANCOUVER, BRITISH COLUMBIA, CANADA, FILED 4-23-2004.

SIERRA SYSTEMS

THE MARK CONSISTS OF STANDARD CHARACTERS WITHOUT CLAIM TO ANY PARTICULAR FONT, STYLE, SIZE, OR COLOR.

NO CLAIM IS MADE TO THE EXCLUSIVE RIGHT TO USE "SYSTEMS", APART FROM THE MARK AS SHOWN.

CLASS 35—ADVERTISING AND BUSINESS

FOR BUSINESS MANAGEMENT CONSULTATION IN THE FIELD OF INFORMATION TECHNOLOGY (U.S. CLS. 100, 101 AND 102).

FIRST USE 5-1-2000; IN COMMERCE 5-1-2000.

CLASS 42—SCIENTIFIC, COMPUTER AND LEGAL SERVICES

FOR TECHNOLOGY CONSULTATION IN THE FIELD OF COMPUTER SOFTWARE AND HARDWARE FOR INFORMATION MANAGEMENT; COMPUTER SOFTWARE CONSULTATION, DESIGN AND DEVELOPMENT; CONSULTING SERVICES IN THE FIELD OF DESIGN, SELECTION AND IMPLEMENTATION OF COMPUTER HARDWARE AND SOFTWARE SYSTEMS FOR OTHERS IN THE FIELDS OF HEALTH CARE, LAW ENFORCEMENT, THE JUDICIARY, FINANCIAL SERVICES, INSURANCE AND GOVERNMENT (U.S. CLS. 100 AND 101).

FIRST USE 5-1-2000; IN COMMERCE 5-1-2000.
IRA J. GOODSAD, EXAMINING ATTORNEY

SN 78-407,428. CHA YAU SPONGE ENTERPRISE CO., LTD.,
CHANG HWA HSIEN, TAIWAN, FILED 4-23-2004.



CHA YAU

THE COLOR(S) BLUE AND PURPLE IS/ARE CLAIMED
AS A FEATURE OF THE MARK.

THE MARK CONSISTS OF THE WORDS CHA YAU AND
AN ARBITRARY DESIGN IN BLUE AND PURPLE. THE
COLOR PURPLE APPEARS IN THE SINGLE INTERSECT-
ING CURVED LINE AND THE COLOR BLUE APPEARS IN
THE DOUBLE PARALLEL CURVED LINES.

CLASS 27—FLOOR COVERINGS

FOR BATH MATS, DOOR MATS, GYMNASIUM EX-
ERCISE MATS, PROTECTIVE FLOOR COVERINGS (U.S.
CLS. 19, 20, 37, 42 AND 50).

FIRST USE 9-1-2000; IN COMMERCE 2-15-2004.

CLASS 28—TOYS AND SPORTING GOODS

FOR PERSONAL EXERCISE MATS, PLAY MATS
CONTAINING INFANT TOYS, JIGSAW PUZZLES, MA-
NIPULATIVE PUZZLES, CUBE-TYPE PUZZLES, PUZ-
ZLES, CONSTRUCTION TOYS, TOY CONSTRUCTION
BLOCKS AND CONNECTING LINKS THEREFOR, TOY
CONSTRUCTION KITS (U.S. CLS. 22, 23, 38 AND 50).

FIRST USE 9-1-2000; IN COMMERCE 2-15-2004.

HENRY S. ZAK, EXAMINING ATTORNEY

SN 78-407,502. STANLEY, LASHAWNNA D, MIAMI BEACH,
FL. FILED 4-24-2004.

Ethnicity

THE MARK CONSISTS OF STANDARD CHARACTERS
WITHOUT CLAIM TO ANY PARTICULAR FONT, STYLE,
SIZE, OR COLOR.

CLASS 25—CLOTHING

FOR CLOTHING, NAMELY, HEADWEAR, UNDER-
GARMENTS AND OUTERWEAR, NAMELY, JEANS,
SHIRTS, SHORTS, SUITS, TOPS, DRESSES, SKIRTS,
PANTS AND JACKETS (U.S. CLS. 22 AND 39).

CLASS 35—ADVERTISING AND BUSINESS

FOR TALENT MANAGEMENT AND DEVELOPMENT
SERVICES IN THE FIELD OF MODELING (U.S. CLS.
100, 101 AND 102).

FIRST USE 1-1-2000; IN COMMERCE 1-1-2004.

DANIEL BRODY, EXAMINING ATTORNEY

SN 78-407,641. EUROFASE INC., RICHMOND HILL, ON-
TARIO, CANADA, FILED 4-25-2004.



THE MARK CONSISTS OF THE WORD EUROFASE, A
CIRCULAR PATTERN OF STARS, AND A RECTANGULAR
PATTERN IN THE CENTER OF THE CIRCLE WITH A
STYLIZED LION'S HEAD, IN PROFILE.

**CLASS 9—ELECTRICAL AND SCIENTIFIC
APPARATUS**

FOR ACCESSORIES, NAMELY TRANSFORMERS (U.S.
CLS. 21, 23, 26, 36 AND 38).

FIRST USE 9-1-2001; IN COMMERCE 9-1-2001.

**CLASS 11—ENVIRONMENTAL CONTROL AP-
PARATUS**

FOR LIGHT FIXTURES, NAMELY RECESSED LIGHT
FIXTURES, MINIATURE CABINET RECESSED LIGHTS,
TRACK LIGHTING, CHANDELIERS, WALL SCONCES,
CEILING MOUNT LIGHT FIXTURES, PENDANT LIGHT
FIXTURES, TABLE LAMPS, FLOOR LAMPS, CABLE
LIGHTING, INCANDESCENT LAMPS, FLUORESCENT
LAMPS, HALOGEN FLOOR LAMPS, HALOGEN WALL
LAMPS, LOW VOLTAGE HALOGEN SPOTLIGHTS, IN-
CANDESCENT SPOTLIGHTS; ACCESSORIES, NAMELY-
RECESSED TRIM FOR LIGHT FIXTURES, HOUSINGS
FOR LIGHT FIXTURES, INCANDESCENT LIGHT
BULBS, HALOGEN LIGHT BULBS, GLASS LAMP
SHADES, METAL LAMP SHADES, CERAMIC LAMP
SHADES, RAIL LIGHTING TRACKS (U.S. CLS. 13, 21,
23, 31 AND 34).

FIRST USE 9-1-2001; IN COMMERCE 9-1-2001.

DANIEL BRODY, EXAMINING ATTORNEY

SN 78-407,642. EUROFASE INC., RICHMOND HILL, CANADA, FILED 4-25-2004.

EUROFASE

THE MARK CONSISTS OF STANDARD CHARACTERS WITHOUT CLAIM TO ANY PARTICULAR FONT, STYLE, SIZE, OR COLOR.

THE FOREIGN WORDING IN THE MARK TRANSLATES INTO ENGLISH AS EUROPHASE.

CLASS 9—ELECTRICAL AND SCIENTIFIC APPARATUS

FOR ACCESSORIES, NAMELY TRANSFORMERS (U.S. CLS. 21, 23, 26, 36 AND 38).

FIRST USE 9-1-2001; IN COMMERCE 9-1-2001.

CLASS 11—ENVIRONMENTAL CONTROL APPARATUS

FOR LIGHT FIXTURES, NAMELY RECESSED LIGHT FIXTURES, MINIATURE CABINET RECESSED LIGHTS, TRACK LIGHTING, CHANDELIERS, WALL SCONCES, CEILING MOUNT LIGHT FIXTURES, PENDANT LIGHT FIXTURES, TABLE LAMPS, FLOOR LAMPS, CABLE LIGHTING, INCANDESCENT LAMPS, FLUORESCENT LAMPS, HALOGEN FLOOR LAMPS, HALOGEN WALL LAMPS, LOW VOLTAGE HALOGEN SPOTLIGHTS, INCANDESCENT SPOTLIGHTS; ACCESSORIES, NAMELY: RECESSED TRIM FOR LIGHT FIXTURES, HOUSINGS FOR LIGHT FIXTURES, INCANDESCENT LIGHT BULBS, HALOGEN LIGHT BULBS, GLASS LAMP SHADES, METAL LAMP SHADES, CERAMIC LAMP SHADES, RAIL LIGHTING TRACKS (U.S. CLS. 13, 21, 23, 31 AND 34).

FIRST USE 9-1-2001; IN COMMERCE 9-1-2001.

DANIEL BRODY, EXAMINING ATTORNEY

SN 78-407,928. FR PRODUCTIONS, LLC, PORTLAND, OR, FILED 4-26-2004.

HORNED AVENGER

THE MARK CONSISTS OF STANDARD CHARACTERS WITHOUT CLAIM TO ANY PARTICULAR FONT, STYLE, SIZE, OR COLOR.

CLASS 25—CLOTHING

FOR CLOTHING, NAMELY, T-SHIRTS, SWEAT-SHIRTS AND HATS (U.S. CLS. 22 AND 39).

CLASS 28—TOYS AND SPORTING GOODS

FOR BOARD GAMES; MANIPULATIVE PUZZLES (U.S. CLS. 22, 23, 38 AND 50).

RENEE MCCRAY, EXAMINING ATTORNEY

SN 78-408,109. FINANCIAL DIMENSIONS, INC., PITTSBURGH, PA. FILED 4-26-2004.

FINANCIAL DIMENSIONS

THE MARK CONSISTS OF STANDARD CHARACTERS WITHOUT CLAIM TO ANY PARTICULAR FONT, STYLE, SIZE, OR COLOR.

NO CLAIM IS MADE TO THE EXCLUSIVE RIGHT TO USE "FINANCIAL", APART FROM THE MARK AS SHOWN.

CLASS 35—ADVERTISING AND BUSINESS

FOR SERVICES TO THE MORTGAGE INDUSTRY, NAMELY, INVESTOR DELIVERY SERVICES FOR MORTGAGES, NAMELY, POST-CLOSING FILE REVIEW OF MORTGAGES FOR LENDERS; SERVICES TO THE MORTGAGE INDUSTRY, NAMELY, ACQUIRING A MORTGAGE INSURANCE CERTIFICATE FROM FHA OR VA FOR THE LENDER TO INSURE THE LENDER AGAINST LOSSES ASSOCIATED WITH A FORECLOSURE (U.S. CLS. 100, 101 AND 102).

FIRST USE 12-31-2001; IN COMMERCE 12-31-2001.

CLASS 36—INSURANCE AND FINANCIAL

FOR SERVICES TO THE MORTGAGE INDUSTRY, NAMELY, REAL ESTATE APPRAISAL AND MORTGAGE CREDIT REPORTING (U.S. CLS. 100, 101 AND 102).

FIRST USE 1-31-1987; IN COMMERCE 1-31-1987.

CLASS 42—SCIENTIFIC, COMPUTER AND LEGAL SERVICES

FOR SERVICES TO THE MORTGAGE INDUSTRY, NAMELY, TITLE SEARCHING; REAL ESTATE SETTLEMENT SERVICES; PUBLIC DOCUMENT RETRIEVAL; AND PREPARING AND RECORDING IN THE PUBLIC RECORDS DOCUMENTS AFFECTING TITLE TO REAL ESTATE AND MORTGAGES (U.S. CLS. 100 AND 101).

FIRST USE 1-31-1997; IN COMMERCE 1-31-1997.

CLASS 45—PERSONAL SERVICES

FOR PUBLIC RECORDS SEARCH SERVICES PROVIDED TO THE MORTGAGE INDUSTRY, NAMELY, SEARCHING MARRIAGE RECORDS, CRIMINAL RECORDS, PROPERTY RECORDS, BIRTH CERTIFICATES, JUDGMENTS, AND LIENS, ALL FOR THE PURPOSE OF EVALUATING A WOULD-BE BORROWER'S CREDIT-WORTHINESS (U.S. CLS. 100 AND 101).

FIRST USE 1-31-1988; IN COMMERCE 1-31-1988.

KIM SAITO, EXAMINING ATTORNEY

SN 78-408,121. FINANCIAL DIMENSIONS, INC., PITTSBURGH, PA. FILED 4-26-2004.

SN 78-408,182. MAGELLAN PLASTICS, INC., DUBLIN, CA. FILED 4-26-2004.

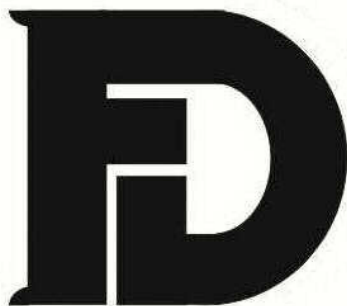

CLASS 35—ADVERTISING AND BUSINESS

FOR SERVICES TO THE MORTGAGE INDUSTRY, NAMELY, INVESTOR DELIVERY SERVICES FOR MORTGAGES, NAMELY, POST-CLOSING FILE REVIEW OF MORTGAGES FOR LENDERS; SERVICES TO THE MORTGAGE INDUSTRY, NAMELY, ACQUIRING A MORTGAGE INSURANCE CERTIFICATE FROM FHA OR VA FOR THE LENDER TO INSURE THE LENDER AGAINST LOSSES ASSOCIATED WITH A FORECLOSURE (U.S. CLS. 100, 101 AND 102).

FIRST USE 12-31-2001; IN COMMERCE 12-31-2001.

CLASS 36—INSURANCE AND FINANCIAL

FOR SERVICES TO THE MORTGAGE INDUSTRY, NAMELY, REAL ESTATE APPRAISAL AND MORTGAGE CREDIT REPORTING (U.S. CLS. 100, 101 AND 102).

FIRST USE 1-31-1987; IN COMMERCE 1-31-1987.

CLASS 42—SCIENTIFIC, COMPUTER AND LEGAL SERVICES

FOR SERVICES TO THE MORTGAGE INDUSTRY, NAMELY, TITLE SEARCHING; REAL ESTATE SETTLEMENT SERVICES; PUBLIC DOCUMENT RETRIEVAL; AND PREPARING AND RECORDING IN THE PUBLIC RECORDS DOCUMENTS AFFECTING TITLE TO REAL ESTATE AND MORTGAGES (U.S. CLS. 100 AND 101).

FIRST USE 1-31-1997; IN COMMERCE 1-31-1997.

CLASS 45—PERSONAL SERVICES

FOR PUBLIC RECORDS SEARCH SERVICES PROVIDED TO THE MORTGAGE INDUSTRY, NAMELY, SEARCHING MARRIAGE RECORDS, CRIMINAL RECORDS, PROPERTY RECORDS, BIRTH CERTIFICATES, JUDGMENTS, AND LIENS, ALL FOR THE PURPOSE OF EVALUATING A WOULD-BE BORROWER'S CREDIT-WORTHINESS (U.S. CLS. 100 AND 101).

FIRST USE 1-31-1988; IN COMMERCE 1-31-1988.
MICHAEL HALL, EXAMINING ATTORNEY

NO CLAIM IS MADE TO THE EXCLUSIVE RIGHT TO USE "PLASTICS", APART FROM THE MARK AS SHOWN.

CLASS 16—PAPER GOODS AND PRINTED MATTER

FOR PLASTIC BAGS, NAMELY, GENERAL PURPOSE PLASTIC BAGS, BAGS FOR PACKING, BAGS FOR PACKAGING, SHOPPING BAGS, BAGS WITH CORDS RUN THROUGH TO TIGHTEN OR CLOSE THE BAG OPENING, BAGS WITH HANDLES THAT SNAP AND SEAL BAG CLOSED, BAGS WITH DRAWSTRINGS USED TO CLOSE BAG OPENING, GARBAGE BAGS, TRASH CAN LINERS AND BAGS, DRUM LINERS, PLASTIC CAT BOX LINERS, PLASTIC BAGS FOR DISPOSING PET WASTE, PLASTIC BAGS FOR USE IN HOLDING MATTRESSES, SMALL PLASTIC BAGS FOR USE IN CARRYING T-SHIRTS, CUSTOM PRINTED BAGS FOR GENERAL USE, PLASTIC BAGS FOR USE IN HOLDING ICE CUBES, FOOD STORAGE BAGS FOR HOUSEHOLD USE (U.S. CLS. 2, 5, 22, 23, 29, 37, 38 AND 50).

CLASS 17—RUBBER GOODS

FOR PLASTIC SHEETING USED IN THE CONSTRUCTION INDUSTRY AS A VAPOR BARRIER; PLASTIC SHEETING USED AS DROP CLOTHS; NON-METAL TUBING AND TUBING COUPLINGS FOR JOINING AND TERMINATING PIPES (U.S. CLS. 1, 5, 12, 13, 35 AND 50).

LA TONIA FISHER, EXAMINING ATTORNEY

SN 78-409,758. ROBIN HOOD FOUNDATION, NEW YORK, NY. FILED 4-28-2004.

SN 78-409,927. VLASSARA, HELEN, NEW YORK, NY. FILED 4-28-2004.

Single Stop

THE MARK CONSISTS OF STANDARD CHARACTERS WITHOUT CLAIM TO ANY PARTICULAR FONT, STYLE, SIZE, OR COLOR.

CLASS 36—INSURANCE AND FINANCIAL

FOR CHARITABLE SERVICES IN THE NATURE OF PROVIDING FREE COUNSELING REGARDING OBTAINING FINANCIAL BENEFITS, NAMELY, GOVERNMENT BENEFITS AND ENTITLEMENTS, PUBLIC ASSISTANCE, FOOD STAMPS, HOUSING, HEALTHCARE, SCHOOL LUNCH, HEATING ASSISTANCE, MEDICAID AND SOCIAL SECURITY DISABILITY TO LOW-INCOME FAMILIES; CHARITABLE SERVICES IN THE NATURE OF PROVIDING FREE FINANCIAL SERVICES, NAMELY FINANCIAL COUNSELING, FINANCIAL PLANNING, DEBT COUNSELING, TAX CONSULTATION, CREDIT REPAIR TO LOW INCOME FAMILIES (U.S. CLS. 100, 101 AND 102).

FIRST USE 10-1-2003; IN COMMERCE 4-20-2004.

CLASS 42—SCIENTIFIC, COMPUTER AND LEGAL SERVICES

FOR CHARITABLE SERVICES IN THE NATURE OF PROVIDING FREE LEGAL SERVICES TO LOW-INCOME FAMILIES; CHARITABLE SERVICES IN THE NATURE OF PROVIDING FREE LEGAL COUNSELING IN THE AREAS OF LANDLORD/TENANT, CHILD CUSTODY/SUPPORT, DOMESTIC VIOLENCE, DIVORCE, IMMIGRATION, EMPLOYMENT, AND IN OBTAINING GOVERNMENT BENEFITS AND ENTITLEMENTS, PUBLIC ASSISTANCE, FOOD STAMPS, HOUSING, HEALTHCARE, SCHOOL LUNCH, HEATING ASSISTANCE, MEDICAID AND SOCIAL SECURITY DISABILITY TO LOW-INCOME FAMILIES (U.S. CLS. 100 AND 101).

FIRST USE 10-1-2003; IN COMMERCE 4-20-2004.

CLASS 44—MEDICAL, BEAUTY AND AGRICULTURAL SERVICES

FOR CHARITABLE SERVICES IN THE NATURE OF PROVIDING FREE PSYCHOLOGICAL COUNSELING AND COUNSELING REGARDING DOMESTIC VIOLENCE, MENTAL HEALTH CARE, HOMELESSNESS, SUBSTANCE ABUSE, MEDICAID AND HEALTHCARE TO LOW-INCOME FAMILIES (U.S. CLS. 100 AND 101).

FIRST USE 10-1-2003; IN COMMERCE 4-20-2004.
SUE LAWRENCE, EXAMINING ATTORNEY

AGE-LESS

THE MARK CONSISTS OF STANDARD CHARACTERS WITHOUT CLAIM TO ANY PARTICULAR FONT, STYLE, SIZE, OR COLOR.

CLASS 29—MEATS AND PROCESSED FOODS

FOR FOOD PRODUCTS, NAMELY, MEAT, FISH, POULTRY AND GAME; MEAT EXTRACTS, PRESERVED, DRIED AND COOKED FRUITS AND VEGETABLES; JELLIES, JAMS, FRUIT SAUCES, EGGS, MILK AND DAIRY PRODUCTS EXCLUDING ICE CREAM, ICE MILK AND FROZEN YOGURT MILK PRODUCTS; EDIBLE OILS AND FATS; ALL HAVING A REDUCED CONTENT OF UNHEALTHY SUBSTANCES ARISING DURING PROCESSING (U.S. CL. 46).

CLASS 30—STAPLE FOODS

FOR FOOD PRODUCTS, NAMELY COFFEE, TEA, COCOA, SUGAR, RICE, TAPIOCA, SAGO, ARTIFICIAL COFFEE, FLOUR AND PREPARATIONS MADE FROM CEREALS, BREAD, PASTRY AND CONFECTIONERY; ICES, HONEY, TREACLE, YEAST, MUSTARD, VINEGAR, SAUCES AND SPICES, ALL HAVING A REDUCED CONTENT OF UNHEALTHY SUBSTANCES ARISING DURING PROCESSING (U.S. CL. 46).

JOHN DALIER, EXAMINING ATTORNEY

SN 78-409,934. REALTYTRAC INC., IRVINE, CA. FILED 4-28-2004.



OWNER OF U.S. REG. NOS. 2,330,474 AND 2,341,111.
THE COLOR(S) RED AND BLACK IS/ARE CLAIMED AS A FEATURE OF THE MARK.

THE MARK CONSISTS OF AN ICON CONSISTING OF ONE KEY FROM A COMPUTER KEYBOARD ON WHICH THERE IS A STYLIZED OUTLINE IMAGE OF A HOUSE WITH CHIMNEY IN WHITE ON A RED BACKGROUND WITH THE INTERNAL SPACE OF THE HOUSE FORMING A DIRECTIONAL ARROW POINTING UPWARD AND THE WORD "REALTYTRAC" WITH "REALTY" IN BLACK AND "TRAC" IN RED.

CLASS 36—INSURANCE AND FINANCIAL

SN 78-410,973. 180S, INC., BALTIMORE, MD. FILED 4-30-2004.

FOR PROVIDING REAL ESTATE SERVICES AND INFORMATION REGARDING PRE-FORECLOSURE AND FORECLOSURE PROPERTIES VIA THE INTERNET; PROVIDING AN ON-LINE DATABASE OF PRE-FORECLOSURE AND FORECLOSURE PROPERTIES; PROVIDING INTERNET BASED MARKETPLACE TO ALLOW SUBSCRIBERS TO MAKE OFFERS FOR REAL ESTATE OR CONTACT SELLERS OR SELLERS' AGENTS; PROVIDING INFORMATION IN THE FIELD OF REAL ESTATE BY LINKS TO OTHER WEB SITES FEATURING REAL ESTATE INFORMATION AND PROFESSIONAL SERVICES IN REAL ESTATE FIELD (U.S. CLS. 100, 101 AND 102).

FIRST USE 1-1-2004; IN COMMERCE 1-1-2004.

CLASS 42—SCIENTIFIC, COMPUTER AND LEGAL SERVICES

FOR PROVIDING TEMPORARY USE OF NON-DOWNLOADABLE SOFTWARE TO THAT ENABLE CONSUMERS TO CONDUCT RESEARCH ON REAL ESTATE VALUATION AND COMPARATIVE SALES (U.S. CLS. 100 AND 101).

FIRST USE 1-1-2004; IN COMMERCE 1-1-2004.
INGA ERVIN, EXAMINING ATTORNEY

PUSH

SN 78-410,343. GARDEN CREEK VINEYARDS, LLC, GEYSERVILLE, CA. FILED 4-29-2004.

GARDEN CREEK

THE MARK CONSISTS OF STANDARD CHARACTERS WITHOUT CLAIM TO ANY PARTICULAR FONT, STYLE, SIZE, OR COLOR.

CLASS 9—ELECTRICAL AND SCIENTIFIC APPARATUS

FOR SUNGLASSES AND HEADGEAR, NAMELY, SPORT HELMETS AND SPORT HELMET LINERS (U.S. CLS. 21, 23, 26, 36 AND 38).

CLASS 25—CLOTHING

FOR CLOTHING, NAMELY, ATHLETIC UNIFORMS, BEACH WEAR, BELTS, BLAZERS, BODY SUITS, BOTTOMS, CAFTANS, COATS, FISHING VESTS, FISHING WADERS, FOUL WEATHER GEAR, GLOVES, GYM SUITS, JACKETS, JERSEYS, JOGGING SUITS, LOUNGEWEAR, MITTENS, MUFFLERS, NECKWEAR, OVERALLS, PANTS, PANTSUITS, RAINWEAR, ROBES, SASHES, SCARVES, SHAWLS, SHIRTS, SHORTS, SKIWEAR, SLACKS, SLEEPWEAR, SOCKS, SWEATPANTS, SWEATSHIRTS, SWEATSUITS, SWEATERS, SWIMWEAR, SWIMSUITS, SUIT COATS, SUITS, THERMAL UNDERWEAR, TIGHTS, TOPS, TROUSERS, T-SHIRTS, UNDERWEAR, UNIFORMS, UNITARDS, VESTS, WARM-UP SUITS, AND WRISTBANDS; FOOTWEAR, NAMELY, SHOES, BOOTS AND SANDALS; AND HEADWEAR, NAMELY, CAPS, EAR MUFFS, EAR WARMERS, HATS, AND HEADBANDS (U.S. CLS. 22 AND 39).
DEZMONA MIZELLE, EXAMINING ATTORNEY

THE MARK CONSISTS OF STANDARD CHARACTERS WITHOUT CLAIM TO ANY PARTICULAR FONT, STYLE, SIZE, OR COLOR.

CLASS 29—MEATS AND PROCESSED FOODS

FOR JELLIES AND JAMS; EDIBLE OILS, NAMELY, OLIVE OIL. (U.S. CL. 46).

CLASS 33—WINES AND SPIRITS

FOR WINE (U.S. CLS. 47 AND 49).
JASON TURNER, EXAMINING ATTORNEY

SN 78-411,055. MAGGIEMOO'S INTERNATIONAL, LLC,
COLUMBIA, MD. FILED 4-30-2004.

CLASS 37—CONSTRUCTION AND REPAIR

FOR ROCK QUARRY SERVICES (U.S. CLS. 100, 103
AND 106).
FIRST USE 3-16-1987; IN COMMERCE 3-16-1987.
TRACY CROSS, EXAMINING ATTORNEY

TREATERY

SN 78-411,873. DURHAM, LINDA E., HOUSTON, TX. FILED
5-2-2004.

Organizing Matters

THE MARK CONSISTS OF STANDARD CHARACTERS
WITHOUT CLAIM TO ANY PARTICULAR FONT, STYLE,
SIZE, OR COLOR.
OWNER OF U.S. REG. NO. 2,282,514.

CLASS 30—STAPLE FOODS

FOR ICE CREAM; FROZEN YOGURT; SORBET; ICE
CREAM SUNDAES; ICE CREAM CAKES; MILK
SHAKES; ICE CREAM WITH TOPPING, NAMELY
FRUIT TOPPING, NUT TOPPING AND CANDY TOP-
PING; BAKERY DESSERTS; BAKERY PRODUCTS;
AND, FROZEN CONFECTIONS CONSISTING PRIMAR-
ILY OF ICE CREAM, ALL FOR CONSUMPTION ON OR
OFF THE PREMISES (U.S. CL. 46).
FIRST USE 4-8-1997; IN COMMERCE 4-15-1997.

CLASS 43—HOTEL AND RESTAURANT SERVICES

FOR RESTAURANT SERVICES AND CARRY-OUT
RESTAURANTS (U.S. CLS. 100 AND 101).
FIRST USE 4-8-1997; IN COMMERCE 4-15-1997.
ROBERT C. CLARK JR., EXAMINING ATTORNEY

THE MARK CONSISTS OF STANDARD CHARACTERS
WITHOUT CLAIM TO ANY PARTICULAR FONT, STYLE,
SIZE, OR COLOR.

CLASS 35—ADVERTISING AND BUSINESS

FOR ORGANIZING SERVICES FOR INDIVIDUALS
AND BUSINESSES, NAMELY, ORGANIZING PAPERS,
TIME AND STUFF OF LIFE; ORGANIZING RESI-
DENCES, OFFICES AND BUSINESSES TO REMOVE
CLUTTER AND CREATE ORDER; ARRANGING FUR-
NITURE AND BELONGINGS TO INCREASE EFFI-
CIENCY AND MAXIMIZING SPACE (U.S. CLS. 100, 101
AND 102).
FIRST USE 8-20-2000; IN COMMERCE 8-20-2000.

SN 78-411,560. SEMCO DISTRIBUTING, INC., PERRYVILLE,
MO. FILED 4-30-2004.

SEMCO DISTRIBUTING, INC.

CLASS 41—EDUCATION AND ENTERTAINMENT

FOR PROVIDING INSTRUCTION IN THE FIELD OF
RESIDENTIAL AND BUSINESS MANAGEMENT; EDU-
CATIONAL SERVICES, NAMELY, CONDUCTING
WORKSHOPS, SEMINARS OR CLASSES ON TOPICS
RELATED TO ELIMINATING CLUTTER, GETTING
AND STAYING ORGANIZED (U.S. CLS. 100, 101 AND
107).
FIRST USE 8-20-2000; IN COMMERCE 8-20-2000.
AISHA CLARKE, EXAMINING ATTORNEY

THE MARK CONSISTS OF STANDARD CHARACTERS
WITHOUT CLAIM TO ANY PARTICULAR FONT, STYLE,
SIZE, OR COLOR.
NO CLAIM IS MADE TO THE EXCLUSIVE RIGHT TO
USE "DISTRIBUTING, INC.", APART FROM THE MARK
AS SHOWN.

CLASS 35—ADVERTISING AND BUSINESS

FOR RETAIL DISTRIBUTORSHIPS, RETAIL STORE
SERVICES, RETAIL SERVICES BY DIRECT SOLICITA-
TION BY SALES AGENTS, WHOLESALE DISTRIBUTOR-
SHIP SERVICES, WHOLESALE SERVICES BY
DIRECT SOLICITATION BY SALES AGENTS, ALL
FEATURING STONE AND LANDSCAPING MATERIALS
FOR OTHERS FOR USE IN BUILDING, CONSTRUCTION,
AND LANDSCAPING (U.S. CLS. 100, 101 AND
102).
FIRST USE 3-16-1987; IN COMMERCE 3-16-1987.

SN 78-412,038. UNITEDHEALTH GROUP INCORPORATED,
MINNETONKA, MN. FILED 5-3-2004.

CLASS 35—ADVERTISING AND BUSINESS

FOR PROVIDING A WEBSITE FEATURING CONSU-
MER DISCOUNTS ON THE GOODS AND SERVICES OF
OTHERS (U.S. CLS. 100, 101 AND 102).

CLASS 38—COMMUNICATION

FOR PROVIDING CHAT ROOMS USED BY INDIVIDUALS TO IDENTIFY AREAS FOR IMPROVING THEIR HEALTH AND TO ASSIST INDIVIDUALS IN MAINTAINING HEALTHY LIFESTYLE CHOICES (U.S. CLS. 100, 101 AND 104).

CLASS 41—EDUCATION AND ENTERTAINMENT

FOR PROVIDING ONLINE PUBLICATIONS IN THE FIELD OF HEALTHCARE, NAMELY, ARTICLES AND JOURNALS (U.S. CLS. 100, 101 AND 107).

CLASS 42—SCIENTIFIC, COMPUTER AND LEGAL SERVICES

FOR PROVIDING TEMPORARY USE OF ONLINE NON-DOWNLOADABLE SOFTWARE FEATURING HEALTH RISK APPRAISALS, QUIZZES, SELF-ASSESSMENTS, CALCULATORS, AND GOAL TRACKING IN THE FIELD OF HEALTHCARE (U.S. CLS. 100 AND 101).

CLASS 44—MEDICAL, BEAUTY AND AGRICULTURAL SERVICES

FOR PROVIDING INFORMATION AND INFORMATION RESOURCES IN THE FIELDS OF HEALTH, WELLNESS, AND DAILY LIVING ISSUES; PROVIDING INFORMATION IN THE FIELDS OF HEALTH, WELLNESS, AND DAILY LIVING ISSUES VIA THE INTERNET (U.S. CLS. 100 AND 101).

JIM RINGLE, EXAMINING ATTORNEY

CLASS 42—SCIENTIFIC, COMPUTER AND LEGAL SERVICES

FOR PROVIDING TEMPORARY USE OF ONLINE NON-DOWNLOADABLE SOFTWARE FEATURING HEALTH RISK APPRAISALS, QUIZZES, SELF-ASSESSMENTS, CALCULATORS, AND GOAL TRACKING IN THE FIELD OF HEALTH CARE (U.S. CLS. 100 AND 101).

CLASS 44—MEDICAL, BEAUTY AND AGRICULTURAL SERVICES

FOR PROVIDING INFORMATION AND INFORMATION RESOURCES IN THE FIELDS OF HEALTH, WELLNESS, AND DAILY LIVING ISSUES; PROVIDING INFORMATION IN THE FIELDS OF HEALTH, WELLNESS, AND DAILY LIVING ISSUES VIA THE INTERNET (U.S. CLS. 100 AND 101).

SOPHIA S. KIM, EXAMINING ATTORNEY

SN 78-412,093. ACES HIGH AVIATION GALLERY, LLC, OJAI, CA. FILED 5-3-2004.

SN 78-412,041. UNITEDHEALTH GROUP INCORPORATED, MINNETONKA, MN. FILED 5-3-2004.

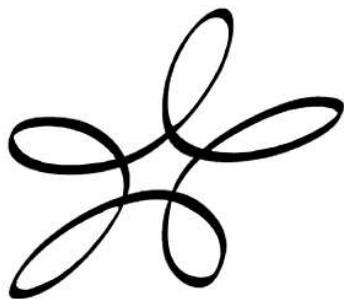

ACES HIGH

CLASS 35—ADVERTISING AND BUSINESS

FOR PROVIDING A WEBSITE FEATURING CONSUMER DISCOUNTS ON THE GOODS AND SERVICES OF OTHERS (U.S. CLS. 100, 101 AND 102).

CLASS 38—COMMUNICATION

FOR PROVIDING CHAT ROOMS USED BY INDIVIDUALS TO IDENTIFY AREAS FOR IMPROVING THEIR HEALTH AND TO ASSIST INDIVIDUALS IN MAINTAINING HEALTHY LIFESTYLE CHOICES (U.S. CLS. 100, 101 AND 104).

CLASS 41—EDUCATION AND ENTERTAINMENT

FOR PROVIDING ONLINE PUBLICATIONS IN THE FIELD OF HEALTHCARE, NAMELY, ARTICLES AND JOURNALS (U.S. CLS. 100, 101 AND 107).

THE MARK CONSISTS OF STANDARD CHARACTERS WITHOUT CLAIM TO ANY PARTICULAR FONT, STYLE, SIZE, OR COLOR.

CLASS 16—PAPER GOODS AND PRINTED MATTER

FOR GRAPHIC ART REPRODUCTIONS, PAINTING REPRODUCTIONS, PRINTED ART REPRODUCTIONS, PRINTED BROCHURES FEATURING INFORMATION REGARDING AVIATION ART (U.S. CLS. 2, 5, 22, 23, 29, 37, 38 AND 50).

FIRST USE 3-1-1998; IN COMMERCE 3-1-1998.

CLASS 35—ADVERTISING AND BUSINESS

FOR RETAIL STORE SERVICES FEATURING ORIGINAL ART, PRINTS AND PRINTED ART; ART GALLERY (U.S. CLS. 100, 101 AND 102).

FIRST USE 3-1-1998; IN COMMERCE 3-1-1998.
LINDA E. BLOHM, EXAMINING ATTORNEY

SN 78-412,606. THOMAS, JAMES F., JR., LA JOLLA, CA.
FILED 5-4-2004.

THE WIDOW'S BRIDGE

THE MARK CONSISTS OF STANDARD CHARACTERS WITHOUT CLAIM TO ANY PARTICULAR FONT, STYLE, SIZE, OR COLOR.

CLASS 16—PAPER GOODS AND PRINTED MATTER

FOR PRINTED MATTER AND PAPER GOODS, NAMELY, BOOKS, MAGAZINES, AND NEWSLETTERS FEATURING INFORMATION, STORIES AND ADVICE PERTAINING TO LIFESTYLE AND FINANCIAL MANAGEMENT ISSUES (U.S. CLS. 2, 5, 22, 23, 29, 37, 38 AND 50).

CLASS 36—INSURANCE AND FINANCIAL

FOR CONSULTING SERVICES, NAMELY, FINANCIAL PORTFOLIO CONSULTING AND ADVISORY SERVICES, ESTATE PLANNING SERVICES (U.S. CLS. 100, 101 AND 102).

CLASS 45—PERSONAL SERVICES

FOR CONSULTING SERVICES, NAMELY, PERSONAL LIFESTYLE CONSULTING AND ADVISORY SERVICES (U.S. CLS. 100 AND 101).
MICHAEL HALL, EXAMINING ATTORNEY

SN 78-412,681. THE VWE GROUP, INC., YONKERS, NY.
FILED 5-4-2004.

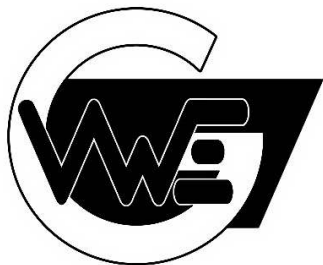

THE MARK CONSISTS OF THE LETTERS VWE SUPERIMPOSED OVER A LARGER IMAGE REPRESENTING THE LETTER G.

CLASS 16—PAPER GOODS AND PRINTED MATTER

FOR PRINTED MATTER, NAMELY BLANK EMPLOYMENT FORMS, LABOR FORMS AND PERSONNEL FORMS; HUMAN RESOURCE PRODUCTS, NAMELY, COMPLIANCE POSTERS FEATURING HUMAN RESOURCE AND EMPLOYMENT SAFETY INFORMATION, BOOKS IN THE FIELD OF HUMAN RESOURCE MANAGEMENT, MOTIVATIONAL PRODUCTS, NAMELY, PRINTED AWARD CERTIFICATES, LITHOGRAPHS, PRINTED PERSONALIZED AWARDS AND ALL OCCASION GREETING CARDS; OFFICE SUPPLIES, NAMELY, PERSONAL ORGANIZERS, PRINTED OFFICE FORMS AND ANNUAL LAMINATED DESK TOP PLANNERS AND CALENDARS (U.S. CLS. 2, 5, 22, 23, 29, 37, 38 AND 50).

FIRST USE 3-1-2004; IN COMMERCE 3-1-2004.

CLASS 35—ADVERTISING AND BUSINESS

FOR TELEMARKETING SERVICES; MAIL ORDER CATALOG SERVICES AND ONLINE ORDERING SERVICES OFFERED OVER A GLOBAL COMPUTER NETWORK FEATURING PRINTED MATTER, NAMELY, BLANK EMPLOYMENT FORMS, LABOR FORMS AND PERSONNEL FORMS; HUMAN RESOURCE PRODUCTS, NAMELY, COMPLIANCE POSTERS, SAFETY PRODUCTS, SOFTWARE AND BOOKS, MOTIVATIONAL PRODUCTS, NAMELY, AWARD CERTIFICATES AND FRAMES, LITHOGRAPHS, PERSONALIZED AWARDS AND ALL OCCASION GREETING CARDS; OFFICE SUPPLIES, NAMELY ORGANIZERS, OFFICE FORMS AND ANNUAL LAMINATED PLANNERS AND CALENDARS (U.S. CLS. 100, 101 AND 102).

FIRST USE 3-1-2004; IN COMMERCE 3-1-2004.

SHAUNIA WALLACE, EXAMINING ATTORNEY

SN 78-412,930. NORTHERN LIPIDS INC., VANCOUVER, CANADA, FILED 5-4-2004.

LIPEX

THE MARK CONSISTS OF STANDARD CHARACTERS WITHOUT CLAIM TO ANY PARTICULAR FONT, STYLE, SIZE, OR COLOR.

OWNER OF CANADA REG. NO. TMA601,197, DATED 2-3-2004, EXPIRES 2-3-2019.

CLASS 5—PHARMACEUTICALS

FOR LIPIDS FOR USE IN PHARMACEUTICALS; LIPOSOMES FOR USE IN PHARMACEUTICALS (U.S. CLS. 6, 18, 44, 46, 51 AND 52).

CLASS 7—MACHINERY

FOR MACHINES FOR THE MANUFACTURE OF LIPIDS AND LIPOSOMES; MACHINES IN THE NATURE OF APPARATUS FOR THE PRODUCTION, REFINEMENT, EXTRUSION AND STORAGE OF LIPIDS AND LIPOSOMES (U.S. CLS. 13, 19, 21, 23, 31, 34 AND 35).

LOURDES AYALA, EXAMINING ATTORNEY

SN 78-413,129. PARAGON REAL ESTATE RESOURCES, INC., RANCHO SANTA MARGARITA, CA. FILED 5-4-2004.



NO CLAIM IS MADE TO THE EXCLUSIVE RIGHT TO USE "REAL ESTATE RESOURCES, INC.", APART FROM THE MARK AS SHOWN.

THE MARK CONSISTS OF THE WORDS PARAGON REAL ESTATE RESOURCES, INC. WITH THE WORD PARAGON ABOVE A LINE AND THE WORDS REAL ESTATE RESOURCES, INC. BELOW THE LINE. TWO INTERSECTING DIAMOND SHAPES ARE TO THE LEFT OF THE WORDS.

CLASS 36—INSURANCE AND FINANCIAL

FOR RETAIL REAL ESTATE BROKERAGE AND CONSULTATION SERVICES TO COORDINATE THE BUYING AND SELLING OF RESIDENTIAL REAL ESTATE FOR A VARIETY OF INDIVIDUALS; PROVIDING REAL ESTATE INFORMATION TO OTHERS ABOUT REAL ESTATE AGENTS (U.S. CLS. 100, 101 AND 102).
FIRST USE 5-21-2003; IN COMMERCE 3-1-2004.

CLASS 39—TRANSPORTATION AND STORAGE

FOR MOVING SERVICES, NAMELY, ASSISTING WITH THE SHIPMENT OF HOUSEHOLD GOODS AND PROVIDING MOVING INFORMATION TO OTHERS (U.S. CLS. 100 AND 105).
FIRST USE 5-21-2003; IN COMMERCE 3-1-2004.
RICHARD A. STRASER, EXAMINING ATTORNEY

SN 78-413,293. RADIO RECONNAISSANCE TECHNOLOGIES, INC., FREDERICKSBURG, VA. FILED 5-5-2004.



NO CLAIM IS MADE TO THE EXCLUSIVE RIGHT TO USE "RADIO" AND "TECHNOLOGIES INC.", APART FROM THE MARK AS SHOWN.

CLASS 9—ELECTRICAL AND SCIENTIFIC APPARATUS

FOR ELECTRONIC COMMUNICATIONS INSTRUMENTS AND COMPONENTS, NAMELY RECEIVERS (U.S. CLS. 21, 23, 26, 36 AND 38).
FIRST USE 1-1-1992; IN COMMERCE 1-1-1992.

CLASS 41—EDUCATION AND ENTERTAINMENT

FOR TRAINING IN THE USE AND OPERATION OF ELECTRONIC COMMUNICATIONS INSTRUMENTS (U.S. CLS. 100, 101 AND 107).
FIRST USE 1-1-1992; IN COMMERCE 1-1-1992.

CLASS 42—SCIENTIFIC, COMPUTER AND LEGAL SERVICES

FOR TECHNICAL CONSULTATION IN THE FIELD OF ELECTRONIC COMMUNICATIONS INSTRUMENTS (U.S. CLS. 100 AND 101).
FIRST USE 1-1-1992; IN COMMERCE 1-1-1992.
LINDA MICKLEBURGH, EXAMINING ATTORNEY

SN 78-413,462. EPILEPSY FOUNDATION OF AMERICA, LANDOVER, MD. FILED 5-5-2004.

STROLL FOR EPILEPSY

THE MARK CONSISTS OF STANDARD CHARACTERS WITHOUT CLAIM TO ANY PARTICULAR FONT, STYLE, SIZE, OR COLOR.

OWNER OF U.S. REG. NO. 1,834,881.
NO CLAIM IS MADE TO THE EXCLUSIVE RIGHT TO USE "EPILEPSY", APART FROM THE MARK AS SHOWN.

CLASS 35—ADVERTISING AND BUSINESS

FOR ASSOCIATION SERVICES, NAMELY, PROMOTING THE INTERESTS OF PEOPLE WITH EPILEPSY THROUGH ADVOCACY, AND DISSEMINATION OF INFORMATION RELATING TO EPILEPSY AND THE CHALLENGES FACED BY PERSONS WITH EPILEPSY (U.S. CLS. 100, 101 AND 102).
FIRST USE 0-0-1999; IN COMMERCE 0-0-1999.

CLASS 36—INSURANCE AND FINANCIAL

FOR CHARITABLE FUND RAISING SERVICES FOR SPONSORING RESEARCH IN THE TREATMENT OF EPILEPSY (U.S. CLS. 100, 101 AND 102).
FIRST USE 0-0-1999; IN COMMERCE 0-0-1999.
DOMINICK J. SALEMI, EXAMINING ATTORNEY

SN 78-415,114. PREMIER BANCSHARES, INC., JEFFERSON CITY, MO. FILED 5-7-2004.

PALS

THE MARK CONSISTS OF STANDARD CHARACTERS WITHOUT CLAIM TO ANY PARTICULAR FONT, STYLE, SIZE, OR COLOR.

CLASS 16—PAPER GOODS AND PRINTED MATTER

FOR NEWSLETTERS, BROCHURES AND FLYERS IN THE FIELDS OF GENERAL INTEREST TOPICS, NAMELY, SURFING THE INTERNET, CHECKBOOK BALANCING, SCRAP BOOKING, LIVING WILLS, ADVANCED DIRECTIVES, ESTATE PLANNING, INTERNET BANKING, CRAFTS, COOKING, GARDENING, DECORATING, STAINED GLASS WINDOWS, ANTIQUE ROAD SHOWS, PREPARING FOR DISASTER, COMMUNITY VOLUNTEERING, IDENTITY THEFT, PHISHING, SELF HELP, DANCING, SPECIAL EVENTS, CLUB ACTIVITIES, TRIPS, TRAVEL, TOURS, CRUISES, TRAVEL REWARDS, BANKING SERVICES, CDARS (CERTIFICATE OF DEPOSIT ACCOUNT REGISTRY SERVICE), SPECIAL OFFERS, ENTERTAINMENT, MOVIES, PICNICS, WINE TASTING, DINING, SOCIAL AND EDUCATIONAL ACTIVITIES, SAFE DRIVING, FINANCIAL PLANNING, INSURANCE, SELF DEFENSE AND SEMINARS IN THE FIELDS OF ALL OF THE FOREGOING TOPICS (U.S. CLS. 2, 5, 22, 23, 29, 37, 38 AND 50).

FIRST USE 11-17-2003; IN COMMERCE 11-17-2003.

CLASS 35—ADVERTISING AND BUSINESS

FOR BANK LOYALTY PROGRAM SERVICES, NAMELY ADMINISTRATION OF A DISCOUNT PROGRAM ENABLING MEMBERS TO OBTAIN DISCOUNTS ON GOODS AND SERVICES (U.S. CLS. 100, 101 AND 102).

FIRST USE 11-17-2003; IN COMMERCE 11-17-2003.

CLASS 36—INSURANCE AND FINANCIAL

FOR BANKING SERVICES; CHECKING ACCOUNT SERVICES (U.S. CLS. 100, 101 AND 102).

FIRST USE 11-17-2003; IN COMMERCE 11-17-2003.

CLASS 39—TRANSPORTATION AND STORAGE

FOR TRAVEL AND TRANSPORTATION SERVICES, NAMELY ARRANGING TRAVEL TOURS AND MAKING RESERVATIONS AND BOOKINGS FOR TRANSPORTATION; BANK CLUB SERVICES, NAMELY PROVIDING A TRAVEL CLUB FOR MEMBERS (U.S. CLS. 100 AND 105).

FIRST USE 11-17-2003; IN COMMERCE 11-17-2003.

CLASS 41—EDUCATION AND ENTERTAINMENT

FOR ENTERTAINMENT SERVICES, NAMELY, ARRANGING, ORGANIZING AND HOSTING SOCIAL EVENTS, GET-TOGETHERS, PARTIES, MOVIES, GOLF OUTINGS, THEATRE EVENTS, BROADWAY SHOWS, SPA DAYS, DANCES AND DANCING EVENTS, HISTORICAL JOURNEYS, PICNICS AND DINING FOR CLUB MEMBERS; EDUCATIONAL SERVICES, NAMELY, PROVIDING SEMINARS AND PRESENTATIONS IN THE FIELDS OF GENERAL INTEREST TOPICS, NAMELY, SURFING THE INTERNET, CHECKBOOK BALANCING, SCRAP BOOKING, LIVING WILLS, ADVANCED DIRECTIVES, ESTATE PLANNING, INTERNET BANKING, CRAFTS, COOKING, GARDENING, DECORATING, STAINED GLASS WINDOWS, ANTIQUE ROAD SHOWS, PREPARING FOR DISASTER, COMMUNITY VOLUNTEERING, IDENTITY THEFT, PHISHING, SELF HELP, DANCING, SPECIAL EVENTS, CLUB ACTIVITIES, TRIPS, TRAVEL, TOURS, CRUISES, TRAVEL REWARDS, BANKING SERVICES, CDARS (CERTIFICATE OF DEPOSIT ACCOUNT REGISTRY SERVICE), MOVIES, PICNICS, WINE TASTING, DINING, SAFE DRIVING, FINANCIAL PLANNING, INSURANCE, AND SELF DEFENSE (U.S. CLS. 100, 101 AND 107).

FIRST USE 11-17-2003; IN COMMERCE 11-17-2003.

CLASS 45—PERSONAL SERVICES

FOR BANK-SPONSORED SOCIAL CLUB MEMBER SERVICES (U.S. CLS. 100 AND 101).

FIRST USE 11-17-2003; IN COMMERCE 11-17-2003.

ODESSA BIBBINS, EXAMINING ATTORNEY

SN 78-415,189. GLOBAL VILLAGE CONSULTING GROUP, LLC, ALLENTOWN, PA. FILED 5-7-2004.

GLOBAL BUSINET

THE MARK CONSISTS OF STANDARD CHARACTERS WITHOUT CLAIM TO ANY PARTICULAR FONT, STYLE, SIZE, OR COLOR.

NO CLAIM IS MADE TO THE EXCLUSIVE RIGHT TO USE "GLOBAL", APART FROM THE MARK AS SHOWN.

CLASS 35—ADVERTISING AND BUSINESS

FOR INTERNATIONAL CONSULTATION SERVICES IN THE FIELD OF BUSINESS STRATEGY, MARKETING, PRODUCTION, TECHNOLOGY, PERSONNEL AND RETAIL SALE MATTERS; INTERNATIONAL BUSINESS SERVICES IN THE NATURE OF PARTNER MATCHING, RELATING TO PRODUCT DISTRIBUTION, OPERATIONS MANAGEMENT, LOGISTICS, REVERSE LOGISTICS, SUPPLY CHAIN, AND PRODUCTION SYSTEMS AND DISTRIBUTION SYSTEMS IN THE FIELD OF IMPORTS AND EXPORTS (U.S. CLS. 100, 101 AND 102).

CLASS 41—EDUCATION AND ENTERTAINMENT

FOR INTERNATIONAL TRANSLATION SERVICES (U.S. CLS. 100, 101 AND 107).

CLASS 42—SCIENTIFIC, COMPUTER AND LEGAL SERVICES

FOR INTERNATIONAL WEBSITE DESIGN (U.S. CLS. 100 AND 101).
ALLISON HOLTZ, EXAMINING ATTORNEY

SN 78-415,371. SCHAEFER-WILSON, JAMIE, CHAPPAQUA, NY. FILED 5-7-2004.

THE TODDLER BEAT

THE MARK CONSISTS OF STANDARD CHARACTERS WITHOUT CLAIM TO ANY PARTICULAR FONT, STYLE, SIZE, OR COLOR.

NO CLAIM IS MADE TO THE EXCLUSIVE RIGHT TO USE "TODDLER", APART FROM THE MARK AS SHOWN.

CLASS 9—ELECTRICAL AND SCIENTIFIC APPARATUS

FOR PRE-RECORDED VIDEOTAPES, VIDEODISCS, DVDS, CD-ROMS AND AUDIO TAPES AND DISCS FEATURING EARLY LEARNING EDUCATIONAL ACTIVITIES AND ENTERTAINMENT FOR CHILDREN (U.S. CLS. 21, 23, 26, 36 AND 38).

CLASS 41—EDUCATION AND ENTERTAINMENT

FOR ENTERTAINMENT SERVICES, NAMELY THE PRODUCTION AND DISTRIBUTION OF TELEVISION AND CABLE TELEVISION PROGRAMS (U.S. CLS. 100, 101 AND 107).
BARBARA BROWN, EXAMINING ATTORNEY

SNAP VPN

THE MARK CONSISTS OF STANDARD CHARACTERS WITHOUT CLAIM TO ANY PARTICULAR FONT, STYLE, SIZE, OR COLOR.

NO CLAIM IS MADE TO THE EXCLUSIVE RIGHT TO USE "VPN", APART FROM THE MARK AS SHOWN.

CLASS 9—ELECTRICAL AND SCIENTIFIC APPARATUS

FOR VIRTUAL PRIVATE NETWORKING SOLUTIONS; NAMELY COMPUTER HARDWARE AND SOFTWARE FOR CREATING, DEPLOYING AND MAINTAINING VIRTUAL PRIVATE NETWORKS; NETWORK MANAGEMENT SYSTEMS, NAMELY COMPUTER HARDWARE AND SOFTWARE FOR CREATING AUTOMATED NETWORK CONFIGURATION, SECURITY, REPORTING, AND MANAGEMENT OF COMPUTER NETWORKS; NETWORK STORAGE SYSTEMS, NAMELY COMPUTER HARDWARE AND SOFTWARE FOR NETWORK DATA STORAGE; REMOTE ACCESS MANAGEMENT, NAMELY COMPUTER HARDWARE AND SOFTWARE FOR PROVIDING REMOTE ACCESS TO VIRTUAL PRIVATE NETWORKS (U.S. CLS. 21, 23, 26, 36 AND 38).

CLASS 41—EDUCATION AND ENTERTAINMENT

FOR PARTNER SUPPORT AND TRAINING, NAMELY PROVIDING TRAINING IN THE DEPLOYMENT, MANAGEMENT, MAINTENANCE AND OPERATION OF SECURE NETWORK ENVIRONMENTS (U.S. CLS. 100, 101 AND 107).

CLASS 42—SCIENTIFIC, COMPUTER AND LEGAL SERVICES

FOR CONSULTING SERVICES IN THE FIELD OF IMPLEMENTATION AND USE OF COMPUTER HARDWARE AND SOFTWARE SYSTEMS (U.S. CLS. 100 AND 101).

INGRID C. EULIN, EXAMINING ATTORNEY

SN 78-416,542. ASTRAZENECA AB, SODERTALJE, SWEDEN, FILED 5-11-2004.

NOW YOU'RE GETTING SOMEWHERE

THE MARK CONSISTS OF STANDARD CHARACTERS WITHOUT CLAIM TO ANY PARTICULAR FONT, STYLE, SIZE, OR COLOR.

PRIORITY CLAIMED UNDER SEC. 44(D) ON SWEDEN APPLICATION NO. 2004/03246, FILED 5-4-2004, REG. NO. 370347, DATED 1-21-2005, EXPIRES 1-21-2015.

CLASS 5—PHARMACEUTICALS

FOR PHARMACEUTICAL PREPARATIONS FOR THE TREATMENT OF CARDIOVASCULAR DISEASES FOR HUMANS ONLY (U.S. CLS. 6, 18, 44, 46, 51 AND 52).

CLASS 16—PAPER GOODS AND PRINTED MATTER

FOR PRINTED MATTER, NAMELY NEWSLETTERS, STATIONERY TEMPLATES, BOOKLETS, POSTERS, SIGNBOARDS OF PAPER OR CARDBOARD, PAMPHLETS, AND PRINTED PUBLICATIONS, NAMELY, MAGAZINES, BOOKS, BROCHURES AND JOURNALS, ALL IN RELATION TO SCIENTIFIC RESEARCH WITHIN THE CARDIOVASCULAR AREA (U.S. CLS. 2, 5, 22, 23, 29, 37, 38 AND 50).

CLASS 44—MEDICAL, BEAUTY AND AGRICULTURAL SERVICES

FOR MEDICAL SERVICES, NAMELY, PROVIDING INFORMATION ABOUT PHARMACEUTICAL PREPARATIONS FOR THE TREATMENT OF CARDIOVASCULAR DISEASES FOR HUMANS ONLY (U.S. CLS. 100 AND 101).

MICHAEL HALL, EXAMINING ATTORNEY

SN 78-416,848. WIRELESS SERVICES CORPORATION, BELLEVUE, WA. FILED 5-11-2004.

SINGLEPOINT

THE MARK CONSISTS OF STANDARD CHARACTERS WITHOUT CLAIM TO ANY PARTICULAR FONT, STYLE, SIZE, OR COLOR.

SN 78-416,800. ATHLETIC VENTURES OF OHIO, INC., CLEVELAND, OH. FILED 5-11-2004.

CLASS 38—COMMUNICATION

FOR TELECOMMUNICATIONS GATEWAY SERVICES, NAMELY THE DELIVERY OF ONLINE CONTENT TO AND BETWEEN WIRELESS CARRIERS, SUBSCRIBERS, AND CONTENT PROVIDERS (U.S. CLS. 100, 101 AND 104).

FIRST USE 6-2-2003; IN COMMERCE 6-2-2003.

CLASS 42—SCIENTIFIC, COMPUTER AND LEGAL SERVICES

FOR PROTOCOL CONVERSION AND TRANSLATION TO ENABLE ACCESS, SELECTION, AND DISPLAY OF ONLINE CONTENT VIA A WIRELESS NETWORK (U.S. CLS. 100 AND 101).

FIRST USE 6-2-2003; IN COMMERCE 6-2-2003.

STEVEN R. FINE, EXAMINING ATTORNEY



SN 78-417,328. BILD- & DATAANALYS T GUSTAVSSON AB, ORGANISATION, GOTEORG, SWEDEN, FILED 5-12-2004.

CLASS 41—EDUCATION AND ENTERTAINMENT

FOR GYMNASIUMS AND HEALTH CLUB SERVICES FOR GAY MEN, NAMELY PROVIDING EQUIPMENT IN THE FIELD OF PHYSICAL EXERCISE, PROVIDING FACILITIES FOR RECREATIONAL ACTIVITIES (U.S. CLS. 100, 101 AND 107).

FIRST USE 1-31-1990; IN COMMERCE 1-31-1990.

CLASS 44—MEDICAL, BEAUTY AND AGRICULTURAL SERVICES

FOR PROVIDING BATH, WHIRLPOOL, STEAM ROOM, SAUNA, LOCKER AND PRIVATE DRESSING ROOM FACILITIES FOR GAY MEN (U.S. CLS. 100 AND 101).

FIRST USE 1-31-1990; IN COMMERCE 1-31-1990.

CLASS 45—PERSONAL SERVICES

FOR PRIVATE SOCIAL CLUB FOR GAY MEN (U.S. CLS. 100 AND 101).

FIRST USE 1-31-1990; IN COMMERCE 1-31-1990.

ANGELA M. MICHELI, EXAMINING ATTORNEY

Q-IMT

THE MARK CONSISTS OF STANDARD CHARACTERS WITHOUT CLAIM TO ANY PARTICULAR FONT, STYLE, SIZE, OR COLOR.

OWNER OF SWEDEN REG. NO. 2003/06748, DATED 11-13-2003, EXPIRES 11-13-2013.

CLASS 9—ELECTRICAL AND SCIENTIFIC APPARATUS

FOR COMPUTER SOFTWARE FOR USE WITH MEDICAL EQUIPMENT FOR ARTERY MEASUREMENT AND MANUALS THEREFOR (U.S. CLS. 21, 23, 26, 36 AND 38).

FIRST USE 12-2-2003; IN COMMERCE 12-2-2003.

CLASS 10—MEDICAL APPARATUS

FOR MEDICAL EQUIPMENT, NAMELY, MEDICAL EQUIPMENT FOR ARTERY MEASUREMENT (U.S. CLS. 26, 39 AND 44).

SN 78-417,529. ADT SECURITY SERVICES, INC., BOCA RATON, FL. FILED 5-12-2004.

CLASS 41—EDUCATION AND ENTERTAINMENT

FOR EDUCATIONAL SERVICES, NAMELY, CLASSES, SEMINARS, CONFERENCES AND WORKSHOPS IN THE FIELD OF ARTERY MEASUREMENT (U.S. CLS. 100, 101 AND 107).

STILL THE FIRST

CLASS 42—SCIENTIFIC, COMPUTER AND LEGAL SERVICES

FOR PROGRAMMING CONSULTATION SERVICES IN THE FIELD OF ARTERY MEASUREMENT; CONSULTATION AND RESEARCH IN THE FIELD OF ARTERY MEASUREMENT (U.S. CLS. 100 AND 101).
PAULA MAYS, EXAMINING ATTORNEY

THE MARK CONSISTS OF STANDARD CHARACTERS WITHOUT CLAIM TO ANY PARTICULAR FONT, STYLE, SIZE, OR COLOR.

NO CLAIM IS MADE TO THE EXCLUSIVE RIGHT TO USE "FIRST", APART FROM THE MARK AS SHOWN.

CLASS 37—CONSTRUCTION AND REPAIR

FOR INSTALLATION, REPAIR, AND MAINTENANCE OF SECURITY, VEHICLE OR BUILDING ACCESS, FIRE ALERT AND TEMPERATURE CONTROL SYSTEMS (U.S. CLS. 100, 103 AND 106).

SN 78-417,370. UDIG TECHNOLOGIES LLC, GLEN ALLEN, VA. FILED 5-12-2004.

CLASS 45—PERSONAL SERVICES

FOR SECURITY SURVEILLANCE AND MONITORING SECURITY SYSTEMS FOR OTHERS (U.S. CLS. 100 AND 101).
FRED MANDIR, EXAMINING ATTORNEY

UDIG

SN 78-418,073. HOTELS.COM, L.P., DALLAS, TX. FILED 5-13-2004.



THE MARK CONSISTS OF STANDARD CHARACTERS WITHOUT CLAIM TO ANY PARTICULAR FONT, STYLE, SIZE, OR COLOR.

CLASS 35—ADVERTISING AND BUSINESS

FOR BUSINESS SERVICES NAMELY, TEMPORARY AND PERMANENT STAFFING SERVICES FOR OTHERS (U.S. CLS. 100, 101 AND 102).
FIRST USE 4-1-2001; IN COMMERCE 4-1-2001.

OWNER OF U.S. REG. NOS. 2,793,744 AND 2,918,738.
NO CLAIM IS MADE TO THE EXCLUSIVE RIGHT TO USE "ROAD TRIPS USA", APART FROM THE MARK AS SHOWN.

THE MARK CONSISTS OF A LICENSE PLATE DESIGN THAT CONTAINS THE WORDING "HOTELS.COM" ON THE TOP OF THE WORDING "ROAD TRIPS" ON THE TOP OF THE WORDING "USA".
SEC. 2(F) AS TO "HOTELS.COM".

CLASS 42—SCIENTIFIC, COMPUTER AND LEGAL SERVICES

FOR CONSULTING SERVICES IN THE FIELD OF INFORMATION TECHNOLOGY (U.S. CLS. 100 AND 101).
PAULA MAYS, EXAMINING ATTORNEY

CLASS 35—ADVERTISING AND BUSINESS

FOR PROMOTIONAL CONTESTS TO PROMOTE THE SALE OF PRODUCTS AND SERVICES OF OTHERS (U.S. CLS. 100, 101 AND 102).
FIRST USE 3-25-2004; IN COMMERCE 3-25-2004.

CLASS 39—TRANSPORTATION AND STORAGE

FOR PROVIDING INFORMATION FOR OTHERS ABOUT TRANSPORTATION IN THE NATURE OF VEHICLE TRANSPORTATION; TRAVEL AGENCY SERVICES, NAMELY, MAKING RESERVATIONS AND BOOKINGS FOR TRANSPORTATION FOR OTHERS VIA COMPUTER NETWORKS, WIRELESS NETWORKS, THE INTERNET AND VIA TELEPHONE; ARRANGING TRAVEL TOUR VACATION PACKAGES FOR OTHERS VIA COMPUTER NETWORKS, WIRELESS NETWORKS, THE INTERNET AND VIA TELEPHONE; TRAVEL DESTINATION INFORMATION SERVICES FEATURING MAPS, CITY DIRECTORIES AND LISTINGS VIA COMPUTER NETWORKS, WIRELESS NETWORKS, THE INTERNET AND VIA TELEPHONE (U.S. CLS. 100 AND 105).

FIRST USE 3-25-2004; IN COMMERCE 3-25-2004.
RAMONA ORTIGA, EXAMINING ATTORNEY

SN 78-418,324. VECTORMAX CORPORATION, FARMINGDALE, NY. FILED 5-13-2004.

Present Anywhere

THE MARK CONSISTS OF STANDARD CHARACTERS WITHOUT CLAIM TO ANY PARTICULAR FONT, STYLE, SIZE, OR COLOR.

CLASS 9—ELECTRICAL AND SCIENTIFIC APPARATUS

FOR TWO WAY DESKTOP VIDEO CONFERENCING SOFTWARE (U.S. CLS. 21, 23, 26, 36 AND 38).

SN 78-418,101. GUTHY-RENKER CORPORATION, PALM DESERT, CA. FILED 5-13-2004.

CLASS 38—COMMUNICATION

FOR TWO WAY DESKTOP VIDEO CONFERENCING SERVICES (U.S. CLS. 100, 101 AND 104).
NELSON SNYDER, EXAMINING ATTORNEY

SN 78-418,361. ARES TRADING S.A., AUBONNE, SWITZERLAND, FILED 5-13-2004.

**3 SIMPLE STEPS TO
ENTER THE CLEAR
ZONE**

THE MARK CONSISTS OF STANDARD CHARACTERS WITHOUT CLAIM TO ANY PARTICULAR FONT, STYLE, SIZE, OR COLOR.

OWNER OF U.S. REG. NO. 2,258,095.

CLASS 3—COSMETICS AND CLEANING PREPARATIONS

FOR SKIN AND BODY CARE PREPARATIONS NAMELY, SKIN CLEANSERS, SKIN MOISTURIZERS, SKIN LOTIONS, SKIN SOAPS, SUN SCREEN PREPARATIONS, COSMETICS, NON-MEDICATED SKIN CARE PREPARATIONS (U.S. CLS. 1, 4, 6, 50, 51 AND 52).
FIRST USE 7-21-2004; IN COMMERCE 7-21-2004.

CLASS 5—PHARMACEUTICALS

FOR ACNE TREATMENT PREPARATIONS (U.S. CLS. 6, 18, 44, 46, 51 AND 52).
FIRST USE 7-21-2004; IN COMMERCE 7-21-2004.
JOHN GARTNER, EXAMINING ATTORNEY

THE MARK CONSISTS OF STANDARD CHARACTERS WITHOUT CLAIM TO ANY PARTICULAR FONT, STYLE, SIZE, OR COLOR.

OWNER OF SWITZERLAND REG. NO. 523577, DATED 5-12-2004, EXPIRES 5-12-2014.

CLASS 5—PHARMACEUTICALS

FOR PHARMACEUTICAL PREPARATIONS, NAMELY, PREPARATIONS TO TREAT IMMUNOLOGICAL AND INFLAMMATORY DISEASES AND DISORDERS, CARDIOVASCULAR DISEASES AND DISORDERS, ONCOLOGICAL DISEASES AND DISORDERS, NEUROLOGICAL DISEASES AND DISORDERS, GASTROENTEROLOGICAL DISEASES AND DISORDERS AND METABOLIC DISEASES AND DISORDERS (U.S. CLS. 6, 18, 44, 46, 51 AND 52).

LOBREVO

CLASS 44—MEDICAL, BEAUTY AND AGRICULTURAL SERVICES

FOR MEDICAL SERVICES, PROVIDING MEDICAL INFORMATION, MEDICAL COUNSELING (U.S. CLS. 100 AND 101).

MARY CRAWFORD, EXAMINING ATTORNEY

SN 78-418,894. DETICA LIMITED, GUILDFORD, SURREY, UNITED KINGDOM, FILED 5-14-2004.

**CLASS 9—ELECTRICAL AND SCIENTIFIC APPARATUS**

FOR COMPUTER HARDWARE, FIRMWARE AND SOFTWARE, NAMELY, FOR USE IN THE MANIPULATION AND EXPLOITATION OF LARGE DATA VOLUMES, INFORMATION SECURITY APPLICATIONS, WIRED AND WIRELESS COMMUNICATIONS, WEB INTERFACES; APPARATUS AND INSTRUMENTS FOR USE IN RELATION TO COMMUNICATIONS, WIRELESS COMMUNICATIONS, INTERACTIVE TELEVISION, THE INTERNET, ELECTRONIC DATABASES, ELECTRONIC COMMERCE, CUSTOMER CONTACT CENTERS, INFORMATION SECURITY, SIGNAL PROCESSING AND SIGNAL ENCRYPTION, NAMELY, DIGITAL SIGNAL PROCESSORS, AUDIO AND VIDEO RECEIVERS, INTERNET PROTOCOL (IP) PROCESSING; DOWNLOADABLE AND ELECTRONIC PUBLICATIONS RECORDED ON COMPUTER MEDIA, NAMELY BOOKS, PAMPHLETS, ARTICLES, MAGAZINE SECTIONS, TECHNICAL MANUALS, INSTRUCTION AND TEACHING MATERIALS AND REPORTS ALL IN THE FIELD OF WIRED AND WIRELESS COMMUNICATIONS, INFORMATION SECURITY, DATA EXPLOITATION, BUSINESS AND TECHNOLOGY CONSULTING, AND PROGRAM MANAGEMENT (U.S. CLS. 21, 23, 26, 36 AND 38).

CLASS 16—PAPER GOODS AND PRINTED MATTER

FOR PRINTED MATTER, NAMELY, BOOKS, PAMPHLETS, ARTICLES, NAMELY, MAGAZINE SECTIONS AND TECHNICAL MANUALS, INSTRUCTION AND TEACHING MATERIALS AND REPORTS IN THE FIELD OF WIRED AND WIRELESS COMMUNICATIONS, INFORMATION SECURITY, DATA EXPLOITATION, BUSINESS AND TECHNOLOGY CONSULTING, AND PROGRAM MANAGEMENT (U.S. CLS. 2, 5, 22, 23, 29, 37, 38 AND 50).

CLASS 35—ADVERTISING AND BUSINESS

FOR BUSINESS CONSULTATION; BUSINESS MANAGEMENT CONSULTATION; BUSINESS STRATEGY CONSULTATION; BUSINESS MARKETING SERVICES; BUSINESS MANAGEMENT CONSULTATION FOR RETAILERS; BUSINESS PROCESS ADVISORY SERVICES, NAMELY BUSINESS MANAGEMENT CONSULTANCY AS WELL AS DEVELOPMENT OF PROCESSES FOR THE ANALYSIS AND THE IMPLEMENTATION OF STRATEGY PLANS AND MANAGEMENT PROJECTS; BUSINESS MANAGEMENT INFORMATION ON A WIDE VARIETY OF TOPICS TO SERVICE PROVIDING PROFESSIONALS RELATING TO THE CAPTURE, STORAGE, ANALYSIS AND DISTRIBUTION OF INFORMATION; DATABASE MANAGEMENT SERVICES (U.S. CLS. 100, 101 AND 102).

CLASS 37—CONSTRUCTION AND REPAIR

FOR INSTALLATION, REPAIR AND MAINTENANCE SERVICES IN THE FIELD OF COMPUTER HARDWARE AND COMMUNICATION EQUIPMENT, NAMELY HARDWARE APPARATUS AND INSTRUMENTS FOR USE IN RELATION TO COMMUNICATIONS, WIRELESS COMMUNICATIONS, INTERACTIVE TELEVISION, THE INTERNET, ELECTRONIC DATABASES, ELECTRONIC COMMERCE, CUSTOMER CONTACT CENTERS, INFORMATION SECURITY, SIGNAL PROCESSING AND SIGNAL ENCRYPTION (U.S. CLS. 100, 103 AND 106).

CLASS 38—COMMUNICATION

FOR TELECOMMUNICATIONS CONSULTATION (U.S. CLS. 100, 101 AND 104).

CLASS 41—EDUCATION AND ENTERTAINMENT

FOR ONLINE NON-DOWNLOADABLE PUBLICATIONS, NAMELY BOOKS, PAMPHLETS, ARTICLES, NAMELY MAGAZINE SECTIONS, TECHNICAL MANUALS, INSTRUCTION AND TEACHING MATERIALS AND REPORTS IN THE FIELD OF WIRED AND WIRELESS COMMUNICATIONS, INFORMATION SECURITY, DATA EXPLOITATION, BUSINESS AND TECHNOLOGY CONSULTING, AND PROGRAM MANAGEMENT (U.S. CLS. 100, 101 AND 107).

CLASS 42—SCIENTIFIC, COMPUTER AND LEGAL SERVICES

FOR COMPUTER CONSULTATION AND DESIGN FOR OTHERS IN THE FIELDS OF COMPUTER HARDWARE, FIRMWARE AND SOFTWARE, APPARATUS AND INSTRUMENTS FOR USE IN RELATION TO COMMUNICATIONS, WIRELESS COMMUNICATIONS, INTERACTIVE TELEVISION, THE INTERNET, ELECTRONIC DATABASES, ELECTRONIC COMMERCE, CUSTOMER CONTACT CENTERS, INFORMATION SECURITY, SIGNAL PROCESSING AND SIGNAL ENCRYPTION (U.S. CLS. 100 AND 101).

SAMUEL E. SHARPER JR., EXAMINING ATTORNEY

SN 78-418,976. VIACOM INTERNATIONAL INC., NEW YORK, NY. FILED 5-14-2004.

VH1 SAVE THE MUSIC

THE MARK CONSISTS OF STANDARD CHARACTERS WITHOUT CLAIM TO ANY PARTICULAR FONT, STYLE, SIZE, OR COLOR.

OWNER OF U.S. REG. NOS. 2,165,655, 2,173,881 AND OTHERS.

CLASS 35—ADVERTISING AND BUSINESS

FOR PROVIDING A CONTINUING SERIES OF PUBLIC SERVICE CAMPAIGNS PROMOTING PUBLIC AWARENESS OF THE SOCIAL AND CULTURAL SIGNIFICANCE OF MUSIC VIA ALL FORMS OF MEDIA, INCLUDING TELEVISION, LIVE EVENTS, PRINT, THE GLOBAL COMPUTER NETWORK AND RADIO (U.S. CLS. 100, 101 AND 102).

FIRST USE 1-1-1997; IN COMMERCE 1-1-1997.

CLASS 41—EDUCATION AND ENTERTAINMENT

FOR CHARITABLE SERVICES, NAMELY PROVIDING MUSICAL INSTRUMENTS (U.S. CLS. 100, 101 AND 107). FIRST USE 4-1-1997; IN COMMERCE 4-1-1997. LA TONIA FISHER, EXAMINING ATTORNEY

SN 78-419,027. AUSTRALIAN BIGHT SEAFOOD PTY. LTD., SOUTH AUSTRALIA 5606, AUSTRALIA, FILED 5-14-2004.

AUSSEA

THE MARK CONSISTS OF STANDARD CHARACTERS WITHOUT CLAIM TO ANY PARTICULAR FONT, STYLE, SIZE, OR COLOR.

CLASS 29—MEATS AND PROCESSED FOODS

FOR SEAFOOD, NAMELY PRAWNS, SHRIMP, LOBSTER, FISH, FINFISH, CRUSTACEANS AND MOLLUSKS (U.S. CL. 46).

CLASS 30—STAPLE FOODS

FOR PRAWN PRODUCTS, NAMELY PRAWN DUMPLINGS AND SHRIMP PRODUCTS, NAMELY SHRIMP DUMPLINGS (U.S. CL. 46). MARK RADEMACHER, EXAMINING ATTORNEY

SN 78-419,271. TON SERVICES INC., OGDEN, UT. FILED 5-14-2004.

**SCAN &
go**

NO CLAIM IS MADE TO THE EXCLUSIVE RIGHT TO USE SCAN, APART FROM THE MARK AS SHOWN.

CLASS 39—TRANSPORTATION AND STORAGE

FOR ELECTRONIC STORAGE OF FILES AND DOCUMENTS (U.S. CLS. 100 AND 105). FIRST USE 2-26-2004; IN COMMERCE 3-15-2004.

CLASS 40—MATERIAL TREATMENT

FOR ELECTRONIC IMAGING, SCANNING, DIGITIZING, ALTERATION AND/OR RETOUCHING OF VISUAL MATERIALS, NAMELY, PHOTOGRAPHIC IMAGES AND BUSINESS DOCUMENTS (U.S. CLS. 100, 103 AND 106).

FIRST USE 2-26-2004; IN COMMERCE 3-15-2004. BARBARA GAYNOR, EXAMINING ATTORNEY

SN 78-419,638. NEIGHBORCARE HOLDINGS, INC., BALTIMORE, MD. FILED 5-17-2004.



HospicareRx

THE MARK CONSISTS OF A STYLIZED VERSION OF THE LETTER "R," THE LETTER "X," AND A STYLIZED RENDERING OF A PERSON WITH THE WORDS HOSPI-CARERX BELOW.

CLASS 35—ADVERTISING AND BUSINESS

FOR PHARMACY SERVICES; NAMELY, RETAIL AND INSTITUTIONAL PHARMACY SERVICES (U.S. CLS. 100, 101 AND 102).

CLASS 44—MEDICAL, BEAUTY AND AGRICULTURAL SERVICES

FOR HEALTH CARE SERVICES IN THE NATURE OF HOME INTRAVENOUS THERAPY (U.S. CLS. 100 AND 101).

SHARON MEIER, EXAMINING ATTORNEY

SN 78-419,651. WIN-WIN AG, BELP, SWITZERLAND, FILED 5-17-2004.

WINNERGY

THE MARK CONSISTS OF STANDARD CHARACTERS WITHOUT CLAIM TO ANY PARTICULAR FONT, STYLE, SIZE, OR COLOR.

CLASS 35—ADVERTISING AND BUSINESS

FOR ADVERTISING SERVICES; MANAGEMENT CONSULTATION IN THE FIELD OF BUSINESS; BUSINESS ENTERPRISE ADMINISTRATION; OFFICE WORK; BUSINESS MANAGEMENT AND BUSINESS SUPPORT OF ENTERPRISES; BUSINESS ORGANIZATION AND MANAGEMENT CONSULTATION; MARKET SURVEY AND MARKET RESEARCH; ORGANIZATION OF COMMERCIAL FAIRS AND EXHIBITIONS FOR BUSINESS, ECONOMIC AND ADVERTISING PURPOSES (U.S. CLS. 100, 101 AND 102).

CLASS 41—EDUCATION AND ENTERTAINMENT

FOR EDUCATION SERVICES, NAMELY, ORGANIZATION AND EXECUTION OF SEMINARS, WORKSHOPS, COLLOQUIA, CONFERENCES, CONGRESSES AND SYMPOSIA IN THE FIELD OF BUSINESS AND HEALTH MANAGEMENT; TRAINING, NAMELY, TRAINING IN THE FIELD OF BUSINESS AND HEALTH MANAGEMENT; CULTURAL ACTIVITIES, NAMELY, LIVE MUSICAL PERFORMANCES AND THEATRICAL PRODUCTIONS (U.S. CLS. 100, 101 AND 107).
KATHY DE JONGE, EXAMINING ATTORNEY

SN 78-419,755. TOR CONSULTING, INC., SANTA ROSA, CA. FILED 5-17-2004.

TOR

THE MARK CONSISTS OF STANDARD CHARACTERS WITHOUT CLAIM TO ANY PARTICULAR FONT, STYLE, SIZE, OR COLOR.

CLASS 35—ADVERTISING AND BUSINESS

FOR CONSULTING SERVICES, NAMELY, BUSINESS MANAGEMENT CONSULTATION; MANAGEMENT CONSULTING; CONSULTING SERVICES REGARDING BUSINESS STRATEGIES; BUSINESS MARKETING CONSULTING REGARDING NEW PRODUCT AND SERVICE DEVELOPMENT; MARKETING CONSULTING; BUSINESS CONSULTING RELATED TO OPERATIONS AND LOGISTICS; MARKETING AND CONSUMER RESEARCH REGARDING PRODUCTS AND SERVICES; DISSEMINATION OF MARKETING AND PERFORMANCE-RELATED BUSINESS INFORMATION, NAMELY, NEWS, REPORTS, AND COMMENTARY, VIA A GLOBAL COMPUTER NETWORK (U.S. CLS. 100, 101 AND 102).
FIRST USE 5-5-2004; IN COMMERCE 5-10-2004.

CLASS 41—EDUCATION AND ENTERTAINMENT

FOR EDUCATIONAL SERVICES; NAMELY, CONDUCTING WORKSHOPS ON BUSINESS TOPICS FOR CORPORATE BUSINESS, INDIVIDUAL, AND NON-PROFIT CLIENTS (U.S. CLS. 100, 101 AND 107).
FIRST USE 5-5-2004; IN COMMERCE 5-10-2004.
SUELLEN HICKEY, EXAMINING ATTORNEY

SN 78-420,381. TIFFANY C. KRAFT AND GAIL K. LEFSAKER PARTNERSHIP, THE, ELK GROVE, CA. FILED 5-17-2004.

BABY PUPPIE

NO CLAIM IS MADE TO THE EXCLUSIVE RIGHT TO USE "BABY", APART FROM THE MARK AS SHOWN.

CLASS 18—LEATHER GOODS

FOR PURSES AND HANDBAGS (U.S. CLS. 1, 2, 3, 22 AND 41).

CLASS 25—CLOTHING

FOR PANTS, SHIRTS, SHORTS, SKIRTS, HATS (U.S. CLS. 22 AND 39).
ELLEN B. AWRICH, EXAMINING ATTORNEY

SN 78-420,431. LEGAL REFERENCE SERVICE INC., HUNTINGTON, NY. FILED 5-18-2004.

H.O.L.M.E.S

THE MARK CONSISTS OF STANDARD CHARACTERS WITHOUT CLAIM TO ANY PARTICULAR FONT, STYLE, SIZE, OR COLOR.

CLASS 35—ADVERTISING AND BUSINESS

FOR LIBRARY MANAGEMENT SERVICES, NAMELY, PROVIDING TECHNICAL ASSISTANCE IN THE ORGANIZATION AND MANAGEMENT OF LAW LIBRARIES; PROVIDING AN INTERACTIVE COMPUTER DATABASE IN THE FIELD OF LAW LIBRARY MANAGEMENT (U.S. CLS. 100, 101 AND 102).
FIRST USE 12-31-2003; IN COMMERCE 12-31-2003.

CLASS 42—SCIENTIFIC, COMPUTER AND LEGAL SERVICES

FOR COMPUTER SERVICES, NAMELY, PROVIDING SEARCH ENGINES FOR OBTAINING LIBRARY DATA VIA AN EXTRANET; PROVIDING USE OF ONLINE NON-DOWNLOADABLE SOFTWARE FOR USE IN FACILITATING ACCESS TO AND RETRIEVAL OF LIBRARY DATA, COMMUNICATIONS AMONG USERS AND EXCHANGES AND SHARING OF INFORMATION AND DOCUMENTS, REAL-TIME CHATS, AND INTEGRATION OF OFFICE AND LIBRARY FUNCTIONS (U.S. CLS. 100 AND 101).
FIRST USE 12-31-2003; IN COMMERCE 12-31-2003.

AMY GEARIN, EXAMINING ATTORNEY

SN 78-420,583. SUSAN MELCHERT, BOTHELL, WA. FILED 5-18-2004.

SBA Consulting

THE MARK CONSISTS OF STANDARD CHARACTERS WITHOUT CLAIM TO ANY PARTICULAR FONT, STYLE, SIZE, OR COLOR.

NO CLAIM IS MADE TO THE EXCLUSIVE RIGHT TO USE CONSULTING, APART FROM THE MARK AS SHOWN.

CLASS 35—ADVERTISING AND BUSINESS

FOR BUSINESS CONSULTING SERVICES RELATING TO PRODUCT DISTRIBUTION, OPERATIONS MANAGEMENT SERVICES, LOGISTICS, REVERSE LOGISTICS, SUPPLY CHAIN, AND PRODUCTION SYSTEMS AND DISTRIBUTION SOLUTIONS (U.S. CLS. 100, 101 AND 102).

CLASS 42—SCIENTIFIC, COMPUTER AND LEGAL SERVICES

FOR COMPUTER CONSULTATION, COMPUTER DIAGNOSTIC SERVICES, PROGRAMMING FOR OTHERS, COMPUTER CODE CONVERSION FOR OTHERS, COMPUTER DISASTER RECOVERY SERVICES PLANNING COMPUTER PROGRAMMING FOR OTHERS, COMPUTER SITE DESIGN, SOFTWARE DESIGN FOR OTHERS, AND UPDATING SOFTWARE FOR OTHERS (U.S. CLS. 100 AND 101).

CAROLYN GRAY, EXAMINING ATTORNEY

SN 78-420,735. GAY LEA FOODS CO-OPERATIVE LIMITED, MISSISSAUGA, ONTARIO, CANADA, FILED 5-18-2004.

GAY LEA

THE MARK CONSISTS OF STANDARD CHARACTERS WITHOUT CLAIM TO ANY PARTICULAR FONT, STYLE, SIZE, OR COLOR.

OWNER OF CANADA REG. NO. TMA121,413, DATED 3-3-1961, EXPIRES 3-3-2006.

OWNER OF U.S. REG. NOS. 1,031,588 AND 2,155,990.

CLASS 29—MEATS AND PROCESSED FOODS

FOR (BASED ON 44(E)) MILK POWDER; BUTTER AND CHEESE; POULTRY; EGGS; FLUID MILK AND CREAM; CHIP DIP; YOGURT; SOUR CREAM; COTTAGE CHEESE; MARGARINE; VEGETABLE OILS; DAIRY SPREAD, NAMELY, BUTTER SPREAD; AND (BASED ON INTENT TO USE) WHIP TOPPING (U.S. CL. 46).

CLASS 30—STAPLE FOODS

FOR CHEESECAKE DESSERT; PUDDING; ICE CREAM; SALAD DRESSING (U.S. CL. 46).

CLASS 32—LIGHT BEVERAGES

FOR ORANGE JUICE; FRUIT DRINKS AND FRUIT JUICES (U.S. CLS. 45, 46 AND 48).

WON TEAK OH, EXAMINING ATTORNEY

SN 78-420,739. CSX IP, INC., RICHMOND, VA. FILED 5-18-2004.



CLASS 41—EDUCATION AND ENTERTAINMENT

FOR PROVIDING SPORTING CLUB, NAMELY GOLF CLUB SERVICES; RECREATIONAL SERVICES IN THE NATURE OF PROVIDING FACILITIES FOR SWIMMING, SQUASH, TENNIS, EQUESTRIAN ACTIVITIES, SPORTING CLAYS, FISHING, HUNTING, HIKING, NATURE APPRECIATION, MOUNTAIN BIKING, KAYAKING, WHITE WATER RAFTING, CANOEING, AND INDOOR ROCK CLIMBING; HEALTH CLUB SERVICES, NAMELY PROVIDING INSTRUCTION AND EQUIPMENT IN THE FIELD OF PHYSICAL EXERCISE; GOLF COURSES (U.S. CLS. 100, 101 AND 107).

CLASS 43—HOTEL AND RESTAURANT SERVICES

FOR RESTAURANT AND HOTEL SERVICES (U.S. CLS. 100 AND 101).

CLASS 44—MEDICAL, BEAUTY AND AGRICULTURAL SERVICES

FOR HEALTH SPA SERVICES, NAMELY, COSMETIC BODY CARE SERVICES (U.S. CLS. 100 AND 101).

CLASS 45—PERSONAL SERVICES

FOR SOCIAL CLUBS (U.S. CLS. 100 AND 101).
WON TEAK OH, EXAMINING ATTORNEY

SN 78-421,367. WIREPATH HOME SYSTEMS, LLC, CHARLOTTE, NC. FILED 5-19-2004.

ZOBO

THE MARK CONSISTS OF STANDARD CHARACTERS WITHOUT CLAIM TO ANY PARTICULAR FONT, STYLE, SIZE, OR COLOR.

CLASS 9—ELECTRICAL AND SCIENTIFIC APPARATUS

FOR SECURITY SYSTEMS, NAMELY, FIRE, BURGLAR, ANTI-INTRUSION AND MONITORING ALARMS; SATELLITE SYSTEMS, NAMELY, DISHES, MOTORS, PROCESSORS, RECEIVERS, CIRCUITRY AND ALL ASSOCIATED WIRING, CABLE, MOUNTING BRACKETS, AND ELECTRICAL CONNECTORS; HOME ENTERTAINMENT SYSTEMS, NAMELY, TELEVISIONS, VIDEO RECORDERS AND PLAYERS, AUDIO RECEIVERS, TAPE RECORDERS AND PLAYERS, DVD PLAYERS, CD RECORDERS AND PLAYERS, ANTENNAE AND SPEAKERS, SEATING, CABINETRY, FURNITURE AND UPHOLSTERY; STRUCTURED WIRING SYSTEMS, NAMELY, CONTROL PANELS, ELECTRICAL, TELEPHONE, AND COMPUTER OUTLETS, ELECTRICAL, TELEPHONE, AND COMPUTER OUTLET COVERS, AND ALL ASSOCIATED WIRING, CABLE, MOUNTING BRACKETS, AND ELECTRICAL CONNECTORS; VIDEO PROJECTORS AND FILM SCREENS (U.S. CLS. 21, 23, 26, 36 AND 38).

FIRST USE 5-17-2004; IN COMMERCE 5-17-2004.

CLASS 37—CONSTRUCTION AND REPAIR

FOR INSTALLATION OF SECURITY SYSTEMS AND ALARMS, SATELLITE SYSTEMS, HOME ENTERTAINMENT SYSTEMS, STRUCTURED WIRING SYSTEMS, AND CENTRAL VACUUM SYSTEMS (U.S. CLS. 100, 103 AND 106).

FIRST USE 5-17-2004; IN COMMERCE 5-17-2004.
ALEXANDER L. POWERS, EXAMINING ATTORNEY

SN 78-421,536. SIEMENS AKTIENGESSELLSCHAFT, MUNCHEN, FED REP GERMANY, FILED 5-19-2004.

dtmINSPECTOR

THE MARK CONSISTS OF STANDARD CHARACTERS WITHOUT CLAIM TO ANY PARTICULAR FONT, STYLE, SIZE, OR COLOR.

CLASS 9—ELECTRICAL AND SCIENTIFIC APPARATUS

FOR COMPUTER SOFTWARE FOR USE IN CONTROLLING AND CONFIGURING DEVICES IN AUTOMATION NETWORKS TO CONFORM TO AN INDUSTRY STANDARD (U.S. CLS. 21, 23, 26, 36 AND 38).

CLASS 42—SCIENTIFIC, COMPUTER AND LEGAL SERVICES

FOR COMPUTER SOFTWARE DEVELOPMENT; RENTING OUT SOFTWARE; TECHNICAL CONSULTANCY IN THE FIELD OF DATA PROCESSING AND INDUSTRIAL AUTOMATION (U.S. CLS. 100 AND 101).
BRENDAN REGAN, EXAMINING ATTORNEY

SN 78-421,725. BARRIERMED GLOVE CO., LAKE MARY, FL. FILED 5-19-2004.

BARRIERBUDDIES

THE MARK CONSISTS OF STANDARD CHARACTERS WITHOUT CLAIM TO ANY PARTICULAR FONT, STYLE, SIZE, OR COLOR.

CLASS 9—ELECTRICAL AND SCIENTIFIC APPARATUS

FOR SYNTHETIC PLASTIC GLOVES FOR LABORATORY USE; GLOVES FOR FOOD HANDLING SERVICE INDUSTRIES, NAMELY PROTECTIVE GLOVES FOR HANDLING PRODUCE, PREPARED FOODS, DAIRY PRODUCTS, MEAT AND POULTRY; INDUSTRIAL GLOVES, NAMELY PROTECTIVE WORK GLOVES AND GLOVES FOR CLEAN ROOM USE (U.S. CLS. 21, 23, 26, 36 AND 38).

CLASS 10—MEDICAL APPARATUS

FOR SYNTHETIC LATEX GLOVES FOR MEDICAL USE; MEDICAL KITS PRIMARILY CONTAINING SYNTHETIC GLOVES FOR HOSPITAL AND MEDICAL USE (U.S. CLS. 26, 39 AND 44).

GENE MACIOL, EXAMINING ATTORNEY

SN 78-421,739. SOUTH PUGET SOUND COMMUNITY COLLEGE, OLYMPIA, WA. FILED 5-19-2004.



CLASS 16—PAPER GOODS AND PRINTED MATTER

FOR PAPER PRODUCTS, PRINTS AND PUBLICATIONS, NAMELY— COURSE CATALOGS; PRINTED PROGRAMS FOR ATHLETIC EVENTS, EXHIBITS, CONCERTS, LECTURES, DANCE AND THEATRICAL EVENTS; YEARBOOKS; NOTEBOOKS; BINDERS; NOTEPADS; ENVELOPES; INVITATIONS; STATIONERY; DECALS; PENNANTS; POSTERS; CALENDARS; BUSINESS FORMS; PRINTED INVITATIONS; NAPKINS AND BUMPER STICKERS (U.S. CLS. 2, 5, 22, 23, 29, 37, 38 AND 50).

FIRST USE 12-31-1984; IN COMMERCE 12-31-1984.

CLASS 25—CLOTHING

FOR CLOTHING FOR MEN, WOMEN AND CHILDREN, NAMELY HATS, CAPS, SHIRTS, T-SHIRTS, SWEATSHIRTS, JACKETS AND SHORTS (U.S. CLS. 22 AND 39).

FIRST USE 10-31-1999; IN COMMERCE 10-31-1999.

CLASS 41—EDUCATION AND ENTERTAINMENT

FOR EDUCATIONAL SERVICES, NAMELY, PROVIDING COURSES OF INSTRUCTION AT THE UNDERGRADUATE LEVEL; ENTERTAINMENT SERVICES, NAMELY, ARRANGING AND CONDUCTING ATHLETIC EVENTS AND EXHIBITS, LIVE MUSICAL CONCERTS, LECTURES AND DANCE AND THEATRICAL EVENTS (U.S. CLS. 100, 101 AND 107).

FIRST USE 12-31-1984; IN COMMERCE 12-31-1984.

GENE MACIOL, EXAMINING ATTORNEY

SN 78-421,744. SOUTH PUGET SOUND COMMUNITY COLLEGE, OLYMPIA, WA. FILED 5-19-2004.

SPSCC

THE MARK CONSISTS OF STANDARD CHARACTERS WITHOUT CLAIM TO ANY PARTICULAR FONT, STYLE, SIZE, OR COLOR.

CLASS 16—PAPER GOODS AND PRINTED MATTER

FOR PAPER PRODUCTS, PRINTS, AND PUBLICATIONS, NAMELY— COURSE CATALOGS; PRINTED PROGRAMS FOR ATHLETIC EVENTS, EXHIBITS, CONCERTS, LECTURES, DANCE AND THEATRICAL EVENTS; YEARBOOKS; NOTEBOOKS; BINDERS; NOTEPADS; ENVELOPES; INVITATIONS; STATIONERY; DECALS; PENNANTS; POSTERS; CALENDARS; BUSINESS FORMS; PRINTED INVITATIONS; NAPKINS AND BUMPER STICKERS (U.S. CLS. 2, 5, 22, 23, 29, 37, 38 AND 50).

CLASS 25—CLOTHING

FOR CLOTHING FOR MEN, WOMEN AND CHILDREN, NAMELY HATS, CAPS, SHIRTS, SWEATSHIRTS, T-SHIRTS, SHORTS AND PANTS (U.S. CLS. 22 AND 39).

CLASS 41—EDUCATION AND ENTERTAINMENT

FOR EDUCATIONAL SERVICES, NAMELY, PROVIDING COURSES OF INSTRUCTION AT THE UNDERGRADUATE LEVEL; ENTERTAINMENT SERVICES, NAMELY, ARRANGING AND CONDUCTING ATHLETIC EVENTS AND EXHIBITS, LIVE MUSICAL CONCERTS, LECTURES AND DANCE AND THEATRICAL EVENTS (U.S. CLS. 100, 101 AND 107).

GENE MACIOL, EXAMINING ATTORNEY

SN 78-421,840. GLOBAL BUSINESS CENTER, INC., PORTLAND, OR. FILED 5-19-2004.

BLUEDRIVE

THE MARK CONSISTS OF STANDARD CHARACTERS WITHOUT CLAIM TO ANY PARTICULAR FONT, STYLE, SIZE, OR COLOR.

CLASS 9—ELECTRICAL AND SCIENTIFIC APPARATUS

FOR PORTABLE ELECTRONIC DATA STORAGE DEVICES, NAMELY, COMPUTER MEMORIES, ELECTRONIC MEMORIES, FLASH MEMORIES, UNIVERSAL SERIAL BUS (USB) COMPUTER HARDWARE MEMORIES AND DRIVES, COMPUTER MEMORY CARDS AND FLASH MEMORY CARDS, AND BLANK MEMORY COMPUTER DEVICES IN THE FORM OF CARDS, DISCS OR TAPES (U.S. CLS. 21, 23, 26, 36 AND 38).

CLASS 38—COMMUNICATION

FOR COMPUTER NETWORK SERVICES, NAMELY, PROVISION OF ACCESS TO DATA OR DOCUMENTS STORED ELECTRONICALLY FOR REMOTE CONSULTATION (U.S. CLS. 100, 101 AND 104).

CLASS 39—TRANSPORTATION AND STORAGE

FOR COMPUTER NETWORK SERVICES, NAMELY, ELECTRONIC STORAGE OF FILES, DOCUMENTS, ELECTRONIC MEDIA, AND DATA (U.S. CLS. 100 AND 105).
CHRISTOPHER ADKINS, EXAMINING ATTORNEY

SN 78-421,870. SILPADA DESIGNS, INC., LENEXA, KS. FILED 5-19-2004.

SILPADA DESIGNS

THE MARK CONSISTS OF STANDARD CHARACTERS WITHOUT CLAIM TO ANY PARTICULAR FONT, STYLE, SIZE, OR COLOR.

OWNER OF U.S. REG. NOS. 2,308,977 AND 2,881,357.
NO CLAIM IS MADE TO THE EXCLUSIVE RIGHT TO USE "DESIGNS", APART FROM THE MARK AS SHOWN.

CLASS 25—CLOTHING

FOR LADIES' AND MEN'S BELTS (U.S. CLS. 22 AND 39).
FIRST USE 9-0-1999; IN COMMERCE 9-0-1999.

CLASS 35—ADVERTISING AND BUSINESS

FOR RETAIL MERCHANDISING OF PRODUCTS, DISTRIBUTORSHIP SERVICES, RETAIL SERVICES BY DIRECT SOLICITATION BY INDEPENDENT SALES REPRESENTATIVES, TELEPHONE SHOP AT HOME SERVICES, MAIL ORDER CATALOG SERVICES, INTERACTIVE RETAIL STORE SERVICES RENDERED BY MEANS OF A GLOBAL COMPUTER INFORMATION NETWORK, DIRECT SALES ORGANIZATION AND PLANNING, NAMELY OFFERING ASSISTANCE IN THE ESTABLISHMENT AND/OR OPERATION OF HOME PARTIES, AND ADMINISTRATION OF PROGRAMS THAT PROVIDE INCENTIVES TO PEOPLE TO CONDUCT HOME PRODUCT SALES PARTIES ALL IN THE FIELDS OF JEWELRY, GIFT ITEMS, HANDBAGS, WATCHES, BELTS, AND OTHER FASHION ACCESSORIES; RETAIL STORE SERVICES FEATURING JEWELRY, GIFT ITEMS, HANDBAGS, WATCHES, BELTS, AND OTHER FASHION ACCESSORIES BY MEANS OF HOME PARTIES, CATALOGS, TELEPHONE, AND A GLOBAL COMPUTER INFORMATION NETWORK (U.S. CLS. 100, 101 AND 102).

FIRST USE 7-0-1997; IN COMMERCE 7-0-1997.
JOHN WILKE, EXAMINING ATTORNEY

SN 78-421,976. MACDONALD, GUY J., MT. CLEMENS, MI. FILED 5-20-2004.

Jack Belly Bean

THE MARK CONSISTS OF STANDARD CHARACTERS WITHOUT CLAIM TO ANY PARTICULAR FONT, STYLE, SIZE, OR COLOR.

JACK BELLY BEAN DOES NOT IDENTIFY A LIVING INDIVIDUAL.

CLASS 16—PAPER GOODS AND PRINTED MATTER

FOR PUBLICATIONS, NAMELY, CHILDREN'S BOOKS (U.S. CLS. 2, 5, 22, 23, 29, 37, 38 AND 50).

CLASS 25—CLOTHING

FOR CLOTHING, NAMELY, SHIRTS, PANTS, JACKETS, SHORTS, DRESSES, HATS, SOCKS, OVERALLS AND PAJAMAS (U.S. CLS. 22 AND 39).
MATTHEW PAPPAS, EXAMINING ATTORNEY

SN 78-422,109. THE EDUCATION RESOURCES INSTITUTE, INC., BOSTON, MA. FILED 5-20-2004.

**BRINGING A BETTER
FUTURE WITHIN
REACH**

THE MARK CONSISTS OF STANDARD CHARACTERS WITHOUT CLAIM TO ANY PARTICULAR FONT, STYLE, SIZE, OR COLOR.

CLASS 36—INSURANCE AND FINANCIAL

FOR FINANCIAL SERVICES, NAMELY, GUARANTEEING AND ADMINISTERING OF EDUCATION LOANS; CONSULTATION IN THE FIELDS OF FINANCIAL AID, COLLEGE SCHOLARSHIPS, AND THE FINANCIAL AID APPLICATION PROCESS; AND PROVIDING ONLINE INFORMATION IN THE FIELD OF FINANCIAL AID (U.S. CLS. 100, 101 AND 102).
FIRST USE 5-10-2004; IN COMMERCE 5-10-2004.

CLASS 41—EDUCATION AND ENTERTAINMENT

FOR CAREER COUNSELING SERVICES; AND PROVIDING ONLINE INFORMATION IN THE FIELDS OF COLLEGE APPLICATIONS, COLLEGES, AND CAREER CHOICES FOR STUDENTS (U.S. CLS. 100, 101 AND 107).
FIRST USE 5-10-2004; IN COMMERCE 5-10-2004.
ERNEST SHOSHO, EXAMINING ATTORNEY

SN 78-422,259. GAMELOGIC INC., WALTHAM, MA. FILED 5-20-2004.

HOMEPLAY LOTTERY

THE MARK CONSISTS OF STANDARD CHARACTERS WITHOUT CLAIM TO ANY PARTICULAR FONT, STYLE, SIZE, OR COLOR.

NO CLAIM IS MADE TO THE EXCLUSIVE RIGHT TO USE "LOTTERY", APART FROM THE MARK AS SHOWN.

CLASS 9—ELECTRICAL AND SCIENTIFIC APPARATUS

FOR COMPUTER GAME SOFTWARE; COMPUTER SOFTWARE FOR USE IN GAMING MACHINES; ELECTRONIC GAMING MACHINES; COMPUTER SOFTWARE FOR ONLINE PAYMENT AND TRANSACTION PROCESSING; VIDEO GAME MACHINES FOR USE WITH TELEVISIONS (U.S. CLS. 21, 23, 26, 36 AND 38).

CLASS 28—TOYS AND SPORTING GOODS

FOR CARDS, NAMELY BINGO CARDS, LOTTERY CARDS AND KENO CARDS AND TICKETS, NAMELY LOTTERY TICKETS, FOR PLAYING GAMES OF CHANCE; COMPUTER GAME MACHINES, NAMELY STAND ALONE VIDEO GAME MACHINES (U.S. CLS. 22, 23, 38 AND 50).
BRENDAN MCCAULEY, EXAMINING ATTORNEY

SN 78-422,263. GAMELOGIC INC., WALTHAM, MA. FILED 5-20-2004.

HOMEPLAY LOTTERY

THE MARK CONSISTS OF STANDARD CHARACTERS WITHOUT CLAIM TO ANY PARTICULAR FONT, STYLE, SIZE, OR COLOR.

NO CLAIM IS MADE TO THE EXCLUSIVE RIGHT TO USE "LOTTERY", APART FROM THE MARK AS SHOWN.

CLASS 41—EDUCATION AND ENTERTAINMENT

FOR ENTERTAINMENT SERVICES, NAMELY, PROVIDING AN ONLINE COMPUTER GAME; ELECTRONIC CASINO GAMING SERVICES (U.S. CLS. 100, 101 AND 107).

CLASS 42—SCIENTIFIC, COMPUTER AND LEGAL SERVICES

FOR COMPUTER SOFTWARE DESIGN AND DEVELOPMENT SERVICES FOR OTHERS; DESIGN SERVICES FOR OTHERS IN THE FIELD OF COMPUTER GAMES AND GAMING MACHINES (U.S. CLS. 100 AND 101).
JOHN HWANG, EXAMINING ATTORNEY

SN 78-422,282. THE EDUCATION RESOURCES INSTITUTE, INC., BOSTON, MA. FILED 5-20-2004.

TERI  Bringing A Better Future
Within Reach

CLASS 36—INSURANCE AND FINANCIAL

FOR FINANCIAL SERVICES, NAMELY, GUARANTEEING AND ADMINISTERING OF EDUCATION LOANS; CONSULTATION IN THE FIELDS OF FINANCIAL AID, COLLEGE SCHOLARSHIPS, AND THE FINANCIAL AID APPLICATION PROCESS; AND PROVIDING ONLINE INFORMATION IN THE FIELD OF FINANCIAL AID (U.S. CLS. 100, 101 AND 102).
FIRST USE 3-10-2004; IN COMMERCE 3-10-2004.

CLASS 41—EDUCATION AND ENTERTAINMENT

FOR CAREER COUNSELING SERVICES; AND PROVIDING ONLINE INFORMATION IN THE FIELDS OF COLLEGE APPLICATIONS, COLLEGES, AND CAREER CHOICES FOR STUDENTS (U.S. CLS. 100, 101 AND 107).
FIRST USE 3-10-2004; IN COMMERCE 3-10-2004.
KIMBERLY FRYE, EXAMINING ATTORNEY

SN 78-422,290. THE EDUCATION RESOURCES INSTITUTE, INC., BOSTON, MA. FILED 5-20-2004.



THE MARK CONSISTS OF THE WORD TERI IN A STYLIZED FORM.

CLASS 36—INSURANCE AND FINANCIAL

FOR FINANCIAL SERVICES, NAMELY, GUARANTEEING AND ADMINISTERING OF EDUCATION LOANS; CONSULTATION IN THE FIELDS OF FINANCIAL AID, COLLEGE SCHOLARSHIPS, AND THE FINANCIAL AID APPLICATION PROCESS; AND PROVIDING ONLINE INFORMATION IN THE FIELD OF FINANCIAL AID. (U.S. CLS. 100, 101 AND 102).
FIRST USE 5-10-2004; IN COMMERCE 5-10-2004.

CLASS 41—EDUCATION AND ENTERTAINMENT

FOR CAREER COUNSELING SERVICES; AND PROVIDING ONLINE INFORMATION IN THE FIELDS OF COLLEGE APPLICATIONS, COLLEGES, AND CAREER CHOICES FOR STUDENTS. (U.S. CLS. 100, 101 AND 107).
FIRST USE 5-10-2004; IN COMMERCE 5-10-2004.
ANNE FARRELL, EXAMINING ATTORNEY

SN 78-422,387. EMPLOYER CONSULTANCY, INC., FLEMINGTON, NJ. FILED 5-20-2004.

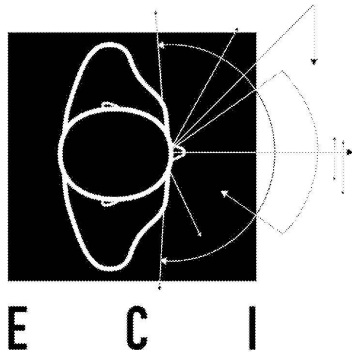

THE PICTORIAL PORTION OF THE MARK CONSISTS OF AN OVERHEAD VIEW OF A SILHOUETTE OF A HUMAN BEING'S HEAD AND SHOULDERS.

CLASS 35—ADVERTISING AND BUSINESS

FOR CONSULTING SERVICES FOR HIRING, MANAGING AND MOTIVATING PRODUCTIVITY OF PERSONNEL; ADMINISTRATION OF TESTING AND ANALYSIS OF TEST RESULTS FOR SELECTION AND DEVELOPMENT OF PERSONNEL; CONDUCTING COMPARATIVE STUDIES TO IDENTIFY BEHAVIORAL FACTORS RELATED TO TOP PERFORMING PERSONNEL (U.S. CLS. 100, 101 AND 102).
FIRST USE 4-1-2000; IN COMMERCE 4-1-2000.

CLASS 41—EDUCATION AND ENTERTAINMENT

FOR CONSULTING SERVICES FOR TRAINING OF PERSONNEL (U.S. CLS. 100, 101 AND 107).
FIRST USE 4-1-2000; IN COMMERCE 4-1-2000.

CLASS 42—SCIENTIFIC, COMPUTER AND LEGAL SERVICES

FOR PROVIDING TEMPORARY NON-DOWNLOADABLE SOFTWARE VIA THE INTERNET FOR PSYCHOLOGICAL AND JOB COMPETENCY TESTING, GENERATION OF ANALYSIS AND REPORTS OF TEST RESULTS, ALL FOR SELECTION AND DEVELOPMENT OF PERSONNEL (U.S. CLS. 100 AND 101).
FIRST USE 4-1-2000; IN COMMERCE 4-1-2000.
MATTHEW PAPPAS, EXAMINING ATTORNEY

SN 78-422,400. UNITED STATES OF AMERICA NATIONAL KARATE-DO FEDERATION, SEATTLE, WA. FILED 5-20-2004.



THE MARK CONSISTS OF STANDARD CHARACTERS WITHOUT CLAIM TO ANY PARTICULAR FONT, STYLE, SIZE, OR COLOR.
OWNER OF U.S. REG. NO. 2,118,564.
NO CLAIM IS MADE TO THE EXCLUSIVE RIGHT TO USE "KARATE-DO", APART FROM THE MARK AS SHOWN.
SEC. 2(F).

CLASS 35—ADVERTISING AND BUSINESS

FOR ASSOCIATION SERVICES, NAMELY, PROMOTING THE INTERESTS OF KARATE-DO PARTICIPANTS (U.S. CLS. 100, 101 AND 102).
FIRST USE 8-13-1994; IN COMMERCE 8-13-1994.

CLASS 36—INSURANCE AND FINANCIAL

FOR CHARITABLE FUNDRAISING (U.S. CLS. 100, 101 AND 102).
FIRST USE 8-13-1994; IN COMMERCE 8-13-1994.

CLASS 41—EDUCATION AND ENTERTAINMENT

FOR OFFICIATING AT SPORTS CONTESTS, ORGANIZING ATHLETIC EVENTS AND COMPETITIONS, ENTERTAINMENT IN THE NATURE OF KARATE-DO EXHIBITIONS AND TOURNAMENTS; EDUCATIONAL SERVICES, NAMELY, CONDUCTING CLASSES AND WORKSHOPS IN THE FIELD OF KARATE-DO; AND SPORTS CAMPS (U.S. CLS. 100, 101 AND 107).

FIRST USE 8-13-1994; IN COMMERCE 8-13-1994.

CLASS 44—MEDICAL, BEAUTY AND AGRICULTURAL SERVICES

FOR PROVIDING EMERGENCY MEDICAL ASSISTANCE AT KARATE-DO EXHIBITIONS AND TOURNAMENTS (U.S. CLS. 100 AND 101).

FIRST USE 8-13-1994; IN COMMERCE 8-13-1994.

G. MAYERSCHOFF, EXAMINING ATTORNEY

CLASS 35—ADVERTISING AND BUSINESS

FOR DISTRIBUTORSHIP IN THE FIELDS OF HEALTH AND BEAUTY CARE PRODUCTS, MEDICAL PRODUCTS, VETERINARY AND SURGICAL PRODUCTS; MARKETING SERVICES FOR OTHER HEALTH CARE PROVIDERS OF PHARMACEUTICAL, HEALTH AND BEAUTY CARE, MEDICAL, VETERINARY AND SURGICAL PRODUCTS; PACKAGING ARTICLES TO ORDER AND SPECIFICATION OF OTHERS, NAMELY PACKAGING LIQUID PHARMACEUTICALS FOR PHARMACEUTICAL MANUFACTURERS; ELECTRONIC CUSTOMER ORDERING SERVICES FOR PHARMACEUTICALS, MEDICAL, SURGICAL, LABORATORY SUPPLIES (U.S. CLS. 100, 101 AND 102).

FIRST USE 6-3-1982; IN COMMERCE 6-3-1982.

SHARI SHEFFIELD, EXAMINING ATTORNEY

SN 78-423,021. AIRGO NETWORKS, INC., PALO ALTO, CA.
FILED 5-21-2004.

SN 78-422,961. R&S SALES LLC, FOUNTAIN RUN, KY.
FILED 5-21-2004.

MI FI

R&S

THE MARK CONSISTS OF STANDARD CHARACTERS WITHOUT CLAIM TO ANY PARTICULAR FONT, STYLE, SIZE, OR COLOR.

CLASS 9—ELECTRICAL AND SCIENTIFIC APPARATUS

FOR COMPUTER CHIPS; COMPUTER HARDWARE; COMPUTER PERIPHERALS; AND, COMPUTER SOFTWARE AND COMPUTER FIRMWARE THAT FUNCTION TO CONTROL, IMPLEMENT AND OPTIMIZE THE COMMUNICATIONS LINK IN NETWORKING, WIRELESS AND COMPUTER COMMUNICATIONS (U.S. CLS. 21, 23, 26, 36 AND 38).

CLASS 42—SCIENTIFIC, COMPUTER AND LEGAL SERVICES

FOR COMPUTER SERVICES, NAMELY, PROVIDING TECHNICAL AND NON-TECHNICAL INFORMATION ON SEMICONDUCTORS, INTEGRATED CIRCUITS, COMPUTER HARDWARE AND SOFTWARE, AND NETWORKING, WIRELESS AND COMPUTER COMMUNICATIONS; COMPUTER HARDWARE AND SOFTWARE CONSULTING SERVICES; COMPUTER DIAGNOSTIC SERVICES; DESIGNING AND TESTING SOFTWARE AND HARDWARE DESIGNS FOR OTHERS; MAINTENANCE OF COMPUTER SOFTWARE; AND TECHNICAL SUPPORT SERVICES, NAMELY, CALL SUPPORT AND TROUBLESHOOTING OF COMPUTER HARDWARE AND SOFTWARE PROBLEMS (U.S. CLS. 100 AND 101).

JENNIFER MARTIN, EXAMINING ATTORNEY

THE MARK CONSISTS OF STANDARD CHARACTERS WITHOUT CLAIM TO ANY PARTICULAR FONT, STYLE, SIZE, OR COLOR.

CLASS 5—PHARMACEUTICALS

FOR NUTRITIONAL SUPPLEMENTS; PHARMACEUTICAL PREPARATIONS FOR THE TREATMENT OF CONDITIONS OF THE BONES, MUSCLES, SKIN, EYES AND EARS, CARDIOVASCULAR SYSTEM, RESPIRATORY SYSTEM, CENTRAL NERVOUS SYSTEM, REPRODUCTIVE SYSTEM, URINARY SYSTEM AND GASTROINTESTINAL SYSTEM; PHARMACEUTICAL PREPARATIONS FOR THE TREATMENT OF TUMORS; PHARMACEUTICAL PREPARATIONS FOR THE TREATMENT OF IMPOTENCE; HORMONES; BLOOD SUBSTITUTE FOR HUMANS; ANTI-INFLAMMATORIES; COUGH AND COLD TREATMENT PREPARATIONS; ANTIBIOTIC AND ANTI-INFECTIVES; VIRAL, BACTERIAL AND RABIES VACCINES; TOXOIDS; ORAL CONTRACEPTIVES; SEDATIVES; ANALGESICS; TOPICAL ANTISEPTICS, CREAMS AND ANTIBIOTICS OINTMENTS FOR DERMATOLOGICAL AND OPHTHALMIC USE (U.S. CLS. 6, 18, 44, 46, 51 AND 52).

FIRST USE 6-3-1982; IN COMMERCE 6-3-1982.

SN 78-423,202. GO OUT NY MAGAZINE, ASTORIA, NY.
FILED 5-21-2004.



NO CLAIM IS MADE TO THE EXCLUSIVE RIGHT TO USE "NY MAGAZINE", APART FROM THE MARK AS SHOWN.

CLASS 16—PAPER GOODS AND PRINTED MATTER

FOR MAGAZINE FEATURING LISTINGS OF ENTERTAINMENT, LEISURE, RECREATION, SHOPPING, TRAVELING, SPORTS, ARTS AND ARTICLES AND COMMENTARY RELATING TO ENTERTAINMENT, LEISURE, RECREATION, SPORTS AND ART ACTIVITIES (U.S. CLS. 2, 5, 22, 23, 29, 37, 38 AND 50).
FIRST USE 11-1-2003; IN COMMERCE 12-1-2003.

CLASS 41—EDUCATION AND ENTERTAINMENT

FOR PUBLICATION OF ELECTRONIC MAGAZINE FEATURING LISTINGS OF ENTERTAINMENT, LEISURE, RECREATION, SHOPPING, TRAVELING, SPORTS, ARTS AND ARTICLES AND COMMENTARY RELATING TO ENTERTAINMENT, LEISURE, RECREATION, SPORTS AND ART ACTIVITIES; MAGAZINE PUBLISHING (U.S. CLS. 100, 101 AND 107).
FIRST USE 11-17-2003; IN COMMERCE 11-17-2003.
MIDGE BUTLER, EXAMINING ATTORNEY

SN 78-424,182. SANDLOT GAMES CORPORATION,
BOTHELL, WA. FILED 5-24-2004.

TRADEWINDS

THE MARK CONSISTS OF STANDARD CHARACTERS WITHOUT CLAIM TO ANY PARTICULAR FONT, STYLE, SIZE, OR COLOR.

CLASS 9—ELECTRICAL AND SCIENTIFIC APPARATUS

FOR ELECTRONIC GAME PROGRAMS; DOWNLOADABLE ELECTRONIC GAME PROGRAMS; ELECTRONIC GAME SOFTWARE; COMPUTER GAME PROGRAMS; DOWNLOADABLE COMPUTER GAME PROGRAMS; INTERACTIVE VIDEO AND COMPUTER GAME PROGRAMS; INTERACTIVE VIDEO AND COMPUTER GAME SOFTWARE; DOWNLOADABLE ELECTRONIC GAME SOFTWARE; DOWNLOADABLE COMPUTER GAME SOFTWARE; DOWNLOADABLE INTERACTIVE COMPUTER AND VIDEO GAME SOFTWARE. (U.S. CLS. 21, 23, 26, 36 AND 38).

CLASS 41—EDUCATION AND ENTERTAINMENT

FOR ENTERTAINMENT SERVICES, NAMELY, PROVIDING ON-LINE COMPUTER GAMES; PROVIDING INFORMATION IN THE FIELD OF ENTERTAINMENT, NAMELY, INFORMATION ABOUT GAMES. (U.S. CLS. 100, 101 AND 107).
RUDY R. SINGLETON, EXAMINING ATTORNEY

SN 78-424,505. THARANGNI, INC., GAINESVILLE, FL.
FILED 5-25-2004.



CLASS 9—ELECTRICAL AND SCIENTIFIC APPARATUS

FOR PRE-RECORDED ENTERTAINMENT MEDIA, NAMELY, CD'S, AUDIO CASSETTES, DVD'S AND VIDEO CASSETTES (U.S. CLS. 21, 23, 26, 36 AND 38).

CLASS 16—PAPER GOODS AND PRINTED MATTER

FOR SHEET MUSIC, POSTERS AND POSTCARDS (U.S. CLS. 2, 5, 22, 23, 29, 37, 38 AND 50).

CLASS 25—CLOTHING

FOR CLOTHING, NAMELY T-SHIRTS, CAPS AND SWEATSHIRTS (U.S. CLS. 22 AND 39).

CLASS 35—ADVERTISING AND BUSINESS

FOR ARTISTS' MANAGEMENT SERVICES (U.S. CLS. 100, 101 AND 102).

CLASS 36—INSURANCE AND FINANCIAL

FOR PROVIDING FINANCIAL SPONSORSHIP OF THE MUSICAL CONCERTS, PERSONAL APPEARANCES, DRAMATIC PRESENTATIONS, COMEDIC PRESENTATIONS AND PLAYS OF OTHERS; FINANCIAL PLANNING AND FINANCIAL MANAGEMENT (U.S. CLS. 100, 101 AND 102).

CLASS 41—EDUCATION AND ENTERTAINMENT

FOR ENTERTAINMENT SERVICES, NAMELY PRODUCING ENTERTAINMENT EVENTS, NAMELY PRODUCING MUSICAL CONCERTS, PRESENTATIONS OF DRAMATIC AND COMEDIC PERFORMANCES, AND PLAYS; ENTERTAINMENT SERVICES, NAMELY PERSONAL APPEARANCES BY MUSICAL PERFORMERS, AND MOVIE STARS (U.S. CLS. 100, 101 AND 107).
HOWARD B. LEVINE, EXAMINING ATTORNEY

SN 78-424,750. MONSOUR, LOUIS, MONROVIA, CA. FILED 5-25-2004.

INNOVATIVE BUSINESS SERVICES

THE MARK CONSISTS OF STANDARD CHARACTERS WITHOUT CLAIM TO ANY PARTICULAR FONT, STYLE, SIZE, OR COLOR.

NO CLAIM IS MADE TO THE EXCLUSIVE RIGHT TO USE "BUSINESS SERVICES", APART FROM THE MARK AS SHOWN.

CLASS 35—ADVERTISING AND BUSINESS

FOR BUSINESS CONSULTATION SERVICES (U.S. CLS. 100, 101 AND 102).

CLASS 41—EDUCATION AND ENTERTAINMENT

FOR BUSINESS EDUCATIONAL SERVICES, NAMELY, PROVIDING COURSES IN THE FIELD OF BUSINESS AND CORPORATE CREDIT (U.S. CLS. 100, 101 AND 107).

CLASS 42—SCIENTIFIC, COMPUTER AND LEGAL SERVICES

FOR PREPARING AND FILING INCORPORATION PAPERS (U.S. CLS. 100 AND 101).
ALLISON HOLTZ, EXAMINING ATTORNEY

SN 78-425,108. TOLLE LEGE PRESS, LLC, DALLAS, GA. FILED 5-26-2004.

TOLLE LEGE

THE MARK CONSISTS OF STANDARD CHARACTERS WITHOUT CLAIM TO ANY PARTICULAR FONT, STYLE, SIZE, OR COLOR.

CLASS 16—PAPER GOODS AND PRINTED MATTER

FOR RELIGIOUS AND CREATION SCIENCE BOOKS (U.S. CLS. 2, 5, 22, 23, 29, 37, 38 AND 50).

CLASS 41—EDUCATION AND ENTERTAINMENT

FOR PUBLISHING OF BOOKS AND PAMPHLETS (U.S. CLS. 100, 101 AND 107).
DANIEL BRODY, EXAMINING ATTORNEY

SN 78-425,546. AMBIENT CORPORATION, NEWTON, MA. FILED 5-26-2004.

**CLASS 9—ELECTRICAL AND SCIENTIFIC APPARATUS**

FOR COMPUTER SOFTWARE PROGRAMS RELATING TO TELECOMMUNICATIONS, NAMELY, BROWSER SOFTWARE USED TO ACCESS, VIEW AND TRANSMIT INFORMATION AND DATA FROM WEBSITES ON GLOBAL NETWORKS; TELECOMMUNICATIONS SYSTEMS COMPOSED OF TERMINAL, EXCHANGE UNITS, RELAY STATIONS, BASE STATIONS, REPEATERS, TRANSCIVERS, TRANSMITTERS, SIGNAL ROUTERS, AND DIGITAL SIGNAL PROCESSORS FOR TELECOMMUNICATIONS NETWORKS; TELECOMMUNICATIONS EQUIPMENT, NAMELY, COMPUTER HARDWARE FOR THE TRANSMISSION AND RECEIVING OF VOICE AND DATA INFORMATION, COMPUTER MODEMS, ELECTRICAL CABLES, ELECTRICAL CONDUITS, ELECTRICAL CIRCUITS, ELECTRICAL POWER SUPPLIES, AND ELECTRICAL SWITCHES (U.S. CLS. 21, 23, 26, 36 AND 38).

CLASS 38—COMMUNICATION

FOR TELECOMMUNICATIONS SERVICES, NAMELY, LOCAL AND LONG DISTANCE TRANSMISSION OF VOICE, DATA AND GRAPHICS BY MEANS OF TELEPHONE, TELEGRAPHIC, POWER LINE, CABLES, AND SATELLITE TRANSMISSIONS; INTERNET SERVICES, NAMELY STREAMING OF AUDIO AND VIDEO MATERIAL ON THE INTERNET; CONSULTING SERVICES IN THE FIELD OF TELECOMMUNICATIONS (U.S. CLS. 100, 101 AND 104).

CLASS 42—SCIENTIFIC, COMPUTER AND LEGAL SERVICES

FOR PRODUCT DEVELOPMENT, NAMELY, DESIGNING AND ENGINEERING TELECOMMUNICATIONS, INTERNET AND ELECTRONIC SYSTEMS, SERVICES, AND EQUIPMENT; DEVELOPMENT OF NEW TECHNOLOGY FOR OTHERS IN THE FIELD OF COMPUTERS AND TELECOMMUNICATIONS; CONSULTING SERVICES IN THE FIELD OF COMPUTERS (U.S. CLS. 100 AND 101).
JENNIFER KRISP, EXAMINING ATTORNEY

SN 78-425,549. TAKARA CO., LTD, TOKYO, JAPAN, FILED 5-26-2004.

MICROMAN

THE MARK CONSISTS OF STANDARD CHARACTERS WITHOUT CLAIM TO ANY PARTICULAR FONT, STYLE, SIZE, OR COLOR.

OWNER OF U.S. REG. NO. 2,778,106.

CLASS 16—PAPER GOODS AND PRINTED MATTER

FOR COMIC BOOKS AND COMIC MAGAZINES; COMIC BOOK REFERENCE GUIDE BOOKS AND BOOKS FEATURING STORIES IN AN ILLUSTRATED FORM; GRAPHIC NOVELS; PICTURE, COMIC, AND PRINTED POSTCARDS; TRADING CARDS; COLLECTOR'S CARDS FEATURING COMIC BOOK CHARACTERS; NOTEBOOKS; BINDERS; DECALS; DESK PADS; WRITING PADS; STATIONERY FOLDERS; STATIONERY; POSTERS; AND INSTRUCTION MANUALS FOR USE WITH COMPUTER AND VIDEO BASED GAMES (U.S. CLS. 2, 5, 22, 23, 29, 37, 38 AND 50).

CLASS 41—EDUCATION AND ENTERTAINMENT

FOR ENTERTAINMENT IN THE NATURE OF A CONTINUING SERIES OF TELEVISION PROGRAMS IN THE FIELD OF ADVENTURE, FEATURING ANIMATED AND/OR LIVE ACTION CHARACTERS; AND ENTERTAINMENT, NAMELY CONTINUING ANIMATED AND/OR LIVE ACTION ADVENTURE SHOWS DISTRIBUTED OVER TELEVISION, SATELLITE, AUDIO, CABLE TELEVISION, AND VIDEO MEDIA (U.S. CLS. 100, 101 AND 107).

STEVEN R. FOSTER, EXAMINING ATTORNEY

SN 78-426,281. V.E.W., LTD., NEW YORK, NY. FILED 5-27-2004.

VERA WANG

THE MARK CONSISTS OF STANDARD CHARACTERS WITHOUT CLAIM TO ANY PARTICULAR FONT, STYLE, SIZE, OR COLOR.

OWNER OF U.S. REG. NOS. 2,635,884 AND 2,844,080.

THE NAME VERA WANG IDENTIFIES A LIVING INDIVIDUAL WHOSE CONSENT IS OF RECORD.

CLASS 9—ELECTRICAL AND SCIENTIFIC APPARATUS

FOR ELECTRONIC PERSONAL ORGANIZERS, MOUSE PADS, PC BASED STATIONERY SOFTWARE, NAMELY, PC BASED WORD PROCESSING SOFTWARE FOR DESIGNING CUSTOMIZED AND PERSONALIZED STATIONERY (U.S. CLS. 21, 23, 26, 36 AND 38).

CLASS 16—PAPER GOODS AND PRINTED MATTER

FOR STATIONERY; PERSONALIZED WRITING MATERIALS, NAMELY, PERSONALIZED WRITING PAPER AND WRITING IMPLEMENTS; PRINTED INVITATIONS, ANNOUNCEMENT CARDS, GREETING CARDS, GIFT CARDS, PAPER GIFT BAGS, FABRIC GIFT BAGS, GIFT WRAP PAPER, PAPER GIFT WRAP BOWS AND PAPER GIFT WRAPPING RIBBONS, TISSUE PAPER, WRAPPING PAPER, DECORATIVE STICKERS, PLACE CARDS; PAPER TABLE ACCESSORIES, NAMELY, TABLECLOTHS, NAPKINS, COASTERS AND TABLE COVERS, PHOTO TRADING CARDS, WRITING TABLETS, NOTE CARDS, NOTE PADS, NOTE BOOKS, GUEST BOOKS, WRITING JOURNALS, PHOTO ALBUMS, SCRAPBOOK ALBUMS, PLACE CARDS, CALENDARS, DESK PADS, DAILY PLANNERS, PERSONAL ORGANIZERS, DESK SET, DIARIES, ENVELOPES, ADDRESS LABELS, DESK PADS, POSTCARDS, WRITING INSTRUMENTS, NAMELY, PEN, AND PENCILS (U.S. CLS. 2, 5, 22, 23, 29, 37, 38 AND 50).

CLASS 42—SCIENTIFIC, COMPUTER AND LEGAL SERVICES

FOR PROVIDING TEMPORARY USE OF WEB-BASED NON-DOWNLOADABLE COMPUTER SOFTWARE FOR DESIGNING CUSTOMIZED AND PERSONALIZED STATIONERY (U.S. CLS. 100 AND 101).

NELSON SNYDER, EXAMINING ATTORNEY

SN 78-427,053. BATMASIAN, JAMES H., BOCA RATON, FL. FILED 5-28-2004.

ROYAL PALM PLACE

THE MARK CONSISTS OF STANDARD CHARACTERS WITHOUT CLAIM TO ANY PARTICULAR FONT, STYLE, SIZE, OR COLOR.

CLASS 36—INSURANCE AND FINANCIAL

FOR REAL ESTATE MANAGEMENT AND LEASING OF CIVIC, MUNICIPAL, CULTURAL, RETAIL, OFFICE, RESIDENTIAL, ENTERTAINMENT, FITNESS, RESTAURANT AND COMMERCIAL DEVELOPMENTS AND PROPERTIES; PROPERTY AND BUILDING MANAGEMENT; REAL ESTATE MANAGEMENT AND LEASING OF SHOPPING CENTERS (U.S. CLS. 100, 101 AND 102).

FIRST USE 10-1-2003; IN COMMERCE 10-1-2003.

CLASS 37—CONSTRUCTION AND REPAIR

FOR REAL ESTATE DEVELOPMENT, PLANNING AND LAYING OUT OF A CIVIC, MUNICIPAL, CULTURAL, RETAIL, OFFICE, RESIDENTIAL, ENTERTAINMENT, FITNESS, RESTAURANT, AND COMMERCIAL DEVELOPMENTS AND PROPERTIES; DEVELOPING SHOPPING CENTERS (U.S. CLS. 100, 103 AND 106).

FIRST USE 1-31-2003; IN COMMERCE 1-31-2003.

MARY BOAGNI, EXAMINING ATTORNEY

SN 78-427,138. GLOBAL ENGINE MANUFACTURING ALLIANCE LLC, AUBURN HILLS, MI. FILED 5-28-2004.



NO CLAIM IS MADE TO THE EXCLUSIVE RIGHT TO USE GLOBAL ENGINE MANUFACTURING ALLIANCE, APART FROM THE MARK AS SHOWN.

THE MARK CONSISTS OF THE WORDS GLOBAL ENGINE MANUFACTURING ALLIANCE WITH AN ARBITRARY LOGO.

CLASS 12—VEHICLES

FOR MOTOR VEHICLE ENGINES; STRUCTURAL PARTS OF MOTOR VEHICLE ENGINES (U.S. CLS. 19, 21, 23, 31, 35 AND 44).

CLASS 37—CONSTRUCTION AND REPAIR

FOR REPAIR AND MAINTENANCE OF MOTOR VEHICLE ENGINES, STRUCTURAL PARTS OF MOTOR VEHICLE ENGINES AND PARTS OF MOTOR VEHICLE ENGINES; REBUILDING MOTOR VEHICLE ENGINES (U.S. CLS. 100, 103 AND 106).

CLASS 42—SCIENTIFIC, COMPUTER AND LEGAL SERVICES

FOR RESEARCH, DESIGN AND ENGINEERING IN THE FIELD OF MOTOR VEHICLE ENGINES, STRUCTURAL PARTS OF MOTOR VEHICLE ENGINES, AND PARTS OF MOTOR VEHICLE ENGINES (U.S. CLS. 100 AND 101).

ASMAT KHAN, EXAMINING ATTORNEY

SN 78-427,247. BLOOMSBURY INNOVATIONS LTD., LONDON, UNITED KINGDOM, FILED 5-28-2004.



PRIORITY CLAIMED UNDER SEC. 44(D) ON UNITED KINGDOM APPLICATION NO. 2356504, FILED 2-21-2004.

CLASS 9—ELECTRICAL AND SCIENTIFIC APPARATUS

FOR SCIENTIFIC APPARATUS AND INSTRUMENTS, NAMELY, NON-MEDICAL TESTING APPARATUS COMPRISED OF A KIT CONSISTING OF COATED PAPER, COATED TUBE OR STRAW, AND A PIPETTE; APPARATUS AND INSTRUMENTS FOR ANALYSIS OF BEVERAGES AND FOOD, NAMELY, APPARATUS FOR TESTING THE PHARMACEUTICAL DRUG CONTENT OF FOOD AND BEVERAGES (U.S. CLS. 21, 23, 26, 36 AND 38).

FIRST USE 4-7-2004; IN COMMERCE 4-7-2004.

CLASS 10—MEDICAL APPARATUS

FOR MEDICAL APPARATUS AND INSTRUMENTS, NAMELY, TESTING APPARATUS IN KIT FORM FOR MEDICAL PURPOSES NAMELY, MEDICAL KIT COMPRISED COATED PAPER AND COATED TUBE OR STRAW, MEDICAL DIAGNOSTIC APPARATUS, ANALYTICAL APPARATUS FOR MEDICAL PURPOSES AND MEASURING THE PHARMACEUTICAL DRUG CONTENT OF BODY FLUIDS; TESTING APPARATUS FOR MEDICAL PURPOSES, NAMELY, BLOOD TESTING APPARATUS; AND ANALYSIS APPARATUS FOR MEDICAL PURPOSES, NAMELY, ANALYTICAL APPARATUS FOR MEDICAL PURPOSES AND MEASURING THE PHARMACEUTICAL DRUG CONTENT OF BODY FLUIDS (U.S. CLS. 26, 39 AND 44).

FIRST USE 4-7-2004; IN COMMERCE 4-7-2004.
INGRID C. EULIN, EXAMINING ATTORNEY

SN 78-428,545. SASSON, MAURICE, TSIM SHA TSUI, HONG KONG, FILED 6-2-2004.



CLASS 18—LEATHER GOODS

FOR LEATHER ACCESSORIES, NAMELY BAGS (U.S. CLS. 1, 2, 3, 22 AND 41).

CLASS 25—CLOTHING

FOR CLOTHING, NAMELY, SHOES, BELTS, HATS, VESTS, SPORTSWEAR, NAMELY, SPORT COATS AND JERSEYS, T-SHIRTS, JEANS, SHIRTS, BLOUSES, SKIRTS, SWEATERS, SHORTS, SWEAT SHIRTS, SWEAT PANTS, JACKETS, COATS AND SOCKS, LEATHER JACKETS (U.S. CLS. 22 AND 39).

JAMES GRIFFIN, EXAMINING ATTORNEY

SN 78-428,652. CALIFORNIA STATE TEACHERS' RETIREMENT SYSTEM, SACRAMENTO, CA. FILED 6-2-2004.

**CALIFORNIA STATE
TEACHERS'
RETIREMENT
SYSTEM**

THE MARK CONSISTS OF STANDARD CHARACTERS WITHOUT CLAIM TO ANY PARTICULAR FONT, STYLE, SIZE, OR COLOR.

NO CLAIM IS MADE TO THE EXCLUSIVE RIGHT TO USE "TEACHERS' RETIREMENT SYSTEM", APART FROM THE MARK AS SHOWN.

SEC. 2(F).

CLASS 36—INSURANCE AND FINANCIAL

FOR ADMINISTRATION OF EMPLOYEE RETIREMENT PLANS; FINANCIAL ANALYSIS AND CONSULTATION; PROVIDING FINANCIAL INFORMATION BY ELECTRONIC MEANS AND IN PRINTED MATERIALS; FINANCIAL PLANNING SERVICES; FINANCIAL SERVICES IN THE NATURE OF AN INVESTMENT SECURITY (U.S. CLS. 100, 101 AND 102).

FIRST USE 6-30-1979; IN COMMERCE 6-30-1979.

CLASS 41—EDUCATION AND ENTERTAINMENT

FOR EDUCATIONAL SERVICES, NAMELY, PROVIDING WORKSHOPS AND SEMINARS IN THE FIELD OF FINANCIAL PLANNING; AND DISTRIBUTION OF WRITTEN MATERIALS IN CONNECTION THEREWITH (U.S. CLS. 100, 101 AND 107).

FIRST USE 6-30-1979; IN COMMERCE 6-30-1979.
RICHARD WHITE, EXAMINING ATTORNEY

SN 78-428,889. FÉDÉRATION INTERNATIONALE DE FOOTBALL ASSOCIATION (FIFA), ZURICH, SWITZERLAND, FILED 6-2-2004.

GERMANY 2006

SN 78-428,712. BRIGADE QUARTERMASTERS, LTD., KENNESAW, GA. FILED 6-2-2004.

THE MARK CONSISTS OF STANDARD CHARACTERS WITHOUT CLAIM TO ANY PARTICULAR FONT, STYLE, SIZE, OR COLOR.

PRIORITY CLAIMED UNDER SEC. 44(D) ON SWITZERLAND APPLICATION NO. 00607/2004, FILED 12-3-2003, REG. NO. 507875, DATED 3-17-2003, EXPIRES 12-3-2013.
SEC. 2(F).

CLASS 1—CHEMICALS

FOR UNEXPOSED FILMS, NAMELY, UNEXPOSED CAMERA AND PHOTOGRAPHIC FILM; CHEMICALS USED IN THE MANUFACTURE OF FABRIC AND TEXTILES; TANNING AGENTS FOR USE IN THE MANUFACTURE OF LEATHER; AND ARTIFICIAL SWEETENERS (U.S. CLS. 1, 5, 6, 10, 26 AND 46).

CLASS 3—COSMETICS AND CLEANING PREPARATIONS

FOR COSMETICS; SOAPS; BEAUTY BATH ADDITIVES, NAMELY, BATH BEADS, BATH FOAM, BATH CRYSTALS, BATH PEARLS AND NON-MEDICATED BATH SALTS; PERFUMES; COLOGNES; PRE-SHAVE AND AFTER SHAVE LOTIONS; SHAVING CREAMS; SHAMPOOS; CONDITIONERS; TOOTHPASTE; MOUTH WASHES; DEODORANTS AND ANTIPERSPIRANTS FOR PERSONAL USE; NOURISHING SKIN CREAMS; SKIN CREAMS; FACIAL CLEANSING CREAM; MAKE-UP REMOVING PREPARATIONS; SUNSCREEN LOTIONS; HAIR LOTIONS; HAIR LACQUERS; MAKE-UP PREPARATIONS, EYE SHADOW; FACE POWDER; COSMETIC PENCILS; CLEANING, POLISHING, SCOURING, AND ABRASIVE PREPARATIONS FOR HOUSEHOLD PURPOSES; LAUNDRY POWDER DETERGENTS; SYNTHETIC HOUSEHOLD DETERGENTS; SHOE POLISH AND WAXES; PRODUCTS FOR PRESERVATION OF LEATHER, NAMELY, PREPARATIONS FOR POLISHING, CLEANING, AND CONDITIONING LEATHER GOODS (U.S. CLS. 1, 4, 6, 50, 51 AND 52).

CLASS 4—LUBRICANTS AND FUELS

FOR LUBRICANTS, NAMELY, ALL PURPOSE LUBRICANTS, AUTOMOBILE LUBRICANTS, AND INDUSTRIAL LUBRICANTS; MOTOR OILS; FUELS, NAMELY, FUEL OIL, BENZENE FUEL, ALCOHOL AND MIXED ALCOHOL FUEL, AND DIESEL FUEL; CANDLES; AND WAXES, NAMELY, CARNAUBA WAX AND WAX FOR USE IN COATING FOOD PACKAGING MATERIALS (U.S. CLS. 1, 6 AND 15).

CLASS 18—LEATHER GOODS

FOR DUFFEL BAGS (U.S. CLS. 1, 2, 3, 22 AND 41).

CLASS 25—CLOTHING

FOR FOOTWEAR, PANTS, HATS, CAPS, VESTS, SOCKS, SHIRTS, GLOVES (U.S. CLS. 22 AND 39).
JOHN LINCOSKI, EXAMINING ATTORNEY

The logo consists of the word "max" in a bold, lowercase, sans-serif font, positioned above the word "tac" in the same font style. A plus sign (+) is placed between the two words, centered vertically between the 'x' and 't'.

CLASS 5—PHARMACEUTICALS

FOR PHARMACEUTICAL PRODUCTS, NAMELY, PHARMACEUTICALS FOR THE TREATMENT OF WOUNDS, RESPIRATORY ILLNESSES, AND CANCER PHARMACEUTICALS, NAMELY, HOMEOPATHIC SUPPLEMENTS, LIPID LOWERING AGENTS, AND PSYCHOTROPICS; MEDICATED CHEWING GUM FOR STOPPING OF SMOKING; MATERIAL FOR STOPPING TEETH; DENTAL WAX; MEDICAL HYGIENE PRODUCTS, NAMELY, DISPOSABLE WIPES IMPREGNATED WITH CHEMICALS; MEDICAL HYGIENE PRODUCTS, NAMELY, SANITARY NAPKINS AND PADS; FEMININE HYGIENIC PRODUCTS, NAMELY, SANITARY NAPKINS; FUNGICIDES AND HERBICIDES FOR DOMESTIC USE; EYE CARE MEDICINES, NAMELY, EYE DROPS, EYE WASHES, MEDICINES FOR THE TREATMENT OF EYE FATIGUE, AND IRRIGATING SOLUTIONS FOR EYE USE; MEDICINAL HERBAL TEA; NUTRITIONAL FOOD SUPPLEMENTS; FOOD FOR BABIES, NAMELY, BABY FOOD; VITAMINS; PRODUCTS FOR PURIFICATION AND DEODORIZATION OF THE AIR, NAMELY, AIR DEODORIZERS AND AIR FRESHENERS; VEHICLE DEODORIZERS; DEODORANTS FOR NON-PERSONAL USE, NAMELY, AIR, HOUSEHOLD, AND ROOM DEODORANTS; PHARMACEUTICAL PREPARATIONS FOR THE TREATMENT OF DISORDERS OF THE MOUTH, NAMELY, MOUTHWASH AND ANTIBIOTIC OINTMENT FOR THE MOUTH; AND VITAMIN AND MINERAL SUPPLEMENTS (U.S. CLS. 6, 18, 44, 46, 51 AND 52).

CLASS 6—METAL GOODS

FOR ALUMINUM FOIL; DECORATIVE KEY CHAINS, NAMELY, METAL KEY CHAINS; MONEY CLIPS, NAMELY, METAL MONEY CLIPS; FIGURINES, NAMELY, FIGURINES OF COMMON METAL; ORNAMENTS, NAMELY, METAL HOLIDAY ORNAMENTS; STATUES, NAMELY, STATUES OF NON-PRECIOUS METAL OR THEIR ALLOYS; STATUETTES, NAMELY, STATUETTES OF NON-PRECIOUS METAL OR THEIR ALLOYS; SCULPTURES, NAMELY, SCULPTURES OF NON-PRECIOUS METAL OR THEIR ALLOYS; TROPHIES, NAMELY, TROPHIES MADE OF NON-PRECIOUS METAL OR THEIR ALLOYS; POGS MADE OF COMMON METAL OR THEIR ALLOYS; METAL NAME BADGES; METAL NON-ENCODED NAME BADGES (U.S. CLS. 2, 12, 13, 14, 23, 25 AND 50).

CLASS 7—MACHINERY

FOR AERATED BEVERAGE MAKING MACHINES; ELECTRIC CAN OPENERS; ELECTRIC KNIVES; ELECTROMECHANICAL FOOD PREPARATION MACHINES, NAMELY, ELECTRIC FOOD PROCESSORS, AND ELECTRIC FOOD SLICERS; DOMESTIC MIXING MACHINES, NAMELY, HAND MIXERS AND STAND MIXERS; ELECTRIC WHISKS FOR HOUSEHOLD PURPOSES; ELECTRIC FRUIT PRESSES FOR HOUSEHOLD PURPOSES; ELECTRIC KITCHEN MACHINES, NAMELY, ELECTRIC CAN OPENERS, ELECTRIC COFFEE GRINDERS, ELECTRIC FOOD CHOPPERS, ELECTRIC FOOD PROCESSORS, ELECTRIC FRUIT PEELERS, ELECTRIC JUICERS, AND ELECTRIC MEAT GRINDERS; ELECTRIC FOOD BLENDERS FOR HOUSEHOLD PURPOSES; DISHWASHERS; DOMESTIC WASHING MACHINES, NAMELY, PRESSURE WASHING MACHINES, CLOTHES WASHING MACHINES, AND FLOOR WASHING MACHINES; DRYING MACHINES, NAMELY, DRY CLEANING MACHINES; SEWING MACHINES; VACUUM CLEANERS AND ACCESSORIES THEREOF, NAMELY, HOSES, PUMPS, AND VACUUM CLEANER BAGS; COMPONENTS OF MOTOR ENGINES, NAMELY, PUSH RODS, ROCKER ARMS, ENGINE CASES, PISTONS, BEARINGS, CAMSHAFTS, AND MUFFLERS (U.S. CLS. 13, 19, 21, 23, 31, 34 AND 35).

CLASS 8—HAND TOOLS

FOR HAND OPERATED HAND TOOLS AND IMPLEMENTS, NAMELY, NON-ELECTRIC CAN OPENERS, NAIL CLIPPERS, AND MULTI-FUNCTIONAL KNIVES WITH RETRACTABLE BLADES; ELECTRIC OR NON-ELECTRIC RAZORS, NAMELY, RAZOR BLADES; CUTLERY, FORKS AND SPOONS; DEPILATORY APPLIANCES; TWEEZERS; CURLING TONGS; KITCHEN SCISSORS; AND SCREW DRIVERS, STATIONERY SCISSORS (U.S. CLS. 23, 28 AND 44).

CLASS 9—ELECTRICAL AND SCIENTIFIC APPARATUS

FOR EYEGLASSES; SUNGLASSES; CASES AND CORDS FOR SUNGLASSES AND EYE GLASSES; BINOCULARS; MAGNETS AND DECORATIVE MAGNETS; DIRECTIONAL COMPASSES; APPARATUS FOR RECORDING, TRANSMITTING AND REPRODUCING OF SOUND AND IMAGES, NAMELY, TELEVISION SETS, RADIOS, VIDEO RECORDERS, COMPACT DISC PLAYERS, AND DIGITAL DISC PLAYERS; LOUDSPEAKERS; HEADPHONES; COMPUTERS; DATA PROCESSORS; COMPUTER KEYBOARDS; COMPUTER MONITORS; MODEMS; ELECTRONIC POCKET TRANSLATORS; DICTATING MACHINES; ELECTRONIC AGENDAS; SCANNERS; PRINTERS; PHOTOCOPY MACHINES; FACSIMILE TRANSMISSION MACHINES; TELEPHONES, TELEPHONE ANSWERING MACHINES; VIDEO TELEPHONES; CELLULAR TELEPHONES; CALCULATING MACHINES, NAMELY, CALCULATORS AND DATA PROCESSORS; CREDIT CARD MACHINES, NAMELY, CREDIT CARD VERIFICATION MACHINES, NAMELY, MAGNETIC CODED CARD READERS; CASH EXCHANGING MACHINES, NAMELY, MACHINES FOR THE CONVERSION OF CURRENCY; VIDEO CAMERAS; CAMCORDERS; PHOTOGRAPHIC EQUIPMENT, NAMELY, CAMERAS, PROJECTORS, EXPOSED FILMS, FLASH BULBS, CAMERA CASES, BATTERIES, AND ACCESSORIES THEREFOR; SLIDES, NAMELY, PHOTOGRAPHIC SLIDE TRANSPARENCIES; FLASH BULB CAMERA CASES; BATTERIES; VIDEO GAME CARTRIDGES AND DISKS; PRE-RECORDED COMPUTER SOFTWARE, NAMELY, SOFTWARE FOR GAMES; COMPUTER SCREEN SAVER SOFTWARE; VIDEO TAPES, MAGNETIC TAPES, MAGNETIC DISKS, DVDS, FLOPPY DISKS, OPTICAL DISKS, COMPACT DISKS, CD-ROMS, AND VIDEO DISKS ALL SOLD EMPTY; PRE-RECORDED VIDEO TAPES, MAGNETIC TAPES, MAGNETIC DISKS, DVDS, FLOPPY DISKS, OPTICAL DISKS, COMPACT DISKS, CD-ROMS, AND VIDEO DISKS FEATURING MUSIC; PRE-RECORDED VIDEO TAPES, MAGNETIC TAPES, MAGNETIC DISKS, DVDS, FLOPPY DISKS, OPTICAL DISKS, COMPACT DISKS, CD-ROMS, AND VIDEO DISKS FEATURING ANIMATION; CD-ROMS AND VIDEO DISKS ALL SOLD EMPTY; PRE-RECORDED VIDEOTAPES, MAGNETIC TAPES, MAGNETIC DISKS, DVDS, FLOPPY DISKS, OPTICAL DISKS, COMPACT DISCS, CD-ROMS, AND VIDEO DISKS FEATURING SPORTS AND/OR ANIMATED CARTOONS; MAGNETICALLY ENCODED DEBIT CARDS, CREDIT CARDS, ATM CARDS, PREPAID TELEPHONE CALLING CARDS, TRAVEL CARDS, ENTERTAINMENT CARDS, AND CHECK GUARANTEE CARDS; COMPUTER HARDWARE, NAMELY, MEMORY CARDS; MICROCHIP CARDS; IRONS, NAMELY, ELECTRIC, FLAT, AND STEAM IRONS; SECURITY ALARMS, NAMELY, ANTI-INTRUSION ALARMS, SMOKE ALARMS, FIRE ALARMS, AND PERSONAL SECURITY ALARMS; ELECTRONIC VENDING MACHINES; WINDSOCKS FOR MEASURING WIND; DISTANCE MEASURING APPARATUS, NAMELY, TAPE MEASURES, ODOMETERS, AND PEDOMETERS; SPEED MEASURING AND INDICATION EQUIPMENT, NAMELY, SPEEDOMETERS LASER SPEED DETECTORS; ELECTRONIC PUBLICATIONS IN THE NATURE OF MAGAZINES, NEWSLETTERS, BROCHURES, PAMPHLETS AND FLIERS IN THE FIELD OF SOCCER RECORDED ON CD-ROMS; GRADUATED RULERS (U.S. CLS. 21, 23, 26, 36 AND 38).

CLASS 10—MEDICAL APPARATUS

FOR PERSONAL DIAGNOSTIC APPLIANCES, NAMELY, EAR THERMOMETERS, BLOOD PRESSURE MEASURING DEVICES, AND HEART MONITORS; MEDICAL MEASUREMENT APPARATUS AND INSTRUMENTS, NAMELY, BLOOD PRESSURE MEASURING APPARATUS, BLOOD DRAWING APPARATUS, BLOOD PRESSURE MONITORS, BLOOD GLUCOSE METERS, ELECTROCARDIOGRAPHS, LARYNGOSCOPES, OTOSCOPES AND RETINOSCOPES; MASSAGE APPARATUS FOR PERSONAL USE; PHYSICAL EXERCISE MACHINES FOR MEDICAL PURPOSES; MEDICAL DIAGNOSTIC IMAGING EQUIPMENT, NAMELY, X-RAY MACHINES AND MRI DIAGNOSTIC APPARATUS; BABY NURSING BOTTLES; CONDOMS; ORTHOPEDIC SUPPORTIVE BANDAGES; AND ICE AND THERMAL BAGS FOR MEDICAL PURPOSES (U.S. CLS. 26, 39 AND 44).

CLASS 11—ENVIRONMENTAL CONTROL APPARATUS

FOR PENLIGHTS; FLASHLIGHTS; TABLE LAMPS; DECORATIVE LAMPS; LAMP SHADES; INCANDESCENT LAMPS; LIGHT BULBS; LIGHTING FIXTURES; PAPER LANTERNS; BICYCLE LIGHTS; LANTERNS, NAMELY, ELECTRIC, OIL, AND CANDLE LANTERNS; REFRIGERATORS; FREEZERS; OVENS; GAS STOVES; ELECTRIC COOKERS, NAMELY, ELECTRIC COOKING OVENS, ELECTRIC BREAD COOKERS, ELECTRIC RICE COOKERS, AND ELECTRIC SLOW COOKERS; BARBECUE GRILLS; ELECTRIC RANGES; MICROWAVE OVENS; ELECTRIC COFFEE MAKERS FOR DOMESTIC USE; ELECTRIC TEA KETTLES; ELECTRIC TOASTERS; ELECTRIC DEEP FRYERS; ELECTRIC CLOTHES DRYERS AND HAND-HELD ELECTRIC HAIR DRYERS; SPACE HEATERS; AIR CONDITIONERS; AIR PURIFYING UNITS, NAMELY, AIR FILTERS FOR DOMESTIC USE, FOR MECHANICAL PURPOSES, AND FOR INDUSTRIAL INSTALLATIONS; AIR PURIFIERS; WATER PURIFICATION UNITS; WATER FILTERS FOR DRINKING WATER; AND DRINKING FOUNTAINS; ELECTRIC FOOD STEAMERS, ELECTRIC FOOD WARMERS (U.S. CLS. 13, 21, 23, 31 AND 34).

CLASS 12—VEHICLES

FOR BICYCLES; MOTORBIKES; AUTOMOBILES; TRUCKS; VANS; BUSES; REFRIGERATED TRAILERS; AIRPLANES; BOATS; VEHICULAR BALLOONS AND AIRSHIPS; AUTOMOBILE ACCESSORIES, NAMELY, SUN VISORS, ROOF RACKS, NAMELY, BICYCLE RACKS, SKI RACKS, LUGGAGE RACKS, AND SPARE TIRE COVERS; HUBCAPS; TIRES; SEAT COVERS, NAMELY, VEHICLE SEAT COVERS; CAR COVERS, NAMELY, FITTED AND SEMI FITTED VEHICLE COVERS; AND PRAMS, NAMELY, BABY CARRIAGES, BABY STROLLERS, AND CAR SEATS FOR BABIES OR CHILDREN (U.S. CLS. 19, 21, 23, 31, 35 AND 44).

CLASS 14—JEWELRY

FOR JEWELRY; WATCHES; CLOCKS; MEDALLIONS; PENDANTS; BROOCHES; DECORATIVE PINS IN THE NATURE OF JEWELRY, NAMELY, ORNAMENTAL LAPEL PINS; TEAM AND PLAYER TRADING LAPEL PINS MADE OF PRECIOUS METALS; TIE CLIPS AND TIE PINS; CUFFLINKS; COMMEMORATIVE MEDALS AND COMMEMORATIVE STATUARY CUPS AND PLATES; TANKARDS OF PRECIOUS METAL; PRECIOUS METAL TROPHIES; STATUES AND SCULPTURES OF PRECIOUS METAL; TEA POTS OF PRECIOUS METAL; POGS MADE OF PRECIOUS METAL; ASHTRAYS AND CIGARETTE CASES MADE OF PRECIOUS METALS; AND COINS, NAMELY, COLLECTIBLE, COMMEMORATIVE, AND NON-MONETARY COINS; DECORATIVE METAL KEY HOLDERS OF PRECIOUS METAL; NON-ENCODED NAME BADGES OF PRECIOUS METAL (U.S. CLS. 2, 27, 28 AND 50).

CLASS 15—MUSICAL INSTRUMENTS

FOR MUSICAL INSTRUMENTS; MUSICAL BOXES; AND ELECTRIC AND ELECTRONIC MUSICAL INSTRUMENTS (U.S. CLS. 2, 21 AND 36).

CLASS 16—PAPER GOODS AND PRINTED MATTER

FOR PAPER TABLE LINEN; PAPER NAPKINS; PAPER TABLE CLOTHS; BAGS OF PAPER; PRINTED INVITATIONS; GREETING CARDS; GIFT WRAP; PAPER COASTERS AND PAPER PLACEMATS; GARBAGE BAGS OF PAPER OR PLASTIC; FOOD STORAGE WRAPPERS; PAPER COFFEE FILTERS; BLANK OR PARTIALLY PRINTED LABELS NOT OF TEXTILES; PAPER TOWELS; TOILET PAPER; BOXED PAPER TISSUES; PAPER HANDKERCHIEFS; BABIES' DIAPERS OF PAPER; STATIONERY AND SCHOOL SUPPLIES, NAMELY, TYPEWRITER PAPER, COPYING PAPER, ENVELOPES, THEME PADS, NOTEBOOKS, NOTE PAPER, WRITING PAPER, SCRIBBLE PADS, BINDER PAPER, BINDERS, BOOK COVERS, COLORING BOOKS, DRAWING PADS, ACTIVITY BOOKS, LUMINOUS PAPER, ADHESIVE NOTE PAPER, CREPE PAPER, TISSUE PAPER, AND STAPLES; FLAGS OF PAPER; PENNANTS OF PAPER; WRITING INSTRUMENTS, NAMELY, PENS, PENCILS, BALL-POINT PENS, PEN SETS, PENCIL SETS, POROUS-POINT PENS, ROLLING BALL PENS, BROAD-TIP MARKERS, COLORING PENCILS, AND LIQUID PAINT FELT TIP MARKING AND COLORING APPLICATORS; INK; INK PADS; RUBBER STAMPS; PAINT BOXES; PAINT AND COLORING PENCILS; CHALK; DECORATIONS FOR PENCILS, NAMELY, DECORATIVE PENCIL TOP ORNAMENTS; PRINTING BLOCKS; MAGAZINES, NEWSPAPERS, BOOKS AND JOURNALS FEATURING ATHLETES OR SPORTS EVENTS; PRINTED TEACHING MATERIALS, NAMELY, ACTIVITY GUIDES AND MANUALS FEATURING SOCCER; SCORE BOOK SCHEDULES FOR RECORDING RESULTS; EVENT PROGRAMS; EVENT ALBUMS; PHOTOGRAPH ALBUMS; AUTOGRAPH BOOKS; ADDRESS BOOKS; DIARIES; PERSONAL ORGANIZERS; ROAD MAPS; PRINTED TICKETS; BANK CHECKS; PRINTED TIME-TABLES; PAMPHLETS AND BROCHURES RELATING TO THE SPORT OF SOCCER; COMIC STRIPS; COLLECTABLE PLAYER TRADING CARDS; BUMPER STICKERS; STICKERS; STICKER ALBUMS; CALENDARS; POSTERS; MOUNTED AND UNMOUNTED PHOTOGRAPHS POSTCARDS; POSTAGE STAMPS; ADVERTISING SIGNS AND BANNERS AND MATERIALS, NAMELY, PRINTED PAPER SIGNS AND BANNERS; DECALS; HEAT TRANSFER PAPERS; OFFICE REQUISITES, NAMELY, CORRECTION FLUID, RUBBER ERASERS, PENCIL SHARPENERS, STANDS FOR WRITING IMPLEMENTS, PAPER CLIPS, DRAWING PINS, NAMELY, CORKBOARD PINS, UNGRADUATED RULERS, ADHESIVE TAPE FOR STATIONERY, DISPENSERS FOR ADHESIVE TAPE, STAPLERS, STENCILS, DOCUMENT HOLDERS, CLIP BOARDS, NOTEPAD HOLDERS, BOOKENDS, AND STAMPS; CREDIT, PHONE, ATM, TRAVEL AND ENTERTAINMENT, CHECK GUARANTEE AND DEBIT CARDS NOT MAGNETICALLY ENCODED AND MADE OF PAPER OR CARDBOARD; DECORATIVE TRANSFERS FOR COSMETIC PURPOSES, NAMELY, TEMPORARY TATTOOS; BOOK STANDS; NON-MAGNETICALLY ENCODED FIDELITY CARDS THAT CONTAIN THE PERSONAL DATA OF THE OWNER; PASSPORT HOLDERS; CHECK BOOK HOLDERS; AND PAPER PARTY HATS; HOLOGRAPHIC STICKERS; PAPER NON-ENCODED NAME BADGES; STANDS FOR STATIONERY, NAMELY, DESK TOP DOCUMENT STANDS; POGS COMPOSED OF PAPER AND CARDBOARD (U.S. CLS. 2, 5, 22, 23, 29, 37, 38 AND 50).

CLASS 18—LEATHER GOODS

FOR LEATHER AND IMITATION LEATHER SOLD IN BULK; UMBRELLAS; PARASOLS; SPORT BAGS OTHER THAN THOSE ADAPTED FOR PRODUCTS THEY ARE DESIGNED TO CONTAIN, NAMELY, ATHLETIC BAGS; ALL PURPOSE LEISURE BAGS; TRAVELING BAGS; BACKPACKS; TOTE BAGS; SCHOOL BAGS; BELT BAGS; HANDBAGS; BALL SHAPED BAGS OF LEATHER, NAMELY, ATHLETIC BAGS AND HAND BAGS; BEACH BAGS; SUIT CARRIERS, NAMELY, SUIT BAGS; SUIT CASES; BRIEFCASES; VANITY CASES SOLD EMPTY; TOILET BAGS; KEY CASES; WALLETTS; AND PURSES (U.S. CLS. 1, 2, 3, 22 AND 41).

CLASS 20—FURNITURE AND ARTICLES NOT OTHERWISE CLASSIFIED

FOR MIRRORS; ARTICLES MADE OF PLASTICS, NAMELY, DESKTOP STATUARY MADE OF PLASTIC, PLASTIC FIGURES, PLASTIC ORNAMENTS, PLASTIC BANNERS, PLASTIC BOXES, PLASTIC FLAGS, PLASTIC KEY RINGS, AND PLASTIC PENNANTS; PLASTIC SOUVENIR STATUES, PLASTIC FIGURINES, PLASTIC TROPHIES, PLASTIC NON-ENCODED NAME BADGES, PLASTIC NON-ENCODED CARD KEYS, AND PLASTIC DECORATIVE KEY HOLDERS; CUSHIONS; SLEEPING BAGS; FURNITURE; SEATS FOR INDOOR AND OUTDOOR USE; FURNITURE RACKS FOR STORAGE AND DISPLAY; DISPLAY STANDS FOR SELLING GOODS, NAMELY, DISPLAY RACKS; DISPENSERS OF KITCHEN TOWELS, NAMELY, FIXED TOWEL DISPENSERS NOT OF METAL; COAT HANGERS; NON-ELECTRIC FANS FOR PERSONAL USE; INFLATABLE PUBLICITY OBJECTS; BOOK SHELVES; AND POGS MADE FROM PLASTIC (U.S. CLS. 2, 13, 22, 25, 32 AND 50).

CLASS 21—HOUSEWARES AND GLASS

FOR NON ELECTRIC HOUSEHOLD OR KITCHEN UTENSILS AND CONTAINERS, NOT OF PRECIOUS METALS OR COATED THEREWITH, NAMELY, GRILLS, GRILL COVERS, WIRE BASKETS, GRADERS, SIEVES, SPATULAS, STRAINERS, TURNERS, ROLLING PINS, POT AND PAN SCRAPERS, AND SKIMMERS; TANKARDS, MUGS, CUPS, AND DRINKING GLASSES, PLATES AND DISHES, COASTERS, NONE OF PRECIOUS METALS; TEA POTS NOT OF PRECIOUS METAL; INSULATED KITCHEN MITTS, NAMELY, CLEANING MITTS OF FABRIC; HOUSEHOLD GLOVES FOR GENERAL USE; BOTTLE OPENERS; BEVERAGE BOTTLES SOLD EMPTY; VACUUM FLASKS; NON-ELECTRIC COOLERS FOR FOOD AND DRINKS, NAMELY, PORTABLE COOLERS; DISPENSERS OF KITCHEN TOWELS NOT MADE OF METAL; COMBS AND HAIRBRUSHES; TOOTHBRUSHES; DENTAL FLOSS; AND STATUES, SCULPTURES, AND TROPHIES RELATED TO THE SPORT OF SOCCER MADE OF PORCELAIN, TERRA-COTTA OR GLASS; FIXED NON-METAL DISPENSERS OF NAPKINS (U.S. CLS. 2, 13, 23, 29, 30, 33, 40 AND 50).

CLASS 24—FABRICS

FOR SHEETS; QUILT COVERS; BEDSPREADS; PILLOW CASES; SHOWER CURTAINS; DRAPERIES; TOWELS; BATH LINENS; DISH CLOTHS; DISH TOWELS; BEACH MATS; STADIUM BLANKETS; CLOTH HANDKERCHIEFS; TEXTILE WALL HANGINGS; FABRIC FLAGS; CLOTH BANNERS; CLOTH PENNANTS; TABLE CLOTHS MADE OF TEXTILE; AND CLOTH LABELS (U.S. CLS. 42 AND 50).

CLASS 25—CLOTHING

FOR FOOTWEAR; HEADGEAR, NAMELY, HATS AND CAPS; SHIRTS; KNIT SHIRTS; JERSEYS AND TANK TOPS; T-SHIRTS; SINGLETTS; DRESSES; SKIRTS; UNDERWEAR; SWIMWEAR; SHORTS; PANTS; SWEATERS; BONNETS; SCARVES; HEADSCARVES; VISORS; WARM-UP SUITS; SWEATSHIRTS; JACKETTS; BLAZERS; RAINWEAR; COATS; UNIFORMS; NECKTIES; WRISTBANDS; HEADBANDS; GLOVES; APRONS; PLASTIC BABY BIBS; PAJAMAS; TODDLER AND INFANT PLAYWEAR, NAMELY, INFANTWEAR; SOCKS AND HOSIERY; SUSPENDERS; AND BELTS (U.S. CLS. 22 AND 39).

CLASS 26—FANCY GOODS

FOR BRAIDS; TASSELS; RIBBONS; BUTTONS FOR CLOTHING; NEEDLES; SEWING BOXES; DECORATIVE PINS AND BADGES NOT MADE OF PRECIOUS METAL, NAMELY, ORNAMENTAL NOVELTY PINS; BROOCHES FOR CLOTHING; PINS FOR BONNETS EXCLUDING THOSE OF PRECIOUS METAL, NAMELY, BOBBY PINS; HAIR NETS; HAIR BANDS; HAIR PINS; HAIR RIBBONS; AND PINS OF NON-PRECIOUS METAL, NAMELY, SAFETY PINS (U.S. CLS. 37, 39, 40, 42 AND 50).

CLASS 27—FLOOR COVERINGS

FOR CARPETS; RUGS; MATS, NAMELY, BATH MATS, CORK MATS, DOOR MATS, GYMNASIUM EXERCISE MATS, REED MATS, AND STRAW MATS; CAR MATS; LINOLEUM FOR COVERING EXISTING FLOORS; WOODEN FLOOR COVERINGS, NAMELY, HARD SURFACE COVERINGS FOR WOOD FLOORS AND CORK FOR USE AS A FLOOR OR WALL COVERING; FLOOR MATS, NAMELY FLOOR MATS FOR VEHICLES, TEXTILE FLOOR MATS FOR USE IN HOMES, AND GYMNASIUM EXERCISE FLOOR MATS; AND ARTIFICIAL TURF (U.S. CLS. 19, 20, 37, 42 AND 50).

CLASS 28—TOYS AND SPORTING GOODS

FOR GAMES AND PLAYTHINGS, NAMELY, ACTION SKILL GAMES, ARCADE GAMES, CARD GAMES, PARLOR GAMES, AND PARTY GAMES; SPORT BALLS, NAMELY, SOCCER BALLS, BASKETBALLS, BASEBALLS, AND FOOTBALLS; BOARD GAMES; TABLES FOR TABLE FOOTBALL; STUFFED DOLLS AND ANIMALS; TOY VEHICLES; JIGSAW PUZZLES; BALLOONS; INFLATABLE TOYS; TOY METAL POGS; SOCCER EQUIPMENT, NAMELY, SOCCER BALLS, SOCCER GLOVES, KNEEPADS, ELBOW PADS, SHOULDER PADS, SHIN GUARDS, AND SOCCER GOALS; HAND HELD UNIT FOR PLAYING VIDEO GAMES OTHER THAN THOSE ADAPTED FOR USE WITH TELEVISION RECEIVERS ONLY; FOAM FINGERS IN THE NATURE OF TOYS; PLAYING CARDS; CONFETTI; PERSONAL EXERCISE FLOOR MATS; AND CHRISTMAS TREE ORNAMENTS (U.S. CLS. 22, 23, 38 AND 50).

CLASS 29—MEATS AND PROCESSED FOODS

FOR MEAT; FISH FOR FOOD PURPOSES; POULTRY AND GAME FOR FOOD PURPOSES; MEAT EXTRACTS; PRESERVED AND COOKED FRUITS AND VEGETABLES; CANNED FRUITS AND VEGETABLES; EDIBLE OILS AND FATS; POTATO CHIPS; FRENCH FRIED POTATOES; PROCESSED NUTS; JAMS; FRUIT PRESERVES AND JELLIES; MILK; DAIRY PRODUCTS EXCLUDING ICE CREAM, ICE MILK, AND FROZEN YOGURT; AND CHEESE (U.S. CL. 46).

CLASS 30—STAPLE FOODS

FOR COFFEE; TEA; COCOA; SUGAR; HONEY; ARTIFICIAL COFFEE; FLOUR; PREPARATIONS MADE FROM CEREALS, NAMELY, CEREAL BASED SNACK FOOD AND READY TO EAT CEREAL DERIVED FOOD BARS; CEREALS, NAMELY, BREAKFAST AND PROCESSED CEREALS; BREAD; PASTRIES; CAKES; COOKIES; CRACKERS; CANDIES; ICE CREAM; FROZEN CONFECTIONS; RICE; CORN CHIPS; MUSTARD; VINEGAR; SAUCES; CONDIMENTS; SPICES; SALT; NUTRITIONAL ADDITIVES NOT FOR MEDICAL OR DIETETIC PURPOSES; NUTRITIONAL ADDITIVES, NAMELY, FLAVORING ADDITIVES FOR NON-NUTRITIONAL PURPOSES, NAMELY, FILLER AND FLAVORING; AND ICE MILK AND FROZEN YOGURT (U.S. CL. 46).

CLASS 31—NATURAL AGRICULTURAL PRODUCTS

FOR FOODSTUFF FOR ANIMALS; GRASS SEED; FRESH FRUITS; FRESH BERRIES; FRESH VEGETABLES; FRESH FLOWERS; LITTER FOR ANIMALS; AND NON-ARTIFICIAL TURF (U.S. CLS. 1 AND 46).

CLASS 32—LIGHT BEVERAGES

FOR SOFT DRINKS; SYRUPS AND POWDER FOR MAKING SOFT DRINKS; MINERAL AND AERATED WATERS; NON-ALCOHOLIC BEERS AND ALES; ISOTONIC DRINKS; FRUIT AND VEGETABLE DRINKS AND JUICES; FROZEN FRUIT DRINKS; BEERS; AND ALES (U.S. CLS. 45, 46 AND 48).

CLASS 33—WINES AND SPIRITS

FOR ALCOHOLIC BEVERAGES EXCEPT BEERS, NAMELY, WINE, LIQUOR, APERITIFS, CHAMPAGNE, CIDER, BRANDY, WHISKY, VODKA, GIN, RUM, AND TEQUILA (U.S. CLS. 47 AND 49).

CLASS 34—SMOKERS' ARTICLES

FOR MATCHES; CIGARETTE LIGHTERS NOT OF PRECIOUS METAL; SMOKERS' ARTICLES, NAMELY, CIGARETTE CASES NOT OF PRECIOUS METAL, ASHTRAYS NOT OF PRECIOUS METAL, CIGARETTE HOLDERS NOT PRECIOUS METAL, AND CIGARETTE PAPERS; CIGARETTES; AND TOBACCO (U.S. CLS. 2, 8, 9 AND 17).

CLASS 35—ADVERTISING AND BUSINESS

FOR EMPLOYMENT AGENCIES; EMPLOYMENT AGENCIES FEATURING PERSONNEL PLACEMENT AND RECRUITMENT SERVICES; ADVERTISING AGENCY SERVICES; ADVERTISING FOR OTHERS VIA THE INTERNET; DISSEMINATION OF ADVERTISING MATTER FOR OTHERS; RENTAL OF ADVERTISING SPACE ON OUTDOOR BILLBOARDS; PREPARING AND PLACING OUTDOOR ADVERTISEMENTS FOR OTHERS; PROVIDING TELEVISION ADVERTISING FOR OTHERS; PROMOTION AGENCY SERVICES, NAMELY, PROMOTING THE GOODS AND SERVICES OF OTHERS THROUGH THE DISTRIBUTION OF PRINTED AND AUDIO PROMOTIONAL MATERIALS AND BY RENDERING SALES PROMOTION ADVICE; PREPARING ADVERTISEMENTS FOR OTHERS IN THE FORM OF ANIMATION; PUBLIC RELATIONS SERVICES IN THE FIELD OF SPORTS; MARKETING RESEARCH SERVICES; INTERNET AND WIRELESS COMMUNICATION ADVERTISING SERVICES, NAMELY, DISSEMINATION OF ADVERTISING FOR OTHERS VIA THE INTERNET AND WIRELESS COMMUNICATION DEVICES; BILLBOARD LEASING SERVICES; ADVERTISING SPACE RENTAL SERVICES; BILLBOARD ADVERTISING SERVICES; TELEVISION AND RADIO ADVERTISING SERVICES, NAMELY, PRODUCTION AND DISTRIBUTION OF RADIO AND TELEVISION COMMERCIALS; PREPARING ADVERTISEMENTS FOR OTHERS IN THE FORM OF ANIMATION; SPORT AND PUBLIC RELATIONS PROMOTION AGENCY SERVICES; MARKETING RESEARCH SER-

VICES; PUBLIC OPINION POLLING SERVICES; ORGANIZATION OF PUBLICITY FOR COMMERCIAL EXHIBITIONS; DATABASE COMPILATION SERVICES, NAMELY, COMPUTERIZED DATABASE MANAGEMENT AND LICENSING OF COMPUTER DATABASES IN THE FIELD OF SPORTS AND ENTERTAINMENT; DATABASE MANAGEMENT SERVICES; PROMOTION OF SOCCER EVENTS FOR OTHERS; RETAIL AND COMPUTERIZED ON-LINE RETAIL STORES FEATURING SOLVENTS, PARAFFIN, WAX, BITUMEN AND PETROLEUM; RETAIL STORE AND ON-LINE RETAIL STORE SERVICES IN THE FIELDS OF CLOTHING, FOOTWEAR, SPORTING GOODS, STATIONERY, MAGNETIC TAPES, COMPACT DISCS, DVDS, VIDEOS, CD-ROMS, BOOKS, NEWSPAPERS, MAGAZINES, PUBLICATIONS, SOLVENTS, PARAFFIN, WAX, BITUMEN, AND PETROLEUM; BUSINESS AND INFORMATION SERVICES IN THE FIELDS OF BUSINESS CONSULTING, BUSINESS MANAGEMENT, BUSINESS PLANNING, AND BUSINESS RESEARCH PROVIDED ON-LINE FROM A COMPUTER DATABASE OR THE INTERNET OR WIRELESS ELECTRONIC COMMUNICATION DEVICE; COMPILATION OF ADVERTISEMENTS FOR USE AS WEB PAGES ON THE INTERNET OR ON WIRELESS ELECTRONIC COMMUNICATION DEVICE, NAMELY, PROVIDING A WEB SITE WHICH FEATURES ADVERTISEMENTS FOR THE GOODS AND SERVICES OF OTHERS ON A GLOBAL COMPUTER NETWORK, AND COMPILATION OF ADVERTISEMENTS FOR USE AS WEB PAGES ON THE INTERNET OR ON WIRELESS ELECTRONIC COMMUNICATION DEVICE, NAMELY, PROVIDING SPACE AT A WEB SITE FOR THE ADVERTISEMENT OF THE GOODS AND SERVICES OF OTHERS; COMPILATION OF DIRECTORIES FOR PUBLISHING ON THE INTERNET OR ON WIRELESS ELECTRONIC COMMUNICATION DEVICE; PROVIDING SPACE AT A WEB SITE FOR THE ADVERTISEMENT OF THE GOODS AND SERVICES OF OTHERS; ADVERTISING SERVICES, NAMELY, ADVERTISING THE PUBLICATIONS OF OTHERS; PROMOTING THE COMMERCIAL EXHIBITIONS OF OTHERS; PROMOTING THE GOODS AND SERVICES OF OTHERS BY PROVIDING HYPERTEXT LINKS TO THE WEB SITES OF OTHERS; AUCTIONEERING PROVIDED ON THE INTERNET OR ON WIRELESS ELECTRONIC COMMUNICATION DEVICES; DATA PROCESSING SERVICES; PROMOTING SOCCER COMPETITIONS, SOCCER EXHIBITIONS, AND SOCCER EVENTS OF OTHERS; PROMOTING THE SPORTS COMPETITIONS AND EVENTS OF OTHERS, NAMELY, FOOTBALL; PROVIDING STATISTICAL INFORMATION FOR SPORTS; ON-LINE TRADING SERVICES IN WHICH SELLER POSTS PRODUCTS TO BE AUCTIONED AND BIDDING IS DONE VIA THE INTERNET; PROVIDING ON-LINE DIRECTORY INFORMATION SERVICES ALSO PROVIDING HYPERLINKS TO OTHER WEB SITES (U.S. CLS. 100, 101 AND 102).

CLASS 36—INSURANCE AND FINANCIAL

FOR CREDIT CARD SERVICES; ISSUANCE OF CREDIT CARDS; TRAVELERS CHECK SERVICES; FINANCING SERVICES; BANKING SERVICES; BANKING, NAMELY, CREDIT AND LOAN SERVICES; INSURANCE SERVICES, NAMELY, INSURANCE UNDERWRITING IN THE FIELDS OF LIFE, HEALTH, ACCIDENT, PROPERTY, AND CASUALTY; FINANCIAL SPONSORSHIP OF SOCCER TOURNAMENTS; PROVIDING FINANCIAL INFORMATION VIA THE INTERNET AND WIRELESS ELECTRONIC COMMUNICATION DEVICE; ONLINE BANKING SERVICES; AND BETTING SERVICES (U.S. CLS. 100, 101 AND 102).

CLASS 37—CONSTRUCTION AND REPAIR

FOR AUTOMOBILE SERVICE STATION SERVICES; VEHICLE CLEANING; VEHICLE LUBRICATION; VEHICLE MAINTENANCE AND REPAIR; AND VEHICLE WASHING SERVICES (U.S. CLS. 100, 103 AND 106).

CLASS 38—COMMUNICATION

FOR COMMUNICATION SERVICES, NAMELY, TRANSMITTING STREAMED SOUND AND AUDIO-VISUAL RECORDINGS VIA THE INTERNET, TELECOMMUNICATIONS CONSULTATION, TELECOMMUNICATIONS GATEWAY SERVICES, ISDN SERVICES, PERSONAL COMMUNICATION SERVICES, AND PROVIDING FIBER OPTIC NETWORK SERVICES; TELECOMMUNICATION SERVICES, NAMELY, PERSONAL COMMUNICATION SERVICES VIA MOBILE PHONES, ELECTRONIC COMPUTER TERMINALS, TELEGRAPH, TELEPHONE, OR FACSIMILE; TELECOMMUNICATIONS SERVICES, NAMELY, PERSONAL COMMUNICATION SERVICES VIA MOBILE PHONES, ELECTRONIC COMPUTER TERMINALS, TELEGRAPH, TELEPHONE, OR FACSIMILE; ELECTRONIC TRANSMISSION OF DATA AND DOCUMENTS AMONG USERS OF COMPUTERS AND MOBILE RADIO COMMUNICATION, NAMELY, ELECTRONIC, ELECTRIC, AND DIGITAL TRANSMISSION OF VOICE, DATA, IMAGES, SIGNALS, AND MESSAGES; PAGING BY RADIO; COMMUNICATIONS BY TELECONFERENCING NAMELY, AUDIO AND VIDEO TELECONFERENCING; TELEVISION BROADCASTING; CABLE TELEVISION BROADCASTING; RADIO BROADCASTING OTHER MESSAGE TRANSMISSION SERVICES, NAMELY, CABLE RADIO TRANSMISSION, ELECTRONIC TRANSMISSION OF DATA AND DOCUMENTS AMONG USERS OF COMPUTERS, TELEGRAM TRANSMISSION, SATELLITE TRANSMISSION SERVICES, AND ELECTRONIC TRANSMISSION OF MESSAGES AND DATA; LEASING OF TELEPHONE SETS, FACSIMILE MACHINES AND OTHER COMMUNICATION EQUIPMENT, NAMELY, TELEPHONES, FACSIMILE MACHINES, RADIOS, AND CELL PHONES; COMMUNICATIONS SERVICES, NAMELY, TRANSMITTING STREAMED SOUND AND AUDIO-VISUAL RECORDINGS VIA THE INTERNET; BROADCASTING RADIO AND TELEVISION PROGRAMS VIA A GLOBAL COMPUTER AND TELECOMMUNICATIONS NETWORK OR WIRELESS ELECTRONIC COMMUNICATION DEVICES; ELECTRONIC MESSAGING, NAMELY, WEB MESSAGING AND WIRELESS DIGITAL MESSAGING SERVICES; PROVIDING ON-LINE CHAT ROOMS FOR TRANSMISSION OF MESSAGES AMONG COMPUTER USERS CONCERNING SPORTS AND ENTERTAINMENT; PROVIDING ON-LINE ELECTRONIC BULLETIN BOARDS FOR TRANSMISSION OF MESSAGES AMONG COMPUTER USERS CONCERNING SPORTS AND ENTERTAINMENT; ELECTRONIC, ELECTRIC, AND DIGITAL TRANSMISSION OF VOICE, DATA, IMAGES, SIGNALS, AND MESSAGES; PROVIDING MULTIPLE USER ACCESS TO A GLOBAL COMPUTER INFORMATION NETWORK, THE INTERNET, AND WIRELESS COMMUNICATION NETWORK; ELECTRONIC MAIL SERVICES (U.S. CLS. 100, 101 AND 104).

CLASS 39—TRANSPORTATION AND STORAGE

FOR TRAVEL AGENCY SERVICES, NAMELY, MAKING RESERVATIONS AND BOOKINGS FOR TRANSPORTATION; AIRLINE, RAILWAY, BUS AND VAN TRANSPORTATION SERVICES; TRANSPORT BY BOAT; TOUR BOAT SERVICES, NAMELY, BOAT CHARTERING AND PROVIDING BOAT CRUISES; TOUR AGENCY AND TOUR GUIDE SERVICES; VEHICLE RENTAL SERVICES; PARKING LOT SERVICES; TAXI SERVICES, NAMELY, TAXI TRANSPORT; FREIGHT SHIPPING SERVICES, NAMELY, FREIGHT BROKERAGE, FREIGHT FORWARDING, AND FREIGHT SHIP TRANSPORT; PUBLIC UTILITY SERVICES, NAMELY, DISTRIBUTION OF WATER, HEAT, GAS, OR ELECTRICITY; POSTAL SERVICES, NAMELY, PARCEL DELIVERY, PACKAGING ARTICLES FOR TRANSPORTATION, AND RENTAL OF MAIL BOXES; COURIER SERVICES; AND MESSENGER SERVICES; WAREHOUSING SERVICES (U.S. CLS. 100 AND 105).

CLASS 40—MATERIAL TREATMENT

FOR FILM DEVELOPING FOR MOVIES; PHOTOGRAPHIC ENLARGEMENT OF PHOTOGRAPHS, PRINTING OF PHOTOGRAPHS, DEVELOPING OF FILMS FOR PHOTOGRAPHS; AND LEASING OR RENTAL OF MACHINES AND INSTRUMENTS FOR DEVELOPMENT, PRINTING, ENLARGING OR FINISHING FOR PHOTOGRAPHY; AND WASTE MANAGEMENT SERVICES (U.S. CLS. 100, 103 AND 106).

CLASS 41—EDUCATION AND ENTERTAINMENT

FOR EDUCATIONAL SERVICES, NAMELY, CONDUCTING CLASSES, SEMINARS, CONFERENCES, AND WORKSHOPS IN THE FIELD OF SPORTS AND DISTRIBUTING COURSE MATERIALS IN CONNECTION THEREWITH; PROVIDING OF TRAINING, NAMELY, PERSONAL TRAINING SERVICES, NAMELY, STRENGTH AND CONDITIONING TRAINING, TRAINING IN THE USE AND OPERATION OF COMPUTERS, AND TRAINING SERVICES IN THE FIELD OF SOCCER; ENTERTAINMENT IN THE NATURE OF SOCCER GAMES; ADMINISTRATION AND CONDUCTING OF LOTTERIES FOR OTHERS; ORGANIZATION OF COMPETITIONS, NAMELY, ARRANGING AND CONDUCTING SOCCER COMPETITIONS; ENTERTAINMENT SERVICES PROVIDED AT OR RELATING TO SPORTS EVENTS, NAMELY, ENTERTAINMENT IN THE NATURE OF LASER SHOWS, LIGHT SHOWS, AUDIO AND VISUAL PERFORMANCES, LIVE PERFORMANCES BY A MUSICAL BAND, PREPARATION OF SPECIAL EFFECTS, AND FIREWORKS DISPLAYS; ORGANIZING CULTURAL AND SPORTING EVENTS; PROVIDING SPORTS FACILITIES; RENTAL SERVICES FOR AUDIO AND VIDEO EQUIPMENT, NAMELY, RENTAL OF AUDIO AND VIDEO EQUIPMENT, RADIO, VIDEO GAMES, COMPACT DISCS, CD-ROMS, COMPUTER PROGRAMS, AND VIDEOTAPES FEATURING TELEVISION PROGRAMS; PRODUCTION OF RADIO AND TELEVISION PROGRAMS; PRODUCTION OF VIDEO DISCS FOR OTHERS; MUSIC PRODUCTION SERVICES; AUDIO RECORDING AND PRODUCTION; DISTRIBUTION OF RADIO AND TELEVISION PROGRAMS FOR OTHERS; TELEVISION PROGRAM SYNDICATION; RENTAL OF FILMS; RENTAL OF VIDEOTAPES; RENTAL OF DVDS; PRODUCTION OF VIDEO DISCS FOR OTHERS; RENTAL OF DVDS; PRODUCTION OF RADIO AND TELEVISION PROGRAMS ABOUT SPORTS; PRODUCTION OF ANIMATED MOVIES; PRODUCTION OF ANIMATED TELEVISION PROGRAMS; SEAT BOOKING SERVICES FOR SHOWS AND SPORTING EVENTS, NAMELY, ARRANGING FOR TICKET RESERVATIONS FOR SHOWS AND OTHER ENTERTAINMENT EVENTS; TIMING OF SPORTS EVENTS; ENTERTAINMENT IN THE NATURE OF BEAUTY CONTESTS INTERACTIVE ENTERTAINMENT, NAMELY, PROVIDING A COMPUTER GAME THAT MAYBE ACCESSED NETWORK-WIDE BY NETWORK USERS; PROVIDING INFORMATION ON-LINE RELATING TO COMPUTER GAMES AND COMPUTER ENHANCEMENTS FOR GAMES; SUPPLYING OF RAFFLE SERVICES, NAMELY, LOTTERY SERVICES; ADVANTAGE PROGRAMS FOR CUSTOMERS AND ACCESS CONTROL IN SPORTING STADIUMS THROUGH THE ISSUING OF SUPPORTER FIDELITY CARDS, NAMELY, PREFERRED CUSTOMER BENEFIT PROGRAM IN THE NATURE OF SUPPORTER FIDELITY CARDS THAT CONTAIN PERSONAL DATA OF THE OWNER FOR USE IN CONJUNCTION WITH SPORTING EVENTS; PROVIDING EDUCATION INFORMATION ABOUT SOCCER VIA A COMPUTER DATABASE, THE INTERNET, OR WIRELESS ELECTRONIC COMMUNICATION DEVICES; ENTERTAINMENT SERVICES, NAMELY, PROVIDING ON-LINE COMPUTER GAMES VIA THE INTERNET OR WIRELESS ELECTRONIC COMMUNICATION DEVICE; PROVIDING ON-LINE NON-DOWNLOADABLE ELECTRONIC PUBLICATIONS, NAMELY, MAGAZINES, BOOKS, BROCHURES, NEWSLETTERS, AND PAMPHLETS IN THE FIELD OF SOCCER; PUBLICATION OF ELECTRONIC BOOKS AND JOURNALS ON-LINE IN THE FIELD OF SOCCER; PROVIDING ONLINE ELECTRONIC PUBLICATIONS, NAMELY, MAGAZINES, BOOKS, BROCHURES, NEWSLETTERS, AND PAMPHLETS IN THE FIELD OF SOCCER; PROVIDING DIGITAL MUSIC FROM MP3 INTERNET WEB SITES, NAMELY, PROVIDING A WEB SITE FEATURING MUSICAL PERFORMANCES, MUSI-

CAL VIDEOS, AND OTHER MULTIMEDIA MATERIALS; PHOTOGRAPHY SERVICES; AUDIO PRODUCTION SERVICES, NAMELY, AUDIO RECORDING AND PRODUCTION; PRODUCTION OF VIDEO DISCS FOR OTHERS; PRODUCTION OF VIDEOTAPES FOR OTHERS; RENTAL OF PHOTOGRAPHS, SOUND RECORDINGS, MOVING IMAGE RECORDINGS; AND PROVISION OF DATABASES FEATURING INFORMATION ON SOCCER; ELECTRONIC PUBLICATIONS SUPPLIED BY DATABASES, AND THE INTERNET IN THE NATURE OF MAGAZINES, NEWSLETTERS, BROCHURES, PAMPHLETS, AND FLIERS IN THE FIELD OF SOCCER; PROVIDING ACCESS TO DIGITAL MUSIC AND MP3'S ON THE INTERNET (U.S. CLS. 100, 101 AND 107).

CLASS 42—SCIENTIFIC, COMPUTER AND LEGAL SERVICES

FOR COMPUTER CONSULTING SERVICES; COMPUTER PROGRAMMING FOR OTHERS; COMPUTER SOFTWARE DESIGN SERVICES FOR OTHERS; LICENSING OF INTELLECTUAL PROPERTY RIGHTS; COMPUTER RENTAL; CREATING, DESIGNING, IMPLEMENTING, AND MAINTAINING THE WEB SITES OF OTHERS; INSTALLATION AND MAINTENANCE OF COMPUTER SOFTWARE; REGISTRATION OF DOMAIN NAMES FOR IDENTIFICATION OF USERS ON A GLOBAL COMPUTER NETWORK; COMPUTER SERVICES, NAMELY, PROVIDING SEARCH ENGINES FOR OBTAINING DATA ON A GLOBAL COMPUTER NETWORK; PROVIDING CUSTOMIZED ON-LINE WEB PAGES FEATURING USER-DEFINED INFORMATION, WHICH INCLUDES SEARCH ENGINES AND ONLINE WEB LINKS TO OTHER WEB SITES; STOCK PHOTOGRAPHY SERVICES, NAMELY, LEASING REPRODUCTION RIGHTS OF PHOTOGRAPHS TO OTHERS; AND HOSTING THE WEB SITES OF OTHERS ON COMPUTER SERVER FOR A GLOBAL COMPUTER NETWORK (U.S. CLS. 100 AND 101).

CLASS 43—HOTEL AND RESTAURANT SERVICES

FOR PROVIDING OF FOOD AND DRINK IN CONNECTION WITH FAST FOOD RESTAURANTS, CAFETERIAS, AND RESTAURANTS; CATERING SERVICES; CONSULTING SERVICES IN THE FIELD OF HOSPITALITY AND THE PROVISION OF FOOD AND DRINK; HOTELS; MAKING HOTEL RESERVATIONS FOR OTHERS; MAKING RESERVATIONS AND BOOKING FOR TEMPORARY LODGING; AND BOARDING HOUSES (U.S. CLS. 100 AND 101).

NAAKWAMA ANKRAH, EXAMINING ATTORNEY

SN 78-429,376. SOULSEEK, LLC, SAN FRANCISCO, CA. FILED 6-3-2004.

SLSK

THE MARK CONSISTS OF STANDARD CHARACTERS WITHOUT CLAIM TO ANY PARTICULAR FONT, STYLE, SIZE, OR COLOR.

CLASS 9—ELECTRICAL AND SCIENTIFIC APPARATUS

FOR COMPUTER SOFTWARE FOR TRANSMITTING, SEARCHING, RETRIEVING, STORING AND SHARING AUDIO, VIDEO, GRAPHICS, TEXT, DATA AND OTHER ELECTRONIC FILES VIA COMPUTER NETWORKS (U.S. CLS. 21, 23, 26, 36 AND 38).

FIRST USE 8-5-2002; IN COMMERCE 8-5-2002.

CLASS 38—COMMUNICATION

FOR TELECOMMUNICATIONS SERVICES, NAMELY ALLOWING USERS TO TRANSMIT AND SHARE ELECTRONIC FILES OVER COMPUTER NETWORKS; PROVIDING ONLINE COMMUNITY FORUMS AND CHAT ROOMS ALLOWING USERS TO TRANSMIT MESSAGES OVER COMMUNICATIONS NETWORKS; ELECTRONIC DATA TRANSMISSION, NAMELY TRANSMISSION OF PEER NETWORKING AND FILE SHARING INFORMATION VIA COMPUTER NETWORKS; AND BROADCASTING RADIO PROGRAMS VIA COMPUTER NETWORKS (U.S. CLS. 100, 101 AND 104).

FIRST USE 8-5-2002; IN COMMERCE 8-5-2002.

CLASS 41—EDUCATION AND ENTERTAINMENT

FOR MUSIC PUBLISHING SERVICES, NAMELY PUBLISHING TEXT, GRAPHIC, AUDIO AND VIDEO WORKS (U.S. CLS. 100, 101 AND 107).

FIRST USE 8-5-2002; IN COMMERCE 8-5-2002.

SAMUEL E. SHARPER JR., EXAMINING ATTORNEY

SN 78-429,476. CALBEE FOODS CO., LTD., TOKYO, JAPAN, FILED 6-3-2004.



OWNER OF U.S. REG. NOS. 872,691, 2,340,398 AND 2,851,166.

NO CLAIM IS MADE TO THE EXCLUSIVE RIGHT TO USE "SNACK SALAD", APART FROM THE MARK AS SHOWN.

CLASS 29—MEATS AND PROCESSED FOODS

FOR (BASED ON USE IN COMMERCE) VEGETABLE-BASED SNACK FOODS, BEAN CHIPS, BEAN CRISPS; (BASED ON INTENT TO USE) FRUIT-BASED SNACK FOODS, POTATO-BASED SNACK FOODS FEATURING VEGETABLES AS INGREDIENTS, FRIED POTATO SNACK FOODS, BEAN CHIPS AND BEAN CRISPS, POTATO-BASED SNACK FOODS, SOY BEAN MILK, BEAN CURD, BEAN-BASE SNACK FOODS, PROCESSED FRUIT AND DRIED FRUITS (U.S. CL. 46).

FIRST USE 10-12-1998; IN COMMERCE 10-12-1998.

CLASS 30—STAPLE FOODS

FOR (BASED ON USE IN COMMERCE) RICE-BASED SNACK FOODS, WHEAT-BASED SNACK FOODS, CORN CHIPS AND CORN CRISPS; (BASED ON INTENT TO USE) WHEAT-BASED SNACK FOODS FEATURING SHRIMPS AS INGREDIENTS (U.S. CL. 46).

FIRST USE 10-12-1999; IN COMMERCE 10-12-1999.
JOHN KELLY, EXAMINING ATTORNEY

SN 78-429,918. H-D MICHIGAN, INC., ANN ARBOR, MI.
FILED 6-4-2004.



SN 78-429,629. PATTERSON COMPANIES, INC., MENDOTA HEIGHTS, MN. FILED 6-3-2004.

PATTERSON

CLASS 14—JEWELRY

FOR CLOTHING ORNAMENTS NOT OF PRECIOUS METAL, NAMELY, MEDALLIONS, PINS, BROOCHES, LAPEL PINS, TIE CLIPS, TIE PINS, AND CUFFLINKS (U.S. CLS. 2, 27, 28 AND 50).

CLASS 26—FANCY GOODS

FOR CLOTHING BUTTONS, HOOKS AND EYES, PINS AND NEEDLES; ORNAMENTS FOR HAIR NOT OF PRECIOUS METAL, NAMELY, BOWS, RIBBONS, HAIR TIES, BARRETTES AND HAIR BANDS, CLOTHING ORNAMENTS NOT OF PRECIOUS METAL, NAMELY, BUTTON STUDS, BELT BUCKLES NOT OF PRECIOUS METAL, BELT CLASPS, EMBROIDERY, SLIDE FASTENERS, ZIPPERS, SHOE BUCKLES, SHOE ORNAMENTS NOT OF PRECIOUS METAL, FABRIC BADGES, AND EMBROIDERED PATCHES FOR CLOTHING, AND PINS OTHER THAN JEWELRY, NAMELY, BONNET, HAIR, BOBBY AND ORNAMENTAL NOVELTY PINS (U.S. CLS. 37, 39, 40, 42 AND 50).

LEIGH LOWRY, EXAMINING ATTORNEY

SN 78-429,990. SCHWAN'S IP LLC, MARSHALL, MN. FILED 6-4-2004.

THE MARK CONSISTS OF STANDARD CHARACTERS WITHOUT CLAIM TO ANY PARTICULAR FONT, STYLE, SIZE, OR COLOR.

OWNER OF U.S. REG. NO. 1,158,304.
SEC. 2(F).

CLASS 35—ADVERTISING AND BUSINESS

FOR ON-LINE RETAIL STORE SERVICES, RETAIL CATALOG ORDERING AND DOOR-TO-DOOR RETAIL SERVICES BY DIRECT SOLICITATION BY SALES AGENTS FEATURING DENTAL EQUIPMENT AND SUPPLIES; CONSULTING SERVICES IN THE FIELD OF DENTAL OFFICE MANAGEMENT (U.S. CLS. 100, 101 AND 102).

FIRST USE 10-27-1976; IN COMMERCE 10-27-1976.

CLASS 37—CONSTRUCTION AND REPAIR

FOR MAINTENANCE AND/OR REPAIR OF DENTAL EQUIPMENT (U.S. CLS. 100, 103 AND 106).

FIRST USE 10-27-1976; IN COMMERCE 10-27-1976.

CLASS 42—SCIENTIFIC, COMPUTER AND LEGAL SERVICES

FOR PLANNING AND LAYOUT DESIGN SERVICES FOR DENTAL OFFICES (U.S. CLS. 100 AND 101).

FIRST USE 10-27-1976; IN COMMERCE 10-27-1976.
JOHN DWYER, EXAMINING ATTORNEY

FRESCHETTA

THE MARK CONSISTS OF STANDARD CHARACTERS WITHOUT CLAIM TO ANY PARTICULAR FONT, STYLE, SIZE, OR COLOR.

OWNER OF U.S. REG. NOS. 2,114,646, 2,307,630 AND OTHERS.

CLASS 39—TRANSPORTATION AND STORAGE

FOR TRANSPORTATION OF GOODS BY BUS FROM AREA TO AREA FOR THE PURPOSE OF SAMPLING FOOD PRODUCTS (U.S. CLS. 100 AND 105).

FIRST USE 10-0-1997; IN COMMERCE 10-0-1997.

CLASS 43—HOTEL AND RESTAURANT SERVICES

FOR CULINARY SERVICES, NAMELY, PROVIDING INFORMATION IN THE FIELD OF CULINARY ARTS (U.S. CLS. 100 AND 101).
 FIRST USE 10-0-1997; IN COMMERCE 10-0-2000.
 MATTHEW PAPPAS, EXAMINING ATTORNEY

CLASS 39—TRANSPORTATION AND STORAGE

FOR TRAVEL SERVICES, NAMELY, PROVIDING AND ARRANGING ALL-INCLUSIVE TRAVEL VACATIONS AND TRAVEL TOUR PACKAGES (U.S. CLS. 100 AND 105).
 FIRST USE 6-1-1998; IN COMMERCE 6-1-1998.

SN 78-430,201. FLOOD COMPANY, THE, HUDSON, OH. FILED 6-4-2004.



OWNER OF U.S. REG. NOS. 1,263,897, 2,791,482 AND OTHERS.
 NO CLAIM IS MADE TO THE EXCLUSIVE RIGHT TO USE "SERIES", APART FROM THE MARK AS SHOWN.

CLASS 43—HOTEL AND RESTAURANT SERVICES

FOR MAKING HOTEL RESERVATIONS FOR OTHERS; PROVIDING INFORMATION ABOUT HOTEL RESORT ACCOMMODATIONS AND SERVICES BY MEANS OF THE GLOBAL COMPUTER NETWORK (U.S. CLS. 100 AND 101).
 FIRST USE 6-1-1998; IN COMMERCE 6-1-1998.
 RUSS HERMAN, EXAMINING ATTORNEY

SN 78-430,591. JOHNSON, STEPHAN, DBA SONROSE, INGLEWOOD, CA. FILED 6-6-2004.

CLASS 2—PAINTS

FOR EXTERIOR WOOD STAINS; EXTERIOR FINISHES FOR SIDING (U.S. CLS. 6, 11 AND 16).
 FIRST USE 6-10-1997; IN COMMERCE 6-10-1997.

CLASS 3—COSMETICS AND CLEANING PREPARATIONS

FOR STRIPPER FOR USE ON WOOD AND SIDING, NAMELY, STRIPPER FOR PAINTS, CLEAR AND PIGMENTED FINISHES, ACRYLIC, OIL STAINS AND MILL GLAZE; CLEANER FOR USE ON WOOD AND SIDING, NAMELY, CLEANER FOR PLASTIC, VINYL, FIBERGLASS, AND POWDER COATED SUBSTRATES (U.S. CLS. 1, 4, 6, 50, 51 AND 52).
 FIRST USE 3-1-1999; IN COMMERCE 3-1-1999.
 BARNEY CHARLON, EXAMINING ATTORNEY



SN 78-430,335. GORSTEW LIMITED, KINGSTON 10, ST. ANDREW, JAMAICA, FILED 6-4-2004.

THE MARK CONSISTS OF A CIRCLE WITH A CROSS/CRUCIFIX (NOT FREE-FLOATING) IN THE MIDDLE WITH THE VERTICAL, BOTTOM-PORTION OF THE CROSS TOUCHING THE BOTTOM-CENTER OF THE CIRCLE.

SANDALS ULTRA ALL-INCLUSIVE

THE MARK CONSISTS OF STANDARD CHARACTERS WITHOUT CLAIM TO ANY PARTICULAR FONT, STYLE, SIZE, OR COLOR.
 NO CLAIM IS MADE TO THE EXCLUSIVE RIGHT TO USE "ALL-INCLUSIVE", APART FROM THE MARK AS SHOWN.

CLASS 14—JEWELRY

FOR JEWELRY, NECKLACES, RINGS, EARRINGS, TOE-RINGS AND BRACELETS (U.S. CLS. 2, 27, 28 AND 50).

CLASS 25—CLOTHING

FOR CLOTHING, NAMELY SWEATSHIRTS, T-SHIRTS, AND CAPS (U.S. CLS. 22 AND 39).
 JOHN LINCOSKI, EXAMINING ATTORNEY

SN 78-431,087. WORLD WIDE FEATURES, INC., CHARLOTTE, NC. FILED 6-7-2004.

SN 78-431,145. APPLIED OPTICAL TECHNOLOGIES HOLDINGS, INC., DENVER, CO. FILED 6-7-2004.

POUCHE

THE MARK CONSISTS OF STANDARD CHARACTERS WITHOUT CLAIM TO ANY PARTICULAR FONT, STYLE, SIZE, OR COLOR.

CLASS 9—ELECTRICAL AND SCIENTIFIC APPARATUS

FOR COMPUTER GAME SOFTWARE FOR HAND HELD ELECTRONIC GAMES; ELECTRONIC VIDEO GAME MACHINES FOR USE WITH TELEVISIONS; INTERACTIVE VIDEO GAMES COMPRISED OF COMPUTER HARDWARE AND SOFTWARE; PRE-RECORDED VIDEOTAPES, CDS AND DVDS FEATURING CHILDREN'S MUSIC (U.S. CLS. 21, 23, 26, 36 AND 38).

CLASS 16—PAPER GOODS AND PRINTED MATTER

FOR SERIES OF ILLUSTRATED CHILDREN'S BOOKS (U.S. CLS. 2, 5, 22, 23, 29, 37, 38 AND 50).

CLASS 21—HOUSEWARES AND GLASS

FOR EASTER BASKETS MADE OF PLASTIC, WOOD, AND CLOTH. (U.S. CLS. 2, 13, 23, 29, 30, 33, 40 AND 50).

CLASS 25—CLOTHING

FOR CHILDREN'S CLOTHING, NAMELY, SHIRTS, BLOUSES, T-SHIRTS, PANTS, SHORTS, SKIRTS, SHORT SETS, SKIRT SETS, PANT SETS, DRESSES, OVERALLS, ROMPERS, SLEEPERS IN THE NATURE OF PAJAMAS AND NIGHTGOWNS FOR PRE-SCHOOL AGE CHILDREN, PAJAMA SETS, NIGHTGOWNS, SWEATERS, JACKETS, CAPS, HATS, SHOES, GLOVES, AND MITTENS (U.S. CLS. 22 AND 39).

CLASS 28—TOYS AND SPORTING GOODS

FOR HAND HELD ELECTRONIC GAMES; ELECTRONIC BOARD GAMES; STAND ALONE ELECTRONIC VIDEO GAME MACHINES; CHILDREN'S TOYS, NAMELY, BOARD GAMES, BUILDING BLOCKS, PLASTIC ACTION FIGURES, PLUSH TOY ANIMALS, DOLLS, AND TOY EASTER EGGS (U.S. CLS. 22, 23, 38 AND 50).

CLASS 30—STAPLE FOODS

FOR STAPLE FOODS, NAMELY, CANDY (U.S. CL. 46). YONG KIM, EXAMINING ATTORNEY

ADVANTAGE ID TECHNOLOGIES

THE MARK CONSISTS OF STANDARD CHARACTERS WITHOUT CLAIM TO ANY PARTICULAR FONT, STYLE, SIZE, OR COLOR.

NO CLAIM IS MADE TO THE EXCLUSIVE RIGHT TO USE "ID TECHNOLOGIES", APART FROM THE MARK AS SHOWN.

CLASS 40—MATERIAL TREATMENT

FOR AFFIXING AUTHENTICATION MATERIALS TO PASSPORTS, VISAS, DRIVERS LICENSES, BIRTH CERTIFICATES, AND IDENTIFICATION CARDS AND DOCUMENTS ISSUED BY GOVERNMENTS AND PRIVATE ENTITIES, TO THE ORDER AND SPECIFICATION OF GOVERNMENTS AND PRIVATE ENTITIES (U.S. CLS. 100, 103 AND 106).

FIRST USE 1-25-2002; IN COMMERCE 1-25-2002.

CLASS 45—PERSONAL SERVICES

FOR ANTI-COUNTERFEITING SERVICES, NAMELY, CONSULTING GOVERNMENTS AND PRIVATE ENTITIES REGARDING STRATEGIES AND TECHNOLOGIES TO AUTHENTICATE PASSPORTS, VISAS, DRIVERS LICENSES, BIRTH CERTIFICATES, AND IDENTIFICATION CARDS AND DOCUMENTS ISSUED BY GOVERNMENTS AND PRIVATE ENTITIES (U.S. CLS. 100 AND 101).

FIRST USE 1-25-2002; IN COMMERCE 1-25-2002.

JOHN LINCOSKI, EXAMINING ATTORNEY

SN 78-431,479. BARRIERMED PACKAGING CO., LAKE MARY, FL. FILED 6-8-2004.

CRASH PACKS

THE MARK CONSISTS OF STANDARD CHARACTERS WITHOUT CLAIM TO ANY PARTICULAR FONT, STYLE, SIZE, OR COLOR.

NO CLAIM IS MADE TO THE EXCLUSIVE RIGHT TO USE "PACKS", APART FROM THE MARK AS SHOWN.

CLASS 9—ELECTRICAL AND SCIENTIFIC APPARATUS

FOR PROTECTIVE SYNTHETIC GLOVES FOR LABORATORY AND INDUSTRIAL USE, INCLUDING CLEAN ROOM AND FOOD SERVICE USE (U.S. CLS. 21, 23, 26, 36 AND 38).

CLASS 10—MEDICAL APPARATUS

FOR SYNTHETIC GLOVES FOR MEDICAL USE; KITS CONTAINING SYNTHETIC GLOVES FOR HOSPITAL AND MEDICAL USE (U.S. CLS. 26, 39 AND 44).
NICHOLAS ALTREE, EXAMINING ATTORNEY

SN 78-431.510. LOVE SAVES THE DAY, INC., NEW YORK, NY. FILED 6-8-2004.

LOVE SAVES THE DAY

THE MARK CONSISTS OF STANDARD CHARACTERS WITHOUT CLAIM TO ANY PARTICULAR FONT, STYLE, SIZE, OR COLOR.
SEC. 2(F).

CLASS 25—CLOTHING

FOR VINTAGE DRESSES, PANTS, SHIRTS, T-SHIRTS, HATS, JACKETS, COATS AND TOPS (U.S. CLS. 22 AND 39).
FIRST USE 0-0-1966; IN COMMERCE 0-0-1966.

CLASS 28—TOYS AND SPORTING GOODS

FOR ACTION FIGURES AND ACCESSORIES THEREFOR, BATTERY OPERATED ACTION TOYS, BENDABLE TOYS, CASES FOR ACTION FIGURES, DOLLS AND ACCESSORIES THEREFOR, ELECTRIC ACTION TOYS, FANTASY CHARACTER TOYS, MECHANICAL ACTION TOYS, MECHANICAL TOYS, MUSIC BOX TOYS, MUSICAL TOYS, PARTY FAVORS IN THE NATURE OF SMALL TOYS, PLASTIC CHARACTER TOYS, PLUSH TOYS, RUBBER CHARACTER TOYS, SOFT SCULPTURE PLUSH TOYS, SOFT SCULPTURE TOYS, SQUEEZABLE SQUEAKING TOYS, SQUEEZE TOYS, STUFFED TOYS, STUFFED TOY ANIMALS, TALKING TOYS, TRANSFORMING ROBOTIC TOYS, WATER SQUIRTING TOYS, WIND-UP TOYS, WIND-UP TALKING TOYS (U.S. CLS. 22, 23, 38 AND 50).
FIRST USE 0-0-1966; IN COMMERCE 0-0-1966.
ARETHA SOMERVILLE, EXAMINING ATTORNEY

SN 78-431.739. AUTOTRONIC CONTROLS CORPORATION, EL PASO, TX. FILED 6-8-2004.

MSD POWERSPORTS

THE MARK CONSISTS OF STANDARD CHARACTERS WITHOUT CLAIM TO ANY PARTICULAR FONT, STYLE, SIZE, OR COLOR.
OWNER OF U.S. REG. NO. 2,299,279.
NO CLAIM IS MADE TO THE EXCLUSIVE RIGHT TO USE "POWER SPORTS", APART FROM THE MARK AS SHOWN.

CLASS 7—MACHINERY

FOR FUEL INJECTOR SYSTEMS COMPRISED OF ANY COMBINATION OF MODULES, IGNITIONS, COILS, DISTRIBUTORS, TIMING COMPUTERS, TIMING MASTERS, RELAYS, TIMING CONTROLS, MODULE SELECTORS, RPM ACTIVATED SWITCHES, SPARK PLUG WIRES AND BOOTS, IGNITION SWITCHES, TACHOMETER ADAPTERS, IGNITION SUPPLY MONITORS, ENGINE GOVERNORS (U.S. CLS. 13, 19, 21, 23, 31, 34 AND 35).

CLASS 12—VEHICLES

FOR MOTORCYCLES, SNOWMOBILES AND FOUR-WHEEL ALL-TERRAIN VEHICLES (U.S. CLS. 19, 21, 23, 31, 35 AND 44).
ALEXANDER L. POWERS, EXAMINING ATTORNEY

SN 78-432.143. INVISON ENTERTAINMENT INC., CALABASAS, CA. FILED 6-9-2004.

PILLOW PEOPLE

THE MARK CONSISTS OF STANDARD CHARACTERS WITHOUT CLAIM TO ANY PARTICULAR FONT, STYLE, SIZE, OR COLOR.
NO CLAIM IS MADE TO THE EXCLUSIVE RIGHT TO USE PILLOW, APART FROM THE MARK AS SHOWN.

CLASS 24—FABRICS

FOR BEACH TOWELS, BLANKET THROWS DESIGNED FOR BEACH USE, KITCHEN TOWELS, HAND TOWELS, WASHCLOTHS, FINGERTIP TOWELS, BATH TOWELS, BODY TOWELS, DISH CLOTHS, POT HOLDERS, OVEN MITTS, TEXTILE WALL HANGINGS, TABLECLOTHS NOT OF PAPER, PLASTIC PLACE MATS, TEXTILE PLACE MATS, VINYL PLACE MATS, FABRIC TABLE RUNNERS, TEXTILE NAPKINS, CLOTH COASTERS, PLASTIC COASTERS, SHOWER CURTAINS, BED SHEETS, PILLOWCASES, COMFORTERS, BEDSPREADS, PILLOW SHAMS, DUVET COVERS, DUST RUFFLES, QUILTS, WINDOW DRAPES, BED DRAPES, FABRIC VALANCES, THROW BLANKETS (U.S. CLS. 42 AND 50).

CLASS 28—TOYS AND SPORTING GOODS

FOR TOYS, NAMELY, PLUSH TOYS, INFANT TOYS, BATH TOYS, STUFFED TOYS AND TOY FIGURES (U.S. CLS. 22, 23, 38 AND 50).
DANIEL CAPSHAW, EXAMINING ATTORNEY

SN 78-432,218. PLATKIN, CHARLES S., NEW YORK, NY.
FILED 6-9-2004.

SN 78-432,403. H-D MICHIGAN, INC., ANN ARBOR, MI.
FILED 6-9-2004.

CALORIE BARGAINS

THE MARK CONSISTS OF STANDARD CHARACTERS WITHOUT CLAIM TO ANY PARTICULAR FONT, STYLE, SIZE, OR COLOR.

NO CLAIM IS MADE TO THE EXCLUSIVE RIGHT TO USE "CALORIE", APART FROM THE MARK AS SHOWN.

CLASS 16—PAPER GOODS AND PRINTED MATTER

FOR SYNDICATED COLUMNS IN THE FIELD OF FOOD, NUTRITION AND HEALTH (U.S. CLS. 2, 5, 22, 23, 29, 37, 38 AND 50).

FIRST USE 3-19-2003; IN COMMERCE 3-19-2003.

CLASS 41—EDUCATION AND ENTERTAINMENT

FOR ONLINE PUBLICATIONS, NAMELY PERIODIC SYNDICATED COLUMNS IN THE FIELD OF FOOD, NUTRITION AND HEALTH (U.S. CLS. 100, 101 AND 107).

FIRST USE 3-19-2003; IN COMMERCE 3-19-2003.

CLASS 44—MEDICAL, BEAUTY AND AGRICULTURAL SERVICES

FOR PROVIDING INFORMATION ABOUT FOOD, NUTRITION AND HEALTH VIA THE INTERNET (U.S. CLS. 100 AND 101).

FIRST USE 3-19-2003; IN COMMERCE 3-19-2003.

C. DIONNE CLYBURN, EXAMINING ATTORNEY

SN 78-432,336. MONITOR COMPANY GROUP LIMITED PARTNERSHIP, CAMBRIDGE, MA. FILED 6-9-2004.

COST ARCHEOLOGY

THE MARK CONSISTS OF STANDARD CHARACTERS WITHOUT CLAIM TO ANY PARTICULAR FONT, STYLE, SIZE, OR COLOR.

NO CLAIM IS MADE TO THE EXCLUSIVE RIGHT TO USE "COST", APART FROM THE MARK AS SHOWN.

CLASS 9—ELECTRICAL AND SCIENTIFIC APPARATUS

FOR COMPUTER SOFTWARE FOR ANALYSIS OF AN ORGANIZATION'S COST STRUCTURE (U.S. CLS. 21, 23, 26, 36 AND 38).

CLASS 35—ADVERTISING AND BUSINESS

FOR BUSINESS CONSULTATION SERVICES (U.S. CLS. 100, 101 AND 102).

KIM SAITO, EXAMINING ATTORNEY

HARLEY-DAVIDSON MUSEUM

THE MARK CONSISTS OF STANDARD CHARACTERS WITHOUT CLAIM TO ANY PARTICULAR FONT, STYLE, SIZE, OR COLOR.

NO CLAIM IS MADE TO THE EXCLUSIVE RIGHT TO USE "MUSEUM", APART FROM THE MARK AS SHOWN.

CLASS 41—EDUCATION AND ENTERTAINMENT

FOR EDUCATION AND ENTERTAINMENT SERVICES, NAMELY, PROVIDING EDUCATIONAL PRESENTATIONS, EXHIBITIONS, AND GUIDED INFORMATIONAL MUSEUM TOURS RELATED TO THE EXPERIENCE OF MOTORCYCLING (U.S. CLS. 100, 101 AND 107).

CLASS 43—HOTEL AND RESTAURANT SERVICES

FOR RESTAURANT SERVICES (U.S. CLS. 100 AND 101).

LEIGH LOWRY, EXAMINING ATTORNEY

SN 78-432,642. INDEPENDENT MARKETING ALLIANCE LP, HOUSTON, TX. FILED 6-9-2004.

COBBLESTONE MARKET

THE MARK CONSISTS OF STANDARD CHARACTERS WITHOUT CLAIM TO ANY PARTICULAR FONT, STYLE, SIZE, OR COLOR.

NO CLAIM IS MADE TO THE EXCLUSIVE RIGHT TO USE "MARKET", APART FROM THE MARK AS SHOWN.

CLASS 29—MEATS AND PROCESSED FOODS

FOR DELI MEATS; COOKED DELI ITEMS, NAMELY, SOUPS, AND VEGETABLES; CHEESE; REFRIGERATED SALADS EXCEPT MACARONI, RICE, AND PASTA SALAD; PICKLES; BAGGED POTATO CHIPS, FROZEN SOUPS; FROZEN ENTREES, NAMELY, ENTREES CONSISTING PRIMARILY OF MEAT, FISH, POULTRY OR VEGETABLES (U.S. CL. 46).

CLASS 30—STAPLE FOODS

FOR DELI MUSTARD; COOKED DELI ITEMS, NAMELY, SANDWICHES (U.S. CL. 46).

MAUREEN DALL, EXAMINING ATTORNEY

SN 78-432,950. INTERNATIONAL DATA GROUP, INC.,
FRAMINGHAM, MA. FILED 6-10-2004.

**CLASS 42—SCIENTIFIC, COMPUTER AND
LEGAL SERVICES**

FOR PROVIDING INFORMATION VIA THE GLOBAL
COMPUTER NETWORK IN THE FIELD OF COMPU-
TERS AND COMPUTER SOFTWARE AS IT RELATES TO
ONLINE SERVICES, HIGH TECHNOLOGY, INFORMA-
TION TECHNOLOGY AND INFORMATION SERVICES
(U.S. CLS. 100 AND 101).

CHRISTOPHER ADKINS, EXAMINING ATTORNEY

CIOCONSORTIUM

SN 78-432,952. INTERNATIONAL DATA GROUP, INC.,
FRAMINGHAM, MA. FILED 6-10-2004.

THE MARK CONSISTS OF STANDARD CHARACTERS
WITHOUT CLAIM TO ANY PARTICULAR FONT, STYLE,
SIZE, OR COLOR.

**CLASS 16—PAPER GOODS AND PRINTED
MATTER**

FOR PRINT PUBLICATIONS, NAMELY, NEWSLET-
TERS, MAGAZINES, AND SUPPLEMENTS SOLD
THEREWITH, COLUMNS, MAGAZINE SECTIONS,
JOURNALS, NEWSPAPERS AND BOOKS IN THE
FIELDS OF COMPUTERS, COMPUTER SOFTWARE,
ONLINE SERVICES, HIGH TECHNOLOGY, INFORMA-
TION TECHNOLOGY AND INFORMATION SERVICES
(U.S. CLS. 2, 5, 22, 23, 29, 37, 38 AND 50).

CIOCLUB

CLASS 35—ADVERTISING AND BUSINESS

FOR ARRANGING AND CONDUCTING BUSINESS
TRADE SHOWS, EXPOSITIONS, EXHIBITIONS AND
SEMINARS RELATING TO THE FIELDS OF COMPU-
TERS, COMPUTER SOFTWARE, ONLINE SERVICES,
HIGH TECHNOLOGY, INFORMATION TECHNOLOGY
AND INFORMATION SERVICES; ADVERTISING AND
MARKETING; BUSINESS RESEARCH AND CONSULT-
ING SERVICES IN THE FIELDS OF COMPUTERS,
COMPUTER SOFTWARE, ONLINE SERVICES, HIGH
TECHNOLOGY, INFORMATION TECHNOLOGY AND
INFORMATION SERVICES (U.S. CLS. 100, 101 AND 102).

THE MARK CONSISTS OF STANDARD CHARACTERS
WITHOUT CLAIM TO ANY PARTICULAR FONT, STYLE,
SIZE, OR COLOR.

CLASS 38—COMMUNICATION

FOR AUDIO AND VIDEO TELECONFERENCING
SERVICES IN THE FIELDS OF COMPUTERS, COMPU-
TER SOFTWARE, ONLINE SERVICES, HIGH TECHNOL-
OGY, INFORMATION TECHNOLOGY AND
INFORMATION SERVICES (U.S. CLS. 100, 101 AND 104).

**CLASS 16—PAPER GOODS AND PRINTED
MATTER**

FOR PRINT PUBLICATIONS, NAMELY, NEWSLET-
TERS, MAGAZINES, AND SUPPLEMENTS SOLD
THEREWITH, COLUMNS, MAGAZINE SECTIONS,
JOURNALS, NEWSPAPERS AND BOOKS IN THE
FIELDS OF COMPUTERS, COMPUTER SOFTWARE,
ONLINE SERVICES, HIGH TECHNOLOGY, INFORMA-
TION TECHNOLOGY AND INFORMATION SERVICES
(U.S. CLS. 2, 5, 22, 23, 29, 37, 38 AND 50).

**CLASS 41—EDUCATION AND ENTERTAIN-
MENT**

FOR ARRANGING AND CONDUCTING EDUCA-
TIONAL CONFERENCES, SEMINARS, SYMPOSIUMS,
COLLOQUIUMS AND DISCUSSION GROUPS IN THE
FIELDS OF COMPUTERS, COMPUTER SOFTWARE,
ONLINE SERVICES, HIGH TECHNOLOGY, INFORMA-
TION TECHNOLOGY AND INFORMATION SERVICES;
PROVIDING ONLINE EDUCATIONAL SYMPOSIUMS,
COLLOQUIUMS, DISCUSSION GROUPS AND LIVE ON-
LINE EDUCATIONAL INTERACTIVE INTERVIEW PRO-
GRAMS, EACH IN THE FIELDS OF COMPUTERS,
COMPUTER SOFTWARE, ONLINE SERVICES, HIGH
TECHNOLOGY, INFORMATION TECHNOLOGY AND
INFORMATION SERVICES THAT MAY BE ACCESSED
THROUGH THE INTERNET; ONLINE NON-DOWN-
LOADABLE PUBLICATIONS, NAMELY NEWSLETTERS,
MAGAZINES, AND SUPPLEMENTS SOLD THEREWITH,
COLUMNS, MAGAZINE SECTIONS, JOURNALS, NEWS-
PAPERS IN THE FIELDS OF COMPUTERS, COMPU-
TERS, COMPUTER SOFTWARE, ONLINE SERVICES,
HIGH TECHNOLOGY, INFORMATION TECHNOLOGY
AND INFORMATION SERVICES (U.S. CLS. 100, 101 AND
107).

CLASS 35—ADVERTISING AND BUSINESS

FOR ARRANGING AND CONDUCTING BUSINESS
TRADE SHOWS, EXPOSITIONS, EXHIBITIONS AND
SEMINARS RELATING TO THE FIELDS OF COMPU-
TERS, COMPUTER SOFTWARE, ONLINE SERVICES,
HIGH TECHNOLOGY, INFORMATION TECHNOLOGY
AND INFORMATION SERVICES; ADVERTISING AND
MARKETING; BUSINESS RESEARCH AND CONSULT-
ING SERVICES IN THE FIELDS OF COMPUTERS,
COMPUTER SOFTWARE, ONLINE SERVICES, HIGH
TECHNOLOGY, INFORMATION TECHNOLOGY AND
INFORMATION SERVICES (U.S. CLS. 100, 101 AND 102).

CLASS 38—COMMUNICATION

FOR AUDIO AND VIDEO TELECONFERENCING
SERVICES IN THE FIELDS OF COMPUTERS, COMPU-
TER SOFTWARE, ONLINE SERVICES, HIGH TECHNOL-
OGY, INFORMATION TECHNOLOGY AND
INFORMATION SERVICES (U.S. CLS. 100, 101 AND 104).

CLASS 41—EDUCATION AND ENTERTAINMENT

FOR ARRANGING AND CONDUCTING EDUCATIONAL CONFERENCES, SEMINARS, SYMPOSIUMS, COLLOQUIUMS AND DISCUSSION GROUPS IN THE FIELDS OF COMPUTERS, COMPUTER SOFTWARE, ONLINE SERVICES, HIGH TECHNOLOGY, INFORMATION TECHNOLOGY AND INFORMATION SERVICES; PROVIDING ONLINE EDUCATIONAL SYMPOSIUMS, COLLOQUIUMS, DISCUSSION GROUPS AND LIVE ONLINE EDUCATIONAL INTERACTIVE INTERVIEW PROGRAMS, EACH IN THE FIELDS OF COMPUTERS, COMPUTER SOFTWARE, ONLINE SERVICES, HIGH TECHNOLOGY, INFORMATION TECHNOLOGY AND INFORMATION SERVICES THAT MAY BE ACCESSED THROUGH THE INTERNET; ONLINE NON-DOWNLOADABLE PUBLICATIONS, NAMELY NEWSLETTERS, MAGAZINES, AND SUPPLEMENTS SOLD THEREWITH, COLUMNS, MAGAZINE SECTIONS, JOURNALS, NEWSPAPERS IN THE FIELDS OF COMPUTERS, COMPUTERS, COMPUTER SOFTWARE, ONLINE SERVICES, HIGH TECHNOLOGY, INFORMATION TECHNOLOGY AND INFORMATION SERVICES (U.S. CLS. 100, 101 AND 107).

CLASS 42—SCIENTIFIC, COMPUTER AND LEGAL SERVICES

FOR PROVIDING INFORMATION VIA THE GLOBAL COMPUTER NETWORK IN THE FIELD OF COMPUTERS AND COMPUTER SOFTWARE AS IT RELATES TO ONLINE SERVICES, HIGH TECHNOLOGY, INFORMATION TECHNOLOGY AND INFORMATION SERVICES (U.S. CLS. 100 AND 101).

CHRISTOPHER ADKINS, EXAMINING ATTORNEY

SN 78-433,200. FARMERS GROUP, INC., LOS ANGELES, CA. FILED 6-10-2004.

FARMERS COD

THE MARK CONSISTS OF STANDARD CHARACTERS WITHOUT CLAIM TO ANY PARTICULAR FONT, STYLE, SIZE, OR COLOR.
OWNER OF U.S. REG. NOS. 1,821,673, 2,723,435 AND OTHERS.

CLASS 35—ADVERTISING AND BUSINESS

FOR AUTOMOBILE INSURANCE CLAIMS UTILIZATION REVIEW; ARRANGING OF CONTRACTUAL SERVICES WITH THIRD PARTIES, NAMELY, ARRANGING OF AUTOMOBILE REPAIR SERVICES FOR OTHERS; TRACKING AND MONITORING OF AUTOMOBILE REPAIR FACILITIES FOR INSURANCE COMPLIANCE (U.S. CLS. 100, 101 AND 102).

CLASS 36—INSURANCE AND FINANCIAL

FOR AUTOMOBILE INSURANCE CLAIMS ADMINISTRATION AND PROCESSING (U.S. CLS. 100, 101 AND 102).

DANIEL CAPSHAW, EXAMINING ATTORNEY

SN 78-433,231. A & M MANUFACTURING AND DISTRIBUTION, L.L.C., VALLEY PARK, MO. FILED 6-10-2004.



NO CLAIM IS MADE TO THE EXCLUSIVE RIGHT TO USE "THE DECK & FENCE STORE", APART FROM THE MARK AS SHOWN.

THE COLOR(S) YELLOW AND BLUE IS/ARE CLAIMED AS A FEATURE OF THE MARK.

THE MARK CONSISTS OF THE WORDS "THE DECK & FENCE STORE" IN STYLIZED BLUE LETTERING INSET ON A YELLOW OVAL HAVING A BLUE OUTLINE.

CLASS 37—CONSTRUCTION AND REPAIR

FOR REPAIR AND CONSTRUCTION OF DECKS, FENCES, GAZEBOS, SHADE STRUCTURES, RAILS, RAIL SYSTEMS AND DECORATIVE COLUMNS FOR PROFIT (U.S. CLS. 100, 103 AND 106).

FIRST USE 1-10-2003; IN COMMERCE 2-15-2003.

CLASS 42—SCIENTIFIC, COMPUTER AND LEGAL SERVICES

FOR DESIGN OF DECKS, FENCES, GAZEBOS, SHADE STRUCTURES, RAILS, RAIL SYSTEMS AND DECORATIVE COLUMNS FOR PROFIT (U.S. CLS. 100 AND 101).

FIRST USE 1-10-2003; IN COMMERCE 2-15-2003.

JAMES A. RAUEN, EXAMINING ATTORNEY

SN 78-433,448. KLECZEK, KATHERINE, DBA LA LUNA LOCA, CANNON BEACH, OR. FILED 6-10-2004.



THE COLOR(S) PURPLE IS/ARE CLAIMED AS A FEATURE OF THE MARK.

THE MARK CONSISTS OF A STYLIZED DRAWING OF THE MOON IN PURPLE AND THE WORDS "LA LUNA LOCA" IN STYLIZED LETTERING, ALSO IN PURPLE.

"LA LUNA LOCA" IS SPANISH FOR "THE CRAZY MOON."

CLASS 25—CLOTHING

FOR CLOTHING, NAMELY SWEATERS, DRESSES, BLOUSES, SHIRTS, SKIRTS, PANTS, SCARVES, HATS, JACKETS, SHORTS, SARONGS, SLEEVELESS TOPS, AND T-SHIRTS (U.S. CLS. 22 AND 39).

FIRST USE 11-1-2000; IN COMMERCE 11-1-2000.

CLASS 35—ADVERTISING AND BUSINESS

FOR RETAIL BOUTIQUE AND GIFT SHOP, MAIL ORDER, AND ON-LINE RETAIL AND WHOLESALE INTERNET SERVICES FOR GOODS, FEATURING CLOTHING, NAMELY SWEATERS, DRESSES, BLOUSES, SHIRTS, SKIRTS, PANTS, SCARVES, HATS, JACKETS, SHORTS, SARONGS, TOPS AND T-SHIRTS AS WELL AS GIFT ITEMS SUCH AS HANDBAGS, JOURNALS, CANDLES, CANDLE HOLDERS, INCENSE, SOAPS, WINE BAGS, AND DECORATIVE OBJECTS SUCH AS PICTURE FRAMES, MASKS, BLANKETS, TAPESTRIES, PLACE MATS AND TABLE RUNNERS (U.S. CLS. 100, 101 AND 102).

FIRST USE 11-1-2000; IN COMMERCE 11-1-2000.
DANIEL CAPSHAW, EXAMINING ATTORNEY

SN 78-433,608. AMERICAN SUPERCONDUCTOR CORPORATION, WESTBOROUGH, MA. FILED 6-11-2004.

POWERED BY AMSC

THE MARK CONSISTS OF STANDARD CHARACTERS WITHOUT CLAIM TO ANY PARTICULAR FONT, STYLE, SIZE, OR COLOR.

CLASS 7—MACHINERY

FOR ELECTRIC MOTORS FOR MACHINES; SUPERCONDUCTOR ELECTRIC MOTORS FOR MACHINES; ELECTRIC ROTATING MACHINES FOR TRANSPORTATION, INDUSTRIAL AND UTILITY APPLICATIONS; SUPERCONDUCTOR ELECTRIC ROTATING MACHINES FOR TRANSPORTATION, INDUSTRIAL AND UTILITY APPLICATIONS; ROTATING MACHINES FOR TRANSPORTATION, INDUSTRIAL AND UTILITY APPLICATIONS; SUPERCONDUCTOR ELECTRIC PROPULSION MOTORS FOR SHIPS (U.S. CLS. 13, 19, 21, 23, 31, 34 AND 35).

SN 78-433,607. AMERICAN SUPERCONDUCTOR CORPORATION, WESTBOROUGH, MA. FILED 6-11-2004.

AMSC

CLASS 9—ELECTRICAL AND SCIENTIFIC APPARATUS

FOR SUPERCONDUCTOR ELECTRIC/ELECTRICAL WIRES; REELS FOR SUPERCONDUCTOR ELECTRIC WIRES; ELECTRICAL POWER CONVERTERS; SYNCHRONOUS CONDENSERS; SUPERCONDUCTOR ELECTRICAL CURRENT CONDUCTORS; ELECTRICAL POWER STORAGE AND POWER QUALITY EQUIPMENT AND SYSTEMS, NAMELY, VOLTAGE RESTORERS USED FOR UTILITY VOLTAGE REGULATION; VOLTAGE RESTORERS PRIMARILY USED FOR VOLTAGE SAG PROTECTION FOR COMMERCIAL AND INDUSTRIAL FACILITIES AND/OR CRITICAL LOADS; ELECTRICAL POWER QUALITY EQUIPMENT AND SYSTEMS FOR USE IN TRANSMISSION AND DISTRIBUTION POWER GRID APPLICATIONS, NAMELY, SYNCHRONOUS CONDENSERS CAPABLE OF GENERATING OR ABSORBING REACTIVE POWER USED TO ENSURE RELIABLE FLOW OF ELECTRICITY THROUGH AC POWER GRIDS (U.S. CLS. 21, 23, 26, 36 AND 38).

KIMBERLY PERRY, EXAMINING ATTORNEY

THE MARK CONSISTS OF STANDARD CHARACTERS WITHOUT CLAIM TO ANY PARTICULAR FONT, STYLE, SIZE, OR COLOR.

CLASS 7—MACHINERY

FOR ELECTRIC MOTORS FOR MACHINES; SUPERCONDUCTOR ELECTRIC MOTORS FOR MACHINES; ELECTRIC ROTATING MACHINES FOR TRANSPORTATION, INDUSTRIAL AND UTILITY APPLICATIONS; SUPERCONDUCTOR ELECTRIC ROTATING MACHINES FOR TRANSPORTATION, INDUSTRIAL AND UTILITY APPLICATIONS; ROTATING MACHINES FOR TRANSPORTATION, INDUSTRIAL AND UTILITY APPLICATIONS; SUPERCONDUCTOR ELECTRIC PROPULSION MOTORS FOR SHIPS (U.S. CLS. 13, 19, 21, 23, 31, 34 AND 35).

SN 78-433,783. GO RECORDS, LLC, WHITE PLAINS, NY. FILED 6-11-2004.

CLASS 9—ELECTRICAL AND SCIENTIFIC APPARATUS

FOR SUPERCONDUCTOR ELECTRIC/ELECTRICAL WIRES; REELS FOR SUPERCONDUCTOR ELECTRIC WIRES; ELECTRICAL POWER CONVERTERS; SYNCHRONOUS CONDENSERS; SUPERCONDUCTOR ELECTRICAL CURRENT CONDUCTORS; ELECTRICAL POWER STORAGE AND POWER QUALITY EQUIPMENT AND SYSTEMS, NAMELY, VOLTAGE RESTORERS USED FOR UTILITY VOLTAGE REGULATION; VOLTAGE RESTORERS PRIMARILY USED FOR VOLTAGE SAG PROTECTION FOR COMMERCIAL AND INDUSTRIAL FACILITIES AND/OR CRITICAL LOADS; ELECTRICAL POWER QUALITY EQUIPMENT AND SYSTEMS FOR USE IN TRANSMISSION AND DISTRIBUTION POWER GRID APPLICATIONS, NAMELY, SYNCHRONOUS CONDENSERS CAPABLE OF GENERATING OR ABSORBING REACTIVE POWER USED TO ENSURE RELIABLE FLOW OF ELECTRICITY THROUGH AC POWER GRIDS (U.S. CLS. 21, 23, 26, 36 AND 38).

KIMBERLY PERRY, EXAMINING ATTORNEY



NO CLAIM IS MADE TO THE EXCLUSIVE RIGHT TO USE "RECORDS", APART FROM THE MARK AS SHOWN.

CLASS 9—ELECTRICAL AND SCIENTIFIC APPARATUS

FOR MUSICAL SOUND RECORDINGS, NAMELY, PRE-RECORDED COMPACT DISCS, AUDIOCASSETTES, DOWNLOADABLE MUSICAL SOUND RECORDINGS AND PHONOGRAPH RECORDS; AND VIDEO RECORDINGS FEATURING MUSIC (U.S. CLS. 21, 23, 26, 36 AND 38).

FIRST USE 9-16-2003; IN COMMERCE 9-16-2003.

CLASS 35—ADVERTISING AND BUSINESS

FOR TALENT AND PUBLICITY AGENCY FOR MUSICAL ARTISTS AND ENTERTAINERS (U.S. CLS. 100, 101 AND 102).

FIRST USE 9-16-2003; IN COMMERCE 9-16-2003.

CLASS 41—EDUCATION AND ENTERTAINMENT

FOR SERVICES IN THE FIELD OF PROFESSIONAL MUSIC, NAMELY, RECORDING STUDIO SERVICES, MUSIC PUBLISHING SERVICES, AND LIVE AND RECORDED MUSIC PRODUCTION SERVICES (U.S. CLS. 100, 101 AND 107).

FIRST USE 9-16-2003; IN COMMERCE 9-16-2003.

JAMES A. RAUEN, EXAMINING ATTORNEY

SN 78-433,945. PROFESSIONAL BOOKS, INC., JACKSON, TN. FILED 6-11-2004.

WOMAN'S HEALTH CONNECTION

THE MARK CONSISTS OF STANDARD CHARACTERS WITHOUT CLAIM TO ANY PARTICULAR FONT, STYLE, SIZE, OR COLOR.

NO CLAIM IS MADE TO THE EXCLUSIVE RIGHT TO USE "WOMAN'S HEALTH", APART FROM THE MARK AS SHOWN.

CLASS 5—PHARMACEUTICALS

FOR NUTRITIONAL SUPPLEMENTS (U.S. CLS. 6, 18, 44, 46, 51 AND 52).

FIRST USE 2-4-2004; IN COMMERCE 3-4-2004.

CLASS 41—EDUCATION AND ENTERTAINMENT

FOR DEVELOPMENT AND DISSEMINATION OF EDUCATIONAL MATERIALS OF OTHERS IN THE FIELD OF WOMEN'S HEALTH (U.S. CLS. 100, 101 AND 107).

FIRST USE 10-30-2003; IN COMMERCE 2-28-2004.

TRICIA SONNEBORN, EXAMINING ATTORNEY

SN 78-434,361. ASPEN SKIING COMPANY, L.L.C., ASPEN, CO. FILED 6-13-2004.

ASPENSNOWMASS

THE MARK CONSISTS OF STANDARD CHARACTERS WITHOUT CLAIM TO ANY PARTICULAR FONT, STYLE, SIZE, OR COLOR.

OWNER OF U.S. REG. NO. 2,800,199.

CLASS 35—ADVERTISING AND BUSINESS

FOR RETAIL STORES FEATURING SPORTING GOODS, SKIING AND SNOWBOARDING GEAR AND EQUIPMENT, HIKING AND BICYCLING GEAR AND EQUIPMENT, CLOTHING, CLOTHING ACCESSORIES, GLOVES, HATS, T-SHIRTS, GIFTS, AND EYEWEAR (U.S. CLS. 100, 101 AND 102).

CLASS 39—TRANSPORTATION AND STORAGE

FOR STORAGE OF SKIING AND SNOW BOARDING GEAR AND EQUIPMENT; BICYCLE AND CYCLING ACCESSORIES RENTAL (U.S. CLS. 100 AND 105).

CLASS 41—EDUCATION AND ENTERTAINMENT

FOR RENTAL OF SKIING AND SNOW BOARDING GEAR AND EQUIPMENT AND SPORTS EQUIPMENT RENTALS (U.S. CLS. 100, 101 AND 107).

WINSTON FOLMAR, EXAMINING ATTORNEY

SN 78-434,574. MR. IDEA, INC., ATTLEBORO, MA. FILED 6-14-2004.



NO CLAIM IS MADE TO THE EXCLUSIVE RIGHT TO USE "BEACH DUDS", APART FROM THE MARK AS SHOWN.

CLASS 18—LEATHER GOODS

FOR CUSTOMIZED BEACH UMBRELLAS AND BEACH BAGS (U.S. CLS. 1, 2, 3, 22 AND 41).

FIRST USE 6-1-2004; IN COMMERCE 6-1-2004.

CLASS 24—FABRICS

FOR CUSTOMIZED BEACH TOWELS (U.S. CLS. 42 AND 50).

FIRST USE 6-1-2004; IN COMMERCE 6-1-2004.

JAMES A. RAUEN, EXAMINING ATTORNEY

SN 78-434,735. CHARMIE INVESTMENTS LIMITED, TORTOLA, BR. VIRGIN ISLANDS, FILED 6-14-2004.

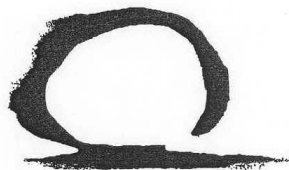

OWNER OF HONG KONG REG. NO. 00565/2004, DATED 11-27-2002, EXPIRES 11-27-2009.

THE MARK CONSISTS OF AN ABSTRACT OPEN CIRCULAR DESIGN WITH A LINE BENEATH IT.

CLASS 3—COSMETICS AND CLEANING PREPARATIONS

FOR SOAPS, PERFUMERY, ESSENTIAL OILS FOR PERSONAL USE, COSMETICS, HAIR LOTIONS, DENTIFRICE (U.S. CLS. 1, 4, 6, 50, 51 AND 52).

CLASS 25—CLOTHING

FOR CLOTHING AND OUTERWEAR, NAMELY T-SHIRTS, BRAS, UNDERWEAR, PULLOVERS, JACKETS, PANTS, JEANS, SHIRTS, SWEATERS, COATS, PARKAS, VESTS, WIND RESISTANT JACKETS, WATER-PROOF JACKETS, RAIN JACKETS, RAIN PANTS, FOOTWEAR, HEADWEAR (U.S. CLS. 22 AND 39).

CLASS 44—MEDICAL, BEAUTY AND AGRICULTURAL SERVICES

FOR BEAUTY SALON SERVICES; HAIRDRESSING SERVICES; HEALTH SPA SERVICES, NAMELY, COSMETIC BODY CARE; MASSAGE; SKIN CARE SALON SERVICES; TANNING SALON SERVICES; COSMETOLOGIST SERVICES; HEALTH AND WELLNESS SERVICES, NAMELY, COLON HYDROTHERAPY, DETOXIFICATION AND CLEANSING THERAPY (U.S. CLS. 100 AND 101).

CHARLES JOYNER, EXAMINING ATTORNEY

SN 78-434,950. KUFNER TEXTILWERKE GMBH, MUNICH, FED REP GERMANY, FILED 6-14-2004.



PRIORITY CLAIMED UNDER SEC. 44(D) ON FED REP GERMANY APPLICATION NO. 30408341, FILED 2-13-2004, REG. NO. 30408341, DATED 5-3-2004, EXPIRES 2-28-2014.

THE COLORS MAGENTA, BLACK AND WHITE ARE CLAIMED AS A FEATURE OF THE MARK.

THE MARK CONSISTS OF THE WORDS DOUBLESPOT XS EXTENDED SAFETY. THERE IS A SOLID CIRCLE SURROUNDING THE LETTER "D" IN THE WORD DOUBLESPOT WHICH IS PRESENTED IN PANTONE RHODAMINE RED. THE LETTERS "XS" ARE ALSO PRESENTED IN PANTONE RHODAMINE RED. THE WORD DOUBLESPOT IS PRESENTED IN BLACK. THE WORDS "EXTENDED SAFETY" ARE PRESENTED IN PANTONE RHODAMINE RED.

CLASS 24—FABRICS

FOR WOVEN AND KNITTED FABRICS, CONSISTING OF NATURAL AND/OR SYNTHETIC FIBERS; NON-WOVEN FABRICS, CONSISTING OF NATURAL AND/OR SYNTHETIC FIBERS; TEXTILE LININGS FOR GARMENTS; WOVEN AND KNITTED INTERLINING FABRICS AS WELL AS FLEECE AND NON-WOVEN INTERLINING FABRICS, ALL FOR GARMENTS; STIFFENING INTERLININGS FOR CLOTHING AS YARD GOODS; LININGS, WOVEN AND KNITTED INTERLINING FABRICS AS WELL AS FLEECE AND NON-WOVEN INTERLINING FABRICS, ALL CUT TO SIZE AS LININGS AND FINISHED INTERLININGS FOR GARMENTS; STIFFENING INTERLINING CLOTH FOR GARMENTS; STIFFENING INTERLINING CLOTH FOR SHIRT COLLARS (U.S. CLS. 42 AND 50).

CLASS 25—CLOTHING

FOR ARTICLES OF CLOTHING, NAMELY, DRESSES, PANTS, SHORTS, SHIRTS, SKIRTS, SUITS, SWEATERS, BLOUSES, BLAZERS, JACKETS, COATS (U.S. CLS. 22 AND 39).

JAMES GRIFFIN, EXAMINING ATTORNEY

SN 78-435,227. TOOLS THAT ROCK, LLC, WEST BEND, WI, FILED 6-15-2004.

TOOLS THAT ROCK

THE MARK CONSISTS OF STANDARD CHARACTERS WITHOUT CLAIM TO ANY PARTICULAR FONT, STYLE, SIZE, OR COLOR.

CLASS 6—METAL GOODS

FOR METAL TOOL TRAYS (U.S. CLS. 2, 12, 13, 14, 23, 25 AND 50).

CLASS 8—HAND TOOLS

FOR HAND-OPERATED TOOLS, NAMELY HAND-OPERATED REELS FOR DISPENSING CONDUIT, TUBING, AND THE LIKE (U.S. CLS. 23, 28 AND 44).

CLASS 25—CLOTHING

FOR CLOTHING, NAMELY SHIRTS, PANTS, JACKETS, FOOTWEAR, AND HEADWEAR (U.S. CLS. 22 AND 39).

JOHN SCHUYLER YARD, EXAMINING ATTORNEY

SN 78-435,330, Y BEAUTY INTERNATIONAL LIMITED,
KWAI HING, HONG KONG, FILED 6-15-2004.

SN 78-436,326, MONARCH HEALTH SCIENCES, INC.,
OREM, UT. FILED 6-16-2004.

Monarch Health Sciences

NAIL ESQUE

THE MARK CONSISTS OF STANDARD CHARACTERS
WITHOUT CLAIM TO ANY PARTICULAR FONT, STYLE,
SIZE, OR COLOR.

NO CLAIM IS MADE TO THE EXCLUSIVE RIGHT TO
USE "NAIL", APART FROM THE MARK AS SHOWN.

CLASS 3—COSMETICS AND CLEANING PRE- PARATIONS

FOR ACRYLIC AND GEL NAIL ENHANCEMENTS,
NAMELY, ARTIFICIAL FINGERNAILS; ADHESIVES
FOR ATTACHING ARTIFICIAL FINGERNAILS AND/
OR EYELASHES; FOOT CARE PREPARATIONS, PRO-
DUCTS, AND CLEANSING PRODUCTS, NAMELY,
NON-MEDICATED FOOT POWDER, NON-MEDICATED
FOOT CREAM, NON-MEDICATED FOOT LOTION;
MASSAGE OILS, TALCUM POWDER; HAND CARE
PREPARATIONS AND PRODUCTS, NON-MEDICATED
HAND MOISTURIZING CREAM, HAND LOTIONS, CU-
TICLE CREAMS AND CUTICLE CONDITIONERS; NAIL
CARE PREPARATIONS AND PRODUCTS, NAMELY,
NAIL CREAM, NAIL ENAMELS, NAIL GLITTER; NAIL
GROOMING PRODUCTS, NAMELY, TIPS, GLUE, LAC-
QUER AND GLITTER; NAIL HARDENERS, NAIL POL-
ISH, NAIL POLISH BASE COAT, NAIL POLISH
REMOVER, NAIL POLISH TOP COAT, NAIL
STRENGTHENERS, AND NAIL BUFFING PREPARA-
TIONS; REMOVERS IN THE NATURE OF CUTICLE
AND CALLUS REMOVING PREPARATIONS (U.S. CLS.
1, 4, 6, 50, 51 AND 52).

CLASS 8—HAND TOOLS

FOR MANICURE IMPLEMENTS, NAMELY, FINGER-
NAIL AND TOENAIL CLIPPERS, TWEEZERS, SAP-
PHIRE NAIL FILES, METAL NAIL FILES, ELECTRIC
AND NON-ELECTRIC NAIL BUFFERS, CUTICLE TRIM-
MERS, NAIL AND TOENAIL NIPPERS, CUTICLE
PUSHERS, CUTICLE SCRAPERS AND CUTTERS, CU-
TICLE SCISSORS, NAIL SCISSORS, SAFETY SCISSORS,
BARREL SPRING TOENAIL NIPPERS, AND FOLDING
NAIL FILES; ELECTRIC AND NON-ELECTRIC RAZORS
WITH BLADES; NOSE AND EAR HAIR TRIMMERS;
MEN'S PERSONAL BATTERY OPERATED AND ELEC-
TRONIC GROOMING APPLIANCES, NAMELY HAIR
REMOVER, RAZORS, NAIL BUFFERS, AND ABRASIVE
GRINDERS; WOMEN'S MANICURE BATTERY AND
ELECTRONIC APPLIANCES, NAMELY, NAIL BUFFERS
AND ABRASIVE GRINDERS (U.S. CLS. 23, 28 AND 44).
RAMONA ORTIGA, EXAMINING ATTORNEY

THE MARK CONSISTS OF STANDARD CHARACTERS
WITHOUT CLAIM TO ANY PARTICULAR FONT, STYLE,
SIZE, OR COLOR.

NO CLAIM IS MADE TO THE EXCLUSIVE RIGHT TO
USE HEALTH SCIENCES, APART FROM THE MARK AS
SHOWN.

CLASS 5—PHARMACEUTICALS

FOR NUTRITIONAL SUPPLEMENTS, VITAMIN AND
MINERAL SUPPLEMENTS, NUTRITIONAL ADDITIVES
FOR USE IN FOODS AND DIETARY SUPPLEMENTS
FOR HUMAN CONSUMPTION, PLANT AND HERB
EXTRACTS FOR MEDICINAL PURPOSES, MEAL RE-
PLACEMENT SHAKES FOR BOOSTING ENERGY (U.S.
CLS. 6, 18, 44, 46, 51 AND 52).

FIRST USE 6-6-2003; IN COMMERCE 6-6-2003.

CLASS 41—EDUCATION AND ENTERTAIN- MENT

FOR PERSONAL COACHING SERVICES IN THE
FIELD OF WEIGHT MANAGEMENT AND WELLNESS;
GROUP COACHING SERVICES IN THE FIELD OF
WEIGHT MANAGEMENT AND WELLNESS; PROVID-
ING INSTRUCTION IN THE FIELD OF PHYSICAL
EXERCISE (U.S. CLS. 100, 101 AND 107).

FIRST USE 6-23-2003; IN COMMERCE 6-23-2003.

CLASS 44—MEDICAL, BEAUTY AND AGRI- CULTURAL SERVICES

FOR WEIGHT REDUCTION DIET PLANNING AND
SUPERVISION; CONSULTATION SERVICES IN THE
FIELD OF MEDICAL WELLNESS; FOOD NUTRITION
CONSULTING SERVICES; NUTRITION COUNSELING
SERVICES (U.S. CLS. 100 AND 101).

FIRST USE 6-23-2003; IN COMMERCE 6-23-2003.

DARRYL SPRUILL, EXAMINING ATTORNEY

SN 78-436,333, UNIVERSITY OF CENTRAL FLORIDA,
ORLANDO, FL. FILED 6-16-2004.



OWNER OF U.S. REG. NOS. 2,167,209 AND 2,231,392.
SEC. 2(F).

CLASS 21—HOUSEWARES AND GLASS

FOR DRINKING GLASSES, MUGS, AND SHOT GLASSES MADE OF GLASS, PLASTIC, CERAMIC, AND EARTHENWARE, SPORT WATER BOTTLES SOLD EMPTY, INSULATING SLEEVE HOLDERS FOR BEVERAGE CANS, PORTABLE BEVERAGE COOLERS, THERMAL INSULATED CONTAINERS FOR FOOD OR BEVERAGE, COASTERS, DECORATIVE FIGURES MADE OF GLASS, PORCELAIN, CERAMIC AND EARTHENWARE, PLATES, SOUVENIR PLATES MADE OF GLASS, PORCELAIN, CERAMIC AND EARTHENWARE, STATUES MADE OF CHINA, CRYSTAL, GLASS OR PORCELAIN, CANDLE HOLDERS MADE OF GLASS, PORCELAIN, CERAMIC AND EARTHENWARE; PAPER PLATES, PAPER CUPS, AND WASTEPAPER BASKETS (U.S. CLS. 2, 13, 23, 29, 30, 33, 40 AND 50).

FIRST USE 4-14-1999; IN COMMERCE 4-14-1999.

SN 78-436,937. COPYLADY, INC., FORT MYERS, FL. FILED 6-17-2004.

CopyLady

CLASS 25—CLOTHING

FOR CLOTHING, FOR MEN, WOMEN AND CHILDREN, NAMELY, PAJAMAS, NIGHTSHIRTS, ROBES, JOGGING SUITS, SWEAT SUITS, WARM UP SUITS, BEACHWEAR, T-SHIRTS, SWEATSHIRTS, JERSEYS, TANK TOPS, SHIRTS, POLO SHIRTS, BLOUSES, SHORTS, BOXER SHORTS, TROUSERS, PANTS, JUMPERS, OVERALLS, ROMPERS, DRESSES, SKIRTS, SHORT SETS COMPRISED OF SHORTS AND TOPS, SWEATERS, CARDIGANS, JACKETS, COATS, ANORAKS, PONCHOS, RAINCOATS, SCARVES, BANDANNAS, UNDERWEAR, LINGERIE, VESTS, HEADWEAR, HATS AND CAPS, VISORS, TIES, BELTS AND SUSPENDERS, SOCKS, TIGHTS, LEGGINGS, HOSIERY, GLOVES, MITTENS, APRONS, SWIMSUITS, CLOTH BABY BIBS, FOOTWEAR, ATHLETIC SHOES, ATHLETIC UNIFORMS, SLIPPERS, AND MASQUERADE COSTUMES (U.S. CLS. 22 AND 39).

FIRST USE 4-14-1999; IN COMMERCE 4-14-1999.

THE MARK CONSISTS OF STANDARD CHARACTERS WITHOUT CLAIM TO ANY PARTICULAR FONT, STYLE, SIZE, OR COLOR.

CLASS 35—ADVERTISING AND BUSINESS

FOR RENTAL AND LEASING OF AUTOMATED OFFICE EQUIPMENT, NAMELY, PHOTOCOPIERS, FULL COLOR PHOTOCOPIERS, TYPEWRITERS, MICROFICHE DUPLICATORS, ERASABLE WRITING BOARDS WITH PHOTOCOPY CAPABILITY, MICROGRAPHIC EQUIPMENT, ELECTRONIC MESSAGING SYSTEMS, MULTIFUNCTIONAL AND MULTITASKING OFFICE MACHINES WHICH SERVE AS FACSIMILE MACHINES, COPIERS, PRINTERS, AND COMPUTER NETWORK PRODUCTS IN THE NATURE OF MODEMS AND SCANNERS; RETAIL STORE SERVICES AND WHOLESALE DISTRIBUTORSHIPS FEATURING AUTOMATED OFFICE EQUIPMENT, NAMELY, PHOTOCOPIERS, FULL COLOR PHOTOCOPIERS, TYPEWRITERS, MICROFICHE DUPLICATORS, ERASABLE WRITING BOARDS WITH PHOTOCOPY CAPABILITY, MICROGRAPHIC EQUIPMENT, ELECTRONIC MESSAGING SYSTEMS, MULTIFUNCTIONAL AND MULTITASKING OFFICE MACHINES WHICH SERVE AS FACSIMILE MACHINES, COPIERS, PRINTERS, AND COMPUTER NETWORK PRODUCTS IN THE NATURE OF MODEMS AND SCANNERS; RETAIL STORE SERVICES AND WHOLESALE DISTRIBUTORSHIPS FEATURING COMPUTER PROGRAMS AND SOFTWARE (U.S. CLS. 100, 101 AND 102).

FIRST USE 1-1-1997; IN COMMERCE 8-14-2000.

CLASS 41—EDUCATION AND ENTERTAINMENT

FOR EDUCATIONAL SERVICES, NAMELY, PROVIDING COURSES OF INSTRUCTION FOR OTHERS AT THE UNDERGRADUATE, GRADUATE AND POSTGRADUATE UNIVERSITY LEVEL; EDUCATIONAL RESEARCH; ENTERTAINMENT SERVICES, NAMELY, ORGANIZING AND CONDUCTING COLLEGE SPORTS COMPETITIONS, ATHLETIC EVENTS AND TOURNAMENTS, EXHIBITIONS, CONFERENCES, LECTURES, CONCERTS, LIVE PERFORMANCES, FESTIVALS AND THEATER AND DANCE PRODUCTIONS (U.S. CLS. 100, 101 AND 107).

FIRST USE 12-28-1996; IN COMMERCE 12-28-1996.
DARRYL SPRUILL, EXAMINING ATTORNEY

CLASS 37—CONSTRUCTION AND REPAIR

FOR MAINTENANCE AND REPAIR OF AUTOMATED OFFICE EQUIPMENT, NAMELY, PHOTOCOPIERS, FULL COLOR PHOTOCOPIERS, TYPEWRITERS, MICROFICHE DUPLICATORS, ERASABLE WRITING BOARDS WITH PHOTOCOPY CAPABILITY, MICROGRAPHIC EQUIPMENT, ELECTRONIC MESSAGING SYSTEMS, MULTIFUNCTIONAL AND MULTITASKING OFFICE MACHINES WHICH SERVE AS FACSIMILE MACHINES, COPIERS, PRINTERS, AND COMPUTER NETWORK PRODUCTS IN THE NATURE OF MODEMS AND SCANNERS (U.S. CLS. 100, 103 AND 106).

FIRST USE 1-1-1997; IN COMMERCE 8-14-2000.
ANDREW RHIM, EXAMINING ATTORNEY

SN 78-437,042. WILLIAM BEAUMONT HOSPITAL, ROYAL OAK, MI. FILED 6-17-2004.

BEAUMONT PHYSICIANS

THE MARK CONSISTS OF STANDARD CHARACTERS WITHOUT CLAIM TO ANY PARTICULAR FONT, STYLE, SIZE, OR COLOR.

OWNER OF U.S. REG. NOS. 1,382,845, 2,917,267 AND OTHERS.

NO CLAIM IS MADE TO THE EXCLUSIVE RIGHT TO USE "PHYSICIANS", APART FROM THE MARK AS SHOWN.

CLASS 41—EDUCATION AND ENTERTAINMENT

FOR EDUCATIONAL SERVICES, NAMELY, CONDUCTING CLASSES, SEMINARS, CONFERENCES AND WORKSHOPS IN THE FIELD OF HEALTH CARE (U.S. CLS. 100, 101 AND 107).

CLASS 42—SCIENTIFIC, COMPUTER AND LEGAL SERVICES

FOR RESEARCH SERVICES IN THE FIELD OF HEALTH CARE (U.S. CLS. 100 AND 101).

CLASS 44—MEDICAL, BEAUTY AND AGRICULTURAL SERVICES

FOR HEALTH CARE SERVICES (U.S. CLS. 100 AND 101).

MICHAEL SOUDERS, EXAMINING ATTORNEY

SN 78-437,049. WILLIAM BEAUMONT HOSPITAL, ROYAL OAK, MI. FILED 6-17-2004.

BEAUMONT DOCTORS

THE MARK CONSISTS OF STANDARD CHARACTERS WITHOUT CLAIM TO ANY PARTICULAR FONT, STYLE, SIZE, OR COLOR.

OWNER OF U.S. REG. NOS. 1,382,845, 2,917,267 AND OTHERS.

NO CLAIM IS MADE TO THE EXCLUSIVE RIGHT TO USE "DOCTORS", APART FROM THE MARK AS SHOWN.

CLASS 41—EDUCATION AND ENTERTAINMENT

FOR EDUCATIONAL SERVICES, NAMELY, CONDUCTING CLASSES, SEMINARS, CONFERENCES AND WORKSHOPS IN THE FIELD OF HEALTH CARE (U.S. CLS. 100, 101 AND 107).

CLASS 42—SCIENTIFIC, COMPUTER AND LEGAL SERVICES

FOR RESEARCH SERVICES IN THE FIELD OF HEALTH CARE (U.S. CLS. 100 AND 101).

CLASS 44—MEDICAL, BEAUTY AND AGRICULTURAL SERVICES

FOR HEALTH CARE SERVICES (U.S. CLS. 100 AND 101).

MICHAEL SOUDERS, EXAMINING ATTORNEY

SN 78-437,177. INTERWRAP INC., MISSION, BRITISH COLUMBIA, CANADA, FILED 6-17-2004.

USE YOUR GRAY MATTER

THE MARK CONSISTS OF STANDARD CHARACTERS WITHOUT CLAIM TO ANY PARTICULAR FONT, STYLE, SIZE, OR COLOR.

CLASS 17—RUBBER GOODS

FOR RADIANT FOIL BARRIERS, NAMELY, FLEXIBLE PLASTIC MATERIALS IN THE FORM OF SHEET ROLLS INCORPORATING COATED WOVEN POLYETHYLENE AND ALUMINUM USED ON ROOFING PRODUCTS TO REFLECT SOLAR RADIATION; RUBBERIZED MATERIALS COMPOSED PRIMARILY OF FLEXIBLE PLASTIC IN THE FORM OF SHEET ROLLS USED AS A MOISTURE PROTECTION BARRIER FOR WINDOW SEAMS; BUILDING PRODUCTS, NAMELY, INSULATION FACING COMPOSED PRIMARILY OF FLEXIBLE PLASTIC IN THE FORM OF SHEET ROLLS; SEALING TAPES FOR USE WITH ROOFING UNDERLAYMENTS, INSULATION FACER COMPOSED PRIMARILY OF FLEXIBLE PLASTIC IN THE FORM OF SHEET ROLLS INSTALLED ON THE SURFACE OF AIR AND MOISTURE BARRIERS FOR BUILDINGS; AND HOUSE WRAPS COMPOSED PRIMARILY OF FLEXIBLE PLASTIC IN THE FORM OF SHEET ROLLS, NAMELY COATED WOVEN AND NON-WOVEN MATERIALS USED AS A MOISTURE AND AIR BARRIER FOR BUILDINGS (U.S. CLS. 1, 5, 12, 13, 35 AND 50).

CLASS 19—NON-METALLIC BUILDING MATERIALS

FOR WATERPROOFING MATERIALS FOR USE ON UNDERGROUND STRUCTURES, NAMELY CONCRETE UNDERLAYMENTS COMPOSED PRIMARILY OF FLEXIBLE PLASTIC IN THE FORM OF SHEET ROLLS; CONCRETE UNDERSLAB VAPOR BARRIERS COMPOSED PRIMARILY OF FLEXIBLE PLASTIC IN THE FORM OF SHEET ROLLS (U.S. CLS. 1, 12, 33 AND 50).

HEATHER THOMPSON, EXAMINING ATTORNEY

SN 78-437,186. BIOCORP, INC., ROGERS, MN. FILED 6-17-2004.

BIOCORP

THE MARK CONSISTS OF STANDARD CHARACTERS WITHOUT CLAIM TO ANY PARTICULAR FONT, STYLE, SIZE, OR COLOR.
OWNER OF U.S. REG. NOS. 2,145,310, 2,371,930 AND OTHERS.

CLASS 17—RUBBER GOODS

FOR BIODEGRADABLE PLASTIC FILMS FOR COMMERCIAL AND INSTITUTIONAL USE, NAMELY AGRICULTURAL FILM (U.S. CLS. 1, 5, 12, 13, 35 AND 50).

CLASS 41—EDUCATION AND ENTERTAINMENT

FOR PROVIDING TRAINING AND EDUCATION SERVICES, IN THE FORM OF SEMINARS, CLASSES AND WORKSHOPS, IN CONNECTION WITH RESIDENTIAL, COMMERCIAL AND INSTITUTIONAL RECYCLING, SOLID WASTE REDUCTION AND WASTE MANAGEMENT PROGRAMS; PROVIDING EVENT PLANNING SERVICES IN CONNECTION WITH RESIDENTIAL, COMMERCIAL AND INSTITUTIONAL RECYCLING, SOLID WASTE REDUCTION AND WASTE MANAGEMENT PROGRAMS (U.S. CLS. 100, 101 AND 107).

HEATHER THOMPSON, EXAMINING ATTORNEY

SN 78-437,207. PACIFIC INTERNATIONAL VEGETABLE MARKETING, INC., SALINAS, CA. FILED 6-17-2004.

PACIFIC

THE MARK CONSISTS OF STANDARD CHARACTERS WITHOUT CLAIM TO ANY PARTICULAR FONT, STYLE, SIZE, OR COLOR.

CLASS 29—MEATS AND PROCESSED FOODS

FOR PROCESSED AND FROZEN PRODUCE, NAMELY, VEGETABLES AND FRUITS (U.S. CL. 46).
FIRST USE 4-7-2004; IN COMMERCE 4-7-2004.

CLASS 35—ADVERTISING AND BUSINESS

FOR BUSINESS MARKETING AND DISTRIBUTORSHIP SERVICES IN THE FIELD OF AGRICULTURAL PRODUCTS, NAMELY, FRESH, FROZEN, PROCESSED AND READY-TO-EAT PRODUCE (U.S. CLS. 100, 101 AND 102).

FIRST USE 1-1-2003; IN COMMERCE 1-1-2003.
STEVEN R. FINE, EXAMINING ATTORNEY

SN 78-437,231. DOLAN MEDIA COMPANY, MINNEAPOLIS, MN. FILED 6-17-2004.

**THE COLORADO
SPRINGS BUSINESS
JOURNAL**

THE MARK CONSISTS OF STANDARD CHARACTERS WITHOUT CLAIM TO ANY PARTICULAR FONT, STYLE, SIZE, OR COLOR.

NO CLAIM IS MADE TO THE EXCLUSIVE RIGHT TO USE "BUSINESS JOURNAL", APART FROM THE MARK AS SHOWN.
SEC. 2(F).

CLASS 16—PAPER GOODS AND PRINTED MATTER

FOR PRINTED PUBLICATIONS, NAMELY, NEWSPAPERS (U.S. CLS. 2, 5, 22, 23, 29, 37, 38 AND 50).
FIRST USE 0-0-1988; IN COMMERCE 0-0-1988.

CLASS 41—EDUCATION AND ENTERTAINMENT

FOR ON-LINE PUBLICATIONS, NAMELY, NEWSPAPERS (U.S. CLS. 100, 101 AND 107).
FIRST USE 0-0-1995; IN COMMERCE 0-0-1995.
KIMBERLY FRYE, EXAMINING ATTORNEY

SN 78-437,723. MUELLER SPORTS MEDICINE, INC., PRAIRIE DU SAC, WI. FILED 6-18-2004.

ADJUST-TO-FIT

THE MARK CONSISTS OF STANDARD CHARACTERS WITHOUT CLAIM TO ANY PARTICULAR FONT, STYLE, SIZE, OR COLOR.
SEC. 2(F).

CLASS 10—MEDICAL APPARATUS

FOR MEDICAL SUPPORTS, NAMELY ANKLE BRACES (U.S. CLS. 26, 39 AND 44).
FIRST USE 1-23-1998; IN COMMERCE 1-23-1998.

CLASS 28—TOYS AND SPORTING GOODS

FOR ATHLETIC SPORTING GOODS, NAMELY ANKLE BRACES (U.S. CLS. 22, 23, 38 AND 50).
FIRST USE 1-23-1998; IN COMMERCE 1-23-1998.
BARBARA BROWN, EXAMINING ATTORNEY

SN 78-437,787. LAXDALE LIMITED, STIRLING, UNITED KINGDOM, FILED 6-18-2004.

MIRAXION

THE MARK CONSISTS OF STANDARD CHARACTERS WITHOUT CLAIM TO ANY PARTICULAR FONT, STYLE, SIZE, OR COLOR.

PRIORITY CLAIMED UNDER SEC. 44(D) ON UNITED KINGDOM APPLICATION NO. 2363309, FILED 5-14-2004, REG. NO. 2363309, DATED 12-3-2004, EXPIRES 5-14-2014.

CLASS 1—CHEMICALS

FOR DIAGNOSTIC REAGENTS FOR SCIENTIFIC OR RESEARCH USE; CHEMICALS FOR USE IN THE MANUFACTURE OF PHARMACEUTICALS AND NUTRITIONAL ADDITIVES; FATTY ACIDS, POLYUNSATURATED FATTY ACIDS, ESTERS PRODUCED FROM FATTY ACIDS, DERIVATIVES OF FATTY ACIDS FOR USE IN THE MANUFACTURE OF PHARMACEUTICALS AND NUTRITIONAL ADDITIVES FOR SCIENTIFIC OR RESEARCH USE (U.S. CLS. 1, 5, 6, 10, 26 AND 46).

CLASS 5—PHARMACEUTICALS

FOR DIAGNOSTIC REAGENTS FOR MEDICINAL USE; PHARMACEUTICAL PREPARATIONS FOR THE TREATMENT OF PSYCHIATRIC AND NEUROLOGICAL DISORDERS; VETERINARY PREPARATIONS FOR THE TREATMENT OF PSYCHIATRIC AND NEUROLOGICAL DISORDERS IN ANIMALS; DIETETIC FOODS ADAPTED FOR MEDICAL USE; BABY FOOD; REAGENTS FOR MEDICAL USE; NUTRITIONAL ADDITIVES FOR USE IN FOODS AND DIETARY SUPPLEMENTS FOR HUMAN CONSUMPTION; NUTRITIONAL SUPPLEMENTS; HEALTH FOOD SUPPLEMENTS; VITAMINS AND MINERALS; PHARMACEUTICAL PREPARATIONS FOR THE TREATMENT OF PSYCHIATRIC AND NEUROLOGICAL DISORDERS CONTAINING FATTY ACIDS AND THEIR DERIVATIVES, NAMELY, FATTY ACID ESTERS; VITAMIN AND NUTRITIONAL ADDITIVES TO FOODSTUFFS FOR ANIMALS, FOR MEDICAL PURPOSES; VITAMIN FORTIFIED BEVERAGES (U.S. CLS. 6, 18, 44, 46, 51 AND 52).

ALEXANDER L. POWERS, EXAMINING ATTORNEY

SN 78-438,039. LOWERMYBILLS, INC., SANTA MONICA, CA. FILED 6-18-2004.

LowerYourBills.com

THE MARK CONSISTS OF STANDARD CHARACTERS WITHOUT CLAIM TO ANY PARTICULAR FONT, STYLE, SIZE, OR COLOR.

OWNER OF U.S. REG. NOS. 2,519,342 AND 2,879,519.

CLASS 35—ADVERTISING AND BUSINESS

FOR PROVIDING COMPARISON SHOPPING INFORMATION BY MEANS OF A GLOBAL COMPUTER NETWORK; SHOPPING CONSULTATION SERVICES PROVIDED TO CONSUMERS, NAMELY, PROVIDING CONSUMER ADVICE (U.S. CLS. 100, 101 AND 102).

CLASS 42—SCIENTIFIC, COMPUTER AND LEGAL SERVICES

FOR PROVIDING TEMPORARY USE OF ONLINE AND NON-DOWNLOADABLE SOFTWARE FOR MAKING FINANCIAL CALCULATIONS (U.S. CLS. 100 AND 101).

STEVEN R. FINE, EXAMINING ATTORNEY

SN 78-438,066. HYDRO-SCAPE PRODUCTS, INC., SAN DIEGO, CA. FILED 6-18-2004.

HYDRO-SAFE

THE MARK CONSISTS OF STANDARD CHARACTERS WITHOUT CLAIM TO ANY PARTICULAR FONT, STYLE, SIZE, OR COLOR.

CLASS 9—ELECTRICAL AND SCIENTIFIC APPARATUS

FOR IRRIGATION SYSTEMS, NAMELY ELECTRICAL CONTROLS AND MECHANICAL CONTROLS FOR IRRIGATION SYSTEMS; ELECTRICAL IRRIGATION EQUIPMENT ENCLOSURE BOXES, HOUSINGS, AND ASSEMBLIES FOR ELECTRICAL AND MECHANICAL CONTROLS FOR IRRIGATION SPRINKLER SYSTEMS (U.S. CLS. 21, 23, 26, 36 AND 38).

FIRST USE 1-1-1987; IN COMMERCE 1-1-1987.

CLASS 11—ENVIRONMENTAL CONTROL APPARATUS

FOR IRRIGATION SYSTEMS, COMPRISED OF VALVES, FILTERS, REGULATORS, AND NOZZLES; NON-ELECTRICAL IRRIGATION EQUIPMENT ENCLOSURE BOXES, HOUSINGS, AND ASSEMBLIES FOR SUCH IRRIGATION SPRINKLER SYSTEMS (U.S. CLS. 13, 21, 23, 31 AND 34).

FIRST USE 1-1-1987; IN COMMERCE 1-1-1987.
ARETHA SOMERVILLE, EXAMINING ATTORNEY

SN 78-438,378. MENASHA CORPORATION, NEENAH, WI. FILED 6-21-2004.

MASTERS OF EXECUTION

THE MARK CONSISTS OF STANDARD CHARACTERS WITHOUT CLAIM TO ANY PARTICULAR FONT, STYLE, SIZE, OR COLOR.

CLASS 35—ADVERTISING AND BUSINESS

FOR BUSINESS CONSULTATION SERVICES FOR RETAILING COMPANIES IN THE AREA OF MARKETING AND PROVIDING STATISTICAL INFORMATION RENDERED IN CONNECTION THEREWITH; PROMOTING THE SALE OF GOODS OF OTHERS THROUGH THE CREATION, ASSEMBLY, AND DISTRIBUTION OF PROMOTIONAL DISPLAYS THROUGH THE DISTRIBUTION OF PRINTED PROMOTIONAL MATERIALS (U.S. CLS. 100, 101 AND 102).

CLASS 40—MATERIAL TREATMENT

FOR MANUFACTURE OF PROMOTIONAL DISPLAYS AND PROMOTIONAL PRINTED MATTER, TO THE ORDER AND SPECIFICATION OF OTHERS (U.S. CLS. 100, 103 AND 106).

CLASS 42—SCIENTIFIC, COMPUTER AND LEGAL SERVICES

FOR DESIGN FOR OTHERS OF PROMOTIONAL DISPLAYS AND PROMOTIONAL MATERIALS (U.S. CLS. 100 AND 101).
LANA PHAM, EXAMINING ATTORNEY

SN 78-438,409. LNT MERCHANDISING COMPANY, LLC, CLIFTON, NJ. FILED 6-21-2004.

HOTEL LIVING

THE MARK CONSISTS OF STANDARD CHARACTERS WITHOUT CLAIM TO ANY PARTICULAR FONT, STYLE, SIZE, OR COLOR.

CLASS 24—FABRICS

FOR HOUSEHOLD TEXTILE GOODS, NAMELY, BED LINEN, BATH LINEN, TOWELS, BED SHEETS, EMBROIDERED SHEET SETS, PILLOW CASES, PILLOW SHAMS, COMFORTERS, BLANKETS, QUILTS, THROWS, BEDSPREADS, COMFORTER AND BLANKET COVERS, DUVET COVERS, MATELASSE COVERLETS (U.S. CLS. 42 AND 50).

CLASS 25—CLOTHING

FOR BATH ROBES (U.S. CLS. 22 AND 39).

CLASS 27—FLOOR COVERINGS

FOR BATH MATS, BATH RUGS (U.S. CLS. 19, 20, 37, 42 AND 50).
BRIAN PINO, EXAMINING ATTORNEY

SN 78-438,487. EATON CORPORATION, CLEVELAND, OH.
FILED 6-21-2004.

EFM

THE MARK CONSISTS OF STANDARD CHARACTERS WITHOUT CLAIM TO ANY PARTICULAR FONT, STYLE, SIZE, OR COLOR.

CLASS 7—MACHINERY

FOR CLUTCH SURFACE LINING AND PADS FOR MACHINES; BRAKE SURFACE LINING AND PADS FOR MACHINES; SYNCHRONIZER SURFACE LINING AND PADS FOR MACHINES; DIFFERENTIAL SURFACE LINING AND PADS FOR MACHINES (U.S. CLS. 13, 19, 21, 23, 31, 34 AND 35).

CLASS 12—VEHICLES

FOR CLUTCH SURFACE LINING AND PADS FOR LAND VEHICLES; BRAKE SURFACE LINING AND PADS FOR LAND VEHICLES; SURFACE LINING AND PADS FOR USE IN A VEHICLE TRANSMISSION SYNCHRONIZER; SURFACE LINING AND PADS FOR USE IN A VEHICLE DIFFERENTIAL (U.S. CLS. 19, 21, 23, 31, 35 AND 44).

RAUL CORDOVA, EXAMINING ATTORNEY

SN 78-438,696. S.C.A.M.I. S.N.C. DI G. GASPARINI & C., I-10024 MONCALIERI, TURIN, ITALY, FILED 6-21-2004.

ALVAN

THE MARK CONSISTS OF STANDARD CHARACTERS WITHOUT CLAIM TO ANY PARTICULAR FONT, STYLE, SIZE, OR COLOR.

CLASS 7—MACHINERY

FOR POWER TOOLS, NAMELY, REAMERS (U.S. CLS. 13, 19, 21, 23, 31, 34 AND 35).
FIRST USE 6-11-1996; IN COMMERCE 6-11-1996.

CLASS 8—HAND TOOLS

FOR HAND TOOLS NAMELY, REAMERS (U.S. CLS. 23, 28 AND 44).
FIRST USE 6-11-1996; IN COMMERCE 6-11-1996.
DAWN FELDMAN, EXAMINING ATTORNEY

SN 78-438,903. BURKINA WEAR, INC., NEW YORK, NY.
FILED 6-21-2004.



CLASS 18—LEATHER GOODS

FOR BACKPACKS, BOOKBAGS, SHOULDER BAGS, HANDBAGS AND PURSES, TOTE BAGS, TRAVEL BAGS AND WAIST PACKS (U.S. CLS. 1, 2, 3, 22 AND 41).

CLASS 25—CLOTHING

FOR CLOTHING, NAMELY, T-SHIRTS, MEN'S AND WOMEN'S JEANS, MEN'S AND WOMEN'S SHIRTS, HATS, CAPS, BASEBALL CAPS, NECK TIES, SOCKS, MEN'S AND WOMEN'S SHORTS, MEN'S AND WOMEN'S SPORT JACKETS AND COATS, WIND RESISTANT JACKETS, RAIN COATS, GOLF SHIRTS, GYM SHORTS, HEADBANDS, JERSEYS, JUMPSUITS, SLACKS, PANTS, PARKAS, SWEATSHIRTS, SKI MASKS, SWEATSUITS, WARM-UP SUITS, SWEATERS, TENNIS WEAR, VESTS, TURTLENECK SHIRTS AND SWEATERS, POLO SHIRTS (U.S. CLS. 22 AND 39).
SUSAN STIGLITZ, EXAMINING ATTORNEY

SN 78-439,401. TOTAL CAR FRANCHISING CORPORATION, CONWAY, SC. FILED 6-22-2004.



NO CLAIM IS MADE TO THE EXCLUSIVE RIGHT TO USE "PAINT DENT INTERIOR SAME DAY REPAIR", APART FROM THE MARK AS SHOWN.

CLASS 25—CLOTHING

FOR CLOTHING, NAMELY, HATS, T-SHIRTS, GOLF SHIRTS, V-NECK SHIRTS AND JACKETS (U.S. CLS. 22 AND 39).

CLASS 37—CONSTRUCTION AND REPAIR

FOR DENT REPAIR AND PAINTING SERVICES FOR AUTOMOBILE EXTERIORS; REPAIR SERVICES FOR AUTOMOBILE INTERIORS (U.S. CLS. 100, 103 AND 106).
SUSAN LESLIE DUBOIS, EXAMINING ATTORNEY

SN 78-441,287. INTEGRATED MOBILE, INC., VIENNA, VA.
FILED 6-25-2004.

SN 78-439,463. HURWITZ, ANDREW S., BROOKLYN, NY.
FILED 6-22-2004.

KAJEET

ROPEADOPE

THE MARK CONSISTS OF STANDARD CHARACTERS WITHOUT CLAIM TO ANY PARTICULAR FONT, STYLE, SIZE, OR COLOR.

CLASS 25—CLOTHING

FOR CLOTHING, NAMELY, T-SHIRTS, SHIRTS, JACKETS, SWEATSHIRTS, HATS (U.S. CLS. 22 AND 39).
FIRST USE 11-25-1999; IN COMMERCE 11-25-1999.

CLASS 35—ADVERTISING AND BUSINESS

FOR DISTRIBUTORSHIPS IN THE FIELD OF MUSICAL SOUND RECORDINGS AND MUSICAL VIDEO RECORDINGS; RETAIL STORE, ONLINE RETAIL STORE AND ONLINE RETAIL ORDERING SERVICES FEATURING MUSICAL SOUND RECORDINGS, MUSICAL VIDEO RECORDINGS AND CLOTHING; PROMOTING THE CONCERTS, MUSICAL SOUND RECORDINGS AND MUSICAL VIDEO RECORDINGS OF OTHERS; PROMOTING PERFORMING ARTISTS THROUGH MERCHANDISING OF GOODS, NAMELY, MUSICAL SOUND RECORDINGS, MUSICAL VIDEO RECORDINGS AND CLOTHING; MANAGEMENT OF RECORDING ARTISTS; PREPARING AND PLACING ADVERTISING FOR RECORDING ARTISTS; DISSEMINATING ADVERTISING FOR RECORDING ARTISTS VIA THE INTERNET; ARRANGING AND CONDUCTING TRADE SHOW EXHIBITIONS IN THE FIELD OF MUSIC (U.S. CLS. 100, 101 AND 102).

FIRST USE 6-1-1999; IN COMMERCE 10-1-1999.
MATTHEW PAPPAS, EXAMINING ATTORNEY

THE MARK CONSISTS OF STANDARD CHARACTERS WITHOUT CLAIM TO ANY PARTICULAR FONT, STYLE, SIZE, OR COLOR.

CLASS 9—ELECTRICAL AND SCIENTIFIC APPARATUS

FOR MOBILE ELECTRONIC DEVICE PROVIDING TRANSMISSION AND STORAGE OF VOICE AND DATA, MESSAGING, GAMES, LOCATION SERVICES, PHOTOGRAPHY, AND OTHER MEDIA AND CONTENT INCLUDING MUSIC, TEXT AND DIGITAL BOOKS AND RELATED TELECOMMUNICATIONS SERVICES, WITH OPTIONAL PARENTAL CONTROLS AND METHODS WHEREBY PARENTS OR OTHERS CAN DETERMINE WHICH SERVICES, FEATURES, AND CONTENT CAN BE USED AND UNDER WHAT CONDITIONS; COMPUTER HARDWARE AND SOFTWARE RELATED THERETO, AND DOWNLOADABLE COMPUTER GAMES, MUSIC AND EDUCATIONAL ACTIVITIES AND GAMES. (U.S. CLS. 21, 23, 26, 36 AND 38).

CLASS 38—COMMUNICATION

FOR TELECOMMUNICATIONS SERVICES VIA A MOBILE ELECTRONIC DEVICE, NAMELY, TRANSMISSION OF VOICE AND DATA, MESSAGING, GAMES, LOCATION SERVICES, PHOTOGRAPHY AND OTHER MEDIA AND CONTENT INCLUDING MUSIC WITH OPTIONAL PARENTAL CONTROLS AND METHODS WHEREBY PARENTS OR OTHERS CAN DETERMINE WHICH SERVICES, FEATURES, AND CONTENT CAN BE USED AND UNDER WHAT CONDITIONS. (U.S. CLS. 100, 101 AND 104).

CLASS 41—EDUCATION AND ENTERTAINMENT

FOR ENTERTAINMENT SERVICES, NAMELY PROVIDING ON-LINE, NON-DOWNLOADABLE COMPUTER GAMES AND MUSIC VIA A MOBILE ELECTRONIC DEVICE; EDUCATION SERVICES, NAMELY PROVIDING ON-LINE, NON-DOWNLOADABLE EDUCATIONAL ACTIVITIES INCLUDING EDUCATIONAL GAMES AND INFORMATION VIA A MOBILE ELECTRONIC DEVICE (U.S. CLS. 100, 101 AND 107).

JULIE WATSON, EXAMINING ATTORNEY

SN 78-442,539. COMMUNITY TELEVISION OF SOUTHERN CALIFORNIA, LOS ANGELES, CA. FILED 6-28-2004.

A PLACE OF OUR OWN

THE MARK CONSISTS OF STANDARD CHARACTERS WITHOUT CLAIM TO ANY PARTICULAR FONT, STYLE, SIZE, OR COLOR.

CLASS 9—ELECTRICAL AND SCIENTIFIC APPARATUS

FOR PRE-RECORDED VIDEOTAPE CASSETTES, DIGITAL VIDEO DISCS IN THE NATURE OF DVDS, LASER DISCS, PICTURE DISCS, COMPACT DISC VIDEOS, PHOTO CDS, MINI DISCS, CD-ROMS, PHONOGRAPH RECORDS, AUDIOCASSETTES, DIGITAL COMPACT CASSETTES, DIGITAL AUDIO TAPES IN THE NATURE OF DATS, AND COMPACT DISCS IN THE NATURE OF CDS FEATURING ENTERTAINMENT, EDUCATIONAL AND INFORMATIVE PROGRAMS AND SHOWS IN THE FIELDS OF AND RELATING TO PARENTING, CHILD REARING, CARE GIVING, FAMILY LIFE, CHILD DEVELOPMENT, EDUCATION AND LITERACY FOR JUVENILE, CHILDHOOD AND EARLY CHILDHOOD STAGES, CHILDREN'S EDUCATIONAL AND ENTERTAINMENT, ARTS AND CRAFTS, AND CHILDREN'S ACTIVITIES, STORIES, CARTOONS, SHOWS AND MOVIES; MOUSE PADS; MOUSE PADS WITH WRIST HOLDERS; COMPACT DISC CASES (U.S. CLS. 21, 23, 26, 36 AND 38).

CLASS 16—PAPER GOODS AND PRINTED MATTER

FOR PRINTED MATERIALS NAMELY, PRINTED BROCHURES, SCHEDULES AND PROGRAM GUIDES WHICH ADVERTISE AND PROMOTE UPCOMING EVENTS, NAMELY, EDUCATIONAL, ENTERTAINMENT AND INFORMATIVE EVENTS, TELEVISION, ON-LINE, SATELLITE, CABLE AND RADIO PROGRAMS, ARTISTIC, THEATRICAL AND NON-THEATRICAL PERFORMANCES, PROMOTIONAL CONTESTS, SWEEPSTAKES, COMPETITIONS, LOTTERIES, ATHLETIC AND ACADEMIC TOURNAMENTS, AND INTERVIEWS; PRINTED MAGAZINES, MINI-MAGAZINES, AND NEWSLETTERS FEATURING PROGRAM SCHEDULES FOR TELEVISION, ON-LINE, SATELLITE, CABLE AND RADIO; PRINTED BOOKS, NEWSLETTERS AND MAGAZINES FEATURING EDUCATIONAL, ENTERTAINMENT AND INFORMATIVE MATERIALS FOR CHILDREN, PARENTS AND CARE GIVERS; PRINTED CHILDREN'S ACTIVITY BOOKS, COMIC BOOKS, FLASHCARDS, AND CHILDREN'S STORY BOOKS; PRINTS; MOUNTED PHOTOGRAPHS; POSTERS; INSTRUCTIONAL AND TEACHING MATERIALS AND INFORMATIONAL FLYERS IN THE FIELDS OF AND RELATED TO PARENTING, CHILD REARING, CARE GIVING, FAMILY LIFE, CHILD DEVELOPMENT, EDUCATION AND LITERACY FOR JUVENILE, CHILDHOOD AND EARLY CHILDHOOD STAGES, ARTS AND CRAFTS, AND CHILDREN'S EDUCATION, ENTERTAINMENT AND ACTIVITIES; BABY BOOKS; SCRAPBOOK ALBUMS; CALENDARS; COUPON BOOKS; BOOKMARKS; STICKERS; DECALS; BUMPER STICKERS; PRINTED CERTIFICATES; NOTE CARDS; POSTERS; FOLDERS; PENCILS; DRAWING PENCILS; PENS; STATIONERY; DESK PADS; NOTE-PADS; ART AND CRAFT PAPER; GIFT WRAPPING PAPER; PAPER AND PLASTIC GIFT BAGS; GREETING CARDS; CRAYONS; CHALK; MARKERS; ARTS AND CRAFTS PAINT KITS; PAINTING SETS; COLORING BOOKS; PAINT BRUSHES; MODELING CLAY; PAPER PARTY HATS; PAPER NAPKINS; TABLECLOTHS OF PAPER; PAPER GIFT WRAP BOWS AND RIBBONS; PAPER PARTY DECORATIONS AND PLACEMATS (U.S. CLS. 2, 5, 22, 23, 29, 37, 38 AND 50).

CLASS 41—EDUCATION AND ENTERTAINMENT

FOR ENTERTAINMENT SERVICES, NAMELY, AN AUDIO-VISUAL SERIES IN THE NATURE OF A TELEVISION SHOW SERIES IN THE FIELDS OF AND RELATING TO PARENTING, CHILD REARING, CARE GIVING, FAMILY LIFE, CHILD DEVELOPMENT, EDUCATION AND LITERACY FOR JUVENILE, CHILDHOOD AND EARLY CHILDHOOD STAGES, ARTS AND CRAFTS, AND CHILDREN'S EDUCATION, ENTERTAINMENT, ACTIVITIES, STORIES, CARTOONS, SHOWS AND MOVIES; PRODUCTION OF LIVE-MUSIC CONCERTS AND THEATER; PRODUCTION OF OTHER ARTISTIC PERFORMANCES, NAMELY, DANCE PERFORMANCES, DRAMATIC READINGS, REENACTMENTS, LIVE PERFORMANCES FEATURING CHARACTERS, DIALOGUE, SONGS AND MUSIC, AND PUPPET SHOWS; ENTERTAINMENT IN THE NATURE OF ATHLETIC AND ACADEMIC TOURNAMENTS; AND PROVIDING ONLINE CREATIVE AND EDUCATIONAL ACTIVITIES, NAMELY, COMPUTER GAMES, PUZZLES, AND TRIVIA, WRITING, ATHLETIC, TALENT, ARTS AND CRAFTS, COOKING, SCIENCE AND CREATIVE WORKS CONTESTS; PROVIDING NON-DOWNLOADABLE ON-LINE EDUCATIONAL, ENTERTAINMENT AND INFORMATIONAL PUBLICATIONS, NAMELY, MAGAZINES IN THE FIELDS OF AND RELATING TO PARENTING, CHILD REARING, CARE GIVING, FAMILY LIFE, CHILD DEVELOPMENT, EDUCATION AND LITERACY FOR JUVENILE, CHILDHOOD AND EARLY CHILDHOOD STAGES, ARTS AND CRAFTS, AND CHILDREN'S EDUCATIONAL, ENTERTAINMENT, ACTIVITIES AND STORIES VIA A WEBSITE ON GLOBAL COMPUTER NETWORKS; PROVIDING EDUCATIONAL, ENTERTAINMENT AND INFORMATIONAL PUBLICATIONS, NAMELY, MAGAZINES IN THE FIELDS OF AND RELATING TO PARENTING, CHILD REARING, CARE GIVING, FAMILY LIFE, CHILD DEVELOPMENT, EDUCATION AND LITERACY FOR JUVENILE, CHILDHOOD AND EARLY CHILDHOOD STAGES, ARTS AND CRAFTS, AND CHILDREN'S EDUCATIONAL, ENTERTAINMENT, ACTIVITIES AND STORIES VIA EMAIL (U.S. CLS. 100, 101 AND 107).

RENEE MCCRAY, EXAMINING ATTORNEY

SN 78-442,619. RIDE SNOWBOARD COMPANY, VASHON, WA. FILED 6-28-2004.



CLASS 18—LEATHER GOODS

FOR ALL-PURPOSE CARRYING BAGS, LUGGAGE, BACKPACKS, RUCKSACKS, ALL-PURPOSE SPORT BAGS, SHOULDER BAGS, WALLETS (U.S. CLS. 1, 2, 3, 22 AND 41).

FIRST USE 1-0-2004; IN COMMERCE 1-0-2004.

CLASS 25—CLOTHING

FOR SNOWBOARD BOOTS, SNOWBOARD BOOT LINERS, FOOTBEDS, JACKETS, COATS, PARKAS, VESTS, FLEECE JACKETS, PANTS, SNOWBOARD PANTS, GLOVES, MITTENS, WRIST BANDS, SHIRTS, T-SHIRTS, SWEATSHIRTS, PULLOVERS, TANK TOPS, UNDERWEAR, JERSEYS, CAPS, HATS, BEANIES, SOCKS, BELTS (U.S. CLS. 22 AND 39).

FIRST USE 1-0-2004; IN COMMERCE 1-0-2004.

CLASS 28—TOYS AND SPORTING GOODS

FOR SNOWBOARDS, SNOWBOARD BINDINGS, SNOWBOARD CARRYING BAGS (U.S. CLS. 22, 23, 38 AND 50).

FIRST USE 1-0-2004; IN COMMERCE 1-0-2001.
ALICIA COLLINS, EXAMINING ATTORNEY

CLASS 42—SCIENTIFIC, COMPUTER AND LEGAL SERVICES

FOR OPERATION OF A BUSINESS DEALING IN ENGINEERING SERVICES, NAMELY, THE CUSTOM DESIGN AND IMPLEMENTATION RUGGED HANDHELD PORTABLE AND IN-VEHICLE COMPUTERS AND SUPPORTING SOFTWARE USED FOR WIRELESS DATA TRANSMISSION AND AUTOMATIC VEHICLE LOCATION (AVL) SOLUTIONS TO AUTOMATE THE DISPATCHING, STATUS REPORTING AND DATA COLLECTION FUNCTIONS OF THE MOBILE WORKFORCE VIA A GLOBAL COMPUTER NETWORK AND SYSTEMS INTEGRATION; COMPUTER PROJECT MANAGEMENT SERVICES; WIRELESS NETWORK ANALYSIS SERVICES, NAMELY, PROVIDING TECHNICAL SUPPORT BY MONITORING OF WIRELESS NETWORK SYSTEMS; AND TECHNICAL SUPPORT SERVICES, NAMELY, TROUBLESHOOTING OF COMPUTER HARDWARE AND SOFTWARE PROBLEMS (U.S. CLS. 100 AND 101).

FIRST USE 4-30-1999; IN COMMERCE 4-30-1999.
DANIEL BRODY, EXAMINING ATTORNEY

SN 78-442,963. MENTOR ENGINEERING LTD., CALGARY, ALBERTA, CANADA, FILED 6-29-2004.

SN 78-443,279. TRIBUNE-REVIEW PUBLISHING COMPANY, PITTSBURGH, PA. FILED 6-29-2004.

SYSTEMS THAT WORK

TribLIVE

THE MARK CONSISTS OF STANDARD CHARACTERS WITHOUT CLAIM TO ANY PARTICULAR FONT, STYLE, SIZE, OR COLOR.

PRIORITY CLAIMED UNDER SEC. 44(D) ON CANADA APPLICATION NO. 1218751, FILED 6-1-2004.

CLASS 9—ELECTRICAL AND SCIENTIFIC APPARATUS

FOR COMPUTER HARDWARE AND SOFTWARE, NAMELY, RUGGED HANDHELD PORTABLE AND IN-VEHICLE COMPUTERS AND SUPPORTING SOFTWARE USED FOR WIRELESS DATA TRANSMISSION AND AUTOMATIC VEHICLE LOCATION (AVL) SOLUTIONS TO AUTOMATE THE DISPATCHING, STATUS REPORTING AND DATA COLLECTION FUNCTIONS OF THE MOBILE WORKFORCE VIA A GLOBAL COMPUTER NETWORK; MIDDLEWARE AND WIRELESS DATA TRANSMISSION SOFTWARE FOR MOBILE WIRELESS DEVICES; DATA COMMUNICATIONS HARDWARE AND SOFTWARE, NAMELY, ELECTRONIC DEVICES FOR REMOTE CONTROL OF INDUSTRIAL EQUIPMENT, MOBILE DATA TERMINALS, COMPUTER CONTROLLED ELECTRONIC SURVEILLANCE AND SECURITY DEVICES, MASTER COMMUNICATION CONTROLLERS AND APPLICATION SOFTWARE; SOFTWARE FOR USE IN THE TRANSPORTATION INDUSTRY THAT CO-ORDINATES INCIDENT, LOCATION AND VEHICLE INFORMATION IN REAL TIME AND ENABLES COMMUNICATION BETWEEN DISPATCHERS AND DRIVERS; COMPUTER HARDWARE, NAMELY, A FIXED-MOUNT COMPUTER TERMINAL IN A VEHICLE (U.S. CLS. 21, 23, 26, 36 AND 38).

FIRST USE 4-30-1999; IN COMMERCE 4-30-1999.

THE MARK CONSISTS OF STANDARD CHARACTERS WITHOUT CLAIM TO ANY PARTICULAR FONT, STYLE, SIZE, OR COLOR.

CLASS 35—ADVERTISING AND BUSINESS

FOR ADVERTISING SERVICES, NAMELY, PROVIDING ADVERTISING SPACE IN ON-LINE NEWSPAPERS VIA THE INTERNET (U.S. CLS. 100, 101 AND 102).

FIRST USE 3-2-1998; IN COMMERCE 3-2-1998.

CLASS 41—EDUCATION AND ENTERTAINMENT

FOR PROVIDING ON-LINE NEWSPAPERS IN THE FIELDS OF NEWS, CURRENT EVENTS, ENTERTAINMENT, EDUCATION, OPINION AND COMMENTARY, SPORTS AND BUSINESS FROM VARIOUS DAILY NEWSPAPERS VIA THE INTERNET (U.S. CLS. 100, 101 AND 107).

FIRST USE 3-2-1998; IN COMMERCE 3-2-1998.
GLENN CLARK, EXAMINING ATTORNEY

SN 78-443,533. CCC INFORMATION SERVICES INC., CHICAGO, IL. FILED 6-30-2004.

SN 78-444,730. CANCER CARE, INC., NEW YORK, NY. FILED 7-1-2004.

COMP-EST

THE MARK CONSISTS OF STANDARD CHARACTERS WITHOUT CLAIM TO ANY PARTICULAR FONT, STYLE, SIZE, OR COLOR.

OWNER OF U.S. REG. NO. 2,524,746.

CLASS 9—ELECTRICAL AND SCIENTIFIC APPARATUS

FOR COMPUTER SOFTWARE AND INSTRUCTIONAL MANUALS SOLD AS A UNIT FOR USE IN THE OPERATION AND MANAGEMENT OF AUTOMOBILE COLLISION REPAIR FACILITIES (U.S. CLS. 21, 23, 26, 36 AND 38).

FIRST USE 12-31-1993; IN COMMERCE 12-31-1993.

CLASS 35—ADVERTISING AND BUSINESS

FOR PROVIDING BUSINESS INFORMATION SERVICES TO INSURANCE COMPANIES, COLLISION REPAIR FACILITIES, AND SALVAGE FACILITIES IN THE AREA OF COLLISION REPAIR ESTIMATING (U.S. CLS. 100, 101 AND 102).

FIRST USE 12-31-1993; IN COMMERCE 12-31-1993.
NICHOLAS ALTREE, EXAMINING ATTORNEY

SN 78-444,634. SAINT-GOBAIN CERAMICS & PLASTICS, INC., WORCESTER, MA. FILED 7-1-2004.



CLASS 1—CHEMICALS

FOR RADIATION DETECTING CRYSTALS WHICH ARE USED IN NUCLEAR INSTRUMENTS (U.S. CLS. 1, 5, 6, 10, 26 AND 46).

FIRST USE 4-15-2004; IN COMMERCE 5-9-2004.

CLASS 9—ELECTRICAL AND SCIENTIFIC APPARATUS

FOR NUCLEAR INSTRUMENTS, NAMELY, SCINTILLATORS AND PULSE COUNTERS (U.S. CLS. 21, 23, 26, 36 AND 38).

FIRST USE 4-15-2004; IN COMMERCE 5-9-2004.
IRENE D. WILLIAMS, EXAMINING ATTORNEY

CANCERCARE ONLINE

THE MARK CONSISTS OF STANDARD CHARACTERS WITHOUT CLAIM TO ANY PARTICULAR FONT, STYLE, SIZE, OR COLOR.

OWNER OF U.S. REG. NOS. 966,727 AND 2,635,878.

NO CLAIM IS MADE TO THE EXCLUSIVE RIGHT TO USE "ONLINE", APART FROM THE MARK AS SHOWN.

CLASS 41—EDUCATION AND ENTERTAINMENT

FOR CONDUCTING EDUCATIONAL WORKSHOPS VIA LIVE WORKSHOPS, TELEPHONE AND THE INTERNET ON THE SUBJECT OF CANCER FOR PEOPLE WITH CANCER, THEIR LOVED ONES, AND HEALTH CARE PROFESSIONALS (U.S. CLS. 100, 101 AND 107).

FIRST USE 7-1-2003; IN COMMERCE 7-1-2003.

CLASS 44—MEDICAL, BEAUTY AND AGRICULTURAL SERVICES

FOR PROVIDING INFORMATION ABOUT CANCER TO PEOPLE WITH CANCER, THEIR LOVED ONES, AND HEALTH CARE PROFESSIONALS VIA TELEPHONE AND THE INTERNET (U.S. CLS. 100 AND 101).

FIRST USE 7-1-2003; IN COMMERCE 7-1-2003.

CLASS 45—PERSONAL SERVICES

FOR PROVIDING EMOTIONAL SUPPORT AND PRACTICAL ASSISTANCE IN THE NATURE OF SUPPORT GROUPS AND COUNSELING TO PEOPLE WITH CANCER, THEIR LOVED ONES, AND HEALTH CARE PROFESSIONALS (U.S. CLS. 100 AND 101).

FIRST USE 7-1-2003; IN COMMERCE 7-1-2003.

C. DIONNE CLYBURN, EXAMINING ATTORNEY

SN 78-444,773. CANCER CARE, INC., NEW YORK, NY. FILED 7-1-2004.

CANCERCARE INFORM

THE MARK CONSISTS OF STANDARD CHARACTERS WITHOUT CLAIM TO ANY PARTICULAR FONT, STYLE, SIZE, OR COLOR.

OWNER OF U.S. REG. NOS. 966,727 AND 2,635,878.

NO CLAIM IS MADE TO THE EXCLUSIVE RIGHT TO USE "INFORM", APART FROM THE MARK AS SHOWN.

CLASS 16—PAPER GOODS AND PRINTED MATTER

FOR PRINTED PUBLICATIONS, NAMELY, BOOKLETS, NEWSLETTERS, FACT SHEETS AND BROCHURES FEATURING INFORMATION ABOUT CANCER (U.S. CLS. 2, 5, 22, 23, 29, 37, 38 AND 50).

FIRST USE 7-1-2003; IN COMMERCE 7-1-2003.

CLASS 41—EDUCATION AND ENTERTAINMENT

FOR CONDUCTING EDUCATIONAL WORKSHOPS VIA LIVE WORKSHOPS, TELEPHONE AND THE INTERNET ON THE SUBJECT OF CANCER FOR PEOPLE WITH CANCER, THEIR LOVED ONES, AND HEALTH CARE PROFESSIONALS (U.S. CLS. 100, 101 AND 107).

FIRST USE 7-1-2003; IN COMMERCE 7-1-2003.

CLASS 44—MEDICAL, BEAUTY AND AGRICULTURAL SERVICES

FOR PROVIDING INFORMATION ABOUT CANCER TO PEOPLE WITH CANCER, THEIR LOVED ONES, AND HEALTH CARE PROFESSIONALS VIA TELEPHONE AND THE INTERNET (U.S. CLS. 100 AND 101).

FIRST USE 7-1-2003; IN COMMERCE 7-1-2003.

C. DIONNE CLYBURN, EXAMINING ATTORNEY

SN 78-444,778. RICCA CHEMICAL COMPANY, LLC, PEQUANNOCK, NJ. FILED 7-1-2004.



NO CLAIM IS MADE TO THE EXCLUSIVE RIGHT TO USE "CHEMICAL COMPANY", APART FROM THE MARK AS SHOWN.

CLASS 1—CHEMICALS

FOR CHEMICALS AND CHEMICAL COMPOUNDS, NAMELY, IN-VITRO DIAGNOSTIC AND/OR CHEMICAL TESTING SOLUTIONS FOR SCIENTIFIC LABORATORY USE (U.S. CLS. 1, 5, 6, 10, 26 AND 46).

FIRST USE 2-1-1976; IN COMMERCE 2-1-1976.

CLASS 5—PHARMACEUTICALS

FOR CHEMICALS AND CHEMICAL COMPOUNDS, NAMELY, IN-VITRO DIAGNOSTIC AND/OR CHEMICAL TESTING SOLUTIONS FOR CLINICAL OR MEDICAL LABORATORY USE (U.S. CLS. 6, 18, 44, 46, 51 AND 52).

FIRST USE 2-1-1976; IN COMMERCE 2-1-1976.

ROBIN CHOSID, EXAMINING ATTORNEY

SN 78-444,810. RICCA CHEMICAL COMPANY, LLC, PEQUANNOCK, NJ. FILED 7-1-2004.



NO CLAIM IS MADE TO THE EXCLUSIVE RIGHT TO USE "CHEMICAL COMPANY", APART FROM THE MARK AS SHOWN.

CLASS 1—CHEMICALS

FOR CHEMICALS AND CHEMICAL COMPOUNDS, NAMELY, IN-VITRO DIAGNOSTIC AND/OR CHEMICAL TESTING SOLUTIONS FOR SCIENTIFIC LABORATORY USE (U.S. CLS. 1, 5, 6, 10, 26 AND 46).

FIRST USE 2-1-1976; IN COMMERCE 2-1-1976.

CLASS 5—PHARMACEUTICALS

FOR CHEMICALS AND CHEMICAL COMPOUNDS, NAMELY, IN-VITRO DIAGNOSTIC AND/OR CHEMICAL TESTING SOLUTIONS FOR CLINICAL OR MEDICAL LABORATORY USE (U.S. CLS. 6, 18, 44, 46, 51 AND 52).

FIRST USE 2-1-1976; IN COMMERCE 2-1-1976.

ROBIN CHOSID, EXAMINING ATTORNEY

SN 78-444,902. ALTIRIS, INC., LINDON, UT. FILED 7-1-2004.

MANAGEFUSION

THE MARK CONSISTS OF STANDARD CHARACTERS WITHOUT CLAIM TO ANY PARTICULAR FONT, STYLE, SIZE, OR COLOR.

CLASS 35—ADVERTISING AND BUSINESS

FOR ARRANGING AND CONDUCTING TRADE SHOWS IN THE FIELDS OF COMPUTER AND INFORMATION TECHNOLOGY (U.S. CLS. 100, 101 AND 102).

FIRST USE 6-2-2003; IN COMMERCE 6-2-2003.

CLASS 41—EDUCATION AND ENTERTAINMENT

FOR ARRANGING AND CONDUCTING EDUCATIONAL CONFERENCES IN THE FIELDS OF COMPUTER AND INFORMATION TECHNOLOGY (U.S. CLS. 100, 101 AND 107).

FIRST USE 6-2-2003; IN COMMERCE 6-2-2003.

ERNEST SHOSHO, EXAMINING ATTORNEY

SN 78-444,989. BELLA NOTTE LINENS, INC., NOVATO, CA. FILED 7-1-2004.

BELLA NOTTE

THE MARK CONSISTS OF STANDARD CHARACTERS WITHOUT CLAIM TO ANY PARTICULAR FONT, STYLE, SIZE, OR COLOR.

THE ENGLISH TRANSLATION OF THE WORD "BELLA NOTTE" IN THE MARK IS "BEAUTIFUL NIGHT".

CLASS 20—FURNITURE AND ARTICLES NOT OTHERWISE CLASSIFIED

FOR HOUSE MARK FOR A FULL LINE OF PILLOWS, NAMELY, BED BOLSTERS, BABY BOLSTERS, CRIB BUMPERS, CRIB PILLOWS, BED PILLOWS AND DECORATIVE THROW PILLOWS (U.S. CLS. 2, 13, 22, 25, 32 AND 50).

FIRST USE 2-14-2000; IN COMMERCE 2-14-2000.

CLASS 24—FABRICS

FOR HOUSE MARK FOR A FULL LINE OF BEDDING AND HOUSEHOLD LINENS NAMELY - DUVET COVERS, COVERLETS, PILLOW SHAMS, BOLSTER COVERS, PILLOW CASES, DUST RUFFLES, CURTAINS, AND BED BLANKETS; AND INFANT AND CHILDREN'S BEDDING NAMELY DUVET COVERS, CRIB BUMPER COVERS, BABY BOLSTER COVERS, SHEETS, DUST RUFFLES, RECEIVING BLANKETS, QUILTS, CRIB AND BED BLANKETS (U.S. CLS. 42 AND 50).

FIRST USE 12-13-1996; IN COMMERCE 1-8-1997.

CLASS 25—CLOTHING

FOR HOUSE MARK FOR A FULL LINE OF WOMEN'S AND GIRL'S LOUNGEWEAR NAMELY ROBES, KIMONOS, PANTS, SHIRTS, SHORTS, T-SHIRTS, CARDIGANS, TOPS, TANK TOPS, SKIRTS, SLIPS, DRESSES, JACKETS, PAJAMAS AND WRAPS (U.S. CLS. 22 AND 39).

FIRST USE 2-14-2000; IN COMMERCE 2-14-2000.
SUSAN STIGLITZ, EXAMINING ATTORNEY

SN 78-445,229. TRILEGIANT CORPORATION, NORWALK, CT. FILED 7-2-2004.

PC SafetyPlus

THE MARK CONSISTS OF STANDARD CHARACTERS WITHOUT CLAIM TO ANY PARTICULAR FONT, STYLE, SIZE, OR COLOR.

NO CLAIM IS MADE TO THE EXCLUSIVE RIGHT TO USE PC, APART FROM THE MARK AS SHOWN.

CLASS 9—ELECTRICAL AND SCIENTIFIC APPARATUS

FOR DOWNLOADABLE COMPUTER SOFTWARE, NAMELY ANTI-VIRUS SOFTWARE; FIREWALL SOFTWARE FOR PREVENTING INTRUSION AND HACKING; SOFTWARE FOR SCREENING AND BLOCKING UNWANTED E-MAIL, SOFTWARE FOR SCANNING COMPUTER HARD DRIVES, MEMORY AND OPERATING SYSTEM REGISTRIES, AND DETECTING, MONITORING, AND FACILITATING REMOVAL OF CERTAIN TYPES OF UNWANTED AND SURREPTITIOUS COMPUTER SOFTWARE FROM COMPUTER HARD DRIVES, MEMORY, AND OPERATING SYSTEM REGISTRIES; COMPUTER SOFTWARE FOR PROTECTING COMPUTER SYSTEMS FROM REMOTE MONITORING AND RECORDING OF COMPUTER-USER ACTIVITY; SOFTWARE FOR PROVIDING SECURITY FEATURES TO DETECT, IDENTIFY, BLOCK AND DELETE TROJAN HORSE PROGRAMS, ADVERTISING PROGRAMS, SYSTEM MONITOR AND OTHER SPYWARE PROGRAMS; AND SOFTWARE FOR USE IN STOPPING AND BLOCKING INTERNET POPUP ADVERTISEMENTS; AND SOFTWARE ALLOWING PARENTAL CONTROL OF INTERNET ACTIVITIES (U.S. CLS. 21, 23, 26, 36 AND 38).

CLASS 36—INSURANCE AND FINANCIAL

FOR ARRANGING FOR INSURANCE COVERAGE FOR DAMAGES CAUSED BY IDENTITY THEFT AND COMPUTER VIRUSES AND OTHER COMPUTER AND SOFTWARE INTRUSIONS AND SECURITY PROBLEMS; PROVIDING REIMBURSEMENT PROGRAMS FOR REPAIRING DAMAGE TO COMPUTERS CAUSED BY COMPUTER VIRUSES AND OTHER COMPUTER AND SOFTWARE INTRUSIONS AND SECURITY PROBLEMS, NAMELY IDENTITY THEFT AND DAMAGE TO CREDIT HISTORY (U.S. CLS. 100, 101 AND 102).

CLASS 42—SCIENTIFIC, COMPUTER AND LEGAL SERVICES

FOR TECHNICAL COMPUTER SUPPORT SERVICES FOR THE DOWNLOADING, INSTALLATION AND RUNNING OF SECURITY SOFTWARE APPLICATIONS, SCREENING AND BLOCKING UNWANTED E-MAIL, AND PARENTAL CONTROLS OF INTERNET ACTIVITIES PROVIDED BY TELEPHONE, E-MAIL, AND ON-LINE VIA THE INTERNET (U.S. CLS. 100 AND 101).

CLASS 45—PERSONAL SERVICES

FOR PERSONAL SUPPORT SERVICES IN THE FIELD OF PREVENTING AND ASSISTING WITH REPAIRING DAMAGE CAUSED BY IDENTITY THEFT AND DAMAGE TO CREDIT HISTORY PROVIDED BY TELEPHONE, E-MAIL, AND ON-LINE VIA THE INTERNET (U.S. CLS. 100 AND 101).

JEFF DEFORD, EXAMINING ATTORNEY

SN 78-446,465. IT'S YOUR WINERY, LLC, AKRON, OH. FILED 7-6-2004.

It's Your Winery

NO CLAIM IS MADE TO THE EXCLUSIVE RIGHT TO USE "WINERY", APART FROM THE MARK AS SHOWN.

CLASS 35—ADVERTISING AND BUSINESS

FOR RETAIL-RETAIL STORE SERVICES, MAIL ORDER SERVICES, AND ON-LINE RETAIL STORE SERVICES FEATURING WINES AND RELATED ACCESSORIES. (U.S. CLS. 100, 101 AND 102).

SN 78-447,782. SLEEVER INTERNATIONAL COMPANY, MORANGIS, FRANCE, FILED 7-8-2004.

CLASS 40—MATERIAL TREATMENT

FOR CUSTOM MANUFACTURE OF WINES (U.S. CLS. 100, 103 AND 106).
KATHY DE JONGE, EXAMINING ATTORNEY

SN 78-446,787. PACIFIC INSTITUTE OF CULINARY ARTS INC., VANCOUVER, BRITISH COLUMBIA, CANADA, FILED 7-7-2004.

DIGISLEEVE

PACIFIC INSTITUTE
OF CULINARY
ARTS

THE MARK CONSISTS OF STANDARD CHARACTERS WITHOUT CLAIM TO ANY PARTICULAR FONT, STYLE, SIZE, OR COLOR.

OWNER OF CANADA REG. NO. TMA483765, DATED 10-8-1997, EXPIRES 10-8-2012.

OWNER OF U.S. REG. NO. 2,339,495.

NO CLAIM IS MADE TO THE EXCLUSIVE RIGHT TO USE "INSTITUTE OF CULINARY ARTS", APART FROM THE MARK AS SHOWN.

CLASS 41—EDUCATION AND ENTERTAINMENT

FOR (BASED ON INTENT TO USE) (BASED ON 44(E)) EDUCATIONAL SERVICES, NAMELY, CONDUCTING COURSES OF INSTRUCTION, SEMINARS AND DEMONSTRATIONS IN THE FIELDS OF CULINARY ARTS AND THE MANAGEMENT AND OPERATION OF RESTAURANTS (BASED ON INTENT TO USE) EDUCATIONAL SERVICES, NAMELY, CONDUCTING COURSES OF INSTRUCTION, SEMINARS AND DEMONSTRATIONS IN THE FIELD OF THE MANAGEMENT AND OPERATION OF BAKESHOPS (U.S. CLS. 100, 101 AND 107).

CLASS 43—HOTEL AND RESTAURANT SERVICES

FOR PROVIDING ON-LINE INFORMATION RELATING TO FOOD, BEVERAGE, COOKING, BAKING AND RECIPES (U.S. CLS. 100 AND 101).

MARY ROSSMAN, EXAMINING ATTORNEY

THE MARK CONSISTS OF STANDARD CHARACTERS WITHOUT CLAIM TO ANY PARTICULAR FONT, STYLE, SIZE, OR COLOR.

OWNER OF FRANCE REG. NO. 043271543, DATED 2-4-2004, EXPIRES 2-4-2014.

OWNER OF U.S. REG. NO. 1,276,722.

CLASS 16—PAPER GOODS AND PRINTED MATTER

FOR PACKAGING PRODUCTS, NAMELY, FILMS, BANDS, SHELLS, ENVELOPES, TUBES OF HEAT SHRINKABLE PLASTIC TO BE APPLIED ONTO OBJECTS OR GROUPS OF OBJECTS FOR IDENTIFICATION, DECORATION, BANDING OR GATHERING PURPOSES, ALL FOR DOMESTIC USE (U.S. CLS. 2, 5, 22, 23, 29, 37, 38 AND 50).

CLASS 17—RUBBER GOODS

FOR PACKAGING PRODUCTS, NAMELY, FILMS, BANDS, SHELLS, ENVELOPES, TUBES OF HEAT SHRINKABLE PLASTIC TO BE APPLIED ONTO CONTAINERS, FLASKS, BOTTLES, CAPS AND CLOSURE DEVICES FOR SAFETY AND INVOLABILITY PURPOSES, ALL FOR INDUSTRIAL AND/OR COMMERCIAL USE (U.S. CLS. 1, 5, 12, 13, 35 AND 50).

GISELLE AGOSTO, EXAMINING ATTORNEY

SN 78-448,393. DON IMUS WFAN PEDIATRIC CENTER FOR TOMORROWS CHILDREN, HACKENSACK, NJ. FILED 7-9-2004.



CLASS 36—INSURANCE AND FINANCIAL

FOR CHARITABLE SERVICES IN THE FIELDS OF ACCEPTING AND ADMINISTERING MONETARY CHARITABLE CONTRIBUTIONS TO PROVIDE FINANCIAL ASSISTANCE TO PATIENTS AND THEIR FAMILIES AND ACCEPTING AND ADMINISTERING MONETARY CHARITABLE CONTRIBUTIONS TO FUND MEDICAL RESEARCH IN THE FIELD OF CHILDHOOD ILLNESS (U.S. CLS. 100, 101 AND 102).
FIRST USE 6-30-2004; IN COMMERCE 6-30-2004.

CLASS 44—MEDICAL, BEAUTY AND AGRICULTURAL SERVICES

FOR CHARITABLE SERVICES, NAMELY, PROVIDING PSYCHOLOGICAL COUNSELING SERVICES IN THE FIELD OF CHILDHOOD DISEASES TO PATIENTS AND THEIR FAMILIES (U.S. CLS. 100 AND 101).
FIRST USE 6-30-2004; IN COMMERCE 6-30-2004.
DOUGLAS LEE, EXAMINING ATTORNEY

SN 78-450,113. STEPHEN L. LAFRANCE HOLDINGS, INC., PINE BLUFF, AR. FILED 7-13-2004.

USADRUG.COM

THE MARK CONSISTS OF STANDARD CHARACTERS WITHOUT CLAIM TO ANY PARTICULAR FONT, STYLE, SIZE, OR COLOR.
OWNER OF U.S. REG. NOS. 2,587,074, 2,769,408 AND OTHERS.
SEC. 2(F).

CLASS 35—ADVERTISING AND BUSINESS

FOR PROVIDING ON-LINE PHARMACY SERVICES; ON-LINE RETAIL DRUG STORES; ON-LINE RETAIL STORE SERVICES IN THE FIELD OF PRESCRIPTION REFILLS AND HEALTH AIDS (U.S. CLS. 100, 101 AND 102).
FIRST USE 3-0-2001; IN COMMERCE 3-0-2001.

CLASS 40—MATERIAL TREATMENT

FOR PHOTO PROCESSING SERVICES (U.S. CLS. 100, 103 AND 106).
FIRST USE 2-0-2001; IN COMMERCE 2-0-2001.
ANDREW BENZMILLER, EXAMINING ATTORNEY

SN 78-450,356. ENDODONTIC EDUCATION SEMINARS, LLC, WEST PALM BEACH, FL. FILED 7-14-2004.



OWNER OF U.S. REG. NOS. 2,850,783 AND 2,873,076.
NO CLAIM IS MADE TO THE EXCLUSIVE RIGHT TO USE "ENDO", APART FROM THE MARK AS SHOWN.
THE MARK CONSISTS OF A PICTURE OF A WORLD GLOBE WITH A BANNER CONTAINING THE WORDS REAL WORLD ENDO.

CLASS 9—ELECTRICAL AND SCIENTIFIC APPARATUS

FOR PRERECORDED AUDIO AND VIDEO TAPES AND DVD'S FEATURING EDUCATIONAL SEMINARS IN THE FIELD OF ENDODONTICS (U.S. CLS. 21, 23, 26, 36 AND 38).
FIRST USE 1-3-2003; IN COMMERCE 1-3-2003.

CLASS 16—PAPER GOODS AND PRINTED MATTER

FOR PRINTED MATTER, NAMELY BOOKS AND MANUALS ON THE TOPIC OF ENDODONTICS (U.S. CLS. 2, 5, 22, 23, 29, 37, 38 AND 50).
FIRST USE 9-30-2001; IN COMMERCE 9-30-2001.
TRACY WHITAKER-BOWN, EXAMINING ATTORNEY

SN 78-450,473. LET'S DISH!, INC., SAVAGE, MN. FILED 7-14-2004.

LET'S DISH!

THE MARK CONSISTS OF STANDARD CHARACTERS WITHOUT CLAIM TO ANY PARTICULAR FONT, STYLE, SIZE, OR COLOR.

CLASS 35—ADVERTISING AND BUSINESS

FOR LICENSING SERVICES IN THE FIELD OF FOOD SERVICES THAT ALLOW CUSTOMERS TO MAKE MULTIPLE MEALS AT ONE TIME (U.S. CLS. 100, 101 AND 102).

FIRST USE 9-1-2003; IN COMMERCE 9-1-2003.

SN 78-450,580. PIPEDREAM PRODUCTS, INC., CANOGA PARK, CA. FILED 7-14-2004.

CLASS 43—HOTEL AND RESTAURANT SERVICES

FOR MEAL PREPARATION ASSISTANCE SERVICES FOR OTHERS (U.S. CLS. 100 AND 101).

FIRST USE 9-1-2003; IN COMMERCE 9-1-2003.
SHARI SHEFFIELD, EXAMINING ATTORNEY

**MONICA
SWEETHEART'S**

SN 78-450,502. GEN-PROBE INCORPORATED, SAN DIEGO, CA. FILED 7-14-2004.

SB100

THE MARK CONSISTS OF STANDARD CHARACTERS WITHOUT CLAIM TO ANY PARTICULAR FONT, STYLE, SIZE, OR COLOR.

MONICA SWEETHEART IDENTIFIES A PARTICULAR INDIVIDUAL WHOSE CONSENT IS OF RECORD

THE MARK CONSISTS OF STANDARD CHARACTERS WITHOUT CLAIM TO ANY PARTICULAR FONT, STYLE, SIZE, OR COLOR.

CLASS 9—ELECTRICAL AND SCIENTIFIC APPARATUS

FOR LABORATORY INCUBATOR AND MIXING APPARATUS FOR CHEMICAL SOLUTIONS FOR LABORATORY USE, AND PARTS, ACCESSORIES IN THE NATURE OF TUBE RACK HOLD-DOWN PLATE, AND OPERATING SOFTWARE SOLD IN CONNECTION WITH THE AFOREMENTIONED GOODS (U.S. CLS. 21, 23, 26, 36 AND 38).

FIRST USE 7-6-2004; IN COMMERCE 7-6-2004.

CLASS 10—MEDICAL APPARATUS

FOR MASSAGE DEVICES, NAMELY, DEVICES FOR MASSAGING OR VIBRATING PORTIONS OF THE FACE AND BODY AND PACIFIERS FOR MASSAGING THE LIPS; DEVICES FOR AIDING IN COPULATION AND MASTURBATION, NAMELY, REPRODUCTION OF PARTS OF THE MALE AND FEMALE ANATOMY, PENISES, VAGINAS, PUMPS, RINGS, CLAMPS, STIMULATORS, VIBRATORS, DILDOS, DONGS, BUTT PLUGS, SLEEVES ON VIBRATORS SOLD TOGETHER WITH THE MASSAGING DEVICES, HARNESSES, MASTURBATORS, NIPPLE CLIPPERS, BODY PROSTHESES, ELECTRICAL APPLIANCES FOR MASSAGING THE BODY, KITS COMPRISED OF TWO OR MORE OF THESE PRODUCTS; SEXUAL AIDS, INFLATABLE LOVE DOLLS; CONDOMS AND MINIATURE CONDOMS; PACIFIERS FOR USE BY ADULTS (U.S. CLS. 26, 39 AND 44).

FIRST USE 3-26-2004; IN COMMERCE 3-26-2004.

CLASS 25—CLOTHING

FOR EROTIC LINGERIE FOR MEN AND WOMEN; FANTASY LEATHER WEAR, NAMELY, BODY SUITS, PANTS, TOPS, BELTS, STRAPS, HOODS, MASKS, BLINDFOLDS, GAGS IN THE NATURE OF A LEATHER STRAP WITH A BALL ATTACHED WHICH IS USED TO TIE AROUND A PERSON'S MOUTH, COLLARS, AND CUFFS; UNDERWEAR (U.S. CLS. 22 AND 39).

FIRST USE 3-26-2004; IN COMMERCE 3-26-2004.

CLASS 10—MEDICAL APPARATUS

FOR MEDICAL LABORATORY INCUBATOR AND MIXING APPARATUS FOR USE WITH DIAGNOSTIC ASSAY PROCEDURES FOR MEDICAL USE (U.S. CLS. 26, 39 AND 44).

FIRST USE 7-6-2004; IN COMMERCE 7-6-2004.
GINNY ISAACSON, EXAMINING ATTORNEY

CLASS 29—MEATS AND PROCESSED FOODS

FOR EDIBLE FRUIT-BASED FOOD PRODUCT, NAMELY, LIQUIDS AND GELS USED AS SEXUAL AIDS (U.S. CL. 46).

FIRST USE 3-26-2004; IN COMMERCE 3-26-2004.
AMY GEARIN, EXAMINING ATTORNEY

SN 78-450,598. SHURFINE FOODS, INC., TIGARD, OR.
FILED 7-14-2004.

SHURFRESH

THE MARK CONSISTS OF STANDARD CHARACTERS WITHOUT CLAIM TO ANY PARTICULAR FONT, STYLE, SIZE, OR COLOR.

OWNER OF U.S. REG. NOS. 663,880, 945,843 AND OTHERS.

CLASS 30—STAPLE FOODS

FOR SANDWICHES (U.S. CL. 46).
FIRST USE 3-1-1997; IN COMMERCE 3-1-1997.

CLASS 43—HOTEL AND RESTAURANT SERVICES

FOR FOOD SERVICES, NAMELY, RESTAURANT SERVICES FEATURING SANDWICHES (U.S. CLS. 100 AND 101).

FIRST USE 3-1-1997; IN COMMERCE 3-1-1997.
REBECCA GILBERT, EXAMINING ATTORNEY

SN 78-450,889. THE COWABUNGA CORPORATION, LAGUNA HILLS, CA. FILED 7-14-2004.

COWABUNGA

THE MARK CONSISTS OF STANDARD CHARACTERS WITHOUT CLAIM TO ANY PARTICULAR FONT, STYLE, SIZE, OR COLOR.

OWNER OF U.S. REG. NO. 2,468,134.

CLASS 18—LEATHER GOODS

FOR BAGS, NAMELY, CARRY BAGS, TOTE BAGS, LUGGAGE CASES, TRAVEL BAGS, ATHLETIC BAGS, BEACH BAGS, GYM BAGS, DUFFEL BAGS, PACKS, NAMELY, FANNY PACKS, SPORTS PACKS, KNAPSACKS, AND BACKPACKS, SHOULDER BAGS, WAIST BAGS, HANDBAGS, BRIEFCASES, WALLETS, PURSES, UMBRELLAS (U.S. CLS. 1, 2, 3, 22 AND 41).

CLASS 24—FABRICS

FOR TEXTILES AND FABRICS, NAMELY BED LINENS, BEDSHEETS, BEDSPREADS, CURTAINS, TOWELS AND BED PILLOW COVERS (U.S. CLS. 42 AND 50).

CLASS 25—CLOTHING

FOR WET SUITS, WET SUIT VESTS, WET SUIT TROUSERS, WET SUIT SHORTS AND WET SUIT BOOTIES (U.S. CLS. 22 AND 39).

CLASS 28—TOYS AND SPORTING GOODS

FOR SURFBOARDS AND SURFBOARD ACCESSORIES, NAMELY SURFBOARD LEASHES, SURFBOARD COVERS, SURFBOARD NOSE PROTECTORS, SURFBOARD SOCKS, SURFBOARD FINS, SURF FINS, SURFBOARD WAX, SKIN SURFBOARDS, BODYBOARDS; SAILBOARDS; SKATEBOARDS, SKATEBOARD ACCESSORIES, NAMELY, SKATEBOARD DECKS, SKATEBOARD TRUCKS, SKATEBOARD WHEEL ASSEMBLIES AND SKATEBOARD WHEELS; PROTECTIVE PADS AND PADDING FOR SKATEBOARDING; WATER SKIS, SNOW SKIS (U.S. CLS. 22, 23, 38 AND 50).

JULIE GUTTADAURO, EXAMINING ATTORNEY

SN 78-451,101. AMERICAN FEDERATION OF TELEVISION AND RADIO ARTISTS, NEW YORK, NY. FILED 7-15-2004.

Your Voice in
Music,
Entertainment and
News &
Information- Your
Union

THE MARK CONSISTS OF STANDARD CHARACTERS WITHOUT CLAIM TO ANY PARTICULAR FONT, STYLE, SIZE, OR COLOR.

CLASS 16—PAPER GOODS AND PRINTED MATTER

FOR PUBLICATION, NAMELY MAGAZINES, BROCHURES, PAMPHLETS, AND NEWSLETTERS FOR PERFORMERS, JOURNALISTS AND OTHER ARTISTS IN THE FIELDS OF TELEVISION, RADIO, SOUND RECORDINGS, AND "NON-BROADCAST," INDUSTRIAL, INTERNET AND DIGITAL PROGRAMMING (U.S. CLS. 2, 5, 22, 23, 29, 37, 38 AND 50).

FIRST USE 4-0-2004; IN COMMERCE 4-0-2004.

CLASS 35—ADVERTISING AND BUSINESS

FOR ASSOCIATION SERVICES, NAMELY PROMOTING THE INTERESTS OF PERFORMERS, JOURNALISTS AND OTHER ARTISTS IN THE FIELDS OF TELEVISION, RADIO, SOUND RECORDINGS, AND "NON-BROADCAST", INDUSTRIAL, INTERNET AND DIGITAL PROGRAMMING (U.S. CLS. 100, 101 AND 102).

FIRST USE 4-0-2004; IN COMMERCE 4-0-2004.
DOUGLAS LEE, EXAMINING ATTORNEY

SN 78-451,173. SOAPBOX LLC, DBA SOAPBOX CONSULTING LLC, WASHINGTON, DC. FILED 7-15-2004.



NO CLAIM IS MADE TO THE EXCLUSIVE RIGHT TO USE "CONSULTING", APART FROM THE MARK AS SHOWN.

THE MARK CONSISTS OF THE WORDS, SOAPBOX CONSULTING, IN WHITE LETTERING ON A SOLID BLACK BACKGROUND.

CLASS 35—ADVERTISING AND BUSINESS

FOR CONSULTATION AND LOBBYING SERVICES IN THE FIELD OF GRASSROOTS POLITICS (U.S. CLS. 100, 101 AND 102).

FIRST USE 2-1-1997; IN COMMERCE 2-1-1997.

CLASS 41—EDUCATION AND ENTERTAINMENT

FOR CONDUCTING TRAINING WORKSHOPS, SEMINARS AND INDIVIDUAL TRAINING SESSIONS IN GRASSROOTS POLITICS (U.S. CLS. 100, 101 AND 107).

FIRST USE 2-1-1997; IN COMMERCE 2-1-1997.

RICHARD A. STRASER, EXAMINING ATTORNEY

CLASS 41—EDUCATION AND ENTERTAINMENT

FOR PROVIDING INFORMATION FOR TEACHERS, PARENTS AND OTHER PROFESSIONALS IN THE FIELD OF EDUCATION BY MEANS OF A GLOBAL COMPUTER NETWORK; PROVIDING AN ONLINE ELECTRONIC DATABASE ON THE INTERNET IN THE FIELDS OF EDUCATION AND TRAINING, PARENTING, COUNSELING, AND CHILD DEVELOPMENT AT THE EARLY CHILDHOOD, PRIMARY, SECONDARY, AND ADULT LEVELS; PROVIDING LINKS TO WEB SITES OF OTHERS IN THE FIELDS OF EDUCATION AND TRAINING, PARENTING, COUNSELING, AND CHILD DEVELOPMENT AT THE EARLY CHILDHOOD, PRIMARY, SECONDARY, AND ADULT LEVELS (U.S. CLS. 100, 101 AND 107).

FIRST USE 4-16-2004; IN COMMERCE 4-16-2004.

KARLA PERKINS, EXAMINING ATTORNEY

SN 78-452,033. STAGECOACH GROUP PLC, PERTH, UNITED KINGDOM, FILED 7-16-2004.

MEGABUS

SN 78-451,542. HEIN, GEORGE, CUPERTINO, CA. FILED 7-15-2004.



THE MARK CONSISTS OF THE STYLIZED LETTERS P AND T. THE VOID BETWEEN THE LETTERS FORMS A HUMAN FIGURE WITH RAISED ARM.

CLASS 38—COMMUNICATION

FOR PROVIDING ONLINE ELECTRONIC BULLETIN BOARDS FOR TRANSMISSION OF MESSAGES AMONG COMPUTER USERS CONCERNING INFORMATION FOR TEACHERS, PARENTS AND OTHER PROFESSIONALS IN THE FIELDS OF EDUCATION AND TRAINING, PARENTING, COUNSELING, AND CHILD DEVELOPMENT, AND STUDENTS AT THE EARLY CHILDHOOD, PRIMARY, SECONDARY, AND ADULT LEVELS (U.S. CLS. 100, 101 AND 104).

FIRST USE 4-16-2004; IN COMMERCE 4-16-2004.

THE MARK CONSISTS OF STANDARD CHARACTERS WITHOUT CLAIM TO ANY PARTICULAR FONT, STYLE, SIZE, OR COLOR.

PRIORITY CLAIMED UNDER SEC. 44(D) ON UNITED KINGDOM APPLICATION NO. 2368349, FILED 7-16-2004, REG. NO. 2368349, DATED 7-16-2004, EXPIRES 7-16-2014.

CLASS 16—PAPER GOODS AND PRINTED MATTER

FOR PRINTED MATTER AND PRINTED PUBLICATIONS; NAMELY, LEAFLETS, BROCHURES, BOOKLETS, AND MANUALS ON THE SUBJECT OF BUS TRANSPORTATION, TRAVEL SCHEDULES AND PASSENGER SERVICES, PRINTED LABELS, PRINTED TICKETS, VOUCHER BOOKS, AND PRINTED TIMETABLES (U.S. CLS. 2, 5, 22, 23, 29, 37, 38 AND 50).

CLASS 39—TRANSPORTATION AND STORAGE

FOR BUS TRANSPORT, TRANSPORTATION OF PASSENGERS BY BUS AND COACH, CO-ORDINATING TRAVEL ARRANGEMENTS FOR INDIVIDUALS, TOUR GROUPS AND BUSINESSES, BOOKING OF SEATS FOR TRAVEL, PROVIDING TRAVEL INFORMATION (U.S. CLS. 100 AND 105).

AMOS T. MATTHEWS, JR., EXAMINING ATTORNEY

SN 78-452,158. ROBIN HOOD FOUNDATION, NEW YORK, NY. FILED 7-16-2004.

SN 78-452,193. NATIONAL COLLEGIATE ATHLETIC ASSOCIATION, INDIANAPOLIS, IN. FILED 7-16-2004.

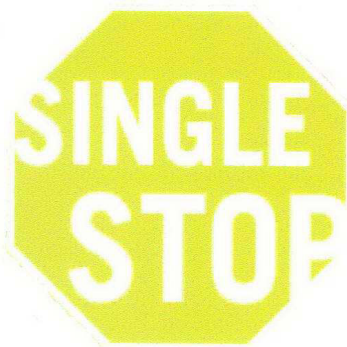

THE COLOR(S) GREEN IS/ARE CLAIMED AS A FEATURE OF THE MARK.

THE MARK CONSISTS OF A GREEN STOP SIGN WITH WHITE LETTERING.

CLASS 36—INSURANCE AND FINANCIAL

FOR CHARITABLE SERVICES IN THE NATURE OF PROVIDING FREE COUNSELING REGARDING OBTAINING FINANCIAL BENEFITS, NAMELY, GOVERNMENT BENEFITS AND ENTITLEMENTS, PUBLIC ASSISTANCE, FOOD STAMPS, HOUSING, HEALTHCARE, SCHOOL LUNCH, HEATING ASSISTANCE, MEDICAID AND SOCIAL SECURITY DISABILITY TO LOW-INCOME FAMILIES; CHARITABLE SERVICES IN THE NATURE OF PROVIDING FREE FINANCIAL SERVICES, NAMELY FINANCIAL COUNSELING, FINANCIAL PLANNING, DEBT COUNSELING, TAX CONSULTATION, CREDIT REPAIR TO LOW INCOME FAMILIES (U.S. CLS. 100, 101 AND 102).

FIRST USE 10-1-2003; IN COMMERCE 4-20-2004.

CLASS 42—SCIENTIFIC, COMPUTER AND LEGAL SERVICES

FOR CHARITABLE SERVICES IN THE NATURE OF PROVIDING FREE LEGAL SERVICES TO LOW-INCOME FAMILIES; CHARITABLE SERVICES IN THE NATURE OF PROVIDING FREE LEGAL COUNSELING IN THE AREAS OF LANDLORD/TENANT, CHILD CUSTODY/SUPPORT, DOMESTIC VIOLENCE, DIVORCE, IMMIGRATION, EMPLOYMENT, AND IN OBTAINING GOVERNMENT BENEFITS AND ENTITLEMENTS, PUBLIC ASSISTANCE, FOOD STAMPS, HOUSING, HEALTHCARE, SCHOOL LUNCH, HEATING ASSISTANCE, MEDICAID AND SOCIAL SECURITY DISABILITY TO LOW-INCOME FAMILIES (U.S. CLS. 100 AND 101).

FIRST USE 10-1-2003; IN COMMERCE 4-20-2004.

CLASS 44—MEDICAL, BEAUTY AND AGRICULTURAL SERVICES

FOR CHARITABLE SERVICES IN THE NATURE OF PROVIDING FREE PSYCHOLOGICAL COUNSELING AND COUNSELING REGARDING DOMESTIC VIOLENCE, MENTAL HEALTH CARE, HOMELESSNESS, SUBSTANCE ABUSE, MEDICAID AND HEALTHCARE TO LOW-INCOME FAMILIES (U.S. CLS. 100 AND 101).

FIRST USE 10-1-2003; IN COMMERCE 4-20-2004.
SUE LAWRENCE, EXAMINING ATTORNEY

J.J. JUMPER

THE MARK CONSISTS OF STANDARD CHARACTERS WITHOUT CLAIM TO ANY PARTICULAR FONT, STYLE, SIZE, OR COLOR.

OWNER OF U.S. REG. NO. 2,678,583.

CLASS 16—PAPER GOODS AND PRINTED MATTER

FOR PRINTED MATTER, NAMELY, SOUVENIR PROGRAMS FOR INTERCOLLEGIATE CHAMPIONSHIPS AND TOURNAMENTS, BROCHURES AND NEWSPAPERS DIRECTED TO SPORTS, POSTERS, PLASTIC SHOPPING BAGS, STAT CARDS, WINDOW CLINGS, AUTOGRAPH CARDS, HANDBILLS AND WRITING INSTRUMENTS, NAMELY, PENS AND PENCILS (U.S. CLS. 2, 5, 22, 23, 29, 37, 38 AND 50).

FIRST USE 1-1-2004; IN COMMERCE 1-1-2004.

CLASS 18—LEATHER GOODS

FOR BACKPACKS AND ATHLETIC BAGS (U.S. CLS. 1, 2, 3, 22 AND 41).

FIRST USE 10-1-2003; IN COMMERCE 1-6-2004.

CLASS 25—CLOTHING

FOR CLOTHING, NAMELY, SHIRTS, SHORTS, SWEATSHIRTS, SWEATPANTS, PANTS, JACKETS, COATS, CAPS AND HATS (U.S. CLS. 22 AND 39).

FIRST USE 2-1-2004; IN COMMERCE 2-1-2004.

CLASS 28—TOYS AND SPORTING GOODS

FOR TOYS AND SPORTING GOODS, NAMELY, BASKETBALLS, RUBBER ACTION BALLS, MINIATURE TOY BASKETBALLS, BACKBOARDS AND BASKETBALL HOOPS, BOBBLEHEADS, PLUSH TOYS AND COLLECTIBLES (U.S. CLS. 22, 23, 38 AND 50).

FIRST USE 1-1-2004; IN COMMERCE 1-1-2004.
ZACHARY BELLO, EXAMINING ATTORNEY

SN 78-452,249. CANNON RUBBER LIMITED, NEW SOUTH-GATE LONDON, UNITED KINGDOM, FILED 7-16-2004.

CLASS 37—CONSTRUCTION AND REPAIR

FOR CONSTRUCTION AND INSTALLATION OF PREFABRICATED AND COMPONENT HOUSES (U.S. CLS. 100, 103 AND 106).
FIRST USE 12-31-1991; IN COMMERCE 12-31-1991.
SCOTT OSLICK, EXAMINING ATTORNEY

ISIS IQ

SN 78-453,977. CBR SYSTEMS, INC., SAN BRUNO, CA. FILED 7-21-2004.

DESIGNATED
TRANSPLANT
PROGRAM

THE MARK CONSISTS OF STANDARD CHARACTERS WITHOUT CLAIM TO ANY PARTICULAR FONT, STYLE, SIZE, OR COLOR.
OWNER OF U.S. REG. NOS. 2,216,735 AND 2,216,736.

THE MARK CONSISTS OF STANDARD CHARACTERS WITHOUT CLAIM TO ANY PARTICULAR FONT, STYLE, SIZE, OR COLOR.
NO CLAIM IS MADE TO THE EXCLUSIVE RIGHT TO USE "TRANSPLANT PROGRAM", APART FROM THE MARK AS SHOWN.

CLASS 10—MEDICAL APPARATUS

FOR FEEDING BOTTLES; TEATS; SOOTHERS AND TEETHING RINGS, ALL FOR BABIES; SPOONS FOR ADMINISTERING MEDICINE; CUPS ADAPTED FOR FEEDING BABIES AND CHILDREN; SPOUTS FOR CUPS ADAPTED FOR FEEDING BABIES AND CHILDREN; INCUBATORS FOR BABIES; BREAST PUMPS; NURSING APPLIANCES FOR USE IN BREAST FEEDING; NIPPLE PROTECTORS FOR USE BEFORE, DURING, AND AFTER BREAST-FEEDING; PARTS AND FITTINGS FOR FEEDING BOTTLES, FEEDING CUPS, AND BREAST PUMPS (U.S. CLS. 26, 39 AND 44).

CLASS 39—TRANSPORTATION AND STORAGE

FOR TRANSPORTATION AND STORAGE OF BLOOD, BLOOD COMPONENTS AND STEM CELLS (U.S. CLS. 100 AND 105).
FIRST USE 2-1-1997; IN COMMERCE 2-1-1997.

CLASS 11—ENVIRONMENTAL CONTROL APPARATUS

FOR STERILIZERS; BABY FOOD AND BABY MILK WARMERS; PARTS AND FITTINGS FOR ALL THE AFORESAID GOODS (U.S. CLS. 13, 21, 23, 31 AND 34).
INGRID C. EULIN, EXAMINING ATTORNEY

CLASS 44—MEDICAL, BEAUTY AND AGRICULTURAL SERVICES

FOR MEDICAL SERVICES, NAMELY, THE COLLECTION, TESTING, PROCESSING AND PRESERVATION OF BLOOD, BLOOD COMPONENTS AND STEM CELLS (U.S. CLS. 100 AND 101).
FIRST USE 2-1-1997; IN COMMERCE 2-1-1997.
LINDA E. BLOHM, EXAMINING ATTORNEY

SN 78-453,927. WARDCRAFT HOMES, INC., CLAY CENTER, KS. FILED 7-21-2004.

SN 78-454,110. FOCUSED FITNESS, LLC, SPOKANE, WA. FILED 7-21-2004.

WARDCRAFT
HOMES

FIVE FOR LIFE
PROGRAM

NO CLAIM IS MADE TO THE EXCLUSIVE RIGHT TO USE "HOMES", APART FROM THE MARK AS SHOWN.
THE MARK CONSISTS OF THE LITERAL ELEMENT WARDCRAFT HOMES IN STYLIZED DESIGN.

THE MARK CONSISTS OF STANDARD CHARACTERS WITHOUT CLAIM TO ANY PARTICULAR FONT, STYLE, SIZE, OR COLOR.
NO CLAIM IS MADE TO THE EXCLUSIVE RIGHT TO USE "PROGRAM", APART FROM THE MARK AS SHOWN.

CLASS 19—NON-METALLIC BUILDING MATERIALS

FOR PREFABRICATED AND PREASSEMBLED HOMES (U.S. CLS. 1, 12, 33 AND 50).
FIRST USE 12-31-1991; IN COMMERCE 12-31-1991.

CLASS 9—ELECTRICAL AND SCIENTIFIC APPARATUS

FOR PRE-RECORDED DVDS AND CD-ROMS FEATURING EDUCATIONAL MATERIALS IN THE FIELDS OF NUTRITIONAL COUNSELING AND PHYSICAL FITNESS ; PRE-RECORDED VHS TAPES FEATURING EDUCATIONAL MATERIALS IN THE FIELDS OF NUTRITIONAL COUNSELING AND PHYSICAL FITNESS (U.S. CLS. 21, 23, 26, 36 AND 38).
FIRST USE 6-0-2003; IN COMMERCE 6-0-2003.

CLASS 16—PAPER GOODS AND PRINTED MATTER

FOR PRINTED EDUCATIONAL MATERIALS, NAMELY, BROCHURES, MAGAZINES, NEWSLETTERS AND KITS COMPRISED OF GUIDES AND LESSON MATERIALS FEATURING NUTRITIONAL COUNSELING AND PHYSICAL FITNESS (U.S. CLS. 2, 5, 22, 23, 29, 37, 38 AND 50).
FIRST USE 6-0-2003; IN COMMERCE 6-0-2003.

CLASS 41—EDUCATION AND ENTERTAINMENT

FOR EDUCATIONAL SERVICES, NAMELY, CONDUCTING TRAINING WORKSHOPS FEATURING PHYSICAL FITNESS CONSULTATION AND DISTRIBUTING PRINTED COURSE MATERIALS IN CONNECTION THEREWITH; AND PROVIDING A WEB SITE FEATURING INFORMATION REGARDING PHYSICAL FITNESS (U.S. CLS. 100, 101 AND 107).
FIRST USE 6-0-2003; IN COMMERCE 6-0-2003.
KIMBERLY PERRY, EXAMINING ATTORNEY

CLASS 41—EDUCATION AND ENTERTAINMENT

FOR FINANCIAL EDUCATION SERVICES, NAMELY, CONDUCTING ACTUAL AND ONLINE CLASSES, WORKSHOPS; SEMINARS IN THE AREAS OF FINANCIAL PLANNING, RETIREMENT PLANNING, INVESTMENTS AND RELATED FINANCIAL MATTERS (U.S. CLS. 100, 101 AND 107).
MARGERY A. TIERNEY, EXAMINING ATTORNEY

SN 78-454,688. NETRANOM COMMUNICATIONS, INC., HURRICANE, WV. FILED 7-22-2004.



NO CLAIM IS MADE TO THE EXCLUSIVE RIGHT TO USE "COMMUNICATIONS", APART FROM THE MARK AS SHOWN.

CLASS 38—COMMUNICATION

FOR TELECOMMUNICATIONS CONSULTATION, NAMELY, CONSULTATION REGARDING TRADITIONAL AND E-BUSINESS ANALYSIS, STRATEGIC PLANNING, DEVELOPMENT, DESIGN AND IMPLEMENTATION (U.S. CLS. 100, 101 AND 104).
FIRST USE 4-1-2002; IN COMMERCE 4-1-2002.

SN 78-454,202. FINANCIAL EDUCATION INSITES, LLC, DEERFIELD, IL. FILED 7-21-2004.

CLASS 42—SCIENTIFIC, COMPUTER AND LEGAL SERVICES

FOR COMPUTER SERVICES, NAMELY, DEVELOPING, DESIGNING, MANAGING AND HOSTING WEB SITES FOR OTHERS; COMPUTER SERVICES, NAMELY, DEVELOPING AND MANAGING COMPUTER NETWORKS AND DATABASES FOR OTHERS; COMPUTER SERVICES, NAMELY, DEVELOPMENT AND MAINTENANCE OF COMPUTER SOFTWARE (U.S. CLS. 100 AND 101).
FIRST USE 4-1-2002; IN COMMERCE 4-1-2002.
WILLIAM P. SHANAHAN, EXAMINING ATTORNEY

Financial Education Insites

THE MARK CONSISTS OF STANDARD CHARACTERS WITHOUT CLAIM TO ANY PARTICULAR FONT, STYLE, SIZE, OR COLOR.

NO CLAIM IS MADE TO THE EXCLUSIVE RIGHT TO USE "FINANCIAL EDUCATION", APART FROM THE MARK AS SHOWN.

CLASS 9—ELECTRICAL AND SCIENTIFIC APPARATUS

FOR CALCULATORS; DOWNLOADABLE ELECTRONIC PUBLICATIONS IN THE NATURE OF BOOKS, PAMPHLETS, WORKBOOKS, NEWSLETTERS AND BROCHURES IN THE FIELD OF FINANCIAL EDUCATION (U.S. CLS. 21, 23, 26, 36 AND 38).

CLASS 36—INSURANCE AND FINANCIAL

FOR FINANCIAL PLANNING SERVICES; RETIREMENT PLANNING (U.S. CLS. 100, 101 AND 102).

SN 78-454,695. NETRANOM COMMUNICATIONS, INC., HURRICANE, WV. FILED 7-22-2004.

NETRANOM COMMUNICATIONS

THE MARK CONSISTS OF STANDARD CHARACTERS WITHOUT CLAIM TO ANY PARTICULAR FONT, STYLE, SIZE, OR COLOR.

NO CLAIM IS MADE TO THE EXCLUSIVE RIGHT TO USE "COMMUNICATIONS", APART FROM THE MARK AS SHOWN.

CLASS 38—COMMUNICATION

FOR TELECOMMUNICATIONS CONSULTATION, NAMELY, CONSULTATION REGARDING TRADITIONAL AND E-BUSINESS ANALYSIS, STRATEGIC PLANNING, DEVELOPMENT, DESIGN AND IMPLEMENTATION (U.S. CLS. 100, 101 AND 104).
FIRST USE 4-1-2002; IN COMMERCE 4-1-2002.

SN 78-454,874. RETAIL BRAND ALLIANCE, INC., ENFIELD, CT. FILED 7-22-2004.

CLASS 42—SCIENTIFIC, COMPUTER AND LEGAL SERVICES

FOR COMPUTER SERVICES, NAMELY, DEVELOPING, DESIGNING, MANAGING AND HOSTING WEB SITES FOR OTHERS; COMPUTER SERVICES, NAMELY, DEVELOPING AND MANAGING COMPUTER NETWORKS AND DATABASES FOR OTHERS; COMPUTER SERVICES, NAMELY, DEVELOPMENT AND MAINTENANCE OF COMPUTER SOFTWARE (U.S. CLS. 100 AND 101).
FIRST USE 4-1-2002; IN COMMERCE 4-1-2002.
WILLIAM P. SHANAHAN, EXAMINING ATTORNEY

BROOKSFLANNEL

THE MARK CONSISTS OF STANDARD CHARACTERS WITHOUT CLAIM TO ANY PARTICULAR FONT, STYLE, SIZE, OR COLOR.
OWNER OF U.S. REG. NOS. 585,767, 1,291,279 AND 2,858,867.

CLASS 24—FABRICS

FOR FABRIC FOR MANUFACTURING APPAREL (U.S. CLS. 42 AND 50).

SN 78-454,718. DREAM ZONE COMPANIES INC, THE, NASHVILLE, TN. FILED 7-22-2004.

CLASS 25—CLOTHING

FOR CLOTHING, NAMELY, JACKETS, PANTS, AND SUITS (U.S. CLS. 22 AND 39).
JOHN LINCOSKI, EXAMINING ATTORNEY

The Dream Zone

SN 78-455,680. BEARINGS LIMITED, HAUPPAUGE, NY. FILED 7-23-2004.

THE MARK CONSISTS OF STANDARD CHARACTERS WITHOUT CLAIM TO ANY PARTICULAR FONT, STYLE, SIZE, OR COLOR.

CLASS 16—PAPER GOODS AND PRINTED MATTER

FOR SERIES OF BOOKS IN THE FIELD OF DREAM INTERPRETATION AND DREAM-RELATED CONTENT; SYNDICATED NEWSPAPER AND MAGAZINE COLUMNS FEATURING DREAM INTERPRETATION AND DREAM-RELATED CONTENT (U.S. CLS. 2, 5, 22, 23, 29, 37, 38 AND 50).
FIRST USE 4-0-1998; IN COMMERCE 6-0-1998.

TRITAN

THE MARK CONSISTS OF STANDARD CHARACTERS WITHOUT CLAIM TO ANY PARTICULAR FONT, STYLE, SIZE, OR COLOR.

CLASS 41—EDUCATION AND ENTERTAINMENT

FOR ENTERTAINMENT SERVICES, NAMELY LIVE AND PRE-RECORDED APPEARANCES ON TELEVISION FEATURING THE INTERPRETATION OF DREAMS; RADIO ENTERTAINMENT SERVICES, NAMELY LIVE AND PRE-RECORDED APPEARANCES ON THE RADIO AND AN ONGOING SYNDICATED SERIES OF RADIO PROGRAMS FEATURING THE INTERPRETATION OF DREAMS (U.S. CLS. 100, 101 AND 107).
FIRST USE 4-0-1998; IN COMMERCE 6-0-1998.
LINDA POWELL, EXAMINING ATTORNEY

CLASS 7—MACHINERY

FOR MACHINE PARTS, NAMELY, BEARINGS, BEARING SEALS, BUSHINGS, BELTS, COUPLINGS, ROLLER CHAIN DRIVES AND ROLLER CHAINS, SPROCKETS, PULLEYS, COLLARS, CLUTCHES, RETAINING RINGS, BRAKES, MECHANICAL SEALS, STARTERS, ELECTRIC MOTORS, SHEAVES, HOSES, V-BELTS, BELT DRIVES, GEARS, GEAR BOXES, LINEAR CAM SHAFTING, AND PULLEYS; STARTERS FOR MOTORS AND ENGINES (U.S. CLS. 13, 19, 21, 23, 31, 34 AND 35).

CLASS 12—VEHICLES

FOR LAND VEHICLE PARTS, NAMELY, WHEEL BEARINGS, WHEEL BEARING SEALS, SUSPENSION BUSHINGS, TRANSMISSION BELTS, TRAILER COUPLINGS, ROLLER CHAIN DRIVES AND ROLLER CHAINS, WHEEL SPROCKETS, PULLEYS, COLLARS, CLUTCHES, RETAINING RINGS, BRAKES, MECHANICAL SEALS, ELECTRIC MOTORS FOR MOTOR CARS, SHEAVES, HOSES, V-BELTS, BELT DRIVES, GEARS, GEAR BOXES, LINEAR DRIVE SHAFTS, AND PULLEYS (U.S. CLS. 19, 21, 23, 31, 35 AND 44).

TRACY CROSS, EXAMINING ATTORNEY

SN 78-457,031. ANABOLIC VIDEO PRODUCTIONS, INC., CHATSWORTH, CA. FILED 7-26-2004.

Anabolic Toys

SN 78-456,084. SHAKLEE CORPORATION, PLEASANTON, CA. FILED 7-23-2004.

NUTRIFERON

THE MARK CONSISTS OF STANDARD CHARACTERS WITHOUT CLAIM TO ANY PARTICULAR FONT, STYLE, SIZE, OR COLOR.

CLASS 5—PHARMACEUTICALS

FOR DIETARY AND NUTRITIONAL SUPPLEMENTS (U.S. CLS. 6, 18, 44, 46, 51 AND 52).

CLASS 16—PAPER GOODS AND PRINTED MATTER

FOR PRINTED MATTER, NAMELY, DIRECT SELLING AIDS AND SALES LITERATURE IN THE NATURE OF ORDER FORMS, PRINTED FORMS, QUESTIONNAIRES, REPORTS, INFORMATIONAL BOOKLETS, BROCHURES, PAMPHLETS, BOOKS, MAGAZINES, COLORING BOOKS, BOOK COVERS, NOTE PADS, AND LESSON PLAN BOOKS, ALL IN THE FIELDS OF NUTRITION, HEALTH AND THE ENVIRONMENT; MAGAZINES, BROCHURES, BOOKLETS, PAMPHLETS, AND BOOKS RELATING TO THE FIELDS OF NUTRITION, HEALTH AND THE ENVIRONMENT; BUSINESS KITS COMPRISED OF PRINTED LITERATURE, BROCHURES, POSTCARDS, FLYERS, INFORMATION SHEETS, PRODUCT BRIEFS, TECHNICAL BULLETINS, AND FACT SHEETS, ALL RELATED TO HEALTH CARE MANAGEMENT AND HEALTH CARE PRODUCTS; BUSINESS CARDS; LETTERHEAD PAPER; WRITING PAPER; ENVELOPES; SHIPPING LABELS; BUSINESS FORMS; DECALS; PRINTED PRODUCT GUIDES FOR NUTRITIONAL AND FOOD SUPPLEMENTS; PRINTED PRODUCT GUIDES FOR HOUSEHOLD PRODUCTS; PRINTED PRODUCT GUIDES FOR PERSONAL CARE PRODUCTS; PRINTED PRODUCT GUIDES FOR WATER PURIFICATION UNITS FOR DOMESTIC USE; PRINTED PRODUCT GUIDES FOR AIR PURIFICATION UNITS FOR DOMESTIC USE; MAGAZINES IN THE FIELD OF EMPLOYEE AND DISTRIBUTOR INFORMATION; AND PRINTED LESSON PLANS IN THE FIELD OF THE ENVIRONMENT FOR USE BY TEACHERS (U.S. CLS. 2, 5, 22, 23, 29, 37, 38 AND 50).

LINDA ESTRADA, EXAMINING ATTORNEY

THE MARK CONSISTS OF STANDARD CHARACTERS WITHOUT CLAIM TO ANY PARTICULAR FONT, STYLE, SIZE, OR COLOR.

OWNER OF U.S. REG. NOS. 2,287,906 AND 2,533,907.

NO CLAIM IS MADE TO THE EXCLUSIVE RIGHT TO USE "TOYS", APART FROM THE MARK AS SHOWN.

CLASS 5—PHARMACEUTICALS

FOR PERSONAL LUBRICANTS (U.S. CLS. 6, 18, 44, 46, 51 AND 52).

CLASS 10—MEDICAL APPARATUS

FOR ELECTRIC AND NON-ELECTRIC MASSAGE DEVICES AND ACCESSORIES FOR MASSAGING OR VIBRATING PORTIONS OF THE FACE AND BODY; PACIFIERS FOR MASSAGING THE LIPS; DEVICES FOR MASSAGING AND STIMULATING THE GENITALS, ANUS AND OTHER PARTS OF THE BODY; DEVICES FOR AIDING IN COPULATION AND MASTURBATION, NAMELY, REPRODUCTIONS OF PARTS OF THE MALE AND FEMALE ANATOMY, PENISES, VAGINAS, PUMPS, RINGS, CLAMPS, STIMULATORS, VIBRATORS, DILDOS, DONGS, BUTT PLUGS, SLEEVES ON VIBRATORS SOLD TOGETHER WITH THE VIBRATORS, SLEEVES FOR VIBRATORS, EXTENSIONS SOLD TOGETHER WITH THE MASSAGING DEVICES, HARNESSSES, MASTURBATORS, NIPPLE CLIPPERS, NIPPLE CLAMPS, NIPPLE AROUSERS, BODY PROSTHESES, ELECTRICAL APPLIANCES FOR MASSAGING THE BODY; LOVE DOLLS; CONDOMS AND MINIATURE CONDOMS; PACIFIERS FOR USE BY ADULTS; DILDO ATTACHMENT HARNESSSES; VACUUM PUMPS AND ACCESSORIES, NAMELY A CYLINDER, SLEEVE AND CUSHION INSERTS FOR USE TO MAINTAIN PENILE RIGIDITY; SEXUAL AUXILIARIES FOR PARTNERS, NAMELY, ENEMA APPARATUS, PUMPS AND CONstriction RINGS FOR USE IN MAINTAINING PENILE RIGIDITY IN MEN WITH ERECTILE DYSFUNCTION AND TO BUILD UP POTENCY; PENIS ENLARGERS; ARTICLES CONDUCTIVE TO ERECTION AND ORGASMS FOR THE EXCLUSIVE USE ON THE HUMAN, NAMELY, RUBBER RINGS TO BE WORN ABOUT THE PENIS, BENWA BALLS; INFLATABLE LIFE-SIZED DOLLS USED IN MASTURBATION, SEXUAL AIDS CONSISTING OF A NYLON HARNESS USED AS A SWING AND TO OBTAIN MULTIPLE POSITIONS DURING SEXUAL INTERCOURSE, WANDS FOR EROTIC MESSAGES, MASSAGE MITTS, MASTURBATION SLEEVES, ANAL INVADERS AND ANAL BEADS FOR SEXUAL STIMULATION, AND CHAINS. (U.S. CLS. 26, 39 AND 44).

WENDY GOODMAN, EXAMINING ATTORNEY

SN 78-457,032. ANABOLIC VIDEO PRODUCTIONS, INC.,
CHATHSWORTH, CA. FILED 7-26-2004.

SN 78-458,488. SSD COMPANY LIMITED, KUSATSU-CITY,
SHIGA, JAPAN, FILED 7-28-2004.

Anabolic Adult Toys

THE MARK CONSISTS OF STANDARD CHARACTERS
WITHOUT CLAIM TO ANY PARTICULAR FONT, STYLE,
SIZE, OR COLOR.

OWNER OF U.S. REG. NOS. 2,287,906 AND 2,533,907.

NO CLAIM IS MADE TO THE EXCLUSIVE RIGHT TO
USE "ADULT TOYS", APART FROM THE MARK AS
SHOWN.

CLASS 5—PHARMACEUTICALS

FOR PERSONAL LUBRICANTS (U.S. CLS. 6, 18, 44, 46,
51 AND 52).

CLASS 10—MEDICAL APPARATUS

FOR ELECTRIC AND NON-ELECTRIC MESSAGE
DEVICES AND ACCESSORIES FOR MASSAGING OR
VIBRATING PORTIONS OF THE FACE AND BODY;
PACIFIERS FOR MASSAGING THE LIPS; DEVICES FOR
MASSAGING AND STIMULATING THE GENITALS,
ANUS AND OTHER PARTS OF THE BODY; DEVICES
FOR AIDING IN COPULATION AND MASTURBATION,
NAMELY, REPRODUCTIONS OF PARTS OF THE MALE
AND FEMALE ANATOMY, PENISES, VAGINAS,
PUMPS, RINGS, CLAMPS, STIMULATORS, VIBRATORS,
DILDOS, DONGS, BUTT PLUGS, SLEEVES ON VIBRA-
TORS SOLD TOGETHER WITH THE VIBRATORS,
SLEEVES FOR VIBRATORS, EXTENSIONS SOLD TO-
GETHER WITH THE MASSAGING DEVICES, HAR-
NESSES, MASTURBATORS, NIPPLE CLIPPERS, NIPPLE
CLAMPS, NIPPLE AROUSERS, BODY PROSTHESES,
ELECTRICAL APPLIANCES FOR MASSAGING THE
BODY; LOVE DOLLS; CONDOMS AND MINIATURE
CONDOMS; PACIFIERS FOR USE BY ADULTS; DILDO
ATTACHMENT HARNESSES; VACUUM PUMPS AND
ACCESSORIES, NAMELY A CYLINDER, SLEEVE AND
CUSHION INSERTS FOR USE TO MAINTAIN PENILE
RIGIDITY; SEXUAL AUXILIARIES FOR PARTNERS,
NAMELY, ENEMA APPARATUS, PUMPS AND CON-
STRICTION RINGS FOR USE IN MAINTAINING PE-
NILE RIGIDITY IN MEN WITH ERECTILE
DYSFUNCTION AND TO BUILD UP POTENCY; PENIS
ENLARGERS; ARTICLES CONDUCTIVE TO ERECTION
AND ORGASMS FOR THE EXCLUSIVE USE ON THE
HUMAN, NAMELY, RUBBER RINGS TO BE WORN
ABOUT THE PENIS, BENWA BALLS; INFLATABLE
LIFE-SIZED DOLLS USED IN MASTURBATION, SEX-
UAL AIDS CONSISTING OF A NYLON HARNESS USED
AS A SWING AND TO OBTAIN MULTIPLE POSITIONS
DURING SEXUAL INTERCOURSE, WANDS FOR EROTIC
MASSAGES, MESSAGE MITTS, MASTURBATION
SLEEVES, ANAL INVADERS AND ANAL BEADS FOR
SEXUAL STIMULATION, AND CHAINS. (U.S. CLS. 26,
39 AND 44).

WENDY GOODMAN, EXAMINING ATTORNEY

XAVIXPORT

THE MARK CONSISTS OF STANDARD CHARACTERS
WITHOUT CLAIM TO ANY PARTICULAR FONT, STYLE,
SIZE, OR COLOR.

OWNER OF U.S. REG. NO. 2,475,182.

CLASS 9—ELECTRICAL AND SCIENTIFIC APPARATUS

FOR COMPUTER AND VIDEO GAME HARDWARE,
NAMELY, MONITORS, CENTRAL PROCESSING UNITS,
DISK DRIVES, KEYBOARDS, MICE, GAME CONTROL-
LERS; COMPUTER GAME SOFTWARE, NAMELY, COM-
PUTER GAME SOFTWARE RECORDED ON
CARTRIDGES, CASSETTES, OPTICAL DISCS, MAG-
NETIC DISCS, MAGNETO OPTIC DISKS AND MEMORY
CARDS, VIDEO GAME SOFTWARE RECORDED ON
CARTRIDGES, CASSETTES, OPTICAL DISCS, MAG-
NETIC DISCS AND MEMORY CARDS, AND MAGNETO
OPTIC DISKS FOR USE WITH CONSOLE AND INDIVI-
DUAL, PORTABLE GAMING SYSTEMS AND ARCADE
GAMING SYSTEMS; COMPUTER GAME CARTRIDGES;
COMPUTER GAME CASSETTES; COMPUTER GAME
DISCS; COMPUTER GAME EQUIPMENT CONTAINING
MEMORY DEVICES NAMELY, DISCS, ROM MEMO-
RIES, CARTRIDGES, AND CASSETTES; COMPUTER
GAME JOYSTICKS; COMPUTER GAME SOFTWARE
FOR USE WITH MOBILE PHONES, PERSONAL DIGI-
TAL ASSISTANTS, HANDHELD COMPUTERS, ELEC-
TRONIC PERSONAL ORGANIZERS AND POCKET
PERSONAL COMPUTERS; COMPUTER GAME SOFT-
WARE; COMPUTER GRAPHICS SOFTWARE; COMPU-
TER HARDWARE AND INTERACTIVE MULTIMEDIA
COMPUTER GAME PROGRAMS; COMPUTER PERIPH-
ERALS DEVICES; COMPUTER SOFTWARE OF MULTI-
MEDIA AND INTERACTIVE COMPUTER GAMES
CONTAINED ON CASSETTES, CARTRIDGES, TAPES
AND CD-ROMS; COMPUTER AND VIDEO GAME SOFT-
WARE DOWNLOADABLE VIA GLOBAL COMPUTER
NETWORK; COMPUTER SOFTWARE USED FOR PRO-
VIDING SINGLE AND MULTI-PLAYER ACCESS TO
OFF-LINE AND ON-LINE GAMES AND GAMING EN-
VIRONMENTS; GAMBLING MACHINES; GAMING MA-
CHINES; HAND HELD INPUT DEVICES FOR PLAYING
VIDEO GAMES, NAMELY CONTROLLERS, JOYSTICKS,
MICE, AND LIQUID CRYSTAL DISPLAYS; HAND
HELD JOY STICK UNITS FOR PLAYING VIDEO
GAMES; INTEGRATED CIRCUIT CHIPS FOR USE AS
A COMPONENT OF VIDEO GAME HARDWARE; IN-
TERACTIVE MULTIMEDIA COMPUTER GAME PRO-
GRAMS; INTERACTIVE VIDEO GAMES COMPRISED
OF COMPUTER HARDWARE AND SOFTWARE; INTER-
ACTIVE VIRTUAL REALITY VIDEO GAMES COMPRI-
SED OF COMPUTER HARDWARE AND
SOFTWARE; MAGNETIC CODED CARDS, NAMELY
ENCODED SMART CARDS CONTAINING PERSONAL
INFORMATION AND HISTORICAL GAMING INFOR-
MATION OF THE USER MAGNETICALLY ENCODED
COMPUTER GAME PROGRAMS; PRINTED CIRCUIT
BOARDS FOR USE AS A COMPONENT OF VIDEO
GAME SOFTWARE AND HARDWARE; AUDIO AND
VIDEO SYNTHESIZING PROCESSORS FOR ELECTRO-
NIC GAMES AND PERIPHERAL DEVICES FOR THOSE
PROCESSORS, NAMELY, COMPUTER MEMORIES; VI-
DEO AND COMPUTER GAME CASSETTES AND CAR-
TRIDGES ADAPTED FOR USE WITH TELEVISION
RECEIVERS; VIDEO GAME CARTRIDGES; VIDEO
GAME CASSETTES; VIDEO GAME DISCS; VIDEO
GAME INTERACTIVE HAND HELD REMOTE CON-

TROLLERS FOR PLAYING ELECTRONIC GAMES; INTERACTIVE VIDEO GAME REMOTE CONTROL UNITS; VIDEO GAME MACHINES FOR USE WITH TELEVISIONS, COMPUTER GAME MACHINES, MOBILE PHONES, PERSONAL DIGITAL ASSISTANTS, HANDHELD COMPUTERS, ELECTRONIC PERSONAL ORGANIZERS AND POCKET PERSONAL COMPUTERS; VIDEO GAME SOFTWARE; VIDEO GAMES COMPRISED OF COMPUTER HARDWARE AND COMPUTER GAME SOFTWARE, ALL SOLD AS A UNIT; VIRTUAL REALITY GAME SOFTWARE; MICROPROCESSORS FOR SYNTHESIZING AUDIO-VIDEO SIGNALS; AUDIO-VISUAL APPARATUS ACCEPTING CARTRIDGES AND CASSETTES FEATURING VIDEO GAMES COMPRISED OF AUDIO AND VIDEO SYNTHESIZING PROCESSORS AND OUTPUTTING AUDIO-VIDEO SIGNALS SYNTHESIZED BY THOSE PROCESSORS TO TELEVISION RECEIVERS, AND CARTRIDGES AND CASSETTES FOR THOSE AUDIOVISUAL APPARATUS; KARAOKE MACHINES; COMPUTER PROGRAMS FOR KARAOKE MACHINES; CARTRIDGES, CASSETTES, OPTICAL DISCS, MAGNETIC DISCS, MAGNETO OPTIC DISKS AND MEMORY CARDS FOR USE WITH KARAOKE MACHINES; PERIPHERAL DEVICES FOR KARAOKE MACHINES, NAMELY, MICROPHONES; DOWNLOADABLE RING TONES, GRAPHICS AND MUSIC VIA A GLOBAL COMPUTER NETWORK AND WIRELESS DEVICES FOR KARAOKE MACHINES; MICROPHONES; ETHERNET CARDS; ADAPTER CARDS FOR COMPUTER NETWORKS, NAMELY, LAN ADAPTER CARDS AND WIRELESS ADAPTER CARDS; NETWORK HARDWARE CONNECTORS, NAMELY, CABLES, USB, SERIAL, PARALLEL, MINI DIN, SCSI, FIREWIRE, S-VIDEO, DV, FIBER OPTIC, AND RCA CONNECTORS; CIRCUIT BOARDS USED TO CONNECT COMPUTERS TO COMPUTER NETWORKS; COMPUTER NETWORK ADAPTERS; LAN ADAPTERS; WIRELESS LAN ADAPTERS; WIRELESS LAN ACCESS POINTS; NETWORK INTERFACE CARDS; COMPUTER SOFTWARE FOR USE IN TRANSMITTING AND RECEIVING DATA AND MULTIMEDIA INFORMATION VIA A GLOBAL COMPUTER NETWORK AND OTHER COMPUTER NETWORKS; COMPUTER SOFTWARE FOR USE OVER NETWORKS, NAMELY, NETWORK MANAGEMENT SOFTWARE, DATA DELIVERY SOFTWARE, NETWORK UTILITY SOFTWARE, SERVER SOFTWARE, PROTOCOL SOFTWARE, AND COMMUNICATIONS SOFTWARE; COMPUTER SOFTWARE FOR MANAGING AND OPERATING COMPUTER AND COMMUNICATIONS HARDWARE OVER ELECTRONIC, OPTICAL, OR WIRELESS COMMUNICATIONS NETWORKS; ELECTRONIC MEASURING DEVICES FOR MEASURING MOVEMENT, POSITION, ORIENTATION, DISTANCE, AREA, VELOCITY OR ACCELERATION NAMELY, INFRARED SENSORS, ACCELERATION SENSORS, IMAGE SENSORS AND STROBOSCOPES USED INDIVIDUALLY AND IN COMBINATION WITH EACH OTHER (U.S. CLS. 21, 23, 26, 36 AND 38).

FIRST USE 11-20-2003; IN COMMERCE 1-8-2004.

CLASS 28—TOYS AND SPORTING GOODS

FOR ARCADE VIDEO GAME MACHINES; AMUSEMENT GAME MACHINES; ARCADE GAMES; STAND-ALONE ELECTRONIC GAME MACHINES FOR CHILDREN, YOUNG ADULTS AND ADULTS; GAME EQUIPMENT, NAMELY, BASEBALLS, BASEBALL BATS, TENNIS BALLS, TENNIS RACQUETS, BOWLING BALLS, BOWLING PINS, GOLF CLUBS, BOXING GLOVES, TABLE TENNIS RACQUETS, SOCCER BALLS, BASKET BALLS, FOOTBALLS, ICE HOCKEY STICKS, BOARDS FOR SNOWBOARDING, TOY GUNS AND TOY SWORDS (U.S. CLS. 22, 23, 38 AND 50).

FIRST USE 11-20-2003; IN COMMERCE 1-8-2004.
SCOTT OSLICK, EXAMINING ATTORNEY

SN 78-458,491. SSD COMPANY LIMITED, KUSATSU-CITY, SHIGA, JAPAN, FILED 7-28-2004.



THE MARK CONSISTS OF FOUR SQUARE BOXES ORIENTED TO FORM A SQUARE WITH SPACES BETWEEN EACH AND A SLIGHTLY LARGER BOX ORIENTED ON ITS SIDE POSITIONED MOSTLY OVER THE TOP RIGHT BOX PREVIOUSLY DESCRIBED.

CLASS 9—ELECTRICAL AND SCIENTIFIC APPARATUS

FOR COMPUTER AND VIDEO GAME HARDWARE, NAMELY, MONITORS, CENTRAL PROCESSING UNITS, DISK DRIVES, KEYBOARDS, MICE, GAME CONTROLLERS; COMPUTER GAME SOFTWARE, NAMELY, COMPUTER GAME SOFTWARE RECORDED ON CARTRIDGES, CASSETTES, OPTICAL DISCS, MAGNETIC DISCS, MAGNETO OPTIC DISKS AND MEMORY CARDS, VIDEO GAME SOFTWARE RECORDED ON CARTRIDGES, CASSETTES, OPTICAL DISCS, MAGNETIC DISCS AND MEMORY CARDS, AND MAGNETO OPTIC DISKS FOR USE WITH CONSOLE AND INDIVIDUAL, PORTABLE GAMING SYSTEMS AND ARCADE GAMING SYSTEMS; COMPUTER GAME CARTRIDGES; COMPUTER GAME CASSETTES; COMPUTER GAME DISCS; COMPUTER GAME EQUIPMENT CONTAINING MEMORY DEVICES NAMELY, DISCS, ROM MEMORIES, CARTRIDGES, AND CASSETTES; COMPUTER GAME JOYSTICKS; COMPUTER GAME SOFTWARE FOR USE WITH MOBILE PHONES, PERSONAL DIGITAL ASSISTANTS, HANDHELD COMPUTERS, ELECTRONIC PERSONAL ORGANIZERS AND POCKET PERSONAL COMPUTERS; COMPUTER GAME SOFTWARE; COMPUTER GRAPHICS SOFTWARE; COMPUTER HARDWARE AND INTERACTIVE MULTIMEDIA COMPUTER GAME PROGRAMS; COMPUTER PERIPHERALS DEVICES; COMPUTER SOFTWARE OF MULTIMEDIA AND INTERACTIVE COMPUTER GAMES CONTAINED ON CASSETTES, CARTRIDGES, TAPES AND CD-ROMS; COMPUTER AND VIDEO GAME SOFTWARE DOWNLOADABLE VIA GLOBAL COMPUTER NETWORK; COMPUTER SOFTWARE USED FOR PROVIDING SINGLE AND MULTI-PLAYER ACCESS TO OFF-LINE AND ON-LINE GAMES AND GAMING ENVIRONMENTS; GAMBLING MACHINES; GAMING MACHINES; HAND HELD INPUT DEVICES FOR PLAYING VIDEO GAMES, NAMELY CONTROLLERS, JOYSTICKS, MICE, AND LIQUID CRYSTAL DISPLAYS; HAND HELD JOY STICK UNITS FOR PLAYING VIDEO GAMES; INTEGRATED CIRCUIT CHIPS FOR USE AS A COMPONENT OF VIDEO GAME HARDWARE; INTERACTIVE MULTIMEDIA COMPUTER GAME PROGRAMS; INTERACTIVE VIDEO GAMES COMPRISED OF COMPUTER HARDWARE AND SOFTWARE; INTERACTIVE VIRTUAL REALITY VIDEO GAMES COMPRISED OF COMPUTER HARDWARE AND SOFTWARE; MAGNETIC CODED CARDS, NAMELY ENCODED SMART CARDS CONTAINING PERSONAL INFORMATION AND HISTORICAL GAMING INFORMATION OF THE USER MAGNETICALLY ENCODED COMPUTER GAME PROGRAMS; PRINTED CIRCUIT BOARDS FOR USE AS A COMPONENT OF VIDEO GAME SOFTWARE AND HARDWARE; AUDIO AND VIDEO SYNTHESIZING PROCESSORS FOR ELECTRONIC GAMES AND PERIPHERAL DEVICES FOR THOSE

PROCESSORS, NAMELY, COMPUTER MEMORIES; VIDEO AND COMPUTER GAME CASSETTES AND CARTRIDGES ADAPTED FOR USE WITH TELEVISION RECEIVERS; VIDEO GAME CARTRIDGES; VIDEO GAME CASSETTES; VIDEO GAME DISCS; VIDEO GAME INTERACTIVE HAND HELD REMOTE CONTROLLERS FOR PLAYING ELECTRONIC GAMES; INTERACTIVE VIDEO GAME REMOTE CONTROL UNITS; VIDEO GAME MACHINES FOR USE WITH TELEVISIONS, COMPUTER GAME MACHINES, MOBILE PHONES, PERSONAL DIGITAL ASSISTANTS, HAND-HELD COMPUTERS, ELECTRONIC PERSONAL ORGANIZERS AND POCKET PERSONAL COMPUTERS; VIDEO GAME SOFTWARE; VIDEO GAMES COMPRISED OF COMPUTER HARDWARE AND COMPUTER GAME SOFTWARE, ALL SOLD AS A UNIT; VIRTUAL REALITY GAME SOFTWARE; MICROPROCESSORS FOR SYNTHESIZING AUDIO-VIDEO SIGNALS; AUDIO-VISUAL APPARATUS ACCEPTING CARTRIDGES AND CASSETTES FEATURING VIDEO GAMES COMPRISED OF AUDIO AND VIDEO SYNTHESIZING PROCESSORS AND OUTPUTTING AUDIO-VIDEO SIGNALS SYNTHESIZED BY THOSE PROCESSORS TO TELEVISION RECEIVERS, AND CARTRIDGES AND CASSETTES FOR THOSE AUDIOVISUAL APPARATUS; KARAOKE MACHINES; COMPUTER PROGRAMS FOR KARAOKE MACHINES; CARTRIDGES, CASSETTES, OPTICAL DISCS, MAGNETIC DISCS, MAGNETO OPTIC DISKS AND MEMORY CARDS FOR USE WITH KARAOKE MACHINES; PERIPHERAL DEVICES FOR KARAOKE MACHINES, NAMELY, MICROPHONES; DOWNLOADABLE RING TONES, GRAPHICS AND MUSIC VIA A GLOBAL COMPUTER NETWORK AND WIRELESS DEVICES FOR KARAOKE MACHINES; MICROPHONES; ETHERNET CARDS; ADAPTER CARDS FOR COMPUTER NETWORKS, NAMELY, LAN ADAPTER CARDS AND WIRELESS ADAPTER CARDS; NETWORK HARDWARE CONNECTORS, NAMELY, CABLES, USB, SERIAL, PARALLEL, MINI DIN, SCSI, FIREWIRE, S-VIDEO, DV, FIBER OPTIC, AND RCA CONNECTORS; CIRCUIT BOARDS USED TO CONNECT COMPUTERS TO COMPUTER NETWORKS; COMPUTER NETWORK ADAPTERS; LAN ADAPTERS; WIRELESS LAN ADAPTERS; WIRELESS LAN ACCESS POINTS; NETWORK INTERFACE CARDS; COMPUTER SOFTWARE FOR USE IN TRANSMITTING AND RECEIVING DATA AND MULTIMEDIA INFORMATION VIA A GLOBAL COMPUTER NETWORK AND OTHER COMPUTER NETWORKS; COMPUTER SOFTWARE FOR USE OVER NETWORKS, NAMELY, NETWORK MANAGEMENT SOFTWARE, DATA DELIVERY SOFTWARE, NETWORK UTILITY SOFTWARE, SERVER SOFTWARE, PROTOCOL SOFTWARE, AND COMMUNICATIONS SOFTWARE; COMPUTER SOFTWARE FOR MANAGING AND OPERATING COMPUTER AND COMMUNICATIONS HARDWARE OVER ELECTRONIC, OPTICAL, OR WIRELESS COMMUNICATIONS NETWORKS; ELECTRONIC MEASURING DEVICES FOR MEASURING MOVEMENT, POSITION, ORIENTATION, DISTANCE, AREA, VELOCITY OR ACCELERATION NAMELY, INFRARED SENSORS, ACCELERATION SENSORS, IMAGE SENSORS AND STROBOSCOPES USED INDIVIDUALLY AND IN COMBINATION WITH EACH OTHER (U.S. CLS. 21, 23, 26, 36 AND 38).

FIRST USE 11-20-2003; IN COMMERCE 11-20-2003.

CLASS 28—TOYS AND SPORTING GOODS

FOR ARCADE VIDEO GAME MACHINES; AMUSEMENT GAME MACHINES; ARCADE GAMES; STAND-ALONE ELECTRONIC GAME MACHINES FOR CHILDREN, YOUNG ADULTS AND ADULTS; GAME EQUIPMENT, NAMELY, BASEBALLS, BASEBALL BATS, TENNIS BALLS, TENNIS RACQUETS, BOWLING BALLS, BOWLING PINS, GOLF CLUBS, BOXING GLOVES, TABLE TENNIS RACQUETS, SOCCER BALLS, BASKET BALLS, FOOTBALLS, ICE HOCKEY STICKS, BOARDS FOR SNOWBOARDING, TOY GUNS AND TOY SWORDS (U.S. CLS. 22, 23, 38 AND 50).

FIRST USE 11-20-2003; IN COMMERCE 11-20-2003.
REBECCA GAN, EXAMINING ATTORNEY

SN 78-458,860. TO-JO FOOD PRODUCTS, INC., AVONDALE, PA. FILED 7-29-2004.

HEALTHY JOE

THE MARK CONSISTS OF STANDARD CHARACTERS WITHOUT CLAIM TO ANY PARTICULAR FONT, STYLE, SIZE, OR COLOR.

NO CLAIM IS MADE TO THE EXCLUSIVE RIGHT TO USE "HEALTHY", APART FROM THE MARK AS SHOWN.

CLASS 29—MEATS AND PROCESSED FOODS

FOR SANDWICH FILLINGS, NAMELY, MEATLESS FILLINGS CONTAINING PROCESSED MUSHROOMS AS THE PRIMARY FOOD FILLING; SANDWICH TOPPINGS, NAMELY, READY TO USE SAUTEED MUSHROOM TOPPINGS AND FLAVORED MUSHROOM TOPPINGS; MEATLESS SIDE DISHES CONSISTING MAINLY OF PROCESSED MUSHROOMS; DIPS EXCLUDING SALSA AND OTHER SAUCES USED AS DIPS, CONTAINING MUSHROOMS AND AT LEAST ONE OTHER VEGETABLE; SOUPS CONTAINING MUSHROOMS (U.S. CL. 46).

CLASS 30—STAPLE FOODS

FOR MUSHROOM FLAVORED SAUCES (U.S. CL. 46).
JENNIFER DIXON, EXAMINING ATTORNEY

SN 78-458,865. TO-JO FOOD PRODUCTS, INC., AVONDALE, PA. FILED 7-29-2004.

BACK-OF-THE-HOUSE

THE MARK CONSISTS OF STANDARD CHARACTERS WITHOUT CLAIM TO ANY PARTICULAR FONT, STYLE, SIZE, OR COLOR.

CLASS 29—MEATS AND PROCESSED FOODS

FOR SANDWICH FILLINGS, NAMELY, MEATLESS FILLINGS CONTAINING PROCESSED MUSHROOMS AS THE PRIMARY FOOD FILLING; SANDWICH TOPPINGS, NAMELY, READY TO USE SAUTEED MUSHROOM TOPPINGS AND FLAVORED MUSHROOM TOPPINGS; DIPS EXCLUDING SALSA AND OTHER SAUCES USED AS DIPS, VEGETABLE SIDE DISHES AND SALADS CONTAINING MUSHROOMS AND AT LEAST ONE OTHER VEGETABLE; SOUPS CONTAINING MUSHROOMS (U.S. CL. 46).

CLASS 30—STAPLE FOODS

FOR MUSHROOM FLAVORED SAUCES (U.S. CL. 46).
GLENN CLARK, EXAMINING ATTORNEY

SN 78-459,083. AMERICAN INTERNATIONAL GROUP, INC., NEW YORK, NY. FILED 7-29-2004.

MEDINNOVATION

THE MARK CONSISTS OF STANDARD CHARACTERS WITHOUT CLAIM TO ANY PARTICULAR FONT, STYLE, SIZE, OR COLOR.

CLASS 35—ADVERTISING AND BUSINESS

FOR COST CONTAINMENT SERVICES FOR MEDICAL AND HEALTH BENEFIT PLANS, NAMELY, CLINICAL AND FINANCIAL REPORTING AND PREDICTIVE MODELING (U.S. CLS. 100, 101 AND 102).

FIRST USE 7-0-2004; IN COMMERCE 7-0-2004.

CLASS 36—INSURANCE AND FINANCIAL

FOR INSURANCE CLAIMS ADMINISTRATION; ELECTRONIC PROCESSING OF INSURANCE CLAIMS AND PAYMENT DATA (U.S. CLS. 100, 101 AND 102).

FIRST USE 7-0-2004; IN COMMERCE 7-0-2004.
WENDY GOODMAN, EXAMINING ATTORNEY

SN 78-459,908. R. J. COGAN SPECIALTY PUBLICATIONS GROUP, INC., SAN LUIS OBISPO, CA. FILED 7-30-2004.

GREEN CAR JOURNAL

THE MARK CONSISTS OF STANDARD CHARACTERS WITHOUT CLAIM TO ANY PARTICULAR FONT, STYLE, SIZE, OR COLOR.

NO CLAIM IS MADE TO THE EXCLUSIVE RIGHT TO USE "CAR JOURNAL", APART FROM THE MARK AS SHOWN.

SEC. 2(F).

CLASS 16—PAPER GOODS AND PRINTED MATTER

FOR PRINTED MAGAZINES, NEWSLETTERS, AND COLUMNS IN THE FIELD OF MOTOR VEHICLES AND THE ENVIRONMENT (U.S. CLS. 2, 5, 22, 23, 29, 37, 38 AND 50).

FIRST USE 12-1-1991; IN COMMERCE 12-1-1991.

CLASS 35—ADVERTISING AND BUSINESS

FOR PROVIDING ON-LINE CONSUMER AND TRADE INFORMATION IN THE FIELD OF ENVIRONMENTALLY-CONSCIOUS VEHICLES (U.S. CLS. 100, 101 AND 102).

FIRST USE 1-1-1997; IN COMMERCE 1-1-1997.

CLASS 41—EDUCATION AND ENTERTAINMENT

FOR PROVIDING ON-LINE MAGAZINES, NEWSLETTERS, AND COLUMNS IN THE FIELD OF ENVIRONMENTALLY-CONSCIOUS VEHICLES (U.S. CLS. 100, 101 AND 107).

FIRST USE 1-1-1997; IN COMMERCE 1-1-1997.

TINA L. SNAPP, EXAMINING ATTORNEY

SN 78-460,201. HAWE BEHEER B.V., DOETINCHEM, NETHERLANDS, FILED 8-2-2004.



NO CLAIM IS MADE TO THE EXCLUSIVE RIGHT TO USE "OFFICE DEVELOPMENT", APART FROM THE MARK AS SHOWN.

THE COLOR(S) BLUE, PURPLE, BLACK, WHITE AND GREY IS/ARE CLAIMED AS A FEATURE OF THE MARK.

THE COLOR BLUE APPEARS IN THE STRIPING ABOVE THE WORDING OFFICE AND IN THE LEFT QUADRANGLE. THE COLOR PURPLE APPEARS IN THE RIGHT AND LOWER QUADRANGLE. THE COLOR BLACK APPEARS IN THE WORD OFFICE, IN THE STRIPING ABOVE THE WORDING DEVELOPMENT AND AS OUTLINING OF THE FOUR QUADRANGLES. THE COLOR WHITE APPEARS IN THE BACKGROUND AND IN THE UPPER QUADRANGLE.

CLASS 9—ELECTRICAL AND SCIENTIFIC APPARATUS

FOR COMPUTERS; COMPUTER PERIPHERALS; COMPUTER TERMINALS; WORD PROCESSORS; COMPUTER PROGRAMS RECORDED ON DATA MEDIA, NAMELY SOFTWARE, DESIGNED FOR USE IN CONSTRUCTION AND AUTOMATED MANUFACTURING (CAD/CAM); COMPUTER MEMORIES; COMPUTER MEMORY HARDWARE AND MEMORY CARDS; BLANK MAGNETIC DATA CARRIERS; AND ACCESSORIES FOR COMPUTERS, NAMELY BLANK COMPUTER DISCS, COMPUTER CABLES, COMPUTER CHIPS, COMPUTER BUFFERS, CD DRIVES FOR COMPUTERS (U.S. CLS. 21, 23, 26, 36 AND 38).

CLASS 35—ADVERTISING AND BUSINESS

FOR MEDIATION AND CONCLUSION OF COMMERCIAL TRANSACTIONS FOR OTHERS AS IT RELATES TO THE SELLING OF COMPUTERS, COMPUTER PERIPHERAL DEVICES, COMPUTER TERMINALS, WORD PROCESSORS, RECORDED PROGRAMS FOR COMPUTERS, SOFTWARE, COMPUTER MEMORIES, APPARATUS FOR THE STORING AND REPRODUCTION OF DATA, MAGNETIC DATA CARRIERS, ACCESSORIES FOR COMPUTERS; INTERIM COMMERCIAL MANAGEMENT SERVICES; COMMERCIAL CONSULTANCY WITH REGARD TO E-COMMERCE (U.S. CLS. 100, 101 AND 102).

CLASS 41—EDUCATION AND ENTERTAINMENT

FOR COMPUTER EDUCATION TRAINING AND CONDUCTING COURSES OF INSTRUCTION IN THE FIELD OF COMPUTER EDUCATION TRAINING (U.S. CLS. 100, 101 AND 107).

CLASS 42—SCIENTIFIC, COMPUTER AND LEGAL SERVICES

FOR COMPUTER CONSULTATION AND CONSULTANCY IN AIDING IN THE CHOICE OF COMPUTER HARDWARE AND SOFTWARE; COMPUTER PROGRAMMING FOR OTHERS; COMPUTER CONSULTATION IN THE NATURE OF PROVIDING IT SPECIALISTS IN THE FIELD OF INFORMATION AND COMMUNICATION TECHNOLOGY; COMPUTER SYSTEMS ANALYSIS; COMPUTER HARDWARE AND SOFTWARE DEVELOPMENT; UPGRADING, IMPLEMENTATION AND MAINTENANCE OF SOFTWARE FOR OTHERS; COMPUTER PROJECT MANAGEMENT SERVICES; COMPUTER CONSULTATION; DESIGNING AND DEVELOPMENT OF WEBSITES; GRAPHIC DESIGN OF WEBSITES (U.S. CLS. 100 AND 101).

MARK T. MULLEN, EXAMINING ATTORNEY

SN 78-460,807. APEX ANALYTIX, INC., GREENSBORO, NC. FILED 8-2-2004.

FIRSTSTRIKE

THE MARK CONSISTS OF STANDARD CHARACTERS WITHOUT CLAIM TO ANY PARTICULAR FONT, STYLE, SIZE, OR COLOR.

CLASS 9—ELECTRICAL AND SCIENTIFIC APPARATUS

FOR COMPUTER SOFTWARE FOR ACCOUNTS PAYABLE RECOVERY AUDITING, PREVENTING OVERPAYMENTS, DUPLICATE PAYMENTS OR FRAUDULENT PAYMENTS, PROCUREMENT ANALYSIS, ENTERPRISE SPEND ANALYSIS, ENTERPRISE SPEND MANAGEMENT, CONTRACT COMPLIANCE, PROCURE-TO-PAY PROCESS IMPROVEMENT AND AUTOMATION, AND SUPPLIER RELATIONSHIP MANAGEMENT (U.S. CLS. 21, 23, 26, 36 AND 38).

CLASS 35—ADVERTISING AND BUSINESS

FOR BUSINESS CONSULTING SERVICES IN THE FIELDS OF ACCOUNTS PAYABLE RECOVERY AUDITING, PREVENTING OVERPAYMENTS, DUPLICATE PAYMENTS OR FRAUDULENT PAYMENTS, PROCUREMENT ANALYSIS, ENTERPRISE SPENDING ANALYSIS, ENTERPRISE SPENDING MANAGEMENT, CONTRACT COMPLIANCE, PROCURE-TO-PAY PROCESS IMPROVEMENT AND AUTOMATION, AND SUPPLIER RELATIONSHIP MANAGEMENT; ACCOUNTS PAYABLE RECOVERY AUDIT SERVICES (U.S. CLS. 100, 101 AND 102).

CHERYL CLAYTON, EXAMINING ATTORNEY

SN 78-460,597. BACKSAVER ACQUISITION CORP., LYWOOD, CA. FILED 8-2-2004.

DREAM GEL

SN 78-462,211. EATON LEONARD ROBOLIX, INC., VISTA, CA. FILED 8-4-2004.

THE MARK CONSISTS OF STANDARD CHARACTERS WITHOUT CLAIM TO ANY PARTICULAR FONT, STYLE, SIZE, OR COLOR.

NO CLAIM IS MADE TO THE EXCLUSIVE RIGHT TO USE "GEL", APART FROM THE MARK AS SHOWN.

CLASS 20—FURNITURE AND ARTICLES NOT OTHERWISE CLASSIFIED

FOR PILLOWS, CUSHIONS AND RECLINER CHAIRS (U.S. CLS. 2, 13, 22, 25, 32 AND 50).

FIRST USE 8-0-2004; IN COMMERCE 8-0-2004.

CLASS 24—FABRICS

FOR MATTRESS COVERS, COMFORTERS, AND DUVET COVERS (U.S. CLS. 42 AND 50).

FIRST USE 8-0-2004; IN COMMERCE 8-0-2004.
TRACY FLETCHER, EXAMINING ATTORNEY



THE NAME(S), PORTRAIT(S), AND/OR SIGNATURE(S) SHOWN IN THE MARK DOES NOT IDENTIFY A PARTICULAR LIVING INDIVIDUAL.

THE MARK CONSISTS OF A STYLIZED COMBINATION OF THE LETTERS E AND L.

CLASS 7—MACHINERY

FOR AUTOMATIC TUBE BENDING, WIRE BENDING AND TUBE END FORMING MACHINES (U.S. CLS. 13, 19, 21, 23, 31, 34 AND 35).

FIRST USE 8-19-1974; IN COMMERCE 12-17-1974.

CLASS 9—ELECTRICAL AND SCIENTIFIC APPARATUS

FOR COMPUTER HARDWARE AND SOFTWARE FOR CONTROLLING TUBE BENDING MACHINES; MEASURING AND INSPECTING INSTRUMENTS FOR BENT TUBES AND SURFACES AND FOR COMPUTING AND PRINTING DATA THEREFOR (U.S. CLS. 21, 23, 26, 36 AND 38).

FIRST USE 8-19-1974; IN COMMERCE 12-17-1974.
SHARI SHEFFIELD, EXAMINING ATTORNEY

SN 78-462,405. AQUASTEL AMERICAS, INC., PALM BEACH GARDENS, FL. FILED 8-5-2004.

AQUASTEL

THE MARK CONSISTS OF STANDARD CHARACTERS WITHOUT CLAIM TO ANY PARTICULAR FONT, STYLE, SIZE, OR COLOR.

CLASS 11—ENVIRONMENTAL CONTROL APPARATUS

FOR WATER STERILIZERS; WATER SOFTENING APPARATUS AND UNITS; WATER PURIFYING APPARATUS AND UNITS; WATER DESALINATION PLANTS; FILTERS FOR DRINKING WATER; AND WATER FILTERS FOR INDUSTRIAL AND HOUSEHOLD USE (U.S. CLS. 13, 21, 23, 31 AND 34).

CLASS 40—MATERIAL TREATMENT

FOR WATER TREATMENT, PURIFICATION, AND STERILIZATION (U.S. CLS. 100, 103 AND 106).
STACY WAHLBERG, EXAMINING ATTORNEY

SN 78-462,522. ATNL, INC., WILMINGTON, DE. FILED 8-5-2004.



OWNER OF U.S. REG. NO. 1,646,540.
NO CLAIM IS MADE TO THE EXCLUSIVE RIGHT TO USE "MEDICAL", APART FROM THE MARK AS SHOWN.

CLASS 1—CHEMICALS

FOR CARBON DIOXIDE ABSORBENT, NAMELY, A MIXTURE OF ALKALI METAL HYDROXIDES, PRINCIPALLY HYDRATED LIME AND SODIUM HYDROXIDE (U.S. CLS. 1, 5, 6, 10, 26 AND 46).

FIRST USE 4-30-2004; IN COMMERCE 4-30-2004.

CLASS 5—PHARMACEUTICALS

FOR MEDICAL GASES, NAMELY, MEDICAL AIR, CARBON DIOXIDE, HELIUM, NITROGEN, NITROUS OXIDE, OXYGEN; MEDICAL GAS MIXTURES, NAMELY, LABORATORY AND TECHNICAL GAS MIXTURES, CLINICAL BLOOD GAS MIXTURES, TONOMETRY STANDARDS, TRANSCUTANEOUS MONITOR STANDARDS, PULMONARY AND LUNG DIFFUSION GAS MIXTURES, STRESS CALIBRATION GAS MIXTURES, MEDICAL LASER GAS MIXTURES, BIOLOGICAL INCUBATION ATMOSPHERES, GAS CHROMOGRAPHY STANDARDS, AND STERILIZING GAS MIXTURES (U.S. CLS. 6, 18, 44, 46, 51 AND 52).

FIRST USE 4-30-2004; IN COMMERCE 4-30-2004.

CLASS 11—ENVIRONMENTAL CONTROL APPARATUS

FOR GAS REGULATORS (U.S. CLS. 13, 21, 23, 31 AND 34).

FIRST USE 4-30-2004; IN COMMERCE 4-30-2004.
ELIZABETH PIGNATELLO, EXAMINING ATTORNEY

SN 78-462,530. ATNL, INC., WILMINGTON, DE. FILED 8-5-2004.

AIRGAS PURITAN MEDICAL

THE MARK CONSISTS OF STANDARD CHARACTERS WITHOUT CLAIM TO ANY PARTICULAR FONT, STYLE, SIZE, OR COLOR.

OWNER OF U.S. REG. NO. 1,646,540.
NO CLAIM IS MADE TO THE EXCLUSIVE RIGHT TO USE "MEDICAL", APART FROM THE MARK AS SHOWN.

CLASS 1—CHEMICALS

FOR CARBON DIOXIDE ABSORBENT, NAMELY, A MIXTURE OF ALKALI METAL HYDROXIDES, PRINCIPALLY HYDRATED LIME AND SODIUM HYDROXIDE (U.S. CLS. 1, 5, 6, 10, 26 AND 46).

FIRST USE 4-30-2005; IN COMMERCE 4-30-2005.

CLASS 5—PHARMACEUTICALS

FOR MEDICAL GASES, NAMELY, MEDICAL AIR, CARBON DIOXIDE, HELIUM, NITROGEN, NITROUS OXIDE, OXYGEN; MEDICAL GAS MIXTURES, NAMELY, LABORATORY AND TECHNICAL GAS MIXTURES, CLINICAL BLOOD GAS MIXTURES, TONOMETRY STANDARDS, TRANSCUTANEOUS MONITOR STANDARDS, PULMONARY AND LUNG DIFFUSION GAS MIXTURES, STRESS CALIBRATION GAS MIXTURES, MEDICAL LASER GAS MIXTURES, BIOLOGICAL INCUBATION ATMOSPHERES, GAS CHROMOGRAPHY STANDARDS, AND STERILIZING GAS MIXTURES (U.S. CLS. 6, 18, 44, 46, 51 AND 52).

FIRST USE 4-30-2004; IN COMMERCE 4-30-2004.

CLASS 11—ENVIRONMENTAL CONTROL APPARATUS

FOR GAS REGULATORS (U.S. CLS. 13, 21, 23, 31 AND 34).
FIRST USE 4-30-2004; IN COMMERCE 4-30-2004.
ELIZABETH PIGNATELLO, EXAMINING ATTORNEY

SN 78-464,863. SAVE-A-LOT FOOD STORES, INC., EARTH CITY, MO. FILED 8-10-2004.

BREAKFAST ORIGINALS

SN 78-464,026. COLWELL INDUSTRIES, INC., MINNEAPOLIS, MN. FILED 8-9-2004.

THE MARK CONSISTS OF STANDARD CHARACTERS WITHOUT CLAIM TO ANY PARTICULAR FONT, STYLE, SIZE, OR COLOR.

NO CLAIM IS MADE TO THE EXCLUSIVE RIGHT TO USE "BREAKFAST", APART FROM THE MARK AS SHOWN.

CLASS 29—MEATS AND PROCESSED FOODS

FOR FROZEN AND READY TO EAT SAUSAGE, SCRAMBLED EGGS, AND HASH BROWNS (U.S. CL. 46).

colwell north america

CLASS 30—STAPLE FOODS

FOR FROZEN AND READY TO EAT FRENCH TOAST AND PANCAKES (U.S. CL. 46).
DAWN FELDMAN, EXAMINING ATTORNEY

SN 78-465,112. PLANET FINANCE CORPORATION, NEW YORK, NY. FILED 8-10-2004.

OWNER OF U.S. REG. NOS. 1,402,152 AND 1,418,553.
NO CLAIM IS MADE TO THE EXCLUSIVE RIGHT TO USE NORTH AMERICA, APART FROM THE MARK AS SHOWN.
SEC. 2(F) AS TO COLWELL.

PLANET FINANCE

CLASS 16—PAPER GOODS AND PRINTED MATTER

FOR MERCHANDISING AIDS TO ASSIST IN THE SELECTION AND MATCHING OF COLOR AND DECORATIVE OR PROTECTIVE SURFACE MATERIALS, NAMELY, SAMPLE BOOKS, ALBUMS, CARDS, CARD SETS, CHARTS, FAN DECKS, SWATCH CARDS, COLOR STANDARDS, COLOR CONTROL AND TOLERANCE CHARTS; PRINTED EDUCATIONAL MATERIALS IN THE FIELD OF COLOR THEORY AND RELATED CONCEPTS; ATLASES, FAN DECKS, MANUALS AND BROCHURES RELATING TO A COMPUTER-GENERATED NUMERICAL CODING SYSTEM WHICH ANALYZES THE PHYSICAL ATTRIBUTES OF COLOR TO ENABLE ACCURATE SELECTION, MATCHING, AND CONTROL OF COLOR IN THE MANUFACTURING PROCESS (U.S. CLS. 2, 5, 22, 23, 29, 37, 38 AND 50).

THE MARK CONSISTS OF STANDARD CHARACTERS WITHOUT CLAIM TO ANY PARTICULAR FONT, STYLE, SIZE, OR COLOR.

NO CLAIM IS MADE TO THE EXCLUSIVE RIGHT TO USE "FINANCE", APART FROM THE MARK AS SHOWN.

CLASS 35—ADVERTISING AND BUSINESS

FOR CONSULTATION SERVICES IN THE FIELD OF BUSINESS MANAGEMENT AND MARKETING PROVIDED TO SMALL AND MICROENTREPRENEURS AROUND THE WORLD (U.S. CLS. 100, 101 AND 102).
FIRST USE 3-1-2000; IN COMMERCE 3-1-2000.

CLASS 35—ADVERTISING AND BUSINESS

FOR BUSINESS MARKETING CONSULTING SERVICES AND BUSINESS RESEARCH, IN THE FIELD OF MERCHANDISING AIDS FOR COLOR OR SURFACE MATERIAL SELECTION AND MATCHING, AND CONTROL OF COLOR IN THE MANUFACTURING PROCESS (U.S. CLS. 100, 101 AND 102).
ANNE MADDEN, EXAMINING ATTORNEY

CLASS 36—INSURANCE AND FINANCIAL

FOR PROVIDING FINANCIAL MANAGEMENT, ANALYSIS AND CONSULTATION SERVICES; FINANCING SERVICES AND RELATED CONSULTATION SERVICES; AND BANKING SERVICES; TO SMALL AND MICROENTREPRENEURS AROUND THE WORLD (U.S. CLS. 100, 101 AND 102).
FIRST USE 3-1-2000; IN COMMERCE 3-1-2000.

CLASS 41—EDUCATION AND ENTERTAINMENT

FOR PROVIDING TRAINING SERVICES IN THE FIELD OF FINANCE AND FINANCIAL MANAGEMENT; TO SMALL AND MICROENTREPRENEURS AROUND THE WORLD (U.S. CLS. 100, 101 AND 107).

FIRST USE 3-1-2000; IN COMMERCE 3-1-2000.

ADA HAN, EXAMINING ATTORNEY

SN 78-465,166. STEPHENS, JOHN R., NEW YORK, NY. FILED 8-10-2004.

JOHN LEGEND

THE MARK CONSISTS OF STANDARD CHARACTERS WITHOUT CLAIM TO ANY PARTICULAR FONT, STYLE, SIZE, OR COLOR.

THE NAME(S), PORTRAIT(S), AND/OR SIGNATURE(S) SHOWN IN THE MARK DOES NOT IDENTIFY A PARTICULAR LIVING INDIVIDUAL.

CLASS 9—ELECTRICAL AND SCIENTIFIC APPARATUS

FOR CDS, DVDS, AUDIOCASSETTES, AND VIDEOCASSETTES FEATURING PRERECORDED MUSIC; DOWNLOADABLE MUSICAL SOUND RECORDINGS (U.S. CLS. 21, 23, 26, 36 AND 38).

FIRST USE 9-1-2003; IN COMMERCE 9-1-2003.

CLASS 41—EDUCATION AND ENTERTAINMENT

FOR LIVE PERFORMANCES FEATURING MUSIC; RECORD PRODUCTION FOR OTHERS; FAN CLUB SERVICES; PROVIDING ONLINE ENTERTAINMENT IN THE NATURE OF FAN CLUB WEB SITES; ENTERTAINMENT, NAMELY, PERSONAL APPEARANCES BY A MUSICIAN (U.S. CLS. 100, 101 AND 107).

FIRST USE 9-1-2003; IN COMMERCE 9-1-2003.

THEODORE MCBRIDE, EXAMINING ATTORNEY

SN 78-465,238. VP COMPONENTS CO., LTD., TAICHUNG HSIEN, TAIWAN, FILED 8-10-2004.

OWNER OF U.S. REG. NO. 2,474,855.
THE MARK INCLUDES THE LETTER "E" IN STYLIZED FORM.

CLASS 4—LUBRICANTS AND FUELS

FOR OILS, GREASES AND LUBRICANTS FOR BICYCLES (U.S. CLS. 1, 6 AND 15).

FIRST USE 8-16-1993; IN COMMERCE 8-16-1993.

CLASS 8—HAND TOOLS

FOR HAND-HELD TOOLS, NAMELY, MANUALLY OPERATED OIL, GREASE AND LUBRICANT GUNS FOR BICYCLES (U.S. CLS. 23, 28 AND 44).

FIRST USE 8-16-1993; IN COMMERCE 8-16-1993.

CLASS 12—VEHICLES

FOR BICYCLES AND ACCESSORIES THEREOF, NAMELY, PEDALS, SADDLES, CARRIERS, FRAMES, FRONT FORKS, HEAD SETS, AND BOTTOM BRACKET SETS (U.S. CLS. 19, 21, 23, 31, 35 AND 44).

FIRST USE 8-16-1993; IN COMMERCE 8-16-1993.

CLASS 25—CLOTHING

FOR CYCLING CLOTHING, NAMELY, CYCLING JERSEYS, CYCLING TROUSERS, CYCLING GLOVES, CYCLING HATS, AND CYCLING STOCKINGS (U.S. CLS. 22 AND 39).

FIRST USE 8-16-1993; IN COMMERCE 8-16-1993.

MATTHEW PAPPAS, EXAMINING ATTORNEY

SN 78-465,365. SEROPIAN, HAGOP SEVAG, JAL EL DIB, METN, LEBANON, FILED 8-10-2004.

HAYASA PRODUCTIONS

THE MARK CONSISTS OF STANDARD CHARACTERS WITHOUT CLAIM TO ANY PARTICULAR FONT, STYLE, SIZE, OR COLOR.

NO CLAIM IS MADE TO THE EXCLUSIVE RIGHT TO USE "PRODUCTIONS", APART FROM THE MARK AS SHOWN.

SEC. 2(F).

CLASS 35—ADVERTISING AND BUSINESS

FOR SERVICES CONSISTING OF THE REGISTRATION, COLLECTION, DOCUMENTATION, TRANSCRIPTION, COMPILATION AND SYSTEMIZATION OF CULTURAL, FOLKLORE AND ENTERTAINMENT DANCING, SINGING AND MUSICAL PERFORMANCES AND ARTISTIC WORKS (U.S. CLS. 100, 101 AND 102).

CLASS 41—EDUCATION AND ENTERTAINMENT

FOR ENTERTAINMENT AND CULTURAL ACTIVITIES, NAMELY, PRODUCTION OF PRERECORDED AUDIO AND VIDEO TAPES, VIDEO DISCS, DVDS AND MOTION PICTURE FILMS FOR OTHERS; PROVIDING ON-LINE INFORMATION IN THE FIELD OF CULTURAL ACTIVITIES VIA A GLOBAL COMMUNICATIONS NETWORK, NAMELY, INFORMATION ABOUT MOTION PICTURES, DOCUMENTARIES, TELEVISION PROGRAMS, INTERACTIVE GAMES, ANIMATION, VIDEOS AND DVDS AND OTHER AUDIOVISUAL WORKS ALL IN THE FIELD OF THEATRICAL AND CULTURAL PERFORMANCES (U.S. CLS. 100, 101 AND 107).

GINNY ISAACSON, EXAMINING ATTORNEY

SN 78-465,623. DESIGN IDEAS, LTD., SPRINGFIELD, IL. FILED 8-11-2004.

SN 78-465,830. KUHN KNIGHT INCORPORATED, BRODHEAD, WI. FILED 8-11-2004.

AccuSpread

DOODLES

THE MARK CONSISTS OF STANDARD CHARACTERS WITHOUT CLAIM TO ANY PARTICULAR FONT, STYLE, SIZE, OR COLOR.
OWNER OF U.S. REG. NO. 2,518,310.

CLASS 9—ELECTRICAL AND SCIENTIFIC APPARATUS

FOR DECORATIVE MAGNETS (U.S. CLS. 21, 23, 26, 36 AND 38).
FIRST USE 12-21-2000; IN COMMERCE 2-26-2001.

CLASS 16—PAPER GOODS AND PRINTED MATTER

FOR DECORATIVE METAL MEMO CLIPS, DECORATIVE METAL ADHESIVE PAPER CLIPS, DECORATIVE MEMO CLIPS NOT MADE OF METAL, DECORATIVE PUSHINS, AND DECORATIVE METAL PAPER WEIGHTS (U.S. CLS. 2, 5, 22, 23, 29, 37, 38 AND 50).
FIRST USE 1-5-2000; IN COMMERCE 1-5-2000.

CLASS 20—FURNITURE AND ARTICLES NOT OTHERWISE CLASSIFIED

FOR PICTURE FRAMES, PICTURE FRAMES IN THE FORM OF MEMO CLIPS, AND PICTURE FRAMES IN THE FORM OF MAGNETS (U.S. CLS. 2, 13, 22, 25, 32 AND 50).
FIRST USE 1-5-2000; IN COMMERCE 1-5-2000.

CLASS 21—HOUSEWARES AND GLASS

FOR DECORATIVE BOWLS NOT OF PRECIOUS METAL, COASTERS NOT OF PRECIOUS METAL OR PAPER OR FABRIC, DECORATIVE BREAD BASKETS MADE OF WIRE, UTENSIL HOLDERS NOT OF PRECIOUS METAL FOR HOUSEHOLD AND COOKING UTENSILS, PAPER TOWEL HOLDERS NOT OF PRECIOUS METAL, AND VASES (U.S. CLS. 2, 13, 23, 29, 30, 33, 40 AND 50).
FIRST USE 9-16-1999; IN COMMERCE 11-12-1999.
JAMES GRIFFIN, EXAMINING ATTORNEY

THE MARK CONSISTS OF STANDARD CHARACTERS WITHOUT CLAIM TO ANY PARTICULAR FONT, STYLE, SIZE, OR COLOR.

CLASS 7—MACHINERY

FOR AGRICULTURAL MACHINES, NAMELY MANURE SPREADERS, FERTILIZER SPREADERS, BEDDING SPREADERS, WASTE SPREADERS, SEED SPREADERS, STRAW BLOWERS, TRUCK MOUNTED SPREADERS AND REPLACEMENT PARTS OR COMPONENTS OF SAID MACHINES (U.S. CLS. 13, 19, 21, 23, 31, 34 AND 35).

CLASS 12—VEHICLES

FOR LAND VEHICLES, NAMELY, FERTILIZER APPLICATION VEHICLES, MANURE HAULING TRAILERS, TRAILERS FOR AGRICULTURAL USE, BEDDING APPLICATION VEHICLES, WASTE APPLICATION VEHICLES, SELF-PROPELLED VEHICLES, NAMELY, AUTOMATIC GUIDED VEHICLES, SELF PROPELLED SPREADER WAGONS AND TRUCKS, AND REPLACEMENT PARTS OR COMPONENTS OF SAID MACHINES (U.S. CLS. 19, 21, 23, 31, 35 AND 44).
SANI KHOURI, EXAMINING ATTORNEY

SN 78-466,009. COLWELL INDUSTRIES, INC., MINNEAPOLIS, MN. FILED 8-11-2004.

colwell technical finishing services

OWNER OF U.S. REG. NOS. 1,402,152 AND 1,418,553.
NO CLAIM IS MADE TO THE EXCLUSIVE RIGHT TO USE TECHNICAL FINISHING SERVICES, APART FROM THE MARK AS SHOWN.
SEC. 2(F) AS TO COLWELL.

CLASS 16—PAPER GOODS AND PRINTED MATTER

SN 78-466,616. NEW VISION USA, INC., SCOTTSDALE, AZ. FILED 8-12-2004.

FOR MERCHANDISING AIDS TO ASSIST IN THE SELECTION AND MATCHING OF COLOR AND DECORATIVE OR PROTECTIVE SURFACE MATERIALS, NAMELY, SAMPLE BOOKS, ALBUMS, CARDS, CARD SETS, CHARTS, FAN DECKS, SWATCH CARDS, COLOR STANDARDS, COLOR CONTROL AND TOLERANCE CHARTS; PRINTED EDUCATIONAL MATERIALS IN THE FIELD OF COLOR THEORY AND RELATED CONCEPTS; ATLASES, FAN DECKS, MANUALS AND BROCHURES RELATING TO A COMPUTER-GENERATED NUMERICAL CODING SYSTEM WHICH ANALYZES THE PHYSICAL ATTRIBUTES OF COLOR TO ENABLE ACCURATE SELECTION, MATCHING, AND CONTROL OF COLOR IN THE MANUFACTURING PROCESS (U.S. CLS. 2, 5, 22, 23, 29, 37, 38 AND 50).

SPA STRUCK**CLASS 35—ADVERTISING AND BUSINESS**

FOR BUSINESS MARKETING CONSULTING SERVICES AND BUSINESS RESEARCH, IN THE FIELD OF MERCHANDISING AIDS FOR COLOR OR SURFACE MATERIAL SELECTION AND MATCHING, AND CONTROL OF COLOR IN THE MANUFACTURING PROCESS (U.S. CLS. 100, 101 AND 102).

ANNE MADDEN, EXAMINING ATTORNEY

THE MARK CONSISTS OF STANDARD CHARACTERS WITHOUT CLAIM TO ANY PARTICULAR FONT, STYLE, SIZE, OR COLOR.

NO CLAIM IS MADE TO THE EXCLUSIVE RIGHT TO USE SPA, APART FROM THE MARK AS SHOWN.

CLASS 21—HOUSEWARES AND GLASS

FOR HOUSE WARES, NAMELY MUGS AND CUPS (U.S. CLS. 2, 13, 23, 29, 30, 33, 40 AND 50).

CLASS 25—CLOTHING

FOR CLOTHING, NAMELY T-SHIRTS, SWEATERS, JACKETS, SPORT SHIRTS, DRESS SHIRTS, SWEATSHIRTS, TANK TOPS AND HATS (U.S. CLS. 22 AND 39).
TARAH HARDY, EXAMINING ATTORNEY

SN 78-466,141. RICHARD ANTHONY GREENE II, AURORA, CO. FILED 8-12-2004.

SN 78-466,966. PFIZER INC., NEW YORK, NY. FILED 8-13-2004.

Heavy Ghetto**MURAL**

THE MARK CONSISTS OF STANDARD CHARACTERS WITHOUT CLAIM TO ANY PARTICULAR FONT, STYLE, SIZE, OR COLOR.

CLASS 9—ELECTRICAL AND SCIENTIFIC APPARATUS

FOR MUSICAL SOUND RECORDING (U.S. CLS. 21, 23, 26, 36 AND 38).
FIRST USE 7-10-2003; IN COMMERCE 6-20-2004.

THE MARK CONSISTS OF STANDARD CHARACTERS WITHOUT CLAIM TO ANY PARTICULAR FONT, STYLE, SIZE, OR COLOR.

CLASS 25—CLOTHING

FOR WOMEN, MEN'S AND CHILDREN'S CLOTHING AND ACCESSORIES, NAMELY, SHIRTS (U.S. CLS. 22 AND 39).
FIRST USE 7-10-2003; IN COMMERCE 6-20-2004.
DARRYL SPRUILL, EXAMINING ATTORNEY

CLASS 16—PAPER GOODS AND PRINTED MATTER

FOR PUBLICATIONS, NAMELY, BROCHURES, PAMPHLETS, LEAFLETS, NEWSLETTERS RELATED TO MEDICAL STUDIES AND RESEARCH REGARDING PHARMACEUTICAL PREPARATIONS (U.S. CLS. 2, 5, 22, 23, 29, 37, 38 AND 50).

CLASS 44—MEDICAL, BEAUTY AND AGRICULTURAL SERVICES

FOR PROVIDING INFORMATION ON THE EFFICACY OF A PHARMACEUTICAL PREPARATION FOR THE TREATMENT OF CARDIOVASCULAR DISEASES AND DISORDERS (U.S. CLS. 100 AND 101).
 ZACHARY BELLO, EXAMINING ATTORNEY

SN 78-468,107. FOAMEX L.P., LINWOOD, PA. FILED 8-16-2004.



OWNER OF U.S. REG. NOS. 2,333,347, 2,611,514 AND OTHERS.

THE COLOR(S) RED, BLUE, YELLOW, AND GREEN IS/ARE CLAIMED AS A FEATURE OF THE MARK.

THE COLORS RED, BLUE, YELLOW, GREEN APPEAR IN THE BLOCK LETTERS THAT FORM THE LITERAL PORTION OF THE MARK.

SN 78-467,185. GAMELOGIC INC., CAMBRIDGE, MA. FILED 8-13-2004.

THE SCIENCE OF FUN

CLASS 20—FURNITURE AND ARTICLES NOT OTHERWISE CLASSIFIED

FOR CHILDREN'S FURNITURE (U.S. CLS. 2, 13, 22, 25, 32 AND 50).

FIRST USE 11-0-2003; IN COMMERCE 11-0-2003.

CLASS 28—TOYS AND SPORTING GOODS

FOR TOYS MADE PRIMARILY OF POLYURETHANE FOAM, NAMELY INFANT TOYS AND CHILDREN'S MULTIPLE ACTIVITY TOYS (U.S. CLS. 22, 23, 38 AND 50).

FIRST USE 11-0-2003; IN COMMERCE 11-0-2003.

GISELLE AGOSTO, EXAMINING ATTORNEY

SN 78-469,872. V2 VENTURES ACQUISITIONS & DEVELOPMENT COMPANY, LLC, PALOS VERDES ESTATES, CA. FILED 8-18-2004.

THE MARK CONSISTS OF STANDARD CHARACTERS WITHOUT CLAIM TO ANY PARTICULAR FONT, STYLE, SIZE, OR COLOR.

CLASS 35—ADVERTISING AND BUSINESS

FOR BUSINESS MANAGEMENT SERVICES, NAMELY MANAGEMENT OF ONLINE GAMES AND INTERACTIVE GAMING FOR OTHERS; BUSINESS PLANNING FOR GAMING ESTABLISHMENTS; BUSINESS PLANNING IN THE FIELDS OF ONLINE GAMES AND INTERACTIVE GAMING; BUSINESS SYSTEM ADMINISTRATION AND SUPPORT IN THE FIELDS OF ONLINE GAMES AND INTERACTIVE GAMING (U.S. CLS. 100, 101 AND 102).

V2V ACQUISITIONS & DEVELOPMENT COMPANY

THE MARK CONSISTS OF STANDARD CHARACTERS WITHOUT CLAIM TO ANY PARTICULAR FONT, STYLE, SIZE, OR COLOR.

NO CLAIM IS MADE TO THE EXCLUSIVE RIGHT TO USE "ACQUISITIONS & DEVELOPMENT COMPANY", APART FROM THE MARK AS SHOWN.

CLASS 41—EDUCATION AND ENTERTAINMENT

FOR ENTERTAINMENT SERVICES, NAMELY, PROVIDING AN ONLINE COMPUTER GAME; ELECTRONIC CASINO GAMING SERVICES (U.S. CLS. 100, 101 AND 107).

CLASS 36—INSURANCE AND FINANCIAL

FOR REAL ESTATE INVESTMENTS AND FINANCING (U.S. CLS. 100, 101 AND 102).

FIRST USE 6-1-2003; IN COMMERCE 6-1-2003.

CLASS 42—SCIENTIFIC, COMPUTER AND LEGAL SERVICES

FOR COMPUTER SOFTWARE DESIGN AND DEVELOPMENT SERVICES FOR OTHERS; DESIGN SERVICES FOR OTHERS IN THE FIELD OF COMPUTER GAMES AND GAMING MACHINES; COMPUTER SYSTEM ADMINISTRATION AND TECHNICAL SUPPORT IN THE FIELDS OF ONLINE GAMES AND INTERACTIVE GAMING (U.S. CLS. 100 AND 101).

KIMBERLY FRYE, EXAMINING ATTORNEY

CLASS 37—CONSTRUCTION AND REPAIR

FOR REAL ESTATE DEVELOPMENT (U.S. CLS. 100, 103 AND 106).

FIRST USE 6-1-2003; IN COMMERCE 6-1-2003.

TRACY CROSS, EXAMINING ATTORNEY

SN 78-470,136, LEWIS LIFETIME TOOLS, POWAY, CA.
FILED 8-19-2004.

YARD BUTLER

THE MARK CONSISTS OF STANDARD CHARACTERS WITHOUT CLAIM TO ANY PARTICULAR FONT, STYLE, SIZE, OR COLOR.

NO CLAIM IS MADE TO THE EXCLUSIVE RIGHT TO USE "YARD", APART FROM THE MARK AS SHOWN.

CLASS 6—METAL GOODS

FOR METAL PRODUCTS FOR USE IN GARDENING AND LANDSCAPING, NAMELY, HOSE HANGERS, HOSE GUIDES, HOSE REELS, HOSE BIB EXTENDERS, SPRINKLER STANDS (U.S. CLS. 2, 12, 13, 14, 23, 25 AND 50).

CLASS 7—MACHINERY

FOR EARTH AUGERS (U.S. CLS. 13, 19, 21, 23, 31, 34 AND 35).

CLASS 8—HAND TOOLS

FOR HAND OPERATED TOOLS FOR LAWN, GARDEN AND HOME, NAMELY, AERATORS, EDGERS, WEEDERS, TILLERS, RAKES, CULTIVATORS, BULB PLANTERS, MATTOCKS, HOES, TROWELS, BAIT APPLICATORS, NAMELY GOPHER/MOLE BAIT APPLICATORS, IRRIGATORS, SOD PLUGGERS, AUGERS, DRILLERS, PLANTERS, SPRINKLER KEYS, SPRINKLER RISER EXTRACTORS, WATER METER VALVE KEYS, WATER SHUT OFF WRENCHES, GAS SHUT OFF WRENCHES, GARBAGE DISPOSAL WRENCHES, PLUMBING PLIERS (U.S. CLS. 23, 28 AND 44).

TIMOTHY FINNEGAN, EXAMINING ATTORNEY

SN 78-471,237, GAME CONNECTION, INC., PORTLAND, OR. FILED 8-20-2004.

GAMESTART

THE MARK CONSISTS OF STANDARD CHARACTERS WITHOUT CLAIM TO ANY PARTICULAR FONT, STYLE, SIZE, OR COLOR.

CLASS 35—ADVERTISING AND BUSINESS

FOR RETAIL STORE SERVICES, AND ONLINE ORDERING AND RETAIL STORE SERVICES PROVIDED VIA THE INTERNET, FEATURING AUDIO-VIDEO RECORDINGS OF FILMS, VIDEO AND COMPUTER GAMES, AND RELATED HOME ENTERTAINMENT PRODUCTS AND EQUIPMENT, NAMELY, COMPUTER HARDWARE, VIDEO GAME CONSOLES AND ACCESSORIES, AND TOYS, FOODSTUFFS, GAMES, BOOKS, MAGAZINES, STRATEGY GUIDES, AND TRADING CARDS; ADVERTISING AND PROMOTIONAL SERVICES FOR OTHERS IN THE NATURE OF DISSEMINATION OF ADVERTISEMENTS AND PROMOTIONS VIA THE INTERNET; PROMOTION AND ADMINISTRATION OF CUSTOMER SALES INCENTIVE AND LOYALTY PROGRAMS FOR THE GOODS AND SERVICES OF OTHERS; RETAIL AND ONLINE RETAIL STORE SERVICES FEATURING VIDEO AND COMPUTER GAME TRADING (U.S. CLS. 100, 101 AND 102).

CLASS 41—EDUCATION AND ENTERTAINMENT

FOR PROVIDING FACILITIES FOR PLAYING VIDEO AND COMPUTER GAMES IN STORES (U.S. CLS. 100, 101 AND 107).

ALICIA COLLINS, EXAMINING ATTORNEY

SN 78-472,026, SESAME WORKSHOP, NEW YORK, NY.
FILED 8-23-2004.

HAPPY HEALTHY MONSTER

THE MARK CONSISTS OF STANDARD CHARACTERS WITHOUT CLAIM TO ANY PARTICULAR FONT, STYLE, SIZE, OR COLOR.

CLASS 9—ELECTRICAL AND SCIENTIFIC APPARATUS

FOR VIDEO TAPES AND DVDS FEATURING EDUCATIONAL AND ENTERTAINMENT THEMES DIRECTED TO CHILDREN, PARENTS AND FAMILIES (U.S. CLS. 21, 23, 26, 36 AND 38).

CLASS 16—PAPER GOODS AND PRINTED MATTER

FOR PRINTED MATERIALS, NAMELY BOOKS, MAGAZINES, NEWSLETTERS, BROCHURES, AND PAMPHLETS ALL FEATURING INFORMATION AND ENTERTAINMENT FOR CHILDREN, PARENTS AND FAMILIES; STORY BOOKS, CHILDREN'S BOOKS, CHILDREN'S ACTIVITY BOOKS, COLORING BOOKS; POSTERS, PRINTED EDUCATIONAL BROCHURES AND PAMPHLETS, STICKERS, AND INSTRUCTIONAL VIDEOS AND DVDS SOLD TOGETHER AS A UNIT (U.S. CLS. 2, 5, 22, 23, 29, 37, 38 AND 50).

CLASS 28—TOYS AND SPORTING GOODS

FOR TOYS, GAMES AND PLAYTHINGS, NAMELY PLUSH TOYS, DOLLS, DOLL CLOTHING AND COSTUMES, DOLL ACCESSORIES, YO-YOS, HOBBY CRAFT KITS FOR CHILDREN FOR MAKING AND DECORATING FINGERNAILS AND TOENAILS, HOBBY CRAFT KITS FOR DECORATING HAIR, HOBBY CRAFT KITS FOR MAKING CANDY, HOBBY CRAFT KITS FOR MAKING SOAP, HOBBY CRAFT KITS FOR MAKING PERFUME, HOBBY CRAFT KITS FOR MAKING CRYSTALS, HOBBY CRAFT KITS FOR MOLDING CHOCOLATE, HOBBY CRAFT KITS FOR MAKING CLAY POTTERY, HOBBY CRAFT KITS FOR MAKING HAND-PAINTED, TRANSLUCENT WINDOW DECORATIONS, HOBBY CRAFT SETS AND PLAY KITS CONSISTING OF PLAY COSMETICS, HOBBY CRAFT KITS FOR MAKING BEADS AND TOY JEWELRY, HOBBY CRAFT SETS FOR DECORATING PICTURE FRAMES, HOBBY CRAFT KITS FOR MAKING SAND ART, HOBBY CRAFT KITS FOR MAKING AND DESIGNING GREETING CARDS CONSISTING OF GLITTER AND GLUE, HOBBY CRAFT KITS FOR MAKING DECORATIVE OBJECTS WITH MAGNETS, ACTION SKILL GAMES, BOARD GAMES, CARD GAMES, MANIPULATIVE PUZZLES, MANIPULATIVE GAMES, HAND HELD UNITS FOR PLAYING ELECTRONIC GAMES, ELECTRONIC LEARNING TOYS, TOY FILM CARTRIDGES AND VIEWERS, SQUEEZE TOYS, BATH TOYS, BEACH TOYS, MULTIPLE ACTIVITY BABY TOYS, PUPPETS, BEAN BAGS, PULL TOYS, BABY RATTLES, RIDE-ON TOYS, TOY VEHICLES, TOY SCOOTERS, ICE SKATES, ROLLER SKATES, SPORTS BALLS, BEACH BALLS, PLAYGROUND BALLS, TOY FOAM BALLS, FLYING DISCS, JUMP ROPES, KITES, WIND UP TOYS, BALLOONS, TOY BUILDING BLOCKS, CONSTRUCTION TOYS, TOY BANKS, TOY SHOVELS, TOY BUILDING STRUCTURES, TOY ACTION FIGURES AND ACCESSORIES THEREFORE, CASES FOR PLAY ACCESSORIES, TOY ENVIRONMENTS FOR USE WITH ACTION FIGURES, PLAY SETS FOR ACTION FIGURES, ROLE-PLAYING GAME SETS, PLAY COSTUMES, MASQUERADE GAMES AND COSTUMES, AIR MATTRESSES FOR RECREATIONAL USE, INFLATABLE SWIM FLOATS FOR RECREATIONAL USE, INFLATABLE SWIMMING POOLS, PLAYGROUND SAND BOXES, SNOW SLEDS FOR RECREATIONAL USE, SNOW BOARDS; CHRISTMAS TREE DECORATIONS, ORNAMENTS, AND SKIRTS (U.S. CLS. 22, 23, 38 AND 50).

CLASS 41—EDUCATION AND ENTERTAINMENT

FOR ONGOING TELEVISION PROGRAM FEATURING EDUCATIONAL AND ENTERTAINMENT THEMES DIRECTED TO CHILDREN, PARENTS, AND FAMILIES; ONLINE COMPUTER SERVICES, NAMELY, PROVIDING INFORMATION FEATURING EDUCATIONAL AND ENTERTAINMENT THEMES AND CONTENT DIRECTED TO CHILDREN, PARENTS AND FAMILIES (U.S. CLS. 100, 101 AND 107).

GEORGE LORENZO, EXAMINING ATTORNEY

SN 78-472,698. HANDI-LIFT INC., CARLSTADT, NJ. FILED 8-24-2004.

**ACCESSIBILITY WITH
DIGNITY**

THE MARK CONSISTS OF STANDARD CHARACTERS WITHOUT CLAIM TO ANY PARTICULAR FONT, STYLE, SIZE, OR COLOR.

CLASS 35—ADVERTISING AND BUSINESS

FOR ONLINE RETAIL STORE SERVICES, RETAIL STORE SERVICES AND DISTRIBUTORSHIP SERVICES FEATURING LIFTS AND ELEVATORS (U.S. CLS. 100, 101 AND 102).

FIRST USE 8-24-2002; IN COMMERCE 8-24-2002.

CLASS 37—CONSTRUCTION AND REPAIR

FOR INSTALLATION, MAINTENANCE AND REPAIR OF LIFTS AND ELEVATORS (U.S. CLS. 100, 103 AND 106).

FIRST USE 8-24-2002; IN COMMERCE 8-24-2002.

KHANH LE, EXAMINING ATTORNEY

SN 78-472,865. CMN INTERNATIONAL LLC, WALNUT CREEK, CA. AND TWINSAYER CO. LTD., GOYANG CITY, REPUBLIC OF KOREA, FILED 8-24-2004.

CALMA

THE MARK CONSISTS OF STANDARD CHARACTERS WITHOUT CLAIM TO ANY PARTICULAR FONT, STYLE, SIZE, OR COLOR.

THE ENGLISH TRANSLATION OF THE WORD "CALMA" IN THE MARK IS "CALM".

CLASS 20—FURNITURE AND ARTICLES NOT OTHERWISE CLASSIFIED

FOR PILLOWS, MATTRESS TOPPERS, MATTRESS, NECK PILLOW, CONTOUR PILLOW, LEG PILLOW, WAIST PILLOW, TRAVEL PILLOW, SEAT CUSHION, KIDS PILLOW, JUNIORS PILLOW (U.S. CLS. 2, 13, 22, 25, 32 AND 50).

CLASS 24—FABRICS

FOR MATTRESS PADS, MATTRESS COVER, PILLOW COVER (U.S. CLS. 42 AND 50).

WON TEAK OH, EXAMINING ATTORNEY

SN 78-473,040. CREDIT SUISSE FIRST BOSTON LLC, NEW YORK, NY. FILED 8-25-2004.

**BROKER DEALER PLUS
(BD+)**

THE MARK CONSISTS OF STANDARD CHARACTERS WITHOUT CLAIM TO ANY PARTICULAR FONT, STYLE, SIZE, OR COLOR.

NO CLAIM IS MADE TO THE EXCLUSIVE RIGHT TO USE "BROKER DEALER", APART FROM THE MARK AS SHOWN.

CLASS 36—INSURANCE AND FINANCIAL

FOR SECURITY BROKERAGE SERVICES, NAMELY EXECUTING FINANCIAL SECURITIES TRADING FOR OTHERS (U.S. CLS. 100, 101 AND 102).

FIRST USE 5-0-2004; IN COMMERCE 5-0-2004.

CLASS 42—SCIENTIFIC, COMPUTER AND LEGAL SERVICES

FOR PROVIDING TEMPORARY USE OF ON-LINE NON-DOWNLOADABLE SOFTWARE FOR THE PURCHASE AND SALE OF FINANCIAL SECURITIES (U.S. CLS. 100 AND 101).

FIRST USE 5-0-2004; IN COMMERCE 5-0-2004.
ANNE MADDEN, EXAMINING ATTORNEY

SN 78-473,456. PAYROLL EASE LLC, KENT, CT. FILED 8-25-2004.

PAYROLL Ease

NO CLAIM IS MADE TO THE EXCLUSIVE RIGHT TO USE "PAYROLL", APART FROM THE MARK AS SHOWN. THE COLOR(S) RED AND GREEN IS/ARE CLAIMED AS A FEATURE OF THE MARK.

THE MARK CONSISTS OF THE WORD PAYROLL IN GREEN, WITH A CLOCK FACE SUBSTITUTED FOR THE O, AND THE WORD EASE IN RED, WITH A GREEN DOLLAR SIGN SUBSTITUTED FOR THE S.

CLASS 35—ADVERTISING AND BUSINESS

FOR PAYROLL PREPARATION SERVICES (U.S. CLS. 100, 101 AND 102).

FIRST USE 1-10-1999; IN COMMERCE 1-15-1999.

CLASS 36—INSURANCE AND FINANCIAL

FOR TAX PAYMENT PROCESSING SERVICES; PAYMENT SERVICES, NAMELY ELECTRONIC PROCESSING AND TRANSMISSION OF PAYMENT DATA (U.S. CLS. 100, 101 AND 102).

FIRST USE 1-10-1999; IN COMMERCE 1-15-1999.
MARK SPARACINO, EXAMINING ATTORNEY

SN 78-473,519. WINDSORTECH, INC., HIGHTSTOWN, NJ. FILED 8-25-2004.

**Solid In
everything we do**

THE MARK CONSISTS OF STANDARD CHARACTERS WITHOUT CLAIM TO ANY PARTICULAR FONT, STYLE, SIZE, OR COLOR.

CLASS 35—ADVERTISING AND BUSINESS

FOR WHOLESALE AND DISTRIBUTORSHIP SERVICES IN THE FIELD OF COMPUTER HARDWARE AND SOFTWARE (U.S. CLS. 100, 101 AND 102).

FIRST USE 12-12-2002; IN COMMERCE 12-12-2002.

CLASS 37—CONSTRUCTION AND REPAIR

FOR PROVIDING COMPUTER HARDWARE MAINTENANCE AND INFORMATION TO OTHERS (U.S. CLS. 100, 103 AND 106).

FIRST USE 12-12-2002; IN COMMERCE 12-12-2002.

CLASS 40—MATERIAL TREATMENT

FOR DATA DESTRUCTION AND DATA ERASURE SERVICES (U.S. CLS. 100, 103 AND 106).

FIRST USE 12-12-2002; IN COMMERCE 12-12-2002.

CLASS 41—EDUCATION AND ENTERTAINMENT

FOR EDUCATIONAL SERVICES, NAMELY, PROVIDING COURSES AND SEMINARS RELATING TO DATA ERASURE, LIABILITY ASSOCIATED WITH DATA RELEASE AND COMPUTER HARDWARE EDUCATIONAL SERVICES, NAMELY, PROVIDING COURSES AND SEMINARS IN THE FIELD OF DATA ERASURE, LIABILITY AND COMPUTER HARDWARE (U.S. CLS. 100, 101 AND 107).

FIRST USE 12-12-2002; IN COMMERCE 12-12-2002.
MARGERY A. TIERNEY, EXAMINING ATTORNEY

SN 78-473,586. SBD TRADEMARK LIMITED PARTNERSHIP, BOCA RATON, FL. FILED 8-25-2004.

**LIFE IS BETTER ON
THE BEACH**

THE MARK CONSISTS OF STANDARD CHARACTERS WITHOUT CLAIM TO ANY PARTICULAR FONT, STYLE, SIZE, OR COLOR.

CLASS 29—MEATS AND PROCESSED FOODS

FOR PREPARED ENTREES, SIDE DISHES AND MEALS CONSISTING PRIMARILY OF MEAT, SEA-FOOD, POULTRY OR VEGETABLES; PREPARED DINNERS CONSISTING OF MEAT SUBSTITUTES; MEAT; PROCESSED MEAT, NAMELY HAM, POULTRY OR BEEF; VEGETABLE BASED READY TO EAT FOOD BARS, PROTEIN BASED READY TO EAT FOOD BARS, PROTEIN BASED NUTRIENT DENSE SNACK BARS; SUGAR-FREE PEANUT BUTTER, BUTTER SUBSTITUTES; SUGAR-FREE AND LOW SUGAR JAMS, JEL-LIES, AND FRUIT SPREADS; FRUIT TOPPINGS, WHIPPED TOPPINGS, NUT TOPPINGS; COOKING OILS, OLIVE OIL, CANOLA OIL, VEGETABLE OIL, MAYONNAISE, SOUR CREAM, PROCESSED NUTS, MILK-BASED BEVERAGES CONTAINING COFFEE; SNACK MIX CONSISTING PRIMARILY OF PROCESSED FRUITS, PROCESSED NUTS AND/OR RAISINS; YOGURT, YOGURT-BASED BEVERAGES; CHEESE, CHEESE SPREADS, CHEESE AND CRACKER COMBINATIONS; FOOD PACKAGE COMBINATIONS CONSISTING PRIMARILY OF CHEESE, MEAT AND/OR PROCESSED FRUIT (U.S. CL. 46).

CLASS 30—STAPLE FOODS

FOR READY TO EAT FOOD BARS AND SNACK FOODS MADE WITH WHOLE GRAINS; READY TO EAT, CEREAL DERIVED FOOD BARS; GRANOLA BASED SNACK BARS; OATMEAL; WHOLE GRAIN BREADS, WHOLE GRAIN PASTAS, WHOLE GRAIN BREAKFAST CEREALS, BREAKFAST CEREALS, PROCESSED CEREALS, WHOLE GRAIN MUFFIN MIXES, AND WHOLE GRAIN PANCAKE MIXES; SUGAR-FREE CHOCOLATE, CHOCOLATES, SUGAR-FREE CHOCOLATE POWDER, COCOA POWDER, SUGAR-FREE CANDY, SUGAR-FREE GUM, SUGAR-FREE FLAVORED GELATIN, SWEETENED FLAVORED GELATIN DESERTS, FAT-FREE AND SUGAR-FREE PUDDING, PUDDINGS, CHEESECAKE, SHAKES, SHAKE MIXES, TEA, SUGAR SUBSTITUTES, SALAD DRESSINGS, SALSA, SAUCES, SEASONINGS, SPICES; SUGAR-FREE DESERTS, NAMELY SUGAR-FREE COOKIES, CARAMEL CORN, PIES, CAKES, CHEESECAKES, BROWNIES, MARSHMALLOW TOPPING, CHOCOLATE TOPPING, CHOCOLATE SYRUP, FLAVORING SYRUP, TOPPING SYRUP AND BAKERY DESSERTS; SUGAR-FREE FROZEN CONFECTIONS, MARSHMALLOW TOPPING, CHOCOLATE TOPPING, CHOCOLATE SYRUP, FLAVORING SYRUP, TOPPING SYRUP, COOKIES, CRACKERS, POPPED POPCORN, CARAMEL POPCORN, RICE CAKES, PRETZELS, CHEESE FLAVORED PUFFED CORN SNACKS; CHEESE FLAVORED SNACKS, NAMELY CHEESE CURLS; SNACK MIX CONSISTING PRIMARILY OF CRACKERS, PRETZELS, CANDIED NUTS AND/OR POPPED CORN, PIZZA, SANDWICHES (U.S. CL. 46).

CAROL SPILS, EXAMINING ATTORNEY

SN 78-474,258. SAFETY & HEALTH COUNCIL OF GREATER OMAHA, INC., DBA NATIONAL SAFETY COUNCIL, GREATER OMAHA CHAPTER, OMAHA, NE. FILED 8-26-2004.

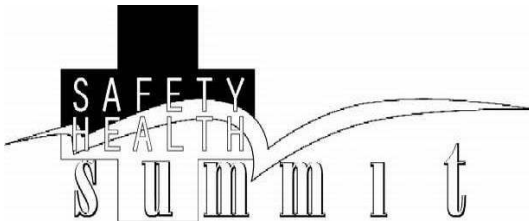

NO CLAIM IS MADE TO THE EXCLUSIVE RIGHT TO USE SAFETY HEALTH SUMMIT, APART FROM THE MARK AS SHOWN.

CLASS 35—ADVERTISING AND BUSINESS

FOR ARRANGING AND CONDUCTING TRADE SHOWS IN THE FIELD OF SAFETY AND HEALTH (U.S. CLS. 100, 101 AND 102).

FIRST USE 1-9-2004; IN COMMERCE 1-9-2004.

CLASS 41—EDUCATION AND ENTERTAINMENT

FOR EDUCATION SERVICES, NAMELY CONDUCTING CLASSES, SEMINARS, CONFERENCES AND WORKSHOPS IN THE FIELD OF SAFETY AND HEALTH AND DISTRIBUTING EDUCATIONAL MATERIALS IN CONNECTION THEREWITH (U.S. CLS. 100, 101 AND 107).

FIRST USE 1-9-2004; IN COMMERCE 1-9-2004.
LINDA E. BLOHM, EXAMINING ATTORNEY

SN 78-474,296. GREAT RIVER REGIONAL WASTE AUTHORITY, FORT MADISON, IA. FILED 8-26-2004.

Earthly Goods

THE MARK CONSISTS OF STANDARD CHARACTERS WITHOUT CLAIM TO ANY PARTICULAR FONT, STYLE, SIZE, OR COLOR.

CLASS 1—CHEMICALS

FOR ORGANIC AGRICULTURAL MATERIALS, NAMELY, COMPOST AND POTTING SOIL (U.S. CLS. 1, 5, 6, 10, 26 AND 46).

FIRST USE 1-1-1999; IN COMMERCE 1-1-1999.

CLASS 31—NATURAL AGRICULTURAL PRODUCTS

FOR ORGANIC AGRICULTURAL MATERIALS, NAMELY, TOP SOIL AND MULCH (U.S. CLS. 1 AND 46).

FIRST USE 1-1-1999; IN COMMERCE 1-1-1999.

GWEN STOKOLS, EXAMINING ATTORNEY

SN 78-475,801. PHILLIPS INTERNATIONAL, INC., PLYMOUTH, MI. FILED 8-30-2004.

WEALTH ACADEMY

THE MARK CONSISTS OF STANDARD CHARACTERS WITHOUT CLAIM TO ANY PARTICULAR FONT, STYLE, SIZE, OR COLOR.

NO CLAIM IS MADE TO THE EXCLUSIVE RIGHT TO USE "WEALTH", APART FROM THE MARK AS SHOWN.

CLASS 35—ADVERTISING AND BUSINESS

FOR MARKETING SERVICES, NAMELY, COLLECTION AND DISSEMINATION OF ADVERTISING FOR OTHERS, AND PROVIDING CONSUMER DATA REGARDING USER CLICK TRAFFIC AND VISITS TO DEFINED TOPICS ON A WEBSITE SORTED BY AREAS OF THE WEBSITE VISITED (U.S. CLS. 100, 101 AND 102).

FIRST USE 2-28-2004; IN COMMERCE 2-28-2004.

CLASS 36—INSURANCE AND FINANCIAL

FOR FINANCIAL SERVICES, NAMELY PROVIDING INFORMATION IN THE AREAS OF COMMERCIAL AND RESIDENTIAL REAL ESTATE FINANCING, BUSINESS FINANCE MANAGEMENT, PERSONAL FINANCE MANAGEMENT, CONSUMER CREDIT MANAGEMENT, DEBT MANAGEMENT, INVESTMENT PLANNING, ONLINE MARKETING AND DATABASE MANAGEMENT, TAX PLANNING, AND PROVIDING AN ONLINE KNOWLEDGE REPOSITORY FOR INFORMATION RELATED TO CREATING AND PRESERVING WEALTH (U.S. CLS. 100, 101 AND 102).

FIRST USE 2-28-2004; IN COMMERCE 2-28-2004.
ANDREW BENZMILLER, EXAMINING ATTORNEY

CLASS 16—PAPER GOODS AND PRINTED MATTER

FOR COOK BOOKS; PRINTED COLUMNS IN THE FIELDS OF COOKING AND FOOD (U.S. CLS. 2, 5, 22, 23, 29, 37, 38 AND 50).

CLASS 35—ADVERTISING AND BUSINESS

FOR PROMOTING THE GOODS AND SERVICES OF OTHERS BY PROVIDING HYPERTEXT LINKS TO THE WEB SITES OF OTHERS; ONLINE RETAIL STORE SERVICES FEATURING COOKBOOKS, KITCHEN APPLIANCES, DINNERWARE, GLASSWARE, HOUSEWARES, TABLE LINENS, PICNIC BASKETS AND WINE PRODUCTS (U.S. CLS. 100, 101 AND 102).

SN 78-475,900. NIGHTINGALE-CONANT CORPORATION, NILES, IL. FILED 8-30-2004.

CLASS 41—EDUCATION AND ENTERTAINMENT

FOR ONLINE EDUCATIONAL SERVICES, NAMELY TUTORIALS, SEMINARS, AND CLASSES IN THE FIELD OF COOKING TECHNIQUES AND METHODS (U.S. CLS. 100, 101 AND 107).

YOU BECOME WHAT
YOU THINK ABOUT.

CLASS 43—HOTEL AND RESTAURANT SERVICES

FOR PROVIDING AN ONLINE DATABASE REGARDING RECIPES AND FOOD (U.S. CLS. 100 AND 101).
BRIAN NEVILLE, EXAMINING ATTORNEY

THE MARK CONSISTS OF STANDARD CHARACTERS WITHOUT CLAIM TO ANY PARTICULAR FONT, STYLE, SIZE, OR COLOR.

SN 78-475,952. BROWNING, MORGAN, UT. FILED 8-30-2004.

CLASS 35—ADVERTISING AND BUSINESS

FOR ON-LINE, DIRECT MAIL AND CATALOG RETAIL SERVICES FEATURING PRE-RECORDED AUDIO TAPES, COMPACT DISCS, VIDEO TAPES, DVDS, DOWNLOADABLE PERSONAL DEVELOPMENT PUBLICATIONS AND PERSONAL DEVELOPMENT BOOKS (U.S. CLS. 100, 101 AND 102).

FIRST USE 0-0-1975; IN COMMERCE 0-0-1975.

CLASS 41—EDUCATION AND ENTERTAINMENT

FOR EDUCATIONAL SERVICES, NAMELY, HOME STUDY COURSES, CONDUCTING SEMINARS AND TRAINING PROGRAMS IN THE FIELDS OF PERSONAL DEVELOPMENT, BUSINESS STRATEGY, WEALTH BUILDING, SKILLS AND LEARNING, MIND AND BODY, AND SPIRITUAL GROWTH (U.S. CLS. 100, 101 AND 107).

FIRST USE 0-0-1975; IN COMMERCE 0-0-1975.
MARGERY A. TIERNEY, EXAMINING ATTORNEY

BROWNING

THE MARK CONSISTS OF STANDARD CHARACTERS WITHOUT CLAIM TO ANY PARTICULAR FONT, STYLE, SIZE, OR COLOR.

OWNER OF U.S. REG. NO. 1,620,728.
SEC. 2(F).

SN 78-475,930. ADAMS, BARBARA, SAUSALITO, CA. FILED 8-30-2004.

CLASS 20—FURNITURE AND ARTICLES NOT OTHERWISE CLASSIFIED

FOR SLEEPING BAGS AND CAMPING FURNITURE INCLUDING CHAIRS, COTS, STOOLS AND TABLES (U.S. CLS. 2, 13, 22, 25, 32 AND 50).

FIRST USE 6-1-2004; IN COMMERCE 8-1-2004.

BARBARA ADAMS
BEYOND WONDERFUL

CLASS 22—CORDAGE AND FIBERS

FOR TENTS AND TENT BAGS (U.S. CLS. 1, 2, 7, 19, 22, 42 AND 50).

FIRST USE 6-1-2004; IN COMMERCE 8-1-2004.
ADA HAN, EXAMINING ATTORNEY

THE MARK CONSISTS OF STANDARD CHARACTERS WITHOUT CLAIM TO ANY PARTICULAR FONT, STYLE, SIZE, OR COLOR.

SN 78-476,490. SPEEDCO, INC., CAYUGA, IN. FILED 8-31-2004.

SN 78-476,664. THE ZOHOURI GROUP, LLC, ATLANTA, GA. FILED 8-31-2004.

INTEGRUS TITLE & CLOSING SERVICES



THE MARK CONSISTS OF STANDARD CHARACTERS WITHOUT CLAIM TO ANY PARTICULAR FONT, STYLE, SIZE, OR COLOR.

NO CLAIM IS MADE TO THE EXCLUSIVE RIGHT TO USE "TITLE & CLOSING SERVICES", APART FROM THE MARK AS SHOWN.

CLASS 36—INSURANCE AND FINANCIAL

FOR PROVIDING REAL ESTATE TITLE INSURANCE SERVICES (U.S. CLS. 100, 101 AND 102).
FIRST USE 11-1-2004; IN COMMERCE 11-1-2004.

CLASS 42—SCIENTIFIC, COMPUTER AND LEGAL SERVICES

FOR PROVIDING RESIDENTIAL AND COMMERCIAL REAL ESTATE CLOSING SERVICES (U.S. CLS. 100 AND 101).

FIRST USE 11-1-2004; IN COMMERCE 11-1-2004.
KEVON CHISOLM, EXAMINING ATTORNEY

SN 78-476,956. PRAENDEX INCORPORATED, WELLESLEY HILLS, MA. FILED 9-1-2004.

THE DRAWING IS LINED WITH VERTICAL LINES TO IDENTIFY THE COLOR ORANGE AND IS LINED WITH CROSS-HATCHING TO IDENTIFY THE COLOR YELLOW.

THE COLORS YELLOW, ORANGE, WHITE AND BLACK ARE CLAIMED AS FEATURES OF THE MARK.

THE MARK CONSISTS OF A LARGE DROP BELOW A SMALLER DROP WITH THE COLOR ORANGE AND THE COLOR YELLOW IN FLAME-LIKE STREAKS CONCENTRATED ON THE LOWER PORTIONS OF THE LARGE DROP. THE RIGHT SIDE AND LOWER RIGHT SIDE OF BOTH DROPS ARE SHADED IN WHITE. THE LEFT AND LOWER LEFT SIDES OF BOTH DROPS ARE SHADED IN YELLOW AND ORANGE. THE INTERIOR PORTION OF BOTH DROPS IS BLACK. BOTH DROPS ARE SET AGAINST A RECTANGULAR BACKGROUND DESIGN THAT IS COLORED BLACK.

CLASS 21—HOUSEWARES AND GLASS

FOR MUGS (U.S. CLS. 2, 13, 23, 29, 30, 33, 40 AND 50).

CLASS 25—CLOTHING

FOR CLOTHING, NAMELY, T-SHIRTS, HATS AND JACKETS (U.S. CLS. 22 AND 39).

CLASS 37—CONSTRUCTION AND REPAIR

FOR TRUCK MAINTENANCE SERVICES, NAMELY, LUBRICATION, OIL CHANGE, ANTI-FREEZE TESTING AND ANALYSIS OF OIL FOR IMPURITIES (U.S. CLS. 100, 103 AND 106).

RUSS HERMAN, EXAMINING ATTORNEY

PI WORLDWIDE

THE MARK CONSISTS OF STANDARD CHARACTERS WITHOUT CLAIM TO ANY PARTICULAR FONT, STYLE, SIZE, OR COLOR.

OWNER OF U.S. REG. NOS. 1,531,158, 2,501,161 AND OTHERS.

NO CLAIM IS MADE TO THE EXCLUSIVE RIGHT TO USE "WORLDWIDE" ONLY IN INTERNATIONAL CLASSES 35, 38 AND 41, APART FROM THE MARK AS SHOWN.

CLASS 9—ELECTRICAL AND SCIENTIFIC APPARATUS

FOR (BASED ON INTENT TO USE) SOFTWARE FOR TESTING AND ASSESSMENT IN THE FIELD OF HUMAN RESOURCES, AND INSTRUCTIONAL MANUALS PROVIDED THEREWITH (U.S. CLS. 21, 23, 26, 36 AND 38).

CLASS 16—PAPER GOODS AND PRINTED MATTER

FOR (BASED ON INTENT TO USE) PRE-PRINTED EDUCATIONAL, INSTRUCTIONAL, TESTING, ASSESSMENT, AND TEACHING MATERIALS IN THE FIELD OF MANAGEMENT TRAINING, HUMAN RESOURCES DEVELOPMENT AND ORGANIZATION, NAMELY, EDUCATIONAL MATERIALS, TESTING AND ASSESSMENT MATERIALS, SURVEYS, AND DATASHEETS (U.S. CLS. 2, 5, 22, 23, 29, 37, 38 AND 50).

CLASS 35—ADVERTISING AND BUSINESS

FOR (BASED ON USE IN COMMERCE) CONSULTING SERVICES AND PROVIDING INFORMATION IN THE FIELDS OF HUMAN RESOURCE DEVELOPMENT AND ORGANIZATION, AND PERSONNEL MANAGEMENT; PROVIDING ON-LINE ASSESSMENT, SCORING AND COMPILATION SERVICES TO BETTER UNDERSTAND EMPLOYEE BEHAVIOR, DETERMINE LEADERSHIP AND COMMUNICATION STYLES AND EMPLOYMENT SKILLS AND COMPETENCY IN THE FIELD OF HUMAN RESOURCES (U.S. CLS. 100, 101 AND 102).
FIRST USE 11-17-2003; IN COMMERCE 11-17-2003.

CLASS 38—COMMUNICATION

FOR (BASED ON USE IN COMMERCE) PROVIDING AN ON-LINE FORUM AND ELECTRONIC BULLETIN BOARD FOR TRANSMISSION OF MESSAGES AMONG USERS CONCERNING MANAGEMENT AND HUMAN RESOURCE DEVELOPMENT AND ORGANIZATION (U.S. CLS. 100, 101 AND 104).
FIRST USE 11-17-2003; IN COMMERCE 11-17-2003.

CLASS 41—EDUCATION AND ENTERTAINMENT

FOR (BASED ON USE IN COMMERCE) TRAINING SERVICES AND CONDUCTING WORKSHOPS IN THE FIELDS OF MANAGEMENT AND HUMAN RESOURCE DEVELOPMENT AND ORGANIZATION (U.S. CLS. 100, 101 AND 107).
FIRST USE 11-17-2003; IN COMMERCE 11-17-2003.
JEFFERY COWARD, EXAMINING ATTORNEY

SN 78-477,358. TERRA DENUO, INC., ROCKLIN, CA. FILED 9-1-2004.

TERRA DENUO

THE MARK CONSISTS OF STANDARD CHARACTERS WITHOUT CLAIM TO ANY PARTICULAR FONT, STYLE, SIZE, OR COLOR.

THE FOREIGN WORDING "TERRA" IN THE MARK TRANSLATES INTO ENGLISH AS "EARTH". THE FOREIGN WORDING "DENUO" IN THE MARK TRANSLATES INTO ENGLISH AS "NEW".

CLASS 9—ELECTRICAL AND SCIENTIFIC APPARATUS

FOR COMPUTER GAME SOFTWARE (U.S. CLS. 21, 23, 26, 36 AND 38).

CLASS 28—TOYS AND SPORTING GOODS

FOR GAMES, NAMELY, BOARD GAMES AND CARD GAMES (U.S. CLS. 22, 23, 38 AND 50).
ELISSA GARBER KON, EXAMINING ATTORNEY

SN 78-477,506. EPOCH BIOSCIENCES, INC., BOTHELL, WA. FILED 9-1-2004.

SUPER A

THE MARK CONSISTS OF STANDARD CHARACTERS WITHOUT CLAIM TO ANY PARTICULAR FONT, STYLE, SIZE, OR COLOR.

NO CLAIM IS MADE TO THE EXCLUSIVE RIGHT TO USE "A", APART FROM THE MARK AS SHOWN.

CLASS 1—CHEMICALS

FOR PHOSPHORAMIDITES OF MODIFIED BASES, NUCLEOSIDE TRIPHOSPHATES OF MODIFIED BASES, ACTIVATED MONOMERS OF MODIFIED BASES, MODIFIED NUCLEOTIDE BASES, OLIGONUCLEOTIDE CONJUGATES, DNA PRIMERS, OLIGONUCLEOTIDES, AND OLIGOMER PROBES, FOR SCIENTIFIC AND RESEARCH USE, NUCLEIC ACID DETECTION, GENETIC ANALYSIS, AND SYNTHESIS OF OLIGOPOLYMERS, TOGETHER WITH INSTRUCTION MANUALS THEREFOR PACKAGED AS A UNIT (U.S. CLS. 1, 5, 6, 10, 26 AND 46).

FIRST USE 5-13-2002; IN COMMERCE 5-13-2002.

CLASS 5—PHARMACEUTICALS

FOR PHOSPHORAMIDITES OF MODIFIED BASES, NUCLEOSIDE TRIPHOSPHATES OF MODIFIED BASES, ACTIVATED MONOMERS OF MODIFIED BASES, MODIFIED NUCLEOTIDE BASES, OLIGONUCLEOTIDE CONJUGATES, DNA PRIMERS, OLIGONUCLEOTIDES, AND OLIGOMER PROBES, FOR MEDICAL AND PHARMACEUTICAL USE, TOGETHER WITH INSTRUCTION MANUALS THEREFOR PACKAGED AS A UNIT (U.S. CLS. 6, 18, 44, 46, 51 AND 52).

FIRST USE 5-13-2002; IN COMMERCE 5-13-2002.

MARIA-VICTORIA SUAREZ, EXAMINING ATTORNEY

SN 78-477,511, EPOCH BIOSCIENCES, INC., BOTHELL, WA.
FILED 9-1-2004.

SN 78-477,519, EPOCH BIOSCIENCES, INC., BOTHELL, WA.
FILED 9-1-2004.

SUPER G

SUPER T

THE MARK CONSISTS OF STANDARD CHARACTERS WITHOUT CLAIM TO ANY PARTICULAR FONT, STYLE, SIZE, OR COLOR.

NO CLAIM IS MADE TO THE EXCLUSIVE RIGHT TO USE "G", APART FROM THE MARK AS SHOWN.

CLASS 1—CHEMICALS

FOR PHOSPHORAMIDITES OF MODIFIED BASES, NUCLEOSIDE TRIPHOSPHATES OF MODIFIED BASES, ACTIVATED MONOMERS OF MODIFIED BASES, MODIFIED NUCLEOTIDE BASES, OLIGONUCLEOTIDE CONJUGATES, DNA PRIMERS, OLIGONUCLEOTIDES, AND OLIGOMER PROBES, FOR SCIENTIFIC AND RESEARCH USE, NUCLEIC ACID DETECTION, GENETIC ANALYSIS, AND SYNTHESIS OF OLIGOPOLYMERS, TOGETHER WITH INSTRUCTION MANUALS THEREFOR PACKAGED AS A UNIT (U.S. CLS. 1, 5, 6, 10, 26 AND 46).

FIRST USE 5-13-2002; IN COMMERCE 5-13-2002.

CLASS 5—PHARMACEUTICALS

FOR PHOSPHORAMIDITES OF MODIFIED BASES, NUCLEOSIDE TRIPHOSPHATES OF MODIFIED BASES, ACTIVATED MONOMERS OF MODIFIED BASES, MODIFIED NUCLEOTIDE BASES, OLIGONUCLEOTIDE CONJUGATES, DNA PRIMERS, OLIGONUCLEOTIDES, AND OLIGOMER PROBES, FOR MEDICAL AND PHARMACEUTICAL USE, TOGETHER WITH INSTRUCTION MANUALS THEREFOR PACKAGED AS A UNIT (U.S. CLS. 6, 18, 44, 46, 51 AND 52).

FIRST USE 5-13-2002; IN COMMERCE 5-13-2002.

MARIA-VICTORIA SUAREZ, EXAMINING ATTORNEY

THE MARK CONSISTS OF STANDARD CHARACTERS WITHOUT CLAIM TO ANY PARTICULAR FONT, STYLE, SIZE, OR COLOR.

NO CLAIM IS MADE TO THE EXCLUSIVE RIGHT TO USE "T", APART FROM THE MARK AS SHOWN.

CLASS 1—CHEMICALS

FOR PHOSPHORAMIDITES OF MODIFIED BASES, NUCLEOSIDE TRIPHOSPHATES OF MODIFIED BASES, ACTIVATED MONOMERS OF MODIFIED BASES, MODIFIED NUCLEOTIDE BASES, OLIGONUCLEOTIDE CONJUGATES, DNA PRIMERS, OLIGONUCLEOTIDES, AND OLIGOMER PROBES, FOR SCIENTIFIC AND RESEARCH USE, NUCLEIC ACID DETECTION, GENETIC ANALYSIS, AND SYNTHESIS OF OLIGOPOLYMERS, TOGETHER WITH INSTRUCTION MANUALS THEREFOR PACKAGED AS A UNIT (U.S. CLS. 1, 5, 6, 10, 26 AND 46).

FIRST USE 5-13-2002; IN COMMERCE 5-13-2002.

CLASS 5—PHARMACEUTICALS

FOR PHOSPHORAMIDITES OF MODIFIED BASES, NUCLEOSIDE TRIPHOSPHATES OF MODIFIED BASES, ACTIVATED MONOMERS OF MODIFIED BASES, MODIFIED NUCLEOTIDE BASES, OLIGONUCLEOTIDE CONJUGATES, DNA PRIMERS, OLIGONUCLEOTIDES, AND OLIGOMER PROBES, FOR MEDICAL AND PHARMACEUTICAL USE, TOGETHER WITH INSTRUCTION MANUALS THEREFOR PACKAGED AS A UNIT (U.S. CLS. 6, 18, 44, 46, 51 AND 52).

FIRST USE 5-13-2002; IN COMMERCE 5-13-2002.

MARIA-VICTORIA SUAREZ, EXAMINING ATTORNEY

SN 78-477,921. GREEN CANYON CORPORATION, CHARLESTON, WV. FILED 9-2-2004.

SN 78-478,597. ANDALIB, A. HAMID, CHATTANOOGA, TN. FILED 9-3-2004.



CDI BUSINESS SOLUTIONS

THE MARK CONSISTS OF STANDARD CHARACTERS WITHOUT CLAIM TO ANY PARTICULAR FONT, STYLE, SIZE, OR COLOR.

OWNER OF U.S. REG. NOS. 1,052,098, 1,349,940 AND OTHERS.

NO CLAIM IS MADE TO THE EXCLUSIVE RIGHT TO USE "BUSINESS SOLUTIONS", APART FROM THE MARK AS SHOWN.

CLASS 35—ADVERTISING AND BUSINESS

FOR DATA PROCESSING SERVICES, EMPLOYMENT AGENCY SERVICES, LONG TERM AND SHORT TERM PLACEMENT OF CONSULTANTS, MANAGEMENT, MARKETING, PROFESSIONAL, LEGAL, ACCOUNTING, FINANCIAL, ADMINISTRATIVE, SALES, OFFICE AND CLERICAL PERSONNEL, TECHNICAL, ELECTRONIC DATA PROCESSING SUPPORT, PROGRAMMERS AND OTHER COMPUTER PERSONNEL, ENGINEERING AND INDUSTRIAL PERSONNEL AND THE MANAGEMENT OF SUCH PLACEMENTS FOR OTHERS (U.S. CLS. 100, 101 AND 102).

FIRST USE 11-1-2003; IN COMMERCE 1-1-2004.

CLASS 37—CONSTRUCTION AND REPAIR

FOR SHORT TERM COMPUTER HARDWARE MAINTENANCE (U.S. CLS. 100, 103 AND 106).

FIRST USE 11-1-2003; IN COMMERCE 1-1-2004.

CLASS 42—SCIENTIFIC, COMPUTER AND LEGAL SERVICES

FOR SHORT TERM COMPUTER SOFTWARE MAINTENANCE, TECHNICAL CONSULTING AND TECHNICAL SUPPORT SERVICES, NAMELY, TROUBLESHOOTING OF COMPUTER HARDWARE AND SOFTWARE PROBLEMS IN THE FIELDS OF DATA PROCESSING, SOFTWARE ENGINEERING, SOFTWARE DESIGN, HARDWARE ENGINEERING, HARDWARE DESIGN AND COMPUTER PROGRAMMING, COMPUTER SOFTWARE DESIGN FOR OTHERS, COMPUTER AIDED DESIGN (CAD), NAMELY, PROVIDING DESIGN, DRAFTING, AND LEGACY CONVERSION SERVICES, ENGINEERING, DRAFTING AND DESIGN SERVICE FOR OTHERS IN THE FIELDS OF ELECTRONICS, CHEMICALS, AUTOMOBILES, PETROLEUM, PHARMACEUTICALS, AIRCRAFT, NAVAL ENGINEERING AND DESIGN, AND POWER PLANTS (U.S. CLS. 100 AND 101).

FIRST USE 11-1-2003; IN COMMERCE 1-1-2004.
RON FAIRBANKS, EXAMINING ATTORNEY

OWNER OF U.S. REG. NOS. 2,519,848, 2,542,386 AND OTHERS.

THE MARK CONSISTS OF THE STYLIZED WORDING VIPGIFT.COM WITH A STYLIZED REPRESENTATION OF A GIFT WRAPPED BOX TO THE LEFT OF THE WORDING.

CLASS 16—PAPER GOODS AND PRINTED MATTER

FOR GIFT CARDS THAT ENABLE AUTHORIZED HOLDER THEREOF TO SELECT GIFT CERTIFICATES AND OTHER GOODS AND SERVICES FROM MULTIPLE MERCHANTS AND/OR VENDORS OF VARIOUS GOODS AND SERVICES (U.S. CLS. 2, 5, 22, 23, 29, 37, 38 AND 50).

CLASS 35—ADVERTISING AND BUSINESS

FOR GIFT CERTIFICATES SERVICES, NAMELY, ARRANGING VIA DISTRIBUTION OF CARDS, PHYSICALLY OR ELECTRONICALLY, TO AUTHORIZED PERSONS FOR THE SELECTION OF GIFT CERTIFICATES FROM MULTIPLE MERCHANTS AND/OR VENDORS OF VARIOUS GOODS AND SERVICES (U.S. CLS. 100, 101 AND 102).

AMY ALFIERI, EXAMINING ATTORNEY

SN 78-479,500. EARTHLINK, INC., ATLANTA, GA. FILED 9-7-2004.



NO CLAIM IS MADE TO THE EXCLUSIVE RIGHT TO USE "ACCELERATOR", APART FROM THE MARK AS SHOWN.

CLASS 9—ELECTRICAL AND SCIENTIFIC APPARATUS

FOR COMPUTER SOFTWARE THAT ENABLES USERS TO ACCESS WEB PAGES, ELECTRONIC MAIL, AND DOWNLOAD DATA AND IMAGES AT HIGH SPEEDS (U.S. CLS. 21, 23, 26, 36 AND 38).

FIRST USE 8-0-2003; IN COMMERCE 8-0-2003.

CLASS 38—COMMUNICATION

FOR PROVIDING MULTIPLE-USER ACCESS TO A GLOBAL COMPUTER INFORMATION NETWORK; COMPUTER SERVICES, NAMELY, ENABLING USERS TO ACCESS WEB PAGES, ELECTRONIC MAIL, AND DOWNLOAD DATA AND IMAGES AT HIGH SPEEDS (U.S. CLS. 100, 101 AND 104).

FIRST USE 8-0-2003; IN COMMERCE 8-0-2003.
ODESSA BIBBINS, EXAMINING ATTORNEY

SN 78-479,584. HELENA HOLDING COMPANY, WILMINGTON, DE. FILED 9-7-2004.

SETRE

SN 78-479,582. LIFESTYLE CUSTOM CYCLES, LLC, VILLA PARK, CA. FILED 9-7-2004.

LIFESTYLE CYCLES

THE MARK CONSISTS OF STANDARD CHARACTERS WITHOUT CLAIM TO ANY PARTICULAR FONT, STYLE, SIZE, OR COLOR.

CLASS 1—CHEMICALS

FOR SEED PRODUCTS, NAMELY, SEED INOCULANTS, SEED TREATMENT NUTRIENTS, AND MICRONUTRIENTS (U.S. CLS. 1, 5, 6, 10, 26 AND 46).

CLASS 5—PHARMACEUTICALS

FOR PESTICIDES, FUNGICIDES, HERBICIDES AND BIOPESTICIDES (U.S. CLS. 6, 18, 44, 46, 51 AND 52).
MICHELE SWAIN, EXAMINING ATTORNEY

SN 78-480,303. LADY JAYNE LLC, CYPRESS, CA. FILED 9-8-2004.

LADY JAYNE

THE MARK CONSISTS OF STANDARD CHARACTERS WITHOUT CLAIM TO ANY PARTICULAR FONT, STYLE, SIZE, OR COLOR.

NO CLAIM IS MADE TO THE EXCLUSIVE RIGHT TO USE "CYCLES", APART FROM THE MARK AS SHOWN.

CLASS 25—CLOTHING

FOR CLOTHING, NAMELY T-SHIRTS, TANK TOPS, WORK SHIRTS, SWEATSHIRTS, PANTS, SWEAT PANTS, SKIRTS, CHAPS, JACKETS, VESTS, HATS, BEANIES, BANDANAS, GLOVES, UNDERWEAR, LEATHER PANTS, LEATHER JACKETS, LEATHER GLOVES, LEATHER CHAPS AND LEATHER VESTS (U.S. CLS. 22 AND 39).

FIRST USE 3-0-2000; IN COMMERCE 3-0-2000.

CLASS 35—ADVERTISING AND BUSINESS

FOR RETAIL STORE SERVICES FEATURING MOTORCYCLES, MOTORCYCLE PARTS, MOTORCYCLE ACCESSORIES, AND CLOTHING (U.S. CLS. 100, 101 AND 102).

FIRST USE 3-0-2000; IN COMMERCE 3-0-2000.

CLASS 37—CONSTRUCTION AND REPAIR

FOR MOTORCYCLE SERVICE, REPAIR, MAINTENANCE, AND CUSTOMIZATION (U.S. CLS. 100, 103 AND 106).

FIRST USE 3-0-2000; IN COMMERCE 3-0-2000.
MICHELE SWAIN, EXAMINING ATTORNEY

THE MARK CONSISTS OF STANDARD CHARACTERS WITHOUT CLAIM TO ANY PARTICULAR FONT, STYLE, SIZE, OR COLOR.

CLASS 16—PAPER GOODS AND PRINTED MATTER

FOR STATIONERY AND PAPERWEIGHTS (U.S. CLS. 2, 5, 22, 23, 29, 37, 38 AND 50).

FIRST USE 2-15-1988; IN COMMERCE 5-15-1988.

CLASS 20—FURNITURE AND ARTICLES NOT OTHERWISE CLASSIFIED

FOR FIGURINES; NAMELY CERAMIC AND RESIN (U.S. CLS. 2, 13, 22, 25, 32 AND 50).

FIRST USE 1-31-1990; IN COMMERCE 1-31-1990.

CLASS 21—HOUSEWARES AND GLASS

FOR GLASS CONTAINERS FOR HOME AND OFFICE USE (U.S. CLS. 2, 13, 23, 29, 30, 33, 40 AND 50); FIRST USE 1-31-1997; IN COMMERCE 1-31-1997. CAROLYN CATALDO, EXAMINING ATTORNEY

SN 78-480,326. CREATRIX! LLC, COTTAGE GROVE, WI. FILED 9-8-2004.

CREATRIX

THE MARK CONSISTS OF STANDARD CHARACTERS WITHOUT CLAIM TO ANY PARTICULAR FONT, STYLE, SIZE, OR COLOR.

CLASS 16—PAPER GOODS AND PRINTED MATTER

FOR BOOKS RELATING TO FEMINIST PHILOSOPHY AND SPIRITUALITY AND CULTURAL AND HISTORICAL PERSPECTIVES, THE OCCULT ARTS, AND THEATRICAL PLAYS, AND SPECIFICALLY EXCLUDING BOOKS RELATING TO BUSINESS, BUSINESS PERFORMANCE, AND BUSINESS COACHING (U.S. CLS. 2, 5, 22, 23, 29, 37, 38 AND 50).

CLASS 41—EDUCATION AND ENTERTAINMENT

FOR BOOK PUBLISHING (U.S. CLS. 100, 101 AND 107). KIMBERLY FRYE, EXAMINING ATTORNEY

SN 78-480,854. THE PREMIUM CONNECTION, INC., LAS VEGAS, NV. FILED 9-9-2004.

WORTHY

THE MARK CONSISTS OF STANDARD CHARACTERS WITHOUT CLAIM TO ANY PARTICULAR FONT, STYLE, SIZE, OR COLOR.

CLASS 3—COSMETICS AND CLEANING PREPARATIONS

FOR TOOTHPASTE; SHOE SHINE KITS NAMELY, KITS CONSISTING OF SHOE POLISH, SHOE POLISH APPLICATORS CONTAINING SHOE POLISH, SPONGES, SHOE SHINE CLOTHS AND POLISHING MITS AND SHOE HORNS SOLD AS A UNIT. (U.S. CLS. 1, 4, 6, 50, 51 AND 52).

CLASS 8—HAND TOOLS

FOR MANICURE SETS, NAMELY CUTICLE TRIMMERS, NAIL FILE, NAIL NIPPER, TWEEZERS, CUTICLE PUSHER, CUTICLE CUTTER, SCISSORS, NAIL CLIPPERS (U.S. CLS. 23, 28 AND 44).

CLASS 9—ELECTRICAL AND SCIENTIFIC APPARATUS

FOR CALCULATORS, MINI BINOCULARS, ELECTRIC IRONS FOR TRAVEL, GARMENT STEAMERS FOR TRAVEL; PORTABLE CD/DVD HOLDERS (U.S. CLS. 21, 23, 26, 36 AND 38).

CLASS 11—ENVIRONMENTAL CONTROL APPARATUS

FOR MINIATURE REFRIGERATORS; TRAVEL MINIATURE BOOK LIGHTS; MINIATURE FLASHLIGHTS, PORTABLE BARBECUE GRILLS (U.S. CLS. 13, 21, 23, 31 AND 34).

CLASS 18—LEATHER GOODS

FOR ALL PURPOSE CARRYING BAGS, NAMELY CARRYING BAGS FOR INSULATED BEVERAGE TRAVEL SETS; INSULATED BACKPACKS; CARRYING BAGS FOR PORTABLE BEVERAGE COOLERS; LUGGAGE, NAMELY, LUGGAGE SETS, TRAVEL BAGS, UMBRELLAS; TOILETRY KITS SOLD EMPTY (U.S. CLS. 1, 2, 3, 22 AND 41).

CLASS 21—HOUSEWARES AND GLASS

FOR MUGS, INSULATED BEVERAGE TRAVEL SETS CONTAINING INSULATED MUGS, CUPS AND VACUUM FLASKS STORED IN A CARRYING BAG; MUGS, CUPS, VACUUM FLASKS; PORTABLE BEVERAGE COOLERS; TRAVEL UTENSILS SETS, NAMELY FORKS, SPOONS AND KNIVES; PICNIC SETS, NAMELY PLASTIC PLATES, CUPS, SPOONS, KNIVES AND FORKS, TOOTH BRUSHES SOAP CONTAINERS (U.S. CLS. 2, 13, 23, 29, 30, 33, 40 AND 50).

CLASS 24—FABRICS

FOR BLANKETS, WASHCLOTHS (U.S. CLS. 42 AND 50).

CLASS 26—FANCY GOODS

FOR SEWING KITS NAMELY, THREAD, NEEDLES, BUTTONS, SNAPS, SAFETY PINS, BOBBY PINS, NEEDLE THREADER, SCISSORS AND /OR SAFETY PINS SOLD AS A UNIT (U.S. CLS. 37, 39, 40, 42 AND 50). TIMOTHY FINNEGAN, EXAMINING ATTORNEY

SN 78-480,995. THAYER INTERACTIVE GROUP, LLC, WASHINGTON, DC. FILED 9-9-2004.

SN 78-481,478. GENETIC SAVINGS & CLONE, INC., SAUSALITO, CA. FILED 9-10-2004.

DOGBANK

TIG GLOBAL

THE MARK CONSISTS OF STANDARD CHARACTERS WITHOUT CLAIM TO ANY PARTICULAR FONT, STYLE, SIZE, OR COLOR.

CLASS 42—SCIENTIFIC, COMPUTER AND LEGAL SERVICES

FOR RESEARCH AND DEVELOPMENT SERVICES IN THE FIELDS OF ANIMAL CLONING, GENE THERAPY AND GENETIC DIAGNOSTICS (U.S. CLS. 100 AND 101).

CLASS 44—MEDICAL, BEAUTY AND AGRICULTURAL SERVICES

FOR GENE BANK SERVICES, IN THE NATURE OF GENE HARVESTING, PRESERVATION AND STORAGE SERVICES; CELL CULTURING AND STORAGE SERVICES (U.S. CLS. 100 AND 101).

APRIL L. RADEMACHER, EXAMINING ATTORNEY

THE MARK CONSISTS OF STANDARD CHARACTERS WITHOUT CLAIM TO ANY PARTICULAR FONT, STYLE, SIZE, OR COLOR.

NO CLAIM IS MADE TO THE EXCLUSIVE RIGHT TO USE "GLOBAL", APART FROM THE MARK AS SHOWN.

CLASS 35—ADVERTISING AND BUSINESS

FOR BUSINESS CONSULTATION SERVICES IN THE FIELDS OF BRANDING CORPORATE IDENTITY, MARKETING STRATEGY AND PLANNING, MARKETING COMMUNICATIONS PLANNING AND PROJECT MANAGEMENT, WEB-BASED STRATEGY, MARKET RESEARCH, ANALYSIS AND REPORTING, COMMUNICATIONS MEASUREMENT AND BENCHMARKING; BUSINESS MANAGEMENT CONSULTATION SERVICES; ADVERTISING SERVICES, NAMELY, CREATING AND DISSEMINATION OF ADVERTISING MATERIALS AND THE MARKETING OF GOODS AND SERVICES OF ON-LINE RETAIL SERVICES PROVIDERS VIA A GLOBAL COMMUNICATIONS NETWORK; BUSINESS MARKETING CONSULTING SERVICES IN THE FIELD OF ELECTRONIC COMMERCE, NAMELY SEARCH ENGINE MARKETING, GUERILLA MARKETING, PAY-PER-CLICK MARKETING, AND ASSISTING ON-LINE RETAIL SERVICE PROVIDERS WITH DEFINING AND TARGETING A CONSUMER MARKET AND CONSUMER AUDIENCE (U.S. CLS. 100, 101 AND 102).

CLASS 43—HOTEL AND RESTAURANT SERVICES

FOR MAKING HOTEL RESERVATIONS FOR OTHERS, NAMELY, RECEIVING, SORTING, PROCESSING AND CANCELING HOTEL RESERVATIONS (U.S. CLS. 100 AND 101).

BILL DAWE, EXAMINING ATTORNEY

SN 78-481,617. PREMIERETRADE, LLC, ALTAMONTE SPRINGS, FL. FILED 9-10-2004.

TREND GENIE

THE MARK CONSISTS OF STANDARD CHARACTERS WITHOUT CLAIM TO ANY PARTICULAR FONT, STYLE, SIZE, OR COLOR.

CLASS 9—ELECTRICAL AND SCIENTIFIC APPARATUS

FOR COMPUTER SOFTWARE FOR USE IN THE ANALYSIS, PURCHASE AND TRADE OF SECURITIES, STOCKS, BONDS, OPTIONS, MUTUAL FUNDS AND FOREIGN CURRENCY (U.S. CLS. 21, 23, 26, 36 AND 38).

CLASS 36—INSURANCE AND FINANCIAL

FOR FINANCIAL SERVICES, NAMELY BROKERAGE SERVICES RELATING TO THE ANALYSIS, PURCHASE AND TRADE OF SECURITIES, STOCKS, BONDS, OPTIONS, MUTUAL FUNDS AND FOREIGN CURRENCY (U.S. CLS. 100, 101 AND 102).

SKYE YOUNG, EXAMINING ATTORNEY

SN 78-482,073. VOLUME DISTRIBUTORS, INC., VERNON, CA. FILED 9-11-2004.

PERFECT MEMORIES

THE MARK CONSISTS OF STANDARD CHARACTERS WITHOUT CLAIM TO ANY PARTICULAR FONT, STYLE, SIZE, OR COLOR.

CLASS 16—PAPER GOODS AND PRINTED MATTER

FOR PHOTOGRAPH ALBUMS, COIN ALBUMS, SCRAPBOOK ALBUMS, STAMP ALBUMS, WEDDING ALBUMS, ADDRESS BOOKS, ANNIVERSARY BOOKS, APPOINTMENT BOOKS, AUTOGRAPH BOOKS, BABY BOOKS, COUPON BOOKS, PICTURE BOOKS, RECIPE BOOKS, SCRAPBOOKS, SKETCH BOOKS, AND WEDDING BOOKS (U.S. CLS. 2, 5, 22, 23, 29, 37, 38 AND 50).

FIRST USE 6-1-2002; IN COMMERCE 6-1-2002.

CLASS 20—FURNITURE AND ARTICLES NOT OTHERWISE CLASSIFIED

FOR PICTURE FRAMES FOR PHOTOGRAPHS AND ARTWORK, PICTURE FRAME MOLDINGS, DIPLOMA FRAMES, PLAQUES, JEWELRY BOXES NOT MADE OF METAL OR PRECIOUS METAL (U.S. CLS. 2, 13, 22, 25, 32 AND 50).

FIRST USE 6-1-2002; IN COMMERCE 6-1-2002.
REBECCA HAN, EXAMINING ATTORNEY

SN 78-482,153. MCLELAND, CARLA JEANNE, CHICAGO, IL. FILED 9-12-2004.

To Bean
or Not to Bean

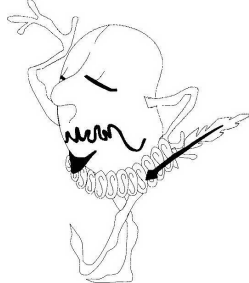
**CLASS 21—HOUSEWARES AND GLASS**

FOR COFFEE MUGS; COFFEE CUPS (U.S. CLS. 2, 13, 23, 29, 30, 33, 40 AND 50).

CLASS 25—CLOTHING

FOR SHIRTS (U.S. CLS. 22 AND 39).
EVELYN BRADLEY, EXAMINING ATTORNEY

SN 78-482,701. FITNESS EDUCATION WORLDWIDE, INC., CALABASAS, CA. FILED 9-13-2004.

NASM

THE MARK CONSISTS OF STANDARD CHARACTERS WITHOUT CLAIM TO ANY PARTICULAR FONT, STYLE, SIZE, OR COLOR.

OWNER OF U.S. REG. NO. 1,814,110.

CLASS 41—EDUCATION AND ENTERTAINMENT

FOR EDUCATIONAL SERVICES, NAMELY CONDUCTING CLASSES AND SEMINARS FOR PERSONAL FITNESS TRAINERS IN THE FIELD OF NUTRITION AND PHYSICAL FITNESS AND DISTRIBUTION OF COURSE MATERIALS IN CONNECTION THEREWITH. (U.S. CLS. 100, 101 AND 107).

CLASS 44—MEDICAL, BEAUTY AND AGRICULTURAL SERVICES

FOR MEDICAL TESTING SERVICES, NAMELY FITNESS ASSESMENT SERVICES; MEDICAL TESTING SERVICES, NAMELY PROVIDING ON-LINE TOOLS FOR PERSONAL FITNESS TRAINERS AND NONPROFESSIONALS TO UTILIZE IN PERFORMING FITNESS ASSESMENT TESTS. (U.S. CLS. 100 AND 101).

MICHELLE S. WISEMAN, EXAMINING ATTORNEY

SN 78-483,113. STRATEGIC PARTNERSHIPS, INC., AUSTIN, TX. FILED 9-14-2004.

**California
Government Insider**

THE MARK CONSISTS OF STANDARD CHARACTERS WITHOUT CLAIM TO ANY PARTICULAR FONT, STYLE, SIZE, OR COLOR.

NO CLAIM IS MADE TO THE EXCLUSIVE RIGHT TO USE "CALIFORNIA GOVERNMENT", APART FROM THE MARK AS SHOWN.

CLASS 35—ADVERTISING AND BUSINESS

FOR PROVIDING INFORMATION IN THE FIELD OF CALIFORNIA GOVERNMENT AFFAIRS VIA A GLOBAL COMPUTER NETWORK (U.S. CLS. 100, 101 AND 102).
FIRST USE 10-12-2004; IN COMMERCE 10-12-2004.

CLASS 41—EDUCATION AND ENTERTAINMENT

FOR COMPUTER SERVICES, NAMELY, PROVIDING ON-LINE NEWSLETTERS VIA GLOBAL COMPUTER NETWORK IN THE FIELDS OF CALIFORNIA STATE AND LOCAL GOVERNMENTS ACTIVITIES AND FEDERAL GOVERNMENT ACTIVITIES THAT AFFECT CALIFORNIA (U.S. CLS. 100, 101 AND 107).
FIRST USE 10-12-2004; IN COMMERCE 10-12-2004.
ROBIN CHOSID, EXAMINING ATTORNEY

SN 78-484,341. FYTEK LIMITED, LONDON, UNITED KINGDOM, FILED 9-15-2004.

FYTEK BODY MASTERS

THE MARK CONSISTS OF STANDARD CHARACTERS WITHOUT CLAIM TO ANY PARTICULAR FONT, STYLE, SIZE, OR COLOR.

CLASS 9—ELECTRICAL AND SCIENTIFIC APPARATUS

FOR AUDIO-VISUAL RECORDINGS IN THE FIELD OF HEALTH AND FITNESS (U.S. CLS. 21, 23, 26, 36 AND 38).

CLASS 41—EDUCATION AND ENTERTAINMENT

FOR ENTERTAINMENT SERVICES IN THE NATURE OF WEB CASTS AND TELEVISION PROGRAMS IN THE FIELD OF HEALTH AND FITNESS (U.S. CLS. 100, 101 AND 107).
YONG KIM, EXAMINING ATTORNEY

SN 78-484,178. BEAD HAPPY, PALO ALTO, CA. FILED 9-15-2004.



NO CLAIM IS MADE TO THE EXCLUSIVE RIGHT TO USE "BEADSHOP.COM" AND "THE BEAD SHOP", APART FROM THE MARK AS SHOWN.

THE MARK CONSISTS OF TOP BANNER STRIP CONSISTING OF WORDS ONLY AT BEADSHOP.COM; WORDS BELOW BANNER CONSIST OF THE BEAD SHOP IN STYLIZED SCRIPT.

CLASS 9—ELECTRICAL AND SCIENTIFIC APPARATUS

FOR PRERECORDED CDS, VIDEO TAPES, AND DVDS FEATURING THE ART AND CRAFT OF JEWELRY, BEADWORK, CLAY, AND WIRE (U.S. CLS. 21, 23, 26, 36 AND 38).

FIRST USE 5-24-2001; IN COMMERCE 5-24-2001.

CLASS 14—JEWELRY

FOR JEWELRY; BRACELETS; EARRINGS; NECKLACES; RINGS; JEWELRY COMPONENTS FOR USE IN THE MANUFACTURE OF JEWELRY, NAMELY, BEADS, CHARMS, PENDANTS, WIRE, CHAIN, CLASPS, END CAPS, SPACER BARS, END CONES, RINGS, PINS, ROUNDELLES, COILS, BALLS, PADS, PINCH ENDS, CRIMP ENDS, WATCH FACES, ORGANZA, BUCKLES, WIRE MESH; PRECIOUS AND SEMI-PRECIOUS METAL, GEMSTONES, AND STONES (U.S. CLS. 2, 27, 28 AND 50).
FIRST USE 12-31-1990; IN COMMERCE 12-31-1990.

CLASS 41—EDUCATION AND ENTERTAINMENT

FOR EDUCATIONAL SERVICES, NAMELY, CONDUCTING CLASSES IN THE FIELD OF JEWELRY MAKING (U.S. CLS. 100, 101 AND 107).
FIRST USE 12-31-1990; IN COMMERCE 9-22-1994.
SEAN DWYER, EXAMINING ATTORNEY

SN 78-484,390. MOLNER, DAVID L., BEVERLY HILLS, CA. FILED 9-15-2004.

SCREEN CAPITAL INTERNATIONAL

NO CLAIM IS MADE TO THE EXCLUSIVE RIGHT TO USE CAPITAL INTERNATIONAL, APART FROM THE MARK AS SHOWN.

THE COLORS GRAY AND BLUE ARE CLAIMED AS A FEATURE OF THE MARK.

THE COLOR GRAY APPEARS IN THE WORDS SCREEN AND INTERNATIONAL AND THE COLOR BLUE APPEARS IN THE WORD CAPITAL.

CLASS 35—ADVERTISING AND BUSINESS

FOR BUSINESS CONSULTING, MANAGEMENT, PLANNING AND SUPERVISION (U.S. CLS. 100, 101 AND 102).

CLASS 36—INSURANCE AND FINANCIAL

FOR BUSINESS FINANCE PROCUREMENT SERVICES (U.S. CLS. 100, 101 AND 102).
TRICIA SONNEBORN, EXAMINING ATTORNEY

SN 78-484,394. MOLNER, DAVID L., BEVERLY HILLS, CA.
FILED 9-15-2004.

G-CAPITAL
INTERNATIONAL

NO CLAIM IS MADE TO THE EXCLUSIVE RIGHT TO USE INTERNATIONAL, APART FROM THE MARK AS SHOWN.

THE COLORS GRAY AND BLUE IS/ARE CLAIMED AS A FEATURE OF THE MARK.

THE COLOR GRAY APPEARS IN THE WORD INTERNATIONAL AND THE COLOR BLUE APPEARS IN THE WORD G-CAPITAL.

CLASS 35—ADVERTISING AND BUSINESS

FOR BUSINESS CONSULTING, MANAGEMENT, PLANNING AND SUPERVISION (U.S. CLS. 100, 101 AND 102).

CLASS 36—INSURANCE AND FINANCIAL

FOR BUSINESS FINANCE PROCUREMENT SERVICES (U.S. CLS. 100, 101 AND 102).

TRICIA SONNEBORN, EXAMINING ATTORNEY

SN 78-484,945. MICROSASIC SYSTEMS LIMITED, LONDON,
UNITED KINGDOM, FILED 9-16-2004.

IONCHIP

THE MARK CONSISTS OF STANDARD CHARACTERS WITHOUT CLAIM TO ANY PARTICULAR FONT, STYLE, SIZE, OR COLOR.

CLASS 9—ELECTRICAL AND SCIENTIFIC APPARATUS

FOR MICRO ELECTRO MECHANICAL SYSTEMS (MEMS) STRUCTURES NAMELY INTEGRATED CIRCUITS, SOLID STATE INTEGRATED CIRCUITS; SOLID STATE ELECTRICAL INTEGRATED CIRCUITS; MASS SPECTROMETERS; MINIATURE MASS SPECTROMETERS; ELECTRONIC SENSORS FOR USE IN MASS SPECTROMETRY APPLICATIONS (U.S. CLS. 21, 23, 26, 36 AND 38).

CLASS 16—PAPER GOODS AND PRINTED MATTER

FOR PRINTED MATTER NAMELY TEXTBOOKS, DATA BOOKS, INSTRUCTIONAL MANUALS, PRODUCT CATALOGUES, CIRCUIT SPECIFICATION SHEETS, PAPERS, PAPER ARTICLES ALL IN THE FIELD OF ENGINEERING AND DESIGN OF MICRO ELECTRO MECHANICAL SYSTEMS (U.S. CLS. 2, 5, 22, 23, 29, 37, 38 AND 50).

CLASS 42—SCIENTIFIC, COMPUTER AND LEGAL SERVICES

FOR ENGINEERING SERVICES; CIRCUIT DESIGN SERVICES; MICRO ELECTRO MECHANICAL SYSTEMS MEMS DESIGN SERVICES AND TECHNICAL CONSULTATION SERVICES THEREOF (U.S. CLS. 100 AND 101).
JOHN HWANG, EXAMINING ATTORNEY

SN 78-485,091. VOLUME DISTRIBUTORS, INC., VERNON,
CA. FILED 9-16-2004.

MEADOWOODS

THE MARK CONSISTS OF STANDARD CHARACTERS WITHOUT CLAIM TO ANY PARTICULAR FONT, STYLE, SIZE, OR COLOR.

CLASS 3—COSMETICS AND CLEANING PREPARATIONS

FOR GENERAL HOUSEHOLD ALL PURPOSE CLEANING PREPARATIONS, TOILET BOWL DETERGENTS (U.S. CLS. 1, 4, 6, 50, 51 AND 52).

FIRST USE 9-1-2002; IN COMMERCE 9-1-2002.

CLASS 5—PHARMACEUTICALS

FOR DISINFECTANT TOILET BOWL CLEANERS; HOUSEHOLD DEODORIZER; AIR FRESHENERS (U.S. CLS. 6, 18, 44, 46, 51 AND 52).

FIRST USE 9-1-2002; IN COMMERCE 9-1-2002.

DAVID ELTON, EXAMINING ATTORNEY

SN 78-485,587. GLOBAL BRAIN, INC., KULA MAUI, HI.
FILED 9-17-2004.

**PROJECTS AT WARP-
SPEED**

THE MARK CONSISTS OF STANDARD CHARACTERS WITHOUT CLAIM TO ANY PARTICULAR FONT, STYLE, SIZE, OR COLOR.

CLASS 16—PAPER GOODS AND PRINTED MATTER

FOR EDUCATIONAL PUBLICATIONS, NAMELY, GUIDEBOOKS, COURSE HANDOUTS, AND POCKET GUIDANCE REFERENCES IN THE FIELD OF BUSINESS AND TECHNOLOGY DEVELOPMENT (U.S. CLS. 2, 5, 22, 23, 29, 37, 38 AND 50).

FIRST USE 10-1-1997; IN COMMERCE 10-1-1997.

SN 78-485,899. WILLOUGHBY, SUSAN B., BANNOCKBURN, IL. AND WILLOUGHBY, DAVID G., BANNOCKBURN, IL. FILED 9-19-2004.

CLASS 41—EDUCATION AND ENTERTAINMENT

FOR EDUCATIONAL SERVICES, NAMELY, CONDUCTING WORKSHOPS IN THE FIELD OF BUSINESS AND TECHNOLOGY DEVELOPMENT AND THE DISTRIBUTION OF COURSE MATERIALS, POCKET REFERENCES, AND GUIDEBOOKS IN CONNECTION THEREWITH (U.S. CLS. 100, 101 AND 107).

FIRST USE 10-1-1997; IN COMMERCE 10-1-1997. SKYE YOUNG, EXAMINING ATTORNEY

**Naked Without It
Bondy Pet Products**

THE MARK CONSISTS OF STANDARD CHARACTERS WITHOUT CLAIM TO ANY PARTICULAR FONT, STYLE, SIZE, OR COLOR.

NO CLAIM IS MADE TO THE EXCLUSIVE RIGHT TO USE "PET PRODUCTS", APART FROM THE MARK AS SHOWN.

SN 78-485,897. WILLOUGHBY, SUSAN B., BANNOCKBURN, IL. AND WILLOUGHBY, DAVID G., BANNOCKBURN, IL. FILED 9-19-2004.

CLASS 18—LEATHER GOODS

FOR PET PRODUCTS, NAMELY, GARMENTS FOR PETS AND PET CLOTHING (U.S. CLS. 1, 2, 3, 22 AND 41).

CLASS 20—FURNITURE AND ARTICLES NOT OTHERWISE CLASSIFIED

FOR BEDS FOR HOUSEHOLD PETS; PET CUSHIONS, PLAYHOUSES FOR HOUSEHOLD PETS (U.S. CLS. 2, 13, 22, 25, 32 AND 50).

CAROLYN CATALDO, EXAMINING ATTORNEY

Bondy Pet Products

SN 78-486,022. UAI TECHNOLOGY, INC., RESEARCH TRIANGLE PARK, NC. FILED 9-20-2004.

THE MARK CONSISTS OF STANDARD CHARACTERS WITHOUT CLAIM TO ANY PARTICULAR FONT, STYLE, SIZE, OR COLOR.

NO CLAIM IS MADE TO THE EXCLUSIVE RIGHT TO USE "PET PRODUCTS", APART FROM THE MARK AS SHOWN.

CLASS 18—LEATHER GOODS

FOR PET PRODUCTS, NAMELY, GARMENTS FOR PETS AND PET CLOTHING (U.S. CLS. 1, 2, 3, 22 AND 41).

CLASS 20—FURNITURE AND ARTICLES NOT OTHERWISE CLASSIFIED

FOR BEDS FOR HOUSEHOLD PETS; PET CUSHIONS; PLAYHOUSE FOR HOUSEHOLD PETS (U.S. CLS. 2, 13, 22, 25, 32 AND 50).

CAROLYN CATALDO, EXAMINING ATTORNEY

**THE BLUE BOOK OF
BANK PRICES**

THE MARK CONSISTS OF STANDARD CHARACTERS WITHOUT CLAIM TO ANY PARTICULAR FONT, STYLE, SIZE, OR COLOR.

NO CLAIM IS MADE TO THE EXCLUSIVE RIGHT TO USE "BOOK", APART FROM THE MARK AS SHOWN. SEC. 2(F).

CLASS 16—PAPER GOODS AND PRINTED MATTER

FOR PRINTED MATERIALS, NAMELY BOOKS, BOOKLETS, BROCHURES, REPORTS AND PERIODICALS, ALL IN THE FIELDS OF BANKING AND CASH MANAGEMENT (U.S. CLS. 2, 5, 22, 23, 29, 37, 38 AND 50).

FIRST USE 12-31-1990; IN COMMERCE 12-31-1990.

CLASS 36—INSURANCE AND FINANCIAL

FOR ON-LINE WEBSITE OFFERING INFORMATION SERVICES IN THE FIELDS OF BANKING AND CASH MANAGEMENT (U.S. CLS. 100, 101 AND 102).
FIRST USE 12-31-1990; IN COMMERCE 12-31-1990.
MICHAEL KEATING, EXAMINING ATTORNEY

SN 78-486,227. CUSTOM BLENDS, INC., BROCKTON, MA.
FILED 9-20-2004.

SINGLES-TO-GO

THE MARK CONSISTS OF STANDARD CHARACTERS WITHOUT CLAIM TO ANY PARTICULAR FONT, STYLE, SIZE, OR COLOR.

CLASS 29—MEATS AND PROCESSED FOODS

FOR DIP FOR VEGETABLES (U.S. CL. 46).
FIRST USE 9-1-2004; IN COMMERCE 9-1-2004.

CLASS 30—STAPLE FOODS

FOR SALAD DRESSING (U.S. CL. 46).
FIRST USE 9-1-2004; IN COMMERCE 9-1-2004.
APRIL L. RADEMACHER, EXAMINING ATTORNEY

SN 78-486,239. CITY OF LOS ANGELES, LOS ANGELES, CA.
FILED 9-20-2004.



NO CLAIM IS MADE TO THE EXCLUSIVE RIGHT TO USE "CITY OF LOS ANGELES", APART FROM THE MARK AS SHOWN.

THE STIPPLING IS FOR SHADING PURPOSES ONLY.
THE MARK CONSISTS OF THE DESIGN OF A BADGE WITH AN EAGLE ON TOP OF THE BADGE, AN "X" DESIGN ON THE TOP PORTION OF THE BADGE UNDERNEATH THE EAGLE; THE MIDDLE OF THE BADGE CONTAINS A CROSS DESIGN BETWEEN TWO AX HEADS AND THE LETTERS LAFD UNDERNEATH THE CROSS DESIGN; A HERALDIC DESIGN CONTAINING STARS AND BARS IN UPPER LEFT, A BEAR WITH A STAR AT UPPER RIGHT, AN EAGLE HOLDING A SERPENT AT LOWER LEFT, A CASTLE TURRET AT BOTTOM CENTER, AND A LION AT BOTTOM RIGHT, ALL LOCATED UNDER THE LETTERS LAFD AND ABOVE THE WORDS CITY OF LOS ANGELES.

CLASS 9—ELECTRICAL AND SCIENTIFIC APPARATUS

FOR COMPUTER GAME SOFTWARE, AND PRERECORDED DVDS AND CD-ROMS FEATURING GAMES AND MOVIES (U.S. CLS. 21, 23, 26, 36 AND 38).

CLASS 16—PAPER GOODS AND PRINTED MATTER

FOR PRINTED MATERIALS, NAMELY, POSTERS, CALENDARS AND POSTCARDS (U.S. CLS. 2, 5, 22, 23, 29, 37, 38 AND 50).

CLASS 18—LEATHER GOODS

FOR BACKPACKS (U.S. CLS. 1, 2, 3, 22 AND 41).

CLASS 25—CLOTHING

FOR CLOTHING, NAMELY, HATS, SHIRTS AND JACKETS (U.S. CLS. 22 AND 39).
DAHLIA GEORGE, EXAMINING ATTORNEY

SN 78-486,358. GENERAL MOTORS CORPORATION, DETROIT, MI. FILED 9-20-2004.

FLEXIBLE EARNINGS CARD

THE MARK CONSISTS OF STANDARD CHARACTERS WITHOUT CLAIM TO ANY PARTICULAR FONT, STYLE, SIZE, OR COLOR.

NO CLAIM IS MADE TO THE EXCLUSIVE RIGHT TO USE "EARNINGS CARD", APART FROM THE MARK AS SHOWN.

CLASS 35—ADVERTISING AND BUSINESS

FOR FINANCIAL SERVICES, NAMELY, PROMOTING THE SALE AND USAGE OF CREDIT CARD ACCOUNTS THROUGH A USAGE AWARD ACCUMULATION AND REDEMPTION PROGRAM (U.S. CLS. 100, 101 AND 102).

CLASS 36—INSURANCE AND FINANCIAL

FOR FINANCIAL SERVICES, NAMELY, CREDIT CARD SERVICES (U.S. CLS. 100, 101 AND 102).
SUSAN LESLIE DUBOIS, EXAMINING ATTORNEY

SN 78-486,431. SOCIETE DES PRODUITS NESTLE S.A., VEVEY, SWITZERLAND, FILED 9-20-2004.

PET PROMISE

THE MARK CONSISTS OF STANDARD CHARACTERS WITHOUT CLAIM TO ANY PARTICULAR FONT, STYLE, SIZE, OR COLOR.

NO CLAIM IS MADE TO THE EXCLUSIVE RIGHT TO USE "PET", APART FROM THE MARK AS SHOWN.

CLASS 3—COSMETICS AND CLEANING PREPARATIONS

FOR PET SHAMPOO; STAIN REMOVER; PET ODOR REMOVER (U.S. CLS. 1, 4, 6, 50, 51 AND 52).
FIRST USE 10-4-2004; IN COMMERCE 10-4-2004.

SN 78-486,622. ANTHONY E. ROACH, ABILENE, TX. FILED 9-20-2004.

CLASS 5—PHARMACEUTICALS

FOR NUTRITIONAL SUPPLEMENTS FOR PETS (U.S. CLS. 6, 18, 44, 46, 51 AND 52).
FIRST USE 10-4-2004; IN COMMERCE 10-4-2004.
APRIL L. RADEMACHER, EXAMINING ATTORNEY

God's Love Bank

SN 78-486,620. ASSET MARKETING SYSTEMS, LLC, SAN DIEGO, CA. FILED 9-20-2004.

THE MARK CONSISTS OF STANDARD CHARACTERS WITHOUT CLAIM TO ANY PARTICULAR FONT, STYLE, SIZE, OR COLOR.

FOREVERCARE

THE MARK CONSISTS OF STANDARD CHARACTERS WITHOUT CLAIM TO ANY PARTICULAR FONT, STYLE, SIZE, OR COLOR.

CLASS 16—PAPER GOODS AND PRINTED MATTER

FOR RELIGIOUS BOOKS; RELIGIOUS CALENDARS; RELIGIOUS JOURNALS; PRINTED EDUCATIONAL MATERIALS, NAMELY, CHURCH CLASSROOM EDUCATION CURRICULUMS (U.S. CLS. 2, 5, 22, 23, 29, 37, 38 AND 50).
FIRST USE 5-31-1992; IN COMMERCE 1-31-1995.

CLASS 41—EDUCATION AND ENTERTAINMENT

FOR RELIGIOUS BASED TRAINING SEMINARS (U.S. CLS. 100, 101 AND 107).
FIRST USE 5-1-1992; IN COMMERCE 10-15-1992.
YONG KIM, EXAMINING ATTORNEY

CLASS 9—ELECTRICAL AND SCIENTIFIC APPARATUS

FOR PRE-RECORDED AUDIO AND VIDEO TAPES, CDS AND DVDS FEATURING TRAINING AND EDUCATIONAL MATERIAL IN THE FIELDS OF FINANCIAL PLANNING AND FINANCIAL PRODUCTS (U.S. CLS. 21, 23, 26, 36 AND 38).

SN 78-486,682. WILLOUGHBY, SUSAN B., BANNOCKBURN, IL. AND WILLOUGHBY, DAVID G., BANNOCKBURN, IL. FILED 9-20-2004.

CLASS 16—PAPER GOODS AND PRINTED MATTER

FOR PRINTED TRAINING AND EDUCATIONAL MATERIALS IN THE FIELDS OF FINANCIAL PLANNING AND FINANCIAL PRODUCTS (U.S. CLS. 2, 5, 22, 23, 29, 37, 38 AND 50).

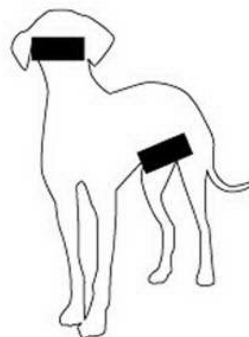
**CLASS 35—ADVERTISING AND BUSINESS**

FOR DISTRIBUTION OF ADVERTISING MATTER FOR OTHERS VIA DIRECT MAIL, EMAIL, PRINT, RADIO AND TELEVISION, AND BUSINESS MANAGEMENT SERVICES IN THE FIELD OF FINANCIAL PLANNING AND FINANCIAL PRODUCTS (U.S. CLS. 100, 101 AND 102).

CLASS 18—LEATHER GOODS

FOR PET PRODUCTS, NAMELY, GARMENTS FOR PETS AND PET CLOTHING (U.S. CLS. 1, 2, 3, 22 AND 41).
FIRST USE 8-19-2004; IN COMMERCE 9-16-2004.

CLASS 36—INSURANCE AND FINANCIAL

FOR PROVIDING FINANCIAL INFORMATION, ANALYSIS AND CONSULTATION (U.S. CLS. 100, 101 AND 102).

CLASS 41—EDUCATION AND ENTERTAINMENT

FOR EDUCATIONAL SERVICES, NAMELY, CLASSES AND SEMINARS IN THE FIELDS OF FINANCIAL PLANNING AND FINANCIAL PRODUCTS (U.S. CLS. 100, 101 AND 107).
YONG KIM, EXAMINING ATTORNEY

CLASS 20—FURNITURE AND ARTICLES NOT OTHERWISE CLASSIFIED

FOR BEDS FOR HOUSEHOLD PETS; PET CUSHIONS; PLAYHOUSES FOR HOUSEHOLD PETS (U.S. CLS. 2, 13, 22, 25, 32 AND 50).
FIRST USE 8-19-2004; IN COMMERCE 9-16-2004.
JUDITH HELFMAN, EXAMINING ATTORNEY

SN 78-486,928. RIVERPARK INCORPORATED, ELKHART, IN. FILED 9-21-2004.



THE MARK CONSISTS OF A DARK BOX WITH WHIRLY LINES WITH A HOUSE IN THE MIDDLE AND WITH THE WORD "E-VOLUTION" UNDERNEATH THE BOX.

CLASS 35—ADVERTISING AND BUSINESS

FOR RETAIL STORE SERVICES FEATURING HOME ENTERTAINMENT EQUIPMENT AND LOW VOLTAGE EQUIPMENT, NAMELY, HOME AUDIO, VIDEO AND TELEPHONE EQUIPMENT AND ACCESSORIES AND COMPONENTS THEREFOR (U.S. CLS. 100, 101 AND 102).

FIRST USE 5-28-2004; IN COMMERCE 5-28-2004.

CLASS 37—CONSTRUCTION AND REPAIR

FOR INSTALLATION OF HOME ENTERTAINMENT EQUIPMENT AND LOW VOLTAGE EQUIPMENT, NAMELY, HOME AUDIO, VIDEO AND TELEPHONE EQUIPMENT (U.S. CLS. 100, 103 AND 106).

FIRST USE 5-28-2004; IN COMMERCE 5-28-2004.

KEVIN DINALLO, EXAMINING ATTORNEY

SN 78-487,089. SUMMIT CONSULTING, INC., LAKELAND, FL. FILED 9-21-2004.



OWNER OF U.S. REG. NO. 1,669,724.

CLASS 36—INSURANCE AND FINANCIAL

FOR ADMINISTRATION AND MANAGEMENT OF WORKERS' COMPENSATION FUNDS AND CLAIMS; INSURANCE ADMINISTRATION SERVICES (U.S. CLS. 100, 101 AND 102).

FIRST USE 11-30-2002; IN COMMERCE 11-30-2002.

CLASS 44—MEDICAL, BEAUTY AND AGRICULTURAL SERVICES

FOR MANAGED HEALTH CARE SERVICES IN THE FIELD OF WORK-RELATED INJURIES (U.S. CLS. 100 AND 101).

FIRST USE 11-30-2002; IN COMMERCE 11-30-2002.
CAROLINE WOOD, EXAMINING ATTORNEY

SN 78-487,190. RATH, MATTHIAS, CAPE TOWN, SOUTH AFRICA, FILED 9-21-2004.

CELL CENTER

THE MARK CONSISTS OF STANDARD CHARACTERS WITHOUT CLAIM TO ANY PARTICULAR FONT, STYLE, SIZE, OR COLOR.

PRIORITY CLAIMED UNDER SEC. 44(D) ON FED REP GERMANY APPLICATION NO. 30446762641, FILED 8-12-2004, REG. NO. 30446762, DATED 10-27-2004, EXPIRES 8-31-2014.

OWNER OF U.S. REG. NOS. 2,690,160, 2,827,786 AND 2,927,924.

NO CLAIM IS MADE TO THE EXCLUSIVE RIGHT TO USE "CENTER", APART FROM THE MARK AS SHOWN.

CLASS 5—PHARMACEUTICALS

FOR FOOD SUPPLEMENTS FOR NON-MEDICAL PURPOSES, CONSISTING PRIMARILY OF VITAMINS, AMINO ACIDS AND TRACE ELEMENTS; DIETETIC SUPPLEMENTS FOR NON-MEDICAL USE, NAMELY AMINO ACIDS AND TRACE ELEMENTS IN THE NATURE OF DIETARY SUPPLEMENTS; NUTRITIONALLY FORTIFIED BEVERAGES (U.S. CLS. 6, 18, 44, 46, 51 AND 52).

CLASS 16—PAPER GOODS AND PRINTED MATTER

FOR PRINTED MATERIALS, NAMELY BOOKS, PAMPHLETS, MAGAZINES, JOURNALS, NEWSPAPERS, AND PRINTED TEACHING AND EDUCATIONAL MATERIALS, IN THE FIELDS OF HEALTH CARE, PREVENTATIVE HEALTH CARE, NUTRITIONAL SUPPLEMENTS, DIETARY SUPPLEMENTS, VITAMINS AND MINERAL SUPPLEMENTS (U.S. CLS. 2, 5, 22, 23, 29, 37, 38 AND 50).

CLASS 32—LIGHT BEVERAGES

FOR MINERAL AND CARBONATED WATER; OTHER NON-ALCOHOLIC BEVERAGES, NAMELY FRUIT DRINKS AND FRUIT JUICES; PREPARATIONS, NAMELY SYRUPS, POWDERS, AND TABLETS FOR MAKING FORTIFIED BEVERAGES (U.S. CLS. 45, 46 AND 48).

CLASS 41—EDUCATION AND ENTERTAINMENT

FOR EDUCATION AND TRAINING, NAMELY CLASSES, SEMINARS, CONFERENCES AND WORKSHOPS, IN THE FIELDS OF HEALTH CARE, PREVENTATIVE HEALTH CARE AND NUTRITIONAL SUPPLEMENTS (U.S. CLS. 100, 101 AND 107).

CLASS 43—HOTEL AND RESTAURANT SERVICES

FOR PROVIDING OF FOODS AND DRINKS FOR PATIENTS AND GUESTS (U.S. CLS. 100 AND 101).
MICHAEL TANNER, EXAMINING ATTORNEY

SN 78-487,323. THE CENTURY COUNCIL, WASHINGTON, DC. FILED 9-21-2004.

SN 78-488,073. SOBRINO, MARIA DE LOURDES, ANAHEIM, CA. FILED 9-22-2004.

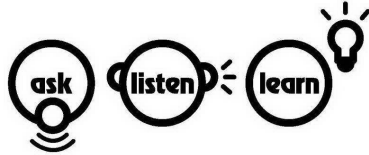

Kids and alcohol don't mix.

CLASS 35—ADVERTISING AND BUSINESS

FOR PROMOTING PUBLIC AWARENESS OF UNDERAGE DRINKING (U.S. CLS. 100, 101 AND 102).
FIRST USE 8-10-2004; IN COMMERCE 8-13-2004.

CLASS 41—EDUCATION AND ENTERTAINMENT

FOR EDUCATIONAL SERVICES, NAMELY, CONDUCTING WORKSHOPS, IN-HOME SELF-INSTRUCTION, AND LECTURES ON THE DANGERS OF UNDERAGE DRINKING AND DISTRIBUTION OF COURSE MATERIALS IN CONNECTION THEREWITH; PROVIDING EDUCATIONAL INFORMATION ON THE DANGERS OF UNDERAGE DRINKING VIA THE INTERNET (U.S. CLS. 100, 101 AND 107).
FIRST USE 8-10-2004; IN COMMERCE 8-13-2004.
TARAH HARDY, EXAMINING ATTORNEY

MARIA'S TREAT

THE MARK CONSISTS OF STANDARD CHARACTERS WITHOUT CLAIM TO ANY PARTICULAR FONT, STYLE, SIZE, OR COLOR.
NO CLAIM IS MADE TO THE EXCLUSIVE RIGHT TO USE "TREAT", APART FROM THE MARK AS SHOWN.

CLASS 30—STAPLE FOODS

FOR FLAVORED SWEETENED GELATING DESERTS, FLAN, PUDDINGS AND CANDY (U.S. CL. 46).
FIRST USE 2-11-1996; IN COMMERCE 2-11-1996.

CLASS 32—LIGHT BEVERAGES

FOR FRUIT DRINKS AND FRUIT JUICES (U.S. CLS. 45, 46 AND 48).
FIRST USE 2-11-1996; IN COMMERCE 2-11-1996.
TARAH HARDY, EXAMINING ATTORNEY

SN 78-487,566. PARAGON HOLDING COMPANY, INC., NASHVILLE, TN. FILED 9-22-2004.

SN 78-488,495. STEWART, DAVE, LOS ANGELES, CA. FILED 9-23-2004.

PARAGON

WEAPONS OF MASS ENTERTAINMENT

THE MARK CONSISTS OF STANDARD CHARACTERS WITHOUT CLAIM TO ANY PARTICULAR FONT, STYLE, SIZE, OR COLOR.

THE MARK CONSISTS OF STANDARD CHARACTERS WITHOUT CLAIM TO ANY PARTICULAR FONT, STYLE, SIZE, OR COLOR.
NO CLAIM IS MADE TO THE EXCLUSIVE RIGHT TO USE ENTERTAINMENT, APART FROM THE MARK AS SHOWN.

CLASS 35—ADVERTISING AND BUSINESS

FOR PHOTOCOPYING SERVICES, RECORDS MANAGEMENT, NAMELY, DOCUMENT INDEXING FOR OTHERS (U.S. CLS. 100, 101 AND 102).
FIRST USE 3-1-2004; IN COMMERCE 3-1-2004.

CLASS 9—ELECTRICAL AND SCIENTIFIC APPARATUS

FOR SOUND RECORDINGS, AUDIO-VISUAL RECORDINGS, DOWNLOADABLE SOUND RECORDINGS, AND DOWNLOADABLE AUDIO-VISUAL RECORDINGS FEATURING MUSIC, MUSICAL BASED ENTERTAINMENT, TELEVISION PROGRAMS, MOTION PICTURE FILMS, AND GENERAL FEATURE ENTERTAINMENT; DOWNLOADABLE RING TONES FOR CELL PHONES FEATURING MUSIC AND MUSICAL BASED ENTERTAINMENT; DOWNLOADABLE SONGS FEATURING MUSIC (U.S. CLS. 21, 23, 26, 36 AND 38).

CLASS 40—MATERIAL TREATMENT

FOR DOCUMENT SCANNING (U.S. CLS. 100, 103 AND 106).
FIRST USE 3-1-2004; IN COMMERCE 3-1-2004.
JOHN E. MICHOS, EXAMINING ATTORNEY

CLASS 38—COMMUNICATION

FOR STREAMING OF SOUND AND AUDIO-VISUAL RECORDINGS FEATURING MUSIC, MUSICAL BASED ENTERTAINMENT, TELEVISION PROGRAMS, MOTION PICTURE FILMS, AND GENERAL FEATURE ENTERTAINMENT; LIVE WEB CASTS OF MUSICAL PERFORMANCES ON THE INTERNET; WIRELESS TRANSMISSION, UPLOADING AND DOWNLOADING OF RING TONES AND IMAGES VIA THE INTERNET AND CELL PHONES (U.S. CLS. 100, 101 AND 104).

CLASS 41—EDUCATION AND ENTERTAINMENT

FOR ENTERTAINMENT SERVICES, NAMELY, PROVIDING A WEBSITE OVER A GLOBAL COMPUTER NETWORK FEATURING INFORMATION ON SOUND, AUDIO VISUAL RECORDINGS, MOTION PICTURES, TELEVISION PROGRAMS AND GENERAL FEATURE ENTERTAINMENT; PRODUCTION AND DISTRIBUTION OF SOUND RECORDINGS, TELEVISION PROGRAMS, AND MOTION PICTURES; PRODUCTION SERVICES, NAMELY, MUSIC PRODUCTION SERVICES (U.S. CLS. 100, 101 AND 107).

NAAKWAMA ANKRAH, EXAMINING ATTORNEY

SN 78-488,979. HANDI-FOIL CORPORATION, WHEELING, IL. FILED 9-24-2004.

BBQ BASICS

THE MARK CONSISTS OF STANDARD CHARACTERS WITHOUT CLAIM TO ANY PARTICULAR FONT, STYLE, SIZE, OR COLOR.

NO CLAIM IS MADE TO THE EXCLUSIVE RIGHT TO USE "BBQ", APART FROM THE MARK AS SHOWN.

CLASS 6—METAL GOODS

FOR ALUMINUM FOIL (U.S. CLS. 2, 12, 13, 14, 23, 25 AND 50).

CLASS 21—HOUSEWARES AND GLASS

FOR CONTAINERS FORMED OF ALUMINUM FOIL WITH PLASTIC LIDS; TRAYS AND PANS FORMED OF ALUMINUM FOIL; AND PANS FORMED OF ALUMINUM FOIL WITH WIRE HANDLES (U.S. CLS. 2, 13, 23, 29, 30, 33, 40 AND 50).

TEJBIR SINGH, EXAMINING ATTORNEY

SN 78-488,930. HAVE TORCH / WILL TRAVEL, CHINO VALLEY, AZ. FILED 9-23-2004.

HAVE TORCH / WILL TRAVEL

THE MARK CONSISTS OF STANDARD CHARACTERS WITHOUT CLAIM TO ANY PARTICULAR FONT, STYLE, SIZE, OR COLOR.

CLASS 6—METAL GOODS

FOR METAL SCULPTURE, STRUCTURAL STEEL (U.S. CLS. 2, 12, 13, 14, 23, 25 AND 50).
FIRST USE 6-5-1998; IN COMMERCE 6-5-1998.

CLASS 20—FURNITURE AND ARTICLES NOT OTHERWISE CLASSIFIED

FOR FURNITURE (U.S. CLS. 2, 13, 22, 25, 32 AND 50).
FIRST USE 6-5-2000; IN COMMERCE 6-5-2000.

CLASS 40—MATERIAL TREATMENT

FOR METAL FABRICATION SERVICE (U.S. CLS. 100, 103 AND 106).
FIRST USE 4-1-1997; IN COMMERCE 4-1-1997.
BARBARA GAYNOR, EXAMINING ATTORNEY

SN 78-489,397. BATH & BODY WORKS, INC., REYNOLDSBURG, OH. FILED 9-24-2004.

BREATHE WELLBEING

THE MARK CONSISTS OF STANDARD CHARACTERS WITHOUT CLAIM TO ANY PARTICULAR FONT, STYLE, SIZE, OR COLOR.

OWNER OF U.S. REG. NO. 2,896,014.

CLASS 3—COSMETICS AND CLEANING PREPARATIONS

FOR PERSONAL CARE PRODUCTS, NAMELY, BATH MILK, BATH OIL, BODY BAR, BODY BUTTER, BODY CONDITIONER, BODY CREAM, BODY LOTION, BODY OIL, BODY SCRUBS, BODY SPLASH, BODY WASH, BUBBLE BATH, EAU DE TOILETTE, EFFERVESCENT BATH TABLETS, FRAGRANCE GEL, FRAGRANCE OIL, HAND CREAM, SHOWER GEL, SOAP FOR THE BODY, SOAP FOR THE FACE, AND SOAP FOR THE HANDS (U.S. CLS. 1, 4, 6, 50, 51 AND 52).

CLASS 4—LUBRICANTS AND FUELS

FOR CANDLES (U.S. CLS. 1, 6 AND 15).
GRETTA YAO, EXAMINING ATTORNEY

SN 78-489,694. DUNBAR, AMANDA, ALLEN, TX. FILED 9-26-2004.

SN 78-490,030. OZBURN-HESSEY LOGISTICS, LLC, NASHVILLE, TN. FILED 9-27-2004.

OHL

THERE'S ONLY ONE
ORIGINAL

THE MARK CONSISTS OF STANDARD CHARACTERS WITHOUT CLAIM TO ANY PARTICULAR FONT, STYLE, SIZE, OR COLOR.

CLASS 35—ADVERTISING AND BUSINESS

FOR BUSINESS MANAGEMENT SERVICES, NAMELY, MANAGING LOGISTICS, REVERSE LOGISTICS, SUPPLY CHAIN SERVICES, WAREHOUSES AND PRODUCT DISTRIBUTION AND FULFILLMENT PROCESSES FOR OTHERS (U.S. CLS. 100, 101 AND 102).
FIRST USE 1-31-1995; IN COMMERCE 1-31-1995.

CLASS 39—TRANSPORTATION AND STORAGE

FOR LOGISTICS, REVERSE LOGISTICS, AND SUPPLY CHAIN SERVICES, NAMELY, WAREHOUSING AND PARCEL DELIVERY (U.S. CLS. 100 AND 105).
FIRST USE 1-31-1995; IN COMMERCE 1-31-1995.
SCOTT OSCLICK, EXAMINING ATTORNEY

THE MARK CONSISTS OF STANDARD CHARACTERS WITHOUT CLAIM TO ANY PARTICULAR FONT, STYLE, SIZE, OR COLOR.

CLASS 16—PAPER GOODS AND PRINTED MATTER

FOR WORKS OF ART AND PICTORIAL ART PRINTS, NAMELY PAINTINGS, PORTRAITS, SERIGRAPHS, DRAWINGS, SKETCHES, MURALS, GRAPHIC ART PRINTS, PRINTED ART REPRESENTATIONS AND REPRODUCTIONS, LITHOGRAPHS AND LITHOGRAPHIC PRINTS, MOUNTED AND UNMOUNTED POSTERS, WATERCOLOR PICTURES, BOOKS FEATURING VISUAL ART, SCULPTURES, PAINTING, ART PRINTS, GRAPHIC PRINTS, REPRESENTATIONS AND REPRODUCTIONS; BOOKS AND INFORMATION BROCHURES FEATURING DRAWINGS, NAMELY, SKETCHES, ART REPRODUCTION DRAWINGS, AND GRAPHIC PRINTS; PAINTINGS AND PHOTOGRAPHIC REPRODUCTIONS ON POSTCARDS, GREETING CARDS, ALL OCCASION CARDS, CALENDARS, DAILY PLANNERS, STATIONERY, NOTE PADS, PAPERBOARD AND DIARIES (U.S. CLS. 2, 5, 22, 23, 29, 37, 38 AND 50).
FIRST USE 5-24-2005; IN COMMERCE 5-24-2005.

SN 78-490,062. OZBURN-HESSEY LOGISTICS, LLC, NASHVILLE, TN. FILED 9-27-2004.

Ozburn-Hessey Logistics

CLASS 41—EDUCATION AND ENTERTAINMENT

FOR ENTERTAINMENT SERVICES, NAMELY PERSONAL APPEARANCES BY A VISUAL ARTIST; ENTERTAINMENT SERVICES, NAMELY LIVE, TELEVISED AND MOVIE APPEARANCES BY A PROFESSIONAL VISUAL ARTIST ENTERTAINER; SPEAKING ENGAGEMENTS BY A VISUAL ARTIST IN THE FIELD OF ART AND ART EDUCATION; PROVIDING A WEBSITE FEATURING WORKS OF ART AND RELATED VIDEO AND TELEVISION CLIPS, PHOTOGRAPHS AND OTHER MULTIMEDIA MATERIALS RELATED TO A VISUAL ARTIST (U.S. CLS. 100, 101 AND 107).
FIRST USE 5-24-2005; IN COMMERCE 5-24-2005.
MARK SPARACINO, EXAMINING ATTORNEY

THE MARK CONSISTS OF STANDARD CHARACTERS WITHOUT CLAIM TO ANY PARTICULAR FONT, STYLE, SIZE, OR COLOR.

NO CLAIM IS MADE TO THE EXCLUSIVE RIGHT TO USE LOGISTICS, APART FROM THE MARK AS SHOWN.

CLASS 35—ADVERTISING AND BUSINESS

FOR BUSINESS MANAGEMENT SERVICES, NAMELY, MANAGING LOGISTICS, REVERSE LOGISTICS, SUPPLY CHAIN SERVICES, WAREHOUSES AND PRODUCT DISTRIBUTION AND FULFILLMENT PROCESSES FOR OTHERS (U.S. CLS. 100, 101 AND 102).
FIRST USE 3-31-1991; IN COMMERCE 3-31-1991.

CLASS 39—TRANSPORTATION AND STORAGE

FOR LOGISTICS, REVERSE LOGISTICS, AND SUPPLY CHAIN SERVICES, NAMELY, WAREHOUSING AND PARCEL DELIVERY (U.S. CLS. 100 AND 105).

FIRST USE 3-31-1995; IN COMMERCE 3-31-1995.
CARRIE ACHEN, EXAMINING ATTORNEY

CLASS 16—PAPER GOODS AND PRINTED MATTER

FOR PRINTED MATTER, NAMELY, PERIODICALS AND MAGAZINES IN THE FIELDS OF THE FASHION, COSMETICS AND BEAUTY INDUSTRIES; PHOTOGRAPHS; STATIONERY; PRINTED INSTRUCTIONAL TEACHING MATERIALS IN THE FIELDS OF THE FASHION, COSMETICS AND BEAUTY INDUSTRIES (U.S. CLS. 2, 5, 22, 23, 29, 37, 38 AND 50).

SN 78-490,179. OZBURN-HESSEY LOGISTICS, LLC, NASHVILLE, TN. FILED 9-27-2004.



THE MARK CONSISTS OF THE LETTERS "O" AND "H", BORDERED ON THE RIGHT BY A TRIANGLE.

CLASS 35—ADVERTISING AND BUSINESS

FOR BUSINESS MANAGEMENT SERVICES, NAMELY, MANAGING LOGISTICS, REVERSE LOGISTICS, SUPPLY CHAIN SERVICES, WAREHOUSES AND PRODUCT DISTRIBUTION AND FULFILLMENT PROCESSES FOR OTHERS (U.S. CLS. 100, 101 AND 102).

FIRST USE 4-30-2001; IN COMMERCE 4-30-2001.

CLASS 39—TRANSPORTATION AND STORAGE

FOR LOGISTICS, REVERSE LOGISTICS, AND SUPPLY CHAIN SERVICES, NAMELY, WAREHOUSING AND PARCEL DELIVERY (U.S. CLS. 100 AND 105).

FIRST USE 4-30-2001; IN COMMERCE 4-30-2001.
MICHELE SWAIN, EXAMINING ATTORNEY

CLASS 35—ADVERTISING AND BUSINESS

FOR RETAIL STORE SERVICES, AVAILABLE THROUGH STORES, THE INTERNET AND MAIL ORDER, AND WHOLESALE ORDERING AND DISTRIBUTORSHIP SERVICES, ALL IN THE FIELD OF COSMETICS, COLOGNE, PERFUME, ANTI-AGING CREAM, ASTRINGENTS FOR COSMETIC PURPOSES, BEAUTY MASKS, FACIAL CLEANSERS, SKIN CONDITIONERS, BODY CREAM, BODY OIL, BATH OIL, BATH CRYSTALS, BATH BEADS, BLUSH, FACIAL MAKE-UP, FOUNDATION MAKE-UP, COMPACTS CONTAINING MAKE-UP, EYE MAKE-UP, LIPSTICK, AND NAIL POLISH (U.S. CLS. 100, 101 AND 102).

CLASS 41—EDUCATION AND ENTERTAINMENT

FOR EDUCATION SERVICES, NAMELY DEMONSTRATIONS, CLASSES, SEMINARS, CONFERENCES, WORKSHOPS, AND COURSES, ALL IN THE FIELDS OF THE FASHION, COSMETICS AND BEAUTY INDUSTRIES; PRODUCTION OF MOTION PICTURE FILMS AND TELEVISION PROGRAMS IN THE FIELDS OF THE FASHION, COSMETICS AND BEAUTY INDUSTRIES; PRODUCTION OF LIVE MUSIC, THEATRE, SHOWS, WEBCASTS, NON-DOWNLOADABLE ELECTRONIC PUBLICATIONS AND OTHER INTERNET PROGRAMS IN THE FIELDS OF THE FASHION, COSMETICS AND BEAUTY INDUSTRIES; PUBLICATION OF PERIODICALS, MAGAZINES, BROCHURES, MANUALS, PUBLICITY TEXTS AND BOOKS IN THE FIELDS OF THE FASHION, COSMETICS AND BEAUTY INDUSTRIES; PRODUCTION AND PRESENTATION OF FASHION SHOWS AND EXHIBITIONS, COSMETIC SHOWS AND EXHIBITIONS, AND BEAUTY SHOWS AND BEAUTY PAGEANTS AND EXHIBITIONS (U.S. CLS. 100, 101 AND 107).

CLASS 44—MEDICAL, BEAUTY AND AGRICULTURAL SERVICES

FOR SERVICES OF APPLYING COSMETICS AND MAKE-UP (U.S. CLS. 100 AND 101).

BARBARA RUTLAND, EXAMINING ATTORNEY

SN 78-490,544. NAPOLEON PERDIS LLC, WILMINGTON, DE. FILED 9-28-2004.

NAPOLEON PERDIS

THE MARK CONSISTS OF STANDARD CHARACTERS WITHOUT CLAIM TO ANY PARTICULAR FONT, STYLE, SIZE, OR COLOR.

THE NAME "NAPOLEON PERDIS" IDENTIFIES A LIVING INDIVIDUAL WHOSE CONSENT IS OF RECORD.

SN 78-490,999. INNOVATION INVESTMENTS, LLC, SAN FRANCISCO, CA. FILED 9-28-2004.

TRUTHMENT

THE MARK CONSISTS OF STANDARD CHARACTERS WITHOUT CLAIM TO ANY PARTICULAR FONT, STYLE, SIZE, OR COLOR.

CLASS 38—COMMUNICATION

FOR COMMUNICATION SERVICES, NAMELY, ELECTRONIC TRANSMISSION OF INFORMATION AND MESSAGES TO USERS OF COMPUTERS CONCERNING MATTERS OF GENERAL INTEREST TO THE PUBLIC (U.S. CLS. 100, 101 AND 104).

SN 78-491,190. DEVELOPMENT GATEWAY FOUNDATION, INC., WASHINGTON, DC. FILED 9-29-2004.

CLASS 41—EDUCATION AND ENTERTAINMENT

FOR NEWS AGENCIES, NAMELY GATHERING AND DISSEMINATING OF NEWS AND INFORMATION OF GENERAL INTEREST TO THE PUBLIC (U.S. CLS. 100, 101 AND 107).
MIDGE BUTLER, EXAMINING ATTORNEY



SN 78-491,184. DEVELOPMENT GATEWAY FOUNDATION, INC., WASHINGTON, DC. FILED 9-29-2004.

CLASS 35—ADVERTISING AND BUSINESS

FOR ELECTRONIC TECHNOLOGY SERVICES, NAMELY, PROVIDING A PORTAL ON A GLOBAL COMPUTER NETWORK MAKING AVAILABLE GLOBAL, NATIONAL, REGIONAL AND LOCAL INFORMATION RELATED TO DEVELOPMENT ACTIVITIES AIMED AT REDUCING POVERTY (U.S. CLS. 100, 101 AND 102).
FIRST USE 10-1-2000; IN COMMERCE 10-1-2000.

CLASS 36—INSURANCE AND FINANCIAL

FOR FINANCIAL SERVICES, NAMELY PROVIDING A GRANT PROGRAM FOR THE USE OF INFORMATION TECHNOLOGY IN THE FIELD OF DEVELOPMENT OF POVERTY (U.S. CLS. 100, 101 AND 102).
FIRST USE 8-1-2002; IN COMMERCE 8-1-2002.



CLASS 41—EDUCATION AND ENTERTAINMENT

FOR EDUCATION SERVICES, NAMELY, PROVIDING RESEARCH AND TRAINING CENTERS IN AFRICA AND ASIA FOR THE PURPOSE OF EDUCATION IN THE USE OF INFORMATION TECHNOLOGY IN THE FIELD OF DEVELOPMENT AND REDUCTION OF POVERTY (U.S. CLS. 100, 101 AND 107).
FIRST USE 9-1-2002; IN COMMERCE 9-1-2002.
BRENDAN REGAN, EXAMINING ATTORNEY

CLASS 9—ELECTRICAL AND SCIENTIFIC APPARATUS

FOR COMPUTER SOFTWARE, NAMELY, SOFTWARE APPLICATIONS FOR MANAGEMENT OF INFORMATION RELATED GLOBAL, NATIONAL, REGIONAL AND LOCAL DEVELOPMENT ACTIVITIES AIMED AT REDUCING POVERTY AND FOR USE IN THE MANAGEMENT OF GOVERNMENT AND OTHER PROCUREMENT OPPORTUNITIES (U.S. CLS. 21, 23, 26, 36 AND 38).

SN 78-491,196. DEVELOPMENT GATEWAY FOUNDATION, INC., WASHINGTON, DC. FILED 9-29-2004.

dgMarket

CLASS 16—PAPER GOODS AND PRINTED MATTER

FOR PRINTED MATERIALS, NAMELY, BOOKS, PAMPHLETS AND BROCHURES PROVIDING INFORMATION ABOUT PROGRAMS AND SERVICES AS THEY RELATE TO GLOBAL, NATIONAL, REGIONAL AND LOCAL DEVELOPMENT ACTIVITIES AIMED AT REDUCING POVERTY (U.S. CLS. 2, 5, 22, 23, 29, 37, 38 AND 50).
BRENDAN REGAN, EXAMINING ATTORNEY

THE MARK CONSISTS OF STANDARD CHARACTERS WITHOUT CLAIM TO ANY PARTICULAR FONT, STYLE, SIZE, OR COLOR.

CLASS 9—ELECTRICAL AND SCIENTIFIC APPARATUS

FOR COMPUTER SOFTWARE, NAMELY, SOFTWARE USED TO MANAGE GOVERNMENT AND OTHER PROCUREMENT RELATED ACTIVITIES (U.S. CLS. 21, 23, 26, 36 AND 38).

FIRST USE 3-1-2003; IN COMMERCE 3-1-2003.

CLASS 35—ADVERTISING AND BUSINESS

FOR ELECTRONIC TECHNOLOGY SERVICES, NAMELY, PROVIDING A PORTAL ON A GLOBAL COMPUTER NETWORK MAKING AVAILABLE INFORMATION ON GOVERNMENT AND OTHER PROCUREMENT OPPORTUNITIES AND ACTIVITIES AS A MEANS OF ENCOURAGING PUBLIC SECTOR TRANSPARENCY AND EFFICIENCY OF GOVERNMENT (U.S. CLS. 100, 101 AND 102).

FIRST USE 8-1-2002; IN COMMERCE 8-1-2002.
BRENDAN REGAN, EXAMINING ATTORNEY

SN 78-491,349. LIFE'SWORK OF WESTERN PA, INC., PITTSBURGH, PA. FILED 9-29-2004.



SN 78-491,209. CURRENT PUBLISHING CORP., RANCHO SANTA MARGARITA, CA. FILED 9-29-2004.

**LIFE ON AN OCEAN
PLANET**

CLASS 35—ADVERTISING AND BUSINESS

FOR ASSISTING PERSONS WITH DISABILITIES OR OTHER BARRIERS ACHIEVE EMPLOYMENT OPPORTUNITIES, NAMELY SKILLS ASSESSMENT IN THE NATURE OF TESTING TO DETERMINE EMPLOYMENT SKILLS AND TESTING TO DETERMINE JOB COMPETENCY, JOB PLACEMENT SERVICES, EMPLOYMENT COUNSELING AND RECRUITING (U.S. CLS. 100, 101 AND 102).

FIRST USE 7-26-2004; IN COMMERCE 7-26-2004.

CLASS 41—EDUCATION AND ENTERTAINMENT

FOR VOCATIONAL TRAINING IN THE FIELD OF PROVIDING EMPLOYMENT TRAINING ASSISTANCE TO PERSONS WITH DISABILITIES OR OTHER BARRIERS TO EMPLOYMENT (U.S. CLS. 100, 101 AND 107).

FIRST USE 7-26-2004; IN COMMERCE 7-26-2004.
TIMOTHY FINNEGAN, EXAMINING ATTORNEY

SN 78-491,476. BED BATH & BEYOND PROCUREMENT CO. INC., FARMINGDALE, NY. FILED 9-29-2004.

**REFRESH...
REVIVE...REVEAL
YOUR STYLE**

THE MARK CONSISTS OF STANDARD CHARACTERS WITHOUT CLAIM TO ANY PARTICULAR FONT, STYLE, SIZE, OR COLOR.

CLASS 9—ELECTRICAL AND SCIENTIFIC APPARATUS

FOR EDUCATIONAL MATERIALS ON CD-ROM, NAMELY, RESEARCH AND REFERENCE MATERIALS, AUDIOVISUAL PRESENTATIONS, LESSON PLANS, LAB DATA SHEETS, TEACHER MATERIALS AND INTERACTIVE ASSESSMENT TOOLS, ALL IN THE FIELD OF MARINE SCIENCE (U.S. CLS. 21, 23, 26, 36 AND 38).

FIRST USE 11-0-2004; IN COMMERCE 11-0-2004.

CLASS 16—PAPER GOODS AND PRINTED MATTER

FOR PRINTED EDUCATIONAL MATERIALS, NAMELY, TEXTBOOKS, TESTS, MANUALS, TEACHER CURRICULUM GUIDES, PHOTOGRAPHIC SLIDE TRANSPARENCIES, AND STUDENT ASSESSMENT MATERIALS IN THE FIELD OF MARINE SCIENCE (U.S. CLS. 2, 5, 22, 23, 29, 37, 38 AND 50).

FIRST USE 11-0-2004; IN COMMERCE 11-0-2004.
ELIZABETH J. WINTER, EXAMINING ATTORNEY

THE MARK CONSISTS OF STANDARD CHARACTERS WITHOUT CLAIM TO ANY PARTICULAR FONT, STYLE, SIZE, OR COLOR.

CLASS 20—FURNITURE AND ARTICLES NOT OTHERWISE CLASSIFIED

FOR FITTED FABRIC FUTON COVERS, FITTED FABRIC FURNITURE COVERS, AND PILLOWS (U.S. CLS. 2, 13, 22, 25, 32 AND 50).

CLASS 24—FABRICS

FOR THROWS, UNFITTED FABRIC FURNITURE COVERS, AND UNFITTED FABRIC FUTON COVERS (U.S. CLS. 42 AND 50).
VERNA BETH RIRIE, EXAMINING ATTORNEY

CLASS 44—MEDICAL, BEAUTY AND AGRICULTURAL SERVICES

FOR BEAUTY CONSULTATION SERVICES (U.S. CLS. 100 AND 101).
KEVIN DINALLO, EXAMINING ATTORNEY

SN 78-491,499. ESTEE LAUDER INC., NEW YORK, NY.
FILED 9-29-2004.

iMATCH

THE MARK CONSISTS OF STANDARD CHARACTERS WITHOUT CLAIM TO ANY PARTICULAR FONT, STYLE, SIZE, OR COLOR.

CLASS 3—COSMETICS AND CLEANING PREPARATIONS

FOR COSMETICS (U.S. CLS. 1, 4, 6, 50, 51 AND 52).

CLASS 44—MEDICAL, BEAUTY AND AGRICULTURAL SERVICES

FOR BEAUTY CONSULTATION SERVICES (U.S. CLS. 100 AND 101).
KEVIN DINALLO, EXAMINING ATTORNEY

SN 78-491,523. ESTEE LAUDER INC., NEW YORK, NY.
FILED 9-29-2004.

**ESTEE LAUDER
iMATCH**

THE MARK CONSISTS OF STANDARD CHARACTERS WITHOUT CLAIM TO ANY PARTICULAR FONT, STYLE, SIZE, OR COLOR.

OWNER OF U.S. REG. NOS. 530,305, 2,861,296 AND OTHERS.

THE NAME ESTEE LAUDER IDENTIFIES A LIVING INDIVIDUAL WHOSE CONSENT IS OF RECORD.

CLASS 3—COSMETICS AND CLEANING PREPARATIONS

FOR COSMETICS (U.S. CLS. 1, 4, 6, 50, 51 AND 52).

SN 78-491,531. UNITED STATES NAVY, CRANE DIVISION, NAVAL SURFACE WARFARE CENTER, CRANE, IN.
FILED 9-29-2004.

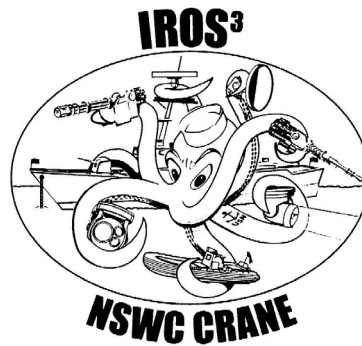

NO CLAIM IS MADE TO THE EXCLUSIVE RIGHT TO USE "CRANE", APART FROM THE MARK AS SHOWN.

THE MARK CONSISTS OF A BACKGROUND THAT IS ESSENTIALLY BISECTED BY WATER ON THE BOTTOM AND SKY ON THE TOP. AN ANCHORED SHIP IS FLOATING IN THE WATER. AN OCTOPUS IS IN THE FOREGROUND AND IS WEARING A HAT AND HAS A TATOO ON ONE OF ITS TENTACLES. THE OCTOPUS IS USING SIX OF ITS TENTACLES TO HOLD SIX OBJECTS, AND HAS ITS REMAINING TWO TENTACLES IN CONTACT WITH THE ANCHORED SHIP.

CLASS 9—ELECTRICAL AND SCIENTIFIC APPARATUS

FOR ELECTRONIC ANTI-TERRORIST AND FORCE PROTECTION SYSTEMS PRIMARILY COMPOSED OF A COMPUTER, COMPUTER OPERATING SOFTWARE, RADAR AND ELECTRO-OPTIC SIGHTING AND SURVEILLANCE DEVICES (U.S. CLS. 21, 23, 26, 36 AND 38).

CLASS 37—CONSTRUCTION AND REPAIR

FOR INSTALLATION, MAINTENANCE OR REPAIR OF ELECTRONIC ANTITERRORIST/FORCE PROTECTION SYSTEMS (U.S. CLS. 100, 103 AND 106).
VERNA BETH RIRIE, EXAMINING ATTORNEY

SN 78-491,887. WANG, JESSIE LI-KUO, HAYWARD, CA.
FILED 9-29-2004.

CLASS 43—HOTEL AND RESTAURANT SERVICES

FOR TRAVEL AGENCY SERVICES, NAMELY, MAKING RESERVATIONS AND BOOKINGS FOR TEMPORARY LODGINGS AND FOR RESTAURANTS AND MEALS (U.S. CLS. 100 AND 101).

FIRST USE 1-1-2001; IN COMMERCE 1-1-2001.
MICHAEL TANNER, EXAMINING ATTORNEY

RAINDANCE

THE MARK CONSISTS OF STANDARD CHARACTERS WITHOUT CLAIM TO ANY PARTICULAR FONT, STYLE, SIZE, OR COLOR.

SN 78-492,271. SYNGENTA PARTICIPATIONS AG, BASEL, SWITZERLAND, FILED 9-30-2004.

CLASS 18—LEATHER GOODS

FOR UMBRELLAS (U.S. CLS. 1, 2, 3, 22 AND 41).
FIRST USE 12-0-1993; IN COMMERCE 12-0-1993.

CLASS 25—CLOTHING

FOR CLOTHING, NAMELY, RAINCOATS, RAIN-SUITS, PONCHOS, OVERSHOES, RAIN JACKETS, RAIN-PROOF JACKETS, WIND RESISTANT JACKETS, WATERPROOF JACKETS AND PANTS, AND JACKETS, SHIRTS AND VESTS (U.S. CLS. 22 AND 39).

FIRST USE 12-0-1993; IN COMMERCE 12-0-1993.
JAMES A. RAUEN, EXAMINING ATTORNEY

ALTURA

SN 78-492,067. BOB MALMBERG, INC., DBA MALMBERG TRAVEL GROUP, THE, BOSTON, MA. FILED 9-30-2004.

SC
superior
choices
u s a

THE MARK CONSISTS OF STANDARD CHARACTERS WITHOUT CLAIM TO ANY PARTICULAR FONT, STYLE, SIZE, OR COLOR.

NO CLAIM IS MADE TO THE EXCLUSIVE RIGHT TO USE "U S A", APART FROM THE MARK AS SHOWN.

CLASS 1—CHEMICALS

FOR CHEMICAL PREPARATIONS FOR USE IN AGRICULTURE, HORTICULTURE AND FORESTRY, NAMELY, CHEMICAL PREPARATIONS FOR THE TREATMENT OF SEEDS (U.S. CLS. 1, 5, 6, 10, 26 AND 46).

CLASS 39—TRANSPORTATION AND STORAGE

FOR TRAVEL SERVICES, NAMELY, ARRANGING TRAVEL TOURS; COORDINATING TRAVEL ARRANGEMENTS FOR INDIVIDUALS AND GROUPS; ORGANIZATION OF EXCURSIONS, SIGHTSEEING TOURS, HOLIDAYS, TOURS AND TRAVEL; TRAVEL BOOKING AGENCIES (U.S. CLS. 100 AND 105).

FIRST USE 1-1-2001; IN COMMERCE 1-1-2001.

CLASS 5—PHARMACEUTICALS

FOR PREPARATIONS FOR DESTROYING VERMIN; FUNGICIDES, HERBICIDES, INSECTICIDES AND PESTICIDES FOR AGRICULTURAL USE (U.S. CLS. 6, 18, 44, 46, 51 AND 52).

DAWN HAN, EXAMINING ATTORNEY

SN 78-492,669. ROBSON COMMUNITIES, INC., SUN LAKES, AZ. FILED 9-30-2004.

SN 78-493,092. HOWDY HORSEY, L.P., PLANO, TX. FILED 10-1-2004.

EJ RANCH

THE MARK CONSISTS OF STANDARD CHARACTERS WITHOUT CLAIM TO ANY PARTICULAR FONT, STYLE, SIZE, OR COLOR.

NO CLAIM IS MADE TO THE EXCLUSIVE RIGHT TO USE RANCH, APART FROM THE MARK AS SHOWN.

CLASS 35—ADVERTISING AND BUSINESS

FOR HOMEOWNER ASSOCIATION SERVICES, NAMELY, PROMOTING THE INTEREST OF HOMEOWNERS THAT RESIDE IN THE COMMUNITY (U.S. CLS. 100, 101 AND 102).

CLASS 37—CONSTRUCTION AND REPAIR

FOR REAL ESTATE DEVELOPMENT SERVICES, NAMELY, THE DEVELOPMENT OF MASTER PLANNED COMMUNITIES, PLANNING AND DEVELOPMENT OF RESIDENTIAL COMMUNITIES, INCLUDING HOUSES AND APARTMENTS; AND COMMERCIAL PROPERTIES, INCLUDING INDUSTRIAL BUILDINGS, OFFICE AND RETAIL SPACE (U.S. CLS. 100, 103 AND 106).

MELVIN AXILBUND, EXAMINING ATTORNEY

SN 78-492,864. HILL'S PET NUTRITION, INC., TOPEKA, KS. FILED 10-1-2004.

LIVE BETTER. LOVE LONGER.

THE MARK CONSISTS OF STANDARD CHARACTERS WITHOUT CLAIM TO ANY PARTICULAR FONT, STYLE, SIZE, OR COLOR.

CLASS 5—PHARMACEUTICALS

FOR VETERINARIAN SUPERVISED DIETARY PET FOOD (U.S. CLS. 6, 18, 44, 46, 51 AND 52).

CLASS 31—NATURAL AGRICULTURAL PRODUCTS

FOR ANIMAL FOODS FOR DOGS, CATS AND OTHER DOMESTICATED HOUSEHOLD PETS (U.S. CLS. 1 AND 46).

NANCY CLARKE, EXAMINING ATTORNEY

HOWDY HORSEY

THE MARK CONSISTS OF STANDARD CHARACTERS WITHOUT CLAIM TO ANY PARTICULAR FONT, STYLE, SIZE, OR COLOR.

CLASS 16—PAPER GOODS AND PRINTED MATTER

FOR SPIRAL NOTEBOOKS, LOOSE-LEAF NOTEBOOKS, STICKERS, STATIONERY, DIARIES, PENS, PENCILS, PENCIL CASES, SEALING STAMPS, AND RUBBER STAMPS (U.S. CLS. 2, 5, 22, 23, 29, 37, 38 AND 50).

CLASS 18—LEATHER GOODS

FOR BACKPACKS, HANDBAGS, COIN PURSES, AND WALLETS (U.S. CLS. 1, 2, 3, 22 AND 41).

CLASS 25—CLOTHING

FOR LONG-SLEEVED T-SHIRTS, SHORT-SLEEVED T-SHIRTS, TANK T-SHIRTS, SWEAT SHIRTS, PANTS, JEANS, OVERALLS, DENIM JACKETS, PAJAMAS, AND UNDERWEAR (U.S. CLS. 22 AND 39).

MELISSA VALLILLO, EXAMINING ATTORNEY

SN 78-493,138. UBICS, INC., CANONSBURG, PA. FILED 10-1-2004.

ANYTIME. ANYSHORE. WE DO IT.

THE MARK CONSISTS OF STANDARD CHARACTERS WITHOUT CLAIM TO ANY PARTICULAR FONT, STYLE, SIZE, OR COLOR.

CLASS 35—ADVERTISING AND BUSINESS

FOR BUSINESS CONSULTING SERVICES IN THE FIELD OF LOCAL AND WIDE AREA NETWORKS AND COMPUTER SYSTEMS; COMPUTER OUTSOURCING SERVICES AND OUTSOURCING SERVICES IN THE AREA OF COMPUTER INFORMATION TECHNOLOGY PROJECTS ONSITE, OFFSITE OR OFFSHORE (U.S. CLS. 100, 101 AND 102).

FIRST USE 3-31-2003; IN COMMERCE 3-31-2003.

CLASS 42—SCIENTIFIC, COMPUTER AND LEGAL SERVICES

SN 78-493,634. MURDOCH, DOUGLAS HARLAND, SANTA ROSA, CA. FILED 10-3-2004.

FOR COMPUTER SOFTWARE DESIGN FOR OTHERS; COMPUTER CODE AND SYSTEM CONVERSION FOR OTHERS; COMPUTER CONSULTATION; COMPUTER DIAGNOSTIC SERVICES; COMPUTER PROGRAMMING FOR OTHERS; COMPUTER NETWORK DESIGN FOR OTHERS; COMPUTER PROJECT MANAGEMENT SERVICES; COMPUTER SERVICES, NAMELY, DESIGNING AND IMPLEMENTING NETWORK WEB PAGES FOR OTHERS AND CREATING, DESIGNING, IMPLEMENTING AND MAINTAINING WEB SITES FOR OTHERS; COMPUTER SYSTEMS ANALYSIS; MANAGEMENT IN THE FIELD OF LOCAL AND WIDE AREA NETWORKS AND COMPUTER SYSTEMS (U.S. CLS. 100 AND 101).

FIRST USE 3-31-2003; IN COMMERCE 3-31-2003.
MICHAEL KAZAZIAN, EXAMINING ATTORNEY

THINK TANK

SN 78-493,240. NAVIGATE, INC., HIGH POINT, NC. FILED 10-1-2004.

NAVIGATE: THE OUTPLACEMENT ALTERNATIVE

THE MARK CONSISTS OF STANDARD CHARACTERS WITHOUT CLAIM TO ANY PARTICULAR FONT, STYLE, SIZE, OR COLOR.

OWNER OF U.S. REG. NO. 2,860,235.

CLASS 35—ADVERTISING AND BUSINESS

FOR BUSINESS MANAGEMENT AND CONSULTATION SERVICES IN THE FIELD OF HUMAN RESOURCES, NAMELY, ADVISING BUSINESSES IN THE FIELD OF RECRUITING, RETENTION, PERSONNEL TRANSITIONS; EMPLOYMENT RECRUITING, PLACEMENT AND CAREER NETWORKING; EMPLOYMENT COUNSELING (U.S. CLS. 100, 101 AND 102).

FIRST USE 5-6-2004; IN COMMERCE 5-6-2004.

CLASS 41—EDUCATION AND ENTERTAINMENT

FOR BUSINESS CONSULTATION SERVICES, NAMELY, ADVISING BUSINESSES IN THE FIELD OF EMPLOYEE COACHING; EXECUTIVE COACHING (U.S. CLS. 100, 101 AND 107).

FIRST USE 5-6-2004; IN COMMERCE 5-6-2004.
MICHAEL TANNER, EXAMINING ATTORNEY

THE MARK CONSISTS OF STANDARD CHARACTERS WITHOUT CLAIM TO ANY PARTICULAR FONT, STYLE, SIZE, OR COLOR.

CLASS 9—ELECTRICAL AND SCIENTIFIC APPARATUS

FOR CARRYING CASES, NAMELY BACKPACKS WITH AND WITHOUT ROLLING WHEELS, BELT PACKS, FOAM PADDED CASES, SHOULDER BAGS, ROLLING CASES INCLUDING ROLLING CARRY-ON CASES, TOTE BAGS, POCKETS, AND POUCHES, ALL DESIGNED FOR CARRYING CAMERAS, PHOTOGRAPHIC EQUIPMENT, OPTICAL EQUIPMENT, VIDEO CAMERAS, VIDEOGRAPHIC EQUIPMENT, CINEMA CAMERAS, CINEMATOGRAPHIC EQUIPMENT, AUDIO ELECTRONIC EQUIPMENT, COMPUTERS AND COMPUTER ACCESSORIES, COMMUNICATIONS ELECTRONIC EQUIPMENT, AND INDUSTRIAL ELECTRONIC EQUIPMENT SUCH AS ELECTRONIC TESTING EQUIPMENT; WAIST HARNESSSES AND SHOULDER HARNESSSES DESIGNED FOR USE WITH THE FOREGOING GOODS (U.S. CLS. 21, 23, 26, 36 AND 38).

CLASS 18—LEATHER GOODS

FOR LUGGAGE; NAMELY BACK PACKS WITH AND WITHOUT ROLLING WHEELS, CARRYING CASES, SHOULDER BAGS, ROLLING CASES INCLUDING ROLLING CARRY-ON CASES, ORGANIZER BAGS, PADDED CASES, BELT PACKS, CARRY-ALLS, TOTE BAGS, BRIEFCASES, ATTACHE CASES, POUCHES, AND POCKETS; WAIST HARNESSSES AND SHOULDER HARNESSSES DESIGNED FOR USE WITH THE FOREGOING GOODS (U.S. CLS. 1, 2, 3, 22 AND 41).

KEVIN DINALLO, EXAMINING ATTORNEY

SN 78-493,756. THOMPSON, DANIEL S, SAN RAFAEL, CA.
FILED 10-4-2004.

SN 78-493,759. THOMPSON, DANIEL S, SAN RAFAEL, CA.
FILED 10-4-2004.

Flotovoltaics

Phlotovoltaics

THE MARK CONSISTS OF STANDARD CHARACTERS WITHOUT CLAIM TO ANY PARTICULAR FONT, STYLE, SIZE, OR COLOR.

THE MARK CONSISTS OF STANDARD CHARACTERS WITHOUT CLAIM TO ANY PARTICULAR FONT, STYLE, SIZE, OR COLOR.

CLASS 6—METAL GOODS

FOR SINGLE DESIGN FRAME AND MOUNTING SYSTEM FOR FLOATING BUOYANT PHOTOVOLTAIC SOLAR POWER STATIONS, NAMELY, METAL STANCHIONS AND CURTAINWALLS FOR MOUNTING SOLAR PANELS TO ROOFS (U.S. CLS. 2, 12, 13, 14, 23, 25 AND 50).

CLASS 6—METAL GOODS

FOR SINGLE DESIGN FRAME AND MOUNTING SYSTEM FOR FLOATING BUOYANT PHOTOVOLTAIC SOLAR POWER STATIONS, NAMELY, METAL STANCHIONS AND CURTAINWALLS FOR MOUNTING SOLAR PANELS TO ROOFS (U.S. CLS. 2, 12, 13, 14, 23, 25 AND 50).

CLASS 7—MACHINERY

FOR FLOAT MOUNTED CENTRIFUGAL PUMPS FOR WATER DISPLACEMENT IN FLOATING BUOYANT PHOTOVOLTAIC SOLAR POWER STATIONS (U.S. CLS. 13, 19, 21, 23, 31, 34 AND 35).

CLASS 7—MACHINERY

FOR FLOAT MOUNTED CENTRIFUGAL PUMPS FOR WATER DISPLACEMENT IN FLOATING BUOYANT PHOTOVOLTAIC SOLAR POWER STATIONS (U.S. CLS. 13, 19, 21, 23, 31, 34 AND 35).

CLASS 9—ELECTRICAL AND SCIENTIFIC APPARATUS

FOR FLOATING BUOYANT PHOTOVOLTAIC SOLAR POWER STATIONS AND SYSTEMS COMPRISED OF PHOTOVOLTAIC SOLAR MODULES AND PHOTOVOLTAIC SOLAR-THERMAL HYBRID MODULES FOR CONVERTING ELECTRONIC RADIATION TO ELECTRICAL ENERGY; PHOTOVOLTAIC CLADDING PANELS FOR CONVERTING ELECTRONIC RADIATION TO ELECTRICAL ENERGY; ELECTRIC CURRENT COLLECTORS AND PHOTOVOLTAIC COLLECTION PANELS AND PHOTOVOLTAIC CELLS FOR THE COLLECTION AND STORAGE OF SOLAR GENERATED ELECTRIC POWER; BUOYANCY COMPENSATORS TO SUPPORT SOLAR ARRAYS; AND EQUIPMENT FOR THE MONITORING, CONTROL AND DISTRIBUTION OF SOLAR GENERATED ELECTRIC POWER, NAMELY, ELECTRONIC SENSORS AND DIGITAL ELECTRIC METERS FOR MEASURING SOLAR RADIATION, CHARGE CONTROLLERS, DC/AC INVERTERS, PHOTOVOLTAIC DISTRIBUTION PANELS, ELECTRONIC CONTROL CONSOLES USED FOR ROTATING SOLAR PANELS TO FOLLOW THE PATH OF THE SUN EAST TO WEST; AND WIRES, TRANSFORMERS AND CIRCUIT BREAKERS ASSOCIATED WITH THE AFORESAID (U.S. CLS. 21, 23, 26, 36 AND 38).

BARBARA A. LOUGHRAN, EXAMINING ATTORNEY

CLASS 9—ELECTRICAL AND SCIENTIFIC APPARATUS

FOR FLOATING BUOYANT PHOTOVOLTAIC SOLAR POWER STATIONS AND SYSTEMS COMPRISED OF PHOTOVOLTAIC SOLAR MODULES AND PHOTOVOLTAIC SOLAR-THERMAL HYBRID MODULES FOR CONVERTING ELECTRONIC RADIATION TO ELECTRICAL ENERGY; PHOTOVOLTAIC CLADDING PANELS FOR CONVERTING ELECTRONIC RADIATION TO ELECTRICAL ENERGY; ELECTRIC CURRENT COLLECTORS AND PHOTOVOLTAIC COLLECTION PANELS AND PHOTOVOLTAIC CELLS FOR THE COLLECTION AND STORAGE OF SOLAR GENERATED ELECTRIC POWER; BUOYANCY COMPENSATORS TO SUPPORT SOLAR ARRAYS; AND EQUIPMENT FOR THE MONITORING, CONTROL AND DISTRIBUTION OF SOLAR GENERATED ELECTRIC POWER, NAMELY, ELECTRONIC SENSORS AND DIGITAL ELECTRIC METERS FOR MEASURING SOLAR RADIATION, CHARGE CONTROLLERS, DC/AC INVERTERS, PHOTOVOLTAIC DISTRIBUTION PANELS, ELECTRONIC CONTROL CONSOLES USED FOR ROTATING SOLAR PANELS TO FOLLOW THE PATH OF THE SUN EAST TO WEST; AND WIRES, TRANSFORMERS AND CIRCUIT BREAKERS ASSOCIATED WITH THE AFORESAID (U.S. CLS. 21, 23, 26, 36 AND 38).

BARBARA A. LOUGHRAN, EXAMINING ATTORNEY

SN 78-493,765. THOMPSON, DANIEL S., SAN RAFAEL, CA.
FILED 10-4-2004.

SN 78-493,904. DA-VIZHEN RECORDS, INC., CHICAGO, IL.
FILED 10-4-2004.



Phloatovoltaics

THE MARK CONSISTS OF STANDARD CHARACTERS WITHOUT CLAIM TO ANY PARTICULAR FONT, STYLE, SIZE, OR COLOR.

CLASS 6—METAL GOODS

FOR SINGLE DESIGN FRAME AND MOUNTING SYSTEM FOR FLOATING BUOYANT PHOTOVOLTAIC SOLAR POWER STATIONS, NAMELY, METAL STANCHIONS AND CURTAINWALLS FOR MOUNTING SOLAR PANELS TO ROOFS (U.S. CLS. 2, 12, 13, 14, 23, 25 AND 50).

CLASS 7—MACHINERY

FOR FLOAT MOUNTED CENTRIFUGAL PUMPS FOR WATER DISPLACEMENT IN FLOATING BUOYANT PHOTOVOLTAIC SOLAR POWER STATIONS (U.S. CLS. 13, 19, 21, 23, 31, 34 AND 35).

CLASS 9—ELECTRICAL AND SCIENTIFIC APPARATUS

FOR FLOATING BUOYANT PHOTOVOLTAIC SOLAR POWER STATIONS AND SYSTEMS COMPRISED OF PHOTOVOLTAIC SOLAR MODULES AND PHOTOVOLTAIC SOLAR-THERMAL HYBRID MODULES FOR CONVERTING ELECTRONIC RADIATION TO ELECTRICAL ENERGY; PHOTOVOLTAIC CLADDING PANELS FOR CONVERTING ELECTRONIC RADIATION TO ELECTRICAL ENERGY; ELECTRIC CURRENT COLLECTORS AND PHOTOVOLTAIC COLLECTION PANELS AND PHOTOVOLTAIC CELLS FOR THE COLLECTION AND STORAGE OF SOLAR GENERATED ELECTRIC POWER; BUOYANCY COMPENSATORS TO SUPPORT SOLAR ARRAYS; AND EQUIPMENT FOR THE MONITORING, CONTROL AND DISTRIBUTION OF SOLAR GENERATED ELECTRIC POWER, NAMELY, ELECTRONIC SENSORS AND DIGITAL ELECTRIC METERS FOR MEASURING SOLAR RADIATION, CHARGE CONTROLLERS, DC/AC INVERTERS, PHOTOVOLTAIC DISTRIBUTION PANELS, ELECTRONIC CONTROL CONSOLES USED FOR ROTATING SOLAR PANELS TO FOLLOW THE PATH OF THE SUN EAST TO WEST; AND WIRES, TRANSFORMERS AND CIRCUIT BREAKERS ASSOCIATED WITH THE AFORESAID (U.S. CLS. 21, 23, 26, 36 AND 38).

BARBARA A. LOUGHRAN, EXAMINING ATTORNEY

NO CLAIM IS MADE TO THE EXCLUSIVE RIGHT TO USE "RECORDS", APART FROM THE MARK AS SHOWN.

THE MARK CONSISTS OF THE WORDS "DA-VIZHEN RECORDS" IN STYLIZED FORM, WITH THREE PHOTOGRAPHIC IMAGES OF HUMAN EYES, ONE ON TOP OF THE OTHER.

CLASS 9—ELECTRICAL AND SCIENTIFIC APPARATUS

FOR AUDIO RECORDINGS FEATURING MUSIC (U.S. CLS. 21, 23, 26, 36 AND 38).

CLASS 41—EDUCATION AND ENTERTAINMENT

FOR ENTERTAINMENT, NAMELY LIVE MUSIC CONCERTS (U.S. CLS. 100, 101 AND 107).
JOHN WILKE, EXAMINING ATTORNEY

SN 78-494,466. AKZO NOBEL COATINGS INTERNATIONAL B.V., ARNHEM, NETHERLANDS, FILED 10-5-2004.

WANDA

THE MARK CONSISTS OF STANDARD CHARACTERS WITHOUT CLAIM TO ANY PARTICULAR FONT, STYLE, SIZE, OR COLOR.

CLASS 2—PAINTS

FOR COATINGS, PAINTS, VARNISHES, LACQUERS, PAINT PRIMERS, THINNERS FOR PAINTS, THICKENERS FOR PAINTS, PRESERVATIVE COATINGS AGAINST RUST, AND COLORING MATERIALS, NAMELY, DYES, DYESTUFFS, MORDANT DYES, ALL FOR USE IN THE MANUFACTURING AND REPAIR OF VEHICLES; NATURAL RESINS FOR INDUSTRIAL USE IN THE MANUFACTURING AND REPAIR OF VEHICLES, METALS IN FOIL AND POWDER FORM FOR PAINTERS AND DECORATORS FOR USE IN THE MANUFACTURING AND REPAIR OF VEHICLES (U.S. CLS. 6, 11 AND 16).

CLASS 3—COSMETICS AND CLEANING PREPARATIONS

FOR BLEACHING PREPARATIONS FOR LAUNDRY USE; GENERAL CLEANING, POLISHING, SCOURING AND ABRASIVE PREPARATIONS FOR USE IN AUTOMOTIVE MANUFACTURING AND REPAIR INDUSTRY (U.S. CLS. 1, 4, 6, 50, 51 AND 52).

CLASS 17—RUBBER GOODS

FOR PUTTIES AND CAULKING FOR USE IN THE AUTOMOTIVE MANUFACTURING AND REPAIR INDUSTRY (U.S. CLS. 1, 5, 12, 13, 35 AND 50).
DAYNA BROWNE, EXAMINING ATTORNEY

SN 78-494,556. DEVELOPMENT GATEWAY FOUNDATION, INC., WASHINGTON, DC. FILED 10-5-2004.

Development Gateway

THE MARK CONSISTS OF STANDARD CHARACTERS WITHOUT CLAIM TO ANY PARTICULAR FONT, STYLE, SIZE, OR COLOR.

NO CLAIM IS MADE TO THE EXCLUSIVE RIGHT TO USE "DEVELOPMENT", APART FROM THE MARK AS SHOWN.

SN 78-494,541. DEVELOPMENT GATEWAY FOUNDATION, INC., WASHINGTON, DC. FILED 10-5-2004.

CLASS 9—ELECTRICAL AND SCIENTIFIC APPARATUS

FOR COMPUTER SOFTWARE, NAMELY, SOFTWARE PROVIDING APPLICATIONS FOR MANAGEMENT OF INFORMATION RELATED GLOBAL, NATIONAL, REGIONAL AND LOCAL DEVELOPMENT ACTIVITIES AIMED AT REDUCING POVERTY AND FOR USE IN THE MANAGEMENT OF GOVERNMENT AND OTHER PROCUREMENT OPPORTUNITIES AND ACTIVITIES (U.S. CLS. 21, 23, 26, 36 AND 38).

CLASS 16—PAPER GOODS AND PRINTED MATTER

FOR PRINTED MATERIALS, NAMELY, BOOKS, PAMPHLETS AND BROCHURES PROVIDING INFORMATION ABOUT PROGRAMS AND SERVICES AS THEY RELATE TO GLOBAL, NATIONAL, REGIONAL AND LOCAL DEVELOPMENT ACTIVITIES AIMED AT REDUCING POVERTY (U.S. CLS. 2, 5, 22, 23, 29, 37, 38 AND 50).

BRENDAN REGAN, EXAMINING ATTORNEY



NO CLAIM IS MADE TO THE EXCLUSIVE RIGHT TO USE "DEVELOPMENT", APART FROM THE MARK AS SHOWN.

CLASS 9—ELECTRICAL AND SCIENTIFIC APPARATUS

FOR COMPUTER SOFTWARE, NAMELY, SOFTWARE PROVIDING APPLICATIONS FOR MANAGEMENT OF INFORMATION RELATED GLOBAL, NATIONAL, REGIONAL AND LOCAL DEVELOPMENT ACTIVITIES AIMED AT REDUCING POVERTY AND FOR USE IN THE MANAGEMENT OF GOVERNMENT AND OTHER PROCUREMENT OPPORTUNITIES AND ACTIVITIES (U.S. CLS. 21, 23, 26, 36 AND 38).

CLASS 16—PAPER GOODS AND PRINTED MATTER

FOR PRINTED MATERIALS, NAMELY, BOOKS, PAMPHLETS AND BROCHURES PROVIDING INFORMATION ABOUT PROGRAMS AND SERVICES AS THEY RELATE TO GLOBAL, NATIONAL, REGIONAL AND LOCAL DEVELOPMENT ACTIVITIES AIMED AT REDUCING POVERTY (U.S. CLS. 2, 5, 22, 23, 29, 37, 38 AND 50).

BRENDAN REGAN, EXAMINING ATTORNEY

SN 78-494,566. DEVELOPMENT GATEWAY FOUNDATION, INC., WASHINGTON, DC. FILED 10-5-2004.

Development Gateway

THE MARK CONSISTS OF STANDARD CHARACTERS WITHOUT CLAIM TO ANY PARTICULAR FONT, STYLE, SIZE, OR COLOR.

NO CLAIM IS MADE TO THE EXCLUSIVE RIGHT TO USE "DEVELOPMENT", APART FROM THE MARK AS SHOWN.

CLASS 35—ADVERTISING AND BUSINESS

FOR ELECTRONIC TECHNOLOGY SERVICES, NAMELY, PROVIDING A PORTAL ON A GLOBAL COMPUTER NETWORK MAKING AVAILABLE GLOBAL, NATIONAL, REGIONAL AND LOCAL INFORMATION RELATED TO DEVELOPMENT ACTIVITIES AIMED AT REDUCING POVERTY (U.S. CLS. 100, 101 AND 102).

FIRST USE 10-1-2000; IN COMMERCE 10-1-2000.

CLASS 36—INSURANCE AND FINANCIAL

FOR FINANCIAL SERVICES, NAMELY, PROVIDING A GRANT PROGRAM FOR THE USE OF INFORMATION TECHNOLOGY IN THE FIELD OF DEVELOPMENT AND REDUCTION OF POVERTY (U.S. CLS. 100, 101 AND 102).

FIRST USE 8-1-2002; IN COMMERCE 8-1-2002.

CLASS 41—EDUCATION AND ENTERTAINMENT

FOR EDUCATION SERVICES, NAMELY, PROVIDING RESEARCH AND TRAINING CENTERS IN AFRICA AND ASIA FOR THE PURPOSE OF EDUCATION IN THE USE OF INFORMATION TECHNOLOGY IN THE FIELD OF DEVELOPMENT AND REDUCTION OF POVERTY (U.S. CLS. 100, 101 AND 107).

FIRST USE 9-1-2002; IN COMMERCE 9-1-2002.
BRENDAN REGAN, EXAMINING ATTORNEY

SN 78-494,660. MARINE RESOURCES GROUP, INC., SEATTLE, WA. FILED 10-5-2004.



NO CLAIM IS MADE TO THE EXCLUSIVE RIGHT TO USE "MARINE RESOURCES GROUP", APART FROM THE MARK AS SHOWN.

CLASS 37—CONSTRUCTION AND REPAIR

FOR GENERAL REPAIR AND MAINTENANCE OF VESSELS; SHIP FUELING SERVICES (U.S. CLS. 100, 103 AND 106).

FIRST USE 8-27-2004; IN COMMERCE 9-23-2004.

CLASS 39—TRANSPORTATION AND STORAGE

FOR TRANSPORT BY TUGBOAT AND BARGE SHIP ASSIST SERVICES, SHIP BUNKERING SERVICES, SHIP RESCUE SERVICES, VESSEL LINE HANDLING SERVICES, VESSEL SALVAGE AND NAVAL SHIPYARD SERVICES (U.S. CLS. 100 AND 105).

FIRST USE 8-27-2004; IN COMMERCE 9-23-2004.
MARK SPARACINO, EXAMINING ATTORNEY

SN 78-494,597. BOEING MANAGEMENT COMPANY, SEAL BEACH, CA. FILED 10-5-2004.

SN 78-494,747. MOONLIGHT BASIN RANCH, ENNIS, MT. FILED 10-5-2004.

SONIC CRUISER

THE MARK CONSISTS OF STANDARD CHARACTERS WITHOUT CLAIM TO ANY PARTICULAR FONT, STYLE, SIZE, OR COLOR.

NO CLAIM IS MADE TO THE EXCLUSIVE RIGHT TO USE "SONIC", APART FROM THE MARK AS SHOWN.

CLASS 12—VEHICLES

FOR AIRCRAFT AND AIRCRAFT STRUCTURAL PARTS (U.S. CLS. 19, 21, 23, 31, 35 AND 44).

CLASS 14—JEWELRY

FOR CLOCKS AND WATCHES (U.S. CLS. 2, 27, 28 AND 50).

CLASS 18—LEATHER GOODS

FOR LUGGAGE (U.S. CLS. 1, 2, 3, 22 AND 41).
CAROLINE WOOD, EXAMINING ATTORNEY

**THE CLUB AT
MOONLIGHT**

THE MARK CONSISTS OF STANDARD CHARACTERS WITHOUT CLAIM TO ANY PARTICULAR FONT, STYLE, SIZE, OR COLOR.

OWNER OF U.S. REG. NOS. 1,869,974 AND 2,011,576.
NO CLAIM IS MADE TO THE EXCLUSIVE RIGHT TO USE "CLUB", APART FROM THE MARK AS SHOWN.

CLASS 35—ADVERTISING AND BUSINESS

FOR RETAIL STORE SERVICES, NAMELY, A PRO SHOP FEATURING SPORTING GOODS, GOLF EQUIPMENT AND GOLF APPAREL (U.S. CLS. 100, 101 AND 102).

CLASS 41—EDUCATION AND ENTERTAINMENT

FOR GOLF CLUB SERVICES (U.S. CLS. 100, 101 AND 107).
CARRIE ACHEN, EXAMINING ATTORNEY

SN 78-494,752. GRAF & MARC MARKETING AND DESIGN CORP, MIAMI LAKES, FL. FILED 10-5-2004.



NO CLAIM IS MADE TO THE EXCLUSIVE RIGHT TO USE "IRREGULAR VERBS" AND "VERBOS IRREGULARES", APART FROM THE MARK AS SHOWN.

THE COLOR(S) BLUE, ORANGE AND YELLOW IS/ARE CLAIMED AS A FEATURE OF THE MARK.

THE COLOR BLUE APPEARS IN THE MARK IN A DOTTED ARROW AND IN THE WORDING "FLIP TO LEARN," "IRREGULAR VERBS" AND "VERBOS IRREGULARES," THE WORDING "TO" IN THE PHRASE "FLIP TO LEARN," IS SURROUNDED BY A BLUE OVAL. ALL WORDING APPEARS ON A RECTANGULAR BACKGROUND, THE TOP HALF OF WHICH IS YELLOW AND THE BOTTOM HALF IS ORANGE.

THE ENGLISH TRANSLATION OF THE WORDING "VERBOS IRREGULARES" IS "IRREGULAR VERBS."

CLASS 9—ELECTRICAL AND SCIENTIFIC APPARATUS

FOR EDUCATIONAL SOFTWARE FEATURING INSTRUCTION IN THE SPELLING AND PRONUNCIATION OF IRREGULAR VERBS (U.S. CLS. 21, 23, 26, 36 AND 38).

CLASS 16—PAPER GOODS AND PRINTED MATTER

FOR EDUCATIONAL FLASHCARDS, NAMELY 2" X 3" FLASHCARDS FEATURING THE MOST COMMONLY USED IRREGULAR VERBS (U.S. CLS. 2, 5, 22, 23, 29, 37, 38 AND 50).

KATRINA EDGE, EXAMINING ATTORNEY

SN 78-494,942. THE KROGER CO. OF MICHIGAN, LIVONIA, MI. FILED 10-5-2004.

**FIRST CHOICE YOUR
CHOICE FOR
SUPERIOR VALUE**

THE MARK CONSISTS OF STANDARD CHARACTERS WITHOUT CLAIM TO ANY PARTICULAR FONT, STYLE, SIZE, OR COLOR.

CLASS 29—MEATS AND PROCESSED FOODS

FOR POTATO SALADS (U.S. CL. 46).
FIRST USE 12-0-2001; IN COMMERCE 12-0-2001.

CLASS 30—STAPLE FOODS

FOR MACARONI SALADS (U.S. CL. 46).
FIRST USE 12-0-2001; IN COMMERCE 12-0-2001.
WON TEAK OH, EXAMINING ATTORNEY

SN 78-494,985. CAPOTE, YENNIER, MIAMI, FL. FILED 10-5-2004.



THE COLOR(S) RED, BLACK AND GREEN IS/ARE CLAIMED AS A FEATURE OF THE MARK.

THE MARK CONSISTS OF RED AND BLACK SLASH W/ NAME IN GREEN ON TOP RED AND BLACK SPLASH W/ THE NAME ABOVE RED AND BLACK SPLASH W/ NAME ON TOP.

CLASS 16—PAPER GOODS AND PRINTED MATTER

FOR MAGAZINES ON RELIGION AND WORSHIP (U.S. CLS. 2, 5, 22, 23, 29, 37, 38 AND 50).

CLASS 25—CLOTHING

FOR CLOTHING, NAMELY, HATS, SHIRTS, PANTS, JACKETS, AND COATS (U.S. CLS. 22 AND 39).

CLASS 34—SMOKERS' ARTICLES

FOR TOBACCO (U.S. CLS. 2, 8, 9 AND 17).

CLASS 41—EDUCATION AND ENTERTAINMENT

FOR ENTERTAINMENT SERVICES, NAMELY, TELEVISION PROGRAM ON RELIGIOUS TOPICS AND PROVIDING A WEBSITE FOR RELIGIOUS INSTRUCTION AND TRAINING (U.S. CLS. 100, 101 AND 107).

JOHN E. MICHOS, EXAMINING ATTORNEY

SN 78-495,004. TC LICENSE, LTD, HUMMELSTOWN, PA.
FILED 10-5-2004.

SN 78-495,331. MULTINATIONAL UNDERWRITERS, INC.,
INDIANAPOLIS, IN. FILED 10-6-2004.

TAGTELLER HELPLINK

THE MARK CONSISTS OF STANDARD CHARACTERS WITHOUT CLAIM TO ANY PARTICULAR FONT, STYLE, SIZE, OR COLOR.

CLASS 35—ADVERTISING AND BUSINESS

FOR CUSTOMER SERVICES IN THE FIELD OF TRANSPORTATION; INTERACTIVE CUSTOMER SERVICES IN THE FIELD OF TRANSPORTATION ACCESSIBLE FROM REMOTE LOCATIONS (U.S. CLS. 100, 101 AND 102).

CLASS 36—INSURANCE AND FINANCIAL

FOR ELECTRONIC PAYMENT SERVICES, NAMELY, ELECTRONIC PROCESSING AND TRANSMISSION OF BILL PAYMENT DATA; PROVIDING ELECTRONIC PAYMENT SERVICES THROUGH INTERACTIVE CUSTOMER SERVICE ACCESSIBLE FROM REMOTE LOCATIONS BY MEANS OF A CUSTOMER OPERATED ELECTRONIC TERMINAL (U.S. CLS. 100, 101 AND 102).
ROBERT LORENZO, EXAMINING ATTORNEY

SN 78-495,321. MULTINATIONAL UNDERWRITERS, INC.,
INDIANAPOLIS, IN. FILED 10-6-2004.

MULTINATIONAL UNDERWRITERS

THE MARK CONSISTS OF STANDARD CHARACTERS WITHOUT CLAIM TO ANY PARTICULAR FONT, STYLE, SIZE, OR COLOR.

NO CLAIM IS MADE TO THE EXCLUSIVE RIGHT TO USE "UNDERWRITERS", APART FROM THE MARK AS SHOWN.

SEC. 2(F).

CLASS 36—INSURANCE AND FINANCIAL

FOR UNDERWRITING AND ADMINISTERING TRAVEL, ACCIDENT, AND HEALTH INSURANCE SERVICES (U.S. CLS. 100, 101 AND 102).

FIRST USE 7-0-1998; IN COMMERCE 7-0-1998.

CLASS 39—TRANSPORTATION AND STORAGE

FOR PROVIDING TRAVEL TRANSPORTATION RESERVATION SERVICES AND TRAVEL INFORMATION REGARDING TRAVEL ALERTS, SAFETY ISSUES IN TRAVEL AND OTHER NEWS OF INTEREST TO TRAVELERS (U.S. CLS. 100 AND 105).

FIRST USE 7-0-1998; IN COMMERCE 7-0-1998.

KARANENDRA S. CHHINA, EXAMINING ATTORNEY

MNUI

THE MARK CONSISTS OF STANDARD CHARACTERS WITHOUT CLAIM TO ANY PARTICULAR FONT, STYLE, SIZE, OR COLOR.

CLASS 36—INSURANCE AND FINANCIAL

FOR UNDERWRITING AND ADMINISTERING TRAVEL, ACCIDENT, AND HEALTH INSURANCE SERVICES (U.S. CLS. 100, 101 AND 102).

FIRST USE 4-0-1999; IN COMMERCE 4-0-1999.

CLASS 39—TRANSPORTATION AND STORAGE

FOR PROVIDING TRAVEL TRANSPORTATION RESERVATION SERVICES AND TRAVEL INFORMATION REGARDING TRAVEL ALERTS, SAFETY ISSUES IN TRAVEL AND OTHER NEWS OF INTEREST TO TRAVELERS (U.S. CLS. 100 AND 105).

FIRST USE 4-0-1999; IN COMMERCE 4-0-1999.

KARANENDRA S. CHHINA, EXAMINING ATTORNEY

SN 78-495,524. MOON, JUNG W, LOS ANGELES, CA. FILED
10-6-2004.

DR. SALT

THE MARK CONSISTS OF STANDARD CHARACTERS WITHOUT CLAIM TO ANY PARTICULAR FONT, STYLE, SIZE, OR COLOR.

CLASS 3—COSMETICS AND CLEANING PREPARATIONS

FOR BEAUTY AND COSMETIC PRODUCTS, NAMELY, HAND SOAPS, BATH SOAPS, SHOWER SOAPS AND GELS, BUBBLE BATH, SHAMPOO (U.S. CLS. 1, 4, 6, 50, 51 AND 52).

FIRST USE 7-18-2002; IN COMMERCE 7-17-2003.

CLASS 30—STAPLE FOODS

FOR SALT FOR FOOD AND COOKING PURPOSES (U.S. CL. 46).

FIRST USE 7-18-2002; IN COMMERCE 7-17-2003.

HEATHER THOMPSON, EXAMINING ATTORNEY

SN 78-495,667. AMERICAN HOTEL REGISTER COMPANY,
VERNON HILLS, IL. FILED 10-6-2004.

SN 78-495,697. ZOHNI, TAREK, BROOKLYN, NY. FILED 10-
6-2004.



AMERICAN HOTEL REGISTER COMPANY

THE MARK CONSISTS OF STANDARD CHARACTERS WITHOUT CLAIM TO ANY PARTICULAR FONT, STYLE, SIZE, OR COLOR.

OWNER OF U.S. REG. NOS. 1,317,352 AND 2,862,118.

NO CLAIM IS MADE TO THE EXCLUSIVE RIGHT TO USE "COMPANY", APART FROM THE MARK AS SHOWN. SEC. 2(F) AS TO AMERICAN HOTEL REGISTER.

CLASS 35—ADVERTISING AND BUSINESS

FOR DIRECT MAIL ORDER SERVICES FEATURING A WIDE VARIETY OF HOTEL AND HOSPITALITY SUPPLIES AND FURNISHINGS; ELECTRONIC CATALOG SERVICES FEATURING A WIDE VARIETY OF HOTEL AND HOSPITALITY SUPPLIES AND FURNISHINGS; MAIL ORDER CATALOG SERVICES FEATURING A WIDE VARIETY OF HOTEL AND HOSPITALITY SUPPLIES AND FURNISHINGS; ON-LINE ORDERING SERVICES FEATURING A WIDE VARIETY OF HOTEL AND HOSPITALITY SUPPLIES AND FURNISHINGS; PROCUREMENT, NAMELY, PURCHASING A WIDE VARIETY OF HOTEL AND HOSPITALITY SUPPLIES AND FURNISHINGS FOR OTHERS; WHOLESALE DISTRIBUTORSHIPS FEATURING A WIDE VARIETY OF HOTEL AND HOSPITALITY SUPPLIES AND FURNISHINGS; WHOLESALE ORDERING SERVICES IN THE FIELD OF THE HOTEL AND HOSPITALITY SUPPLIES AND FURNISHINGS TO THE HOSPITALITY, HEALTHCARE, EDUCATIONAL AND GOVERNMENTAL INSTITUTIONS (U.S. CLS. 100, 101 AND 102).

FIRST USE 0-0-1910; IN COMMERCE 0-0-1910.

CLASS 42—SCIENTIFIC, COMPUTER AND LEGAL SERVICES

FOR CONSULTING SERVICES IN THE FIELD OF INTERIOR DESIGN (U.S. CLS. 100 AND 101).

FIRST USE 12-0-1998; IN COMMERCE 12-0-1998.
ADA HAN, EXAMINING ATTORNEY

NO CLAIM IS MADE TO THE EXCLUSIVE RIGHT TO USE "HOT RODS & CHOPPERS", "CUSTOMS" AND "BROOKLYN, NEW YORK", APART FROM THE MARK AS SHOWN.

THE COLORS BLACK, WHITE, SILVER AND ORANGE ARE CLAIMED AS FEATURES OF THE MARK

THE MARK CONSISTS OF A WHITE AND BLACK SPADE DESIGN BORDERED IN SILVER AND BLACK WITH THE NUMBER 13 ON THE OUTER, BOTTOM RIGHT CORNER. INSIDE THE SPADE DESIGN THERE IS A SKULL HEAD WITH ORANGE FLAMES INSIDE THE EYES AND TWO HANDS HOLDING TWO SILVER GUNS. THE WORDS "HOT RODS & CHOPPERS" ARE THE COLOR ORANGE AND ARE ABOVE THE DESIGN; AND THE WORDING "ZONI CUSTOMS, BROOKLYN, NEW YORK", ALSO IN ORANGE, ARE BELOW THE SPADE DESIGN.

CLASS 35—ADVERTISING AND BUSINESS

FOR AUTOMOBILE AND MOTORCYCLE DEALERSHIP SERVICES; RETAIL STORE SERVICES FEATURING AUTOMOBILE AND MOTORCYCLE PARTS AND ACCESSORIES (U.S. CLS. 100, 101 AND 102).

CLASS 37—CONSTRUCTION AND REPAIR

FOR AUTOMOBILE AND MOTORCYCLE SERVICE AND REPAIR SERVICES (U.S. CLS. 100, 103 AND 106).
KEVIN DINALLO, EXAMINING ATTORNEY

SN 78-495,981. POLAROID CORPORATION, WALTHAM,
MA. FILED 10-7-2004.

ZERO INK

THE MARK CONSISTS OF STANDARD CHARACTERS WITHOUT CLAIM TO ANY PARTICULAR FONT, STYLE, SIZE, OR COLOR.

CLASS 1—CHEMICALS

FOR UNEXPOSED PHOTOGRAPHIC FILM; SENSITIZED PHOTOGRAPHIC FILM; CHEMICALS FOR USE IN PHOTOGRAPHY; CHEMICALS FOR USE IN PRINTING PAPER; PHOTOGRAPHIC PAPERS; PRINTING MATERIALS, NAMELY PHOTSENSITIVE PAPER (U.S. CLS. 1, 5, 6, 10, 26 AND 46).

SN 78-495,986. OLLYDOG LLC, BERKELY, CA. FILED 10-7-2004.

CLASS 7—MACHINERY

FOR PRINTING MACHINES; PRINTING APPARATUS, NAMELY MACHINERY AND PARTS THEREFOR USED FOR VIEWING, PROCESSING, MODIFYING, REPRODUCING, AND PRINTING IMAGES, GRAPHICS, AND PHOTOGRAPHS (U.S. CLS. 13, 19, 21, 23, 31, 34 AND 35).

NEW TRICKS**CLASS 9—ELECTRICAL AND SCIENTIFIC APPARATUS**

FOR PRINTERS; PRINTING TECHNOLOGY FOR VIEWING, PROCESSING, MODIFYING, REPRODUCING, AND PRINTING IMAGES, GRAPHICS, AND PHOTOGRAPHS, NAMELY APPARATUS FOR TRANSMITTING AND REPRODUCING IMAGES, COMPUTERS, HANDHELD COMPUTERS, PERSONAL DIGITAL ASSISTANTS, COMPUTER PERIPHERALS, COLOR PRINTERS, ID CARD PRINTERS, LABEL PRINTERS, WIRELESS COMPUTER PERIPHERALS, FACSIMILE APPARATUS, SOFTWARE, COMPUTER MONITORS, LCD MONITORS, TELEVISION MONITORS, VIDEO MONITORS, TELEVISIONS, PRINTER CABLES, AND RASTER IMAGE PROCESSORS; DIGITAL IMAGING DEVICES FOR VIEWING, PROCESSING, MODIFYING, REPRODUCING, AND PRINTING IMAGES, GRAPHICS, AND PHOTOGRAPHS, NAMELY APPARATUS FOR TRANSMITTING AND REPRODUCING IMAGES, COMPUTERS, HANDHELD COMPUTERS, PERSONAL DIGITAL ASSISTANTS, COMPUTER PERIPHERALS, COLOR PRINTERS, ID CARD PRINTERS, LABEL PRINTERS, WIRELESS COMPUTER PERIPHERALS, FACSIMILE APPARATUS, CAMERAS, DIGITAL CAMERAS, COMPUTER CAMERAS, CAMCORDERS, DIGITAL VIDEO RECORDERS, DVD MACHINES, COMPUTER MONITORS, LCD MONITORS, TELEVISION MONITORS, VIDEO MONITORS, TELEVISIONS, SCANNERS, OPTICAL SCANNERS, SOFTWARE, CELLULAR PHONES WITH A CAMERA FUNCTION, CELLULAR PHONE DOCKING STATIONS, BLANK COMPUTER DISKS AND CD-ROMS, COMPUTER MEMORY HARDWARE, MEMORY CARDS, AND BLANK MAGNETIC DATA CARRIERS (U.S. CLS. 21, 23, 26, 36 AND 38).

THE MARK CONSISTS OF STANDARD CHARACTERS WITHOUT CLAIM TO ANY PARTICULAR FONT, STYLE, SIZE, OR COLOR.

CLASS 18—LEATHER GOODS

FOR DOG ACCESSORIES, NAMELY, COLLARS, LEASHES, AND HARNESES; DOG BACKPACKS; DOG CLOTHING; PROTECTIVE GARMENTS FOR DOGS, NAMELY, BOOTIES, HARNESS JACKETS AND HARNESS VESTS (U.S. CLS. 1, 2, 3, 22 AND 41).

CLASS 20—FURNITURE AND ARTICLES NOT OTHERWISE CLASSIFIED

FOR DOG BEDS (U.S. CLS. 2, 13, 22, 25, 32 AND 50).

CLASS 21—HOUSEWARES AND GLASS

FOR COLLAPSIBLE AND NON-COLLAPSIBLE DOG BOWLS (U.S. CLS. 2, 13, 23, 29, 30, 33, 40 AND 50).
ODESSA BIBBINS, EXAMINING ATTORNEY

CLASS 16—PAPER GOODS AND PRINTED MATTER

FOR PRINTING PAPER; PRINTING MATERIALS, NAMELY DIGITAL PRINTING PAPER, PHOTOGRAPHS, PRINTS, LABEL PAPER, PAPER TAGS, PRINTED TICKETS, ID CARDS WITHOUT MAGNETIC ENCODING, AND PLASTIC SHEETS FOR PRINTING; PHOTOGRAPHIC PRINTS; PHOTO SHEETS, NAMELY PHOTOGRAPHIC PRINTS IN THE NATURE OF PHOTO SHEETS (U.S. CLS. 2, 5, 22, 23, 29, 37, 38 AND 50).

SN 78-496,153. JOHNNY LINDY COMPANY, DBA VIN DI BONA PRODUCTIONS, LOS ANGELES, CA. FILED 10-7-2004.

CLASS 40—MATERIAL TREATMENT

FOR PRINTING SERVICES; DIGITAL IMAGING SERVICES (U.S. CLS. 100, 103 AND 106).

CLASS 41—EDUCATION AND ENTERTAINMENT

FOR PHOTOGRAPHY SERVICES (U.S. CLS. 100, 101 AND 107).
ZACHARY BELLO, EXAMINING ATTORNEY

NO CLAIM IS MADE TO THE EXCLUSIVE RIGHT TO USE "COMEDY REALITY TELEVISION NETWORK", APART FROM THE MARK AS SHOWN.

THE COLORS YELLOW, BEIGE, WHITE, AND BLACK ARE CLAIMED AS A FEATURE OF THE MARK.

THE COLOR YELLOW APPEARS IN THE SKIN OF THE BANANA DESIGN, THE COLOR BEIGE APPEARS IN THE INNER PORTION OF THE BANANA DESIGN, THE COLOR WHITE APPEARS IN THE EYES AND TEETH OF THE BANANA DESIGN, AND THE COLOR BLACK APPEARS IN THE LETTERING AND THE LINING OF THE BANANA DESIGN.



CLASS 9—ELECTRICAL AND SCIENTIFIC APPARATUS

FOR MOTION PICTURE FILMS, PRE-RECORDED VIDEO TAPES, PRE-RECORDED VIDEO CASSETTES, PRE-RECORDED VIDEO DISCS, PRE-RECORDED DIGITAL VIDEO DISCS, AND PRE-RECORDED COMPACT DISCS. ALL FEATURING UNSCRIPTED AND SCRIPTED COMEDY AND/OR REALITY-THEMED PROGRAMMING (U.S. CLS. 21, 23, 26, 36 AND 38).

CLASS 38—COMMUNICATION

FOR TELEVISION AND CABLE TELEVISION BROADCASTING SERVICES; BROADCASTING PROGRAMS VIA A GLOBAL COMPUTER NETWORK; SATELLITE TELEVISION BROADCASTING (U.S. CLS. 100, 101 AND 104).

CLASS 41—EDUCATION AND ENTERTAINMENT

FOR PRODUCTION OF TELEVISION PROGRAMS; ENTERTAINMENT SERVICES, NAMELY PRODUCTION OF MOTION PICTURE FILMS AND TELEVISION PROGRAMS, SERIES AND SEGMENTS FEATURING DRAMA, COMEDY, REALITY AND/OR DOCUMENTARY; PRODUCTION OF PRE-RECORDED VIDEO TAPES, DIGITAL VIDEO DISCS AND COMPACT DISCS; PROVIDING ENTERTAINMENT AND INFORMATION IN THE FIELD OF ENTERTAINMENT VIA A GLOBAL COMPUTER NETWORK; DISTRIBUTION FOR OTHERS OF MOTION PICTURE FILMS; ENTERTAINMENT IN THE NATURE OF ON-GOING TELEVISION PROGRAMS AND/OR SPECIALS IN THE FIELD OF VARIETY; ENTERTAINMENT SERVICES, NAMELY A TELEVISION SERIES IN THE FIELD OF COMEDY (U.S. CLS. 100, 101 AND 107).
SUNG IN, EXAMINING ATTORNEY

CLASS 11—ENVIRONMENTAL CONTROL APPARATUS

FOR APPARATUS FOR WATER SUPPLY AND SANITARY PURPOSES, NAMELY FAUCETS, SHOWERS AND BATH TUBS (U.S. CLS. 13, 21, 23, 31 AND 34).

CLASS 20—FURNITURE AND ARTICLES NOT OTHERWISE CLASSIFIED

FOR FURNITURE; METAL RACKS FOR CUPS AND PLATES (U.S. CLS. 2, 13, 22, 25, 32 AND 50).
DANIEL BRODY, EXAMINING ATTORNEY

SN 78-496,180. LAFLAMME, DAVID G., SHERMAN OAKS, CA. FILED 10-7-2004.

SN 78-496,155. EASTWEST INTERNATIONAL (TAIWAN) ENTERPRISES, TAICHUNG, TAIWAN, FILED 10-7-2004.

It's A Beautiful Day

METALAB

THE MARK CONSISTS OF STANDARD CHARACTERS WITHOUT CLAIM TO ANY PARTICULAR FONT, STYLE, SIZE, OR COLOR.

CLASS 9—ELECTRICAL AND SCIENTIFIC APPARATUS

FOR MUSICAL SOUND RECORDINGS AND MUSICAL VIDEO RECORDINGS (U.S. CLS. 21, 23, 26, 36 AND 38).

CLASS 41—EDUCATION AND ENTERTAINMENT

FOR ENTERTAINMENT IN THE NATURE OF LIVE PERFORMANCES BY A MUSICAL BAND (U.S. CLS. 100, 101 AND 107).
JASON TURNER, EXAMINING ATTORNEY

THE MARK CONSISTS OF STANDARD CHARACTERS WITHOUT CLAIM TO ANY PARTICULAR FONT, STYLE, SIZE, OR COLOR.

OWNER OF U.S. REG. NO. 2,261,546.

CLASS 6—METAL GOODS

FOR METAL GOODS, NAMELY PIPES, PIPE FITTINGS, HOSE FITTINGS, TUBING, AND HANDLES FOR CABINET DOORS AND DRAWERS (U.S. CLS. 2, 12, 13, 14, 23, 25 AND 50).

SN 78-496,202. BEDBUG LIGHTS, INC., ORLANDO, FL.
FILED 10-7-2004.



THE MARK CONSISTS OF DESIGN OF CHILD ON ROCKING CRADLE WITH WINDOW AND MOON ENCLOSED IN A CIRCLE.

CLASS 20—FURNITURE AND ARTICLES NOT OTHERWISE CLASSIFIED

FOR PILLOWS (U.S. CLS. 2, 13, 22, 25, 32 AND 50).

CLASS 24—FABRICS

FOR BEDDING, NAMELY, BED BLANKETS, BED COMFORTERS, BED SHEETS, PILLOW CASES, SHAMS AND DUST RUFFLES (U.S. CLS. 42 AND 50).
JOHN KELLY, EXAMINING ATTORNEY

SN 78-496,211. GOSMILE, INC., NEW YORK, NY. FILED 10-7-2004.

**ELEVATING ORAL
CARE TO
SMILEBEAUTY**

THE MARK CONSISTS OF STANDARD CHARACTERS WITHOUT CLAIM TO ANY PARTICULAR FONT, STYLE, SIZE, OR COLOR.

CLASS 3—COSMETICS AND CLEANING PREPARATIONS

FOR PRODUCTS FOR THE CARE AND TREATMENT OF THE TEETH, LIPS AND BREATH, NAMELY MOUTH RINSE IN A SPRAY DEVICE, MOUTHWASH, TOOTH-PASTE, LIP BALM, AND TOOTH WHITENERS COMPRISED OF PEROXIDE GELS (U.S. CLS. 1, 4, 6, 50, 51 AND 52).

CLASS 5—PHARMACEUTICALS

FOR MEDICATED DENTAL FLOSS, THROAT LOZENGES AND MEDICATED LIP BALM (U.S. CLS. 6, 18, 44, 46, 51 AND 52).

CLASS 21—HOUSEWARES AND GLASS

FOR TOOTHBRUSHES AND DENTAL FLOSS (U.S. CLS. 2, 13, 23, 29, 30, 33, 40 AND 50).

CLASS 30—STAPLE FOODS

FOR BREATH MINTS (U.S. CL. 46).

CLASS 35—ADVERTISING AND BUSINESS

FOR WHOLESALE AND RETAIL STORE SERVICES FEATURING ORAL CARE PRODUCTS (U.S. CLS. 100, 101 AND 102).
GENE MACIOL, EXAMINING ATTORNEY

SN 78-496,242. SIERRA HEALTHSTYLES LLC, TUCSON, AZ.
FILED 10-7-2004.

LIFE IN BALANCE

THE MARK CONSISTS OF STANDARD CHARACTERS WITHOUT CLAIM TO ANY PARTICULAR FONT, STYLE, SIZE, OR COLOR.

OWNER OF U.S. REG. NOS. 2,114,500 AND 2,114,511.

CLASS 41—EDUCATION AND ENTERTAINMENT

FOR CONDUCTING WORKSHOPS, SEMINARS AND LECTURES IN THE FIELDS OF STRESS MANAGEMENT, SELF DISCOVERY, THE HEALTH AND WELLNESS OF THE BODY, MIND AND SPIRIT, FITNESS, NUTRITION, COOKING, WELLNESS, SEXUALITY, VITALITY, WOMEN'S HEALTH AND MOTHERHOOD, MOVEMENT, PERSONAL GROWTH, HEALING, YOGA, ADVENTURE, MEDITATION, ASTRONOMY, NATIVE AMERICAN CULTURE, BIKING, PHOTOGRAPHY, SWIMMING, GOLF, TENNIS, AND HORSE RIDING, AND DISTRIBUTING COURSE MATERIALS IN CONNECTION THEREWITH; PROVIDING FACILITIES FOR FITNESS AND EXERCISE, AND FOR RECREATION ACTIVITIES IN THE NATURE OF TENNIS AND AQUATIC FACILITIES, HORSE RIDING, COUNTRY CLUB AND HEALTH CLUB FACILITIES; PHYSICAL FITNESS INSTRUCTION AND CONSULTATION (U.S. CLS. 100, 101 AND 107).

FIRST USE 10-0-1995; IN COMMERCE 10-0-1995.

CLASS 43—HOTEL AND RESTAURANT SERVICES

FOR RESORT HOTELS AND LODGING, RESTAURANT AND BAR SERVICES (U.S. CLS. 100 AND 101).

FIRST USE 7-19-1995; IN COMMERCE 7-19-1995.
JENNIFER CHICOSKI, EXAMINING ATTORNEY

SN 78-496,351. FOOD CONCEPTS INTERNATIONAL, LLC,
HENDERSON, NV. FILED 10-7-2004.

CLASS 41—EDUCATION AND ENTERTAINMENT

FOR EDUCATIONAL SERVICES, NAMELY CONDUCTING CONFERENCES, SEMINARS, WORKSHOPS, INTERACTIVE INTERNET COURSES, AND CLASSES IN THE FIELD OF ORTHOPAEDIC SURGICAL TECHNIQUES (U.S. CLS. 100, 101 AND 107).

TIMOTHY FINNEGAN, EXAMINING ATTORNEY

SENIOR SWEETS

THE MARK CONSISTS OF STANDARD CHARACTERS WITHOUT CLAIM TO ANY PARTICULAR FONT, STYLE, SIZE, OR COLOR.

NO CLAIM IS MADE TO THE EXCLUSIVE RIGHT TO USE "SWEETS", APART FROM THE MARK AS SHOWN.

SN 78-496,728. NIELSEN MEDIA RESEARCH, INC., NEW YORK, NY. FILED 10-8-2004.

CLASS 35—ADVERTISING AND BUSINESS

FOR RETAIL STORE SERVICES FEATURING ICE CREAM AND OTHER FROZEN CONFECTIONS, CANDY, BAKERY GOODS AND DESSERTS, COFFEE, TEA, DAIRY-BASED BEVERAGES, FRUIT DRINKS AND FRUIT JUICES, NON-ALCOHOLIC BEVERAGES CONTAINING FRUIT JUICES, AND NON-ALCOHOLIC BEVERAGES, NAMELY, CARBONATED BEVERAGES (U.S. CLS. 100, 101 AND 102).

CLASS 43—HOTEL AND RESTAURANT SERVICES

FOR RESTAURANT AND TAKE-OUT RESTAURANT SERVICES (U.S. CLS. 100 AND 101).

MARLENE BELL, EXAMINING ATTORNEY

PLACE*VIEWS

SN 78-496,502. ZIMMER TECHNOLOGY, INC., CHICAGO, IL. FILED 10-7-2004.

THE MARK CONSISTS OF STANDARD CHARACTERS WITHOUT CLAIM TO ANY PARTICULAR FONT, STYLE, SIZE, OR COLOR.

CLASS 35—ADVERTISING AND BUSINESS

FOR MARKET RESEARCH AND MEDIA RESEARCH SERVICES RELATING TO PRODUCT PLACEMENTS AND APPEARANCES; PROVIDING NOTIFICATION OF RESEARCH RESULTS TO SUBSCRIBERS; AND PROVIDING AN ON-LINE COMPUTER DATABASE IN THE FIELDS OF MARKET RESEARCH, MEDIA RESEARCH, AND PRODUCT PLACEMENT RESEARCH (U.S. CLS. 100, 101 AND 102).

CARE

CLASS 42—SCIENTIFIC, COMPUTER AND LEGAL SERVICES

FOR PROVIDING TEMPORARY USE OF ONLINE NON-DOWNLOADABLE SOFTWARE FOR ACCESSING, UPDATING, DOWNLOADING, VIEWING AND MANIPULATING INFORMATION FROM COMPUTER DATABASES VIA A GLOBAL COMPUTER NETWORK, DIAL-UP COMPUTER, OR OTHER COMPUTER NETWORK, IN THE FIELDS OF ADVERTISING, MEDIA RESEARCH, PRODUCT PLACEMENT, AND MARKET RESEARCH, AND GENERATING, PRINTING, AND DOWNLOADING INFORMATION AND REPORTS FROM SAID ELECTRONIC DATABASES (U.S. CLS. 100 AND 101).

GINA FINK, EXAMINING ATTORNEY

THE MARK CONSISTS OF STANDARD CHARACTERS WITHOUT CLAIM TO ANY PARTICULAR FONT, STYLE, SIZE, OR COLOR.

CLASS 16—PAPER GOODS AND PRINTED MATTER

FOR PRINTED MATERIALS, NAMELY, TRAINING MANUALS, COURSE MATERIALS, INFORMATIONAL BOOKLETS, BROCHURES AND PAMPHLETS IN THE FIELD OF ORTHOPAEDICS (U.S. CLS. 2, 5, 22, 23, 29, 37, 38 AND 50).

SN 78-497,251. DIJONN, INC., GLENDALE, AZ. FILED 10-8-2004.

SN 78-497,853. CHROMA MEDICAL SYSTEMS, INC., SAN BRUNO, CA. FILED 10-11-2004.

THE SANDMAN

THE MARK CONSISTS OF STANDARD CHARACTERS WITHOUT CLAIM TO ANY PARTICULAR FONT, STYLE, SIZE, OR COLOR.

CLASS 37—CONSTRUCTION AND REPAIR

FOR REFINISHING AND RESURFACING OF CUTTING BOARDS (U.S. CLS. 100, 103 AND 106).
FIRST USE 7-0-2002; IN COMMERCE 7-0-2002.

CLASS 40—MATERIAL TREATMENT

FOR CUSTOM MANUFACTURE OF CUTTING BOARDS (U.S. CLS. 100, 103 AND 106).
FIRST USE 7-0-2002; IN COMMERCE 7-0-2002.
ZACHARY BELLO, EXAMINING ATTORNEY

SN 78-497,318. WILD PLANET TOYS, INC., SAN FRANCISCO, CA. FILED 10-8-2004.

POLYPOINT

THE MARK CONSISTS OF STANDARD CHARACTERS WITHOUT CLAIM TO ANY PARTICULAR FONT, STYLE, SIZE, OR COLOR.

CLASS 9—ELECTRICAL AND SCIENTIFIC APPARATUS

FOR MEDICAL IMAGING SOFTWARE (U.S. CLS. 21, 23, 26, 36 AND 38).

CLASS 44—MEDICAL, BEAUTY AND AGRICULTURAL SERVICES

FOR MEDICAL IMAGING SERVICES (U.S. CLS. 100 AND 101).
GINA HAYES, EXAMINING ATTORNEY

SN 78-497,857. CHROMA MEDICAL SYSTEMS, INC., SAN BRUNO, CA. FILED 10-11-2004.

SPY SEEKER

THE MARK CONSISTS OF STANDARD CHARACTERS WITHOUT CLAIM TO ANY PARTICULAR FONT, STYLE, SIZE, OR COLOR.

CLASS 9—ELECTRICAL AND SCIENTIFIC APPARATUS

FOR TWO ELECTRONIC TRACKING PODS PAIRED WITH A HANDHELD RADAR-LIKE RECEIVING DEVICE THAT INDICATES THE POSITION OF THE USER FROM EITHER OF THE TWO TRACKING PODS (U.S. CLS. 21, 23, 26, 36 AND 38).

CLASS 28—TOYS AND SPORTING GOODS

FOR TOYS AND PLAYTHINGS, NAMELY, TWO TOY TRACKING PODS PAIRED WITH A TOY HANDHELD RADAR-LIKE DISPLAY THAT INDICATES THE DISTANCE OF THE USER FROM THE PODS (U.S. CLS. 22, 23, 38 AND 50).
DAYNA BROWN, EXAMINING ATTORNEY

VOLUMEVIEW

THE MARK CONSISTS OF STANDARD CHARACTERS WITHOUT CLAIM TO ANY PARTICULAR FONT, STYLE, SIZE, OR COLOR.

CLASS 9—ELECTRICAL AND SCIENTIFIC APPARATUS

FOR MEDICAL IMAGING SOFTWARE (U.S. CLS. 21, 23, 26, 36 AND 38).

CLASS 44—MEDICAL, BEAUTY AND AGRICULTURAL SERVICES

FOR MEDICAL IMAGING SERVICES (U.S. CLS. 100 AND 101).
GINA HAYES, EXAMINING ATTORNEY

SN 78-497,862. ELITE TEXTILE, INC., LOS ANGELES, CA.
FILED 10-11-2004.

KUCUKCALIK

THE MARK CONSISTS OF STANDARD CHARACTERS WITHOUT CLAIM TO ANY PARTICULAR FONT, STYLE, SIZE, OR COLOR.

THE FOREIGN WORDING IN THE MARK TRANSLATES INTO ENGLISH AS "LITTLE SMILE" (TURKISH).

CLASS 20—FURNITURE AND ARTICLES NOT OTHERWISE CLASSIFIED

FOR DECORATIVE PILLOWS (U.S. CLS. 2, 13, 22, 25, 32 AND 50).

CLASS 24—FABRICS

FOR DRAPERIES, CURTAINS, BATH LINENS, BED LINENS, HOUSEHOLD LINENS, TABLE LINENS, COMFORTERS, BED SHEETS, PILLOW CASES, PILLOW SHAMS, BEDSPREADS, BED LINEN SETS FEATURING COMBINATIONS OF TWO OR MORE BED SHEETS, PILLOW CASES, PILLOW SHAMS, BEDSPREADS, DECORATIVE PILLOWS, COMFORTERS, AND BED SKIRTS; FABRICS, NAMELY, CHIFFON, GEORGETTE, VISCOSE, AND POLYESTER-BLEND FABRICS, UPHOLSTERY FABRICS, CURTAIN FABRICS (U.S. CLS. 42 AND 50).

GINA HAYES, EXAMINING ATTORNEY

CLASS 41—EDUCATION AND ENTERTAINMENT

FOR ENTERTAINMENT IN THE NATURE OF VISUAL AND AUDIO PERFORMANCES, AND MUSICAL, VARIETY, NEWS AND COMEDY SHOWS; ENTERTAINMENT IN THE NATURE OF VISUAL AND AUDIO PERFORMANCES, NAMELY, MUSICAL BAND AND ROCK GROUP PERFORMANCES; ENTERTAINMENT NAMELY, PRODUCTION OF LIVE PERFORMANCES BY A MUSICAL BAND; ENTERTAINMENT SERVICES, NAMELY, PROVIDING A RADIO PROGRAM IN THE FIELD OF MUSIC VIA A GLOBAL COMPUTER NETWORK; ENTERTAINMENT SERVICES, NAMELY, PROVIDING A TELEVISION PROGRAM IN THE FIELD OF MUSIC VIA A GLOBAL COMPUTER NETWORK; ENTERTAINMENT SERVICES, NAMELY, PROVIDING A WEB SITE FEATURING MUSICAL PERFORMANCES, MUSICAL VIDEOS, RELATED FILM CLIPS, PHOTOGRAPHS, AND OTHER MULTIMEDIA MATERIALS; ENTERTAINMENT SERVICES, NAMELY, PROVIDING ON-LINE REVIEWS OF MOVIES, BOOKS, MUSIC, COMPUTER GAMES; ENTERTAINMENT SERVICES, NAMELY, PROVIDING PRERECORDED MUSIC, INFORMATION IN THE FIELD OF MUSIC, AND COMMENTARY AND ARTICLES ABOUT MUSIC, ALL ON-LINE VIA A GLOBAL COMPUTER NETWORK; ENTERTAINMENT, NAMELY LIVE PERFORMANCES BY MUSICAL BANDS; ENTERTAINMENT, NAMELY LIVE MUSIC CONCERTS; RADIO ENTERTAINMENT PRODUCTION (U.S. CLS. 100, 101 AND 107).

FIRST USE 6-24-2004; IN COMMERCE 6-24-2004.
KELLY CHOE, EXAMINING ATTORNEY

SN 78-498,350. CONSULTING INVESTMENT GROUP, LLC,
VIENNA, VA. FILED 10-12-2004.

INFORMATION TECHNOLOGY IS JUST PART OF IT

SN 78-497,968. SMOOCH, INC., ENCINO, CA. FILED 10-11-2004.

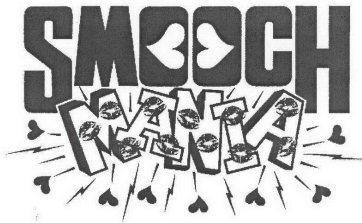

CLASS 25—CLOTHING

FOR CLOTHING FOR MEN, WOMEN AND CHILDREN, NAMELY, HATS, SHIRTS, PAJAMAS, T-SHIRTS, JERSEYS, SWEATSHIRTS, TOPS, SWEATERS, BELTS, TIES, STOCKINGS, PANTS, SHORTS, BATHING SUITS, ROBES, JUMPSUITS, JACKETS, COATS (U.S. CLS. 22 AND 39).

FIRST USE 8-15-2004; IN COMMERCE 8-15-2004.

THE MARK CONSISTS OF STANDARD CHARACTERS WITHOUT CLAIM TO ANY PARTICULAR FONT, STYLE, SIZE, OR COLOR.

CLASS 35—ADVERTISING AND BUSINESS

FOR INFORMATION TECHNOLOGY CONSULTING SERVICES, NAMELY PERSONNEL PLACEMENT AND PERSONNEL SUPPLEMENTATION, NAMELY, PROVIDING PERSONNEL ON A TEMPORARY BASIS FOR INFORMATION TECHNOLOGY SUPPORT (U.S. CLS. 100, 101 AND 102).

FIRST USE 6-20-2002; IN COMMERCE 2-15-2003.

CLASS 42—SCIENTIFIC, COMPUTER AND LEGAL SERVICES

FOR INFORMATION TECHNOLOGY CONSULTING SERVICES, NAMELY COMPUTER SYSTEMS INTEGRATION (U.S. CLS. 100 AND 101).

FIRST USE 6-20-2002; IN COMMERCE 2-15-2003.
REBECCA GAN, EXAMINING ATTORNEY

SN 78-498,560. DIGITAL PRAISE, INC., FREMONT, CA.
FILED 10-12-2004.

SN 78-499,057. FARMERVISION, INC., LOS ANGELES, CA.
FILED 10-13-2004.

DIGITAL PRAISE

THE MARK CONSISTS OF STANDARD CHARACTERS WITHOUT CLAIM TO ANY PARTICULAR FONT, STYLE, SIZE, OR COLOR.

CLASS 9—ELECTRICAL AND SCIENTIFIC APPARATUS

FOR INTERACTIVE MULTIMEDIA COMPUTER GAME PROGRAMS (U.S. CLS. 21, 23, 26, 36 AND 38).
FIRST USE 9-14-2004; IN COMMERCE 9-14-2004.

CLASS 42—SCIENTIFIC, COMPUTER AND LEGAL SERVICES

FOR PROVIDING CUSTOM COMPUTER GAME DEVELOPMENT SERVICES FOR OTHERS (U.S. CLS. 100 AND 101).
FIRST USE 5-27-2003; IN COMMERCE 5-27-2003.
KIMBERLY FRYE, EXAMINING ATTORNEY

SN 78-499,014. SU-KAM COMMUNICATION SYSTEMS LTD., NEW DELHI 110046, INDIA, FILED 10-13-2004.

Su-Kam

CLASS 9—ELECTRICAL AND SCIENTIFIC APPARATUS

FOR INVERTERS; LINE INTERACTIVE UPS (UNINTERRUPTIBLE POWER SUPPLIES); ONLINE UPS; BATTERIES; AND BATTERY CHARGERS (U.S. CLS. 21, 23, 26, 36 AND 38).

CLASS 28—TOYS AND SPORTING GOODS

FOR HEALTH AND FITNESS EQUIPMENT, NAMELY, TREADMILLS (U.S. CLS. 22, 23, 38 AND 50).
SUNG IN, EXAMINING ATTORNEY

FARMERVISION

THE MARK CONSISTS OF STANDARD CHARACTERS WITHOUT CLAIM TO ANY PARTICULAR FONT, STYLE, SIZE, OR COLOR.

CLASS 9—ELECTRICAL AND SCIENTIFIC APPARATUS

FOR PRE-RECORDED CD'S, VIDEOTAPES, LASER DISKS AND DVD'S FEATURING TELEVISION NEWS, TELEVISION ENTERTAINMENT, MUSIC, CORPORATE MEETINGS, MOTION PICTURE FILMS AND INSTRUCTIONAL MOTION PICTURES (U.S. CLS. 21, 23, 26, 36 AND 38).
FIRST USE 1-4-2002; IN COMMERCE 1-4-2002.

CLASS 41—EDUCATION AND ENTERTAINMENT

FOR MUSIC PRODUCTION SERVICES; MOTION PICTURE FILM PRODUCTION; MOTION PICTURE SONG PRODUCTION; PRODUCTION OF TELEVISION PROGRAMS; VIDEOTAPE PRODUCTION (U.S. CLS. 100, 101 AND 107).
FIRST USE 1-4-2002; IN COMMERCE 1-4-2002.
CHRIS WELLS, EXAMINING ATTORNEY

SN 78-499,219. AMERICAN SPORTSMAN SIGN CO., INC., COLUMBIA, MO. FILED 10-13-2004.

AMERICAN SPORTSMAN SIGN COMPANY

THE MARK CONSISTS OF STANDARD CHARACTERS WITHOUT CLAIM TO ANY PARTICULAR FONT, STYLE, SIZE, OR COLOR.

OWNER OF U.S. REG. NO. 2,693,492.
NO CLAIM IS MADE TO THE EXCLUSIVE RIGHT TO USE "SIGN COMPANY", APART FROM THE MARK AS SHOWN.
SEC. 2(F).

CLASS 20—FURNITURE AND ARTICLES NOT OTHERWISE CLASSIFIED

FOR DECORATIVE PLAQUES (U.S. CLS. 2, 13, 22, 25, 32 AND 50).
FIRST USE 1-1-1999; IN COMMERCE 1-1-1999.

CLASS 35—ADVERTISING AND BUSINESS

FOR WHOLESALE ORDERING SERVICES IN THE FIELD OF DECORATIVE PLAQUES (U.S. CLS. 100, 101 AND 102).
 FIRST USE 1-1-1999; IN COMMERCE 1-1-1999.
 IRA J. GOODSAY, EXAMINING ATTORNEY

SN 78-499,323. SILVERLAND DEVELOPMENT, LLC, CASTLE ROCK, CO. FILED 10-13-2004.

Silverland

THE MARK CONSISTS OF STANDARD CHARACTERS WITHOUT CLAIM TO ANY PARTICULAR FONT, STYLE, SIZE, OR COLOR.

CLASS 36—INSURANCE AND FINANCIAL

FOR FINANCIAL SERVICES IN THE FIELD OF REAL ESTATE, NAMELY, MORTGAGE LENDING AND INVESTMENT IN LAND DEVELOPMENT AND HOME-BUILDING (U.S. CLS. 100, 101 AND 102).

CLASS 37—CONSTRUCTION AND REPAIR

FOR CONSTRUCTION OF HOMES AND REAL ESTATE DEVELOPMENT (U.S. CLS. 100, 103 AND 106).
 FIRST USE 1-27-2004; IN COMMERCE 1-27-2004.
 BRIAN NEVILLE, EXAMINING ATTORNEY

SN 78-499,326. HOLLYWOOD MANAGEMENT COMPANY, WILSONVILLE, OR. FILED 10-13-2004.



THE MARK CONSISTS OF A STYLISTIC REPRESENTATION OF THE LETTERS "G" AND "C" WITHIN A FLAME.

CLASS 35—ADVERTISING AND BUSINESS

FOR RETAIL STORE SERVICES FEATURING VIDEO AND COMPUTER GAMES AND ASSOCIATED EQUIPMENT AND ACCESSORIES, PRE-RECORDED ENTERTAINMENT MEDIA AND ASSOCIATED EQUIPMENT AND ACCESSORIES, MUSIC AND RELATED HOME ENTERTAINMENT EQUIPMENT AND ACCESSORIES, GAMES, PRINTED PUBLICATIONS, FOODSTUFFS, CLOTHING, TOYS, AND COMPUTER SOFTWARE AND HARDWARE ALL PROVIDED VIA PHYSICAL ESTABLISHMENTS AND VIA A GLOBAL COMMUNICATION NETWORK (U.S. CLS. 100, 101 AND 102).
 FIRST USE 10-6-2004; IN COMMERCE 10-6-2004.

CLASS 41—EDUCATION AND ENTERTAINMENT

FOR PROVIDING A WIDE VARIETY OF ONLINE INFORMATION FEATURING THE VIDEO AND COMPUTER GAME INDUSTRY AND THE ENTERTAINMENT INDUSTRY, NAMELY, PREVIEWS, REVIEWS, AND COMMENTARIES ABOUT FILMS, MOVIES, SHOWS, VIDEO AND COMPUTER GAMES, MUSIC AND ASSOCIATED EQUIPMENT AND ACCESSORIES (U.S. CLS. 100, 101 AND 107).
 FIRST USE 10-6-2004; IN COMMERCE 10-6-2004.
 BRIAN NEVILLE, EXAMINING ATTORNEY

SN 78-499,449. FOOT-O-PEDICS S.C., SCARBOROUGH, ME. FILED 10-13-2004.

FOOT-O-PEDICS

THE MARK CONSISTS OF STANDARD CHARACTERS WITHOUT CLAIM TO ANY PARTICULAR FONT, STYLE, SIZE, OR COLOR.

CLASS 10—MEDICAL APPARATUS

FOR ORTHOTIC INSERTS FOR FOOTWEAR (U.S. CLS. 26, 39 AND 44).
 FIRST USE 7-1-2004; IN COMMERCE 7-1-2004.

CLASS 35—ADVERTISING AND BUSINESS

FOR RETAIL STORE SERVICES IN THE FIELD OF SHOE SUPPORTS, SHOE CUSHIONS AND FOOT ORTHOTICS; ON-LINE RETAIL STORE AND MAIL ORDER SERVICES IN THE FIELD OF SHOE SUPPORTS, SHOE CUSHIONS AND FOOT ORTHOTICS; AND DISTRIBUTORSHIPS IN THE FIELD OF SHOE SUPPORTS, SHOE CUSHIONS AND FOOT ORTHOTICS (U.S. CLS. 100, 101 AND 102).
 FIRST USE 7-1-2004; IN COMMERCE 7-1-2004.
 WANDA KAY PRICE, EXAMINING ATTORNEY

SN 78-499,702. ROCKING CHAIR STUDIO, KINTNERSVILLE, PA. FILED 10-14-2004.

SN 78-499,794. NORTH CAROLINA ASSOCIATION OF WOMEN ATTORNEYS, INC., RESEARCH TRIANGLE PARK, NC. FILED 10-14-2004.



THE MARK CONSISTS OF THE TERMS "CAN" AND "YOU" TYPESET IN BANNER FORM OVER THE TERM "FIND", WITH A QUESTION MARK INTERPOSED BETWEEN THE TERMS "CAN" AND "YOU", WITH THE "DOT" OF THE QUESTION MARK ALSO FORMING THE "DOT" OF THE "I" IN "FIND".

CLASS 16—PAPER GOODS AND PRINTED MATTER

FOR GREETING CARDS, WRAPPING PAPER, PAPER PARTY FAVORS, PAPER PARTY HATS, PAPER GIFT BAGS, STATIONERY, CHILDREN'S BOOKS, ENVELOPES, POSTCARDS, PAPER GIFT TAGS, PAPER NAPKINS, PAPER TABLE CLOTHS (U.S. CLS. 2, 5, 22, 23, 29, 37, 38 AND 50).

CLASS 21—HOUSEWARES AND GLASS

FOR PAPER PLATES, PAPER CUPS (U.S. CLS. 2, 13, 23, 29, 30, 33, 40 AND 50).
MICHAEL WEBSTER, EXAMINING ATTORNEY



CLASS 14—JEWELRY

FOR JEWELRY (U.S. CLS. 2, 27, 28 AND 50).
FIRST USE 10-1-2003; IN COMMERCE 10-1-2003.

CLASS 35—ADVERTISING AND BUSINESS

FOR ASSOCIATION SERVICES, NAMELY, PROMOTING THE INTERESTS OF WOMEN AND OF WOMEN ATTORNEYS (U.S. CLS. 100, 101 AND 102).
FIRST USE 10-1-2003; IN COMMERCE 10-1-2003.
KELLY BOULTON, EXAMINING ATTORNEY

SN 78-499,759. ROBIN INDUSTRIES, INC., CLEVELAND, OH. FILED 10-14-2004.

SN 78-499,836. ROBIN INDUSTRIES, INC., CLEVELAND, OH. FILED 10-14-2004.

ROBIN INDUSTRIES

THE MARK CONSISTS OF STANDARD CHARACTERS WITHOUT CLAIM TO ANY PARTICULAR FONT, STYLE, SIZE, OR COLOR.

NO CLAIM IS MADE TO THE EXCLUSIVE RIGHT TO USE "INDUSTRIES", APART FROM THE MARK AS SHOWN.

ROBIN

CLASS 12—VEHICLES

FOR TOWING DEVICES AND TOWING ACCESSORIES FOR VEHICLES, NAMELY TOW BARS, HITCHES, BALL MOUNTS, AND SWAY CONTROL BARS (U.S. CLS. 19, 21, 23, 31, 35 AND 44).
FIRST USE 0-0-2003; IN COMMERCE 0-0-2003.

THE MARK CONSISTS OF STANDARD CHARACTERS WITHOUT CLAIM TO ANY PARTICULAR FONT, STYLE, SIZE, OR COLOR.

CLASS 40—MATERIAL TREATMENT

FOR CUSTOM MANUFACTURE OF ELASTOMERIC AND THERMOPLASTIC MOLDED COMPONENTS FOR OTHERS FOR GENERAL INDUSTRIAL USE AND FOR USE IN THE AUTOMOTIVE AND HEALTHCARE INDUSTRIES (U.S. CLS. 100, 103 AND 106).
FIRST USE 12-31-1947; IN COMMERCE 12-31-1950.
CHRISTOPHER ADKINS, EXAMINING ATTORNEY

CLASS 12—VEHICLES

FOR TOWING DEVICES AND TOWING ACCESSORIES FOR VEHICLES, NAMELY TOW BARS, HITCHES, BALL MOUNTS, AND SWAY CONTROL BARS (U.S. CLS. 19, 21, 23, 31, 35 AND 44).
FIRST USE 0-0-2003; IN COMMERCE 0-0-2003.

CLASS 40—MATERIAL TREATMENT

FOR CUSTOM MANUFACTURE OF ELASTOMERIC AND THERMOPLASTIC MOLDED COMPONENTS FOR OTHERS FOR GENERAL INDUSTRIAL USE AND FOR USE IN THE AUTOMOTIVE AND HEALTHCARE INDUSTRIES (U.S. CLS. 100, 103 AND 106).

FIRST USE 12-31-1947; IN COMMERCE 1-1-1950.
CHRISTOPHER ADKINS, EXAMINING ATTORNEY

CLASS 41—EDUCATION AND ENTERTAINMENT

FOR PROVIDING INFORMATION REGARDING RACING NEWS, VIA THE INTERNET, NAMELY MOTORSPORT RACING NEWS (U.S. CLS. 100, 101 AND 107).

FIRST USE 3-1-2000; IN COMMERCE 3-1-2000.
RUSS HERMAN, EXAMINING ATTORNEY

SN 78-499,838. TROPIC IMAGES, INC., CHICKASHA, OK. FILED 10-14-2004.

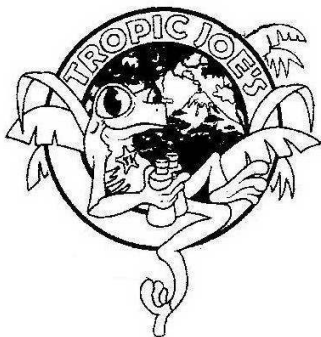
**CLASS 25—CLOTHING**

FOR CLOTHING, NAMELY, T-SHIRTS (U.S. CLS. 22 AND 39).

FIRST USE 1-31-2003; IN COMMERCE 1-31-2003.

CLASS 39—TRANSPORTATION AND STORAGE

FOR TRAVEL AGENCY SERVICES, NAMELY, MAKING RESERVATIONS AND BOOKINGS FOR TRANSPORTATION; TOUR GUIDE SERVICES; CONDUCTING SIGHTSEEING TOURS FOR OTHERS; TRAVEL INFORMATION SERVICES (U.S. CLS. 100 AND 105).

FIRST USE 1-31-2003; IN COMMERCE 1-31-2003.
CHRISTOPHER ADKINS, EXAMINING ATTORNEY

SN 78-499,902. AUTOSALES, INCORPORATED, TALLMADGE, OH. FILED 10-14-2004.

DRAG RACE CENTRAL

THE MARK CONSISTS OF STANDARD CHARACTERS WITHOUT CLAIM TO ANY PARTICULAR FONT, STYLE, SIZE, OR COLOR.

NO CLAIM IS MADE TO THE EXCLUSIVE RIGHT TO USE DRAG RACE, APART FROM THE MARK AS SHOWN.

CLASS 35—ADVERTISING AND BUSINESS

FOR ADVERTISING AND PROMOTING AUTOMOTIVE PARTS OF OTHERS (U.S. CLS. 100, 101 AND 102).

FIRST USE 3-1-2000; IN COMMERCE 3-1-2000.

SN 78-500,205. GUTHY-RENKER CORPORATION, PALM DESERT, CA. FILED 10-14-2004.

FINALLY CLEAR

THE MARK CONSISTS OF STANDARD CHARACTERS WITHOUT CLAIM TO ANY PARTICULAR FONT, STYLE, SIZE, OR COLOR.

CLASS 3—COSMETICS AND CLEANING PREPARATIONS

FOR SKIN AND BODY CARE PREPARATIONS NAMELY, SKIN CLEANSERS, SKIN MOISTURIZERS, SKIN LOTIONS, SKIN SOAPS, SUN SCREEN PREPARATIONS, COSMETICS, NON-MEDICATED HAIR CARE PREPARATIONS, NAIL CARE PREPARATIONS, NON-MEDICATED SKIN CARE PREPARATIONS, COLOGNES, PERFUMES AND TOOTH WHITENING PREPARATIONS (U.S. CLS. 1, 4, 6, 50, 51 AND 52).

CLASS 5—PHARMACEUTICALS

FOR ACNE TREATMENT PREPARATIONS (U.S. CLS. 6, 18, 44, 46, 51 AND 52).

LAURA KOVAISKY, EXAMINING ATTORNEY

SN 78-500,285. TEAM ONE NETWORK, LLC, FREDERICKSBURG, VA. FILED 10-15-2004.



NO CLAIM IS MADE TO THE EXCLUSIVE RIGHT TO USE NETWORK, APART FROM THE MARK AS SHOWN.

THE MARK CONSISTS OF THE WORDS "TEAM," "ONE" AND "NETWORK" STACKED ONE OVER THE OTHER WITH A STYLIZED EAGLE ABOVE THE WORDS.

CLASS 25—CLOTHING

FOR CLOTHING AND ACCESSORIES, NAMELY, SHIRTS, VESTS, POLAR FLEECES AND HATS FOR PROMOTIONAL PURPOSES IN CONNECTION WITH LAW ENFORCEMENT TRAINING SERVICES (U.S. CLS. 22 AND 39).

FIRST USE 3-31-2003; IN COMMERCE 3-31-2003.

CLASS 35—ADVERTISING AND BUSINESS

FOR PROVIDING A WEB SITE WHICH FEATURES ADVERTISEMENTS FOR THE GOODS AND SERVICES OF OTHERS AND HYPERLINKS TO OTHER WEB SITES IN THE FIELD OF LAW ENFORCEMENT ON A GLOBAL COMPUTER NETWORK (U.S. CLS. 100, 101 AND 102).

FIRST USE 3-31-2003; IN COMMERCE 3-31-2003.

CLASS 41—EDUCATION AND ENTERTAINMENT

FOR EDUCATIONAL SERVICES, NAMELY, TACTICAL TEAM, OFFICER SURVIVAL AND FIREARMS TRAINING COURSES FOR LAW ENFORCEMENT OFFICERS, INCLUDING THE DISTRIBUTION OF INSTRUCTIONAL MATERIALS IN CONNECTION THEREWITH (U.S. CLS. 100, 101 AND 107).

FIRST USE 3-31-2003; IN COMMERCE 3-31-2003.

RUSS HERMAN, EXAMINING ATTORNEY

CLASS 36—INSURANCE AND FINANCIAL

FOR PROVIDING AN ON-LINE COMPUTER DATABASE IN THE FIELD OF FINANCIAL INFORMATION; FINANCIAL INFORMATION PROVIDED BY ELECTRONIC MEANS (U.S. CLS. 100, 101 AND 102).

FIRST USE 1-0-2000; IN COMMERCE 1-0-2000.

CLASS 41—EDUCATION AND ENTERTAINMENT

FOR EDUCATIONAL SERVICES, NAMELY, CONDUCTING WORKSHOPS, ON-LINE WORKSHOPS, SEMINARS AND CERTIFICATION PROGRAMS IN THE FIELD OF FINANCIAL INVESTMENTS; PROVIDING ON-LINE NEWSLETTERS AND NEWSPAPERS IN THE FIELD OF FINANCIAL INFORMATION (U.S. CLS. 100, 101 AND 107).

FIRST USE 1-0-2000; IN COMMERCE 1-0-2000.

BRENDAN REGAN, EXAMINING ATTORNEY

SN 78-500,634. PUBLIC COMPANY ACCOUNTING OVERSIGHT BOARD, WASHINGTON, DC. FILED 10-15-2004.

SN 78-500,453. DATA ANALYSIS INC., LOS ANGELES, CA. FILED 10-15-2004.

PCAOB

IBD

THE MARK CONSISTS OF STANDARD CHARACTERS WITHOUT CLAIM TO ANY PARTICULAR FONT, STYLE, SIZE, OR COLOR.

OWNER OF U.S. REG. NO. 2,401,074.

CLASS 16—PAPER GOODS AND PRINTED MATTER

FOR NEWSPAPERS, PAMPHLETS AND NEWSLETTERS IN THE FIELD OF FINANCIAL INFORMATION (U.S. CLS. 2, 5, 22, 23, 29, 37, 38 AND 50).

FIRST USE 1-0-1997; IN COMMERCE 1-0-1997.

CLASS 35—ADVERTISING AND BUSINESS

FOR ON-LINE ORDERING SERVICES IN THE FIELD OF BOOKS, PUBLICATIONS AND AUDIO CDS (U.S. CLS. 100, 101 AND 102).

FIRST USE 1-0-2000; IN COMMERCE 1-0-2000.

THE MARK CONSISTS OF STANDARD CHARACTERS WITHOUT CLAIM TO ANY PARTICULAR FONT, STYLE, SIZE, OR COLOR.

CLASS 35—ADVERTISING AND BUSINESS

FOR CONDUCTING BUSINESS INSPECTIONS OF REGISTERED PUBLIC ACCOUNTING FIRMS, THEIR PRACTICES, AND PERSONNEL; REGISTERING PUBLIC ACCOUNTING FIRMS (U.S. CLS. 100, 101 AND 102).

FIRST USE 6-0-2003; IN COMMERCE 6-0-2003.

CLASS 42—SCIENTIFIC, COMPUTER AND LEGAL SERVICES

FOR ESTABLISHING AND REVIEWING THE STANDARDS AND PRACTICES OF REGISTERED PUBLIC ACCOUNTING FIRMS TO ENSURE COMPLIANCE WITH ACCOUNTING AND SECURITIES LAWS, REGULATIONS, AND STANDARDS; ENFORCEMENT OF COMPLIANCE BY REGISTERED PUBLIC ACCOUNTING FIRMS AND PERSONS ASSOCIATED WITH SUCH FIRMS WITH ACCOUNTING AND SECURITIES LAWS, REGULATIONS, AND STANDARDS (U.S. CLS. 100 AND 101).

FIRST USE 4-0-2003; IN COMMERCE 4-0-2003.

KIMBERLY FRYE, EXAMINING ATTORNEY

SN 78-500,800. POLAROID CORPORATION, WALTHAM, MA. FILED 10-15-2004.

COLOR RELEASE

THE MARK CONSISTS OF STANDARD CHARACTERS WITHOUT CLAIM TO ANY PARTICULAR FONT, STYLE, SIZE, OR COLOR.

NO CLAIM IS MADE TO THE EXCLUSIVE RIGHT TO USE "COLOR", APART FROM THE MARK AS SHOWN.

CLASS 1—CHEMICALS

FOR UNEXPOSED PHOTOGRAPHIC FILM; SENSITIZED PHOTOGRAPHIC FILM; CHEMICALS FOR USE IN PHOTOGRAPHY; CHEMICALS FOR USE IN PRINTING PAPER; PHOTOGRAPHIC PAPERS; PRINTING MATERIALS, NAMELY PHOTSENSITIVE PAPER (U.S. CLS. 1, 5, 6, 10, 26 AND 46).

CLASS 7—MACHINERY

FOR PRINTING MACHINES; PRINTING APPARATUS, NAMELY MACHINERY AND PARTS THEREFOR USED FOR VIEWING, PROCESSING, MODIFYING, REPRODUCING, AND PRINTING IMAGES, GRAPHICS, AND PHOTOGRAPHS (U.S. CLS. 13, 19, 21, 23, 31, 34 AND 35).

CLASS 9—ELECTRICAL AND SCIENTIFIC APPARATUS

FOR PRINTERS; PRINTING TECHNOLOGY FOR VIEWING, PROCESSING, MODIFYING, REPRODUCING, AND PRINTING IMAGES, GRAPHICS, AND PHOTOGRAPHS, NAMELY APPARATUS FOR TRANSMITTING AND REPRODUCING IMAGES, COMPUTERS, HANDHELD COMPUTERS, PERSONAL DIGITAL ASSISTANTS, COMPUTER PERIPHERALS, COLOR PRINTERS, ID CARD PRINTERS, LABEL PRINTERS, WIRELESS COMPUTER PERIPHERALS, FACSIMILE APPARATUS, SOFTWARE, COMPUTER MONITORS, LCD MONITORS, TELEVISION MONITORS, VIDEO MONITORS, TELEVISIONS, PRINTER CABLES, AND RASTER IMAGE PROCESSORS; DIGITAL IMAGING DEVICES FOR VIEWING, PROCESSING, MODIFYING, REPRODUCING, AND PRINTING IMAGES, GRAPHICS, AND PHOTOGRAPHS, NAMELY APPARATUS FOR TRANSMITTING AND REPRODUCING IMAGES, COMPUTERS, HANDHELD COMPUTERS, PERSONAL DIGITAL ASSISTANTS, COMPUTER PERIPHERALS, COLOR PRINTERS, ID CARD PRINTERS, LABEL PRINTERS, WIRELESS COMPUTER PERIPHERALS, FACSIMILE APPARATUS, CAMERAS, DIGITAL CAMERAS, COMPUTER CAMERAS, CAMCORDERS, DIGITAL VIDEO RECORDERS, DVD MACHINES, COMPUTER MONITORS, LCD MONITORS, TELEVISION MONITORS, VIDEO MONITORS, TELEVISIONS, SCANNERS, OPTICAL SCANNERS, SOFTWARE, CELLULAR PHONES WITH A CAMERA FUNCTION, CELLULAR PHONE DOCKING STATIONS, BLANK COMPUTER DISKS AND CD-ROMS, COMPUTER MEMORY HARDWARE, MEMORY CARDS, AND BLANK MAGNETIC DATA CARRIERS (U.S. CLS. 21, 23, 26, 36 AND 38).

CLASS 16—PAPER GOODS AND PRINTED MATTER

FOR PRINTING PAPER; PRINTING MATERIALS, NAMELY DIGITAL PRINTING PAPER, PHOTOGRAPHS, PRINTS, LABEL PAPER, PAPER TAGS, PRINTED TICKETS, ID CARDS WITHOUT MAGNETIC ENCODING, AND PLASTIC SHEETS FOR PRINTING; PHOTOGRAPHIC PRINTS; PHOTO SHEETS, NAMELY PHOTOGRAPHIC PRINTS IN THE NATURE OF PHOTO SHEETS (U.S. CLS. 2, 5, 22, 23, 29, 37, 38 AND 50).

CLASS 40—MATERIAL TREATMENT

FOR PRINTING SERVICES; DIGITAL IMAGING SERVICES (U.S. CLS. 100, 103 AND 106).

CLASS 41—EDUCATION AND ENTERTAINMENT

FOR PHOTOGRAPHY SERVICES (U.S. CLS. 100, 101 AND 107).

ZACHARY BELLO, EXAMINING ATTORNEY

SN 78-500,817. ITW FOOD EQUIPMENT GROUP LLC, TROY, OH. FILED 10-15-2004.

AXIOM

THE MARK CONSISTS OF STANDARD CHARACTERS WITHOUT CLAIM TO ANY PARTICULAR FONT, STYLE, SIZE, OR COLOR.

CLASS 7—MACHINERY

FOR DISHWASHING MACHINES, UNDERCOUNTER DISHWASHING MACHINES, SINGLE-RACK UPRIGHT DISHWASHING MACHINES, DOUBLE-RACK UPRIGHT DISHWASHING MACHINES; ELECTRICALLY OPERATED FOOD PREPARATION MACHINES, NAMELY, SLICERS, MIXERS, FOOD PROCESSORS, CUTTERS, CHOPPERS, BLENDERS, TENDERIZERS, PEELERS, AND MEAT SAWS (U.S. CLS. 13, 19, 21, 23, 31, 34 AND 35).

CLASS 11—ENVIRONMENTAL CONTROL APPARATUS

FOR REFRIGERATORS AND FREEZERS; REACH-IN REFRIGERATORS AND FREEZERS; COMPACT UNDERCOUNTER REFRIGERATORS, FREEZERS, AND PREPARATION TOP UNITS SOLD AS A COMPONENT THEREOF (U.S. CLS. 13, 21, 23, 31 AND 34).

KHANH LE, EXAMINING ATTORNEY

SN 78-500,839. VOITSP INC., CITY OF INDUSTRY, CA.
FILED 10-15-2004.

SN 78-500,936. UNIVERSITY OF GEORGIA RESEARCH
FOUNDATION, INC., ATHENS, GA. FILED 10-15-2004.

MERITPHONE

THE MARK CONSISTS OF STANDARD CHARACTERS WITHOUT CLAIM TO ANY PARTICULAR FONT, STYLE, SIZE, OR COLOR.

CLASS 9—ELECTRICAL AND SCIENTIFIC APPARATUS

FOR TELECOMMUNICATIONS-BASED HARDWARE, EQUIPMENT AND ACCESSORIES, NAMELY, TELEPHONES, INTERNET TELEPHONES, AND TELEPHONE ADAPTERS; COMPUTER TELEPHONY SOFTWARE (U.S. CLS. 21, 23, 26, 36 AND 38).

FIRST USE 3-15-2004; IN COMMERCE 3-19-2004.

CLASS 38—COMMUNICATION

FOR TELECOMMUNICATIONS SERVICES, NAMELY, VOICE OVER INTERNET PROTOCOL (VOIP) SERVICES, INTERNET TELEPHONY SERVICES, AND PROVIDING TELEPHONE CONFERENCE SERVICES (U.S. CLS. 100, 101 AND 104).

FIRST USE 1-22-2004; IN COMMERCE 1-22-2004.
PATRICIA EVANKO, EXAMINING ATTORNEY

SN 78-500,853. INFOSPACE, INC., BELLEVUE, WA. FILED
10-15-2004.

COMPETITION GOES MOBILE

THE MARK CONSISTS OF STANDARD CHARACTERS WITHOUT CLAIM TO ANY PARTICULAR FONT, STYLE, SIZE, OR COLOR.

NO CLAIM IS MADE TO THE EXCLUSIVE RIGHT TO USE "MOBILE", APART FROM THE MARK AS SHOWN.

CLASS 9—ELECTRICAL AND SCIENTIFIC APPARATUS

FOR DOWNLOADABLE INTERACTIVE COMPUTER GAME SOFTWARE (U.S. CLS. 21, 23, 26, 36 AND 38).

FIRST USE 11-28-2003; IN COMMERCE 11-28-2003.

CLASS 41—EDUCATION AND ENTERTAINMENT

FOR ENTERTAINMENT SERVICES, NAMELY, CONDUCTING INTERACTIVE GAMES VIA MOBILE PHONES (U.S. CLS. 100, 101 AND 107).

FIRST USE 11-28-2003; IN COMMERCE 11-28-2003.
CAROLYN CATALDO, EXAMINING ATTORNEY

THE CLOUD

THE MARK CONSISTS OF STANDARD CHARACTERS WITHOUT CLAIM TO ANY PARTICULAR FONT, STYLE, SIZE, OR COLOR.

CLASS 35—ADVERTISING AND BUSINESS

FOR MARKETING AND PROMOTING THE GOODS AND SERVICES OF OTHERS VIA A WIRELESS NETWORK (U.S. CLS. 100, 101 AND 102).

FIRST USE 6-3-2004; IN COMMERCE 7-14-2004.

CLASS 38—COMMUNICATION

FOR TEXT AND NUMERIC WIRELESS DIGITAL MESSAGING SERVICES (U.S. CLS. 100, 101 AND 104).

FIRST USE 6-3-2004; IN COMMERCE 7-14-2004.

CLASS 42—SCIENTIFIC, COMPUTER AND LEGAL SERVICES

FOR HOSTING OF DIGITAL CONTENT ON THE INTERNET (U.S. CLS. 100 AND 101).

FIRST USE 6-3-2004; IN COMMERCE 7-14-2004.

MATTHEW KLINE, EXAMINING ATTORNEY

SN 78-501,362. PIERRE FABRE S.A. CORPORATION, LAS
VEGAS, NV. FILED 10-18-2004.

Visible Effects

THE MARK CONSISTS OF STANDARD CHARACTERS WITHOUT CLAIM TO ANY PARTICULAR FONT, STYLE, SIZE, OR COLOR.

CLASS 3—COSMETICS AND CLEANING PREPARATIONS

FOR NON-MEDICATED SKIN CARE PREPARATIONS; WRINKLE REMOVING SKIN CARE PREPARATIONS; NON-MEDICATED SKIN CARE PREPARATIONS, NAMELY, ANTI-CELLULITE GEL AND STRETCH MARK REDUCING CREAM (U.S. CLS. 1, 4, 6, 50, 51 AND 52).

FIRST USE 12-21-2004; IN COMMERCE 12-21-2004.

CLASS 5—PHARMACEUTICALS

FOR DIETARY SUPPLEMENTS TO CONTROL APPETITE (U.S. CLS. 6, 18, 44, 46, 51 AND 52).
FIRST USE 12-21-2004; IN COMMERCE 12-21-2004.
YONG KIM, EXAMINING ATTORNEY

CLASS 39—TRANSPORTATION AND STORAGE

FOR AIRPORT SERVICES; AIRCRAFT FUEL TRANSPORTATION; AIRCRAFT CARGO HANDLING; AIRPORT PASSENGER SERVICES, NAMELY, ARRANGING RESERVATIONS AND BOOKINGS FOR FLIGHTS AND GROUND TRANSPORTATION, SKY CAP, PRE-FLIGHT TICKETING, CHECK-IN, AIRCRAFT BOARDING SERVICES; AND AIRCRAFT FLIGHT DISPATCHING SERVICES (U.S. CLS. 100 AND 105).

SN 78-501.402. ROSS, PHILIP G. III, MAHWAH, NJ. FILED 10-18-2004.

CLASS 45—PERSONAL SERVICES

FOR PROVIDING AIRCRAFT PRE-BOARDING SECURITY SCREENING (U.S. CLS. 100 AND 101).
MIDGE BUTLER, EXAMINING ATTORNEY

F.A.S.T

THE MARK CONSISTS OF STANDARD CHARACTERS WITHOUT CLAIM TO ANY PARTICULAR FONT, STYLE, SIZE, OR COLOR.

SN 78-501.481. CARIBBEAN WINDS, LONGBOAT KEY, FL. FILED 10-18-2004.

CLASS 9—ELECTRICAL AND SCIENTIFIC APPARATUS

FOR SELF DEFENSE FITNESS DVD (U.S. CLS. 21, 23, 26, 36 AND 38).
FIRST USE 11-18-2003; IN COMMERCE 11-20-2003.

Caribbean Winds

CLASS 41—EDUCATION AND ENTERTAINMENT

FOR CONDUCTING SELF DEFENSE SEMINARS AND LECTURES (U.S. CLS. 100, 101 AND 107).
FIRST USE 11-18-2003; IN COMMERCE 11-20-2003.
CYNTHIA SLOAN, EXAMINING ATTORNEY

SN 78-501.480. AIRCRAFT SERVICE INTERNATIONAL, INC., ORLANDO, FL. FILED 10-18-2004.

THE MARK CONSISTS OF STANDARD CHARACTERS WITHOUT CLAIM TO ANY PARTICULAR FONT, STYLE, SIZE, OR COLOR.

**Exceptional
Service from the
Ground Up**

CLASS 39—TRANSPORTATION AND STORAGE

FOR PROVIDING INFORMATION FOR OTHERS ABOUT TRANSPORTATION; TRAVEL AGENCY SERVICES, NAMELY, MAKING VACATION TRANSPORTATION RESERVATIONS AND BOOKINGS FOR OTHERS VIA COMPUTER NETWORKS, WIRELESS NETWORKS, THE INTERNET, AND VIA TELEPHONE; PROVIDING INFORMATION IN THE FIELD OF TRAVEL VIA COMPUTER NETWORKS, WIRELESS NETWORKS, THE INTERNET, AND VIA TELEPHONE (U.S. CLS. 100 AND 105).
FIRST USE 1-1-2004; IN COMMERCE 1-1-2004.

THE MARK CONSISTS OF STANDARD CHARACTERS WITHOUT CLAIM TO ANY PARTICULAR FONT, STYLE, SIZE, OR COLOR.

CLASS 43—HOTEL AND RESTAURANT SERVICES

FOR PROVIDING INFORMATION FOR OTHERS ABOUT HOTEL RESERVATIONS AND TEMPORARY LODGING; TRAVEL AGENCY SERVICES, NAMELY, MAKING RESERVATIONS AND BOOKINGS FOR TEMPORARY LODGING FOR OTHERS BY MEANS OF COMPUTER NETWORKS, WIRELESS NETWORKS, THE INTERNET, AND VIA TELEPHONE (U.S. CLS. 100 AND 101).
FIRST USE 1-1-2004; IN COMMERCE 1-1-2004.
LINDA M. KING, EXAMINING ATTORNEY

CLASS 37—CONSTRUCTION AND REPAIR

FOR AIRCRAFT REFUELING AND CLEANING SERVICES; AIRCRAFT GROUND EQUIPMENT REPAIR AND MAINTENANCE (U.S. CLS. 100, 103 AND 106).

SN 78-501,497. TARGETED CONVERGENCE CORPORATION, COPPELL, TX. FILED 10-18-2004.

SN 78-501,553. GRAND PACIFIC RESOURCES, INC., DBA NICKY SHOE COMPANY, HONOLULU, HI. FILED 10-18-2004.

TARGETED CONVERGENCE

THE MARK CONSISTS OF STANDARD CHARACTERS WITHOUT CLAIM TO ANY PARTICULAR FONT, STYLE, SIZE, OR COLOR.

CLASS 9—ELECTRICAL AND SCIENTIFIC APPARATUS

FOR COMPUTER SOFTWARE FOR THE PLANNING AND MANAGEMENT OF PRODUCT DEVELOPMENT, NAMELY, SOFTWARE FOR USE IN TRACKING AND EDITING PRODUCT DESIGN AND DEVELOPMENT DECISIONS, FOR IDENTIFYING GAPS IN PRODUCT DEVELOPMENT KNOWLEDGE, FOR USE IN CREATING AND MAINTAINING A DATABASE OF KNOWLEDGE LEARNED BY COMPANIES WHILE DEVELOPING PRODUCTS FOR OTHERS, AND FOR GRAPHICALLY MAPPING OUT THE KNOWLEDGE RELATING TO PRODUCT DEVELOPMENT DECISIONS ALL FOR USE IN THE PROCESS IMPROVEMENT, PRODUCT DEVELOPMENT, PROJECT PLANNING, KNOWLEDGE MANAGEMENT AND CORPORATE LEARNING FIELDS (U.S. CLS. 21, 23, 26, 36 AND 38).

CLASS 35—ADVERTISING AND BUSINESS

FOR INDUSTRIAL MANAGEMENT CONSULTATION INCLUDING COST/YIELD ANALYSES FOR USE IN THE PROCESS IMPROVEMENT, PRODUCT DEVELOPMENT, PROJECT PLANNING, KNOWLEDGE MANAGEMENT AND CORPORATE LEARNING FIELDS; BUSINESS MANAGEMENT SERVICES; BUSINESS MANAGEMENT ANALYSIS SERVICES, NAMELY, BUSINESS MANAGEMENT CONSULTANCY FOR DEVELOPING PROCESSES FOR THE ANALYSIS AND IMPLEMENTATION OF BUSINESS STRATEGY PLANS AND BUSINESS MANAGEMENT PLANS AND PROJECTS; BUSINESS CONSULTATION SERVICES FOR MANAGEMENT OF BUSINESS ENTERPRISES AND IMPROVING PRODUCT DEVELOPMENT CAPABILITIES AND CORPORATE LEARNING (U.S. CLS. 100, 101 AND 102).

CLASS 42—SCIENTIFIC, COMPUTER AND LEGAL SERVICES

FOR COMPUTER SOFTWARE DESIGN AND DEVELOPMENT SERVICES FOR USE IN THE PROCESS IMPROVEMENT, PRODUCT DEVELOPMENT, PROJECT PLANNING, KNOWLEDGE MANAGEMENT AND CORPORATE LEARNING FIELDS (U.S. CLS. 100 AND 101).
MICHAEL TANNER, EXAMINING ATTORNEY



NO CLAIM IS MADE TO THE EXCLUSIVE RIGHT TO USE "SHOE COMPANY", APART FROM THE MARK AS SHOWN.

THE NAME(S), PORTRAIT(S), AND/OR SIGNATURE(S) SHOWN IN THE MARK DOES NOT IDENTIFY A PARTICULAR LIVING INDIVIDUAL.

THE COLOR(S) PINK IS/ARE CLAIMED AS A FEATURE OF THE MARK.

THE MARK CONSISTS OF THE WORD "NICKY" IN LARGE SCRIPTED PINK FONT WITH A DAISY FLOWER REPRESENTING THE "DOT" OF THE LOWER CASE "I", THE WORDS "SHOE COMPANY" IN PLAIN FONT BELOW, ALL SURROUNDED BY VERTICAL PINK STRIPES.

CLASS 18—LEATHER GOODS

FOR HANDBAGS AND PURSES (U.S. CLS. 1, 2, 3, 22 AND 41).
FIRST USE 7-23-2004; IN COMMERCE 7-23-2004.

CLASS 25—CLOTHING

FOR CLOTHING, NAMELY SHOES, HATS, AND CAPS (U.S. CLS. 22 AND 39).
FIRST USE 7-23-2004; IN COMMERCE 7-23-2004.
MATTHEW KLINE, EXAMINING ATTORNEY

SN 78-501,611. AIRCRAFT SERVICE INTERNATIONAL, INC., ORLANDO, FL. FILED 10-18-2004.

Grounded in Safety,
Soaring in Service

THE MARK CONSISTS OF STANDARD CHARACTERS WITHOUT CLAIM TO ANY PARTICULAR FONT, STYLE, SIZE, OR COLOR.

CLASS 37—CONSTRUCTION AND REPAIR

FOR AIRCRAFT REFUELING AND CLEANING SERVICES; AIRCRAFT GROUND EQUIPMENT REPAIR AND MAINTENANCE (U.S. CLS. 100, 103 AND 106).

SN 78-501,709. EVERGREEN IP, LLC, EVERGREEN, CO. FILED 10-18-2004.

CLASS 39—TRANSPORTATION AND STORAGE

FOR AIRPORT SERVICES; AIRCRAFT FUEL TRANSPORTATION; AIRCRAFT CARGO HANDLING; AIRPORT PASSENGER SERVICES, NAMELY, ARRANGING RESERVATIONS AND BOOKINGS FOR FLIGHTS AND GROUND TRANSPORTATION, SKY CAP, PRE-FLIGHT TICKETING, CHECK-IN, AIRCRAFT BOARDING SERVICES; AND AIRCRAFT FLIGHT DISPATCHING SERVICES (U.S. CLS. 100 AND 105).

Product
Capitalists

CLASS 45—PERSONAL SERVICES

FOR PROVIDING AIRCRAFT PRE-BOARDING SECURITY SCREENING (U.S. CLS. 100 AND 101).
CAROLINE WOOD, EXAMINING ATTORNEY

THE MARK CONSISTS OF STANDARD CHARACTERS WITHOUT CLAIM TO ANY PARTICULAR FONT, STYLE, SIZE, OR COLOR.

SN 78-501,686. ONESOURCE MANAGEMENT, INC., ATLANTA, GA. FILED 10-18-2004.

CLASS 35—ADVERTISING AND BUSINESS

FOR BUSINESS CONSULTATION AND MANAGEMENT REGARDING MARKETING ACTIVITIES AND LAUNCHING OF NEW PRODUCTS (U.S. CLS. 100, 101 AND 102).
FIRST USE 10-11-2004; IN COMMERCE 10-11-2004.

PEOPLE WHO CLEAN.
SERVICE THAT
SHINES.

CLASS 42—SCIENTIFIC, COMPUTER AND LEGAL SERVICES

FOR LICENSING OF INTELLECTUAL PROPERTY (U.S. CLS. 100 AND 101).
FIRST USE 10-11-2004; IN COMMERCE 10-11-2004.
STEVEN R. FOSTER, EXAMINING ATTORNEY

SN 78-502,471. ALGORITHMICS INCORPORATED, TORONTO, ONTARIO, CANADA, FILED 10-19-2004.

THE MARK CONSISTS OF STANDARD CHARACTERS WITHOUT CLAIM TO ANY PARTICULAR FONT, STYLE, SIZE, OR COLOR.

MARK-TO-FUTURE

CLASS 37—CONSTRUCTION AND REPAIR

FOR COMMERCIAL JANITORIAL AND BUILDING AND OFFICE CLEANING SERVICES; INSTALLATION, REPAIR AND MAINTENANCE OF COMMERCIAL HEATING, VENTILATION, AND AIR CONDITIONING EQUIPMENT; MAINTENANCE, REPAIR AND RESTORATION OF COMMERCIAL BUILDINGS; AND INSTALLATION OF SEASONAL HOLIDAY DECORATIONS FOR OTHERS (U.S. CLS. 100, 103 AND 106).
FIRST USE 6-29-2003; IN COMMERCE 6-29-2003.

THE MARK CONSISTS OF STANDARD CHARACTERS WITHOUT CLAIM TO ANY PARTICULAR FONT, STYLE, SIZE, OR COLOR.
OWNER OF U.S. REG. NO. 2,875,990.

CLASS 44—MEDICAL, BEAUTY AND AGRICULTURAL SERVICES

FOR COMMERCIAL LANDSCAPING GARDENING (U.S. CLS. 100 AND 101).
FIRST USE 6-29-2003; IN COMMERCE 6-29-2003.
LINDA M. KING, EXAMINING ATTORNEY

CLASS 36—INSURANCE AND FINANCIAL

FOR FINANCIAL RISK MANAGEMENT AND MEASUREMENT; FINANCIAL CONSULTING; FINANCIAL CONSULTING CONCERNING FINANCIAL RISK MANAGEMENT AND MEASUREMENT (U.S. CLS. 100, 101 AND 102).
FIRST USE 0-0-2001; IN COMMERCE 0-0-2001.

CLASS 42—SCIENTIFIC, COMPUTER AND LEGAL SERVICES

FOR COMPUTER SOFTWARE DEVELOPMENT, IMPLEMENTATION AND CONSULTING SERVICES RELATED TO FINANCIAL RISK MANAGEMENT AND MEASUREMENT SOFTWARE (U.S. CLS. 100 AND 101).

FIRST USE 0-0-2001; IN COMMERCE 0-0-2001.
CHRISIE B. KING, EXAMINING ATTORNEY

SN 78-503,325. DOCUSIGN, INC., SEATTLE, WA. FILED 10-20-2004.

**THE FASTEST WAY TO
GET A SIGNATURE**

SN 78-503,121. WORLD HEALING CENTER CHURCH, INC., GRAPEVINE, TX. FILED 10-20-2004.



THE MARK CONSISTS OF A STYLIZED DRAWING OF A DOVE WITH A DEPICTION OF THE WORLD SHELTERED BENEATH ITS WING.

CLASS 9—ELECTRICAL AND SCIENTIFIC APPARATUS

FOR PRE-RECORDED AUDIO TAPES, VIDEO TAPES, COMPACT DISCS AND DVD'S IN THE FIELD OF RELIGION (U.S. CLS. 21, 23, 26, 36 AND 38).

FIRST USE 1-1-1998; IN COMMERCE 1-1-1998.

CLASS 16—PAPER GOODS AND PRINTED MATTER

FOR BOOKS, NEWSLETTERS, PRAYER JOURNALS, PRAYER CARDS, RELIGIOUS BOOKLETS, DEVOTIONALS, CALENDARS, NOTE CARDS, POSTERS, PHOTOGRAPHS, BOOK MARKS, LEATHER BOOK COVERS, PAPERWEIGHTS, PENS, STUDY GUIDES, AND EDUCATIONAL AND TEACHING MATERIALS IN THE FIELD OF RELIGION (U.S. CLS. 2, 5, 22, 23, 29, 37, 38 AND 50).

FIRST USE 1-1-1998; IN COMMERCE 1-1-1998.

CLASS 41—EDUCATION AND ENTERTAINMENT

FOR EDUCATIONAL AND ENTERTAINMENT SERVICES IN THE NATURE OF CONFERENCES, CONVENTIONS AND CRUSADES IN THE FIELD OF RELIGION; ENTERTAINMENT SERVICES IN THE NATURE OF ONGOING TELEVISION PROGRAMS IN THE FIELD OF RELIGION (U.S. CLS. 100, 101 AND 107).

FIRST USE 1-1-1998; IN COMMERCE 1-1-1998.

CLASS 45—PERSONAL SERVICES

FOR EVANGELISTIC AND MINISTERIAL SERVICES (U.S. CLS. 100 AND 101).

FIRST USE 1-1-1998; IN COMMERCE 1-1-1998.
JILL C. ALT, EXAMINING ATTORNEY

THE MARK CONSISTS OF STANDARD CHARACTERS WITHOUT CLAIM TO ANY PARTICULAR FONT, STYLE, SIZE, OR COLOR.

CLASS 38—COMMUNICATION

FOR ELECTRONIC DELIVERY OF DOCUMENTS AND FILES (U.S. CLS. 100, 101 AND 104).

FIRST USE 10-12-2004; IN COMMERCE 10-12-2004.

CLASS 42—SCIENTIFIC, COMPUTER AND LEGAL SERVICES

FOR ELECTRONIC DATA VERIFICATION SERVICES, NAMELY, PROVIDING SERVICES FOR THE ISSUANCE OF LEGALLY BINDING ELECTRONIC SIGNATURES FOR DOCUMENTS OR FILES VIA A GLOBAL COMPUTER NETWORK; PROVIDING ELECTRONIC NOTARIZATION SERVICES VIA A GLOBAL COMPUTER NETWORK FOR OTHERS TO LEGALLY NOTARIZE ELECTRONIC DOCUMENTS OR FILES; PROVIDING TRANSFERABLE RECORD SERVICES FOR IDENTIFICATION OF THE OWNERS OF DOCUMENTS OR CHATTEL; PROVIDING ELECTRONIC DATA MANAGEMENT SERVICES, NAMELY, VERIFYING DOCUMENTS AND FILES (U.S. CLS. 100 AND 101).

FIRST USE 10-12-2004; IN COMMERCE 10-12-2004.

EDWARD NELSON, EXAMINING ATTORNEY

SN 78-503,396. PT. BINTANG TOEDJOE, JAKARTA, INDONESIA, FILED 10-21-2004.



PRIORITY CLAIMED UNDER SEC. 44(D) ON INDONESIA APPLICATION NO. D00-02-19290, FILED 8-28-2002, REG. NO. 551039, DATED 10-24-2003, EXPIRES 8-28-2012.

THE COLOR(S) BLUE, RED, BLACK IS/ARE CLAIMED AS A FEATURE OF THE MARK.

THE MARK CONSISTS OF THE WORDING IREX IN BLACK AND BLUE WITH A GRADATION TO LIGHT BLUE ON A DARK BLUE BACKGROUND. A RED CIRCLE WITH A CENTAUR-LIKE FIGURE FIRING A BOW APPEARS TO THE LEFT OF THE WORDING IN THE MARK.

CLASS 5—PHARMACEUTICALS

FOR PHARMACEUTICAL PREPARATIONS, NAMELY, ANAESTHETICS, ANTHELMINTICS, AND CHLOROFORM; VETERINARY PREPARATIONS, NAMELY, BACTERIAL PREPARATIONS FOR MEDICAL AND VETERINARY USE, BIOLOGICAL PREPARATIONS FOR VETERINARY PURPOSES, CHEMICAL REAGENTS FOR MEDICAL AND VETERINARY PURPOSES; SANITARY PREPARATIONS FOR MEDICAL USE; DIETETIC FOODS ADAPTED FOR MEDICAL USE; DIETETIC SUGAR FOR MEDICAL USE; BABY FOOD; MEDICAL PLASTERS, BANDAGES AND GAUZE FOR DRESSINGS; MATERIAL FOR STOPPING TEETH; DENTAL WAX; DISINFECTANTS FOR SANITARY AND HYGIENIC PURPOSES; PREPARATIONS FOR DESTROYING VERMIN; FUNGICIDES FOR MEDICAL AND DOMESTIC USE; HERBICIDES FOR HOME AND PROFESSIONAL USE (U.S. CLS. 6, 18, 44, 46, 51 AND 52).

CLASS 32—LIGHT BEVERAGES

FOR AERATED WATERS, PREPARATIONS FOR MAKING AERATED WATERS, NON-ALCOHOLIC APERITIFS, BEERS, BEER WORT, NON-ALCOHOLIC BEVERAGES, NAMELY, CARBONATED BEVERAGES, PREPARATIONS FOR MAKING FRUIT DRINKS, MINERAL WATER, WHEY BEVERAGES, NON-ALCOHOLIC COCKTAILS, PASTILLES AND POWDERS USED IN EFFERVESCING BEVERAGES, ESSENCES FOR USE IN MAKING BEVERAGES, NON-ALCOHOLIC FRUIT EXTRACTS USED IN THE PREPARATION OF BEVERAGES, NON-ALCOHOLIC FRUIT BEVERAGES, FRUIT JUICE, NON-ALCOHOLIC FRUIT NECTARS, GINGER ALE, GINGER BEER, UNFERMENTED GRAPE MUST, HOP EXTRACTS FOR MANUFACTURING BEER, ISOTONIC DRINKS, LEMONADE, LITHIA WATER, MALT BEER, MALT WORT, PEANUT MILK SOFT DRINKS, ORGEAT, SARSAPARILLA SOFT DRINKS, SELTZER WATER, SYRUPS FOR BEVERAGES, SYRUP FOR MAKING LEMONADE, TABLE WATER, TOMATO JUICE, AND VEGETABLE JUICE (U.S. CLS. 45, 46 AND 48).

CAROLYN GRAY, EXAMINING ATTORNEY

CLASS 42—SCIENTIFIC, COMPUTER AND LEGAL SERVICES

FOR DESIGNING, DEVELOPING, ENGINEERING, IMPLEMENTING, PROGRAMMING AND TESTING CUSTOM SOFTWARE APPLICATIONS, COMPUTER SYSTEMS AND COMPUTER DATABASES FOR COMPUTER HARDWARE FOR OTHERS; TECHNICAL CONSULTING SERVICES, NAMELY CONSULTING IN THE FIELD OF IMPLEMENTATION AND MAINTENANCE OF INFORMATION TECHNOLOGY STRATEGIES, TECHNOLOGY NEEDS ASSESSMENT AND MANAGEMENT; INFORMATION TECHNOLOGY CONSULTING IN THE FIELD OF BUSINESS MANAGEMENT FOR OTHER; DESIGNING, DEVELOPING, ENGINEERING, PROGRAMMING, AND IMPLEMENTING WEB SITE AND WEB PAGES FOR OTHERS; DESIGNING, DEVELOPING, ENGINEERING, IMPLEMENTING AND INSTALLING DIAGNOSTIC AND SYSTEMIC TESTS OF COMPUTER HARDWARE IN THE FIELD OF BUSINESS FOR COMPUTER USERS (U.S. CLS. 100 AND 101).

FIRST USE 10-15-2004, THE MARK WAS FIRST USED ANYWHERE IN A DIFFERENT FORM OTHER THAN THAT SOUGHT TO BE REGISTERED ON 02/13/1999.; IN COMMERCE 10-15-2004, THE MARK WAS FIRST USED IN COMMERCE IN A DIFFERENT FORM OTHER THAN THAT SOUGHT TO BE REGISTERED ON 02/13/1999..

MARK RADEMACHER, EXAMINING ATTORNEY

SN 78-503,802, BENEFACOR FUNDING CORPORATION, DENVER, CO. FILED 10-21-2004.

BENEFACOR

SN 78-503,398, HARBINGER PARTNERS, INC., ST. PAUL, MN. FILED 10-21-2004.



NO CLAIM IS MADE TO THE EXCLUSIVE RIGHT TO USE "PARTNERS", APART FROM THE MARK AS SHOWN.

CLASS 35—ADVERTISING AND BUSINESS

FOR BUSINESS CONSULTING, NAMELY, CONSULTING IN THE AREAS OF TECHNOLOGY NEEDS ASSESSMENT AND MANAGEMENT FOR BUSINESSES, CUSTOMER RELATIONSHIP MANAGEMENT, AND MARKETING FUNCTIONS IN THE FIELDS OF BUSINESS MANAGEMENT, BUSINESS ADMINISTRATION AND INFORMATION MANAGEMENT (U.S. CLS. 100, 101 AND 102).

FIRST USE 10-15-2004, THE MARK WAS FIRST USED ANYWHERE IN A DIFFERENT FORM OTHER THAN THAT SOUGHT TO BE REGISTERED ON 02/13/1999.; IN COMMERCE 10-15-2004, THE MARK WAS FIRST USED IN COMMERCE IN A DIFFERENT FORM OTHER THAN THAT SOUGHT TO BE REGISTERED ON 02/12/1999..

THE MARK CONSISTS OF STANDARD CHARACTERS WITHOUT CLAIM TO ANY PARTICULAR FONT, STYLE, SIZE, OR COLOR.

OWNER OF U.S. REG. NOS. 2,126,986, 2,126,991 AND 2,498,896.

CLASS 35—ADVERTISING AND BUSINESS

FOR ACCOUNTS RECEIVABLE SERVICES (U.S. CLS. 100, 101 AND 102).

FIRST USE 7-26-1993; IN COMMERCE 7-26-1993.

CLASS 36—INSURANCE AND FINANCIAL

FOR FINANCING SERVICES, NAMELY, ASSET-BASED LENDING, AUTOMOBILE LOANS AND CONSUMER LOANS AND FACTORING AGENCIES (U.S. CLS. 100, 101 AND 102).

FIRST USE 7-26-1993; IN COMMERCE 7-26-1993.

CLASS 42—SCIENTIFIC, COMPUTER AND LEGAL SERVICES

FOR PROVIDING TEMPORARY USE OF ON-LINE NON-DOWNLOADABLE SOFTWARE FOR OBTAINING AND VIEWING FINANCIAL, LOAN, FACTORING, AND CREDIT INFORMATION (U.S. CLS. 100 AND 101).

FIRST USE 5-30-2000; IN COMMERCE 5-30-2000.
NICHOLAS ALTREE, EXAMINING ATTORNEY

SN 78-503,923. CODY TURKEY CALLS, LLC, HALIFAX, PA.
FILED 10-21-2004.

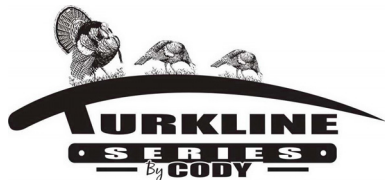

OWNER OF U.S. REG. NOS. 2,853,053, 2,857,544 AND 2,923,901.

NO CLAIM IS MADE TO THE EXCLUSIVE RIGHT TO USE "SERIES", APART FROM THE MARK AS SHOWN.

THE MARK CONSISTS OF A "T" IN THE WORD "TURKLINE" BEING STYLIZED SUCH THAT TURKEYS ARE SEEN WALKING AND GRAZING ALONG THE TOP PART OF THE "T".

CLASS 9—ELECTRICAL AND SCIENTIFIC APPARATUS

FOR AUDIOVISUAL PROGRAMMING DESIGNED TO EDUCATE HUNTING ENTHUSIASTS, NAMELY, PRE-RECORDED VIDEOTAPES, VIDEODISCS, DVDS AND CD-ROMS (U.S. CLS. 21, 23, 26, 36 AND 38).

CLASS 25—CLOTHING

FOR CLOTHING, NAMELY, JACKETS, VESTS, PANTS, SHORTS, HATS, GLOVES, THERMAL UNDERWEAR, HUNTING AND SHOOTING VESTS AND COATS (U.S. CLS. 22 AND 39).

CLASS 28—TOYS AND SPORTING GOODS

FOR ANIMAL CALLS AND ANIMAL CALL ACCESSORIES, NAMELY, STRIKERS, STRIKER SAVERS, GLASS DRESSING STONES AND CALL HOLDERS (U.S. CLS. 22, 23, 38 AND 50).

YONG KIM, EXAMINING ATTORNEY

SN 78-503,945. GOODMAN MEDIA GROUP, INC., NEW YORK, NY. FILED 10-21-2004.

BARBARIANS

THE MARK CONSISTS OF STANDARD CHARACTERS WITHOUT CLAIM TO ANY PARTICULAR FONT, STYLE, SIZE, OR COLOR.

CLASS 9—ELECTRICAL AND SCIENTIFIC APPARATUS

FOR MOTION PICTURE FILMS FEATURING COMEDY, DRAMA, ACTION, ADVENTURE AND/OR ANIMATION, AND MOTION PICTURE FILMS FOR BROADCAST ON TELEVISION FEATURING COMEDY, DRAMA, ACTION, ADVENTURE AND/OR ANIMATION; PRERECORDED VINYL RECORDS, AUDIO TAPES, AUDIO-VIDEO TAPES, VIDEOTAPES, AUDIO VIDEO CASSETTES, VIDEO CASSETTES, AUDIO VIDEO DISCS, VIDEO DISCS, AND DIGITAL VERSATILE DISCS FEATURING MUSIC, COMEDY, DRAMA, ACTION, ADVENTURE, AND/OR ANIMATION; CD ROM COMPUTER GAME DISCS; SHORT MOTION PICTURE FILM CASSETTES AND DISCS FEATURING COMEDY, DRAMA, ACTION, ADVENTURE AND/OR ANIMATION TO BE USED WITH HAND-HELD VIEWERS OR PROJECTORS AND ELECTRICAL CASSETTE AND DISC PLAYERS; MOUSE PADS; AUDIO TAPES, VIDEO TAPES AND PRE-RECORDED DISCS AND BOOKLETS SOLD AS A UNIT FEATURING COMEDY, DRAMA, ACTION, ADVENTURE, ANIMATION AND MUSIC INFORMATION; COMPUTER PROGRAMS, NAMELY, SOFTWARE FOR USE IN HYPERLINKING DIGITIZED VIDEO AND AUDIO MEDIA TO A GLOBAL COMPUTER INFORMATION NETWORK; GAME EQUIPMENT SOLD AS A UNIT FOR PLAYING COMPUTER GAMES, NAMELY JOYSTICKS AND COMPUTER GAME SOFTWARE; VIDEO AND COMPUTER GAME PROGRAMS; VIDEO GAME CARTRIDGES AND CASSETTES; AND DECORATIVE MAGNETS (U.S. CLS. 21, 23, 26, 36 AND 38).

CLASS 16—PAPER GOODS AND PRINTED MATTER

FOR ADDRESS BOOKS; PHOTOGRAPH ALBUMS; APPLIQUES IN THE FORM OF DECALS; APPOINTMENT BOOKS; ARTS AND CRAFT PAINT KITS; AUTOGRAPH BOOKS; BABY BOOKS; PAPER PARTY BAGS; BALL-POINT PENS; BINDERS; BOOKENDS; BOOKMARKS; BOOK COVERS; BOOKS, NAMELY A SERIES OF FICTION BOOKS; PERIODICALS, MAGAZINES AND NEWSPAPERS, FEATURING STORIES, GAMES AND ACTIVITIES FOR CHILDREN; PAPER GIFT WRAP BOWS; PAPER CAKE DECORATIONS; CALENDARS; GIFT CARDS; NOTE CARDS; GREETING CARDS; CARTOON PRINTS, CARTOON STRIPS AND NEWS-PAPER CARTOONS; PEN AND PENCIL CASES; DECORATIVE PAPER CENTERPIECES; CHALK; CHILDREN'S ACTIVITY BOOKS; MODELING CLAY; PAPER TABLE CLOTHS; COLORING BOOKS; COMIC STRIPS; COMIC BOOKS; PAPER PARTY DECORATIONS; DIARIES; GIFT WRAPPING PAPER; PAPER PARTY HATS; PAPER NAPKINS; PENS; PENCILS; STATIONERY; STICKERS; POSTERS; NOTEBOOKS; MEMO PADS; ERASERS; PENCIL SHARPENERS; STAPLERS; WRITING PAPER; ENVELOPES; PAPER WEIGHTS; PAPER COASTERS; PAPER MATS; PAPER PARTY FAVORS; PAPER NAPKINS; PAPER PLACE MATS; PAPER HATS; PRINTED INVITATIONS; PAPER CAKE DECORATIONS; PRINTED TRANSFERS FOR EMBROIDERY OR FABRIC APPLIQUES; PRINTED PATTERNS FOR COSTUMES, PAJAMAS, SWEATSHIRTS AND T-SHIRTS; PAPER PHOTO FRAMES; NON-CALIBRATED DRAWING RULERS; PHOTOGRAPHS; POSTCARDS; AND TRADING CARDS (U.S. CLS. 2, 5, 22, 23, 29, 37, 38 AND 50).

RAUL CORDOVA, EXAMINING ATTORNEY

SN 78-503,978. GOODMAN MEDIA GROUP, INC., NEW YORK, NY. FILED 10-21-2004.

CLASS 16—PAPER GOODS AND PRINTED MATTER

FOR ADDRESS BOOKS; PHOTOGRAPH ALBUMS; APPLIQUES IN THE FORM OF DECALS; APPOINTMENT BOOKS; ARTS AND CRAFT PAINT KITS; AUTOGRAPH BOOKS; BABY BOOKS; PAPER PARTY BAGS; BALL-POINT PENS; BINDERS; BOOKENDS; BOOKMARKS; BOOK COVERS; BOOKS, NAMELY A SERIES OF FICTION BOOKS; PERIODICALS, MAGAZINES AND NEWSPAPERS, FEATURING STORIES, GAMES AND ACTIVITIES FOR CHILDREN AND ADULTS; PAPER GIFT WRAP BOWS; PAPER CAKE DECORATIONS; CALENDARS; GIFT CARDS; NOTE CARDS; GREETING CARDS; CARTOON PRINTS, CARTOON STRIPS AND NEWSPAPER CARTOONS; PEN AND PENCIL CASES; DECORATIVE PAPER CENTERPIECES; CHALK; CHILDREN'S ACTIVITY BOOKS; MODELING CLAY; PAPER TABLE CLOTHS; COLORING BOOKS; COMIC STRIPS; COMIC BOOKS; PAPER PARTY DECORATIONS; DIARIES; GIFT WRAPPING PAPER; PAPER PARTY HATS; PAPER NAPKINS; PENS; PENCILS; STATIONERY; STICKERS; POSTERS; NOTEBOOKS; MEMO PADS; ERASERS; PENCIL SHARPENERS; STAPLERS; WRITING PAPER; ENVELOPES; PAPER WEIGHTS; PAPER COASTERS; PAPER MATS; PAPER PARTY FAVORS; PAPER PLACE MATS; PAPER PARTY HATS; PRINTED INVITATIONS; PRINTED TRANSFERS FOR EMBROIDERY OR FABRIC APPLIQUES; PRINTED PATTERNS FOR COSTUMES, PAJAMAS, SWEATSHIRTS AND T-SHIRTS; NON-CALIBRATED DRAWING RULERS; PHOTOGRAPHS; POSTCARDS; AND TRADING CARDS (U.S. CLS. 2, 5, 22, 23, 29, 37, 38 AND 50).
WON TEAK OH, EXAMINING ATTORNEY

IRON JAW

SN 78-503,986. GOODMAN MEDIA GROUP, INC., NEW YORK, NY. FILED 10-21-2004.

PLANET OF VAMPIRES

THE MARK CONSISTS OF STANDARD CHARACTERS WITHOUT CLAIM TO ANY PARTICULAR FONT, STYLE, SIZE, OR COLOR.

THE MARK CONSISTS OF STANDARD CHARACTERS WITHOUT CLAIM TO ANY PARTICULAR FONT, STYLE, SIZE, OR COLOR.

CLASS 9—ELECTRICAL AND SCIENTIFIC APPARATUS

CLASS 9—ELECTRICAL AND SCIENTIFIC APPARATUS

FOR MOTION PICTURE FILMS FEATURING COMEDY, DRAMA, ACTION, ADVENTURE AND/OR ANIMATION, AND MOTION PICTURE FILMS FOR BROADCAST ON TELEVISION FEATURING COMEDY, DRAMA, ACTION, ADVENTURE AND/OR ANIMATION; PRERECORDED VINYL RECORDS, AUDIO TAPES, AUDIO-VIDEO TAPES, VIDEOTAPES, AUDIO VIDEO CASSETTES, VIDEO CASSETTES, AUDIO VIDEO DISCS, VIDEO DISCS, AND DIGITAL VERSATILE DISCS FEATURING MUSIC, COMEDY, DRAMA, ACTION, ADVENTURE, AND/OR ANIMATION; CD ROM COMPUTER GAME DISCS; SHORT MOTION PICTURE FILM CASSETTES AND DISCS FEATURING COMEDY, DRAMA, ACTION, ADVENTURE AND/OR ANIMATION TO BE USED WITH HAND-HELD VIEWERS OR PROJECTORS AND ELECTRICAL CASSETTE AND DISC PLAYERS; MOUSE PADS; AUDIO TAPES, VIDEO TAPES AND PRE-RECORDED DISCS AND BOOKLETS SOLD AS A UNIT FEATURING COMEDY, DRAMA, ACTION, ADVENTURE, ANIMATION AND MUSIC INFORMATION; COMPUTER PROGRAMS, NAMELY, SOFTWARE LINKING DIGITIZED VIDEO AND AUDIO MEDIA TO A GLOBAL COMPUTER INFORMATION NETWORK; GAME EQUIPMENT, NAMELY JOYSTICKS AND COMPUTER GAME SOFTWARE SOLD AS A UNIT FOR PLAYING COMPUTER GAMES; VIDEO AND COMPUTER GAME PROGRAMS; VIDEO GAME CARTRIDGES AND CASSETTES; AND DECORATIVE MAGNETS (U.S. CLS. 21, 23, 26, 36 AND 38).

FOR MOTION PICTURE FILMS FEATURING COMEDY, DRAMA, ACTION, ADVENTURE AND/OR ANIMATION, AND MOTION PICTURE FILMS FOR BROADCAST ON TELEVISION FEATURING COMEDY, DRAMA, ACTION, ADVENTURE AND/OR ANIMATION; PRERECORDED VINYL RECORDS, AUDIO TAPES, AUDIO-VIDEO TAPES, VIDEOTAPES, AUDIO VIDEO CASSETTES, VIDEO CASSETTES, AUDIO VIDEO DISCS, VIDEO DISCS, AND DIGITAL VERSATILE DISCS FEATURING MUSIC, COMEDY, DRAMA, ACTION, ADVENTURE, AND/OR ANIMATION; CD ROM COMPUTER GAME DISCS; SHORT MOTION PICTURE FILM CASSETTES AND DISCS FEATURING COMEDY, DRAMA, ACTION, ADVENTURE AND/OR ANIMATION TO BE USED WITH HAND-HELD VIEWERS OR PROJECTORS AND ELECTRICAL CASSETTE AND DISC PLAYERS; MOUSE PADS; AUDIO TAPES, VIDEO TAPES AND PRE-RECORDED DISCS AND BOOKLETS SOLD AS A UNIT FEATURING COMEDY, DRAMA, ACTION, ADVENTURE, ANIMATION AND MUSIC INFORMATION; COMPUTER PROGRAMS, NAMELY, SOFTWARE LINKING DIGITIZED VIDEO AND AUDIO MEDIA TO A GLOBAL COMPUTER INFORMATION NETWORK; GAME EQUIPMENT, NAMELY JOYSTICKS AND COMPUTER GAME SOFTWARE SOLD AS A UNIT FOR PLAYING COMPUTER GAMES; VIDEO AND COMPUTER GAME PROGRAMS; VIDEO GAME CARTRIDGES AND CASSETTES; AND DECORATIVE MAGNETS (U.S. CLS. 21, 23, 26, 36 AND 38).

CLASS 16—PAPER GOODS AND PRINTED MATTER

FOR ADDRESS BOOKS; PHOTOGRAPH ALBUMS; APPLIQUES IN THE FORM OF DECALS; APPOINTMENT BOOKS; ARTS AND CRAFT PAINT KITS; AUTOGRAPH BOOKS; BABY BOOKS; PAPER PARTY BAGS; BALL-POINT PENS; BINDERS; BOOKENDS; BOOKMARKS; BOOK COVERS; BOOKS, NAMELY A SERIES OF FICTION BOOKS; PERIODICALS, MAGAZINES AND NEWSPAPERS, FEATURING STORIES, GAMES AND ACTIVITIES FOR CHILDREN AND ADULTS; PAPER GIFT WRAP BOWS; PAPER CAKE DECORATIONS; CALENDARS; GIFT CARDS; NOTE CARDS; GREETING CARDS; CARTOON PRINTS, CARTOON STRIPS AND NEWSPAPER CARTOONS; PEN AND PENCIL CASES; DECORATIVE PAPER CENTERPIECES; CHALK; CHILDREN'S ACTIVITY BOOKS; MODELING CLAY; PAPER TABLE CLOTHS; COLORING BOOKS; COMIC STRIPS; COMIC BOOKS; PAPER PARTY DECORATIONS; DIARIES; GIFT WRAPPING PAPER; PAPER PARTY HATS; PAPER NAPKINS; PENS; PENCILS; STATIONERY; STICKERS; POSTERS; NOTEBOOKS; MEMO PADS; ERASERS; PENCIL SHARPENERS; STAPLERS; WRITING PAPER; ENVELOPES; PAPER WEIGHTS; PAPER COASTERS; PAPER MATS; PAPER PARTY FAVORS; PAPER PLACE MATS; PAPER PARTY HATS; PRINTED INVITATIONS; PRINTED TRANSFERS FOR EMBROIDERY OR FABRIC APPLIQUES; PRINTED PATTERNS FOR COSTUMES, PAJAMAS, SWEATSHIRTS AND T-SHIRTS; NON-CALIBRATED DRAWING RULERS; PHOTOGRAPHS; POSTCARDS; AND TRADING CARDS (U.S. CLS. 2, 5, 22, 23, 29, 37, 38 AND 50).

WON TEAK OH, EXAMINING ATTORNEY

CLASS 9—ELECTRICAL AND SCIENTIFIC APPARATUS

FOR MOTION PICTURE FILMS FEATURING COMEDY, DRAMA, ACTION, ADVENTURE AND/OR ANIMATION, AND MOTION PICTURE FILMS FOR BROADCAST ON TELEVISION FEATURING COMEDY, DRAMA, ACTION, ADVENTURE AND/OR ANIMATION; PRERECORDED VINYL RECORDS, AUDIO TAPES, AUDIO-VIDEO TAPES, VIDEOTAPES, AUDIO VIDEO CASSETTES, VIDEO CASSETTES, AUDIO VIDEO DISCS, VIDEO DISCS, AND DIGITAL VERSATILE DISCS FEATURING MUSIC, COMEDY, DRAMA, ACTION, ADVENTURE, AND/OR ANIMATION; CD ROM COMPUTER GAME DISCS; SHORT MOTION PICTURE FILM CASSETTES AND DISCS FEATURING COMEDY, DRAMA, ACTION, ADVENTURE AND/OR ANIMATION TO BE USED WITH HAND-HELD VIEWERS OR PROJECTORS AND ELECTRICAL CASSETTE AND DISC PLAYERS; MOUSE PADS; AUDIO TAPES, VIDEO TAPES AND PRE-RECORDED DISCS AND BOOKLETS SOLD AS A UNIT FEATURING COMEDY, DRAMA, ACTION, ADVENTURE, ANIMATION AND MUSIC INFORMATION; COMPUTER PROGRAMS, NAMELY, SOFTWARE FOR USE IN HYPER LINKING DIGITIZED VIDEO AND AUDIO MEDIA TO A GLOBAL COMPUTER INFORMATION NETWORK; VIDEO AND COMPUTER GAME PROGRAMS; VIDEO GAME CARTRIDGES AND CASSETTES; AND DECORATIVE MAGNETS (U.S. CLS. 21, 23, 26, 36 AND 38).

CLASS 16—PAPER GOODS AND PRINTED MATTER

FOR ADDRESS BOOKS; PHOTOGRAPH ALBUMS; APPLIQUES IN THE FORM OF DECALS; APPOINTMENT BOOKS; ARTS AND CRAFT PAINT KITS; AUTOGRAPH BOOKS; BABY BOOKS; PAPER PARTY BAGS; BALL-POINT PENS; BINDERS; BOOKENDS; BOOKMARKS; BOOK COVERS; BOOKS, NAMELY A SERIES OF FICTION BOOKS; PERIODICALS, MAGAZINES AND NEWSPAPERS, FEATURING STORIES, GAMES AND ACTIVITIES FOR CHILDREN AND ADULTS; PAPER GIFT WRAP BOWS; PAPER CAKE DECORATIONS; CALENDARS; GIFT CARDS; NOTE CARDS; GREETING CARDS; CARTOON PRINTS, CARTOON STRIPS AND NEWSPAPER CARTOONS; PEN AND PENCIL CASES; DECORATIVE PAPER CENTERPIECES; CHALK; CHILDREN'S ACTIVITY BOOKS; MODELING CLAY; PAPER TABLE CLOTHS; COLORING BOOKS; COMIC STRIPS; COMIC BOOKS; PAPER PARTY DECORATIONS; DIARIES; GIFT WRAPPING PAPER; PAPER PARTY HATS; PAPER NAPKINS; PENS; PENCILS; STATIONERY; STICKERS; POSTERS; NOTEBOOKS; MEMO PADS; ERASERS; PENCIL SHARPENERS; STAPLERS; WRITING PAPER; ENVELOPES; PAPER WEIGHTS; PAPER COASTERS; PAPER MATS; PAPER PARTY FAVORS; PAPER NAPKINS; PAPER PLACE MATS; PAPER HATS; PRINTED INVITATIONS; PAPER CAKE DECORATIONS; PRINTED TRANSFERS FOR EMBROIDERY OR FABRIC APPLIQUES; PRINTED PATTERS FOR COSTUMES, PAJAMAS, SWEATSHIRTS AND T-SHIRTS; NON-CALIBRATED DRAWING RULERS; PHOTOGRAPHS; POSTCARDS; AND TRADING CARDS (U.S. CLS. 2, 5, 22, 23, 29, 37, 38 AND 50).

DEZMONA MIZELLE, EXAMINING ATTORNEY

SN 78-503,999. GOODMAN MEDIA GROUP, INC., NEW YORK, NY. FILED 10-21-2004.

TARGITT

SN 78-504,106. CNF INC., PALO ALTO, CA. FILED 10-21-2004.

CON-WAY EEXPRESS

THE MARK CONSISTS OF STANDARD CHARACTERS WITHOUT CLAIM TO ANY PARTICULAR FONT, STYLE, SIZE, OR COLOR.

THE MARK CONSISTS OF STANDARD CHARACTERS WITHOUT CLAIM TO ANY PARTICULAR FONT, STYLE, SIZE, OR COLOR.

CLASS 35—ADVERTISING AND BUSINESS

FOR BUSINESS CONSULTING SERVICES RELATED TO PRODUCT DISTRIBUTION, OPERATIONS MANAGEMENT SERVICES, LOGISTICS, REVERSE LOGISTICS, SUPPLY CHAIN, AND PRODUCTION SYSTEMS, DISTRIBUTION SOLUTIONS, AND THE SHIPPING AND TRANSPORTATION OF GOODS; BUSINESS MANAGEMENT SERVICES, NAMELY, MANAGING LOGISTICS, REVERSE LOGISTICS, SUPPLY CHAIN SERVICES, SUPPLY CHAIN VISIBILITY AND SYNCHRONIZATION, SUPPLY AND DEMAND FORECASTING AND PRODUCT DISTRIBUTION PROCESSES FOR OTHERS (U.S. CLS. 100, 101 AND 102).

FIRST USE 8-0-2004; IN COMMERCE 8-0-2004.

CLASS 39—TRANSPORTATION AND STORAGE

FOR SUPPLY CHAIN, LOGISTICS AND REVERSE LOGISTICS SERVICES, NAMELY, PICK UP, STORAGE, TRANSPORTATION, AND DELIVERY OF DOCUMENTS, PACKAGES, RAW MATERIALS, AND OTHER FREIGHT FOR OTHERS BY AIR, RAIL, SHIP OR TRUCK; FREIGHT FORWARDING SERVICES; TRANSPORTATION OF THE GOODS OF OTHERS BY AIR, RAIL, SHIP, OR TRUCK; WAREHOUSING SERVICES, NAMELY, STORAGE, DISTRIBUTION, PICK UP, AND PACKING FOR SHIPMENT OF DOCUMENTS, PACKAGES, RAW MATERIALS, AND OTHER FREIGHT FOR OTHERS (U.S. CLS. 100 AND 105).

FIRST USE 8-0-2004; IN COMMERCE 8-0-2004.
BRENDAN MCCAULEY, EXAMINING ATTORNEY

SN 78-504,109. THERAPEUTIC ASSOCIATES, INC., SEATTLE, WA. FILED 10-21-2004.

**CLASS 16—PAPER GOODS AND PRINTED MATTER**

FOR PRINTED MATTER, NAMELY, BOOKS, PAMPHLETS, MAGAZINES, JOURNALS, NEWSLETTERS, AND PRINTED TEACHING AND EDUCATIONAL MATERIALS IN THE FIELDS OF HEALTHCARE AND HEALTHCARE MANAGEMENT (U.S. CLS. 2, 5, 22, 23, 29, 37, 38 AND 50).

FIRST USE 0-0-1998; IN COMMERCE 0-0-1998.

CLASS 35—ADVERTISING AND BUSINESS

FOR BUSINESS MANAGEMENT CONSULTING SERVICES, NAMELY, CLINICAL HEALTHCARE PRACTICE MANAGEMENT CONSULTING SERVICES; PROVIDING BUSINESS MANAGEMENT INFORMATION AND CONSULTING SERVICES IN THE FIELD OF ADMINISTRATIVE STRUCTURE TO HEALTHCARE PROVIDERS; PROVIDING HEALTHCARE BUSINESS INFORMATION MANAGEMENT SERVICES TO HEALTHCARE PROVIDERS AND HEALTHCARE INSURERS, NAMELY, PROVIDING PATIENT SATISFACTION INFORMATION AND CLINICAL OUTCOME REPORTS, PROVIDING INFORMATION CONCERNING CLINICAL TREATMENT PROTOCOLS, PROVIDING DATA, REPORTS AND INTERPRETATIONS CONCERNING UTILIZATION OF HEALTHCARE SERVICES; PROVIDING HEALTHCARE PRACTICE MANAGEMENT SERVICES TO HEALTHCARE PROVIDERS AND HEALTHCARE INSURERS (U.S. CLS. 100, 101 AND 102).

FIRST USE 0-0-1998; IN COMMERCE 0-0-1998.

CLASS 42—SCIENTIFIC, COMPUTER AND LEGAL SERVICES

FOR PROVIDING TEMPORARY USE OF NON-DOWNLOADABLE SOFTWARE FOR THE ADMINISTRATION, DISTRIBUTION, COLLECTION, REPORTING AND ANALYSIS OF PATIENT INFORMATION AND EFFECTIVENESS OF TREATMENT INFORMATION (U.S. CLS. 100 AND 101).

FIRST USE 0-0-1998; IN COMMERCE 0-0-1998.

CLASS 44—MEDICAL, BEAUTY AND AGRICULTURAL SERVICES

FOR PROVISION OF PHYSICAL, OCCUPATIONAL, SPEECH AND MASSAGE THERAPY SERVICES; PROVISION OF HEALTHCARE INFORMATION TO PATIENTS, PHYSICIANS, NURSE PRACTITIONERS, PHYSICIAN'S ASSISTANTS, CASE MANAGERS AND PAYERS IN THE HEALTHCARE FIELD (U.S. CLS. 100 AND 101).

FIRST USE 0-0-1998; IN COMMERCE 0-0-1998.
JOHN DWYER, EXAMINING ATTORNEY

SN 78-504,111. CNF INC., PALO ALTO, CA. FILED 10-21-2004.

CLASS 35—ADVERTISING AND BUSINESS

FOR BUSINESS CONSULTING SERVICES RELATED TO PRODUCT DISTRIBUTION, OPERATIONS MANAGEMENT SERVICES, LOGISTICS, REVERSE LOGISTICS, SUPPLY CHAIN, AND PRODUCTION SYSTEMS, DISTRIBUTION SOLUTIONS, AND THE SHIPPING AND TRANSPORTATION OF GOODS; BUSINESS MANAGEMENT SERVICES, NAMELY, MANAGING LOGISTICS, REVERSE LOGISTICS, SUPPLY CHAIN SERVICES, SUPPLY CHAIN VISIBILITY AND SYNCHRONIZATION, SUPPLY AND DEMAND FORECASTING AND PRODUCT DISTRIBUTION PROCESSES FOR OTHERS (U.S. CLS. 100, 101 AND 102).

FIRST USE 8-0-2004; IN COMMERCE 8-0-2004.

CLASS 39—TRANSPORTATION AND STORAGE

FOR SUPPLY CHAIN, LOGISTICS AND REVERSE LOGISTICS SERVICES, NAMELY, PICK UP, STORAGE, TRANSPORTATION, AND DELIVERY OF DOCUMENTS, PACKAGES, RAW MATERIALS, AND OTHER FREIGHT FOR OTHERS BY AIR, RAIL, SHIP OR TRUCK; FREIGHT FORWARDING SERVICES; TRANSPORTATION OF THE GOODS OF OTHERS BY AIR, RAIL, SHIP, OR TRUCK; WAREHOUSING SERVICES, NAMELY, STORAGE, DISTRIBUTION, PICK UP, AND PACKING FOR SHIPMENT OF DOCUMENTS, PACKAGES, RAW MATERIALS, AND OTHER FREIGHT FOR OTHERS (U.S. CLS. 100 AND 105).

FIRST USE 8-0-2004; IN COMMERCE 8-0-2004.

BRENDAN MCCAULEY, EXAMINING ATTORNEY

SN 78-504,768. CHC DEVELOPMENT CO., INC., ST. GEORGE, UT. FILED 10-22-2004.

GREEN VALLEY SPA

SN 78-504,244. RSP ARCHITECTS, LTD, MINNEAPOLIS, MN. FILED 10-22-2004.

RSP

THE MARK CONSISTS OF STANDARD CHARACTERS WITHOUT CLAIM TO ANY PARTICULAR FONT, STYLE, SIZE, OR COLOR.

OWNER OF U.S. REG. NO. 2,473,460.

CLASS 35—ADVERTISING AND BUSINESS

FOR BUSINESS MANAGEMENT CONSULTATION SERVICES RELATING TO EMERGENCY RESPONSE; BUSINESS MANAGEMENT CONSULTATION SERVICES RELATING TO FACILITIES MANAGEMENT OF TECHNICAL OPERATIONS; BUSINESS MANAGEMENT CONSULTATION SERVICES, NAMELY, PROVIDING BUILDING FLOOR PLANS AND BUILDING INFORMATION FOR USE BY FIREFIGHTERS, POLICE AND OTHER EMERGENCY PERSONNEL FOR EMERGENCY RESPONSE PLANNING; PROVIDING ON-LINE COMPUTER DATABASES FEATURING BUILDING FLOOR PLANS AND BUILDING INFORMATION FOR USE BY FIREFIGHTERS, POLICE AND OTHER EMERGENCY PERSONNEL FOR EMERGENCY RESPONSE PLANNING; PROVIDING ON-LINE COMPUTER DATABASES FEATURING INFORMATION ABOUT FACILITIES MANAGEMENT OF TECHNICAL OPERATIONS (U.S. CLS. 100, 101 AND 102).

FIRST USE 12-7-2000; IN COMMERCE 12-7-2000.

CLASS 45—PERSONAL SERVICES

FOR PROVIDING CONSULTATION AND INFORMATION IN THE FIELD OF EMERGENCY RESPONSE FOR COMMUNITIES (U.S. CLS. 100 AND 101).

FIRST USE 12-7-2000; IN COMMERCE 12-7-2000.

BARBARA A. GOLD, EXAMINING ATTORNEY

THE MARK CONSISTS OF STANDARD CHARACTERS WITHOUT CLAIM TO ANY PARTICULAR FONT, STYLE, SIZE, OR COLOR.

NO CLAIM IS MADE TO THE EXCLUSIVE RIGHT TO USE "SPA", APART FROM THE MARK AS SHOWN.

CLASS 3—COSMETICS AND CLEANING PREPARATIONS

FOR SKIN CARE PREPARATIONS, AND HAIR CARE PREPARATIONS (U.S. CLS. 1, 4, 6, 50, 51 AND 52).

FIRST USE 7-10-1987; IN COMMERCE 7-10-1987.

CLASS 41—EDUCATION AND ENTERTAINMENT

FOR PROVIDING TENNIS COURT FACILITIES; TENNIS INSTRUCTION; PROVIDING GOLF FACILITIES; GOLF INSTRUCTION; HEALTH CLUB SERVICES, NAMELY PROVIDING INSTRUCTION AND EQUIPMENT IN THE FIELD OF PHYSICAL EXERCISE; EDUCATIONAL SERVICES, NAMELY CONDUCTING PROGRAMS AND SEMINARS ON HEALTH, PHYSICAL FITNESS, MENTAL AND SPIRITUAL WELL-BEING (U.S. CLS. 100, 101 AND 107).

FIRST USE 4-15-1984; IN COMMERCE 4-15-1984.

CLASS 43—HOTEL AND RESTAURANT SERVICES

FOR HEALTH RESORT SERVICES, NAMELY PROVIDING FOOD AND LODGING THAT SPECIALIZE IN PROMOTING PATRONS' GENERAL HEALTH AND WELL-BEING; RESTAURANT SERVICES (U.S. CLS. 100 AND 101).

FIRST USE 4-15-1984; IN COMMERCE 4-15-1984.

CLASS 44—MEDICAL, BEAUTY AND AGRICULTURAL SERVICES

FOR HEALTH SPA SERVICES FOR HEALTH AND WELLNESS OF THE BODY AND SPIRIT OFFERED AT A HEALTH RESORT; HEALTH SPA SERVICES, NAMELY, COSMETIC BODY CARE SERVICES; PROVIDING HEALTH INFORMATION; MEDICAL EVALUATION AND COUNSELING SERVICES IN THE FIELD OF HEALTH AND PHYSICAL FITNESS; MEDICAL TESTING SERVICES IN THE FIELD OF HEALTH AND PHYSICAL FITNESS (U.S. CLS. 100 AND 101).

FIRST USE 7-10-1987; IN COMMERCE 7-10-1987.

ESTHER BELENKER, EXAMINING ATTORNEY

SN 78-504,913. B&B ISLAND DISTRIBUTING LLC, HONOLULU, HI. FILED 10-24-2004.

...GO HAWAIIAN!

THE MARK CONSISTS OF STANDARD CHARACTERS WITHOUT CLAIM TO ANY PARTICULAR FONT, STYLE, SIZE, OR COLOR.

NO CLAIM IS MADE TO THE EXCLUSIVE RIGHT TO USE "HAWAIIAN", APART FROM THE MARK AS SHOWN.

CLASS 3—COSMETICS AND CLEANING PREPARATIONS

FOR SUN CARE PRODUCTS, NAMELY, SUN TAN OILS AND LOTIONS, SUN SCREEN OIL AND LOTIONS WITH AN SPF SUN SCREEN, SUNSCREENS FOR LIPS WITH AN SPF, SUN SCREEN FOR SCALP WITH AN SPF AND AFTER-SUN LOTIONS (U.S. CLS. 1, 4, 6, 50, 51 AND 52).
FIRST USE 1-8-2003; IN COMMERCE 1-8-2003.

CLASS 5—PHARMACEUTICALS

FOR MEDICATED BURN RELIEF GELS (U.S. CLS. 6, 18, 44, 46, 51 AND 52).
FIRST USE 1-8-2003; IN COMMERCE 1-8-2003.

CLASS 25—CLOTHING

FOR T-SHIRTS AND HATS (U.S. CLS. 22 AND 39).
FIRST USE 1-8-2003; IN COMMERCE 1-8-2003.
INGA ERVIN, EXAMINING ATTORNEY

CLASS 6—METAL GOODS

FOR MANUALLY OPERATED METAL VALVES AND LINE-STOPPING VALVES WHICH STOP THE FLOW OF WATER OR GAS IN WATER PIPES, GAS PIPES, AND PETRO-CHEMICAL PIPES USED FOR INDUSTRIAL PURPOSES (U.S. CLS. 2, 12, 13, 14, 23, 25 AND 50).
FIRST USE 7-2-2003; IN COMMERCE 7-2-2003.

CLASS 7—MACHINERY

FOR EQUIPMENT, NAMELY TAPPING EQUIPMENT USED TO CUT AN ACCESS IN A PIPE FOR THE FITTING OF A VALVE (U.S. CLS. 13, 19, 21, 23, 31, 34 AND 35).
FIRST USE 7-2-2003; IN COMMERCE 7-2-2003.
RONALD MCMORROW, EXAMINING ATTORNEY

SN 78-505,555. DUGAN'S INC., WINTERSET, IA. FILED 10-25-2004.

SN 78-505,352. ADVANCED VALVE TECHNOLOGIES, INC., LAPORTE, IN. FILED 10-25-2004.

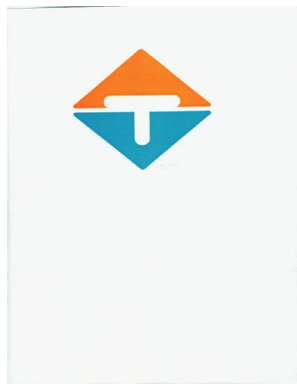

THE COLOR(S) ORANGE, WHITE AND BLUE IS/ARE CLAIMED AS A FEATURE OF THE MARK.
THE MARK CONSISTS OF THE MARK CONSISTS OF A DIAMOND OF WHICH THE TOP HALF IS ORANGE AND THE BOTTOM HALF IS BLUE. THE LETTER "T" IN WHITE LETTERING IS IMPOSED OVER THE DIAMOND.

Harvest Creek

THE MARK CONSISTS OF STANDARD CHARACTERS WITHOUT CLAIM TO ANY PARTICULAR FONT, STYLE, SIZE, OR COLOR.

CLASS 30—STAPLE FOODS

FOR CANDIES AND COFFEE (U.S. CL. 46).
FIRST USE 7-0-2001; IN COMMERCE 7-0-2001.

CLASS 35—ADVERTISING AND BUSINESS

FOR RETAIL STORE SERVICES FEATURING GENERAL CONSUMER MERCHANDISE (U.S. CLS. 100, 101 AND 102).
FIRST USE 8-27-2004; IN COMMERCE 8-27-2004.
GRETTA YAO, EXAMINING ATTORNEY

SN 78-505,893. 8X8, INC., SANTA CLARA, CA. FILED 10-26-2004.

SN 78-506,806. WEST VIRGINIA HIGH TECHNOLOGY CONSORTIUM FOUNDATION, FAIRMONT, WV. FILED 10-27-2004.

8X8

THE MARK CONSISTS OF STANDARD CHARACTERS WITHOUT CLAIM TO ANY PARTICULAR FONT, STYLE, SIZE, OR COLOR.

OWNER OF U.S. REG. NOS. 2,212,310, 2,360,445 AND OTHERS.

CLASS 9—ELECTRICAL AND SCIENTIFIC APPARATUS

FOR COMPUTER HARDWARE THAT ENABLES VIDEO COMMUNICATIONS, VOICE COMMUNICATIONS, VOICE-OVER INTERNET PROTOCOL COMMUNICATIONS, VIDEO-OVER INTERNET PROTOCOL COMMUNICATIONS, ONLINE COMMUNICATIONS, VOICE-OVER-DIGITAL-SUBSCRIBER LINE COMMUNICATIONS, VIDEO-OVER-DIGITAL-SUBSCRIBER LINE COMMUNICATIONS, VOICE MAIL, VIDEO MAIL, CALL FORWARDING, CALLER ID, CONFERENCING, CUSTOMIZED PHONE NUMBER DIRECTORIES, CALL ROUTING SERVICES AND VOICE-OVER DIGITAL LINE COMMUNICATIONS; COMPUTER SOFTWARE THAT ENABLES VIDEO COMMUNICATIONS, VOICE COMMUNICATIONS, VOICE-OVER INTERNET PROTOCOL COMMUNICATIONS, VIDEO-OVER INTERNET PROTOCOL COMMUNICATIONS, ONLINE COMMUNICATIONS, VOICE-OVER-DIGITAL-SUBSCRIBER LINE COMMUNICATIONS, VIDEO-OVER-DIGITAL-SUBSCRIBER LINE COMMUNICATIONS, VOICE MAIL, VIDEO MAIL, CALL FORWARDING, CALLER ID, CONFERENCING, CUSTOMIZED PHONE NUMBER DIRECTORIES, CALL ROUTING SERVICES AND VOICE-OVER DIGITAL LINE COMMUNICATIONS (U.S. CLS. 21, 23, 26, 36 AND 38).

FIRST USE 4-0-1996; IN COMMERCE 4-0-1996.

CLASS 38—COMMUNICATION

FOR INTERNET TELEPHONY SERVICES, STREAMING OF AUDIO AND VIDEO MATERIAL ON THE INTERNET, LOCAL AND LONG DISTANCE TELEPHONE SERVICES, VOICE MAIL SERVICES, VIDEO MAIL SERVICES, CALL FORWARDING SERVICES, CALLER ID SERVICES, TELEPHONE CONFERENCING SERVICES AND TELEPHONY CALL ROUTING SERVICES (U.S. CLS. 100, 101 AND 104).

FIRST USE 11-1-2002; IN COMMERCE 11-1-2002.

CLASS 42—SCIENTIFIC, COMPUTER AND LEGAL SERVICES

FOR TECHNICAL SUPPORT SERVICES, NAMELY, IMPLEMENTING AND TROUBLESHOOTING OF COMPUTER HARDWARE AND SOFTWARE PROBLEMS FOR WEB-BASED CUSTOMERS (U.S. CLS. 100 AND 101).

FIRST USE 11-1-2002; IN COMMERCE 11-1-2002.
INGA ERVIN, EXAMINING ATTORNEY

GLOBAL GRID
EXCHANGE

NO CLAIM IS MADE TO THE EXCLUSIVE RIGHT TO USE "GLOBAL GRID EXCHANGE", APART FROM THE MARK AS SHOWN.

THE COLORS GREEN AND BLACK ARE CLAIMED AS FEATURES OF THE MARK.

THE COLOR GREEN APPEARS AS A FORWARD SLASH IN THE LETTER X AND THE REMAINDER OF THE MARK IS BLACK.

CLASS 36—INSURANCE AND FINANCIAL

FOR GRID COMPUTING SERVICES, NAMELY, BROKERING USE OF THE EXCESS COMPUTING CAPACITY OF COMPUTERS THAT ARE ACCESSED VIA THE INTERNET (U.S. CLS. 100, 101 AND 102).

FIRST USE 9-28-2004; IN COMMERCE 9-29-2004.

CLASS 42—SCIENTIFIC, COMPUTER AND LEGAL SERVICES

FOR COMPUTER SERVICES, NAMELY, ANALYZING THE COMPUTATIONAL NEEDS OF OTHERS AND DIVIDING THEM INTO DISCRETE UNITS FOR SOLUTION ON AN AGGREGATE COMPUTER GRID PLATFORM AND NETWORK (U.S. CLS. 100 AND 101).

FIRST USE 9-28-2004; IN COMMERCE 9-29-2004.
MELVIN AXILBUND, EXAMINING ATTORNEY

SN 78-507,277. HISTORY ASSOCIATES INCORPORATED, ROCKVILLE, MD. FILED 10-28-2004.

The Best Company
in History

THE MARK CONSISTS OF STANDARD CHARACTERS WITHOUT CLAIM TO ANY PARTICULAR FONT, STYLE, SIZE, OR COLOR.

CLASS 35—ADVERTISING AND BUSINESS

FOR RECORDS AND ARCHIVAL MANAGEMENT CONSULTING SERVICES (U.S. CLS. 100, 101 AND 102).

FIRST USE 9-0-2000; IN COMMERCE 9-0-2000.

CLASS 39—TRANSPORTATION AND STORAGE

FOR WAREHOUSING SERVICES, NAMELY, DOCUMENT AND ARTIFACT STORAGE FOR OTHERS (U.S. CLS. 100 AND 105).

FIRST USE 9-0-2000; IN COMMERCE 9-0-2000.

CLASS 42—SCIENTIFIC, COMPUTER AND LEGAL SERVICES

FOR HISTORICAL RESEARCH AND ANALYSIS, NAMELY, REVIEWING HISTORICAL SOURCES, TAKING ORAL HISTORIES, AND PRESENTING FINDINGS IN REPORTS, EXHIBITS, AND OTHER MEDIA; AND LITIGATION SUPPORT SERVICES, NAMELY, HISTORICAL RESEARCH AND ANALYSIS FOR LITIGATION (U.S. CLS. 100 AND 101).

FIRST USE 9-0-2000; IN COMMERCE 9-0-2000.
JULIE WATSON, EXAMINING ATTORNEY

SN 78-507,699. NORTHROP GRUMMAN CORPORATION, LOS ANGELES, CA. FILED 10-28-2004.

TERRA HAWK

SN 78-507,595. STONE SPA, LTD., NEW YORK, NY. FILED 10-28-2004.

ECOLUX

THE MARK CONSISTS OF STANDARD CHARACTERS WITHOUT CLAIM TO ANY PARTICULAR FONT, STYLE, SIZE, OR COLOR.

CLASS 3—COSMETICS AND CLEANING PREPARATIONS

FOR FACIAL MASK CREAMS AND FACIAL SCRUB CREAMS; NON-MEDICATED SKIN CARE PRODUCTS, NAMELY, FACE AND BODY LOTIONS, FACE AND BODY GELS AND FACE AND BODY CREAMS; NON-MEDICATED BATH SALTS, BATH MINERALS, BATH OILS AND BATH CRYSTALS; NON-MEDICATED TALCUM BODY POWDER; SKIN EMOLLIENTS, ESSENTIAL OILS FOR PERSONAL USE AND MASSAGE OIL; BATH GEL, FOOT CREAMS, LOTIONS, AND GELS; EYE CREAMS, LOTIONS, AND GELS, BODY SCRUBS (U.S. CLS. 1, 4, 6, 50, 51 AND 52).

CLASS 44—MEDICAL, BEAUTY AND AGRICULTURAL SERVICES

FOR SPA SERVICES, NAMELY MASSAGE THERAPY, HYDROTHERAPY MASSAGE SERVICES, WATER MASSAGE THERAPY, AND STEAM THERAPY; COSMETIC SERVICES, NAMELY FACIALS, WAXING, NAIL CARE, PEDICURES, HYDROTHERAPY INCLUDING WATER THERAPY AND STEAM THERAPY; SKIN CARE SALON TREATMENTS IN THE NATURE OF FACIALS, REFLEXOLOGY, MANICURES, PEDICURES, BODY POLISHING, BODY WRAPS, BODY SCRUBS AND BODY TREATMENTS; HEALTH SPA SERVICES FOR HEALTH AND WELLNESS OF THE BODY AND SPIRIT OFFERED AT A HEALTH RESORT AND COSMETIC BODY CARE SERVICES (U.S. CLS. 100 AND 101).

LAURA KOVAISKY, EXAMINING ATTORNEY

THE MARK CONSISTS OF STANDARD CHARACTERS WITHOUT CLAIM TO ANY PARTICULAR FONT, STYLE, SIZE, OR COLOR.

CLASS 9—ELECTRICAL AND SCIENTIFIC APPARATUS

FOR AIRBORNE SURVEILLANCE AND AIRCRAFT CONTROL APPARATUS, NAMELY, RADARS, LOW LIGHT CAMERAS, THERMAL IMAGING CAMERAS, GPS RECEIVERS, RADIO ALTIMETERS, INERTIAL NAVIGATION SYSTEMS AND GROUND PROXIMITY SENSORS (U.S. CLS. 21, 23, 26, 36 AND 38).

CLASS 12—VEHICLES

FOR VEHICLES; NAMELY UNMANNED AERIAL VEHICLES (U.S. CLS. 19, 21, 23, 31, 35 AND 44).

CLASS 28—TOYS AND SPORTING GOODS

FOR SCALE MODEL AIRCRAFT (U.S. CLS. 22, 23, 38 AND 50).

GLENN CLARK, EXAMINING ATTORNEY

SN 78-507,817. AARDVARK COMPUTER SERVICE, LTD., BROOMFIELD, CO. FILED 10-28-2004.

**SMARTPOINT**

IT Planning & Implementation

NO CLAIM IS MADE TO THE EXCLUSIVE RIGHT TO USE "IT PLANNING & IMPLEMENTATION", APART FROM THE MARK AS SHOWN.

CLASS 37—CONSTRUCTION AND REPAIR

FOR INSTALLATION AND MAINTENANCE OF COMPUTER NETWORKS (U.S. CLS. 100, 103 AND 106).

FIRST USE 10-21-2004; IN COMMERCE 10-21-2004.

CLASS 42—SCIENTIFIC, COMPUTER AND LEGAL SERVICES

FOR COMPUTER CONSULTATION SERVICES IN THE NATURE OF PROVIDING TECHNICAL ASSISTANCE RELATING TO THE IMPLEMENTATION, INTEGRATION, CONDUCT AND MAINTENANCE OF SOFTWARE AND NETWORK EQUIPMENT INVOLVING ELECTRONIC COMMERCE ACTIVITIES AND COMPUTER NETWORKS, INCLUDING LOCAL AREA NETWORKS AND WIDE AREA NETWORKS, DESIGNING, CREATING, IMPLEMENTING, TECHNICAL MONITORING AND MAINTAINING COMPUTER SYSTEMS FOR OTHERS, TECHNICAL CONSULTATION IN THE FIELD OF COMPUTER SYSTEM INTEGRATION, TECHNICAL CONSULTATION IN THE FIELD OF VOICE OVER INTERNET PROTOCOL (VOIP) TELEPHONY FOR OTHERS, TECHNICAL CONSULTATION FOR WIRELESS COMPUTER NETWORKS FOR OTHERS, TECHNICAL CONSULTATION IN THE FIELD OF COMPUTER SECURITY AND AUDITING, TECHNICAL CONSULTATION IN THE FIELD OF ETHERNET BASED SECURITY CAMERAS, COMPUTER SECURITY SERVICES, NAMELY, RESTRICTING ACCESS TO AND BY COMPUTER NETWORKS TO AND OF UNDESIRED WEB SITES, MEDIA AND INDIVIDUALS AND FACILITIES (U.S. CLS. 100 AND 101).

FIRST USE 10-21-2004; IN COMMERCE 10-21-2004.
MICHAEL KEATING, EXAMINING ATTORNEY

CLASS 5—PHARMACEUTICALS

FOR MEDICATED SKIN CARE PREPARATIONS, MEDICATED CLEANSERS, TONERS, MOISTURIZERS, CREAMS FOR SKIN CARE, MEDICAL MEDICATED LOTION FOR SKIN CARE PREPARATIONS, MEDICATED SKIN PREPARATIONS FOR USE IN TREATING ACNE, BLEMISHES, MEDICATED WRINKLE REMOVING SKIN CARE PREPARATION, SKIN CARE KITS COMPRISING, MEDICATED ACNE CLEANSERS, MEDICATED ACNE WASHES, FACIAL PIGMENT CONTROL, FACIAL EXFOLIANTS (U.S. CLS. 6, 18, 44, 46, 51 AND 52).

FIRST USE 11-1-2003; IN COMMERCE 11-1-2003.
JIM RINGLE, EXAMINING ATTORNEY

SN 78-509,155. MORENO VALLEY PROPERTIES, MORENO VALLEY, CA. FILED 11-1-2004.

SN 78-508,950. SPERON, SAM, PARK RIDGE, IL. FILED 11-1-2004.

Humans Can Live
Weeks Without Food,
Days Without Water,
But Only Minutes
Without Oxygen.

AQUABELLA

THE MARK CONSISTS OF STANDARD CHARACTERS WITHOUT CLAIM TO ANY PARTICULAR FONT, STYLE, SIZE, OR COLOR.

CLASS 3—COSMETICS AND CLEANING PREPARATIONS

FOR NON MEDICATED COSMETICS, SKIN CARE PRODUCTS, AND HAIR CARE PRODUCTS, NAMELY, SKIN SERUMS, LOTIONS, WRINKLE REMOVING SKIN CARE PREPARATIONS, SKIN AND HAIR CARE SOAPS, SKIN CLARIFIERS, SKIN CLEANSING CREAMS, LOTIONS, CONDITIONERS, MOISTURIZERS, SKIN LIGHTENERS, TEXTURIZERS, TOPICAL SKIN SPRAYS FOR TANNING, SHAMPOOS, WASHES, TONERS, SKIN CARE KITS COMPRISING, FACIAL CLEANSERS, WASHES, FACIAL TONERS, FACIAL MOISTURIZING CREAMS, SUN BLOCK PROTECTION, EYE CREAMS AND BODY LOTIONS (U.S. CLS. 1, 4, 6, 50, 51 AND 52).

FIRST USE 11-1-2003; IN COMMERCE 11-1-2003.

THE MARK CONSISTS OF STANDARD CHARACTERS WITHOUT CLAIM TO ANY PARTICULAR FONT, STYLE, SIZE, OR COLOR.

THE FOREIGN WORDING IN THE MARK TRANSLATES INTO ENGLISH AS BEAUTIFUL WATER.

CLASS 36—INSURANCE AND FINANCIAL

FOR REAL ESTATE CONSULTING; REAL ESTATE MANAGEMENT; AND REAL ESTATE BROKERAGE SERVICES (U.S. CLS. 100, 101 AND 102).

FIRST USE 8-26-2004; IN COMMERCE 8-26-2004.

CLASS 37—CONSTRUCTION AND REPAIR

FOR REAL ESTATE DEVELOPMENT (U.S. CLS. 100, 103 AND 106).

FIRST USE 8-26-2004; IN COMMERCE 8-26-2004.
DOMINIC J. FERRAIUOLO, EXAMINING ATTORNEY

SN 78-509,584. TRACFONE WIRELESS, INC., MIAMI, FL. FILED 11-2-2004.

NET-10

THE MARK CONSISTS OF STANDARD CHARACTERS WITHOUT CLAIM TO ANY PARTICULAR FONT, STYLE, SIZE, OR COLOR.

CLASS 36—INSURANCE AND FINANCIAL

FOR MONITORING THE USE OF DEBIT CARDS (U.S. CLS. 100, 101 AND 102).

CLASS 38—COMMUNICATION

FOR PROVIDING MONITORING AND CONTROL SERVICES FOR USE IN CONJUNCTION WITH PREPAID AIR TIME CELLULAR AND MOBILE PHONES (U.S. CLS. 100, 101 AND 104).
HOWARD B. LEVINE, EXAMINING ATTORNEY

SN 78-509,782. GROOMER, SANDRA, FRISCO, TX. FILED 11-2-2004.

CHULITA

THE MARK CONSISTS OF STANDARD CHARACTERS WITHOUT CLAIM TO ANY PARTICULAR FONT, STYLE, SIZE, OR COLOR.

CLASS 9—ELECTRICAL AND SCIENTIFIC APPARATUS

FOR CHILDREN'S ENTERTAINMENT VIDEO AND AUDIO RECORDINGS; CHILDREN'S ENTERTAINMENT SOFTWARE; CHILDREN'S EDUCATIONAL SOFTWARE; VIDEO GAME SOFTWARE; VIDEO GAME MACHINES FOR USE WITH TELEVISIONS (U.S. CLS. 21, 23, 26, 36 AND 38).

CLASS 16—PAPER GOODS AND PRINTED MATTER

FOR PRINTED MATTER, NAMELY CHILDREN'S BOOKS, COLORING BOOKS, COMIC BOOKS, NOTE PAPER, STATIONERY, NOTE CARDS, NOTEBOOKS, BINDERS, FOLDERS, PHOTO ALBUMS, SCRAPBOOKS, ADDRESS BOOKS, CALENDARS, BOOK COVERS, BOOKMARKS, DECALS, TRADING CARDS, POSTERS, BULLETIN BOARDS, PENCILS, PENS, MARKERS, PEN AND PENCIL CASES, GIFT WRAPPING PAPER, GIFT AND GREETING CARDS (U.S. CLS. 2, 5, 22, 23, 29, 37, 38 AND 50).

CLASS 18—LEATHER GOODS

FOR PURSES AND HANDBAGS; BACKPACKS; ATHLETIC BAGS; BOOK BAGS; TRAVEL BAGS; TOTE BAGS; VANITY CASES SOLD EMPTY; OVERNIGHT AND TOILETRY CASES SOLD EMPTY; UMBRELLAS; LUGGAGE AND LUGGAGE TAGS (U.S. CLS. 1, 2, 3, 22 AND 41).

CLASS 25—CLOTHING

FOR CHILDREN'S CLOTHING, NAMELY DRESSES, SKIRTS, BLOUSES, SHIRTS, PANTS, SHORTS, SWEATERS, HALLOWEEN COSTUMES, SLEEPWEAR, UNDERGARMENTS, JACKETS, GLOVES AND NECKWEAR; CHILDREN'S HEADWEAR, NAMELY HATS AND HEADBANDS; CHILDREN'S FOOTWEAR, NAMELY HOSIERY AND SHOES (U.S. CLS. 22 AND 39).

CLASS 28—TOYS AND SPORTING GOODS

FOR TOYS AND PLAYTHINGS, NAMELY DOLLS, DOLL CLOTHING, DOLL ACCESSORIES, PLUSH TOYS, PUPPETS, ACTION FIGURES, ACTION FIGURE ACCESSORIES, CHILDREN'S PLAY COSMETICS, TOY VEHICLES, CRAFT SETS, PARTY FAVORS AND CHRISTMAS TREE DECORATIONS; GAMES, NAMELY ARCADE GAMES, ACTION SKILL GAMES, BOARD GAMES, CARD GAMES, PUZZLES, AND STAND ALONE VIDEO GAME MACHINES, ELECTRONIC STAND ALONE AMUSEMENT GAME MACHINES; SPORTING ARTICLES, NAMELY SKATES, ROLLER SKATES, SKATE BOARDS, FOOTBALLS, BASKETBALLS, SOCCER BALLS, BASEBALLS, BASEBALL BATS, AND BASEBALL GLOVES, SWIM FINS, SWIM MASKS, SWIM FLOATS, AND ATHLETIC PROTECTIVE PADS FOR USE PLAYING FOOTBALL, SOCCER, BASEBALL AND HOCKEY (U.S. CLS. 22, 23, 38 AND 50).

CLASS 41—EDUCATION AND ENTERTAINMENT

FOR ENTERTAINMENT, NAMELY, TELEVISION PROGRAMS, MOTION PICTURES, AND TELEVISION AND RADIO PROGRAMS DISTRIBUTED THROUGH A COMPUTER NETWORK IN THE FIELD OF CHILDREN'S ANIMATED ENTERTAINMENT (U.S. CLS. 100, 101 AND 107).
TRACY FLETCHER, EXAMINING ATTORNEY

SN 78-510,119. ZANE STATE COLLEGE, ZANESVILLE, OH.
FILED 11-2-2004.



CLASS 25—CLOTHING

FOR CLOTHING, NAMELY, T-SHIRTS, SWEAT-SHIRTS, SWEATPANTS, AND HATS (U.S. CLS. 22 AND 39).

FIRST USE 10-1-2004; IN COMMERCE 10-1-2004.

CLASS 41—EDUCATION AND ENTERTAINMENT

FOR EDUCATION SERVICES IN THE NATURE OF COURSES AT A UNIVERSITY LEVEL (U.S. CLS. 100, 101 AND 107).

FIRST USE 6-30-2004; IN COMMERCE 6-30-2004.
STEVEN PEREZ, EXAMINING ATTORNEY

SN 78-510,189. THE SEABERG COMPANY, INC., NEWPORT, OR. FILED 11-2-2004.

**SAM MEDICAL
PRODUCTS**

THE MARK CONSISTS OF STANDARD CHARACTERS WITHOUT CLAIM TO ANY PARTICULAR FONT, STYLE, SIZE, OR COLOR.

OWNER OF U.S. REG. NOS. 1,384,137, 2,287,654 AND 2,918,142.

NO CLAIM IS MADE TO THE EXCLUSIVE RIGHT TO USE "MEDICAL PRODUCTS", APART FROM THE MARK AS SHOWN.

CLASS 5—PHARMACEUTICALS

FOR ADHESIVE BANDAGES FOR RELIEVING SKIN FRICTION (U.S. CLS. 6, 18, 44, 46, 51 AND 52).

FIRST USE 9-16-2004; IN COMMERCE 9-16-2004.

CLASS 10—MEDICAL APPARATUS

FOR MEDICAL PRODUCTS, NAMELY, ORTHOPEDIC SPLINTS; DEVICES FOR IMMOBILIZATION OF PELVIC FRACTURES, NAMELY, CIRCUMFERENTIAL BELTS INCORPORATING PRECISION TENSION-REGULATING BUCKLES THAT STABILIZE AND REDUCE PELVIC FRACTURES; FOREARM ORTHOSES; ANKLE ORTHOSES; MEDICAL ANKLE BRACES; MEDICAL FOREARM BRACES (U.S. CLS. 26, 39 AND 44).

FIRST USE 9-16-2004; IN COMMERCE 9-16-2004.

CLASS 16—PAPER GOODS AND PRINTED MATTER

FOR PRINTED MATTER, NAMELY, PRINTED NOTE-PADS AND INTERVIEW GUIDES FOR USE BY MEDICAL EMERGENCY CARE PROVIDERS IN ASSESSING PATIENT STATUS (U.S. CLS. 2, 5, 22, 23, 29, 37, 38 AND 50).

FIRST USE 9-16-2004; IN COMMERCE 9-16-2004.
MICHAEL TANNER, EXAMINING ATTORNEY

SN 78-510,617. VERIFIED IDENTITY PASS, INC., NEW YORK, NY. FILED 11-3-2004.

KNOWN TRAVELER

THE MARK CONSISTS OF STANDARD CHARACTERS WITHOUT CLAIM TO ANY PARTICULAR FONT, STYLE, SIZE, OR COLOR.

NO CLAIM IS MADE TO THE EXCLUSIVE RIGHT TO USE "TRAVELER", APART FROM THE MARK AS SHOWN.

CLASS 9—ELECTRICAL AND SCIENTIFIC APPARATUS

FOR MAGNETIC CODED CARD SWIPE READERS; ELECTRONIC CARD READERS; OPTICAL SWIPE READERS; BIOMETRIC THUMB PRINT READERS (U.S. CLS. 21, 23, 26, 36 AND 38).

CLASS 16—PAPER GOODS AND PRINTED MATTER

FOR NON-MAGNETICALLY ENCODED BIOMETRIC CARDS USED FOR ACCESS CONTROL THAT ARE CONTINUOUSLY UPDATED FOR SECURED ENTRY INTO AND EXIT FROM BUILDINGS (U.S. CLS. 2, 5, 22, 23, 29, 37, 38 AND 50).

ALICIA COLLINS, EXAMINING ATTORNEY

SN 78-510,655. TEMPUR WORLD, LLC, LEXINGTON, KY. FILED 11-3-2004.

**THE SOLUTION
MATTRESS BY
TEMPUR-PEDIC**

THE MARK CONSISTS OF STANDARD CHARACTERS WITHOUT CLAIM TO ANY PARTICULAR FONT, STYLE, SIZE, OR COLOR.

OWNER OF U.S. REG. NOS. 2,823,185, 2,840,686 AND 2,840,687.

CLASS 10—MEDICAL APPARATUS

SN 78-510,795. ANGEL LEARNING, INC., INDIANAPOLIS, IN. FILED 11-3-2004.

FOR SEATING AND COUCHING MATS IN THE NATURE OF A PILLOW OR SEAT LINER, PILLOWS, CUSHIONS, MATTRESSES, TOP MATTRESSES, BOLSTERS AND CHAIR PADS FOR ORTHOPEDIC, MEDICAL, AND MEDICAL NURSING HOME AND HOSPITAL USE (U.S. CLS. 26, 39 AND 44).

ANGEL

CLASS 20—FURNITURE AND ARTICLES NOT OTHERWISE CLASSIFIED

FOR SEATING AND COUCHING MATS IN THE NATURE OF A PILLOW OR SEAT LINER, PILLOWS, CUSHIONS, MATTRESSES, TOP MATTRESSES, BOLSTERS AND CHAIR PADS (U.S. CLS. 2, 13, 22, 25, 32 AND 50).

KIMBERLY FRYE, EXAMINING ATTORNEY

THE MARK CONSISTS OF STANDARD CHARACTERS WITHOUT CLAIM TO ANY PARTICULAR FONT, STYLE, SIZE, OR COLOR.

CLASS 9—ELECTRICAL AND SCIENTIFIC APPARATUS

SN 78-510,663. DILENSCHNEIDER, JOHN, LAKE FOREST, IL. FILED 11-3-2004.

FOR LEARNING MANAGEMENT SOFTWARE THAT ALLOWS USERS TO ADMINISTER COURSES, MANAGE COURSE MATERIAL AND COMMUNICATE WITH TEACHERS, STUDENTS, ADVISORS, AND PARENTS (U.S. CLS. 21, 23, 26, 36 AND 38).

FIRST USE 7-0-2000; IN COMMERCE 7-0-2000.

CLASS 42—SCIENTIFIC, COMPUTER AND LEGAL SERVICES

KEEP THE RIDE
ALIVE

FOR APPLICATION SERVICE PROVIDER FEATURING SOFTWARE IN THE FIELD OF LEARNING MANAGEMENT THAT ALLOWS USERS TO ADMINISTER COURSES, MANAGE COURSE MATERIAL AND COMMUNICATE WITH TEACHERS, STUDENTS, ADVISORS, AND PARENTS; TECHNICAL SUPPORT SERVICES, NAMELY, TROUBLESHOOTING OF LEARNING MANAGEMENT COMPUTER HARDWARE AND SOFTWARE PROBLEMS; COMPUTER CONSULTATION CONCERNING THE INSTALLATION, CUSTOMIZATION, MAINTENANCE AND TRAINING IN THE USE OF LEARNING MANAGEMENT COMPUTER SOFTWARE (U.S. CLS. 100 AND 101).

FIRST USE 7-0-2000; IN COMMERCE 7-0-2000.

BARBARA RUTLAND, EXAMINING ATTORNEY

SN 78-512,036. THRESHOLD BY DESIGN, LLC, SAN FRANCISCO, CA. FILED 11-5-2004.

THE MARK CONSISTS OF STANDARD CHARACTERS WITHOUT CLAIM TO ANY PARTICULAR FONT, STYLE, SIZE, OR COLOR.

CLASS 25—CLOTHING

FOR APPAREL, NAMELY T-SHIRTS (U.S. CLS. 22 AND 39).

FIRST USE 4-30-1997; IN COMMERCE 4-30-2001.

THRESHOLD BY
DESIGN

CLASS 35—ADVERTISING AND BUSINESS

FOR PROMOTING THE PUBLIC AWARENESS OF HISTORY PERTAINING TO PAUL REVERE (U.S. CLS. 100, 101 AND 102).

FIRST USE 4-30-1997; IN COMMERCE 4-30-2001.
CATHERINE FAINT, EXAMINING ATTORNEY

THE MARK CONSISTS OF STANDARD CHARACTERS WITHOUT CLAIM TO ANY PARTICULAR FONT, STYLE, SIZE, OR COLOR.

CLASS 35—ADVERTISING AND BUSINESS

FOR RETAIL STORE SERVICES AND ON-LINE RETAIL STORE SERVICES FEATURING ANTIQUES, HOME FURNISHINGS, AND ACCESSORIES (U.S. CLS. 100, 101 AND 102).

SN 78-512,536. DIVERSIFIED FINANCIAL, INCORPORATED, BILLINGS, MT. FILED 11-5-2004.

CLASS 42—SCIENTIFIC, COMPUTER AND LEGAL SERVICES

FOR INTERIOR DESIGN AND DECORATION SERVICES (U.S. CLS. 100 AND 101).
TARAH HARDY, EXAMINING ATTORNEY

CHECKINHAND.COM

THE MARK CONSISTS OF STANDARD CHARACTERS WITHOUT CLAIM TO ANY PARTICULAR FONT, STYLE, SIZE, OR COLOR.

CLASS 35—ADVERTISING AND BUSINESS

FOR WEB-BASED BUSINESS CONSULTING SERVICES FOR NEW AND USED AUTOMOBILE DEALERS AND THEIR CUSTOMERS, INCLUDING MANAGEMENT OF MARKETING AND ADVERTISING BUDGETS, PROVISION OF CREDIT BUREAU INFORMATION, PROVISION OF AUTOMOBILE WHOLESALE AND RETAIL VALUATION INFORMATION, DISTRIBUTION OF CUSTOMER LEADS, AND PROCUREMENT OF WEB DESIGNS THAT ARE TAILORED TO THE REQUIREMENTS OF CERTAIN FINANCE DEPARTMENTS (U.S. CLS. 100, 101 AND 102).

SN 78-512,465. MOSHIER, MICHAEL W., LOS ALTOS, CA. FILED 11-5-2004.

CLASS 42—SCIENTIFIC, COMPUTER AND LEGAL SERVICES

FOR APPLICATION SERVICE PROVIDER FEATURING SOFTWARE FOR THE PREPARATION AND SUBMISSION OF FINANCE APPLICATIONS FOR THE PURCHASE OF NEW AND USED AUTOMOBILES (U.S. CLS. 100 AND 101).
GIANCARLO CASTRO, EXAMINING ATTORNEY

SOLARSAVVY

SN 78-513,132. RANDO, CATERINA, SAN FRANCISCO, CA. FILED 11-8-2004.

THE MARK CONSISTS OF STANDARD CHARACTERS WITHOUT CLAIM TO ANY PARTICULAR FONT, STYLE, SIZE, OR COLOR.

CLASS 3—COSMETICS AND CLEANING PREPARATIONS

FOR SUN TAN GEL, SUN TAN LOTION, SUN TAN OIL, SUNTAN CREAM, COSMETIC SUNTAN LOTIONS, SUN SCREEN PREPARATIONS, PATCHES CONTAINING SUN SCREEN AND SUN BLOCK FOR USE ON THE SKIN, SUNSCREEN CREAM, FOAMS CONTAINING COSMETICS AND SUNSCREENS, SUN-BLOCK LOTIONS, SUN BLOCK PREPARATIONS, NON-MEDICATED PREPARATIONS FOR REPAIRING DAMAGE DONE TO THE SKIN BY THE SUN AND FOR REDUCING WRINKLES CAUSED BY THE SUN, AND NON-MEDICATED LOTIONS FOR REPAIRING DAMAGE DONE TO THE SKIN BY THE SUN AND FOR REDUCING WRINKLES CAUSED BY THE SUN (U.S. CLS. 1, 4, 6, 50, 51 AND 52).

THE MARK CONSISTS OF STANDARD CHARACTERS WITHOUT CLAIM TO ANY PARTICULAR FONT, STYLE, SIZE, OR COLOR.

NO CLAIM IS MADE TO THE EXCLUSIVE RIGHT TO USE "DIRECT SELLING", APART FROM THE MARK AS SHOWN.

CLASS 9—ELECTRICAL AND SCIENTIFIC APPARATUS**CLASS 25—CLOTHING**

FOR CLOTHING, NAMELY HATS, CAPS, VISORS, SHORTS, BATHING SUITS, SLACKS, SHIRTS, BLOUSES, T-SHIRTS, AND HEADBANDS (U.S. CLS. 22 AND 39).

JASON TURNER, EXAMINING ATTORNEY

FOR PRERECORDED AUDIO CASSETTES AND CDS IN THE FIELD OF PERSONAL DEVELOPMENT, BUSINESS DEVELOPMENT, MARKETING AND SALES; DOWNLOADABLE ELECTRONIC PUBLICATIONS IN THE NATURE OF NEWSLETTERS, BOOKLETS, BOOKS, ALL IN THE FIELD OF DIRECT SALES, BUSINESS DEVELOPMENT, AND MARKETING (U.S. CLS. 21, 23, 26, 36 AND 38).

FIRST USE 9-24-2004; IN COMMERCE 10-4-2004.

CLASS 16—PAPER GOODS AND PRINTED MATTER

FOR PUBLICATIONS, NAMELY NEWSPAPER AND JOURNAL ARTICLES, BOOKS, AND SPECIAL REPORTS, IN THE DIRECT SALES, BUSINESS DEVELOPMENT, AND MARKETING; PRINTED INSTRUCTIONAL, EDUCATIONAL, AND TEACHING MATERIALS IN THE FIELD OF DIRECT SALES, BUSINESS DEVELOPMENT, AND MARKETING (U.S. CLS. 2, 5, 22, 23, 29, 37, 38 AND 50).

FIRST USE 9-24-2004; IN COMMERCE 10-4-2004.

CLASS 41—EDUCATION AND ENTERTAINMENT

FOR EDUCATIONAL SERVICES, NAMELY, PROVIDING WORKSHOPS AND SEMINARS IN THE FIELD OF DIRECT SALES, BUSINESS DEVELOPMENT, AND MARKETING; PROVIDING MOTIVATIONAL SPEAKER; AND PERSONAL COACHING IN THE FIELD OF DIRECT SALES, BUSINESS DEVELOPMENT, AND MARKETING (U.S. CLS. 100, 101 AND 107).

FIRST USE 9-24-2004; IN COMMERCE 10-4-2004.

KAREN K. BUSH, EXAMINING ATTORNEY

CLASS 41—EDUCATION AND ENTERTAINMENT

FOR EDUCATIONAL SERVICES, NAMELY, PROVIDING WORKSHOPS AND SEMINARS IN THE FIELD OF DIRECT SALES, BUSINESS DEVELOPMENT, AND MARKETING; PROVIDING MOTIVATIONAL SPEAKER; AND PERSONAL COACHING IN THE FIELD OF DIRECT SALES, BUSINESS DEVELOPMENT, AND MARKETING (U.S. CLS. 100, 101 AND 107).

FIRST USE 1-1-2002; IN COMMERCE 2-2-2002.

KAREN K. BUSH, EXAMINING ATTORNEY

SN 78-513,185, WELLS FARGO & COMPANY, MINNEAPOLIS, MN. FILED 11-8-2004.

SN 78-513,161, RANDO, CATERINA, SAN FRANCISCO, CA. FILED 11-8-2004.

A PROGRAM AS
UNIQUE AS YOUR
CAMPUS

ATTRACT CLIENTS
WITH EASE

THE MARK CONSISTS OF STANDARD CHARACTERS WITHOUT CLAIM TO ANY PARTICULAR FONT, STYLE, SIZE, OR COLOR.

THE MARK CONSISTS OF STANDARD CHARACTERS WITHOUT CLAIM TO ANY PARTICULAR FONT, STYLE, SIZE, OR COLOR.

CLASS 9—ELECTRICAL AND SCIENTIFIC APPARATUS

FOR PRERECORDED AUDIO CASSETTES AND CDS IN THE FIELD OF PERSONAL DEVELOPMENT, BUSINESS DEVELOPMENT, MARKETING AND SALES; DOWNLOADABLE ELECTRONIC PUBLICATIONS IN THE NATURE OF NEWSLETTERS, BOOKLETS, BOOKS, ALL IN THE FIELD OF BUSINESS DEVELOPMENT AND MARKETING (U.S. CLS. 21, 23, 26, 36 AND 38).

FIRST USE 1-1-2002; IN COMMERCE 2-2-2002.

CLASS 16—PAPER GOODS AND PRINTED MATTER

FOR PUBLICATIONS, NAMELY NEWSPAPER AND JOURNAL ARTICLES, BOOKS, AND SPECIAL REPORTS, IN THE FIELD OF BUSINESS DEVELOPMENT AND MARKETING; PRINTED INSTRUCTIONAL, EDUCATIONAL, AND TEACHING MATERIALS IN THE FIELD OF BUSINESS DEVELOPMENT AND MARKETING (U.S. CLS. 2, 5, 22, 23, 29, 37, 38 AND 50).

FIRST USE 1-1-2002; IN COMMERCE 2-2-2002.

CLASS 36—INSURANCE AND FINANCIAL

FOR BANKING SERVICES; ONLINE BANKING SERVICES; CREDIT CARD AND DEBIT CARD SERVICES; INVESTMENT CONSULTATION, BROKERAGE AND MANAGEMENT SERVICES; FINANCIAL INVESTMENT SERVICES IN THE FIELDS OF SECURITIES, MUTUAL FUNDS, CERTIFICATES OF DEPOSIT AND PORTFOLIO MANAGEMENT; CONSUMER LENDING SERVICES AND BANKING SERVICES IN THE NATURE OF DEPOSIT SERVICES; FINANCIAL CONSULTATION FOR EDUCATIONAL FINANCIAL ASSISTANCE; STUDENT LOAN SERVICES; AND PROVIDING INFORMATION ABOUT BANKING, CREDIT, MONEY MANAGEMENT, INVESTING, INVESTMENTS AND FINANCIAL MATTERS (U.S. CLS. 100, 101 AND 102).

CLASS 41—EDUCATION AND ENTERTAINMENT

FOR EDUCATIONAL SERVICES, NAMELY, PROVIDING ON-LINE TRAINING IN THE FIELD OF BANKING, CREDIT, MONEY MANAGEMENT, INVESTING, INVESTMENTS AND FINANCIAL MATTERS (U.S. CLS. 100, 101 AND 107).

DOUGLAS LEE, EXAMINING ATTORNEY

SN 78-513,593. GRM FACILITIES MANAGEMENT, INC.,
RICHWOOD, NJ. FILED 11-9-2004.

We'll Take Care Of It

THE MARK CONSISTS OF STANDARD CHARACTERS
WITHOUT CLAIM TO ANY PARTICULAR FONT, STYLE,
SIZE, OR COLOR.

CLASS 35—ADVERTISING AND BUSINESS

FOR MANAGEMENT OF BUILDING FACILITIES FOR
BUSINESSES, HEALTHCARE AND EDUCATIONAL IN-
STITUTIONS, AND MUNICIPALITIES; CONSULTING
SERVICES IN THE FIELD OF MANAGEMENT OF
BUILDING FACILITIES (U.S. CLS. 100, 101 AND 102).
FIRST USE 10-0-2000; IN COMMERCE 10-0-2000.

CLASS 42—SCIENTIFIC, COMPUTER AND LEGAL SERVICES

FOR CONSULTING SERVICES IN THE FIELD OF
HEALTHCARE REGULATORY COMPLIANCE (U.S.
CLS. 100 AND 101).
FIRST USE 10-0-2000; IN COMMERCE 10-0-2000.
CAROLINE WOOD, EXAMINING ATTORNEY

SN 78-513,643. DAVID R. MUSICH, D.D.S. & MATTHEW J.
BUSCH, D.D.S., LTD., SCHAUMBURG, IL. FILED 11-9-
2004.



Form & Function Through
Art, Science & Teamwork

NO CLAIM IS MADE TO THE EXCLUSIVE RIGHT TO
USE ORTHODONTIC TEAM, APART FROM THE MARK AS
SHOWN.

THE MARK CONSISTS OF THREE OVERLAPPING
HEADS IN SILHOUETTE WITH THE WORDS "MUSICH &
BUSCH ORTHODONTIC TEAM" ARCHED ABOVE THE
HEADS, AND THE WORDS "FORM & FUNCTION
THROUGH ART, SCIENCE & TEAMWORK" UNDER-
NEATH THE HEADS.

CLASS 25—CLOTHING

FOR CLOTHING, NAMELY T-SHIRTS (U.S. CLS. 22
AND 39).

CLASS 44—MEDICAL, BEAUTY AND AGRICULTURAL SERVICES

FOR ORTHODONTIC SERVICES (U.S. CLS. 100 AND
101).
MICHELE SWAIN, EXAMINING ATTORNEY

SN 78-514,682. CROWN EQUIPMENT CORPORATION, NEW
BREMEN, OH. FILED 11-10-2004.

INTEGRITY SERVICE SYSTEM

THE MARK CONSISTS OF STANDARD CHARACTERS
WITHOUT CLAIM TO ANY PARTICULAR FONT, STYLE,
SIZE, OR COLOR.

NO CLAIM IS MADE TO THE EXCLUSIVE RIGHT TO
USE SERVICE SYSTEM, APART FROM THE MARK AS
SHOWN.

CLASS 37—CONSTRUCTION AND REPAIR

FOR MAINTENANCE AND REPAIR OF MATERIAL
LIFTING, TRANSPORTING, AND HANDLING EQUIP-
MENT (U.S. CLS. 100, 103 AND 106).

CLASS 42—SCIENTIFIC, COMPUTER AND LEGAL SERVICES

FOR INSPECTION SERVICES IN THE FIELD OF
MATERIAL LIFTING, TRANSPORTING, AND HAND-
LING EQUIPMENT (U.S. CLS. 100 AND 101).
YONG KIM, EXAMINING ATTORNEY

SN 78-514,922. CEREUS PRODUCT DEVELOPMENT COR-
PORATION, SANTA ANA, CA. FILED 11-10-2004.

CEREUS

THE MARK CONSISTS OF STANDARD CHARACTERS
WITHOUT CLAIM TO ANY PARTICULAR FONT, STYLE,
SIZE, OR COLOR.

CLASS 35—ADVERTISING AND BUSINESS

FOR ADVICE IN THE FIELDS OF BUSINESS MANAGEMENT AND MARKETING; BUSINESS CONSULTATION AND MANAGEMENT REGARDING MARKETING ACTIVITIES AND LAUNCHING OF NEW PRODUCTS; BUSINESS MANAGEMENT CONSULTING WITH RELATION TO STRATEGY, MARKETING, PRODUCTION, PERSONNEL AND RETAIL SALE MATTERS; BUSINESS MARKETING CONSULTING SERVICES; BUSINESS MARKETING SERVICES; COMMERCIAL INFORMATION AGENCIES; CONDUCTING MARKETING STUDIES; CREATION OF MARKETING TOOLS DESIGNED TO INCREASE A CLIENT COMPANY'S KNOWLEDGE OF CUSTOMER NEEDS, AND ITS COMPETITORS' PRODUCTS AND SERVICES, PRICING, ADVERTISING STRATEGY AND SALES STRATEGY; DEVELOPMENT OF MARKETING STRATEGIES AND CONCEPTS; PROVIDING BUSINESS MARKETING INFORMATION; ADVERTISING AGENCIES; ADVERTISING, MARKETING, ADVERTISEMENT, AND PUBLICITY SERVICES; ADVERTISING SERVICES, NAMELY, CREATING CORPORATE LOGOS FOR OTHERS AND CREATING CORPORATE AND BRAND IDENTITY FOR OTHERS; CONCEPT AND BRAND DEVELOPMENT IN THE FIELDS OF PERFUME, COSMETICS, PERSONAL CARE PRODUCTS, APPAREL, ACCESSORIES, AND GENERAL MERCHANDISE; PREPARATION AND REALIZATION OF MEDIA AND ADVERTISING PLANS AND CONCEPTS, ADVERTISING AND PUBLICITY SERVICES; PREPARATION OF CUSTOM ADVERTISEMENTS AND CUSTOM PROMOTIONAL PRODUCTS FOR OTHERS; PROMOTING THE GOODS AND SERVICES OF OTHERS BY DISTRIBUTING ADVERTISING AND PRINTED MATERIALS THROUGH A VARIETY OF METHODS; SERVICES RELATING TO THE ANALYSIS, EVALUATION, CREATION AND BRAND ESTABLISHMENT OF TRADEMARKS, TRADE NAMES AND DOMAIN NAMES (U.S. CLS. 100, 101 AND 102).

CLASS 42—SCIENTIFIC, COMPUTER AND LEGAL SERVICES

FOR RESEARCH AND DEVELOPMENT OF NEW PRODUCTS FOR OTHERS; PRODUCT DEVELOPMENT CONSULTATION; PRODUCT DEVELOPMENT AND PRODUCT RESEARCH; DESIGN AND TESTING FOR NEW PRODUCT DEVELOPMENT; DESIGN AND TESTING OF NEW PRODUCTS FOR OTHERS; DESIGN FOR OTHERS IN THE FIELDS OF PERFUMERY, COSMETICS, PERSONAL CARE ARTICLES, APPAREL, ACCESSORIES, AND GENERAL MERCHANDISE; PRODUCT SAFETY TESTING (U.S. CLS. 100 AND 101).
ANDREA SAUNDERS, EXAMINING ATTORNEY

SN 78-515,441. LANE BRYANT PURCHASING CORP., BEN-
SLEM, PA. FILED 11-11-2004.

LB WOMAN

THE MARK CONSISTS OF STANDARD CHARACTERS WITHOUT CLAIM TO ANY PARTICULAR FONT, STYLE, SIZE, OR COLOR.

OWNER OF U.S. REG. NOS. 1,210,665 AND 1,211,680.
NO CLAIM IS MADE TO THE EXCLUSIVE RIGHT TO USE "WOMAN", APART FROM THE MARK AS SHOWN.

CLASS 25—CLOTHING

FOR FULL LINE OF WOMEN'S WEARING APPAREL FOR PLUS-SIZES (U.S. CLS. 22 AND 39).

CLASS 35—ADVERTISING AND BUSINESS

FOR RETAIL STORE SERVICES FEATURING WOMEN'S WEARING APPAREL AND ACCESSORIES; COMPUTERIZED ON-LINE RETAIL STORE SERVICES FEATURING WOMEN'S WEARING APPAREL AND ACCESSORIES; MAIL ORDER CATALOG SERVICES FEATURING WOMEN'S WEARING APPAREL AND ACCESSORIES (U.S. CLS. 100, 101 AND 102).
MARCIE MILONE, EXAMINING ATTORNEY

SN 78-515,588. THE SAVVY GOURMET, L.L.C., NEW OR-
LEANS, LA. FILED 11-11-2004.

THE SAVVY GOURMET

NO CLAIM IS MADE TO THE EXCLUSIVE RIGHT TO USE "GOURMET", APART FROM THE MARK AS SHOWN.

CLASS 35—ADVERTISING AND BUSINESS

FOR RETAIL STORES FEATURING COOKWARE; COMPUTERIZED ONLINE ORDERING SERVICES IN THE FIELD OF COOKWARE (U.S. CLS. 100, 101 AND 102).
FIRST USE 4-1-2004; IN COMMERCE 4-1-2004.

CLASS 41—EDUCATION AND ENTERTAINMENT

FOR EDUCATIONAL SERVICES, NAMELY, CONDUCTING CLASSES ON THE SUBJECT OF COOKING, WINE APPRECIATION, AND FOOD AND WINE PAIRING (U.S. CLS. 100, 101 AND 107).
FIRST USE 4-1-2004; IN COMMERCE 4-1-2004.

CLASS 43—HOTEL AND RESTAURANT SERVICES

FOR CATERING (U.S. CLS. 100 AND 101).
FIRST USE 4-1-2004; IN COMMERCE 4-1-2004.
SUSAN LESLIE DUBOIS, EXAMINING ATTORNEY

SN 78-516,248. MAMA MIO LIMITED, LONDON, ENGLAND, FILED 11-12-2004.

MAMA MIO

SN 78-515,655. SUPREME MARKETING INC., FREMONT, CA. FILED 11-11-2004.



THE MARK CONSISTS OF THE MARK CONSISTS OF A STYLIZED LETTERS OF UP IN A CIRCLE.

CLASS 8—HAND TOOLS

FOR KITCHENWARE, NAMELY, KNIVES, SPOONS, FORKS, NON-ELECTRIC FRUIT AND VEGETABLE PEELERS, BUTTER SPREADERS, CHEESE SLICERS (U.S. CLS. 23, 28 AND 44).
FIRST USE 1-1-2000; IN COMMERCE 1-1-2000.

CLASS 9—ELECTRICAL AND SCIENTIFIC APPARATUS

FOR FOOD TIMERS (U.S. CLS. 21, 23, 26, 36 AND 38).
FIRST USE 1-1-2000; IN COMMERCE 1-1-2000.

CLASS 21—HOUSEWARES AND GLASS

FOR HOUSE WARE, NAMELY, PORCELAIN TEA POTS AND MUGS, COASTERS NOT OF PAPER AND NOT BEING TABLE LINEN, AND CUTTING BOARDS; BAKERWARE, NAMELY, BAKING DISHES FOR REGULAR, CONVENTION AND MICROWAVE BAKING; GIFTWARE, NAMELY, CERAMIC GIFT SETS FOR HOUSEHOLD USE, NAMELY SALT AND PEPPER SHAKERS, NAPKIN HOLDERS, BOTTLE HOLDERS; DINERWARE, NAMELY, CERAMIC AND PLASTIC SPICE JARS, BOWLS; TABLEWARE, NAMELY, CERAMIC AND PLASTIC TOOTHPICK HOLDERS, SERVING TONGS MADE OF STAINLESS STEEL (U.S. CLS. 2, 13, 23, 29, 30, 33, 40 AND 50).
FIRST USE 1-1-2000; IN COMMERCE 1-1-2000.
GEORGIA CARTY, EXAMINING ATTORNEY

THE MARK CONSISTS OF STANDARD CHARACTERS WITHOUT CLAIM TO ANY PARTICULAR FONT, STYLE, SIZE, OR COLOR.

THE ENGLISH TRANSLATION OF THE "MIO" IS "MINE".

CLASS 3—COSMETICS AND CLEANING PREPARATIONS

FOR PERFUME; EAU DE COLOGNE; ESSENTIAL OILS FOR PERSONAL USE; FRAGRANCES FOR PERSONAL USE; NON-MEDICATED SKIN CARE PREPARATIONS; BATH BEADS, BATH FOAMS, BATH GELS, BATH OILS AND BATH SALTS; SOAP; LIP BALM; SHAVING PREPARATIONS; DISPOSABLE WIPES IMPREGNATED WITH CLEANING AGENTS FOR PERSONAL HYGIENE; BABY SHAMPOO, BABY LOTION AND BABY OIL; ROOM FRAGRANCES; SCENTED LINEN SPRAYS; FURNITURE POLISH; HOUSEHOLD CLEANING PREPARATIONS (U.S. CLS. 1, 4, 6, 50, 51 AND 52).

CLASS 4—LUBRICANTS AND FUELS

FOR CANDLES (U.S. CLS. 1, 6 AND 15).
DAVID MURRAY, EXAMINING ATTORNEY

SN 78-516,250. MILLER SUTHERLAND LIMITED, LONDON, UNITED KINGDOM, FILED 11-12-2004.

MIO MODERN

THE MARK CONSISTS OF STANDARD CHARACTERS WITHOUT CLAIM TO ANY PARTICULAR FONT, STYLE, SIZE, OR COLOR.

THE ENGLISH TRANSLATION OF MIO IS MINE.

CLASS 3—COSMETICS AND CLEANING PREPARATIONS

SN 78-516,793. METZ, JERRY E, CAMERON PARK, CA. FILED 11-15-2004.

FOR PERFUME; EAU DE COLOGNE; ESSENTIAL OILS FOR PERSONAL USE; FRAGRANCES FOR PERSONAL USE; SKIN CARE PREPARATIONS; BATH BEADS, FOAMS, GELS, OILS AND SALTS; SOAP; LIP BALM; SHAVING PREPARATIONS; DISPOSABLE WIPES IMPREGNATED WITH CHEMICALS OR COMPOUNDS FOR PERSONAL HYGIENE USE; BABY SHAMPOO, BABY LOTION, BABY OILS; ROOM FRAGRANCES; SCENTED LINEN SPRAYS; FURNITURE POLISH; HOUSEHOLD CLEANING PREPARATIONS (U.S. CLS. 1, 4, 6, 50, 51 AND 52).

BYOC

CLASS 4—LUBRICANTS AND FUELS

FOR CANDLES (U.S. CLS. 1, 6 AND 15).
LINDA E. BLOHM, EXAMINING ATTORNEY

THE MARK CONSISTS OF STANDARD CHARACTERS WITHOUT CLAIM TO ANY PARTICULAR FONT, STYLE, SIZE, OR COLOR.

CLASS 35—ADVERTISING AND BUSINESS

SN 78-516,328. FAMOUS INVESTMENTS, LLC, BLOOMINGTON, MN. FILED 11-12-2004.

FOR ONLINE RETAIL ORDERING SERVICES FEATURING GAMING SUPPLIES, NAMELY, POKER CHIPS (U.S. CLS. 100, 101 AND 102).

CLASS 41—EDUCATION AND ENTERTAINMENT

FOR PROVIDING INFORMATION ABOUT CARD GAMING VIA THE INTERNET; ARRANGING AND CONDUCTING CARD GAMES VIA THE INTERNET (U.S. CLS. 100, 101 AND 107).
HOWARD B. LEVINE, EXAMINING ATTORNEY

CASABLANCA ICE

SN 78-517,010. BENHAMOU, MARCEL, PARIS, FRANCE, FILED 11-15-2004.

THE MARK CONSISTS OF STANDARD CHARACTERS WITHOUT CLAIM TO ANY PARTICULAR FONT, STYLE, SIZE, OR COLOR.

NO CLAIM IS MADE TO THE EXCLUSIVE RIGHT TO USE "ICE", APART FROM THE MARK AS SHOWN.

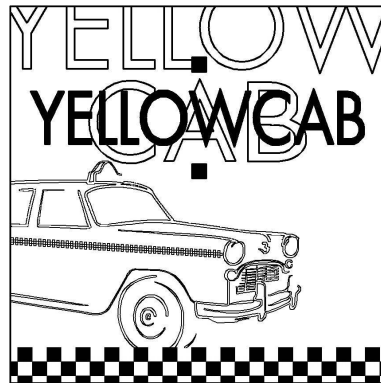

CLASS 30—STAPLE FOODS

FOR ICE CREAM, ICE MILK, FROZEN YOGURT, FROZEN CUSTARD, FROZEN CONFECTIONS, ICE CREAM NOVELTIES, SUNDAES, MILK SHAKES, CONES FOR ICE CREAM, ICE CREAM SANDWICHES, ICE CREAM CAKES, FLAVORED ICES, SHERBET, AND SORBET (U.S. CL. 46).

PRIORITY CLAIMED UNDER SEC. 44(D) ON FRANCE APPLICATION NO. 043297268, FILED 6-14-2004, REG. NO. 043297268, DATED 6-17-2005, EXPIRES 6-14-2014.

THE MARK CONSISTS OF THE WORDS "YELLOWCAB" IN THE BACKGROUND AND THE WORDS "YELLOWCAB" IN THE FOREGROUND; A STYLIZED IMAGE OF CHECKERED TAXI CAB IN THE BACKGROUND; AND IT IS FRAMED IN A SQUARE WITH A CHECKERED LINE ALONG THE BASE OF THE FRAME.

CLASS 43—HOTEL AND RESTAURANT SERVICES

FOR RESTAURANTS (U.S. CLS. 100 AND 101).
DORITT L. CARROLL, EXAMINING ATTORNEY

CLASS 32—LIGHT BEVERAGES

FOR BEER; MINERAL AND AERATED WATERS; FRUIT DRINKS AND FRUIT JUICES; SYRUP AND OTHER PREPARATIONS FOR MAKING SOFT DRINKS; LEMONADES; FRUIT NECTARS; SODA WATER; NON ALCOHOLIC COCKTAIL MIXES (U.S. CLS. 45, 46 AND 48).

SN 78-517,302. VISIONMOS INTERNATIONAL, INC., TEMPE, AZ. FILED 11-15-2004.

CLASS 33—WINES AND SPIRITS

FOR ALCOHOLIC DRINKS NAMELY HARD CIDER; CORDIALS; WINES; DISTILLED SPIRITS; ALCOHOLIC EXTRACTS AND ALCOHOLIC ESSENCES (U.S. CLS. 47 AND 49).

ROBERT LORENZO, EXAMINING ATTORNEY

SN 78-517,217. HECKLER & KOCH GMBH, OBERNDORF/NECKAR D 78727, FED REP GERMANY, FILED 11-15-2004.

VISIONMOS

G 36

THE MARK CONSISTS OF STANDARD CHARACTERS WITHOUT CLAIM TO ANY PARTICULAR FONT, STYLE, SIZE, OR COLOR.

THE MARK CONSISTS OF STANDARD CHARACTERS WITHOUT CLAIM TO ANY PARTICULAR FONT, STYLE, SIZE, OR COLOR.

PRIORITY CLAIMED UNDER SEC. 44(D) ON FED REP GERMANY APPLICATION NO. 30457548.8/1, FILED 10-7-2004, REG. NO. 30457548, DATED 11-29-2004, EXPIRES 10-31-2014.

CLASS 8—HAND TOOLS

FOR BAYONETS, FISHING AND HUNTING KNIVES, SIDE ARMS, NAMELY SWORDS, MANUALLY OPERATED JACKS AND STSANDS FOR HAND JACKS, POCKET KNIVES, SPORT KNIVES, FOLDING KNIVES, CHEF'S KNIVES, KITCHEN KNIVES, BUTCHER KNIVES, PARING KNIVES, KNIVES OF PRECIOUS METALS AND UTILITY KNIVES (U.S. CLS. 23, 28 AND 44).

CLASS 13—FIREARMS

FOR FIREARMS, AMMUNITION AND PROJECTILES, EXPLOSIVES, FIREWORKS (U.S. CLS. 2 AND 9).

CLASS 25—CLOTHING

FOR CLOTHING, FOOTWEAR, HEADGEAR, NAMELY—ANORAKS, BELTS, BLAZERS, BOOTS, CAPS, FLIGHT SUITS, GOLF SHIRTS, JACKETS, NECKTIES, OVERALLS, PARKAS, POLO SHIRTS, PULLOVERS, RAIN COATS, DRESS SHIRTS, STOCKINGS, SWEATERS, T-SHIRTS, WIND JACKETS (U.S. CLS. 22 AND 39).

MELVIN AXILBUND, EXAMINING ATTORNEY

CLASS 9—ELECTRICAL AND SCIENTIFIC APPARATUS

FOR COMPUTERS, COMPUTER HARDWARE; SEMICONDUCTORS; MICROPROCESSORS AND SEMICONDUCTOR DEVICES; INTEGRATED CIRCUITS; INTEGRATED CIRCUIT CHIPS; SEMICONDUCTOR PROCESSORS; SEMICONDUCTOR PROCESSOR CHIPS; MICROPROCESSOR CORES; MACRO CELLS; MICROCONTROLLERS BUS INTERFACES; PRINTED CIRCUIT BOARDS; ELECTRONIC CIRCUIT BOARDS; COMPUTER MEMORY DEVICES, NAMELY COMPUTER MEMORY HARDWARE, COMPUTER MEMORY DRIVES, COMPUTER MEMORIES, MEMORY BOARDS, MEMORY CARDS, SOLID STATE MEMORY CARDS, SEMICONDUCTOR MEMORIES; COMPUTER CHIPSETS, NAMELY, FOR USE IN TRANSMITTING DATA TO AND FROM A CENTRAL PROCESSING UNIT, MULTIMEDIA DEVICES, AND DIGITAL CAMERAS; COMPUTER MOTHERBOARDS AND DAUGHTERBOARDS; MICROCOMPUTERS; SOFTWARE PROGRAMMABLE MICROPROCESSORS; COMPUTER PERIPHERALS; COMPUTER FIRMWARE, NAMELY, COMPUTER UTILITY SOFTWARE AND OTHER COMPUTER SOFTWARE USED TO MAINTAIN AND OPERATE COMPUTER SYSTEMS ALL STORED IN A COMPUTER'S READ-ONLY MEMORY (ROM) OR ELSEWHERE IN THE COMPUTER'S CIRCUITRY, AND OPERATING SYSTEM SOFTWARE; COMPUTER FIRMWARE FOR OPERATING AND MAINTAINING COMPUTER SYSTEMS, DIGITAL CAMERAS, DIGITAL VIDEO CAMERAS, PERSONAL MEDIA PLAYERS, PERSONAL RECORDING DEVICES, CELLULAR TELEPHONES, PDAS, AND COMPUTER PERIPHERAL DEVICES; ALL THE FOREGOING SOLD WITH OR WITHOUT USER MANUALS FOR USE THEREWITH AND PARTS THEREFORE (U.S. CLS. 21, 23, 26, 36 AND 38).

CLASS 42—SCIENTIFIC, COMPUTER AND LEGAL SERVICES

SN 78-517,607. GUARDIAN BUILDING PRODUCTS, INC., ALBION, MI. FILED 11-16-2004.

FOR TECHNICAL CONSULTATION IN THE FIELDS OF COMPUTERS AND SEMICONDUCTORS, CIRCUITS, CHIPSETS, CIRCUIT BOARD, PROCESSORS, COMPUTER FIRMWARE AND COMPUTER UTILITY SOFTWARE AND OTHER COMPUTER SOFTWARE USED TO MAINTAIN AND OPERATE COMPUTER SYSTEM; DESIGN OF COMPUTERS AND SEMICONDUCTORS, CIRCUITS, CHIPSETS, CIRCUIT BOARD, PROCESSOR, COMPUTER FIRMWARE AND COMPUTER UTILITY SOFTWARE AND OTHER COMPUTER SOFTWARE USED TO MAINTAIN AND OPERATE COMPUTER SYSTEM FOR OTHERS; COMPUTER SOFTWARE AND FIRMWARE DEVELOPMENT FOR OTHERS; SEMICONDUCTOR, CIRCUIT, CHIPSET, PROCESSOR, AND CIRCUIT BOARD DEVELOPMENT FOR OTHERS; COMPUTER SOFTWARE, COMPUTER FIRMWARE, COMPUTER HARDWARE AND COMPUTER COMPONENT DESIGN SERVICES; PRODUCT RESEARCH AND DEVELOPMENT, DESIGN FOR OTHERS, AND CONSULTATION IN THE AREAS OF COMPUTER HARDWARE AND COMPUTER COMPONENTS; TECHNICAL SUPPORT SERVICES IN THE FIELD OF COMPUTERS AND COMPUTER COMPONENTS, NAMELY TROUBLESHOOTING OF COMPUTER HARDWARE, COMPUTER PERIPHERAL DEVICES, COMPUTER COMPONENTS, AND COMPUTER SOFTWARE PROBLEMS (U.S. CLS. 100 AND 101).

HOWARD B. LEVINE, EXAMINING ATTORNEY

ATS

THE MARK CONSISTS OF STANDARD CHARACTERS WITHOUT CLAIM TO ANY PARTICULAR FONT, STYLE, SIZE, OR COLOR.

CLASS 17—RUBBER GOODS

FOR FIBERGLASS INSULATION FOR BUILDINGS (U.S. CLS. 1, 5, 12, 13, 35 AND 50).

CLASS 37—CONSTRUCTION AND REPAIR

FOR INSTALLATION, MAINTENANCE AND REPAIR SERVICES IN THE FIELD OF FIBERGLASS INSULATION FOR BUILDINGS (U.S. CLS. 100, 103 AND 106).
LINDA MICKLEBURGH, EXAMINING ATTORNEY

SN 78-517,448. ADVOCARE INTERNATIONAL, L.P., CARROLLTON, TX. FILED 11-16-2004.

SN 78-517,633. BISHOP, DEBBIE, DBA LEFT FIELD PRODUCTIONS, GLENDALE, CA. FILED 11-16-2004.



FSN

OWNER OF U.S. REG. NOS. 1,959,765 AND 2,215,866.

CLASS 3—COSMETICS AND CLEANING PREPARATIONS

FOR NON-MEDICATED SKIN CARE PRODUCTS, NAMELY SKIN CLEANSER, SKIN GEL AND SKIN CREAM (U.S. CLS. 1, 4, 6, 50, 51 AND 52).

THE MARK CONSISTS OF STANDARD CHARACTERS WITHOUT CLAIM TO ANY PARTICULAR FONT, STYLE, SIZE, OR COLOR.

CLASS 16—PAPER GOODS AND PRINTED MATTER

CLASS 5—PHARMACEUTICALS

FOR DIETARY, NUTRITIONAL AND VITAMIN SUPPLEMENTS (U.S. CLS. 6, 18, 44, 46, 51 AND 52).
CAROLINE WOOD, EXAMINING ATTORNEY

FOR PRINTED GOODS, NAMELY, STATIONERY, NOTE PADS, NOTEBOOKS, PENS, PENCILS, POSTERS, BOOKS, COMIC BOOKS, NOTEPADS, INVITATIONS, STICKERS, DIARIES, DAILY PLANNERS (U.S. CLS. 2, 5, 22, 23, 29, 37, 38 AND 50).

CLASS 25—CLOTHING

FOR CLOTHING NAMELY SHIRTS, PANTS, T-SHIRTS, SWEATERS, SWEATSHIRTS, SWEATPANTS, PAJAMAS, SOCKS, HATS, JACKETS, SHOES, SKIRTS, STOCKINGS (U.S. CLS. 22 AND 39).
SUNG IN, EXAMINING ATTORNEY

SN 78-517,674. SWAGELOK COMPANY, SOLON, OH. FILED
11-16-2004.

Axess

CLASS 1—CHEMICALS

FOR CHEMICAL AND WATER-BASED SEALANTS FOR RESEARCH AND INDUSTRIAL APPLICATIONS (U.S. CLS. 1, 5, 6, 10, 26 AND 46).

CLASS 2—PAINTS

FOR LATEX AND OIL-BASED PAINTS FOR RESEARCH AND INDUSTRIAL APPLICATIONS (U.S. CLS. 6, 11 AND 16).

CLASS 3—COSMETICS AND CLEANING PREPARATIONS

FOR CHEMICAL AND WATER-BASED CLEANING SOLUTIONS FOR RESEARCH AND INDUSTRIAL APPLICATIONS (U.S. CLS. 1, 4, 6, 50, 51 AND 52).

CLASS 4—LUBRICANTS AND FUELS

FOR LUBRICANT OILS FOR RESEARCH AND INDUSTRIAL APPLICATIONS; SYNTHETIC LUBRICANTS FOR RESEARCH AND INDUSTRIAL APPLICATIONS (U.S. CLS. 1, 6 AND 15).

CLASS 6—METAL GOODS

FOR METAL VALVES FOR TUBES, PIPES AND HOSES; METAL GASKETS, GLANDS, FERRULES AND NUTS FOR TUBES, PIPES AND HOSES; METAL STRAIGHT, ELBOW, TEE AND CROSS FITTINGS FOR TUBES, PIPES AND HOSES; METAL VACUUM FITTINGS FOR TUBES, PIPES AND HOSES; METAL COUPLINGS FOR TUBES, PIPES AND HOSES; METAL REDUCER FITTINGS FOR TUBES, PIPES AND HOSES; METAL ADAPTER FITTINGS FOR TUBES, PIPES AND HOSES; METAL PORT CONNECTOR FITTINGS FOR TUBES, PIPES AND HOSES; METAL QUICK DISCONNECT FITTINGS FOR TUBE, PIPE AND HOSE END CONNECTIONS; METAL TUBING; FLEXIBLE METAL TUBING AND HOSE; METAL CONVOLUTED TUBING; METAL PIPES USED FOR GAS AND FLUID DISTRIBUTION; METAL SEALS FOR TUBES, PIPES AND HOSES; METAL CLAMPS FOR TUBES, PIPES AND HOSES; METAL CAPS FOR TUBES, PIPES AND HOSES; METAL PLUGS FOR TUBES, PIPES AND HOSES; METAL FILTERS FOR GASES AND FLUIDS; METAL COMPRESSED GAS CYLINDERS; METAL CYLINDERS FOR FLUIDS; METAL FLANGES FOR PIPES; METAL STRUTS, HANGERS AND SUPPORTS FOR PIPES, HOSES AND TUBES; METAL NOZZLES FOR PIPES, HOSES AND TUBES; METAL SCREWS AND BOLTS; THREADED METAL RODS; METAL ORIFICE PLATES FOR PIPES; METAL RUPTURE DISKS FOR TUBES, PIPES AND HOSES (U.S. CLS. 2, 12, 13, 14, 23, 25 AND 50).

CLASS 7—MACHINERY

FOR CENTRIFUGAL AND POSITIVE DISPLACEMENT PUMPS; RECIPROCATING PUMPS AND COMPRESSORS FOR GAS AND FLUID DISTRIBUTION AND PURIFICATION IN BIOPHARMACEUTICAL, CHEMICAL, PETROCHEMICAL, FOOD, BEVERAGE, DAIRY, OIL AND GAS, POWER, PULP AND PAPER, AND SEMI-CONDUCTOR FIELDS; MACHINES AND MACHINE TOOLS FOR CUTTING, BENDING, DEBURRING, AND SWAGING TUBE AND HOSE; ELECTRIC TUBE BENDER MACHINE; PNEUMATIC VALVE ACTUATORS (U.S. CLS. 13, 19, 21, 23, 31, 34 AND 35).

CLASS 8—HAND TOOLS

FOR HAND-OPERATED TOOLS FOR CUTTING, SAWING, BENDING, DEBURRING AND SWAGING TUBE AND HOSE (U.S. CLS. 23, 28 AND 44).

CLASS 9—ELECTRICAL AND SCIENTIFIC APPARATUS

FOR ELECTRIC VALVE ACTUATORS; ELECTRICAL SWITCHES, PLUGS, CONNECTORS AND RECEPTACLES; ELECTRICAL CABLE; ELECTRICAL RELAYS; ELECTRIC WELDING EQUIPMENT AND PARTS AND FITTINGS THEREOF, NAMELY, ELECTRIC ARC WELDERS, WELD HEAD EXTENSION CABLES, CENTERING GAUGES, COOLING PLATES, BENCH MOUNTING BRACKETS, ARC GAP GAUGES, POWER CORDS, ELECTRODES, TUBE AND PIPE COLLETS; TEMPERATURE, PRESSURE AND FLOW-RATE GAUGES, SENSORS AND METERS FOR GASES AND FLUIDS; ELECTRICAL TRANSMITTERS FOR SENSORS, GAUGES AND METERS; ELECTRICAL PROBES FOR SAMPLE EXTRACTION AND TESTING OF GASES AND FLUIDS; ELECTRICAL INSTRUMENT DISPLAYS FOR SENSORS, GAUGES AND METERS; HOUSINGS FOR SENSORS, GAUGES AND METERS, NAMELY, LED DIGITAL DISPLAYS (U.S. CLS. 21, 23, 26, 36 AND 38).

CLASS 11—ENVIRONMENTAL CONTROL APPARATUS

FOR GAS AND LIQUID PURIFICATION FILTERS FOR USE IN BIOPHARMACEUTICAL, CHEMICAL, PETROCHEMICAL, FOOD, BEVERAGE, DAIRY, OIL AND GAS, POWER, PULP AND PAPER, AND SEMI-CONDUCTOR FIELDS (U.S. CLS. 13, 21, 23, 31 AND 34).

CLASS 17—RUBBER GOODS

FOR ADHESIVE THREAD SEALANTS; PIPE COUPLINGS AND GASKETS NOT OF METAL; PLASTIC HOSE; PLASTIC PIPE; FLEXIBLE PIPE NOT OF METAL; NON-METAL GASKETS FOR USE IN BIOPHARMACEUTICAL, CHEMICAL, PETROCHEMICAL, FOOD, BEVERAGE, DAIRY, OIL AND GAS, POWER, PULP AND PAPER, AND SEMI-CONDUCTOR FIELDS; PLASTIC HOSE FOR GAS AND FLUID USE IN BIOPHARMACEUTICAL, CHEMICAL, PETROCHEMICAL, FOOD, BEVERAGE, DAIRY, OIL AND GAS, POWER, PULP AND PAPER, SEMI-CONDUCTOR AND SHIP BUILDING FIELDS; PLASTIC PIPES FOR GAS AND FLUID USE IN BIOPHARMACEUTICAL, CHEMICAL, PETROCHEMICAL, FOOD, BEVERAGE, DAIRY, OIL AND GAS, POWER, PULP AND PAPER, AND SEMI-CONDUCTOR FIELDS (U.S. CLS. 1, 5, 12, 13, 35 AND 50).

CLASS 20—FURNITURE AND ARTICLES NOT OTHERWISE CLASSIFIED

FOR PLASTIC VALVES BEING OTHER THAN MACHINE PARTS; NON-METAL PIPE FITTINGS; GLANDS, NAMELY, O-RING FACE SEAL FITTINGS FOR USE IN PIPE, TUBE AND WELDED SYSTEMS IN BIOPHARMACEUTICAL, CHEMICAL, PETROCHEMICAL, FOOD, BEVERAGE, DAIRY, OIL AND GAS, POWER, PULP AND PAPER, AND SEMI-CONDUCTOR FIELDS; NON-METAL FERRULES, CAPS, PLUGS AND NUTS FOR USE IN PIPE, TUBE AND WELDED SYSTEMS USED IN BIOPHARMACEUTICAL, CHEMICAL, PETROCHEMICAL, FOOD, BEVERAGE, DAIRY, OIL AND GAS, POWER, PULP AND PAPER, AND SEMI-CONDUCTOR FIELDS (U.S. CLS. 2, 13, 22, 25, 32 AND 50).
ZACHARY BELLO, EXAMINING ATTORNEY

SN 78-518,058. HERRERA ALE, CARLOS MANUEL, GOMEZ PALACIO, DURANGO, MEXICO, AND HERRERA ALE, ERNESTO, GOMEZ PALACIO, DURANGO, MEXICO, FILED 11-16-2004.

**CHILCHOTA
TROPIFRUIT**

THE MARK CONSISTS OF STANDARD CHARACTERS WITHOUT CLAIM TO ANY PARTICULAR FONT, STYLE, SIZE, OR COLOR.

CLASS 29—MEATS AND PROCESSED FOODS

FOR YOGURT BASED BEVERAGES; DRINKING YOGURTS (U.S. CL. 46).

CLASS 32—LIGHT BEVERAGES

FOR SMOOTHIES (U.S. CLS. 45, 46 AND 48).
ELIZABETH J. WINTER, EXAMINING ATTORNEY

SN 78-518,051. MAY DEPARTMENT STORES INTERNATIONAL, INC., ST. LOUIS, MO. FILED 11-16-2004.

SN 78-518,364. HEALING WATERS LODGE, L.L.C., TWINBRIDGES, MT. FILED 11-17-2004.

**Wear it your own
way.**

**MASTER THE
TRADITION**

THE MARK CONSISTS OF STANDARD CHARACTERS WITHOUT CLAIM TO ANY PARTICULAR FONT, STYLE, SIZE, OR COLOR.

CLASS 25—CLOTHING

FOR WOMEN'S SPORTSWEAR APPAREL, NAMELY, PANTS, SKIRTS, SHORTS, DRESSES, SWEATERS, BLOUSES, T-SHIRTS, KNIT SHIRTS, JACKETS AND COATS (U.S. CLS. 22 AND 39).

THE MARK CONSISTS OF STANDARD CHARACTERS WITHOUT CLAIM TO ANY PARTICULAR FONT, STYLE, SIZE, OR COLOR.

CLASS 41—EDUCATION AND ENTERTAINMENT

FOR FISHING GUIDE SERVICES (U.S. CLS. 100, 101 AND 107).

CLASS 35—ADVERTISING AND BUSINESS

FOR RETAIL DEPARTMENT STORE SERVICES FEATURING WOMEN'S SPORTSWEAR APPAREL, NAMELY, PANTS, SKIRTS, SHORTS, DRESSES, SWEATERS, BLOUSES, T-SHIRTS, KNIT SHIRTS, JACKETS AND COATS (U.S. CLS. 100, 101 AND 102).
ELIZABETH J. WINTER, EXAMINING ATTORNEY

CLASS 43—HOTEL AND RESTAURANT SERVICES

FOR LODGING SERVICES AND RESTAURANT SERVICES (U.S. CLS. 100 AND 101).
RAUL CORDOVA, EXAMINING ATTORNEY

SN 78-518,476. ARBY'S IP HOLDER TRUST, FT. LAUDERDALE, FL. FILED 11-17-2004.

MARKET FRESH IXPRESS

THE MARK CONSISTS OF STANDARD CHARACTERS WITHOUT CLAIM TO ANY PARTICULAR FONT, STYLE, SIZE, OR COLOR.

OWNER OF U.S. REG. NOS. 2,619,643, 2,720,357 AND 2,815,992.

CLASS 29—MEATS AND PROCESSED FOODS

FOR VEGETABLE AND FRUIT SALADS FOR THE CONSUMPTION ON OR OFF THE PREMISES (U.S. CL. 46).

CLASS 30—STAPLE FOODS

FOR SANDWICHES FOR THE CONSUMPTION ON OR OFF THE PREMISES (U.S. CL. 46).

CLASS 43—HOTEL AND RESTAURANT SERVICES

FOR RESTAURANT SERVICES (U.S. CLS. 100 AND 101).
ARETHA SOMERVILLE, EXAMINING ATTORNEY

SN 78-518,481. GEORGIA-PACIFIC CORPORATION, ATLANTA, GA. FILED 11-17-2004.

FOR THE WORLD YOU'VE BUILT

THE MARK CONSISTS OF STANDARD CHARACTERS WITHOUT CLAIM TO ANY PARTICULAR FONT, STYLE, SIZE, OR COLOR.

CLASS 35—ADVERTISING AND BUSINESS

FOR WHOLESALE DISTRIBUTORSHIP SERVICES IN THE FIELDS OF COMMERCIAL BUILDING PRODUCTS, CHEMICALS, CONSUMER PRODUCTS, FOOD SERVICE PRODUCTS, PAPER PRODUCTS, PACKAGING AND PAPERBOARD (U.S. CLS. 100, 101 AND 102).

CLASS 40—MATERIAL TREATMENT

FOR CUSTOM MANUFACTURE OF COMMERCIAL BUILDING PRODUCTS, CHEMICALS, CONSUMER PRODUCTS, FOOD SERVICE PRODUCTS, OFFICE PAPER PRODUCTS, PACKAGING AND PAPERBOARD (U.S. CLS. 100, 103 AND 106).
REBECCA GAN, EXAMINING ATTORNEY

SN 78-518,482. SANIBEL INVESTMENTS, INC., SHAWNEE, KS. FILED 11-17-2004.



THE COLOR(S) GREEN, WHITE & BLACK IS/ARE CLAIMED AS A FEATURE OF THE MARK.

THE PORTION OF THE DIAMONDS ON THE OUTSIDE OF THE CIRCLE IS GREEN. THE PORTION OF THE DIAMONDS ON THE INSIDE OF THE CIRCLE IS WHITE. THE REMAINDER OF THE CIRCLE IS GREEN. THE WORDING IN THE MARK IS BLACK.

THE MARK CONSISTS OF A THREE POINT CROWN MADE UP OF THREE DIAMONDS PARTIALLY INSIDE A CIRCLE.

CLASS 37—CONSTRUCTION AND REPAIR

FOR INSTALLATION AND MAINTENANCE OF IRRIGATION SYSTEMS (U.S. CLS. 100, 103 AND 106).
FIRST USE 3-1-2002; IN COMMERCE 3-1-2002.

CLASS 44—MEDICAL, BEAUTY AND AGRICULTURAL SERVICES

FOR LANDSCAPE GARDENING; LANDSCAPE GARDENING DESIGN; LAWN CARE (U.S. CLS. 100 AND 101).
FIRST USE 3-1-2002; IN COMMERCE 3-1-2002.
DANIEL CAPSHAW, EXAMINING ATTORNEY

SN 78-518,485. GEORGIA-PACIFIC CORPORATION, ATLANTA, GA. FILED 11-17-2004.

VITAL SIMPLICITY

THE MARK CONSISTS OF STANDARD CHARACTERS WITHOUT CLAIM TO ANY PARTICULAR FONT, STYLE, SIZE, OR COLOR.

CLASS 35—ADVERTISING AND BUSINESS

FOR WHOLESALE DISTRIBUTORSHIP SERVICES IN THE FIELDS OF BUILDING PRODUCTS, CHEMICALS, CONSUMER PRODUCTS, COMMERCIAL PRODUCTS, FOOD SERVICE PRODUCTS, PAPER PRODUCTS, PACKAGING AND PAPERBOARD (U.S. CLS. 100, 101 AND 102).

CLASS 40—MATERIAL TREATMENT

FOR CUSTOM MANUFACTURE OF BUILDING PRODUCTS, CHEMICALS, CONSUMER PRODUCTS, COMMERCIAL PRODUCTS, FOOD SERVICE PRODUCTS, OFFICE PAPER PRODUCTS, PACKAGING AND PAPERBOARD (U.S. CLS. 100, 103 AND 106).
ELISSA GARBER KON, EXAMINING ATTORNEY

SN 78-518,900. THE ACTIVE NETWORK, INC., LA JOLLA, CA. FILED 11-17-2004.

SN 78-519,135. DIOGEN LIGHTING, LLC, LITTLETON, CO. FILED 11-18-2004.

ACTIVE COMMUNITY SOLUTIONS

THE MARK CONSISTS OF STANDARD CHARACTERS WITHOUT CLAIM TO ANY PARTICULAR FONT, STYLE, SIZE, OR COLOR.

NO CLAIM IS MADE TO THE EXCLUSIVE RIGHT TO USE "COMMUNITY SOLUTIONS", APART FROM THE MARK AS SHOWN.

CLASS 9—ELECTRICAL AND SCIENTIFIC APPARATUS

FOR SOFTWARE FOR ORGANIZING AND PUBLISHING DATA RELATED TO PARTICIPATORY SPORTS AND RECREATIONAL ACTIVITIES (U.S. CLS. 21, 23, 26, 36 AND 38).

CLASS 35—ADVERTISING AND BUSINESS

FOR ONLINE REGISTRATION SERVICES FOR PARTICIPATORY SPORTS AND RECREATIONAL ACTIVITIES; SPORTS MANAGEMENT SERVICES, NAMELY, PROVIDING REGISTRATION APPLICATIONS, REPORTS, STATISTICS, PATTERNS OF USAGE, DEMOGRAPHIC STATISTICS, AND REGISTRATION LISTS (U.S. CLS. 100, 101 AND 102).

JENNIFER MARTIN, EXAMINING ATTORNEY

SN 78-519,066. CRABTREE & EVELYN, LTD., WOODSTOCK, CT. FILED 11-18-2004.

PRESERVING A FINE TRADITION

THE MARK CONSISTS OF STANDARD CHARACTERS WITHOUT CLAIM TO ANY PARTICULAR FONT, STYLE, SIZE, OR COLOR.

OWNER OF U.S. REG. NO. 1,624,230.

CLASS 29—MEATS AND PROCESSED FOODS

FOR FRUIT PRESERVES; MARMALADE; LEMON CURD (U.S. CL. 46).

CLASS 30—STAPLE FOODS

FOR TEA; COOKIES; BISCUITS; SHORTBREAD; CANDY; HONEY; MUSTARD; CHUTNEY; RELISH (U.S. CL. 46).

ROBERT LAVACHE, EXAMINING ATTORNEY

Diogen

THE MARK CONSISTS OF STANDARD CHARACTERS WITHOUT CLAIM TO ANY PARTICULAR FONT, STYLE, SIZE, OR COLOR.

CLASS 9—ELECTRICAL AND SCIENTIFIC APPARATUS

FOR LIGHT EMITTING DIODES, LIGHT EMITTING DIODE DISPLAYS (U.S. CLS. 21, 23, 26, 36 AND 38).

CLASS 11—ENVIRONMENTAL CONTROL APPARATUS

FOR ELECTRIC HOLIDAY LIGHTS, ELECTRIC LIGHT BULBS, ELECTRIC LIGHTING FIXTURES, ELECTRIC LIGHTS FOR CHRISTMAS TREES, FLASHLIGHTS, LIGHTED OUTDOOR HOLIDAY SCULPTURES (U.S. CLS. 13, 21, 23, 31 AND 34).

JENNIFER CHICOSKI, EXAMINING ATTORNEY

SN 78-520,272. TRIALNET, INC., RICHMOND, VA. FILED 11-19-2004.



THE COLORS RED ON THE GLOBE SYMBOL BESIDE THE NAME, WITH WHITE LATITUDE AND LONGITUDE LINES ARE CLAIMED AS A FEATURE OF THE MARK.

THE MARK CONSISTS OF TRIALNET IN LARGE AND SMALL CAPITALS (T AND N ONLY IN LARGE CAPS), BESIDE A RED GLOBE SYMBOL WITH WHITE LATITUDE AND LONGITUDE LINES.

CLASS 35—ADVERTISING AND BUSINESS

FOR WEB-BASED BILLING AND FILE MANAGEMENT SERVICES (U.S. CLS. 100, 101 AND 102).

FIRST USE 9-1-2004; IN COMMERCE 9-1-2004.

CLASS 38—COMMUNICATION

FOR PROVIDING CLIENT-COUNSEL COMMUNICATIONS SERVICES THROUGH INTRANETS THAT FACILITATE E-MAIL, CHAT ROOMS, MESSAGE BOARDS, AND ON-LINE DATABASES, WHICH ALLOW FOR TRANSMISSION OF MESSAGES AND SHARING OF INFORMATION CONCERNING LEGAL CASES AND ISSUES (U.S. CLS. 100, 101 AND 104).

FIRST USE 9-1-2004; IN COMMERCE 9-1-2004.
LESLEY LAMOTHE, EXAMINING ATTORNEY

SN 78-520,290. TRIALNET, INC., RICHMOND, VA. FILED 11-19-2004.

OUR CLIENTS ALWAYS
WIN

THE MARK CONSISTS OF STANDARD CHARACTERS WITHOUT CLAIM TO ANY PARTICULAR FONT, STYLE, SIZE, OR COLOR.

CLASS 35—ADVERTISING AND BUSINESS

FOR WEB-BASED BILLING AND FILE MANAGEMENT SERVICES (U.S. CLS. 100, 101 AND 102).
FIRST USE 9-1-2004; IN COMMERCE 9-1-2004.

CLASS 38—COMMUNICATION

FOR CLIENT-COUNSEL COMMUNICATIONS SERVICES, NAMELY, PROVIDING E-MAIL SERVICES, CHAT ROOMS, AND MESSAGE BOARDS THAT ALLOW FOR THE TRANSMISSION OF MESSAGES AND INFORMATION CONCERNING LEGAL CASES AND ISSUES (U.S. CLS. 100, 101 AND 104).

FIRST USE 9-1-2004; IN COMMERCE 9-1-2004.
KIMBERLY FRYE, EXAMINING ATTORNEY

SN 78-520,601. DOROTHY GRANT LTD., DELTA, BRITISH COLUMBIA, CANADA, FILED 11-20-2004.

DOROTHY GRANT

THE NAME(S), PORTRAIT(S), AND/OR SIGNATURE(S) SHOWN IN THE MARK IDENTIFIES DOROTHY GRANT, WHOSE CONSENT(S) TO REGISTER IS SUBMITTED.

CLASS 18—LEATHER GOODS

FOR HAND BAGS, PURSES, BRIEFCASES, BACKPACKS (U.S. CLS. 1, 2, 3, 22 AND 41).
FIRST USE 4-1-1994; IN COMMERCE 4-1-1994.

CLASS 25—CLOTHING

FOR CLOTHING, NAMELY, MEN'S AND WOMEN'S SHIRTS, BLAZERS, VESTS, JACKETS, SUITS; WOMEN'S COATS, PANTS, SKIRTS, DRESSES, KIMONOS, BLOUSES, SHAWLS, SCARVES, STOLES (U.S. CLS. 22 AND 39).

FIRST USE 4-1-1994; IN COMMERCE 4-1-1994.
PAULA MAHONEY, EXAMINING ATTORNEY

SN 78-520,603. DOROTHY GRANT LTD., DELTA, BRITISH COLUMBIA, CANADA, FILED 11-20-2004.



THE MARK CONSISTS OF HANDS DESIGN.

CLASS 18—LEATHER GOODS

FOR HAND BAGS, PURSES, BRIEFCASES, BACKPACKS (U.S. CLS. 1, 2, 3, 22 AND 41).
FIRST USE 12-31-1988; IN COMMERCE 12-31-1988.

CLASS 25—CLOTHING

FOR CLOTHING, NAMELY, MEN'S AND WOMEN'S SHIRTS, BLAZERS, VESTS, JACKETS, SUITS; WOMEN'S COATS, PANTS, SKIRTS, DRESSES, KIMONOS, BLOUSES, SHAWLS, SCARVES, STOLES (U.S. CLS. 22 AND 39).

FIRST USE 12-31-1988; IN COMMERCE 12-31-1988.
PAULA MAHONEY, EXAMINING ATTORNEY

SN 78-521,093. SENTINEL VISION, INC., PALO ALTO, CA. FILED 11-22-2004.

SENTINEL VISION

THE MARK CONSISTS OF STANDARD CHARACTERS WITHOUT CLAIM TO ANY PARTICULAR FONT, STYLE, SIZE, OR COLOR.

OWNER OF U.S. REG. NO. 2,824,057.

CLASS 6—METAL GOODS

FOR METAL KEY FOB; METAL BRACKETS TO ASSEMBLE AND MOUNT SECURITY ALARM AND EVENT NOTIFICATION SYSTEMS (U.S. CLS. 2, 12, 13, 14, 23, 25 AND 50).

CLASS 9—ELECTRICAL AND SCIENTIFIC APPARATUS

FOR SECURITY ALARM SYSTEMS; EVENT NOTIFICATION SYSTEMS COMPRISED OF MONITORS, CAMERAS, SIRENS, KEY FOBs, AND PANIC BUTTONS FOR USE IN DETECTING, MONITORING, AND ALERTING SUBSCRIBERS OF BUILDING ENTRY, BUILDING INTRUSIONS, AND BUILDING EXITS, AND EMERGENCIES; INTRUDER DETECTION, ACCESS CONTROL, AND ALARM MONITORING SYSTEMS; MONITORS FOR USE IN DETECTING MOTION AND IN OBTAINING AND SENDING IMAGE, AUDIO, AND TEXT ALERT INFORMATION; AC CHARGERS; SIRENS; BATTERIES (U.S. CLS. 21, 23, 26, 36 AND 38).

CLASS 20—FURNITURE AND ARTICLES NOT OTHERWISE CLASSIFIED

FOR NON-METAL KEY FOB; NON-METAL SECURITY ALARM AND EVENT NOTIFICATION SYSTEMS WALL AND CEILING MOUNTS (U.S. CLS. 2, 13, 22, 25, 32 AND 50).

CLASS 42—SCIENTIFIC, COMPUTER AND LEGAL SERVICES

FOR CUSTOMER SUPPORT SERVICES, NAMELY TROUBLESHOOTING OF SECURITY ALARM SYSTEM AND EVENT NOTIFICATION SYSTEM PROBLEMS (U.S. CLS. 100 AND 101).

CLASS 45—PERSONAL SERVICES

FOR SECURITY ALARM AND EVENT NOTIFICATION SERVICES; ELECTRONIC MONITORING SERVICES OF PHYSICAL PREMISES FOR SECURITY AND EMERGENCY PURPOSES; NOTIFICATION SERVICES FOR EMERGENCY AND PHYSICAL PREMISES SECURITY PURPOSES; HOME AND BUSINESS ENTRY AND EXIT NOTIFICATION SERVICES (U.S. CLS. 100 AND 101).

YONG KIM, EXAMINING ATTORNEY

SN 78-521,501. GIFT CERTIFICATE CENTER, INC., MINNEAPOLIS, MN. FILED 11-23-2004.

CHOICEAWARD

THE MARK CONSISTS OF STANDARD CHARACTERS WITHOUT CLAIM TO ANY PARTICULAR FONT, STYLE, SIZE, OR COLOR.
OWNER OF U.S. REG. NO. 2,209,401.

CLASS 16—PAPER GOODS AND PRINTED MATTER

FOR AWARD CARDS FOR RECOGNIZING AND REWARDING EMPLOYEES OF OTHERS BY ALLOWING REDEMPTION FOR GIFT CERTIFICATES AT ISSUER AUTHORIZED WEBSITES OR FOR PURCHASE OF GOODS AND SERVICES AT PARTICIPATING MERCHANTS (U.S. CLS. 2, 5, 22, 23, 29, 37, 38 AND 50).
FIRST USE 1-14-2005; IN COMMERCE 1-14-2005.

CLASS 35—ADVERTISING AND BUSINESS

FOR PROMOTING THE SALE OF GOODS AND SERVICES OF OTHERS BY MEANS OF SELLING AWARD CARDS FOR RECOGNIZING AND REWARDING EMPLOYEES OF OTHERS BY ALLOWING REDEMPTION FOR GIFT CERTIFICATES AT ISSUER AUTHORIZED WEBSITES OR FOR PURCHASE OF GOODS AND SERVICES AT PARTICIPATING MERCHANTS (U.S. CLS. 100, 101 AND 102).
FIRST USE 1-14-2005; IN COMMERCE 1-14-2005.
JOHN WILKE, EXAMINING ATTORNEY

SN 78-521,719. PFIZER INC., NEW YORK, NY. FILED 11-23-2004.



THE MARK CONSISTS OF A DESIGN OF FOUR INTERLOCKING RECTANGLES.

CLASS 16—PAPER GOODS AND PRINTED MATTER

FOR PUBLICATIONS, NAMELY, BROCHURES, PAMPHLETS, LEAFLETS, NEWSLETTERS RELATED TO MEDICAL STUDIES AND RESEARCH REGARDING PHARMACEUTICAL PREPARATIONS (U.S. CLS. 2, 5, 22, 23, 29, 37, 38 AND 50).

CLASS 44—MEDICAL, BEAUTY AND AGRICULTURAL SERVICES

FOR PROVIDING INFORMATION ON THE EFFICACY OF A PHARMACEUTICAL PREPARATION FOR THE TREATMENT OF CARDIOVASCULAR DISEASES AND DISORDERS (U.S. CLS. 100 AND 101).
ZACHARY BELLO, EXAMINING ATTORNEY

SN 78-521,857. PESBAN S.A., 35008 LAS PALMAS DE GRAN CANARIA, SPAIN, FILED 11-23-2004.



OWNER OF SPAIN REG. NO. 2401977-1, DATED 1-27-2003, EXPIRES 5-22-2022.

CLASS 29—MEATS AND PROCESSED FOODS

FOR FISH, NAMELY, FRESH AND FROZEN FOR FOOD PURPOSES (U.S. CL. 46).

CLASS 39—TRANSPORTATION AND STORAGE

FOR PACKAGING OF FOOD PRODUCTS FOR TRANSPORTATION, STORAGE AND DELIVERY; STORAGE OF FOOD PRODUCTS; AND DELIVERY OF FOOD PRODUCTS BY COMMON CARRIER (U.S. CLS. 100 AND 105).
ANNE E. GUSTASON, EXAMINING ATTORNEY

SN 78-522,145. PLAYBOY ENTERPRISES INTERNATIONAL, INC., CHICAGO, IL. FILED 11-23-2004.



CLASS 38—COMMUNICATION

FOR CABLE TELEVISION AND TELEVISION BROADCASTING, SATELLITE TRANSMISSION SERVICES, ALL FEATURING ADULT ENTERTAINMENT (U.S. CLS. 100, 101 AND 104).

FIRST USE 6-28-2004; IN COMMERCE 6-28-2004.

CLASS 41—EDUCATION AND ENTERTAINMENT

FOR ENTERTAINMENT SERVICES, NAMELY TELEVISION PROGRAMMING SERVICES FEATURING ADULT PROGRAMS AND MOVIES (U.S. CLS. 100, 101 AND 107).

FIRST USE 6-28-2004; IN COMMERCE 6-28-2004.
ALEXANDER L. POWERS, EXAMINING ATTORNEY

SN 78-522,576. GARDNER ASPHALT CORPORATION, TAMPA, FL. FILED 11-24-2004.

APOC

THE MARK CONSISTS OF STANDARD CHARACTERS WITHOUT CLAIM TO ANY PARTICULAR FONT, STYLE, SIZE, OR COLOR.

OWNER OF U.S. REG. NOS. 2,327,740 AND 2,344,432.

CLASS 2—PAINTS

FOR PAINTS; LIQUID SEALER COATINGS FOR USE ON ROOFS, PAVEMENT, DRIVEWAYS, WALLS, FOUNDATIONS, DECKS AND MOBILE HOMES (U.S. CLS. 6, 11 AND 16).

FIRST USE 4-15-1996; IN COMMERCE 4-15-1996.

CLASS 17—RUBBER GOODS

FOR ADHESIVE SEALANTS AND CAULKING COMPOUNDS (U.S. CLS. 1, 5, 12, 13, 35 AND 50).
FIRST USE 4-15-1996; IN COMMERCE 4-15-1996.

CLASS 19—NON-METALLIC BUILDING MATERIALS

FOR ASPHALT-BASED, TAR-BASED, BITUMEN-BASED, ELASTOMERIC AND ALUMINIZED COATINGS FOR USE ON ROOFS, PAVEMENT, DRIVEWAYS, WALLS, FOUNDATIONS, DECKS AND MOBILE HOMES; WATERPROOFING PANELS FOR USE ON ROOFS (U.S. CLS. 1, 12, 33 AND 50).

FIRST USE 4-15-1996; IN COMMERCE 4-15-1996.
MARIA-VICTORIA SUAREZ, EXAMINING ATTORNEY

SN 78-523,584. MANAGESTAR.COM, INC., EMERYVILLE, CA. FILED 11-29-2004.

REAL CLEAR

THE MARK CONSISTS OF STANDARD CHARACTERS WITHOUT CLAIM TO ANY PARTICULAR FONT, STYLE, SIZE, OR COLOR.

CLASS 9—ELECTRICAL AND SCIENTIFIC APPARATUS

FOR COMPUTER SOFTWARE THAT ASSISTS USERS IN MARKETING AND DELIVERING THEIR SERVICES (U.S. CLS. 21, 23, 26, 36 AND 38).

CLASS 41—EDUCATION AND ENTERTAINMENT

FOR COMPUTER EDUCATION TRAINING (U.S. CLS. 100, 101 AND 107).

CLASS 42—SCIENTIFIC, COMPUTER AND LEGAL SERVICES

FOR CONSULTATION IN THE FIELD OF COMPUTER SOFTWARE (U.S. CLS. 100 AND 101).
KIMBERLY FRYE, EXAMINING ATTORNEY

SN 78-524,146. COMMONWEALTH OF KENTUCKY, FRANKFORT, KY. FILED 11-30-2004.

Kentucky
UNBRIDLED SPIRIT

NO CLAIM IS MADE TO THE EXCLUSIVE RIGHT TO USE KENTUCKY, APART FROM THE MARK AS SHOWN.

CLASS 21—HOUSEWARES AND GLASS

FOR DRINKING GLASSES, PLASTIC CUPS, MUGS, COFFEE CUPS, AND PLATES (U.S. CLS. 2, 13, 23, 29, 30, 33, 40 AND 50).

CLASS 25—CLOTHING

FOR APPAREL, NAMELY, T-SHIRTS, SWEATSHIRTS, POLO SHIRTS, DRESS SHIRTS, JACKETS, SWEATERS, CARDIGANS, PANTS, SHORTS, SWEATPANTS, SOCKS, HATS, CAPS, BELTS, AND FOOTWEAR (U.S. CLS. 22 AND 39).

CLASS 35—ADVERTISING AND BUSINESS

FOR PROMOTING TOURISM AND ECONOMIC, EDUCATIONAL, AGRICULTURAL, SCIENTIFIC, AND COMMUNITY DEVELOPMENT IN THE COMMONWEALTH OF KENTUCKY; PROMOTING PUBLIC AWARENESS OF THE ENVIRONMENT, HEALTH AND PUBLIC SAFETY IN THE COMMONWEALTH OF KENTUCKY (U.S. CLS. 100, 101 AND 102).

CLASS 41—EDUCATION AND ENTERTAINMENT

FOR EDUCATIONAL SERVICES, NAMELY, PROVIDING COURSES OF INSTRUCTION AT THE PRIMARY, SECONDARY, COLLEGIATE, AND POST-GRADUATE LEVELS AND THE DISTRIBUTION OF COURSE MATERIAL IN CONNECTION THEREWITH (U.S. CLS. 100, 101 AND 107).

TARAH HARDY, EXAMINING ATTORNEY

CLASS 16—PAPER GOODS AND PRINTED MATTER

FOR DIARIES; STATIONERY; WRAPPING PAPER; PAPER AND FABRIC GIFT BAGS; CHILDREN'S BOOKS (U.S. CLS. 2, 5, 22, 23, 29, 37, 38 AND 50).

CLASS 18—LEATHER GOODS

FOR TOTE BAGS (U.S. CLS. 1, 2, 3, 22 AND 41).

CLASS 20—FURNITURE AND ARTICLES NOT OTHERWISE CLASSIFIED

FOR HOLIDAY ORNAMENTS MADE OF PLASTIC AND WOOD (U.S. CLS. 2, 13, 22, 25, 32 AND 50).

CLASS 21—HOUSEWARES AND GLASS

FOR HOLIDAY ORNAMENTS MADE OF CRYSTAL AND GLASS; THERMAL INSULATED TRAVEL TUMBLERS FOR BEVERAGES (U.S. CLS. 2, 13, 23, 29, 30, 33, 40 AND 50).

CLASS 24—FABRICS

FOR QUILTS; BED BLANKETS (U.S. CLS. 42 AND 50).

CLASS 28—TOYS AND SPORTING GOODS

FOR SNOW GLOBES; CHRISTMAS TREE ORNAMENTS (U.S. CLS. 22, 23, 38 AND 50).

IRA J. GOODSID, EXAMINING ATTORNEY

SN 78-524,193. BARNES & NOBLE, INC., NEW YORK, NY. FILED 11-30-2004.

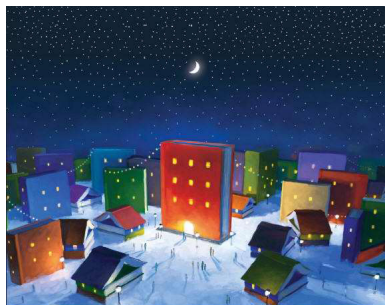

THE COLOR(S) BLUE, WHITE, RED, ORANGE, GREEN, RED, YELLOW AND PURPLE IS/ARE CLAIMED AS A FEATURE OF THE MARK.

THE COLOR BLUE APPEARS IN THE NIGHT SKY, IN SHADING AND SHADOWS ON THE GROUND, AND IN SEVERAL OF THE BOOKS. THE COLOR WHITE APPEARS IN THE STARS, THE DOOR OF THE CENTRAL BOOK, THE GROUND COVER, STRING LIGHTS AND SOME WINDOWS. THE COLORS ORANGE AND RED APPEAR IN THE CENTER BOOK AND SOME OF THE SURROUNDING BOOKS. THE COLORS GREEN AND PURPLE APPEAR IN SOME OF THE BOOKS. THE COLOR YELLOW APPEARS IN MOST OF THE WINDOWS.

THE MARK CONSISTS OF A SMALL TOWN SETTING WITH THE BUILDINGS MADE OF BOOKS, AND SEVERAL PEOPLE IN SHADOW FORM AROUND THE TOWN

CLASS 9—ELECTRICAL AND SCIENTIFIC APPARATUS

FOR MOUSE PADS (U.S. CLS. 21, 23, 26, 36 AND 38).

SN 78-524,631. VOLUME DISTRIBUTORS, INC., VERNON, CA. FILED 11-30-2004.

Elegant
DINING

NO CLAIM IS MADE TO THE EXCLUSIVE RIGHT TO USE "DINING", APART FROM THE MARK AS SHOWN.

THE MARK CONSISTS OF ELEGANT DINING IN STYLIZED WORDING; THE TWO "I"'S IN THE WORD DINING ARE IN THE SHAPE OF A SPOON AND A FORK.

CLASS 8—HAND TOOLS

FOR CUTLERY, NAMELY, FORKS, KNIVES SPOONS, BAGEL SLICERS, NON-ELECTRIC CHEESE SLICERS, CAKE CUTTERS, BLADES FOR KNIVES, BUTCHER KNIVES, CHEESE KNIVES, CHEF KNIVES, CARVING KNIVES, CLEAVERS, KITCHEN KNIVES, STEAK KNIVES, TABLE KNIVES, THIN-BLADED KITCHEN KNIVES, FIXED BLADE KNIVES, PARING KNIVES, POCKET KNIVES, PIZZA SLICERS, AND PIZZA CUTTERS (U.S. CLS. 23, 28 AND 44).

FIRST USE 7-10-2000; IN COMMERCE 7-10-2000.

CLASS 21—HOUSEWARES AND GLASS

FOR KITCHEN ACCESSORIES AND UTENSILS, NAMELY BAKEWARE, MIXING BOWLS, POTS, PANS, POT AND PAN SCRAPERS, PAN LIDS, DOUBLE BOILERS, SKILLETS, ROLLING PINS, SPATULAS, TURNERS, WHISKS, PAILS, COOKING PANS, PITCHERS, TRAYS, COLANDERS, ICE CUBE TRAYS, DECANTERS, PLASTIC CUTTING BOARD, MEASURING CUPS, AND PAPER TOWEL HOLDERS; BREAKFAST CEREAL STORAGE CONTAINERS, PITCHERS, JARS, CUPS, GLASSES, PLATES, BOWLS, TUMBLERS, SAUCERS, MUGS, STEMWARE, TEAPOTS NOT OF PRECIOUS METAL, AND CREAMERS; ICE BUCKETS, SERVING DISHES, SERVING UTENSILS MADE OF CHINA, NON-ELECTRIC KETTLES; KITCHEN ACCESSORIES MADE OF PORCELAIN, NAMELY PLATES, SAUCERS, SERVING DISHES, PLATTERS, CAKE PLATTERS, CHEESE PLATTER, CASSEROLE DISH, FRUIT BOWL; OIL AND VINEGAR CRUETS, SALT AND PEPPER SHAKER, CANISTER, SERVING UTENSILS, GLASS STEMWARE, CHAMPAGNE GLASSES, WINE GLASSES, GOBLET GLASSES, TUMBLERS, SNIFFERS AND DECANTERS (U.S. CLS. 2, 13, 23, 29, 30, 33, 40 AND 50).

FIRST USE 7-10-2000; IN COMMERCE 7-10-2000.

REBECCA HAN, EXAMINING ATTORNEY

SN 78-524,632. SMITH NEWS COMPANY, INC., SAN FRANCISCO, CA. FILED 11-30-2004.

SNCO

THE MARK CONSISTS OF STANDARD CHARACTERS WITHOUT CLAIM TO ANY PARTICULAR FONT, STYLE, SIZE, OR COLOR.

CLASS 6—METAL GOODS

FOR KEYCHAINS MADE OF METAL; TIN BOXES, SOLD EMPTY (U.S. CLS. 2, 12, 13, 14, 23, 25 AND 50).

FIRST USE 12-6-1994; IN COMMERCE 12-6-1994.

CLASS 8—HAND TOOLS

FOR SPOONS (U.S. CLS. 23, 28 AND 44).

FIRST USE 4-2-2002; IN COMMERCE 4-2-2002.

CLASS 15—MUSICAL INSTRUMENTS

FOR MUSIC BOXES (U.S. CLS. 2, 21 AND 36).

FIRST USE 6-21-1994; IN COMMERCE 6-21-1994.

CLASS 16—PAPER GOODS AND PRINTED MATTER

FOR PENCILS; PHOTO ALBUMS; POSTCARDS; PAPER SHOPPING BAGS; PENS; PENCIL CASES; ADDRESS BOOKS (U.S. CLS. 2, 5, 22, 23, 29, 37, 38 AND 50).

FIRST USE 1-4-2000; IN COMMERCE 1-4-2000.

CLASS 18—LEATHER GOODS

FOR BACKPACKS; EMBROIDERED HANDBAGS; TEXTILE SHOPPING BAGS (U.S. CLS. 1, 2, 3, 22 AND 41).

FIRST USE 6-9-2001; IN COMMERCE 6-9-2001.

CLASS 20—FURNITURE AND ARTICLES NOT OTHERWISE CLASSIFIED

FOR NONMETAL KEYCHAINS; PICTURE FRAMES (U.S. CLS. 2, 13, 22, 25, 32 AND 50).

FIRST USE 11-29-1993; IN COMMERCE 11-29-1993.

CLASS 21—HOUSEWARES AND GLASS

FOR CERAMIC PIGGY BANKS; CERAMIC FIGURINES IN THE NATURE OF BELLS; MUGS, SPOON RESTS; TRIVETS; COASTERS NOT OF PAPER AND NOT BEING TABLE LINEN; THERMAL INSULATED CONTAINERS FOR FOOD OR BEVERAGE; TRAYS NOT OF PRECIOUS METAL; CERAMIC PLATES; LUNCH BOXES; SHOT GLASSES (U.S. CLS. 2, 13, 23, 29, 30, 33, 40 AND 50).

FIRST USE 2-13-1995; IN COMMERCE 2-13-1995.

CLASS 24—FABRICS

FOR POT HOLDERS; BEACH TOWELS; PLASTIC PLACEMATS (U.S. CLS. 42 AND 50).

FIRST USE 3-5-1974; IN COMMERCE 3-15-1974.

CLASS 25—CLOTHING

FOR BASEBALL CAPS; SOCKS; T-SHIRTS (U.S. CLS. 22 AND 39).

FIRST USE 4-2-2001; IN COMMERCE 4-2-2001.

CLASS 26—FANCY GOODS

FOR PORCELAIN THIMBLES; ORNAMENTAL NOVELTY PINS (U.S. CLS. 37, 39, 40, 42 AND 50).

FIRST USE 5-14-1998; IN COMMERCE 5-14-1998.

CLASS 28—TOYS AND SPORTING GOODS

FOR WATER BALLS, NAMELY, BEACH BALLS; SNOW GLOBES (U.S. CLS. 22, 23, 38 AND 50).

FIRST USE 2-20-1997; IN COMMERCE 2-20-1997.

CLASS 30—STAPLE FOODS

FOR CHOCOLATE CANDY AND MINTS (U.S. CL. 46).

FIRST USE 5-15-2003; IN COMMERCE 5-15-2003.

CLASS 34—SMOKERS' ARTICLES

FOR CERAMIC ASHTRAYS; CIGARETTE LIGHTERS NOT OF PRECIOUS METAL (U.S. CLS. 2, 8, 9 AND 17).

FIRST USE 3-10-1999; IN COMMERCE 3-10-1999.
GEORGE LORENZO, EXAMINING ATTORNEY

SN 78-524,753. CYAN WORLDS, INC., MEAD, WA. FILED 11-30-2004.

LATUS

THE MARK CONSISTS OF STANDARD CHARACTERS WITHOUT CLAIM TO ANY PARTICULAR FONT, STYLE, SIZE, OR COLOR.

CLASS 9—ELECTRICAL AND SCIENTIFIC APPARATUS

FOR COMPUTER GAME SOFTWARE (U.S. CLS. 21, 23, 26, 36 AND 38).

CLASS 25—CLOTHING

FOR CLOTHING, NAMELY, T-SHIRTS, JACKETS, SWEATSHIRTS, HATS (U.S. CLS. 22 AND 39).

CLASS 41—EDUCATION AND ENTERTAINMENT

FOR PROVIDING ONLINE REAL TIME COMPUTER SOFTWARE GAME SERVICES FOR OTHERS OVER GLOBAL AND LOCAL AREA COMPUTER NETWORKS (U.S. CLS. 100, 101 AND 107).
JUDITH HELFMAN, EXAMINING ATTORNEY

SN 78-525,066. ARBONNE INTERNATIONAL, INC., IRVINE, CA. FILED 12-1-2004.

ARBONNE NOW

THE MARK CONSISTS OF STANDARD CHARACTERS WITHOUT CLAIM TO ANY PARTICULAR FONT, STYLE, SIZE, OR COLOR.
OWNER OF U.S. REG. NOS. 1,770,981 AND 2,096,008.

CLASS 16—PAPER GOODS AND PRINTED MATTER

FOR PRINTED MATERIALS, NAMELY, PRESS RELEASES, BOOKLETS, LEAFLETS, BROCHURES, CATALOGS AND NEWSLETTERS FEATURING MOTIVATIONAL, INSTRUCTIONAL, EDUCATIONAL AND TEACHING MATERIALS IN THE FIELDS OF FRAGRANCES, TOILETRIES, SKIN, HAIR, BEAUTY AND HEALTH CARE PRODUCTS FOR INDEPENDENT SALE FORCE (U.S. CLS. 2, 5, 22, 23, 29, 37, 38 AND 50).

CLASS 35—ADVERTISING AND BUSINESS

FOR RETAIL SHOP-AT HOME PARTIES, MAIL ORDER CATALOG SERVICES AND COMPUTERIZED ONLINE RETAIL STORE SERVICES IN THE FIELDS OF FRAGRANCES, TOILETRIES, SKIN, HAIR, BEAUTY AND HEALTH CARE PRODUCTS (U.S. CLS. 100, 101 AND 102).
SAMUEL E. SHARPER JR., EXAMINING ATTORNEY

SN 78-525,533. DS WATERS OF AMERICA, LP, ATLANTA, GA. FILED 12-1-2004.

PURELY REFRESHING

THE MARK CONSISTS OF STANDARD CHARACTERS WITHOUT CLAIM TO ANY PARTICULAR FONT, STYLE, SIZE, OR COLOR.

CLASS 25—CLOTHING

FOR CLOTHING, NAMELY SHIRTS AND HATS (U.S. CLS. 22 AND 39).

CLASS 32—LIGHT BEVERAGES

FOR BOTTLED WATER PRODUCTS, NAMELY SPRING WATER AND DISTILLED WATER (U.S. CLS. 45, 46 AND 48).

CLASS 39—TRANSPORTATION AND STORAGE

FOR HOME AND OFFICE DELIVERY OF BOTTLED WATER PRODUCTS (U.S. CLS. 100 AND 105).
CAROLINE WOOD, EXAMINING ATTORNEY

SN 78-525,556. ELVINS, EILEEN MCDARGH, DANA POINT, CA. FILED 12-1-2004.

IN HER OWN VOICE

THE MARK CONSISTS OF STANDARD CHARACTERS WITHOUT CLAIM TO ANY PARTICULAR FONT, STYLE, SIZE, OR COLOR.

CLASS 16—PAPER GOODS AND PRINTED MATTER

FOR PRINTED EDUCATIONAL MATERIALS FOR WOMEN IN THE FIELD OF PROFESSIONAL AND PERSONAL DEVELOPMENT (U.S. CLS. 2, 5, 22, 23, 29, 37, 38 AND 50).

CLASS 41—EDUCATION AND ENTERTAINMENT

FOR ARRANGING SEMINARS; CONDUCTING SEMINARS FOR WOMEN IN THE FIELD OF PERSONAL AND PROFESSIONAL DEVELOPMENT (U.S. CLS. 100, 101 AND 107).

RUDY R. SINGLETON, EXAMINING ATTORNEY

SN 78-525,779. CALESA, EDWARD, MANSFIELD, TX. FILED 12-2-2004.

**BIGGER RESULTS:
STORIES THAT
ENTERTAIN AND
EXPLAIN**

THE MARK CONSISTS OF STANDARD CHARACTERS WITHOUT CLAIM TO ANY PARTICULAR FONT, STYLE, SIZE, OR COLOR.

NO CLAIM IS MADE TO THE EXCLUSIVE RIGHT TO USE "STORIES THAT ENTERTAIN AND EXPLAIN", APART FROM THE MARK AS SHOWN.

CLASS 9—ELECTRICAL AND SCIENTIFIC APPARATUS

FOR PRE-RECORDED DVD'S, CD-ROM'S AND VIDEOTAPES FEATURING MOTIVATIONAL TOPICS, NAMELY, PERSONAL AND PROFESSIONAL IMPROVEMENT (U.S. CLS. 21, 23, 26, 36 AND 38).

CLASS 16—PAPER GOODS AND PRINTED MATTER

FOR SERIES OF BOOKS AND PRINTED INSTRUCTIONAL MATERIALS ON MOTIVATIONAL TOPICS, NAMELY, PERSONAL AND PROFESSIONAL IMPROVEMENT (U.S. CLS. 2, 5, 22, 23, 29, 37, 38 AND 50).

CLASS 41—EDUCATION AND ENTERTAINMENT

FOR EDUCATIONAL SERVICES; NAMELY CONDUCTING SEMINARS, LECTURES, WORKSHOPS AND TRAINING PROGRAMS ON MOTIVATIONAL TOPICS, NAMELY, PERSONAL AND PROFESSIONAL IMPROVEMENT (U.S. CLS. 100, 101 AND 107).

REBECCA SMITH, EXAMINING ATTORNEY

SN 78-526,068. THE DANNON COMPANY, INC., WHITE PLAINS, NY. FILED 12-2-2004.

**COMMIT TO BE LIGHT
'N FIT**

THE MARK CONSISTS OF STANDARD CHARACTERS WITHOUT CLAIM TO ANY PARTICULAR FONT, STYLE, SIZE, OR COLOR.

OWNER OF U.S. REG. NO. 2,720,798.

CLASS 29—MEATS AND PROCESSED FOODS

FOR YOGURT AND YOGURT-BASED BEVERAGES (U.S. CL. 46).

CLASS 32—LIGHT BEVERAGES

FOR FRUIT JUICES AND FRUIT DRINKS; FRUIT-BASED BEVERAGES WITH YOGURT; SMOOTHIES (U.S. CLS. 45, 46 AND 48).

BARBARA A. LOUGHRAN, EXAMINING ATTORNEY

SN 78-526,095. BRINE, INC, MILFORD, MA. FILED 12-2-2004.



OWNER OF U.S. REG. NOS. 2,243,875 AND 2,293,465.
THE MARK CONSISTS OF STYLIZED WING DESIGN.

CLASS 9—ELECTRICAL AND SCIENTIFIC APPARATUS

FOR ATHLETIC HEADGEAR; NAMELY, HELMETS; AND PROTECTIVE EYEWEAR; NAMELY LACROSSE EYEWEAR AND FIELD HOCKEY EYEWEAR (U.S. CLS. 21, 23, 26, 36 AND 38).

FIRST USE 11-26-2003; IN COMMERCE 11-26-2003.

CLASS 28—TOYS AND SPORTING GOODS

FOR LACROSSE STICKS, LACROSSE STICK HEADS, LACROSSE STICK HANDLES, LACROSSE BALL STOPS, LACROSSE BALLS, LACROSSE GLOVES, LACROSSE ARM PADS, LACROSSE SHOULDER PADS, LACROSSE RIB PADS, LACROSSE CHEST PROTECTORS, LACROSSE GOALS, LACROSSE NETS, SOCCER GOALS, SOCCER NETS, FIELD HOCKEY STICKS (U.S. CLS. 22, 23, 38 AND 50).

FIRST USE 9-4-2003; IN COMMERCE 9-4-2003.
JOHN KELLY, EXAMINING ATTORNEY

SN 78-526,105. DAABON INTERNATIONAL, INC., PANAMA CITY, PANAMA, FILED 12-2-2004.

FRESHPRESS

THE MARK CONSISTS OF STANDARD CHARACTERS WITHOUT CLAIM TO ANY PARTICULAR FONT, STYLE, SIZE, OR COLOR.

CLASS 3—COSMETICS AND CLEANING PREPARATIONS

FOR COSMETICS (U.S. CLS. 1, 4, 6, 50, 51 AND 52).

CLASS 29—MEATS AND PROCESSED FOODS

FOR EDIBLE OIL (U.S. CL. 46).
GIANCARLO CASTRO, EXAMINING ATTORNEY

SN 78-526,253. GRASSROOTS COMMUNICATIONS, INC., PALM DESERT, CA. FILED 12-2-2004.



THE COLOR(S) BLACK AND GOLD IS/ARE CLAIMED AS A FEATURE OF THE MARK.
THE MARK CONSISTS OF THE LOWER-CASE LETTER "G" SHOWN IN GOLD IN THE LOWER RIGHT CORNER OF A SOLID BLACK SQUARE

CLASS 9—ELECTRICAL AND SCIENTIFIC APPARATUS

FOR COMPUTER SOFTWARE FOR MULTI-MEDIA CONFERENCING VIA A GLOBAL COMPUTER NETWORK; COMPUTER SOFTWARE FOR WEB-BASED COLLABORATION BY MULTIMEDIA CONFERENCING AND PRESENTATION VIA A GLOBAL COMPUTER NETWORK; COMPUTER SOFTWARE FOR CONNECTING PERSONAL COMPUTERS TO A GLOBAL COMPUTER NETWORK; COMPUTER SOFTWARE FOR CONNECTING PERSONAL COMPUTERS TO EACH OTHER VIA A GLOBAL COMPUTER NETWORK; COMPUTER SOFTWARE FOR REAL-TIME VIDEO AND AUDIO CONFERENCING, APPLICATION SHARING, CALENDAR AND SCHEDULING, DOCUMENT SHARING, FILE SHARING AND FILE TRANSFER, RECORD AND PLAYBACK OF CONFERENCES, REMOTE PRINTING, REMOTE ACCESS WEB CONFERENCING, VOIP TELEPHONY AND CONFERENCING, INSTANT MESSAGING, AND ONLINE POLLING, ALL VIA A GLOBAL COMPUTER NETWORK; COMPUTER SOFTWARE FOR THE TRANSMISSION OF DATA, VOICE, IMAGES, AND DOCUMENTS OVER A GLOBAL COMPUTER NETWORK AND VIA COMPUTER TERMINALS (U.S. CLS. 21, 23, 26, 36 AND 38).

CLASS 38—COMMUNICATION

FOR TELECOMMUNICATIONS SERVICES, NAMELY, PROVIDING USERS WITH ACCESS TO A GLOBAL COMPUTER NETWORK FOR THE SHARING, TRANSFER, AND DISSEMINATION OF DATA, VOICE, IMAGES, AND DOCUMENTS; TELECOMMUNICATIONS SERVICES, NAMELY, INTERACTIVE MEDIA, VIDEO, AUDIO, AND TELEPHONE INTERNET CONFERENCING SERVICES; ELECTRONIC AND DIGITAL TRANSMISSION OF VOICE, DATA, MESSAGES, E-MAIL, FILE TRANSFERS, WEB DOWNLOADS, VISUAL IMAGES, SOUND AND OTHER INFORMATION VIA THE INTERNET; AUDIO, VIDEO, AND TELEPHONE INTERNET CONFERENCING SERVICES; TELECOMMUNICATIONS SERVICES, NAMELY, THE TRANSMISSION OF DATA, VOICE, IMAGES, AND DOCUMENTS OVER A GLOBAL COMPUTER NETWORK AND VIA COMPUTER TERMINALS (U.S. CLS. 100, 101 AND 104).
DAVID YONTEF, EXAMINING ATTORNEY

SN 78-527,131. LUX CAPITAL, NEW YORK, NY. FILED 12-4-2004.



NO CLAIM IS MADE TO THE EXCLUSIVE RIGHT TO USE "CAPITAL", APART FROM THE MARK AS SHOWN.
THE COLOR(S) GOLD AND BLACK IS/ARE CLAIMED AS A FEATURE OF THE MARK.
THE WORD "LUX" APPEARS IN BLACK AND THE WORD "CAPITAL" AND THE DESIGN OF FOUR CIRCLES, THREE OF WHICH ARE CONNECTED, APPEAR IN GOLD.

CLASS 16—PAPER GOODS AND PRINTED MATTER

FOR NEWSLETTERS AND RESEARCH REPORTS DEALING WITH ANALYSES FROM A FINANCIAL, MARKETING, AND TECHNICAL POINT OF VIEW OF THE NANOTECHNOLOGY AND OTHER HIGH TECHNOLOGY INDUSTRIES (U.S. CLS. 2, 5, 22, 23, 29, 37, 38 AND 50).
FIRST USE 3-1-2000; IN COMMERCE 3-1-2000.

CLASS 36—INSURANCE AND FINANCIAL

FOR FINANCIAL CONSULTING (U.S. CLS. 100, 101 AND 102).

FIRST USE 3-1-2000; IN COMMERCE 3-1-2000.
DAVID ELTON, EXAMINING ATTORNEY

SN 78-527,842. TOUCHSTONE RESEARCH LABORATORY, LTD., TRIADELPHIA, WV. FILED 12-6-2004.

CFOAM

THE MARK CONSISTS OF STANDARD CHARACTERS WITHOUT CLAIM TO ANY PARTICULAR FONT, STYLE, SIZE, OR COLOR.

OWNER OF U.S. REG. NO. 2,559,559.

CLASS 1—CHEMICALS

FOR CARBONACEOUS CHEMICALS, NAMELY POROUS CARBON AND NON-POROUS CARBON FOR USE IN THE MANUFACTURE OF FINISHED, SEMI-FINISHED, AND UNFINISHED GOODS (U.S. CLS. 1, 5, 6, 10, 26 AND 46).

FIRST USE 8-1-2000; IN COMMERCE 8-1-2000.

CLASS 17—RUBBER GOODS

FOR SEMI-FINISHED FOAM, NAMELY CARBON FOAM FOR USE IN THE MANUFACTURE OF FINISHED, SEMI-FINISHED AND UNFINISHED GOODS (U.S. CLS. 1, 5, 12, 13, 35 AND 50).

FIRST USE 8-1-2000; IN COMMERCE 8-1-2000.
KATRINA EDGE, EXAMINING ATTORNEY

SN 78-528,238. GIZMOCHINE, INC., HOUSTON, TX. FILED 12-7-2004.

KOPPERHED

THE MARK CONSISTS OF STANDARD CHARACTERS WITHOUT CLAIM TO ANY PARTICULAR FONT, STYLE, SIZE, OR COLOR.

OWNER OF U.S. REG. NO. 2,172,025.

CLASS 6—METAL GOODS

FOR METAL KEY CHAINS (U.S. CLS. 2, 12, 13, 14, 23, 25 AND 50).

CLASS 14—JEWELRY

FOR JEWELRY, NAMELY, PINS, NECKLACES, BRACELETS, PENDANTS, RINGS, CUFF LINKS, TIE PINS, WATCHES AND BELT BUCKLES OF PRECIOUS METAL (U.S. CLS. 2, 27, 28 AND 50).

CLASS 20—FURNITURE AND ARTICLES NOT OTHERWISE CLASSIFIED

FOR NON-METAL KEY CHAINS (U.S. CLS. 2, 13, 22, 25, 32 AND 50).

CLASS 28—TOYS AND SPORTING GOODS

FOR PLAYING CARDS (U.S. CLS. 22, 23, 38 AND 50).
MATTHEW PAPPAS, EXAMINING ATTORNEY

SN 78-528,300. JIBJAB MEDIA INC., SANTA MONICA, CA. FILED 12-7-2004.

GRUMPY SANTA

THE MARK CONSISTS OF STANDARD CHARACTERS WITHOUT CLAIM TO ANY PARTICULAR FONT, STYLE, SIZE, OR COLOR.

OWNER OF U.S. REG. NO. 2,713,128.
NO CLAIM IS MADE TO THE EXCLUSIVE RIGHT TO USE "SANTA", APART FROM THE MARK AS SHOWN.

CLASS 16—PAPER GOODS AND PRINTED MATTER

FOR PAPER GOODS, NAMELY GREETING CARDS AND GIFT WRAPPING PAPER (U.S. CLS. 2, 5, 22, 23, 29, 37, 38 AND 50).

CLASS 25—CLOTHING

FOR CLOTHING, NAMELY SHIRTS (U.S. CLS. 22 AND 39).

CLASS 28—TOYS AND SPORTING GOODS

FOR TOYS, NAMELY PLUSH TOYS, TOY FIGURES, TALKING TOYS AND TOY SNOW GLOBES; CHRISTMAS DECORATIONS, NAMELY, CHRISTMAS TREE ORNAMENTS (U.S. CLS. 22, 23, 38 AND 50).

MATTHEW PAPPAS, EXAMINING ATTORNEY

SN 78-528,554. NATIONAL LIBRARY OF MEDICINE, THE, BETHESDA, MD. FILED 12-7-2004.

ENTREZ

THE MARK CONSISTS OF STANDARD CHARACTERS WITHOUT CLAIM TO ANY PARTICULAR FONT, STYLE, SIZE, OR COLOR.

THE FOREIGN WORDING IN THE MARK TRANSLATES INTO ENGLISH AS ENTER.

CLASS 42—SCIENTIFIC, COMPUTER AND LEGAL SERVICES

FOR PROVIDING A TEXT-BASED SEARCH AND RETRIEVAL SYSTEM FOR COMPUTER ONLINE DATABASES AND DATA BANKS CONTAINING INFORMATION IN THE FIELD OF MEDICAL RESEARCH (U.S. CLS. 100 AND 101).

FIRST USE 0-0-1991; IN COMMERCE 0-0-1991.

CLASS 44—MEDICAL, BEAUTY AND AGRICULTURAL SERVICES

FOR PROVIDING A TEXT-BASED SEARCH AND RETRIEVAL SYSTEM FOR COMPUTER ONLINE DATABASES AND DATA BANKS CONTAINING INFORMATION IN THE FIELD OF BIOMEDICINE, BIOTECHNOLOGY, GENETICS, MEDICAL TOXICOLOGY, HEALTH-RELATED ENVIRONMENTAL ISSUES, PUBLIC HEALTH, AND HEALTH CARE (U.S. CLS. 100 AND 101).

FIRST USE 0-0-1991; IN COMMERCE 0-0-1991.
ALINA MORRIS, EXAMINING ATTORNEY

SN 78-528,571. SIERRA TEL COMMUNICATIONS GROUP, OAKHURST, CA. FILED 12-7-2004.

SIERRA TEL BUSINESS CENTER

THE MARK CONSISTS OF STANDARD CHARACTERS WITHOUT CLAIM TO ANY PARTICULAR FONT, STYLE, SIZE, OR COLOR.

OWNER OF U.S. REG. NOS. 2,478,286, 2,850,092 AND OTHERS.

NO CLAIM IS MADE TO THE EXCLUSIVE RIGHT TO USE TEL BUSINESS CENTER, APART FROM THE MARK AS SHOWN.

CLASS 35—ADVERTISING AND BUSINESS

FOR BUSINESS SERVICES, NAMELY, PHOTOCOPYING SERVICES INCLUDING REPRODUCING AND COMPILING DOCUMENTS FOR OTHERS; RENTAL OF OFFICE MACHINERY AND EQUIPMENT; LEASE AND RENTAL OF COPY MACHINES, AND WORD PROCESSORS; RETAIL STORE SERVICES FEATURING BOOKS (U.S. CLS. 100, 101 AND 102).

FIRST USE 1-1-2004; IN COMMERCE 1-1-2004.

CLASS 38—COMMUNICATION

FOR COMMUNICATION SERVICES, NAMELY, ELECTRONIC MAIL SERVICES AND ELECTRONIC TRANSMISSION OF DATA AND DOCUMENTS VIA COMPUTER TERMINALS; FACSIMILE TRANSMISSION SERVICES; RENTAL OF TELEPHONE, FACSIMILE AND TELECOMMUNICATION EQUIPMENT; VIDEO TELECONFERENCING (U.S. CLS. 100, 101 AND 104).

FIRST USE 1-1-2004; IN COMMERCE 1-1-2004.

CLASS 40—MATERIAL TREATMENT

FOR PRINTING SERVICES (U.S. CLS. 100, 103 AND 106).

FIRST USE 1-1-2004; IN COMMERCE 1-1-2004.

CLASS 41—EDUCATION AND ENTERTAINMENT

FOR TRAINING IN THE FIELD OF COMPUTER AND INTERNET OPERATION (U.S. CLS. 100, 101 AND 107).

FIRST USE 1-1-2004; IN COMMERCE 1-1-2004.

CLASS 42—SCIENTIFIC, COMPUTER AND LEGAL SERVICES

FOR LEASE AND RENTAL OF COMPUTERS AND COMPUTER PERIPHERALS (U.S. CLS. 100 AND 101).

FIRST USE 1-1-2004; IN COMMERCE 1-1-2004.

TARAH HARDY, EXAMINING ATTORNEY

SN 78-528,672. VOLUME DISTRIBUTORS, INC., VERNON, CA. FILED 12-7-2004.



OWNER OF U.S. REG. NO. 2,562,992.

THE MARK CONSISTS OF THE WORDING BEBELLE WITH A BACKGROUND OF VERTICAL LINES; A TEDDY BEAR TO THE RIGHT AND A CAT TO THE LEFT OF THE WORDING.

CLASS 3—COSMETICS AND CLEANING PREPARATIONS

FOR BABY SHAMPOO, BABY HAIR CONDITIONER, BABY LOTION, BABY POWDER, BABY OIL, BABY WIPES, COTTON SWABS FOR COSMETIC PURPOSES (U.S. CLS. 1, 4, 6, 50, 51 AND 52).

FIRST USE 2-1-1999; IN COMMERCE 2-1-1999.

CLASS 10—MEDICAL APPARATUS

FOR BABY BOTTLES; BABY BOTTLE NIPPLES; BABY NURSERS, BABY TEETHING RINGS (U.S. CLS. 26, 39 AND 44).

FIRST USE 2-1-1999; IN COMMERCE 2-1-1999.

CLASS 21—HOUSEWARES AND GLASS

FOR HAIR COMBS FOR BABIES, HAIR BRUSHES FOR BABIES, BABY TRAINERS, BABY BATHTUBS (U.S. CLS. 2, 13, 23, 29, 30, 33, 40 AND 50).

FIRST USE 2-1-1999; IN COMMERCE 2-1-1999.

CLASS 24—FABRICS

FOR BABY BLANKETS (U.S. CLS. 42 AND 50).

FIRST USE 2-1-1999; IN COMMERCE 2-1-1999.

CLASS 25—CLOTHING

FOR CLOTHING, NAMELY, T-SHIRTS, CREEPERS, TANK TOPS, HATS, BOOTIES, SOCKS; CLOTH BABY BIBS (U.S. CLS. 22 AND 39).

FIRST USE 2-1-1999; IN COMMERCE 2-1-1999.

REBECCA GAN, EXAMINING ATTORNEY

CLASS 24—FABRICS

FOR FABRICS FOR USE IN THE MANUFACTURE OF CLOTHING (U.S. CLS. 42 AND 50).

CLASS 25—CLOTHING

FOR CLOTHING, NAMELY, SUITS, SPORTS JACKETS, JACKETS, COATS, PANTS, TROUSERS, SLACKS, SHORTS, JEANS, SHIRTS, T-SHIRTS, TOPS, SWEATERS, CARDIGANS, VESTS, TIES, SWEATSHIRTS, SWEATPANTS, SOCKS, UNDERWEAR, HATS, CAPS, GLOVES, SCARVES (U.S. CLS. 22 AND 39).

CHRIS WELLS, EXAMINING ATTORNEY

SN 78-529,743. ERMENEGILDO ZEGNA CORPORATION, ENGLEWOOD, NJ. FILED 12-9-2004.

**ERMENEGILDO ZEGNA
MICRONSPHERE**

THE MARK CONSISTS OF STANDARD CHARACTERS WITHOUT CLAIM TO ANY PARTICULAR FONT, STYLE, SIZE, OR COLOR.

OWNER OF U.S. REG. NOS. 1,264,309, 2,335,315 AND OTHERS.

THE NAME(S), PORTRAIT(S), AND/OR SIGNATURE(S) SHOWN IN THE MARK DOES NOT IDENTIFY A PARTICULAR LIVING INDIVIDUAL.

CLASS 24—FABRICS

FOR FABRICS FOR USE IN THE MANUFACTURE OF CLOTHING (U.S. CLS. 42 AND 50).

CLASS 25—CLOTHING

FOR CLOTHING, NAMELY, SUITS, SPORTS JACKETS, JACKETS, COATS, PANTS, TROUSERS, SLACKS, SHORTS, JEANS, SHIRTS, T-SHIRTS, TOPS, SWEATERS, CARDIGANS, VESTS, TIES, SWEATSHIRTS, SWEATPANTS, SOCKS, UNDERWEAR, HATS, CAPS, GLOVES, SCARVES (U.S. CLS. 22 AND 39).

ALINA MORRIS, EXAMINING ATTORNEY

SN 78-529,968. ERMENEGILDO ZEGNA CORPORATION, ENGLEWOOD, NJ. FILED 12-9-2004.

**ERMENEGILDO ZEGNA
μICRONSPHERE**

THE MARK CONSISTS OF STANDARD CHARACTERS WITHOUT CLAIM TO ANY PARTICULAR FONT, STYLE, SIZE, OR COLOR.

OWNER OF U.S. REG. NOS. 1,264,309, 2,335,315 AND OTHERS.

THE NAME(S), PORTRAIT(S), AND/OR SIGNATURE(S) SHOWN IN THE MARK DOES NOT IDENTIFY A PARTICULAR LIVING INDIVIDUAL.

SN 78-530,162. PINK PROJECT, INC., HOUSTON, TX. FILED 12-9-2004.

TOUR DE PINK

THE MARK CONSISTS OF STANDARD CHARACTERS WITHOUT CLAIM TO ANY PARTICULAR FONT, STYLE, SIZE, OR COLOR.

THE ENGLISH TRANSLATION OF THE MARK, TOUR DE PINK, IS TOUR OF PINK.

CLASS 35—ADVERTISING AND BUSINESS

FOR CHARITABLE SERVICES, NAMELY, PROMOTING PUBLIC AWARENESS OF THE NEED FOR FUNDING TO FIGHT BREAST CANCER (U.S. CLS. 100, 101 AND 102).

CLASS 36—INSURANCE AND FINANCIAL

FOR CHARITABLE FUNDRAISING SERVICES, NAMELY, RAISING MONEY FOR BREAST CANCER DETECTION, RESEARCH, EDUCATION AND TREATMENT (U.S. CLS. 100, 101 AND 102).

DEZMONA MIZELLE, EXAMINING ATTORNEY

SN 78-530,469. GALOIS CONNECTIONS INC., BEAVERTON, OR. FILED 12-10-2004.

| galois |

THE MARK CONSISTS OF THE WORD ELEMENT GALOIS FLANKED ON EITHER SIDE BY A SOLID VERTICAL LINE.

CLASS 9—ELECTRICAL AND SCIENTIFIC APPARATUS

FOR COMPUTER SOFTWARE APPLICATIONS PROVIDING DATA AND INFORMATION ASSURANCE AND SECURITY, DATA AND INFORMATION VALIDATION, AND DATA AND INFORMATION CRYPTOGRAPHY IN THE FIELDS OF DATA, INFORMATION AND COMPUTER NETWORK PROTECTION AND SECURITY (U.S. CLS. 21, 23, 26, 36 AND 38).
FIRST USE 4-28-2003; IN COMMERCE 4-28-2003.

CLASS 42—SCIENTIFIC, COMPUTER AND LEGAL SERVICES

FOR DESIGN AND DEVELOPMENT OF COMPUTER SOFTWARE FOR OTHERS IN THE FIELDS OF DATA AND INFORMATION SECURITY, DATA AND INFORMATION VALIDATION, DATA AND INFORMATION ASSURANCE, AND DATA AND INFORMATION CRYPTOGRAPHY (U.S. CLS. 100 AND 101).
FIRST USE 4-28-2003; IN COMMERCE 4-28-2003.
GENE MACIOL, EXAMINING ATTORNEY

SN 78-530,641. BECTON, DICKINSON AND COMPANY, FRANKLIN LAKES, NJ. FILED 12-10-2004.



OWNER OF U.S. REG. NOS. 507,884, 1,141,176 AND 1,399,295.
THE COLOR(S) WHITE, BLUE AND RED IS/ARE CLAIMED AS A FEATURE OF THE MARK.
THE MARK CONSISTS OF WHITE LETTERS OUTLINED IN BLUE ON A RED BACKGROUND.

CLASS 5—PHARMACEUTICALS

FOR ADHESIVE BANDAGES (U.S. CLS. 6, 18, 44, 46, 51 AND 52).
FIRST USE 2-28-2001; IN COMMERCE 2-28-2001.

CLASS 10—MEDICAL APPARATUS

FOR BODY SUPPORTS AND BRACES FOR MEDICAL USE ON KNEES, ELBOWS, ANKLES, AND WRISTS; CHEMICALLY ACTIVATED COLD COMPRESSES; COMPRESSION BANDAGES; ELASTIC BANDAGES AND BANDAGE FASTENING CLIPS SOLD THEREWITH (U.S. CLS. 26, 39 AND 44).
FIRST USE 2-28-2001; IN COMMERCE 2-28-2001.

CLASS 25—CLOTHING

FOR ATHLETIC SUPPORTER BRIEFS (U.S. CLS. 22 AND 39).
FIRST USE 2-28-2001; IN COMMERCE 2-28-2001.
LINDA POWELL, EXAMINING ATTORNEY

SN 78-530,728. DLC CORP., SAN ANTONIO, TX. FILED 12-10-2004.

TEAPARTY CONCERTS

THE MARK CONSISTS OF STANDARD CHARACTERS WITHOUT CLAIM TO ANY PARTICULAR FONT, STYLE, SIZE, OR COLOR.
NO CLAIM IS MADE TO THE EXCLUSIVE RIGHT TO USE "CONCERTS", APART FROM THE MARK AS SHOWN.

CLASS 35—ADVERTISING AND BUSINESS

FOR PROMOTING A VARIETY OF LIVE ENTERTAINMENT EVENTS FOR OTHERS AND PROMOTING MERCHANDISE RELATED THERETO; BUSINESS MANAGEMENT AND PROMOTING THE SPECIAL EVENTS OF OTHERS, ALL IN THE FIELD OF MUSICAL, THEATRICAL, EDUCATIONAL, CULTURAL, AND FAMILY/VARIETY TOURS AND PRESENTATIONS; BUSINESS OPERATION AND BUSINESS MANAGEMENT OF ENTERTAINMENT VENUES; RETAIL STORE SERVICES FEATURING ARTIST AND TOUR-RELATED MERCHANDISE AND COLLECTIBLES; PROMOTING TICKET SALES AND VIP PRIVILEGES FOR LIVE ENTERTAINMENT EVENTS FOR OTHERS (U.S. CLS. 100, 101 AND 102).
FIRST USE 11-1-2004; IN COMMERCE 11-1-2004.

CLASS 41—EDUCATION AND ENTERTAINMENT

FOR PRODUCTION OF LIVE ENTERTAINMENT EVENTS, NAMELY, LIVE CONCERTS, FESTIVALS, THEATRICAL SHOWS, EDUCATIONAL AND CULTURAL EVENTS, AND SHOWS FOR THE ENTERTAINMENT OF CHILDREN; ENTERTAINMENT SERVICES IN THE NATURE OF ORGANIZING MUSICAL, THEATRICAL, EDUCATIONAL, CULTURAL, AND FAMILY/VARIETY TOURS AND PRESENTATIONS (U.S. CLS. 100, 101 AND 107).
FIRST USE 11-1-2004; IN COMMERCE 11-1-2004.
ELLEN B. AWRICH, EXAMINING ATTORNEY

SN 78-530,734. DLC CORP., SAN ANTONIO, TX. FILED 12-10-2004.



NO CLAIM IS MADE TO THE EXCLUSIVE RIGHT TO USE "CONCERTS", APART FROM THE MARK AS SHOWN.

CLASS 35—ADVERTISING AND BUSINESS

FOR PROMOTING A VARIETY OF LIVE ENTERTAINMENT EVENTS FOR OTHERS AND PROMOTING MERCHANDISE RELATED THERETO; BUSINESS MANAGEMENT AND PROMOTING THE SPECIAL EVENTS OF OTHERS, ALL IN THE FIELD OF MUSICAL, THEATRICAL, EDUCATIONAL, CULTURAL, AND FAMILY/VARIETY TOURS AND PRESENTATIONS; BUSINESS OPERATION AND BUSINESS MANAGEMENT OF ENTERTAINMENT VENUES; RETAIL STORE SERVICES FEATURING ARTIST AND TOUR-RELATED MERCHANDISE AND COLLECTIBLES; PROMOTING TICKET SALES AND VIP PRIVILEGES FOR LIVE ENTERTAINMENT EVENTS FOR OTHERS (U.S. CLS. 100, 101 AND 102).

FIRST USE 11-1-2004; IN COMMERCE 11-1-2004.

CLASS 41—EDUCATION AND ENTERTAINMENT

FOR PRODUCTION OF LIVE ENTERTAINMENT EVENTS, NAMELY, LIVE CONCERTS, FESTIVALS, THEATRICAL SHOWS, EDUCATIONAL AND CULTURAL EVENTS, AND SHOWS FOR THE ENTERTAINMENT OF CHILDREN; ENTERTAINMENT SERVICES IN THE NATURE OF ORGANIZING MUSICAL, THEATRICAL, EDUCATIONAL, CULTURAL, AND FAMILY/VARIETY TOURS AND PRESENTATIONS (U.S. CLS. 100, 101 AND 107).

FIRST USE 11-1-2004; IN COMMERCE 11-1-2004.
SANI KHOURI, EXAMINING ATTORNEY

SN 78-531,352. GEROSOLUTIONS, LLC, SUN CITY WEST, AZ. FILED 12-13-2004.

GEROSOLUTIONS

THE MARK CONSISTS OF STANDARD CHARACTERS WITHOUT CLAIM TO ANY PARTICULAR FONT, STYLE, SIZE, OR COLOR.

CLASS 9—ELECTRICAL AND SCIENTIFIC APPARATUS

FOR VIDEOTAPES AND COMPUTER SOFTWARE FOR USE IN INTERACTIVE LEARNING PROGRAMS IN THE FIELD OF GERIATRIC HEALTH CARE TRAINING (U.S. CLS. 21, 23, 26, 36 AND 38).

FIRST USE 11-30-2004; IN COMMERCE 11-30-2004.

CLASS 16—PAPER GOODS AND PRINTED MATTER

FOR PRINTED MATERIALS; NAMELY INSTRUCTION MANUALS IN THE AREA OF GERIATRIC HEALTH CARE TRAINING (U.S. CLS. 2, 5, 22, 23, 29, 37, 38 AND 50).

FIRST USE 11-30-2004; IN COMMERCE 11-30-2004.
SANI KHOURI, EXAMINING ATTORNEY

SN 78-531,672. SIGNALS POWER AND GROUNDING SPECIALISTS, INC., MANSFIELD, OH. FILED 12-13-2004.

GroundingPlus

THE MARK CONSISTS OF STANDARD CHARACTERS WITHOUT CLAIM TO ANY PARTICULAR FONT, STYLE, SIZE, OR COLOR.

CLASS 37—CONSTRUCTION AND REPAIR

FOR ELECTRICAL CONTRACTOR SERVICES, NAMELY, GROUNDING WORK, RESIDENTIAL AND BUILDING CONSTRUCTION CONSULTING NAMELY FOR ELECTRICAL WORK (U.S. CLS. 100, 103 AND 106).

FIRST USE 1-1-2004; IN COMMERCE 1-1-2004.

CLASS 42—SCIENTIFIC, COMPUTER AND LEGAL SERVICES

FOR ENGINEERING IN THE FIELD OF RESIDENTIAL AND BUILDING CONSTRUCTION (U.S. CLS. 100 AND 101).

FIRST USE 1-1-2004; IN COMMERCE 1-1-2004.
CATHERINE FAINT, EXAMINING ATTORNEY

SN 78-531,731. RUBICON RESOURCES, LLC, BEVERLY HILLS, CA. FILED 12-13-2004.

RUBICON RESOURCES

THE MARK CONSISTS OF STANDARD CHARACTERS WITHOUT CLAIM TO ANY PARTICULAR FONT, STYLE, SIZE, OR COLOR.

NO CLAIM IS MADE TO THE EXCLUSIVE RIGHT TO USE "RESOURCES", APART FROM THE MARK AS SHOWN.

CLASS 35—ADVERTISING AND BUSINESS

FOR BUSINESS MARKETING SERVICES FOR OTHERS IN THE FIELD OF FISH, SHELLFISH AND OTHER SEAFOOD PRODUCTS (U.S. CLS. 100, 101 AND 102).

FIRST USE 8-30-1999; IN COMMERCE 8-30-1999.

CLASS 36—INSURANCE AND FINANCIAL

FOR BROKERAGE IN THE FIELD OF SHRIMP (U.S. CLS. 100, 101 AND 102).
FIRST USE 8-30-1999; IN COMMERCE 8-30-1999.
JEFFERY COWARD, EXAMINING ATTORNEY

SN 78-532,732. ASSOCIATED CONTENT INC., DENVER, CO.
FILED 12-15-2004.

SN 78-532,059. INTELLIPHARMACEUTICS CORP., TORONTO, ONTARIO, CANADA, FILED 12-14-2004.

**DRUG DELIVERY
ENGINE**



ASSOCIATEDCONTENT

THE MARK CONSISTS OF STANDARD CHARACTERS WITHOUT CLAIM TO ANY PARTICULAR FONT, STYLE, SIZE, OR COLOR.

NO CLAIM IS MADE TO THE EXCLUSIVE RIGHT TO USE "DRUG DELIVERY", APART FROM THE MARK AS SHOWN.

CLASS 5—PHARMACEUTICALS

FOR DRUG DELIVERY AGENTS CONSISTING OF COMPOUNDS THAT FACILITATE TIMED-RELEASE DELIVERY OF A WIDE RANGE OF PHARMACEUTICALS, SOLD AS A COMPONENT OF THE ACTIVE END PRODUCT (U.S. CLS. 6, 18, 44, 46, 51 AND 52).

CLASS 35—ADVERTISING AND BUSINESS

FOR PROMOTING THE GOODS AND SERVICES OF OTHERS BY PREPARING AND CONTEXTUALLY PLACING TARGETED TEXT ADVERTISEMENTS IN ON-LINE CONTENT AND WEBSITES ON A GLOBAL COMPUTER NETWORK; DISSEMINATION OF ADVERTISING FOR OTHERS VIA AN ON-LINE ELECTRONIC COMMUNICATIONS NETWORK; ADVERTISING SERVICES, NAMELY, PROVIDING ADVERTISING SPACE ON TARGETED WEBSITES AND ON-LINE CONTENT ON A GLOBAL COMPUTER NETWORK (U.S. CLS. 100, 101 AND 102).

CLASS 42—SCIENTIFIC, COMPUTER AND LEGAL SERVICES

FOR PHARMACEUTICAL RESEARCH AND DEVELOPMENT EMPHASIZING TIMED-RELEASE PHARMACEUTICALS (U.S. CLS. 100 AND 101).

IRA J. GOODSaid, EXAMINING ATTORNEY

CLASS 42—SCIENTIFIC, COMPUTER AND LEGAL SERVICES

FOR COMPUTER SERVICES, NAMELY, PROVIDING TEMPORARY USE OF ON-LINE, NON-DOWNLOADABLE SOFTWARE FOR USE BY MEMBER CONTRIBUTORS TO DEVELOP AND MANAGE PROPRIETARY CONTENT ON MULTIPLE TOPICS FOR PUBLICATION ON A GLOBAL COMPUTER NETWORK; HOSTING AND PROVIDING APPLICATION SERVICES THAT FACILITATE ON-LINE CONTENT PUBLICATION FOR OTHERS ON A PRIVATE LABEL AND/OR CO-BRANDED BASIS (U.S. CLS. 100 AND 101).

KIMBERLY PERRY, EXAMINING ATTORNEY

SN 78-532,198. INVEST N RETIRE, LLC, PORTLAND, OR.
FILED 12-14-2004.

INVEST N RETIRE

SN 78-533,144. ISOLD IT, LLC, PASADENA, CA. FILED 12-15-2004.

THE MARK CONSISTS OF STANDARD CHARACTERS WITHOUT CLAIM TO ANY PARTICULAR FONT, STYLE, SIZE, OR COLOR.

CLASS 9—ELECTRICAL AND SCIENTIFIC APPARATUS

FOR COMPUTER SOFTWARE FOR MANAGING TAX-DEFERRED RETIREMENT ACCOUNTS (U.S. CLS. 21, 23, 26, 36 AND 38).

ISOLD IT ONLINE

CLASS 36—INSURANCE AND FINANCIAL

FOR MANAGEMENT OF TAX-DEFERRED RETIREMENT ACCOUNTS (U.S. CLS. 100, 101 AND 102).
ELLEN BURNS, EXAMINING ATTORNEY

THE MARK CONSISTS OF STANDARD CHARACTERS WITHOUT CLAIM TO ANY PARTICULAR FONT, STYLE, SIZE, OR COLOR.

OWNER OF U.S. REG. NO. 2,906,614.

NO CLAIM IS MADE TO THE EXCLUSIVE RIGHT TO USE ONLINE, APART FROM THE MARK AS SHOWN.

CLASS 35—ADVERTISING AND BUSINESS

FOR ONLINE RETAIL STORE CONSIGNMENT SERVICES FEATURING CONSUMER GOODS AND AUTOMOBILES; AUCTION CONSULTATION AND LISTING SERVICES FOR CONSUMER GOODS AND AUTOMOBILES (U.S. CLS. 100, 101 AND 102).

FIRST USE 12-2-2004; IN COMMERCE 12-2-2004.

CLASS 36—INSURANCE AND FINANCIAL

FOR REAL ESTATE LISTING SERVICES (U.S. CLS. 100, 101 AND 102).

FIRST USE 12-2-2004; IN COMMERCE 12-2-2004.

ANN LINNEHAN, EXAMINING ATTORNEY

SN 78-533,278. I.S.A. CORPORATION, SALEM, OR. FILED 12-15-2004.

CLASS 35—ADVERTISING AND BUSINESS

FOR BUSINESS MANAGEMENT CONSULTING WITH RELATION TO STRATEGY, MARKETING, PRODUCTION, PERSONNEL AND RETAIL SALE MATTERS BUSINESS CONSULTING AND BUSINESS INFORMATION FOR ENTERPRISES EDUCATION LEADERSHIP DEVELOPMENT BUSINESS MANAGEMENT CONSULTATION IN THE FIELD OF EXECUTIVE AND LEADERSHIP DEVELOPMENT (U.S. CLS. 100, 101 AND 102).

CLASS 41—EDUCATION AND ENTERTAINMENT

FOR COMPUTER EDUCATION TRAINING COMPUTER EDUCATION TRAINING SERVICES BUSINESS TRAINING PUBLICATION OF DOCUMENTS IN THE FIELD OF TRAINING, SCIENCE, PUBLIC LAW AND SOCIAL AFFAIRS TRAINING SERVICES IN THE FIELD OF EXECUTIVE EDUCATION (U.S. CLS. 100, 101 AND 107).

MARIAM MAHMOUDI, EXAMINING ATTORNEY

BLACK VELVET

THE MARK CONSISTS OF STANDARD CHARACTERS WITHOUT CLAIM TO ANY PARTICULAR FONT, STYLE, SIZE, OR COLOR.

CLASS 9—ELECTRICAL AND SCIENTIFIC APPARATUS

FOR RUBBER AND PLASTIC TYPE PROTECTIVE GLOVES FOR INDUSTRIAL USE (U.S. CLS. 21, 23, 26, 36 AND 38).

CLASS 10—MEDICAL APPARATUS

FOR RUBBER AND PLASTIC TYPE GLOVES FOR MEDICAL USE (U.S. CLS. 26, 39 AND 44).

CLASS 21—HOUSEWARES AND GLASS

FOR RUBBER AND PLASTIC TYPE DISPOSABLE GLOVES FOR GENERAL USE AND RUBBER AND PLASTIC TYPE DISPOSABLE GLOVES FOR USE IN THE BEAUTY INDUSTRY (U.S. CLS. 2, 13, 23, 29, 30, 33, 40 AND 50).

WON TEAK OH, EXAMINING ATTORNEY

SN 78-533,677. NORTH STAR LEADERSHIP GROUP, INC., PHOENIX, AZ. FILED 12-16-2004.

Gamer Generation

THE MARK CONSISTS OF STANDARD CHARACTERS WITHOUT CLAIM TO ANY PARTICULAR FONT, STYLE, SIZE, OR COLOR.

SN 78-534,245. HARTFORD LIFE INSURANCE COMPANY, HARTFORD, CT. FILED 12-17-2004.

ION

THE MARK CONSISTS OF STANDARD CHARACTERS WITHOUT CLAIM TO ANY PARTICULAR FONT, STYLE, SIZE, OR COLOR.

CLASS 35—ADVERTISING AND BUSINESS

FOR ONLINE INSURANCE LEAD COLLECTION AND MATCHING SERVICES, NAMELY, MATCHING CONSUMER REQUESTS FOR TERM INSURANCE POLICY QUOTES COLLECTED OVER THE INTERNET TO PREQUALIFIED INSURANCE BROKERS, AGENTS AND AGENCIES INTERESTED IN THOSE REQUESTS (U.S. CLS. 100, 101 AND 102).

FIRST USE 7-13-2004; IN COMMERCE 7-13-2004.

CLASS 36—INSURANCE AND FINANCIAL

FOR LIFE INSURANCE BROKERAGE SERVICE (U.S. CLS. 100, 101 AND 102).

FIRST USE 7-13-2004; IN COMMERCE 7-13-2004.
SHARON MEIER, EXAMINING ATTORNEY

SN 78-534,550. MINCHEFF, ROGER, BEVERLY HILLS, CA. FILED 12-17-2004.

SN 78-534,924. RENHARD, DJI, SEATTLE, WA. FILED 12-17-2004.



CLASS 16—PAPER GOODS AND PRINTED MATTER

FOR SERIES OF GRAPHIC NOVELS (U.S. CLS. 2, 5, 22, 23, 29, 37, 38 AND 50).
FIRST USE 9-1-2003; IN COMMERCE 5-1-2004.

CLASS 25—CLOTHING

FOR SHIRTS, SWEATERS, JEANS, PANTS, COMPRESSION WORKOUT WEAR, NAMELY, SHIRTS, SHORTS AND PANTS, SWEATPANTS, HATS, BEANIES, HEAD AND WRISTBANDS, BANDANAS, SNEAKERS, SOCKS, UNDERGARMENTS, AND MASQUERADE COSTUMES AND MASKS SOLD AS A UNIT (U.S. CLS. 22 AND 39).
FIRST USE 9-1-2003; IN COMMERCE 5-1-2004.
PATRICIA EVANKO, EXAMINING ATTORNEY

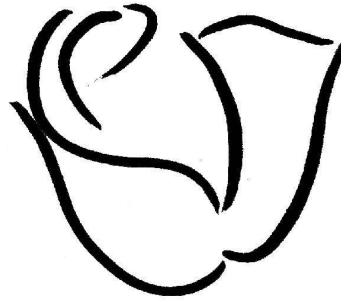

CLASS 18—LEATHER GOODS

FOR HAND BAGS, PURSE (U.S. CLS. 1, 2, 3, 22 AND 41).

CLASS 25—CLOTHING

FOR WOMEN'S CLOTHING, NAMELY, SCARVES, MITTENS; SLIPPERS (U.S. CLS. 22 AND 39).
TONI HICKEY, EXAMINING ATTORNEY

SN 78-534,815. PACKET DIGITAL LLC, FARGO, ND. FILED 12-17-2004.

SN 78-535,094. DADDY'S CLOSET, LLC, WILTON MANORS, FL. FILED 12-18-2004.



Daddy's Closet

THE MARK CONSISTS OF STANDARD CHARACTERS WITHOUT CLAIM TO ANY PARTICULAR FONT, STYLE, SIZE, OR COLOR.

CLASS 9—ELECTRICAL AND SCIENTIFIC APPARATUS

FOR SEMICONDUCTOR CHIPS, SEMICONDUCTOR CHIP SETS COMPRISED PRIMARILY OF SEMICONDUCTOR CHIPS, CIRCUIT BOARD ASSEMBLIES AND INTEGRATED CIRCUITS (U.S. CLS. 21, 23, 26, 36 AND 38).

CLASS 42—SCIENTIFIC, COMPUTER AND LEGAL SERVICES

FOR ENGINEERING AND DESIGN SERVICES IN THE FIELDS OF SEMICONDUCTOR CHIP PACKAGING AND ELECTRONICS SYSTEMS DESIGN (U.S. CLS. 100 AND 101).
MICHAEL SOUDERS, EXAMINING ATTORNEY

CLASS 25—CLOTHING

FOR CLOTHING, NAMELY, HATS, PANTS, UNDERSHIRTS, VESTS, SHIRTS, JACKETS, SHORTS, BELTS, CAPS, JACKETS, JEANS, T-SHIRTS, SWEATSHIRTS, SWIMWEAR, UNDERWEAR, CHAPS, JERSEYS, TANK TOPS, COD PIECES, GAUNTLETS, ARMBANDS, JOCKSTRAPS (U.S. CLS. 22 AND 39).
FIRST USE 6-17-2004; IN COMMERCE 7-1-2004.

CLASS 35—ADVERTISING AND BUSINESS

FOR RETAIL STORE SERVICES AND COMPUTERIZED ONLINE RETAIL SERVICES IN THE FIELD OF CLOTHING, LEATHER, RUBBER AND IMITATION LEATHER GOODS, ACCESSORIES AND RELATED ITEMS (U.S. CLS. 100, 101 AND 102).
FIRST USE 6-17-2004; IN COMMERCE 7-1-2004.
ROBIN CHOSID, EXAMINING ATTORNEY

SN 78-535,270. MODWEST, INC., MISSOULA, MT. FILED 12-20-2004.

MODWEST

THE MARK CONSISTS OF STANDARD CHARACTERS WITHOUT CLAIM TO ANY PARTICULAR FONT, STYLE, SIZE, OR COLOR.

CLASS 38—COMMUNICATION

FOR PROVIDING A HIGH SPEED ACCESS TO AREA NETWORKS AND A GLOBAL COMPUTER INFORMATION NETWORK (U.S. CLS. 100, 101 AND 104).
FIRST USE 10-17-2001; IN COMMERCE 10-17-2001.

CLASS 42—SCIENTIFIC, COMPUTER AND LEGAL SERVICES

FOR HOSTING THE WEB SITES OF OTHERS ON A COMPUTER SERVER FOR A GLOBAL COMPUTER NETWORK; CONSULTING SERVICES IN THE FIELD OF DESIGN, SELECTION, IMPLEMENTATION AND USE OF COMPUTER HARDWARE AND SOFTWARE SYSTEMS FOR OTHERS; COMPUTER SOFTWARE DESIGN, COMPUTER PROGRAMMING, OR MAINTENANCE OF COMPUTER SOFTWARE; APPLICATION SERVICE PROVIDER (ASP), NAMELY, HOSTING COMPUTER SOFTWARE APPLICATIONS OF OTHERS (U.S. CLS. 100 AND 101).

FIRST USE 10-17-2001; IN COMMERCE 10-17-2001.
JENNIFER CHICOSKI, EXAMINING ATTORNEY

SN 78-535,342. MILLER AND SOLOT, ALBANY, NY. FILED 12-20-2004.

I ♥
**FEMALE
ORGASM**

CLASS 25—CLOTHING

FOR CLOTHING, NAMELY T-SHIRTS, SWEAT SHIRTS, UNDERWEAR, SHIRTS, SWEAT PANTS, PANTS, AND HATS (U.S. CLS. 22 AND 39).
FIRST USE 9-9-2004; IN COMMERCE 9-9-2004.

CLASS 26—FANCY GOODS

FOR NOVELTY BUTTONS (U.S. CLS. 37, 39, 40, 42 AND 50).
FIRST USE 11-29-2001; IN COMMERCE 11-29-2001.
SANI KHOURI, EXAMINING ATTORNEY

SN 78-535,607. PAPADAKIS, ALEC, ATLANTA, GA. FILED 12-20-2004.

SUPER KICK

THE MARK CONSISTS OF STANDARD CHARACTERS WITHOUT CLAIM TO ANY PARTICULAR FONT, STYLE, SIZE, OR COLOR.

CLASS 35—ADVERTISING AND BUSINESS

FOR FRANCHISING, NAMELY, OFFERING TECHNICAL ASSISTANCE IN THE ESTABLISHMENT AND/OR OPERATION OF TRAINING SERVICES IN THE FIELD OF SPORTS AND ATHLETICS (U.S. CLS. 100, 101 AND 102).

FIRST USE 9-1-2003; IN COMMERCE 9-1-2003.

CLASS 41—EDUCATION AND ENTERTAINMENT

FOR TRAINING SERVICES IN THE FIELD OF SPORTS AND ATHLETICS (U.S. CLS. 100, 101 AND 107).
FIRST USE 9-1-2004; IN COMMERCE 9-1-2004.
STEPHANIE DAVIS, EXAMINING ATTORNEY

SN 78-535,642. TRIUMPH LEARNING LLC, WHITE PLAINS, NY. FILED 12-20-2004.

COACH

THE MARK CONSISTS OF STANDARD CHARACTERS WITHOUT CLAIM TO ANY PARTICULAR FONT, STYLE, SIZE, OR COLOR.

CLASS 9—ELECTRICAL AND SCIENTIFIC APPARATUS

SN 78-536,112. TRIUMPH LEARNING LLC, WHITE PLAINS, NY. FILED 12-21-2004.

FOR COMPUTER SOFTWARE FOR USE IN CHILD AND ADULT EDUCATION, NAMELY, SOFTWARE TO ASSIST TEACHERS AND STUDENTS AT ALL LEVELS IN MASTERING STANDARDS-BASED CURRICULA AND IN PREPARING FOR STANDARDIZED EXAMS; PRERECORDED AUDIO AND VIDEO TAPES IN THE FIELD OF CHILD AND ADULT EDUCATION, FEATURING MATERIALS TO ASSIST TEACHERS AND STUDENTS AT ALL LEVELS IN MASTERING STANDARDS-BASED CURRICULA AND IN PREPARING FOR STANDARDIZED EXAMS (U.S. CLS. 21, 23, 26, 36 AND 38).
FIRST USE 0-0-2003; IN COMMERCE 0-0-2003.

CLASS 16—PAPER GOODS AND PRINTED MATTER

FOR PRINTED MATERIALS IN THE FIELD OF CHILD AND ADULT EDUCATION, NAMELY TEXTBOOKS, WORKBOOKS, TEACHER GUIDES AND MANUALS, POSTERS AND FLASHCARDS, ALL FEATURING MATERIALS TO ASSIST TEACHERS AND STUDENTS AT ALL LEVELS IN MASTERING STANDARDS-BASED CURRICULA AND IN PREPARING FOR STANDARDIZED EXAMS (U.S. CLS. 2, 5, 22, 23, 29, 37, 38 AND 50).
FIRST USE 4-30-1986; IN COMMERCE 4-30-1986.
NAAKWAMA ANKRAH, EXAMINING ATTORNEY

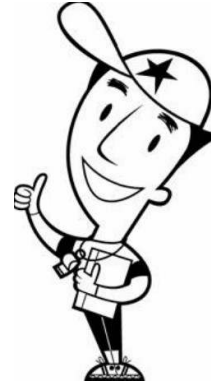

SN 78-536,065. TRIUMPH LEARNING LLC, WHITE PLAINS, NY. FILED 12-21-2004.

Coach

THE MARK CONSISTS OF THE WORD COACH DISPLAYED IN STYLIZED FONT.

THE MARK CONSISTS OF A STYLIZED DEPICTION OF A MAN DRESSED AS AN ATHLETIC COACH, WITH A WHISTLE AROUND HIS NECK, WEARING SNEAKERS AND A BASEBALL CAP, AND CARRYING A BOOK OR CLIPBOARD. COLOR IS NOT CLAIMED AS A FEATURE OF THE MARK.

CLASS 9—ELECTRICAL AND SCIENTIFIC APPARATUS

CLASS 9—ELECTRICAL AND SCIENTIFIC APPARATUS

FOR COMPUTER SOFTWARE FOR USE IN CHILD AND ADULT EDUCATION, NAMELY, SOFTWARE TO ASSIST TEACHERS AND STUDENTS AT ALL LEVELS IN MASTERING STANDARDS-BASED CURRICULA AND IN PREPARING FOR STANDARDIZED EXAMS; PRERECORDED AUDIO AND VIDEO TAPES IN THE FIELD OF CHILD AND ADULT EDUCATION, FEATURING MATERIALS TO ASSIST TEACHERS AND STUDENTS AT ALL LEVELS IN MASTERING STANDARDS-BASED CURRICULA AND IN PREPARING FOR STANDARDIZED EXAMS (U.S. CLS. 21, 23, 26, 36 AND 38).
FIRST USE 9-0-2004; IN COMMERCE 9-0-2004.

FOR COMPUTER SOFTWARE FOR USE IN CHILD AND ADULT EDUCATION, NAMELY, SOFTWARE TO ASSIST TEACHERS AND STUDENTS AT ALL LEVELS IN MASTERING STANDARDS-BASED CURRICULA AND IN PREPARING FOR STANDARDIZED EXAMS; PRERECORDED AUDIO AND VIDEO TAPES IN THE FIELD OF CHILD AND ADULT EDUCATION, FEATURING MATERIALS TO ASSIST TEACHERS AND STUDENTS AT ALL LEVELS IN MASTERING STANDARDS-BASED CURRICULA AND IN PREPARING FOR STANDARDIZED EXAMS (U.S. CLS. 21, 23, 26, 36 AND 38).
FIRST USE 9-0-2004; IN COMMERCE 9-0-2004.

CLASS 16—PAPER GOODS AND PRINTED MATTER

CLASS 16—PAPER GOODS AND PRINTED MATTER

FOR PRINTED MATERIALS IN THE FIELD OF CHILD AND ADULT EDUCATION, NAMELY TEXTBOOKS, WORKBOOKS, TEACHER GUIDES AND MANUALS, POSTERS AND FLASHCARDS, ALL FEATURING MATERIALS TO ASSIST TEACHERS AND STUDENTS AT ALL LEVELS IN MASTERING STANDARDS-BASED CURRICULA AND IN PREPARING FOR STANDARDIZED EXAMS (U.S. CLS. 2, 5, 22, 23, 29, 37, 38 AND 50).
FIRST USE 9-0-2004; IN COMMERCE 9-0-2004.
NAAKWAMA ANKRAH, EXAMINING ATTORNEY

FOR PRINTED MATERIALS IN THE FIELD OF CHILD AND ADULT EDUCATION, NAMELY TEXTBOOKS, WORKBOOKS, TEACHER GUIDES AND MANUALS, POSTERS AND FLASHCARDS, ALL FEATURING MATERIALS TO ASSIST TEACHERS AND STUDENTS AT ALL LEVELS IN MASTERING STANDARDS-BASED CURRICULA AND IN PREPARING FOR STANDARDIZED EXAMS (U.S. CLS. 2, 5, 22, 23, 29, 37, 38 AND 50).
FIRST USE 9-0-2004; IN COMMERCE 9-0-2004.
JAMES A. RAUEN, EXAMINING ATTORNEY

SN 78-536,143. TRIUMPH LEARNING LLC, WHITE PLAINS, NY. FILED 12-21-2004.



THE MARK CONSISTS OF THE WORD COACH DISPLAYED IN STYLIZED FONT. BENEATH THE WORD COACH IN SMALLER STYLIZED TYPE ARE THE WORDS AMERICA'S BEST FOR STUDENT SUCCESS. TO THE RIGHT OF THE WORDING IS A STYLIZED DEPICTION OF A MAN DRESSED AS AN ATHLETIC COACH, WITH A WHISTLE AROUND HIS NECK, WEARING SNEAKERS AND A BASEBALL CAP, AND CARRYING A BOOK OR CLIPBOARD.

CLASS 9—ELECTRICAL AND SCIENTIFIC APPARATUS

FOR COMPUTER SOFTWARE FOR USE IN CHILD AND ADULT EDUCATION, NAMELY, SOFTWARE TO ASSIST TEACHERS AND STUDENTS AT ALL LEVELS IN MASTERING STANDARDS-BASED CURRICULA AND IN PREPARING FOR STANDARDIZED EXAMS; PRERECORDED AUDIO AND VIDEO TAPES IN THE FIELD OF CHILD AND ADULT EDUCATION, FEATURING MATERIALS TO ASSIST TEACHERS AND STUDENTS AT ALL LEVELS IN MASTERING STANDARDS-BASED CURRICULA AND IN PREPARING FOR STANDARDIZED EXAMS (U.S. CLS. 21, 23, 26, 36 AND 38).
FIRST USE 9-0-2004; IN COMMERCE 9-0-2004.

CLASS 16—PAPER GOODS AND PRINTED MATTER

FOR PRINTED MATERIALS IN THE FIELD OF CHILD AND ADULT EDUCATION, NAMELY TEXTBOOKS, WORKBOOKS, TEACHER GUIDES AND MANUALS, POSTERS AND FLASHCARDS, ALL FEATURING MATERIALS TO ASSIST TEACHERS AND STUDENTS AT ALL LEVELS IN MASTERING STANDARDS-BASED CURRICULA AND IN PREPARING FOR STANDARDIZED EXAMS (U.S. CLS. 2, 5, 22, 23, 29, 37, 38 AND 50).
FIRST USE 9-0-2004; IN COMMERCE 9-0-2004.
JILL C. ALT, EXAMINING ATTORNEY

SN 78-536,167. TRIUMPH LEARNING LLC, WHITE PLAINS, NY. FILED 12-21-2004.

**AMERICA'S BEST FOR
STUDENT SUCCESS**

THE MARK CONSISTS OF STANDARD CHARACTERS WITHOUT CLAIM TO ANY PARTICULAR FONT, STYLE, SIZE, OR COLOR.

CLASS 9—ELECTRICAL AND SCIENTIFIC APPARATUS

FOR COMPUTER SOFTWARE FOR USE IN CHILD AND ADULT EDUCATION, NAMELY, SOFTWARE TO ASSIST TEACHERS AND STUDENTS AT ALL LEVELS IN MASTERING STANDARDS-BASED CURRICULA AND IN PREPARING FOR STANDARDIZED EXAMS; PRERECORDED AUDIO AND VIDEO TAPES IN THE FIELD OF CHILD AND ADULT EDUCATION, FEATURING MATERIALS TO ASSIST TEACHERS AND STUDENTS AT ALL LEVELS IN MASTERING STANDARDS-BASED CURRICULA AND IN PREPARING FOR STANDARDIZED EXAMS (U.S. CLS. 21, 23, 26, 36 AND 38).
FIRST USE 9-0-2004; IN COMMERCE 9-0-2004.

CLASS 16—PAPER GOODS AND PRINTED MATTER

FOR PRINTED MATERIALS IN THE FIELD OF CHILD AND ADULT EDUCATION, NAMELY TEXTBOOKS, WORKBOOKS, TEACHER GUIDES AND MANUALS, POSTERS AND FLASHCARDS, ALL FEATURING MATERIALS TO ASSIST TEACHERS AND STUDENTS AT ALL LEVELS IN MASTERING STANDARDS-BASED CURRICULA AND IN PREPARING FOR STANDARDIZED EXAMS (U.S. CLS. 2, 5, 22, 23, 29, 37, 38 AND 50).
FIRST USE 9-0-2004; IN COMMERCE 9-0-2004.
CATHERINE FAINT, EXAMINING ATTORNEY

SN 78-536,239. MBNA AMERICA BANK, NATIONAL ASSOCIATION, WILMINGTON, DE. FILED 12-21-2004.

WORLDPOINTS

THE MARK CONSISTS OF STANDARD CHARACTERS WITHOUT CLAIM TO ANY PARTICULAR FONT, STYLE, SIZE, OR COLOR.

OWNER OF U.S. REG. NO. 2,896,210.

CLASS 35—ADVERTISING AND BUSINESS

FOR PROMOTING THE SALE OF CREDIT CARD ACCOUNTS THROUGH THE ADMINISTRATION OF INCENTIVE AWARD PROGRAMS (U.S. CLS. 100, 101 AND 102).

CLASS 36—INSURANCE AND FINANCIAL

FOR BANKING AND FINANCIAL SERVICES, NAMELY, PROVIDING CREDIT CARD, DEBIT CARD, CHARGE CARD AND STORED VALUE SMART CARD SERVICES; ELECTRONIC FUNDS TRANSFER SERVICES; ELECTRONIC BILL PAYMENT SERVICES; CASH DISBURSEMENTS SERVICES, AND CREDIT CARD TRANSACTION AUTHORIZATION AND SETTLEMENT SERVICES; VALUE EXCHANGE SERVICES, NAMELY, THE SECURE EXCHANGE OF MONETARY VALUE, NAMELY, ELECTRONIC CASH, OVER PUBLIC COMPUTER NETWORKS TO FACILITATE ELECTRONIC COMMERCE; SMART CARDS SERVICES FOR EXCHANGING MONETARY VALUE, AND ELECTRONIC CASH SERVICES, NAMELY, CURRENCY EXCHANGE IN A SECURE ENVIRONMENT OVER GLOBAL ELECTRONIC COMMUNICATIONS NETWORKS (U.S. CLS. 100, 101 AND 102).

ALEX KEAM, EXAMINING ATTORNEY

SN 78-536,278. RIO VISTA, LIMITED, LOS ANGELES, CA.
FILED 12-21-2004.

LOVE OF THE LAND

THE MARK CONSISTS OF STANDARD CHARACTERS WITHOUT CLAIM TO ANY PARTICULAR FONT, STYLE, SIZE, OR COLOR.

CLASS 31—NATURAL AGRICULTURAL PRODUCTS

FOR FRESH FRUITS AND VEGETABLES (U.S. CLS. 1 AND 46).

CLASS 35—ADVERTISING AND BUSINESS

FOR DISTRIBUTORSHIP SERVICES IN THE FIELD OF FRESH PRODUCE (U.S. CLS. 100, 101 AND 102).
MICHELLE DUBOIS, EXAMINING ATTORNEY

SN 78-536,551. CHAN LUU INC., LOS ANGELES, CA. FILED
12-21-2004.

CHAN LUU

THE MARK CONSISTS OF STANDARD CHARACTERS WITHOUT CLAIM TO ANY PARTICULAR FONT, STYLE, SIZE, OR COLOR.

OWNER OF U.S. REG. NO. 2,869,029.
THE MARK IS THE NAME OF A LIVING INDIVIDUAL WHOSE CONSENT IS OF RECORD.

CLASS 14—JEWELRY

FOR JEWELRY, BROOCHES, ORNAMENTAL PINS, BRACELETS, AND WRIST TIES IN THE NATURE OF JEWELRY (U.S. CLS. 2, 27, 28 AND 50).
FIRST USE 0-0-1995; IN COMMERCE 0-0-1995.

CLASS 18—LEATHER GOODS

FOR HANDBAGS, WALLETS AND PURSES (U.S. CLS. 1, 2, 3, 22 AND 41).
FIRST USE 0-0-2001; IN COMMERCE 0-0-2001.

CLASS 25—CLOTHING

FOR SCARVES, BELTS, FOOTWEAR, TOPS, BLOUSES, CAMISOLES, TANK TOPS, BOTTOMS, SKIRTS, DRESSES AND SHIRTS (U.S. CLS. 22 AND 39).
FIRST USE 0-0-2001; IN COMMERCE 0-0-2001.
STEVEN PEREZ, EXAMINING ATTORNEY

SN 78-536,636. STRIKE HOLDINGS LLC, NEW YORK, NY.
FILED 12-21-2004.



OWNER OF U.S. REG. NOS. 2,862,629 AND 2,862,630.
NO CLAIM IS MADE TO THE EXCLUSIVE RIGHT TO USE "MIAMI", APART FROM THE MARK AS SHOWN.
THE MARK CONSISTS OF THE LETTERS S-T-R-I-K-E EACH WITHIN ADJOINING MULTI-COLORED BOXES. THE WORD MIAMI IS ENCLOSED IN A RECTANGULAR BOX BELOW.

CLASS 41—EDUCATION AND ENTERTAINMENT

FOR ENTERTAINMENT SERVICES, NAMELY BOWLING ALLEY SERVICES (U.S. CLS. 100, 101 AND 107).
FIRST USE 11-9-2004; IN COMMERCE 11-9-2004.

CLASS 43—HOTEL AND RESTAURANT SERVICES

FOR RESTAURANT AND BAR SERVICES (U.S. CLS. 100 AND 101).
FIRST USE 11-9-2004; IN COMMERCE 11-9-2004.
LINDA E. BLOHM, EXAMINING ATTORNEY

SN 78-536,685. ASK JEEVES, INC., OAKLAND, CA. FILED
12-21-2004.



THE MARK CONSISTS OF THE WORDS ASK.COM AND ASK JEEVES IN A STYLIZED FONT WITH WORD ASK IN A FILLED IN OVAL DESIGN.

CLASS 35—ADVERTISING AND BUSINESS

FOR PROVIDING CONSUMER PRODUCT INFORMATION; PROVIDING COMPARISON SHOPPING INFORMATION, PROVIDING ONLINE DIRECTORY INFORMATION SERVICES ALSO FEATURING HYPERLINKS TO OTHER WEBSITES, DISSEMINATION OF ADVERTISING FOR OTHERS VIA THE INTERNET; ONLINE ADVERTISING SERVICES FOR OTHERS, NAMELY PROVIDING ADVERTISING SPACE ON INTERNET WEB SITES (U.S. CLS. 100, 101 AND 102).

FIRST USE 2-0-2000; IN COMMERCE 2-0-2000.

CLASS 42—SCIENTIFIC, COMPUTER AND LEGAL SERVICES

FOR COMPUTER SERVICES, NAMELY, PROVIDING SEARCH ENGINES FOR OBTAINING DATA ON A GLOBAL COMPUTER NETWORK (U.S. CLS. 100 AND 101).

FIRST USE 2-0-2000; IN COMMERCE 2-0-2000.
ZHALEH DELANEY, EXAMINING ATTORNEY

SN 78-536,688. ASK JEEVES, INC., OAKLAND, CA. FILED 12-21-2004.



THE MARK CONSISTS OF THE WORDS ASK JEEVES IN A STYLIZED FONT WITH THE WORD ASK IN A FILLED IN OVAL DESIGN.

CLASS 9—ELECTRICAL AND SCIENTIFIC APPARATUS

FOR DOWNLOADABLE COMPUTER SOFTWARE FOR USE IN PROVIDING SEARCH ENGINE SERVICES WHICH IS PROVIDED THROUGH A BROWSER TOOL BAR (U.S. CLS. 21, 23, 26, 36 AND 38).

FIRST USE 2-0-2003; IN COMMERCE 2-0-2003.

CLASS 35—ADVERTISING AND BUSINESS

FOR PROVIDING CONSUMER PRODUCT INFORMATION; PROVIDING COMPARISON SHOPPING INFORMATION, PROVIDING ONLINE DIRECTORY INFORMATION SERVICES ALSO FEATURING HYPERLINKS TO OTHER WEBSITES, DISSEMINATION OF ADVERTISING FOR OTHERS VIA THE INTERNET; ONLINE ADVERTISING SERVICES FOR OTHERS, NAMELY PROVIDING ADVERTISING SPACE ON INTERNET WEB SITES (U.S. CLS. 100, 101 AND 102).

FIRST USE 10-0-1999; IN COMMERCE 10-0-1999.

CLASS 42—SCIENTIFIC, COMPUTER AND LEGAL SERVICES

FOR COMPUTER SERVICES, NAMELY, PROVIDING SEARCH ENGINES FOR OBTAINING DATA ON A GLOBAL COMPUTER NETWORK (U.S. CLS. 100 AND 101).

FIRST USE 0-0-1998; IN COMMERCE 0-0-1998.
ZHALEH DELANEY, EXAMINING ATTORNEY

SN 78-536,764. URETHANE SOY SYSTEMS COMPANY, VOLGA, SD. FILED 12-22-2004.

SoyTherm

THE MARK CONSISTS OF STANDARD CHARACTERS WITHOUT CLAIM TO ANY PARTICULAR FONT, STYLE, SIZE, OR COLOR.

CLASS 1—CHEMICALS

FOR CHEMICAL PREPARATIONS FOR USE IN THE POLYURETHANE INDUSTRY, NAMELY, CHEMICAL PREPARATIONS FOR FORMING INSULATION (U.S. CLS. 1, 5, 6, 10, 26 AND 46).

CLASS 17—RUBBER GOODS

FOR POLYURETHANE SPRAY FOAM FOR USE AS INSULATION (U.S. CLS. 1, 5, 12, 13, 35 AND 50).

TEJBIR SINGH, EXAMINING ATTORNEY

SN 78-536,772. IONBOND, LLC, WILMINGTON, DE. FILED 12-22-2004.

VANGUARD

THE MARK CONSISTS OF STANDARD CHARACTERS WITHOUT CLAIM TO ANY PARTICULAR FONT, STYLE, SIZE, OR COLOR.

CLASS 2—PAINTS

FOR HARD, LUBRICIOUS COATINGS FOR TOOLS AND METAL WORKING EQUIPMENT (U.S. CLS. 6, 11 AND 16).

CLASS 40—MATERIAL TREATMENT

FOR COATING OF SUBSTRATES WITH HARD, LUBRICIOUS COATINGS (U.S. CLS. 100, 103 AND 106).

BRIAN PINO, EXAMINING ATTORNEY

SN 78-537,328. SPIEGEL CATALOG HOLDINGS CORPORATION, NEW YORK, NY. FILED 12-22-2004.

MODA SPIEGEL

THE MARK CONSISTS OF STANDARD CHARACTERS WITHOUT CLAIM TO ANY PARTICULAR FONT, STYLE, SIZE, OR COLOR.

OWNER OF U.S. REG. NOS. 1,496,715, 1,891,553 AND OTHERS.

NO CLAIM IS MADE TO THE EXCLUSIVE RIGHT TO USE "MODA", APART FROM THE MARK AS SHOWN. THE TRANSLATION OF MODA IS "FASHION".

CLASS 16—PAPER GOODS AND PRINTED MATTER

FOR GENERAL MERCHANDISE CATALOGS FEATURING CLOTHING (U.S. CLS. 2, 5, 22, 23, 29, 37, 38 AND 50).

CLASS 25—CLOTHING

FOR CLOTHING, NAMELY JACKETS, SKIRTS, PANTS, SWEATERS, BLOUSES, SHIRTS, COATS, SPORT COATS, SUITS, SHORTS, TOPS, T-SHIRTS, DRESSES AND TIES (U.S. CLS. 22 AND 39).

JENNIFER KRISP, EXAMINING ATTORNEY

SN 78-537,376. D & S ASSOCIATES CONSULTANTS FOR A BETTER TOMORROW, LLC, MIDDLEFIELD, CT. FILED 12-22-2004.

MAKING EFFECTIVE MENTAL STATUS EXAMS AND SUICIDE ASSESSMENTS

THE MARK CONSISTS OF STANDARD CHARACTERS WITHOUT CLAIM TO ANY PARTICULAR FONT, STYLE, SIZE, OR COLOR.

SEC. 2(F).

CLASS 16—PAPER GOODS AND PRINTED MATTER

FOR PRINTED PUBLICATIONS, NAMELY, BOOKS, MANUALS, WORKBOOKS AND NEWSLETTERS IN THE FIELD OF MENTAL HEALTH AND SUBSTANCE ABUSE (U.S. CLS. 2, 5, 22, 23, 29, 37, 38 AND 50).

FIRST USE 12-31-1996; IN COMMERCE 12-31-1996.

CLASS 41—EDUCATION AND ENTERTAINMENT

FOR EDUCATIONAL SERVICES, NAMELY, CONDUCTING SEMINARS, COURSES AND WORKSHOPS IN THE FIELD OF MENTAL HEALTH AND SUBSTANCE ABUSE (U.S. CLS. 100, 101 AND 107).

FIRST USE 12-31-1996; IN COMMERCE 12-31-1996.
NAAKWAMA ANKRAH, EXAMINING ATTORNEY

SN 78-537,669. DAP BRANDS COMPANY, MEDINA, OH. FILED 12-23-2004.

WELDWOOD

THE MARK CONSISTS OF STANDARD CHARACTERS WITHOUT CLAIM TO ANY PARTICULAR FONT, STYLE, SIZE, OR COLOR.

CLASS 1—CHEMICALS

FOR GLUES AND ADHESIVES FOR CONSTRUCTION AND GENERAL INDUSTRIAL USE (U.S. CLS. 1, 5, 6, 10, 26 AND 46).

FIRST USE 5-4-1933; IN COMMERCE 5-4-1933.

CLASS 16—PAPER GOODS AND PRINTED MATTER

FOR GLUES AND ADHESIVES FOR STATIONERY AND HOUSEHOLD USE (U.S. CLS. 2, 5, 22, 23, 29, 37, 38 AND 50).

FIRST USE 5-4-1933; IN COMMERCE 5-4-1933.

WILLIAM VERHOSEK, EXAMINING ATTORNEY

SN 78-537,711. CAREOREGON, INC., PORTLAND, OR. FILED 12-23-2004.

CAREOREGON

THE MARK CONSISTS OF STANDARD CHARACTERS WITHOUT CLAIM TO ANY PARTICULAR FONT, STYLE, SIZE, OR COLOR.

SEC. 2(F).

CLASS 36—INSURANCE AND FINANCIAL

FOR ORGANIZING, ADMINISTERING, AND FINANCING PRE-PAID HEALTH CARE PLANS; UNDERWRITING INSURANCE FOR PRE-PAID HEALTH CARE (U.S. CLS. 100, 101 AND 102).

FIRST USE 1-1-1994; IN COMMERCE 1-1-1994.

CLASS 44—MEDICAL, BEAUTY AND AGRICULTURAL SERVICES

FOR HEALTH CARE SERVICES (U.S. CLS. 100 AND 101).

FIRST USE 1-1-1994; IN COMMERCE 1-1-1994.
ZHALEH DELANEY, EXAMINING ATTORNEY

SN 78-537,773. FIDELCO GUIDE DOG FOUNDATION, INC., BLOOMFIELD, CT. FILED 12-23-2004.

FIDELCO

THE MARK CONSISTS OF STANDARD CHARACTERS WITHOUT CLAIM TO ANY PARTICULAR FONT, STYLE, SIZE, OR COLOR.

OWNER OF U.S. REG. NO. 780,747.

CLASS 41—EDUCATION AND ENTERTAINMENT

FOR TRAINING DOGS TO SERVE AS GUIDE DOGS FOR ASSISTING BLIND AND VISUALLY IMPAIRED PERSONS, PLACING SUCH TRAINED DOGS WITH RECIPIENTS IN NEED OF THEIR SERVICES, AND TRAINING SUCH TRAINED DOGS AND THEIR RECIPIENTS TO ACT TOGETHER AS TEAMS (U.S. CLS. 100, 101 AND 107).

FIRST USE 12-0-1962; IN COMMERCE 12-0-1962.

CLASS 44—MEDICAL, BEAUTY AND AGRICULTURAL SERVICES

FOR BREEDING AND RAISING DOGS INTENDED TO SERVE AS GUIDE DOGS FOR ASSISTING BLIND AND VISUALLY IMPAIRED PERSONS, PLACING SUCH DOGS IN FOSTER HOMES UNTIL REACHING SUITABLE AGE FOR TRAINING AS GUIDES, AND PLACING SUCH DOGS IN CARETAKING HOMES AFTER BEING RETIRED FROM GUIDE SERVICE (U.S. CLS. 100 AND 101).

FIRST USE 12-0-1962; IN COMMERCE 12-0-1962.
JUDITH HELFMAN, EXAMINING ATTORNEY

SN 78-537,713. CAREOREGON, INC., PORTLAND, OR. FILED 12-23-2004.



THE DESIGN PORTION OF THE MARK CONSISTS OF THE STYLIZED LETTERS C AND O FORMING AN OVAL SHAPE.

SEC. 2(F) AS TO "CAREOREGON".

CLASS 36—INSURANCE AND FINANCIAL

FOR ORGANIZING, ADMINISTERING, AND FINANCING PRE-PAID HEALTH CARE PLANS; UNDERWRITING INSURANCE FOR PRE-PAID HEALTH CARE (U.S. CLS. 100, 101 AND 102).

FIRST USE 1-1-1999; IN COMMERCE 1-1-1999.

CLASS 44—MEDICAL, BEAUTY AND AGRICULTURAL SERVICES

FOR HEALTH CARE SERVICES (U.S. CLS. 100 AND 101).

FIRST USE 1-1-1999; IN COMMERCE 1-1-1999.
ZHALEH DELANEY, EXAMINING ATTORNEY

SN 78-537,784. FIDELCO GUIDE DOG FOUNDATION, INC., BLOOMFIELD, CT. FILED 12-23-2004.



OWNER OF U.S. REG. NO. 780,747.
NO CLAIM IS MADE TO THE EXCLUSIVE RIGHT TO USE "GUIDE DOG FOUNDATION", APART FROM THE MARK AS SHOWN.

THE MARK CONSISTS OF THE WORDS "FIDELCO GUIDE DOG FOUNDATION" WITH A SILHOUETTE OF A MAN WALKING WITH A GUIDE DOG.

CLASS 41—EDUCATION AND ENTERTAINMENT

FOR TRAINING DOGS TO SERVE AS GUIDE DOGS FOR ASSISTING BLIND AND VISUALLY IMPAIRED PERSONS, PLACING SUCH TRAINED DOGS WITH RECIPIENTS IN NEED OF THEIR SERVICES, AND TRAINING SUCH TRAINED DOGS AND THEIR RECIPIENTS TO ACT TOGETHER AS TEAMS (U.S. CLS. 100, 101 AND 107).

FIRST USE 1-0-2002; IN COMMERCE 1-0-2002.

CLASS 44—MEDICAL, BEAUTY AND AGRICULTURAL SERVICES

FOR BREEDING AND RAISING DOGS INTENDED TO SERVE AS GUIDE DOGS FOR ASSISTING BLIND AND VISUALLY IMPAIRED PERSONS, PLACING SUCH DOGS IN FOSTER HOMES UNTIL REACHING SUITABLE AGE FOR TRAINING AS GUIDES, AND PLACING SUCH DOGS IN CARETAKING HOMES AFTER BEING RETIRED FROM GUIDE SERVICE (U.S. CLS. 100 AND 101).

FIRST USE 1-0-2002; IN COMMERCE 1-0-2002.
JUDITH HELFMAN, EXAMINING ATTORNEY

CLASS 41—EDUCATION AND ENTERTAINMENT

FOR EDUCATIONAL AND ENTERTAINMENT SERVICES IN THE NATURE OF CONFERENCES, CONVENTIONS AND CRUSADES IN THE FIELD OF RELIGION; EDUCATIONAL AND ENTERTAINMENT SERVICES IN THE NATURE OF ONGOING TELEVISION PROGRAMS IN THE FIELD OF RELIGION (U.S. CLS. 100, 101 AND 107).

FIRST USE 1-1-1990; IN COMMERCE 1-1-1990.
GEORGE LORENZO, EXAMINING ATTORNEY

SN 78-538,053. RETAIL BRAND ALLIANCE, INC., ENFIELD, CT. FILED 12-23-2004.

SN 78-537,843. WORLD HEALING CENTER CHURCH, INC., GRAPEVINE, TX. FILED 12-23-2004.

Brooks Brothers

Benny Hinn Ministries

OWNER OF U.S. REG. NOS. 640,370, 1,835,798 AND OTHERS.

THE MARK CONSISTS OF STANDARD CHARACTERS WITHOUT CLAIM TO ANY PARTICULAR FONT, STYLE, SIZE, OR COLOR.

NO CLAIM IS MADE TO THE EXCLUSIVE RIGHT TO USE "MINISTRIES", APART FROM THE MARK AS SHOWN.

THE NAME(S), PORTRAIT(S), AND/OR SIGNATURE(S) SHOWN IN THE MARK IDENTIFIES BENNY HINN, WHOSE CONSENT(S) TO REGISTER IS SUBMITTED.

CLASS 9—ELECTRICAL AND SCIENTIFIC APPARATUS

FOR PRE-RECORDED AUDIO TAPES, VIDEO TAPES, COMPACT DISCS AND DVDS IN THE FIELD OF RELIGION (U.S. CLS. 21, 23, 26, 36 AND 38).

FIRST USE 1-1-1990; IN COMMERCE 1-1-1990.

CLASS 16—PAPER GOODS AND PRINTED MATTER

FOR BOOKS, NEWSLETTERS, PRAYER JOURNALS, PRAYER CARDS, RELIGIOUS BOOKLETS, DEVOTIONALS, CALENDARS, NOTE CARDS, POSTERS, PHOTOGRAPHS, BOOK MARKS, LEATHER BOOK COVERS, PAPERWEIGHTS, PENS, STUDY GUIDES, AND EDUCATIONAL AND TEACHING MATERIALS IN THE FIELD OF RELIGION (U.S. CLS. 2, 5, 22, 23, 29, 37, 38 AND 50).

FIRST USE 1-1-1990; IN COMMERCE 1-1-1990.

CLASS 25—CLOTHING

FOR MEN'S, WOMEN'S, BOYS' AND GIRL' SHIRTS, TOPS, SWEATERS, JACKETS, PANTS, SUITS, BOTTOMS, SOCKS, HATS AND CAPS; SHOES; SHORTS, COATS, NECKTIES, UNDERWEAR, VESTS, ROBES, HOSIERY, SKIRTS, DRESSES, LOUNGEWEAR, SCARVES, RAINWEAR, TROUSERS, ASCOTS, TIES, OUTER SHIRTS INCLUDING EVENING, DRESS, POLO AND SPORTS SHIRTS, COLLARS, PAJAMAS, ROBES, SMOKING JACKETS, DRESSING GOWNS, MUFFLERS, GLOVES, HOSE, BELTS, SUSPENDERS, GARTERS, BOOTS, SLIPPERS, SHOES, OVERSHOES, BEACH WEAR, SWIMWEAR, AND FORMAL WEAR, NAMELY, JACKETS, PANTS, SUITS, SHIRTS, SHOES, CUMMERBUNDS, TIES, SUSPENDERS AND GOWNS (U.S. CLS. 22 AND 39).

FIRST USE 8-1-1998. THE MARK WAS FIRST USED ANYWHERE IN A DIFFERENT FORM OTHER THAN THAT SOUGHT TO BE REGISTERED ON 01/01/1818.; IN COMMERCE 8-1-1998, THE MARK WAS FIRST USED IN COMMERCE IN A DIFFERENT FORM OTHER THAN THAT SOUGHT TO BE REGISTERED ON 01/01/1818..

CLASS 35—ADVERTISING AND BUSINESS

FOR RETAIL STORE, ON-LINE ECOMMERCE STORE, AND MAIL ORDER CATALOG SERVICES FEATURING CLOTHING AND ACCESSORIES THEREFOR, LEATHER GOODS, SOAPS AND COSMETICS, GLASSWARE, TABLEWARE, EYEWEAR, HOME FURNISHINGS, AND GIFTWARE (U.S. CLS. 100, 101 AND 102).

FIRST USE 8-1-1998. THE MARK WAS FIRST USED ANYWHERE IN A DIFFERENT FORM OTHER THAN THAT SOUGHT TO BE REGISTERED ON 01/01/1856.; IN COMMERCE 8-1-1998, THE MARK WAS FIRST USED IN COMMERCE IN A DIFFERENT FORM OTHER THAN THAT SOUGHT TO BE REGISTERED ON 01/01/1856..

JIM RINGLE, EXAMINING ATTORNEY

SN 78-538,155. CALIFORNIA QUIVERS INC., SAN DIEGO, CA. FILED 12-23-2004.

SN 78-538,433. VML, INC., KANSAS CITY, MO. FILED 12-27-2004.

QUIVERTINIS

THE MARK CONSISTS OF STANDARD CHARACTERS WITHOUT CLAIM TO ANY PARTICULAR FONT, STYLE, SIZE, OR COLOR.

CLASS 32—LIGHT BEVERAGES

FOR ICED FRUIT BEVERAGE (U.S. CLS. 45, 46 AND 48).
FIRST USE 4-11-1997; IN COMMERCE 4-11-1997.

CLASS 33—WINES AND SPIRITS

FOR ICED FRUIT BEVERAGE WITH ALCOHOL (U.S. CLS. 47 AND 49).
FIRST USE 1-6-2002; IN COMMERCE 10-10-2002.
JEFF DEFORD, EXAMINING ATTORNEY

SN 78-538,281. TRIANGLE SOFTWARE, SUNNYVALE, CA. FILED 12-24-2004.

The Right Traffic at the Right Time

THE MARK CONSISTS OF STANDARD CHARACTERS WITHOUT CLAIM TO ANY PARTICULAR FONT, STYLE, SIZE, OR COLOR.

CLASS 35—ADVERTISING AND BUSINESS

FOR PLACING ADVERTISEMENTS FOR OTHERS ON THE RADIO, TELEVISION AND THE INTERNET (U.S. CLS. 100, 101 AND 102).
FIRST USE 11-1-2003; IN COMMERCE 11-1-2003.

CLASS 39—TRANSPORTATION AND STORAGE

FOR TRAFFIC INFORMATION SERVICES (U.S. CLS. 100 AND 105).
FIRST USE 11-1-2003; IN COMMERCE 11-1-2003.
WENDY GOODMAN, EXAMINING ATTORNEY

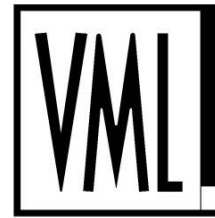

CLASS 35—ADVERTISING AND BUSINESS

FOR ADVERTISING SERVICES, NAMELY, CREATING CORPORATE AND BRAND IDENTITY FOR OTHERS; CREATING CORPORATE LOGOS FOR OTHERS; CREATING TRADEMARKS FOR OTHERS; DEVELOPING PROMOTIONAL CAMPAIGNS FOR BUSINESS; MARKET ANALYSIS AND RESEARCH IN THE NATURE OF IDENTIFYING COMPETITORS AND CONSUMER PREFERENCES; PREPARATION OF CUSTOM ADVERTISEMENTS AND CUSTOM PROMOTIONAL PRODUCTS FOR OTHERS; PREPARING AUDIO-VISUAL PRESENTATIONS FOR USE IN ADVERTISING; PREPARING PROMOTION AND MERCHANDISING MATERIAL FOR OTHERS; PROVIDING BUSINESS MARKETING INFORMATION; PURCHASE AND PROCUREMENT OF MEDIA TIME FOR OTHERS; PLANNING, RESEARCH AND PLACEMENT OF PRINT, RADIO, TELEVISION, INTERNET AND WEBSITE ADVERTISING FOR OTHERS (U.S. CLS. 100, 101 AND 102).
FIRST USE 1-1-1996; IN COMMERCE 1-1-1996.

CLASS 42—SCIENTIFIC, COMPUTER AND LEGAL SERVICES

FOR COMMERCIAL ART DESIGN; COMPUTER WEBSITE DESIGN; GRAPHIC ART DESIGN; PACKAGING DESIGN FOR OTHERS; COMPUTER SERVICES, NAMELY, CREATING, DESIGNING, IMPLEMENTING AND MAINTAINING WEB SITES FOR OTHERS; COMPUTER SERVICES, NAMELY, MANAGING WEB SITES FOR OTHERS; PROVIDING CUSTOMIZED ON-LINE WEB PAGES FEATURING USER-DEFINED INFORMATION, WHICH INCLUDES SEARCH ENGINES AND ONLINE WEB LINKS TO OTHER WEB SITE; COMPUTER SOFTWARE DESIGN FOR OTHERS AND COMPUTER CONSULTATION SERVICES (U.S. CLS. 100 AND 101).
FIRST USE 1-1-1996; IN COMMERCE 1-1-1996.
ALLISON HOLTZ, EXAMINING ATTORNEY

SN 78-538,436. VML, INC., KANSAS CITY, MO. FILED 12-27-2004.

The letters 'V', 'M', and 'L' in a bold, sans-serif font, identical to the logo in the first image but without the square frame.

THE MARK CONSISTS OF STANDARD CHARACTERS WITHOUT CLAIM TO ANY PARTICULAR FONT, STYLE, SIZE, OR COLOR.

CLASS 35—ADVERTISING AND BUSINESS

FOR ADVERTISING SERVICES, NAMELY, CREATING CORPORATE AND BRAND IDENTITY FOR OTHERS; CREATING CORPORATE LOGOS FOR OTHERS; CREATING TRADEMARKS FOR OTHERS; DEVELOPING PROMOTIONAL CAMPAIGNS FOR BUSINESS; MARKET ANALYSIS AND RESEARCH IN THE NATURE OF IDENTIFYING COMPETITORS AND CONSUMER PREFERENCES; PREPARATION OF CUSTOM ADVERTISEMENTS AND CUSTOM PROMOTIONAL PRODUCTS FOR OTHERS; PREPARING AUDIO-VISUAL PRESENTATIONS FOR USE IN ADVERTISING; PREPARING PROMOTION AND MERCHANDISING MATERIAL FOR OTHERS; PROVIDING BUSINESS MARKETING INFORMATION; PURCHASE AND PROCUREMENT OF MEDIA TIME FOR OTHERS; PLANNING, RESEARCH AND PLACEMENT OF PRINT, RADIO, TELEVISION, INTERNET AND WEBSITE ADVERTISING FOR OTHERS (U.S. CLS. 100, 101 AND 102).

FIRST USE 1-1-1996; IN COMMERCE 1-1-1996.

CLASS 42—SCIENTIFIC, COMPUTER AND LEGAL SERVICES

FOR COMMERCIAL ART DESIGN; COMPUTER WEBSITE DESIGN; GRAPHIC ART DESIGN; PACKAGING DESIGN FOR OTHERS; COMPUTER SERVICES, NAMELY, CREATING, DESIGNING, IMPLEMENTING AND MAINTAINING WEB SITES FOR OTHERS; COMPUTER SERVICES, NAMELY, MANAGING WEB SITES FOR OTHERS; PROVIDING CUSTOMIZED ON-LINE WEB PAGES FEATURING USER-DEFINED INFORMATION, WHICH INCLUDES SEARCH ENGINES AND ONLINE WEB LINKS TO OTHER WEB SITE; COMPUTER SOFTWARE DESIGN FOR OTHERS AND COMPUTER CONSULTATION SERVICES (U.S. CLS. 100 AND 101).

FIRST USE 1-1-1996; IN COMMERCE 1-1-1996.
ALLISON HOLTZ, EXAMINING ATTORNEY

SN 78-538,485. TAYLOR, JAMES M., EL CAJON, CA. FILED 12-27-2004.

gheddo
incorporated

THE MARK CONSISTS OF STANDARD CHARACTERS WITHOUT CLAIM TO ANY PARTICULAR FONT, STYLE, SIZE, OR COLOR.

NO CLAIM IS MADE TO THE EXCLUSIVE RIGHT TO USE "INCORPORATED", APART FROM THE MARK AS SHOWN.

CLASS 16—PAPER GOODS AND PRINTED MATTER

FOR STICKERS, DECALS, PENS, NOTE PADS, AND PAPER BANNERS (U.S. CLS. 2, 5, 22, 23, 29, 37, 38 AND 50).

CLASS 25—CLOTHING

FOR CLOTHING ITEMS, NAMELY, HATS, SOCKS, T-SHIRTS, SHORTS, SHIRTS, LONG-SLEEVE SHIRTS, PANTS, JEANS, SWEATSHIRTS, TANK TOPS, SANDALS, BELTS, SWEATERS, SWEATBANDS, VISORS, BEANIES, JACKETS, WIND RESISTANT JACKETS, BOARDSHORTS, BATHING SUITS, UNDERWEAR, SHOES, BOOTS, JERSEYS, GLOVES, DO-RAGS, SKIRTS, SLEEP WEAR, SCARVES, BANDANAS, POLO SHIRTS, SWEAT SUITS (U.S. CLS. 22 AND 39).

ELLEN BURNS, EXAMINING ATTORNEY

SN 78-538,682. KGI (FAR EAST) LTD., KOWLOON, HONG KONG, FILED 12-27-2004.

E-GROOVZ

THE MARK CONSISTS OF STANDARD CHARACTERS WITHOUT CLAIM TO ANY PARTICULAR FONT, STYLE, SIZE, OR COLOR.

CLASS 15—MUSICAL INSTRUMENTS

FOR MUSICAL INSTRUMENTS (U.S. CLS. 2, 21 AND 36).

FIRST USE 8-1-2001; IN COMMERCE 8-1-2001.

CLASS 28—TOYS AND SPORTING GOODS

FOR TOYS AND TOY SETS FEATURING MUSIC; TOYS AND TOY SETS FEATURING TALKING, SOUND OR LIGHTS (U.S. CLS. 22, 23, 38 AND 50).

FIRST USE 8-1-2001; IN COMMERCE 8-1-2001.

ALICE SUE CARRUTHERS, EXAMINING ATTORNEY

SN 78-538,713. BREAUTL RESEARCH ORGANIZATION, INC., TUCSON, AZ. FILED 12-27-2004.

ASAP

THE MARK CONSISTS OF STANDARD CHARACTERS WITHOUT CLAIM TO ANY PARTICULAR FONT, STYLE, SIZE, OR COLOR.

CLASS 9—ELECTRICAL AND SCIENTIFIC APPARATUS

FOR COMPUTER SOFTWARE FOR MODELING, DESIGNING, ANALYZING AND USE OF OPTICAL AND LIGHTING SYSTEMS, AND DOCUMENTATION THEREFOR, WHEN SOLD AS A UNIT (U.S. CLS. 21, 23, 26, 36 AND 38).
FIRST USE 12-31-1986; IN COMMERCE 12-31-1986.

CLASS 41—EDUCATION AND ENTERTAINMENT

FOR TRAINING IN THE MODELING, DESIGN, ANALYSIS AND USE OF OPTICAL AND LIGHTING SYSTEMS (U.S. CLS. 100, 101 AND 107).
FIRST USE 12-31-1986; IN COMMERCE 12-31-1986.
JENNIFER MARTIN, EXAMINING ATTORNEY

SN 78-538,744. GREGG A CHANDLER, DBA ENTHUSIASTIC SOFTWARE, ST. JOSEPH, MI. FILED 12-27-2004.

CTESTAR

THE MARK CONSISTS OF STANDARD CHARACTERS WITHOUT CLAIM TO ANY PARTICULAR FONT, STYLE, SIZE, OR COLOR.

CLASS 9—ELECTRICAL AND SCIENTIFIC APPARATUS

FOR COMPUTER SOFTWARE FOR ASSESSING STUDENTS IN ANY SUBJECT MATTER AT ANY GRADE LEVEL (U.S. CLS. 21, 23, 26, 36 AND 38).
FIRST USE 12-1-2002; IN COMMERCE 1-21-2003.

CLASS 16—PAPER GOODS AND PRINTED MATTER

FOR COMPUTER MANUAL FOR A SOFTWARE PROGRAM FOR ASSESSING STUDENTS (U.S. CLS. 2, 5, 22, 23, 29, 37, 38 AND 50).
FIRST USE 12-1-2002; IN COMMERCE 1-21-2003.

CLASS 41—EDUCATION AND ENTERTAINMENT

FOR COMPUTER EDUCATION TRAINING FOR A SOFTWARE PROGRAM FOR ASSESSING STUDENTS (U.S. CLS. 100, 101 AND 107).
FIRST USE 12-1-2002; IN COMMERCE 1-21-2003.

CLASS 42—SCIENTIFIC, COMPUTER AND LEGAL SERVICES

FOR COMPUTER SOFTWARE DESIGN FOR OTHERS INVOLVING SOFTWARE FOR ASSESSING STUDENTS (U.S. CLS. 100 AND 101).
FIRST USE 12-1-2001; IN COMMERCE 1-21-2003.
ANN LINNEHAN, EXAMINING ATTORNEY

SN 78-538,874. DUN & BRADSTREET, INC., SHORT HILLS, NJ. FILED 12-28-2004.

DECIDERIGHT JOURNAL

THE MARK CONSISTS OF STANDARD CHARACTERS WITHOUT CLAIM TO ANY PARTICULAR FONT, STYLE, SIZE, OR COLOR.

NO CLAIM IS MADE TO THE EXCLUSIVE RIGHT TO USE "JOURNAL", APART FROM THE MARK AS SHOWN.

CLASS 9—ELECTRICAL AND SCIENTIFIC APPARATUS

FOR DOWNLOADABLE ELECTRONIC PUBLICATION IN THE NATURE OF A JOURNAL IN THE FIELD OF BUSINESS DATA ANALYTICS (U.S. CLS. 21, 23, 26, 36 AND 38).
FIRST USE 7-1-2004; IN COMMERCE 7-1-2004.

CLASS 41—EDUCATION AND ENTERTAINMENT

FOR PROVIDING AN ONLINE JOURNAL IN THE FIELD OF BUSINESS DATA ANALYTICS (U.S. CLS. 100, 101 AND 107).
FIRST USE 7-1-2004; IN COMMERCE 7-1-2004.
CYNTHIA SLOAN, EXAMINING ATTORNEY

SN 78-538,888. DUN & BRADSTREET, INC., SHORT HILLS, NJ. FILED 12-28-2004.

SN 78-538,949. BRINKER INTERNATIONAL HOLDINGS, L.P., DALLAS, TX. FILED 12-28-2004.

DECIDERight
JOURNAL



NO CLAIM IS MADE TO THE EXCLUSIVE RIGHT TO USE "JOURNAL", APART FROM THE MARK AS SHOWN.

CLASS 9—ELECTRICAL AND SCIENTIFIC APPARATUS

FOR DOWNLOADABLE ELECTRONIC PUBLICATION IN THE NATURE OF A JOURNAL IN THE FIELD OF BUSINESS DATA ANALYTICS (U.S. CLS. 21, 23, 26, 36 AND 38).

FIRST USE 7-1-2004; IN COMMERCE 7-1-2004.

CLASS 41—EDUCATION AND ENTERTAINMENT

FOR PROVIDING AN ONLINE JOURNAL IN THE FIELD OF BUSINESS DATA ANALYTICS (U.S. CLS. 100, 101 AND 107).

FIRST USE 7-1-2004; IN COMMERCE 7-1-2004.
CYNTHIA SLOAN, EXAMINING ATTORNEY

OWNER OF U.S. REG. NO. 2,361,927.

NO CLAIM IS MADE TO THE EXCLUSIVE RIGHT TO USE "STARTERS", APART FROM THE MARK AS SHOWN. THE MARK CONSISTS OF THE WORD STARTERS CONTAINED IN A RECTANGLE. INTERSECTING THE RECTANGLE IS THE IMAGE OF A LIT MATCH. THE TOP OF THE RECTANGLE IS CONSUMED IN FLAMES.

CLASS 29—MEATS AND PROCESSED FOODS

FOR PREPARED APPETIZER CONSISTING PRIMARILY OF FRIED CHICKEN STRIPS, BUFFALO WINGS AND EGGROLLS; FRIED CHEESE STICKS; GARDEN AND CAESAR SALADS; BUFFALO WINGS; FRIED WHOLE SLICED ONIONS; ONION RINGS; AND FRENCH FRIED POTATOES (U.S. CL. 46).

FIRST USE 10-1-2001; IN COMMERCE 10-1-2001.

CLASS 30—STAPLE FOODS

FOR NACHOS; EGGROLLS; AND TORTILLIA CHIPS (U.S. CL. 46).

FIRST USE 10-1-2001; IN COMMERCE 10-1-2001.
ANNE E. GUSTASON, EXAMINING ATTORNEY

SN 78-538,900. SHOREACRES, INC., LAKE BLUFF, IL. FILED 12-28-2004.

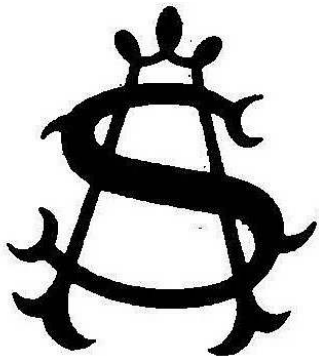

CLASS 25—CLOTHING

FOR CLOTHING, NAMELY SHIRTS, HATS AND NECKTIES (U.S. CLS. 22 AND 39).

FIRST USE 0-0-1965; IN COMMERCE 0-0-1965.

CLASS 28—TOYS AND SPORTING GOODS

FOR GOLF EQUIPMENT, NAMELY GOLF BALLS, GOLF CLUB BAGS AND TAGS (U.S. CLS. 22, 23, 38 AND 50).

FIRST USE 0-0-1965; IN COMMERCE 0-0-1965.

CLASS 41—EDUCATION AND ENTERTAINMENT

FOR PRIVATE GOLF COURSE AND COUNTRY CLUB SERVICES (U.S. CLS. 100, 101 AND 107).

FIRST USE 0-0-1949; IN COMMERCE 0-0-1949.
RICHARD WHITE, EXAMINING ATTORNEY

SN 78-539,071. EMPRESS HAIR PRODUCTS, LTD., IRVING, TX. FILED 12-28-2004.

Re-Gro

THE MARK CONSISTS OF THE WORDS RE-GRO IN STYLIZED FORM WITH A CROSS MARK THROUGH THE RIGHT LEG OF THE LETTER R TO FORM A STYLIZED "RX".

CLASS 3—COSMETICS AND CLEANING PREPARATIONS

FOR HAIR CARE PREPARATIONS, NAMELY, HAIR MOISTURIZING LOTION AND SCALP MOISTURIZER (U.S. CLS. 1, 4, 6, 50, 51 AND 52).

FIRST USE 6-4-2004; IN COMMERCE 6-4-2004.

CLASS 5—PHARMACEUTICALS

FOR MEDICATED HAIR CARE PREPARATIONS, NAMELY, HAIR GROWTH STIMULANTS (U.S. CLS. 6, 18, 44, 46, 51 AND 52).

FIRST USE 6-4-2004; IN COMMERCE 6-4-2004.
KRISTINA KLOIBER, EXAMINING ATTORNEY

SN 78-539,692. AMERICAN INTELLECTUAL PROPERTY LAW ASSOCIATION, INC., ARLINGTON, VA. FILED 12-29-2004.

CLASS 25—CLOTHING

FOR CLOTHING, NAMELY, WINDSHIRTS, NECKTIES (U.S. CLS. 22 AND 39).

FIRST USE 1-23-2002; IN COMMERCE 1-23-2002.

CLASS 35—ADVERTISING AND BUSINESS

FOR ASSOCIATION SERVICES; NAMELY, PROMOTING THE INTEREST OF LAWYERS WHO HAVE AN INTEREST IN DOMESTIC AND FOREIGN INTELLECTUAL PROPERTY LAW (U.S. CLS. 100, 101 AND 102).

FIRST USE 1-1-1984; IN COMMERCE 1-1-1984.

CLASS 41—EDUCATION AND ENTERTAINMENT

FOR EDUCATIONAL SERVICES; NAMELY, CONDUCTING MEETINGS, LECTURES AND SEMINARS IN THE FIELD OF DOMESTIC AND FOREIGN INTELLECTUAL PROPERTY LAW (U.S. CLS. 100, 101 AND 107).

FIRST USE 1-1-1984; IN COMMERCE 1-1-1984.

ZACHARY BELLO, EXAMINING ATTORNEY

AIPLA

SN 78-540,023. EIVIA, INC., EDEN PRAIRIE, MN. FILED 12-30-2004.

THE MARK CONSISTS OF STANDARD CHARACTERS WITHOUT CLAIM TO ANY PARTICULAR FONT, STYLE, SIZE, OR COLOR.

CLASS 9—ELECTRICAL AND SCIENTIFIC APPARATUS

FOR AUDIOTAPES, PRE-RECORDED CDS, VIDEOTAPES AND DVDS OF LECTURES AND SEMINARS IN THE FIELD OF DOMESTIC AND FOREIGN INTELLECTUAL PROPERTY LAW; COMPUTER MEMORY STICKS (U.S. CLS. 21, 23, 26, 36 AND 38).

FIRST USE 1-1-1984; IN COMMERCE 1-1-1984.

CLASS 14—JEWELRY

FOR TIMEPIECES, NAMELY, CLOCKS; JEWELRY, NAMELY CUFFLINKS (U.S. CLS. 2, 27, 28 AND 50).

FIRST USE 10-31-2000; IN COMMERCE 10-31-2000.

CLASS 16—PAPER GOODS AND PRINTED MATTER

FOR BULLETINS, BOOKS, SCHOLARLY JOURNALS, MONOGRAPHS AND COLLECTIONS OF SCHOLARLY PAPERS IN THE FIELD OF DOMESTIC AND FOREIGN INTELLECTUAL PROPERTY LAW (U.S. CLS. 2, 5, 22, 23, 29, 37, 38 AND 50).

FIRST USE 1-1-1984; IN COMMERCE 1-1-1984.

CLASS 18—LEATHER GOODS

FOR TOTE BAGS, BACKPACKS, BRIEFCASES AND BRIEFCASE TYPE PORTFOLIOS (U.S. CLS. 1, 2, 3, 22 AND 41).

FIRST USE 1-31-1999; IN COMMERCE 1-31-1999.

CLASS 24—FABRICS

FOR BEACH TOWELS (U.S. CLS. 42 AND 50).

FIRST USE 1-21-2003; IN COMMERCE 1-21-2003.

EIVIA

THE MARK CONSISTS OF STANDARD CHARACTERS WITHOUT CLAIM TO ANY PARTICULAR FONT, STYLE, SIZE, OR COLOR.

CLASS 9—ELECTRICAL AND SCIENTIFIC APPARATUS

FOR COMPUTER SOFTWARE FOR BUSINESS PERFORMANCE MANAGEMENT, DATA MANAGEMENT, BUSINESS OPERATIONS MANAGEMENT, FINANCIAL MANAGEMENT, AND BUSINESS FORECASTING (U.S. CLS. 21, 23, 26, 36 AND 38).

FIRST USE 1-1-2004; IN COMMERCE 1-1-2004.

CLASS 42—SCIENTIFIC, COMPUTER AND LEGAL SERVICES

FOR CONSULTING SERVICES IN THE FIELD OF DESIGN, SELECTION, IMPLEMENTATION AND USE OF COMPUTER SYSTEMS FOR OTHERS; COMPUTER SYSTEMS INTEGRATION SERVICES (U.S. CLS. 100 AND 101).

FIRST USE 1-1-2004; IN COMMERCE 1-1-2004.

DARRYL SPRUILL, EXAMINING ATTORNEY

SN 78-540,364. GARDNER DENVER, INC., QUINCY, IL. FILED 12-30-2004.

AIR RELIEF

THE MARK CONSISTS OF STANDARD CHARACTERS WITHOUT CLAIM TO ANY PARTICULAR FONT, STYLE, SIZE, OR COLOR.
NO CLAIM IS MADE TO THE EXCLUSIVE RIGHT TO USE "AIR", APART FROM THE MARK AS SHOWN.

CLASS 35—ADVERTISING AND BUSINESS

FOR RETAIL STORE SERVICES AND RETAIL DISTRIBUTORSHIP SERVICES FEATURING REMANUFACTURED INDUSTRIAL AIR COMPRESSORS (U.S. CLS. 100, 101 AND 102).
FIRST USE 0-0-1985; IN COMMERCE 0-0-1985.

CLASS 37—CONSTRUCTION AND REPAIR

FOR MAINTENANCE, REPAIR, INSTALLATION, AND SERVICING OF INDUSTRIAL AIR COMPRESSORS AND OF COMPONENTS FOR INDUSTRIAL AIR COMPRESSORS (U.S. CLS. 100, 103 AND 106).
FIRST USE 0-0-1985; IN COMMERCE 0-0-1985.

CLASS 40—MATERIAL TREATMENT

FOR CUSTOM REMANUFACTURE OF INDUSTRIAL AIR COMPRESSORS (U.S. CLS. 100, 103 AND 106).
FIRST USE 0-0-1985; IN COMMERCE 0-0-1985.
CYNTHIA SLOAN, EXAMINING ATTORNEY

SN 78-541,800. INTERTECH MEDIA, LLC, OLD GREENWICH, CT. FILED 1-4-2005.

LISTENERSTATION

THE MARK CONSISTS OF STANDARD CHARACTERS WITHOUT CLAIM TO ANY PARTICULAR FONT, STYLE, SIZE, OR COLOR.

CLASS 38—COMMUNICATION

FOR TELECOMMUNICATIONS SERVICES, NAMELY, ELECTRONIC TRANSMISSION OF AUDIO FILES VIA A COMPUTER NETWORK (U.S. CLS. 100, 101 AND 104).
FIRST USE 10-29-2004; IN COMMERCE 10-29-2004.

CLASS 41—EDUCATION AND ENTERTAINMENT

FOR ENTERTAINMENT SERVICES, NAMELY, PROVIDING A WEB SITE FEATURING MUSICAL RECORDINGS, TEXT, PHOTOGRAPHS AND OTHER MULTIMEDIA CONTENT AND AN INTERACTIVE MESSAGING AND RATING SYSTEM ENABLING WEB SITE USERS TO COMMUNICATE REVIEWS OF ARTISTS' CONTENT; PROVIDING INFORMATION ABOUT ARTISTS, MUSICAL GROUPS AND ENTERTAINMENT-RELATED EVENTS (U.S. CLS. 100, 101 AND 107).
FIRST USE 10-29-2004; IN COMMERCE 10-29-2004.
CAROLYN CATALDO, EXAMINING ATTORNEY

SN 78-548,048. CLIF BAR INC., BERKELEY, CA. FILED 1-14-2005.

CLIF SHOT

THE MARK CONSISTS OF STANDARD CHARACTERS WITHOUT CLAIM TO ANY PARTICULAR FONT, STYLE, SIZE, OR COLOR.
OWNER OF U.S. REG. NOS. 2,089,042, 2,089,043 AND 2,573,420.

CLASS 30—STAPLE FOODS

FOR HIGH ENERGY GELS MADE PRIMARILY FROM BROWN RICE SYRUP (U.S. CL. 46).
FIRST USE 4-0-2005; IN COMMERCE 4-0-2005.

CLASS 32—LIGHT BEVERAGES

FOR NON-ALCOHOLIC BEVERAGES, NAMELY, SPORTS DRINKS (U.S. CLS. 45, 46 AND 48).
FIRST USE 4-0-2005; IN COMMERCE 4-0-2005.
MITCHELL FRONT, EXAMINING ATTORNEY

SN 78-559,208. MYELIN MEDIA LLC, NEW YORK, NY.
FILED 2-2-2005.

STACKED

THE MARK CONSISTS OF STANDARD CHARACTERS WITHOUT CLAIM TO ANY PARTICULAR FONT, STYLE, SIZE, OR COLOR.

CLASS 9—ELECTRICAL AND SCIENTIFIC APPARATUS

FOR DVDS, VHS TAPES AND OTHER DIGITAL AUDIO AND VIDEO RECORDINGS FEATURING PROGRAMMING RELATED TO POKER. (U.S. CLS. 21, 23, 26, 36 AND 38).

CLASS 41—EDUCATION AND ENTERTAINMENT

FOR ENTERTAINMENT SERVICES, NAMELY, A TELEVISION SERIES AND RADIO PROGRAMS RELATING TO POKER; EXHIBITION AND PERSONAL APPEARANCES BY POKER PLAYERS RENDERED THROUGH THE MEDIA, NAMELY TELEVISION AND RADIO SHOWS; ENTERTAINMENT AND RECREATIONAL SERVICES IN THE NATURE OF ORGANIZING AND CONDUCTING POKER GAMES, POKER LEAGUES AND POKER TOURNAMENTS AND ON-LINE POKER GAMES, POKER LEAGUES AND POKER TOURNAMENTS; ORGANIZING AND CONDUCTING SEMINARS, CONFERENCES AND TRAINING SESSIONS RELATING TO POKER; AND DEVELOPMENT AND DISSEMINATION OF EDUCATIONAL TRAINING MATERIALS IN CONNECTION THEREWITH, IN CD ROM, DVD, AND OTHER DIGITAL AND/OR ELECTRONIC MEDIA, AND PRINT FORMAT (U.S. CLS. 100, 101 AND 107).

ELLEN B. AWRICH, EXAMINING ATTORNEY

SN 78-560,631. GEEKS ON CALL AMERICA, INC., NORFOLK, VA. FILED 2-4-2005.

Make The **Right** CALL!

OWNER OF U.S. REG. NO. 2,479,548.
THE COLOR(S) YELLOW IS/ARE CLAIMED AS A FEATURE OF THE MARK.
THE MARK CONSISTS IN PART OF A YELLOW BACKGROUND BEHIND THE WORD "RIGHT".

CLASS 37—CONSTRUCTION AND REPAIR

FOR INSTALLATION, MAINTENANCE AND REPAIR OF COMPUTER HARDWARE; INSTALLATION, MAINTENANCE AND REPAIR OF COMPUTER NETWORKS; UPGRADE OF COMPUTER HARDWARE (U.S. CLS. 100, 103 AND 106).

FIRST USE 1-10-2005; IN COMMERCE 1-10-2005.

CLASS 40—MATERIAL TREATMENT

FOR CUSTOM MANUFACTURE OF COMPUTERS FOR OTHERS (U.S. CLS. 100, 103 AND 106).

FIRST USE 1-10-2005; IN COMMERCE 1-10-2005.

CLASS 41—EDUCATION AND ENTERTAINMENT

FOR EDUCATIONAL SERVICES, NAMELY, TRAINING SERVICES IN THE FIELDS OF COMPUTER HARDWARE AND SOFTWARE, COMPUTER AND NETWORK SECURITY, INTERNET SECURITY, COMPUTER AND NETWORK TECHNOLOGY, COMPUTER AND NETWORK HARDWARE, AND COMPUTER AND NETWORK SOFTWARE; EDUCATIONAL SERVICES, NAMELY TRAINING SERVICES IN THE USE AND MAINTENANCE OF COMPUTER SYSTEMS AND NETWORKS (U.S. CLS. 100, 101 AND 107).

FIRST USE 1-10-2005; IN COMMERCE 1-10-2005.

CLASS 42—SCIENTIFIC, COMPUTER AND LEGAL SERVICES

FOR DESIGN OF COMPUTERS, COMPUTER SOFTWARE AND COMPUTER NETWORKS; CONSULTING SERVICES IN THE FIELD OF DESIGN, SELECTION, IMPLEMENTATION AND USE OF COMPUTER HARDWARE AND SOFTWARE SYSTEMS FOR OTHERS; COMPUTER SERVICES, NAMELY VIRUS PROTECTION, DATA BACK UP AND RECOVERY SERVICES; COMPUTER SYSTEM SECURITY SERVICES, NAMELY, RESTRICTING ACCESS TO AND BY COMPUTER NETWORKS TO AND OF UNDESIRED WEB SITES, MEDIA AND INDIVIDUALS AND FACILITIES; MAINTAINING WEB SITES FOR OTHERS; COMPUTER WEB SITE DESIGN FOR OTHERS (U.S. CLS. 100 AND 101).

FIRST USE 1-10-2005; IN COMMERCE 1-10-2005.

CLASS 45—PERSONAL SERVICES

FOR MONITORING OF COMPUTER SYSTEMS FOR SECURITY PURPOSES (U.S. CLS. 100 AND 101).

FIRST USE 1-10-2005; IN COMMERCE 1-10-2005.

ANGELA M. MICHELI, EXAMINING ATTORNEY

SN 78-566,825. REALIZE, INC., FISHERS, IN. FILED 2-14-2005.

REALIZE

THE MARK CONSISTS OF STANDARD CHARACTERS WITHOUT CLAIM TO ANY PARTICULAR FONT, STYLE, SIZE, OR COLOR.

CLASS 40—MATERIAL TREATMENT

FOR CUSTOM FABRICATION AND MANUFACTURE OF NEW PRODUCT PROTOTYPES AND PROTOTYPE MODELS FOR OTHERS (U.S. CLS. 100, 103 AND 106).
FIRST USE 4-9-1999; IN COMMERCE 4-9-1999.

CLASS 42—SCIENTIFIC, COMPUTER AND LEGAL SERVICES

FOR CUSTOM DESIGN AND ENGINEERING OF NEW PRODUCT PROTOTYPES AND PROTOTYPE MODELS FOR OTHERS; INDUSTRIAL PRODUCT DESIGN (U.S. CLS. 100 AND 101).
FIRST USE 4-9-1999; IN COMMERCE 4-9-1999.
MICHAEL TANNER, EXAMINING ATTORNEY

SN 78-568,008. THE CLUB AT SPANISH PEAKS, LLC, BIG SKY, MT. FILED 2-15-2005.



NO CLAIM IS MADE TO THE EXCLUSIVE RIGHT TO USE BIG SKY, MONTANA, APART FROM THE MARK AS SHOWN.

THE MARK CONSISTS OF GEOMETRIC BRAND DESIGN FEATURING MOUNTAIN PEAKS, THE LETTERS SP WITH THE WORDS BELOW, SPANISH PEAKS BIG SKY, MONTANA.

CLASS 36—INSURANCE AND FINANCIAL

FOR REAL ESTATE BROKERAGE, REAL ESTATE LEASING, REAL ESTATE LISTING AND REAL ESTATE MANAGEMENT (U.S. CLS. 100, 101 AND 102).
FIRST USE 1-31-2005; IN COMMERCE 1-31-2005.

CLASS 37—CONSTRUCTION AND REPAIR

FOR REAL ESTATE DEVELOPMENT AND LAND DEVELOPMENT SERVICES, NAMELY, PLANNING AND LAYING OUT OF RESORTS, RESIDENTIAL COMMUNITIES, HOMES AND CONDOMINIUMS (U.S. CLS. 100, 103 AND 106).
FIRST USE 1-31-2005; IN COMMERCE 1-31-2005.

CLASS 41—EDUCATION AND ENTERTAINMENT

FOR PROVIDING FACILITIES FOR RECREATIONAL ACTIVITIES, NAMELY, GOLF, SKIING, SPA, SWIMMING, HORSEBACK RIDING, OUTFITTING, AND FISHING; HEALTH CLUB SERVICES, NAMELY PROVIDING INSTRUCTION AND EQUIPMENT IN THE FIELD OF PHYSICAL EXERCISE (U.S. CLS. 100, 101 AND 107).
FIRST USE 1-31-2005; IN COMMERCE 1-31-2005.
AMY GEARIN, EXAMINING ATTORNEY

SN 78-571,471. THE CLUB AT SPANISH PEAKS, LLC, BIG SKY, MT. FILED 2-21-2005.



THE MARK CONSISTS OF A GEOMETRIC BRAND DESIGN FEATURING MOUNTAIN PEAKS AND THE LETTERS SP PROMINENTLY DISPLAYED.

CLASS 36—INSURANCE AND FINANCIAL

FOR REAL ESTATE BROKERAGE, REAL ESTATE LEASING, REAL ESTATE LISTING AND REAL ESTATE MANAGEMENT (U.S. CLS. 100, 101 AND 102).
FIRST USE 12-4-2004; IN COMMERCE 12-4-2004.

CLASS 37—CONSTRUCTION AND REPAIR

FOR REAL ESTATE DEVELOPMENT AND LAND DEVELOPMENT SERVICES, NAMELY, PLANNING AND LAYING OUT OF RESORTS, RESIDENTIAL COMMUNITIES, HOMES AND CONDOMINIUMS (U.S. CLS. 100, 103 AND 106).
FIRST USE 12-4-2004; IN COMMERCE 12-4-2004.

CLASS 41—EDUCATION AND ENTERTAINMENT

FOR PROVIDING FACILITIES FOR RECREATIONAL ACTIVITIES, NAMELY, GOLF, SKIING, SPA, SWIMMING, HORSEBACK RIDING, OUTFITTING, AND FISHING; HEALTH CLUB SERVICES, NAMELY PROVIDING INSTRUCTION AND EQUIPMENT IN THE FIELD OF PHYSICAL EXERCISE (U.S. CLS. 100, 101 AND 107).
FIRST USE 12-4-2004; IN COMMERCE 12-4-2004.
AMY GEARIN, EXAMINING ATTORNEY

SN 78-574,535. REALIZE, INC., FISHERS, IN. FILED 2-24-2005.

SN 78-594,441. PELLA, INC., ATLANTA, GA. FILED 3-24-2005.



NO CLAIM IS MADE TO THE EXCLUSIVE RIGHT TO USE "INC.", APART FROM THE MARK AS SHOWN.

CLASS 40—MATERIAL TREATMENT

FOR CUSTOM FABRICATION AND MANUFACTURE OF NEW PRODUCT PROTOTYPES AND PROTOTYPE MODELS FOR OTHERS (U.S. CLS. 100, 103 AND 106).
FIRST USE 7-26-2004; IN COMMERCE 7-26-2004.

CLASS 42—SCIENTIFIC, COMPUTER AND LEGAL SERVICES

FOR CUSTOM DESIGN AND ENGINEERING OF NEW PRODUCT PROTOTYPES AND PROTOTYPE MODELS FOR OTHERS; INDUSTRIAL PRODUCT DESIGN (U.S. CLS. 100 AND 101).
FIRST USE 7-26-2004; IN COMMERCE 7-26-2004.
MICHAEL TANNER, EXAMINING ATTORNEY

SN 78-574,586. REALIZE, INC., FISHERS, IN. FILED 2-24-2005.



CLASS 40—MATERIAL TREATMENT

FOR CUSTOM FABRICATION AND MANUFACTURE OF NEW PRODUCT PROTOTYPES AND PROTOTYPE MODELS FOR OTHERS (U.S. CLS. 100, 103 AND 106).
FIRST USE 7-26-2004; IN COMMERCE 7-26-2004.

CLASS 42—SCIENTIFIC, COMPUTER AND LEGAL SERVICES

FOR CUSTOM DESIGN AND ENGINEERING OF NEW PRODUCT PROTOTYPES AND PROTOTYPE MODELS FOR OTHERS; INDUSTRIAL PRODUCT DESIGN (U.S. CLS. 100 AND 101).
FIRST USE 7-26-2004; IN COMMERCE 7-26-2004.
MICHAEL TANNER, EXAMINING ATTORNEY

PELLA

THE MARK CONSISTS OF STANDARD CHARACTERS WITHOUT CLAIM TO ANY PARTICULAR FONT, STYLE, SIZE, OR COLOR.

CLASS 9—ELECTRICAL AND SCIENTIFIC APPARATUS

FOR FOOTWEAR (U.S. CLS. 21, 23, 26, 36 AND 38).
FIRST USE 3-13-1976; IN COMMERCE 11-7-1988.

CLASS 35—ADVERTISING AND BUSINESS

FOR RETAIL STORE SERVICES FEATURING FOOTWEAR AND RELATED ACCESSORIES (U.S. CLS. 100, 101 AND 102).
FIRST USE 3-13-1976; IN COMMERCE 11-7-1988.
LAURIE MAYES, EXAMINING ATTORNEY

SN 78-599,329. STEELWORKS HARDWARE, L.L.C., NORTHFIELD, IL. FILED 3-31-2005.

**STEELWORKS
PROFESSIONAL HAND
TOOLS**

THE MARK CONSISTS OF STANDARD CHARACTERS WITHOUT CLAIM TO ANY PARTICULAR FONT, STYLE, SIZE, OR COLOR.

OWNER OF U.S. REG. NO. 2,800,554.
NO CLAIM IS MADE TO THE EXCLUSIVE RIGHT TO USE "PROFESSIONAL HAND TOOLS", APART FROM THE MARK AS SHOWN.

CLASS 6—METAL GOODS

FOR METAL GOODS, NAMELY, TOOLBOXES, HOOKS, FASTENING ANCHORS FOR SECURING PICTURES AND SIMILAR OBJECTS TO WALLS, LOCKSETS, PADLOCKS, TIE DOWNS, BOLTS, NUTS, SCREWS, TACKS AND BRADS, THREADED FASTENERS, NAILS, KNOBS, CHAINS, AND STAPLES FOR CONSTRUCTION USE (U.S. CLS. 2, 12, 13, 14, 23, 25 AND 50).

CLASS 7—MACHINERY

FOR POWER DRILL BITS; POWER SAW BLADES; PNEUMATIC TOOLS, NAMELY, SOCKET DRIVERS, NAIL GUNS, STAPLE GUNS, PNEUMATIC SCREWDRIVERS AND IMPACT WRENCHES; ELECTRIC GLUE GUNS (U.S. CLS. 13, 19, 21, 23, 31, 34 AND 35).

SN 78-665,879. RETAIL BRAND ALLIANCE, INC., ENFIELD, CT. FILED 7-7-2005.

CLASS 8—HAND TOOLS

FOR HAND TOOLS, NAMELY, STAPLE GUNS AND DRILL BITS FOR HAND DRILLS; DRYWALL TOOLS, NAMELY, PUTTY KNIVES, SCRAPERS AND TAPING KNIVES; HANDHELD SCREWDRIVER BIT SETS; PLIERS; LOCKING PLIERS; SCREWDRIVERS; SOCKET SETS; BENCH VISES MADE OF METAL; RATCHETING SCREWDRIVERS; HAMMERS; WRENCHES; SAWS; KNIVES, NAMELY HUNTING KNIVES, FISHING KNIVES, POCKET KNIVES, UTILITY KNIVES, RAZOR KNIVES, AND RAZOR BLADES; WIRE STRIPPERS; WIRE CUTTERS; AND CLAMPS; SOCKET SETS FOR USE AS WRENCHES (U.S. CLS. 23, 28 AND 44).



OWNER OF U.S. REG. NOS. 2,185,431, 2,439,280 AND OTHERS.

CLASS 9—ELECTRICAL AND SCIENTIFIC APPARATUS

FOR INTERNATIONAL SURVEYING TOOLS, NAMELY, SURVEYING CHAINS AND LEVELS; RESPIRATORS OTHER THAN FOR ARTIFICIAL RESPIRATION; METAL MEASURING TAPES; VOLT METERS; PROTECTIVE ARTICLES FOR INDUSTRIAL USE, NAMELY, HELMETS, EAR PLUGS, BACK SUPPORTS AND KNEE PADS FOR WORKERS (U.S. CLS. 21, 23, 26, 36 AND 38).

CLASS 14—JEWELRY

FOR WATCHES, WATCHBANDS, CLOCKS, KEY CHAINS MADE OF PRECIOUS METAL, AND JEWELRY (U.S. CLS. 2, 27, 28 AND 50).
FIRST USE 3-31-2003; IN COMMERCE 3-31-2003.

CLASS 12—VEHICLES

FOR HAND TRUCKS AND DOLLIES (U.S. CLS. 19, 21, 23, 31, 35 AND 44).

CLASS 16—PAPER GOODS AND PRINTED MATTER

FOR PRINTED MATERIALS AND PUBLICATIONS, NAMELY, BOOKS ON A VARIETY OF SUBJECTS, NAMELY, GOLF, AND GAME RULE BOOKS; PERSONAL ORGANIZERS; CALENDARS; GIFT WRAPPING PAPER; GIFT BOXES; GIFT BAGS; APPOINTMENT BOOKS; MAIL ORDER CATALOGS FEATURING ALL OF THE FOREGOING AS WELL AS CLOTHING AND ACCESSORIES (U.S. CLS. 2, 5, 22, 23, 29, 37, 38 AND 50).
FIRST USE 3-31-2003; IN COMMERCE 3-31-2003.

CLASS 20—FURNITURE AND ARTICLES NOT OTHERWISE CLASSIFIED

FOR WORKBENCHES AND TOOLBOXES NOT MADE OF METAL; SHELVING (U.S. CLS. 2, 13, 22, 25, 32 AND 50).

CLASS 18—LEATHER GOODS

FOR HANDBAGS, TOTE BAGS, BACKPACKS, LUGGAGE, WALLETS, PURSES, BRIEF CASES, DUFFLE BAGS, ALL-PURPOSE SPORT BAGS, BUSINESS CARD CASES, CREDIT CARD CASES, BRIEFCASE-TYPE PORTFOLIOS, BILLFOLDS, ATTACHE CASES, KEY CASES, PASSPORT CASES, SUIT BAGS, WAIST AND FANNY PACKS; TRUNKS, TRAVEL BAGS, HAT BOXES FOR TRAVEL, LUGGAGE TAGS, OVERNIGHT BAGS AND CASES; COSMETIC, TOILETRY AND VANITY CASES SOLD EMPTY; UMBRELLAS, CANES AND WALKING STICKS (U.S. CLS. 1, 2, 3, 22 AND 41).
FIRST USE 3-31-2003; IN COMMERCE 3-31-2003.

CLASS 22—CORDAGE AND FIBERS

FOR ROPES; NONMETAL BANDS FOR WRAPPING OR BINDING (U.S. CLS. 1, 2, 7, 19, 22, 42 AND 50).

CLASS 25—CLOTHING

FOR MEN'S, WOMEN'S, BOYS'S AND GIRL'S SHIRTS, TOPS, SWEATERS, JACKETS, PANTS, SUITS, BOTTOMS, SOCKS, HATS AND CAPS; SHOES; SHORTS, COATS, NECKTIES, UNDERWEAR, VESTS, ROBES, HOSIERY, SKIRTS, DRESSES, LOUNGEWEAR, SCARVES, RAINWEAR, TROUSERS, ASCOTS, TIES, OUTER SHIRTS INCLUDING EVENING, DRESS, POLO AND SPORTS SHIRTS, COLLARS, PAJAMAS, ROBES, SMOKING JACKETS, DRESSING GOWNS, MUFFLERS, GLOVES, HOSE, BELTS, SUSPENDERS, GARTERS, BOOTS, SLIPPERS, SHOES, OVERSHOES, BEACH WEAR, SWIMWEAR, AND FORMAL WEAR, NAMELY, JACKETS, PANTS, SUITS, SHIRTS, SHOES, CUMMERBUNDS, TIES, SUSPENDERS AND GOWNS (U.S. CLS. 22 AND 39).
FIRST USE 3-31-2003; IN COMMERCE 3-31-2003.

CLASS 25—CLOTHING

FOR GLOVES FOR INDUSTRIAL USE (U.S. CLS. 22 AND 39).
PRISCILLA MILTON, EXAMINING ATTORNEY

CLASS 28—TOYS AND SPORTING GOODS

FOR GOLF ACCESSORIES AND GOLF EQUIPMENT, NAMELY, DIVOT TOOLS, BALL MARKERS, GOLF BALLS, GOLF CLUBS, GOLF BAGS, GOLF BALL WASHERS, NON-MOTORIZED GOLF CARTS, GOLF TEES, AND GOLF CLUB COVERS (U.S. CLS. 22, 23, 38 AND 50).

FIRST USE 3-31-2003; IN COMMERCE 3-31-2003.
JIM RINGLE, EXAMINING ATTORNEY

SN 78-666,736. RETAIL BRAND ALLIANCE, INC., ENFIELD, CT. FILED 7-8-2005.

BROOKS BROTHERS

THE MARK CONSISTS OF STANDARD CHARACTERS WITHOUT CLAIM TO ANY PARTICULAR FONT, STYLE, SIZE, OR COLOR.

OWNER OF U.S. REG. NOS. 1,835,478, 1,839,876 AND OTHERS.

CLASS 3—COSMETICS AND CLEANING PREPARATIONS

FOR COSMETICS AND TOILETRIES, NAMELY, EMERY BOARDS, COLOGNE, COLOGNE SPRAY, AFTER-SHAVE LOTION, AFTER-SHAVING BALMS, SHAVING CREAM, SOAP, DEODORANT FOR PERSONAL USE, SHAMPOO, STYLING GELS, BODY LOTION, BODY GEL, FRAGRANCES FOR PERSONAL USE, BODY CREAMS, SHOWER GELS, SKIN CLEANSING CREAM, AND SKIN AND BODY LOTIONS FOR PERSONAL USE (U.S. CLS. 1, 4, 6, 50, 51 AND 52).

FIRST USE 9-13-1964; IN COMMERCE 9-13-1964.

CLASS 8—HAND TOOLS

FOR NAIL IMPLEMENTS, NAMELY, FINGERNAIL AND TOENAIL CLIPPERS, TWEEZERS, CUTICLE NIPPERS AND SCISSORS, AND NAIL BUFFERS; FLATWARE, NAMELY, FORKS, TABLE AND KITCHEN KNIVES AND SPOONS; POCKET KNIVES (U.S. CLS. 23, 28 AND 44).

FIRST USE 12-31-1948; IN COMMERCE 12-31-1948.

CLASS 9—ELECTRICAL AND SCIENTIFIC APPARATUS

FOR EYEGLASSES, COMPRISING SPECTACLES, SPECTACLE FRAMES, SUNGLASSES, EYEGLASS CHAINS, EYEGLASS RETAINING BANDS, EYEGLASS CASES AND LENS; BINOCULARS, TAPE MEASURES AND Pedometers, CALCULATORS, ELECTRONIC CALENDARS, ELECTRICALLY OPERATED SHOE SHINE UNITS; BAROMETERS; ELECTRIC OR BATTERY OPERATED TRAVEL IRONS, VOLTAGE CONVERSION DEVICES (U.S. CLS. 21, 23, 26, 36 AND 38).

FIRST USE 3-31-1993; IN COMMERCE 3-31-1993.

CLASS 14—JEWELRY

FOR WATCHES, WATCHBANDS, CLOCKS, KEY CHAINS MADE OF PRECIOUS METAL, AND JEWELRY (U.S. CLS. 2, 27, 28 AND 50).

FIRST USE 12-31-1948; IN COMMERCE 12-31-1948.

CLASS 16—PAPER GOODS AND PRINTED MATTER

FOR TIE CASES MADE OF CARDBOARD AND COVERED WITH PAPER OR FABRIC AND SOLD EMPTY, SHOE BAGS FOR TRAVEL, GARMENT BAGS FOR TRAVEL, DIARIES; THESAURI; DICTIONARIES; BOOKS ON A VARIETY OF SUBJECTS, NAMELY, HISTORY, WINE, DINING, ETIQUETTE, FASHION, PUBLIC SPEAKING, AND GAME RULE BOOKS; PERSONAL ORGANIZERS; CALENDARS; STATIONERY; GIFT WRAPPING PAPER; GIFT BOXES; GIFT BAGS; APPOINTMENT BOOKS; GREETING CARDS; MAIL ORDER CATALOGS FEATURING ALL OF THE FOREGOING AS WELL AS CLOTHING AND ACCESSORIES, AND COSMETICS (U.S. CLS. 2, 5, 22, 23, 29, 37, 38 AND 50).

FIRST USE 1-3-1903; IN COMMERCE 1-3-1903.

CLASS 18—LEATHER GOODS

FOR HANDBAGS, TOTE BAGS, BACKPACKS, LUGGAGE, WALLETS, PURSES, KEY CASES, BRIEFCASES, DUFFEL BAGS, ALL-PURPOSE SPORT BAGS, BUSINESS CARD CASES, CREDIT CARD CASES; BRIEF-CASE-TYPE PORTFOLIOS, BILLFOLDS, TIE CASE, ATTACHÉ CASES, PASSPORT CASES AND UMBRELLAS (U.S. CLS. 1, 2, 3, 22 AND 41).

FIRST USE 1-13-1903; IN COMMERCE 1-13-1903.

CLASS 20—FURNITURE AND ARTICLES NOT OTHERWISE CLASSIFIED

FOR PICTURE FRAMES, FURNITURE AND PILLOWS (U.S. CLS. 2, 13, 22, 25, 32 AND 50).

FIRST USE 12-31-1981; IN COMMERCE 12-31-1981.

CLASS 21—HOUSEWARES AND GLASS

FOR HAIR COMBS AND BRUSHES, SERVING SPOONS AND FORKS NOT MADE OF METAL; WOODENWARE, PORCELAIN AND CHINA, NAMELY, DISHES, BOWLS, PLATES, SERVING PLATTERS, SALAD BOWLS, SALAD SERVERS, CAKE SERVERS, CUPS, SAUCERS, SALT AND PEPPER SHAKERS, NON-ELECTRIC COFFEE POTS, TEA POTS NOT MADE OF METAL, CONTAINERS FOR SERVING CREAM NOT MADE OF METAL, NAPKIN HOLDERS, NAPKIN RINGS NOT OF PRECIOUS METAL, CANDLESTICK HOLDERS NOT MADE OF METAL, VASES AND PITCHERS; CRYSTAL AND GLASS BEVERAGE GLASSWARE, NAMELY, COCKTAIL SHAKERS, MUGS, GOBLET, WINEGLASSES, COASTERS, DECANTERS, PITCHERS, BOWLS, VASES, CARAFES, FLASKS, ICE BUCKETS, ICE TONGS NOT MADE OF METAL; CERAMIC AND LAMINATED ACCESSORIES, NAMELY, SOAP DISHES AND TOOTHBRUSH HOLDERS; CORKSCREWS (U.S. CLS. 2, 13, 23, 29, 30, 33, 40 AND 50).

FIRST USE 0-0-1914; IN COMMERCE 0-0-1914.

CLASS 24—FABRICS

FOR BED SHEETS, COMFORTERS, BED BLANKETS, DUST RUFFLES, DUVET COVERS, PILLOW CASES, PILLOW SHAMS, BED SHAMS, BED SPREADS, SHOWER CURTAINS, TOWELS, WASH CLOTHS, FABRIC NAPKINS, FABRIC PLACEMATS, FABRIC TABLECLOTHS AND CURTAINS (U.S. CLS. 42 AND 50).

FIRST USE 1-3-1903; IN COMMERCE 1-3-1903.

CLASS 25—CLOTHING

FOR MEN'S, WOMEN'S, BOY'S AND GIRL'S SHIRTS, TOPS, SWEATERS, JACKETS, PANTS, SUITS, BOTTOMS, SOCKS, HATS AND CAPS; SHOES; SHORTS, COATS, NECKTIES, UNDERWEAR, VESTS, ROBES, HOSIERY, SKIRTS, DRESSES, LOUNGEWEAR, SCARVES, RAINWEAR, TROUSERS, ASCOTS, TIES, OUTER SHIRTS INCLUDING EVENING, DRESS, POLO AND SPORTS SHIRTS, COLLARS, PAJAMAS, ROBES, SMOKING JACKETS, DRESSING GOWNS, MUFFLERS, GLOVES, HOSE, BELTS, SUSPENDERS, GARTERS, BOOTS, SLIPPERS, SHOES, OVERSHOES, BEACH WEAR, SWIMWEAR, AND FORMAL WEAR, NAMELY, JACKETS, PANTS, SUITS, SHIRTS, SHOES, CUMMERBUNDS, TIES, SUSPENDERS AND GOWNS (U.S. CLS. 22 AND 39).

FIRST USE 0-0-1856; IN COMMERCE 0-0-1856.

CLASS 27—FLOOR COVERINGS

FOR WALLPAPER (U.S. CLS. 19, 20, 37, 42 AND 50).
FIRST USE 3-31-2005; IN COMMERCE 3-31-2005.

CLASS 28—TOYS AND SPORTING GOODS

FOR GOLF ACCESSORIES AND GOLF EQUIPMENT, NAMELY, DIVOT TOOLS, BALL MARKERS, GOLF BALLS, GOLF CLUBS, GOLF BAGS, GOLF BALL WASHERS, NON-MOTORIZED GOLF CARTS, GOLF TEES, AND GOLF CLUB COVERS (U.S. CLS. 22, 23, 38 AND 50).

FIRST USE 3-31-1903; IN COMMERCE 3-31-1903.

CLASS 35—ADVERTISING AND BUSINESS

FOR RETAIL STORE SERVICES, ONLINE RETAIL STORE SERVICES AND MAIL ORDER CATALOG SERVICES FEATURING CLOTHING FOR MEN, WOMEN AND CHILDREN, SPORTING GOODS, EYEWEAR, FRAGRANCE, BODY LOTIONS, HOUSEWARES, PERSONAL ACCESSORIES AND LUGGAGE (U.S. CLS. 100, 101 AND 102).

FIRST USE 0-0-1818; IN COMMERCE 0-0-1818.
JIM RINGLE, EXAMINING ATTORNEY

SN 78-975,787. MARK ANTHONY INTERNATIONAL SRL, ST. JAMES, BARBADOS, FILED 12-11-2003.

**GREAT TASTE. LIME
AFTER LIME**

THE MARK CONSISTS OF STANDARD CHARACTERS WITHOUT CLAIM TO ANY PARTICULAR FONT, STYLE, SIZE, OR COLOR.

CLASS 32—LIGHT BEVERAGES

FOR FLAVORED BREWED MALT-BASED ALCOHOLIC BEVERAGES IN THE NATURE OF BEER (U.S. CLS. 45, 46 AND 48).

FIRST USE 12-24-2003; IN COMMERCE 12-24-2003.

CLASS 33—WINES AND SPIRITS

FOR ALCOHOLIC FLAVORED MALT COOLERS (U.S. CLS. 47 AND 49).

FIRST USE 12-24-2003; IN COMMERCE 12-24-2003.
ANN E. SAPPENFIELD, EXAMINING ATTORNEY

SN 78-975,882. NEUFELD, KLAUS DDR., HEILIGENKREUZ, AUSTRIA, FILED 5-23-2003.

FLEASCAN

PRIORITY CLAIMED UNDER SEC. 44(D) ON AUSTRIA APPLICATION NO. AM83342002, FILED 12-27-2002, REG. NO. 208752, DATED 3-4-2003, EXPIRES 3-30-2013.

CLASS 5—PHARMACEUTICALS

FOR MEDICATED GROOMING PREPARATIONS FOR PET ANIMALS, NAMELY, CREAMS, LOTIONS AND POWDER FOR THE CARE OF SKIN AND FUR; PREPARATIONS FOR DESTROYING OR DETERRING INSECTS, VERMIN AND PARASITES; DIAGNOSTIC MEANS FOR USE IN VETERINARY MEDICINE AND HUMAN MEDICINE, NAMELY, DIAGNOSTIC PREPARATIONS FOR CLINICAL OR MEDICAL LABORATORY USE (U.S. CLS. 6, 18, 44, 46, 51 AND 52).

CLASS 21—HOUSEWARES AND GLASS

FOR BRUSHES AND COMBS FOR PETS (U.S. CLS. 2, 13, 23, 29, 30, 33, 40 AND 50).

BRENDAN MCCAULEY, EXAMINING ATTORNEY

SN 78-976,064. PROMETHEAN LIMITED, LANCASHIRE, UNITED KINGDOM, FILED 9-30-2003.

PROMETHEAN

PRIORITY CLAIMED UNDER SEC. 44(D) ON UNITED KINGDOM APPLICATION NO. 2340264, FILED 8-11-2003, REG. NO. 2340264, DATED 8-11-2003, EXPIRES 8-11-2010.

CLASS 37—CONSTRUCTION AND REPAIR

FOR INSTALLATION, MAINTENANCE AND REPAIR OF COMPUTER AND ELECTRONIC TEACHING EQUIPMENT (U.S. CLS. 100, 103 AND 106).

CLASS 42—SCIENTIFIC, COMPUTER AND LEGAL SERVICES

FOR COMPUTER ADVISORY AND CONSULTANCY SERVICES; COMPUTER SOFTWARE SERVICES, NAMELY, INSTALLATION AND MAINTENANCE OF COMPUTER SOFTWARE, INDUSTRIAL AND INTERIOR DESIGN SERVICES; COMPUTER SOFTWARE DESIGN (U.S. CLS. 100 AND 101).

JENNIFER CHICOSKI, EXAMINING ATTORNEY

SN 78-976,175. KIRKBI AG, CH-6340 BAAR, SWITZERLAND, FILED 4-27-2004.



NO CLAIM IS MADE TO THE EXCLUSIVE RIGHT TO USE KNIGHTS, APART FROM THE MARK AS SHOWN.

CLASS 9—ELECTRICAL AND SCIENTIFIC APPARATUS

FOR VIDEO GAME SOFTWARE (U.S. CLS. 21, 23, 26, 36 AND 38).
FIRST USE 10-0-2004; IN COMMERCE 10-0-2004.

SN 79-000,255. GAMING SUPPORT B.V., NETHERLANDS,
FILED 11-7-2003.

CLASS 28—TOYS AND SPORTING GOODS

FOR CONSTRUCTION TOYS, TOY BUILDING ELEMENTS AND CONNECTING LINKS; TOY CONSTRUCTION SETS; TOY KITS CONTAINING TOY FIGURES AND TOY CONSTRUCTION ELEMENTS FOR BUILDING HUMAN FIGURE, ANIMAL FIGURE AND ACTION FIGURE ROBOTS, BOARD GAMES (U.S. CLS. 22, 23, 38 AND 50).

FIRST USE 1-0-2004; IN COMMERCE 7-0-2004.
WILLIAM BRECKENFELD, EXAMINING ATTORNEY

GAMING
support

SN 78-976,316. BATES, BRANDON, LA CONNER, WA.
FILED 5-24-2004.

PRIORITY DATE OF 5-13-2003 IS CLAIMED.
OWNER OF INTERNATIONAL REGISTRATION 0815853
DATED 11-7-2003, EXPIRES 11-7-2013.

NO CLAIM IS MADE TO THE EXCLUSIVE RIGHT TO USE GAMING SUPPORT, APART FROM THE MARK AS SHOWN.

CLASS 9—ELECTRICAL AND SCIENTIFIC APPARATUS

FOR COMPUTER SOFTWARE AND HARDWARE, IN PARTICULAR FOR USE IN THE OPERATION OF AMUSEMENT GAMES, LOTTERIES, GAMBLING AND SLOT MACHINES; VIDEO GAME MACHINES FOR USE WITH TELEVISIONS (U.S. CLS. 21, 23, 26, 36 AND 38).

CLASS 28—TOYS AND SPORTING GOODS

FOR PLAYING CARDS, DICE; MACHINES FOR PLAYING GAMES OF CHANCE; DISPOSABLE TICKET SETS FOR PLAYING GAMES OF CHANCE; AUTOMATIC AND COIN-OPERATED SLOT MACHINES (U.S. CLS. 22, 23, 38 AND 50).

CLASS 37—CONSTRUCTION AND REPAIR

FOR INSTALLATION, MAINTENANCE AND REPAIR OF COMPUTER SOFTWARE AND HARDWARE FOR USE IN THE OPERATION OF AMUSEMENT GAMES, LOTTERIES, GAMBLING AND SLOT MACHINES, VIDEO GAMES, TELEVISION GAMES (U.S. CLS. 100, 103 AND 106).

CLASS 41—EDUCATION AND ENTERTAINMENT

FOR ENTERTAINMENT AND AMUSEMENT SERVICES, NAMELY, AMUSEMENT PARKS; AMUSEMENT ARCADES; CASINO FACILITIES; CONSULTATION SERVICES IN THE FIELD OF ENTERTAINMENT; TECHNICAL CONSULTATION IN THE FIELD OF VIDEO GAME MACHINES FOR USE WITH TELEVISIONS, GAMES OF CHANCE, AMUSEMENT GAMES AND SLOT MACHINES (U.S. CLS. 100, 101 AND 107).

CLASS 42—SCIENTIFIC, COMPUTER AND LEGAL SERVICES

FOR TECHNICAL CONSULTATION IN THE FIELD OF COMPUTER SOFTWARE AND HARDWARE FOR USE IN THE OPERATION OF AMUSEMENT GAMES, LOTTERIES, GAMBLING AND SLOT MACHINES (U.S. CLS. 100 AND 101).

ANGELA M. MICHELI, EXAMINING ATTORNEY



THE MARK CONSISTS OF THE WORDS BEER DRINKING OUTFITTERS IMPRINTED ON THE TOP OF A REPRESENTATION OF A BOTTLE CAP AND IN THE CENTER SECTION THERE IS AN ARTISTIC ACRONYM-LIKE SYMBOL OF THE WORDING OF THE MARK.

CLASS 16—PAPER GOODS AND PRINTED MATTER

FOR STICKERS, DECALS, POSTERS AND BUMPER STICKERS (U.S. CLS. 2, 5, 22, 23, 29, 37, 38 AND 50).
FIRST USE 2-10-2004; IN COMMERCE 3-27-2004.

CLASS 21—HOUSEWARES AND GLASS

FOR FOAM DRINK HOLDERS AND BOTTLE OPENERS (U.S. CLS. 2, 13, 23, 29, 30, 33, 40 AND 50).
FIRST USE 2-10-2004; IN COMMERCE 3-27-2004.
MARGERY A. TIERNEY, EXAMINING ATTORNEY

SN 79-000,256. GAMING SUPPORT B.V., NETHERLANDS,
FILED 11-7-2003.

JACKPOT NAVIGATOR

THE MARK CONSISTS OF STANDARD CHARACTERS WITHOUT CLAIM TO ANY PARTICULAR FONT, STYLE, SIZE, OR COLOR.

PRIORITY DATE OF 5-12-2003 IS CLAIMED.

OWNER OF INTERNATIONAL REGISTRATION 0815854 DATED 11-7-2003, EXPIRES 11-7-2013.

NO CLAIM IS MADE TO THE EXCLUSIVE RIGHT TO USE "JACKPOT", APART FROM THE MARK AS SHOWN.

CLASS 9—ELECTRICAL AND SCIENTIFIC APPARATUS

FOR COMPUTER SOFTWARE AND HARDWARE, IN PARTICULAR FOR USE IN THE OPERATION OF AMUSEMENT GAMES, LOTTERIES, GAMBLING AND SLOT MACHINES; VIDEO GAME MACHINES FOR USE WITH TELEVISIONS (U.S. CLS. 21, 23, 26, 36 AND 38).

CLASS 28—TOYS AND SPORTING GOODS

FOR PLAYING CARDS, DICE; MACHINES FOR PLAYING GAMES OF CHANCE; DISPOSABLE TICKET SETS FOR PLAYING GAMES OF CHANCE; AUTOMATIC AND COIN-OPERATED SLOT MACHINES (U.S. CLS. 22, 23, 38 AND 50).

CLASS 37—CONSTRUCTION AND REPAIR

FOR INSTALLATION, MAINTENANCE AND REPAIR OF COMPUTER SOFTWARE AND HARDWARE FOR USE IN THE OPERATION OF AMUSEMENT GAMES, LOTTERIES, GAMBLING AND SLOT MACHINES, VIDEO GAMES, TELEVISION GAMES (U.S. CLS. 100, 103 AND 106).

CLASS 41—EDUCATION AND ENTERTAINMENT

FOR ENTERTAINMENT AND AMUSEMENT SERVICES, NAMELY, AMUSEMENT PARKS; AMUSEMENT ARCADES; CASINO FACILITIES; CONSULTATION SERVICES IN THE FIELD OF ENTERTAINMENT; TECHNICAL CONSULTATION IN THE FIELD OF VIDEO GAME MACHINES FOR USE WITH TELEVISIONS, GAMES OF CHANCE, AMUSEMENT GAMES AND SLOT MACHINES IN (U.S. CLS. 100, 101 AND 107).

CLASS 42—SCIENTIFIC, COMPUTER AND LEGAL SERVICES

FOR TECHNICAL CONSULTATION IN THE FIELD OF COMPUTER SOFTWARE AND HARDWARE FOR USE IN THE OPERATION OF AMUSEMENT GAMES, LOTTERIES, GAMBLING AND SLOT MACHINES (U.S. CLS. 100 AND 101).

ANGELA M. MICHELI, EXAMINING ATTORNEY

SN 79-000,270. HAGER & WERKEN GMBH & CO. KG, FED
REP GERMANY, FILED 11-4-2003.

CARAT

OWNER OF INTERNATIONAL REGISTRATION 0589554 DATED 7-14-1992, EXPIRES 7-14-2012.

CLASS 5—PHARMACEUTICALS

FOR DENTAL MATERIALS, NAMELY, DENTAL CERAMICS (U.S. CLS. 6, 18, 44, 46, 51 AND 52).

CLASS 10—MEDICAL APPARATUS

FOR DENTAL INSTRUMENTS, NAMELY, FOR THE DOSING AND MIXING OF CERAMIC POWDERS AND A GLASS PLATE FOR MIXING CERAMIC POWDERS (U.S. CLS. 26, 39 AND 44).

SHAUNIA WALLACE, EXAMINING ATTORNEY

SN 79-000,577. AHOLD COFFEE COMPANY B.V., NETHERLANDS, FILED 12-2-2003.

BON BEANIES

THE MARK CONSISTS OF STANDARD CHARACTERS WITHOUT CLAIM TO ANY PARTICULAR FONT, STYLE, SIZE, OR COLOR.

PRIORITY DATE OF 6-26-2003 IS CLAIMED.

OWNER OF INTERNATIONAL REGISTRATION 0817307 DATED 12-2-2003, EXPIRES 12-2-2013.

CLASS 29—MEATS AND PROCESSED FOODS

FOR MILK AND MILK PRODUCTS, NAMELY, MILK POWDER AND CONDENSED MILK; BEVERAGES AND FOODSTUFFS, NAMELY, MILK BEVERAGES WITH HIGH MILK CONTENT, MILK BEVERAGES CONTAINING FRUITS, AND MILK-BASED BEVERAGE CONTAINING COFFEE (U.S. CL. 46).

CLASS 30—STAPLE FOODS

FOR COFFEE; TEA; COCOA; ARTIFICIAL COFFEE; BEVERAGES AND FOODSTUFFS, NAMELY, COFFEE-BASED BEVERAGE CONTAINING MILK AND COCOA BEVERAGES WITH MILK; CONFECTIONARY CHIPS FOR BAKING (U.S. CL. 46).

STANLEY I. OSBORNE, EXAMINING ATTORNEY

SN 79-000,696. ÅMIC AB, SWEDEN, FILED 11-3-2003.

THE MARK CONSISTS OF STANDARD CHARACTERS WITHOUT CLAIM TO ANY PARTICULAR FONT, STYLE, SIZE, OR COLOR.

OWNER OF INTERNATIONAL REGISTRATION 0817713 DATED 11-3-2003, EXPIRES 11-3-2013.

CLASS 7—MACHINERY

FOR MACHINE TOOLS FOR TURNING, CUTTING, GRINDING, LAPPING, POLISHING AND SPARKLING; MACHINE TOOLS FOR ELECTRO PLATING ON METALS AND ON POLYMERS; MACHINE TOOLS FOR INJECTION MOULDING, CASTING AND/OR EMBOSSEING; LITHOGRAPHIC AND ETCHING MACHINES; MACHINES FOR TURNING, CUTTING, GRINDING, LAPPING, POLISHING AND SPARKLING; MACHINES FOR ELECTRO PLATING ON METALS AND ON POLYMERS; MACHINES FOR INJECTION MOULDING, CASTING AND/OR EMBOSSEING; CENTRIFUGAL, WASHING, RINSING, DRYING, COATING, PLATING AND EMBOSSEING MACHINES FOR USE IN THE PRODUCTION OF MICRO MECHANICAL DETAILS; MACHINES FOR PATTERNING OF POLYMER COATING AND SCREEN PRINTING; MACHINES FOR LAMINATING; MACHINES FOR CLEANING OF PLATES AND COMPONENTS; MACHINES FOR ALIGNMENT AND GLUEING; MACHINES FOR SURFACE MODIFICATION WITH CORONA, PLASMA OR UV TREATMENT; PARTS AND COMPONENTS FOR ALL THE AFOREMENTIONED GOODS (U.S. CLS. 13, 19, 21, 23, 31, 34 AND 35).

CLASS 9—ELECTRICAL AND SCIENTIFIC APPARATUS

FOR THERMAL PLASTIC SUBSTRATES FEATURING MICRO DETAILS, NAMELY FLUIDICAL COMPONENTS SUCH AS MIXERS, SAMPLE CLEANING AND FILTRATION, CHROMATOGRAPHIC DEVICES, LIQUID TIMING COMPONENTS, LIQUID RESTRICTION, LIQUID VALVES, SURFACE MODIFICATION WITH POLYMERS AND/OR SELF ASSEMBLED LAYERS OF MOLECULES AND/OR METAL LAYERS AND/OR BIOCOMPATIBLE SURFACES SUCH AS HEPARIN TREATMENT, ELECTRONIC AND MICRO MECHANICAL CIRCUITS, CONNECTIONS, CONNECTION UNITS, COUPLER PLUGS, DISTRIBUTORS, SPLITTERS, ATTACHMENTS, ADAPTERS AND SOCKETS, REFRACTIVE AND DIFFRACTIVE OPTICAL FUNCTIONS; SENSORS FOR MICRO DETAILS, NAMELY DETECTORS FOR DETECTING THE PRESENCE OF PHYSICAL, CHEMICAL OR BIOLOGICAL ENTITIES, SUCH AS PARTICLES, CELLS, CELL FRAGMENTS, MOLECULES, MACROMOLECULES, BIOMOLECULES SUCH AS PROTEINS AND/OR PEPTIDES AND/OR DNA, TEMPERATURE, MAGNETIC PARTICLES, RADIATION AND MOVEMENT, AND THE COMPONENTS OR SUB-UNITS OF DETECTORS; THERMAL PLASTIC SUBSTRATES FEATURING MICRO DETAILS AND SENSORS FOR MICRO DETAILS INCLUDED IN TELECOMMUNICATION NETWORKS FOR USE WITHIN THE FIELDS OF MICRO MECHANICS, FINE MECHANICS, INCLUDING BIOLOGICAL, MEDICAL AND VETERINARY ANALYSIS, DIAGNOSIS AND STORAGE, AND/OR PRODUCTION OF TOOLS; THERMAL PLASTIC SUBSTRATES FEATURING MICRO DETAILS AND SENSORS FOR MICRO DETAILS FOR ENVIRONMENTAL MEASURING FOR USE WITHIN THE FIELDS OF MICRO MECHANICS, FINE MECHANICS, INCLUDING BIOLOGICAL, MEDICAL AND VETERINARY ANALYSIS, DIAGNOSIS AND STORAGE, AND/OR PRODUCTION OF TOOLS; THERMAL PLASTIC SUBSTRATES FEATURING MICRO DETAILS AND SENSORS FOR MICRO DETAILS FOR MEASURING BIOTECHNOLOGICAL UNITS FOR USE WITHIN THE FIELDS OF MICRO MECHANICS, FINE MECHANICS, INCLUDING BIOLOGICAL, MEDICAL AND VETERINARY ANALYSIS, DIAGNOSIS AND STORAGE, AND/OR PRODUCTION OF TOOLS; THERMAL PLASTIC SUBSTRATES FEATURING MICRO DETAILS AND SENSORS FOR MICRO DETAILS FOR SCIENTIFIC RESEARCH IN LABORATORIES FOR USE WITHIN THE FIELDS OF MICRO MECHANICS, FINE MECHANICS, INCLUDING BIOLOGICAL, MEDICAL AND VETERINARY ANALYSIS, DIAGNOSIS AND STORAGE, AND/OR PRODUCTION OF TOOLS (U.S. CLS. 21, 23, 26, 36 AND 38).

CLASS 14—JEWELRY

FOR MICRO MECHANICAL DETAILS COATED WITH PRECIOUS METALS, NAMELY METAL COATED TEST STRIPS, ARRAYS AND CHROMATOGRAPHIC SUBSTRATES (U.S. CLS. 2, 27, 28 AND 50).

CLASS 17—RUBBER GOODS

FOR MOULDABLE PLASTICS, NAMELY THERMOPLASTICS AND POLYMER PLASTICS FOR USE IN THE PRODUCTION OF MICRO MECHANICAL DETAILS (U.S. CLS. 1, 5, 12, 13, 35 AND 50).

CLASS 37—CONSTRUCTION AND REPAIR

FOR CONSULTATION SERVICES REGARDING POLISHING, SPARKLING WITHIN THE FIELDS OF MICRO MECHANICS, FINE MECHANICS AND/OR PRODUCTION OF TOOLS; CONSULTATION SERVICES WITHIN THE FIELD OF POLISHING (U.S. CLS. 100, 103 AND 106).

CLASS 38—COMMUNICATION

FOR CONSULTATION SERVICES WITHIN THE FIELD OF TELECOMMUNICATIONS (U.S. CLS. 100, 101 AND 104).

CLASS 40—MATERIAL TREATMENT

FOR CONSULTATION SERVICES REGARDING ETCHING, TURNING, CUFFING, GRINDING, LAPPING, ELECTRO-PLATING, INJECTION MOULDING, CASTING AND EMBOSSEING WITHIN THE FIELDS OF MICRO MECHANICS, FINE MECHANICS AND/OR PRODUCTION OF TOOLS; CONSULTATION SERVICES WITHIN THE FIELD OF LITHOGRAPHY, ETCHING; CONSULTATION SERVICES WITHIN THE FIELD OF FINE MECHANICS, NAMELY TURNING, CUTTING, GRINDING, LAPPING; CONSULTATION SERVICES WITHIN THE FIELD OF PRODUCTION OF TOOLS, NAMELY ELECTRO-PLATING ON METALS AND ON POLYMERS, INJECTION MOULDING, CASTING AND EMBOSSEING (U.S. CLS. 100, 103 AND 106).

CLASS 42—SCIENTIFIC, COMPUTER AND LEGAL SERVICES

FOR CONSULTATION SERVICES WITHIN THE FIELD OF MICRO MECHANICS, NAMELY SEMICONDUCTOR PROCESSES, SILICON TECHNOLOGY, DEPOSITION; CONSULTATION SERVICES WITHIN THE FIELD OF BIOTECHNOLOGY, SENSORS, ENVIRONMENTAL MEASURING, OPTICS AND MECHANICS (U.S. CLS. 100 AND 101).

CHARLES JOYNER, EXAMINING ATTORNEY

SN 79-000,702. KGR, FRANCE, FILED 12-4-2003.



PRIORITY DATE OF 6-5-2003 IS CLAIMED.
OWNER OF INTERNATIONAL REGISTRATION 0817782
DATED 12-4-2003, EXPIRES 12-4-2013.
THE COLOR(S) BLACK, WHITE AND RED IS/ARE
CLAIMED AS A FEATURE OF THE MARK.
THE COLOR(S) THE TRADEMARK CONSISTS OF THE
STYLIZED INITIALS APO DEPICTED IN BLACK ON A
WHITE BACKGROUND; A RED DOT IS SITUATED AT THE
RIGHT-HAND EXTREMITY OF THE STYLIZED "O" IS/
ARE CLAIMED AS A FEATURE OF THE MARK.

CLASS 16—PAPER GOODS AND PRINTED MATTER

FOR NEWSPAPERS FOR GENERAL CIRCULATION; PRINTED MATTER, NAMELY, PAMPHLETS, BOOKLETS AND PERIODICALS, ALL IN THE FIELD OF SNOWBOARDING, ALMANACS, CALENDARS; MAGAZINES, JOURNALS, BOOKS AND GUIDEBOOKS, ALL IN THE FIELD OF SNOWBOARDING; PAMPHLETS FEATURING BUSINESS PROSPECTUSES IN THE FIELD OF SNOWBOARDING; ADVERTISING SIGNS OF PAPER OR CARDBOARD; DECALS; SELF-ADHESIVE PAPER LABELS; PRINTED PAPER OR CARDBOARD SIGNS; PRINTING TYPE; PRINTING BLOCKS (U.S. CLS. 2, 5, 22, 23, 29, 37, 38 AND 50).

CLASS 25—CLOTHING

FOR CLOTHING AND SPORTSWEAR, NAMELY COMBINATIONS, TROUSERS, SWEATERS; FOOTWEAR; HEADGEAR, NAMELY HATS, CAPS, CAP PEAKS; SNOWBOARD BOOTS; SPORTS FOOTWEAR (U.S. CLS. 22 AND 39).

CLASS 28—TOYS AND SPORTING GOODS

FOR GYMNASIAC AND SPORTING ARTICLES, NAMELY SKIS, SURF BOARDS, SKIS AND BOARDS FOR SURFING, STRAPS FOR SURFBOARDS; COVERS DESIGNED FOR SKIS AND SURF BOARDS, SKI POLES, SKI BINDINGS (U.S. CLS. 22, 23, 38 AND 50).

KATHLEEN M. VANSTON, EXAMINING ATTORNEY

SN 79-000,708. DEUTSCHE TELEKOM AG, D-53113 BONN, FED REP GERMANY, FILED 11-7-2003.

on-sports

THE MARK CONSISTS OF STANDARD CHARACTERS WITHOUT CLAIM TO ANY PARTICULAR FONT, STYLE, SIZE, OR COLOR.

PRIORITY DATE OF 5-8-2003 IS CLAIMED.
OWNER OF INTERNATIONAL REGISTRATION 0817800
DATED 11-7-2003, EXPIRES 11-7-2013.

CLASS 9—ELECTRICAL AND SCIENTIFIC APPARATUS

FOR ELECTRIC, ELECTRONIC, OPTICAL, MEASURING, SIGNALING, CONTROLLING AND TEACHING APPARATUS AND INSTRUMENTS, ALL FOR USE WITH TELECOMMUNICATIONS, NAMELY, APPARATUS FOR PRODUCING SOUND, IMAGES OR DATA; BLANK MAGNETIC AND OPTICAL DATA CARRIERS; DATA PROCESSORS; COMPUTERS, NAMELY, MICROCOMPUTERS, MINICOMPUTERS, COMPUTER CENTRAL PROCESSORS, COMPUTER MONITORS, COMPUTER KEYBOARDS, COMPUTER TERMINALS, COMPUTER MEMORIES, COMPUTER LASER PRINTERS, COMPUTER IMPACT PRINTERS, COMPUTER DOT MATRIX PRINTERS, COMPUTERS AND INSTRUCTIONAL MANUALS SOLD AS A UNIT; COMPUTER MEMORY HARDWARE; COMPUTER INTERFACE APPARATUS, NAMELY, COMPUTER INTERFACE BOARDS, COMPUTER MOUSE AND MOUSE PAD, COMPUTER PERIPHERALS AND PARTS THEREOF; COMPUTER SOFTWARE PROGRAMS FOR USE IN OPERATING TELECOMMUNICATIONS AND BUSINESS MANAGEMENT SYSTEMS AND RELATED INSTRUCTION MANUALS SOLD AS A UNIT; COMPUTER SOFTWARE FOR FINANCIAL ACCOUNTING, FOR THE PROVISION OF ONLINE INFORMATION SERVICE IN THE FIELD OF BUSINESS AND FINANCE, WEATHER AND TRAVEL, NETWORK MANAGEMENT, COMPUTER PROXY, FOR CONTROLLING ACCESS AND ALARM MONITORING OF HOMES, APARTMENTS, BUILDINGS AND OTHER PROPERTIES, BILLING ANALYSIS, NETWORK ACCESS CONTROL FOR CREATING AND MAINTAINING FIREWALLS; COMPUTER SOFTWARE PROGRAMS FOR ACCESSING A GLOBAL COMPUTER NETWORK AND INTERACTIVE COMPUTER COMMUNICATIONS NETWORKS; OPTICAL FIBERS SOLD AS A COMPONENT OF FIBER OPTICAL CABLES; FIBER OPTIC CABLES; OPTICAL SCANNERS; OPTICAL CHARACTER READERS; OPTICAL BLANK DISCS; OPTICAL GLASS FOR SIGNAL TRANSMISSION; OPTIC TRANSMITTERS FOR RADIO, TELEPHONE; OPTIC RECEIVERS FOR TELEPHONE, AUDIO, VIDEO; OPTICAL SIGNAL PROCESSORS; OPTIC TELECOMMUNICATIONS SWITCHES; OPTICAL ATTENUATORS; OPTICAL AMPLIFIERS; OPTICAL CHARACTER RECOGNITION APPARATUS, FOR USE IN THE TELECOMMUNICATIONS FIELD, AND PARTS THEREOF; TELEPHONE LOCAL AREA NETWORKS; TELECOMMUNICATION AUDIO, VIDEO AND DATA COMMUNICATIONS SYSTEMS, NAMELY, DIGITAL AND ANALOGUE SIGNAL TRANSMITTERS; RECEIVERS AND CONVERTERS FOR USE WITH TELEPHONE, AUDIO, VIDEO; RADIO AND TELEPHONE TRANSMITTERS; COMMUNICATION RECEIVERS AND SERVERS FOR TELEPHONE, AUDIO, VIDEO; TELEPHONE ANSWERING MACHINES; TELEPROMPTERS; TELETYPEWRITERS AND PARTS THEREOF, NAMELY, CALLER IDENTIFICATION BOXES, DIALING ASSEMBLIES, TELEPHONE UNITS, AUDIO OPERATED RELAYS, AUDIO/VIDEO SIGNAL AND OPTICAL FILTERS AND PROTECTORS, TELEMETERS, WIRELESS AND CELLULAR TELEPHONES, AND RADIO PAGERS; INTERCOMS; FACSIMILE MACHINE; ELECTRONIC MAIL APPARATUS FOR ELECTRONIC EXCHANGE OF DATA IMAGES AND MESSAGES; ELECTRICAL WIRE; ELECTRICAL WIRE CONNECTORS; INTEGRATED CIRCUITS; PRINTED CIRCUITS; ELECTRIC CIRCUITS; CIRCUIT BREAKERS; PRINTED CIRCUIT BOARDS; CIRCUIT CONNECTORS; ELECTRICAL CONTROLLERS; ELECTRICAL CONVERTERS; ELECTRICAL CONDUCTORS; ELECTRICAL FUSES; ELECTRIC LUMINESCENT DISPLAY PANELS; ELECTRICAL SWITCH PLATES; ELECTRIC PLUGS; ELECTRIC COILS; ANTENNAS; ELECTRICAL CABLES; COMPUTER CABLES; COMPUTER CHIPS; SILICON CHIPS; CHRONOGRAPHS FOR USE AS SPECIALIZED TIME RECORDING APPARATUS; COMPUTER BUFFERS; BLANK COMPUTER DISCS; BLANK COMPUTER FLOPPY DISKS; COMPUTER HARD DISCS; ACOUSTIC CONDUITS; ELECTRICAL CONDUITS; FIBER OPTIC CONDUITS AND PARTS THEREOF; COMPACT DISC PLAYERS; AUDIO AND VIDEO TAPE RECORDERS; AUDIO AND VIDEOTAPE PLAYERS; AUDIO AND VIDEOCASSETTE RECORDERS; AUDIO AND VIDEOCASSETTE PLAYERS; BLANK AUDIO AND VIDEOTAPES, CASSETTES, DISCS AND MICROFICHE; AUDIO AND VIDEO TAPES, CASSETTES, DISCS AND MICROFICHE FEATURING INFORMATION CONCERNING TELECOMMUNICATIONS, AND CONCERN-

ING PERSONAL AND BUSINESS MANAGEMENT SYSTEMS; AUDIO AND VIDEO RECORDINGS IN THE FIELD OF TELECOMMUNICATIONS, INFORMATION TECHNOLOGY AND SAFETY; TELEVISION AND TELEVISION PERIPHERAL EQUIPMENT, NAMELY, CAMERAS, SET TOP BOXES, REMOTE CONTROL UNITS FOR INTERACTIVE AND NON-INTERACTIVE USE; VIDEO MONITORS; AUTOMATIC VENDING MACHINES AND TIMING MECHANISMS THEREFOR AND PARTS THEREOF; MACHINE READABLE, MAGNETICALLY ENCODED CARDS, NAMELY, PREPAID TELEPHONE CALLING CARDS AND CREDIT CARDS; BLANK SMART CARDS; MAGNETIC CODED CARD READERS; DATA PROCESSORS AND READERS; WORD PROCESSORS; MICROPROCESSORS; ELECTRONIC ENCRYPTION UNITS; DEMAGNETIZERS FOR MAGNETIC TAPES AND PARTS THEREOF; LASERS NOT FOR MEDICAL USE; LIGHT EMITTING DIODES; LIGHT EMITTING DIODE DISPLAYS; COMPUTER, DATA AND VIDEO NETWORKING AND CONFERENCING EQUIPMENT, NAMELY, TELECONFERENCING EQUIPMENT AND AUDIOVISUAL TEACHING EQUIPMENT IN THE NATURE OF OVERHEAD FILM, PHOTOGRAPHIC AND SLIDE PROJECTORS; PROJECTION SCREENS; COMPUTER BASED INFORMATION DISPLAY EQUIPMENT, NAMELY, COMPUTERS WHICH DISPLAY INFORMATION ON AN OVERHEAD SCREEN; PORTABLE DEVICES, NAMELY, LAPTOPS, HANDHELD AND POCKET COMPUTERS, WIRELESS FAX MACHINES; PERSONAL COMMUNICATIONS EQUIPMENT, NAMELY, PERSONAL DIGITAL ASSISTANTS; CALCULATORS AND RELATED PERIPHERALS; SATELLITE PROCESSORS, SATELLITE AND SATELLITE COMMUNICATION EARTH STATIONS BOTH STATIONARY AND MOVEABLE; COMPUTER GAME PROGRAMS FOR CHILDREN AND ADULTS; VIDEO AND COMPUTER GAME CARTRIDGES; PRERECORDED COMPACT DISCS, AUDIOCASSETTE TAPES, VIDEOCASSETTE TAPES, DIGITAL AUDIOTAPES AND DIGITAL VIDEO DISCS FEATURING MUSICAL, VARIETY, NEWS AND COMEDY SHOWS; CARRYING CASES FOR POCKET CALCULATORS AND CELLPHONES (U.S. CLS. 21, 23, 26, 36 AND 38).

CLASS 16—PAPER GOODS AND PRINTED MATTER

FOR PRINTED MATTER, NAMELY, TELEPHONE DIRECTORIES, SERIES OF BOOKS, NEWSLETTERS, PAMPHLETS, BROCHURES, MAGAZINES AND PAPERBACKS, ALL IN THE FIELD OF TELECOMMUNICATIONS; PRINTED AND STAMPED PLASTIC AND CARDBOARD GREETING, BLANK, NOTE, AND INDEX CARDS; NOTE PAPER AND ENVELOPES; NAMETAGS AND LABELS MADE FROM PAPER OR CARDBOARD; NOTEBOOKS; NOTE PADS; STATIONERY; PAPER, NAMELY, BOND PAPER AND ART PAPER; GIFT-WRAP PAPER; DIARIES; ADDRESS BOOKS; STUDENT CALENDARS; STAMP ALBUMS AND PHOTO-ALBUMS; FOLDERS FOR LETTERS AND LOOSE PAPERS; STATIONERY CLEAR HOLE TAB REINFORCEMENTS; RUBBER STAMPS AND IMPRESSION STAMPS; PAPER WEIGHTS; LETTER OPENERS; DRAWING AND UNGRADUATED RULERS; ERASERS; STAPLERS; PAPER CLIPS; BLOTTER PADS; DESK FILE TRAYS; DESK STANDS AND HOLDERS FOR HOLDING STATIONERY AND OFFICE IMPLEMENTS; PRINTED INSTRUCTIONAL AND TEACHING MATERIALS, ALL IN THE FIELDS OF TELECOMMUNICATIONS, INFORMATION TECHNOLOGY, SAFETY, NEWS, ENTERTAINMENT, CULTURE, BUSINESS AND FINANCE, WEATHER AND TRAVEL; BOOKMARKERS; STENCILS; SCRATCH PICTURES; PVC STICKERS; BLACKBOARDS; CHALK STICKS; ADHESIVES FOR STATIONERY OR HOUSEHOLD PURPOSES; DRAWING AND PAINTING MATERIALS, NAMELY, PENCILS, DRAWING PENCILS, PENS, DRAWING PENS, PAINT TRAYS, PAINTING SETS FOR ARTISTS, PAINTING SETS FOR CHILDREN, ARTS AND CRAFT PAINT KITS, AND PENCIL CASES; NON-MAGNETICALLY ENCODED PREPAID TELEPHONE CALLING CARDS (U.S. CLS. 2, 5, 22, 23, 29, 37, 38 AND 50).

CLASS 35—ADVERTISING AND BUSINESS

FOR TELEPHONE DIRECTORY ASSISTANCE SERVICES; ADVERTISING SERVICES, NAMELY, PREPARING AND PLACING ADVERTISEMENTS FOR OTHERS PROMOTING THE GOODS AND SERVICES OF OTHERS THROUGH PRINTED ADVERTISING, PRINTED DIRECTORIES, THROUGH ENCODED MEDIA, THROUGH THE DISSEMINATION OF PROMOTIONAL MATERIALS, THROUGH DIRECT MAIL ADVERTISING, THROUGH ELECTRONIC BILLBOARD ADVERTISING, PREPARING AUDIO-VISUAL PRESENTATIONS FOR USE IN ADVERTISING; BUSINESS MANAGEMENT SERVICES, NAMELY, BUSINESS APPRAISALS, BUSINESS AUDITING, PROVIDING BUSINESS INFORMATION, NAMELY, PREPARING BUSINESS REPORTS AND CONDUCTING BUSINESS RESEARCH, ANALYSIS AND SURVEYS, BUSINESS MANAGEMENT PLANNING, BUSINESS MANAGEMENT CONSULTATION, BUSINESS MANAGEMENT SUPERVISION, CONDUCTING BUSINESS NETWORKING FOR OTHERS; BUSINESS MANAGEMENT AND CONSULTING SERVICES, EXCLUDING AGRICULTURAL BUSINESS MANAGEMENT AND CONSULTING SERVICES; PROVIDING INFORMATION VIA THE TELEPHONE AND THE GLOBAL COMMUNICATION NETWORKS IN THE FIELD OF ADVERTISING AND BUSINESS MARKETING; PROFESSIONAL CONSULTANCY IN THE FIELD OF DATA PROCESSING; RENTAL OF AUTOMATIC VENDING MACHINES; RENTAL OF DATA PROCESSING EQUIPMENT; ORGANIZING JOB FAIRS (U.S. CLS. 100, 101 AND 102).

CLASS 36—INSURANCE AND FINANCIAL

FOR INSURANCE SERVICES, NAMELY, INSURANCE BROKERAGE, INSURANCE CLAIMS PROCESSING; FINANCIAL SERVICES, NAMELY, CLEARING OF SECURE FINANCIAL TRANSACTIONS THROUGH ONLINE SERVICES; FINANCIAL ANALYSIS AND CONSULTATION; FINANCIAL INFORMATION PROVIDED BY ELECTRONIC MEANS; FINANCIAL INFORMATION PROCESSING; FINANCIAL PORTFOLIO MANAGEMENT; FINANCIAL SERVICES, NAMELY, SECURITIES CONSULTING AND SAFE KEEPING; FINANCIAL SPONSORSHIP OF SPORTS, EDUCATIONAL AND ENTERTAINMENT PROGRAMS AND EVENTS; COMMERCIAL LENDING SERVICES; MONETARY EXCHANGE; CREDIT CARD SERVICES; TELEPHONE CALLING CARD SERVICES; ELECTRONIC COMMERCE SERVICES, NAMELY, ELECTRONIC DEBIT AID CREDIT CARD TRANSACTION PROCESSING SERVICES, FUNDS TRANSFER AND BILL PAYMENT-PROCESSING SERVICES; DISCOUNT BROKERAGE SERVICES; SECURITY BROKERAGE; BROKERAGE IN THE FIELD OF INSURANCE, STOCKS, COMMODITIES; CUSTOM BROKERAGE FOR THIRD PARTIES IN THE FIELD OF INSURANCE, STOCKS, COMMODITIES; BROKERAGE OF SHARES AND VENTURE CAPITAL FUNDING SERVICES TO START-UP COMPANIES; BROKERAGE OF FUND SHARES; BROKERAGE OF PRODUCTIVE INVESTMENT OF FUNDS; REAL ESTATE SERVICES, NAMELY, BROKERAGE, MANAGEMENT, LEASING, AND APPRAISAL OF REAL PROPERTY; CONSULTING SERVICES RELATING TO INSURANCE SERVICES, NAMELY, PROVIDING INFORMATION AND BROKERAGE OF INSURANCES IN THE FIELD OF HOME INSURANCE, ACCIDENT INSURANCE AND HEALTH INSURANCE; CONSULTING SERVICES RELATING TO BANK SERVICES; PROVIDING INFORMATION VIA THE TELEPHONE AND THE GLOBAL COMMUNICATION NETWORKS IN THE FIELD OF FINANCE (U.S. CLS. 100, 101 AND 102).

CLASS 38—COMMUNICATION

FOR TELECOMMUNICATION AND INFORMATION TECHNOLOGY SERVICES, NAMELY, ELECTRIC, DIGITAL, CELLULAR AND WIRELESS TRANSMISSION OF VOICE, DATA, INFORMATION IMAGES, SIGNALS AND MESSAGES AND TRANSMISSION OF VOICE, DATA, IMAGES, AUDIO, VIDEO AND INFORMATION VIA TELEPHONE, TELEVISION AND GLOBAL COMMUNICATION NETWORKS; PROVIDING TELECOMMUNICATIONS CONNECTIONS OVER A GLOBAL COMMUNICATIONS NETWORK, ELECTRONIC MAIL, VOICE MAIL AND MESSAGING SERVICES, NAMELY, THE RECORDING AND SUBSEQUENT TRANSMISSION

OF VOICE MESSAGES BY TELEPHONE; RENTAL OF TELECOMMUNICATIONS EQUIPMENT, NAMELY, EQUIPMENT FOR ELECTRONIC ACCESS TO GLOBAL TELECOMMUNICATIONS NETWORK, EQUIPMENT FOR TRANSMITTING, RECEIVING, RECORDING AND MONITORING VOICE, DATA, INFORMATION IMAGES, SIGNALS, MESSAGES COMPRISED OF DATA AND WORD PROCESSORS, AND TELECOMMUNICATIONS HARDWARE COMPONENTS AND PERIPHERALS THEREOF FOR USE IN THE TELECOMMUNICATIONS INDUSTRY, AND RENTAL OF EQUIPMENT FOR TRANSMITTING, RECEIVING, RECORDING AND MONITORING COMPUTER PROGRAMS FOR USE IN OPERATING AND ACCESSING TELECOMMUNICATIONS SYSTEMS; AUDIO AND VIDEO BROADCASTING; PROVIDING MULTIPLE-USER DIAL-UP AND DEDICATED ACCESS TO THE INTERNET; PERSONAL COMMUNICATIONS SERVICES; PAGER SERVICES; TRANSMISSION AND BROADCAST OF AUDIO AND VIDEO PROGRAMMING; LEASING OF TELECOMMUNICATIONS EQUIPMENT, COMPONENTS AND SYSTEMS; PROVIDING INFORMATION VIA THE TELEPHONE AND THE GLOBAL COMMUNICATION NETWORKS IN THE FIELD OF TELECOMMUNICATIONS; CONSULTING IN THE FIELD OF TELECOMMUNICATIONS (U.S. CLS. 100, 101 AND 104).

CLASS 42—SCIENTIFIC, COMPUTER AND LEGAL SERVICES

FOR COMPUTER PROGRAMMING SERVICES FOR OTHERS; RENTAL OF COMPUTER SOFTWARE AND HARDWARE FOR ONLINE ACCESS; DATA ENCRYPTION SERVICES, NAMELY, ADMINISTRATION OF DIGITAL KEYS AND DIGITAL CERTIFICATES; APPLICATION SERVICE PROVIDER, NAMELY, HOSTING COMPUTER SOFTWARE APPLICATIONS FOR OTHERS, HOSTING OF DIGITAL CONTENT ON THE INTERNET; HOSTING THE WEBSITES OF OTHERS ON A COMPUTER SERVER FOR A GLOBAL COMPUTER NETWORK; COMPUTER SERVICES, NAMELY, CREATING INDEXES OF INFORMATION AVAILABLE ON COMPUTER NETWORKS; PROVIDING INFORMATION VIA THE TELEPHONE AND THE GLOBAL COMMUNICATION NETWORKS IN THE FIELD OF INFORMATION TECHNOLOGY; CONSULTING SERVICES IN THE FIELD OF DESIGN, SELECTION, IMPLEMENTATION AND USE OF COMPUTER HARDWARE AND SOFTWARE SYSTEMS FOR OTHERS; INSTALLATION, MAINTENANCE AND REPAIR OF COMPUTER SOFTWARE; TECHNICAL PROJECT PLANNING SERVICES RELATED TO TELECOMMUNICATIONS EQUIPMENT (U.S. CLS. 100 AND 101).

SOPHIA S. KIM, EXAMINING ATTORNEY

CLASS 9—ELECTRICAL AND SCIENTIFIC APPARATUS

FOR ELECTRIC, ELECTRONIC, OPTICAL, MEASURING, SIGNALING, CONTROLLING AND TEACHING APPARATUS AND INSTRUMENTS, ALL FOR USE WITH TELECOMMUNICATIONS, NAMELY, APPARATUS FOR PRODUCING SOUND, IMAGES OR DATA; BLANK MAGNETIC AND OPTICAL DATA CARRIERS; DATA PROCESSORS; COMPUTERS, NAMELY, MICROCOMPUTERS, MINICOMPUTERS, COMPUTER CENTRAL PROCESSORS, COMPUTER MONITORS, COMPUTER KEYBOARDS, COMPUTER TERMINALS, COMPUTER MEMORIES, COMPUTER LASER PRINTERS, COMPUTER IMPACT PRINTERS, COMPUTER DOT MATRIX PRINTERS, COMPUTERS AND INSTRUCTIONAL MANUALS SOLD AS A UNIT; COMPUTER MEMORY HARDWARE; COMPUTER INTERFACE APPARATUS, NAMELY, COMPUTER INTERFACE BOARDS, COMPUTER MOUSE AND MOUSE PAD, COMPUTER PERIPHERALS AND PARTS THEREOF; COMPUTER SOFTWARE PROGRAMS FOR USE IN OPERATING TELECOMMUNICATIONS AND BUSINESS MANAGEMENT SYSTEMS AND RELATED INSTRUCTION MANUALS SOLD AS A UNIT; COMPUTER SOFTWARE FOR FINANCIAL ACCOUNTING, FOR THE PROVISION OF ONLINE INFORMATION SERVICE IN THE FIELD OF BUSINESS AND FINANCE, WEATHER AND TRAVEL, NETWORK MANAGEMENT, COMPUTER PROXY, FOR CONTROLLING ACCESS AND ALARM MONITORING OF HOMES, APARTMENTS, BUILDINGS AND OTHER PROPERTIES, BILLING ANALYSIS, NETWORK ACCESS CONTROL FOR CREATING AND MAINTAINING FIREWALLS; COMPUTER SOFTWARE PROGRAMS FOR ACCESSING A GLOBAL COMPUTER NETWORK AND INTERACTIVE COMPUTER COMMUNICATIONS NETWORKS; OPTICAL FIBERS SOLD AS A COMPONENT OF FIBER OPTICAL CABLES; FIBER OPTIC CABLES; OPTICAL SCANNERS; OPTICAL CHARACTER READERS; OPTICAL BLANK DISCS; OPTICAL GLASS FOR SIGNAL TRANSMISSION; OPTIC TRANSMITTERS FOR RADIO, TELEPHONE; OPTIC RECEIVERS FOR TELEPHONE, AUDIO, VIDEO; OPTICAL SIGNAL PROCESSORS; OPTIC TELECOMMUNICATIONS SWITCHES; OPTICAL ATTENUATORS; OPTICAL AMPLIFIERS; OPTICAL CHARACTER RECOGNITION APPARATUS, FOR USE IN THE TELECOMMUNICATIONS FIELD, AND PARTS THEREOF; TELEPHONE LOCAL AREA NETWORKS; TELECOMMUNICATION AUDIO, VIDEO AND DATA COMMUNICATIONS SYSTEMS, NAMELY, DIGITAL AND ANALOGUE SIGNAL TRANSMITTERS; RECEIVERS AND CONVERTERS FOR USE WITH TELEPHONE, AUDIO, VIDEO; RADIO AND TELEPHONE TRANSMITTERS; COMMUNICATION RECEIVERS AND SERVERS FOR TELEPHONE, AUDIO, VIDEO; TELEPHONE ANSWERING MACHINES; TELEPROMPTERS; TELETYPEWRITERS AND PARTS THEREOF, NAMELY, CALLER IDENTIFICATION BOXES, DIALING ASSEMBLIES, TELEPHONE UNITS, AUDIO OPERATED RELAYS, AUDIO/VIDEO SIGNAL AND OPTICAL FILTERS AND PROTECTORS, TELEMETERS, WIRELESS AND CELLULAR TELEPHONES, AND RADIO PAGERS; INTERCOMS; FACSIMILE MACHINE; ELECTRONIC MAIL APPARATUS FOR ELECTRONIC EXCHANGE OF DATA IMAGES AND MESSAGES; ELECTRICAL WIRE; ELECTRICAL WIRE CONNECTORS; INTEGRATED CIRCUITS; PRINTED CIRCUITS; ELECTRIC CIRCUITS; CIRCUIT BREAKERS; PRINTED CIRCUIT BOARDS; CIRCUIT CONNECTORS; ELECTRICAL CONTROLLERS; ELECTRICAL CONVERTERS; ELECTRICAL CONDUCTORS; ELECTRICAL FUSES; ELECTRIC LUMINESCENT DISPLAY PANELS; ELECTRICAL SWITCH PLATES; ELECTRIC PLUGS; ELECTRIC COILS; ANTENNAS; ELECTRICAL CABLES; COMPUTER CABLES; COMPUTER CHIPS; SILICON CHIPS; CHRONOGRAPHS FOR USE AS SPECIALIZED TIME RECORDING APPARATUS; COMPUTER BUFFERS; BLANK COMPUTER DISCS; BLANK COMPUTER FLOPPY DISKS; COMPUTER HARD DISCS; ACOUSTIC CONDUITS; ELECTRICAL CONDUITS; FIBER OPTIC CONDUITS AND PARTS THEREOF; COMPACT DISC PLAYERS; AUDIO AND VIDEO TAPE RECORDERS; AUDIO AND VIDEOTAPE PLAYERS; AUDIO AND VIDEOCASSETTE RECORDERS; AUDIO AND VIDEOCASSETTE PLAYERS; BLANK AUDIO AND VIDEOTAPES, CASSETTES, DISCS AND MICROFICHE; AUDIO AND VIDEO TAPES, CASSETTES, DISCS AND MICROFICHE FEATURING INFORMATION CONCERNING TELECOMMUNICATIONS, AND CONCERN-

SN 79-000,714. DEUTSCHE TELEKOM AG, FED REP GERMANY, FILED 11-7-2003.

on-showbiz

THE MARK CONSISTS OF STANDARD CHARACTERS WITHOUT CLAIM TO ANY PARTICULAR FONT, STYLE, SIZE, OR COLOR.

PRIORITY DATE OF 5-8-2003 IS CLAIMED.

OWNER OF INTERNATIONAL REGISTRATION 0817845 DATED 11-7-2003, EXPIRES 11-7-2013.

ING PERSONAL AND BUSINESS MANAGEMENT SYSTEMS; AUDIO AND VIDEO RECORDINGS IN THE FIELD OF TELECOMMUNICATIONS, INFORMATION TECHNOLOGY AND SAFETY; TELEVISION AND TELEVISION PERIPHERAL EQUIPMENT, NAMELY, CAMERAS, SET TOP BOXES, REMOTE CONTROL UNITS FOR INTERACTIVE AND NON-INTERACTIVE USE; VIDEO MONITORS; AUTOMATIC VENDING MACHINES AND TIMING MECHANISMS THEREFOR AND PARTS THEREOF; MACHINE READABLE, MAGNETICALLY ENCODED CARDS, NAMELY, PREPAID TELEPHONE CALLING CARDS AND CREDIT CARDS; BLANK SMART CARDS; MAGNETIC CODED CARD READERS; DATA PROCESSORS AND READERS; WORD PROCESSORS; MICROPROCESSORS; ELECTRONIC ENCRYPTION UNITS; DEMAGNETIZERS FOR MAGNETIC TAPES AND PARTS THEREOF; LASERS NOT FOR MEDICAL USE; LIGHT EMITTING DIODES; LIGHT EMITTING DIODE DISPLAYS; COMPUTER, DATA AND VIDEO NETWORKING AND CONFERENCING EQUIPMENT, NAMELY, TELECONFERENCING EQUIPMENT AND AUDIOVISUAL TEACHING EQUIPMENT IN THE NATURE OF OVERHEAD FILM, PHOTOGRAPHIC AND SLIDE PROJECTORS; PROJECTION SCREENS; COMPUTER BASED INFORMATION DISPLAY EQUIPMENT, NAMELY, COMPUTERS WHICH DISPLAY INFORMATION ON AN OVERHEAD SCREEN; PORTABLE DEVICES, NAMELY, LAPTOPS, HANDHELD AND POCKET COMPUTERS, WIRELESS FAX MACHINES; PERSONAL COMMUNICATIONS EQUIPMENT, NAMELY, PERSONAL DIGITAL ASSISTANTS; CALCULATORS AND RELATED PERIPHERALS; SATELLITE PROCESSORS, SATELLITE AND SATELLITE COMMUNICATION EARTH STATIONS BOTH STATIONARY AND MOVEABLE; COMPUTER GAME PROGRAMS FOR CHILDREN AND ADULTS; VIDEO AND COMPUTER GAME CARTRIDGES; PRERECORDED COMPACT DISCS, AUDIOCASSETTE TAPES, VIDEOCASSETTE TAPES, DIGITAL AUDIOTAPES AND DIGITAL VIDEO DISCS FEATURING MUSICAL, VARIETY, NEWS AND COMEDY SHOWS; CARRYING CASES FOR POCKET CALCULATORS AND CELLPHONES (U.S. CLS. 21, 23, 26, 36 AND 38).

CLASS 16—PAPER GOODS AND PRINTED MATTER

FOR PRINTED MATTER, NAMELY, TELEPHONE DIRECTORIES, SERIES OF BOOKS, NEWSLETTERS, PAMPHLETS, BROCHURES, MAGAZINES AND PAPERBACKS, ALL IN THE FIELD OF TELECOMMUNICATIONS; PRINTED AND STAMPED PLASTIC AND CARDBOARD GREETING, BLANK, NOTE, AND INDEX CARDS; NOTE PAPER AND ENVELOPES; NAMETAGS AND LABELS MADE FROM PAPER OR CARDBOARD; NOTEBOOKS; NOTE PADS; STATIONERY; PAPER, NAMELY, BOND PAPER AND ART PAPER; GIFT-WRAP PAPER; DIARIES; ADDRESS BOOKS; STUDENT CALENDARS; STAMP ALBUMS AND PHOTO-ALBUMS; FOLDERS FOR LETTERS AND LOOSE PAPERS; STATIONERY CLEAR HOLE TAB REINFORCEMENTS; RUBBER STAMPS AND IMPRESSION STAMPS; PAPER WEIGHTS; LETTER OPENERS; DRAWING AND UNGRADUATED RULERS; ERASERS; STAPLERS; PAPER CLIPS; BLOTTER PADS; DESK FILE TRAYS; DESK STANDS AND HOLDERS FOR HOLDING STATIONERY AND OFFICE IMPLEMENTS; PRINTED INSTRUCTIONAL AND TEACHING MATERIALS, ALL IN THE FIELDS OF TELECOMMUNICATIONS, INFORMATION TECHNOLOGY, SAFETY, NEWS, ENTERTAINMENT, CULTURE, BUSINESS AND FINANCE, WEATHER AND TRAVEL; BOOKMARKERS; STENCILS; SCRATCH PICTURES; PVC STICKERS; BLACKBOARDS; CHALK STICKS; ADHESIVES FOR STATIONERY OR HOUSEHOLD PURPOSES; DRAWING AND PAINTING MATERIALS, NAMELY, PENCILS, DRAWING PENCILS, PENS, DRAWING PENS, PAINT TRAYS, PAINTING SETS FOR ARTISTS, PAINTING SETS FOR CHILDREN, ARTS AND CRAFT PAINT KITS, AND PENCIL CASES; NON-MAGNETICALLY ENCODED PREPAID TELEPHONE CALLING CARDS (U.S. CLS. 2, 5, 22, 23, 29, 37, 38 AND 50).

CLASS 35—ADVERTISING AND BUSINESS

FOR TELEPHONE DIRECTORY ASSISTANCE SERVICES; ADVERTISING SERVICES, NAMELY, PREPARING AND PLACING ADVERTISEMENTS FOR OTHERS PROMOTING THE GOODS AND SERVICES OF OTHERS THROUGH PRINTED ADVERTISING, PRINTED DIRECTORIES, THROUGH ENCODED MEDIA, THROUGH THE DISSEMINATION OF PROMOTIONAL MATERIALS, THROUGH DIRECT MAIL ADVERTISING, THROUGH ELECTRONIC BILLBOARD ADVERTISING, PREPARING AUDIO-VISUAL PRESENTATIONS FOR USE IN ADVERTISING; BUSINESS MANAGEMENT SERVICES, NAMELY, BUSINESS APPRAISALS, BUSINESS AUDITING, PROVIDING BUSINESS INFORMATION, NAMELY, PREPARING BUSINESS REPORTS AND CONDUCTING BUSINESS RESEARCH, ANALYSIS AND SURVEYS, BUSINESS MANAGEMENT PLANNING, BUSINESS MANAGEMENT CONSULTATION, BUSINESS MANAGEMENT SUPERVISION, CONDUCTING BUSINESS NETWORKING FOR OTHERS; BUSINESS MANAGEMENT AND CONSULTING SERVICES, EXCLUDING AGRICULTURAL BUSINESS MANAGEMENT AND CONSULTING SERVICES; PROVIDING INFORMATION VIA THE TELEPHONE AND THE GLOBAL COMMUNICATION NETWORKS IN THE FIELD OF ADVERTISING AND BUSINESS MARKETING; PROFESSIONAL CONSULTANCY IN THE FIELD OF DATA PROCESSING; RENTAL OF AUTOMATIC VENDING MACHINES; RENTAL OF DATA PROCESSING EQUIPMENT; ORGANIZING JOB FAIRS (U.S. CLS. 100, 101 AND 102).

CLASS 36—INSURANCE AND FINANCIAL

FOR INSURANCE SERVICES, NAMELY, INSURANCE BROKERAGE, INSURANCE CLAIMS PROCESSING; FINANCIAL SERVICES, NAMELY, CLEARING OF SECURE FINANCIAL TRANSACTIONS THROUGH ON LINE SERVICES; FINANCIAL ANALYSIS AND CONSULTATION; FINANCIAL INFORMATION PROVIDED BY ELECTRONIC MEANS; FINANCIAL INFORMATION PROCESSING; FINANCIAL PORTFOLIO MANAGEMENT; FINANCIAL SERVICES, NAMELY, SECURITIES CONSULTING AND SAFE KEEPING; FINANCIAL SPONSORSHIP OF SPORTS, EDUCATIONAL AND ENTERTAINMENT PROGRAMS AND EVENTS; COMMERCIAL LENDING SERVICES; MONETARY EXCHANGE; CREDIT CARD SERVICES; TELEPHONE CALLING CARD SERVICES; ELECTRONIC COMMERCE SERVICES, NAMELY, ELECTRONIC DEBIT AND CREDIT CARD TRANSACTION PROCESSING SERVICES, FUNDS TRANSFER AND BILL PAYMENT-PROCESSING SERVICES; DISCOUNT BROKERAGE SERVICES; SECURITY BROKERAGE; BROKERAGE IN THE FIELD OF INSURANCE, STOCKS, COMMODITIES; CUSTOM BROKERAGE FOR THIRD PARTIES IN THE FIELD OF INSURANCE, STOCKS, COMMODITIES; BROKERAGE OF SHARES AND VENTURE CAPITAL FUNDING SERVICES TO START-UP COMPANIES; BROKERAGE OF FUND SHARES; BROKERAGE OF PRODUCTIVE INVESTMENT OF FUNDS; REAL ESTATE SERVICES, NAMELY, BROKERAGE, MANAGEMENT, LEASING, AND APPRAISAL OF REAL PROPERTY; CONSULTING SERVICES RELATING TO INSURANCE SERVICES, NAMELY, PROVIDING INFORMATION AND BROKERAGE OF INSURANCES IN THE FIELD OF HOME INSURANCE, ACCIDENT INSURANCE AND HEALTH INSURANCE; CONSULTING SERVICES RELATING TO BANK SERVICES; PROVIDING INFORMATION VIA THE TELEPHONE AND THE GLOBAL COMMUNICATION NETWORKS IN THE FIELD OF FINANCE (U.S. CLS. 100, 101 AND 102).

CLASS 38—COMMUNICATION

FOR TELECOMMUNICATION AND INFORMATION TECHNOLOGY SERVICES, NAMELY, ELECTRIC, DIGITAL, CELLULAR AND WIRELESS TRANSMISSION OF VOICE, DATA, INFORMATION IMAGES, SIGNALS AND MESSAGES AND TRANSMISSION OF VOICE, DATA, IMAGES, AUDIO, VIDEO AND INFORMATION VIA TELEPHONE, TELEVISION AND GLOBAL COMMUNICATION NETWORKS; PROVIDING TELECOMMUNICATIONS CONNECTIONS OVER A GLOBAL COMMUNICATIONS NETWORK, ELECTRONIC MAIL, VOICE MAIL AND MESSAGING SERVICES, NAMELY, THE RECORDING AND SUBSEQUENT TRANSMISSION

OF VOICE MESSAGES BY TELEPHONE; RENTAL OF TELECOMMUNICATIONS EQUIPMENT, NAMELY, EQUIPMENT FOR ELECTRONIC ACCESS TO GLOBAL TELECOMMUNICATIONS NETWORK, EQUIPMENT FOR TRANSMITTING, RECEIVING, RECORDING AND MONITORING VOICE, DATA, INFORMATION IMAGES, SIGNALS, MESSAGES COMPRISED OF DATA AND WORD PROCESSORS, AND TELECOMMUNICATIONS HARDWARE COMPONENTS AND PERIPHERALS THEREOF FOR USE IN THE TELECOMMUNICATIONS INDUSTRY, AND RENTAL OF EQUIPMENT FOR TRANSMITTING, RECEIVING, RECORDING AND MONITORING COMPUTER PROGRAMS FOR USE IN OPERATING AND ACCESSING TELECOMMUNICATIONS SYSTEMS; AUDIO AND VIDEO BROADCASTING; PROVIDING MULTIPLE-USER DIAL-UP AND DEDICATED ACCESS TO THE INTERNET; PERSONAL COMMUNICATIONS SERVICES; PAGER SERVICES; TRANSMISSION AND BROADCAST OF AUDIO AND VIDEO PROGRAMMING; LEASING OF TELECOMMUNICATIONS EQUIPMENT, COMPONENTS AND SYSTEMS; PROVIDING INFORMATION VIA THE TELEPHONE AND THE GLOBAL COMMUNICATION NETWORKS IN THE FIELD OF TELECOMMUNICATIONS; CONSULTING IN THE FIELD OF TELECOMMUNICATIONS (U.S. CLS. 100, 101 AND 104).

CLASS 42—SCIENTIFIC, COMPUTER AND LEGAL SERVICES

FOR COMPUTER PROGRAMMING SERVICES FOR OTHERS; RENTAL OF COMPUTER SOFTWARE AND HARDWARE FOR ONLINE ACCESS; DATA ENCRYPTION SERVICES, NAMELY, ADMINISTRATION OF DIGITAL KEYS AND DIGITAL CERTIFICATES; APPLICATION SERVICE PROVIDER, NAMELY, HOSTING COMPUTER SOFTWARE APPLICATIONS FOR OTHERS, HOSTING OF DIGITAL CONTENT ON THE INTERNET; HOSTING THE WEBSITES OF OTHERS ON A COMPUTER SERVER FOR A GLOBAL COMPUTER NETWORK; COMPUTER SERVICES, NAMELY, CREATING INDEXES OF INFORMATION AVAILABLE ON COMPUTER NETWORKS; PROVIDING INFORMATION VIA THE TELEPHONE AND THE GLOBAL COMMUNICATION NETWORKS IN THE FIELD OF INFORMATION TECHNOLOGY; CONSULTING SERVICES IN THE FIELD OF DESIGN, SELECTION, IMPLEMENTATION AND USE OF COMPUTER HARDWARE AND SOFTWARE SYSTEMS FOR OTHERS; INSTALLATION, MAINTENANCE AND REPAIR OF COMPUTER SOFTWARE; TECHNICAL PROJECT PLANNING SERVICES RELATED TO TELECOMMUNICATIONS EQUIPMENT (U.S. CLS. 100 AND 101).

SOPHIA S. KIM, EXAMINING ATTORNEY

CLASS 9—ELECTRICAL AND SCIENTIFIC APPARATUS

FOR SOFTWARE FOR USE IN DATABASE MANAGEMENT AS A SPREADSHEET FOR DATA MANAGEMENT FOR PROCUREMENT, HUMAN RESOURCES, INVENTORY AND WAREHOUSE MANAGEMENT, SALES, LABORATORY INFORMATION AND MANAGEMENT SYSTEMS, ADVANCED PRODUCTION SCHEDULING AND INDUSTRY SPECIFIC APPLICATIONS STORED ON DISKETTES, MAGNETIC DISKS, MAGNETIC TAPES AND OTHER COMPUTER MEDIA; DATABANKS WITH MODULAR PROGRAMS, FULLY MODIFIABLE, NAMELY SOFTWARE MODULES STORED ON DATA MEDIA FOR IMAGE ANALYSIS METHODS IN THE FIELD OF MEDICINE, INTEGRATING TELEPHONES IN THE GENERAL, PERSONAL COMPUTER ENVIRONMENT, EXPORTING COMPUTER MEDIA TO TELECOMMUNICATIONS, AND FOOD INDUSTRIES; COMPUTER PERIPHERALS FOR DATA MANAGEMENT, NAMELY HARDWARE FOR OUTPUT FILE STORAGE, COMPUTER INSTRUMENTS, NAMELY COMPUTERS, MODEMS AND MONITORS AND PERIPHERAL EQUIPMENT IN THE FIELD OF COMPUTING, NAMELY, INTERFACE UNITS FOR CONTROLLING LIQUID-RESISTANT KEYBOARDS, SCANNING SYSTEMS, NAMELY, SCANNERS, PRINTERS AND SWITCH BOXES FOR CONNECTING AND DISCONNECTING LIQUID-RESISTANT MONITORS, LIQUID-RESISTANT KEYBOARDS AND PRINTERS, MULTIPLEXERS, COMPUTERS CONSISTING OF AN ELECTRONIC PLATE, COMPUTER CONNECTION CABLES, PARTICULARLY PERIPHERAL SPLASH-PROOF COMPUTER HARDWARE FOR USE IN HUMID ENVIRONMENTS AND COLD ROOMS; ULTRASONIC MEASURING INSTRUMENTS AS WELL AS COMPONENTS THEREOF FOR CLASSIFYING LAYERS OF MEAT; ELECTRONIC SCALES WITH HEAD BRIDGES THAT CAN BE CONNECTED TO COMPUTERS, ECHOGRAPHIC COMPUTERS DESIGNED FOR MANAGEMENT OF IMAGE ANALYSIS, MULTIFUNCTION IMAGE ANALYSIS SYSTEMS, NAMELY, MULTIFUNCTION IMAGE ANALYZERS FOR ALL IMAGE DATA TECHNIQUES (U.S. CLS. 21, 23, 26, 36 AND 38).

CLASS 16—PAPER GOODS AND PRINTED MATTER

FOR DOCUMENTATION, NAMELY, BOOKS, LEAFLETS, AND MAGAZINES IN THE FIELD OF COMPUTING AND DESCRIPTIONS OF COMPUTER SOFTWARE (U.S. CLS. 2, 5, 22, 23, 29, 37, 38 AND 50).

CLASS 35—ADVERTISING AND BUSINESS

FOR ADVICE AND ASSISTANCE IN ENTERPRISE MANAGEMENT (U.S. CLS. 100, 101 AND 102).

CLASS 37—CONSTRUCTION AND REPAIR

FOR COMPUTER SOFTWARE MAINTENANCE; ASSEMBLING COMPUTER APPLIANCES (U.S. CLS. 100, 103 AND 106).

CLASS 41—EDUCATION AND ENTERTAINMENT

FOR ORGANIZATION AND IMPLEMENTATION OF SEMINARS IN THE FIELD OF COMPUTERS AND COMPUTER SOFTWARE FOR COMMUNICATION ORIENTED COMPANIES, ADAPTED TO EACH INDIVIDUAL NEED AND USING A DATABANK SUPPLIED WITH A MODULAR AND STRUCTURED SOFTWARE; PUBLISHING OF BOOKS AND MAGAZINES SPECIALIZING IN COMPUTER HARDWARE AND SOFTWARE, BASIC ORGANIZATIONAL RULES FOR ENTERPRISE ORGANIZATION IN THE MARKET AND, INTER ALIA, CALCULATION SYSTEMS FOR SPECIFIC FIELDS AND STANDARD ANALYSIS BASED ON COMPUTER SYSTEMS (U.S. CLS. 100, 101 AND 107).

SN 79-000,841. CSB SYSTEM SOFTWARE-ENTWICKLUNG; & UNTERNEHMENSBERATUNG GMBH, FED REP GERMANY, FILED 12-23-2003.



OWNER OF INTERNATIONAL REGISTRATION 0618190 DATED 1-8-1994, EXPIRES 1-8-2014.
OWNER OF U.S. REG. NOS. 2,337,496, 2,337,497 AND 2,376,597.

CLASS 42—SCIENTIFIC, COMPUTER AND LEGAL SERVICES

FOR COMPUTER EQUIPMENT DESIGN, SOFTWARE DEVELOPMENT, NAMELY DESIGN, UPDATING AND USE OF DATABANK STRUCTURED MODULAR SOFTWARE FOR PROVIDING SOLUTIONS TO NEEDS; SOFTWARE DESIGN FOR THE IMPLEMENTATION OF BASIC ORGANIZATIONAL RULES FOR COMPANY MANAGEMENT AND APPLICATION TO COMPUTER SYSTEMS, IMPLEMENTATION OF CALCULATION SYSTEMS FOR SPECIFIC FIELDS, QUALITY AND STANDARD ANALYSIS AND, INTER ALIA, MODELS BASED ON COMPUTER MANAGEMENT OF IMAGE ANALYSIS METHODS (U.S. CLS. 100 AND 101).

MATTHEW PAPPAS, EXAMINING ATTORNEY

CLASS 21—HOUSEWARES AND GLASS

FOR HOUSEHOLD UTENSILS, NAMELY, POT AND PAN SCRAPERS, ROLLING PINS, SPATULAS, TURNERS, AND WHISKS; PLASTIC TABLEWARE, NAMELY, TABLE PLATES, GOBLETS, BOWLS, AND DISHES; BASINS; SERVING TRAYS NOT OF PRECIOUS METALS FOR HOUSEHOLD PURPOSES; BEVERAGE WARE; LUNCH BOXES; PAPER TOWEL DISPENSERS; ELECTRIC AND NON-ELECTRIC TOOTHBRUSHES; ARTICLES FOR CLEANING PURPOSES, NAMELY, BROOMS, DUSTING BRUSHES, POT CLEANING BRUSHES, AND POLISHING RAGS; GARBAGE CANS (U.S. CLS. 2, 13, 23, 29, 30, 33, 40 AND 50).

CLASS 43—HOTEL AND RESTAURANT SERVICES

FOR RESTAURANT SERVICES, CATERING, FAST-FOOD RESTAURANT, SNACK BAR, CANTEEN, CAFETERIA, COFFEE HOUSE AND BAR SERVICES (U.S. CLS. 100 AND 101).

CHRIS WELLS, EXAMINING ATTORNEY

SN 79-001,162. DE STER.ACS HOLDING B.V., NL-4824 EH BREDA, NETHERLANDS, FILED 11-18-2003.



PRIORITY DATE OF 6-5-2003 IS CLAIMED.
OWNER OF INTERNATIONAL REGISTRATION 0819491 DATED 11-18-2003, EXPIRES 11-18-2013.

THE COLOR(S) GREEN IS/ARE CLAIMED AS A FEATURE OF THE MARK.

THE MARK IS COMPOSED OF A GREEN AND WHITE MOSAIC CIRCULAR DESIGN COMPRISING MULTIPLE GREEN SQUARE SEGMENTS, CREATING THE IMPRESSION OF THE LETTER "E"; THE WORDING ETIME PROJECTING THEREFROM HAS THE SAME GREEN MOSAIC PATTERN.

CLASS 8—HAND TOOLS

FOR TABLEWARE, NAMELY, KNIVES, FORKS AND SPOONS, DISPOSABLE OR NOT (U.S. CLS. 23, 28 AND 44).

CLASS 16—PAPER GOODS AND PRINTED MATTER

FOR CARDBOARD PACKAGING, NAMELY, BOXES, CONTAINERS, CARTONS, AND MAILING TUBES; PAPER PACKAGING, NAMELY, BOXES, CONTAINERS AND ENVELOPES; WRITING PAPER; WRITING SETS COMPRISED OF WRITING PAPER AND ENVELOPES; PAPER BAGS; FILTER PAPER (U.S. CLS. 2, 5, 22, 23, 29, 37, 38 AND 50).

CLASS 20—FURNITURE AND ARTICLES NOT OTHERWISE CLASSIFIED

FOR PACKAGING OF PLASTIC, NAMELY, BOXES, CONTAINERS FOR COMMERCIAL USE, AND MAILING TUBES; DISPENSING EQUIPMENT NOT MADE OF METAL, NAMELY, FIXED PAPER TOWEL DISPENSERS (U.S. CLS. 2, 13, 22, 25, 32 AND 50).

SN 79-001,342. OETTINGER IMEX AG, CH-4002 BÄLE, SWITZERLAND, FILED 2-17-2004.

THE MARK CONSISTS OF STANDARD CHARACTERS WITHOUT CLAIM TO ANY PARTICULAR FONT, STYLE, SIZE, OR COLOR.

OWNER OF INTERNATIONAL REGISTRATION 0679492 DATED 8-13-1997, EXPIRES 8-13-2007.

OWNER OF U.S. REG. NOS. 1,857,852, 2,306,490 AND OTHERS.

CLASS 14—JEWELRY

FOR SNUFF BOXES MADE OF PRECIOUS METALS (U.S. CLS. 2, 27, 28 AND 50).

CLASS 34—SMOKERS' ARTICLES

FOR RAW OR MANUFACTURED TOBACCO GOODS, NAMELY, CIGARS, CIGARILLOS, CHERROOTS AND CIGARETTES, TOBACCO FOR SMOKING AND TOBACCO FOR CHEWING; SMOKERS' REQUISITES, NAMELY, TOBACCO PIPES, PIPE CLEANERS, PIPE TAMPERS, CIGAR CUTTERS, CIGAR AND CIGARETTE HOLDERS, ELECTRIC AND NON-ELECTRIC CIGAR AND CIGARETTE LIGHTERS; LIGHTER FLINTS; CIGAR AND CIGARETTE CASES AND BOXES; STORAGE CASES FOR CIGARS AND CIGARETTES; SNUFF BOXES; HUMIDORS FOR CIGARS, ASHTRAYS; ALL THE FOREGOING NOT BEING OF PRECIOUS METAL OR COATED WITH PRECIOUS METAL; CIGARETTE PAPER; CIGARETTE FILTERS; MATCHES (U.S. CLS. 2, 8, 9 AND 17).

ROBERT COGGINS, EXAMINING ATTORNEY

SN 79-001,350. DAVIDOFF & CIE SA, SWITZERLAND, FILED 2-17-2004.

ZINO PLATINUM

OWNER OF INTERNATIONAL REGISTRATION 0765617 DATED 9-20-2001, EXPIRES 9-20-2011.

OWNER OF U.S. REG. NOS. 2,725,768, 2,866,553 AND OTHERS.

NO CLAIM IS MADE TO THE EXCLUSIVE RIGHT TO USE "PLATINUM", APART FROM THE MARK AS SHOWN.

CLASS 14—JEWELRY

FOR SMOKERS' ARTICLES MADE IN WHOLE OR IN SIGNIFICANT PART OF PLATINUM, NAMELY, CIGAR CASES, CIGARETTE BOXES, TOBACCO JARS, CIGAR AND CIGARETTE HOLDERS, AND ASHTRAYS (U.S. CLS. 2, 27, 28 AND 50).

CLASS 34—SMOKERS' ARTICLES

FOR TOBACCO, RAW OR MANUFACTURED, CIGARILLOS, CIGARETTES, PIPE TOBACCO; SMOKERS ARTICLES MADE OF PLATINUM, NAMELY CIGAR HUMIDIFIERS, FILTER MOUTHPIECES, CIGAR CUTTERS, SMOKING PIPES, AND SMOKING PIPE ACCESSORIES, NAMELY PIPE CLEANERS AND PIPE TAMPERS; LIGHTERS FOR SMOKERS MADE IN WHOLE OR IN SIGNIFICANT PART OF PLATINUM, AND FLINTS FOR USE THEREWITH; MATCHES (U.S. CLS. 2, 8, 9 AND 17).

ANDREA SAUNDERS, EXAMINING ATTORNEY

SN 79-001,421. FUZHOU INTAIWA INDUSTRY CO., LTD., XIAMEN, FUJIAN PROVINCE, CHINA, FILED 2-28-2004.



OWNER OF INTERNATIONAL REGISTRATION 0820733 DATED 2-28-2004, EXPIRES 2-28-2014.

CLASS 9—ELECTRICAL AND SCIENTIFIC APPARATUS

FOR CHRONOGRAPHS FOR USE AS SPECIALIZED TIME RECORDING APPARATUSES; FLASHING SAFETY LIGHTS; ELECTRIC WIRES AND CABLES FOR ELECTRIC MAINS; ELECTRICAL CONNECTORS; ELECTRICAL CONTROLS FOR REMOTE CONTROL OF INDUSTRIAL OPERATIONS; FIRE EXTINGUISHERS; PROTECTIVE HELMETS; FIRE ALARMS; BATTERIES; AND ELECTRIC DEVICES FOR ATTRACTING AND KILLING INSECTS (U.S. CLS. 21, 23, 26, 36 AND 38).

CLASS 11—ENVIRONMENTAL CONTROL APPARATUS

FOR LIGHTERS PRIMARILY FOR LIGHTING GRILLS, FIREPLACES AND CANDLES; SOLDERING LAMPS; GAS LIGHTERS PRIMARILY FOR LIGHTING GRILLS, FIREPLACES AND CANDLES; ELECTRIC HOT PLATES; ELECTRIC AIR CONDITIONERS; ELECTRIC HEATING FANS; PIPES BEING PART OF SANITARY FACILITIES; ELECTRIC RADIANT HEATERS FOR BATHROOM USE; ELECTRIC RADIATORS FOR HEATING BUILDINGS; AND SPARK IGNITORS FOR LIGHTING GAS APPLIANCES (U.S. CLS. 13, 21, 23, 31 AND 34).

VERNA BETH RIRIE, EXAMINING ATTORNEY

SN 79-001,458. M-REAL DEUTSCHLAND GMBH, HAMBURG, FED REP GERMANY, FILED 1-23-2004.

nasty beast

THE MARK CONSISTS OF STANDARD CHARACTERS WITHOUT CLAIM TO ANY PARTICULAR FONT, STYLE, SIZE, OR COLOR.

PRIORITY DATE OF 7-23-2003 IS CLAIMED.

OWNER OF INTERNATIONAL REGISTRATION 0820919 DATED 1-23-2004, EXPIRES 1-23-2014.

CLASS 3—COSMETICS AND CLEANING PREPARATIONS

FOR PERFUMERY, ESSENTIAL OILS FOR PERSONAL USE, COSMETICS, HAIR LOTIONS (U.S. CLS. 1, 4, 6, 50, 51 AND 52).

CLASS 16—PAPER GOODS AND PRINTED MATTER

FOR BOND PAPER, CARBON PAPER, COPIER PAPER; CARDBOARD, CARDBOARD BOXES; INDUSTRIAL PACKAGING CONTAINERS OF PAPER; CARDBOARD PACKAGING; PACKAGING, NAMELY BLISTER CARDS AND BOXES FOR PERFUMERY AND COSMETICS; PRINTED MATTER, NAMELY LIFESTYLE MAGAZINES; AND PRINTED GUIDES FOR FASHION, COSMETICS, SPORTSWEAR, MUSIC, ACCESSORIES, COMMUNICATIONS AND WEB DESIGN (U.S. CLS. 2, 5, 22, 23, 29, 37, 38 AND 50).

MICHAEL SOUDERS, EXAMINING ATTORNEY

SN 79-001,481. EKO, S.R.L., ITALY, FILED 12-29-2003.

OWNER OF INTERNATIONAL REGISTRATION 0382558 DATED 10-26-1971, EXPIRES 10-26-2011.

CLASS 9—ELECTRICAL AND SCIENTIFIC APPARATUS

FOR AMPLIFIERS (U.S. CLS. 21, 23, 26, 36 AND 38).

CLASS 15—MUSICAL INSTRUMENTS

FOR GUITARS OF ALL TYPES, ELECTRONIC ORGANS, ACCORDIONS AND ALL OTHER MUSICAL INSTRUMENTS (U.S. CLS. 2, 21 AND 36).

ANN LINNEHAN, EXAMINING ATTORNEY

SN 79-001,558. J. RETTENMAIER & SÖHNE GMBH & CO. KG, FED REP GERMANY, FILED 12-24-2003.

VITACEL

THE MARK CONSISTS OF STANDARD CHARACTERS WITHOUT CLAIM TO ANY PARTICULAR FONT, STYLE, SIZE, OR COLOR.

OWNER OF INTERNATIONAL REGISTRATION 0821181 DATED 12-24-2003, EXPIRES 12-24-2013.
OWNER OF U.S. REG. NO. 1,520,355.

CLASS 1—CHEMICALS

FOR CELLULOSE AND BOTANICAL CEREAL AND RICE FIBER EXTRACTS FOR USE IN MAKING FOODSTUFFS (U.S. CLS. 1, 5, 6, 10, 26 AND 46).

CLASS 29—MEATS AND PROCESSED FOODS

FOR PROCESSED VEGETABLES SOLD AS EDIBLE FIBRE (U.S. CL. 46).

CLASS 30—STAPLE FOODS

FOR PROCESSED CEREAL AND RICE PARINGS FOR USE AS DIETARY FIBER AND AS ADDITIVES TO OTHER FOODS (U.S. CL. 46).

CLASS 31—NATURAL AGRICULTURAL PRODUCTS

FOR FIBERS FROM CEREAL AND RICE PARINGS FOR USE AS ANIMAL FEED AND FOODSTUFFS, AND AS NUTRITIONAL ADDITIVES IN THE PRODUCTION OF ANIMAL FEED AND FOODSTUFFS (U.S. CLS. 1 AND 46).

IRA J. GOODSAD, EXAMINING ATTORNEY

SN 79-001,559. FILATI DRAGO S.P.A., ITALY, FILED 12-4-2003.



OWNER OF INTERNATIONAL REGISTRATION 0821184 DATED 12-4-2003, EXPIRES 12-4-2013.

THE COLORS BLACK, BLUE AND YELLOW ARE CLAIMED AS A FEATURE OF THE MARK.

THE TRADEMARK CONSISTS OF A BLACK QUADRILATERAL WITHIN WHICH IS A BLUE OVAL WITH THE WORDS "COMPATTO DRAGO" PRINTED INSIDE IT IN THE COLOR YELLOW; "COMPATTO" RUNS ACROSS HORIZONTALLY WITH "DRAGO" CUTTING THROUGH IT OBLIQUELY, FROM TOP TO BOTTOM AND INTERSECTING IT AT THE LETTER "A" WHICH THEY SHARE.

THE WORDING COMPATTO DRAGO CAN BE TRANSLATED TO COMPACT DRAGON IN ENGLISH.

CLASS 23—YARNS AND THREADS

FOR YARNS AND THREADS (U.S. CL. 43).

CLASS 24—FABRICS

FOR FABRICS, NAMELY WOOLEN FABRICS AND MIXED FIBER FABRICS, NAMELY WOOL-SILK BLENDS AND WOOL-CASHMERE BLENDS (U.S. CLS. 42 AND 50).

MARY BOAGNI, EXAMINING ATTORNEY

SN 79-001,788. NAF NAF DISTRIBUTION B.V., NETHERLANDS, FILED 3-3-2004.

CHEVIGNON

THE MARK CONSISTS OF STANDARD CHARACTERS WITHOUT CLAIM TO ANY PARTICULAR FONT, STYLE, SIZE, OR COLOR.

OWNER OF INTERNATIONAL REGISTRATION 0556238 DATED 6-18-1990, EXPIRES 6-18-2010.

OWNER OF U.S. REG. NOS. 1,536,460, 2,330,714 AND OTHERS.

CLASS 3—COSMETICS AND CLEANING PREPARATIONS

FOR LAUNDRY BLEACH; BLUING FOR LAUNDRY; LAUNDRY DETERGENT; LAUNDRY PRE-SOAK; LAUNDRY STARCH; ALL-PURPOSE CLEANING PREPARATIONS; CHROME POLISH; FLOOR POLISH; FURNITURE POLISH; SCOURING LIQUIDS; SCOURING POWDERS; DISINFECTANT SOAPS; DEODORANT SOAP; DETERGENT SOAP; SKIN SOAP; TOILET SOAP; SHAVING SOAP; PERFUMERY, ESSENTIAL OILS FOR PERSONAL USE; COSMETICS; HAIR LOTION; DENTIFRICES (U.S. CLS. 1, 4, 6, 50, 51 AND 52).

CLASS 9—ELECTRICAL AND SCIENTIFIC APPARATUS

FOR GLASS TUBES FOR SCIENTIFIC PURPOSES; PRISMS FOR SCIENTIFIC PURPOSES; SATELLITES FOR SCIENTIFIC PURPOSES; NAVIGATIONAL BUOYS; SATELLITE NAVIGATIONAL SYSTEM, NAMELY, A GLOBAL POSITIONING SYSTEM KNOWN AS GPS; ELECTRIC FENCES; ELECTRIC OUTLET COVERS; ELECTRIC SWITCH PLATES; ELECTRIC GATE OPERATORS; ELECTRIC HAIR CURLERS; ELECTRIC HAIR CURLING IRONS; ELECTRIC DEVICES FOR ATTRACTING AND KILLING INSECTS; ELECTRIC IRONS; ELECTRIC LIGHT DIMMERS; ELECTRIC CIGARETTE LIGHTERS FOR LAND VEHICLES; ELECTRIC LOCKS; ELECTRIC LUMINESCENT DISPLAY PANELS; ELECTRIC PLUGS; ELECTRIC SIGNS; ELECTRIC SOCKETS; ELECTRIC ARC WELDERS; ELECTRIC DOOR BELLS; ELECTRIC HOT BRUSHES; ELECTRIC COILS; ELECTRIC CONVERTERS; SURVEYING CHAINS; PHOTOGRAPHIC CAMERAS; PHOTOGRAPHIC FLASHBULBS; PHOTOGRAPHIC PROJECTORS; PHOTOGRAPHIC SLIDE TRANSPARENCIES; PHOTOGRAPHY DARKROOM LAMPS; X-RAY PHOTOGRAPHS, OTHER THAN FOR MEDICAL PURPOSES; EXPOSED CAMERA FILM; COLOR SEPARATION FILM; EXPOSED X-RAY FILM; MOTION PICTURE FILMS FEATURING COMEDY, DRAMA, ACTION, ADVENTURE AND/OR ANIMATION; OPTICAL DISCS; OPTICAL FILTERS; OPTICAL MIRRORS, OPTICAL CHARACTER RECOGNITION APPARATUS; OPTICAL INSPECTION APPARATUS FOR INDUSTRIAL USE; OPTICAL LENS SIGHTS; OPTICAL MIRRORS; OPTICAL SCANNERS; OPTICAL OR TELESCOPIC LENS SIGHTS; EYE GLASSES; SUNGLASSES; SCALES; MEASURING CUPS; MEASURING SPOONS; POCKET CALIPERS FOR MEASURING; SIGNALING BUOYS; ANTI-INTRUSION ALARMS; BURGLAR ALARMS; FIRE ALARMS; PERSONAL SECURITY ALARMS, THEFT ALARMS; VIDEO CAMERAS; LIFE SAVING RAFTS; BASEBALL BATTING HELMETS; CATCHERS' HELMETS; CHIN STRAPS FOR FOOTBALL HELMETS; DIVING HELMETS; PROTECTIVE OR SAFETY HELMETS; MOTORCYCLE HELMETS; CHRONOGRAPHS FOR USE AS SPECIALIZED TIME

RECORDING APPARATUSES; AUDIO CASSETTE RECORDERS; AUDIO TAPE RECORDERS; VIDEO CASSETTE RECORDERS; EVENT RECORDERS; VIDEO TAPE RECORDERS; TELEVISION SETS; DIGITAL AUDIO TAPE PLAYERS; COMPACT DISC PLAYERS; PHONOGRAPH RECORD PLAYERS; STEREO AMPLIFIERS; STEREO RECEIVERS; STEREO TUNERS; RADIO INCORPORATING CLOCKS; RADIOS FOR VEHICLES; RADIOS; MOVIE PROJECTORS; BLANK MAGNETIC COMPUTER TAPES; MAGNETIC CODED CARD READERS; MAGNETIC CODED CARDS; MAGNETIC TAPE DRIVES; COMPUTER FIRMWARE, COMPUTER PROGRAMS, AND COMPUTER SOFTWARE THAT MAY BE DOWNLOADED FROM A GLOBAL COMPUTER NETWORK FOR USE IN DATABASE MANAGEMENT, DATABASE SEARCHING, FOR USE AS SPREADSHEETS, FOR WORD PROCESSING, AND FOR USE AS GAMES; DATA PROCESSORS; PRE-RECORDED AUDIO DISCS, PRE-RECORDED COMPACT DISCS, AND PRE-RECORDED VIDEO DISCS FEATURING MUSIC, COMEDY, DRAMA, ACTION, ADVENTURE AND/OR ANIMATION; BLANK FLOPPY COMPUTER DISCS; BLANK HARD COMPUTER DISCS; BLANK COMPUTER DISCS; COMPUTER GAME DISCS; COMPLETE INTERACTIVE AUDIO GAME DISCS CONTAINING ROLE PLAYING GAME, ACTION GAME, HAZARD GAMES; AUTOMATIC VENDING MACHINES; CASH REGISTERS; CALCULATORS; COMPUTERS; FIRE BLANKETS; FIRE EXTINGUISHERS; FIRE HOSE NOZZLES; FIRE SPRINKLERS (U.S. CLS. 21, 23, 26, 36 AND 38).

CLASS 14—JEWELRY

FOR ASHTRAYS OF PRECIOUS METAL; BADGES OF PRECIOUS METAL; TEA BALLS OF PRECIOUS METAL; PIGGY BANKS MADE OF PRECIOUS METAL; BELT BUCKLES OF PRECIOUS METAL FOR CLOTHING; DECORATIVE BOXES MADE OF PRECIOUS METAL; JEWELRY BOXES OF PRECIOUS METAL; JEWELRY CASES OF PRECIOUS METAL; BRACELETS OF PRECIOUS METAL; BUSTS OF PRECIOUS METAL; NON-ELECTRIC CANDELABRAS MADE OF PRECIOUS METAL; CANDLE HOLDERS OF PRECIOUS METAL; CANDLE RINGS OF PRECIOUS METAL; CANDLE SNUFFERS OF PRECIOUS METAL; CANDLETICKS OF PRECIOUS METAL; CIGARETTE CASES MADE OF PRECIOUS METAL; CIGARETTE HOLDERS MADE OF PRECIOUS METAL; CIGARETTE LIGHTERS MADE OF PRECIOUS METAL; PRECIOUS METAL MONEY CLIPS; COFFEE POTS OF PRECIOUS METAL; NON-ELECTRIC COFFEE SERVERS OF PRECIOUS METAL; COFFEE SERVICES OF PRECIOUS METAL; NON-MONETARY COINS OF PRECIOUS METALS; CRUET STANDS FOR OIL OR VINEGAR OF PRECIOUS METAL; CRUETS OF PRECIOUS METAL; FIGURES OF PRECIOUS METAL; FIGURINES OF PRECIOUS METAL; PRECIOUS GEMSTONES; GRAVE MARKERS OF PRECIOUS METAL; HAT ORNAMENTS OF PRECIOUS METAL; HAT PINS OF PRECIOUS METAL; TEA INFUSERS OF PRECIOUS METAL; INGOTS OF PRECIOUS METAL; MATCH BOXES OF PRECIOUS METAL; MATCH HOLDERS OF PRECIOUS METAL; NAPKIN RINGS OF PRECIOUS METAL; NUT CRACKERS OF PRECIOUS METAL; SHOE ORNAMENTS OF PRECIOUS METAL; SERVING PLATTERS OF PRECIOUS METAL; TEA POTS OF PRECIOUS METAL; COFFEE POTS OF PRECIOUS METAL; PRECIOUS METAL; PRECIOUS METALS AND THEIR ALLOYS SOLD IN BULK; SERVIETTE RINGS OF PRECIOUS METAL; SNUFF BOXES OF PRECIOUS METAL; CANDLE SNUFFERS OF PRECIOUS METAL; STATUES OF PRECIOUS METAL; TANKARDS OF PRECIOUS METAL; PRECIOUS METAL TROPHIES; PRECIOUS METAL TROPHIES COLUMNS; CHRONOGRAPHS FOR USE AS WATCHES; WATCHES CONTAINING AN ELECTRIC GAME FUNCTION; POCKET WATCHES; STOP WATCHES; PARTS FOR WATCHES; WATCHES (U.S. CLS. 2, 27, 28 AND 50).

CLASS 16—PAPER GOODS AND PRINTED MATTER

FOR ART PAPER; PAPER NAME BADGES; PAPER GARBAGE BAGS; PAPER PARTY BAGS; PAPER REFUSE BAGS; PAPER BAGS; PAPER BAGS FOR HOUSEHOLD USE; PAPER BANNERS; PAPER BATH MATS; PAPER BIBS; BLANK PAPER COMPUTER TAPES; PAPER BLINDS; PAPER ILLUSTRATION BOARDS; PAPER BOARDS; PAPER DRAWING BOARDS; BOND PAPER; PAPER GIFT WRAP BOWS; PAPER BOXES; PAPER BUNTING; PAPER CAKE DECORATIONS; CARBON PAPER; DECORATIVE PAPER CENTERPIECES; PAPER CLOSURES FOR SEALING CONTAINERS; PAPER CONTAINERS; COPY PAPER; PLASTIC COATED COPYING PAPER; CORRUGATED PAPER; PAPER COVERS FOR TELEPHONE RECEIVERS; CRAFT PAPER; CREPE PAPER; CUSHIONING OR PADDING MADE OF PAPER FOR PACKING PURPOSES; PAPER CUTTERS; PAPER DOILIES; DRAWING PAPER; PAPER ENVELOPES FOR PACKAGING; PAPER EXPANDING FILES; FACSIMILE TRANSMISSION PAPER; PAPER FILE JACKETS; FILLER PAPER; FILTER PAPER; PAPER FILTERS FOR COFFEE MAKERS; PAPER FLAGS; GIFT WRAPPING PAPER; PAPER GIFT WRAPPING RIBBONS; GROCERY PAPER; GUMMED PAPER; PAPER HANDKERCHIEFS; PAPER PARTY HATS; HEAT TRANSFER PAPER; PAPER SIGN HOLDERS; ILLUSTRATION PAPER; LAMINATED PAPER; PAPER TABLE LINEN; LINING PAPER; LOOSE LEAF PAPER; PAPER MAIL POUCHES; MANIFOLD PAPER; MASKING PAPER; PAPER BATH MATS; PAPER MATS; PLACE MATS OF PAPER; PAPER PICTURE MOUNTS; PAPER NAPKINS; PAPER NEWSPRINT; NOTE PAPER; NOTEBOOK PAPER; ONION SKIN PAPER; OPAQUE PAPER; COMPUTER PAPER; SHELF PAPER; SYNTHETIC PAPER; TISSUE PAPER; TOILET SEAT COVER PAPER; TOILET PAPER; TRACING PAPER; TYPEWRITER PAPER; WAX PAPER; PAPER TOWELS; PAPER TRAYS; PAPER WASHCLOTHS; PAPER PILLOW CASES; PLACE MATS OF PAPER; PRINTING PAPER; PROOFING PAPER; PUBLICATION PAPER; STATIONERY WRITING PAPER AND ENVELOPES; TABLE CLOTHS OF PAPER; TABLE LINENS OF PAPER; PAPER TAPE; CARDBOARD BOXES; CARDBOARD CARTONS; CARDBOARD CONTAINERS; CARDBOARD; CARDBOARD MAILING TUBES; PRINTED MATTER, NAMELY, MAGAZINES, NEWSPAPERS, GUIDES, BOOKLETS AND NEWSLETTERS, ALL IN THE FIELD OF COMEDY, DRAMA, ACTION, ADVENTURE AND/OR ANIMATION; CLOTH FOR BOOKBINDING; BOOKBINDING TAPE; BOOKBINDING WIRE; MOUNTED PHOTOGRAPHS; UNMOUNTED PHOTOGRAPHS; STATIONERY; ADHESIVES FOR STATIONERY OR HOUSEHOLD PURPOSES; ART ETCHINGS; ART MOUNTS; ART PADS; ART SKETCHING BOARDS; ARTISTS' BRUSHES; PAINTING SETS FOR ARTISTS; ARTISTS' PASTELS; ARTISTS' PENCILS; ARTISTS' PENS; PAINT BRUSHES; TYPEWRITERS; OFFICE REQUISITES, NAMELY, PAPER STAPLERS, PENS, PENCILS, RUBBER BANDS, PAPER CLIPS, PAPER STAPLES, MARKERS, HIGHLIGHTING MARKERS, ADHESIVE NOTE PAPER; PRINTED INSTRUCTIONAL AND TEACHING MATERIALS IN THE FIELD OF LITERATURE, MOTION PICTURES, ARTS, GAMES, COMPUTER PROGRAMS; PLASTIC GARBAGE BAGS; GENERAL PURPOSE PLASTIC BAGS; PLASTIC SANDWICH BAGS; PLASTIC FOOD STORAGE BAGS FOR HOUSEHOLD USE; PLASTIC WRAP; PLASTIC WRAPPING FILM NOT FOR COMMERCIAL OR INDUSTRIAL PURPOSES; PLASTIC BUBBLE PACKS FOR WRAPPING OR PACKAGING; PLAYING CARDS; PRINTING TYPE; PRINTING BLOCKS (U.S. CLS. 2, 5, 22, 23, 29, 37, 38 AND 50).

CLASS 18—LEATHER GOODS

FOR LEATHER SHOPPING BAGS; LEATHER BAGS FOR MERCHANDISE PACKAGING; LEATHER KEY FOBs; LEATHER SOLD IN BULK; LEATHER PURSES; LEATHER BRIEFCASES; LEATHER CARRY-ON BAGS; LEATHER CLUTCH BAGS; LEATHER DUFFEL BAGS; LEATHER GYM BAGS; LEATHER OVERNIGHT BAGS; LEATHER SCHOOL BOOK BAGS; LEATHER SHOULDER BAGS; LEATHER TOTE BAGS; LEATHER TRAVEL BAGS; LEATHER CLUTCH BAGS; LEATHER LUGGAGE; ANIMAL SKINS AND HIDES; LUGGAGE TRUNKS; UMBRELLAS; PARASOLS; WALKING STICKS; WHIPS; HARNESSSES; SADDLERY (U.S. CLS. 1, 2, 3, 22 AND 41).

CLASS 20—FURNITURE AND ARTICLES NOT OTHERWISE CLASSIFIED

FOR FURNITURE; MIRRORS BEING FURNITURE; PICTURE FRAMES; WOOD CHOPPING BLOCK TABLES; WOOD BOXES; WOOD BUSTS; WOOD CRATES; WOOD DOORKNOBS; WOOD FIGURES; WOOD FIGURINES; WOOD KEGS; WOOD LETTER BOXES; WOOD ORNAMENTS, NOT BEING CHRISTMAS TREE ORNAMENTS; WOOD SCULPTURES; WOOD STATUES; WOOD STATUETTES; WOOD BARRELS; BONE BUSTS; BONE FIGURES; BONE FIGURINES; BONE ORNAMENTS; BONE SCULPTURES; BONE STATUES; BONE STATUETTES; IVORY BUSTS; IVORY FIGURINES; IVORY FIGURES; IVORY; IVORY ORNAMENTS; IVORY SCULPTURES; IVORY STATUES; IVORY STATUETTES; SEA SHELLS; RAW MOTHER OF PEARL; CLEAR PLASTIC HOLDERS FOR BADGES; PLASTIC BANNERS; PLASTIC BIBS; PLASTIC BOXES; PLASTIC BUNTING; PLASTIC BUSTS; PLASTIC CAKE DECORATIONS; PLASTIC CAPS; PLASTIC CARD KEYS; PLASTIC CASTERS; CONTAINER CLOSURES OF PLASTIC; PLASTIC INSERTS FOR USE AS CONTAINER LINERS; PLASTIC MEDICATION CONTAINERS; PLASTIC CRATES; GIFT PACKAGE DECORATIONS MADE OF PLASTIC; PLASTIC GARAGE DOOR ROLLERS; DOOR STOPS OF PLASTIC; PLASTIC DOORKNOBS; PLASTIC STORAGE DRUMS; PLASTIC FIGURES; PLASTIC FIGURINES; PLASTIC FLAGS; PLASTIC KEY CHAIN TAGS; PLASTIC KEY TAGS; PLASTIC LETTER BOXES; PLASTIC NOVELTY LICENSE PLATES; PLASTIC LIDS; PLASTIC DRAWER LINING MATERIAL; PLASTIC LUGGAGE LINING MATERIAL; PLASTIC SHELF LINING MATERIAL; PLASTIC MAILING TUBES; PLASTIC ORNAMENTS, NOT BEING CHRISTMAS TREE ORNAMENTS; PLASTIC PENNANTS; PLASTIC PILLBOXES; PLASTIC EGG CARTONS FOR COMMERCIAL USE; PLASTIC LABELS; PULLEYS OF PLASTIC; PLASTIC SCULPTURES; PLASTIC STATUES; PLASTIC STATUETTES; PLASTIC TUBS, NOT BEING BATH TUBS (U.S. CLS. 2, 13, 22, 25, 32 AND 50).

CLASS 21—HOUSEWARES AND GLASS

FOR WOOD CHOPPING BLOCKS; WOOD CHOPPING BOARDS FOR KITCHEN USE; CONTAINERS FOR KITCHEN OR HOUSEHOLD USE, NOT OF PRECIOUS METAL; KITCHEN LADLES; HOUSEHOLD UTENSILS, NAMELY, GRATERS, GRILLS, POT AND PAN SCRAPERS, ROLLING PINS, SPATULAS, TURNERS, WHISKS, SIEVES, STRAINERS; CINDER SIFTERS FOR HOUSEHOLD USE; COLANDERS FOR HOUSEHOLD USE; ALL PURPOSE PORTABLE HOUSEHOLD CONTAINERS; CONTAINERS FOR KITCHEN OR HOUSEHOLD USE, NOT OF PRECIOUS METAL; DISPENSERS FOR LIQUID SOAP; CONTAINERS FOR HOUSEHOLD USE, NAMELY, GLASS BULBS; CONTAINERS FOR HOUSEHOLD USE, NAMELY, GLOBES; PLASTIC HOUSEHOLD GLOVES; RUBBER HOUSEHOLD GLOVES; HOUSEHOLD GLOVES FOR GENERAL USE; HOLDERS FOR HOUSEHOLD IRONS; LOOFAHS FOR HOUSEHOLD PURPOSES; SQUEEGEES FOR HOUSEHOLD USE; PRE-MOISTENED TOWELETTES FOR HOUSEHOLD CLEANING; TRASH CONTAINERS FOR HOUSEHOLD USE; SOAP CONTAINERS; THERMAL INSULATED CONTAINERS FOR FOOD OR BEVERAGES; CONTAINERS FOR FOODS; CLEANING COMBS; CURRY COMBS; HAIR COMBS; COMB CASES; SPONGEHOLDERS; SCOURING SPONGES; SPONGES FOR APPLYING BODY POWDER; SPONGES FOR HOUSEHOLD PURPOSES; BRUSHES FOR BILLIARD TABLES; BLACKING BRUSHES; CLOTHES BRUSHES; COSMETIC BRUSHES; CRUMB BRUSHES; DISHWASHING BRUSHES; DUSTING BRUSHES; EYEBROW BRUSHES; FILE BRUSHES; FIREPLACE BRUSHES; FLOOR BRUSHES; HAIR BRUSHES; HORSE BRUSHES; LAMP GLASS BRUSHES; MUSHROOM BRUSHES; NAIL BRUSHES; POT CLEANING BRUSHES; SCRAPING BRUSHES; SCRUBBING BRUSHES; SHAVING BRUSHES; SHOE BRUSHES; TOILET BRUSHES; ELECTRIC AND NON-ELECTRIC TOOTH BRUSHES; BRUSHES FOR BASTING MEAT; BRUSHES FOR FOOTWEAR; BRUSHES FOR PARQUET FLOORS; BRUSHES FOR PETS; BRUSHES FOR USE ON BARK OF TREES; WIRE BRUSHES, NOT BEING MACHINE PARTS; MATERIAL FOR BRUSH MAKING; IMPREGNATED CLEANING CLOTHS; CLEANING CLOTHS; CLEANING COTTON; CLEANING MITTS OF FABRIC; CLEANING PADS; CLEANING RAGS; METAL

WOOL FOR CLEANING; MITTS OF FABRIC FOR CLEANING; IMPREGNATED PAPER TISSUES FOR CLEANING DISHWARE; IMPREGNATED STEEL WOOL FOR CLEANING; GLASS BOWLS; GLASS BOXES; GLASS BUSTS; GLASS CASTERS; GLASS FABRICS FOR INDUSTRIAL USE; GLASS FIGURES; GLASS FIGURINES; ENAMELED GLASS; GROUND PLATE GLASS; OPAL GLASS; OPALINE GLASS; POLISHED PLATE GLASS; PRESSED GLASS; SMOOTHED PLATE GLASS; SPECKLED GLASS; SPUN GLASS; STAINED GLASS; STAMPED GLASS; UNWROUGHT GLASS; GLASS BEVERAGEWARE; GLASS ETCHED BY ACID; GLASS FIBERS FOR NON-TEXTILE PURPOSES; GLASS FIBERS FOR REINFORCING PLASTICS; PLATE GLASS FOR CARS; GLASS FOR SIGNAL LIGHTS OR HEADLIGHTS FOR VEHICLES; UNFINISHED GLASS FOR VEHICLE WINDOWS; GLASS MOSAICS NOT FOR BUILDINGS; GLASS RODS; GLASS STOPPERS; GLASS THREADS FOR NON-TEXTILE PURPOSES; GLASS TUBES NOT FOR SCIENTIFIC PURPOSES; GLASS WOOL NOT FOR INSULATION; GLASS YARNS; GLASS JARS FOR JAMS AND JELLIES; GLASS KNOBS; MOSAICS OF GLASS, NOT FOR BUILDINGS; GLASS MUGS; GLASS ORNAMENTS, NOT INCLUDING CHRISTMAS TREE ORNAMENTS; GLASS PANS; PLATE GLASS; GLASS SCULPTURES; SIGNAL LIGHT GLASS; STAINED GLASS FIGURINES; GLASS STATUES; GLASS STATUETTES; WINDOW GLASS FOR VEHICLES; PORCELAIN BUSTS; PORCELAIN DOORKNOBS; PORCELAIN EGGS; PORCELAIN FIGURES; PORCELAIN FIGURINES; PORCELAIN JARS FOR JAMS AND JELLIES; PORCELAIN KNOBS; PORCELAIN MUGS; PORCELAIN ORNAMENTS, NOT INCLUDING CHRISTMAS TREE ORNAMENTS; PORCELAIN SCULPTURES; PORCELAIN STATUES; PORCELAIN STATUETTES; EARTHENWARE BASINS; EARTHENWARE BUSTS; EARTHENWARE DOORKNOBS; EARTHENWARE FIGURES; EARTHENWARE FIGURINES; EARTHENWARE JARS FOR JAMS OR JELLIES; EARTHENWARE MUGS; EARTHENWARE SCULPTURES; EARTHENWARE STATUES; EARTHENWARE STATUETTES (U.S. CLS. 2, 13, 23, 29, 30, 33, 40 AND 50).

CLASS 24—FABRICS

FOR TEXTILES AND TEXTILE GOODS, NAMELY, COTTON FABRIC, HEMP FABRIC, SILK CLOTH, SPUN SILK FABRIC, RAW SILK FABRIC, WOOLEN FABRIC, SYNTHETIC FIBER FABRIC, MIXED COTTON FABRIC, MIXED HEMPEN FABRIC, MIXED SILK FABRIC, MIXED WOOLEN FABRIC, WOOL-COTTON FABRIC, HEMP-COTTON FABRIC, SILK-WOOL FABRIC, HEMP-WOOL FABRIC, COTTON KNITTED FABRIC, SILK KNITTED FABRIC, WOOL KNITTED FABRIC, CHEMICAL FIBER KNITTED FABRIC; BED SPREADS; DUVETS; EIDERDOWNS; TABLE CLOTHS NOT OF PAPER; FABRIC TABLE RUNNERS; TEXTILE NAPKINS; BED SHEETS; PILLOW CASES; COVERS FOR CUSHIONS (U.S. CLS. 42 AND 50).

CLASS 25—CLOTHING

FOR CLOTHING, NAMELY JEANS, SHORTS, BERMUDA SHORTS, TROUSERS, DUNGAREES, COMBINATIONS, SHIRTS, WIND RESISTANT JACKETS, PULLOVERS, TEE-SHIRTS, SWEATSHIRTS, UNDERWEAR, SOCKS, BATHROBES, LINGERIE, LAYETTES, TIES, GLOVES, STOLE, SCARVES, SASHES FOR WEAR, SHAWLS; SHOES, SLIPPERS; HEADWEAR, HATS, CAPS, BERETS, BONNETS; BATHROBES; BATH SANDALS; BATH SLIPPERS; BATHING CAPS; BATHING DRAWERS; BATHING SUITS; BATHING TRUNKS; BEACH CLOTHES; BEACH SHOES; BELTS; BLAZERS; BODICES IN THE NATURE OF LINGERIE; BOMBER JACKETS; BOOTS; BOOTS FOR SPORTS; MOTORCYCLE BOOTS; BRACES AND SUSPENDERS; BRASSIERES; CAMISOLES; COATS; CLOTHING COMBINATIONS; NAMELY, OVERALLS AND DUNGAREES; CORSETS; CYCLISTS' CLOTHING; NAMELY, CYCLING SHORTS, SINGLET, HEAD CAPS AND CYCLING SHOES; DRESSES; DRESSING GOWNS; EAR MUFFS; FOOTBALL BOOTS; FOOTBALL SHOES; FROCKS; GABERDINES; GAITERS; GALOSHES; GARTERS; GIRDLES; GLOVES; GYMNASIUM SHOES; HALF BOOTS; HATS; HEADBANDS; HOSIERY; JERSEYS; JUMPERS; CARDIGANS; LEGGINGS; BODY LINEN, NAMELY, UNDERWEAR AND UNDERGARMENTS; MITTENS;

MOTORCYCLISTS' CLOTHING AND MOTORCYCLE RIDING CLOTHES; NAMELY, BOOTS, PANTS, JACKETS AND GLOVES FOR RIDING MOTORCYCLES; NECKTIES; OUTER CLOTHING; NAMELY, COATS, ANORAKS, RAINCOATS, CAPES, JACKETS; OVERALLS; OVERCOATS; PAJAMAS; PANTS; PARKAS; PETTICOATS; SANDALS; SCARVES; SHAWLS; SHOES; SINGLET; SKIRTS; SLIPS; SMOCKS; SOCK SUSPENDERS; SOCKS; SPORTS JERSEYS; SPORT SHOES; STOCKING SUSPENDERS; STOCKINGS; SUITS; SWEATERS; SWIMSUITS; TEDDIES; TIGHTS; UNDERPANTS; UNDERWEAR; VESTS; AND WAISTCOATS (U.S. CLS. 22 AND 39).

CLASS 34—SMOKERS' ARTICLES

FOR TOBACCO; MATCHES; SMOKING PIPE CLEANERS; SMOKING PIPES; CIGARS; CIGARETTES (U.S. CLS. 2, 8, 9 AND 17).

SONYA STEPHENS, EXAMINING ATTORNEY

SN 79-001.987. ANTON HULSHOF, NETHERLANDS, FILED 3-9-2004.

EXPANTIUM

THE MARK CONSISTS OF STANDARD CHARACTERS WITHOUT CLAIM TO ANY PARTICULAR FONT, STYLE, SIZE, OR COLOR.

PRIORITY DATE OF 11-20-2003 IS CLAIMED.

OWNER OF INTERNATIONAL REGISTRATION 0820052 DATED 12-23-2003, EXPIRES 12-23-2013.

SN 79-001.891. LAUREUS WORLD SPORTS AWARDS LIMITED, UNITED KINGDOM, FILED 1-23-2004.

SPORT FOR GOOD

THE MARK CONSISTS OF STANDARD CHARACTERS WITHOUT CLAIM TO ANY PARTICULAR FONT, STYLE, SIZE, OR COLOR.

OWNER OF INTERNATIONAL REGISTRATION 0728377 DATED 12-29-1999, EXPIRES 12-29-2009.

OWNER OF U.S. REG. NO. 2,557,828.

NO CLAIM IS MADE TO THE EXCLUSIVE RIGHT TO USE "SPORT", APART FROM THE MARK AS SHOWN.

CLASS 41—EDUCATION AND ENTERTAINMENT

FOR EDUCATION SERVICES, NAMELY, PROVIDING INCENTIVES TO PEOPLE IN ORGANIZATIONS WHO DEMONSTRATE EXCELLENCE IN THE FIELD OF SPORTS AND ATHLETICS FOR THE ISSUANCE OF AWARDS; TRAINING SERVICES IN THE FIELD OF SPORTS, NAMELY, VOLLEYBALL, BASKETBALL, SOCCER, ICE HOCKEY, BOXING, GOLF, TAE KWAN DO, AND TRACK AND FIELD, AND IN THE FIELD OF CONDUCTING SPORTING EVENTS, SPORTING EXHIBITIONS AND AWARD PROGRAMS; ORGANIZING COMMUNITY SPORTING AND CULTURAL EVENTS; ENTERTAINMENT SERVICES, NAMELY, PROVIDING TELEVISION AND RADIO PROGRAMS FEATURING SPORTING EVENTS, SPORTS AND ATHLETIC COMPETITIONS, AWARD SHOWS, THE HISTORY OF SPORTS AND ATHLETICS, HISTORICAL FIGURES AND FAMOUS PERSONS IN THE ATHLETIC AND SPORTING FIELDS (U.S. CLS. 100, 101 AND 107).

CLASS 42—SCIENTIFIC, COMPUTER AND LEGAL SERVICES

FOR RESTAURANT SERVICES; PROVIDING TEMPORARY ACCOMMODATIONS; MEDICAL HYGIENIC AND BEAUTY CARE; VETERINARY AND AGRICULTURAL SERVICES; LEGAL SERVICES; SCIENTIFIC AND INDUSTRIAL RESEARCH, NAMELY, RESEARCH IN THE AREA OF HOW SPORTS AND TEAM ACTIVITIES CONTRIBUTE TO THE DEVELOPMENT OF LEADERSHIP SKILLS, MOTIVATION SKILLS AND SOCIAL CHANGE; COMPUTER PROGRAMMING SERVICES FOR OTHERS (U.S. CLS. 100 AND 101).

AMOS T. MATTHEWS, JR., EXAMINING ATTORNEY

CLASS 35—ADVERTISING AND BUSINESS

FOR ADVERTISING SERVICES, NAMELY MEDIATION OF ADVERTISING, PREPARING AND PLACING ADVERTISEMENTS FOR OTHERS, DIRECT MARKETING ADVERTISING FOR OTHERS, PLANNING AND CONDUCTING OF TRADE FAIRS, EXHIBITIONS AND PRESENTATIONS FOR ADVERTISING PURPOSES AND ADVERTISING AGENCIES; BUSINESS MANAGEMENT; BUSINESS ADMINISTRATION AND OFFICE FUNCTIONS (U.S. CLS. 100, 101 AND 102).

CLASS 36—INSURANCE AND FINANCIAL

FOR INSURANCE SERVICES, NAMELY INSURANCE ACTUARIAL SERVICES, INSURANCE CONSULTATION AND FINANCIAL EVALUATION FOR INSURANCE PURPOSES; FINANCIAL AFFAIRS, NAMELY FINANCIAL ANALYSIS AND CONSULTATION, FINANCIAL RESEARCH, FINANCIAL FORECASTING, FINANCIAL PLANNING, FINANCIAL MANAGEMENT, BUSINESS FINANCE PROCUREMENT SERVICES, PROJECT FINANCING, FACILITATING AND ARRANGING FOR THE FINANCING OF BUSINESS INITIATIVES AND INDUSTRIAL ACTIVITIES, FINANCIAL RISK MANAGEMENT, FISCAL VALUATIONS AND ASSESSMENTS, INVESTMENT BANKING SERVICES, ADVICE RELATING TO INVESTMENTS, INVESTMENT MANAGEMENT, CAPITAL INVESTMENT CONSULTATION, MANAGEMENT OF A CAPITAL INVESTMENT FUND, FUNDS INVESTMENT AND INVESTMENT OF FUNDS FOR OTHERS, MANAGEMENT OF PORTFOLIOS COMPRISING SECURITIES, ASSET MANAGEMENT AND BANKING SERVICES INCLUDING ON-LINE BANKING AND PROVIDING BANKING SERVICES VIA THE INTERNET; MONETARY SERVICES, NAMELY BROKERAGE OF SHARES OR STOCKS AND OTHER SECURITIES AND MONETARY EXCHANGE; REAL ESTATE BUSINESS, NAMELY REAL ESTATE INVESTMENT AND REAL ESTATE CONSULTATION (U.S. CLS. 100, 101 AND 102).

CLASS 42—SCIENTIFIC, COMPUTER AND LEGAL SERVICES

FOR SCIENTIFIC AND TECHNOLOGICAL CONSULTATION AND RELATED RESEARCH SERVICES IN THE FIELD OF INFORMATION TECHNOLOGY AND INFORMATION SYSTEMS; DESIGN SERVICES FOR OTHERS IN THE FIELD OF INFORMATION SYSTEMS; INDUSTRIAL ANALYSIS AND RESEARCH SERVICES; COMPUTER AND SOFTWARE DESIGN AND DEVELOPMENT; LEGAL SERVICES (U.S. CLS. 100 AND 101).

PRISCILLA MILTON, EXAMINING ATTORNEY

SN 79-002,044. KNEIPP-WERKE KNEIPP-MITTEL-ZENTRALE; GMBH & CO. KG, FED REP GERMANY, FILED 11-13-2003.



PRIORITY DATE OF 5-13-2003 IS CLAIMED.
OWNER OF INTERNATIONAL REGISTRATION 0823001
DATED 11-13-2003, EXPIRES 11-13-2013.

OWNER OF U.S. REG. NOS. 1,742,620, 2,742,716 AND OTHERS.

THE PORTRAIT DOES NOT IDENTIFY A PARTICULAR LIVING INDIVIDUAL.

CLASS 3—COSMETICS AND CLEANING PREPARATIONS

FOR PERFUMERY, COSMETIC PREPARATIONS FOR BATHS, NAMELY BATH SALTS, BATH OILS, HERBAL BATHS, HERBAL SHOWER PREPARATIONS, NAMELY HERBAL SHOWER GELS AND FOAMS; SOAPS, PERFUMES, ESSENTIAL OILS, FRAGRANT SPRAYS, COSMETICS, NAMELY SKIN MILKS, SKIN CREAMS, FACIAL MASKS, CREAMS AND SCRUBS, HAIR LOTIONS, MASSAGE OILS, SKIN OILS, FOOT BALM, FOOT BATH SALTS, FOOT SPRAYS, FOOT BATH TABLETS, BATH TABLETS, SPARKLING BATH TABLETS, INCLUDING ALL THE AFORESAID GOODS WITH HERBS; DENTIFRICES, DENTAL AND MOUTHWASH (U.S. CLS. 1, 4, 6, 50, 51 AND 52).

CLASS 5—PHARMACEUTICALS

FOR PHARMACEUTICAL PREPARATIONS FOR STRENGTHENING THE IMMUNE SYSTEM, WEIGHT MANAGEMENT, WITH DIURETIC EFFECT, AGAINST WRINKLES, FOR STIMULATING BLOOD CIRCULATION, WITH ANTI DEPRESSIVE EFFECT, FOR THE TREATMENT OF RHEUMATISM, MUSCLE ACHES AND PAINS, HEADACHE, MIGRAINE, INSOMNIA, STRESS, AGEING, CIRCULATION, CELLULITIS, HIGH BLOOD PRESSURE, HEAVY AND TIRED LEGS, CYSTITIS, NEURODERMATITIS, PSORIASIS AND ALL KIND OF OTHER SKIN DISEASES, ALLERGIES, ACUTE AND CHRONIC COLDS (CATARRHS) OF THE RESPIRATORY TRACTS, ARTHROSIS, GALL ILLNESSES, KIDNEY ILLNESSES, CARDIAC TROUBLES, DIGESTIVE TROUBLES, ARTERIOSCLEROSIS, BLOOD CIRCULATION DISTURBANCES, FURUNCLE, COUGH, DEHYDRATION, CONSTIPATION, COLDS, THE BILE, DEPRESSIONS, IN THE FORM OF MEDICINES EXTRACTED FROM MEDICINAL PLANTS AND HERBS, NAMELY SWEETMEATS (CANDY), PILLS, DRAGEES, POWDERS, PACKAGES, SALVES, BALMS, OILS, DROPS AND JUICES, PHARMACEUTICAL BATH ADDITIVES; COUGH EXPECTORANTS, LOZENGES AND SYRUPS, MEDICATED FOOT POWDER, GARGLES, LINIMENTS; PHARMACEUTICAL, VETERINARY AND SANITARY PREPARATIONS FOR STRENGTHENING THE IMMUNE SYSTEM, WEIGHT MANAGEMENT, WITH DIURETIC EFFECT, AGAINST WRINKLES, FOR STIMULATING BLOOD CIRCULATION, FOR THE TREATMENT OF RHEUMATISM, MUSCLE ACHES AND PAINS, HEADACHE, MIGRAINE, INSOMNIA, STRESS, AGEING, CIRCULATION, CELLULITIS, HIGH BLOOD PRESSURE, HEAVY AND TIRED LEGS, LEG PAIN, CYSTITIS, NEURODERMATITIS, ALLERGIES, ACUTE AND CHRONIC COLDS (CATARRHS) OF THE RE-

SPIRATORY TRACTS, ARTHROSIS, GALL ILLNESSES, KIDNEY ILLNESSES, CARDIAC TROUBLES, DIGESTIVE TROUBLES, ARTERIOSCLEROSIS, BLOOD CIRCULATION DISTURBANCES, FURUNCLE, COUGH, DEHYDRATION, CONSTIPATION, COLDS, THE BILE; PHYTOTHERAPEUTIC MEDICINAL PREPARATIONS FOR STRENGTHENING THE IMMUNE SYSTEM, WEIGHT MANAGEMENT, WITH DIURETIC EFFECT, AGAINST WRINKLES, FOR STIMULATING BLOOD CIRCULATION, FOR THE TREATMENT OF RHEUMATISM, MUSCLE ACHES AND PAINS, HEADACHE, MIGRAINE, INSOMNIA, STRESS, AGEING, CIRCULATION, CELLULITIS, HIGH BLOOD PRESSURE, HEAVY AND TIRED LEGS, CYSTITIS, NEURODERMATITIS, ALLERGIES, ACUTE AND CHRONIC COLDS (CATARRHS) OF THE RESPIRATORY TRACTS, ARTHROSIS, GALL ILLNESSES, KIDNEY ILLNESSES, CARDIAC TROUBLES, DIGESTIVE TROUBLES, ARTERIOSCLEROSIS, BLOOD CIRCULATION DISTURBANCES, FURUNCLE, COUGH, DEHYDRATION, CONSTIPATION, COLDS, THE BILE; HEALTH CARE PREPARATIONS, NAMELY PREPARATIONS USING NATURAL PLANT EXTRACTS USED IN THE TREATMENT OF RHEUMATISM, MUSCLE ACHES AND PAINS, HEADACHE, MIGRAINE, INSOMNIA, STRESS, AGEING, AGAINST WRINKLES, CIRCULATION, CELLULITIS, FOR STRENGTHENING THE IMMUNE SYSTEM, WEIGHT MANAGEMENT; MEDICAL HERBS FOR STRENGTHENING THE IMMUNE SYSTEM, WEIGHT MANAGEMENT, WITH DIURETIC EFFECT, AGAINST WRINKLES, FOR STIMULATING BLOOD CIRCULATION, FOR THE TREATMENT OF RHEUMATISM, MUSCLE ACHES AND PAINS, HEADACHE, MIGRAINE, INSOMNIA, STRESS, AGEING, CIRCULATION, CELLULITIS, HIGH BLOOD PRESSURE, HEAVY AND TIRED LEGS, CYSTITIS, NEURODERMATITIS, ALLERGIES, ACUTE AND CHRONIC COLDS, (CATARRHS) OF THE RESPIRATORY TRACTS, ARTHROSIS, GALL ILLNESSES, KIDNEY ILLNESSES, CARDIAC TROUBLES, DIGESTIVE TROUBLES, ARTERIOSCLEROSIS, BLOOD CIRCULATION DISTURBANCES, FURUNCLE, COUGH, DEHYDRATION, CONSTIPATION, COLDS, THE BILE; MEDICINAL DIETETIC PREPARATIONS, IN PARTICULAR DIETETIC FOOD STUFFS FOR INVALIDS AND/OR FOOD FOR MEDICALLY RESTRICTED DIETS, NAMELY FRUIT-FIBRE LOZENGES; FOOD FOR BABIES; HEALTH TREATMENT SUPPLEMENTS, NAMELY VITAMINS, MINERALS, PROTEINS, PROTEINHYDROLYSATES, AMINOACIDS, CARBOHYDRATES, DIETETIC SUBSTANCES FOR MEDICAL USE, NAMELY FRUIT-FIBRE LOZENGES; TEAS CONTAINING MEDICINAL DRUGS, MEDICINAL TEAS, TEAS MADE OF MEDICINAL HERBS, MEDICINAL VINEGAR, MEDICINAL WINES, HERBAL ESSENCES WITH ALCOHOL FOR MEDICAL PURPOSES, MEDICINAL JUICES, INCLUDING PLANT JUICES, MIXED DRINKS FOR MEDICAL PURPOSES MADE FROM THE AFORESAID BEVERAGES, MEDICINAL HONEY ALL USED FOR THE TREATMENT OF MUSCLE ACHES AND PAINS, INSOMNIA, STRESS, AGEING, AGAINST WRINKLES, CIRCULATION, CELLULITIS, AND FOR STRENGTHENING THE IMMUNE SYSTEM, CYSTITIS, NEURODERMATITIS, ALLERGIES, ACUTE AND CHRONIC COLDS (CATARRHS) OF THE RESPIRATORY TRACTS, DIGESTIVE TROUBLES, COUGH, COLDS; MEDICATED BATH PREPARATIONS; SANITARY COMPRESSES AND BANDAGES (U.S. CLS. 6, 18, 44, 46, 51 AND 52).

CLASS 30—STAPLE FOODS

FOR COFFEE AND COFFEE EXTRACTS; ARTIFICIAL COFFEE AND ARTIFICIAL COFFEE EXTRACTS; TEA, INFUSIONS, INCLUDING TEAS MADE FROM HERBAL MIXTURES, TEA EXTRACTS, TEA SUBSTITUTES, FRUIT TEA, TEA DRINKS, NAMELY MIXED DRINKS CONTAINING TEA TOGETHER WITH FRUIT AND/OR HERBAL SUBSTANCES; COCOA AND PREPARATIONS MADE FROM COCOA, CONFECTIONERY AND CHOCOLATE PRODUCTS, NAMELY BARS, TABLETS OF CHOCOLATE, BEANS, WAFFLES, DROPS; SUGAR CONFECTIONERY; SUGAR, RICE, TAPIOKA, SAGO; FLOUR AND PREPARATIONS MADE FROM CEREALS, NAMELY, BREAKFAST CEREALS; DESSERTS CONSISTING PRINCIPALLY OF RICE, SEMOLINA AND/OR STARCH, PUDDINGS, NAMELY DESSERT PUDDINGS; EDIBLE ICES, PRODUCTS FOR MAKING EDIBLE ICES, NAMELY ICE-CREAM POWDER, ICE CREAM MIXES FOR EDIBLE FRUIT ICES AND ICE-CREAM; HONEY

AND HONEY SUBSTITUTES, TREACLE; YEAST, BAKING POWDER, SALT, MUSTARD; VINEGAR; SAUCE CONDIMENTS, NAMELY SEASONINGS MADE OF BARLEY, MALT OR OTHER GRAINS (CEREALS), PEPPER, JUNIPER, ROSEMARY, THYME, CAYENNE PEPPER, GINGER, CLOVES; MAYONNAISE; PRODUCTS FOR FLAVORING OR SEASONING FOODSTUFFS, NAMELY BARLEY, MALT OR OTHER GRAINS (CEREALS), MALT COFFEE, PEPPER, JUNIPER, ROSEMARY, THYME, CAYENNE PEPPER, GINGER, CLOVES; BAKERY GOODS; PASTRIES AND CONFECTIONERY, NAMELY SUGAR CONFECTIONERY, NAMELY CANDY, MINTS; BREAD, MEAL REPLACEMENT BARS; ICE (U.S. CL. 46).

MARK SPARACINO, EXAMINING ATTORNEY

SN 79-002,144. ANZI BESSON INTERNATIONAL S.A.S; DI BESSON GIULIANO & C., I-10121 TORINO (TO), ITALY, FILED 1-14-2004.



Besson
ANZI BESSON

PRIORITY DATE OF 10-3-2003 IS CLAIMED.
OWNER OF INTERNATIONAL REGISTRATION 0823336 DATED 1-14-2004, EXPIRES 1-14-2014.
OWNER OF U.S. REG. NO. 2,796,700.

THE MARK COMPRISES THE NAME "ABESSON" IN BOLD FANCY FONT WITH THE LETTER A HIGHLY STYLIZED AND IN A TRAPEZOIDAL SHAPE, WITH THE SIDES DEFINING THE RIGHT ASCENDING STEM AND THE BAR OF THE LETTER WHILST FORMING A SINGLE UNIT WITH THE LETTER B; BELOW THIS NAME THERE ARE THE WORDS "ANZI BESSON" IN SMALLER AND MORE SUBTLE TYPE.

CLASS 3—COSMETICS AND CLEANING PREPARATIONS

FOR PERFUMES; PERFUMES IN SOLID FORM; ESSENTIAL OILS FOR PERSONAL USE; SOAPS; LIQUID SOAPS; CAKES OF SOAP; BUBBLE BATHS; BATH SALTS; HAIR-CARE PRODUCTS, NAMELY SHAMPOOS, HAIR LOTIONS, PREPARATIONS FOR THE CLEANING, CARE AND BEAUTIFICATION OF THE SKIN, SCALP AND HAIR, HAIR STYLING MOUSSES, HAIR SPRAY; PERSONAL DEODORANTS; DENTIFRICES; COSMETIC PRODUCTS, NAMELY COSMETIC SKIN CREAMS, MASCARA, EYELINERS, EYE SHADOWS, MAKE-UP PENCILS, FACE POWDERS, LIPSTICKS, FOUNDATIONS, MAKE-UP BAGS CONTAINING THE AFORESAID PRODUCTS, COSMETIC PRODUCTS FOR SLIMMING, NAMELY BODY CREAMS; NAIL VARNISH FOR COSMETIC PURPOSES; NAIL HARDENERS; NAIL VARNISH REMOVERS, SUN TANNING OILS AND CREAMS; SHAVING PRODUCTS, NAMELY DEPILATORY CREAMS; CLEANING PRODUCTS, NAMELY SKIN LOTIONS; MAKE-UP REMOVAL PRODUCTS, NAMELY MAKE-UP REMOVAL GELS; PEELING PRODUCTS, NAMELY FACIAL MASKS (U.S. CLS. 1, 4, 6, 50, 51 AND 52).

CLASS 5—PHARMACEUTICALS

FOR DIETARY SUPPLEMENTS MADE WITH VITAMINS, MINERALS, AMINO ACIDS, ESSENTIAL FATTY ACIDS, FIBRES, PLANTS AND VEGETABLE EXTRACTS (U.S. CLS. 6, 18, 44, 46, 51 AND 52).

CLASS 25—CLOTHING

FOR CLOTHING, NAMELY JACKETS OF DOWN, WAISTCOATS, CARDIGANS, JACKETS, SKI JACKETS AND JACKETS FOR LEISURE; SKI SETS CONSISTING OF ANORAKS WITH OVERALLS OR OF SKI SUITS WITH VESTS, COVERALLS, TROUSERS, DUNGAREES, GLOVES, JUMPERS, PULLOVERS, STOCKINGS AND TIGHTS, BELTS, SASHES FOR WEAR, SHIRTS, SCARVES, SKIRTS, NECKTIES, COATS, SHOES, SKI BOOTS, AND SWIMMING COSTUMES; HEADGEAR FOR WEAR, NAMELY HATS AND CAPS (U.S. CLS. 22 AND 39).

DAWN HAN, EXAMINING ATTORNEY

SN 79-002,209. FRANCK PETOUD, SWITZERLAND, FILED 4-1-2004.



SNOW SCOOT
BICYCLE SNOW MACHINE _____ DISTRIBUTION

OWNER OF INTERNATIONAL REGISTRATION 0745168 DATED 10-26-2000, EXPIRES 10-26-2010.

NO CLAIM IS MADE TO THE EXCLUSIVE RIGHT TO USE "BICYCLE SNOW MACHINE", APART FROM THE MARK AS SHOWN.

CLASS 12—VEHICLES

FOR MOUNTAIN BICYCLES (U.S. CLS. 19, 21, 23, 31, 35 AND 44).

CLASS 25—CLOTHING

FOR CLOTHING, NAMELY, SHIRTS, JACKETS, PANTS, FOOTWEAR, HATS, CAPS (U.S. CLS. 22 AND 39).

CLASS 28—TOYS AND SPORTING GOODS

FOR BICYCLES WITH SKI RUNNERS FOR GLIDING OVER SNOW (U.S. CLS. 22, 23, 38 AND 50).

G. MAYERSCHOFF, EXAMINING ATTORNEY

SN 79-002,338. FRANÇOIS JONCOURT, SWITZERLAND, FILED 4-6-2004.



Carvil

OWNER OF INTERNATIONAL REGISTRATION 0803785 DATED 2-20-2003, EXPIRES 2-20-2013.

CLASS 12—VEHICLES

FOR WHEELBARROW (U.S. CLS. 19, 21, 23, 31, 35 AND 44).

CLASS 28—TOYS AND SPORTING GOODS

FOR WHEELED, DETACHABLE, FOLDING, PORTABLE, LIGHT SLED/CARRIAGE FOR USE IN TRANSPORTING BAGS OR OTHER ARTICLES DURING WALKING, TREKKING, CLIMBING, DIVING, CAMPING, CARAVANNING, GLIDING, SAILING AND OTHER SPORTING ACTIVITIES WHERE EASY CARRYING OF A TRAVEL LOAD IS DESIRABLE (U.S. CLS. 22, 23, 38 AND 50).

ALICE BENMAMAN, EXAMINING ATTORNEY

SN 79-002,368. PIRANHA STUDIOS LIMITED, UNITED KINGDOM, FILED 1-21-2004.

BAD TASTE BEARS

THE MARK CONSISTS OF STANDARD CHARACTERS WITHOUT CLAIM TO ANY PARTICULAR FONT, STYLE, SIZE, OR COLOR.

PRIORITY DATE OF 7-22-2003 IS CLAIMED.

OWNER OF INTERNATIONAL REGISTRATION 0824118 DATED 1-21-2004, EXPIRES 1-21-2014.

OWNER OF U.S. REG. NO. 2,905,618.

NO CLAIM IS MADE TO THE EXCLUSIVE RIGHT TO USE BEARS, APART FROM THE MARK AS SHOWN.

CLASS 6—METAL GOODS

FOR METAL WALL ORNAMENTS, METAL FIGURINES AND METAL MODELS IN THE NATURE OF BEARS; KEY RINGS MADE FROM NON PRECIOUS METALS; KEY RINGS MADE FROM PEWTER; METAL KEY FOBs; METAL HOLIDAY ORNAMENTS IN THE SHAPE OF BEARS (U.S. CLS. 2, 12, 13, 14, 23, 25 AND 50).

CLASS 9—ELECTRICAL AND SCIENTIFIC APPARATUS

FOR MOUSE PADS; MOBILE PHONE CASES; MOBILE TELEPHONE ACCESSORIES IN THE NATURE OF HEADSETS; SUNGLASSES (U.S. CLS. 21, 23, 26, 36 AND 38).

CLASS 10—MEDICAL APPARATUS

FOR CONDOMS (U.S. CLS. 26, 39 AND 44).

CLASS 14—JEWELRY

FOR JEWELRY; TRINKETS IN THE NATURE OF SILVER CHARMS, BRACELETS AND RINGS AND KEY RINGS OF PRECIOUS METAL; FIGURINES, MODELS OF BEARS AND WALL ORNAMENTS OF PRECIOUS METAL; WATCHES AND CLOCKS; COSTUME JEWELRY; BADGES OF PRECIOUS METAL; BROOCHES AND NAME PLATES ALL MADE OF PRECIOUS METALS; TRINKETS IN THE NATURE OF CHARMS, BRACELETS, AND RINGS, ALL MADE FROM PEWTER AND OTHER NON PRECIOUS METALS; TRINKETS IN THE NATURE OF CHARMS, BRACELETS AND RINGS (U.S. CLS. 2, 27, 28 AND 50).

CLASS 16—PAPER GOODS AND PRINTED MATTER

FOR PAPER IN THE NATURE OF NOTE PAPER; STATIONERY; WRITING IMPLEMENTS; ENVELOPES; NOTE PADS; PENS; PENCILS; ERASERS; PRINTED MATTER IN THE NATURE OF POSTERS AND PRINTS IN THE FIELD OF BEARS; MAGAZINES IN THE FIELD OF BEARS; BOOKS IN THE FIELD OF BEARS; DRAWINGS; PHOTOGRAPHS; ARTISTS DRAWINGS; CARTOON PRINTS; PRINTED ART REPRODUCTIONS; PAINTINGS; CALENDARS; DIARIES; ARTISTS MATERIALS IN THE NATURE OF PAINTING SETS FOR ARTISTS, PAINT BRUSHES, EASELS, CRAYONS, CHALK, OIL PASTELS; PAPER SERVIETTES; PAPER BAGS; GREETING CARDS; TRANSFERS IN THE NATURE OF IRON-ON AND PLASTIC; DECALCOMANIA; STICKERS; FIGURINES AND STATUETTES MADE OF PAPER; PLACE MATS AND COASTERS OF PAPER; CARDBOARD CUT-OUTS; BAGS FOR KEEPING FOOD AND DRINK IN THE NATURE OF PLASTIC AND PAPER BAGS FOR HOUSEHOLD USE AND FOR RETAILERS (U.S. CLS. 2, 5, 22, 23, 29, 37, 38 AND 50).

CLASS 18—LEATHER GOODS

FOR HANDBAGS; WALLETS; PURSES; UMBRELLAS; OTHER ITEMS MADE OF LEATHER INCLUDED IN THIS CLASS IN THE NATURE OF LEATHER KEY CASES AND TRAVELING BAGS. (U.S. CLS. 1, 2, 3, 22 AND 41).

CLASS 20—FURNITURE AND ARTICLES NOT OTHERWISE CLASSIFIED

FOR FIGURINES, MODELS OF BEARS, AND WALL ORNAMENTS MADE FROM WOOD, WAX, PLASTER OR PLASTIC; NAMES PLATES, NOT OF METAL; KEY RINGS ALL MADE FROM PLASTIC, RESIN, PLASTER OR WOOD; KEY FOBs, NOT OF METAL (U.S. CLS. 2, 13, 22, 25, 32 AND 50).

CLASS 21—HOUSEWARES AND GLASS

FOR HOUSEHOLD AND KITCHEN UTENSILS, NAMELY, BOTTLE TOPPERS, FOIL CUTTERS FOR WINE BOTTLES, POT AND PAN SCRAPERS, ROLLING PINS, SPATULAS, TURNERS AND WHISKS; HOUSEHOLD CONTAINERS FOR FOOD; COMBS; CLEANING SPONGES; HAIR BRUSHES; BATH BRUSHES, GLASS FLASKS AND CONTAINERS FOR BEVERAGES; FIGURINES, MODELS OF BEARS AND WALL ORNAMENTS OF CERAMICS, PORCELAIN OR GLASS; DRINKING GLASSES; DRINKING CUPS; DISHES, PLATES; CROCKERY, NAMELY, CASSEROLES; CORKSCREWS, BOTTLE OPENERS; TRAYS NOT OF PRECIOUS METAL; HOUSEHOLD CONTAINERS FOR KEEPING FOOD AND DRINK; HOLDERS FOR BOTTLES, GLASSES OR CANS MADE OF RUBBER, PLASTIC OR VINYL; CHINAWARE AND TABLEWARE IN THE NATURE OF DISHES (U.S. CLS. 2, 13, 23, 29, 30, 33, 40 AND 50).

CLASS 24—FABRICS

FOR TEXTILES IN THE NATURE OF NAPKINS; BED SPREADS; TEXTILE TABLE COVERS; HOUSEHOLD LINENS; TOWELS; BAR TOWELS; CLOTH BUNTING; FABRIC FLAGS. (U.S. CLS. 42 AND 50).

CLASS 25—CLOTHING

FOR CLOTHING, NAMELY, T-SHIRTS, PANTS AND SHIRTS; HEADWEAR; FOOTWEAR; UNDERWEAR; HATS; BELTS; SLEEPWEAR; BATHROBES; SOCKS, SILK NECK TIES, SCARVES, GLOVES, BEACH CLOTHING, NAMELY, BEACH COVER-UPS, SHIRTS, SHORTS, AND SWIMSUITS; SLIPPERS AND BANDANAS. (U.S. CLS. 22 AND 39).

CLASS 26—FANCY GOODS

FOR CLOTH DECORATIVE BADGES FOR WEAR, NOT OF PRECIOUS METAL; BUTTONS FOR CLOTHING; ORNAMENTAL NOVELTY PINS; OTHER DECORATIVE ARTICLES FOR PERSONAL USE NOT MADE OF PRECIOUS METALS IN THE NATURE OF ORNAMENTAL CLOTH PATCHES. (U.S. CLS. 37, 39, 40, 42 AND 50).

CLASS 28—TOYS AND SPORTING GOODS

FOR TOYS IN THE NATURE OF FANTASY CHARACTER TOYS; PLAYTHINGS, NAMELY, TOY ACTION FIGURES; BOARD GAMES; PLUSH TOYS; PLUSH STUFFED TOYS; PLAYING CARDS, METAL CHRISTMAS TREE ORNAMENTS IN THE SHAPE OF BEARS (U.S. CLS. 22, 23, 38 AND 50).

CLASS 30—STAPLE FOODS

FOR SWEETS, NAMELY, CANDY; CHOCOLATES; BISCUITS; CAKES; SNACK FOODS IN THE NATURE OF WHEAT-BASED SNACK FOODS; BAKERY DESERTS; CUSTARD-BASED FILLINGS AND CHOCOLATE BASED FILLINGS FOR CAKES AND PIES; CHEWING GUM, BUBBLE GUM; OTHER CONFECTIONERY INCLUDED IN THIS CLASS IN THE NATURE OF PASTRIES (U.S. CL. 46).

CLASS 32—LIGHT BEVERAGES

FOR BEERS; MINERAL AND AERATED WATERS; NON-ALCOHOLIC DRINKS IN THE NATURE OF SOFT DRINKS, LEMONADE, ROOT BEER, ORANGEADE AND CHERRYADE; FRUIT DRINKS AND FRUIT JUICES; SYRUPS FOR MAKING FRUIT DRINKS AND SOFT DRINKS; PREPARATIONS FOR MAKING FRUIT DRINKS AND SOFT DRINKS. (U.S. CLS. 45, 46 AND 48).

CLASS 33—WINES AND SPIRITS

FOR ALCOHOLIC BEVERAGES, NAMELY, WINE, DISTILLED SPIRITS, LIQUEURS, AND ALCOPOPS IN THE NATURE OF AN ALCOHOLIC FRUIT DRINK. (U.S. CLS. 47 AND 49).

ANN E. SAPPENFIELD, EXAMINING ATTORNEY

CLASS 41—EDUCATION AND ENTERTAINMENT

FOR ARRANGING AND CONDUCTING EDUCATIONAL COLLOQUIUMS, CONFERENCES AND CONVENTIONS; EDUCATIONAL SERVICES, NAMELY, TEACHING AND TRAINING IN THE FIELD OF INFORMATION TECHNOLOGY AND COMMUNICATIONS, INCLUDING BY VIDEOCONFERENCING; PROVIDING INFORMATION IN THE FIELD OF EDUCATION OR ENTERTAINMENT; ORGANIZATION OF GAMES, EDUCATIONAL AND ENTERTAINMENT COMPETITIONS, LOTTERIES AND INFORMATION CAMPAIGNS, FOR CULTURAL OR EDUCATIONAL PURPOSES; ARRANGING AND CONDUCTING OF TRAINING WORKSHOPS, PRACTICAL TRAINING, TRAINING AND FURTHER TRAINING IN THE FIELD OF INFORMATION TECHNOLOGY AND TELECOMMUNICATIONS; CONDUCTING SEMINARS, CONVENTIONS AND COURSES IN THE FIELD OF INFORMATION TECHNOLOGY AND TELECOMMUNICATIONS; TRAINING AND INSTRUCTION IN THE FIELD OF PROGRAMMING, INSTALLATION, OPERATION, MANAGEMENT, MAINTENANCE OF COMPUTERS AND TELECOMMUNICATIONS APPARATUS, EQUIPMENT AND SOFTWARE, RELATED TO COMPUTERS AND TELECOMMUNICATIONS APPARATUS AND INSTRUMENTS; EDITING AND PUBLISHING SERVICES FOR ALL SOUND AND/OR VISUAL MEDIA, FOR MEDIA FOR RECORDING, TRANSMITTING AND REPRODUCING SOUND AND/OR IMAGES, EXCLUDING ADVERTISING MEDIA; PUBLISHING OF MULTIMEDIA CARRIERS IN THE NATURE OF ELECTRONIC PUBLISHING SERVICES, NAMELY, PUBLICATION OF WORKS OF OTHERS CONTAINING TEXT, GRAPHICS, SOUNDS AND IMAGES, ON CDS, DVDS AND ON-LINE, FEATURING INFORMATION RELATING TO INFORMATION TECHNOLOGY AND TELECOMMUNICATIONS; BOOK LOANING, CORRESPONDENCE COURSES IN THE FIELD OF INFORMATION TECHNOLOGY AND TELECOMMUNICATIONS; SHOW PRODUCTION, NAMELY, TELEVISION, MOTION PICTURE FILMS AND LIVE SHOW PERFORMANCES; FILM PRODUCTION; SERVICES PROVIDED BY A FRANCHISER, NAMELY BASIC STAFF TRAINING; ORGANIZATION OF EXHIBITIONS FOR CULTURAL OR EDUCATIONAL PURPOSES; SPORTING AND CULTURAL ACTIVITIES, NAMELY, ORGANIZING CULTURAL SHOWS AND FAIRS; ORGANIZATION OF SPORTS COMPETITIONS, BOOKING OF SEATS FOR SHOWS; RENTAL OF VIDEO APPARATUS, SOUND RECORDINGS, VIDEOTAPES (U.S. CLS. 100, 101 AND 107).

SN 79-002,370. FRANCE TELECOM, FRANCE, FILED 12-23-2003.

GMS GREEN MOBILE STATION

THE MARK CONSISTS OF STANDARD CHARACTERS WITHOUT CLAIM TO ANY PARTICULAR FONT, STYLE, SIZE, OR COLOR.

OWNER OF INTERNATIONAL REGISTRATION 0824135 DATED 12-23-2003, EXPIRES 12-23-2013.

NO CLAIM IS MADE TO THE EXCLUSIVE RIGHT TO USE "GREEN MOBILE STATION", APART FROM THE MARK AS SHOWN.

CLASS 9—ELECTRICAL AND SCIENTIFIC APPARATUS

FOR TELEPHONE AND RADIOTELEPHONE EMITTERS AND RECEIVERS WITH ENERGY-SAVING OPERATING MODE; TELEPHONE ANSWERING MACHINES; EQUIPMENT FOR FIXED, TRANSPORTABLE, MOBILE, HANDS-FREE OR VOICE-ACTIVATED TELEPHONES WITH ENERGY-SAVING OPERATING MODE, NAMELY, EARPHONES, BATTERY PACKS, BATTERY CHARGERS, HANDS-FREE KITS, NAMELY, DEVICES FOR HANDS FREE USE OF MOBILE PHONES, WIRELESS ADAPTERS FOR ENABLING WIRELESS COMMUNICATION, POWER ADAPTERS (U.S. CLS. 21, 23, 26, 36 AND 38).

CLASS 42—SCIENTIFIC, COMPUTER AND LEGAL SERVICES

FOR CONSULTING IN COMPUTERS AND COMPUTER PROGRAMMING, NAMELY, PROVIDING ADVICE AND TECHNICAL EXPERTISE AND ASSISTANCE, IN THE FIELD OF INFORMATION TECHNOLOGY AND TELECOMMUNICATIONS; TECHNICAL ASSISTANCE SERVICES, NAMELY, TROUBLESHOOTING OF PROBLEMS IN OPERATING AND MONITORING COMPUTER, TELECOMMUNICATIONS AND DATA TRANSMISSION NETWORKS IN THE FIELD OF INFORMATION TECHNOLOGY AND TELECOMMUNICATIONS; TECHNICAL EXPERTISE, CONSULTATION AND ADVICE IN THE FIELD OF TELECOMMUNICATIONS AND INFORMATION TECHNOLOGY; TELECOMMUNICATIONS NETWORKS ENGINEERING, AND SOFTWARE PROGRAMMING FOR OTHERS; ENGINEERING SERVICES FOR OTHERS WITH RESPECT TO COMMISSIONING TELECOMMUNICATION TERMINALS AND TELEPHONE APPARATUS WITH ENERGY-SAVING OPERATING MODE; COMPUTER RENTAL; COMPUTER PROGRAMMING FOR OTHERS IN THE FIELD OF INFORMATION TECHNOLOGY AND TELECOMMUNICATIONS; TECHNICAL CONSULTATION IN INFORMATION TECHNOLOGY ORGANIZATION, NAMELY, TELECOMMUNICATION AND INFORMATION NEEDS AND NETWORKING REQUIREMENTS OF AN ENTITY; TECHNICAL ADVICE ON HOW TO CHOOSE AND OPERATE TELECOMMUNICATIONS EQUIPMENT AND COMPUTERS THEREFOR (U.S. CLS. 100 AND 101).

ALEX KEAM, EXAMINING ATTORNEY

SN 79-002,451. FAVATA IGNAZIA, ITALY, FILED 1-28-2004.

JOE COLOMBO

PRIORITY DATE OF 11-14-2003 IS CLAIMED.
OWNER OF INTERNATIONAL REGISTRATION 0824419
DATED 1-28-2004, EXPIRES 1-28-2014.
JOE COLOMBO DOES NOT IDENTIFY A LIVING IN-
DIVIDUAL.

CLASS 8—HAND TOOLS

FOR CUTLERY, NAMELY FORKS, SPOONS AND
KNIVES (U.S. CLS. 23, 28 AND 44).

CLASS 11—ENVIRONMENTAL CONTROL AP- PARATUS

FOR APPARATUS FOR LIGHTING, NAMELY ELEC-
TRIC LIGHTING FIXTURES, SCONCES, ARC LAMPS,
TABLE LAMPS, FLOOR LAMPS, Klieg LIGHTS, WALL
LIGHTS, LIGHT DIFFUSERS; APPARATUS FOR VEN-
TILATING, NAMELY VENTILATING FANS FOR COM-
MERCIAL AND INDUSTRIAL USE, VENTILATING
EXHAUST FANS; APPARATUS FOR SANITARY PUR-
POSES, NAMELY WATER CLOSETS, SINKS, BATHS,
BIDETS (U.S. CLS. 13, 21, 23, 31 AND 34).

CLASS 14—JEWELRY

FOR HOROLOGICAL AND CHRONOMETRIC IN-
STRUMENTS, NAMELY WATCHES AND CLOCKS,
CHRONOMETERS, PARTS THEREOF AND CASES
THEREFOR (U.S. CLS. 2, 27, 28 AND 50).

CLASS 20—FURNITURE AND ARTICLES NOT OTHERWISE CLASSIFIED

FOR FURNITURE, NAMELY, CHAIRS, EASY
CHAIRS, ARMCHAIRS; TABLES, NAMELY DINING
ROOM TABLES, OFFICE TABLES; TROLLEYS,
NAMELY SERVING TROLLEYS; ITEMS OF PLASTIC,
NAMELY PLASTIC BOXES, PLASTIC STORAGE CON-
TAINERS (U.S. CLS. 2, 13, 22, 25, 32 AND 50).

CLASS 21—HOUSEWARES AND GLASS

FOR HOUSEHOLD OR KITCHEN UTENSILS AND
CONTAINERS NOT OF PRECIOUS METAL OR COATED
THEREWITH, NAMELY, DISPENSERS FOR LIQUID
SOAP, GRILLS, PORTABLE PLASTIC CONTAINERS
FOR STORING HOUSEHOLD AND KITCHEN GOODS,
GRATERS, SPATULAS, TURNERS, ROLLING PINS,
WHISKS; GLASSWARE, NAMELY BEVERAGE GLASS-
WARE; PORCELAIN, NAMELY PLATES, DISHES,
DRINKING GLASSES AND COOKING POTS (U.S. CLS.
2, 13, 23, 29, 30, 33, 40 AND 50).

MARY I. SPARROW, EXAMINING ATTORNEY

SN 79-002,494. ISDIN, S.A., E-08006 BARCELONA, SPAIN,
FILED 4-14-2004.

UREADYL

THE MARK CONSISTS OF STANDARD CHARACTERS
WITHOUT CLAIM TO ANY PARTICULAR FONT, STYLE,
SIZE, OR COLOR.

PRIORITY DATE OF 10-17-2003 IS CLAIMED.
OWNER OF INTERNATIONAL REGISTRATION 0824557
DATED 4-14-2004, EXPIRES 4-14-2014.

CLASS 1—CHEMICALS

FOR INGREDIENTS FOR USE IN THE MANUFAC-
TURE OF SKIN CARE AND DERMATOLOGY PRO-
DUCTS (U.S. CLS. 1, 5, 6, 10, 26 AND 46).

CLASS 3—COSMETICS AND CLEANING PRE- PARATIONS

FOR PERFUME; COSMETICS, NAMELY, MAKEUP
AND NAIL POLISH; ESSENTIAL OILS FOR PERSONAL
USE; SKIN SOAP; TALCUM POWDER; HAIR SHAMPOO;
NON-MEDICATED SKIN CARE PREPARATIONS; NON-
MEDICATED HAIR CARE PREPARATIONS; BATH
GELS; NON-MEDICATED BATH SALTS; PERSONAL
DEODORANTS (U.S. CLS. 1, 4, 6, 50, 51 AND 52).

CLASS 5—PHARMACEUTICALS

FOR DERMATOLOGICAL PHARMACEUTICAL PRO-
DUCTS; DERMATOLOGICAL PHARMACEUTICAL
PRODUCTS FOR THE TREATMENT OF SKIN AF-
FECTED WITH PSORIASIS (U.S. CLS. 6, 18, 44, 46, 51
AND 52).

MICHAEL SOUDERS, EXAMINING ATTORNEY

SN 79-002,502. TOM TAILOR AG, FED REP GERMANY,
FILED 1-8-2004.



TOM TAILOR

PRIORITY DATE OF 7-8-2003 IS CLAIMED.
OWNER OF INTERNATIONAL REGISTRATION 0824616
DATED 1-8-2004, EXPIRES 1-8-2014.
OWNER OF U.S. REG. NOS. 1,973,500, 2,479,295 AND
OTHERS.

THE NAME TOM TAILOR DOES NOT IDENTIFY A
LIVING INDIVIDUAL.

CLASS 3—COSMETICS AND CLEANING PRE- PARATIONS

FOR LIQUID AND SKIN SOAPS, PERFUMERY, ES-
SENTIAL OILS FOR PERSONAL USE, COSMETICS, AND
HAIR LOTIONS (U.S. CLS. 1, 4, 6, 50, 51 AND 52).

CLASS 5—PHARMACEUTICALS

FOR PHARMACEUTICAL PREPARATIONS AND PRE-
PARATIONS FOR HEALTHY PURPOSES, NAMELY,
DIETETIC SUBSTANCES ADAPTED FOR MEDICAL
USE, NAMELY, DIETETIC FOODS ADAPTED FOR
MEDICAL USE, DIETETIC SUGAR FOR MEDICAL
USE, DIETETIC FOOD SUPPLEMENTS AND DIETETIC
DIETARY SUPPLEMENTS (U.S. CLS. 6, 18, 44, 46, 51
AND 52).

CLASS 6—METAL GOODS

FOR METAL MONEY CLIPS, METAL KEY CHAINS
AND METAL KEY RINGS; SCULPTURES, ORNAMENT
AND DECORATIONS OF METAL, NAMELY, DECORA-
TIVE BOXES MADE OF METAL; STATUES OF NON-
PRECIOUS METAL (U.S. CLS. 2, 12, 13, 14, 23, 25 AND
50).

CLASS 9—ELECTRICAL AND SCIENTIFIC APPARATUS

FOR APPARATUS FOR RECORDING, TRANSMISSION OR REPRODUCTION OF SOUND AND IMAGES, NAMELY, AERIALS, RADIOS, TELEVISIONS, VIDEO-TELEPHONES, CINEMATOGRAPHIC PROJECTORS, MOVIE PROJECTORS, CINEMATOGRAPHIC CAMERAS, DIGITAL CAMERAS; EYE GLASS FRAMES AND SETTINGS, NAMELY, EYEGLASS LENSES, EYEGLASSES, SUNGLASSES AND THEIR CASES (U.S. CLS. 21, 23, 26, 36 AND 38).

CLASS 14—JEWELRY

FOR PRECIOUS METAL AND THEIR ALLOYS, AND GOODS OF PRECIOUS METALS OR COATED THEREWITH, NAMELY, BADGES, ASHTRAYS, HARNESS FITTINGS, NAMELY, FITTINGS FOR ANIMAL HARNESSES, WATCH BOXES, JEWELRY BOXES, EGG CUPS, FLASKS, PURSES, HAT ORNAMENTS, CANDLE STICKS, BASKETS FOR THE HOUSEHOLD, POWDER COMPACTS, SALAD BOWLS, JEWEL CASES, BELT BUCKLES, SHOE BUCKLES, SHOE ORNAMENTS, NAPKIN RINGS, MATCH BOXES, TABLE PLATES, TEA STRAINERS, VASES, CIGARETTE CASES, CIGAR CASES; JEWELRY, NAMELY, RINGS, EARRINGS, NECKLACES, BRACELETS, PINS, AND KEY RINGS OF PRECIOUS METALS, PENDANTS (U.S. CLS. 2, 27, 28 AND 50).

CLASS 16—PAPER GOODS AND PRINTED MATTER

FOR PAPER AND CARDBOARD, ADDRESS BOOKS, PHOTO ALBUMS, NOTE BOOKS, WRITING PAPER, POSTCARDS, ADHESIVE NOTE PADS AND ADHESIVE NOTE PAPER, CARDBOARD BOXES AND PRINTED PUBLICATIONS, NAMELY, FASHION MAGAZINES AND BOOKS ON FASHION AND HOME DECORATING (U.S. CLS. 2, 5, 22, 23, 29, 37, 38 AND 50).

CLASS 18—LEATHER GOODS

FOR LEATHER AND IMITATION LEATHER AND GOODS MADE OF THESE MATERIALS, NAMELY, TOTE BAGS, KNAPSACKS, WALLETS, HANDBAGS, SHOULDER BAGS, BACKPACKS, LUGGAGE, BRIEF-CASE, VANITY CASES SOLD EMPTY, ATTACHE CASES AND SUITCASES (U.S. CLS. 1, 2, 3, 22 AND 41).

CLASS 20—FURNITURE AND ARTICLES NOT OTHERWISE CLASSIFIED

FOR FURNITURE, MIRRORS, PICTURE FRAMES (U.S. CLS. 2, 13, 22, 25, 32 AND 50).

CLASS 21—HOUSEWARES AND GLASS

FOR HOUSEHOLD OR KITCHEN UTENSILS, NAMELY, BUTTER DISHES, EGG CUPS, FLASKS, BOTTLE OPENERS, WATERING CANS, TRAYS, CUPS, BOWLS, PANS, CONTAINERS FOR HOUSEHOLD OR KITCHEN USE NOT OF PRECIOUS METALS OR COATED THEREWITH; SCRUB, BATH OR CLEANING SPONGES; BRUSHES, NAMELY, HORSE BRUSHES OF WIRE, LIP BRUSHES, HAIR BRUSHES, NAIL BRUSHES, SHAVING BRUSHES, TOOTH BRUSHES, EYEBROW BRUSHES, SCRUBBING BRUSHES AND POT CLEANING BRUSHES; ARTICLES FOR CLEANING PURPOSES, NAMELY, BROOMS, MOPS, DUST MOPS, DUSTERS, DUST PANS, RAGS AND PAILS, STEEL WOOL FOR CLEANING, IMPREGNATED STEEL WOOL FOR CLEANING, UNDERWORKED OR SEMI-WORDED GLASS NOT FOR BUILDING; GLASSWARE PORCELAIN AND EARTHENWARE, NAMELY, BEVERAGE GLASSWARE, DINNERWARE, CHINA PORCELAINWARE, NAMELY, PORCELAIN DINNERWARE, CHINA ORNAMENTS, FIGURES AND SCULPTURES (U.S. CLS. 2, 13, 23, 29, 30, 33, 40 AND 50).

CLASS 24—FABRICS

FOR TEXTILE AND TEXTILE GOODS NAMELY; TEXTILE PLACEMATS, AND TEXTILE NAPKINS; BED AND BATH PRODUCTS, NAMELY; BED BLANKETS, BED SHEETS, PILLOW CASES, DUVET COVERS, QUILTS, SHAMS, BATH LINEN, TOWELS, FACE CLOTHS AND WASH CLOTHS (U.S. CLS. 42 AND 50).

CLASS 27—FLOOR COVERINGS

FOR MATERIALS FOR COVERING EXISTING FLOOR, NAMELY, DOOR MATS OF TEXTILE, BATH MATS OF TEXTILE, WALL HANGING NOT OF TEXTILE MATERIAL (U.S. CLS. 19, 20, 37, 42 AND 50).

CLASS 28—TOYS AND SPORTING GOODS

FOR GAMES, NAMELY, BOARD GAMES, CARD GAMES, CHESS SETS AND CHESS PIECES, BUILDING GAMES, NAMELY, PARLOR GAMES, BALLS FOR GAMES, NAMELY, RUBBER BALLS; PLAYTHING, NAMELY, PLUSH TOYS, MUSICAL TOYS AND PULL TOYS, REMOTE CONTROL TOYS, NAMELY, REMOTE CONTROL PLAY MOTOR CARS; GYMNASTIC AND SPORTING ARTICLES, NAMELY, GYMNASTIC EQUIPMENT, NAMELY, GYMNASTIC APPARATUS, GYMNASTIC HORIZONTAL BARS AND GYMNASTIC PARALLEL BARS, GYMNASTIC VAULTING HORSES AND SPORTS BALLS, NAMELY, SOCCER BALLS, BASKETBALLS AND BASEBALLS (U.S. CLS. 22, 23, 38 AND 50).

CLASS 35—ADVERTISING AND BUSINESS

FOR ADVERTISING; BUSINESS MANAGEMENT; BUSINESS ADMINISTRATION, BUSINESS MANAGEMENT AND ORGANIZATION CONSULTANCY CONCERNING THE FITTING AND FURNISHING OF SALES OFFICES, IN PARTICULAR IN THE RETAIL TRADE; BUSINESS MANAGEMENT AND ORGANIZATION CONSULTANCY CONCERNING RETAIL SHOPS AND SHOP-IN-SHOP SALES OFFICES (U.S. CLS. 100, 101 AND 102).

BRENDAN MCCAULEY, EXAMINING ATTORNEY

SN 79-002,512. A & G CALZATURIFICIO S.P.A., ITALY, FILED 3-31-2004.



PRIORITY DATE OF 12-24-2003 IS CLAIMED.
OWNER OF INTERNATIONAL REGISTRATION 0824677 DATED 3-31-2004, EXPIRES 3-31-2014.

NO CLAIM IS MADE TO THE EXCLUSIVE RIGHT TO USE SPORT, APART FROM THE MARK AS SHOWN.

THE MARK CONSISTS OF THE WORDING JANET SPORT UNDERNEATH A STYLIZED LETTER J INSIDE AN ELLIPTICAL BORDER. DOT OF THE LETTER J APPEARS OUTSIDE OF THE ELLIPTICAL BORDER.

CLASS 18—LEATHER GOODS

FOR LEATHER STRAPS OF SHOULDER BAGS, FOLDING BRIEFCASES, SHOULDER BAGS, GLADSTONE BAGS, BRIEFCASES, BRIEFCASE-TYPE PORTFOLIOS, PURSES, KEY CASES, WALLETS AND BILLFOLDS, WALLETS FOR KEEPING CREDIT CARDS, PASSES AND NAME CARDS; ANIMAL SKINS AND HIDES; TRUNKS AND TRAVELING BAGS; UMBRELLAS, PARASOLS AND WALKING STICKS; WHIPS, HARNESS AND SADDLERY (U.S. CLS. 1, 2, 3, 22 AND 41).

CLASS 25—CLOTHING

FOR FOOTWEAR (U.S. CLS. 22 AND 39).
AMY ALFIERI, EXAMINING ATTORNEY

SN 79-002,655. EBERHARD-KARLS-UNIVERSITÄT; TÜBINGEN UNIVERSITÄTSKLINIKUM, FED REP GERMANY, FILED 12-22-2003.

ARDIS

THE MARK CONSISTS OF STANDARD CHARACTERS WITHOUT CLAIM TO ANY PARTICULAR FONT, STYLE, SIZE, OR COLOR.

OWNER OF INTERNATIONAL REGISTRATION 0825200 DATED 12-22-2003, EXPIRES 12-22-2013.

CLASS 9—ELECTRICAL AND SCIENTIFIC APPARATUS

FOR COMPUTER SOFTWARE, NAMELY COMPUTER SOFTWARE FOR USE IN MANAGING MEDICAL AND RHEUMATOLOGIC DATABASES; MACHINE-READABLE DATA MEDIA, NAMELY, PRE-RECORDED MAGNETIC AND OPTICAL DATA CARRIERS FEATURING DATABASES OF INFORMATION IN THE FIELDS OF MEDICINE AND RHEUMATOLOGY (U.S. CLS. 21, 23, 26, 36 AND 38).

CLASS 35—ADVERTISING AND BUSINESS

FOR MANAGEMENT AND COMPILATION OF COMPUTERIZED DATABASES IN THE FIELDS OF MEDICINE AND RHEUMATOLOGY (U.S. CLS. 100, 101 AND 102).

CLASS 42—SCIENTIFIC, COMPUTER AND LEGAL SERVICES

FOR RENTAL OF A DATABASE SERVER TO THIRD PARTIES IN THE FIELDS OF MEDICINE AND RHEUMATOLOGY; DESIGN OF COMPUTER DATABASE PROGRAMS FOR OTHERS IN THE FIELDS OF MEDICINE AND RHEUMATOLOGY; CONSULTATION SERVICES IN THE FIELD OF COMPUTER DATABASE SOFTWARE FOR THE MEDICAL AND RHEUMATOLOGIC INDUSTRIES (U.S. CLS. 100 AND 101).
MARTHA FROMM, EXAMINING ATTORNEY

SN 79-002,715. KONINKLIJKE VERENIGING "HET FRIESCH PAARDEN-STAMBOEK", NETHERLANDS, FILED 4-28-2004.



PRIORITY DATE OF 3-2-2004 IS CLAIMED.
OWNER OF INTERNATIONAL REGISTRATION 0825400 DATED 4-28-2004, EXPIRES 4-28-2014.
THE MARK CONSISTS, IN PART, OF THE LETTERS "FPS".

CLASS 31—NATURAL AGRICULTURAL PRODUCTS

FOR LIVE ANIMALS (U.S. CLS. 1 AND 46).

CLASS 35—ADVERTISING AND BUSINESS

FOR BUSINESS ADMINISTRATION; BUSINESS MANAGEMENT; ADMINISTRATIVE ACCOUNTING, NAMELY, MAINTAINING A STUDBOOK (U.S. CLS. 100, 101 AND 102).

CLASS 41—EDUCATION AND ENTERTAINMENT

FOR ENTERTAINMENT IN THE NATURE OF HORSE RIDING; ORGANIZING EXHIBITIONS FOR HORSES (U.S. CLS. 100, 101 AND 107).

CLASS 42—SCIENTIFIC, COMPUTER AND LEGAL SERVICES

FOR INSPECTION OF HORSES (U.S. CLS. 100 AND 101).

CLASS 44—MEDICAL, BEAUTY AND AGRICULTURAL SERVICES

FOR VETERINARY SERVICES AND ANIMAL BREEDING SERVICES (U.S. CLS. 100 AND 101).
VIVIAN MICZNIK FIRST, EXAMINING ATTORNEY

SN 79-002,716. KISTLER HOLDING AG, SWITZERLAND,
FILED 3-10-2004.

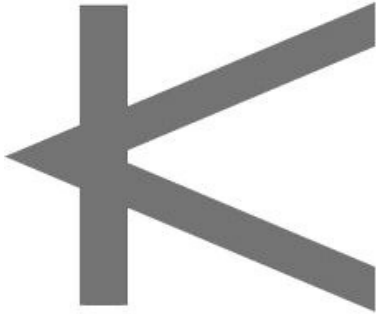

PRIORITY DATE OF 2-5-2004 IS CLAIMED.
OWNER OF INTERNATIONAL REGISTRATION 0825403
DATED 3-10-2004, EXPIRES 3-10-2014.

CLASS 9—ELECTRICAL AND SCIENTIFIC APPARATUS

FOR SCIENTIFIC MEASURING APPARATUS, INSTRUMENTS AND DETECTORS, NAMELY PRESSURE, FORCE, STRAIN, TORQUE, ACCELERATION, VIBRATION AND TEMPERATURE SENSORS, MICROPHONES, PIEZOELECTRIC, PIEZORESISTIVE AND OPTICAL SENSORS, STRAIN GAGES; APPARATUS FOR RECORDING, TRANSMITTING, MONITORING AND REPRODUCTION OF ELECTRIC, ELECTRONIC, OPTICAL AND ACOUSTIC SIGNALS, NAMELY SIGNAL CONDITIONERS, CHARGE AMPLIFIERS, CHARGE CALIBRATORS, CALIBRATION CAPACITORS, PRESSURE GENERATORS, ELECTROMECHANICAL SHAKERS, AMPLIFIERS, PIEZORESISTIVE AMPLIFIERS, ELECTRIC CONTROL MONITORS; INFORMATION PROCESSING APPARATUS AND INSTALLATIONS, NAMELY COMPUTER SOFTWARE FOR MANAGING AND ANALYZING DATA MEASUREMENTS AND MEASUREMENT SETUPS (U.S. CLS. 21, 23, 26, 36 AND 38).

CLASS 42—SCIENTIFIC, COMPUTER AND LEGAL SERVICES

FOR SCIENTIFIC RESEARCH AND TECHNOLOGY CONSULTATION AND RESEARCH IN THE FIELD OF ENGINES, VEHICLES; MANUFACTURING; INJECTION MOULDING, EXTRUSION, BIOMECHANICS, BALLISTICS, HYDRAULICS, AEROSPACE, CONDITION MONITORING AND MODAL ANALYSIS; DESIGN FOR OTHERS IN THE FIELD OF TEST- AND MEASUREMENT EQUIPMENT, SENSORS, SIGNAL CONDITIONERS, AMPLIFIERS, MONITORS AND SIGNAL ANALYSERS; CALIBRATION SERVICES; COMPUTER AND SOFTWARE DESIGN DEVELOPMENT FOR OTHERS; LEGAL SERVICES (U.S. CLS. 100 AND 101).
ALICE BENMAMAN, EXAMINING ATTORNEY

SN 79-002,722. HUMAN BIOS GMBH, SWITZERLAND,
FILED 3-1-2004.

FRONTSAVE

THE MARK CONSISTS OF STANDARD CHARACTERS WITHOUT CLAIM TO ANY PARTICULAR FONT, STYLE, SIZE, OR COLOR.
PRIORITY DATE OF 9-3-2003 IS CLAIMED.
OWNER OF INTERNATIONAL REGISTRATION 0825409
DATED 3-1-2004, EXPIRES 3-1-2014.

CLASS 36—INSURANCE AND FINANCIAL

FOR INTERACTIVE ELECTRONIC PROCESSING OF FINANCIAL TRANSACTIONS VIA THE INTERNET (U.S. CLS. 100, 101 AND 102).

CLASS 42—SCIENTIFIC, COMPUTER AND LEGAL SERVICES

FOR COMPUTER PROGRAMMING SERVICES FOR OTHERS; COMPUTER CONSULTING SERVICES IN THE FIELD OF COMPUTER DATA STORAGE, DATA SECURITY AND COMPUTER SYSTEMS SECURITY; SOFTWARE INSTALLATION FOR NETWORKING OF COMPUTERS AND COMPUTER STORAGE DEVICES; COMPUTER SYSTEMS ANALYSIS FOR OTHERS; DESIGN OF COMPUTER SYSTEMS FOR OTHERS; INSTALLATION OF COMPUTER PROGRAMS FOR OTHERS; SECURITY SERVICES, NAMELY PROTECTION OF COMPUTER NETWORKS ON LINE AGAINST UNAUTHORIZED THIRD-PARTY ACCESS; COMPUTER SOFTWARE RENTAL, NAMELY ACTING AS A COMPUTER SOFTWARE APPLICATION SERVICE PROVIDER IN THE FIELDS OF DATA BACKUP, DATA STORAGE, DATA MANAGEMENT AND DATA RECOVERY; COMPUTER DATA RESTORATION; RENTAL OF STORAGE SPACE FOR USE IN HOSTING INTERNET WEB SITES; COMPUTER CONSULTING SERVICES IN THE FIELDS OF ELECTRONIC MANAGEMENT OF BUSINESS TRANSACTIONS AND DATA PROCESSING; LICENSING OF INTELLECTUAL PROPERTY RIGHTS (U.S. CLS. 100 AND 101).

TERESA M. RUPP, EXAMINING ATTORNEY

SN 79-002,737. ESTHÈTE S.A., SWITZERLAND, FILED 4-13-2004.

DANIELLA DI ROYALE

THE MARK CONSISTS OF STANDARD CHARACTERS WITHOUT CLAIM TO ANY PARTICULAR FONT, STYLE, SIZE, OR COLOR.

PRIORITY DATE OF 10-25-2003 IS CLAIMED.
OWNER OF INTERNATIONAL REGISTRATION 0825458
DATED 4-13-2004, EXPIRES 4-13-2014.
DANIELLA DI ROYALE, IDENTIFIES A LIVING INDIVIDUAL WHOSE CONSENT IS OF RECORD.

CLASS 3—COSMETICS AND CLEANING PREPARATIONS

FOR COSMETICS, NAMELY, SKIN SOAPS, PERFUMERY, ESSENTIAL OILS, COSMETIC PREPARATIONS, BODY LOTIONS, HAIR LOTIONS, DENTIFRICES, DEODORANTS FOR PERSONAL USE, ANTI-PERSPIRANTS, MAKE-UP AND MAKE-UP REMOVER, NON-MEDICATED SKIN CARE PREPARATIONS AND COSMETIC PREPARATIONS FOR SKIN RENEWAL; NON-MEDICATED TOILETRIES (U.S. CLS. 1, 4, 6, 50, 51 AND 52).

CLASS 25—CLOTHING

FOR READY-TO-WEAR CLOTHING, NAMELY, SHIRTS, T-SHIRTS, SWEATSHIRTS, SUITS, LADIES' SUITS, JEANS, SKIRTS, TROUSERS, DRESSES; SHOES; HEADGEAR, NAMELY, HATS AND CAPS (U.S. CLS. 22 AND 39).

DORITT L. CARROLL, EXAMINING ATTORNEY

SN 79-002.827. LIDL STIFTUNG & CO. KG, FED REP GERMANY, FILED 4-27-2004.



OWNER OF INTERNATIONAL REGISTRATION 0737646 DATED 5-25-2000, EXPIRES 5-25-2010.
 NO CLAIM IS MADE TO THE EXCLUSIVE RIGHT TO USE "HIGH TECHNOLOGY FIXING", APART FROM THE MARK AS SHOWN.

CLASS 7—MACHINERY

FOR MECHANICALLY OPERATED HAND TOOLS, NAMELY, DRILLING MACHINES, POWER OPERATED DRILLING SCREW DRIVERS, POWER OPERATED DRILLING HAMMERS, POWER STAPLERS, ELECTRIC PLANES, JIG SAWS, CIRCULAR CROSS-CUT SAWS, VIBRATING GRINDERS AND ANGLE GRINDERS (U.S. CLS. 13, 19, 21, 23, 31, 34 AND 35).

CLASS 9—ELECTRICAL AND SCIENTIFIC APPARATUS

FOR ELECTRIC SOLDERING APPARATUS, IN PARTICULAR SOLDERING GUNS (U.S. CLS. 21, 23, 26, 36 AND 38).

CLASS 11—ENVIRONMENTAL CONTROL APPARATUS

FOR HOT AIR APPARATUS, NAMELY, HOT AIR GUNS IN THE NATURE OF HEAT GUNS (U.S. CLS. 13, 21, 23, 31 AND 34).
 MAUREEN DALL, EXAMINING ATTORNEY

SN 79-002.886. ASAI SOLUTIONS, FRANCE, FILED 3-8-2004.

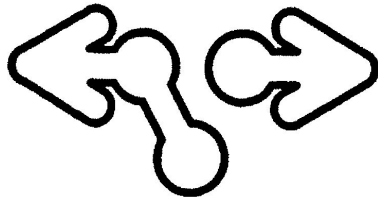

PRIORITY DATE OF 9-17-2003 IS CLAIMED.
 OWNER OF INTERNATIONAL REGISTRATION 0825912 DATED 3-8-2004, EXPIRES 3-8-2014.

CLASS 9—ELECTRICAL AND SCIENTIFIC APPARATUS

FOR DEVICES FOR REGULATING, CONTROLLING OR INTERRUPTING A COMPUTER NETWORK DATA LINE OR COMPUTER NETWORK CONNECTIONS, NAMELY COMPUTER TERMINALS; COMPUTERS; COMPUTER HARDWARE FOR USE IN DATABASE MANAGEMENT, DIGITAL MESSAGING DEVICES, COMPUTER NETWORKS, GLOBAL COMMUNICATIONS, AND MANAGING AUDIOVISUAL DATA; MULTIMEDIA COMPUTER HARDWARE; IMAGE PROCESSING COMPUTER HARDWARE; NETWORK INTERFACES; COMPUTER NETWORK HUBS, SWITCHES, BRIDGES AND ROUTERS; RADIOS; CELLULAR PHONES; TELEPHONES; PERSONAL DIGITAL ASSISTANTS; DIGITAL VIDEO RECORDERS; DATA MEASUREMENT UNITS; DIGITAL DISPLAYS, INDUSTRIAL CONTROLLERS AND CONTROLLER TEST SYSTEMS COMPRISED OF COMPUTER HARDWARE FOR TESTING INDUSTRIAL EQUIPMENT; SCIENTIFIC AND MEDICAL IMAGING SYSTEMS COMPRISED OF GRAPHICAL DISPLAYS FOR IMAGES, DIGITAL CAMERAS AND IMAGE PROCESSING COMPUTER HARDWARE; SECURITY DEVICES FOR COMPUTERS, NAMELY COMPUTER TERMINALS; CONVERTER BOXES; VIDEO PROJECTORS; RADIOS; SPEAKERS; MICROPHONES; HEADPHONES; EARPHONES; TUNERS; DIGITAL MESSAGING DEVICES, COMPUTER NETWORKS, GLOBAL COMMUNICATIONS, AND MANAGING AUDIOVISUAL DATA; COMPUTER PERIPHERALS; IMAGE PROCESSING HARDWARE; SCANNERS; MONITORS; TOUCH SCREENS; MODEMS; PRINTERS; KEYBOARDS; MICE; GRAPHICS TABLETS; DIGITIZERS; ADAPTERS; ADAPTER CARDS; CABLES AND CONNECTORS; INTEGRATED CIRCUITS; SEMICONDUCTORS; MAGNETO-OPTICAL DRIVES; HARD DISK DRIVES; FLOPPY DISK DRIVES; PCMCIA DRIVES; CARTRIDGE AND TAPE DRIVES; CD-ROM DRIVES; CD-RECORDABLE DRIVES; CD REWRITABLE DRIVES; DVD-ROM DRIVES; DVD REWRITABLE DRIVES; COMPUTER SERVERS; DATA STORAGE HARDWARE FOR RAID ("REDUNDANT ARRAY OF INEXPENSIVE DISKS); NETWORK INTERFACES; CABLE MODEMS; COMPUTER NETWORK HUBS, SWITCHES, BRIDGES AND ROUTERS; RADIOS; CELLULAR PHONES; VIDEOTAPE RECORDERS; TELEVISIONS, DIGITAL TELEVISIONS; SET-TOP BOXES; STEREO RECEIVERS; DVD PLAYERS; CD PLAYERS; MP3 PLAYERS; DIGITAL AUDIO PLAYERS AND RECORDERS; VIDEO GAME MACHINES FOR USE WITH A TELEVISION OR COMPUTER; PROFESSIONAL AND CONSUMER AUDIO AND MUSICAL AMPLIFIERS; MUSIC SYNTHESIZERS; VIDEO SPECIAL EFFECTS GENERATORS; STILL CAMERAS; VIDEO CAMERAS; VIDEO DECKS; VIDEO CONVERTS; DATA MEASUREMENT UNITS; DIGITAL DISPLAYS, INDUSTRIAL CONTROLLERS AND CONTROLLER TEST SYSTEMS COMPRISED OF COMPUTER FOR TESTING INDUSTRIAL EQUIPMENT; SCIENTIFIC AND MEDICAL IMAGING SYSTEMS COMPRISED OF GRAPHICAL DISPLAYS FOR IMAGES, DIGITAL CAMERAS AND IMAGE PROCESSING COMPUTER HARDWARE; BAR-CODE READERS; AND MAGNETIC STRIP READERS; SECURITY DEVICES FOR COMPUTER HARDWARE DESIGNED FOR A SINGLE COMPUTER AND/OR A COMPUTER NETWORK CONSISTING OF SEVERAL COMPUTERS AND/OR ANY NETWORK DEVICE, NAMELY CONVERTER BOXES; VIDEO PROJECTORS; RADIOS; SPEAKERS; MICROPHONES; HEADPHONES; EARPHONES; TUNERS; COMPUTER HARDWARE FOR USE IN DATABASE MANAGEMENT, DIGITAL MESSAGING DEVICES, COMPUTER NETWORKS, GLOBAL COMMUNICATIONS, AND MANAGING AUDIOVISUAL DATA; MULTIMEDIA COMPUTER HARDWARE; COMPUTER PERIPHERALS; IMAGE PROCESSING COMPUTER HARDWARE; SCANNERS; MONITORS; TOUCH SCREENS; MODEMS; PRINTERS; KEYBOARDS; MICE; GRAPHICS TABLETS; DIGITIZERS; ADAPTERS; ADAPTER CARDS; CABLES AND CONNECTORS; INTEGRATED CIRCUITS; SEMICONDUCTORS; MAGNETO-OPTICAL DRIVES; HARD DISK DRIVES; FLOPPY DISK DRIVES; PCMCIA DRIVES; CARTRIDGE AND TAPE DRIVES; CD-ROM DRIVES; CD-RECORDABLE DRIVES; CD REWRITABLE DRIVES; DVD-ROM DRIVES; DVD REWRITABLE DRIVES; COMPUTER SERVERS; DATA STORAGE HARDWARE FOR RAID ("REDUNDANT ARRAY OF INEXPENSIVE DISKS); NETWORK INTERFACES; CABLE MODEMS; COMPUTER NETWORK HUBS, SWITCHES, BRIDGES AND ROUTERS; CELLU-

LAR PHONES; VIDEOTAPE RECORDERS; TELEVISIONS; DIGITAL TELEVISIONS; SET-TOP BOXES; STEREO RECEIVERS; DVD PLAYERS; CD PLAYERS; MP3 PLAYERS; DIGITAL AUDIO PLAYERS AND RECORDERS; PROFESSIONAL AND CONSUMER AUDIO AND MUSICAL AMPLIFIERS; MUSIC SYNTHESIZERS; VIDEO SPECIAL EFFECTS GENERATORS; STILL CAMERAS; VIDEO CAMERAS; VIDEO DECKS; VIDEO CONVERTERS; DATA MEASUREMENT UNITS; DIGITAL DISPLAYS, INDUSTRIAL CONTROLLERS AND CONTROLLER TEST SYSTEMS COMPRISED OF COMPUTER HARDWARE FOR TESTING INDUSTRIAL EQUIPMENT; SCIENTIFIC AND MEDICAL IMAGING SYSTEMS COMPRISED OF GRAPHICAL DISPLAYS FOR IMAGES, DIGITAL CAMERAS AND IMAGE PROCESSING COMPUTER HARDWARE; BARCODE READERS; AND MAGNETIC STRIP READERS (U.S. CLS. 21, 23, 26, 36 AND 38).

CLASS 35—ADVERTISING AND BUSINESS

FOR ADVERTISING BY TRANSMISSION OF ONLINE PUBLICITY FOR THIRD PARTIES THROUGH ELECTRONIC COMMUNICATIONS NETWORKS, DISSEMINATION OF ADVERTISING MATERIAL, PARTICULARLY LEAFLETS, ELECTRONIC MAIL, PROSPECTUSES, PRINTED MATTER, SAMPLES; ORGANIZATION OF EXHIBITIONS FOR COMMERCIAL OR ADVERTISING PURPOSES; ON-LINE ADVERTISING ON A COMPUTER NETWORK, AND RENTAL OF ADVERTISING SPACE ON INTERNET (U.S. CLS. 100, 101 AND 102).

CLASS 38—COMMUNICATION

FOR TELECOMMUNICATION SERVICES, NAMELY TRANSMISSION BY NETWORKED COMPUTER TERMINALS; AND COMMUNICATION BY COMPUTERS OR BY OTHER ELECTRONIC COMPUTER TERMINALS (U.S. CLS. 100, 101 AND 104).

KIMBERLY PERRY, EXAMINING ATTORNEY

SN 79-002,899. STREET ONE MARKENRECHT GMBH & CO. KG, FED REP GERMANY, FILED 4-21-2004.

THE MARK CONSISTS OF STANDARD CHARACTERS WITHOUT CLAIM TO ANY PARTICULAR FONT, STYLE, SIZE, OR COLOR.

PRIORITY DATE OF 11-24-2003 IS CLAIMED.
OWNER OF INTERNATIONAL REGISTRATION 0825947 DATED 4-21-2004, EXPIRES 4-21-2014.

CLASS 18—LEATHER GOODS

FOR UMBRELLAS, PARASOLS, AND WALKING STICKS (U.S. CLS. 1, 2, 3, 22 AND 41).

CLASS 23—YARNS AND THREADS

FOR YARNS AND THREADS FOR TEXTILE USE (U.S. CL. 43).

CLASS 24—FABRICS

FOR HOUSEHOLD LINEN; TABLE CLOTHS NOT OF PAPER; BED SPREADS; MATTRESS COVERS; AND BED CANOPIES (U.S. CLS. 42 AND 50).

CLASS 26—FANCY GOODS

FOR HAIR ORNAMENTS, HAIR BANDS, HAIR SLIDES (U.S. CLS. 37, 39, 40, 42 AND 50).
MAUREEN DALL, EXAMINING ATTORNEY

SN 79-003,032. KEIRAN GLOSSOP, MCCRAE, VICTORIA 3938, AUSTRALIA, AND TRACEE THOMSON, MCCRAE, VICTORIA 3938, AUSTRALIA, FILED 1-30-2004.

SEASENSES SPA

THE MARK CONSISTS OF STANDARD CHARACTERS WITHOUT CLAIM TO ANY PARTICULAR FONT, STYLE, SIZE, OR COLOR.

PRIORITY DATE OF 12-5-2003 IS CLAIMED.
OWNER OF INTERNATIONAL REGISTRATION 0826350 DATED 1-30-2004, EXPIRES 1-30-2014.

NO CLAIM IS MADE TO THE EXCLUSIVE RIGHT TO USE SPA, APART FROM THE MARK AS SHOWN.

CLASS 3—COSMETICS AND CLEANING PREPARATIONS

FOR SOAPS; PERFUMERY, ESSENTIAL OILS TO AID IN MEDITATION AND SPIRITUALISM GROWTH, COSMETICS, HAIR LOTIONS; DENTIFRICES (U.S. CLS. 1, 4, 6, 50, 51 AND 52).

CLASS 44—MEDICAL, BEAUTY AND AGRICULTURAL SERVICES

FOR MEDICAL SERVICES; HYGIENIC AND BEAUTY CARE FOR HUMAN BEINGS OR ANIMALS (U.S. CLS. 100 AND 101).

KELLY BOULTON, EXAMINING ATTORNEY

SN 79-003,052. BÖE, HANS PETER, D-46049 OBERHAUSEN, FED REP GERMANY, FILED 2-6-2004.

POLYTRANSMITTER

THE MARK CONSISTS OF STANDARD CHARACTERS WITHOUT CLAIM TO ANY PARTICULAR FONT, STYLE, SIZE, OR COLOR.

OWNER OF INTERNATIONAL REGISTRATION 0826402 DATED 2-6-2004, EXPIRES 2-6-2014.

CLASS 1—CHEMICALS

FOR ADHESIVE AGENTS FOR INDUSTRIAL PURPOSES, ADHESIVE AGENTS OF SYNTHETIC RESIN, IN PARTICULAR BASED ON DERIVATIVES OF POLYACRYLIC ACID (U.S. CLS. 1, 5, 6, 10, 26 AND 46).

CLASS 19—NON-METALLIC BUILDING MATERIALS

FOR READY-MADE MORTAR (U.S. CLS. 1, 12, 33 AND 50).
LOURDES AYALA, EXAMINING ATTORNEY

SN 79-003,081. STAYL MEDIZINTECHNIK GMBH, D-51503 RÖSRATH, FED REP GERMANY, FILED 4-15-2004.

STAYL

PRIORITY DATE OF 10-20-2003 IS CLAIMED.
OWNER OF INTERNATIONAL REGISTRATION 0826469
DATED 4-15-2004, EXPIRES 4-15-2014.

CLASS 3—COSMETICS AND CLEANING PREPARATIONS

FOR LAUNDRY BLEACH; GENERAL PURPOSE CLEANING, POLISHING, SCOURING AND ABRASIVE LIQUIDS AND POWDERS; DETERGENT SOAPS; PERFUMERY, ESSENTIAL OILS FOR PERSONAL USE; COSMETICS, HAIR LOTIONS; DENTIFRICES (U.S. CLS. 1, 4, 6, 50, 51 AND 52).

CLASS 11—ENVIRONMENTAL CONTROL APPARATUS

FOR APPARATUS FOR LIGHTING, HEATING, STEAM GENERATING, COOKING, REFRIGERATING, DRYING, VENTILATING, WATER SUPPLY AND SANITARY PURPOSES, NAMELY, BATHTUBS, SHOWERS; SOLARIA, NAMELY, TANNING BEDS (U.S. CLS. 13, 21, 23, 31 AND 34).

CLASS 44—MEDICAL, BEAUTY AND AGRICULTURAL SERVICES

FOR MEDICAL SERVICES; VETERINARY SERVICES; HYGIENIC AND BEAUTY CARE FOR HUMAN BEINGS OR ANIMALS, NAMELY, BEAUTY AND TANNING SALON SERVICES (U.S. CLS. 100 AND 101).
RENEE MCCRAY, EXAMINING ATTORNEY

SN 79-003,288. SIFLOX HOLDING GMBH, D-48282 EMSDETEN, FED REP GERMANY, FILED 4-30-2004.

Click Fish

THE MARK CONSISTS OF STANDARD CHARACTERS WITHOUT CLAIM TO ANY PARTICULAR FONT, STYLE, SIZE, OR COLOR.

PRIORITY DATE OF 11-19-2003 IS CLAIMED.
OWNER OF INTERNATIONAL REGISTRATION 0827144
DATED 4-30-2004, EXPIRES 4-30-2014.

CLASS 6—METAL GOODS

FOR RETAINING DEVICES, MADE OF METAL, NAMELY, BINDER RINGS AND HANGING BINDER RINGS FOR COLOR SAMPLE CARDS, MATERIALS SAMPLE CARDS, OR MATERIAL SAMPLES (U.S. CLS. 2, 12, 13, 14, 23, 25 AND 50).

CLASS 16—PAPER GOODS AND PRINTED MATTER

FOR PRINTED MATTER, NAMELY, BOOKS, BOOKLETS, FOLDERS, BROCHURES, PAMPHLETS, POSTERS, PAGES, CARDS, PAPER CHIPS AND CARDBOARD CHIPS AS SAMPLES AND EXAMPLES OF COLORS, TEXTURES, PATTERNS, AND MATERIALS (U.S. CLS. 2, 5, 22, 23, 29, 37, 38 AND 50).

CLASS 20—FURNITURE AND ARTICLES NOT OTHERWISE CLASSIFIED

FOR RETAINING DEVICES, NOT MADE OF METAL, NAMELY, BINDER RINGS AND HANGING BINDER RINGS FOR COLOR SAMPLE CARDS, MATERIALS SAMPLE CARDS, OR MATERIAL SAMPLES (U.S. CLS. 2, 13, 22, 25, 32 AND 50).

WANDA KAY PRICE, EXAMINING ATTORNEY

SN 79-003,301. QIAGEN GMBH, FED REP GERMANY, FILED 12-16-2003.

EasyXpress

THE MARK CONSISTS OF STANDARD CHARACTERS WITHOUT CLAIM TO ANY PARTICULAR FONT, STYLE, SIZE, OR COLOR.

PRIORITY DATE OF 6-25-2003 IS CLAIMED.
OWNER OF INTERNATIONAL REGISTRATION 0827231
DATED 12-16-2003, EXPIRES 12-16-2013.

CLASS 1—CHEMICALS

FOR CHEMICAL PRODUCTS FOR SCIENTIFIC AND COMMERCIAL USE, COMPRISING CHEMICALS FOR PERFORMING POLYMERASE CHAIN REACTION (PCR), CHEMICALS FOR PERFORMING IN-VITRO PROTEIN SYNTHESSES NAMELY IN-VITRO TRANSCRIPTION AND IN-VITRO TRANSLATION, NAMELY NUCLEIC ACIDS, OLIGONUCLEOTIDES, DEOXYNUCLEOSIDES, BUFFER SOLUTIONS, SALT, ENZYMES, PROKARYOTIC AND EUKARYOTIC CELL LYSATES; KITS CONTAINING CHEMICAL PRODUCTS FOR SCIENTIFIC AND COMMERCIAL USE, COMPRISING CHEMICALS FOR PERFORMING POLYMERASE CHAIN REACTION (PCR), CHEMICALS FOR PERFORMING IN-VITRO PROTEIN SYNTHESSES NAMELY, IN-VITRO TRANSCRIPTION AND IN-VITRO TRANSLATION, NAMELY NUCLEIC ACIDS, OLIGONUCLEOTIDES, DEOXYNUCLEOSIDES, BUFFER SOLUTIONS, SALT, ENZYMES, PROKARYOTIC AND EUKARYOTIC CELL LYSATES (U.S. CLS. 1, 5, 6, 10, 26 AND 46).

CLASS 5—PHARMACEUTICALS

FOR DIAGNOSTIC AGENTS FOR HUMAN-MEDICAL AND VETERINARY USE, COMPRISING CHEMICALS FOR PERFORMING POLYMERASE CHAIN REACTION (PCR), CHEMICALS FOR PERFORMING IN-VITRO PROTEIN SYNTHESSES NAMELY, IN-VITRO TRANSCRIPTION AND IN-VITRO TRANSLATION, NAMELY NUCLEIC ACIDS, OLIGONUCLEOTIDES, DEOXYNUCLEOSIDES, BUFFER SOLUTIONS, ENZYMES, SALT, PROKARYOTIC AND EUKARYOTIC CELL LYSATES; DIAGNOSTIC KITS CONTAINING CHEMICAL PRODUCTS FOR DIAGNOSTIC USE, COMPRISING CHEMICALS FOR PERFORMING POLYMERASE CHAIN REACTION (PCR), CHEMICALS FOR PERFORMING IN-VITRO PROTEIN SYNTHESSES NAMELY IN-VITRO TRANSCRIPTION AND IN-VITRO TRANSLATION, NAMELY NUCLEIC ACID, OLIGONUCLEOTIDES, DEOXYNUCLEOSIDES, BUFFER SOLUTIONS, ENZYMES, SALT, PROKARYOTIC AND EUKARYOTIC CELL LYSATES (U.S. CLS. 6, 18, 44, 46, 51 AND 52).

CLASS 9—ELECTRICAL AND SCIENTIFIC APPARATUS

FOR KITS FOR PERFORMING AND EVALUATING POLYMERASE CHAIN REACTION PCR, IN-VITRO TRANSCRIPTION AND IN-VITRO TRANSLATION AS WELL AS FOR THE SEPARATION, PURIFICATION AND/OR ISOLATION OF SUBSTANCES, COMPRISING LABORATORY EQUIPMENT, NAMELY TUBES, FILTERS, MULTI-Well OLATES, MAGNETIC BEADS, MAGNETIC SEPARATORS AND PIPETTES (U.S. CLS. 21, 23, 26, 36 AND 38).

SAMUEL E. SHARPER JR., EXAMINING ATTORNEY

SN 79-003,406. VISCOM VISUAL COMMUNICATIONS, SWITZERLAND, FILED 4-21-2004.

IIP Industrial Internet Platform

THE MARK CONSISTS OF STANDARD CHARACTERS WITHOUT CLAIM TO ANY PARTICULAR FONT, STYLE, SIZE, OR COLOR.

PRIORITY DATE OF 10-27-2003 IS CLAIMED.

OWNER OF INTERNATIONAL REGISTRATION 0827616 DATED 4-21-2004, EXPIRES 4-21-2014.

NO CLAIM IS MADE TO THE EXCLUSIVE RIGHT TO USE INDUSTRIAL INTERNET PLATFORM, APART FROM THE MARK AS SHOWN.

CLASS 9—ELECTRICAL AND SCIENTIFIC APPARATUS

FOR COMPUTER SOFTWARE DEVELOPMENT TOOLS (U.S. CLS. 21, 23, 26, 36 AND 38).

CLASS 42—SCIENTIFIC, COMPUTER AND LEGAL SERVICES

FOR COMPUTER SOFTWARE DEVELOPMENT (U.S. CLS. 100 AND 101).

JENNIFER MARTIN, EXAMINING ATTORNEY

SN 79-003,415. SARL LABORATOIRE FERRIER, FRANCE, FILED 5-12-2004.

PHYTO SCULPT

THE MARK CONSISTS OF STANDARD CHARACTERS WITHOUT CLAIM TO ANY PARTICULAR FONT, STYLE, SIZE, OR COLOR.

OWNER OF INTERNATIONAL REGISTRATION 0827650 DATED 5-12-2004, EXPIRES 5-12-2014.

CLASS 3—COSMETICS AND CLEANING PREPARATIONS

FOR SOAPS, COSMETICS, HAIR LOTIONS; DENTIFRICES (U.S. CLS. 1, 4, 6, 50, 51 AND 52).

CLASS 5—PHARMACEUTICALS

FOR DIETARY SUPPLEMENTS DERIVED FROM ORGANIC FARMING OR MADE FROM PRODUCTS DERIVED FROM ORGANIC FARMING (U.S. CLS. 6, 18, 44, 46, 51 AND 52).

ALICIA COLLINS, EXAMINING ATTORNEY

SN 79-003,436. RENAULT S.A.S.; SOCIÉTÉ PAR ACTIONS SIMPLIFIÉE, FRANCE, FILED 3-23-2004.



RENAULT

OWNER OF INTERNATIONAL REGISTRATION 0589202 DATED 3-30-1992, EXPIRES 3-30-2012.

OWNER OF U.S. REG. NO. 1,976,203.

CLASS 12—VEHICLES

FOR LAND VEHICLES, NAMELY, AUTOMOBILES, TRUCKS AND SPORT UTILITY VEHICLES, RAIL VEHICLE APPARATUS, NAMELY, PASSENGER CARRIAGE APRONS, PASSENGER CASTING CARRIAGES, LINE TRANSPORT AND MAINTENANCE RAILWAY CARRIAGES, CATERPILLAR TRACTORS, TRACTORS, AMPHIBIOUS VEHICLES, AIR CUSHION VEHICLES, LAND MOTOR VEHICLES, NAMELY, AUTOMOBILES, TRUCKS, SPORT UTILITY VEHICLES AND BUSES FOR USE IN THE TRANSPORT OF PERSONS AND GOODS, SPACE VEHICLES, AIRCRAFT, AEROSTATS, PERSONAL WATERCRAFT, NAMELY, BOATS, SAFETY DEVICES, NAMELY, BRAKES FOR LAND VEHICLES, BRAKE SHOES FOR LAND VEHICLES AND MOTOR CARS, FRICTION BRAKE PADS FOR LAND VEHICLES, RUBBER BRAKE FACINGS FOR VEHICLES, REAR-VIEW MIRRORS, AUTOMOBILE AND BOAT BUMPERS, HOOD SHIELDS AS STRUCTURAL PARTS OF VEHICLES, SIDE SHIELDS AS STRUCTURAL PARTS OF VEHICLES, METAL SHOCK ABSORBING BUFFER SPRINGS FOR MOTOR CARS, MUDGUARDS, SAFETY BELTS FOR VEHICLES FOR MOTOR CARS, ANTI-SKID AND ANTI-SLIP WHEEL HUBS AND BEARINGS FOR AUTOMOBILE, TRUCK AND SPORT UTILITY LAND VEHICLES, STRUCTURAL PARTS OF AUTOMOBILES, NAMELY, GRILLES, AUTOMOBILE HOODS, AUTOMOBILE BODIES, AUTOMOBILE CHASSIS, SHIPS' HULLS, WINDSCREENS FOR MOTOR CARS, LUGGAGE CARRIERS FOR VEHICLES, GAS TANKS FOR MOTOR VEHICLES, VEHICLE SEATS, MOTOR VEHICLE SUNROOFS, VEHICLE PARTS, NAMELY, SHOCK ABSORBERS, RAILWAY BOGIES, LAND VEHICLE PARTS, NAMELY, AXLES, AXLE BOOT KITS FOR USE WITH LAND VEHICLES CONSISTING OF AXLE BOXES, WHEEL CENTERS, SHRINK RINGS, AXLE JOURNALS AND AXLE WHEEL HUBS, LAND VEHICLE PARTS, NAMELY, WHEELS, UNDERCARRIAGES OF RAILWAY CARS, TUBULAR TIRES FOR VEHICLES, WHEEL RIMS, WHEEL SPOKES FOR BICYCLES, ANTI-THEFT WARNING APPARATUS FOR MOTOR CARS, WINDSCREEN WIPERS, DIRECTIONAL SIGNALS FOR VEHICLES, VEHICLE PARTS, NAMELY, STEERING WHEEL WITH ELECTRIC CONTROL OF AUTOMOBILE LIGHT APPLIANCES, AUTOMOBILE ENGINES AND ENGINES FOR LAND VEHICLES, ELECTRIC ENGINES FOR MOTOR CARS, INTERNAL COMBUSTION ENGINES FOR LAND VEHICLES, AUTOMOBILE ENGINES THAT RUN ON THERMAL ENERGY POWER, STEAM ENGINES FOR LAND VEHICLES, AIR TURBINES FOR LAND VEHICLES, TRAILER AND RAILWAY COUPLINGS, GEAR-BOXES, GEAR SHIFTS, CLUTCHES FOR LAND VEHICLES, LAND VEHICLE PARTS, NAMELY, GEARS AND TRANSMISSIONS; BRAKE CYLINDERS, AIR PUMPS FOR PNEUMATIC TIRES, AIRPLANE AND VEHICLE PROPELLERS, CHAINS FOR MOTOR CARS, LAND VEHICLE PARTS, NAMELY, TIRE CHAINS, TRANSMISSION BELTS FOR LAND VEHICLES, LAND VEHICLE PARTS, NAMELY, DRIVE BELTS, SEATBELTS FOR USE IN VEHICLES, TORQUE CONVERTERS FOR LAND VEHICLES AND MOTOR CARS (U.S. CLS. 19, 21, 23, 31, 35 AND 44).

CLASS 37—CONSTRUCTION AND REPAIR

FOR INSTALLATION AND REPAIR OF AIR CONDITIONING APPARATUS, ELECTRICAL REPAIRS AND INSTALLATION OF MOTORS AND HEATING APPARATUS; PAINTING OR REPAIR OF SIGNS, WAREHOUSE AND SHIPYARD CONSTRUCTION AND REPAIR, AUTOMOBILE TIRE RETREADING, REPAIR AND VULCANIZATION REPAIR OF AUTOMOBILE TIRES, AUTOMOBILE SERVICE STATION SERVICES, RUST PROOFING AND RUST REMOVAL SERVICES FOR VEHICLES, AUTOMOBILE POLISHING, VEHICLE PAINTING, AUTOMOBILE REPAIR AND MAINTENANCE, AUTOMOBILE LUBRICATION, AUTOMOBILE WASHING AND AUTOMOBILE CLEANING (U.S. CLS. 100, 103 AND 106).

CLASS 39—TRANSPORTATION AND STORAGE

FOR PACKAGING ARTICLES FOR TRANSPORTATION, VEHICLE PARKING SERVICES, WAREHOUSE STORAGE, PARKING GARAGE SERVICES, VEHICLE TOWING, CAR TRANSPORT, BUS TRANSPORT, MARINE TRANSPORT, LEASING OF MOTOR CARS, RAILWAY TRANSPORT AND AIR TRANSPORT OF GOODS AND TRAVELERS (U.S. CLS. 100 AND 105).

CHRISTOPHER ADKINS, EXAMINING ATTORNEY

SN 79-003,533. LIMONOV VICTOR L'VOVICH, RUSSIAN FED., FILED 2-13-2004.

МЕРОПЕНАБОЛ

OWNER OF INTERNATIONAL REGISTRATION 0827931
DATED 2-13-2004, EXPIRES 2-13-2014.
MEROOPENABOL

CLASS 5—PHARMACEUTICALS

FOR ANTIBIOTICS; ANTIALLERGIC MEDICINES, ANTIBACTERIAL SUBSTANCES FOR MEDICAL PURPOSES, ANTICONVULSANTS, ANTIDEPRESSANTS, ANTIDIABETIC PREPARATIONS, ANTIPIRETTIC ANALGESICS, ANTI-COUGH DROPS, ANTI-INFECTION PRODUCTS FOR VETERINARY USE, BRONCHIAL DILATORS, BRONCHODILATORS, SULPHONAMIDES, SYNTHETIC NARCOTICS, AND BACTERIOSTATS FOR MEDICINAL, DENTAL AND VETERINARY USE; ACNE MEDICATIONS, ACNE TREATMENT PREPARATIONS, ADJUVANTS FOR USE WITH VACCINES, ALLERGY MEDICATIONS, ANESTHETICS FOR NON-SURGICAL USE, ANESTHETICS FOR SURGICAL USE, ANESTHETICS FOR SURGICAL AND NON-SURGICAL USE, ANTHELMINTICS, ANTIPIRETTIC ANALGESICS, ANTI-ITCH CREAM, ANTI-ITCH OINTMENT, BACTERIAL AND BACTERIOLOGICAL PREPARATIONS FOR MEDICAL OR VETERINARY PURPOSES, BLOOD SUBSTITUTE FOR HUMANS, DIURETICS, MEDICATED BATH PREPARATIONS, MEDICATED LOTIONS FOR SKIN, MEDICATED SKIN CARE PREPARATIONS, BIOCHEMICAL PREPARATIONS FOR MEDICAL OR VETERINARY PURPOSES, PHARMACEUTICAL PRODUCTS AND PREPARATIONS FOR HYDRATING THE SKIN DURING PREGNANCY, TOPICAL ANESTHETICS, AND PAIN RELIEF MEDICATIONS FOR HEADACHES; BACTERIAL AND BACTERIOLOGICAL PREPARATIONS FOR MEDICAL OR VETERINARY PURPOSES, PHARMACEUTICAL ANTITUSSIVE-COLD PREPARATIONS, PHARMACEUTICAL ANTI-ALLERGIC PREPARATIONS AND SUBSTANCES, PHARMACEUTICALS FOR THE TREATMENT OF ERECTILE DYSFUNCTION, PHARMACEUTICAL PREPARATIONS FOR USE IN CHEMOTHERAPY, PHARMACEUTICAL PREPARATION FOR THE TREATMENT OF GOAT, PHARMACEUTICAL PREPARATION FOR THE TREATMENT OF HEART RHYTHM DISORDERS, PHARMACEUTICAL PREPARATIONS FOR THE TREATMENT OF INFECTIOUS DISEASES, PHARMACEUTICAL PREPARATIONS ACTING ON THE CENTRAL NERVOUS SYSTEM, PHARMACEUTICAL PREPARATIONS AND SUBSTANCES FOR THE TREATMENT OF GASTRO*INTESTINAL DISEASES,

PHARMACEUTICAL PREPARATIONS FOR ANIMAL SKINCARE, PHARMACEUTICAL PREPARATIONS FOR INHALATION FOR THE TREATMENT OF PULMONARY HYPERTENSION, PHARMACEUTICAL PREPARATIONS FOR OCULAR OR INTRAOCULAR SURGERY, PHARMACEUTICAL PREPARATIONS FOR THE TREATMENT OF HORMONAL DISORDERS AND THE PREVENTION OF OSTEOPOROSIS, PHARMACEUTICAL PREPARATIONS FOR TREATING ALLERGIC RHINITIS AND ASTHMA, PHARMACEUTICAL PREPARATIONS FOR TREATING DIABETES, PHARMACEUTICAL PREPARATIONS FOR TREATING SKIN DISORDERS, PHARMACEUTICAL PREPARATIONS FOR USE IN DERMATOLOGY, PHARMACEUTICAL PREPARATIONS FOR WOUNDS, PHARMACEUTICAL PRODUCTS AND PREPARATIONS AGAINST DRY SKIN CAUSED BY PREGNANCY, PHARMACEUTICAL PRODUCTS AND PREPARATIONS FOR CHLOASMA, PHARMACEUTICAL PRODUCTS AND PREPARATIONS FOR HYDRATING THE SKIN DURING PREGNANCY, PHARMACEUTICAL PRODUCTS AND PREPARATIONS FOR PREGNANCY BLEMISHES, PHARMACEUTICAL PRODUCTS AND PREPARATIONS TO PREVENT SKIN BLEMISHES DURING PREGNANCY, PHARMACEUTICAL PRODUCTS AND PREPARATIONS TO PREVENT STRETCH MARKS, PHARMACEUTICAL PRODUCTS AND PREPARATIONS TO PREVENT SWELLING IN THE LEGS, PHARMACEUTICAL PRODUCTS FOR OPHTHALMOLOGICAL USE, PHARMACEUTICAL PRODUCTS FOR SKIN CARE FOR ANIMALS, PHARMACEUTICAL PRODUCTS FOR THE TREATMENT OF BONE DISEASES, PHARMACEUTICAL PRODUCTS FOR THE TREATMENT OF VIRAL AND INFECTIOUS DISEASES, FOR THE TREATMENT OF CANCER, PHARMACEUTICAL PRODUCTS FOR TREATING RESPIRATORY DISEASES AND ASTHMA, PHARMACEUTICAL SKIN LOTIONS, PHARMACEUTICAL SOLUTIONS USED IN DIALYSIS, ANTIBACTERIAL PHARMACEUTICALS, ANTI-DIABETIC PHARMACEUTICALS, AT-TRINGENTS, CARDIOVASCULAR PHARMACEUTICALS, AND DERMATOLOGICAL PHARMACEUTICAL PRODUCTS; ANESTHETICS FOR NON-SURGICAL USE, ANESTHETICS FOR SURGICAL AND NON-SURGICAL USE, BIOLOGICAL PREPARATIONS FOR MEDICAL PURPOSES, BIOLOGICAL AND CHEMICAL PREPARATIONS AND REAGENTS FOR MEDICAL OR VETERINARY USE, FERMENTS FOR MEDICAL OR VETERINARY USE, TOPICAL ANESTHETICS, SANITARY STERILIZING PREPARATIONS, PHARMACEUTICAL PREPARATIONS FOR USE IN CHEMOTHERAPY, AND VETERINARY VACCINES; ALL PURPOSE DISINFECTANTS, CHEMICAL CONDUCTORS FOR USE WITH ELECTROCARDIOGRAPH ELECTRODES, CHEMICAL PREPARATIONS FOR SANITARY PURPOSES, CHEMICAL PREPARATIONS FOR SANITARY USE, CHEMICALLY TREATED PAPERS FOR USE IN THE DETECTION OF FECAL OCCULT BLOOD, CHEMOTHERAPEUTICS, CHLORAMPHENICOL PREPARATIONS, CHOLESTEROL REDUCERS, CHONDROITIN PREPARATIONS, DENTAL ABRASIVES, DENTAL ALLOYS, DENTAL AMALGAMS, DENTAL CEMENT, DENTAL CEMENTS, DENTAL CERAMICS, DENTAL COMPOSITE MATERIALS, DENTAL IMPRESSION MATERIALS, DENTAL POLISH, DENTAL RESTORATION COMPOUNDS, DENTAL RESTORATION COMPOUNDS, NAMELY, DUAL CORE CEMENT, DENTAL RINSE, DENTAL VENEERS, DENTAL WAX, DENTAL WAXES, DENTURE ADHESIVES, DERMATOLOGICALS, DIAGNOSTIC PREPARATIONS FOR CLINICAL OR MEDICAL LABORATORY USE, DIAGNOSTIC PREPARATIONS FOR MEDICAL AND VETERINARY USE, DIAGNOSTIC REAGENTS FOR MEDICINAL USE, DISINFECTANTS FOR MEDICAL INSTRUMENTS, DISINFECTANTS FOR SANITARY PURPOSES, PARASITICIDES FOR MEDICAL USE, MEDICATED CHEWING GUM, MEDICATED GUM FOR [SPECIFY MEDICAL USE], REAGENTS AND MEDIA FOR MEDICAL AND VETERINARY DIAGNOSTIC PURPOSES; AMINO ACIDS FOR MEDICAL OR VETERINARY PURPOSES, ANALGESIC BALM, ANALGESIC PREPARATIONS, ANALGESICS, EAR DROPS, EMETIC PREPARATIONS, FUNGAL MEDICATIONS, CHILBLAIN PREPARATIONS, ANTI-DERMOINFECTIVES, NOSE DROPS, TOPICAL ANALGESICS, SYNTHETIC PEPTIDES FOR PHARMACEUTICAL PURPOSES, VITAMIN AND MINERAL PREPARATIONS FOR USE AS INGREDIENTS IN THE PHARMACEUTICAL INDUSTRY, AND MEDICATED SUNBURN PREPARATIONS (U.S. CLS. 6, 18, 44, 46, 51 AND 52).

CLASS 35—ADVERTISING AND BUSINESS

FOR CONDUCTING MARKETING STUDIES; IMPORT AND EXPORT AGENCIES; PROMOTING THE SALES OF GOODS AND SERVICES OF OTHERS THROUGH THE DISTRIBUTION OF PRINTING MATERIAL AND PROMOTING CONTESTS; DISSEMINATION OF ADVERTISING MATER (U.S. CLS. 100, 101 AND 102).

LINDA M. KING, EXAMINING ATTORNEY

SN 79-003,592. SICAM S.R.L., I-42015 CORREGGIO (REGGIO EMILIA), ITALY, FILED 4-22-2004.



OWNER OF INTERNATIONAL REGISTRATION 0696912 DATED 7-17-1998, EXPIRES 7-17-2008.

THE MARK COMPRISES THE SCRIPT "SICAM" WRITTEN IN FULL, BLOCK, UPPER-CASE TYPE AND PLACED BELOW THE STYLISED IMAGE OF A BIRD IN FLIGHT.

CLASS 7—MACHINERY

FOR HYDRAULIC JACKS; MACHINES FOR CHANGING TIRES; HYDRAULIC AUTOMOBILE LIFTERS; CAR WHEEL WASHING MACHINES; TIRE AND TUBE VULCANIZING MACHINES AND PARTS THEREOF; WINDING AND UNWINDING YARN MACHINES; TIRE INFLATING MACHINES (U.S. CLS. 13, 19, 21, 23, 31, 34 AND 35).

CLASS 9—ELECTRICAL AND SCIENTIFIC APPARATUS

FOR TIRE GAUGES; TIRE BALANCING MACHINES FOR MOTOR VEHICLES; WHEEL ALIGNMENT MEASURING MACHINES; INSPECTION MACHINES FOR INSPECTING THE INTERNAL SURFACE OF TIRES (U.S. CLS. 21, 23, 26, 36 AND 38).

MICHAEL ENGEL, EXAMINING ATTORNEY

SN 79-003,606. LIMONOV VICTOR L'VOVICH, RUSSIAN FED., FILED 2-13-2004.



OWNER OF INTERNATIONAL REGISTRATION 0812053 DATED 5-28-2003, EXPIRES 5-28-2013.

MAXICEF

CLASS 5—PHARMACEUTICALS

FOR ANTIBIOTICS; ANTIALLERGIC MEDICINES, ANTIBACTERIAL SUBSTANCES FOR MEDICAL PURPOSES, ANTICONVULSANTS, ANTIDEPRESSANTS, ANTIDIABETIC PREPARATIONS, ANTIPYRETIC ANALGESICS, ANTI-COUGH DROPS, ANTI-INFECTIVE PRODUCTS FOR VETERINARY USE, BRONCHIAL DILATORS, BRONCHODILATORS, SULPHONAMIDES [MEDICINES], SYNTHETIC NARCOTICS, BACTERIOSTATS FOR MEDICINAL, DENTAL AND VETERINARY USE; ACNE MEDICATIONS, ACNE TREATMENT PREPARATIONS, ADJUVANTS FOR USE WITH VACCINES, ALLERGY MEDICATIONS, ANESTHETICS FOR NON-SURGICAL USE, ANESTHETICS FOR SURGICAL USE,

ANESTHETICS FOR SURGICAL AND NON-SURGICAL USE, ANTHELMINTICS, ANTIPYRETIC ANALGESICS, ANTI-ITCH CREAM, ANTI-ITCH OINTMENT, BACTERIAL AND BACTERIOLOGICAL PREPARATIONS FOR MEDICAL OR VETERINARY PURPOSES, BLOOD SUBSTITUTE FOR HUMAN, DIURETICS, MEDICATED BATH PREPARATIONS, MEDICATED LOTIONS FOR SKIN, MEDICATED SKIN CARE PREPARATIONS, BIO-CHEMICAL PREPARATIONS FOR MEDICAL OR VETERINARY PURPOSES, PHARMACEUTICAL PRODUCTS AND PREPARATIONS FOR HYDRATING THE SKIN DURING PREGNANCY, TOPICAL ANESTHETICS; PAIN RELIEF MEDICATIONS FOR HEADACHES; BACTERIAL AND BACTERIOLOGICAL PREPARATIONS FOR MEDICAL OR VETERINARY PURPOSES, PHARMACEUTICAL ANTITUSSIVE-COLD PREPARATIONS, PHARMACEUTICAL ANTI-ALLERGIC PREPARATIONS AND SUBSTANCES, PHARMACEUTICAL FOR THE TREATMENT OF ERECTILE DYSFUNCTION, PHARMACEUTICAL PREPARATIONS FOR USE IN CHEMOTHERAPY, PHARMACEUTICAL PREPARATION FOR THE TREATMENT OF GOUT, PHARMACEUTICAL PREPARATIONS FOR THE TREATMENT OF HEART RHYTHM DISORDERS, PHARMACEUTICAL PREPARATIONS FOR THE TREATMENT OF INFECTIOUS DISEASES PHARMACEUTICAL PREPARATIONS ACTING ON THE CENTRAL NERVOUS SYSTEM, PHARMACEUTICAL PREPARATIONS AND SUBSTANCES FOR THE TREATMENT OF GASTRO-INTESTINAL DISEASES, PHARMACEUTICAL PREPARATIONS FOR ANIMAL SKINCARE, PHARMACEUTICAL PREPARATIONS FOR INHALATION FOR THE TREATMENT OF PULMONARY HYPERTENSION, PHARMACEUTICAL PREPARATIONS FOR OCULAR OR INTRAOCULAR SURGERY, PHARMACEUTICAL PREPARATIONS FOR THE TREATMENT OF HORMONAL DISORDERS AND THE PREVENTION OF OSTEOPOROSIS, PHARMACEUTICAL PREPARATIONS FOR TREATING ALLERGIC RHINITIS AND ASTHMA, PHARMACEUTICAL PREPARATIONS FOR TREATING DIABETES, PHARMACEUTICAL PREPARATIONS FOR TREATING SKIN DISORDERS, PHARMACEUTICAL PREPARATIONS FOR USE IN DERMATOLOGY, PHARMACEUTICAL PREPARATIONS FOR WOUNDS, PHARMACEUTICAL PRODUCTS AND PREPARATIONS AGAINST DRY SKIN CAUSED BY PREGNANCY, PHARMACEUTICAL PRODUCTS AND PREPARATIONS FOR CHLOASMA, PHARMACEUTICAL PRODUCTS AND PREPARATIONS FOR HYDRATING THE SKIN DURING PREGNANCY, PHARMACEUTICAL PRODUCTS AND PREPARATIONS FOR PREGNANCY BLEMISHES, PHARMACEUTICAL PRODUCTS AND PREPARATIONS FOR PREVENTING SKIN BLEMISHES DURING PREGNANCY, PHARMACEUTICAL PRODUCTS AND PREPARATIONS TO PREVENT STRETCH MARKS, PHARMACEUTICAL PRODUCTS AND PREPARATIONS TO PREVENT SWELLING IN THE LEGS, PHARMACEUTICAL PRODUCTS FOR OPHTHALMOLOGICAL USE, PHARMACEUTICAL PRODUCTS FOR SKIN CARE FOR ANIMALS, PHARMACEUTICAL PRODUCTS FOR THE TREATMENT OF BONE DISEASES, PHARMACEUTICAL PRODUCTS FOR THE TREATMENT OF VIRAL AND INFECTIOUS DISEASES, FOR THE TREATMENT OF CANCER, PHARMACEUTICAL PRODUCTS FOR TREATING RESPIRATORY DISEASES AND ASTHMA, PHARMACEUTICAL SKIN LOTIONS PHARMACEUTICAL SOLUTIONS USED IN DIALYSIS, PHARMACEUTICALS FOR THE TREATMENT OF ERECTILE DYSFUNCTION, ANTIBACTERIAL PHARMACEUTICALS, ANTI-DIABETIC PHARMACEUTICALS, ASTRINGENTS [PHARMACEUTICAL], CARDIOVASCULAR PHARMACEUTICALS, DERMATOLOGICAL PHARMACEUTICAL PRODUCTS; ANESTHETICS FOR NON-SURGICAL USE, ANESTHETICS FOR SURGICAL AND NON-SURGICAL USE, BIOLOGICAL PREPARATIONS FOR MEDICAL PURPOSES, BIOLOGICAL AND CHEMICAL PREPARATIONS AND REAGENTS FOR MEDICAL OR VETERINARY USE, FERMENTS FOR MEDICAL OR VETERINARY USE, TOPICAL ANESTHETICS, SANITARY STERILISING PREPARATIONS, PHARMACEUTICAL PREPARATIONS FOR USE IN CHEMOTHERAPY, VETERINARY VACCINES (U.S. CLS. 6, 18, 44, 46, 51 AND 52).

CLASS 16—PAPER GOODS AND PRINTED MATTER

FOR STICKERS, PAPER LABELS (U.S. CLS. 2, 5, 22, 23, 29, 37, 38 AND 50).

CLASS 35—ADVERTISING AND BUSINESS

FOR CONDUCTING MARKETING STUDIES; IMPORT AND EXPORT AGENCIES; PROMOTING THE SALES OF GOODS AND SERVICES OF OTHERS THROUGH THE DISTRIBUTION OF PRINTING MATERIAL AND PROMOTING CONTESTS; DISSEMINATION OF ADVERTISING MATTER (U.S. CLS. 100, 101 AND 102).

LINDA M. KING, EXAMINING ATTORNEY

CLASS 5—PHARMACEUTICALS

FOR ANTIBIOTICS; ANTIALLERGIC MEDICINES, ANTIBACTERIAL SUBSTANCES FOR MEDICAL PURPOSES, ANTICONVULSANTS, ANTIDEPRESSANTS, ANTIDIABETIC PREPARATIONS, ANTIPYRETIC ANALGESICS, ANTI-COUGH DROPS, ANTI-INFECTIVE PRODUCTS FOR VETERINARY USE, BRONCHIAL DILATORS, BRONCHODILATORS, SULPHONAMIDES [MEDICINES], SYNTHETIC NARCOTICS, BACTERIOSTATS FOR MEDICINAL, DENTAL AND VETERINARY USE; ACNE MEDICATIONS, ACNE TREATMENT PREPARATIONS, ADJUVANTS FOR USE WITH VACCINES, ALLERGY MEDICATIONS, ANESTHETICS FOR NON-SURGICAL USE, ANESTHETICS FOR SURGICAL USE, ANESTHETICS FOR SURGICAL AND NON-SURGICAL USE, ANTHELMINTICS, ANTIPYRETIC ANALGESICS, ANTI-ITCH CREAM, ANTI-ITCH OINTMENT, BACTERIAL AND BACTERIOLOGICAL PREPARATIONS FOR MEDICAL OR VETERINARY PURPOSES, BLOOD SUBSTITUTE FOR HUMAN, DIURETICS, MEDICATED BATH PREPARATIONS, MEDICATED LOTIONS FOR SKIN, MEDICATED SKIN CARE PREPARATIONS, BIO-CHEMICAL PREPARATIONS FOR MEDICAL OR VETERINARY PURPOSES, PHARMACEUTICAL PRODUCTS AND PREPARATIONS FOR HYDRATING THE SKIN DURING PREGNANCY, TOPICAL ANESTHETICS, PAIN RELIEF MEDICATIONS FOR HEADACHES; BACTERIAL AND BACTERIOLOGICAL PREPARATIONS FOR MEDICAL OR VETERINARY PURPOSES, PHARMACEUTICAL ANTITUSSIVE-COLD PREPARATIONS, PHARMACEUTICAL ANTI-ALLERGIC PREPARATIONS AND SUBSTANCES, PHARMACEUTICAL FOR THE TREATMENT OF ERECTILE DYSFUNCTION, PHARMACEUTICAL PREPARATIONS FOR USE IN CHEMOTHERAPY, PHARMACEUTICAL PREPARATION FOR THE TREATMENT OF GOUT, PHARMACEUTICAL PREPARATIONS FOR THE TREATMENT OF HEART RHYTHM DISORDERS, PHARMACEUTICAL PREPARATIONS FOR THE TREATMENT OF INFECTIOUS DISEASES PHARMACEUTICAL PREPARATIONS ACTING ON THE CENTRAL NERVOUS SYSTEM, PHARMACEUTICAL PREPARATIONS AND SUBSTANCES FOR THE TREATMENT OF GASTRO-INTESTINAL DISEASES, PHARMACEUTICAL PREPARATIONS FOR ANIMAL SKINCARE, PHARMACEUTICAL PREPARATIONS FOR INHALATION FOR THE TREATMENT OF PULMONARY HYPERTENSION, PHARMACEUTICAL PREPARATIONS FOR OCULAR OR INTRAOCULAR SURGERY, PHARMACEUTICAL PREPARATIONS FOR THE TREATMENT OF HORMONAL DISORDERS AND THE PREVENTION OF OSTEOPOROSIS, PHARMACEUTICAL PREPARATIONS FOR TREATING ALLERGIC RHINITIS AND ASTHMA, PHARMACEUTICAL PREPARATIONS FOR TREATING DIABETES, PHARMACEUTICAL PREPARATIONS FOR TREATING SKIN DISORDERS, PHARMACEUTICAL PREPARATIONS FOR USE IN DERMATOLOGY, PHARMACEUTICAL PREPARATIONS FOR WOUNDS, PHARMACEUTICAL PRODUCTS AND PREPARATIONS AGAINST DRY SKIN CAUSED BY PREGNANCY, PHARMACEUTICAL PRODUCTS AND PREPARATIONS FOR CHLOASMA, PHARMACEUTICAL PRODUCTS AND PREPARATIONS FOR HYDRATING THE SKIN DURING PREGNANCY, PHARMACEUTICAL PRODUCTS AND PREPARATIONS FOR PREVENTING SKIN BLEMISHES DURING PREGNANCY, PHARMACEUTICAL PRODUCTS AND PREPARATIONS TO PREVENT STRETCH MARKS, PHARMACEUTICAL PRODUCTS AND PREPARATIONS TO PREVENT SWELLING IN THE LEGS, PHARMACEUTICAL PRODUCTS FOR OPHTHALMOLOGICAL USE, PHARMACEUTICAL PRODUCTS FOR SKIN CARE FOR ANIMALS, PHARMACEUTICAL PRODUCTS FOR THE TREATMENT OF BONE DISEASES, PHARMACEUTICAL PRODUCTS FOR THE TREATMENT OF VIRAL AND INFECTIOUS DISEASES, FOR THE TREATMENT OF CANCER, PHARMACEUTICAL PRODUCTS FOR TREATING RESPIRATORY DISEASES AND ASTHMA, PHARMACEUTICAL SKIN LOTIONS PHARMACEUTICAL SOLUTIONS USED IN DIALYSIS, PHARMACEUTICALS FOR THE TREATMENT OF ERECTILE DYSFUNCTION, ANTIBACTERIAL PHARMACEUTICALS, ANTI-DIABETIC PHARMACEUTICALS, ASTRINGENTS [PHARMACEUTICAL], CARDIOVASCULAR PHARMACEUTICALS, DERMATOLOGICAL PHARMACEUTICAL PRODUCTS; ANESTHETICS FOR NON-SUR-

SN 79-003,637. PRODUITS BERGER, FRANCE, FILED 3-26-2004.



PRIORITY DATE OF 10-6-2003 IS CLAIMED.
OWNER OF INTERNATIONAL REGISTRATION 0828156
DATED 3-26-2004, EXPIRES 3-26-2014.

NO CLAIM IS MADE TO THE EXCLUSIVE RIGHT TO USE "PARFUMS", APART FROM THE MARK AS SHOWN. THE FOREIGN WORDING IN THE MARK TRANSLATES INTO ENGLISH AS PERFUMES.

CLASS 3—COSMETICS AND CLEANING PREPARATIONS

FOR PERFUMERY PRODUCTS FOR USE IN APPARATUS OR LAMPS FOR DISINFECTION, CLEANING AND PURIFICATION OF THE ATMOSPHERE AND FOR ABSORBING ODOURS AND FUMES, IN PARTICULAR TOBACCO FUMES; STAIN-REMOVERS; PERFUMERY PRODUCTS (U.S. CLS. 1, 4, 6, 50, 51 AND 52).

CLASS 4—LUBRICANTS AND FUELS

FOR INDUSTRIAL OIL, GREASE AND LUBRICANTS; OIL BASED DUST ABSORBING AND BINDING COMPOSITIONS FOR GENERAL PURPOSES; ILLUMINANTS, NAMELY LAMP OIL (U.S. CLS. 1, 6 AND 15).

H. M. FISHER, EXAMINING ATTORNEY

SN 79-003,729. LIMONOV VICTOR L'VOVICH, RUSSIAN FED., FILED 2-13-2004.

СУЛЬПЕРАЦЕФ

OWNER OF INTERNATIONAL REGISTRATION 0812054
DATED 5-28-2003, EXPIRES 5-28-2013.
SULPERACEF

GICAL USE, ANESTHETICS FOR SURGICAL AND NON-SURGICAL USE, BIOLOGICAL PREPARATIONS FOR MEDICAL PURPOSES, BIOLOGICAL AND CHEMICAL PREPARATIONS AND REAGENTS FOR MEDICAL OR VETERINARY USE, FERMENTS FOR MEDICAL OR VETERINARY USE, TOPICAL ANESTHETICS, SANITARY STERILIZING PREPARATIONS, PHARMACEUTICAL PREPARATIONS FOR USE IN CHEMOTHERAPY, VETERINARY VACCINES (U.S. CLS. 6, 18, 44, 46, 51 AND 52).

CLASS 16—PAPER GOODS AND PRINTED MATTER

FOR STICKERS, PAPER LABELS (U.S. CLS. 2, 5, 22, 23, 29, 37, 38 AND 50).

CLASS 35—ADVERTISING AND BUSINESS

FOR CONDUCTING MARKETING STUDIES; IMPORT AND EXPORT AGENCIES; PROMOTING THE SALES OF GOODS AND SERVICES OF OTHERS THROUGH THE DISTRIBUTION OF PRINTING MATERIAL AND PROMOTING CONTESTS; DISSEMINATION OF ADVERTISING MATER (U.S. CLS. 100, 101 AND 102).

LINDA M. KING, EXAMINING ATTORNEY

SN 79-003,743. PHARMADULE EMTUNGA AB, NACKA, SWEDEN, FILED 4-5-2004.

SUPERSKID

THE MARK CONSISTS OF STANDARD CHARACTERS WITHOUT CLAIM TO ANY PARTICULAR FONT, STYLE, SIZE, OR COLOR.

PRIORITY DATE OF 10-7-2003 IS CLAIMED.

OWNER OF INTERNATIONAL REGISTRATION 0828471 DATED 4-5-2004, EXPIRES 4-5-2014.

CLASS 37—CONSTRUCTION AND REPAIR

FOR BUILDING CONSTRUCTION OF CHEMICAL AND PHARMACEUTICAL PLANTS AND OTHER BUILDINGS; ASSEMBLAGE AND INSTALLATION OF TRANSPORTABLE AND/OR PREFABRICATED BUILDINGS; INSTALLATION OF CONSTRUCTION EQUIPMENT; INSTALLATION OF EQUIPMENT AND INSTRUMENTS FOR BIOTECHNICAL, CHEMICAL AND PHARMACEUTICAL USES (U.S. CLS. 100, 103 AND 106).

CLASS 42—SCIENTIFIC, COMPUTER AND LEGAL SERVICES

FOR SCIENTIFIC RESEARCH RELATED TO DESIGN AND CONSTRUCTION OF BIOTECHNICAL, CHEMICAL AND PHARMACEUTICAL PROCESSES AND FACILITIES; ARCHITECT SERVICES FOR CHEMICAL AND PHARMACEUTICAL PLANTS AND OTHER BUILDINGS; INDUSTRIAL DESIGN; INDUSTRIAL DESIGN FOR CHEMICAL AND PHARMACEUTICAL PLANTS AND OTHER BUILDINGS; DRAFTING; DRAFTING FOR THE CONSTRUCTION OF CHEMICAL AND PHARMACEUTICAL PLANTS AND OTHER BUILDINGS; ENGINEERING SERVICES FOR THE CONSTRUCTION OF CHEMICAL AND PHARMACEUTICAL PLANTS AND OTHER BUILDINGS (U.S. CLS. 100 AND 101).

CHRIS WELLS, EXAMINING ATTORNEY

SN 79-003,745. Merial Limited, Harlow, CM19 5QA, UNITED KINGDOM, FILED 5-27-2004.

ORAVET

PRIORITY DATE OF 12-9-2003 IS CLAIMED.
OWNER OF INTERNATIONAL REGISTRATION 0828473 DATED 5-27-2004, EXPIRES 5-27-2014.

CLASS 3—COSMETICS AND CLEANING PREPARATIONS

FOR COSMETICS; DENTAL CLEANING PREPARATIONS FOR ANIMALS, NAMELY, NON-MEDICATED DENTAL RINSE (U.S. CLS. 1, 4, 6, 50, 51 AND 52).

CLASS 5—PHARMACEUTICALS

FOR VETERINARY PREPARATIONS, NAMELY, DENTAL CLEANING PREPARATIONS TO PREVENT THE BUILD-UP OF PLAQUE AND BACTERIA (U.S. CLS. 6, 18, 44, 46, 51 AND 52).

ROBERT C. CLARK JR., EXAMINING ATTORNEY

SN 79-003,754. OXFORD BIOMEDICA PLC, UNITED KINGDOM, FILED 2-24-2004.

PROCASTAT

THE MARK CONSISTS OF STANDARD CHARACTERS WITHOUT CLAIM TO ANY PARTICULAR FONT, STYLE, SIZE, OR COLOR.

OWNER OF INTERNATIONAL REGISTRATION 0828507 DATED 2-24-2004, EXPIRES 2-24-2014.

OWNER OF U.S. REG. NO. 2,222,448.

CLASS 5—PHARMACEUTICALS

FOR CLINICAL MEDICAL REAGENTS FOR USE IN GENE THERAPY; PHARMACEUTICAL PREPARATIONS, NAMELY, VACCINES FOR USE IN GENE THERAPY; THERAPEUTIC COMPOSITIONS CONTAINING LIPOSOME REAGENTS OR NUCLEIC ACID SUITABLE FOR GENE THERAPY FOR USE IN THE TREATMENT OF CANCER AND AUTO-IMMUNE DISORDERS; PHARMACEUTICAL PREPARATIONS CONTAINING NUCLEIC ACIDS FOR USE IN THE TREATMENT OF VIRAL AND BACTERIAL INFECTIONS, CANCER, HIV AND AIDS-RELATED INFECTIONS AND BODILY CONDITIONS ASSOCIATED WITH IMPAIRED IMMUNOSYSTEMS, SINGLE GENE DISORDERS, HEMOPHILIA, BLOOD DISORDERS, VASCULAR DISORDERS AND DISORDERS ARISING FROM INAPPROPRIATE VASCULARIZATION DISEASES OF THE NERVOUS SYSTEM, CARDIAC DISORDERS, INFLAMMATORY AND AUTO-IMMUNE DISEASES; PHARMACEUTICAL PREPARATIONS AND VACCINES FOR USE IN THE TREATMENT OF CANCER, SINGLE GENE DISORDERS, HEMOPHILIA, BLOOD DISORDERS, VASCULAR DISORDERS AND DISORDERS ARISING FROM INAPPROPRIATE VASCULARIZATION, DISEASES OF THE NERVOUS SYSTEM, CARDIAC DISORDERS, INFLAMMATORY AND AUTO-IMMUNE DISEASES; ENZYMES AND ENZYMATIC PREPARATIONS FOR MEDICAL USE IN THE TREATMENT OF BACTERIAL INFECTIONS; RETROVIRAL VECTOR PREPARATIONS FOR MEDICAL USE IN THE TREATMENT OF CANCER; AND CHEMOTHERAPEUTICS FOR MEDICAL USE (U.S. CLS. 6, 18, 44, 46, 51 AND 52).

CLASS 10—MEDICAL APPARATUS

FOR INSTRUMENTS AND APPARATUS FOR THE ADMINISTRATION OF GENE THERAPY PRODUCTS, NAMELY, VIALS, SYRINGES, INJECTORS, CATHETERS AND TUBES; AND SURGICAL AND MEDICAL APPARATUS AND INSTRUMENTS, NAMELY, SCALPELS, KNIVES, FORCEPS AND SURGICAL CLIPS (U.S. CLS. 26, 39 AND 44).

VERNA BETH RIRIE, EXAMINING ATTORNEY

SN 79-003,799. HENKEL KGAA, FED REP GERMANY, FILED 2-27-2004.

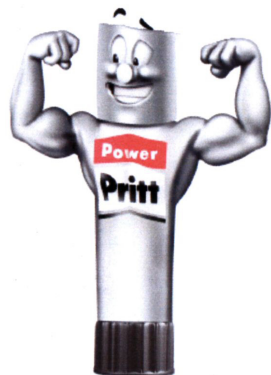

PRIORITY DATE OF 12-6-2003 IS CLAIMED.
OWNER OF INTERNATIONAL REGISTRATION 0828645
DATED 2-27-2004, EXPIRES 2-27-2014.
OWNER OF U.S. REG. NO. 973,171.

THE COLORS RED, BLACK, WHITE, AND SILVER IS/ARE CLAIMED AS A FEATURE OF THE MARK.

THE COLOR RED APPEARS ON THE TOP CHEVRON DESIGN. THE COLOR BLACK IS USED FOR THE WORD "PRITT", FOR THE EYES AND EYEBROWS OF THE STICK MAN, IN A LINE AT THE BOTTOM OF THE BOTTOM CHEVRON, AND IN A BAND AROUND THE BOTTOM OF THE STICK. WHITE IS USED FOR THE WORD "POWER", FOR THE EYES, THE NOSE, THE TEETH, AND INSIDE THE BOTTOM CHEVRON DESIGN. THE STICK MAN IS IN WHITE AND IN VARIOUS SHADES OF SILVER.

CLASS 1—CHEMICALS

FOR ADHESIVES FOR INDUSTRIAL PURPOSES (U.S. CLS. 1, 5, 6, 10, 26 AND 46).

CLASS 16—PAPER GOODS AND PRINTED MATTER

FOR PRINTED MATTER, NAMELY CRAFT BOOKS; CORRECTION MATERIALS, NAMELY, CORRECTION FLUIDS, CORRECTION PENS AND CORRECTION TAPES FOR DOCUMENTS; INSTRUMENTS FOR WRITING, DRAWING, PAINTING, AND MARKING, NAMELY ROLLERBALL PAINT MARKERS; ADHESIVE TAPES AND ADHESIVE PADS FOR STATIONERY OR HOUSEHOLD PURPOSES; ADHESIVES FOR DO-IT-YOURSELF AND HOUSEHOLD PURPOSES; DRAWING, PAINTING AND MODELING MATERIALS, NAMELY WATER COLOR PAINTS, GLUES, GLITTER PENS, GLITTER AND DECORATIVE SHAPES (U.S. CLS. 2, 5, 22, 23, 29, 37, 38 AND 50).

CLASS 35—ADVERTISING AND BUSINESS

FOR ADVERTISING (U.S. CLS. 100, 101 AND 102).
JOSETTE BEVERLY, EXAMINING ATTORNEY

SN 79-003,835. EPC ENGINEERING UND PROJEKTMANAGEMENT CONSULTING GMBH, FED REP GERMANY, FILED 3-8-2004.



PRIORITY DATE OF 9-12-2003 IS CLAIMED.
OWNER OF INTERNATIONAL REGISTRATION 0828833
DATED 3-8-2004, EXPIRES 3-8-2014.

CLASS 35—ADVERTISING AND BUSINESS

FOR PROFESSIONAL BUSINESS CONSULTANCY; EMPLOYMENT AGENCIES, BUSINESS APPRAISALS; ECONOMIC FORECASTING; INTERNET ADVERTISING FOR OTHERS (U.S. CLS. 100, 101 AND 102).

CLASS 36—INSURANCE AND FINANCIAL

FOR INVESTMENT PLANNING; FINANCIAL ANALYSIS/EVALUATION (U.S. CLS. 100, 101 AND 102).

CLASS 37—CONSTRUCTION AND REPAIR

FOR CONSTRUCTION CONSULTATION; BUILDING CONSTRUCTION; DEMOLITION WORKS ON BUILDINGS; SUPERINTENDENCE OF CONSTRUCTION WORKS; INSTALLATION OF VENTILATION AND REFRIGERATION SYSTEMS; BUILDING INSULATING; MAINTENANCE AND SERVICING OF INDUSTRIAL PLANTS; RESTORATION OF INDUSTRIAL PLANTS (U.S. CLS. 100, 103 AND 106).

CLASS 41—EDUCATION AND ENTERTAINMENT

FOR INSTRUCTION AND TRAINING OF PERSONNEL; ORGANIZATION AND ARRANGEMENT OF EXHIBITIONS AND FAIRS FOR SCIENTIFIC PURPOSES (U.S. CLS. 100, 101 AND 107).

CLASS 42—SCIENTIFIC, COMPUTER AND LEGAL SERVICES

FOR SCIENTIFIC, AND TECHNOLOGICAL SERVICES, NAMELY, IN THE FIELDS OF INDUSTRIAL PLANTS AND INDUSTRIAL BUILDINGS, AND RESEARCH PROJECTS AND DESIGNER SERVICES RELATING THERETO; INDUSTRIAL ANALYSIS AND RESEARCH SERVICES; ENGINEERING CONSULTATION IN VIEW OF PLANNING, CONSTRUCTING AND IMPLEMENTING INDUSTRIAL PLANTS AND INDUSTRIAL BUILDINGS; ARCHITECTURE; CHEMICAL ANALYSIS; CHEMISTRY CONSULTATION AND RESEARCH IN THE FIELD OF CHEMISTRY; GEOLOGICAL SURVEYS; SURVEYING; LAND SURVEYING, URBAN PLANNING; CONSULTATION IN ENVIRONMENT PROTECTION; ENGINEERING; COMPUTER PROGRAMMING FOR OTHERS; DESIGN OF COMPUTER SOFTWARE; DEVELOPMENT OF DATABASES; COUNSELING IN VIEW OF HOME PAGE AND INTERNET PAGE DESIGN; DEVELOPMENT AND RESEARCH SERVICES RELATING TO NEW PRODUCTS FOR OTHERS; DEVELOPMENT AND PLANNING OF CHEMICAL TECHNOLOGIES AND METHODS (U.S. CLS. 100 AND 101).

IRENE D. WILLIAMS, EXAMINING ATTORNEY

SN 79-003,862. LIDL STIFTUNG & CO. KG, D-74167 NECK-ARSULM, FED REP GERMANY, FILED 3-26-2004.

SN 79-003,899. HENKEL KGAA, FED REP GERMANY, FILED 2-27-2004.

Siempre



PRIORITY DATE OF 9-30-2003 IS CLAIMED.
OWNER OF INTERNATIONAL REGISTRATION 0828957
DATED 3-26-2004, EXPIRES 3-26-2014.
THE FOREIGN WORDING IN THE MARK TRANSLATES
INTO ENGLISH AS ALWAYS.

CLASS 3—COSMETICS AND CLEANING PREPARATIONS

FOR COTTON WOOL PRODUCTS FOR NON-MEDICAL PURPOSES, NAMELY, COTTON WOOL BALLS AND SWABS FOR COSMETIC USE, AND PRE-MOISTENED COTTON WOOL COSMETIC WIPES (U.S. CLS. 1, 4, 6, 50, 51 AND 52).

CLASS 5—PHARMACEUTICALS

FOR HYGIENE PRODUCTS FOR WOMEN, NAMELY, MENSTRUATION BANDAGES, PANTY LINERS, TAMPONS, INCONTINENCE PADS AND DIAPERS AND COTTON WOOL FOR MEDICAL PURPOSES (U.S. CLS. 6, 18, 44, 46, 51 AND 52).

CLASS 16—PAPER GOODS AND PRINTED MATTER

FOR GOODS MADE FROM PAPER AND CARDBOARD, NAMELY, PAPER TOWELS, TABLE NAPKINS OF PAPER, FILTER PAPER, PAPER HANDKERCHIEFS, TOILET PAPER, BABY DIAPERS OF PAPER, INDUSTRIAL PACKAGING CONTAINERS AND PAPER BAGS FOR PACKAGING, FACIAL TISSUES AND TISSUE PAPER (U.S. CLS. 2, 5, 22, 23, 29, 37, 38 AND 50).

CLASS 25—CLOTHING

FOR PANTS FOR BABIES; BABY DIAPERS OF TEXTILE MATERIAL (U.S. CLS. 22 AND 39).
H. M. FISHER, EXAMINING ATTORNEY

PRIORITY DATE OF 12-6-2003 IS CLAIMED.
OWNER OF INTERNATIONAL REGISTRATION 0829053
DATED 2-27-2004, EXPIRES 2-27-2014.
OWNER OF U.S. REG. NO. 973,171.

THE COLOR(S) RED, BLACK, WHITE AND GRAY IS/ARE CLAIMED AS A FEATURE OF THE MARK.

THE COLOR RED APPEARS ON THE BOTTOM HALF OF THE STICK MAN, AND IS USED ON HIS TONGUE, LIPS AND CHEEKS. THE COLOR BLACK IS USED FOR THE WORD "PRITT", FOR THE EYES, EYEBROWS, AND INSIDE THE MOUTH, IN TWO LINES AT THE BOTTOM OF THE CHEVRON DESIGN, AND IN A BAND AROUND THE BOTTOM OF THE STICK. THE HEAD AND ARMS OF THE STICK MAN ARE IN VARIOUS SHADES OF GRAY, AND THE FINGERS ARE OUTLINED IN VARIOUS SHADES OF GRAY. WHITE IS USED FOR THE FINGERS, THE NOSE, AND INSIDE THE CHEVRON DESIGN.

CLASS 1—CHEMICALS

FOR ADHESIVES FOR INDUSTRIAL PURPOSES (U.S. CLS. 1, 5, 6, 10, 26 AND 46).

CLASS 16—PAPER GOODS AND PRINTED MATTER

FOR PRINTED MATTER, NAMELY CRAFT BOOKS; CORRECTION MATERIALS, NAMELY, CORRECTION FLUIDS, CORRECTION PENS AND CORRECTION TAPES FOR DOCUMENTS; INSTRUMENTS FOR WRITING, DRAWING, PAINTING, AND MARKING, NAMELY ROLLERBALL PAINT MARKERS; ADHESIVE TAPES AND ADHESIVE PADS FOR STATIONERY OR HOUSEHOLD PURPOSES; ADHESIVES FOR DO-IT-YOURSELF AND HOUSEHOLD PURPOSES; DRAWING, PAINTING AND MODELING MATERIALS, NAMELY WATER COLOR PAINTS, GLUES, GLITTER PENS, GLITTER AND DECORATIVE SHAPES (U.S. CLS. 2, 5, 22, 23, 29, 37, 38 AND 50).

CLASS 35—ADVERTISING AND BUSINESS

FOR ADVERTISING (U.S. CLS. 100, 101 AND 102).
JOSETTE BEVERLY, EXAMINING ATTORNEY

SN 79-003,932. GIVAUDAN S.A., SWITZERLAND, FILED 6-15-2004.

SN 79-003,934. GIVAUDAN S.A., SWITZERLAND, FILED 6-15-2004.

NETSCREEN BRANDCAST

THE MARK CONSISTS OF STANDARD CHARACTERS WITHOUT CLAIM TO ANY PARTICULAR FONT, STYLE, SIZE, OR COLOR.

PRIORITY DATE OF 12-16-2003 IS CLAIMED.
OWNER OF INTERNATIONAL REGISTRATION 0829189 DATED 6-15-2004, EXPIRES 6-15-2014.

CLASS 16—PAPER GOODS AND PRINTED MATTER

FOR PRINTED INSTRUCTIONAL AND TEACHING MATERIAL IN CONNECTION WITH CLASSIFYING AROMAS AND PERFUMES (U.S. CLS. 2, 5, 22, 23, 29, 37, 38 AND 50).

CLASS 35—ADVERTISING AND BUSINESS

FOR ADVERTISING, MARKETING SERVICES IN CONNECTION WITH THE USE AROMAS AND PERFUMES (U.S. CLS. 100, 101 AND 102).

CLASS 41—EDUCATION AND ENTERTAINMENT

FOR EDUCATION, NAMELY TEACHING, TRAINING IN THE FIELD OF AROMAS AND PERFUMES (U.S. CLS. 100, 101 AND 107).
JAMES A. RAUEN, EXAMINING ATTORNEY

SN 79-003,933. GIVAUDAN S.A., SWITZERLAND, FILED 6-15-2004.

SCENTCAST

THE MARK CONSISTS OF STANDARD CHARACTERS WITHOUT CLAIM TO ANY PARTICULAR FONT, STYLE, SIZE, OR COLOR.

PRIORITY DATE OF 12-16-2003 IS CLAIMED.
OWNER OF INTERNATIONAL REGISTRATION 0829190 DATED 6-15-2004, EXPIRES 6-15-2014.

CLASS 16—PAPER GOODS AND PRINTED MATTER

FOR PRINTED INSTRUCTIONAL AND TEACHING MATERIAL IN CONNECTION WITH CLASSIFYING AROMAS AND PERFUMES (U.S. CLS. 2, 5, 22, 23, 29, 37, 38 AND 50).

CLASS 35—ADVERTISING AND BUSINESS

FOR ADVERTISING, MARKETING SERVICES IN CONNECTION WITH THE USE AROMAS AND PERFUMES (U.S. CLS. 100, 101 AND 102).

CLASS 41—EDUCATION AND ENTERTAINMENT

FOR EDUCATION, NAMELY TEACHING, TRAINING IN THE FIELD OF AROMAS AND PERFUMES (U.S. CLS. 100, 101 AND 107).
JAMES A. RAUEN, EXAMINING ATTORNEY

THE MARK CONSISTS OF STANDARD CHARACTERS WITHOUT CLAIM TO ANY PARTICULAR FONT, STYLE, SIZE, OR COLOR.

PRIORITY DATE OF 12-16-2003 IS CLAIMED.
OWNER OF INTERNATIONAL REGISTRATION 0829191 DATED 6-15-2004, EXPIRES 6-15-2014.

CLASS 16—PAPER GOODS AND PRINTED MATTER

FOR PRINTED INSTRUCTIONAL AND TEACHING MATERIAL IN CONNECTION WITH CLASSIFYING AROMAS AND PERFUMES (U.S. CLS. 2, 5, 22, 23, 29, 37, 38 AND 50).

CLASS 35—ADVERTISING AND BUSINESS

FOR ADVERTISING, MARKETING SERVICES IN CONNECTION WITH THE USE AROMAS AND PERFUMES (U.S. CLS. 100, 101 AND 102).

CLASS 41—EDUCATION AND ENTERTAINMENT

FOR EDUCATION, NAMELY TEACHING, TRAINING IN THE FIELD OF AROMAS AND PERFUMES (U.S. CLS. 100, 101 AND 107).
JAMES A. RAUEN, EXAMINING ATTORNEY

SN 79-003,946. TKB MEDICAL AG, SWITZERLAND, FILED 3-10-2004.

TKB ORTHOMED

THE MARK CONSISTS OF STANDARD CHARACTERS WITHOUT CLAIM TO ANY PARTICULAR FONT, STYLE, SIZE, OR COLOR.

PRIORITY DATE OF 11-4-2003 IS CLAIMED.
OWNER OF INTERNATIONAL REGISTRATION 0829229 DATED 3-10-2004, EXPIRES 3-10-2014.

CLASS 10—MEDICAL APPARATUS

FOR SURGICAL APPARATUSES AND INSTRUMENTS, NAMELY, BONE CEMENTATION TOOLS AND EQUIPMENT, SURGICAL SAWS AND ELECTRIC BONE OPERATING MACHINES; ORTHOPEDIC ARTICLES, NAMELY, PROSTHETIC IMPLANTS, SURGICAL SPLINTS, VERTEBRAL ORTHOPEDIC APPARATUS AND FIXATION DEVICES; SUTURES. (U.S. CLS. 26, 39 AND 44).

CLASS 44—MEDICAL, BEAUTY AND AGRICULTURAL SERVICES

FOR MEDICAL SERVICES (U.S. CLS. 100 AND 101).
KATHLEEN M. VANSTON, EXAMINING ATTORNEY

SN 79-003,987. MINELCO AB, SWEDEN, FILED 2-11-2004.

SN 79-004,238. OHAYON MAURICE, ITALY, FILED 6-7-2004.

MINELCO**NFY**

PRIORITY DATE OF 9-24-2003 IS CLAIMED.
OWNER OF INTERNATIONAL REGISTRATION 0829375
DATED 2-11-2004, EXPIRES 2-11-2014.

CLASS 1—CHEMICALS

FOR CHEMICALS USED IN INDUSTRY, NAMELY, OLIVINE; TEMPERING CHEMICALS AND SOLDERING CHEMICAL PREPARATIONS; PROCESSED AND UN-PROCESSED INDUSTRIAL MINERALS, NAMELY, FUSED ALUMINA, ANDALUSITE, BARITES, BAUXITE, BENTONITE, BRUCITE, CALCIUM CARBONATE, CHROMITE, DOLOMITE, FLUORSPAR, GARNET, GRAPHITE, IRON OXIDE, MAGNESITE, MICACCEOUS IRON OXIDE, MULLITE, SYNTHETIC QUARTZ, TALC AND STEATITE, VERMICULITE, WOLLASTONITE, ZIRCON, BORON, ILMENITE, KYANITE, MANGANESE, SILICON CARBIDE (U.S. CLS. 1, 5, 6, 10, 26 AND 46).

CLASS 6—METAL GOODS

FOR COMMON METALS AND THEIR ALLOYS, NAMELY, CHROME IRON, ZIRCONIUM; ORES, NAMELY, IRON ORE, MANGANESE ORE AND ANNEALING ORE (U.S. CLS. 2, 12, 13, 14, 23, 25 AND 50).

CLASS 19—NON-METALLIC BUILDING MATERIALS

FOR QUARTZ; REFRACTORY CLAY; SILICON CARBIDE FOR REFRACTORY PURPOSES (U.S. CLS. 1, 12, 33 AND 50).

KIMBERLY PERRY, EXAMINING ATTORNEY

SN 79-004,011. ROTH & CIE AG, SWITZERLAND, FILED 6-28-2004.

ROVIVA

OWNER OF INTERNATIONAL REGISTRATION 0517097
DATED 9-16-1987, EXPIRES 9-16-2007.

CLASS 20—FURNITURE AND ARTICLES NOT OTHERWISE CLASSIFIED

FOR PADDED STRUCTURES, NAMELY, FURNITURE AND MATTRESSES (U.S. CLS. 2, 13, 22, 25, 32 AND 50).

CLASS 24—FABRICS

FOR BED BLANKETS AND BED COVERS (U.S. CLS. 42 AND 50).
KAREN K. BUSH, EXAMINING ATTORNEY

THE MARK CONSISTS OF STANDARD CHARACTERS WITHOUT CLAIM TO ANY PARTICULAR FONT, STYLE, SIZE, OR COLOR.

OWNER OF INTERNATIONAL REGISTRATION 0830107
DATED 6-7-2004, EXPIRES 6-7-2014.

OWNER OF U.S. REG. NO. 2.906,304.

CLASS 3—COSMETICS AND CLEANING PREPARATIONS

FOR SOAPS; PERFUMERY, ESSENTIAL OILS FOR PERSONAL USE; COSMETICS; HAIR LOTIONS (U.S. CLS. 1, 4, 6, 50, 51 AND 52).

CLASS 9—ELECTRICAL AND SCIENTIFIC APPARATUS

FOR SPECTACLES, SPECTACLE FRAMES, SUNGLASSES, SPORTS GLASSES, SPECTACLE LENSES, SPECTACLE CASES (U.S. CLS. 21, 23, 26, 36 AND 38).

CLASS 14—JEWELRY

FOR JEWELRY, TIMEPIECES, CHRONOMETRIC INSTRUMENTS, WATCHES, WATCH BANDS (U.S. CLS. 2, 27, 28 AND 50).

CLASS 18—LEATHER GOODS

FOR LUGGAGE TRUNKS AND SUITCASES, DOCUMENT HOLDERS, ATTACHÉ CASES, RUCKSACKS, HANDBAGS, BEACH BAGS, TRAVELING BAGS, SCHOOL BAGS, PURSES NOT MADE OF PRECIOUS METAL, WALLETS, LEATHER KEY CASES, UMBRELLAS, PARASOLS, AND WALKING STICKS (U.S. CLS. 1, 2, 3, 22 AND 41).
AMY ALFIERI, EXAMINING ATTORNEY

SN 79-004,259. LABORATOIRES ARKOPHARMA, F-06510 CARROS, FRANCE, FILED 6-18-2004.

AQUAPLANTA

THE MARK CONSISTS OF STANDARD CHARACTERS WITHOUT CLAIM TO ANY PARTICULAR FONT, STYLE, SIZE, OR COLOR.

PRIORITY DATE OF 12-24-2003 IS CLAIMED.
OWNER OF INTERNATIONAL REGISTRATION 0830184
DATED 6-18-2004, EXPIRES 6-18-2014.

THE ENGLISH TRANSLATION OF AQUAPLANTA IS "WATER PLANT".

CLASS 5—PHARMACEUTICALS

FOR PHARMACEUTICAL AND VETERINARY PREPARATIONS FOR THE TREATMENT OF INFECTIOUS DISEASES; SANITARY PREPARATIONS FOR MEDICAL USE, AND SANITARY PRODUCTS FOR PERSONAL HYGIENE, NAMELY, SANITARY NAPKINS, SANITARY PADS, DIAPERS, FEMININE HYGIENE CLEANSING TOWELETTES; FOOD SUPPLEMENTS AND DIETETIC FOOD ADAPTED FOR MEDICAL USE; DISINFECTANTS FOR MEDICAL USE AND SANITARY PURPOSES, EXCLUDING SOAPS (U.S. CLS. 6, 18, 44, 46, 51 AND 52).

CLASS 32—LIGHT BEVERAGES

FOR BEERS; MINERAL AND AERATED WATERS, AND OTHER NON-ALCOHOLIC DRINKS, NAMELY, COLAS, SPORTS DRINKS, CIDER, COCKTAIL MIXES, GINGER ALE, LEMONADE, PUNCH, SPRING WATER; FRUIT DRINKS AND FRUIT JUICES; SYRUPS AND PREPARATIONS FOR MAKING FRUIT DRINKS, FRUIT JUICES, AND SOFT DRINKS (U.S. CLS. 45, 46 AND 48).
LEIGH LOWRY, EXAMINING ATTORNEY

SN 79-004,285. SIEMENS SCHWEIZ AG, SWITZERLAND, FILED 4-1-2004.

HUSKY

THE MARK CONSISTS OF STANDARD CHARACTERS WITHOUT CLAIM TO ANY PARTICULAR FONT, STYLE, SIZE, OR COLOR.

PRIORITY DATE OF 1-8-2004 IS CLAIMED.
OWNER OF INTERNATIONAL REGISTRATION 0830329 DATED 4-1-2004, EXPIRES 4-1-2014.

CLASS 9—ELECTRICAL AND SCIENTIFIC APPARATUS

FOR COMPUTER HARDWARE AND SOFTWARE FOR ELECTRONIC HANDLING OF ADMINISTRATIVE TASKS, NAMELY, ONLINE ADMINISTRATION OF CITIZEN DATA, COMPANY DATA, EMPLOYEE DATA, INSURANCE DATA AND PENSION FUND DATA, ELECTRONIC VOTING, AND ELECTRONIC TAX RETURNS FOR USE BY ADMINISTRATIONS, BUSINESSES AND INDIVIDUALS (U.S. CLS. 21, 23, 26, 36 AND 38).

CLASS 16—PAPER GOODS AND PRINTED MATTER

FOR COMPUTER PROGRAM MANUALS FOR ELECTRONIC HANDLING OF ADMINISTRATIVE TASKS, NAMELY, ONLINE ADMINISTRATION OF CITIZEN DATA, COMPANY DATA, EMPLOYEE DATA, INSURANCE DATA AND PENSION FUND DATA, ELECTRONIC VOTING, AND ELECTRONIC TAX RETURNS FOR USE BY ADMINISTRATIONS, BUSINESSES AND INDIVIDUALS (U.S. CLS. 2, 5, 22, 23, 29, 37, 38 AND 50).

CLASS 42—SCIENTIFIC, COMPUTER AND LEGAL SERVICES

FOR DEVELOPMENT, WRITING AND RENTAL OF COMPUTER PROGRAMS; TECHNICAL CONSULTING IN CONNECTION WITH DATA PROCESSING; COMPUTER PROGRAMMING; EXCEPT CONSULTING SERVICE WITH REGARD TO DESIGN AND DEVELOPMENT OF MACHINE TOOLS AND MANUFACTURE OF PLASTIC GOODS (U.S. CLS. 100 AND 101).
ASMAT KHAN, EXAMINING ATTORNEY

SN 79-004,338. TÜRKAS IM- UND EXPORT TÜRKER KG, FED REP GERMANY, FILED 6-14-2004.

kymo

THE MARK CONSISTS OF STANDARD CHARACTERS WITHOUT CLAIM TO ANY PARTICULAR FONT, STYLE, SIZE, OR COLOR.

OWNER OF INTERNATIONAL REGISTRATION 0830477 DATED 6-14-2004, EXPIRES 6-14-2014.

CLASS 18—LEATHER GOODS

FOR LEATHER; IMITATION LEATHER SOLD IN BULK; KEY-CASES OF LEATHER, LEATHER BAGS, SUITCASES, WALLETS, LEATHER HAND BAGS, LEATHER KEY CHAINS (U.S. CLS. 1, 2, 3, 22 AND 41).

CLASS 27—FLOOR COVERINGS

FOR CARPETS; MATERIALS FOR COVERING EXISTING FLOORS; NAMELY, RUGS, MATS, MATTING AND LINOLEUM FOR COVERING EXISTING FLOORS (U.S. CLS. 19, 20, 37, 42 AND 50).

TANYA AMOS, EXAMINING ATTORNEY

SN 79-004,429. HENKEL KGAA, FED REP GERMANY, FILED 4-1-2004.

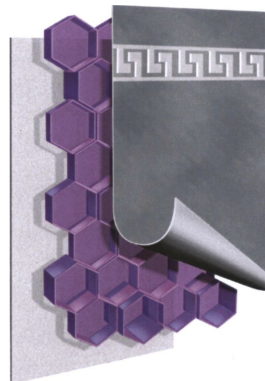

PRIORITY DATE OF 12-2-2003 IS CLAIMED.
OWNER OF INTERNATIONAL REGISTRATION 0830703 DATED 4-1-2004, EXPIRES 4-1-2014.

THE COLOR(S) VIOLET (PANTONE 258), GREY IS/ARE CLAIMED AS A FEATURE OF THE MARK.

VARYING SHADES OF THE COLOR VIOLET ARE USED FOR THE HONEYCOMB. VARYING SHADES OF THE COLOR GREY ARE USED FOR THE REST OF THE MARK.

CLASS 1—CHEMICALS

FOR CHEMICALS FOR USE IN INDUSTRY; UNPROCESSED AND ARTIFICIAL RESINS AS RAW MATERIALS IN THE FORM OF LIQUIDS, POWDERS, PASTES AND GRANULATES; ADHESIVES FOR GENERAL INDUSTRIAL USE; ADDITIVES FOR CEMENT AND CONCRETE (U.S. CLS. 1, 5, 6, 10, 26 AND 46).

CLASS 16—PAPER GOODS AND PRINTED MATTER

FOR ADHESIVES FOR STATIONERY, HOUSEHOLD AND DO-IT-YOURSELF PURPOSES; PAINT BRUSHES (U.S. CLS. 2, 5, 22, 23, 29, 37, 38 AND 50).

CLASS 35—ADVERTISING AND BUSINESS

FOR ADVERTISING (U.S. CLS. 100, 101 AND 102).
ASMAT KHAN, EXAMINING ATTORNEY

SN 79-004,430. GEKAKONUS GMBH, FED REP GERMANY,
FILED 3-16-2004.



THE MARK CONSISTS OF STANDARD CHARACTERS WITHOUT CLAIM TO ANY PARTICULAR FONT, STYLE, SIZE, OR COLOR.

PRIORITY DATE OF 11-21-2003 IS CLAIMED.

OWNER OF INTERNATIONAL REGISTRATION 0830705
DATED 3-16-2004, EXPIRES 3-16-2014.

CLASS 7—MACHINERY

FOR CIRCULATION PUMPS, FITTINGS, AND CONTROL MECHANISMS, ALL FOR FURNACES FOR SOLID, LIQUID AND GASEOUS FUELS, STEAM GENERATORS, CIRCULATION HEATERS, HEAT TRANSFER MEDIA, AND HEAT EXCHANGERS (U.S. CLS. 13, 19, 21, 23, 31, 34 AND 35).

CLASS 11—ENVIRONMENTAL CONTROL APPARATUS

FOR STEAM GENERATORS, IN PARTICULAR HIGH-PRESSURE STEAM GENERATORS AND HIGH-SPEED STEAM GENERATORS; THERMAL OIL CIRCULATION HEATERS FOR GENERATING HEAT; FURNACES FOR SOLID, LIQUID AND GASEOUS FUELS; HEAT TRANSFER MEDIA; HEAT EXCHANGERS; FILTERS AND FITTINGS THEREFOR (U.S. CLS. 13, 21, 23, 31 AND 34).
MICHAEL ENGEL, EXAMINING ATTORNEY

SN 79-004,440. TAKASAGO KORYO KOGYO KABUSHIKI KAISHA; (ALSO TRADING AS TAKASAGO; INTERNATIONAL CORPORATION), JAPAN, FILED 6-1-2004.



PRIORITY DATE OF 5-26-2004 IS CLAIMED.

OWNER OF INTERNATIONAL REGISTRATION 0830717
DATED 6-1-2004, EXPIRES 6-1-2014.

OWNER OF U.S. REG. NO. 2,061,925.

CLASS 1—CHEMICALS

FOR CHEMICALS FOR USE IN THE MANUFACTURE OF PERFUMERY, FLAVORINGS, COSMETICS, TOILETRIES, DEODORANTS AND HOUSEHOLD PRODUCTS; AROMATIC CHEMICALS FOR USE IN THE MANUFACTURE OF PERFUMERY, FLAVORINGS, COSMETICS, TOILETRIES, DEODORANTS AND HOUSEHOLD PRODUCTS (U.S. CLS. 1, 5, 6, 10, 26 AND 46).

CLASS 3—COSMETICS AND CLEANING PREPARATIONS

FOR PERFUMERY; ESSENTIAL OILS FOR PERSONAL USE; AROMATIC SUBSTANCES AND PREPARATIONS, NAMELY, ESSENTIAL OILS FOR USE IN THE MANUFACTURE OF PERFUMERY, FLAVORINGS, COSMETICS, TOILETRIES, DEODORANTS AND HOUSEHOLD PRODUCTS; ESSENTIAL OILS WITH SYNTHETIC AROMATIC COMPONENT FOR USE IN THE MANUFACTURE OF PERFUMERY, FLAVORINGS, COSMETICS, TOILETRIES, DEODORANTS AND HOUSEHOLD PRODUCTS (U.S. CLS. 1, 4, 6, 50, 51 AND 52).

ANNE MADDEN, EXAMINING ATTORNEY

SN 79-004,522. MARAZZI GRUPPO CERAMICHE S.P.A., I-40123 BOLOGNA, ITALY, FILED 5-4-2004.

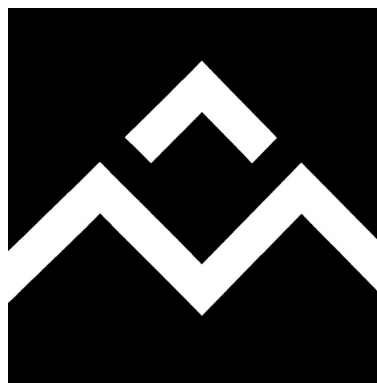

PRIORITY DATE OF 1-27-2004 IS CLAIMED.

OWNER OF INTERNATIONAL REGISTRATION 0830992
DATED 5-4-2004, EXPIRES 5-4-2014.

OWNER OF U.S. REG. NO. 1,195,214.

THE MARK CONSISTS IN THE LETTERS AM, STYLIZED IN THE FORM OF BROKEN LINES, IN A SQUARE DEVICE.

CLASS 11—ENVIRONMENTAL CONTROL APPARATUS

FOR SANITARY APPARATUS AND INSTALLATIONS, NAMELY, SINKS, BATHTUBS, BIDETS, WASH-HAND BASINS, WATER CLOSETS, SHOWERS AND SHOWER CUBICLES, TAPS AND PLUMBING FITTINGS, NAMELY, SHOWER CONTROL VALVES, TUB CONTROL VALVES, FAUCET AERATORS, DRAINS, FAUCET FILTERS, SANITARY PIPES AND JOINTS FOR SANITARY PIPES, SIPHONS, HYDRAULIC UNITS FOR WATER CLOSETS, SHOWER AND BATHTUB SPOUTS (U.S. CLS. 13, 21, 23, 31 AND 34).

CLASS 19—NON-METALLIC BUILDING MATERIALS

FOR WALL AND FLOOR COVERING MATERIALS, NAMELY, CERAMIC TILES (U.S. CLS. 1, 12, 33 AND 50).

CLASS 20—FURNITURE AND ARTICLES NOT OTHERWISE CLASSIFIED

FOR BATHROOM FURNITURE, NAMELY, WASHSTANDS, TOILET CABINETS, FURNITURE SHELVES, AND MIRRORS (U.S. CLS. 2, 13, 22, 25, 32 AND 50).

JEFF DEFORD, EXAMINING ATTORNEY

SN 79-004,671. FIRMENICH SA, SWITZERLAND, FILED 6-11-2004.

ENDURASCENT

THE MARK CONSISTS OF STANDARD CHARACTERS WITHOUT CLAIM TO ANY PARTICULAR FONT, STYLE, SIZE, OR COLOR.

PRIORITY DATE OF 1-22-2004 IS CLAIMED.

OWNER OF INTERNATIONAL REGISTRATION 0831487 DATED 6-11-2004, EXPIRES 6-11-2014.

CLASS 1—CHEMICALS

FOR CHEMICALS FOR USE IN FRAGRANCES AND FRAGRANCED PRODUCTS, NAMELY SKIN CARE AND BODY CARE, NAMELY FACE AND BODY CREAMS AND LOTIONS, SHOWER AND BATH MILKS, GELS, SALTS, AND LOTIONS, AND DEODORANTS FOR PERSONAL USE, HAIR-CARE PREPARATIONS, NAMELY SHAMPOOS, CONDITIONERS, HAIR SPRAYS AND HAIR LOTIONS, SOAPS AND ALL-PURPOSE CLEANING PRODUCTS FOR HOUSEHOLD OR INDUSTRIAL USE, AND FABRIC SOFTENERS. (U.S. CLS. 1, 5, 6, 10, 26 AND 46).

CLASS 3—COSMETICS AND CLEANING PREPARATIONS

FOR PERFUMES; ESSENTIAL OILS FOR USE IN THE PREPARATION OF PERFUMES AND COLOGNES; ESSENTIAL OILS FOR USE IN FRAGRANCE PREPARATIONS FOR SKIN CARE AND BODY CARE, NAMELY FACE AND BODY CREAMS AND LOTIONS, SHOWER AND BATH MILKS, GELS, SALTS AND LOTIONS, AND IN DEODORANTS FOR PERSONAL USE; ESSENTIAL OILS FOR USE IN HAIR-CARE PREPARATIONS, NAMELY SHAMPOOS, CONDITIONERS, HAIR SPRAYS AND HAIR LOTIONS; ESSENTIAL OILS FOR USE IN SOAPS AND ALL-PURPOSE CLEANING PRODUCTS FOR HOUSEHOLD OR INDUSTRIAL USE; ESSENTIAL OILS FOR USE IN FABRIC SOFTENERS. (U.S. CLS. 1, 4, 6, 50, 51 AND 52).

DORITT L. CARROLL, EXAMINING ATTORNEY

SN 79-004,676. ORLANE S.A., FRANCE, FILED 1-30-2004.

PURE SKINCARE PURE BEAUTY

THE MARK CONSISTS OF STANDARD CHARACTERS WITHOUT CLAIM TO ANY PARTICULAR FONT, STYLE, SIZE, OR COLOR.

PRIORITY DATE OF 8-1-2003 IS CLAIMED.

OWNER OF INTERNATIONAL REGISTRATION 0831515 DATED 1-30-2004, EXPIRES 1-30-2014.

CLASS 3—COSMETICS AND CLEANING PREPARATIONS

FOR EAU-DE-TOILET; PERFUMES; DEODORANTS AND ANTIPERSPIRANTS; COSMETIC AND SANITARY PRODUCTS AND TOILETRIES, NAMELY, GELS, LOTIONS, FLUIDS, EMULSIONS, SERUMS FOR FACE AND BODY CARE; SOAPS; COSMETIC PREPARATIONS FOR SLIMMING PURPOSES, NAMELY, CELLULITE CREAM, SLIMMING DETOXINATING GEL, BEAUTY GELS; MAKE-UP PRODUCTS FOR THE FACE AND BODY AND MAKE-UP REMOVING PRODUCTS FOR THE FACE, EYES, LIPS, NAILS AND HANDS; PRE-MOISTENED COSMETIC TISSUES; TANNING AND INSTANT TANNING PREPARATIONS, SUN-CARE LOTIONS; AFTER-SUN CREAMS AND LOTIONS; SUN-BLOCK PREPARATIONS; HAIR LOTIONS, SHAMPOOS AND HAIR CARE PREPARATIONS; FALSE EYELASHES AND NAILS; SHAVING PREPARATIONS AND AFTER-SHAVE BALM, CREAM, GEL, EMULSIONS AND LOTIONS; DEPILATORIES; DEPILATORY CREAMS; ESSENTIAL OILS FOR PERSONAL USE; DENTIFRICES; TOILETRY CASES CONTAINING SKIN CARE, NAMELY, NON-MEDICATED SHIN CARE PREPARATIONS, NAMELY, SKIN SOAPS, SKIN LOTIONS, SKIN CREAMS, SKIN SERUMS (U.S. CLS. 1, 4, 6, 50, 51 AND 52).

CLASS 5—PHARMACEUTICALS

FOR PHARMACEUTICAL SKIN LOTIONS, MILKS, POMADES AND OINTMENTS, MEDICAL PREPARATIONS FOR SLIMMING PURPOSES, NAMELY, CELLULITE CREAMS, SLIMMING DETOXINATING GELS, BEAUTY GELS, MEDICATED PRE-MOISTENED TISSUES; HOUSEHOLD DEODORANT; BURN RELIEF MEDICATION, VITAMIN AND MINERAL SUPPLEMENTS, AIR FRESHENERS, SANITARY PREPARATIONS FOR MEDICAL USE (U.S. CLS. 6, 18, 44, 46, 51 AND 52).

CLASS 21—HOUSEWARES AND GLASS

FOR PERFUME ATOMIZERS SOLD EMPTY; PERFUME SPRAYERS SOLD EMPTY, HAIR COMBS, SPONGES, NAMELY, BATH SPONGES, ABRASIVE SPONGES FOR SCRUBBING THE SKIN, SEA SPONGES, LOOFAH SPONGES, BODY SPONGES, CLEANING SPONGES, FACIAL SPONGES FOR APPLYING MAKE-UP, SCOURING SPONGES, SCRUBBING SPONGES, SPONGE HOLDERS, SPONGE MASSAGERS, SPONGES FOR APPLYING BODY POWDER, SPONGES FOR HOUSEHOLD PURPOSES, TOILET SPONGES; BRUSHES, NAMELY, HAIR BRUSHES, BATH BRUSHES, COSMETIC BRUSHES, EYEBROW BRUSHES, LIP BRUSHES, NAIL BRUSHES, SHAVING BRUSHES, TOILET BRUSHES; FLASKS NOT OF PRECIOUS METAL SOLD EMPTY; SOAP HOLDERS, NAPKIN HOLDERS NOT OF PRECIOUS METAL, POWDER COMPACTS NOT OF PRECIOUS METAL SOLD EMPTY, PERFUME BURNERS (U.S. CLS. 2, 13, 23, 29, 30, 33, 40 AND 50).

CLASS 44—MEDICAL, BEAUTY AND AGRICULTURAL SERVICES

FOR HEALTH SPA SERVICES, NAMELY, COSMETIC BODY CARE SERVICES; BEAUTY SALON SERVICES (U.S. CLS. 100 AND 101).

ANNE E. GUSTASON, EXAMINING ATTORNEY

SN 79-004,681. RENATO BALESTRA, ITALY, FILED 4-8-2004.



OWNER OF INTERNATIONAL REGISTRATION 0422884 DATED 5-6-1976, EXPIRES 5-6-2006.

THE NAME RENATO BALESTRA IDENTIFIES A LIVING INDIVIDUAL WHOSE CONSENT IS OF RECORD.

CLASS 3—COSMETICS AND CLEANING PREPARATIONS

FOR COSMETICS AND PERFUMES (U.S. CLS. 1, 4, 6, 50, 51 AND 52).

CLASS 18—LEATHER GOODS

FOR ARTICLES OF LEATHER OR IMITATION OF LEATHER, NAMELY, KEY CASES, PURSES, WALLETS, BAGS, BEAUTY CASES SOLD EMPTY, TRAVEL BAGS, SUITCASES (U.S. CLS. 1, 2, 3, 22 AND 41).

CLASS 25—CLOTHING

FOR ARTICLES OF CLOTHING, NAMELY SHIRTS, KNITWEAR, PULLOVERS, TROUSERS, SUITS, BLOUSES, SKIRTS, DRESSES, TIES, GLOVES, HATS, SCARVES (U.S. CLS. 22 AND 39).

DOMINIC J. FERRAIUOLO, EXAMINING ATTORNEY

SN 79-004,692. JOYCARE ITALIA S.P.A., ITALY, FILED 5-27-2004.

JOYCARE

THE MARK CONSISTS OF STANDARD CHARACTERS WITHOUT CLAIM TO ANY PARTICULAR FONT, STYLE, SIZE, OR COLOR.

OWNER OF INTERNATIONAL REGISTRATION 0755174 DATED 11-28-2000, EXPIRES 11-28-2010.

CLASS 8—HAND TOOLS

FOR HAND-OPERATED TOOLS AND INSTRUMENTS, NAMELY, CUTLERY, SIDE ARMS, NOT INCLUDING FIREARMS, NAMELY HUNTING KNIVES, AND RAZORS (U.S. CLS. 23, 28 AND 44).

CLASS 9—ELECTRICAL AND SCIENTIFIC APPARATUS

FOR SCALES, ELECTRICAL DEVICES RUNNING TIME METERS BUILT-IN TO PILL BOXES, PEDOMETERS FOR SPORTS PURPOSES; PEDOMETERS FOR MEDICAL PURPOSES (U.S. CLS. 21, 23, 26, 36 AND 38).

CLASS 10—MEDICAL APPARATUS

FOR BLOOD PRESSURE MEASURING APPARATUS, APPARATUS FOR AEROSOL THERAPY, NAMELY, NEBULIZERS, TRANSCUTANEOUS ELECTRIC SIMULATOR FOR NERVES, SKIN, MUSCLES; DIGITAL THERMOMETER WITH MUSIC, ORAL DIGITAL THERMOMETER, EAR THERMOMETERS, ALL FOR MEDICAL PURPOSES; RHYTHMICAL MASSAGING APPARATUS FOR PERSONAL USE, MULTIFUNCTIONAL INFRARED MASSAGING APPARATUS FOR PERSONAL USE; PLANTAR WHIRLPOOL AGITATORS FOR THERAPEUTIC USE (U.S. CLS. 26, 39 AND 44).

CLASS 11—ENVIRONMENTAL CONTROL APPARATUS

FOR SAUNAS, ULTRASOUND HUMIDIFIERS, AIR PURIFYING UNITS FOR EITHER COMMERCIAL, DOMESTIC, OR INDIVIDUAL USE (U.S. CLS. 13, 21, 23, 31 AND 34).

STEVEN JACKSON, EXAMINING ATTORNEY

SN 79-004,761. HAGER & WERKEN GMBH & CO. KG, FED REP GERMANY, FILED 4-30-2004.



PRIORITY DATE OF 10-30-2003 IS CLAIMED.
OWNER OF INTERNATIONAL REGISTRATION 0831585 DATED 4-30-2004, EXPIRES 4-30-2014.

THE LINING IS A FEATURE OF THE MARK AND DOES NOT INDICATE COLOR.

THE NAME "HAGER WERKEN" DOES NOT IDENTIFY A LIVING INDIVIDUAL.

THE MARK CONSISTS OF THE WORD "HAGER" OVER THE WORD "WERKEN" AND TO THE LEFT OF THESE A CIRCULAR DESIGN OF ALTERNATING, CONTRASTING HORIZONTAL LINES FORMING A CIRCLE AND A TOOTH WITHIN A CIRCLE.

CLASS 3—COSMETICS AND CLEANING PREPARATIONS

FOR NON-MEDICATED DENTIFRICES, MOUTHWASHES, NOT FOR MEDICAL PURPOSES; MEDICATED DENTIFRICES (U.S. CLS. 1, 4, 6, 50, 51 AND 52).

CLASS 5—PHARMACEUTICALS

FOR DENTAL WAX, MATERIAL FOR STOPPING TEETH; MODELING SUBSTANCES, NAMELY DENTAL IMPRESSION MATERIAL, EMBEDDING MATERIAL FOR DENTAL AND DENTAL TECHNICAL PURPOSES, ADHESIVE SUBSTANCES FOR DENTISTRY AND DENTAL TECHNICAL PURPOSES, SOLDER EMBEDDING MATERIAL AND DUPLICATING MATERIAL FOR DENTAL AND DENTAL TECHNICAL PURPOSES, NAMELY DENTAL COMPOSITE MATERIALS, COTTON ROLLS FOR DENTAL PURPOSES, MOUTHWASHES FOR MEDICAL PURPOSES (U.S. CLS. 6, 18, 44, 46, 51 AND 52).

CLASS 10—MEDICAL APPARATUS

FOR DENTAL APPARATUS, INSTRUMENTS AND DEVICES, NAMELY MIXING BOWLS, MIXING CUPS, MIXING SPATULAS, MODEL FORMERS, HOLDING SPLIT SYSTEM FOR DENTAL MODELS; WATER PROOF MARKERS FOR DENTAL PURPOSES; BASE PLATES FOR THE JAW; MODELING SYSTEMS, PREFORMED BITE INDEXES; ARTICULATING PAPER, ARTICULATING PAPER HOLDER, DISPENSER FOR FINISHING PAPER, BUR STAND FOR DENTAL OR DENTAL TECHNICAL INSTRUMENTS, POLISHERS, DRILLING DEVICES, CUTTERS, GRINDING PAPER, MANDRELS, LIGHT AND/OR HEAT POLYMERIZATION UNITS, SUCTION DEVICES, VIBRATORS, PRESSURE POLYMERIZATION VESSELS, CHISELS, BURNERS, SOLDERING AND WELDING DEVICES, SOLDERING TWEEZERS, CASTING RINGS, GRIPPERS, TWEEZERS, MELDING MOULD FORCEPS, CLEANING UNITS FOR DENTURES, MODELING INSTRUMENTS, BRUSHES, STEEL MESH FOR CLEANING OF DENTAL CROWNS, DENTAL BRIDGES AND DENTAL BURS, STICKS FOR THE TRANSPORT OF DENTAL CROWNS, INLAYS AND VENEERS, FIXATION INSTRUMENTS, INSTRUMENTS FOR REMOVAL OF SCALPEL BLADES, HOLDERS TO FIX DENTAL CROWNS AND DENTAL BRIDGES, DOSING INSTRUMENTS, SAWS, INSTRUMENTS FOR LIFTING HOT FLASKS OUT OF THE WATER BASIN; DENTAL MODEL HOLDERS, CUTTERS, SCISSORS, MODELING INSTRUMENTS, MEASURING INSTRUMENTS FOR DENTAL USE, ALSO FOR THE THICKNESS OF WAX, THE DENTINE LAYER, DENTAL GOLD CROWNS, AND DENTAL BRIDGES, LOUPS, TRANSPORT AND STORAGE BOXES, SAFETY GLASSES, FACE PROTECTION SHIELDS, PROTECTION SHIELDS, X-RAY MASKS, GLOVES, PROSTHETIC MODELS, COAGULATION INSTRUMENTS, SYRINGES, INJECTION NEEDLES, STANDS FOR INJECTION NEEDLES.

DLES AND SYRINGES, CHEEK AND/OR LIP EXTRACTORS, HOLDER FOR DENTAL COTTON ROLLS, DISPENSER FOR DENTAL COTTON ROLLS, APPLICATION BRUSHES AND INSTRUMENTS, MOUTH MIRRORS, HANDLES FOR MOUTH MIRRORS, BOTTLES FOR CONTROLLED APPLICATION OF LIQUIDS, IMPRESSION TRAYS, CANNULAS, ASPIRATORS, ASPIRATOR TIPS, ADAPTERS FOR ASPIRATION HOSES, EVACUATION HANDPIECES, CLEANING BRUSHES, DENTAL DAMS, DENTAL DAM CLAMPS, DENTAL PUNCHES, DENTAL DAM FRAMES, DENTAL DAM TEMPLATES, BOARD FOR HOLDING DENTAL CLAPS, INSTRUMENT FOR THE ENLARGEMENT OF THE INTERPROXIMAL SPACES, GRID SCALE FOR X-RAY FILMS, PROTECTIVE HYGIENIC POUCHES FOR SENSORS AND FILMS FOR RADIOGRAPHY, FILM MOUNTS, X-RAY FILM POCKETS, X-RAY FILM VIEWERS, X-RAY FILM DEVELOPING SOLUTION, X-RAY FILM HOLDERS, FOAM TABS FOR POSITIONING OF X-RAY FILMS, CHEMICAL REMOVER FOR X-RAY CHEMICALS, IODINE, RUST AND THE LIKE, X-RAY MARKING PEN, CONCENTRATE AGAINST ALGA IN THE WATER BATH OF X-RAY FILM DEVELOPING DEVICES, ROOT CANAL LENGTH LOCATORS, PIPETTES, STANDS FOR ROOT CANAL INSTRUMENTS, SURGICAL UNITS, GROUND PLATE FOR DERIVATION OF HF WAVES, DENTAL INSTRUMENTS FOR ABRADING, ADAPTERS, REPLACEMENT NOZZLES, POWDER AND DUST COLLECTOR BOXES FOR DENTAL INSTRUMENTS FOR ABRADING, INLAY FORMS, ORGANIZER BOX FOR DENTAL INSERTS, DENTAL INSERTS, APPLICATION AND FILLING INSTRUMENTS FOR COMPOSITES, PLASTIC CAPS FOR CORE BUILD-UPS, MOLAR AND PREMOLAR STAMPS, HOLDER FOR INTERDENTAL WEDGES, WHITE LIGHT INTENSIFYING TIPS, WEDGES, MATRIXES, SPLINTS, SPLINT NETS, MYLAR STRIPS, HOLDERS, MATRIX RETAINERS, MATRIX BANDS, AMALGAM CARRIERS, AMALGAM WELL, POSTS, ANCHORS, CURETTES, REPLACEMENT TIPS FOR CURETTES, RETRACTION CORD PACKERS, SCALPEL BLADES, RINGS FOR DENTAL INSTRUMENTS, INDICATOR PEN, ROOT LIFTERS, INSTRUMENT TRAYS AND CUPS, REMOVERS FOR DENTAL CROWNS, DENTAL BRIDGES, INLAYS AND THE LIKE, ADAPTERS FOR DENTAL CROWNS AND INLAYS, FINDER FOR SEATERS AND FRACTURES OF DENTAL CROWNS AND INLAYS, CONTRA-ANGLES AND HANDPIECES FOR DENTAL MICROMOTORS, CARTS FOR DENTAL APPARATUS AND INSTRUMENTS AND TRAYS FOR SUCH CARTS, CLEANING UNITS FOR DENTURES, FELT WHEELS, POLISHERS, POLISHING AND FINISHING BANDS, MARKER PELLETS, STERILIZATION UNITS AND BOXES, CONTAINERS, SURGICAL HANDBRUSHES, NAPKINS, NAPKIN HOLDERS, APPLICATION INSTRUMENTS, MEASURING BRUSHES, CLEANING BRUSHES, MANDRILLS, PROTECTION CUPS AND CLEANING CUPS FOR DENTAL INSTRUMENTS, DAPPEN DISH, CUPS FOR HOLDING PASTES OR LIQUIDS FOR DENTAL USE, PROHYLAXE UNITS, ALL FOR DENTAL AND DENTAL TECHNICAL PURPOSES; ARTIFICIAL TEETH, DENTAL CROWNS AND DENTURES (U.S. CLS. 26, 39 AND 44).

CLASS 21—HOUSEWARES AND GLASS

FOR FLOSS FOR DENTAL PURPOSES, TOOTH BRUSHES, NAMELY ELECTRIC AND NON-ELECTRIC TOOTHBRUSHES, TOOTH BRUSH HEADS (U.S. CLS. 2, 13, 23, 29, 30, 33, 40 AND 50).
FLORENTINA BLANDU, EXAMINING ATTORNEY

SN 79-004,850. HEIDELBERGER DRUCKMASCHINEN AG, FED REP GERMANY, FILED 6-25-2004.

CoatingStar

THE MARK CONSISTS OF STANDARD CHARACTERS WITHOUT CLAIM TO ANY PARTICULAR FONT, STYLE, SIZE, OR COLOR.

PRIORITY DATE OF 1-23-2004 IS CLAIMED.

OWNER OF INTERNATIONAL REGISTRATION 0831914 DATED 6-25-2004, EXPIRES 6-25-2014.

CLASS 7—MACHINERY

FOR PERIPHERAL DEVICES FOR PRINTING PRESSES, NAMELY, VARNISH SUPPLY MACHINES FOR SUPPLYING VARNISH TO PRINTING UNITS OF A PRINTING PRESS (U.S. CLS. 13, 19, 21, 23, 31, 34 AND 35).

CLASS 9—ELECTRICAL AND SCIENTIFIC APPARATUS

FOR CONTROL CONSOLES FOR CONTROLLING PRINTING PRESSES OR VARNISH SUPPLY MACHINES; CONTROL DEVICES, NAMELY, COMPUTERS AND PROCESSORS FOR CONTROLLING PRINTING PRESSES OR VARNISH SUPPLY MACHINES; AND COMPUTER SOFTWARE FOR CONTROLLING PERIPHERAL DEVICES, NAMELY, VARNISH SUPPLY MACHINES (U.S. CLS. 21, 23, 26, 36 AND 38).

KEVON CHISOLM, EXAMINING ATTORNEY

SN 79-004,877. WEBASTO AG, D-82131 STOCKDORF, FED REP GERMANY, FILED 1-27-2004.

PanAirama

THE MARK CONSISTS OF STANDARD CHARACTERS WITHOUT CLAIM TO ANY PARTICULAR FONT, STYLE, SIZE, OR COLOR.

PRIORITY DATE OF 8-22-2003 IS CLAIMED.

OWNER OF INTERNATIONAL REGISTRATION 0831987 DATED 1-27-2004, EXPIRES 1-27-2014.

CLASS 9—ELECTRICAL AND SCIENTIFIC APPARATUS

FOR COMPUTER SOFTWARE FOR USE IN DATABASE MANAGEMENT, COMPUTER AIDED DESIGN (CAD), COMPUTER AIDED MANUFACTURING (CAM), COMPUTER ANIMATION, COMPUTER GRAPHICS, PRODUCT DATA MANAGEMENT (PDM), ALL FOR USE IN THE AUTOMOTIVE INDUSTRY; REMOTE CONTROLS FOR LAND VEHICLE COMPONENTS; RADIO TRANSMITTING AND RECEIVING DEVICES FOR REMOTE CONTROL OF VEHICLE COMPONENTS, NAMELY, REMOTE CONTROL TRANSMITTERS AND RECEIVERS; MEASURING, TESTING AND CONTROL DEVICES AND APPARATUS FOR USE IN THE AUTOMOTIVE INDUSTRY, NAMELY, THERMOMETERS, ALTIMETERS, NOISE METERS, SPEED CHECKING APPARATUS, HYGROMETERS, PRESSURE GAUGES, PRESSURE INDICATORS, PRESSURE MEASURING APPARATUS, FLOW METERS, HUMIDITY CONTROL APPARATUS, AUTOMATIC COMBUSTION CONTROL APPARATUS, VOLTAGE REGULATORS, ELECTRIC CURRENT SENSORS, ACCELERATION SENSORS, POSITION SENSORS, RPM SENSORS, TANK CAP SENSORS; CABLE HARNESSSES, ELECTRIC PLUG CONNECTIONS, ELECTRICAL FUSES, ELECTRIC RELAYS, ELECTRIC SWITCHES, AUTOMATIC PRESSURE CONTROLS, POWER CONTACTORS, CIRCUIT BREAKER DEVICES, THERMOSTATS, TEMPERATURE LIMITING SENSORS, VOLTAGE REGULATORS AND INTERFERENCE SUPPRESSION SETS FOR AIR-CONDITIONING UNITS; SOLAR HEAT COLLECTION PANELS FOR THE POWER SUPPLY OF LAND VEHICLES AND BOATS AND THEIR COMPONENTS; ELECTRIC AND MECHANICAL CONTROL DEVICES FOR USE IN ELECTRIC AND MECHANICAL CONTROL DEVICES FOR USE IN VEHICLES; HEATER BATTERIES; FUEL CELLS AND FUEL REFORMERS AS UNITS FOR GENERATING AND USING HYDROGEN AS FUEL OR COMBUSTIBLE IN LAND VEHICLES (U.S. CLS. 21, 23, 26, 36 AND 38).

CLASS 11—ENVIRONMENTAL CONTROL APPARATUS

FOR AIR-CONDITIONING, COOLING, VENTILATING AND WATER AND AIR HEATING DEVICES FOR VEHICLES, INCLUDING HVAC UNITS, NAMELY, WINDOW DEFROSTERS, ELECTRIC WATER HEATERS AND ENGINE PREHEATING DEVICES FOR VEHICLES, ENGINE-INDEPENDENT AIR CONDITIONERS FOR VEHICLES, ELECTRIC HEATING DEVICES AND AUXILIARY HEATING DEVICES IN THE NATURE OF ELECTRIC HEATING UNITS FOR VEHICLES; ROOF MOUNTED AIR CONDITIONERS; LIGHTS FOR VEHICLES; FILTERS, NAMELY, AIR, GAS AND OIL FILTERS, FOR HEATING, VENTILATION AND AIR-CONDITIONING DEVICES IN VEHICLES; COMPONENT PARTS FOR AIR-CONDITIONING AND HEATING DEVICES IN VEHICLES, NAMELY, COOLANT COLLECTORS, COOLANT DISTRIBUTORS, AND COOLANT EVAPORATORS; HEAT EXCHANGERS; CONTINUOUS FLOW HEATERS, TANK DRAINING DEVICES FOR DRAINING COMBUSTIBLE FOR COMBUSTIBLE RESERVOIRS OF VEHICLES, AND CONDENSATE SUCTION DEVICES FOR AIR-CONDITIONING DEVICES IN VEHICLES (U.S. CLS. 13, 21, 23, 31 AND 34).

CLASS 12—VEHICLES

FOR VEHICLE ROOF TOP PANELS, NAMELY, SLIDING, LIFTING AND SLIDING/LIFTING, SPOILER, LOUVERED, SUN, FOLDING AND TILTING ROOF PANELS, ALL-GLASS ROOF PANELS, RETRACTABLE HARDTOP ROOF PANELS, CONVERTIBLE VEHICLE ROOF PANEL TOPS; SUN SHADES AND VENTILATION FLAPS FOR VEHICLES; ADJUSTABLE VEHICLE WINDOWS IN THE NATURE OF SIDE AND REAR WINDOWS, FOLDING, TILTING AND LOUVERED WINDOWS; COMPONENT PARTS FOR VEHICLES, NAMELY, VEHICLE WINDOW RAISING MECHANISMS; VEHICLE ROOF LINERS AND STRUCTURAL PARTS THEREFORE; VEHICLE BODY AND STRUC-

TURAL PARTS THEREFOR, NAMELY, BODY PANELS, HOODS AND TAIL GATES; SPOILERS FOR VEHICLES, WIND AND WATER DEFLECTORS, AIR FLOW DEVICES, SKI AND LUGGAGE RACKS FOR VEHICLES, MODULE ROOFS FOR VEHICLES; PARTS FOR VEHICLES IN THE NATURE OF MOVABLE SURFACES FOR VEHICLES, NAMELY, SLIDING FLOORS AND TELESCOPIC LOADING FLOORS; DARKENING GLASS WINDOWS FOR VEHICLES; DOOR PANELS FOR VEHICLES; SOLAR ROOF PANELS FOR VEHICLES; ROOF HATCHES FOR VEHICLES (U.S. CLS. 19, 21, 23, 31, 35 AND 44).

RENEE MCCRAY, EXAMINING ATTORNEY

SN 79-004,892. LANIFICIO LUIGI BOTTO S.P.A., I-13825 VALLEMOSSE (BIELLA), ITALY, FILED 6-14-2004.



PRIORITY DATE OF 5-19-2004 IS CLAIMED.
OWNER OF INTERNATIONAL REGISTRATION 0832022 DATED 6-14-2004, EXPIRES 6-14-2014.

THE TRADEMARK CONSISTS IN A CIRCULAR PRINT, IN WHICH THERE ARE THE LETTERS X T IN FANCY CHARACTERS (FIGURE DEVICE).

CLASS 23—YARNS AND THREADS

FOR YARNS AND THREADS FOR TEXTILE USE (U.S. CL. 43).

CLASS 24—FABRICS

FOR FABRICS FOR THE MANUFACTURE OF CLOTHING (U.S. CLS. 42 AND 50).

REBECCA GILBERT, EXAMINING ATTORNEY

SN 79-004,920. GILMAR S.P.A., ITALY, FILED 5-27-2004.

THE MARK CONSISTS OF STANDARD CHARACTERS WITHOUT CLAIM TO ANY PARTICULAR FONT, STYLE, SIZE, OR COLOR.

PRIORITY DATE OF 5-5-2004 IS CLAIMED.
OWNER OF INTERNATIONAL REGISTRATION 0832107 DATED 5-27-2004, EXPIRES 5-27-2014.

OWNER OF U.S. REG. NOS. 1,477,298, 2,909,353 AND OTHERS.

CLASS 18—LEATHER GOODS

FOR LEATHER AND IMITATIONS OF LEATHER, AND GOODS MADE OF THESE MATERIALS AND NOT INCLUDED IN OTHER CLASSES, NAMELY, BAGS, TRAVEL BAGS, WALLETS, HAND BAGS, BRIEF CASES, PURSES, BELTS, CARD HOLDERS, KEY RINGS, KEY-CHAINS, UMBRELLAS, ATTACHÉ CASES, GARMENT BAGS, SUITCASES, ATHLETICS BAGS, DUFFLE BAGS, OVERNIGHT CASES, VANITY CASES, KEY CASES, SHOULDER BAGS, AND TRUNKS (U.S. CLS. 1, 2, 3, 22 AND 41).

CLASS 25—CLOTHING

FOR CLOTHING, NAMELY, SKIRTS, DRESSES, SUITS, PANTS, JEANS, BLAZERS, JACKETS, COATS, RAINWEAR, SPORT COATS, T-SHIRTS, SWEATERS, SWEAT SHIRTS, BLOUSES, HOSIERY, GILETS, VESTS, TOPS, SHORTS, BATHING SUITS, JOGGING SUITS, LOUNGEWEAR, PANTSUITS, SHAWLS, FOULARDS, SCARVES, GLOVES, SOCKS, BELTS, TIES, HATS, CAPS, SHOES, BOOTS AND SLIPPERS (U.S. CLS. 22 AND 39).
MELVIN AXILBUND, EXAMINING ATTORNEY

SN 79-004,921. GILMAR S.P.A., ITALY, FILED 5-27-2004.



PRIORITY DATE OF 5-5-2004 IS CLAIMED.
OWNER OF INTERNATIONAL REGISTRATION 0832108 DATED 5-27-2004, EXPIRES 5-27-2014.
OWNER OF U.S. REG. NOS. 1,269,297, 2,909,353 AND OTHERS.

THE COLOR(S) WHITE, LIGHT GRAY AND DARK GRAY IS/ARE CLAIMED AS A FEATURE OF THE MARK.
THE WHITE APPEARS IN THE WORD ICE. THE LIGHT GRAY APPEARS IN THE LETTER B AND THE REPEATED WORD ICEBERG. THOSE ELEMENTS ARE SET IN A DARK GRAY RECTANGLE.

THE TRADEMARK CONSISTS OF A DARK RECTANGULAR DEVICE, CONTAINING, IN THE MIDDLE, THE WORD ICE WRITTEN IN LIGHT FANCY CHARACTERS AND THE LETTER B IN A FANCY CHARACTER WITH DARKER BACKGROUND; IN A LOWER POSITION THERE IS THE WORD ICEBERG IN SMALLER CHARACTERS WITH LIGHT BACKGROUND WRITTEN REPEATEDLY AND WITHOUT INTERRUPTION.

CLASS 18—LEATHER GOODS

FOR LEATHER AND IMITATIONS OF LEATHER, AND GOODS MADE OF THESE MATERIALS AND NOT INCLUDED IN OTHER CLASSES, NAMELY, BAGS, TRAVEL BAGS, WALLETS, HAND BAGS, BRIEF CASES, PURSES, BELTS, CARD HOLDERS, KEY RINGS, KEY-CHAINS, UMBRELLAS, ATTACHÉ CASES, GARMENT BAGS, SUITCASES, ATHLETICS BAGS, DUFFLE BAGS, OVERNIGHT CASES, VANITY CASES, KEY CASES, SHOULDER BAGS, AND TRUNKS (U.S. CLS. 1, 2, 3, 22 AND 41).

CLASS 25—CLOTHING

FOR CLOTHING, NAMELY, SKIRTS, DRESSES, SUITS, PANTS, JEANS, BLAZERS, JACKETS, COATS, RAINWEAR, SPORT COATS, T-SHIRTS, SWEATERS, SWEAT SHIRTS, BLOUSES, HOSIERY, GILETS, VESTS, TOPS, SHORTS, BATHING SUITS, JOGGING SUITS, LOUNGEWEAR, PANTSUITS, SHAWLS, FOULARDS, SCARVES, GLOVES, SOCKS, BELTS, TIES, HATS, CAPS, SHOES, BOOTS AND SLIPPERS (U.S. CLS. 22 AND 39).
MELVIN AXILBUND, EXAMINING ATTORNEY

SN 79-004,975. LANIFICIO LUIGI BOTTO S.P.A., I-13825 VALLEMOSSO (BIELLA), ITALY, FILED 6-14-2004.



PRIORITY DATE OF 5-19-2004 IS CLAIMED.
OWNER OF INTERNATIONAL REGISTRATION 0832250 DATED 6-14-2004, EXPIRES 6-14-2014.

THE TRADEMARK CONSISTS IN A CIRCULAR PRINT, IN WHICH THERE ARE THE LETTERS X T IN FANCY CHARACTERS AND UNDER THEM THERE IS THE WORD PROCESS; FROM THE CIRCULAR PRINT, UP ON THE RIGHT, A FURTHER CIRCULAR PRINT OF MORE LITTLE DIMENSIONS EXTENDS AND IN IT THERE IS THE LETTER F AS THE INITIAL OF THE WORD FOUR THAT CONTINUES OUT OF THE CIRCULAR PRINT.

CLASS 23—YARNS AND THREADS

FOR YARNS AND THREADS FOR TEXTILE USE (U.S. CL. 43).

CLASS 24—FABRICS

FOR FABRICS FOR THE MANUFACTURE OF CLOTHING (U.S. CLS. 42 AND 50).
REBECCA GILBERT, EXAMINING ATTORNEY

SN 79-005,015. VS VEREINIGTE SPEZIALMÖBELFABRIKEN; GMBH & CO, FED REP GERMANY, FILED 6-4-2004.



OWNER OF INTERNATIONAL REGISTRATION 0667101 DATED 8-2-1996, EXPIRES 8-2-2006.

THE COLOR(S) BLACK, RED AND WHITE IS/ARE CLAIMED AS A FEATURE OF THE MARK.
THE LETTERS VS APPEAR IN THE COLOR BLACK AND THE LINE APPEARS IN THE COLOR RED.

CLASS 9—ELECTRICAL AND SCIENTIFIC APPARATUS

FOR PROJECTION SCREENS; MAGNETS; MAGNETIC BOARDS, MAGNETIC CARDS (U.S. CLS. 21, 23, 26, 36 AND 38).

CLASS 16—PAPER GOODS AND PRINTED MATTER

FOR PAINTINGS, PAPER SCHOOL BOARDS; BLACK BOARDS, AND PAPER FLIPOVER CHARTS (U.S. CLS. 2, 5, 22, 23, 29, 37, 38 AND 50).

CLASS 20—FURNITURE AND ARTICLES NOT OTHERWISE CLASSIFIED

FOR FURNITURE, MOBILE FURNITURE, OFFICE FURNITURE, FURNITURE FOR CONFERENCES, SCHOOL FURNITURE, NURSERY FURNITURE, WARDROBES, WALL CABINETS, TABLES, DESKS, SEATS, CHAIRS, BEDS, RACKS USED FOR STORAGE, SHELVING FOR BOOKS, COAT STANDS, GLASS DISPLAY CASES, DISPLAY BOARDS, HOLDERS FOR CHARTS, MIRRORS (U.S. CLS. 2, 13, 22, 25, 32 AND 50).
MIDGE BUTLER, EXAMINING ATTORNEY

SN 79-005,042. DONE INFORMATION OY, FINLAND,
FILED 2-17-2004.

DONE PRODIARY

OWNER OF INTERNATIONAL REGISTRATION 0832372
DATED 2-17-2004, EXPIRES 2-17-2014.

CLASS 9—ELECTRICAL AND SCIENTIFIC APPARATUS

FOR COMPUTER PROGRAMS AND COMPUTER DATABASES FOR USE IN SHARING, REPORTING, STORING, PROCESSING, RECORDING AND DISTRIBUTING INFORMATION FROM DATABASE TO USERS; COMPUTER PROGRAMS AND COMPUTER DATABASES FOR USE IN DATABASE MANAGEMENT; ELECTRONIC DATABASES IN THE FIELD OF INDUSTRY, RECORDED ON COMPUTER MEDIA; COMPUTERS (U.S. CLS. 21, 23, 26, 36 AND 38).

CLASS 35—ADVERTISING AND BUSINESS

FOR MANAGING AN ON-LINE COMPUTER DATABASE FEATURING INFORMATION IN THE FIELD OF INDUSTRY (U.S. CLS. 100, 101 AND 102).

CLASS 42—SCIENTIFIC, COMPUTER AND LEGAL SERVICES

FOR COMPUTER PROGRAMMING FOR OTHERS; COMPUTER, COMPUTER PROGRAM AND DATABASE CONSULTATION; COMPUTER HARDWARE DEVELOPMENT; MAINTENANCE OF COMPUTER PROGRAMS; MONITORING THE COMPUTER SYSTEMS OF OTHERS FOR TECHNICAL PURPOSES AND PROVIDING BACK-UP COMPUTER PROGRAMS AND FACILITIES; TECHNICAL SUPPORT SERVICES, NAMELY, TROUBLESHOOTING OF COMPUTER SOFTWARE PROBLEMS; CONSULTANCY IN THE FIELD OF COMPUTER HARDWARE (U.S. CLS. 100 AND 101).
CATHERINE CAIN, EXAMINING ATTORNEY

SN 79-005,082. NIPPON MIRACTRAN CO., LTD., JAPAN,
FILED 6-21-2004.



OWNER OF INTERNATIONAL REGISTRATION 0832485
DATED 6-21-2004, EXPIRES 6-21-2014.

CLASS 1—CHEMICALS

FOR UNPROCESSED PLASTICS; UNPROCESSED SYNTHETIC RESINS; AND UNPROCESSED POLYURETHANE RESINS (U.S. CLS. 1, 5, 6, 10, 26 AND 46).

CLASS 17—RUBBER GOODS

FOR PLASTIC COMPOSITE MATERIALS IN THE FORM OF PROFILES, BOARDS, SHEETS, BLOCKS, RODS, POWER AND PELLETS FOR USE IN MANUFACTURING; SYNTHETIC RESINS IN BAR, BLOCKS, PELLETS, RODS, SHEETS, FOR GENERAL INDUSTRIAL USE; POLYURETHANE RESINS IN BAR, BLOCKS, PELLETS, RODS, SHEETS FOR USE IN FURTHER MANUFACTURE; RAW AND SEMI-WORKED RUBBER (U.S. CLS. 1, 5, 12, 13, 35 AND 50).
CHRISIE B. KING, EXAMINING ATTORNEY

SN 79-005,088. SOLVAY (SOCIÉTÉ ANONYME), BELGIUM,
FILED 6-16-2004.

SOLKAFLAM

THE MARK CONSISTS OF STANDARD CHARACTERS WITHOUT CLAIM TO ANY PARTICULAR FONT, STYLE, SIZE, OR COLOR.

PRIORITY DATE OF 12-17-2003 IS CLAIMED.
OWNER OF INTERNATIONAL REGISTRATION 0832514
DATED 6-16-2004, EXPIRES 6-16-2014.

CLASS 1—CHEMICALS

FOR INDUSTRIAL CHEMICALS, NAMELY HYDROFLUOROCARBONS; FIRE EXTINGUISHING COMPOSITIONS (U.S. CLS. 1, 5, 6, 10, 26 AND 46).

CLASS 9—ELECTRICAL AND SCIENTIFIC APPARATUS

FOR FIRE EXTINGUISHERS (U.S. CLS. 21, 23, 26, 36 AND 38).
HOWARD SMIGA, EXAMINING ATTORNEY

SN 79-005,100. CONSORZIO VERA PELLE ITALIANA; CONCIATA AL VEGETALE, I-56024 PONTE A EGOLA (PISA), ITALY, FILED 5-4-2004.

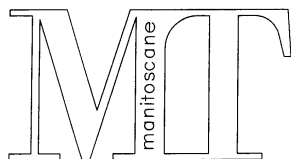

PRIORITY DATE OF 1-29-2004 IS CLAIMED.
OWNER OF INTERNATIONAL REGISTRATION 0832566 DATED 5-4-2004, EXPIRES 5-4-2014.

THE MARK COMPRISES THE WORDS MANI TOSCANE WRITTEN VERTICALLY BETWEEN THE LETTERS M AND T.

THE ENGLISH TRANSLATION OF THE WORDING "MANI TOSCANE" IN THE MARK IS "TUSCAN HANDS."

CLASS 35—ADVERTISING AND BUSINESS

FOR ORGANIZATION OF EXHIBITIONS FOR COMMERCIAL OR ADVERTISING PURPOSES (U.S. CLS. 100, 101 AND 102).

CLASS 41—EDUCATION AND ENTERTAINMENT

FOR ORGANIZATION OF EXHIBITIONS FOR CULTURAL OR EDUCATIONAL PURPOSES (U.S. CLS. 100, 101 AND 107).

JEFF DEFORD, EXAMINING ATTORNEY

SN 79-005,133. AUDI AG, FED REP GERMANY, FILED 6-16-2004.

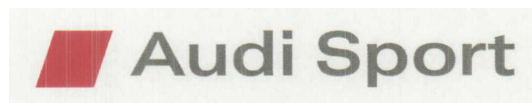

PRIORITY DATE OF 2-9-2004 IS CLAIMED.
OWNER OF INTERNATIONAL REGISTRATION 0832689 DATED 6-16-2004, EXPIRES 6-16-2014.
OWNER OF U.S. REG. NOS. 708,352, 2,912,419 AND OTHERS.

NO CLAIM IS MADE TO THE EXCLUSIVE RIGHT TO USE SPORT, APART FROM THE MARK AS SHOWN.

THE COLOR(S) RED, SILVER, WHITE IS/ARE CLAIMED AS A FEATURE OF THE MARK.

THE COLOR RED APPEARS IN THE PARALLELOGRAM DESIGN, THE COLOR SILVER APPEARS IN THE WORDS AUDI SPORT AND THE BACKGROUND IS WHITE.

CLASS 9—ELECTRICAL AND SCIENTIFIC APPARATUS

FOR OPTICAL INSTRUMENTS, NAMELY, SUNGLASSES (U.S. CLS. 21, 23, 26, 36 AND 38).

CLASS 12—VEHICLES

FOR AUTOMOBILES (U.S. CLS. 19, 21, 23, 31, 35 AND 44).

CLASS 14—JEWELRY

FOR JEWELRY; PRECIOUS METALS AND THEIR ALLOYS AND GOODS OF PRECIOUS METALS OR COATED THEREWITH, NAMELY, MONEY CLIPS, TIEPINS, KEY RINGS, KEY HOLDERS, BELT BUCKLES; WATCHES (U.S. CLS. 2, 27, 28 AND 50).

CLASS 16—PAPER GOODS AND PRINTED MATTER

FOR BOOKS AND MAGAZINES FEATURING TOPICS RELATING TO AUTOMOBILES; STATIONERY (U.S. CLS. 2, 5, 22, 23, 29, 37, 38 AND 50).

CLASS 18—LEATHER GOODS

FOR LEATHER BAGS, LEATHER PURSES, LEATHER HANDBAGS, LEATHER KEY CHAINS, PURSES, WALLETS, BRIEF CASES, BILLFOLDS, LEATHER KEY CASES; SUITCASES, TRUNKS AND TRAVELING BAGS; UMBRELLAS (U.S. CLS. 1, 2, 3, 22 AND 41).

CLASS 25—CLOTHING

FOR CLOTHING, NAMELY, SHIRTS, T-SHIRTS, KNIT SHIRTS, SHAWLS, PANTS, TIES, DRESSES, PANTS, SWEATERS, JACKETS, SKIRTS, BELTS; FOOTWEAR; HEADGEAR, NAMELY, HATS, CAPS, BASEBALL CAPS (U.S. CLS. 22 AND 39).

CLASS 28—TOYS AND SPORTING GOODS

FOR GAMES AND PLAYTHINGS, NAMELY, TOY CARS, SCALE MODEL CARS (U.S. CLS. 22, 23, 38 AND 50).

CLASS 37—CONSTRUCTION AND REPAIR

FOR REPAIR AND MAINTENANCE OF MOTOR VEHICLES (U.S. CLS. 100, 103 AND 106).

HOWARD SMIGA, EXAMINING ATTORNEY

SN 79-005,139. OY JURILAB LTD, FINLAND, FILED 8-4-2004.

BlockMap

THE MARK CONSISTS OF STANDARD CHARACTERS WITHOUT CLAIM TO ANY PARTICULAR FONT, STYLE, SIZE, OR COLOR.

PRIORITY DATE OF 2-6-2004 IS CLAIMED.

OWNER OF INTERNATIONAL REGISTRATION 0832711 DATED 8-4-2004, EXPIRES 8-4-2014.

CLASS 42—SCIENTIFIC, COMPUTER AND LEGAL SERVICES

FOR SCIENTIFIC AND TECHNOLOGICAL SERVICES AND RESEARCH AND DESIGN, NAMELY, DRUG TARGET AND DIAGNOSTIC MARKER DISCOVERY AND GENE-DISEASE ASSOCIATION ANALYSIS (U.S. CLS. 100 AND 101).

CLASS 44—MEDICAL, BEAUTY AND AGRICULTURAL SERVICES

FOR MEDICAL SERVICES, NAMELY, PERSONALIZED MEDICINE RELATED ANALYSIS AND SERVICES (U.S. CLS. 100 AND 101).

ANGELA M. MICHELI, EXAMINING ATTORNEY

SN 79-005.162. C.E.I.A. - COSTRUZIONI ELETTRONICHE; INDUSTRIALI AUTOMATISMI - S.P.A., I-52040 CIVITELLA IN AL DI CHIANA (AR), ITALY, FILED 4-8-2004.

POWER CUBE

THE MARK CONSISTS OF STANDARD CHARACTERS WITHOUT CLAIM TO ANY PARTICULAR FONT, STYLE, SIZE, OR COLOR.

PRIORITY DATE OF 12-4-2003 IS CLAIMED.

OWNER OF INTERNATIONAL REGISTRATION 0832802 DATED 4-8-2004, EXPIRES 4-8-2014.

CLASS 7—MACHINERY

FOR ELECTRIC WELDING MACHINES, INDUCTION HEATING GENERATORS FOR WELDING MACHINES, GENERATORS FOR THE INDUCTIVE HEATING OF ELECTRICAL CONDUCTIVE MATERIALS (U.S. CLS. 13, 19, 21, 23, 31, 34 AND 35).

CLASS 11—ENVIRONMENTAL CONTROL APPARATUS

FOR ELECTRICAL HEATING APPARATUS FOR COMMERCIAL USE (U.S. CLS. 13, 21, 23, 31 AND 34).
DOMINIC J. FERRAIUOLO, EXAMINING ATTORNEY

SN 79-005.166. ENTREPRISE DE CONFECTION ET DE COMMERCIALISATION EUROPÉENNE SOCIÉTÉ PAR ACTION SIMPLIFIÉE, FRANCE, FILED 12-29-2003.

ECCE

THE MARK CONSISTS OF STANDARD CHARACTERS WITHOUT CLAIM TO ANY PARTICULAR FONT, STYLE, SIZE, OR COLOR.

OWNER OF INTERNATIONAL REGISTRATION 0832824 DATED 12-29-2003, EXPIRES 12-29-2013.

OWNER OF U.S. REG. NO. 2,593,374.

CLASS 3—COSMETICS AND CLEANING PREPARATIONS

FOR SOAPS; PERFUMERY, NAMELY, PERFUMES, COLOGNES, EAU DE TOILET, ESSENTIAL OILS FOR PERSONAL USE, COSMETICS, HAIR LOTIONS; DENTIFRICES (U.S. CLS. 1, 4, 6, 50, 51 AND 52).

CLASS 9—ELECTRICAL AND SCIENTIFIC APPARATUS

FOR MAGNETIC CARDS (U.S. CLS. 21, 23, 26, 36 AND 38).

CLASS 14—JEWELRY

FOR TIMEPIECES AND CHRONOMETRIC INSTRUMENTS, NAMELY, WATCHES AND WALL CLOCKS OF ALL TYPES, ALARM CLOCKS, BRACELETS, TIE PINS, JEWELRY, PRECIOUS STONES; PRECIOUS METALS AND THEIR ALLOYS, TABLEWARE OF PRECIOUS METAL, NAMELY, EGG CUPS, SAUCERS, SUGAR BOWLS, SALT AND PEPPER SHAKERS; BUSTS OF PRECIOUS METAL, CANDLESTICKS OF PRECIOUS METAL, FIGURINES OF PRECIOUS METAL, STATUETTES OF PRECIOUS METAL, STATUES OF PRECIOUS METAL; CIGAR BOXES OF PRECIOUS METAL, CIGARETTE BOXES OF PRECIOUS METAL, MATCH BOXES OF PRECIOUS METAL; ASHTRAYS OF PRECIOUS METAL FOR SMOKERS, LARGE CIGAR CASES OF PRECIOUS METAL, CIGAR CASES OF PRECIOUS METAL, CIGAR HOLDERS OF PRECIOUS METAL FOR SMOKING, CIGARETTE HOLDERS OF PRECIOUS METAL FOR SMOKING, MATCH HOLDERS OF PRECIOUS METAL, CIGAR HOLDERS OF PRECIOUS METAL, CIGARETTE HOLDERS OF PRECIOUS METAL, TOBACCO JARS OF PRECIOUS METAL, SNUFF BOXES OF PRECIOUS METAL, JEWELRY CASES OF PRECIOUS METAL; COIN PURSES OF PRECIOUS METAL; BADGES OF PRECIOUS METAL (U.S. CLS. 2, 27, 28 AND 50).

CLASS 16—PAPER GOODS AND PRINTED MATTER

FOR PENS OF ALL TYPES AND REFILLS FOR PENS; PRINTED PUBLICATIONS, NAMELY, PERIODICALS, MAGAZINES, JOURNALS AND BOOKS, ALL IN THE FIELD OF FASHION AND BEAUTY; NEWSPAPERS, DATE BOOKS; PHOTOGRAPHS, FILE TRAYS, LETTER TRAYS, DESK BASKET FOR DESK ACCESSORIES; PAPER LABELS, ADHESIVE LABELS, ADDRESS LABELS; COPIER PAPER; LETTER PAPER; CARDBOARD; PRINTED MATTER, NAMELY, PAMPHLETS, NEWSLETTERS, ALL IN THE FIELD OF FASHION AND BEAUTY; PRINTED CARDBOARD SIGNS; SHIELDS, NAMELY, PAPER SEALS, SIGNBOARDS OF PAPER OR CARDBOARD, PAPER PENNANTS, PAPER BOXES, DESK MOUNTED STATIONERY CABINETS AND DESKTOP STATIONERY CABINETS, PAPER AND CARDBOARD NOTICE OR ADVERTISEMENT BOARDS, PAPER AND PLASTIC BAGS, PAPER BAGS; SMALL PAPER BAGS; PLASTIC BAGS FOR HOUSEHOLD USE; SMALL PLASTIC BAGS FOR HOUSEHOLD USE; ENVELOPES, SMALL PAPER AND PLASTIC BAGS, POSTERS, POSTCARDS, BLUEPRINTS (U.S. CLS. 2, 5, 22, 23, 29, 37, 38 AND 50).

CLASS 22—CORDAGE AND FIBERS

FOR RAW FIBROUS TEXTILE MATERIALS; ROPES NOT MADE OF RUBBER, NOT INTENDED AS STRINGS FOR RACKETS OR MUSICAL INSTRUMENTS; TARPULINS NOT AS SAFETY TARPULINS, NOR AS PUSHCHAIR COVERS; SAILS, RIG SAILS; NON METAL RIGGING CHAINS; PADDING AND STUFFING MATERIALS NOT OF RUBBER OR PLASTIC (U.S. CLS. 1, 2, 7, 19, 22, 42 AND 50).

CLASS 35—ADVERTISING AND BUSINESS

FOR ADVERTISING AND MARKETING, BUSINESS MARKETING AND BUSINESS MARKETING CONSULTING SERVICES; ADVISORY AND ASSISTANCE SERVICES FOR BUSINESS ORGANIZATION AND MANAGEMENT; BUSINESS CONSULTING; BILL-POSTING, DISTRIBUTION OF SAMPLES, OF ADVERTISING MATERIAL NAMELY LEAFLETS, PRINTED MATTER, PROSPECTUSES, SIGNS, PRODUCT DISPLAY AND/OR DEMONSTRATION PARTS, ESPECIALLY FOR MAIL-ORDER SALE; SERVICES PROVIDED BY A FRANCHISER NAMELY, ASSISTANCE REGARDING THE OPERATION OR MANAGEMENT OF INDUSTRIAL OR COMMERCIAL COMPANIES; COMMERCIAL INFORMATION AND CONSULTING SERVICES; SALES PROMOTION FOR OTHERS PROVIDED THROUGH THE DISTRIBUTION AND ADMINISTRATION OF PRIVI-

LEGED USER CARDS; DATA INPUT AND PROCESSING SERVICES; SUBSCRIPTIONS FOR BOOKLETS AND UPDATES, NEWSPAPERS, JOURNALS, PERIODICALS, MAGAZINES; SERVICES COMPRISING THE RECORDING, TRANSCRIPTION, COMPOSITION, COMPILATION AND SYSTEMATIZATION OF WRITTEN COMMUNICATIONS AND RECORDINGS, AS WELL AS THE COMPILATION OF MATHEMATICAL OR STATISTICAL DATA; ACCOUNTING; DOCUMENT REPRODUCTION; ORGANIZATION OF EXHIBITIONS, TRADE FAIRS AND SHOWS FOR COMMERCIAL OR ADVERTISING PURPOSES (U.S. CLS. 100, 101 AND 102).

CLASS 38—COMMUNICATION

FOR RADIO, TELEPHONE, TELEGRAPH AND COMPUTER TERMINAL COMMUNICATION; TRANSMISSION OF INFORMATION THROUGH VIDEO COMMUNICATION SYSTEMS, VIDEOPHONE, DIGITAL NETWORKS AND VIDEO TELECONFERENCING; SENDING OR TRANSMISSION OF TELEGRAMS AND MESSAGES; TELEVISION AND RADIO BROADCASTING; BROADCASTING PROGRAMS VIA A GLOBAL COMPUTER NETWORK FOR INTERACTIVE OR OTHER USE; TRANSMISSION OF DATA BY TELETYPEWRITER, TRANSMISSION OF INFORMATION VIA COMPUTERS CONNECTED TO THE SAME TELEMATIC NETWORK; TRANSMISSION AND RECEPTION OF DATA BANK INFORMATION VIA THE TELECOMMUNICATION NETWORK; TRANSMISSION OF INFORMATION VIA ELECTRONIC COMMUNICATIONS NETWORK; COMMUNICATION SERVICES, NAMELY, PROVIDING ELECTRONIC TRANSMISSION OF DATA AND DOCUMENTS AMONG USERS OF COMPUTERS; TRANSMISSION OF INFORMATION IN THE AUDIO-VISUAL FIELD; STREAMING OF VIDEO MATERIAL ON THE INTERNET (U.S. CLS. 100, 101 AND 104).

CLASS 42—SCIENTIFIC, COMPUTER AND LEGAL SERVICES

FOR LICENSING INTELLECTUAL PROPERTY AND COPYRIGHT MANAGEMENT; COMPILATION AND SYSTEMATIZATION OF INFORMATION INTO DATABASES, DEVELOPMENT, UPDATING AND MAINTENANCE OF DATABASES; PROGRAMMING FOR ELECTRONIC INSTRUMENTS AND APPARATUS, FOR COMPUTERS, FOR TELECOMPUTING AND COMPUTER COMMUNICATION SYSTEMS, FOR MULTIMEDIA EQUIPMENT; PROGRAMMING OF MULTIMEDIA EQUIPMENT; DATA INPUT AND PROCESSING SERVICES; RENTAL OF COMPUTER, TELECOMPUTING AND COMPUTER COMMUNICATION APPARATUS AND INSTRUMENTS (U.S. CLS. 100 AND 101).

KELLEY WELLS, EXAMINING ATTORNEY

SN 79-005,188. FULLSIX, FRANCE, FILED 4-16-2004.

FullSIX

OWNER OF INTERNATIONAL REGISTRATION 0832913 DATED 4-16-2004, EXPIRES 4-16-2014.

CLASS 9—ELECTRICAL AND SCIENTIFIC APPARATUS

FOR COMPUTERS, NAMELY, GENERAL PURPOSE COMPUTERS (U.S. CLS. 21, 23, 26, 36 AND 38).

CLASS 35—ADVERTISING AND BUSINESS

FOR ADVERTISING; BUSINESS MANAGEMENT; BUSINESS ADMINISTRATION; OFFICE FUNCTIONS, DISTRIBUTION OF PROSPECTUSES AND SAMPLES; BUSINESS CONSULTING, INFORMATION OR INQUIRIES, DOCUMENT REPRODUCTION, MANAGEMENT OF COMPUTER FILES, ORGANISATION OF EXHIBITIONS FOR COMMERCIAL OR ADVERTISING PURPOSES (U.S. CLS. 100, 101 AND 102).

CLASS 38—COMMUNICATION

FOR COMMUNICATIONS VIA COMPUTER TERMINALS (U.S. CLS. 100, 101 AND 104).

CLASS 41—EDUCATION AND ENTERTAINMENT

FOR PUBLISHING OF BOOKS, MAGAZINES, ARRANGING AND CONDUCTING OF COLLOQUIUMS, CONFERENCES AND CONVENTIONS (U.S. CLS. 100, 101 AND 107).

CLASS 42—SCIENTIFIC, COMPUTER AND LEGAL SERVICES

FOR COMPUTER PROGRAMMING FOR OTHERS, NAMELY, DESIGN AND DEVELOPMENT OF WEB SITES FOR OTHERS; EXPERT REPORTS OF ENGINEERS (U.S. CLS. 100 AND 101).

JOHN LINCOSKI, EXAMINING ATTORNEY

SN 79-005,257. DENKAVIT INTERNATIONAAL B.V., NETHERLANDS, FILED 7-7-2004.



OWNER OF INTERNATIONAL REGISTRATION 0466038 DATED 12-7-1981, EXPIRES 12-7-2011.

CLASS 5—PHARMACEUTICALS

FOR PHARMACEUTICAL PRODUCTS FOR SKIN CARE FOR ANIMALS; VETERINARY PRODUCTS, NAMELY, ANTI-INFECTIVE PRODUCTS FOR VETERINARY USE; DIETETIC FOODSTUFFS ADAPTED FOR MEDICAL USE; MEDICAL PLASTERS; BANDAGES FOR DRESSINGS; MATERIALS FOR DENTAL TECHNICIANS, NAMELY, DENTAL CEMENTS; DISINFECTANTS FOR HYGIENIC PURPOSES; PREPARATIONS FOR KILLING WEEDS; PREPARATIONS FOR PEST CONTROL, NAMELY, INSECT REPELLANTS; VITAMIN-ENRICHED PREPARATIONS, NAMELY, NUTRITIONAL ADDITIVES TO FOODSTUFFS FOR ANIMALS FOR MEDICAL PURPOSES (U.S. CLS. 6, 18, 44, 46, 51 AND 52).

CLASS 31—NATURAL AGRICULTURAL PRODUCTS

FOR ANIMAL FODDER (U.S. CLS. 1 AND 46).
AMY GEARIN, EXAMINING ATTORNEY

SN 79-005,263. JORGE COLL MORRO, SPAIN, FILED 12-11-2003.

GEORGE'S COLL

OWNER OF INTERNATIONAL REGISTRATION 0657460
DATED 7-19-1996, EXPIRES 7-19-2016.
OWNER OF U.S. REG. NO. 2,150,109.

CLASS 18—LEATHER GOODS

FOR HANDBAGS OF LEATHER, UNPROCESSED IMITATION LEATHER SOLD IN BULK, TRAVELLING TRUNKS, SUITCASES, BRIEFCASES, PURSES, ATTACHE CASES, OVERNIGHT CASES, UMBRELLAS, PARASOLS, WHIPS AND SADDLERY (U.S. CLS. 1, 2, 3, 22 AND 41).

CLASS 25—CLOTHING

FOR SHOES AND BOOTS (U.S. CLS. 22 AND 39).

CLASS 35—ADVERTISING AND BUSINESS

FOR IMPORT-EXPORT SERVICES FOR SHOES AND BOOTS, HANDBAGS OF LEATHER, UNPROCESSED IMITATION LEATHER, TRAVELLING TRUNKS, SUITCASES, BRIEFCASES, PURSES, CASES, UMBRELLAS, PARASOLS, WHIPS AND SADDLERY (U.S. CLS. 100, 101 AND 102).

KELLEY WELLS, EXAMINING ATTORNEY

SN 79-005,278. THIOMATRIX FORSCHUNGS- UND BERATUNGS-GMBH, AUSTRIA, FILED 7-19-2004.

THIOMATRIX

THE MARK CONSISTS OF STANDARD CHARACTERS WITHOUT CLAIM TO ANY PARTICULAR FONT, STYLE, SIZE, OR COLOR.

PRIORITY DATE OF 2-27-2004 IS CLAIMED.

OWNER OF INTERNATIONAL REGISTRATION 0833180
DATED 7-19-2004, EXPIRES 7-19-2014.

CLASS 1—CHEMICALS

FOR CHEMICALS USED IN INDUSTRY, SCIENCE AND PHOTOGRAPHY; AS WELL AS CHEMICALS USED IN INDUSTRY, NAMELY, THE AGRICULTURE, HORTICULTURE AND FORESTRY INDUSTRIES (U.S. CLS. 1, 5, 6, 10, 26 AND 46).

CLASS 5—PHARMACEUTICALS

FOR PHARMACEUTICAL PREPARATIONS FOR USE IN THE TREATMENT OF DIABETES, OSTEOPOROSIS AND THROMBOSIS; VETERINARY PREPARATIONS, NAMELY, VETERINARY PREPARATIONS FOR TREATMENT OF INFLAMMATIONS (U.S. CLS. 6, 18, 44, 46, 51 AND 52).

CLASS 42—SCIENTIFIC, COMPUTER AND LEGAL SERVICES

FOR SCIENTIFIC SERVICES, NAMELY, SCIENTIFIC INVESTIGATIONS FOR PHARMACEUTICAL PURPOSES AND RESEARCH RELATED THERETO; SCIENTIFIC DESIGN SERVICES RELATING TO SCIENTIFIC INVESTIGATIONS FOR PHARMACEUTICAL PURPOSES, NAMELY, DESIGN OF DRUG DELIVERY SYSTEMS; TECHNOLOGICAL SERVICES, NAMELY, FORMULATION DEVELOPMENT IN THE NATURE OF MEDICAL DEVICE PRODUCT DEVELOPMENT AND RESEARCH RELATED THERETO; TECHNOLOGICAL DESIGN SERVICES RELATING TO FORMULATION DEVELOPMENT, NAMELY, DESIGN OF DRUG DELIVERY SYSTEMS (U.S. CLS. 100 AND 101).

MAUREEN DALL, EXAMINING ATTORNEY

SN 79-005,285. IHG LOGISTICS GMBH & CO. KG, FED REP GERMANY, FILED 2-18-2004.



OWNER OF INTERNATIONAL REGISTRATION 0833206
DATED 2-18-2004, EXPIRES 2-18-2014.

THE COLORS BLUE, ORANGE AND GREEN ARE CLAIMED AS A FEATURE OF THE MARK.

THE COLOR BLUE APPEARS IN THE LETTERS OF "IHG" AND IN THE LEFT OF THE TWO "WAVES". THE COLOR GREEN APPEARS IN THE RIGHT OF THE TWO "WAVES" AND IN THE ARROW. THE COLOR GREEN APPEARS IN THE TWO "WAVES" AND IN THE LETTERS OF "THE LOGISTICS PEOPLE".

CLASS 36—INSURANCE AND FINANCIAL

FOR CUSTOMS BROKERAGE FOR THIRD PARTIES (U.S. CLS. 100, 101 AND 102).

CLASS 38—COMMUNICATION

FOR COMMUNICATION BY ELECTRONIC COMPUTER TERMINALS; COMMUNICATIONS BY COMPUTER TERMINALS; COMMUNICATIONS VIA ANALOGUE AND DIGITAL COMPUTER TERMINALS; ELECTRONIC DATA INTERCHANGE (EDI) SERVICES; ELECTRONIC TRANSMISSION OF DATA AND DOCUMENTS VIA COMPUTER TERMINALS; ELECTRONIC, ELECTRIC AND DIGITAL TRANSMISSION OF VOICE, DATA, IMAGES, SIGNALS AND MESSAGES; ON-LINE DOCUMENT DELIVERY VIA A GLOBAL COMPUTER NETWORK; TRANSMISSION OF DATABASE INFORMATION VIA TELECOMMUNICATIONS NETWORKS; WEB MESSAGING WIRELESS ELECTRONIC TRANSMISSION OF VOICE SIGNALS, DATA, FACSIMILES, IMAGES AND INFORMATIONS (U.S. CLS. 100, 101 AND 104).

CLASS 39—TRANSPORTATION AND STORAGE

FOR AIR TRANSPORTATION; DELIVERY OF GOODS BY AIR, TRUCK, SHIP OR TRAIN; EXPRESS DELIVERY OF GOODS BY TRUCK OR AIR; PARCEL DELIVERY; POSTAL SERVICES, NAMELY, PARCEL DELIVERY, PACKAGING ARTICLES FOR TRANSPORTATION; FREIGHT BROKERAGE; FREIGHT FORWARDING; FREIGHT SHIP TRANSPORT; FREIGHT TRAIN TRANSPORT; FREIGHT TRANSPORTATION BY SHIP, TRAIN, AIR OR TRUCK; FUR STORAGE; FURNITURE STORAGE; GOODS WAREHOUSING; STORAGE IN GENERAL; STORAGE OF CLOTHES; STORAGE OF CLOTHING; STORAGE OF ELECTRONIC MEDIA, NAMELY, IMAGES, TEXT AND AUDIO DATA; STORAGE SERVICES OF ARCHIVING DATABASES, IMAGES AND OTHER ELECTRONIC DATA; STORING, SAFEKEEPING OF CLOTHES; CONSULTANCY IN THE FIELD OF AIR, SHIP, TRAIN AND TRUCK TRANSPORT (U.S. CLS. 100 AND 105).

CLASS 42—SCIENTIFIC, COMPUTER AND LEGAL SERVICES

FOR CREATING, MAINTENANCE AND UPDATING OF ELECTRONIC DATA PROCESSING PROGRAMS (U.S. CLS. 100 AND 101).

JACQUELINE A. LAVINE, EXAMINING ATTORNEY

SN 79-005,289. TRAVELLERS EXCHANGE CORPORATION LIMITED, UNITED KINGDOM, FILED 2-11-2004.

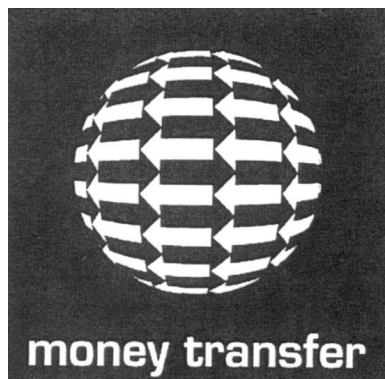

PRIORITY DATE OF 8-15-2003 IS CLAIMED.
OWNER OF INTERNATIONAL REGISTRATION 0833222 DATED 2-11-2004, EXPIRES 2-11-2014.

NO CLAIM IS MADE TO THE EXCLUSIVE RIGHT TO USE MONEY TRANSFER, APART FROM THE MARK AS SHOWN.

CLASS 9—ELECTRICAL AND SCIENTIFIC APPARATUS

FOR MAGNETICALLY CODED CREDIT CARDS, DEBIT CARDS, CHARGE CARDS, CHEQUE GUARANTEE CARDS, AND MAGNETIC CARD READERS USED IN RELATION TO THE ELECTRONIC TRANSFER OF FUNDS AND OTHER FINANCIAL TRANSACTIONS (U.S. CLS. 21, 23, 26, 36 AND 38).

CLASS 16—PAPER GOODS AND PRINTED MATTER

FOR PERIODICAL PUBLICATIONS AND BOOKS IN THE FIELD OF FINANCIAL SERVICES—INDEX CARDS; RECORD CARDS; IRON-ON TRANSFERS; TRAVELLERS CHEQUES; CHEQUE BOOKS; MONEY ORDERS; ADHESIVE MATERIALS FOR STATIONERY PURPOSES; PENS, PENCILS, MARKERS (U.S. CLS. 2, 5, 22, 23, 29, 37, 38 AND 50).

CLASS 35—ADVERTISING AND BUSINESS

FOR RETAIL SERVICES, NAMELY RETAIL STORE SERVICES, MAIL ORDER SERVICES AND INTERNET RETAIL SERVICES IN THE AREAS OF TRAVEL AND FINANCIAL SERVICES; CONSULTANCY SERVICES RELATING TO RETAIL SERVICES IN THE AREAS OF TRAVEL AND FINANCIAL SERVICES; BUSINESS ADVISORY AND INFORMATION SERVICES; PROVISION OF TRADE, BUSINESS, ECONOMIC AND STATISTICAL INFORMATION; BUSINESS RESEARCH SERVICES; COMPILATION AND PROVISION OF BUSINESS INFORMATION; DISSEMINATION OF BUSINESS INFORMATION RELATING TO MONEY, CASH TRANSFERS AND FINANCIAL MARKETS; FINANCIAL INFORMATION SERVICES, NAMELY THE RETRIEVAL AND PROVISION OF INFORMATION RELATING TO MONEY, CASH TRANSFERS, CURRENCY EXCHANGE, INSURANCE, AND FINANCIAL MARKETS (U.S. CLS. 100, 101 AND 102).

CLASS 36—INSURANCE AND FINANCIAL

FOR MONEY EXCHANGE AND MONEY TRANSFER SERVICES; CREDIT, DEBIT AND CHARGE CARD SERVICES; INSURANCE BROKERAGE SERVICES, NAMELY PROVIDING HEALTH, TRAVEL AND TRIP DISRUPTION INSURANCE; PROMOTING THE GOODS AND SERVICES OF OTHERS THROUGH THE DISTRIBUTION OF DISCOUNT CARDS; AUTOMATED PAYMENT SERVICES; ISSUE AND REDEMPTION OF TOKENS AND VOUCHERS; FINANCIAL SERVICES RELATING TO THE ISSUING OF NOTES, COINS, DRAFTS AND BILLS OF EXCHANGE; ISSUE AND REDEMPTION OF TRAVELLERS CHEQUES, PROVISION OF INFORMATION RELATING TO THE RATES OF EXCHANGE; CURRENCY EXCHANGE SERVICES; INFORMATION AND ADVISORY SERVICES RELATING TO THE AFORESAID SERVICES (U.S. CLS. 100, 101 AND 102).

JACQUELINE A. LAVINE, EXAMINING ATTORNEY

SN 79-005,336. DECATHLON, FRANCE, FILED 2-13-2004.

ROCKRIDER

THE MARK CONSISTS OF STANDARD CHARACTERS WITHOUT CLAIM TO ANY PARTICULAR FONT, STYLE, SIZE, OR COLOR.

PRIORITY DATE OF 8-13-2003 IS CLAIMED.

OWNER OF INTERNATIONAL REGISTRATION 0833360 DATED 2-13-2004, EXPIRES 2-13-2014.

CLASS 9—ELECTRICAL AND SCIENTIFIC APPARATUS

FOR PRE-RECORDED VIDEO TAPES FEATURING MOUNTAINEERING SPORTS, BICYCLING, TRAVELS AND SPORTS EVENTS; SOUND RECORDING SUPPORTS, NAMELY BLANK AND PRE-RECORDED AUDIO CDS; VIDEO RECORDING SUPPORTS, NAMELY BLANK VIDEO CDS; BLANK AND PRE-RECORDED OPTICAL DISKS; BLANK AND PRE-RECORDED COMPACT OPTICAL DISKS; BLANK AND PRE-RECORDED FLOPPY DISKS; APPARATUS FOR RECORDING, TRANSMITTING OR REPRODUCING SOUND, NAMELY DATA PROCESSORS, AUDIO AND DIGITAL AUDIO TAPE RECORDERS; INTERCOMMUNICATION APPARATUS, NAMELY COMPUTERS; VIDEO GAME MACHINES FOR USE WITH TELEVISION RECEIVERS; APPARATUS AND INSTRUMENTS FOR ASTRONOMY, NAMELY TELESCOPES AND BINOCULARS METEROLOGICAL INFORMATION SYSTEM, NAMELY PORTABLE GLOBAL POSITIONING SYSTEM; OPTICAL LAMPS; MEASURING INSTRUMENTS, NAMELY TAPE MEASURES; INSTRUMENTS FOR NAVIGATION NAMELY, SATELLITE NAVIGATIONAL SYSTEM CONSISTING OF A GLOBAL POSITIONING SYSTEM; INSTRUMENTS FOR OBSERVATION NAMELY, CAMCORDERS AND BINOCULARS (U.S. CLS. 21, 23, 26, 36 AND 38).

CLASS 21—HOUSEWARES AND GLASS

FOR PORTABLE COOLERS FOR PRESERVING AND REFRESHING BEVERAGES, NAMELY REFRIGERATING BOTTLES (U.S. CLS. 2, 13, 23, 29, 30, 33, 40 AND 50).
JACQUELINE A. LAVINE, EXAMINING ATTORNEY

SN 79-005,340. CARLO CHIONNA, I-40133 BOLOGNA (BO), ITALY, FILED 6-14-2004.



PRIORITY DATE OF 5-7-2004 IS CLAIMED.
OWNER OF INTERNATIONAL REGISTRATION 0833367 DATED 6-14-2004, EXPIRES 6-14-2014.

THE STIPPLING IN THE DRAWING IS FOR SHADING PURPOSES ONLY.

THE TRADEMARK CONSISTS OF AN IRREGULAR SHAPE OF TWO HOOKED ELEMENTS FORMING A SORT OF BOOMERANG WITH A PROLONGATION ON ONE SIDE OF THE TWO ELEMENTS; ABOVE AND PARALLEL TO THE PROLONGATION IS THE WORDING "BY CARLO CHIONNA", WHILE ON THE OPPOSITE RIGHT SIDE, AFTER ONE OF THE HOOKED ELEMENTS, THE NUMBERS "9" AND "2" ARE REPRESENTED, SEPARATED BY A FULL STOP AND GRAPHICALLY CHARACTERIZED; THE TRADEMARK CAN BE REPRODUCED IN ANY COLOR OR COMBINATION OF COLORS.

CLASS 3—COSMETICS AND CLEANING PREPARATIONS

FOR PERFUMERY AND COSMETICS, NAMELY, AFTER SHAVE LOTIONS, SOAPS, BUBBLE BATHS, BEAUTY MASKS; DEPILATORY PREPARATIONS, COSMETICS CREAMS, SHAMPOOS AND HAIR LOTIONS; EYE MAKE-UP, NAMELY, EYE PENCILS, EYEBROW PENCILS, MASCARA; LIPSTICKS, NAIL VARNISHES; MAKE-UP REMOVERS, MAKE-UP POWDER, EAU DE COLOGNE, PERFUMES; TOOTHPASTE, PERSONAL DEODORANTS; ESSENTIAL OILS FOR PERSONAL USE; HAIR COLORANTS, HAIR SPRAY (U.S. CLS. 1, 4, 6, 50, 51 AND 52).

CLASS 9—ELECTRICAL AND SCIENTIFIC APPARATUS

FOR SPECTACLES AND EYEGLASSES, CASES FOR SPECTACLES AND EYEGLASSES; APPARATUS FOR RECORDING, TRANSMITTING AND REPRODUCTION OF SOUND OR IMAGES, NAMELY, CD PLAYERS; BLANK MAGNETIC DATA CARRIERS, PRERECORDED MAGNETIC DATA CARRIERS FEATURING MUSIC; BLANK AUDIO DISCS, COMPACT DISCS, VIDEO CASSETTE TAPES AND AUDIO CASSETTE TAPES; PRERECORDED AUDIO DISCS, COMPACT DISCS, VIDEO CASSETTE TAPES AND AUDIO CASSETTE TAPES FEATURING MUSIC (U.S. CLS. 21, 23, 26, 36 AND 38).

CLASS 14—JEWELRY

FOR PRECIOUS METALS AND THEIR ALLOYS, ARTICLES OF JEWELRY, PRECIOUS STONES, CLOCKS AND WATCHES; CHRONOMETRIC INSTRUMENTS, PRECIOUS METAL ASHTRAYS FOR SMOKERS (U.S. CLS. 2, 27, 28 AND 50).

CLASS 18—LEATHER GOODS

FOR LEATHER AND IMITATIONS OF LEATHER, AND GOODS MADE OF THESE MATERIALS NOT INCLUDED IN OTHER CLASSES, NAMELY, HANDBAGS, POUCHES, TRAVELING BAGS, LUGGAGE TRUNKS, RUCKSACKS, SACHELS, BRIEFCASES, SUITCASES, ATTACHE CASES; WALLETS, PURSES, DOCUMENT CASES, CHECK BOOK CASES, KEY HOLDERS; SMALL LEATHER POUCHES, EMPTY CASES FOR COSMETICS AND PERFUMES, TRAVELING CASES OF LEATHER, EMPTY MAKE-UP AND VANITY CASES; UMBRELLAS (U.S. CLS. 1, 2, 3, 22 AND 41).

CLASS 25—CLOTHING

FOR CLOTHING FOR MEN, LADIES AND CHILDREN, NAMELY, SUITS, SKIRTS, TROUSERS, SHIRTS, JACKETS, SWEATERS AND PULLOVERS, BOMBER JACKETS, COATS, OVERCOATS, RAINCOATS, RAINCOATS OF FUR, FUR COATS, FUR HATS, TRACK SUITS, WINDCHEATERS, SCARVES, HEADSCARVES, SHAWLS; NECKTIES, GLOVES, STOCKINGS, SOCKS; CLOTHING BELTS, BATHING COSTUMES AND BATHING TRUNKS, BEACH ROBES AND BEACHWEAR, BATHROBES, PAJAMAS AND DRESSING GOWNS, UNDERWEAR, BRASSIERES, VESTS, UNDERPANTS; HATS, SHOES, GYM SHOES, BOOTS, SANDALS, CLOGS AND SLIPPERS (U.S. CLS. 22 AND 39).

REBECCA GILBERT, EXAMINING ATTORNEY

SN 79-005,342. KORSCH AG, FED REP GERMANY, FILED 2-25-2004.

KORSCH

THE MARK CONSISTS OF STANDARD CHARACTERS WITHOUT CLAIM TO ANY PARTICULAR FONT, STYLE, SIZE, OR COLOR.

PRIORITY DATE OF 8-25-2003 IS CLAIMED.

OWNER OF INTERNATIONAL REGISTRATION 0833373 DATED 2-25-2004, EXPIRES 2-25-2014.

SEC. 2(F).

CLASS 7—MACHINERY

FOR MACHINES FOR THE PHARMACEUTICAL, CHEMICAL AND TECHNICAL INDUSTRY, NAMELY TABLETTING MACHINES, TABLET PRESSES AND INDUSTRIAL MACHINE PRESSES, MACHINES FOR THE POWDER AND GRANULES PROCESSING INDUSTRY, NAMELY TABLETTING MACHINES, TABLET PRESSES AND INDUSTRIAL MACHINE PRESSES, MACHINES FOR THE MANUFACTURING OF PRODUCTS MADE FROM POWDER AND GRANULES, NAMELY TABLETTING MACHINES, TABLET PRESSES AND INDUSTRIAL MACHINE PRESSES (U.S. CLS. 13, 19, 21, 23, 31, 34 AND 35).

CLASS 9—ELECTRICAL AND SCIENTIFIC APPARATUS

FOR SCIENTIFIC, WEIGHING AND MEASURING AND CONTROL DEVICES AND INSTRUMENTS, NAMELY SCALES, MATERIAL CHECKING INSTRUMENTS AND MACHINES FOR THE INSPECTION OF THE COMPOSITION OF TABLETS, DATA PROCESSING COMPUTER PROGRAMS AND COMPUTER DATABASES FOR OPERATING TABLETTING MACHINES, TABLET PRESSES, INDUSTRIAL MACHINE PRESSES, SCALES, LABORATORY PRESSES (U.S. CLS. 21, 23, 26, 36 AND 38).

SN 79-005,446. RED BULL GMBH, AUSTRIA, FILED 2-10-2004.

CLASS 37—CONSTRUCTION AND REPAIR

FOR INSTALLATION, MAINTENANCE AND REPAIR OF TABLETTING MACHINES, TABLET PRESSES, INDUSTRIAL MACHINE PRESSES, SCALES, LABORATORY PRESSES (U.S. CLS. 100, 103 AND 106).

CLASS 42—SCIENTIFIC, COMPUTER AND LEGAL SERVICES

FOR RESEARCH AND DEVELOPMENT IN THE SECTOR OF MACHINE CONSTRUCTION, NAMELY FOR TABLETTING MACHINES, TABLET PRESSES, INDUSTRIAL MACHINE PRESSES, SCALES, LABORATORY PRESSES AND AUTOMATIC PRODUCTION CENTERS FOR THE FABRICATION OF TABLETS, DEVELOPMENT OF PROGRAMS FOR THE DATA PROCESSING FOR THE CONTROL OF TABLETTING MACHINES, TABLET PRESSES, INDUSTRIAL MACHINE PRESSES, SCALES AND AUTOMATIC PRODUCTION CENTERS FOR THE FABRICATION OF TABLETS, SERVICES OF A COMPUTER DATABASE, FOR OTHERS, FOR OPERATING TABLETTING MACHINES, TABLET PRESSES, INDUSTRIAL MACHINE PRESSES, SCALES AND AUTOMATIC PRODUCTION CENTERS FOR THE FABRICATION OF TABLETS (U.S. CLS. 100 AND 101).

JACQUELINE A. LAVINE, EXAMINING ATTORNEY

CIRCLE OF BALANCE

THE MARK CONSISTS OF STANDARD CHARACTERS WITHOUT CLAIM TO ANY PARTICULAR FONT, STYLE, SIZE, OR COLOR.

PRIORITY DATE OF 11-3-2003 IS CLAIMED.

OWNER OF INTERNATIONAL REGISTRATION 0833545 DATED 2-10-2004, EXPIRES 2-10-2014.

SN 79-005,406. "S.A. LHOIST RECHERCHE ET; DEVELOPEMENT"; EN ABREGE "L.R.D."; SOCIÉTÉ ANONYME, BELGIUM, FILED 6-9-2004.

PROVIACAL

OWNER OF INTERNATIONAL REGISTRATION 0689784 DATED 2-17-1998, EXPIRES 2-17-2008.

CLASS 4—LUBRICANTS AND FUELS

FOR DUST ABSORBING AND BINDING PRODUCTS NAMELY DUST-BINDING COMPOSITIONS, PETROLEUM BASED DUST-ABSORBING COMPOSITIONS, FOR USE IN SOIL TREATMENT AND CIVIL ENGINEERING (U.S. CLS. 1, 6 AND 15).

CLASS 19—NON-METALLIC BUILDING MATERIALS

FOR NON-METALLIC BUILDING MATERIALS, IN PARTICULAR LIME (U.S. CLS. 1, 12, 33 AND 50).

JACQUELINE A. LAVINE, EXAMINING ATTORNEY

CLASS 25—CLOTHING

FOR FOOTWEAR, NAMELY, SPORTS SHOES AND BOOTS, FOOTBALL OR SOCCER BOOTS AND STUDS THEREFOR, SKI BOOTS; HEADGEAR, NAMELY, HATS, CAPS, HEADBANDS AND CAP PEAKS; CLOTHING, NAMELY, T-SHIRTS, LADIES' SHIRTS, SWEATERS, ANORAKS, WIND RESISTANT JACKETS, APRONS, SUSPENDERS, MONEY-BELTS; SPORTSWEAR, NAMELY, SHIRTS, PANTS, SWEAT SHIRTS AND SWEAT PANTS, SHORTS, BLOUSES, SKIRTS, JUMPERS, JACKETS AND COATS (U.S. CLS. 22 AND 39).

CLASS 28—TOYS AND SPORTING GOODS

FOR GAMES AND TOYS, NAMELY, PLAYING CARDS, DECKS OF CARDS, GADGETS FOR PLAYING JOKES AND PERFORMING CONJURING TRICKS, ELECTRIC AND ELECTRONIC GAMES NOT FOR USE WITH TELEVISIONS; SPORTING APPARATUS INCLUDING APPARATUS FOR WINTER SPORTS, NAMELY, SKIS, SNOWBOARDS, ICE SKATES AND SNOW BOOTS, SKI POLES, SKI EDGES, SOLE COVERINGS FOR SKIS, BINDINGS FOR SNOWBOARDS; SPECIAL BAGS FOR SPORTS GEAR, INCLUDING FOR SKIS, SURF BOARDS; BALLS FOR GAMES, NAMELY, GOLF BALLS AND SOCCER BALLS; INLINE ROLLER SKATES; NETS FOR BALL GAMES; PARAGLIDERS, HANG GLIDERS; SKATE BOARDS; SURF BOARDS; EXERCISE BOARDS; BODY BOARDS; SAIL BOARDS; MASTS FOR SURF BOARDS; ELBOW GUARDS AND KNEE GUARDS FOR SPORT USE; COIN-OPERATED GAMES OF CHANCE AND AMUSEMENT MACHINES (U.S. CLS. 22, 23, 38 AND 50).

CLASS 41—EDUCATION AND ENTERTAINMENT

FOR EDUCATIONAL SERVICES, NAMELY, PROVIDING, ARRANGING AND CONDUCTING SEMINARS, CLASSES, COURSES, CONFERENCES AND WORKSHOPS IN THE FIELD OF SPORTS, ATHLETIC COMPETITION, PHYSICAL FITNESS AND MUSICAL ENTERTAINMENT, AND TRAINING SERVICES IN THE FIELD OF SPORTS, ATHLETIC COMPETITION, PHYSICAL FITNESS AND MUSICAL ENTERTAINMENT; ORGANIZING, CONDUCTING AND PROVIDING FACILITIES FOR ATHLETIC COMPETITIONS, SPORTS EXHIBITION, ENTERTAINMENT EVENTS AND CONTESTS IN THE NATURE OF COMPETITIONS, RACES, EXHIBITIONS AND SKILLS-BASED EVENTS FOR AMATEUR AND/OR PROFESSIONAL ATHLETES; ORGANIZING AND CONDUCTING INDOOR AND OUTDOOR MUSICAL COMPETITIONS, BAND CONCERTS AND MUSIC FESTIVALS; ENTERTAINMENT SERVICES, NAMELY PROVIDING LIVE MUSICAL PERFORMANCES, TELEVISION PROGRAMS, CABLE TELEVISION PROGRAMS, VIDEO AND STILL PHOTO EXHIBITIONS AND WEBCAST TELEVISION OR VIDEO PROGRAMS VIA A GLOBAL COMPUTER NETWORK, ALL IN THE FIELD OF SPORTS, ATHLETIC COMPETITIONS, PHYSICAL FITNESS AND MUSICAL ENTERTAINMENT; VIDEO TAPE AND FILM PRODUCTION; VIDEOTAPING AND MICROFILMING FOR OTHERS; ONLINE PUBLICATION OF ELECTRONIC BOOKS AND JOURNALS IN THE FIELD OF SPORTS, ATHLETIC COMPETITION, PHYSICAL FITNESS AND MUSICAL ENTERTAINMENT; ENTERTAINMENT SERVICES, NAMELY, PROVIDING ON-LINE COMPUTER GAMES; DISC JOCKEYS FOR USE IN PROVIDING KARAOKE SERVICES AT PARTIES AND SPECIAL EVENTS; MUSIC COMPOSITION FOR OTHERS (U.S. CLS. 100, 101 AND 107).

MELVIN AXILBUND, EXAMINING ATTORNEY

SN 79-005,530. DR. RUDDA GMBH, AUSTRIA, FILED 6-30-2004.



PRIORITY DATE OF 1-15-2004 IS CLAIMED.
OWNER OF INTERNATIONAL REGISTRATION 0833786 DATED 6-30-2004, EXPIRES 6-30-2014.

NO CLAIM IS MADE TO THE EXCLUSIVE RIGHT TO USE WOODDESIGN, APART FROM THE MARK AS SHOWN.

THE COLOR(S) ORANGE, BLACK, RED, BEIGE AND GREEN IS/ARE CLAIMED AS A FEATURE OF THE MARK. THE WORD WOOD IS IN GREEN AND THERE IS A FANCIFUL DESIGN OF A TREE ABOVE THE LETTER D. THE WORD DESIGN IS IN ORANGE AND THE LETTER D IS SUPERIMPOSED OVER THE LETTER D IN WOOD.

THE WORDING TEKA CONSISTS OF THE COLORS ORANGE, BLACK, RED AND BEIGE ON VARIOUS PARTS OF THE INDIVIDUAL LETTERS. THE WORD WOOD IS IN GREEN AND THERE IS A FANCIFUL DESIGN OF A TREE ABOVE THE LETTER D. THE WORD DESIGN IS IN ORANGE AND THE LETTER D IS SUPERIMPOSED OVER THE LETTER D IN WOOD.

CLASS 19—NON-METALLIC BUILDING MATERIALS

FOR NON-METAL FLOORS, PARQUET WOOD FLOORING, WOOD PANELING, WINDOW FRAMES OF WOOD, PARTLY PROCESSED WOOD, NAMELY, SEMI-WORKED WOOD, DOORS OF WOOD (U.S. CLS. 1, 12, 33 AND 50).

CLASS 20—FURNITURE AND ARTICLES NOT OTHERWISE CLASSIFIED

FOR FURNITURE (U.S. CLS. 2, 13, 22, 25, 32 AND 50).
BARBARA BROWN, EXAMINING ATTORNEY

SN 79-005,624. POTEL ET CHABOT, SOCIÉTÉ ANONYME, FRANCE, FILED 4-6-2004.

POTEL CHABOT

PRIORITY DATE OF 10-13-2003 IS CLAIMED.
OWNER OF INTERNATIONAL REGISTRATION 0834045 DATED 4-6-2004, EXPIRES 4-6-2014.

OWNER OF U.S. REG. NOS. 1,252,657 AND 1,601,511.
THE ENGLISH TRANSLATION OF THE WORD CHABOT IS "BULL-HEAD" OR "CHUB".

CLASS 5—PHARMACEUTICALS

FOR DIETETIC SUBSTANCES ADAPTED FOR MEDICAL USE; BABY FOOD (U.S. CLS. 6, 18, 44, 46, 51 AND 52).

CLASS 29—MEATS AND PROCESSED FOODS

FOR MEAT, FISH, POULTRY AND GAME; MEAT EXTRACTS; PRESERVED, DRIED AND COOKED FRUITS AND VEGETABLES; JELLIES; JAMS; COMPOSITES; EGGS; MILK; CHEESE AND DAIRY PRODUCTS EXCLUDING ICE CREAM, ICE MILK AND FROZEN YOGURT; EDIBLE OILS AND FATS (U.S. CL. 46).

CLASS 30—STAPLE FOODS

FOR COFFEE; TEA; COCOA; SUGAR; RICE; TAPIOCA; SAGO AND ARTIFICIAL COFFEE; FLOURS; PREPARATIONS MADE FROM CEREALS, NAMELY, BREAKFAST CEREALS, READY TO EAT, CEREAL DERIVED FOOD BARS, CEREAL BASED FOOD; BREAD, PASTRY; CONFECTIONERY, NAMELY, CHOCOLATE AND CANDY; EDIBLE FLAVORED ICES; HONEY; TREACLE SYRUP; YEAST; BAKING-POWDER; SALT; MUSTARD; VINEGAR; SAUCES, SPICES; ICE FOR REFRESHMENT (U.S. CL. 46).

CLASS 31—NATURAL AGRICULTURAL PRODUCTS

FOR AGRICULTURAL, HORTICULTURAL AND FORESTRY PRODUCTS, NAMELY, UNPROCESSED GRAINS AND SEEDS; LIVE ANIMALS; FRESH FRUITS AND VEGETABLES; NATURAL SEEDS FOR FRUITS AND VEGETABLES; PLANTS; FLOWERS; ANIMAL FOODSTUFFS; MALT FOR BREWING AND DISTILLING AND MALT FOR FOOD PURPOSES (U.S. CLS. 1 AND 46).

CLASS 32—LIGHT BEVERAGES

FOR BEERS; MINERAL AND AERATED WATERS AND OTHER NON-ALCOHOLIC DRINKS, NAMELY, FRUIT FLAVORED BEVERAGES; FRUIT JUICES; SYRUPS AND OTHER PREPARATIONS FOR MAKING FRUIT DRINKS; SOFT DRINKS; CONCENTRATES USED IN THE PREPARATION OF SOFT DRINKS; ENERGY DRINKS; ESSENCES FOR USE IN MAKING SOFT DRINKS (U.S. CLS. 45, 46 AND 48).

CLASS 33—WINES AND SPIRITS

FOR ALCOHOLIC BEVERAGES, NAMELY ALCOHOLIC BEVERAGES PRODUCED FROM A BREWED MALT BASE WITH NATURAL FLAVORS; ALCOHOLIC BEVERAGES OF FRUITS; APERITIFS; CHAMPAGNE; DISTILLED SPIRITS; LIQUEURS; LIQUOR; PREPARED ALCOHOLIC COCKTAILS; WINES (U.S. CLS. 47 AND 49).

CLASS 41—EDUCATION AND ENTERTAINMENT

FOR PUBLICATION OF BOOKS; MOTION PICTURE PRODUCTION; ARRANGING COMPETITIONS IN THE FIELDS OF EDUCATION AND ENTERTAINMENT; EDUCATIONAL SERVICES, NAMELY, ARRANGING AND CONDUCTING EDUCATIONAL COLLOQUIUMS, CONFERENCES, CONGRESSES; ORGANIZING EDUCATIONAL AND CULTURAL EXHIBITIONS (U.S. CLS. 100, 101 AND 107).

CLASS 43—HOTEL AND RESTAURANT SERVICES

FOR RESTAURANT SERVICES, CATERING SERVICES, TEMPORARY ACCOMMODATION (U.S. CLS. 100 AND 101).

INGRID C. EULIN, EXAMINING ATTORNEY

SN 79-005,905. NETSUPPORT GMBH; NETZWERK - CONSULTING & SOFTWARE, FED REP GERMANY, FILED 5-24-2004.

enteo

THE MARK CONSISTS OF STANDARD CHARACTERS WITHOUT CLAIM TO ANY PARTICULAR FONT, STYLE, SIZE, OR COLOR.

PRIORITY DATE OF 11-24-2003 IS CLAIMED.

OWNER OF INTERNATIONAL REGISTRATION 0834830 DATED 5-24-2004, EXPIRES 5-24-2014.

CLASS 9—ELECTRICAL AND SCIENTIFIC APPARATUS

FOR SOFTWARE FOR USE IN THE FIELD OF FACILITY MANAGEMENT, NETWORK MANAGEMENT SERVICES OR DESKTOP COMPUTERS OR SERVER MANAGEMENT TO DEPLOY, MANAGE, UPDATE AND MAINTAIN COMPUTER SOFTWARE VIA LOCAL NETWORKS, WIDE AREA NETWORKS AND/OR GLOBAL COMPUTER NETWORKS (U.S. CLS. 21, 23, 26, 36 AND 38).

CLASS 35—ADVERTISING AND BUSINESS

FOR BUSINESS ORGANIZATIONAL PROJECT MANAGEMENT SERVICES FOR OTHERS IN ALL AREAS OF ELECTRONIC DATA PROCESSING (U.S. CLS. 100, 101 AND 102).

CLASS 41—EDUCATION AND ENTERTAINMENT

FOR TRAINING SERVICES IN THE FIELD OF NETWORK MANAGEMENT (U.S. CLS. 100, 101 AND 107).

CLASS 42—SCIENTIFIC, COMPUTER AND LEGAL SERVICES

FOR DESIGN AND DEVELOPMENT OF SOFTWARE FOR ALL TYPES OF NETWORK MONITORING, SUPERVISION AND CONTROL FOR OTHERS (U.S. CLS. 100 AND 101).

GEORGE LORENZO, EXAMINING ATTORNEY

SN 79-005,906. NETSUPPORT GMBH; NETZWERK - CONSULTING & SOFTWARE, FED REP GERMANY, FILED 5-24-2004.

solys

THE MARK CONSISTS OF STANDARD CHARACTERS WITHOUT CLAIM TO ANY PARTICULAR FONT, STYLE, SIZE, OR COLOR.

PRIORITY DATE OF 11-24-2003 IS CLAIMED.

OWNER OF INTERNATIONAL REGISTRATION 0834831 DATED 5-24-2004, EXPIRES 5-24-2014.

CLASS 9—ELECTRICAL AND SCIENTIFIC APPARATUS

FOR SOFTWARE FOR USE IN THE FIELD OF FACILITY MANAGEMENT, NETWORK MANAGEMENT SERVICES OR DESKTOP COMPUTERS OR SERVER MANAGEMENT TO DEPLOY, MANAGE, UPDATE AND MAINTAIN COMPUTER SOFTWARE VIA LOCAL NETWORKS, WIDE AREA NETWORKS AND/OR GLOBAL COMPUTER NETWORKS (U.S. CLS. 21, 23, 26, 36 AND 38).

CLASS 35—ADVERTISING AND BUSINESS

FOR BUSINESS ORGANIZATIONAL PROJECT MANAGEMENT SERVICES FOR OTHERS IN ALL AREAS OF ELECTRONIC DATA PROCESSING (U.S. CLS. 100, 101 AND 102).

CLASS 41—EDUCATION AND ENTERTAINMENT

FOR TRAINING SERVICES IN THE FIELD OF NETWORK MANAGEMENT (U.S. CLS. 100, 101 AND 107).

CLASS 42—SCIENTIFIC, COMPUTER AND LEGAL SERVICES

FOR DESIGN AND DEVELOPMENT OF SOFTWARE FOR ALL TYPES OF NETWORK MONITORING, SUPERVISION AND CONTROL FOR OTHERS (U.S. CLS. 100 AND 101).

GEORGE LORENZO, EXAMINING ATTORNEY

SN 79-005,907. NETSUPPORT GMBH; NETZWERK - CONSULTING & SOFTWARE, FED REP GERMANY, FILED 5-24-2004.

insotic

THE MARK CONSISTS OF STANDARD CHARACTERS WITHOUT CLAIM TO ANY PARTICULAR FONT, STYLE, SIZE, OR COLOR.

PRIORITY DATE OF 11-24-2003 IS CLAIMED.
OWNER OF INTERNATIONAL REGISTRATION 0834832 DATED 5-24-2004, EXPIRES 5-24-2014.

CLASS 9—ELECTRICAL AND SCIENTIFIC APPARATUS

FOR SOFTWARE FOR USE IN THE FIELD OF FACILITY MANAGEMENT, NETWORK MANAGEMENT SERVICES OR DESKTOP COMPUTERS OR SERVER MANAGEMENT TO DEPLOY, MANAGE, UPDATE AND MAINTAIN COMPUTER SOFTWARE VIA LOCAL NETWORKS, WIDE AREA NETWORKS AND/OR GLOBAL COMPUTER NETWORKS (U.S. CLS. 21, 23, 26, 36 AND 38).

CLASS 35—ADVERTISING AND BUSINESS

FOR BUSINESS ORGANIZATIONAL PROJECT MANAGEMENT SERVICES FOR OTHERS IN ALL AREAS OF ELECTRONIC DATA PROCESSING (U.S. CLS. 100, 101 AND 102).

CLASS 41—EDUCATION AND ENTERTAINMENT

FOR TRAINING SERVICES IN THE FIELD OF NETWORK MANAGEMENT (U.S. CLS. 100, 101 AND 107).

CLASS 42—SCIENTIFIC, COMPUTER AND LEGAL SERVICES

FOR DESIGN AND DEVELOPMENT OF SOFTWARE FOR ALL TYPES OF NETWORK MONITORING, SUPERVISION AND CONTROL FOR OTHERS (U.S. CLS. 100 AND 101).

GEORGE LORENZO, EXAMINING ATTORNEY

SN 79-005,943. KEITH PROWSE LIMITED, UNITED KINGDOM, FILED 5-15-2004.

INSIDE THE RINGS

THE MARK CONSISTS OF STANDARD CHARACTERS WITHOUT CLAIM TO ANY PARTICULAR FONT, STYLE, SIZE, OR COLOR.

OWNER OF INTERNATIONAL REGISTRATION 0834957 DATED 5-15-2004, EXPIRES 5-15-2014.

CLASS 16—PAPER GOODS AND PRINTED MATTER

FOR PRINTED MATTER, NAMELY ANSWER SHEETS FOR QUIZZES RELATED TO SPORT, AWARDS, CHARTS, EMBLEMS, FORMS, GUIDES FOR SPORTING OCCASIONS, INVITATIONS, LABELS NOT OF TEXTILE, MAIL RESPONSE CARDS RELATING TO SPORTS EVENTS AND SPORTING OCCASIONS, MUSIC BOOKS, PATTERNS, PLANS, RECIPES SOLD AS A COMPONENT OF FOOD PACKAGING, SEMINAR NOTES, SURVEY ANSWER SHEETS, TABLE TENTS, TABLES CONCERNING SPORTING INFORMATION, TIMETABLES AND TICKETS; PRINTED PUBLICATIONS, NAMELY MAGAZINES FEATURING SPORT, NEWSLETTERS FEATURING SPORT, BROCHURES FEATURING SPORT, DINING, ENTERTAINMENT AND ACCOMMODATION, MAPS, PRINTED MENUS, BROCHURES ABOUT SPORT EVENTS, SPORTS OCCASIONS, DINING, ENTERTAINMENT AND ACCOMMODATION, POSTERS, PRINTED CARDS, NAMELY, GREETING CARDS, SPORTS CARDS, TRIVIA CARDS; PHOTOGRAPHS, WRITING IMPLEMENTS (U.S. CLS. 2, 5, 22, 23, 29, 37, 38 AND 50).

CLASS 39—TRANSPORTATION AND STORAGE

FOR TRAVEL ARRANGEMENT AND TRANSPORTATION RESERVATION ARRANGEMENT; ARRANGING AND CONDUCTING TOURS (U.S. CLS. 100 AND 105).

CLASS 41—EDUCATION AND ENTERTAINMENT

FOR TICKETING SERVICES, NAMELY, ARRANGING FOR TICKET RESERVATION, BOOKING OF SEATS FOR SHOWS, BOOKING OF THEATER TICKETS, BOOKING OF TICKETS RELATING TO SPORTING EVENTS, PROVIDING WILL-CALL TICKET SERVICES, TICKET RESERVATION SERVICES AND TICKET INFORMATION SERVICES, ALL OF THE AFOREGOING RELATING TO ENTERTAINMENT, CONCERTS, SPORTING, CULTURAL, EDUCATIONAL, AND THEATRICAL EVENTS, ORGANIZATION AND CONDUCTING OF ENTERTAINMENT IN THE NATURE OF LIVE MUSIC, LIVE SPORTING EVENTS, CONCERTS, SPORTING EVENTS, CULTURAL EVENTS, EDUCATIONAL EVENTS AND THEATRICAL EVENTS (U.S. CLS. 100, 101 AND 107).

CLASS 43—HOTEL AND RESTAURANT SERVICES

FOR PROVISION OF FOOD AND DRINK AND TEMPORARY ACCOMMODATION; TEMPORARY ACCOMMODATION RESERVATION SERVICES (U.S. CLS. 100 AND 101).

BRENDAN REGAN, EXAMINING ATTORNEY

SN 79-005,995. PONTHER S.A., FRANCE, FILED 9-10-2004.

SN 79-006,038. ASEM; INDUSTRIEBERATUNG UND VERMITTLUNG GMBH, FED REP GERMANY, FILED 4-13-2004.



PONTHER
LE MEILLEUR DU FRUIT

PRIORITY DATE OF 4-7-2004 IS CLAIMED.
OWNER OF INTERNATIONAL REGISTRATION 0835099
DATED 9-10-2004, EXPIRES 9-10-2014.
OWNER OF U.S. REG. NO. 2,437,510.

NO CLAIM IS MADE TO THE EXCLUSIVE RIGHT TO USE LE MEILLEUR DU FRUIT, APART FROM THE MARK AS SHOWN.

THE COLOR(S) DARK GREEN, RED, LIGHT GREEN AND PURPLE IS/ARE CLAIMED AS A FEATURE OF THE MARK.

THE COLORS CLAIMED AS A FEATURE OF THE MARK ARE DARK GREEN, RED, LIGHT GREEN AND PURPLE, WITH THE QUADRILATERAL DARK GREEN, THE FRUIT IS RED WITH A LIGHT GREEN LEAF, AND THE VERTICAL LINE IS IN PURPLE.

THE ENGLISH TRANSLATION OF LE MEILLEUR DU FRUIT IS THE BEST OF FRUIT.

CLASS 29—MEATS AND PROCESSED FOODS

FOR MEAT, FISH, POULTRY AND GAME; CAVIAR, SHELLFISH THAT IS NOT LIVE; CHARCUTERIE, PREPARED MEAT-BASED DISHES, PREPARED FISH-BASED DISHES; MEAT EXTRACTS; PRESERVED, DRIED AND COOKED FRUIT AND VEGETABLES, FRUIT AND VEGETABLE SALADS; POTATO CHIPS; SOUPS; JELLIES, JAMS, COMPOTES; FRUIT PRESERVED IN ALCOHOL; EGGS, MILK AND DAIRY PRODUCTS, NAMELY YOGURT; EDIBLE OILS AND FATS (U.S. CL. 46).

CLASS 31—NATURAL AGRICULTURAL PRODUCTS

FOR FRESH FRUIT AND VEGETABLES (U.S. CLS. 1 AND 46).

CLASS 32—LIGHT BEVERAGES

FOR BEERS; MINERAL AND AERATED WATERS AND OTHER NON-ALCOHOLIC DRINKS, NAMELY, SPORTS DRINKS; FRUIT DRINKS AND FRUIT JUICES; SYRUPS AND OTHER PREPARATIONS IN THE NATURE OF CONCENTRATES FOR MAKING NON-ALCOHOLIC COCKTAILS, NON-ALCOHOLIC FRUIT EXTRACTS, FRUIT JUICES, LEMONADES, FRUIT NECTARS (U.S. CLS. 45, 46 AND 48).

TANYA AMOS, EXAMINING ATTORNEY

WELLNESSA

THE MARK CONSISTS OF STANDARD CHARACTERS WITHOUT CLAIM TO ANY PARTICULAR FONT, STYLE, SIZE, OR COLOR.

PRIORITY DATE OF 10-13-2003 IS CLAIMED.
OWNER OF INTERNATIONAL REGISTRATION 0835224
DATED 4-13-2004, EXPIRES 4-13-2014.

CLASS 11—ENVIRONMENTAL CONTROL APPARATUS

FOR PLUMBING PRODUCTS AND FIXTURES NAMELY, TOILETS, BIDETS, BATHROOM SINKS, TOILET SEATS, BATHTUBS, WHIRLPOOLS, HOT TUBS, SHOWER STANDS, SHOWER PLATFORMS, SHOWER ENCLOSURES, STEAM SHOWERS, SHOWER ENCLOSURE PANELS, SHOWER COMPONENTS, NAMELY, SHOWER DOORS, SHOWER HEADS, SHOWER HEAD SPRAYERS, HAND HELD SHOWER HEADS (U.S. CLS. 13, 21, 23, 31 AND 34).

CLASS 20—FURNITURE AND ARTICLES NOT OTHERWISE CLASSIFIED

FOR FURNITURE, MIRRORS, PICTURE FRAMES, BATHROOM AND SHOWER MIRRORS, BATH TUB GRAB BAR NOT MADE OF METAL AND BATHROOM VANITIES (U.S. CLS. 2, 13, 22, 25, 32 AND 50).

LESLEY LAMOTHE, EXAMINING ATTORNEY

SN 79-006,048. FRANZ SACHS GMBH & CO. KG, FED REP GERMANY, FILED 8-9-2004.

frasaco

OWNER OF INTERNATIONAL REGISTRATION 0486923
DATED 3-2-1984, EXPIRES 3-2-2014.
OWNER OF U.S. REG. NO. 1,386,597.

CLASS 10—MEDICAL APPARATUS

FOR ARTICLES FOR DENTAL USE, NAMELY SPOONS FOR IMPRESSIONS, SPECIAL HOUSINGS FOR DENTAL PROSTHESES, FILLING INSTRUMENTS, HINGES, ATTACHMENTS, CAPS, CROWNS, MODELING STRIPS, STRUCTURE AND RETENTION RINGS, SYRINGES, DROPPERS, CAST METAL PINS, BASE FORMERS, SPATULAS AND SEPARATION PLATES; ORTHOPAEDIC SOLES FOR SHOES (U.S. CLS. 26, 39 AND 44).

CLASS 16—PAPER GOODS AND PRINTED MATTER

FOR MODELS FOR TEACHING AND DEMONSTRATION FOR DENTAL USE, AS WELL AS MODELS OF TEETH FOR TEACHING AND DEMONSTRATION; MODEL HEADS FOR TEACHING AND DEMONSTRATION FOR DENTAL USE (U.S. CLS. 2, 5, 22, 23, 29, 37, 38 AND 50).

CHERYL CLAYTON, EXAMINING ATTORNEY

SN 79-006,085. THE WHITE COMPANY (UK) LIMITED, UNITED KINGDOM, FILED 6-14-2004.

THE WHITE COMPANY

THE MARK CONSISTS OF STANDARD CHARACTERS WITHOUT CLAIM TO ANY PARTICULAR FONT, STYLE, SIZE, OR COLOR.

OWNER OF INTERNATIONAL REGISTRATION 0835262 DATED 6-14-2004, EXPIRES 6-14-2014.

NO CLAIM IS MADE TO THE EXCLUSIVE RIGHT TO USE COMPANY, APART FROM THE MARK AS SHOWN.

CLASS 3—COSMETICS AND CLEANING PREPARATIONS

FOR SOAPS; PERFUMERY; ESSENTIAL OILS FOR PERSONAL USE AND FOR SCENTING ARTICLES AND OBJECTS; COSMETICS, AND NON-MEDICATED TOILETRIES; INCENSE (U.S. CLS. 1, 4, 6, 50, 51 AND 52).

CLASS 4—LUBRICANTS AND FUELS

FOR CANDLES; LAMP WICKS AND LAMP OIL (U.S. CLS. 1, 6 AND 15).

CLASS 8—HAND TOOLS

FOR HAND TOOLS AND IMPLEMENTS, NAMELY, SHOVELS, TROWELS, GARDENING FORKS, GARDENING CULTIVATORS, LAWN EDGERS; CUTLERY; RAZORS (U.S. CLS. 23, 28 AND 44).

CLASS 14—JEWELRY

FOR NAPKIN RINGS OF PRECIOUS METAL; PRECIOUS STONES; HOROLOGICAL AND CHRONOMETRIC INSTRUMENTS (U.S. CLS. 2, 27, 28 AND 50).

CLASS 16—PAPER GOODS AND PRINTED MATTER

FOR WRITING PAPER; PHOTOGRAPHS; STATIONERY; CATALOGUES IN THE FIELD OF GENERAL HOUSEWARES, GIFTWARE, FURNITURE, BEDDING AND BED LINENS, TABLE LINENS, AND APPAREL; CALENDARS; PAPER ORGANIZATIONAL SHELF LABELS AND TAGS; PACKAGING MATERIALS, NAMELY, CARDBOARD GIFT BOXES AND STORAGE BOXES (U.S. CLS. 2, 5, 22, 23, 29, 37, 38 AND 50).

CLASS 18—LEATHER GOODS

FOR LEATHER AND IMITATIONS OF LEATHER, AND GOODS MADE OF THESE MATERIALS AND NOT INCLUDED IN OTHER CLASSES, NAMELY, PURSES, LUGGAGE TRUNKS, STORAGE TRUNKS AND TRAVELING BAGS; UMBRELLAS, PARASOLS AND WALKING STICKS (U.S. CLS. 1, 2, 3, 22 AND 41).

CLASS 21—HOUSEWARES AND GLASS

FOR HOUSEHOLD AND KITCHEN UTENSILS, NAMELY, CONTAINERS FOR HOUSEHOLD AND KITCHEN USE NOT MADE OF PRECIOUS METAL; COMBS; BATH SPONGES; HAIR AND BATH BRUSHES; UN-WORKED OR SEMI-WORKED GLASS NOT FOR BUILDING; BEVERAGE GLASSWARE, PORCELAIN AND EARTHENWARE DISHES, PLATTERS, JUGS, PITCHERS, BOWLS, CUPS, SAUCERS, AND MUGS; CROCKERY DISHES, PLATTERS, JUGS, PITCHERS, BOWLS, CUPS, SAUCERS, AND MUGS (U.S. CLS. 2, 13, 23, 29, 30, 33, 40 AND 50).

CLASS 24—FABRICS

FOR TEXTILES AND TEXTILE GOODS, NAMELY, BED SHEETS, TEXTILE TABLE CLOTHS, BATH TOWELS, HAND TOWELS, BED BLANKETS, DUVETS, BEDSPREADS, CUSHION COVERS, MATTRESS PADS, MATTRESS COVERS, BED BLANKET INCORPORATING A PROTECTIVE IMPERMEABLE LAYER; CURTAINS; LAP RUGS; TEXTILE WALL HANGINGS (U.S. CLS. 42 AND 50).

CLASS 25—CLOTHING

FOR CLOTHING, NAMELY, SHIRTS, PANTS, SKIRTS, SWEATERS, BATH ROBES, AND SLIPPERS; FOOTWEAR; HEADGEAR, NAMELY, HATS, CAPS, HEADWEAR (U.S. CLS. 22 AND 39).

CLASS 27—FLOOR COVERINGS

FOR CARPETS, RUGS, MATS AND MATTING FOR COVERING EXISTING FLOORS; NON-TEXTILE WALL HANGINGS (U.S. CLS. 19, 20, 37, 42 AND 50).

CLASS 28—TOYS AND SPORTING GOODS

FOR GAMES AND PLAYTHINGS, NAMELY, BOARD GAMES, SPINNING TOPS, CUP AND BALL, JUGGLING EQUIPMENT; DECORATIONS FOR CHRISTMAS TREES; SOFT SCULPTURE AND PLUSH TOYS; STUFFED ANIMALS (U.S. CLS. 22, 23, 38 AND 50).

CLASS 35—ADVERTISING AND BUSINESS

FOR GENERAL BUSINESS MERCHANDISING SERVICES, NAMELY, MARKETING; THE BRINGING TOGETHER, FOR THE BENEFIT OF OTHERS, OF A VARIETY OF GOODS, ENABLING CUSTOMERS TO CONVENIENTLY VIEW AND PURCHASE THOSE GOODS IN A DEPARTMENT STORE, EXCLUDING FURNITURE AND GOODS RELATED TO FURNITURE; THE BRINGING TOGETHER, FOR THE BENEFIT OF OTHERS, OF A VARIETY OF GOODS, ENABLING CUSTOMERS TO CONVENIENTLY VIEW AND PURCHASE THOSE GOODS FROM A HOUSEHOLD, CLOTHING AND ACCESSORIES CATALOGUE BY MAIL ORDER, BY AN INTERNET WEBSITE, OR BY MEANS OF TELECOMMUNICATIONS, EXCLUDING FURNITURE AND GOODS RELATED TO FURNITURE; THE BRINGING TOGETHER, FOR THE BENEFIT OF OTHERS, OF A VARIETY OF GOODS, EXCLUDING FURNITURE AND GOODS RELATED TO FURNITURE, ENABLING CUSTOMERS TO CONVENIENTLY VIEW AND PURCHASE THOSE GOODS FROM A GENERAL MERCHANDISE INTERNET WEB SITE OR FROM A CATALOGUE; THE BRINGING TOGETHER, FOR THE BENEFIT OF OTHERS, OF A VARIETY OF GOODS NAMELY TOILETRIES AND COSMETICS, CANDLES AND INCENSE, HAND TOOLS AND IMPLEMENTS, CUTLERY AND RAZORS, GOODS OF PRECIOUS METALS AND THEIR ALLOYS, NAPKIN RINGS OF PRECIOUS METAL, JEWELRY AND PRECIOUS STONES, HOROLOGICAL AND CHRONOMETRIC INSTRUMENTS, WRITING PAPER, PHOTOGRAPHS, STATIONERY, LEATHER AND IMITATION LEATHER PURSES, TRAVELING TRUNKS AND TRAVELING BAGS, UMBRELLAS, HOUSEHOLD AND KITCHEN UTENSILS AND CONTAINERS, COMBS AND SPONGES, BRUSHES, GOODS OF UNWORKED OR SEMI-WORKED GLASS OTHER THAN FURNITURE, BEVERAGE GLASSWARE, PORCELAIN AND EARTHENWARE DISHES, PLAT-

TERS, JUGS, PITCHERS, BOWLS, CUPS, SAUCERS, AND MUGS; CROCKERY, BED SHEETS, TEXTILE TABLE CLOTHS, BATH TOWELS, HAND TOWELS, BED BLANKETS, DUVETS, BEDSPREADS, CUSHION COVERS, MATTRESS PADS, MATTRESS COVERS, BED BLANKETS INCORPORATING A PROTECTIVE IMPERMEABLE LAYER, AND TABLE WARE, CURTAINS AND RUGS, CLOTHING, FOOTWEAR, HEADGEAR, CARPETS, TRAVELING RUGS, MATS AND MATTING, NON-TEXTILE WALL HANGINGS, GAMES AND PLAY-THINGS, DECORATIONS FOR CHRISTMAS TREES, SOFT TOYS, ENABLING CUSTOMERS TO CONVENIENTLY VIEW AND PURCHASE THOSE GOODS FROM A CATALOGUE BY MAIL ORDER, BY AN INTERNET WEBSITE, OR BY MEANS OF TELECOMMUNICATIONS (U.S. CLS. 100, 101 AND 102).

CLASS 39—TRANSPORTATION AND STORAGE

FOR WRAPPING SERVICES FOR BAGGAGE PROTECTION DURING SHIPPING; PACKAGING GOODS FOR TRANSPORTATION, STORAGE OF GOODS IN GENERAL, AND DELIVERY OF GOODS BY TRUCK, AIR (U.S. CLS. 100 AND 105).

CLASS 45—PERSONAL SERVICES

FOR WEDDING GIFT LIST REGISTRY SERVICES AND GIFT LIST REGISTRY SERVICES (U.S. CLS. 100 AND 101).

REBECCA GILBERT, EXAMINING ATTORNEY

SN 79-006,095. AFE TECHNOLOGIES, FRANCE, FILED 6-4-2004.

CRONITE

PRIORITY DATE OF 12-10-2003 IS CLAIMED.
OWNER OF INTERNATIONAL REGISTRATION 0835290
DATED 6-4-2004, EXPIRES 6-4-2014.

CLASS 6—METAL GOODS

FOR DUCTILE IRON AND IRON SOLD IN BULK; ALLOYS USED FOR CASTING; CAST AND FORGED STEEL SOLD IN BULK; NICKEL AND NICKEL ALLOYS SOLD IN BULK; BUILDING GIRDERS, JOISTS AND BUILDING FRAMING MADE FROM STEEL; TRANSPORTABLE BUILDINGS OF METAL; RAILROAD TRACKS MADE FROM METAL; NON-ELECTRIC METALLIC CABLES AND WIRES; METAL LOCKS AND KEYS THEREFOR; METAL PIPES; METAL SAFES; IRON ORES; FOUNDRY MOLDS AND CASTING FORMS OF METAL; WROUGHT IRON, SEMI-WROUGHT IRON; FOUNDRY SCREENS FOR CONTROLLING GRAIN SIZES OF MOLD SAND. (U.S. CLS. 2, 12, 13, 14, 23, 25 AND 50).

CLASS 11—ENVIRONMENTAL CONTROL APPARATUS

FOR ELECTRIC LIGHTING FIXTURES; STEAM GENERATORS AND STEAM VALVES; WATER CONDITIONING UNITS; WASTE WATER PURIFICATION UNITS; SEWAGE DISPOSAL PLANTS; WASTE RECOVERY SYSTEMS; INCINERATORS FOR DOMESTIC REFUSE; FURNACES, OTHER THAN FOR EXPERIMENTAL PURPOSES; LOADING APPARATUS FOR FURNACES; STRUCTURAL PLATES FOR OVENS, OVEN CONVEYOR BELTS SOLD AS COMPONENTS FOR OVENS; WATER COOLING TUBS; KILNS; INCINERATION BARS AND ELECTRICALLY HEATED CONVEYOR BELTS SOLD AS COMPONENTS FOR INCINERATORS. (U.S. CLS. 13, 21, 23, 31 AND 34).

CLASS 40—MATERIAL TREATMENT

FOR RESOURCE RECOVERY OF INDUSTRIAL CO-PRODUCTS AND BYPRODUCTS CONTAINING METALS; WASTE TREATMENT AND RECOVERY; BATTERY RECYCLING. (U.S. CLS. 100, 103 AND 106).
SCOTT OSCLICK, EXAMINING ATTORNEY

SN 79-006,114. NAVITIME JAPAN CO., LTD., JAPAN, FILED 5-12-2004.

MULTIMODAL NAVI

THE MARK CONSISTS OF STANDARD CHARACTERS WITHOUT CLAIM TO ANY PARTICULAR FONT, STYLE, SIZE, OR COLOR.

PRIORITY DATE OF 4-22-2004 IS CLAIMED.
OWNER OF INTERNATIONAL REGISTRATION 0835359
DATED 5-12-2004, EXPIRES 5-12-2014.

NO CLAIM IS MADE TO THE EXCLUSIVE RIGHT TO USE "MULTIMODAL", APART FROM THE MARK AS SHOWN.

CLASS 9—ELECTRICAL AND SCIENTIFIC APPARATUS

FOR COMPUTER PROGRAMS, NAMELY NAVIGATION, ROUTE SEARCH AND MAP DRAWING PROGRAMS; RADIOTELEPHONY SETS, PERSONAL DIGITAL ASSISTANTS (PDAS), TELEPHONE RECEIVERS, MOBILE TERMINALS FOR TELECOMMUNICATIONS (U.S. CLS. 21, 23, 26, 36 AND 38).

CLASS 39—TRANSPORTATION AND STORAGE

FOR PROVIDING ROAD AND TRAFFIC INFORMATION, PROVIDING INFORMATION ABOUT VEHICLE TRAFFIC ROUTES, PROVIDING INFORMATION ABOUT WALKING ROUTES, FLIGHT SCHEDULE INFORMATION, TRAIN DIAGRAM INFORMATION AND PROVIDING INFORMATION ABOUT PUBLIC TRANSPORTATION SERVICES (U.S. CLS. 100 AND 105).

CLASS 42—SCIENTIFIC, COMPUTER AND LEGAL SERVICES

FOR PROVIDING ON-LINE NON-DOWNLOADABLE COMPUTER PROGRAMS FOR MAPPING ROUTE AND NAVIGATION SERVICES (U.S. CLS. 100 AND 101).
CHERYL CLAYTON, EXAMINING ATTORNEY

SN 79-006,260. FRITONEX AG, SWITZERLAND, FILED 8-8-2004.

QuickZap

THE MARK CONSISTS OF STANDARD CHARACTERS WITHOUT CLAIM TO ANY PARTICULAR FONT, STYLE, SIZE, OR COLOR.

OWNER OF INTERNATIONAL REGISTRATION 0815190
DATED 6-30-2003, EXPIRES 6-30-2013.

CLASS 9—ELECTRICAL AND SCIENTIFIC APPARATUS

FOR ELECTRIC TENS THERAPY APPARATUS IN THE NATURE OF A POWER SOURCE, A CONTROLLER, CABLES, CONTACT SURFACES AND/OR ELECTRODES, FOR BALANCING BODY ENERGY AND FOR RENDERING BACTERIA, VIRUSES AND PARASITES HARMLESS, ALL FOR NON-MEDICAL USE (U.S. CLS. 21, 23, 26, 36 AND 38).

CLASS 10—MEDICAL APPARATUS

FOR ELECTRIC TENS THERAPY APPARATUS IN THE NATURE OF A POWER SOURCE, A CONTROLLER, CABLES, CONTACT SURFACES AND/OR ELECTRODES, FOR BALANCING BODY ENERGY AND FOR RENDERING BACTERIA, VIRUSES AND PARASITES HARMLESS, ALL FOR MEDICAL OR VETERINARY USE (U.S. CLS. 26, 39 AND 44).

CLASS 41—EDUCATION AND ENTERTAINMENT

FOR ARRANGING AND CONDUCTING EDUCATIONAL CONFERENCES, EXHIBITIONS AND SEMINARS IN THE FIELD OF SANITARY CARE, BODY CARE AND NATURAL MEDICINE; ORGANIZING PROFESSIONAL TRAINING CONFERENCES AND SYMPOSIA IN THE FIELD OF MEDICAL SCIENCE REGARDING SANITARY CARE, BODY CARE AND NATURAL MEDICINE; AND ARRANGING PROFESSIONAL MEDICAL WORKSHOPS AND TRAINING COURSES IN THE FIELD OF SANITARY CARE, BODY CARE AND NATURAL MEDICINE (U.S. CLS. 100, 101 AND 107).

MATTHEW PAPPAS, EXAMINING ATTORNEY

SN 79-006,276. ZAKLAD PRODUKCYJNO-HANDLOWY; "LITEX" STANISLAW LITWIN, POLAND, FILED 6-8-2004.



OWNER OF INTERNATIONAL REGISTRATION 0835846 DATED 6-8-2004, EXPIRES 6-8-2014.

NO CLAIM IS MADE TO THE EXCLUSIVE RIGHT TO USE PRODUCENT, APART FROM THE MARK AS SHOWN.

THE COLORS YELLOW AND BLUE ARE CLAIMED AS A FEATURE OF THE MARK.

THE MARK CONSISTS OF AN UMBRELLA WHICH SHADES TWO OVALS. THE UMBRELLA APPEARS IN YELLOW AND BLUE. THE OUTER OVAL APPEARS IN YELLOW. THE INNER OVAL APPEARS IN BLUE. THE LETTERING LITEX IS SUPERIMPOSED IN THE MIDDLE OF THE INNER OVAL AND APPEARS IN YELLOW. THE WORD PRODUCENT APPEARS IN BLUE AND IS SUPERIMPOSED OVER THE LOWER PORTION OF THE OUTER YELLOW OVAL.

THE ENGLISH TRANSLATION OF THE WORD PRODUCENT IN THE MARK IS PRODUCER.

CLASS 18—LEATHER GOODS

FOR ADVERTISING UMBRELLAS, CAFÉ UMBRELLAS, GARDEN UMBRELLAS (U.S. CLS. 1, 2, 3, 22 AND 41).

CLASS 24—FABRICS

FOR CLOTH FLAGS, CLOTH ADVERTISING FLAGS, CLOTH ENSIGNS, PLASTIC MATERIAL AND CLOTH BANNERS, TEXTILE TABLECLOTHS (U.S. CLS. 42 AND 50).

CLASS 40—MATERIAL TREATMENT

FOR PRINTING SERVICES IN THE FIELD OF MAKING OVER-SIZED PRINTS FOR ADVERTISING, PRINTING OF VISUAL OUTDOOR ADVERTISEMENTS (U.S. CLS. 100, 103 AND 106).

PAULA MAHONEY, EXAMINING ATTORNEY

SN 79-006,374. GAVINA FLAVIA, I-20121 MILANO (MI), ITALY, FILED 5-12-2004.

GAVINA

THE MARK CONSISTS OF STANDARD CHARACTERS WITHOUT CLAIM TO ANY PARTICULAR FONT, STYLE, SIZE, OR COLOR.

OWNER OF INTERNATIONAL REGISTRATION 0836213 DATED 5-12-2004, EXPIRES 5-12-2014.

CLASS 3—COSMETICS AND CLEANING PREPARATIONS

FOR COSMETIC PREPARATIONS, CREAMS, POMADES, SOAPS, CLEANING PREPARATIONS, OILS AND LOTIONS ALL BEING FOR THE CARE OF THE SKIN, THE FACE, THE BODY AND THE HAIR, ESSENTIAL OILS FOR PERSONAL USE, PERFUMERY, PERFUMES, EAU DE TOILETTE, PERSONAL DEODORANTS (U.S. CLS. 1, 4, 6, 50, 51 AND 52).

CLASS 18—LEATHER GOODS

FOR HANDBAGS, TRAVELING BAGS, SUITCASES, TRUNKS, PURSES, WALLETS, LEATHER CASES FOR CARDS, FOR PAPERS, AND FOR KEYS, UMBRELLAS (U.S. CLS. 1, 2, 3, 22 AND 41).

CLASS 25—CLOTHING

FOR FEMALE FORMAL CLOTHING, NAMELY HATS, SCARVES, SHIRTS, WAISTCOATS, CARDIGANS, OVERCOATS, DRESSES, SKIRTS, STOCKINGS, BOOTS, SHOES, GLOVES, AND BELTS (U.S. CLS. 22 AND 39).

JENNIFER CHICOSKI, EXAMINING ATTORNEY

SN 79-006,640. TYCHE PORCELLANE D'ARTE; DI PEREGO FRANCO, ITALY, FILED 3-31-2004.



PRIORITY DATE OF 12-24-2003 IS CLAIMED.
OWNER OF INTERNATIONAL REGISTRATION 0836928 DATED 3-31-2004, EXPIRES 3-31-2014.

THE TRADEMARK CONSISTS IN THE WORD TICHE IN PARTICULAR SCRIPT LOCATED IN THE MIDDLE AND CROSSED BY TWO OBLIQUE SEGMENTS JOINING UNDERNEATH THE SAID WORD AND INTERRUPTED AT ITS HEIGHT; ABOVE THE WORD TICHE, INCLUDED IN TWO SEGMENTS, THERE IS THE FANCY PICTURE OF A CROWN, NAMELY OF TWO PARALLEL SEMI-CIRCULAR SEGMENTS AND THERE ABOVE THERE ARE FIVE SIGNS OF BRUSH-STROKES.

CLASS 14—JEWELRY

FOR CANDLESTICKS OF PRECIOUS METAL; CLOCKS; DECORATIVE BOXES MADE OF PRECIOUS METAL; FIGURES OF PRECIOUS METAL; FIGURINES OF PRECIOUS METAL; FLOWER BOWLS OF PRECIOUS METAL; NON-ELECTRIC CANDELABRAS MADE OF PRECIOUS METAL; PARTS OF CLOCK; POTPOURRI DISHES MADE IN WHOLE OR IN PART OF PRECIOUS METAL; STATUES OF PRECIOUS METAL; STATUETTES OF PRECIOUS METAL; VASES OF PRECIOUS METAL; ALARM CLOCKS (U.S. CLS. 2, 27, 28 AND 50).

CLASS 20—FURNITURE AND ARTICLES NOT OTHERWISE CLASSIFIED

FOR FURNITURE; FURNITURE PARTS, NAMELY TABLE LEAVES; JEWELRY BOXES NOT OF METAL; JEWELRY CASES NOT OF PRECIOUS METAL; MIRRORS; MIRRORS FRAMES; NON-METAL BOXES; NON-METAL TROPHY COLUMNS; STATUES OF IVORY, BONE, PLASTER, PLASTIC, WAX, WOOD; STATUETTES OF IVORY, BONE, PLASTER, PLASTIC, WAX, WOOD; TABLES; DECORATIVE MOBILES; PEDESTALS (U.S. CLS. 2, 13, 22, 25, 32 AND 50).

CLASS 21—HOUSEWARES AND GLASS

FOR NON-ELECTRIC CANDELABRA, NOT OF PRECIOUS METAL; DECORATIVE BOXES MADE OF PORCELAIN; PORCELAIN BOXES; BOWLS; PORCELAIN BUSTS; CANDLE HOLDERS NOT OF PRECIOUS METAL; CANDLESTICKS NOT OF PRECIOUS METAL; CHINA ORNAMENTS; COFFEE CUPS; COFFEE POTS NOT OF PRECIOUS METAL; COFFEE SERVICES NOT OF PRECIOUS METAL; COMMEMORATIVE PLATES OF PORCELAIN; CUPS; DECORATIVE PLATES OF PORCELAIN; DESKTOP STATUARY MADE OF PORCELAIN; EPERGNES; PORCELAIN FIGURES; PORCELAIN FIGURINES; HOLIDAY ORNAMENTS OF PORCELAIN; MEAL TRAYS; PORCELAIN ORNAMENTS; PLATES; PORCELAIN EGGS; POTS; PORCELAIN MUGS; PORCELAIN SCULPTURES; SOUP TUREENS; PORCELAIN STATUES; PORCELAIN STATUETTES; VASES; PORCELAIN VASES; TEA SERVICES; TEA SETS (U.S. CLS. 2, 13, 23, 29, 30, 33, 40 AND 50).

ANDREA SAUNDERS, EXAMINING ATTORNEY

SN 79-006,815. OXBOW INTERNATIONAL, FRANCE, FILED 8-5-2004.

OXBOW

THE MARK CONSISTS OF STANDARD CHARACTERS WITHOUT CLAIM TO ANY PARTICULAR FONT, STYLE, SIZE, OR COLOR.

OWNER OF INTERNATIONAL REGISTRATION 0837386 DATED 8-5-2004, EXPIRES 8-5-2014.

OWNER OF U.S. REG. NOS. 1,535,373, 1,733,271 AND 2,349,528.

CLASS 20—FURNITURE AND ARTICLES NOT OTHERWISE CLASSIFIED

FOR FURNITURE, NAMELY, SHELVES, CUPBOARDS, OFFICE FURNITURE, CHAIRS, SHELVES AS SELLING DISPLAYS FOR RETAIL STORES (U.S. CLS. 2, 13, 22, 25, 32 AND 50).

CLASS 24—FABRICS

FOR TEXTILES AND TEXTILE GOODS, NOT INCLUDED IN OTHER CLASSES, NAMELY, HOUSEHOLD LINENS, TABLE CLOTHS, BED SHEETS, TOWELS AND FACE TOWELS, BEACH TOWELS (U.S. CLS. 42 AND 50).

CLASS 25—CLOTHING

FOR CLOTHING, NAMELY, SHIRTS, POLO SHIRTS, SHORTS, TEE-SHIRTS, SWEATERS, SWEATSHIRTS, JUMPERS, JACKETS, PARKAS, PANTS, SKIRTS, DRESSES, SOCKS, GLOVES, DRESSING GOWNS, PAROS, BATH ROBES, BATHING SUITS, SCARVES, BANDANAS, NECKERCHIEFS; FOOTWEAR, NAMELY SPORT SHOES AND SNOWBOARDING SHOES; HEADGEAR, NAMELY, HATS, CAPS (U.S. CLS. 22 AND 39).

CLASS 35—ADVERTISING AND BUSINESS

FOR ADVERTISING AGENCY SERVICES IN THE FIELD OF SPORTS, SPORTING EVENTS, SPORTING COMPETITIONS; BUSINESS CONSULTATION SERVICES IN THE FIELD OF SPORTS, SPORTING EVENTS, SPORTING COMPETITIONS (U.S. CLS. 100, 101 AND 102).

CLASS 36—INSURANCE AND FINANCIAL

FOR FINANCIAL SERVICES, NAMELY, INVESTMENT IN THE FIELDS OF REAL ESTATE, SPORTS, SPORTING EVENTS AND SPORTING COMPETITIONS (U.S. CLS. 100, 101 AND 102).

ANN LINNEHAN, EXAMINING ATTORNEY

SN 79-006,827. BAYERISCHE MOTOREN WERKE AKTIENGESELLSCHAFT, FED REP GERMANY, FILED 8-12-2004.

100EX

THE MARK CONSISTS OF STANDARD CHARACTERS WITHOUT CLAIM TO ANY PARTICULAR FONT, STYLE, SIZE, OR COLOR.

PRIORITY DATE OF 2-17-2004 IS CLAIMED.
OWNER OF INTERNATIONAL REGISTRATION 0837415 DATED 8-12-2004, EXPIRES 8-12-2014.

CLASS 12—VEHICLES

FOR AUTOMOBILES AND STRUCTURAL PARTS THEREFOR (U.S. CLS. 19, 21, 23, 31, 35 AND 44).

CLASS 16—PAPER GOODS AND PRINTED MATTER

FOR MANUALS AND USER INSTRUCTION MANUALS IN THE AUTOMOTIVE FIELD (U.S. CLS. 2, 5, 22, 23, 29, 37, 38 AND 50).

CLASS 28—TOYS AND SPORTING GOODS

FOR SCALE MODEL VEHICLES AND THEIR PARTS (U.S. CLS. 22, 23, 38 AND 50).
CHERYL CLAYTON, EXAMINING ATTORNEY

SN 79-006,833. M. FABRICE ALLOUCHE, FRANCE, FILED 4-23-2004.

PRIORITY DATE OF 10-24-2003 IS CLAIMED.
OWNER OF INTERNATIONAL REGISTRATION 0837438
DATED 4-23-2004, EXPIRES 4-23-2014.

NO CLAIM IS MADE TO THE EXCLUSIVE RIGHT TO USE "KICK BOXING", APART FROM THE MARK AS SHOWN.

CLASS 9—ELECTRICAL AND SCIENTIFIC APPARATUS

FOR SCIENTIFIC (OTHER THAN MEDICAL) APPARATUS AND INSTRUMENTS, NAMELY SCREEN DISPLAYS; TRANSFORMERS, ELECTRICAL CONDUCTORS, CABLES, SHEATHS FOR ELECTRICAL CABLES AND CONDUITS; TEACHING APPARATUS AND INSTRUMENTS, NAMELY EDUCATIONAL SOFTWARE FEATURING INSTRUCTION IN SPORTS; SPECTACLES, SPECTACLE CASES, SPECTACLE FRAMES; ELECTRIC CASINGS; ELECTRIC INSTALLATIONS FOR THE REMOTE CONTROL OF INDUSTRIAL OR AUDIOVISUAL OPERATIONS; ELECTRONIC INFORMATION PROCESSING APPARATUS, NAMELY, COMPUTERS AND COMPUTER MONITORS AND SCREENS; ELECTRONIC APPARATUS FOR SOUND AMPLIFICATION AND ELECTRONIC SIGNAL TRANSMITTERS FOR MOTION PICTURE PRODUCTION; APPARATUS AND INSTRUMENTS FOR RECORDING, TRANSMITTING, REPRODUCING, STORING TRANSFORMING AND PROCESSING SOUND OR IMAGES FOR MODULATION, NAMELY TELEVISION SETS, AUDIO AND VIDEO TAPE RECORDERS; AUDIOVISUAL, TELECOMMUNICATIONS, TELEMATIC APPARATUS AND INSTRUMENTS, NAMELY, TELEVISION SETS; REMOTE CONTROLS FOR RADIOS, TELEVISION, AND STEREO RECEIVERS; AUDIO AND VIDEO TAPE RECORDERS, MOTION PICTURE, VIDEO AND LASER LIGHT PROJECTORS; AUTOMOBILE RADIOS; LOUDSPEAKER CABINETS; AMPLIFIERS; HIGH FIDELITY SYSTEMS COMPRISED OF RECEIVERS, AUDIO AND VIDEO COMPACT DISC AND CASSETTE PLAYERS AND LOUDSPEAKERS; COMPUTERS, COMPUTER KEYBOARDS, COMPUTER PERIPHERALS AND MODEMS; COMPUTER SOFTWARE FOR USE IN DATABASE MANAGEMENT AND WORD PROCESSING; MICROPHONES; EXPOSED CAMERA AND MOTION PICTURE FILM INCLUDING MUSIC AND VIDEO RECORDINGS; BLANK MAGNETIC TAPE FOR TAPE RECORDERS; VIDEO TAPES FEATURING BOXING; PRERECORDED AUDIO AND VIDEO TAPES AND COMPACT DISCS FEATURING BOXING; OPTICAL DISCS, CD-ROMS, DIGITAL VIDEO DISCS, MAGNETIC DISCS, AND DVDS

FEATURING BOXING; MAGNETIC RECORDING MEDIA AND MAGNETIC CARDS, CHIPS AND ELECTRONIC CARDS, ALL FEATURING SPORTS ACTIVITIES; HARD DRIVES FOR COMPUTERS; VIDEOGAME CARTRIDGES, ELECTRONIC MEDIA IN GAME CONSOLES, NAMELY COMPUTER GAME EQUIPMENT CONTAINING MEMORY DISCS; TELEPHONES; ELECTRONIC AND MAGNETIC ID CARDS FOR USE IN CONNECTION WITH PAYMENT FOR SERVICES; INTEGRATED CIRCUITS AND MICROCIRCUITS, NAMELY MICRO NETWORKS FOR USE IN THE DESIGN OF INTEGRATED CIRCUITS; ELECTRONIC CARD READERS; CABLE TELEVISION TRANSMITTERS AND DIGITAL TRANSMITTERS; SOUND RECORDINGS FEATURING SPORTS EVENTS; VIDEO COMPUTER MONITORS USED FOR THE DISPLAY OF DATA RECEIVED FROM A GLOBAL COMPUTER NETWORK; COMPUTER COMMUNICATION SERVERS; RADIOS; AUTOMATIC VENDING MACHINES AND COIN COUNTING AND SORTING MACHINES FOR COIN OPERATED MECHANISMS; CASH REGISTERS, CALCULATORS, AND DATA PROCESSORS; SATELLITES FOR TELECOMMUNICATION AND SCIENTIFIC PURPOSES; TELEVISION SCREENS; SOFTWARE FOR ACCESS TO A COMPUTER OR DATA TRANSMISSION NETWORK, NAMELY THE INTERNET OR TO A PRIVATE RESERVED-ACCESS NETWORK OR INTRANET; ELECTRONIC MESSAGING APPARATUS, NAMELY PERSONAL DIGITAL ASSISTANTS (PDAS); INTERACTIVE ELECTRONICALLY CONTROLLED APPARATUS AND INSTRUMENTS, NAMELY DECODERS AND ENCODERS; VIDEO GAME MACHINES FOR USE WITH TELEVISION SETS; VIDEO GAME JOYSTICKS; AND FIRE EXTINGUISHERS (U.S. CLS. 21, 23, 26, 36 AND 38).

CLASS 25—CLOTHING

FOR CLOTHING FOR MEN, WOMEN AND CHILDREN, NAMELY, ANORAKS, APRONS, ASCOTS, BANDANAS, BATHING SUITS, BATHROBES, BELTS, BLAZERS, BLOUSES, BLOUSONS, BODYSUITS, BOLEROS, BOOTS, BOXER SHORTS, BRASSIERES, BRIEFS, BABY BUNTINGS, CAFTANS, CAMISOLES, CARDIGANS, CHEMISES, CLOTH DIAPERS, FUR COATS, SUIT COATS, TOPCOATS, CORSELETES, CULOTTES, DRESSES, EAR MUFFS, GALOSHES, GARTER BELTS, GIRDLES, GLOVES, NIGHTGOWNS, HALTER TOPS, HEADBANDS, HOSIERY, JACKETS, JEANS, JOGGING SUITS, JUMPERS, JUMP SUITS, KERCHIEFS, KIMONOS, LEGGINGS, LEOTARDS, NECKTIES, NECKWEAR, NEGLIGEEES, NIGHT SHIRTS, OVERALLS, OVERCOATS, OVERSHOES, PAJAMAS, PANTIES, PANTS, PANT SUITS, PANTYHOSE, PARKAS, PEIGNOIRS, PINAFORES, PLAY SUITS, PONCHOS, PULLOVERS, RAIN COATS, SCARVES, SHAWLS, SHIRTS, SHORTS, UNDERSHIRTS, SWEATSHIRTS, SWEAT SHORTS, SKIRTS SKI SUITS, SNOW SUITS, SOCKS, SPORT COATS, SPORT SHIRTS, STOCKINGS, STOLES, SUITS, SUSPENDERS, SWEAT PANTS, SWEATERS, T-SHIRTS, TROUSERS, TUXEDOS, UNDERPANTS, VESTS, VESTED SUITS AND WARM-UP SUITS, DRESSING GOWNS, FOOTWEAR, HATS AND CAPS (U.S. CLS. 22 AND 39).

GINA FINK, EXAMINING ATTORNEY

SN 79-006,847. TOMASELLA INDUSTRIA MOBILI S.A.S; DI
TOMASELLA LUIGI & C., ITALY, FILED 4-5-2004.



PRIORITY DATE OF 10-29-2003 IS CLAIMED.
OWNER OF INTERNATIONAL REGISTRATION 0837485
DATED 4-5-2004, EXPIRES 4-5-2014.
NO CLAIM IS MADE TO THE EXCLUSIVE RIGHT TO
USE "GRUPPO", APART FROM THE MARK AS SHOWN.
THE FOREIGN WORD GRUPPO TRANSLATES INTO
ENGLISH AS GROUP.

CLASS 20—FURNITURE AND ARTICLES NOT OTHERWISE CLASSIFIED

FOR ARMCHAIRS, ARMOIRES, BATHROOM VANITIES, BED FRAMES, BEDROOM FURNITURE, BEDS, BEEHIVES, BENCHES, BOOK RESTS, BOOK STANDS, BOOKCASES, BOOSTER SEATS, BOTTLE CLOSURES NOT OF METAL, BOX SPRINGS, BUFFETS, BUMPER GUARDS FOR FURNITURE, FURNITURE CABINETS, CABINET WORK, CARPET COASTERS FOR PROTECTING FURNITURE LEGS, CASKETS OF PLASTIC, CHAIR PADS, CHAIRS, CHAISES LOUNGES, CHESTS OF DRAWERS, CLEAR PLASTIC HOLDERS FOR BADGES, CLOTHES HANGERS, CLOTHES RODS, CLOTHESLINE FASTENER HAVING A PLASTIC FRAME AND PLASTIC GRIPPING PAWNS, CLOTHESLINE SPREADER HAVING A PLASTIC FRAME, COAT HANGERS, COAT RACKS, COAT STANDS, COMMERCIAL WORK STATIONS, NAMELY, FURNITURE INCLUDING ACCESSORIES AND COMPONENTS THEREFOR, COMPUTER FURNITURE, COMPUTER KEYBOARD TRAYS, CONTAINER CLOSURES OF PLASTIC, CONTAINERS FOR INDUSTRIAL AND COMMERCIAL LIQUIDS NOT MADE OF METAL, CONTAINERS, NOT OF METAL FOR COMMERCIAL USE; COUCHES, CREDENZAS, CRIBS, CUPBOARDS, CURTAIN RAILS, CURTAIN RODS, CUSHIONS, DECK CHAIRS, DECORATIVE BEAD CURTAINS, DECORATIVE MOBILES, DECORATIVE WINDOW FINIALS, DESKS, DINING ROOM TABLES, DISPLAY RACKS, DIVANS, DIVIDERS FOR DRAWERS, DOOR STOPS OF PLASTIC, DOORS FOR FURNITURE, DOWELS NOT OF METAL, FURNITURE DRAFTING TABLES, DRAPERY HARDWARE, NAMELY TRAVERSE RODS, POLES, CURTAINS HOOKS, CURTAIN RODS AND FINIALS; DRAWER PULLS OF PLASTIC OR WOOD, CORK, REED, CANE, WICKER, HORN, BONE, IVORY, WHALEBONE, SHELL, AMBER, MOTHER-OF-PEARL, MEERSCHAUM AND SUBSTITUTES FOR ALL THESE MATERIALS; DRAWERS, DRAWERS AND DIVIDERS THEREFOR, DRESSMAKER'S DUMMIES, DRINKING STRAWS, EMBROIDERY FRAMES, FURNITURE FOR ENTERTAINMENT CENTERS, EXTENDIBLE SOFAS, FIGURES MADE OF WOOD, FIGURINES MADE OF WOOD, FILING CABINETS; FIRE SCREENS FOR DOMESTIC USE, FIREGUARDS, NAMELY DOMESTIC SCREENS, FIREPLACE SCREENS, FITTED PLASTIC INSERTS FOR USE AS CONTAINER LINERS, FIXED TOWEL DISPENSERS NOT OF METAL, FLAGPOLES, FOOT RESTS, FOOTSTOOLS, FREE STANDING OFFICE PARTITIONS, NAMELY FURNITURE SCREENS, FREE-STANDING NON-METAL TOOL RACKS, FURNITURE, FURNITURE CHESTS, FURNITURE FRAMES, FURNITURE HARDWARE, NAMELY, DRAWER SLIDES, FURNITURE MOLDINGS, FURNITURE PARTITIONS, FURNITURE PARTS, FURNITURE PARTS, NAMELY COUNTER-TOPS; FURNITURE, NAMELY, DRESSERS; FURNITURE, NAMELY, SALES AND DISPLAY COUNTERS, FURNITURE, NAMELY WALL UNITS, NAMELY FUR-

NITURE SCREENS, GIFT PACKAGE DECORATIONS MADE OF PLASTIC; GOLF COURSE BENCHES, GUN CABINETS, HAMPERS, HAND FANS, HAND-HELD MIRRORS, HANGERS FOR CLOTHES, HIGH CHAIRS, HOLIDAY ORNAMENTS OF PLASTIC, NOT INCLUDING TREE ORNAMENTS, HOSPITAL BEDS, HUTCHES, INDUSTRIAL WORK TABLES, INFANT CRADLES, INFANT WALKERS, INFLATABLE PUBLICITY OBJECTS, JEWELRY BOXES NOT OF METAL, JEWELRY CASES NOT OF PRECIOUS METAL, KENNELS WITH CARRIERS, KEY CABINETS, KITCHEN CABINETS, LABORATORY FURNITURE, LAWN FURNITURE, LEATHER JEWELRY AND ACCESSORY BOXES; LEATHER PICTURE FRAMES, LECTERNS, LETTER BOXES OF WOOD, LETTER BOXES NOT OF METAL, LIVING ROOM FURNITURE, LOCKER MIRRORS, LOCKERS, LOVE SEATS, MAGAZINE RACKS, MANNEQUINS, MATTRESS CUSHIONS, MATTRESSES, MEDICINE CABINETS, METAL DISPLAY STANDS, METAL STORAGE RACKS FOR SKI AND SPORTS EQUIPMENT, MIRROR TILES, FURNITURE MIRRORS, MIRRORS ENHANCED BY ELECTRIC LIGHTS, MOVABLE OFFICE PARTITIONS, NAMELY FURNITURE SCREENS, NAP MATS NAMELY, CUSHIONS OR MATTRESSES, NIGHTSTANDS, NON METAL POLES, NON METAL VALVES FOR CONTAINERS, NON-METAL CASTERS, NON-METAL BINS, NON-METAL BOLTS, NON-METAL BOXES, NON-METAL BROOM HANDLES, NON-METAL BUOYS, NON-METAL CABINET DOOR CATCHES, NON-METAL CABLE CLIPS, NON-METAL CATCHES FOR USE IN FURNITURE CONSTRUCTION; NON-METAL CHAINS, NON-METAL CHESTS, NON-METAL CLAMPS, NON-METAL CLIPS FOR USE IN FURNITURE CONSTRUCTION, NON-METAL CLOSURES FOR CONTAINERS, NON-METAL CLOTHES HOOKS, NON-METAL CUP HOOKS; NON-METAL CURTAIN RINGS, NON-METAL DOOR BOLTS, NON-METAL DOOR LATCHES, NON-METAL DOOR TRIMS, NON-METAL DRAWER TRIMS, NON-METAL EXPANDING SLEEVES FOR AFFIXING SCREWS, NON-METAL FASTENERS, NAMELY BOLTS, SCREWS, NON-METAL FASTENING ANCHORS FOR SECURING PICTURE TO WALLS, NON-METAL GARDEN STAKES, NON-METAL GARMENT HOOKS, NON-METAL HANDLES FOR DRAWERS AND WARDROBE DOORS; NON-METAL HARDWARE, NAMELY, NUTS, NON-METAL HAT RACKS, NON-METAL HINGES, NON-METAL HOOKS, NON-METAL KEY HOLDERS, NON-METAL LADDERS, NON-METAL LATCH BARS, NON-METAL LATCHES, NON-METAL LOCK BOXES, NON-METAL LOCKS (U.S. CLS. 2, 13, 22, 25, 32 AND 50).

CLASS 35—ADVERTISING AND BUSINESS

FOR WHOLESALE AND RETAIL STORE SERVICES FEATURING FURNITURE AND HOUSEHOLD ACCESSORIES (U.S. CLS. 100, 101 AND 102).

LA TONIA FISHER, EXAMINING ATTORNEY

SN 79-006,964. AWM MOLD TECH AG, SWITZERLAND,
FILED 10-4-2004.

THE MARK CONSISTS OF STANDARD CHARACTERS WITHOUT CLAIM TO ANY PARTICULAR FONT, STYLE, SIZE, OR COLOR.

OWNER OF INTERNATIONAL REGISTRATION 0820507
DATED 12-23-2003, EXPIRES 12-23-2013.

OWNER OF U.S. REG. NO. 2,031,560.

CLASS 20—FURNITURE AND ARTICLES NOT OTHERWISE CLASSIFIED

FOR PLASTIC PACKAGING CONTAINERS, BOTTLE CLOSURES OF PLASTIC (U.S. CLS. 2, 13, 22, 25, 32 AND 50).

CLASS 40—MATERIAL TREATMENT

FOR MANUFACTURE OF PLASTIC AND PLASTIC PARTS TO THE ORDER AND SPECIFICATION OF OTHERS (U.S. CLS. 100, 103 AND 106).

LOURDES AYALA, EXAMINING ATTORNEY

SN 79-007,001. HYDROPERFECT INTERNATIONAL, FRANCE, FILED 11-21-2003.



PRIORITY DATE OF 5-23-2003 IS CLAIMED.
OWNER OF INTERNATIONAL REGISTRATION 0837970
DATED 11-21-2003, EXPIRES 11-21-2013.

CLASS 7—MACHINERY

FOR MACHINE TOOLS, NAMELY, THERMOSTATIC PILOT; MOTORS AND ENGINES FOR MACHINES; COUPLINGS FOR MACHINES; POWER TRANSMISSIONS FOR MACHINES; PUMPS, NAMELY, HYDRAULIC PUMPS, HYDRAULIC MOTORS AND TRANSMISSIONS FOR MACHINES; MACHINE PARTS, NAMELY, HYDRAULIC FLAPS AND VALVES; HYDRAULIC CIRCUIT BREAKERS; HYDRAULIC DISTRIBUTORS FOR VEHICLES AND MACHINES; HYDRAULIC TURBINES; HYDRAULIC ACCUMULATORS; ACCESSORIES FOR HYDRAULIC MACHINES NAMELY, FLOW DIVIDERS, FLOW DISTRIBUTORS, THERMOSTATIC PILOTS, HYDRAULIC CONTROL AND REGULATION UNITS, HYDRAULIC JACKS, HYDRAULIC POWER UNITS, COMPLETE OR PARTIAL HYDRAULIC POWER TRANSMISSION UNITS, AND HYDRAULIC POWER STEERING UNITS; FILTERS FOR HYDRAULIC CIRCUITS; HYDROSTATIC COMPONENTS FOR VEHICLES AND OTHER APPARATUS FOR LOCOMOTION BY LAND, AIR OR WATER, NAMELY, FLOW DIVIDERS, FLOW DISTRIBUTORS, THERMOSTATIC PILOTS, HYDRAULIC REGULATION UNITS, HYDRAULIC JACKS; PARTS OF HYDRAULIC MOTORS AND TRANSMISSIONS FOR AIRCRAFT AND BOATS, NAMELY HYDRAULIC REGULATION UNITS, HYDRAULIC POWER UNITS, COMPLETE OR PARTIAL HYDRAULIC POWER TRANSMISSION UNITS, HYDRAULIC POWER STEERING UNITS. (U.S. CLS. 13, 19, 21, 23, 31, 34 AND 35).

CLASS 12—VEHICLES

FOR VEHICLES, APPARATUS FOR LOCOMOTION BY LAND, AIR OR WATER, NAMELY, AUTOMOBILES, AIRPLANES AND BOATS; HYDRAULIC MOTORS AND TRANSMISSIONS FOR LAND MOTOR VEHICLES, NAMELY HYDRAULIC CONTROL UNITS, HYDRAULIC POWER UNITS, COMPLETE OR PARTIAL HYDRAULIC POWER TRANSMISSION UNITS, HYDRAULIC POWER STEERING UNITS; FILTERS FOR HYDRAULIC CIRCUITS. (U.S. CLS. 19, 21, 23, 31, 35 AND 44).

KAREN BRACEY, EXAMINING ATTORNEY

SN 79-007,033. SCHEFENACKER VISION SYSTEMS GERMANY GMBH, 73730 ESSLINGEN, FED REP GERMANY, FILED 6-7-2004.

SCHEFENACKER

THE MARK CONSISTS OF STANDARD CHARACTERS WITHOUT CLAIM TO ANY PARTICULAR FONT, STYLE, SIZE, OR COLOR.

PRIORITY DATE OF 3-5-2004 IS CLAIMED.

OWNER OF INTERNATIONAL REGISTRATION 0838089
DATED 6-7-2004, EXPIRES 6-7-2014.

CLASS 9—ELECTRICAL AND SCIENTIFIC APPARATUS

FOR ELECTRIC AND ELECTRONIC APPARATUS AND INSTRUMENTS, NAMELY, ELECTRONIC CONTROLLERS FOR REFLECTIVE MIRRORS, SOUND SYSTEMS, ELECTRIC MOTORS, AND LIGHTING; SENSORS FOR MEASURING, REGULATING AND CONTROLLING APPARATUS FOR AUTOMOBILES, NAMELY FOR BLIND SPOT DETECTION, MIRROR POSITIONING, TEMPERATURE, AUTOMOBILE WINDOW POSITIONING; MATERIAL FOR ELECTRICITY MAINS, NAMELY, CABLE LOOMS, AND SWITCHES; APPARATUS FOR RECORDING, TRANSMISSION AND/OR REPRODUCTION OF SOUND AND/OR IMAGES FOR AUTOMOBILES, NAMELY, AMPLIFIED SPEAKERS AND BOXES AND MOUNTING FOR SAME; ANTENNAS, LOUDSPEAKERS, AND LOUDSPEAKER BOXES FOR AUTOMOBILES (U.S. CLS. 21, 23, 26, 36 AND 38).

CLASS 11—ENVIRONMENTAL CONTROL APPARATUS

FOR HEADLIGHTS, LIGHTING APPARATUS, NAMELY, ELECTRO-LUMINESCENT LAMPS; AIR CONDITIONERS FOR AUTOMOBILES (U.S. CLS. 13, 21, 23, 31 AND 34).

CLASS 12—VEHICLES

FOR AUTOMOBILES AND PARTS THEREOF, NAMELY, PANES OF SYNTHETIC MATERIAL AND/OR GLASS, NAMELY, WINDSHIELDS, SIDELIGHTS, BACKLIGHTS; DECORATIVE ELEMENTS AND FITTINGS OF PLASTICS, NAMELY TRIMS FOR DECORATING THE CAR EXTERIOR, BODY AND BUMPER PROTECTORS, FENDER TRIMS, SPOILERS AND WINGS, HOODS, GRILLE INSERTS, TRIMS SUCH AS DOOR HANDLES FOR CARS; ACCESSORIES FOR AUTOMOBILES, NAMELY EXTERIOR MIRRORS, INTERIOR MIRRORS, WINDOW LIFTS, DIRECTION INDICATORS, HUB CAPS, VENTILATION JALOUSIES FOR THE STEERING OF CURRENT (U.S. CLS. 19, 21, 23, 31, 35 AND 44).

JOHN LINCOSKI, EXAMINING ATTORNEY

SN 79-007,113. PROPIA CO., LTD., TOKYO 160-0023, JAPAN, FILED 2-19-2004.



PRIORITY DATE OF 11-14-2003 IS CLAIMED.
OWNER OF INTERNATIONAL REGISTRATION 0838361
DATED 2-19-2004, EXPIRES 2-19-2014.

THE ENGLISH TRANSLATION OF THE WORD PROPIA IN THE MARK IS OWN, PROPER OR IDENTICAL.

CLASS 3—COSMETICS AND CLEANING PREPARATIONS

FOR STRIPPING PREPARATIONS FOR WIGS, PLAITED HAIR, TRESSES OF HAIR, AND HAIRPIECES; ADHESIVES FOR AFFIXING WIGS, PLAITED HAIR, TRESSES OF HAIR, AND HAIRPIECES; ADHESIVES FOR AFFIXING FALSE EYELASHES; SHAMPOOS; TOILET WATER, SKIN AND HAIR LOTIONS, SHAVING LOTIONS; HAIR CARE PREPARATIONS, HAIR OILS, COLOR RINSES, COLD WAVING SOLUTIONS, WAVE-SET LOTIONS, HAIR DYES, STICK POMADE, PERMANENT WAVE PREPARATIONS, HAIR CREAMS, HAIR SPRAY, HAIR TONICS, HAIR RINSES, HAIR SHAMPOO AND HAIR CONDITIONER; FALSE EYELASHES (U.S. CLS. 1, 4, 6, 50, 51 AND 52).

SN 79-007,166. MUZZ BUZZ FRANCHISING PTY LTD, AUSTRALIA, FILED 5-17-2004.



PRIORITY DATE OF 11-18-2003 IS CLAIMED.
OWNER OF INTERNATIONAL REGISTRATION 0838472
DATED 5-17-2004, EXPIRES 5-17-2014.

NO CLAIM IS MADE TO THE EXCLUSIVE RIGHT TO USE "DRIVE-THRU COFFEE", APART FROM THE MARK AS SHOWN.

CLASS 8—HAND TOOLS

FOR ELECTRIC RAZORS AND ELECTRIC HAIR CLIPPERS; HAIR CUTTING SCISSORS; SAFETY RAZORS, RAZOR BLADES; HAND-OPERATED HAIR CLIPPERS; SHAVING SETS; PEDICURE SETS; EYELASH CURLERS (U.S. CLS. 23, 28 AND 44).

CLASS 30—STAPLE FOODS

FOR COFFEE, NAMELY, COFFEE BEANS, GROUND COFFEE, COFFEE POWDER AND ARTIFICIAL COFFEE; TEA, NAMELY, HERBAL, NON-HERBAL TEA; COCOA; SUGAR; FLOUR AND PREPARATIONS MADE FROM CEREALS, NAMELY BREAKFAST CEREALS AND CEREAL BASED SNACK-FOODS; BREAD, PASTRIES; CONFECTIONERY, NAMELY SWEETS, NAMELY, CARAMELS, MARZIPAN, NOUGATS, PRALINES, CANDY MINTS, CHEWING GUM, GUM BALLS, LIQUORICES, PASTILLES, BAKERY DESSERTS, COOKIES, BISCUITS, WAFER STICKS, FLAVORED SWEETENED GELATIN DESSERTS, FROZEN CONFECTIONS; CHOCOLATE AND CANDY; PRODUCTS MADE FROM BREAD, NAMELY, SANDWICHES; HONEY; TREACLE; SAUCES; SPICES; ICES, NAMELY FRUIT ICES; ICE AND ICE CREAM; BEVERAGES, NAMELY, HOT, COLD, ICED AND SEMI-FROZEN BEVERAGES MADE WITH THE BASE OF COFFEE, COCOA, TEA, ESPRESSO; POWDERED FOOD FLAVORINGS AND FLAVORING SYRUPS; AND BAKED GOODS, NAMELY, MUFFINS, SCONES, BISCUITS, COOKIES, DONUTS AND CAKES (U.S. CL. 46).

CLASS 26—FANCY GOODS

FOR HAIR ORNAMENTS, HAIR PIECES, HAIR PIECES OR HAIR ATTACHMENTS DIRECTLY ATTACHED TO SKIN, ARTIFICIAL HAIR, TOUPEES, HAIR NETS, HAIR BANDS, BOBBY PINS, HAIR GRIPS, HAIR PINS, CHIGNONS FOR JAPANESE HAIR STYLING, PLAITED HAIR, TRESSES OF HAIR, WIGS, HAIR ACCESSORIES, NAMELY, TWISTERS, HAIR ACCESSORIES, NAMELY, CLAW CLIPS, HAIR ACCESSORIES, NAMELY, SNAP CLIPS, HAIR BOWS, HAIR CLIPS, HAIR SCRUNCHIES; FALSE BEARDS, FALSE MOUSTACHES; HAIR CURLERS (U.S. CLS. 37, 39, 40, 42 AND 50).

CLASS 35—ADVERTISING AND BUSINESS

FOR RETAIL STORES FEATURING EQUIPMENT FOR USE IN THE PREPARATION, DISPENSING AND SERVING OF FOOD AND BEVERAGES; RETAIL STORES FEATURING FOOD AND BEVERAGE PRODUCTS, NAMELY, COFFEE, TEA, COCOA, SUGAR, FLOUR, PREPARATIONS MADE FROM CEREALS, BREAD, PASTRIES, FLAVORINGS, CONFECTIONERY, CHOCOLATE, CANDY, PRODUCTS MADE FROM BREAD, NAMELY, SANDWICHES, HONEY, TREACLE, SAUCES, SPICES, ICES, ICE AND ICE CREAM, BAKED GOODS AND HOT, COLD, ICED OR SEMI-FROZEN BEVERAGES MADE WITH THE BASE OF COFFEE, COCOA, TEA, ESPRESSO, POWDERED FLAVORINGS AND FLAVORING SYRUPS; BUSINESS MANAGEMENT CONSULTING WITH RELATION TO STRATEGY, MARKETING, PRODUCTION, PERSONNEL AND RETAIL MERCHANDISING FOR THE FOOD AND BEVERAGE STORES; AND FRANCHISING, NAMELY OFFERING TECHNICAL ASSISTANCE IN THE ESTABLISHMENT AND/OR OPERATION OF DRIVE-THROUGH TAKE-AWAY FOOD AND BEVERAGE OUTLETS, AND OF RESTAURANTS (U.S. CLS. 100, 101 AND 102).

CLASS 44—MEDICAL, BEAUTY AND AGRICULTURAL SERVICES

FOR NOURISHING, GROWING AND PROMOTING HAIR GROWTH AND HAIR RESTORATION; ADDING ARTIFICIAL HAIR DIRECTLY TO A PERSON'S NATURAL HAIR; HAIRDRESSING SALONS; PROVIDING INFORMATION RELATING TO HAIR SPROUTING, HAIR GROWTH, HAIR RESTORATION, AND HAIR ADDITION; PROVIDING INFORMATION RELATING TO DOCTORS, CLINICS, HOSPITALS, PHARMACIES AND OTHER MEDICAL TREATMENT; RENTAL OF MACHINES AND APPARATUS FOR USE IN BEAUTY SALONS OR BARBER SHOPS; RENTAL OF WIGS, PLAITED HAIR, TRESSES OF HAIR, AND HAIRPIECES; ADVISORY SERVICES FOR THE USE OF HAIR GROWTH PREPARATIONS; ADVISORY SERVICES FOR THE USE OF HAIR TONICS; OPERATION AND CONSULTATION FOR PROMOTING HAIR GROWTH AND HAIR SPROUTING; RENTAL OF MACHINES FOR OPERATION TO PROMOTE HAIR GROWTH AND HAIR SPROUTING, AND FOR SURGICAL OPERATION OF HAIR ADDITION; DIETARY AND NUTRITIONAL CONSULTANCY; RENTAL OF ELECTRIC MASSAGE MACHINES FOR DOMESTIC USE (U.S. CLS. 100 AND 101).
H. M. FISHER, EXAMINING ATTORNEY

CLASS 43—HOTEL AND RESTAURANT SERVICES

FOR SERVICES FOR PROVIDING FOOD AND DRINKS, NAMELY, CAFES; RESTAURANTS; SNACK-BARS; TAKE-OUT RESTAURANT SERVICES; CATERING SERVICES; CAFETERIAS; AND SELF-SERVICE RESTAURANTS (U.S. CLS. 100 AND 101).
STEVEN R. FINE, EXAMINING ATTORNEY

SN 79-007,259. ACTIVEST INVESTMENTGESELLSCHAFT MBH, FED REP GERMANY, FILED 10-8-2004.



OWNER OF INTERNATIONAL REGISTRATION 0838793 DATED 10-8-2004, EXPIRES 10-8-2014.
OWNER OF U.S. REG. NO. 2,551,656.

CLASS 16—PAPER GOODS AND PRINTED MATTER

FOR PRINTED MATTER, NAMELY WRITTEN INSTRUCTIONAL AND TEACHING MATERIALS, FEATURING INFORMATION ABOUT FINANCE AND INVESTMENTS (U.S. CLS. 2, 5, 22, 23, 29, 37, 38 AND 50).

CLASS 35—ADVERTISING AND BUSINESS

FOR ADVERTISING AND MARKETING FOR OTHERS (U.S. CLS. 100, 101 AND 102).

CLASS 36—INSURANCE AND FINANCIAL

FOR FINANCIAL AND INVESTMENT SERVICES, NAMELY INVESTMENT BROKERAGE, INVESTMENT CONSULTATIONS, INVESTMENT MANAGEMENT (U.S. CLS. 100, 101 AND 102).

JOHN DWYER, EXAMINING ATTORNEY

SN 79-007,310. CORPORACION HABANOS, S.A., CUBA, FILED 6-1-2004.

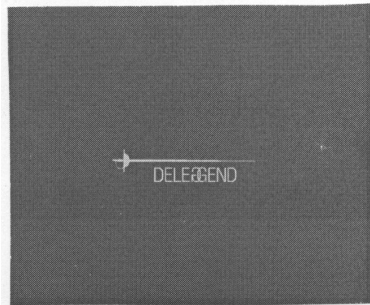

PRIORITY DATE OF 1-14-2004 IS CLAIMED.
OWNER OF INTERNATIONAL REGISTRATION 0838939 DATED 6-1-2004, EXPIRES 6-1-2014.

CLASS 3—COSMETICS AND CLEANING PREPARATIONS

FOR SOAPS, NAMELY SOAP FOR PERSONAL USE AND HAND SOAPS; ESSENTIAL OILS FOR PERSONAL USE; COSMETICS; HAIR LOTION; DENTIFRICES (U.S. CLS. 1, 4, 6, 50, 51 AND 52).

CLASS 14—JEWELRY

FOR JEWELRY; WATCHES; GOODS MADE OF PRECIOUS METALS AND GOODS COATED WITH PRECIOUS METALS, NAMELY CUFFLINKS, TIE PINS, CLIPS, AND TIE FASTENERS (U.S. CLS. 2, 27, 28 AND 50).

CLASS 16—PAPER GOODS AND PRINTED MATTER

FOR PAPER, CARDBOARD AND GOODS MADE FROM THESE MATERIALS, NOT INCLUDED IN OTHER CLASSES, NAMELY DIARIES, NOTE BOOKS, NOTEBOOK PAPER, AND NOTEBOOK DIVIDERS; BOOKBINDING MATERIAL, NAMELY BOOKBINDING WIRE AND TAPES, AND BOOK BINDINGS; PHOTOGRAPHS; ARTIST'S MATERIALS, NAMELY PENS; PAINT BRUSHES; PLASTIC SHEETS FOR WRITING, PRINTING, AND MARKING; PAPER SACKS AND BAGS FOR WRAPPING AND PACKAGING (U.S. CLS. 2, 5, 22, 23, 29, 37, 38 AND 50).

CLASS 18—LEATHER GOODS

FOR LEATHER AND IMITATION LEATHER SOLD IN BULK, HANDBAGS, TRUNKS, UMBRELLAS, PARASOLS, WALKING STICKS, WHIPS, HARNESS AND SADDLERY (U.S. CLS. 1, 2, 3, 22 AND 41).

CLASS 21—HOUSEWARES AND GLASS

FOR TABLE SETS OF BEVERAGE GLASSWARE, KITCHEN CONTAINERS MADE OF PORCELAIN, TABLEWARE, NAMELY COFFEE CUPS AND SAUCERS, NOT MADE OF PRECIOUS METAL (U.S. CLS. 2, 13, 23, 29, 30, 33, 40 AND 50).

CLASS 25—CLOTHING

FOR SHIRTS, T-SHIRTS, SWEAT-SHIRTS, JACKETS, BLOUSES, SKIRTS, TROUSERS, SHORTS, SWIMMING SUITS, PAJAMAS, SCARVES, NECKTIES, HATS, SOCKS, STOCKINGS, SHOES, SPORTS SHOES (U.S. CLS. 22 AND 39).

CLASS 30—STAPLE FOODS

FOR COFFEE, ARTIFICIAL COFFEE, TEA, COCOA, SUGAR, CONFECTIONARY, NAMELY CANDY; SAUCES, SPICES (U.S. CL. 46).

CLASS 33—WINES AND SPIRITS

FOR ALCOHOLIC BEVERAGES, NAMELY BRANDY, COGNAC, RUM, AND WINE (U.S. CLS. 47 AND 49).

CLASS 35—ADVERTISING AND BUSINESS

FOR BUSINESS MANAGEMENT SERVICES, NAMELY MANAGING THE BUSINESS AFFAIRS OF OTHERS (U.S. CLS. 100, 101 AND 102).

CLASS 43—HOTEL AND RESTAURANT SERVICES

FOR RESTAURANTS, BAR SERVICES, CAFETERIAS, HOTELS (U.S. CLS. 100 AND 101).

JENNIFER MARTIN, EXAMINING ATTORNEY

SN 79-007,316. ROBERT BOSCH GMBH, FED REP GERMANY, FILED 8-5-2004.



THE MARK CONSISTS OF STANDARD CHARACTERS WITHOUT CLAIM TO ANY PARTICULAR FONT, STYLE, SIZE, OR COLOR.

OWNER OF INTERNATIONAL REGISTRATION 0838954 DATED 8-5-2004, EXPIRES 8-5-2014.

CLASS 7—MACHINERY

FOR GLOW PLUGS FOR MOTOR VEHICLES (U.S. CLS. 13, 19, 21, 23, 31, 34 AND 35).

CLASS 9—ELECTRICAL AND SCIENTIFIC APPARATUS

FOR ELECTRONIC CONTROLS FOR REGULATION OF GLOW PLUGS, RESPECTIVE CURRENT FOR MOTOR VEHICLES (U.S. CLS. 21, 23, 26, 36 AND 38).

LINDA MICKLEBURGH, EXAMINING ATTORNEY

SN 79-007,366. PLOCKMATIC INTERNATIONAL AB, SWEDEN, FILED 8-23-2004.

PLOCKMATIC

THE MARK CONSISTS OF STANDARD CHARACTERS WITHOUT CLAIM TO ANY PARTICULAR FONT, STYLE, SIZE, OR COLOR.

OWNER OF INTERNATIONAL REGISTRATION 0839031 DATED 8-23-2004, EXPIRES 8-23-2014.

CLASS 7—MACHINERY

FOR GRAPHICAL FINISHING MACHINES FOR INDUSTRIAL PURPOSES FOR PICKING, ASSORTING, STITCHING, FOLDING AND BINDING OF PAPER (U.S. CLS. 13, 19, 21, 23, 31, 34 AND 35).

CLASS 16—PAPER GOODS AND PRINTED MATTER

FOR GRAPHICAL FINISHING APPARATUS FOR OFFICE PURPOSES, NAMELY MACHINES FOR BOOKLET MAKING BY MEANS OF STAPLING/STITCHING AND FOLDING, COLLATING, SORTING, STAPLING/STITCHING, TRIMMING AND MAIL INSERTING (U.S. CLS. 2, 5, 22, 23, 29, 37, 38 AND 50).

MICHAEL WEBSTER, EXAMINING ATTORNEY

SN 79-007,445. ACCOVION GMBH, FED REP GERMANY, FILED 6-2-2004.

Accovion

THE MARK CONSISTS OF STANDARD CHARACTERS WITHOUT CLAIM TO ANY PARTICULAR FONT, STYLE, SIZE, OR COLOR.

PRIORITY DATE OF 2-10-2004 IS CLAIMED.

OWNER OF INTERNATIONAL REGISTRATION 0839258 DATED 6-2-2004, EXPIRES 6-2-2014.

CLASS 35—ADVERTISING AND BUSINESS

FOR BUSINESS MANAGEMENT, IN PARTICULAR PREPARATION OF DOCUMENTS FOR THE DRUG APPROVAL PROCESS AND CORRESPONDENCE WITH DRUG REGULATION OFFICES; BUSINESS ADMINISTRATION; PROVIDING OFFICE FUNCTIONS; ORGANIZATIONAL CONSULTING FOR MEDICAL AFFAIRS; PREPARATION OF CONCEPTS FOR DRUG ADVERTISING AND MARKETING STUDIES; BUSINESS AND ECONOMIC SERVICES IN THE CONTEXT OF DRUG DEVELOPMENT, IN PARTICULAR PHARMACO-ECONOMIC INVESTIGATIONS; RECORDING AND PROCESSING OF DATA IN THE CONTEXT OF DRUG TESTING (U.S. CLS. 100, 101 AND 102).

CLASS 41—EDUCATION AND ENTERTAINMENT

FOR EDUCATION, NAMELY CONDUCTING CLASSES, SEMINARS, CONFERENCES, WORKSHOPS AND ON SITE TRAINING RELATING TO PHARMACEUTICAL PRODUCTS AND DRUG DEVELOPMENT; PUBLISHING OF MEDICAL TEXTS AND DOCUMENTS FOR DRUG APPROVAL; PUBLISHING OF STATISTICAL AND CLINICAL REPORTS (U.S. CLS. 100, 101 AND 107).

CLASS 42—SCIENTIFIC, COMPUTER AND LEGAL SERVICES

FOR SCIENTIFIC SERVICES, IN PARTICULAR DRUG DEVELOPMENT, PLANNING AND CONDUCTING CLINICAL DRUG STUDIES, RECORDING AND EVALUATING MEDICAL RISKS OF DRUGS, BIOMETRICS PLANNING, ANALYSIS AND REPORT AS WELL AS QUALITY CONTROL AND QUALITY ASSURANCE WITH RESPECT TO THE AFORE-MENTIONED SERVICES; INDUSTRIAL ANALYSIS AND RESEARCH SERVICES RELATING TO DRUG DEVELOPMENT; TEST SERVICE FOR BIO-PHARMACEUTICAL AND MEDICAL DEVICES; DEVELOPMENT SERVICE FOR BIOPHARMACEUTICAL AND MEDICAL DEVICES; BIOMEDICAL ZOOLOGY SERVICES; DEVELOPMENT OF NEW PRODUCTS IN THE FIELD OF BIOLOGY, CHEMISTRY AND PHYSICS; LEGAL SERVICES, NAMELY LEGAL ADVICE WITH RESPECT TO THE DRUG APPROVAL PROCESS (U.S. CLS. 100 AND 101).

CLASS 44—MEDICAL, BEAUTY AND AGRICULTURAL SERVICES

FOR MEDICAL SERVICES; VETERINARY SERVICES (U.S. CLS. 100 AND 101).

PATRICIA EVANKO, EXAMINING ATTORNEY

SN 79-007,590. "EUROSTOCK" S.A., BULGARIA, FILED 6-14-2004.

BOLERO

THE MARK CONSISTS OF STANDARD CHARACTERS WITHOUT CLAIM TO ANY PARTICULAR FONT, STYLE, SIZE, OR COLOR.

OWNER OF INTERNATIONAL REGISTRATION 0743112 DATED 7-13-2000, EXPIRES 7-13-2010.

CLASS 5—PHARMACEUTICALS

FOR ANTI-DIABETIC PHARMACEUTICALS; ANTI-BACTERIAL PHARMACEUTICALS; PHARMACEUTICAL PREPARATIONS, NAMELY, APPETITE SUPPRESSANTS; DIETETIC FOOD SUPPLEMENTS FOR MEDICAL USE (U.S. CLS. 6, 18, 44, 46, 51 AND 52).

CLASS 30—STAPLE FOODS

FOR TEA; COFFEE; ARTIFICIAL COFFEE SUBSTITUTE (U.S. CL. 46).

CLASS 32—LIGHT BEVERAGES

FOR NON-ALCOHOLIC BEVERAGES, NAMELY, FRUIT DRINKS AND FRUIT JUICES, AERATED AND NON-AERATED BEVERAGES WITH TEA FLAVOR, BEVERAGES WITH TEA FLAVOR READY TO DRINK OR IN POWDER FORM; PREPARATIONS FOR MAKING FRUIT DRINKS, FRUIT JUICES, TEA-FLAVORED BEVERAGES, MINERAL AND AERATED WATERS (U.S. CLS. 45, 46 AND 48).

BARBARA RUTLAND, EXAMINING ATTORNEY

SN 79-007,773. MERMET S.A.; HAMEAU LE BOIS, FRANCE,
FILED 8-10-2004.

MODULIGHT

THE MARK CONSISTS OF STANDARD CHARACTERS WITHOUT CLAIM TO ANY PARTICULAR FONT, STYLE, SIZE, OR COLOR.

OWNER OF INTERNATIONAL REGISTRATION 0840111 DATED 8-10-2004, EXPIRES 8-10-2014.

CLASS 17—RUBBER GOODS

FOR ASBESTOS FABRICS FOR USE AS CABLE INSULATION AND FIRE CURTAINS; FIBERGLASS FABRICS FOR BUILDING INSULATION; SHEETS OF PLASTIC FABRIC USED AS INSULATING INFILTRATION BARRIER IN BUILDING CONSTRUCTION (U.S. CLS. 1, 5, 12, 13, 35 AND 50).

CLASS 20—FURNITURE AND ARTICLES NOT OTHERWISE CLASSIFIED

FOR SLATTED INDOOR WINDOW BLINDS (U.S. CLS. 2, 13, 22, 25, 32 AND 50).

CLASS 24—FABRICS

FOR PLASTIC FIBERS; FIBERGLASS FABRICS FOR TEXTILE USE; FABRICS FOR MAKING AND PRODUCING CURTAINS AND BLINDS; FIBERGLASS FABRICS FOR TEXTILE ARCHITECTURE AND SIGNAGE; WALL HANGINGS OF TEXTILE AND TEXTILE WALL COVERINGS (U.S. CLS. 42 AND 50).

CLASS 27—FLOOR COVERINGS

FOR WALL PAPER AND NON-TEXTILE WALL COVERINGS; WALL COVERINGS MADE OF PLASTIC (U.S. CLS. 19, 20, 37, 42 AND 50).

Laura Kovaisky, Examining Attorney

SN 79-007,888. PASTARITO S.R.L., ITALY, FILED 7-21-2004.



PRIORITY DATE OF 1-21-2004 IS CLAIMED.
OWNER OF INTERNATIONAL REGISTRATION 0840393 DATED 7-21-2004, EXPIRES 7-21-2014.

THE COLOR(S) RED, WHITE AND YELLOW IS/ARE CLAIMED AS A FEATURE OF THE MARK.

THE MARK CONSISTS OF THE WORD PASTARITO PLACED IN A RECTANGULAR FRAME WITH ROUNDED CORNERS ON A RED BACKGROUND; THE LETTER P AND THE LETTER O BEING IN CAPITALS, THE WORD IS WHITE, IN THE MIDDLE OF THE FRAME AND IN THE UPPER PART, THERE IS A WHITE CAPITAL WITH A THIN RED COLOUR CONTOUR, ON TOP OF WHICH THERE IS A REPRODUCTION OF A YELLOW COLOURED BUTTERFLY SHAPED PASTA WITH A RED CONTOUR.

CLASS 30—STAPLE FOODS

FOR COFFEE, TEA, COCOA, SUGAR, RICE, TAPIOCA, SAGO, ARTIFICIAL COFFEE; FLOUR; BAKERY PRODUCTS AND PREPARATIONS MADE FROM CEREALS, NAMELY, BREAD, CAKES AND PASTRY, PIZZA, FROZEN PIZZA, JAPANESE PANCAKES, NAMELY, FLAT CAKES, COOKED AND FROZEN PASTA, AND PIES; FLOUR BASED CHIPS; ICES CREAMS; HONEY, MOLASSES SYRUP, YEAST BAKING-POWDER; SALT, MUSTARD; VINEGAR, CONDIMENTS, NAMELY, SAUCES; SPICES; ICE (U.S. CL. 46).

CLASS 35—ADVERTISING AND BUSINESS

FOR ADVERTISING AGENCIES; FRANCHISING, NAMELY CONSULTATION AND ASSISTANCE IN BUSINESS MANAGEMENT AND PROMOTION (U.S. CLS. 100, 101 AND 102).

CLASS 43—HOTEL AND RESTAURANT SERVICES

FOR PROVIDING FOOD AND DRINKS FOR PATIENTS AND GUESTS, SERVING OF FOOD AND DRINKS; AND SELF-SERVICE RESTAURANTS, COFFEE SHOPS, SNACK BARS, PIZZA RESTAURANTS, CAFETERIAS, CATERING (U.S. CLS. 100 AND 101).
Sharon Meier, Examining Attorney

SN 79-008,217. DROUJESTVO S OGRANITCHENA; OTGOVORNOST "STS HOLDING GROUP" OOD, BULGARIA, FILED 8-3-2004.

LADY IN COLOR

THE MARK CONSISTS OF STANDARD CHARACTERS WITHOUT CLAIM TO ANY PARTICULAR FONT, STYLE, SIZE, OR COLOR.

OWNER OF INTERNATIONAL REGISTRATION 0814577 DATED 10-6-2003, EXPIRES 10-6-2013.

CLASS 3—COSMETICS AND CLEANING PREPARATIONS

FOR PERFUMERY; COSMETICS; LOTIONS FOR COSMETIC PURPOSES; HAIR DYES; FLOWER EXTRACTS, NAMELY PERFUMES; ETHEREAL ESSENCES FOR PERSONAL USE; FRAGRANT POTPOURRI; ESSENTIAL OILS FOR USE IN THE MANUFACTURE OF SCENTED PRODUCTS; SOAPS; SHAMPOOS; HAIR WAVING PREPARATIONS; COSMETIC DYES; BLEACHING PREPARATIONS FOR COSMETIC PURPOSES; LIPSTICK; SCENTED WATER; PERFUMED DEODORANTS FOR PERSONAL USE; EAU-DE-COLOGNE; COSMETIC CREAMS FOR WHITENING THE SKIN; COSMETIC PENCILS; EYELID PENCILS; EYEBROW PENCILS; MAKE-UP POWDER; COSMETIC PRODUCTS FOR EYELIDS AND EYELASHES, NAMELY MASCARA; EYEBROW COSMETICS; NAIL VARNISH; DECORATIVE TRANSFERS FOR COSMETIC PURPOSES; COSMETIC PREPARATIONS FOR BATHS; COSMETIC SUNTAN PREPARATIONS; EAU DE TOILETTE; COLORANTS FOR TOILET PURPOSES, NAMELY HAIR COLORANTS; TALCUM POWDER FOR TOILETRY USE; COTTON STICKS FOR COSMETIC PURPOSES; FALSE EYELASHES; COSMETICS FOR FALSE EYELASHES; ADHESIVES FOR AFFIXING FALSE EYELASHES; NON-MEDICATED TOILETRIES; TISSUES IMPREGNATED WITH COSMETIC LOTIONS; NON-MEDICATED MOUTH CARE PRODUCTS; DENTIFRICES; BATH SALTS, NOT FOR MEDICAL PURPOSES (U.S. CLS. 1, 4, 6, 50, 51 AND 52).

CLASS 21—HOUSEWARES AND GLASS

FOR HOUSEHOLD OR KITCHEN UTENSILS AND CONTAINERS NOT OF PRECIOUS METAL NOR COATED THEREWITH; COMBS; SPONGES, NAMELY BATH SPONGES, CLEANING SPONGES, SCRUB SPONGES, TOILET SPONGES; LARGE-TOOTHED COMBS FOR THE HAIR; ELECTRIC HAIR COMBS; BRUSHES, NAMELY CLOTHES BRUSHES, DUSTING BRUSHES; HAIRBRUSHES; EYEBROW BRUSHES; NAIL BRUSHES; NON-ELECTRIC APPLIANCES FOR REMOVING MAKE-UP (U.S. CLS. 2, 13, 23, 29, 30, 33, 40 AND 50).
LINDA E. BLOHM, EXAMINING ATTORNEY

CLASS 25—CLOTHING

FOR CLOTHING, NAMELY SHIRTS, BLOUSES, SWEATERS, JACKETS, OVERCOATS, COATS, TROUSERS, UNDERWEAR, STOCKINGS, SOCKS, CAPS, HATS, PEAKED CAPS, SLIPPERS, SHOES, BOOTS, GLOVES, SCARVES, WET SUITS, WAISTCOATS, BATHING SUITS, BATHING TRUNKS, BATH ROBES, NECKTIES, HEADBANDS, SHAWLS, RAINWEAR, PULLOVERS, DRESSES, SKIRTS, VESTS AND SUITS (U.S. CLS. 22 AND 39).

LAURA KOVAISKY, EXAMINING ATTORNEY

SN 79-008,583. HANGZHOU WAHAHA GROUP CO., LTD., HANGZHOU ETDZ, CHINA, FILED 8-9-2004.

SN 79-008,296. KULLSVIK INVEST AB, SWEDEN, FILED 8-10-2004.



PRIORITY DATE OF 6-17-2004 IS CLAIMED.
OWNER OF INTERNATIONAL REGISTRATION 0841489 DATED 8-10-2004, EXPIRES 8-10-2014.

NO CLAIM IS MADE TO THE EXCLUSIVE RIGHT TO USE "SAIL RACING" AS TO INTERNATIONAL CLASS 9, APART FROM THE MARK AS SHOWN.

CLASS 9—ELECTRICAL AND SCIENTIFIC APPARATUS

FOR SCIENTIFIC, NAUTICAL, SURVEYING, PHOTOGRAPHIC, CINEMATOGRAPHIC AND OPTICAL APPARATUS AND INSTRUMENTS, NAMELY, BAROMETERS, CLINOMETERS, THERMOMETERS NOT FOR MEDICAL PURPOSES, MANOMETERS, WIND DIRECTION INDICATORS, AUTOPILOTS IN THE NATURE OF ELECTRONIC AUTOMATIC CONTROLS FOR USE IN ADJUSTING, STEERING AND KEEPING COURSES, AZIMUTH COMPASSES, DIRECTIONAL COMPASSES, SEXTANTS, THEODOLITES, ARTIFICIAL HORIZONS, PARALLEL RULES, NAVIGATIONAL PLOTTING BOARDS, EYEGLASSES, SUNGLASSES, PROTECTION MASKS, SAFETY GOGGLES, PROTECTIVE EYEWEAR; FIRE EXTINGUISHING APPARATUS; ELECTRONIC AND MECHANICAL SPEED AND DISTANCE MEASURING APPARATUS, NAMELY, TRIP LOGS, SPEED INDICATORS, AND DISTANCE-DETERMINING SENSORS; ELECTRONIC POSITIONING INSTRUMENTS, NAMELY, GLOBAL POSITIONING SYSTEM DEVICES CONSISTING OF COMPUTERS, COMPUTER SOFTWARE, TRANSMITTERS, RECEIVERS, AND NETWORK INTERFACE DEVICES; MARINE ELECTRONIC DEPTH INDICATORS; ELECTRONIC WIND INDICATORS IN THE NATURE OF ANEMOMETERS, WIND SLEEVES, WIND SOCKS FOR INDICATING WIND DIRECTION AND INTENSITY; ELECTRONIC INSTRUMENTS FOR INDICATING THE LOCATION OF FISH; ELECTRONIC NAVIGATIONAL INSTRUMENTS; LIFE JACKETS; SWIMMING JACKETS WITH A LIFE-PRESERVING FUNCTION; LIFE SAVING JACKETS AND LIFE RAFTS (U.S. CLS. 21, 23, 26, 36 AND 38).

CLASS 18—LEATHER GOODS

FOR SUITCASES, SCHOOLBAGS, MESH SHOPPING BAGS, HANDBAGS, SHOULDER BAGS, BRIEFCASES, UMBRELLAS AND WALLETS (U.S. CLS. 1, 2, 3, 22 AND 41).



OWNER OF INTERNATIONAL REGISTRATION 0842376 DATED 8-9-2004, EXPIRES 8-9-2014.
IN THE EXTREME.
FEI CHANG.

CLASS 30—STAPLE FOODS

FOR TEA; TEA BASED BEVERAGES (U.S. CL. 46).

CLASS 32—LIGHT BEVERAGES

FOR FRUIT JUICES, SHERBETS, LACTIC ACID BEVERAGES, COLA, VEGETABLE JUICES, DRINKING WATERS, GASEOUS BEVERAGES, NAMELY CARBONATED SOFT DRINKS, NON ALCOHOLIC BEVERAGES, NAMELY, NON-ALCOHOLIC BEVERAGES CONTAINING FRUIT JUICES, NON-ALCOHOLIC BEVERAGES WITH TEA FLAVOR, NON-ALCOHOLIC FRUIT JUICE BEVERAGES, FRUIT DRINKS, FRUIT FLAVORED SOFT DRINKS, FRUIT-FLAVORED BEVERAGES, LOW CALORIE SOFT DRINKS, NON-CARBONATED SOFT DRINKS, BEVERAGES OF VEGETABLE ALBUMEN, BEER, MINERAL WATER, AERATED WATER, LACTIC ACID BEVERAGE MADE OF FRUITS, SYRUPS FOR BEVERAGES (U.S. CLS. 45, 46 AND 48).

RICHARD WHITE, EXAMINING ATTORNEY

SN 79-008,705. GIVAUDAN SA, SWITZERLAND, FILED 12-16-2004.

SERENOLIDE

THE MARK CONSISTS OF STANDARD CHARACTERS WITHOUT CLAIM TO ANY PARTICULAR FONT, STYLE, SIZE, OR COLOR.

PRIORITY DATE OF 8-11-2004 IS CLAIMED.
OWNER OF INTERNATIONAL REGISTRATION 0842719 DATED 12-16-2004, EXPIRES 12-16-2014.

CLASS 1—CHEMICALS

FOR CHEMICALS USED FOR PREPARING PERFUMERY, COSMETICS, SOAP AND DETERGENT COMPOSITIONS (U.S. CLS. 1, 5, 6, 10, 26 AND 46).

CLASS 3—COSMETICS AND CLEANING PREPARATIONS

FOR PERFUMERY GOODS, PERFUMES, COSMETICS, SOAPS, DETERGENTS (U.S. CLS. 1, 4, 6, 50, 51 AND 52).
DAVID TAYLOR, EXAMINING ATTORNEY

CLASS 6—METAL GOODS

FOR METAL PARTICLES WHICH CAN BE APPLIED TO SURFACES AS A FILM BY MEANS OF A CHEMICAL PROCESS (U.S. CLS. 2, 12, 13, 14, 23, 25 AND 50).
JOHN E. MICHOS, EXAMINING ATTORNEY

SN 79-009,415. AKZO NOBEL CHEMICALS B.V., NETHERLANDS, FILED 12-17-2004.

SN 79-009,913. PARFUMS CHRISTIAN DIOR SA, FRANCE, FILED 10-18-2004.

FUZEBOX

Melanin-Off JDEline

PRIORITY DATE OF 4-23-2004 IS CLAIMED.
OWNER OF INTERNATIONAL REGISTRATION 0846405
DATED 10-18-2004, EXPIRES 10-18-2014.

THE MARK CONSISTS OF STANDARD CHARACTERS WITHOUT CLAIM TO ANY PARTICULAR FONT, STYLE, SIZE, OR COLOR.

PRIORITY DATE OF 10-29-2004 IS CLAIMED.
OWNER OF INTERNATIONAL REGISTRATION 0844971
DATED 12-17-2004, EXPIRES 12-17-2014.

CLASS 1—CHEMICALS

FOR CHEMICAL SUBSTANCES AND PRODUCTS FORMING PART OF THE COMPOSITION OF COSMETICS (U.S. CLS. 1, 5, 6, 10, 26 AND 46).

CLASS 2—PAINTS

FOR CORROSION INHIBITORS AND PRESERVATIVES AGAINST RUST (U.S. CLS. 6, 11 AND 16).

CLASS 3—COSMETICS AND CLEANING PREPARATIONS

FOR COSMETICS FOR THE FACE AND BODY (U.S. CLS. 1, 4, 6, 50, 51 AND 52).
JOHN HWANG, EXAMINING ATTORNEY

* * * * *

SECTION 2.— INTERNATIONAL CLASSIFICATION

The short titles associated below with the international class numbers are terms designed merely for quick identification and are not an official part of the international classification. The full names of international classes are given in section 6.1 of the trademark rules of practice.

The designation "U.S. Cl." appearing in this section refers to the U.S. class in effect prior to Sep. 1, 1973 rather than the international class which applies to applications filed on or after that date. For adoption of international classification see notice in the OFFICIAL GAZETTE of Jun. 26, 1973 (911 O.G. TM 210).

Application in one class

CLASS 1—CHEMICALS

SN 76-534,191. BLACK GOLD COMPOST COMPANY, OXFORD, FL. FILED 7-21-2003.

CLASS 1—(Continued).

SN 76-534,194. BLACK GOLD COMPOST COMPANY, OXFORD, FL. FILED 7-21-2003.

BLACK HEN

FOR CHEMICALS FOR AGRICULTURAL AND DOMESTIC USE; NAMELY, FERTILIZERS (U.S. CLS. 1, 5, 6, 10, 26 AND 46).

FIRST USE 1-1-1994; IN COMMERCE 3-1-1994.
RONALD AIKENS, EXAMINING ATTORNEY

BLACK VELVET

FOR CHEMICALS FOR AGRICULTURAL AND DOMESTIC USE; NAMELY, FERTILIZERS AND POTTING SOILS (U.S. CLS. 1, 5, 6, 10, 26 AND 46).

FIRST USE 3-24-1969; IN COMMERCE 3-24-1969.
RONALD AIKENS, EXAMINING ATTORNEY

SN 76-534,192. BLACK GOLD COMPOST COMPANY, OXFORD, FL. FILED 7-21-2003.

KOW POWER

NO CLAIM IS MADE TO THE EXCLUSIVE RIGHT TO USE "COW", APART FROM THE MARK AS SHOWN.

FOR CHEMICALS FOR AGRICULTURAL AND DOMESTIC USE; NAMELY, COW MANURE, COMPOST, FERTILIZER AND POTTING SOIL (U.S. CLS. 1, 5, 6, 10, 26 AND 46).

FIRST USE 2-14-2001; IN COMMERCE 2-14-2001.
RONALD AIKENS, EXAMINING ATTORNEY

SN 76-553,670. ISM, INC., WEXFORD, PA. FILED 10-23-2003.

PRO-SLAG

SN 76-534,193. BLACK GOLD COMPOST COMPANY, OXFORD, FL. FILED 7-21-2003.

BLACK KOW

NO CLAIM IS MADE TO THE EXCLUSIVE RIGHT TO USE "COW", APART FROM THE MARK AS SHOWN.

FOR CHEMICALS FOR AGRICULTURAL AND DOMESTIC USE; NAMELY, FERTILIZERS AND POTTING SOILS (U.S. CLS. 1, 5, 6, 10, 26 AND 46).

FIRST USE 3-24-1969; IN COMMERCE 3-24-1969.
RONALD AIKENS, EXAMINING ATTORNEY

THE MARK CONSISTS OF STANDARD CHARACTERS WITHOUT CLAIM TO ANY PARTICULAR FONT, STYLE, SIZE, OR COLOR.

FOR CHEMICAL PRODUCT IN THE NATURE OF AN ADDITIVE, NAMELY, MAGNESIUM OXIDE CARBON SLAG COMPOUND FOR USE IN THE MANUFACTURE OF STEEL (U.S. CLS. 1, 5, 6, 10, 26 AND 46).

FIRST USE 5-15-2002; IN COMMERCE 8-29-2002.
SCOTT BALDWIN, EXAMINING ATTORNEY

CLASS 1—(Continued).

SN 76-565,545. ATOTECH DEUTSCHLAND GMBH, BERLIN, FED REP GERMANY, FILED 12-5-2003.

UNIPREP

THE MARK CONSISTS OF STANDARD CHARACTERS WITHOUT CLAIM TO ANY PARTICULAR FONT, STYLE, SIZE, OR COLOR.

FOR CHEMICAL PRODUCTS, NAMELY, PRE-TREATMENTS, ACTIVATORS, CONVERSION COATINGS AND SEALS FOR PROMOTING ADHESION OF NON-METALLIC COATINGS SUCH AS PAINTS, POWDER COATINGS OR ANODIZING ON STEEL OR NON-FERROUS SURFACES (U.S. CLS. 1, 5, 6, 10, 26 AND 46).

FIRST USE 10-28-2003; IN COMMERCE 10-28-2003.
CHRISTOPHER BUONGIORNO, EXAMINING ATTORNEY

CLASS 1—(Continued).

SN 76-585,484. FPPF CHEMICAL CO., INC., BUFFALO, NY, FILED 4-5-2004.

MELT DOWN

THE MARK CONSISTS OF STANDARD CHARACTERS WITHOUT CLAIM TO ANY PARTICULAR FONT, STYLE, SIZE, OR COLOR.

FOR CHEMICAL ADDITIVE FOR THE TREATMENT OF DIESEL FUEL; NAMELY, AN EMERGENCY DIESEL FUEL TREATMENT ADDITIVE FOR DISSOLVING ICE AND WAX IN GELLED DIESEL FUEL (U.S. CLS. 1, 5, 6, 10, 26 AND 46).

FIRST USE 7-0-1988; IN COMMERCE 7-0-1988.
CAROLINE WOOD, EXAMINING ATTORNEY

SN 76-574,418. BLUEPLANET, LLC, ENGLEWOOD CLIFFS, NJ, FILED 2-6-2004.

AQUACLEAN

THE MARK CONSISTS OF STANDARD CHARACTERS WITHOUT CLAIM TO ANY PARTICULAR FONT, STYLE, SIZE, OR COLOR.

FOR CHEMICAL PREPARATIONS AND/OR BACTERIAL CULTURES, IN LIQUID OR DRY POWDER FORM, FOR ACCELERATING THE DECOMPOSITION OF ORGANIC WASTE (U.S. CLS. 1, 5, 6, 10, 26 AND 46).

FIRST USE 3-0-2000; IN COMMERCE 3-0-2000.
DORITT L. CARROLL, EXAMINING ATTORNEY

SN 76-586,143. FILTREXX CANADA INC., R.R. #1 PARIS, ONTARIO, CANADA, FILED 4-12-2004.

ECOSOXX

THE MARK CONSISTS OF STANDARD CHARACTERS WITHOUT CLAIM TO ANY PARTICULAR FONT, STYLE, SIZE, OR COLOR.

OWNER OF CANADA REG. NO. TMA1133894, DATED 3-25-2004, EXPIRES 3-25-2019.

FOR COMPOST CONSISTING OF DECOMPOSED ORGANIC MATTER, COMPOSTED MANURES, SEED INJECTED COMPOST (U.S. CLS. 1, 5, 6, 10, 26 AND 46).

MICHAEL WEBSTER, EXAMINING ATTORNEY

SN 76-583,902. STRATAGENE CALIFORNIA, LA JOLLA, CA, FILED 3-29-2004.

INTERPLAY

THE MARK CONSISTS OF STANDARD CHARACTERS WITHOUT CLAIM TO ANY PARTICULAR FONT, STYLE, SIZE, OR COLOR.

FOR REAGENTS FOR SCIENTIFIC RESEARCH USE (U.S. CLS. 1, 5, 6, 10, 26 AND 46).

FIRST USE 3-1-2004; IN COMMERCE 3-1-2004.
ANDREW RHIM, EXAMINING ATTORNEY

SN 76-605,172. FLORALIFE, INC., WALTERBORO, SC, FILED 8-2-2004.

EZ DOSE

THE MARK CONSISTS OF STANDARD CHARACTERS WITHOUT CLAIM TO ANY PARTICULAR FONT, STYLE, SIZE, OR COLOR.

NO CLAIM IS MADE TO THE EXCLUSIVE RIGHT TO USE "DOSE", APART FROM THE MARK AS SHOWN.

FOR FLOWER FOOD (U.S. CLS. 1, 5, 6, 10, 26 AND 46).
DORITT L. CARROLL, EXAMINING ATTORNEY

CLASS 1—(Continued).

SN 76-606,211. SUN & SOIL LLC, LOVELAND, OH. FILED 8-9-2004.

SOLAR SHIELD

THE MARK CONSISTS OF STANDARD CHARACTERS WITHOUT CLAIM TO ANY PARTICULAR FONT, STYLE, SIZE, OR COLOR.

NO CLAIM IS MADE TO THE EXCLUSIVE RIGHT TO USE SOLAR, APART FROM THE MARK AS SHOWN.

FOR CHEMICALS USED IN MANUFACTURING TO PROVIDE A PROTECTIVE COATING TO TEXTILE AND FABRIC MATERIALS FOR INTERIOR USE, NAMELY, CARPETS, RUGS, UPHOLSTERED FURNITURE, DRAPERIES, SPREADS, WALL COVERINGS, PILLOWS, AND VEHICLE INTERIORS (U.S. CLS. 1, 5, 6, 10, 26 AND 46).
JOHN LINCOSKI, EXAMINING ATTORNEY

SN 76-608,438. ECOSORB INTERNATIONAL, INC., HOUSTON, TX. FILED 8-24-2004.

ECOFIBER

THE MARK CONSISTS OF STANDARD CHARACTERS WITHOUT CLAIM TO ANY PARTICULAR FONT, STYLE, SIZE, OR COLOR.

FOR CELLULOSE (U.S. CLS. 1, 5, 6, 10, 26 AND 46).
FIRST USE 9-14-1993; IN COMMERCE 11-22-1993.
APRIL L. RADEMACHER, EXAMINING ATTORNEY

SN 76-609,221. CHEMICAL COMPANY OF AMERICA, DETROIT, MI. FILED 8-26-2004.

CHEMCOA

THE MARK CONSISTS OF STANDARD CHARACTERS WITHOUT CLAIM TO ANY PARTICULAR FONT, STYLE, SIZE, OR COLOR.

FOR CHEMICALS FOR USE IN INDUSTRY (U.S. CLS. 1, 5, 6, 10, 26 AND 46).
FIRST USE 8-30-1966; IN COMMERCE 9-10-1966.
DARRYL SPRUILL, EXAMINING ATTORNEY

CLASS 1—(Continued).

SN 76-615,344. ADVANCED FLUID SOLUTIONS, LLC, ADDISON, TX. FILED 10-12-2004.

JUST POUR IT IN

THE MARK CONSISTS OF STANDARD CHARACTERS WITHOUT CLAIM TO ANY PARTICULAR FONT, STYLE, SIZE, OR COLOR.

FOR CHEMICAL ADDITIVES FOR FUEL AND OIL TREATMENT (U.S. CLS. 1, 5, 6, 10, 26 AND 46).

FIRST USE 9-17-2004; IN COMMERCE 9-17-2004.
ROBERT LORENZO, EXAMINING ATTORNEY

SN 76-616,280. WORLD WIDE IMPORTS ENTERPRISES, INC., FT. LAUDERDALE, FL. FILED 10-18-2004.

LIVE

THE MARK CONSISTS OF STANDARD CHARACTERS WITHOUT CLAIM TO ANY PARTICULAR FONT, STYLE, SIZE, OR COLOR.

FOR SALTWATER, SEAWATER, OCEAN WATER AND FRESHWATER SOLUTIONS, NAMELY SALTWATER, SEAWATER, OCEAN WATER, FRESHWATER, CONCENTRATED SALTWATER, CONCENTRATED SEAWATER, CONCENTRATED OCEAN WATER, AND CONCENTRATED FRESH WATER, EACH ENRICHED WITH PRESERVATIVES AND SOLD IN RETAIL CONTAINERS FOR USE IN FILLING AQUARIUMS DURING INITIAL SET-UP, FOR REPLACING WATER LOST TO EVAPORATION, AND FOR AQUARIUM WATER CHANGES (U.S. CLS. 1, 5, 6, 10, 26 AND 46).

FIRST USE 10-0-2003; IN COMMERCE 10-0-2003.
ELLEN BURNS, EXAMINING ATTORNEY

SN 76-616,368. CLINICAL DATA, INC., NEWTON, MA. FILED 10-18-2004.

Accu-Sed

THE MARK CONSISTS OF STANDARD CHARACTERS WITHOUT CLAIM TO ANY PARTICULAR FONT, STYLE, SIZE, OR COLOR.

FOR DIAGNOSTIC PREPARATIONS OR REAGENTS FOR MAINTAINING QUALITY CONTROL OF APPARATUS AND MEDICAL INSTRUMENTS USED FOR CLINICAL ANALYSIS AND IN MEDICAL LABORATORIES (U.S. CLS. 1, 5, 6, 10, 26 AND 46).

FIRST USE 1-0-2001; IN COMMERCE 1-0-2001.
HENRY S. ZAK, EXAMINING ATTORNEY

CLASS 1—(Continued).

SN 76-616,538. AMERICAN HARLEQUIN CORPORATION, MOORESTOWN, NJ. FILED 10-18-2004.

Confidance

THE MARK CONSISTS OF STANDARD CHARACTERS WITHOUT CLAIM TO ANY PARTICULAR FONT, STYLE, SIZE, OR COLOR.
FOR LIQUID CHEMICAL PREPARATION FOR USE ON HARD SURFACES TO IMPROVE TRACTION THEREON (U.S. CLS. 1, 5, 6, 10, 26 AND 46).
FIRST USE 6-10-2004; IN COMMERCE 6-10-2004.
ANDREA K. NADELMAN, EXAMINING ATTORNEY

SN 76-617,058. MILLENNIUM ADHESIVE PRODUCTS INCORPORATED, CHAGRIN FALLS, OH. FILED 10-18-2004.

HURRICANE FORCE

THE MARK CONSISTS OF STANDARD CHARACTERS WITHOUT CLAIM TO ANY PARTICULAR FONT, STYLE, SIZE, OR COLOR.
FOR ROOFING ADHESIVES (U.S. CLS. 1, 5, 6, 10, 26 AND 46).
FIRST USE 3-20-2000; IN COMMERCE 8-28-2000.
ALLISON HOLTZ, EXAMINING ATTORNEY

SN 76-618,216. MAGCO INCORPORATED, CLARKS GREEN, PA. FILED 10-26-2004.



FOR CHEMICAL PREPARATIONS FOR MELTING ICE AND SNOW (U.S. CLS. 1, 5, 6, 10, 26 AND 46).
FIRST USE 9-3-2004; IN COMMERCE 9-3-2004.
JENNIFER CHICOSKI, EXAMINING ATTORNEY

CLASS 1—(Continued).

SN 76-619,401. STRATAGENE CALIFORNIA, LA JOLLA, CA. FILED 11-4-2004.

PFUULTRA

THE MARK CONSISTS OF STANDARD CHARACTERS WITHOUT CLAIM TO ANY PARTICULAR FONT, STYLE, SIZE, OR COLOR.
FOR REAGENTS FOR USE IN SCIENTIFIC RESEARCH (U.S. CLS. 1, 5, 6, 10, 26 AND 46).
FIRST USE 8-26-2002; IN COMMERCE 8-26-2002.
HENRY S. ZAK, EXAMINING ATTORNEY

SN 76-625,841. MACLAREN, DAVID S., CLEVELAND, OH. FILED 12-27-2004.

BIO JET 7

THE MARK CONSISTS OF STANDARD CHARACTERS WITHOUT CLAIM TO ANY PARTICULAR FONT, STYLE, SIZE, OR COLOR.
NO CLAIM IS MADE TO THE EXCLUSIVE RIGHT TO USE "7", APART FROM THE MARK AS SHOWN.
FOR LIQUID SOLUTION OF MICRO-ORGANISMS FOR ADDITION TO SEWAGE SYSTEMS (U.S. CLS. 1, 5, 6, 10, 26 AND 46).
FIRST USE 12-22-1981; IN COMMERCE 12-22-1981.
YSA DEJESUS, EXAMINING ATTORNEY

SN 76-625,913. HASA, INC., SAUGUS, CA. FILED 12-27-2004.

SUPER STAIN-OUT

THE MARK CONSISTS OF STANDARD CHARACTERS WITHOUT CLAIM TO ANY PARTICULAR FONT, STYLE, SIZE, OR COLOR.
FOR LIQUID COMPOUNDS FOR APPLICATION TO SURFACES OF SWIMMING POOLS AND SPAS FOR PREVENTING AND REMOVING STAINS DUE TO METALS PRESENT IN WATER (U.S. CLS. 1, 5, 6, 10, 26 AND 46).
FIRST USE 8-0-1985; IN COMMERCE 8-0-1985.
ZACHARY BELLO, EXAMINING ATTORNEY

CLASS 1—(Continued).

SN 78-245,467. INSECTIGEN, INC., ATHENS, GA. FILED 5-5-2003.

INSECTIGEN

FOR REAGENTS FOR SCIENTIFIC OR MEDICAL RESEARCH USE (U.S. CLS. 1, 5, 6, 10, 26 AND 46).
CAROLYN GRAY, EXAMINING ATTORNEY

SN 78-298,528. BLANVER FARMOQUIMICA, LTDA., COTIA, BRAZIL, FILED 9-10-2003.

TABULOSE

FOR CHEMICAL AUXILIARIES AND RAW MATERIAL DIRECTED EXCLUSIVELY TO THE WHOLESALE MARKET, NAMELY MICROCRYSTALLINE CELLULOSE POWDER FOR USE AS A COMPRESSION AND COMPACTION AGENT, BINDER AGGLUTINANT, CONSISTENCY AGENT, DISPERSANT, ABSORBENT, SUSPENSION AGENT, THICKENER, VISCOSITY AGENT, OPACIFIER, EMULSIFIER, AND STABILIZER ALL IN THE MANUFACTURE OF PHARMACEUTICALS AND DRUG PRODUCTS (U.S. CLS. 1, 5, 6, 10, 26 AND 46).
FIRST USE 8-14-1990; IN COMMERCE 9-21-1990.
NELSON SNYDER, EXAMINING ATTORNEY

SN 78-299,220. SIGMA-ALDRICH BIOTECHNOLOGY L.P., ST. LOUIS, MO. FILED 9-11-2003.

ILAP

FOR DIAGNOSTIC REAGENTS FOR SCIENTIFIC OR RESEARCH USE, NAMELY, FOR USE IN PROTEIN DETECTION, SEPARATION, PURIFICATION AND ANALYSIS PROCEDURES, NAMELY, AFFINITY GELS, MAGNETIC MICROPARTICLES, AND REAGENT-COATED MULTIWELL PLATES ALL FOR USE IN ANALYZING BIOLOGICAL ASSAYS; CHROMATOGRAPHY CHEMICALS FOR USE IN PROTEIN DETECTION, SEPARATION, PURIFICATION AND ANALYSIS PROCEDURES, NAMELY, AFFINITY GELS, MAGNETIC MICROPARTICLES, CHEMICAL-COATED MULTIWELL PLATES AND CHEMICAL BUFFERS, ALL FOR USE IN ANALYZING BIOLOGICAL ASSAYS (U.S. CLS. 1, 5, 6, 10, 26 AND 46).
LINDA M. KING, EXAMINING ATTORNEY

CLASS 1—(Continued).

SN 78-365,379. CASITE INTRACO, L.L.C., TROY, MI. FILED 2-10-2004.

INJECTOR STING

THE MARK CONSISTS OF STANDARD CHARACTERS WITHOUT CLAIM TO ANY PARTICULAR FONT, STYLE, SIZE, OR COLOR.

NO CLAIM IS MADE TO THE EXCLUSIVE RIGHT TO USE "INJECTOR", APART FROM THE MARK AS SHOWN.

FOR CHEMICAL ADDITIVES FOR USE IN CONNECTION WITH INTERNAL COMBUSTION ENGINE FLUIDS (U.S. CLS. 1, 5, 6, 10, 26 AND 46).

FIRST USE 2-27-1996; IN COMMERCE 2-27-1996.
ANNE MADDEN, EXAMINING ATTORNEY

SN 78-381,398. VICTORIAN CHEMICALS INTERNATIONAL PTY LTD, RICHMOND VIC 3121, AUSTRALIA, FILED 3-10-2004.

VICTORIA

THE MARK CONSISTS OF STANDARD CHARACTERS WITHOUT CLAIM TO ANY PARTICULAR FONT, STYLE, SIZE, OR COLOR.

FOR FRUIT DRYING COMPOSITIONS (U.S. CLS. 1, 5, 6, 10, 26 AND 46).

FIRST USE 6-18-2001; IN COMMERCE 6-18-2001.
SCOTT BALDWIN, EXAMINING ATTORNEY

CLASS 1—(Continued).

SN 78-396,750. BLACKWELL, CHARLES M., FREDERICKSBURG, TX. FILED 4-5-2004.

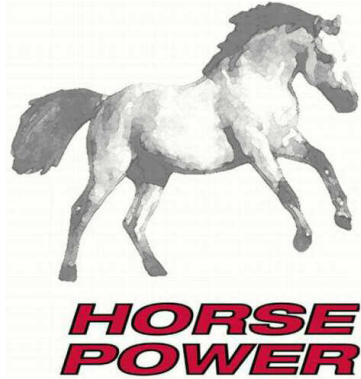

THE COLOR(S) GRAY, WHITE, RED AND BLACK IS/ ARE CLAIMED AS A FEATURE OF THE MARK.

THE COLORS GRAY AND WHITE APPEAR IN THE HORSE DESIGN AND THE COLORS RED AND BLACK APPEAR IN THE WORDING HORSE POWER WITH THE STYLIZED LETTERS APPEARING IN RED WITH BLACK TRIM.

FOR ODOR ELIMINATING TABLETS COMPRISED OF MICROORGANISMS AND ENZYMES TO BE DISSOLVED IN WATER AND USED TO DIGEST ORGANIC WASTE (U.S. CLS. 1, 5, 6, 10, 26 AND 46).

FIRST USE 10-1-1997; IN COMMERCE 8-15-2003.
MARK T. MULLEN, EXAMINING ATTORNEY

CLASS 1—(Continued).

SN 78-418,960. QUANTUM TECHNOLOGIES, INC., MADISON, NE. FILED 5-14-2004.

UVMAX

THE MARK CONSISTS OF STANDARD CHARACTERS WITHOUT CLAIM TO ANY PARTICULAR FONT, STYLE, SIZE, OR COLOR.

FOR CHEMICAL AGENTS FOR COATING OF TEXTILE FABRICS AND NONWOVEN STRAPPING FOR PROVIDING PROTECTION FROM ULTRAVIOLET RADIATION (U.S. CLS. 1, 5, 6, 10, 26 AND 46).

FIRST USE 1-31-2004; IN COMMERCE 4-16-2004.
RUSS HERMAN, EXAMINING ATTORNEY

SN 78-425,146. AMERSHAM BIOSCIENCES UK LIMITED, LITTLE CHALFONT, BUCKINGHAMSHIRE, UNITED KINGDOM, FILED 5-26-2004.

SN 78-406,509. THE GLIDDEN COMPANY, STRONGSVILLE, OH. FILED 4-22-2004.

BUILDER'S CHOICE

CYTOCY5S

THE MARK CONSISTS OF STANDARD CHARACTERS WITHOUT CLAIM TO ANY PARTICULAR FONT, STYLE, SIZE, OR COLOR.

NO CLAIM IS MADE TO THE EXCLUSIVE RIGHT TO USE "BUILDER'S", APART FROM THE MARK AS SHOWN. FOR CONSTRUCTION ADHESIVES (U.S. CLS. 1, 5, 6, 10, 26 AND 46).

FIRST USE 12-31-1996; IN COMMERCE 12-31-1996.
ANNE FARRELL, EXAMINING ATTORNEY

THE MARK CONSISTS OF STANDARD CHARACTERS WITHOUT CLAIM TO ANY PARTICULAR FONT, STYLE, SIZE, OR COLOR.

OWNER OF U.S. REG. NO. 2,768,701.
FOR CHEMICAL REAGENTS, NAMELY, CYANINE AND FLOURESCENT DYES FOR LABELING NUCLEOTIDES AND PROTEINS FOR SCIENTIFIC AND RESEARCH USE (U.S. CLS. 1, 5, 6, 10, 26 AND 46).

MONIQUE MILLER, EXAMINING ATTORNEY

CLASS 1—(Continued).

SN 78-428,616. FUSION 360, TURLOCK, CA. FILED 6-2-2004.



THE MARK CONSISTS OF FLOWER/LEAF/VEGETABLE DESIGN.

FOR CHEMICALS, NAMELY MICROBIAL NUTRIENT COMPOSITIONS FOR AGRICULTURAL AND DOMESTIC USE AND PLANT FOOD BLENDS OF MINERALS AND NUTRIENTS FOR AGRICULTURAL AND DOMESTIC USE (U.S. CLS. 1, 5, 6, 10, 26 AND 46).

FIRST USE 1-0-2002; IN COMMERCE 1-0-2002.
MARGERY A. TIERNEY, EXAMINING ATTORNEY

CLASS 1—(Continued).

SN 78-437,361. SUNBURST PLANT DISEASE CLINIC, INC., TURLOCK, CA. FILED 6-17-2004.

THE FUTURE OF AGRICULTURE

THE MARK CONSISTS OF STANDARD CHARACTERS WITHOUT CLAIM TO ANY PARTICULAR FONT, STYLE, SIZE, OR COLOR.

NO CLAIM IS MADE TO THE EXCLUSIVE RIGHT TO USE AGRICULTURE, APART FROM THE MARK AS SHOWN.

FOR CHEMICALS, NAMELY MICROBIAL NUTRIENT COMPOSITIONS FOR AGRICULTURAL AND DOMESTIC USE AND PLANT FOOD BLENDS FOR AGRICULTURAL AND DOMESTIC USE (U.S. CLS. 1, 5, 6, 10, 26 AND 46).

FIRST USE 11-0-1999; IN COMMERCE 11-0-1999.
CHRISIE B. KING, EXAMINING ATTORNEY

SN 78-433,317. INSULECTRO, LAKE FOREST, CA. FILED 6-10-2004.



FOR INDUSTRIAL CHEMICALS FOR PROCESSING PRINTED CIRCUIT BOARDS (U.S. CLS. 1, 5, 6, 10, 26 AND 46).

FIRST USE 1-8-2003; IN COMMERCE 1-8-2003.
REBECCA GILBERT, EXAMINING ATTORNEY

SN 78-438,943. FOSTER POULTRY FARMS, DBA FOSTER FARMS, LIVINGSTON, CA. FILED 6-21-2004.

ORGANIC FARMS

THE MARK CONSISTS OF STANDARD CHARACTERS WITHOUT CLAIM TO ANY PARTICULAR FONT, STYLE, SIZE, OR COLOR.

OWNER OF U.S. REG. NO. 1,376,451.
SEC. 2(F).
FOR CHICKEN MANURE SOLD AS FERTILIZER (U.S. CLS. 1, 5, 6, 10, 26 AND 46).

FIRST USE 2-9-1982; IN COMMERCE 4-21-1982.
WINSTON FOLMAR, EXAMINING ATTORNEY

CLASS 1—(Continued).

SN 78-443,154. GATTEFOSSE SAS, 69800 SAINT-PRIEST, FRANCE, FILED 6-29-2004.

EMULIUM

THE MARK CONSISTS OF STANDARD CHARACTERS WITHOUT CLAIM TO ANY PARTICULAR FONT, STYLE, SIZE, OR COLOR.

OWNER OF ERPN CMNTY TM OFC REG. NO. 003838588, DATED 5-21-2004, EXPIRES 5-21-2019.

FOR CHEMICAL PREPARATIONS, NAMELY, TEXTURES, BASES, INGREDIENTS AND EMULSIFIERS FOR THE MANUFACTURE OF COSMETIC PRODUCTS (U.S. CLS. 1, 5, 6, 10, 26 AND 46).

JOHN E. MICHOS, EXAMINING ATTORNEY

SN 78-452,136. GORDON, TONYA R, GRANTS PASS, OR. FILED 7-16-2004.



NO CLAIM IS MADE TO THE EXCLUSIVE RIGHT TO USE "THE RECYCLING SYMBOL AND THE WORDING MADE IN OREGON", APART FROM THE MARK AS SHOWN.

THE COLORS BLACK, BROWN, GOLD, YELLOW, GREEN, LIGHT GREEN, LIGHT BLUE, MEDIUM BLUE, BLUE, BRIGHT BLUE, ORANGE, RED, AND PURPLE IS/ ARE CLAIMED AS A FEATURE OF THE MARK.

THE SUNFLOWER CENTER AND OUTER CIRCLE DESIGN ELEMENT ARE OUTLINED IN BLACK AND COLORED BROWN. THE SUNFLOWER'S PETALS ARE GOLD AND YELLOW. THE STEM AND ROOTS ARE GREEN. THE LANDSCAPE BACKGROUND WITHIN THE CIRCLE IS DIVIDED INTO 4 SECTIONS, THE HIGHEST BEING LIGHT BLUE, THE NEXT BEING MEDIUM BLUE, THE NEXT BEING BLUE AND THE LOWEST BEING LIGHT GREEN.

CLASS 1—(Continued).

THE BUTTERFLY IS ORANGE WITH YELLOW AND RED CIRCLES ON THE WINGS. THE LETTER "G" OF GARDEN IS GREEN. THE LETTER "A" IS RED. THE LETTER "R" IS YELLOW. THE LETTER "D" IS BRIGHT BLUE. THE LETTER "E" IS PURPLE AND THE LETTER "N" IN ORANGE. THE WORD GROUNDS IS SHOWN IN BLACK EXCEPT FOR THE LETTER "O" WHICH IS REPRESENTED BY A RECYCLING SYMBOL SHOWN IN BROWN. THE WORDING PERK UP YOUR PLANTS MADE IN OREGON IS SHOWN IN BROWN.

FOR ALL NATURAL GARDEN SOIL AMENDMENT MADE OF RECYCLED COFFEE GROUNDS, ORGANIC FERTILIZER, AMINO ACIDS, CARBOHYDRATES AND MYCORRHIZAL FUNGI (U.S. CLS. 1, 5, 6, 10, 26 AND 46).

FIRST USE 8-1-2003; IN COMMERCE 9-1-2003.
TRACY FLETCHER, EXAMINING ATTORNEY

SN 78-453,153. OGDEN, TONI, PEACHTREE CITY, GA. FILED 7-20-2004.

DOGGIE BE GOOD

THE MARK CONSISTS OF STANDARD CHARACTERS WITHOUT CLAIM TO ANY PARTICULAR FONT, STYLE, SIZE, OR COLOR.

FOR CHEMICAL SPRAY TO AID IN BEHAVIOR MODIFICATION OF DOGS (U.S. CLS. 1, 5, 6, 10, 26 AND 46).

ALICE SUE CARRUTHERS, EXAMINING ATTORNEY

SN 78-455,644. LABORATORIO JAER, S.A., BARCELONA, SPAIN, FILED 7-23-2004.

SOYGREEN

THE MARK CONSISTS OF STANDARD CHARACTERS WITHOUT CLAIM TO ANY PARTICULAR FONT, STYLE, SIZE, OR COLOR.

FOR CHEMICAL PRODUCTS USED IN AGRICULTURE, NAMELY, CHEMICAL PREPARATIONS FOR THE TREATMENT OF SEEDS, SOIL AND WATER; FERTILIZERS FOR SOIL (U.S. CLS. 1, 5, 6, 10, 26 AND 46).

LOURDES AYALA, EXAMINING ATTORNEY

CLASS 1—(Continued).

SN 78-459,354. CLEARWATER INTERNATIONAL, L.L.C., HOUSTON, TX. FILED 7-30-2004.

CLEAR FLOW

THE MARK CONSISTS OF STANDARD CHARACTERS WITHOUT CLAIM TO ANY PARTICULAR FONT, STYLE, SIZE, OR COLOR.

OWNER OF U.S. REG. NO. 2,793,776.
FOR CHEMICAL ADDITIVE, NAMELY A DIESEL FUEL POUR POINT DEPRESSANT (U.S. CLS. 1, 5, 6, 10, 26 AND 46).

FIRST USE 3-27-2001; IN COMMERCE 3-27-2001.
PAULA MAHONEY, EXAMINING ATTORNEY

CLASS 1—(Continued).

SN 78-467,755. GREENSTONE INC. OF DELAWARE, NEW YORK, NY. FILED 8-16-2004.

GreenStone

THE MARK CONSISTS OF STANDARD CHARACTERS WITHOUT CLAIM TO ANY PARTICULAR FONT, STYLE, SIZE, OR COLOR.

FOR FIRE RETARDANT CHEMICALS FOR TREATING WOOD AND PAPER BASED BUILDING MATERIAL FOR THE PREVENTION OF DAMAGE CAUSED BY MOLD, MILDEW, TERMITES, PESTS, MOISTURE, AND ROT (U.S. CLS. 1, 5, 6, 10, 26 AND 46).

MARIAM MAHMOUDI, EXAMINING ATTORNEY

SN 78-466,993. UAP LIMITED, LANCASHIRE, UNITED KINGDOM, FILED 8-13-2004.

GLASSMASTER

THE MARK CONSISTS OF STANDARD CHARACTERS WITHOUT CLAIM TO ANY PARTICULAR FONT, STYLE, SIZE, OR COLOR.

PRIORITY CLAIMED UNDER SEC. 44(D) ON UNITED KINGDOM APPLICATION NO. 2362252, FILED 4-30-2004, REG. NO. 2362252, DATED 4-30-2004, EXPIRES 4-30-2014.

FOR ADHESIVES, OTHER THAN FOR STATIONERY OR HOUSEHOLD PURPOSES; ADHESIVES FOR USE IN BONDING GLASS (U.S. CLS. 1, 5, 6, 10, 26 AND 46).

AMY HELLA, EXAMINING ATTORNEY

SN 78-471,094. VENTANA MEDICAL SYSTEMS INC., TUCSON, AZ. FILED 8-20-2004.

VENTANADX

THE MARK CONSISTS OF STANDARD CHARACTERS WITHOUT CLAIM TO ANY PARTICULAR FONT, STYLE, SIZE, OR COLOR.

OWNER OF U.S. REG. NO. 1,796,632.
THE FOREIGN WORDING IN THE MARK TRANSLATES INTO ENGLISH AS WINDOW.

FOR DIAGNOSTIC AND PROGNOSTIC REAGENTS FOR SCIENTIFIC OR RESEARCH USE SOLD ALONE OR IN KITS COMPRISED OF REAGENTS AND IMMUNODIAGNOSTICS; DIAGNOSTIC AND PROGNOSTIC PREPARATIONS FOR SCIENTIFIC OR RESEARCH USE (U.S. CLS. 1, 5, 6, 10, 26 AND 46).

FLORENTINA BLANDU, EXAMINING ATTORNEY

CLASS 1—(Continued).

SN 78-485,589. CYTEC TECHNOLOGY CORP., WILMINGTON, DE. FILED 9-17-2004.

CLASS 1—(Continued).

SN 78-488,776. CYTEC TECHNOLOGY CORP., WILMINGTON, DE. FILED 9-23-2004.

CY-TEMP

MAX HT

THE MARK CONSISTS OF STANDARD CHARACTERS WITHOUT CLAIM TO ANY PARTICULAR FONT, STYLE, SIZE, OR COLOR.

FOR DRILLING MUD ADDITIVE USED IN THE EXPLORATION AND PRODUCTION OF OIL AND GAS (U.S. CLS. 1, 5, 6, 10, 26 AND 46).

SKYE YOUNG, EXAMINING ATTORNEY

THE MARK CONSISTS OF STANDARD CHARACTERS WITHOUT CLAIM TO ANY PARTICULAR FONT, STYLE, SIZE, OR COLOR.

FOR SODALITE SCALE CONTROL REAGENT FOR USE IN INDUSTRIES WHICH PROCESS BAUXITE INTO ALUMINA (U.S. CLS. 1, 5, 6, 10, 26 AND 46).

JENNIFER KRISP, EXAMINING ATTORNEY

SN 78-486,987. KIWA BIO-TECH PRODUCTS GROUP CORP., CITY OF INDUSTRY, CA. FILED 9-21-2004.

SN 78-490,231. SHELL TRADEMARK MANAGEMENT B. V., HOUSTON, TX. FILED 9-27-2004.



**SHELL INDUSTRIAL
ELC**

THE COLOR(S) GREEN AND WHITE IS/ARE CLAIMED AS A FEATURE OF THE MARK.

THE MARK CONSISTS OF A STYLIZED LETTER "K" IN WHITE, ENCLOSED BY A STYLIZED LETTER "B" IS ALTERNATING GREEN AND WHITE STRIPES.

FOR ORGANIC PLANT FERTILIZER (U.S. CLS. 1, 5, 6, 10, 26 AND 46).

FIRST USE 11-21-2002; IN COMMERCE 6-15-2003.
MARY ROSSMAN, EXAMINING ATTORNEY

THE MARK CONSISTS OF STANDARD CHARACTERS WITHOUT CLAIM TO ANY PARTICULAR FONT, STYLE, SIZE, OR COLOR.

OWNER OF U.S. REG. NOS. 375,560, 2,932,728 AND OTHERS.

NO CLAIM IS MADE TO THE EXCLUSIVE RIGHT TO USE "INDUSTRIAL ELC", APART FROM THE MARK AS SHOWN.

FOR COOLANT, NAMELY ANTI-FREEZE (U.S. CLS. 1, 5, 6, 10, 26 AND 46).

FIRST USE 6-0-2001; IN COMMERCE 6-0-2001.
JOHN GARTNER, EXAMINING ATTORNEY

CLASS 1—(Continued).

SN 78-491,588. FLEXTILE, LTD., ETOBICOKE, CANADA, FILED 9-29-2004.

CLASS 1—(Continued).

SN 78-498,921. ARKEMA, INC., PHILADELPHIA, PA. FILED 10-13-2004.

FLEXFRESH

BIOMET

THE MARK CONSISTS OF STANDARD CHARACTERS WITHOUT CLAIM TO ANY PARTICULAR FONT, STYLE, SIZE, OR COLOR.

FOR ANTIMICROBIAL CHEMICAL ADDITIVE USED IN THE MANUFACTURE OF VINYL COMPOSITION TILE, ADHESIVE, MORTARS AND GROUTS FOR CERAMIC TILES (U.S. CLS. 1, 5, 6, 10, 26 AND 46). DANIEL CAPSHAW, EXAMINING ATTORNEY

THE MARK CONSISTS OF STANDARD CHARACTERS WITHOUT CLAIM TO ANY PARTICULAR FONT, STYLE, SIZE, OR COLOR.

OWNER OF U.S. REG. NOS. 786,983 AND 1,464,233. FOR CHEMICALS AND CHEMICAL COMPOSITIONS FOR USE IN FUNGICIDES, BACTERICIDES, MICROBICIDES AND ANTI-FOULANTS, FOR THE CONTROL OF SLIME, ALGAE AND FUNGI IN INDUSTRIAL AND/OR COMMERCIAL WATER COOLING SYSTEMS, EVAPORATIVE CONDENSER WATER COOLING SYSTEMS, AND OILFIELD AND PETROCHEMICAL WATER SUB-SURFACE INJECTION SYSTEMS; AND FOR USE IN WOOD PRESERVATIVES, MILDEW CONTROL AGENTS AND PESTICIDES FOR AGRICULTURAL APPLICATIONS (U.S. CLS. 1, 5, 6, 10, 26 AND 46). FIRST USE 6-5-1998; IN COMMERCE 6-5-1998. MELVIN AXILBUND, EXAMINING ATTORNEY

SN 78-493,250. STEWART SUPERIOR CORPORATION, SAN LEANDRO, CA. FILED 10-1-2004.

SN 78-499,726. BIOLAB SERVICES, INC., WILMINGTON, DE. FILED 10-14-2004.

SUPERIOR CLEAR

CHLOREXTRA

THE MARK CONSISTS OF STANDARD CHARACTERS WITHOUT CLAIM TO ANY PARTICULAR FONT, STYLE, SIZE, OR COLOR.

NO CLAIM IS MADE TO THE EXCLUSIVE RIGHT TO USE "CLEAR", APART FROM THE MARK AS SHOWN. FOR CHEMICALS, NAMELY, PHOTOPOLYMER LIQUIDS USED IN THE MANUFACTURE OF 3-DIMENSIONAL DIE FOR STAMPING APPARATUS (U.S. CLS. 1, 5, 6, 10, 26 AND 46). SHAUNIA WALLACE, EXAMINING ATTORNEY

THE MARK CONSISTS OF STANDARD CHARACTERS WITHOUT CLAIM TO ANY PARTICULAR FONT, STYLE, SIZE, OR COLOR.

FOR WATER TREATMENT CHEMICALS FOR SWIMMING POOLS, SPAS AND HOT TUBS (U.S. CLS. 1, 5, 6, 10, 26 AND 46). MITCHELL FRONT, EXAMINING ATTORNEY

CLASS 1—(Continued).

SN 78-499,827. ASSAY DESIGNS, INC., ANN ARBOR, MI.
FILED 10-14-2004.

CLASS 1—(Continued).

SN 78-501,337. NEOGEN CORPORATION, LANSING, MI.
FILED 10-18-2004.

FlashLight

ACCUCLEAN

THE MARK CONSISTS OF STANDARD CHARACTERS
WITHOUT CLAIM TO ANY PARTICULAR FONT, STYLE,
SIZE, OR COLOR.

FOR CHEMICAL REAGENTS FOR SCIENTIFIC AND
RESEARCH USE (U.S. CLS. 1, 5, 6, 10, 26 AND 46).
FIRST USE 9-10-1991; IN COMMERCE 10-4-1991.
DOMINIC J. FERRAIUOLO, EXAMINING ATTORNEY

THE MARK CONSISTS OF STANDARD CHARACTERS
WITHOUT CLAIM TO ANY PARTICULAR FONT, STYLE,
SIZE, OR COLOR.

FOR KITS WITH CHEMICALS FOR THE DETECTION
OF LACK OF SANITATION ON ENVIRONMENTAL
SURFACES COMPRISING CHEMICAL REAGENTS
(U.S. CLS. 1, 5, 6, 10, 26 AND 46).
KELLY BOULTON, EXAMINING ATTORNEY

SN 78-499,833. ASSAY DESIGNS, INC., ANN ARBOR, MI.
FILED 10-14-2004.

SN 78-503,365. PENNZOIL-QUAKER STATE COMPANY,
HOUSTON, TX. FILED 10-21-2004.

PhotoLight

ICE-X

THE MARK CONSISTS OF STANDARD CHARACTERS
WITHOUT CLAIM TO ANY PARTICULAR FONT, STYLE,
SIZE, OR COLOR.

FOR BIOLUMINESCENT REAGENTS FOR SCIENTIFIC
AND RESEARCH USE (U.S. CLS. 1, 5, 6, 10, 26 AND
46).
FIRST USE 9-30-2000; IN COMMERCE 9-30-2000.
DOMINIC J. FERRAIUOLO, EXAMINING ATTORNEY

THE MARK CONSISTS OF STANDARD CHARACTERS
WITHOUT CLAIM TO ANY PARTICULAR FONT, STYLE,
SIZE, OR COLOR.

FOR WINDSHIELD ANTIFREEZE FLUIDS (U.S. CLS.
1, 5, 6, 10, 26 AND 46).
FIRST USE 6-15-1999; IN COMMERCE 6-15-1999.
CHRISIE B. KING, EXAMINING ATTORNEY

CLASS 1—(Continued).

SN 78-505,333. ORGANISOIL, LLC., MASON CITY, IA. FILED 10-25-2004.

Soil Liberator

THE MARK CONSISTS OF STANDARD CHARACTERS WITHOUT CLAIM TO ANY PARTICULAR FONT, STYLE, SIZE, OR COLOR.
 NO CLAIM IS MADE TO THE EXCLUSIVE RIGHT TO USE "SOIL", APART FROM THE MARK AS SHOWN.
 FOR SOIL AMENDMENT / FERTILIZER (U.S. CLS. 1, 5, 6, 10, 26 AND 46).
 RONALD MCMORROW, EXAMINING ATTORNEY

SN 78-509,463. KNOWLES, ART, ANDALUSIA, AL. FILED 11-1-2004.

PROAid

THE MARK CONSISTS OF STANDARD CHARACTERS WITHOUT CLAIM TO ANY PARTICULAR FONT, STYLE, SIZE, OR COLOR.
 FOR CHEMICAL ADDITIVE, NAMELY, POLARIZED REFRIGERANT OIL ADDITIVE (PROA), THAT IS ESPECIALLY DESIGNED TO IMPROVE THE EFFICIENCY OF AIR-CONDITIONERS, CHILLERS, HEAT PUMPS, AND REFRIGERATION SYSTEMS, WHICH COATS THE METAL SURFACE OF A COMPRESSOR WITH A FILM THAT IS ONE MOLECULE THICK AND INCREASES THE LUBRICATING ABILITY OF THE REFRIGERANT OIL AND DISPLACES THE BUILD-UP OF OIL IN CONDENSER AND EVAPORATOR COILS RESULTING IN SAVINGS IN ENERGY CONSUMPTION, REDUCED MAINTENANCE AND EXTENDED LIFE OF THE EQUIPMENT (U.S. CLS. 1, 5, 6, 10, 26 AND 46).
 FIRST USE 6-13-2002; IN COMMERCE 6-13-2002.
 APRIL L. RADEMACHER, EXAMINING ATTORNEY

CLASS 1—(Continued).

SN 78-516,235. STRECK LABORATORIES, INC., LA VISTA, NE. FILED 11-12-2004.



The logo for 'Streck' features the word in a bold, black, sans-serif font. The letter 'S' is stylized with a thick horizontal bar in red and a thin white line running through its center. The remaining letters 'treck' are in a standard black font.

OWNER OF U.S. REG. NO. 1,325,237.
 THE COLORS RED, BLACK, AND WHITE ARE CLAIMED AS A FEATURE OF THE MARK.
 THE MARK CONSISTS OF BLACK THICK LETTERS WITH A THIN WHITE LINE RUNNING THROUGH THE MIDDLE OF EVERY LETTER, WHILE THE LETTER "T" IN THE MARK HAS THE HORIZONTAL THICK BAR IN RED WITH A THIN WHITE LINE RUNNING THROUGH THE MIDDLE OF THE BAR.
 SEC. 2(F) AS TO "STRECK".
 FOR IN VITRO DIAGNOSTIC REAGENTS, NAMELY, HEMATOLOGY, CHEMICAL, AND IMMUNOLOGY CONTROLS FOR SCIENTIFIC OR RESEARCH USE (U.S. CLS. 1, 5, 6, 10, 26 AND 46).
 JASON LOTT, EXAMINING ATTORNEY

SN 78-518,131. MIDWEST DISTRIBUTING INC., PEORIA, IL. FILED 11-16-2004.



NO CLAIM IS MADE TO THE EXCLUSIVE RIGHT TO USE "LIQUID PLANT FOOD", APART FROM THE MARK AS SHOWN.
 THE COLOR(S) WHITE, BLACK, AND GOLD IS/ARE CLAIMED AS A FEATURE OF THE MARK.
 THE MARK CONSISTS OF THE MOUNTAIN CAPS IN THE COLOR WHITE; THE WORDS "SUMMIT GOLD" ACROSS THE MOUNTAINS IN THE COLOR GOLD; AND THE WORDING "LIQUID PLANT FOOD" AND THE LOWER PORTION OF THE MOUNTAINS IN THE COLOR BLACK.
 FOR FERTILIZER FOR DOMESTIC USE AND PLANT FOOD (U.S. CLS. 1, 5, 6, 10, 26 AND 46).
 DOUGLAS LEE, EXAMINING ATTORNEY

CLASS 1—(Continued).

SN 78-518,179. ASINEX LTD, MOSCOW, RUSSIAN FED., FILED 11-17-2004.

CLASS 1—(Continued).

SN 78-521,698. SIMPSON TACOMA KRAFT COMPANY, LLC, TACOMA, WA. FILED 11-23-2004.

LeadMax

SIMPSON

THE MARK CONSISTS OF STANDARD CHARACTERS WITHOUT CLAIM TO ANY PARTICULAR FONT, STYLE, SIZE, OR COLOR.

FOR SMALL SYNTHETIC-ORGANIC CHEMICAL COMPOUNDS FOR USE IN THE MANUFACTURING OF PHARMACEUTICALS (U.S. CLS. 1, 5, 6, 10, 26 AND 46).

SHARON MEIER, EXAMINING ATTORNEY

THE MARK CONSISTS OF STANDARD CHARACTERS WITHOUT CLAIM TO ANY PARTICULAR FONT, STYLE, SIZE, OR COLOR.

OWNER OF U.S. REG. NOS. 656,840, 1,002,147 AND 2,217,163.

SEC. 2(F). FOR WOOD PULP FOR MANUFACTURING PURPOSES (U.S. CLS. 1, 5, 6, 10, 26 AND 46).

FIRST USE 9-0-1985; IN COMMERCE 9-0-1985. MELISSA VALLILLO, EXAMINING ATTORNEY

SN 78-519,068. CIBA SPECIALTY CHEMICALS CORPORATION, TARRYTOWN, NY. FILED 11-18-2004.

SN 78-524,154. HALLIBURTON ENERGY SERVICES, INC., CARROLLTON, TX. FILED 11-30-2004.

IRGACOOOL

BARASORB

THE MARK CONSISTS OF STANDARD CHARACTERS WITHOUT CLAIM TO ANY PARTICULAR FONT, STYLE, SIZE, OR COLOR.

FOR CHEMICAL ADDITIVES FOR ANTIFREEZE AND COOLANTS (U.S. CLS. 1, 5, 6, 10, 26 AND 46).

ROBERT LAVACHE, EXAMINING ATTORNEY

THE MARK CONSISTS OF STANDARD CHARACTERS WITHOUT CLAIM TO ANY PARTICULAR FONT, STYLE, SIZE, OR COLOR.

OWNER OF U.S. REG. NOS. 1,184,304 AND 2,803,365.

FOR CHEMICAL COMPOSITIONS USED AS A FILTRATION AID THAT FILTERS AND ABSORBS OIL IN OIL AND GAS WELL DRILLING OPERATIONS. (U.S. CLS. 1, 5, 6, 10, 26 AND 46).

MELISSA SHELLA, EXAMINING ATTORNEY

CLASS 1—(Continued).

SN 78-529,415. IMAGENETIX, SAN DIEGO, CA. FILED 12-8-2004.

CLASS 1—(Continued).

SN 78-531,634. GENENCOR INTERNATIONAL, INC., PALO ALTO, CA. FILED 12-13-2004.

PURICYN

PURABRITE

THE MARK CONSISTS OF STANDARD CHARACTERS WITHOUT CLAIM TO ANY PARTICULAR FONT, STYLE, SIZE, OR COLOR.

FOR ESTERIFIED FATTY ACID COMPLEX FOR USE AS AN INGREDIENT IN FACE CREAM (U.S. CLS. 1, 5, 6, 10, 26 AND 46).

LINDA ORNDORFF, EXAMINING ATTORNEY

THE MARK CONSISTS OF STANDARD CHARACTERS WITHOUT CLAIM TO ANY PARTICULAR FONT, STYLE, SIZE, OR COLOR.

FOR CHEMICALS, NAMELY ENZYME PREPARATIONS, FOR USE IN THE LEATHER PROCESSING, PULP AND PAPER, CLEANING PREPARATIONS, TEXTILES, STARCH PROCESSING, AND FEED AND FOOD INDUSTRIES (U.S. CLS. 1, 5, 6, 10, 26 AND 46).

FIRST USE 12-1-2004; IN COMMERCE 12-1-2004.
MARK SPARACINO, EXAMINING ATTORNEY

SN 78-530,693. TRIM-TEX, INC., LINCOLNWOOD, IL. FILED 12-10-2004.

SN 78-537,500. CI, INC., IRVING, TX. FILED 12-23-2004.

TRIM-TEX

WEARSHIELD

THE MARK CONSISTS OF STANDARD CHARACTERS WITHOUT CLAIM TO ANY PARTICULAR FONT, STYLE, SIZE, OR COLOR.

OWNER OF U.S. REG. NOS. 1,923,669, 2,290,084 AND 2,712,905.

FOR ADHESIVES, ALL FOR USE IN BUILDING CONSTRUCTION, IN BUILDING REMODELING, AND IN INSTALLATION OF DRYWALL-TRIMMING ACCESSORIES (U.S. CLS. 1, 5, 6, 10, 26 AND 46).

FIRST USE 4-0-1996; IN COMMERCE 4-0-1996.
WON TEAK OH, EXAMINING ATTORNEY

THE MARK CONSISTS OF STANDARD CHARACTERS WITHOUT CLAIM TO ANY PARTICULAR FONT, STYLE, SIZE, OR COLOR.

FOR AUTOMOTIVE CAR CARE CHEMICALS, NAMELY FUEL INJECTOR CLEANER, FUEL SYSTEM CLEANER, AND ENGINE TREATMENT FOR GASOLINE POWERED INTERNAL COMBUSTION ENGINES, AND DIESEL FUEL INJECTOR CLEANER FOR DIESEL POWERED INTERNAL COMBUSTION ENGINES (U.S. CLS. 1, 5, 6, 10, 26 AND 46).

MARK RADEMACHER, EXAMINING ATTORNEY

CLASS 1—(Continued).

SN 78-538,898. TAKARA BIO INC., OTSU CITY, SHIGA, JAPAN, FILED 12-28-2004.

CYCLEAVE

THE MARK CONSISTS OF STANDARD CHARACTERS WITHOUT CLAIM TO ANY PARTICULAR FONT, STYLE, SIZE, OR COLOR.
FOR REAGENTS FOR SCIENTIFIC RESEARCH USE (U.S. CLS. 1, 5, 6, 10, 26 AND 46).
FIRST USE 9-0-2003; IN COMMERCE 9-0-2003.
EUGENIA MARTIN, EXAMINING ATTORNEY

SN 78-550,385. STRECK LABORATORIES, INC., LA VISTA, NE. FILED 1-19-2005.

STRECK-MINIPACK

THE MARK CONSISTS OF STANDARD CHARACTERS WITHOUT CLAIM TO ANY PARTICULAR FONT, STYLE, SIZE, OR COLOR.
OWNER OF U.S. REG. NO. 1,325,237.
FOR DIAGNOSTIC REAGENTS FOR SCIENTIFIC OR RESEARCH USE WITH HEMATOLOGY INSTRUMENTS (U.S. CLS. 1, 5, 6, 10, 26 AND 46).
JASON LOTT, EXAMINING ATTORNEY

SN 78-573,105. RECREATIONAL WATER TECHNOLOGIES, LLC, WEST PALM BEACH, FL. FILED 2-23-2005.



FOR WATER TREATMENT CHEMICALS FOR SWIMMING POOLS AND SPAS (U.S. CLS. 1, 5, 6, 10, 26 AND 46).
FIRST USE 1-17-2005; IN COMMERCE 1-17-2005.
ELLEN PERKINS, EXAMINING ATTORNEY

CLASS 1—(Continued).

SN 78-655,213. DANISCO A/S, COPENHAGEN - K, DENMARK, FILED 6-21-2005.

CHYMOSTAR

THE MARK CONSISTS OF STANDARD CHARACTERS WITHOUT CLAIM TO ANY PARTICULAR FONT, STYLE, SIZE, OR COLOR.
FOR ENZYME PREPARATION FOR MAKING CHEESE (U.S. CLS. 1, 5, 6, 10, 26 AND 46).
FIRST USE 7-0-1993; IN COMMERCE 7-0-1993.
MARK RADEMACHER, EXAMINING ATTORNEY

SN 79-002,326. KERAKOLL S.P.A., ITALY, FILED 4-8-2004.

PU31

THE MARK CONSISTS OF STANDARD CHARACTERS WITHOUT CLAIM TO ANY PARTICULAR FONT, STYLE, SIZE, OR COLOR.
PRIORITY DATE OF 12-23-2003 IS CLAIMED.
OWNER OF INTERNATIONAL REGISTRATION 0823999 DATED 4-8-2004, EXPIRES 4-8-2014.
FOR ADHESIVES FOR APPLYING FLOOR TILES; ADHESIVES FOR APPLYING WALL COVERINGS (U.S. CLS. 1, 5, 6, 10, 26 AND 46).
BARBARA RUTLAND, EXAMINING ATTORNEY

SN 79-002,615. STERN-ENZYM GMBH & CO. KG, FED REP GERMANY, FILED 3-29-2004.

POWERZYM

THE MARK CONSISTS OF STANDARD CHARACTERS WITHOUT CLAIM TO ANY PARTICULAR FONT, STYLE, SIZE, OR COLOR.
OWNER OF INTERNATIONAL REGISTRATION 0780954 DATED 4-26-2002, EXPIRES 4-26-2012.
FOR CHEMICALS USED IN INDUSTRY, NAMELY ENZYMES AND ENZYME PREPARATIONS FOR THE FOODS AND FEEDSTUFF INDUSTRY FOR ANIMAL CONSUMPTION (U.S. CLS. 1, 5, 6, 10, 26 AND 46).
ODESSA BIBBINS, EXAMINING ATTORNEY

CLASS 1—(Continued).

SN 79-003,402. D.O.G. DEUTSCHE OELFABRIK GESELLSCHAFT; FÜR CHEMISCHE ERZEUGNISSE MBH & CO.KG, FED REP GERMANY, FILED 5-25-2004.

DeoLink

THE MARK CONSISTS OF STANDARD CHARACTERS WITHOUT CLAIM TO ANY PARTICULAR FONT, STYLE, SIZE, OR COLOR.

OWNER OF INTERNATIONAL REGISTRATION 0827589 DATED 5-25-2004, EXPIRES 5-25-2014.

FOR INDUSTRIAL CHEMICALS, NAMELY, CHEMICAL ADDITIVES USED IN THE MANUFACTURE OF RUBBER FOR ENHANCING THE RUBBER'S CHARACTERISTICS (U.S. CLS. 1, 5, 6, 10, 26 AND 46).

RUDY R. SINGLETON, EXAMINING ATTORNEY

SN 79-004,218. DOG DEUTSCHE OELFABRIK; GESELLSCHAFT FÜR CHEMISCHE; ERZEUGNISSE MBH & CO KG, D-20457 HAMBURG, FED REP GERMANY, FILED 5-19-2004.

DEOFLOW

OWNER OF INTERNATIONAL REGISTRATION 0644383 DATED 9-2-1995, EXPIRES 9-2-2015.

FOR CHEMICALS FOR INDUSTRIAL USE, NAMELY MEANS FOR TREATING RUBBER IN THE FORM OF FATTY ACID ESTERS, FATTY ACID SOAPS AND FATTY ALCOHOLS, WITHOUT ZINC AND WITHOUT WATER (U.S. CLS. 1, 5, 6, 10, 26 AND 46).

JULIE WATSON, EXAMINING ATTORNEY

SN 79-004,222. LAFFORT OENOLOGIE, FRANCE, FILED 6-7-2004.

THIAZOTE

THE MARK CONSISTS OF STANDARD CHARACTERS WITHOUT CLAIM TO ANY PARTICULAR FONT, STYLE, SIZE, OR COLOR.

OWNER OF INTERNATIONAL REGISTRATION 0708063 DATED 1-21-1999, EXPIRES 1-21-2009.

FOR CHEMICALS USED IN ENOLOGY FOR WINE MAKING (U.S. CLS. 1, 5, 6, 10, 26 AND 46).

MARK T. MULLEN, EXAMINING ATTORNEY

CLASS 1—(Continued).

SN 79-004,382. LAFFORT OENOLOGIE, FRANCE, FILED 6-7-2004.

GELAFFORT

THE MARK CONSISTS OF STANDARD CHARACTERS WITHOUT CLAIM TO ANY PARTICULAR FONT, STYLE, SIZE, OR COLOR.

OWNER OF INTERNATIONAL REGISTRATION 0697861 DATED 8-5-1998, EXPIRES 8-5-2008.

FOR CHEMICAL ADDITIVES FOR USE IN THE MANUFACTURE OF MUSTS AND WINES (U.S. CLS. 1, 5, 6, 10, 26 AND 46).

INGA ERVIN, EXAMINING ATTORNEY

SN 79-006,494. JIANGSU QIANGSHENG CHEMICAL; INDUSTRY CO., LTD.; (JIANGSU QIANGSHENG HUAGONG; YOUXIAN GONGSI), CHINA, FILED 6-4-2004.

Enox

OWNER OF INTERNATIONAL REGISTRATION 0836476 DATED 6-4-2004, EXPIRES 6-4-2014.

FOR CHEMICAL REAGENTS OTHER THAN FOR MEDICAL OR VETERINARY PURPOSES; 2,4-DICHLOR-BENZOYL PEROXIDE; 2,5-DIMETHYL-2,5-DI-(BUTYLPEROXY) HEXANE; BENZOL PEROXIDE; T-BUTYL PEROXY BENZOATE; DI TERT BUTYL PEROXIDE; TERT BUTYL HYDROPEROXIDE; 1,1-BIS (T-BUTYL PEROXY) CYCLOHEXANE; 1,1-BIS (T-BUTYL PEROXY)-3,3,5-TRIMETHYL CYCLOHEXANE; CARBOXYLIC SILICON OIL (U.S. CLS. 1, 5, 6, 10, 26 AND 46).

ANDREA SAUNDERS, EXAMINING ATTORNEY

SN 79-007,029. COLETICA, FRANCE, FILED 9-10-2004.

MICROPATCH

OWNER OF INTERNATIONAL REGISTRATION 0838068 DATED 9-10-2004, EXPIRES 9-10-2014.

FOR BIOLOGICAL OR CHEMICAL ADDITIONS FOR USE IN THE MANUFACTURE OF COSMETICS FORMULATIONS (U.S. CLS. 1, 5, 6, 10, 26 AND 46).

SUNG IN, EXAMINING ATTORNEY

CLASS 2—PAINTS

SN 76-562,242. SILBERLINE MANUFACTURING CO., INC.,
TAMAQUA, PA. FILED 11-28-2003.

SPARKLE SILVER ULTRA

THE MARK CONSISTS OF STANDARD CHARACTERS
WITHOUT CLAIM TO ANY PARTICULAR FONT, STYLE,
SIZE, OR COLOR.

OWNER OF U.S. REG. NOS. 956,694, 1,295,382 AND
OTHERS.

SEC. 2(F) SPARKLE SILVER.
FOR NON-LEAFING ALUMINUM PIGMENTS (U.S.
CLS. 6, 11 AND 16).

FIRST USE 11-10-2003; IN COMMERCE 11-10-2003.
SHARON MEIER, EXAMINING ATTORNEY

CLASS 2—(Continued).

SN 76-613,410. QUALITY BORATE COMPANY LLC, CLEVELAND,
OH. FILED 9-29-2004.

BORASOL-WP

THE MARK CONSISTS OF STANDARD CHARACTERS
WITHOUT CLAIM TO ANY PARTICULAR FONT, STYLE,
SIZE, OR COLOR.

OWNER OF U.S. REG. NO. 2,707,602.
FOR WOOD PRESERVATIVE (U.S. CLS. 6, 11 AND 16).
FIRST USE 10-30-2000; IN COMMERCE 10-30-2000.
ANDREA SAUNDERS, EXAMINING ATTORNEY

SN 76-564,711. FEROX, INC., VILLE D'ANJOU, QUEBEC,
CANADA, FILED 12-11-2003.

LIQUENTIS

THE MARK CONSISTS OF STANDARD CHARACTERS
WITHOUT CLAIM TO ANY PARTICULAR FONT, STYLE,
SIZE, OR COLOR.

OWNER OF CANADA REG. NO. TMA621614, DATED 10-
4-2004, EXPIRES 10-4-2019.

FOR SPECIALIZED PROTECTIVE NON-CONDUCTIVE
COATINGS IN THE PAINT INDUSTRY (U.S. CLS. 6, 11
AND 16).

RAUL CORDOVA, EXAMINING ATTORNEY

SN 76-615,448. PIONEER MANUFACTURING COMPANY,
CLEVELAND, OH. FILED 10-12-2004.

WHEN YOUR GAME IS ON THE LINE

THE MARK CONSISTS OF STANDARD CHARACTERS
WITHOUT CLAIM TO ANY PARTICULAR FONT, STYLE,
SIZE, OR COLOR.

FOR PAINT USED FOR MARKING ATHLETIC
FIELDS (U.S. CLS. 6, 11 AND 16).

FIRST USE 12-0-1997; IN COMMERCE 12-0-1997.

RUDY R. SINGLETON, EXAMINING ATTORNEY

SN 76-586,815. SHARP KABUSHIKI KAISHA, TA SHARP
CORPORATION, OSAKA, JAPAN, FILED 4-15-2004.

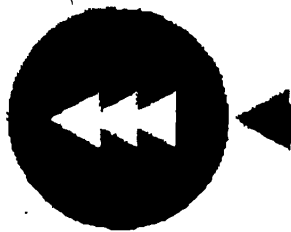

FOR TONER FOR COPYING MACHINE (U.S. CLS. 6,
11 AND 16).
FIRST USE 12-0-1993; IN COMMERCE 12-0-1993.
INGRID C. EULIN, EXAMINING ATTORNEY

SN 76-616,659. ROMAN DECORATING PRODUCTS, INC.,
CALUMET CITY, IL. FILED 10-15-2004.

MULTI-TASK

THE MARK CONSISTS OF STANDARD CHARACTERS
WITHOUT CLAIM TO ANY PARTICULAR FONT, STYLE,
SIZE, OR COLOR.

FOR WALLCOVERING PRIMERS (U.S. CLS. 6, 11 AND
16).

FIRST USE 2-2-2004; IN COMMERCE 2-2-2004.

TARAH HARDY, EXAMINING ATTORNEY

CLASS 2—(Continued).

SN 76-619,771. BOYER INDUSTRIES CORPORATION, LAWRENCE, KS. FILED 11-8-2004.

CONSOLIDECK

THE MARK CONSISTS OF STANDARD CHARACTERS WITHOUT CLAIM TO ANY PARTICULAR FONT, STYLE, SIZE, OR COLOR.

OWNER OF U.S. REG. NO. 1,325,290.
FOR COATING COMPOSITIONS FOR SEALING, STRENGTHENING, HARDENING, AND PRESERVING MASONRY, CONCRETE AND STONE SURFACES (U.S. CLS. 6, 11 AND 16).

FIRST USE 2-0-1984; IN COMMERCE 2-0-1984.
JOHN SCHUYLER YARD, EXAMINING ATTORNEY

SN 76-626,681. NAZDAR COMPANY, SHAWNEE, KS. FILED 1-3-2005.

POWERPRINT

THE MARK CONSISTS OF STANDARD CHARACTERS WITHOUT CLAIM TO ANY PARTICULAR FONT, STYLE, SIZE, OR COLOR.

FOR SCREEN PRINTERS' INK (U.S. CLS. 6, 11 AND 16).

FIRST USE 1-31-2004; IN COMMERCE 1-31-2004.
MARK RADEMACHER, EXAMINING ATTORNEY

SN 78-219,312. CALIFORNIA PRODUCTS CORPORATION, ANDOVER, MA. FILED 2-26-2003.

CLEARGLO

FOR PAINT, NAMELY, COATING FOR ASPHALT AND CONCRETE SURFACES (U.S. CLS. 6, 11 AND 16).
MARLENE BELL, EXAMINING ATTORNEY

SN 78-301,841. ULTIMATE IMAGE MARKETING, INC., CHANDLER, AZ. FILED 9-17-2003.



NO CLAIM IS MADE TO THE EXCLUSIVE RIGHT TO USE ULTIMATE IMAGE INC, "TONER CARTRIDGE EXPERTS SINCE 1989" AND THE RECYCLING SYMBOL, APART FROM THE MARK AS SHOWN.

FOR TONER CARTRIDGES (U.S. CLS. 6, 11 AND 16).
FIRST USE 8-0-1994; IN COMMERCE 8-0-1994.
BRIAN NEVILLE, EXAMINING ATTORNEY

CLASS 2—(Continued).

SN 78-395,597. THE VALSPAR CORPORATION, MINNEAPOLIS, MN. FILED 4-2-2004.

**VALSPAR
RESTORATION SERIES**

THE MARK CONSISTS OF STANDARD CHARACTERS WITHOUT CLAIM TO ANY PARTICULAR FONT, STYLE, SIZE, OR COLOR.

OWNER OF U.S. REG. NOS. 97,293 AND 2,724,138.
NO CLAIM IS MADE TO THE EXCLUSIVE RIGHT TO USE "RESTORTION SERIES", APART FROM THE MARK AS SHOWN.

FOR PAINTS AND COATINGS, NAMELY ENAMELS AND PRIMERS FOR USE ON A VARIETY OF SUBSTRATES (U.S. CLS. 6, 11 AND 16).

MATTHEW PAPPAS, EXAMINING ATTORNEY

SN 78-401,873. IKONICS CORPORATION, DULUTH, MN. FILED 4-14-2004.

IKON METALS

THE MARK CONSISTS OF STANDARD CHARACTERS WITHOUT CLAIM TO ANY PARTICULAR FONT, STYLE, SIZE, OR COLOR.

NO CLAIM IS MADE TO THE EXCLUSIVE RIGHT TO USE METALS, APART FROM THE MARK AS SHOWN.

FOR HYBRID METALS IN POWDER FORM FOR SCREEN PRINTERS AND SIGN FABRICATORS (U.S. CLS. 6, 11 AND 16).

AMY GEARIN, EXAMINING ATTORNEY

CLASS 2—(Continued).

SN 78-406,354. ALSCO METALS CORPORATION, RALEIGH, NC. FILED 4-22-2004.

CLASS 2—(Continued).

SN 78-434,026. CONKLIN COMPANY, INC., SHAKOPEE, MN. FILED 6-11-2004.

DYMALAR

RUST ASIDE

THE MARK CONSISTS OF STANDARD CHARACTERS WITHOUT CLAIM TO ANY PARTICULAR FONT, STYLE, SIZE, OR COLOR.

FOR COATING SYSTEM, NAMELY PAINT CONTAINING CORROSION INHIBITANTS USED ON ALUMINUM GUTTERS, DOWNSPOUTS, GUTTER COIL, DOWNSPOUT COIL, TRIM COIL, SOFFITS, SIDINGS AND ACCESSORIES THEREFOR, NAMELY, FASCIA, ARCHITECTURAL TRIM PRODUCTS, MOLDINGS, J-CHANNELS, F-CHANNELS, CORNERPOSTS, ELBOWS, MITRES, END CAPS, PIPE BANDS, GUTTER COVERS AND SILL TRIM (U.S. CLS. 6, 11 AND 16).

FIRST USE 7-18-2003; IN COMMERCE 7-18-2003.
ELLEN PERKINS, EXAMINING ATTORNEY

THE MARK CONSISTS OF STANDARD CHARACTERS WITHOUT CLAIM TO ANY PARTICULAR FONT, STYLE, SIZE, OR COLOR.

NO CLAIM IS MADE TO THE EXCLUSIVE RIGHT TO USE "RUST", APART FROM THE MARK AS SHOWN.

FOR RUST PREVENTATIVES IN THE NATURE OF A COATING (U.S. CLS. 6, 11 AND 16).

FIRST USE 6-6-1984; IN COMMERCE 6-6-1984.
MELVIN AXILBUND, EXAMINING ATTORNEY

SN 78-411,304. INTERNATIONAL FIRE RESISTANT SYSTEMS, INC., SAN RAFAEL, CA. FILED 4-30-2004.

SN 78-434,030. SURFACE PROTECTION INDUSTRIES, INC., LOS ANGELES, CA. FILED 6-11-2004.

FIREFREE

TUFF RIDER

THE MARK CONSISTS OF STANDARD CHARACTERS WITHOUT CLAIM TO ANY PARTICULAR FONT, STYLE, SIZE, OR COLOR.

FOR COATINGS IN THE NATURE OF FIRE RESISTANT AND FIRE RETARDANT COATING PREPARATIONS FOR USE ON STRUCTURES AND BUILDING MATERIALS; COATINGS IN THE NATURE OF FIRE RESISTANT AND FIRE RETARDANT COATING PREPARATIONS FOR USE IN MANUFACTURING IN THE AEROSPACE, AUTOMOBILE, RAILWAY, AND MARINE INDUSTRIES (U.S. CLS. 6, 11 AND 16).

LAURA KOVAISKY, EXAMINING ATTORNEY

THE MARK CONSISTS OF STANDARD CHARACTERS WITHOUT CLAIM TO ANY PARTICULAR FONT, STYLE, SIZE, OR COLOR.

FOR PROTECTIVE URETHANE COATING FOR USE ON METALS, FIBERGLASS, CONCRETE, PLASTIC AND WOOD IN THE NATURE OF SPRAYABLE LINER (U.S. CLS. 6, 11 AND 16).

MARK RADEMACHER, EXAMINING ATTORNEY

CLASS 2—(Continued).

SN 78-436,346. CHUGOKU MARINE PAINTS, LTD., HIR-OSHIMA, JAPAN, FILED 6-16-2004.

CLASS 2—(Continued).

SN 78-489,623. TLM SUPPLY HOUSE, INC., OZARK, MO. FILED 9-25-2004.

BIOCLEAN

Magic Mix

THE MARK CONSISTS OF STANDARD CHARACTERS WITHOUT CLAIM TO ANY PARTICULAR FONT, STYLE, SIZE, OR COLOR.

OWNER OF JAPAN REG. NO. 1995393, DATED 10-27-1987, EXPIRES 10-27-2007.

FOR MARINE PAINTS, NAMELY, NON-TOXIC ANTI-FOULING COATINGS (U.S. CLS. 6, 11 AND 16).

FIRST USE 3-1-1983; IN COMMERCE 3-1-1983.

APRIL L. RADEMACHER, EXAMINING ATTORNEY

THE MARK CONSISTS OF STANDARD CHARACTERS WITHOUT CLAIM TO ANY PARTICULAR FONT, STYLE, SIZE, OR COLOR.

FOR ARCHIVAL PRINTER INK COMMONLY USED WHEN MAKING HEAT TRANSFERRED PRODUCTS (U.S. CLS. 6, 11 AND 16).

FIRST USE 6-15-2002; IN COMMERCE 6-15-2002.

SUSAN STIGLITZ, EXAMINING ATTORNEY

SN 78-455,439. KUO, FANNY, LOS ALTOS, CA. FILED 7-23-2004.

SN 78-495,320. SWIMC, INC., WILMINGTON, DE. FILED 10-6-2004.

Vivid Ink

SOFTSUEDE

THE MARK CONSISTS OF STANDARD CHARACTERS WITHOUT CLAIM TO ANY PARTICULAR FONT, STYLE, SIZE, OR COLOR.

NO CLAIM IS MADE TO THE EXCLUSIVE RIGHT TO USE "INK", APART FROM THE MARK AS SHOWN.

FOR FILLED INK JET CARTRIDGES AND TONER. (U.S. CLS. 6, 11 AND 16).

ELLEN PERKINS, EXAMINING ATTORNEY

THE MARK CONSISTS OF STANDARD CHARACTERS WITHOUT CLAIM TO ANY PARTICULAR FONT, STYLE, SIZE, OR COLOR.

FOR PROTECTIVE AND DECORATIVE COATINGS USED IN THE NATURE OF PAINT (U.S. CLS. 6, 11 AND 16).

FIRST USE 5-21-2003; IN COMMERCE 5-21-2003.

KARANENDRA S. CHHINA, EXAMINING ATTORNEY

CLASS 2—(Continued).

SN 78-503,137. MORWEAR MANUFACTURING, INC., BEVERLY HILLS, CA. FILED 10-20-2004.

CLASS 2—(Continued).

SN 78-512,444. HILLYARD ENTERPRISES, INC., ST. JOSEPH, MO. FILED 11-5-2004.

**BETTER RESEARCH.
BETTER PAINT.**

THE MARK CONSISTS OF STANDARD CHARACTERS WITHOUT CLAIM TO ANY PARTICULAR FONT, STYLE, SIZE, OR COLOR.

FOR COATINGS IN THE NATURE OF PAINTS, PAINT SEALERS, PAINT PRIMERS, AND PAINT FOR USE AS TOP COATS (U.S. CLS. 6, 11 AND 16).

FIRST USE 6-30-2004; IN COMMERCE 9-30-2004.
BRIAN PINO, EXAMINING ATTORNEY

TROPHY

THE MARK CONSISTS OF STANDARD CHARACTERS WITHOUT CLAIM TO ANY PARTICULAR FONT, STYLE, SIZE, OR COLOR.

FOR LIQUID WOOD FLOOR PRESERVATIVE IN THE NATURE OF A WOOD SEALER (U.S. CLS. 6, 11 AND 16).

FIRST USE 2-2-1953; IN COMMERCE 2-2-1953.
ROBIN CHOSID, EXAMINING ATTORNEY

SN 78-503,143. MORWEAR MANUFACTURING, INC., BEVERLY HILLS, CA. FILED 10-20-2004.

MORWEAR PLUS

THE MARK CONSISTS OF STANDARD CHARACTERS WITHOUT CLAIM TO ANY PARTICULAR FONT, STYLE, SIZE, OR COLOR.

OWNER OF U.S. REG. NOS. 1,975,773 AND 2,266,496.
FOR COATINGS IN THE NATURE OF PAINTS, PAINT SEALERS, PAINT PRIMERS, AND PAINT FOR USE AS TOP COATS (U.S. CLS. 6, 11 AND 16).

FIRST USE 6-30-2004; IN COMMERCE 9-30-2004.
ELISSA GARBER KON, EXAMINING ATTORNEY

SN 78-514,978. POLY-TUFF SYSTEMS INTERNATIONAL CORPORATION, LAS VAGAS, NV. FILED 11-10-2004.

**TUFF PROBLEMS -
TUFF SOLUTIONS**

SN 78-504,540. INDUSTRIAL PROTECTIVE COATINGS, INC., DE PERE, WI. FILED 10-22-2004.

ANCHOR CRETE

THE MARK CONSISTS OF STANDARD CHARACTERS WITHOUT CLAIM TO ANY PARTICULAR FONT, STYLE, SIZE, OR COLOR.

FOR CEMENTITIOUS PROTECTIVE COATING (U.S. CLS. 6, 11 AND 16).

FIRST USE 5-12-2004; IN COMMERCE 5-12-2004.
ANN LINNEHAN, EXAMINING ATTORNEY

THE MARK CONSISTS OF STANDARD CHARACTERS WITHOUT CLAIM TO ANY PARTICULAR FONT, STYLE, SIZE, OR COLOR.

FOR POLYMER COATINGS FOR WATERPROOFING WOOD, CONCRETE AND STEEL SUBSTRATES (U.S. CLS. 6, 11 AND 16).

FIRST USE 10-1-2004; IN COMMERCE 10-1-2004.
KAREN K. BUSH, EXAMINING ATTORNEY

CLASS 2—(Continued).

SN 78-518,672. MORWEAR MANUFACTURING, INC., BEVERLY HILLS, CA. FILED 11-17-2004.

**MORWEAR PLUS
ADVANCED MOLD
CONTROL PAINT**

THE MARK CONSISTS OF STANDARD CHARACTERS WITHOUT CLAIM TO ANY PARTICULAR FONT, STYLE, SIZE, OR COLOR.

OWNER OF U.S. REG. NOS. 1,975,773 AND 2,266,496.

NO CLAIM IS MADE TO THE EXCLUSIVE RIGHT TO USE "MOLD CONTROL PAINT", APART FROM THE MARK AS SHOWN.

FOR COATINGS IN THE NATURE OF PAINTS, PAINT SEALERS, PAINT PRIMERS, AND PAINT FOR USE AS TOP COATS (U.S. CLS. 6, 11 AND 16).

FIRST USE 6-30-2004; IN COMMERCE 9-30-2004.
ELISSA GARBER KON, EXAMINING ATTORNEY

SN 78-527,328. THORWORKS INDUSTRIES, INC., SANDUSKY, OH. FILED 12-6-2004.

GRAY SHIELD

THE MARK CONSISTS OF STANDARD CHARACTERS WITHOUT CLAIM TO ANY PARTICULAR FONT, STYLE, SIZE, OR COLOR.

NO CLAIM IS MADE TO THE EXCLUSIVE RIGHT TO USE "GRAY", APART FROM THE MARK AS SHOWN.

FOR LATEX AND ACRYLIC BASED COATINGS FOR BUILDING FOUNDATIONS (U.S. CLS. 6, 11 AND 16).

FIRST USE 11-4-2004; IN COMMERCE 11-4-2004.
ELIZABETH PIGNATELLO, EXAMINING ATTORNEY

CLASS 2—(Continued).

SN 79-001,946. CCI CORPORATION, GIFU-KEN 501-3923, JAPAN, FILED 3-29-2004.

DIPOLGY

PRIORITY DATE OF 3-17-2004 IS CLAIMED.
OWNER OF INTERNATIONAL REGISTRATION 0822583 DATED 3-29-2004, EXPIRES 3-29-2014.

FOR COATINGS AND PAINTS FOR INDUSTRIAL USE; PAINTS FOR HOME USE; OTHER PAINTS; WALL-PAPER-REMOVING PREPARATIONS; COPAL; SANDARAC; SHELLAC; DAMMAR; MORDANTS; WOOD PRESERVATIVES; DYESTUFFS FOR INDUSTRIAL USE; PIGMENTS; PRIMERS; PRINTING INK; ANTI-RUST GREASES; ANTI-RUST OILS; GLAZIERS' PUTTY; METAL FOIL FOR PAINTERS, DECORATORS, PRINTERS AND ARTISTS; METALS IN POWDER FORM FOR PAINTERS, DECORATORS, PRINTERS AND ARTISTS (U.S. CLS. 6, 11 AND 16).

ALICE SUE CARRUTHERS, EXAMINING ATTORNEY

SN 79-002,243. AKZO NOBEL COATINGS INTERNATIONAL B.V., NL-6824 BM ARNHEM, NETHERLANDS, FILED 3-30-2004.

INTERCHAR

THE MARK CONSISTS OF STANDARD CHARACTERS WITHOUT CLAIM TO ANY PARTICULAR FONT, STYLE, SIZE, OR COLOR.

PRIORITY DATE OF 1-30-2004 IS CLAIMED.
OWNER OF INTERNATIONAL REGISTRATION 0823742 DATED 3-30-2004, EXPIRES 3-30-2014.

FOR PAINTS (U.S. CLS. 6, 11 AND 16).
MONIQUE MILLER, EXAMINING ATTORNEY

SN 79-002,244. AKZO NOBEL COATINGS INTERNATIONAL B.V., NETHERLANDS, FILED 3-30-2004.

INTERCRYL

THE MARK CONSISTS OF STANDARD CHARACTERS WITHOUT CLAIM TO ANY PARTICULAR FONT, STYLE, SIZE, OR COLOR.

PRIORITY DATE OF 1-30-2004 IS CLAIMED.
OWNER OF INTERNATIONAL REGISTRATION 0823743 DATED 3-30-2004, EXPIRES 3-30-2014.

FOR CLEAR AND PIGMENTED PRIMER AND TOP-COAT FOR INDUSTRIAL USE (U.S. CLS. 6, 11 AND 16).
MONIQUE MILLER, EXAMINING ATTORNEY

CLASS 3—COSMETICS AND CLEANING PREPARATIONS

SN 76-431,779. DREAMOUS CORPORATION, TORRANCE, CA. FILED 7-18-2002.

COVITAL

FOR COLD PROCESSED COSMETICS, NAMELY, SKIN CREAMS, HAIR SHAMPOO AND CONDITIONER, AND EYE GELS (U.S. CLS. 1, 4, 6, 50, 51 AND 52).
FIRST USE 5-25-2001; IN COMMERCE 5-25-2001.
VERNA BETH RIRIE, EXAMINING ATTORNEY

SN 76-487,834. DREAM VALLEY FARM, INC., LAWTON, OK. FILED 1-28-2003.

DREAM VALLEY FARM

FOR FULL LINE OF COSMETIC AND NON-MEDICAL SKIN CARE PRODUCTS (U.S. CLS. 1, 4, 6, 50, 51 AND 52).
FIRST USE 0-0-1982; IN COMMERCE 0-0-1982.
NAAKWAMA ANKRAH, EXAMINING ATTORNEY

SN 76-496,232. LAURICE EL BADRY RAHME LTD., DBA LAURICE & CO., NEW YORK, NY. FILED 3-11-2003.

EAU DE NEW YORK

NO CLAIM IS MADE TO THE EXCLUSIVE RIGHT TO USE "NEW YORK", APART FROM THE MARK AS SHOWN. THE ENGLISH TRANSLATION OF EAU DE IS "WATER OF".
FOR FRAGRANCES, NAMELY, PERFUMES, COLOGNES, AFTER BATH SPLASHES, BODY SPRAYS, SHOWER GELS, SOAPS, BODY LOTIONS, AND MASCAGE OIL (U.S. CLS. 1, 4, 6, 50, 51 AND 52).
FIRST USE 4-1-2004; IN COMMERCE 4-1-2004.
MITCHELL FRONT, EXAMINING ATTORNEY

SN 76-497,099. 7546 SOLUTIONS, L.L.C., NEW YORK, NY. FILED 3-6-2003.

SKINCOLA

FOR COSMETICS, NAMELY, A HYDRATING FACIAL MIST; FACE SOAP (U.S. CLS. 1, 4, 6, 50, 51 AND 52).
FIRST USE 2-0-2003; IN COMMERCE 2-0-2003.
NORA BUCHANAN WILL, EXAMINING ATTORNEY

CLASS 3—(Continued).

SN 76-528,715. OVERBREAK, LLC, SUN VALLEY, CA. FILED 7-9-2003.

ETRÉ

THE ENGLISH TRANSLATION OF THE FRENCH WORD ETRÉ IN THE MARK IS TO BE.
FOR SKIN LOTIONS; NON-MEDICATED SKIN CARE PREPARATIONS; CUTICLE OILS; EMERY BOARDS AND SKIN SOAPS (U.S. CLS. 1, 4, 6, 50, 51 AND 52).
FIRST USE 6-30-2001; IN COMMERCE 6-30-2001.
ANGELA M. MICHELI, EXAMINING ATTORNEY

SN 76-535,186. THE ESSENTIAL TOUCH, INC., COLUMBIA HEIGHTS, MN. FILED 8-7-2003.

THE ESSENTIAL TOUCH

FOR COSMETICS, NAMELY, HAND, SKIN, BODY, AND AROMATHERAPY LOTIONS; FACE, FOOT, EYE, BODY, AROMATHERAPY, AND CUTICLE CREAMS; LIP, BODY, AND AROMATHERAPY BALMS; HAND, BODY, BATH, SHOWER, DEODORANT, EXFOLIANT, SHAVING, HAIR, BAR, LIQUID, AND AROMATHERAPY SOAPS; BATH AND AROMATHERAPY SALTS; BATH AND SHOWER PREPARATIONS, NAMELY, GEL, LOTION, AND OIL; HAIR CARE PREPARATIONS, NAMELY, SHAMPOO, POMADE, AND SOAP; AROMATHERAPY AND LIP EMOLLIENTS; BODY, FOOT, BATH, BABY, AND AROMATHERAPY POWDERS; BODY, FOOT, FACE, AND AROMATHERAPY EXFOLIANTS; AFTER-BATH SPLASH; BATH AND AROMATHERAPY BOMBS (U.S. CLS. 1, 4, 6, 50, 51 AND 52).
FIRST USE 12-5-2000; IN COMMERCE 1-6-2001.
CATHERINE CAIN, EXAMINING ATTORNEY

SN 76-543,700. KANEBO KABUSHIKI KAISHA (KANEBO, LTD.), SUMIDA-KU, TOKYO, JAPAN, FILED 9-9-2003.

CHRONOTHERAPIST

FOR COSMETICS, NAMELY, FACE CREAMS, SKIN CREAM, FACE PACKS, SKIN LOTION, MILKY FACE LOTION, LIP CREAM, MAKE-UP BASE, SKIN CLEANSING PREPARATIONS, SOAPS, SKIN WHITENING PREPARATIONS, FOUNDATION MAKE-UP, FACE POWDER, BATH POWDER, EYE MAKE-UP, EYE LINER, MASCARA, EYEBROW PENCILS, LIPSTICKS, CHEEK COLOR, NAILCARE PREPARATIONS, NAMELY, NAIL COLOR AND CUTICLE COAT, COSMETIC PREPARATIONS FOR BATH, NAMELY, NON-MEDICATED BATH SALTS, BUBBLE BATH AND BATH OILS; HAIR CARE PREPARATIONS, NAMELY, SHAMPOO, RINSE, CONDITIONER, LOTION, HAIR CREAMS, HAIR DYE, SPRAY, GEL AND MOUSSE; PERFUMERY, NAMELY, PERFUME, EAU DE COLOGNE, EAU DE TOILETTE, COTTON BALLS FOR COSMETIC PURPOSES (U.S. CLS. 1, 4, 6, 50, 51 AND 52).
GENE MACIOL, EXAMINING ATTORNEY

CLASS 3—(Continued).

SN 76-543,704. KANEBO KABUSHIKI KAISHA (KANEBO, LTD.), SUMIDA-KU, TOKYO, JAPAN, FILED 9-9-2003.

CLASS 3—(Continued).

SN 76-564,296. DURSOL-FABRIK OTTO DURST GMBH & CO. KG, 42655 SOLINGEN, FED REP GERMANY, FILED 11-21-2003.

CHRONOTHERAPY

FOR COSMETICS, NAMELY, FACE CREAMS, SKIN CREAM, FACE PACKS, SKIN LOTION, MILKY FACE LOTION, LIP CREAM, MAKE-UP BASE, SKIN CLEANSING PREPARATIONS, SOAPS, SKIN WHITENING PREPARATIONS, FOUNDATION MAKE-UP, FACE POWDER, BATH POWDER, EYE MAKE-UP, EYE LINER, MASCARA, EYE BROW PENCILS, LIPSTICKS, CHEEK COLOR, NAILCARE PREPARATIONS, NAMELY, NAIL COLOR AND CUTICLE COAT, COSMETIC PREPARATIONS FOR BATH, NAMELY, NON-MEDICATED BATH SALTS, BUBBLE BATH AND BATH OILS; HAIR CARE PREPARATIONS, NAMELY, SHAMPOO, RINSE, CONDITIONER, LOTION, HAIR CREAMS, HAIR DYE, SPRAY, GEL AND MOUSSE; PERFUMERY, NAMELY, PERFUME, EAU DE COLOGNE, EAU DE TOILETTE, COTTON BALLS FOR COSMETIC PURPOSES (U.S. CLS. 1, 4, 6, 50, 51 AND 52).

GENE MACIOL, EXAMINING ATTORNEY

POLISOL

THE MARK CONSISTS OF STANDARD CHARACTERS WITHOUT CLAIM TO ANY PARTICULAR FONT, STYLE, SIZE, OR COLOR.

FOR FURBISHING PREPARATIONS, NAMELY, SHAMPOOS AND SCENTED SHAMPOOS FOR AUTOMOBILE CARPETS AND UPHOLSTERY, UPHOLSTERY CLEANERS, ALL-PURPOSE CLEANERS AND AUTOMOBILE CLEANERS; POLISHING PREPARATIONS, NAMELY, POLISHING POWDER, POLISHING PASTE, AND LIQUID POLISH; CLEANING PREPARATIONS FOR USE IN THE AUTOMOTIVE FIELD (U.S. CLS. 1, 4, 6, 50, 51 AND 52).

TERESA M. RUPP, EXAMINING ATTORNEY

SN 76-574,755. NOF CORPORATTON, SHIBUYA-KU, TOKYO, JAPAN, FILED 2-10-2004.

SN 76-546,622. STOCKHAUSEN GMBH & CO. KG, D-47805 KREFELD, FED REP GERMANY, FILED 9-24-2003.

STOKO HYPERCARE

PRIORITY CLAIMED UNDER SEC. 44(D) ON ERP N CMNTY TM OFC APPLICATION NO. 003329273, FILED 8-27-2003, REG. NO. 003329273, DATED 2-2-2005, EXPIRES 8-27-2013.

FOR LAUNDRY BLEACH; GENERAL PURPOSE CLEANING, POLISHING AND ABRASIVE LIQUIDS AND POWDERS, DEGREASING AGENTS FOR USE IN THE CLEANING OF SURFACES, STAIN REMOVERS; BODY SOAP, BODY SOAPS CONTAINING DISINFECTANTS AND DEODORANTS, IN BAR AND LIQUID FORM, PERFUME, ANTI-ODOR FOOT SPRAY; ESSENTIAL OILS FOR PERSONAL USE; LIQUID AND CREAM SKIN PROTECTION OINTMENTS; SKIN CLEANSERS AND SKIN CARE PREPARATIONS; HAND AND FACE CARE PREPARATION; COSMETICS; SHAMPOO; HAIR CARE LOTIONS AND TOOTHPASTE (U.S. CLS. 1, 4, 6, 50, 51 AND 52).

BARBARA BROWN, EXAMINING ATTORNEY

NOF

THE MARK CONSISTS OF STANDARD CHARACTERS WITHOUT CLAIM TO ANY PARTICULAR FONT, STYLE, SIZE, OR COLOR.

OWNER OF JAPAN REG. NO. 4528766, DATED 12-14-2001, EXPIRES 12-14-2011.

FOR LAUNDRY BLEACH, LAUNDRY SOAPS AND LAUNDRY DETERGENTS; SOAPS, DETERGENTS AND STAIN REMOVING BENZENE FOR HOUSEHOLD USE; PERFUMERY, ESSENTIAL OILS FOR PERSONAL USE, COSMETICS, HAIR LOTIONS; TOILETRIES, NAMELY, DENTIFRICES; ANTISTATIC PREPARATIONS FOR HOUSEHOLD PURPOSES, NAMELY, DRYER SHEETS (U.S. CLS. 1, 4, 6, 50, 51 AND 52).

CHERYL CLAYTON, EXAMINING ATTORNEY

CLASS 3—(Continued).

SN 76-581,552. LANCOME PARFUMS ET BEAUTE & CIE, PARIS, FRANCE, FILED 3-15-2004.

ASBOLUE MAKEUP

THE MARK CONSISTS OF STANDARD CHARACTERS WITHOUT CLAIM TO ANY PARTICULAR FONT, STYLE, SIZE, OR COLOR.

OWNER OF U.S. REG. NOS. 2,592,464, 2,923,993 AND OTHERS.

NO CLAIM IS MADE TO THE EXCLUSIVE RIGHT TO USE "MAKEUP", APART FROM THE MARK AS SHOWN.

THE ENGLISH TRANSLATION OF THE WORD "ABSOLUTE" IN THE MARK IS "ABSOLUTE".

FOR FOUNDATION MAKE-UP (U.S. CLS. 1, 4, 6, 50, 51 AND 52).

ANDREA SAUNDERS, EXAMINING ATTORNEY

SN 76-581,969. LABORATOIRE GARNIER & CIE, PARIS, FRANCE, FILED 3-19-2004.

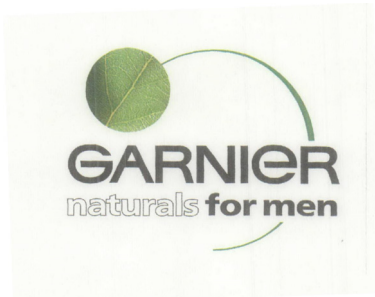

PRIORITY CLAIMED UNDER SEC. 44(D) ON FRANCE APPLICATION NO. 04/3,277,692, FILED 3-4-2004, REG. NO. 04/3,277,692, DATED 3-4-2004, EXPIRES 3-4-2014.

OWNER OF U.S. REG. NOS. 2,274,549, 2,745,974 AND OTHERS.

NO CLAIM IS MADE TO THE EXCLUSIVE RIGHT TO USE "FOR MEN", APART FROM THE MARK AS SHOWN.

THE COLOR(S) LIGHT GREY, LIGHT GREEN, YELLOW, AND DARK GREEN IS/ARE CLAIMED AS A FEATURE OF THE MARK.

THE COLOR LIGHT GREY APPEARS IN THE BACKGROUND. THE COLOR LIGHT GREEN APPEARS IN THE LEAF. THE COLOR YELLOW APPEARS IN THE LEAF'S VEINS. THE COLOR DARK GREEN APPEARS IN THE SEMI-CIRCLE STEM. THE LETTERS GARNIER FOR MEN APPEAR IN BLACK, AND NATURALS APPEARS IN WHITE.

FOR PERFUME, TOILET WATER; GELS, SALTS FOR THE BATH AND THE SHOWER NOT FOR MEDICAL PURPOSE; TOILET SOAPS, BODY DEODORANTS; COSMETIC NAMELY CREAMS, MILKS, LOTIONS, GELS AND POWDERS FOR THE FACE, THE BODY AND THE HANDS; COSMETIC SUN CARE PREPARATIONS; MAKE-UP PREPARATIONS; SHAMPOOS; GELS, SPRAYS, MOUSSES AND BALMS FOR THE HAIR STYLING AND HAIR CARE; HAIR LACQUERS; HAIR COLOURING AND HAIR DECOLORANT PREPARATIONS; PERMANENT WAVING AND CURLING PREPARATIONS; ESSENTIAL OILS FOR PERSONAL USE (U.S. CLS. 1, 4, 6, 50, 51 AND 52).

SHARON MEIER, EXAMINING ATTORNEY

CLASS 3—(Continued).

SN 76-585,136. INNOVATION AND DESIGN, INC., BETHLEHEM, GA. FILED 4-6-2004.

MOISTURE DRENCH

THE MARK CONSISTS OF STANDARD CHARACTERS WITHOUT CLAIM TO ANY PARTICULAR FONT, STYLE, SIZE, OR COLOR.

NO CLAIM IS MADE TO THE EXCLUSIVE RIGHT TO USE "MOISTURE", APART FROM THE MARK AS SHOWN.

FOR BODY AND BATH AIDS, NAMELY, SKIN CARE AND HAIR CARE PRODUCTS, NAMELY, SHOWER GELS, BODY AND FACIAL WASHES, LOTIONS, CREAMS, AND SHAMPOOS (U.S. CLS. 1, 4, 6, 50, 51 AND 52).

DANIEL BRODY, EXAMINING ATTORNEY

SN 76-585,286. L'OREAL, PARIS, FRANCE, FILED 4-6-2004.

CHROMA REFLECT

THE MARK CONSISTS OF STANDARD CHARACTERS WITHOUT CLAIM TO ANY PARTICULAR FONT, STYLE, SIZE, OR COLOR.

OWNER OF FRANCE REG. NO. 04/3,281,004, DATED 3-19-2003, EXPIRES 3-19-2013.

OWNER OF U.S. REG. NO. 2,647,859.

NO CLAIM IS MADE TO THE EXCLUSIVE RIGHT TO USE "CHROMA", APART FROM THE MARK AS SHOWN.

FOR SHAMPOOS; GELS, SPRAYS, MOUSSES AND BALMS FOR THE HAIR STYLING AND HAIR CARE; HAIR LACQUERS; HAIR COLOURING AND HAIR DECOLORANT PREPARATIONS; PERMANENT WAVING AND CURLING PREPARATIONS; ESSENTIAL OILS FOR PERSONAL USE (U.S. CLS. 1, 4, 6, 50, 51 AND 52).

CURTIS FRENCH, EXAMINING ATTORNEY

CLASS 3—(Continued).

SN 76-587,326. DISNEY ENTERPRISES, INC., BURBANK, CA. FILED 4-19-2004.



OWNER OF U.S. REG. NO. 2,700,620.
FOR NON-MEDICATED TOILETRIES, COSMETICS,
PERFUMERY AND DENTIFRICES (U.S. CLS. 1, 4, 6, 50,
51 AND 52).
MARLENE BELL, EXAMINING ATTORNEY

CLASS 3—(Continued).

SN 76-588,122. DISNEY ENTERPRISES, INC., BURBANK, CA. FILED 4-19-2004.



FOR NON-MEDICATED TOILETRIES, COSMETICS,
PERFUMERY AND DENTIFRICES (U.S. CLS. 1, 4, 6, 50,
51 AND 52).
WILLIAM BRECKENFELD, EXAMINING ATTORNEY

SN 76-588,108. DISNEY ENTERPRISES, INC., BURBANK, CA. FILED 4-19-2004.



FOR NON-MEDICATED TOILETRIES, COSMETICS,
PERFUMERY AND DENTIFRICES (U.S. CLS. 1, 4, 6, 50,
51 AND 52).
WILLIAM BRECKENFELD, EXAMINING ATTORNEY

SN 76-588,125. DISNEY ENTERPRISES, INC., BURBANK, CA. FILED 4-19-2004.

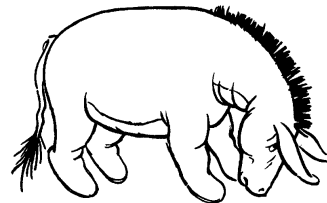

FOR NON-MEDICATED TOILETRIES, COSMETICS,
PERFUMERY AND DENTIFRICES (U.S. CLS. 1, 4, 6, 50,
51 AND 52).
WILLIAM BRECKENFELD, EXAMINING ATTORNEY

CLASS 3—(Continued).

SN 76-590,955. AMOREPACIFIC CORPORATION, SEOUL, REPUBLIC OF KOREA, FILED 5-7-2004.

EGCG THE FIRST

THE MARK CONSISTS OF STANDARD CHARACTERS WITHOUT CLAIM TO ANY PARTICULAR FONT, STYLE, SIZE, OR COLOR.

NO CLAIM IS MADE TO THE EXCLUSIVE RIGHT TO USE "EGCG", APART FROM THE MARK AS SHOWN.

FOR NOURISHING SKIN CREAMS; NAIL ENAMEL REMOVERS; COTTON WOOLS FOR COSMETIC PURPOSES; BATH SOAPS; COSMETIC SOAPS; HAIR SHAMPOOS; PAPER SOAPS; CREAM SOAPS; HAIR RINSES; TOILETTE SOAPS; BODY CLEANSERS; SHAVING SOAPS; HAIR DRYING PREPARATIONS, NAMELY, HAIR STYLING PREPARATIONS; LIQUID SOAPS; ANTI-PERSPIRANT FOOT SOAPS; DEODORANT SOAPS; NON-MEDICATED MOUTH SPRAYS, NAMELY, MOUTH FRESHENERS; NON-MEDICATED MOUTH RINSES; TOOTH POWDERS; TOOTH PASTES; HAIR CARE AND PRESERVATION PREPARATIONS; WHITENING PREPARATIONS FOR TEETH; HAIR DYES; HAIR WAVING PREPARATIONS; HAIR BLEACHING PREPARATIONS; BATH ADDITIVES FOR COSMETIC PURPOSE, NAMELY, BATH BEADS; VANISHING CREAMS FOR COSMETICS; BATH OILS; LIPSTICKS; BATH POWDERS; BABY OILS; BABY POWDERS; CHEEK COLORS; BLUSHERS; POWDERED PERFUMES; NON-MEDICATED DANDRUFF LOTIONS; NON-MEDICATED DANDRUFF CREAMS; NON-MEDICATED BATH SALTS; NON-MEDICATED FRAGRANCES, NAMELY, SCENTED BODY SPRAY; LIQUID ROUGES; SUN MILK, NAMELY, SUN CARE LOTION; SUNSCREEN LOTIONS; SUNSCREEN CREAMS; SUN OILS, NAMELY, SUN TAN OIL; PREPARATIONS FOR SUN TAN; SHAVING CREAMS; NAIL COLORANTS; SKIN MILK, NAMELY, SKIN LOTION; SKIN FRESHENER, NAMELY, ASTRINGENTS FOR COSMETIC PURPOSES; EYE LINERS; MASCARAS; EYE MAKE-UP REMOVERS; EYE SHADOWS; AFTER-SHAVE LOTIONS; EAU DE COLOGNES; DEODORANTS FOR PERSONAL USE; COMMON TOILET WATERS; LIP BRIGHTENERS, NAMELY, LIP POLISHER; LIP NEUTRALIZER, NAMELY, LIP FOUNDATION FOR USE IN EVENING OUT LIP COLOR; FACIAL MASKS; LIP CONDITIONERS; NON-MEDICATED LIP PROTECTORS; NON-MEDICATED COLD CREAMS; FACE POWDERS SOLD IN COMPACT; NON-MEDICATED SKIN CLEANSING CREAMS; DEPILATORY WAXES; DEPILATORY PREPARATIONS; PERMANENT WAVE PREPARATIONS; NEUTRALIZER FOR PERMANENT WAVING; FOUNDATION CREAMS; NON-MEDICATED MASSAGE GELS; FACE POWDERS; POTPOURRIS; SKIN WHITENING CREAMS; HAND CREAMS; PERFUMES; HAIR GELS; HAIR GLAZES; PREPARATIONS FOR DRESSING HAIR, NAMELY, HAIR STYLING GELS; HAIR LACQUERS; HAIR LOTIONS; MASSAGE OILS; HAIR MOISTURIZERS; HAIR MOUSSES; HAIR SPRAYS; HAIR CONDITIONERS; HAIR CREAMS; HAIR TONICS; MAKE-UP POWDERS; ASTRINGENTS FOR COSMETICS; BODY CREAMS; BODY LOTIONS; NAIL POLISH; SKIN CLEANSING FOAMS; SKIN CLEANSING LOTIONS; LIP GLOSS; MASSAGE CREAMS; LIP PENCILS; NON-MEDICATED LIP BALMS; SHOWER COLOGNES; EAU DE TOILETTES; NON-MEDICATED TOILET WATER FOR REMOVING CORNEOUS LAYERS ON THE SKIN; NON-MEDICATED CREAMS FOR REMOVING COMEAL LAYERS ON THE SKIN; NAIL ENAMEL; NON-MEDICATED NUTRITIONAL SKIN MOISTURIZING SERUMS; LAVENDER OILS; INCENSES; ADHESIVES FOR AFFIXING FALSE HAIR; FALSE EYELASHES; FALSE NAILS; TISSUES IMPREGNATED WITH COSMETIC LOTIONS; COTTON STICKS FOR COSMETIC PURPOSES; COSMETIC MASKS; ADHESIVES FOR COSMETIC PURPOSES (U.S. CLS. 1, 4, 6, 50, 51 AND 52).

MARY CRAWFORD, EXAMINING ATTORNEY

CLASS 3—(Continued).

SN 76-592,547. JULIA KAROLY ENTERPRISES, LLC, BUFORD, GA. FILED 5-17-2004.

MOISTURLYNÉ

THE MARK CONSISTS OF STANDARD CHARACTERS WITHOUT CLAIM TO ANY PARTICULAR FONT, STYLE, SIZE, OR COLOR.

FOR COSMETIC SKIN RENEWAL PRODUCTS, NAMELY, MOISTURIZING CREAMS AND LOTIONS, WRINKLE REMOVING AND MINIMIZING SKIN CARE PREPARATIONS; LIP, FACE, AND EYE SERUMS, CREAMS AND LOTIONS (U.S. CLS. 1, 4, 6, 50, 51 AND 52).

ZHALEH DELANEY, EXAMINING ATTORNEY

SN 76-594,480. THE ORGANIC PHARMACY, LONDON, UNITED KINGDOM, FILED 5-27-2004.

The  Organic Pharmacy

NO CLAIM IS MADE TO THE EXCLUSIVE RIGHT TO USE ORGANIC PHARMACY, APART FROM THE MARK AS SHOWN.

FOR SKIN CARE CREAM (U.S. CLS. 1, 4, 6, 50, 51 AND 52).

FIRST USE 7-30-2002; IN COMMERCE 7-30-2002.
KATHY DE JONGE, EXAMINING ATTORNEY

SN 76-595,014. MESO MANAGEMENT LLC, RENO, NV. FILED 6-1-2004.

MESO & ESTETIK

THE MARK CONSISTS OF STANDARD CHARACTERS WITHOUT CLAIM TO ANY PARTICULAR FONT, STYLE, SIZE, OR COLOR.

NO CLAIM IS MADE TO THE EXCLUSIVE RIGHT TO USE "MESO", APART FROM THE MARK AS SHOWN.

THE FOREIGN WORDING IN THE MARK TRANSLATES INTO ENGLISH AS AESTHETIC.

FOR GLYCOLIC SKIN AND BODY LOTIONS; GLYCOLIC EXFOLIATING BODY SCRUBS; SUNSCREEN CREAMS AND LOTIONS; PRE-MOISTENED NON-MEDICATED SKIN TREATMENT PADS CONTAINING SKIN CARE PREPARATIONS; BEAUTY GELS; HAND, SKIN AND BODY LOTIONS; HAND, SKIN AND BODY CREAMS; TONERS; BATH SALTS; BODY OILS (U.S. CLS. 1, 4, 6, 50, 51 AND 52).

FIRST USE 4-0-2004; IN COMMERCE 4-0-2004.
MELISSA SHELLA, EXAMINING ATTORNEY

CLASS 3—(Continued).

SN 76-595,502. DISNEY ENTERPRISES, INC., BURBANK, CA. FILED 6-3-2004.



OWNER OF U.S. REG. NO. 2,702,775.
THE LINING IN THE MARK IS MERELY TO INDICATE SHADING.

THE PORTRAIT IN THE MARK DOES NOT IDENTIFY A LIVING INDIVIDUAL.

FOR NON-MEDICATED TOILETRIES, COSMETICS, PERFUMERY AND DENTIFRICES (U.S. CLS. 1, 4, 6, 50, 51 AND 52).

MARLENE BELL, EXAMINING ATTORNEY

SN 76-598,415. PERFUME OF LIFE, INC., JACKSONVILLE, FL. FILED 6-21-2004.

WANDERLUST

THE MARK CONSISTS OF STANDARD CHARACTERS WITHOUT CLAIM TO ANY PARTICULAR FONT, STYLE, SIZE, OR COLOR.

FOR PERFUME (U.S. CLS. 1, 4, 6, 50, 51 AND 52).

FIRST USE 3-9-2005; IN COMMERCE 3-9-2005.

JOANNA DUKOVIC, EXAMINING ATTORNEY

SN 76-600,724. EISAGE, LLC, DBA ECO-PRODUCTS, BOULDER, CO. FILED 7-6-2004.

ENHANCE

THE MARK CONSISTS OF STANDARD CHARACTERS WITHOUT CLAIM TO ANY PARTICULAR FONT, STYLE, SIZE, OR COLOR.

FOR MULTI PURPOSE HOUSEHOLD SURFACE CLEANER (U.S. CLS. 1, 4, 6, 50, 51 AND 52).

FIRST USE 5-1-2004; IN COMMERCE 5-1-2004.

JOHN LINCOSKI, EXAMINING ATTORNEY

CLASS 3—(Continued).

SN 76-601,089. KIDDE FIRE FIGHTING, INC., EXTON, PA. FILED 7-6-2004.



NO CLAIM IS MADE TO THE EXCLUSIVE RIGHT TO USE "US", APART FROM THE MARK AS SHOWN.

THE COLORS GREEN, BLACK AND ORANGE ARE CLAIMED AS A FEATURE OF THE MARK.

THE MARK CONSISTS OF "ALL-CLEAR" IN LARGE, GREEN, BOLDED LETTERING; AFTER "ALL-CLEAR", THE WORDS, "US GLOBAL NANOSPACE" IN SMALL TYPE, BLACK FONT WITH A PICTORIAL REPRESENTATION OF INTERCONNECTED ORANGE DOTS IN A GEOMETRIC DESIGN ABOVE THE WORDS.

FOR CLEANING PREPARATION IN THE FORM OF FOAM FOR USE IN DECONTAMINATING MILITARY, INDUSTRIAL AND AGRICULTURAL AREAS POLLUTED BY CHEMICAL AND/OR BIOLOGICAL AGENTS (U.S. CLS. 1, 4, 6, 50, 51 AND 52).

ADA HAN, EXAMINING ATTORNEY

SN 76-602,756. SAMY MARK, INC., MIAMI, FL. FILED 7-19-2004.

VOLUMIZING BOOST

THE MARK CONSISTS OF STANDARD CHARACTERS WITHOUT CLAIM TO ANY PARTICULAR FONT, STYLE, SIZE, OR COLOR.

NO CLAIM IS MADE TO THE EXCLUSIVE RIGHT TO USE "VOLUMIZING", APART FROM THE MARK AS SHOWN.

FOR HAIR CARE PREPARATIONS (U.S. CLS. 1, 4, 6, 50, 51 AND 52).

FIRST USE 1-31-2001; IN COMMERCE 1-31-2001.

WINSTON FOLMAR, EXAMINING ATTORNEY

SN 76-605,860. ELINA HERBAL SKIN CARE PRODUCTS, INC., KALAMAZOO, MI. FILED 8-6-2004.

**Elina Natural
Transdermal
Bioenergized**

THE MARK CONSISTS OF STANDARD CHARACTERS WITHOUT CLAIM TO ANY PARTICULAR FONT, STYLE, SIZE, OR COLOR.

NO CLAIM IS MADE TO THE EXCLUSIVE RIGHT TO USE "NATURAL TRANSDERMAL BIOENERGIZED", APART FROM THE MARK AS SHOWN.

FOR SKIN CARE, LIP CARE, AND HAIR CARE PRODUCTS, NAMELY FACIAL CLEANSERS, TONERS, EXFOLIATES, SCRUBS, MAKE-UP, MOISTURIZERS, LOTIONS, SPRAYS, SHAMPOOS, LIPSTICK, EYE SHADOW, AND MASCARA (U.S. CLS. 1, 4, 6, 50, 51 AND 52).

FIRST USE 4-1-2002; IN COMMERCE 4-1-2002.

JENNIFER MARTIN, EXAMINING ATTORNEY

CLASS 3—(Continued).

SN 76-608,932. L'OREAL, PARIS, FRANCE, FILED 8-27-2004.

UV·ACTIV

THE MARK CONSISTS OF STANDARD CHARACTERS WITHOUT CLAIM TO ANY PARTICULAR FONT, STYLE, SIZE, OR COLOR.

NO CLAIM IS MADE TO THE EXCLUSIVE RIGHT TO USE "UV", APART FROM THE MARK AS SHOWN.

FOR DAILY SKIN MOISTURIZER WITH SUNSCREEN (U.S. CLS. 1, 4, 6, 50, 51 AND 52).

WANDA KAY PRICE, EXAMINING ATTORNEY

SN 76-609,507. L'OREAL, PARIS, FRANCE, FILED 8-31-2004.

INCELL

THE MARK CONSISTS OF STANDARD CHARACTERS WITHOUT CLAIM TO ANY PARTICULAR FONT, STYLE, SIZE, OR COLOR.

OWNER OF FRANCE REG. NO. 03/3,239,408, DATED 7-31-2003, EXPIRES 7-31-2013.

FOR HAIR COLOR AND AN INGREDIENT SOLD AS A COMPONENT OF HAIR COLOR (U.S. CLS. 1, 4, 6, 50, 51 AND 52).

DORITT L. CARROLL, EXAMINING ATTORNEY

SN 76-609,771. CONTEC, INC., SPARTANBURG, SC. FILED 9-1-2004.

XWIPES

THE MARK CONSISTS OF STANDARD CHARACTERS WITHOUT CLAIM TO ANY PARTICULAR FONT, STYLE, SIZE, OR COLOR.

FOR CLEANING PRODUCTS, NAMELY EQUIPMENT CLEANING WIPES THAT ARE PRE-SATURATED WITH A CLEANING AGENT FOR USE IN CONJUNCTION WITH CLEANING EXERCISE AND GYM EQUIPMENT (U.S. CLS. 1, 4, 6, 50, 51 AND 52).

FIRST USE 10-0-2003; IN COMMERCE 10-0-2003.

AMY HELLA, EXAMINING ATTORNEY

CLASS 3—(Continued).

SN 76-612,391. MALLYGIRL LLC, NEW YORK, NY. FILED 9-21-2004.

SHIMMER SHAPE & GLOW

THE MARK CONSISTS OF STANDARD CHARACTERS WITHOUT CLAIM TO ANY PARTICULAR FONT, STYLE, SIZE, OR COLOR.

FOR COSMETICS; FACE DEFINING SYSTEM, NAMELY, COMPACT MAKEUP POWDER KIT CONTAINING MAKEUP, BRUSHES, MIRROR AND INSTRUCTIONAL GUIDE (U.S. CLS. 1, 4, 6, 50, 51 AND 52).

EVELYN BRADLEY, EXAMINING ATTORNEY

SN 76-613,001. LANCOME PARFUMS ET BEAUTE & CIE, PARIS, FRANCE, FILED 9-20-2004.

ROUGE VERSATILE

THE MARK CONSISTS OF STANDARD CHARACTERS WITHOUT CLAIM TO ANY PARTICULAR FONT, STYLE, SIZE, OR COLOR.

NO CLAIM IS MADE TO THE EXCLUSIVE RIGHT TO USE "ROUGE", APART FROM THE MARK AS SHOWN.

FOR LIPSTICK (U.S. CLS. 1, 4, 6, 50, 51 AND 52).

DAWN HAN, EXAMINING ATTORNEY

SN 76-613,273. BEAUTE CREATEURS, PARIS, FRANCE, FILED 9-22-2004.

KEEP CONTROL

THE MARK CONSISTS OF STANDARD CHARACTERS WITHOUT CLAIM TO ANY PARTICULAR FONT, STYLE, SIZE, OR COLOR.

PRIORITY CLAIMED UNDER SEC. 44(D) ON FRANCE APPLICATION NO. 04/3,284,890, FILED 4-8-2004, REG. NO. 043284890, DATED 4-8-2004, EXPIRES 4-8-2014.

FOR SHAMPOOS; GELS, SPRAYS, MOUSSES AND BALMS FOR HAIR STYLING AND HAIR CARE; HAIR LACQUERS; HAIR COLOURING AND HAIR DECOLORANT PREPARATIONS; PERMANENT WAVING AND CURLING PREPARATIONS; ESSENTIAL OILS FOR PERSONAL USE (U.S. CLS. 1, 4, 6, 50, 51 AND 52).

JENNIFER KRISP, EXAMINING ATTORNEY

SN 76-616,207. VOTIVO, LTD., SEATTLE, WA. FILED 10-18-2004.

MT. AIRY AZALEA

THE MARK CONSISTS OF STANDARD CHARACTERS WITHOUT CLAIM TO ANY PARTICULAR FONT, STYLE, SIZE, OR COLOR.

OWNER OF U.S. REG. NO. 2,720,910.

NO CLAIM IS MADE TO THE EXCLUSIVE RIGHT TO USE "AZALEA", APART FROM THE MARK AS SHOWN.

FOR SKIN SOAP (U.S. CLS. 1, 4, 6, 50, 51 AND 52).

FIRST USE 1-9-2004; IN COMMERCE 1-9-2004.

GINA FINK, EXAMINING ATTORNEY

CLASS 3—(Continued).

SN 76-616,208. VOTIVO, LTD., SEATTLE, WA. FILED 10-18-2004.

RHONE VALLEY LILAC

THE MARK CONSISTS OF STANDARD CHARACTERS WITHOUT CLAIM TO ANY PARTICULAR FONT, STYLE, SIZE, OR COLOR.

OWNER OF U.S. REG. NO. 2,720,900.
NO CLAIM IS MADE TO THE EXCLUSIVE RIGHT TO USE "LILAC", APART FROM THE MARK AS SHOWN.
FOR SKIN SOAP (U.S. CLS. 1, 4, 6, 50, 51 AND 52).
FIRST USE 1-9-2004; IN COMMERCE 1-9-2004.
GINA FINK, EXAMINING ATTORNEY

CLASS 3—(Continued).

SN 76-616,212. VOTIVO, LTD., SEATTLE, WA. FILED 10-18-2004.

WESTMINSTER BAYBERRY

THE MARK CONSISTS OF STANDARD CHARACTERS WITHOUT CLAIM TO ANY PARTICULAR FONT, STYLE, SIZE, OR COLOR.

OWNER OF U.S. REG. NO. 2,717,255.
NO CLAIM IS MADE TO THE EXCLUSIVE RIGHT TO USE "BAYBERRY", APART FROM THE MARK AS SHOWN.
FOR SKIN SOAP (U.S. CLS. 1, 4, 6, 50, 51 AND 52).
FIRST USE 1-9-2004; IN COMMERCE 1-9-2004.
GINA FINK, EXAMINING ATTORNEY

SN 76-616,209. VOTIVO, LTD., SEATTLE, WA. FILED 10-18-2004.

SQUASH BLOSSOM

THE MARK CONSISTS OF STANDARD CHARACTERS WITHOUT CLAIM TO ANY PARTICULAR FONT, STYLE, SIZE, OR COLOR.

OWNER OF U.S. REG. NO. 2,720,902.
NO CLAIM IS MADE TO THE EXCLUSIVE RIGHT TO USE "SQUASH", APART FROM THE MARK AS SHOWN.
FOR SKIN SOAP (U.S. CLS. 1, 4, 6, 50, 51 AND 52).
FIRST USE 1-9-2004; IN COMMERCE 1-9-2004.
GINA FINK, EXAMINING ATTORNEY

SN 76-616,213. VOTIVO, LTD., SEATTLE, WA. FILED 10-18-2004.

ST. GERMAIN-EN-LAYE LAVENDER

THE MARK CONSISTS OF STANDARD CHARACTERS WITHOUT CLAIM TO ANY PARTICULAR FONT, STYLE, SIZE, OR COLOR.

OWNER OF U.S. REG. NO. 2,720,901.
NO CLAIM IS MADE TO THE EXCLUSIVE RIGHT TO USE "LAVENDER", APART FROM THE MARK AS SHOWN.
FOR SKIN SOAP (U.S. CLS. 1, 4, 6, 50, 51 AND 52).
FIRST USE 1-9-2004; IN COMMERCE 1-9-2004.
GINA FINK, EXAMINING ATTORNEY

SN 76-616,210. VOTIVO, LTD., SEATTLE, WA. FILED 10-18-2004.

SUMATRA LEMONGRASS

THE MARK CONSISTS OF STANDARD CHARACTERS WITHOUT CLAIM TO ANY PARTICULAR FONT, STYLE, SIZE, OR COLOR.

OWNER OF U.S. REG. NO. 2,720,903.
NO CLAIM IS MADE TO THE EXCLUSIVE RIGHT TO USE "LEMONGRASS", APART FROM THE MARK AS SHOWN.
FOR SKIN SOAP (U.S. CLS. 1, 4, 6, 50, 51 AND 52).
FIRST USE 1-9-2004; IN COMMERCE 1-9-2004.
GINA FINK, EXAMINING ATTORNEY

SN 76-616,214. VOTIVO, LTD., SEATTLE, WA. FILED 10-18-2004.

GINGERED CURRANT

THE MARK CONSISTS OF STANDARD CHARACTERS WITHOUT CLAIM TO ANY PARTICULAR FONT, STYLE, SIZE, OR COLOR.

OWNER OF U.S. REG. NO. 2,749,670.
SEC. 2(F).
FOR SKIN SOAP (U.S. CLS. 1, 4, 6, 50, 51 AND 52).
FIRST USE 1-9-2004; IN COMMERCE 1-9-2004.
GINA FINK, EXAMINING ATTORNEY

CLASS 3—(Continued).

SN 76-616,216. VOTIVO, LTD., SEATTLE, WA. FILED 10-18-2004.

ANJOU PEAR

THE MARK CONSISTS OF STANDARD CHARACTERS WITHOUT CLAIM TO ANY PARTICULAR FONT, STYLE, SIZE, OR COLOR.
OWNER OF U.S. REG. NO. 2,749,671.
SEC. 2(F).
FOR SKIN SOAP (U.S. CLS. 1, 4, 6, 50, 51 AND 52).
FIRST USE 1-9-2004; IN COMMERCE 1-9-2004.
GINA FINK, EXAMINING ATTORNEY

SN 76-616,217. VOTIVO, LTD., SEATTLE, WA. FILED 10-18-2004.

PROVENCAL HONEY

THE MARK CONSISTS OF STANDARD CHARACTERS WITHOUT CLAIM TO ANY PARTICULAR FONT, STYLE, SIZE, OR COLOR.
NO CLAIM IS MADE TO THE EXCLUSIVE RIGHT TO USE "HONEY", APART FROM THE MARK AS SHOWN.
FOR SKIN SOAP (U.S. CLS. 1, 4, 6, 50, 51 AND 52).
FIRST USE 1-9-2004; IN COMMERCE 1-9-2004.
GINA FINK, EXAMINING ATTORNEY

SN 76-616,218. VOTIVO, LTD., SEATTLE, WA. FILED 10-18-2004.

TUSCAN OLIVE

THE MARK CONSISTS OF STANDARD CHARACTERS WITHOUT CLAIM TO ANY PARTICULAR FONT, STYLE, SIZE, OR COLOR.
OWNER OF U.S. REG. NO. 2,749,665.
SEC. 2(F).
FOR SKIN SOAP (U.S. CLS. 1, 4, 6, 50, 51 AND 52).
FIRST USE 1-9-2004; IN COMMERCE 1-9-2004.
GINA FINK, EXAMINING ATTORNEY

CLASS 3—(Continued).

SN 76-616,221. VOTIVO, LTD., SEATTLE, WA. FILED 10-18-2004.

NEWBURY HOLLY

THE MARK CONSISTS OF STANDARD CHARACTERS WITHOUT CLAIM TO ANY PARTICULAR FONT, STYLE, SIZE, OR COLOR.
NO CLAIM IS MADE TO THE EXCLUSIVE RIGHT TO USE "HOLLY", APART FROM THE MARK AS SHOWN.
FOR SKIN SOAP (U.S. CLS. 1, 4, 6, 50, 51 AND 52).
FIRST USE 1-9-2004; IN COMMERCE 1-9-2004.
GINA FINK, EXAMINING ATTORNEY

SN 76-616,222. VOTIVO, LTD., SEATTLE, WA. FILED 10-18-2004.

ROSEMARY GARDEN

THE MARK CONSISTS OF STANDARD CHARACTERS WITHOUT CLAIM TO ANY PARTICULAR FONT, STYLE, SIZE, OR COLOR.
OWNER OF U.S. REG. NO. 2,723,693.
NO CLAIM IS MADE TO THE EXCLUSIVE RIGHT TO USE "ROSEMARY", APART FROM THE MARK AS SHOWN.
FOR SKIN SOAP (U.S. CLS. 1, 4, 6, 50, 51 AND 52).
FIRST USE 1-9-2004; IN COMMERCE 1-9-2004.
GINA FINK, EXAMINING ATTORNEY

SN 76-616,898. SPPC PARIS BLEU, 75017 PARIS, FRANCE, FILED 10-19-2004.

PULSATION

THE MARK CONSISTS OF STANDARD CHARACTERS WITHOUT CLAIM TO ANY PARTICULAR FONT, STYLE, SIZE, OR COLOR.
FOR PERFUMERY (U.S. CLS. 1, 4, 6, 50, 51 AND 52).
FIRST USE 8-0-2003; IN COMMERCE 8-0-2003.
MARK RADEMACHER, EXAMINING ATTORNEY

CLASS 3—(Continued).

SN 76-617,176. SPPC PARIS BLEU, 75017 PARIS, FRANCE,
FILED 10-19-2004.

WINFLOWER

THE MARK CONSISTS OF STANDARD CHARACTERS
WITHOUT CLAIM TO ANY PARTICULAR FONT, STYLE,
SIZE, OR COLOR.

FOR PERFUMERY (U.S. CLS. 1, 4, 6, 50, 51 AND 52).
FIRST USE 9-0-2004; IN COMMERCE 9-0-2004.
CHRIS WELLS, EXAMINING ATTORNEY

SN 76-617,179. SPPC PARIS BLEU, 75017 PARIS, FRANCE,
FILED 10-19-2004.

SANDERLING

THE MARK CONSISTS OF STANDARD CHARACTERS
WITHOUT CLAIM TO ANY PARTICULAR FONT, STYLE,
SIZE, OR COLOR.

FOR PERFUMERY (U.S. CLS. 1, 4, 6, 50, 51 AND 52).
FIRST USE 8-0-2004; IN COMMERCE 8-0-2004.
CHRIS WELLS, EXAMINING ATTORNEY

SN 76-617,180. SPPC PARIS BLEU, 75017 PARIS, FRANCE,
FILED 10-19-2004.

SEDUCTRICE DE PARIS

THE MARK CONSISTS OF STANDARD CHARACTERS
WITHOUT CLAIM TO ANY PARTICULAR FONT, STYLE,
SIZE, OR COLOR.

NO CLAIM IS MADE TO THE EXCLUSIVE RIGHT TO
USE "PARIS", APART FROM THE MARK AS SHOWN.

THE ENGLISH TRANSLATION OF THE WORDING IN
THE MARK IS "SEDUCTRESS OF PARIS".

FOR PERFUMERY (U.S. CLS. 1, 4, 6, 50, 51 AND 52).
FIRST USE 8-0-2004; IN COMMERCE 8-0-2004.
CHRIS WELLS, EXAMINING ATTORNEY

CLASS 3—(Continued).

SN 76-617,183. SPPC PARIS BLEU, 75017 PARIS, FRANCE,
FILED 10-19-2004.

SLIDER

THE MARK CONSISTS OF STANDARD CHARACTERS
WITHOUT CLAIM TO ANY PARTICULAR FONT, STYLE,
SIZE, OR COLOR.

FOR PERFUMERY (U.S. CLS. 1, 4, 6, 50, 51 AND 52).
FIRST USE 8-0-2003; IN COMMERCE 8-0-2003.
CHRIS WELLS, EXAMINING ATTORNEY

SN 76-617,227. ENVIROX, L.L.C., DANVILLE, IL. FILED 10-
20-2004.

MINERAL SHOCK

THE MARK CONSISTS OF STANDARD CHARACTERS
WITHOUT CLAIM TO ANY PARTICULAR FONT, STYLE,
SIZE, OR COLOR.

NO CLAIM IS MADE TO THE EXCLUSIVE RIGHT TO
USE "MINERAL", APART FROM THE MARK AS SHOWN.
FOR CLEANERS NAMELY STAIN REMOVERS (U.S.
CLS. 1, 4, 6, 50, 51 AND 52).

FIRST USE 10-31-2002; IN COMMERCE 10-31-2002.
ROBIN CHOSID, EXAMINING ATTORNEY

SN 76-617,341. ALOE VERA OF AMERICA, INC., DALLAS,
TX. FILED 10-22-2004.

FOREVER MARINE MASK

THE MARK CONSISTS OF STANDARD CHARACTERS
WITHOUT CLAIM TO ANY PARTICULAR FONT, STYLE,
SIZE, OR COLOR.

OWNER OF U.S. REG. NOS. 1,724,910, 2,094,053 AND
OTHERS.

NO CLAIM IS MADE TO THE EXCLUSIVE RIGHT TO
USE "MARINE MASK", APART FROM THE MARK AS
SHOWN.

FOR FACE CLEANSER WITH NATURAL SEA MINER-
ALS, SUPER MOISTURIZING AND CONDITIONING
PROPERTIES (U.S. CLS. 1, 4, 6, 50, 51 AND 52).

FIRST USE 8-9-2004; IN COMMERCE 8-9-2004.
LINDA M. KING, EXAMINING ATTORNEY

CLASS 3—(Continued).

SN 76-621,571. FANTASIA ACCESSORIES, LTD., NEW YORK, NY. FILED 11-22-2004.

CLASS 3—(Continued).

SN 76-638,769. ANIMALE GROUP, S.A., PANAMA, PANAMA, FILED 5-17-2005.

JOHNSON PARKER

THE MARK CONSISTS OF STANDARD CHARACTERS WITHOUT CLAIM TO ANY PARTICULAR FONT, STYLE, SIZE, OR COLOR.

THE NAME JOHNSON PARKER DOES NOT IDENTIFY A LIVING INDIVIDUAL.

FOR BUBBLE BATH CONCENTRATES; HAND AND BODY SOAPS; HAND AND BODY CREAMS; HAND AND BODY WASHES; HAIR SHAMPOOS; HAIR GELS AND HAIR CONDITIONERS; PERSONAL DEODORANTS; NON-MEDICATED BABY POWDERS, BABY LOTIONS, BUBBLE BATH ADDITIVES, BABY OILS AND BABY SHAMPOOS; FOOT POWDERS; AND COSMETIC PETROLEUM JELLY (U.S. CLS. 1, 4, 6, 50, 51 AND 52).

FIRST USE 1-0-2003; IN COMMERCE 1-0-2003.
YONG KIM, EXAMINING ATTORNEY



SN 76-626,600. NEUTROGENA CORPORATION, LOS ANGELES, CA. FILED 1-3-2005.

RETHINK COSMETICS

THE MARK CONSISTS OF STANDARD CHARACTERS WITHOUT CLAIM TO ANY PARTICULAR FONT, STYLE, SIZE, OR COLOR.

NO CLAIM IS MADE TO THE EXCLUSIVE RIGHT TO USE COSMETICS, APART FROM THE MARK AS SHOWN.

FOR COSMETICS AND NON-MEDICATED SKIN CARE PREPARATIONS (U.S. CLS. 1, 4, 6, 50, 51 AND 52).
ANGELA M. MICHELI, EXAMINING ATTORNEY



SN 76-626,663. NEUTROGENA CORPORATION, LOS ANGELES, CA. FILED 1-3-2005.

RETHINK BEAUTY

THE MARK CONSISTS OF STANDARD CHARACTERS WITHOUT CLAIM TO ANY PARTICULAR FONT, STYLE, SIZE, OR COLOR.

FOR COSMETICS AND NON-MEDICATED SKIN CARE PREPARATIONS (U.S. CLS. 1, 4, 6, 50, 51 AND 52).
ANGELA M. MICHELI, EXAMINING ATTORNEY

ANIMALE RED

THE MARK CONSISTS OF STANDARD CHARACTERS WITHOUT CLAIM TO ANY PARTICULAR FONT, STYLE, SIZE, OR COLOR.

OWNER OF U.S. REG. NO. 1,419,688.

NO CLAIM IS MADE TO THE EXCLUSIVE RIGHT TO USE "RED", APART FROM THE MARK AS SHOWN.

THE ENGLISH TRANSLATION OF "ANIMALE" IS "ANIMAL".

FOR EAU DE COLOGNE AND PERFUME (U.S. CLS. 1, 4, 6, 50, 51 AND 52).

RONALD MCMORROW, EXAMINING ATTORNEY



SN 76-638,770. ANIMALE GROUP, S.A., PANAMA, PANAMA, FILED 5-17-2005.

ANIMALE ROJO

THE MARK CONSISTS OF STANDARD CHARACTERS WITHOUT CLAIM TO ANY PARTICULAR FONT, STYLE, SIZE, OR COLOR.

OWNER OF U.S. REG. NO. 1,419,688.

NO CLAIM IS MADE TO THE EXCLUSIVE RIGHT TO USE "ROJO", APART FROM THE MARK AS SHOWN.

THE ENGLISH TRANSLATION OF "ANIMALE ROJO" IS "RED ANIMAL".

FOR EAU DE COLOGNE AND PERFUME (U.S. CLS. 1, 4, 6, 50, 51 AND 52).

RONALD MCMORROW, EXAMINING ATTORNEY

CLASS 3—(Continued).

SN 78-203,128. EMAJD LTD, TORONTO, ONTARIO, CANADA, FILED 1-14-2003.

distinct man

PRIORITY CLAIMED UNDER SEC. 44(D) ON CANADA APPLICATION NO. 1163817, FILED 1-7-2003, REG. NO. TMA423617, DATED 2-15-2005, EXPIRES 2-15-2020.

FOR (BASED ON SECTIONS 1(A) AND 44(D)) SKIN CARE AND MAKEUP PRODUCTS NAMELY AFTER SHAVES, FACIAL CLEANSERS, FACE AND SKIN SCRUBS, FACE AND SKIN MASKS, FACE AND SKIN MOISTURIZERS, FACE AND SKIN EXFOLIATORS, UNDER EYE GELS, NON-MEDICATED SKIN SERUMS, FOUNDATIONS, CONCEALERS, SKIN CORRECTORS, FACE POWDERS, DUSTING POWDER, BODY POWDER; (BASED ON SECTION 1(B)) COSMETICS AND TOILETRIES, NAMELY SKIN CARE PRODUCTS, NAMELY PRE-SHAVE OILS, SHAVE CREAMS, ANTI-BUMP REPAIRS, TONERS, FACIAL SPRAYS, SHOWER GELS, BATH GELS, BODY SCRUBS, BODY SOAP, BODY LOTIONS, BODY TREATMENTS, NAMELY, BODY SKIN EXFOLIATORS, BODY MOISTURIZERS, BODY SPRAYS, BODY GELS, BODY OILS, MASSAGE OILS, HAND SOAPS, HAND SCRUBS, HAND LOTIONS, CUTICLE REMOVERS, NAIL POLISH REMOVERS, NAIL TREATMENTS, NAMELY NAIL HARDENER, NAIL ENAMELS, NAIL POLISH, FOOT SCRUBS, NON-MEDICATED FOOT LOTIONS, MAKEUP REMOVERS, EYE MAKEUP REMOVERS, SHAMPOOS, CONDITIONERS, HAIR CLEANSERS, HAIR STYLING SPRAYS, HAIR STYLING GELS, HAIR STYLING POMADE, HAIR TREATMENTS, NAMELY, HAIR COLOR, HAIR DYE, HAIR WAVING LOTION, HAIR STRAIGHTENING LOTION, SUNSCREENS, AFTER-SUN CREAMS, LOTIONS AND GELS, SUNLESS TAN CREAMS, LOTIONS AND GELS, DEODORANTS, ANTI-PERSPIRANTS; MAKEUP PRODUCTS, NAMELY BLUSHES, SHADOW BASES, EYE SHADOWS, EYELINERS, MASCARAS, LIPSTICKS, LIP GLOSSES, LIP CREAMS, LIP LINERS, NAIL POLISHES, BODY GLISTENS, NAMELY, SHIMMER TINTS, BODY BRONZERS, PERFUMES, COLOGNES, EAU DE PERFUMES, EAU DE TOILETTES, TOILET WATERS, ESSENTIAL OILS FOR PERSONAL USE, BODY FRAGRANCES (U.S. CLS. 1, 4, 6, 50, 51 AND 52).

FIRST USE 11-17-2002; IN COMMERCE 1-2-2003.
STACY WAHLBERG, EXAMINING ATTORNEY

SN 78-289,157. DIVERSIFIED SOLUTIONS, LLC, DORAVILLE, GA. FILED 8-19-2003.

BYE BYE GUM

NO CLAIM IS MADE TO THE EXCLUSIVE RIGHT TO USE "GUM", APART FROM THE MARK AS SHOWN.
FOR CLEANING PREPARATIONS FOR USE IN REMOVAL OF CHEWING GUM (U.S. CLS. 1, 4, 6, 50, 51 AND 52).

FIRST USE 6-1-2002; IN COMMERCE 6-1-2002.
LINDA MICKLEBURGH, EXAMINING ATTORNEY

CLASS 3—(Continued).

SN 78-295,621. BERNER OSAKEYHTIO, HELSINKI, FINLAND, FILED 9-3-2003.

HERBINA

OWNER OF ERPN CMNTY TM OFC REG. NO. 340919, DATED 1-7-1999, EXPIRES 4-1-2006.

OWNER OF FINLAND REG. NO. 87054, DATED 10-20-1983, RENEWED AS REG. NO. 87054, DATED 7-3-2003, EXPIRES 10-20-2013.

OWNER OF U.S. REG. NO. 2,096,283.

FOR COSMETICS, NAMELY, BODY CARE, FACE CARE AND HAND CARE PRODUCTS IN THE FORM OF NOURISHING, CONDITIONING AND MOISTURIZING LIQUIDS FOR FACE AND BODY CARE, CREAMS, MASKS, AMPOULES CONTAINING NOURISHING, CONDITIONING AND MOISTURIZING LIQUIDS FOR FACE AND BODY CARE; NOURISHING, CONDITIONING AND MOISTURIZING GELS AND EMULSIONS FOR FACE AND BODY CARE; FACIAL MAKEUP, FOUNDATIONS, SKIN CLEANSING LOTIONS, CLEANING, SOOTHING AND REFRESHING TONICS FOR FACE CARE, NON-MEDICATED ACNE PREPARATIONS, LIPSTICK, LIP GLOSSES, LIP LINER, NAIL POLISH, MASCARA, EYELINERS, EYE SHADOW, EYE MAKE-UP REMOVER, FACE POWDER, FACE CREAMS, ROUGES, NAIL POLISH REMOVER; NAIL CARE PREPARATIONS, SUN PROTECTION PREPARATIONS; BODY SOAPS, LAUNDRY DETERGENTS, HAIR AND BODY SHAMPOOS, HAIR CONDITIONING PREPARATIONS, HAIR WAVING PREPARATIONS, HAIR GELS, HAIR DYES; HAIR SPRAYS; NON-MEDICATED HAIR CARE PREPARATIONS, HAIR COLOR, HAIR COLOR REMOVERS, HAIR LIGHTENERS, HAIR MOUSSE, HAIR MASCARA, HAIR LOTIONS, HAIR STYLING PREPARATIONS, HAIR WAVING LOTIONS; PERSONAL DEODORANTS, PERSONAL ANTIPERSPIRANTS, ESSENTIAL OILS FOR PERSONAL USE AND FOR USE IN THE MANUFACTURE OF SCENTED PRODUCTS; SHAVING PREPARATIONS; TOOTHPASTE (U.S. CLS. 1, 4, 6, 50, 51 AND 52).

ZACHARY BELLO, EXAMINING ATTORNEY

CLASS 3—(Continued).

SN 78-306,134. VALENCIA INTERNATIONAL INC., HOLLYWOOD, CA. FILED 9-26-2003.



THE COLOR(S) BURGUNDY IS/ARE CLAIMED AS A FEATURE OF THE MARK.

THE COLORS OF THE PARTHENA NAME APPEAR IN BURGUNDY THE LETTER P APPEAR IN BURGUNDY (FADED).

FOR COSMETICS AND NON-MEDICATED SKIN CARE PREPARATIONS, NAMELY, SKIN CLEANSERS, SKIN TONERS, EYE MAKE UP REMOVERS, MOISTURIZERS, DAY CREAMS, NIGHT CREAMS, LIP CREAMS, EYE CREAMS, SKIN PEELING CREAMS, BODY CREAMS, SCENTED CREAMS, HAND AND FOOT CREAMS, OIL FREE FACE CREAMS, BLEMISH CREAMS, BLEMISH MASKS, BODY SCRUBS, FACE SCRUBS, EYE GELS, SKIN GELS, NON-MEDICATED HAIR CARE PREPARATIONS, LIPSTICKS, LIP CASES SOLD WITH LIPSTICKS AS A UNIT, EYE SHADOW KITS COMPRISING EYE SHADOWS, MASCARA, EYELINER PENCILS, BROW THICKENER AND LASH CONDITIONER, FACE POWDERS, MASCARA, LASH THICKENERS, EYE PENCILS, LIP PENCILS, FOUNDATIONS, CONCEALERS, MAKEUP KITS COMPRISING LIPSTICKS, EYE SHADOWS, BLUSHERS, PENCILS, POWDERS, AND CONCEALERS, SKIN CARE KITS COMPRISING CLEANSERS, TONERS, DAY CREAMS, EYE CREAMS, EYE MAKE UP REMOVERS, MOISTURIZERS, PEELING CREAMS, EYE GELS, MOISTURIZING GELS, SCRUBS, MASKS, BODY CREAMS, AND HAND AND FOOT CREAMS, FOUNDATION KITS COMPOSED OF POWDERS AND GELS, PERFUME, AND COLOGNE (U.S. CLS. 1, 4, 6, 50, 51 AND 52).

APRIL L. RADEMACHER, EXAMINING ATTORNEY

SN 78-307,172. CAR MATE MFG. CO., LTD., TOKYO, JAPAN, FILED 9-30-2003.

CAR MATE

OWNER OF U.S. REG. NO. 2,828,916.
NO CLAIM IS MADE TO THE EXCLUSIVE RIGHT TO USE "CAR", APART FROM THE MARK AS SHOWN.

FOR PERFUMERY, DETERGENT SOAP FOR VEHICLES, VEHICLE WAXES, AUTOMOBILE POLISHES, WINDOW WASHER FLUID (U.S. CLS. 1, 4, 6, 50, 51 AND 52).

FIRST USE 12-31-1979; IN COMMERCE 4-1-1988.
RONALD MCMORROW, EXAMINING ATTORNEY

CLASS 3—(Continued).

SN 78-309,387. SHANKS, BRUCE, H, ORLANDO, FL. FILED 10-3-2003.



THE "SOL" IN CARIBBEAN SOL, IS THE SPANISH WORD FOR "SUN".

FOR SUNSCREENS; BODY OILS; BODY CREAMS; BODY EMULSIONS; SHAMPOO; HAIR CONDITIONER; BATH GEL (U.S. CLS. 1, 4, 6, 50, 51 AND 52).

FIRST USE 7-20-2003; IN COMMERCE 7-22-2003.
NORA BUCHANAN WILL, EXAMINING ATTORNEY

SN 78-310,786. TSUMURA & CO., TOKYO, JAPAN, FILED 10-8-2003.



NO CLAIM IS MADE TO THE EXCLUSIVE RIGHT TO USE THE JAPANESE CHARACTER(S) MEANING KITCHEN, APART FROM THE MARK AS SHOWN.

THE NON-LATIN CHARACTERS IN THE MARK TRANSLITERATE TO "KIT-CHI-NN", "A-KU-A" AND "SHOT-TO" AND THIS MEANS "KITCHEN, AQUA AND SHOT" RESPECTIVELY IN ENGLISH.

FOR ALMOND SOAP FOR SKIN, ANTIPERSPIRANT SOAP, CAKES OF TOILET SOAP, CLEANING PREPARATIONS FOR KITCHEN UTENSILS AND KITCHEN UNIT, NAMELY, REFRIGERATORS, FREEZERS, GAS RANGES, OVENS, MICROWAVE OVENS, RICE COOKERS, ELECTRIC POTS, DINING TABLES, KITCHEN COUNTERS, SINKS, KITCHEN CABINETS, VENTILATING FANS, DISHWASHERS, DISHDRIERS, TOASTERS, DEEP FRYERS, JUICE MAKERS, FOOD PROCESSORS, ELECTRIC BLENDERS; DEODORANT SOAP, DETERGENTS OTHER THAN FOR USE IN MANUFACTURING OPERATIONS AND FOR MEDICAL PURPOSES, NAMELY, DETERGENTS FOR DISHWASHING, LAUNDRY, GLASS INCLUDING MIRRORS AND WINDOWS, WALL AND FLOOR SURFACES, CARPET, FURNITURE, TELEVISION SETS, TELEPHONE SETS, TOILET SEATS, REFRIGERATORS, FREEZERS, GAS RANGES, OVENS, MICROWAVE OVENS, RICE COOKERS, ELECTRIC POTS, DINING TABLES, KITCHEN COUNTERS, SINKS, KITCHEN CABINETS, VENTILATING FANS, DISH-

CLASS 3—(Continued).

WASHERS, DISHDRIERS, TOASTERS, DEEP FRYERS, JUICE MAKERS, FOOD PROCESSORS, ELECTRIC BLENDERS, TOYS AND INTERIORS OF CAR; DISINFECTANT SOAP, DRY CLEANING FLUID, HOUSEHOLD CLEANING PREPARATIONS, MEDICATED SOAP, SCOURING SOLUTIONS NAMELY, SCOURING FLUID, SCOURING POWDER, SCOURING GEL; HAIR SHAMPOO, SHAMPOO FOR BODY; NON-MEDICATED SHAMPOO FOR PETS, SHAVING SOAP, SOAPS FOR THE BODY, HAIR AND DISHWASHING SOAPS, SOAP FOR FOOT PERSPIRATION, SOAP FOR BRIGHTENING TEXTILES, WASHING PREPARATIONS, NAMELY, CLEANING PREPARATIONS FOR BATHTUBS AND BATHROOMS, MIRRORS, FURNITURE MADE OF PLASTICS, INTERIORS OF CARS, TELEVISION SETS, TELEPHONE SETS, TOILET SEATS, TOYS AND CABINET; NON-MEDICATED ALL PURPOSE CLEANING PREPARATIONS; NON-MEDICATED MOUTH WASHES, DENTIFRICES, DENTURE CLEANING PREPARATIONS, AND DENTURE POLISHES (U.S. CLS. 1, 4, 6, 50, 51 AND 52).

BARBARA A. LOUGHRAN, EXAMINING ATTORNEY

SN 78-330,729. LINACARE HOLDING COMPANY, LTD., VANCOUVER, BRITISH COLUMBIA, CANADA, FILED 11-20-2003.

LINACARE

THE MARK CONSISTS OF STANDARD CHARACTERS WITHOUT CLAIM TO ANY PARTICULAR FONT, STYLE, SIZE, OR COLOR.

PRIORITY CLAIMED UNDER SEC. 44(D) ON CANADA APPLICATION NO. 1179128, FILED 5-23-2003, REG. NO. TMA629511, DATED 1-6-2005, EXPIRES 1-6-2020.

FOR COSMETIC PRODUCTS, NAMELY, FACE, HAND AND SKIN CREAM (U.S. CLS. 1, 4, 6, 50, 51 AND 52).

WON TEAK OH, EXAMINING ATTORNEY

CLASS 3—(Continued).

SN 78-351,533. MATTEL, INC., EL SEGUNDO, CA. FILED 1-13-2004.

FISHER-PRICE

THE MARK CONSISTS OF STANDARD CHARACTERS WITHOUT CLAIM TO ANY PARTICULAR FONT, STYLE, SIZE, OR COLOR.

FOR HAIR SHAMPOO, HAIR SHAMPOO WITH CONDITIONER, HAIR CONDITIONER, HAIR DETANGLER; BODY LOTION, BODY CREAM, BODY SOAP, BODY POWDER WITH CORNSTARCH, PREMOISTENED COSMETIC WASH CLOTHS, BUBBLE BATH, TOOTH PASTE (U.S. CLS. 1, 4, 6, 50, 51 AND 52).

PRISCILLA MILTON, EXAMINING ATTORNEY

SN 78-352,682. SANTEE COSMETICS USA, LOS ANGELES, CA. FILED 1-15-2004.

SANTEE

FOR LIPSTICK, LIP GLOSS, LIP LINERS, LIPLINER PENCILS, LIPSTICK PENCILS, LIQUID LIPLINERS, NON-MEDICATED LIP PROTECTORS, LIP CREAM, EYE MAKEUP, EYE PENCILS, EYE SHADOW, EYE LINERS, LIQUID EYELINERS, EYELINER PENCILS, EYEBROW PENCILS, EYESHADOW PENCILS, MASCARA, PERFUME, NAIL POLISH, NAIL HARDNERS, BLUSH, ARTIFICIAL FINGERNAILS, AND MAKE-UP KITS COMPRISED OF LIPSTICK, LIP GLOSS, AND LIP LINERS (U.S. CLS. 1, 4, 6, 50, 51 AND 52).

FIRST USE 5-1-2002; IN COMMERCE 6-1-2002.
ZACHARY BELLO, EXAMINING ATTORNEY

CLASS 3—(Continued).

SN 78-381,087. GREEN CHEMICAL CO., LTD., KYOUNG-SANGBOOK-DO, REPUBLIC OF KOREA, FILED 3-9-2004.

**CLASS 3—(Continued).**

SN 78-382,670. ROSENHAUS, STEVEN S., NEW YORK, NY, FILED 3-11-2004.

TOXIC

THE MARK CONSISTS OF STANDARD CHARACTERS WITHOUT CLAIM TO ANY PARTICULAR FONT, STYLE, SIZE, OR COLOR.

FOR MEN'S AND WOMEN'S COLOGNE, PERFUME, COSMETICS, NAMELY, LIPSTICK, NAIL POLISH, BLUSH, FOUNDATION, LIPGLOSS, MASCARA, EYELINER, EYE SHADOW, HAIR PRODUCTS, NAMELY, SHAMPOO, HAIR CONDITIONER, HAIRSPRAY, HAIR GEL, SKIN MOISTURIZER LOTIONS AND CREAMS (U.S. CLS. 1, 4, 6, 50, 51 AND 52).

BARBARA GAYNOR, EXAMINING ATTORNEY

SN 78-386,586. FLAGEOLI, LTD., LAS VEGAS, NV, FILED 3-18-2004.

SERIOUS SKIN CARE

NO CLAIM IS MADE TO THE EXCLUSIVE RIGHT TO USE "SUGAR," "ANJEON MARK HOED-DEUK/FDA SEONG-BUN-HWAK IN"; "SEOLTANG-CHUCHULMOOL-EERA INCHE-E MOOHAEHAN"; "JE-SA-SEDAE GEONGANGSEJE;" AND "I-JE SEOLTANG-URO ANJEONHAGE SEOLGEOJI-HASEYO", APART FROM THE MARK AS SHOWN.

THE MARK CONSISTS OF SUGAR BUBBLE IN STYLIZED, UPPER AND LOWER CASE LETTERS WITH KOREAN TEXT ABOVE IT; TO THE RIGHT OF SUGAR BUBBLE IS KOREAN TEXT SURROUNDED BY A BEAN SHAPE; THE STYLIZED LETTERS "S" AND "B" ARE WRITTEN ABOVE AND TO THE RIGHT OF SUGAR BUBBLE IN A CIRCLE, WITH LEAVES EXTENDING FROM THE "S."

THE NON-LATIN CHARACTER(S) IN THE MARK TRANSLITERATES INTO "ANJEON MARK HOED-DEUK/FDA SEONG-BUN-HWAK IN"; "SEOLTANG-CHUCHULMOOL-EERA INCHE-E MOOHAEHAN"; "JE-SA-SEDAE GEONGANGSEJE"; "I-JE SEOLTANG-URO ANJEONHAGE SEOLGEOJI-HASEYO", AND THIS MEANS "SAFETY MARK OBTAINED/FDA CERTIFIED INGREDIENTS"; "HARMLESS TO HUMANS BECAUSE THEY ARE EXTRACTS OF SUGAR"; "THE FOURTH GENERATION HEALTHY DETERGENTS"; "YOU MAY WASH DISHES SAFELY FROM NOW ON WITH SUGAR!" IN ENGLISH.

FOR LAUNDRY DETERGENTS; DISHWASHING DETERGENTS; DETERGENTS EXCLUSIVELY FOR FOOD, NAMELY, DETERGENTS MADE OF SUGAR, OLIVE OIL AND CHITIN, WHICH ARE BIODEGRADABLE, AND WHICH DISSOLVE AGRICULTURAL CHEMICALS SUCH AS INSECTICIDES AND HERBICIDES; FABRIC SOFTENERS FOR DOMESTIC USE; LIQUID SOAP; PAPER SOAP, NAMELY, SOAP IN THE FORM OF POCKET-SIZE, PAPER-LIKE SHEETS; TOILET SOAP; HAIR SHAMPOO; POWDER SOAP; HOUSEHOLD CLEANING PREPARATIONS FOR USE IN CLEANING BATHROOMS (U.S. CLS. 1, 4, 6, 50, 51 AND 52).

FIRST USE 11-30-2002; IN COMMERCE 2-18-2004.
MICHAEL KEATING, EXAMINING ATTORNEY

THE MARK CONSISTS OF STANDARD CHARACTERS WITHOUT CLAIM TO ANY PARTICULAR FONT, STYLE, SIZE, OR COLOR.

OWNER OF U.S. REG. NO. 2,275,096.

NO CLAIM IS MADE TO THE EXCLUSIVE RIGHT TO USE SKIN CARE, APART FROM THE MARK AS SHOWN.

FOR COSMETICS AND SKIN CARE, NAMELY, CREAMS, LOTIONS, MOISTURIZERS, CLEANSERS, OILS, ASTRINGENTS, EXFOLIANTS, SERUMS AND TONERS FOR THE FACE, HANDS AND BODY, SOAPS AND BODY WASHES, FACIAL MASQUES, MOUSSES AND BALMS, SKIN SPRAYS, MASSAGE OILS, ESSENTIAL GELS, FRAGRANCES, NAMELY, COLOGNE, PERFUME AND EAU DE TOILETTE, NAIL PREPARATIONS, NAMELY, NAIL CREAMS, LOTIONS, POLISHES AND COATINGS, MAKEUP, NAMELY, FACE POWDER, FOUNDATION MAKEUP BASES, ROUGES, BLUSHERS, EYE SHADOW, MAKEUP REMOVERS, NON-MEDICATED ANTI-ACNE TREATMENT CLEANSERS, GELS AND CREAMS, LIP BALMS, LIP LOTIONS, SUNSCREENS, SKIN TANNING PREPARATIONS, HAIR SHAMPOOS, CONDITIONERS AND SUNSCREENS (U.S. CLS. 1, 4, 6, 50, 51 AND 52).

SHARON MEIER, EXAMINING ATTORNEY

CLASS 3—(Continued).

SN 78-390,798. RECKITT BENCKISER N. V., HOOFDDORP, NETHERLANDS, FILED 3-25-2004.

VANISH OXI ACTION MAX

THE MARK CONSISTS OF STANDARD CHARACTERS WITHOUT CLAIM TO ANY PARTICULAR FONT, STYLE, SIZE, OR COLOR.

PRIORITY CLAIMED UNDER SEC. 44(D) ON BENELUX APPLICATION NO. 1047665, FILED 1-15-2004, REG. NO. 748182, DATED 1-15-2004, EXPIRES 1-15-2014.

FOR CARPET CLEANERS AND SHAMPOOS; LAUNDRY DETERGENTS; LAUNDRY ADDITIVES, NAMELY LAUNDRY PRE-SOAK AND FABRIC SOFTENERS FOR LAUNDRY USE, AND FABRIC AND CARPET STAIN REMOVERS (U.S. CLS. 1, 4, 6, 50, 51 AND 52).

ELLEN PERKINS, EXAMINING ATTORNEY

SN 78-393,266. NATURAL BRONZE LLC, DELRAY BEACH, FL. FILED 3-30-2004.

Natural Bronze

THE MARK CONSISTS OF STANDARD CHARACTERS WITHOUT CLAIM TO ANY PARTICULAR FONT, STYLE, SIZE, OR COLOR.

NO CLAIM IS MADE TO THE EXCLUSIVE RIGHT TO USE "BRONZE", APART FROM THE MARK AS SHOWN.

FOR SUNLESS TANNING SPRAYS TO BE USED IN PROFESSIONAL TANNING SPRAYBOOTHS (U.S. CLS. 1, 4, 6, 50, 51 AND 52).

FIRST USE 5-7-2003; IN COMMERCE 5-7-2003.

NORA BUCHANAN WILL, EXAMINING ATTORNEY

CLASS 3—(Continued).

SN 78-397,436. MGR DESIGN INTERNATIONAL, INC., OAK PARK, CA. FILED 4-6-2004.

SCENTUAL EXPRESSIONS

THE MARK CONSISTS OF STANDARD CHARACTERS WITHOUT CLAIM TO ANY PARTICULAR FONT, STYLE, SIZE, OR COLOR.

FOR SCENTED PRODUCTS FOR THE HOME, NAMELY, ROOM SPRAYS, POTPOURRI, AND INCENSE (U.S. CLS. 1, 4, 6, 50, 51 AND 52).

FIRST USE 11-15-2003; IN COMMERCE 11-15-2003.

CAROLYN CATALDO, EXAMINING ATTORNEY

SN 78-398,267. YAKIRA, LLC, SOUTH RIVER, NJ. FILED 4-7-2004.

CLIMB

THE MARK CONSISTS OF STANDARD CHARACTERS WITHOUT CLAIM TO ANY PARTICULAR FONT, STYLE, SIZE, OR COLOR.

FOR FRAGRANCES FOR PERSONAL USE; PERFUMES; COSMETICS; HAIR CARE PREPARATIONS; SKIN LOTIONS; AND BATH PRODUCTS, NAMELY BATH OIL AND BATH SALTS (U.S. CLS. 1, 4, 6, 50, 51 AND 52).

WON TEAK OH, EXAMINING ATTORNEY

CLASS 3—(Continued).

SN 78-402,389. SILIPOS INC., NEW YORK, NY. FILED 4-15-2004.

SPATCH AT HOME

THE MARK CONSISTS OF STANDARD CHARACTERS WITHOUT CLAIM TO ANY PARTICULAR FONT, STYLE, SIZE, OR COLOR.

FOR NON-MEDICATED SKIN CARE AND COSMETIC PRODUCTS, NAMELY, MOISTURIZER AND BODY CLEANSER; NON-MEDICATED PATCHES FOR COSMETIC USE (U.S. CLS. 1, 4, 6, 50, 51 AND 52).

CATHERINE FAINT, EXAMINING ATTORNEY

SN 78-402,752. GARDEN TERRITORY, L.L.C., PHOENIX, AZ. FILED 4-15-2004.



OWNER OF U.S. REG. NO. 2,618,634.
NO CLAIM IS MADE TO THE EXCLUSIVE RIGHT TO USE "EST. '99", APART FROM THE MARK AS SHOWN.

THE MARK CONSISTS OF AN OVAL BORDER CONTAINING THE WORDING GARDEN TERRITORY EST. '99 IT'S TO LIVE FOR IN STYLIZED FORMAT WITH DESIGN ELEMENTS.

FOR PERSONAL CARE PRODUCTS AND PERSONAL CARE AROMATHERAPY PRODUCTS, NAMELY, FACIAL MISTS, BODY LOTIONS, BODY SCRUBS, BODY EXFOLIANTS, AND ESSENTIAL OILS FOR PERSONAL USE AND FOR AROMATHERAPY (U.S. CLS. 1, 4, 6, 50, 51 AND 52).

FIRST USE 11-25-2003; IN COMMERCE 12-1-2003.
CURTIS FRENCH, EXAMINING ATTORNEY

CLASS 3—(Continued).

SN 78-406,894. PHILOSOPHY, INC., PHOENIX, AZ. FILED 4-23-2004.

FAKE LIFT

THE MARK CONSISTS OF STANDARD CHARACTERS WITHOUT CLAIM TO ANY PARTICULAR FONT, STYLE, SIZE, OR COLOR.

FOR COSMETICS, NAMELY, LIPSTICK, LIP GLOSS, LIP LINER, LIP BALM, BLUSH, FOUNDATION, EYE SHADOW, EYE LINER, MASCARA, CONCEALER, COSMETIC PENCILS, AND FACIAL POWDER; FRAGRANCES, NAMELY, PERFUME, COLOGNE, AND AFTER-SHAVE LOTION AND GEL; NON-MEDICATED SKIN CARE PRODUCTS, NAMELY, SOAP, SCRUBS, TONER, CONDITIONER, EXFOLIATORS, SKIN CLARIFIER, WRINKLE REMOVING SKIN CARE PREPARATIONS, AND MOISTURIZER; FACE AND BODY LOTION, CREAM, OIL, GEL AND SPRAY; SUN SCREEN PREPARATIONS, NAMELY, LOTION, CREAM, GEL AND SPRAY; NON-MEDICATED FACE AND BODY SKIN LIGHTENER; HAIR CARE PRODUCTS, NAMELY, SHAMPOO, CONDITIONER, RINSE, GEL, MOUSSE, SPRAY AND TONIC; BATH CARE PRODUCTS, NAMELY, SOAP, SALTS CRYSTALS, BEADS, GEL, OIL, POWDER, AND BUBBLE BATH; SCENTED HEAD-TO-TOE BODY WASH; NAIL CARE PREPARATIONS, NAMELY, CUTICLE CREAM, CUTICLE REMOVING PREPARATIONS, NAIL ENAMEL, NAIL POLISH, NAIL POLISH REMOVER, NAIL POLISH BASE COAT, NAIL POLISH TOP COAT, AND NAIL STRENGTHENERS; PERSONAL DEODORANT; TOOTH WHITENING GELS, CREAMS, AND PASTES; FOOT CARE PRODUCTS, NAMELY SCRUBS, LOTIONS, CREAMS, DEODORANT, AND EXFOLIATORS; MEN'S TOILETRIES, NAMELY COLOGNE, AFTER-SHAVE LOTION AND GEL; SKIN CLEANSER, SKIN SCRUBS, SKIN TONER, SKIN CREAM, SHAVING GEL, SHAVING CREAM, TOILET WATER, PERSONAL DEODORANT, SHAMPOO, BODY LOTION, BODY TALC, AND SKIN MOISTURIZER; BABY CARE PRODUCTS, NAMELY, BABY LOTIONS, CREAMS, NON-MEDICATED DIAPER RASH OINTMENTS, SOAPS, POWDERS, AND SHAMPOO; FACIAL AND BODY HAIR DEPILATORY WAXES, CREAMS, LOTIONS, BLEACHING AND COLORING PREPARATIONS; MAKE-UP KITS AND GIFT SETS COMPRISED OF ONE OR MORE OF LIPSTICK, LIP GLOSS, LIP LINER, LIP BALM, BLUSH, FOUNDATION, EYE SHADOW, EYE LINER, MASCARA, CONCEALER, COSMETIC PENCILS, AND FACIAL POWDER, FRAGRANCES, NAMELY, PERFUME, COLOGNE, AND AFTER-SHAVE LOTION AND GEL, NON-MEDICATED SKIN CARE PRODUCTS, NAMELY, SOAP, SCRUBS, TONER, CONDITIONER, EXFOLIATORS, SKIN CLARIFIER, WRINKLE REMOVING SKIN CARE PREPARATIONS, AND MOISTURIZER, FACE AND BODY LOTION, CREAM, OIL, GEL AND SPRAY, SUN SCREEN PREPARATIONS, NAMELY, LOTION, CREAM, GEL, AND SPRAY, NON-MEDICATED FACE AND BODY SKIN LIGHTENER, HAIR CARE PRODUCTS, NAMELY, SHAMPOO, CONDITIONER, RINSE, GEL MOUSSE, SPRAY AND TONIC, BATH CARE PRODUCTS, NAMELY, SOAP, SALTS, CRYSTALS, BEADS, GEL OIL, POWDER, AND BUBBLE BATH, SCENTED HEAD-TO-TOE BODY WASH, NAIL CARE PREPARATIONS, NAMELY, CUTICLE CREAM, CUTICLE REMOVING PREPARATIONS, NAIL ENAMEL, NAIL POLISH, NAIL

CLASS 3—(Continued).

POLISH REMOVER, NAIL POLISH BASE COAT, NAIL POLISH TOP COAT, AND NAIL STRENGTHENERS, PERSONAL DEODORANT, TOOTH WHITENING GELS, CREAMS, AND PASTES, FOOT CARE PRODUCTS, NAMELY, SCRUBS, LOTIONS, CREAMS, DEODORANT, AND EXFOLIATORS, MEN'S TOILETRIES, NAMELY, COLOGNE, AFTER-SHAVE LOTION AND GEL, SKIN CLEANSER, SKIN SCRUBS, SKIN TONER, SKIN CREAM, SHAVING GEL, SHAVING CREAM, TOILET WATER, PERSONAL DEODORANT, SHAMPOO, BODY LOTION, BODY TALC AND SKIN MOISTURIZER, BABY CARE PRODUCTS, NAMELY, BABY LOTIONS, CREAMS, NON-MEDICATED DIAPER RASH OINTMENTS, SOAPS, POWDERS AND SHAMPOO, FACIAL AND BODY HAIR DEPILATORY WAXES, CREAMS, LOTIONS, BLEACHING AND COLORING PREPARATIONS (U.S. CLS. 1, 4, 6, 50, 51 AND 52).

ANNE FARRELL, EXAMINING ATTORNEY

CLASS 3—(Continued).

SN 78-414,823. NAPOLEON PERDIS LLC, WILMINGTON, DE. FILED 5-7-2004.

NAPOLEON PERDIS

THE MARK CONSISTS OF STANDARD CHARACTERS WITHOUT CLAIM TO ANY PARTICULAR FONT, STYLE, SIZE, OR COLOR.

THE NAME NAPOLEON PERDIS IDENTIFIES A LIVING INDIVIDUAL WHOSE CONSENT IS OF RECORD.

FOR COLOGNE; PERFUME, ANTI-AGING CREAM, ASTRINGENTS FOR COSMETIC PURPOSES, BEAUTY MASKS, FACIAL CLEANSERS, SKIN CONDITIONERS, BODY CREAM, BODY OIL, BATH OIL, BATH CRYSTALS, BATH BEADS, BLUSH, FACIAL MAKE-UP, FOUNDATION MAKE-UP, COMPACTS CONTAINING MAKE-UP, EYE MAKE-UP, LIPSTICK, AND NAIL POLISH (U.S. CLS. 1, 4, 6, 50, 51 AND 52).

BARBARA RUTLAND, EXAMINING ATTORNEY

SN 78-406,997. SURFACE TECHNOLOGIES LAND, SEA AND AIR LTD., RIVERSIDE, CA. FILED 4-23-2004.

SN 78-414,986. MAKE-UP ART COSMETICS INC., NEW YORK, NY. FILED 5-7-2004.

Micro Seal

STUDIO MOISTURE CREAM

THE MARK CONSISTS OF STANDARD CHARACTERS WITHOUT CLAIM TO ANY PARTICULAR FONT, STYLE, SIZE, OR COLOR.

FOR AUTOMOBILE CLEANING PREPARATIONS (U.S. CLS. 1, 4, 6, 50, 51 AND 52).

FIRST USE 0-0-1996; IN COMMERCE 0-0-1996.

G. MAYERSCHOFF, EXAMINING ATTORNEY

THE MARK CONSISTS OF STANDARD CHARACTERS WITHOUT CLAIM TO ANY PARTICULAR FONT, STYLE, SIZE, OR COLOR.

NO CLAIM IS MADE TO THE EXCLUSIVE RIGHT TO USE "MOISTURE CREAM", APART FROM THE MARK AS SHOWN.

FOR COSMETICS; NON-MEDIATED SKINCARE PRODUCTS, NAMELY, CLEANSERS, EXFOLIATORS, TONERS, EYE CREAMS, CLEANSING WIPES, MOISTURIZING SPRITZERS, TINTED MOISTURIZERS (U.S. CLS. 1, 4, 6, 50, 51 AND 52).

RICHARD WHITE, EXAMINING ATTORNEY

CLASS 3—(Continued).

SN 78-415,159. SPARTACUS, LLC, DALLAS, TX. FILED 5-7-2004.

CLASS 3—(Continued).

SN 78-422,614. HEALING TREE PRODUCTS, INC., MCMINNVILLE, OR. FILED 5-20-2004.

BRILLANTI

QUIKLENZ

THE MARK CONSISTS OF STANDARD CHARACTERS WITHOUT CLAIM TO ANY PARTICULAR FONT, STYLE, SIZE, OR COLOR.

"BRILLANTI" IS THE ITALIAN EQUIVALENT OF THE ENGLISH TERM "SHINING".

FOR LAUNDRY PRODUCTS, NAMELY, BLEACH (U.S. CLS. 1, 4, 6, 50, 51 AND 52).

RICHARD WHITE, EXAMINING ATTORNEY

THE MARK CONSISTS OF STANDARD CHARACTERS WITHOUT CLAIM TO ANY PARTICULAR FONT, STYLE, SIZE, OR COLOR.

OWNER OF U.S. REG. NO. 2,471,318.

FOR NON-MEDICATED BODY WASHES FOR HORSES, LIVESTOCK AND PETS (U.S. CLS. 1, 4, 6, 50, 51 AND 52).

FIRST USE 6-18-2004; IN COMMERCE 6-18-2004.

MICHAEL HALL, EXAMINING ATTORNEY

SN 78-424,155. SANCHEZ, FRANCISCO JAVIER JIMENEZ, DOSBARRIOS (TOLEDO), SPAIN, FILED 5-24-2004.

SN 78-415,879. DERMACIA, NEWPORT BEACH, CA. FILED 5-10-2004.

CLAUDE FABRI

Clear Skies Ahead

THE MARK CONSISTS OF STANDARD CHARACTERS WITHOUT CLAIM TO ANY PARTICULAR FONT, STYLE, SIZE, OR COLOR.

OWNER OF SPAIN REG. NO. 2375465, DATED 8-6-2001, EXPIRES 2-2-2011.

THE NAME CLAUDE FABRI DOES NOT IDENTIFY A LIVING INDIVIDUAL.

FOR PERFUMES AND COSMETICS (U.S. CLS. 1, 4, 6, 50, 51 AND 52).

BARNEY CHARLON, EXAMINING ATTORNEY

THE MARK CONSISTS OF STANDARD CHARACTERS WITHOUT CLAIM TO ANY PARTICULAR FONT, STYLE, SIZE, OR COLOR.

FOR SKIN TONER, SKIN MOISTURIZER AND SKIN CLEANSER (U.S. CLS. 1, 4, 6, 50, 51 AND 52).

RONALD MCMORROW, EXAMINING ATTORNEY

CLASS 3—(Continued).

SN 78-428,932. E.T. BROWNE DRUG CO., INC., ENGLEWOOD CLIFFS, NJ. FILED 6-2-2004.

**PRESSING OIL
FORMULA**

THE MARK CONSISTS OF STANDARD CHARACTERS WITHOUT CLAIM TO ANY PARTICULAR FONT, STYLE, SIZE, OR COLOR.

OWNER OF U.S. REG. NOS. 2,464,760, 2,722,247 AND 2,806,211.

NO CLAIM IS MADE TO THE EXCLUSIVE RIGHT TO USE "PRESSING OIL", APART FROM THE MARK AS SHOWN.

SEC. 2(F).

FOR HAIR CARE PRODUCTS, NAMELY, CONDITIONERS, POMADES, HAIR STYLING AND SETTING GELS, HAIR SHEEN GEL, HAIR MOISTURIZERS, HAIR SHAPING WAX, HAIR RELAXER CREAM, HAIR TREATMENT FOR DRY AND BREAKING HAIR, HAIR BALM, AND HAIR NOURISHING PREPARATIONS (U.S. CLS. 1, 4, 6, 50, 51 AND 52).

FIRST USE 0-0-1980; IN COMMERCE 0-0-1980.

ANN LINNEHAN, EXAMINING ATTORNEY

CLASS 3—(Continued).

SN 78-429,303. JARAMILLO, JERRY, ALBUQUERQUE, NM. FILED 6-3-2004.

**SCARLET
GLOBEMALLOW**

THE MARK CONSISTS OF STANDARD CHARACTERS WITHOUT CLAIM TO ANY PARTICULAR FONT, STYLE, SIZE, OR COLOR.

THE NAME SCARLET GLOBEMALLOW DOES NOT IDENTIFY A LIVING INDIVIDUAL.

FOR SHAMPOOS, CONDITIONERS, HAIR MOISTURIZING PREPARATIONS, HAIR STYLING PRODUCTS, NAMELY MOUSSES, GELS, HAIR SPRAYS (U.S. CLS. 1, 4, 6, 50, 51 AND 52).

FIRST USE 6-1-1987; IN COMMERCE 12-1-1992.

BARBARA BROWN, EXAMINING ATTORNEY

SN 78-429,289. JARAMILLO, JERRY, ALBUQUERQUE, NM. FILED 6-3-2004.

**YERBA DE LA
NEGRITA**

THE MARK CONSISTS OF STANDARD CHARACTERS WITHOUT CLAIM TO ANY PARTICULAR FONT, STYLE, SIZE, OR COLOR.

NO CLAIM IS MADE TO THE EXCLUSIVE RIGHT TO USE "YERBA", APART FROM THE MARK AS SHOWN.

THE ENGLISH TRANSLATION OF YERBA DE LA NEGRITA IS "GRASS OF THE BOLD FACE" OR "BLACK GRASS" OR "HERB OF THE BLACK".

FOR SHAMPOOS, CONDITIONERS, HAIR MOISTURIZING PREPARATIONS, HAIR STYLING PRODUCTS, NAMELY MOUSSES, GELS, HAIR SPRAYS (U.S. CLS. 1, 4, 6, 50, 51 AND 52).

FIRST USE 6-1-1987; IN COMMERCE 12-1-1992.

KAREN BRACEY, EXAMINING ATTORNEY

SN 78-430,923. HAIR CLUB FOR MEN, LTD., INC., BOCA RATON, FL. FILED 6-7-2004.

**INTENSIVE
CONDITIONING
UNIFIER**

THE MARK CONSISTS OF STANDARD CHARACTERS WITHOUT CLAIM TO ANY PARTICULAR FONT, STYLE, SIZE, OR COLOR.

NO CLAIM IS MADE TO THE EXCLUSIVE RIGHT TO USE "INTENSIVE CONDITIONING", APART FROM THE MARK AS SHOWN.

FOR HAIR CONDITIONER (U.S. CLS. 1, 4, 6, 50, 51 AND 52).

FIRST USE 11-22-2003; IN COMMERCE 11-22-2003.

KIM SAITO, EXAMINING ATTORNEY

CLASS 3—(Continued).

SN 78-431,707. TOMJAI ENTERPRISES, CORPORATION,
MIRAMAR, FL. FILED 6-8-2004.

CLASS 3—(Continued).

SN 78-435,327. Y BEAUTY INTERNATIONAL LIMITED,
KWAI HING, HONG KONG, FILED 6-15-2004.

TETMOSOL

THE MARK CONSISTS OF STANDARD CHARACTERS
WITHOUT CLAIM TO ANY PARTICULAR FONT, STYLE,
SIZE, OR COLOR.

FOR BEAUTY AND SKIN CARE PRODUCTS,
NAMELY SOAPS FOR BODY CARE AND PERSONAL
CLEANSING PRODUCTS, NAMELY CLEANSING
CREAMS, FACIAL CLEANSERS, AND SKIN CLEANS-
ERS (U.S. CLS. 1, 4, 6, 50, 51 AND 52).

FIRST USE 10-1-2003; IN COMMERCE 10-1-2003.

SONYA STEPHENS, EXAMINING ATTORNEY

BEAUTY ESQUE

THE MARK CONSISTS OF STANDARD CHARACTERS
WITHOUT CLAIM TO ANY PARTICULAR FONT, STYLE,
SIZE, OR COLOR.

NO CLAIM IS MADE TO THE EXCLUSIVE RIGHT TO
USE "BEAUTY", APART FROM THE MARK AS SHOWN.

FOR ACRYLIC AND GEL NAIL ENHANCEMENTS,
NAMELY, ARTIFICIAL FINGERNAILS; ADHESIVES
FOR ATTACHING ARTIFICIAL FINGERNAILS AND/
OR EYELASHES; HAIR BLEACH; HAIR BLEACHING
PREPARATIONS; HAIR CARE PREPARATIONS; HAIR
COLOR; HAIR COLOR REMOVERS; HAIR DRESSINGS
FOR MEN; HAIR DYE; HAIR EMOLLIENTS; HAIR
RELAXERS; HAIR RELAXING PREPARATIONS; HAIR
RINSES; HAIR SPRAY; HAIR STRAIGHTENING PRE-
PARATIONS; HAIR WAVING LOTION; HYDROGEN
PEROXIDE FOR USE ON THE HAIR; SKIN SOAPS;
NON-MEDICATED HAIR CARE PREPARATIONS AND
PRODUCTS, NAMELY, SHAMPOOS AND CONDI-
TIONERS; PREPARATIONS FOR HAIR CLEANSING;
HAIR STYLING PREPARATIONS; HAIR VOLUMIZER;
HAIR TONIC; FRAGRANCES IN THE NATURE OF
FRAGRANCES FOR PERSONAL USE; HAIR GLAZES
IN THE NATURE OF STYLING LOTION; HAIR OILS,
HAIR MASCARA, SHAMPOOS, HAIR CONDITIONERS,
HAIR RINSES; HAIR GELS, HAIR MOUSSE; HAIR
LAMINATE; HAIR WAVE LOTIONS; PROTEIN EMOL-
LIENT SPRAYS FOR THE HAIR, HAIR CREAMS, HAIR
POLISHER LOTION, HAIR FIXERS, HAIR RECON-
STRUCTORS; FACE CARE PREPARATIONS AND PRO-
DUCTS, NAMELY, FACIAL MOISTURIZER; FACIAL
CLEANER; FACE EMULSIONS; FACIAL CREAMS, FACI-
AL EMULSIONS, FACIAL MASKS, FACIAL SCRUB,
FACIAL LOTION, FACE FIRING LOTIONS, LIPSTICK,
LIP GLOSS, EYE MAKE-UP, NON-MEDICATED SKIN
CARE PREPARATIONS, SKIN MOISTURIZING CREAM,
SKIN ASTRINGENTS FOR COSMETIC PURPOSES,
MISTS IN THE NATURE OF FACIAL AND BODY
SPRAYS, BATH GELS, LIP BALMS, CLAYS IN THE
NATURE OF FACIAL MASQUE, MUDS IN THE NATURE
OF FACIAL AND BODY MASKS, SHAVING
CREAM, SHAVING LOTION, SHAVING GEL, NON-
MEDICATED ACNE TREATMENT PREPARATIONS,
NON-MEDICATED BLEMISH STICK, SUN BLOCK,
SUN TAN LOTION AND SKIN TONERS, SUNLESS
TANNING LOTION; FOOT CARE PREPARATIONS,
PRODUCTS, AND CLEANSING PRODUCTS, NAMELY,
NON-MEDICATED FOOT POWDER, NON-MEDICATED
FOOT CREAM, NON-MEDICATED FOOT LOTION;
BODY CARE PREPARATIONS; BODY CLEANSING
PRODUCTS, NAMELY, BODY SCRUBS, PUMICE
STONES FOR PERSONAL USE, BODY POWDER, BODY
CREAM, BODY LOTION, BODY OIL, FRAGRANT BODY
SPASH, MAKEUP FOR THE BODY, NON-MEDICATED
BODY SOAKS, MASSAGE OILS, TALCUM POWDER;
HAND CARE PREPARATIONS AND PRODUCTS,
NAMELY, HAND MOISTURIZING CREAM, HAND LO-
TIONS, CUTICLE CREAMS AND CUTICLE CONDI-
TIONERS, NAIL CARE PREPARATIONS, NAIL
CREAM, NAIL ENAMELS, NAIL GLITTER; NAIL
GROOMING PRODUCTS, NAMELY, TIPS, GLUE, LAC-
QUER AND GLITTER; NAIL HARDENERS, NAIL POL-
ISH, NAIL POLISH BASE COAT, NAIL POLISH
REMOVER, NAIL POLISH TOP COAT, NAIL
STRENGTHENERS, AND NAIL BUFFING PREPARA-
TIONS; BATH PRODUCTS, NAMELY, BATH SALTS,

SN 78-433,394. GAP (APPAREL), LLC, SAN FRANCISCO, CA.
FILED 6-10-2004.

CRUSHED PEONY

THE MARK CONSISTS OF STANDARD CHARACTERS
WITHOUT CLAIM TO ANY PARTICULAR FONT, STYLE,
SIZE, OR COLOR.

NO CLAIM IS MADE TO THE EXCLUSIVE RIGHT TO
USE "PEONY", APART FROM THE MARK AS SHOWN.

FOR PERFUME, EAU DE TOILETTE, EAU DE PAR-
FUM, COLOGNE, BODY AND SKIN LOTION, BODY
AND SKIN SOAPS, INCENSE, BODY OIL, ESSENTIAL
OILS FOR PERSONAL USE (U.S. CLS. 1, 4, 6, 50, 51 AND
52).

STEVEN R. FOSTER, EXAMINING ATTORNEY

CLASS 3—(Continued).

BATH MILKS, BUBBLE BATH, BATH CRYSTALS, BATH OIL, BATH BEADS, BATH FOAM, BATH GELS, EXFOLIANTS FOR THE SKIN; SHOWER GEL, HAND, FACE AND BODY SOAPS IN LIQUID AND BAR FORM, PERSONAL DEODORANTS, NON-MEDICATED TOILETRIES, AND INCENSES; PERFUMERY PRODUCTS, NAMELY, PERFUMED POWDER, PERFUME OILS; ESSENTIAL OILS FOR PERSONAL USE; COSMETICS; HYGIENE PRODUCTS, NAMELY, DENTIFRICES, TOOTHPASTE, TOOTH GEL, NON-MEDICATED MOUTHWASH, ANTIPERSPIRANTS. (U.S. CLS. 1, 4, 6, 50, 51 AND 52).

RAMONA ORTIGA, EXAMINING ATTORNEY

CLASS 3—(Continued).

SN 78-440,497. BEAUTYBANK INC., NEW YORK, NY. FILED 6-24-2004.

EYE TINSEL

THE MARK CONSISTS OF STANDARD CHARACTERS WITHOUT CLAIM TO ANY PARTICULAR FONT, STYLE, SIZE, OR COLOR.

NO CLAIM IS MADE TO THE EXCLUSIVE RIGHT TO USE "EYE", APART FROM THE MARK AS SHOWN.

FOR COSMETICS; MAKE-UP; NON-MEDICATED SKINCARE PREPARATIONS; HAIRCARE PREPARATIONS; TOILETRIES, NAMELY BATH AND BODY SOAPS, CLEANSERS, GELS, LOTIONS, CREAMS AND SPRAYS; NON-MEDICATED SUN CARE PREPARATIONS (U.S. CLS. 1, 4, 6, 50, 51 AND 52).

WILLIAM P. SHANAHAN, EXAMINING ATTORNEY

SN 78-435,332. Y BEAUTY INTERNATIONAL LIMITED, KWAI HING, HONG KONG, FILED 6-15-2004.

HAIR ESQUE

SN 78-442,210. CHAMTOWON CO., LTD., SEOUL, REPUBLIC OF KOREA, FILED 6-28-2004.

THE MARK CONSISTS OF STANDARD CHARACTERS WITHOUT CLAIM TO ANY PARTICULAR FONT, STYLE, SIZE, OR COLOR.

NO CLAIM IS MADE TO THE EXCLUSIVE RIGHT TO USE "HAIR", APART FROM THE MARK AS SHOWN.

FOR HAIR BLEACH; HAIR BLEACHING PREPARATIONS; HAIR CARE PREPARATIONS; HAIR COLOR; HAIR COLOR REMOVERS; HAIR DRESSINGS FOR MEN; HAIR DYE; HAIR EMOLLIENTS; HAIR RELAXERS; HAIR RELAXING PREPARATIONS; HAIR RINSES; HAIR SPRAY; HAIR STRAIGHTENING PREPARATIONS; HAIR WAVING LOTION; HYDROGEN PEROXIDE FOR USE ON THE HAIR; HAIR AND SKIN SOAPS; HAIR CARE PREPARATIONS; PRODUCTS FOR HAIR TREATMENT, NAMELY, HAIR CONDITIONERS AND MOISTURIZERS; HAIR CLEANING PREPARATIONS; HAIR STYLING PREPARATIONS; HAIR VOLUMIZER; HAIR TONIC; FRAGRANCES IN THE NATURE OF FRAGRANCES FOR PERSONAL USE; HAIR GLAZES IN THE NATURE OF STYLING LOTION; HAIR OILS, HAIR MASCARA, SHAMPOOS, HAIR CONDITIONERS, HAIR RINSES, HAIR GELS, HAIR MOUSSE, PROTEIN EMOLLIENT SPRAYS FOR THE HAIR, HAIR CREAMS, HAIR POLISHER LOTION, HAIR FIXERS, HAIR RESTRUCTURERS; MAKE UP (U.S. CLS. 1, 4, 6, 50, 51 AND 52).

RAMONA ORTIGA, EXAMINING ATTORNEY

THE COLOR(S) BLACK AND RED IS/ARE CLAIMED AS A FEATURE OF THE MARK.

THE MARK CONSISTS OF BLACK CHINESE CHARACTERS OVER A RED BANNER.

THE FOREIGN WORDING IN THE MARK TRANSLATES INTO ENGLISH AS A BEAUTIFUL AND NATURAL PERSON.

THE NON-LATIN CHARACTER(S) IN THE MARK TRANSLITERATES INTO MEEJAIN, AND THIS MEANS BEAUTIFUL AND NATURAL PERSON IN ENGLISH.

FOR TOILET SOAP, BEAUTY MASKS, MUD PACKS FOR THE FACE AND BODY, BATH GELS, BATH MILKS AND BATH POWDER CONTAINING LOESS, BODY LOTIONS AND CREAMS, SHAMPOO AND CONDITIONERS FOR HAIR (U.S. CLS. 1, 4, 6, 50, 51 AND 52).

TRACY FLETCHER, EXAMINING ATTORNEY



CLASS 3—(Continued).

SN 78-443,211. BERNSTEIN, STANLEY K., TORONTO, ONTARIO, CANADA, FILED 6-29-2004.

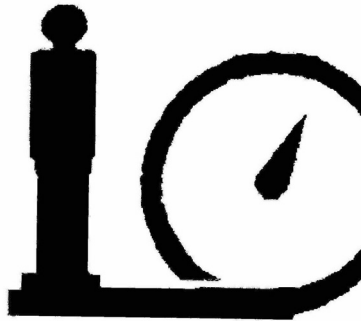

OWNER OF CANADA REG. NO. TMA515186, DATED 8-25-1999, EXPIRES 8-25-2014.
 THE MARK CONSISTS OF A MAN AND A SCALE.
 FOR ANTIBACTERIAL MOISTURIZING HAND GEL SOAP AND ANTIBACTERIAL MOISTURIZING HAND LOTION (U.S. CLS. 1, 4, 6, 50, 51 AND 52).
 FIRST USE 6-15-2001; IN COMMERCE 6-15-2001.
 INGA ERVIN, EXAMINING ATTORNEY

SN 78-443,446. PETUNIA PRODUCTS INC., LOS ANGELES, CA. FILED 6-29-2004.

BILLION DOLLAR BROWS

THE MARK CONSISTS OF STANDARD CHARACTERS WITHOUT CLAIM TO ANY PARTICULAR FONT, STYLE, SIZE, OR COLOR.
 NO CLAIM IS MADE TO THE EXCLUSIVE RIGHT TO USE "BROWS", APART FROM THE MARK AS SHOWN.
 FOR EYE BROW TREATMENT PRODUCTS, NAMELY, CONDITIONERS, PENCILS, AND GELS (U.S. CLS. 1, 4, 6, 50, 51 AND 52).
 FIRST USE 6-8-2004; IN COMMERCE 6-8-2004.
 BARBARA GAYNOR, EXAMINING ATTORNEY

CLASS 3—(Continued).

SN 78-446,902. COSMETICS 2K, INC., NYACK, NY. FILED 7-7-2004.

ARLENE ADAMS

THE MARK CONSISTS OF STANDARD CHARACTERS WITHOUT CLAIM TO ANY PARTICULAR FONT, STYLE, SIZE, OR COLOR.
 THE NAME "ARLENE ADAMS" REFERS TO A LIVING INDIVIDUAL WHOSE CONSENT IS OF RECORD.
 FOR NAIL CARE PREPARATIONS; ADHESIVES FOR ATTACHING ARTIFICIAL FINGERNAILS, ARTIFICIAL FINGERNAILS, CUTICLE CONDITIONERS, CUTICLE CREAM, CUTICLE REMOVING PREPARATIONS, NON-MEDICATED LIP BALM, NON-MEDICATED LIP CREAM, LIP GLOSS, LIP GLOSS PALETTE, LIP LINER, LIPSTICK, MAKE-UP KITS COMPRISED OF LIPSTICK AND LIP GLOSS, NAIL BUFFING PREPARATIONS, NAIL CREAM, NAIL ENAMEL, NAIL GLITTER, NAIL GROOMING PRODUCTS NAMELY, TIPS, GLUE, LACQUER AND GLITTER, NAIL HARDENERS, NAIL POLISH, NAIL POLISH BASE COAT, NAIL POLISH REMOVER, NAIL POLISH TOP COAT, NAIL STRENGTHENERS, NAIL TIPS, NON-MEDICATED LIP CARE PREPARATIONS, NON-MEDICATED LIP PROTECTOR (U.S. CLS. 1, 4, 6, 50, 51 AND 52).
 FIRST USE 8-19-2003; IN COMMERCE 8-19-2003.
 STEVEN R. FOSTER, EXAMINING ATTORNEY

SN 78-447,293. METRO-GOLDWYN-MAYER LION CORP., LOS ANGELES, CA. FILED 7-7-2004.



OWNER OF U.S. REG. NOS. 1,911,153 AND 2,762,813.
 THE STIPLING IS A FEATURE OF THE MARK.
 THE FOREIGN WORDING IN THE MARK TRANSLATES INTO ENGLISH AS ART FOR ART'S SAKE.
 FOR BODY, HAND AND FACE LOTIONS AND CREAMS, EYEBROW LINERS AND PENCILS, EYE LINERS, EYE SHADOWS, FOUNDATION, PRESSED POWDER, HAIR GELS AND MOUSSE, MASCARA, LIP GLOSS, LINERS AND PENCILS, TANNING CREAMS, AND LIPSTICKS (U.S. CLS. 1, 4, 6, 50, 51 AND 52).
 FIRST USE 6-24-2004; IN COMMERCE 6-24-2004.
 ALICE BENMAMAN, EXAMINING ATTORNEY

CLASS 3—(Continued).

SN 78-450,779. SINGMASTER GROUP, INC., FALLBROOK, CA. FILED 7-14-2004.

CLASS 3—(Continued).

SN 78-454,268. WELLNESS NOW, LLC, DARIEN, CT. FILED 7-21-2004.

HEALING ELEMENTS

Avocado Dreamin'

THE MARK CONSISTS OF STANDARD CHARACTERS WITHOUT CLAIM TO ANY PARTICULAR FONT, STYLE, SIZE, OR COLOR.

NO CLAIM IS MADE TO THE EXCLUSIVE RIGHT TO USE "AVOCADO", APART FROM THE MARK AS SHOWN.

FOR BATH, BODY AND PERSONAL CARE PRODUCTS—SPECIFICALLY BODY LOTION, BODY WASH, SALT SCRUB (U.S. CLS. 1, 4, 6, 50, 51 AND 52).

FIRST USE 11-24-2002; IN COMMERCE 11-24-2002.

KIMBERLY PERRY, EXAMINING ATTORNEY

THE MARK CONSISTS OF STANDARD CHARACTERS WITHOUT CLAIM TO ANY PARTICULAR FONT, STYLE, SIZE, OR COLOR.

FOR SKIN AND HAIR CARE PRODUCTS, NAMELY, LIP GLOSS, LIP BALMS, LIP GLOSS; LIP BALMS, HYDRATING GELS AND CREAMS; NIGHT CREAMS; NIGHT GELS; EYE GELS; HAND CREAMS; HAND LOTIONS; BODY LOTIONS; MASSAGE LOTIONS; MASSAGE OILS; BODY, FACE, AND FOOT SCRUBS; FOOT SOAKS; FOOT GELS; FOOT LOTIONS; NATURAL ESSENTIAL OILS; BODY POWDERS; SKIN CLEANSERS; SKIN TONERS; SKIN CARE MASKS; SKIN MOISTURIZERS; EYE CREAMS; FACIAL OILS; HAIR SHAMPOOS; HAIR CONDITIONERS; HAIR CONDITIONING RINSES, SOAPS FOR HANDS, FACE AND BODY; SHOWER GELS; BATH GELS; BATH HERBS; BATH POWDERS; BATH CRYSTALS; BATH OIL POWDERS; MINERAL BATHS; BUBBLE BATHS; BATH OILS; BATH SALTS; SHAVING LOTIONS; SHAVING CREAMS; SHAVING GELS; PERFUMES; COLOGNES; EAU DE TOILETS; PERFUME OIL; SUN SCREEN PREPARATIONS; SUN BLOCK PREPARATIONS; AFTER-SUN PREPARATIONS; MOISTURE CREAMS, LOTIONS AND MISTS; CLEANSING GELS; FRAGRANCE OILS FOR PERSONAL USE; NON-MEDICATED MINERAL SOAKS; DEODORANTS FOR PERSONAL USE; FRAGRANCES FOR PERSONAL USE; SCENTED OILS USED TO PRODUCE AROMAS WHEN HEATED; NON-MEDICATED SKIN BALMS; AFTER SHAVE LOTIONS (U.S. CLS. 1, 4, 6, 50, 51 AND 52).

GEORGE LORENZO, EXAMINING ATTORNEY

SN 78-454,124. SKINNER, DAN A., NASHVILLE, TN. FILED 7-21-2004.

SN 78-456,323. GOLD, STEVEN H., PALM SPRINGS, CA. FILED 7-25-2004.

RELAX WRAPS

THE MARK CONSISTS OF STANDARD CHARACTERS WITHOUT CLAIM TO ANY PARTICULAR FONT, STYLE, SIZE, OR COLOR.

NO CLAIM IS MADE TO THE EXCLUSIVE RIGHT TO USE "WRAPS", APART FROM THE MARK AS SHOWN.

FOR NON-MEDICATED HERBAL AND GRAIN-FILLED AROMATHERAPY WRAPS USED FOR STRESS AND PAIN RELIEF AND GENERAL COMFORT (U.S. CLS. 1, 4, 6, 50, 51 AND 52).

FIRST USE 8-1-2002; IN COMMERCE 8-1-2002.

CAROLYN CATALDO, EXAMINING ATTORNEY

EssentGels

THE MARK CONSISTS OF STANDARD CHARACTERS WITHOUT CLAIM TO ANY PARTICULAR FONT, STYLE, SIZE, OR COLOR.

FOR ESSENTIAL OILS FOR PERSONAL USE; ESSENTIAL OIL PREPARATIONS FOR PERSONAL USE, NAMELY, NON-MEDICATED SKIN CARE PREPARATIONS (U.S. CLS. 1, 4, 6, 50, 51 AND 52).

FIRST USE 3-16-2004; IN COMMERCE 3-16-2004.

APRIL L. RADEMACHER, EXAMINING ATTORNEY

CLASS 3—(Continued).

SN 78-456,396. ALLIANT TECHSYSTEMS INC., EDINA, MN. FILED 7-26-2004.

CLASS 3—(Continued).

SN 78-456,998. OBEROSLER, DANIELLE B., SIMI VALLEY, CA. FILED 7-26-2004.



Cherry Balm

OWNER OF U.S. REG. NOS. 323,141, 714,735 AND OTHERS.

THE COLOR(S) BLUE IS/ARE CLAIMED AS A FEATURE OF THE MARK.

THE COLOR BLUE APPEARS IN THE TERM GUNSLICK AND IN THE WAVY LINES.

FOR CHEMICAL CLEANERS, CLEANERS, SOLVENTS, AND DEGREASING PREPARATIONS FOR CLEANING FIREARMS (U.S. CLS. 1, 4, 6, 50, 51 AND 52).

BRENDAN MCCAULEY, EXAMINING ATTORNEY

THE MARK CONSISTS OF STANDARD CHARACTERS WITHOUT CLAIM TO ANY PARTICULAR FONT, STYLE, SIZE, OR COLOR.

FOR NON-MEDICATED HERBAL OINTMENT FOR TATTOO AND BODY-PIERCING AFTER CARE. (U.S. CLS. 1, 4, 6, 50, 51 AND 52).

FIRST USE 6-1-1997; IN COMMERCE 6-1-1997.

SUSAN LESLIE DUBOIS, EXAMINING ATTORNEY

SN 78-456,442. ALLIANT TECHSYSTEMS INC., EDINA, MN. FILED 7-26-2004.

SN 78-459,463. KARA VITA LLC, ORLANDO, FL. FILED 7-30-2004.



BODY DELICIOUS

OWNER OF U.S. REG. NOS. 323,141, 714,735 AND OTHERS.

FOR CHEMICAL CLEANERS, CLEANERS, SOLVENTS, AND DEGREASING PREPARATIONS FOR CLEANING FIREARMS (U.S. CLS. 1, 4, 6, 50, 51 AND 52).

BRENDAN MCCAULEY, EXAMINING ATTORNEY

THE MARK CONSISTS OF STANDARD CHARACTERS WITHOUT CLAIM TO ANY PARTICULAR FONT, STYLE, SIZE, OR COLOR.

NO CLAIM IS MADE TO THE EXCLUSIVE RIGHT TO USE "BODY", APART FROM THE MARK AS SHOWN.

FOR BODY, FACE AND SKIN MOISTURIZERS, CREAMS AND LOTIONS IN THE NATURE OF COSMETICS; SKIN CARE PREPARATIONS, NAMELY, MOISTURIZERS (U.S. CLS. 1, 4, 6, 50, 51 AND 52).

FIRST USE 8-14-2003; IN COMMERCE 9-1-2003.

TRACY FLETCHER, EXAMINING ATTORNEY

CLASS 3—(Continued).

SN 78-459,478. KARA VITA LLC, ORLANDO, FL. FILED 7-30-2004.

CLASS 3—(Continued).

SN 78-469,376. WRIGHT, CHAD, SALT LAKE CITY, UT. FILED 8-18-2004.

EYEWISH! BIOSERUM

THE MARK CONSISTS OF STANDARD CHARACTERS WITHOUT CLAIM TO ANY PARTICULAR FONT, STYLE, SIZE, OR COLOR.

FOR NON-MEDICATED SKIN CARE PREPARATIONS, NAMELY, MOISTURIZERS, SUNSCREEN CREAMS, SUNBLOCKS, CLEANSERS, TONERS, AND MASKS; NON-MEDICATED COSMETIC FACIAL SKIN CARE PRODUCTS, NAMELY, FACIAL CLEANSERS, FACIAL TONERS, NAMELY, MINERAL SPRAYS, FACIAL LOTIONS, FACIAL MOISTURIZERS, FACIAL MASKS, FACIAL CREAMS FOR NORMAL, DRY, OILY AND ACNE FACIAL SKIN CONDITIONS; ANTI-WRINKLE CREAM, ANTI-WRINKLE SKIN LOTION; ANTI-WRINKLE FACIAL MASKS (U.S. CLS. 1, 4, 6, 50, 51 AND 52).

FIRST USE 8-14-2003; IN COMMERCE 9-1-2003.

JASON TURNER, EXAMINING ATTORNEY

CITY FACE

SN 78-464,297. A.P. DEAUVILLE, LLC, NEW BRUNSWICK, NJ. FILED 8-9-2004.



OWNER OF U.S. REG. NO. 1,466,857.

NO CLAIM IS MADE TO THE EXCLUSIVE RIGHT TO USE "LADY" AND "STICK", APART FROM THE MARK AS SHOWN.

THE MARK CONSISTS OF WORD LADY POWER STICK IN STYLIZED LETTERING.

FOR DEODORANTS AND ANTIPERSPIRANTS FOR PERSONAL USE (U.S. CLS. 1, 4, 6, 50, 51 AND 52).

FIRST USE 2-12-2003; IN COMMERCE 2-12-2003.

KELLY BOULTON, EXAMINING ATTORNEY

THE MARK CONSISTS OF STANDARD CHARACTERS WITHOUT CLAIM TO ANY PARTICULAR FONT, STYLE, SIZE, OR COLOR.

NO CLAIM IS MADE TO THE EXCLUSIVE RIGHT TO USE "FACE", APART FROM THE MARK AS SHOWN.

FOR COSMETICS, NAMELY PREPARATIONS FOR THE FACE INCLUDING CREAMS, LOTIONS, OILS, POWDERS, SCRUBS, EXFOLIANTS, MASKS, MOISTURIZERS, EMOLLIENTS, TEXTURIZERS, TONERS, CLEANSING GELS, SPRAYS AND WASH; FACIAL FRAGRANCES INCLUDING EAU DE TOILETTE; EAU DE PARFUM, COLOGNE, AND ESSENTIAL OILS; AFTER SHAVE PREPARATIONS INCLUDING CREAMS, BALMS, EMULSIONS, GELS AND LOTIONS; MAKE-UP PREPARATIONS INCLUDING FOUNDATION, BLUSH, ROUGE, COMPACTS CONTAINING MAKE-UP, MAKE-UP REMOVING PREPARATIONS AND MAKE-UP PENCILS; COSMETIC SUN-PROTECTING PREPARATIONS FOR THE FACE INCLUDING SUN BLOCK, SUN CARE LOTIONS, OILS, CREAMS AND GELS; COSMETIC PREPARATIONS FOR SHAVING THE FACE INCLUDING SHAVING CREAM, SHAVING FOAM, SHAVING GEL AND SHAVING LOTIONS; NON-MEDICATED SKIN TREATMENT PREPARATIONS; NON-MEDICATED ANTI-WRINKLING TREATMENT PREPARATIONS; NON-MEDICATED ANTI-AGING TREATMENT PREPARATIONS; NON-MEDICATED SKIN CARE TREATMENT PREPARATIONS CONTAINING COLLAGEN AND NON-MEDICATED SKIN CARE TREATMENT PREPARATIONS CONTAINING PEPTIDES (U.S. CLS. 1, 4, 6, 50, 51 AND 52).

NORA BUCHANAN WILL, EXAMINING ATTORNEY

CLASS 3—(Continued).

SN 78-472,757. KARA VITA LLC, ORLANDO, FL. FILED 8-24-2004.

CLASS 3—(Continued).

SN 78-480,903. NEDBOY, ROBIN L, NEW YORK, NY. FILED 9-9-2004.

INDULGENCE

DERMAZONE

THE MARK CONSISTS OF STANDARD CHARACTERS WITHOUT CLAIM TO ANY PARTICULAR FONT, STYLE, SIZE, OR COLOR.

FOR SKIN CARE PREPARATIONS AND COSMETIC SKIN CARE PRODUCTS, NAMELY, MOISTURIZERS; TOPICAL PREPARATIONS, NAMELY, BODY, FACE AND SKIN MOISTURIZERS (U.S. CLS. 1, 4, 6, 50, 51 AND 52).

FIRST USE 8-1-2004; IN COMMERCE 8-1-2004.
JILL C. ALT, EXAMINING ATTORNEY

THE MARK CONSISTS OF STANDARD CHARACTERS WITHOUT CLAIM TO ANY PARTICULAR FONT, STYLE, SIZE, OR COLOR.

FOR HOUSEHOLD CLEANING PREPARATIONS, NAMELY, DISH DETERGENTS, LAUNDRY DETERGENTS, AND GLASS CLEANING PREPARATIONS (U.S. CLS. 1, 4, 6, 50, 51 AND 52).

FIRST USE 9-1-2003; IN COMMERCE 9-1-2003.
MICHAEL TANNER, EXAMINING ATTORNEY

SN 78-477,612. FINNIE, ARHELIA T., MARIETTA, GA. AND BILLUPS, TRACEY D., MARIETTA, GA. FILED 9-2-2004.

SN 78-481,455. CONAIR CORPORATION, STAMFORD, CT. FILED 9-10-2004.

Nature's Break

CURL SILK

THE MARK CONSISTS OF STANDARD CHARACTERS WITHOUT CLAIM TO ANY PARTICULAR FONT, STYLE, SIZE, OR COLOR.

FOR ALL NATURAL BATH AND BODY PRODUCTS, NAMELY, BATH SALTS; ESSENTIAL OILS FOR USE IN THE MANUFACTURE OF SCENTED PRODUCTS; SKIN CARE PRODUCTS, NAMELY, NON-MEDICATED SKIN SERUM; HERBAL PRODUCTS, NAMELY, AROMA THERAPY PACKS CONTAINING HERBS USED FOR AROMA THERAPY; BODY BUTTER; BODY SCRUB; ASTRINGENT FOR COSMETIC PURPOSES; BODY OIL; SCENTED BODY SPRAYS; FACIAL AND SKIN MUD MASKS; SPA PRODUCTS, NAMELY, AROMATHERAPY PILLOWS COMPRISING POTPOURRI IN FABRIC CONTAINERS; BATH MILKS; BATH FIZZ BALLS; BAR SOAPS; LIQUID SOAP (U.S. CLS. 1, 4, 6, 50, 51 AND 52).

BARBARA GAYNOR, EXAMINING ATTORNEY

THE MARK CONSISTS OF STANDARD CHARACTERS WITHOUT CLAIM TO ANY PARTICULAR FONT, STYLE, SIZE, OR COLOR.

NO CLAIM IS MADE TO THE EXCLUSIVE RIGHT TO USE "CURL", APART FROM THE MARK AS SHOWN.

FOR HAIR CARE PREPARATIONS, NAMELY SHAMPOOS, CONDITIONER AND HAIR STYLING PREPARATIONS (U.S. CLS. 1, 4, 6, 50, 51 AND 52).

SKYE YOUNG, EXAMINING ATTORNEY

CLASS 3—(Continued).

SN 78-481,643. GOUNEL, PHILIPPE, CLERMONT FER-
RAND, FRANCE. FILED 9-10-2004.

PATYKA

THE MARK CONSISTS OF STANDARD CHARACTERS
WITHOUT CLAIM TO ANY PARTICULAR FONT, STYLE,
SIZE, OR COLOR.

OWNER OF FRANCE REG. NO. 013112336, DATED 8-28-
2001, EXPIRES 8-28-2011.

FOR PERFUMES, SOAPS AND COSMETICS, NAMELY
PERFUMES, BATH AND SHOWER GELS, FACE, HAND
AND BODY LOTIONS AND SHAMPOOS (U.S. CLS. 1, 4,
6, 50, 51 AND 52).

FIRST USE 12-1-2001; IN COMMERCE 9-1-2002.

JULIE GUTTADAURO, EXAMINING ATTORNEY

SN 78-485,050. ARAMIS INC., NEW YORK, NY. FILED 9-16-
2004.

AB RESCUE

THE MARK CONSISTS OF STANDARD CHARACTERS
WITHOUT CLAIM TO ANY PARTICULAR FONT, STYLE,
SIZE, OR COLOR.

NO CLAIM IS MADE TO THE EXCLUSIVE RIGHT TO
USE "AB", APART FROM THE MARK AS SHOWN.

FOR NON-MEDICATED SKIN CARE PREPARATIONS
(U.S. CLS. 1, 4, 6, 50, 51 AND 52).

WON TEAK OH, EXAMINING ATTORNEY

CLASS 3—(Continued).

SN 78-486,396. FEDERATED WHOLESALE, INC., NOR-
CROSS, GA. FILED 9-20-2004.

ENDLESS COMFORT

THE MARK CONSISTS OF STANDARD CHARACTERS
WITHOUT CLAIM TO ANY PARTICULAR FONT, STYLE,
SIZE, OR COLOR.

FOR SHAVING GEL, NAMELY, A COMBINATION OF
SHAVING GEL, SKIN MOISTURIZER AND AFTER-
SHAVE GEL (U.S. CLS. 1, 4, 6, 50, 51 AND 52).

FIRST USE 9-1-2004; IN COMMERCE 9-1-2004.

ANNE E. GUSTASON, EXAMINING ATTORNEY

SN 78-490,114. HEARTLAND PRODUCTS, INC., VALLEY
CITY, ND. FILED 9-27-2004.

Tidy Up!

THE MARK CONSISTS OF STANDARD CHARACTERS
WITHOUT CLAIM TO ANY PARTICULAR FONT, STYLE,
SIZE, OR COLOR.

FOR ALL-NATURAL SOAP USED AS AN ALL-PUR-
POSE CLEANER (U.S. CLS. 1, 4, 6, 50, 51 AND 52).

FIRST USE 1-5-2004; IN COMMERCE 1-5-2004.

PAUL F. GAST, EXAMINING ATTORNEY

CLASS 3—(Continued).

SN 78-490,771. RIGNEY, AMANDA L., ENCINITAS, CA. FILED 9-28-2004.



FOR COSMETIC PRODUCTS FOR THE FACE AND BODY, NAMELY, HAND CREAMS; LIP BALMS; BODY LOTIONS; FOOT BALMS; LIP GLOSS; SOLID LOTION BARS, NAMELY, SKIN MOISTURIZING BARS CONTAINING WAXES AND OILS FOR USE IN MOISTURIZING SKIN; HAIR OILS; HAIR SHAMPOOS; HAIR CONDITIONERS; HAND AND BODY SOAPS (U.S. CLS. 1, 4, 6, 50, 51 AND 52).

FIRST USE 8-2-2004; IN COMMERCE 9-24-2004. MICHAEL TANNER, EXAMINING ATTORNEY

CLASS 3—(Continued).

SN 78-492,367. BRUMER, BRIANA K., MIAMI BEACH, FL. FILED 9-30-2004.

LIPSMART

THE MARK CONSISTS OF STANDARD CHARACTERS WITHOUT CLAIM TO ANY PARTICULAR FONT, STYLE, SIZE, OR COLOR.

FOR NON-MEDICATED LIP CARE PREPARATIONS, NAMELY, LIP MOISTURIZERS, LIP VOLUMIZERS AND LIP GLOSS DESIGNED TO ENHANCE THE APPEARANCE AND PLUMPNESS OF LIPS (U.S. CLS. 1, 4, 6, 50, 51 AND 52).

RUDY R. SINGLETON, EXAMINING ATTORNEY

SN 78-493,254. GLOBAL VISION PRODUCTS, INC., NEW YORK, NY. FILED 10-1-2004.

RESTORE BY AVACOR

THE MARK CONSISTS OF STANDARD CHARACTERS WITHOUT CLAIM TO ANY PARTICULAR FONT, STYLE, SIZE, OR COLOR.

OWNER OF U.S. REG. NOS. 2,718,517, 2,870,584 AND OTHERS.

FOR COLOR ENHANCING TREATMENTS FOR HAIR (U.S. CLS. 1, 4, 6, 50, 51 AND 52).

DAYNA BROWNE, EXAMINING ATTORNEY

SN 78-492,120. PERFECT SMILE CORPORATION, WESLAKE, OH. FILED 9-30-2004.

**GET 'EM WHITE...
KEEP 'EM WHITE**

SN 78-493,767. HELENE CURTIS, INC., WILMINGTON, DE. FILED 10-4-2004.

**FOR MEN WHO DO
TAKE RISKS**

THE MARK CONSISTS OF STANDARD CHARACTERS WITHOUT CLAIM TO ANY PARTICULAR FONT, STYLE, SIZE, OR COLOR.

FOR DENTAL CARE KITS FOR HOME USE COMPRISED OF TEETH WHITENING GEL AND PEN APPLICATOR THEREFOR, BOIL AND BITE TRAY; TEETH WHITENING GEL AND PEN APPLICATOR THEREFOR; TEETH WHITENING GEL (U.S. CLS. 1, 4, 6, 50, 51 AND 52).

REBECCA SMITH, EXAMINING ATTORNEY

THE MARK CONSISTS OF STANDARD CHARACTERS WITHOUT CLAIM TO ANY PARTICULAR FONT, STYLE, SIZE, OR COLOR.

FOR ANTIPERSPIRANT AND DEODORANT (U.S. CLS. 1, 4, 6, 50, 51 AND 52).

BARBARA A. LOUGHRAN, EXAMINING ATTORNEY

CLASS 3—(Continued).

SN 78-494,453. ECO HOLDINGS, LLC, MIAMI, FL. FILED 10-5-2004.



THE COLOR(S) GREEN, YELLOW AND WHITE IS/ARE CLAIMED AS A FEATURE OF THE MARK.

THE COLOR(S) GREEN APPEARS IN THE LARGEST AND SMALLEST CIRCLE; THE MIDDLE SIZED CIRCLE IS WHITE AND THE "KELP" PORTION OF THE LARGE CIRCLE IS IN VARYING SHADES OF YELLOW.

THE MARK CONSISTS OF A LARGE CIRCLE WITH A DESIGN OF OCEAN KELP INSIDE THE CIRCLE. A MEDIUM CIRCLE IS PARTIALLY SUPERIMPOSED OVER THE LARGE CIRCLE AND A SMALL SEPARATE CIRCLE.

FOR ALL PURPOSE CLEANERS; ALL PURPOSE CLEANERS AND DEGREASERS; AND ALL PURPOSE DEGREASERS NOT USED IN MANUFACTURING PROCESSES (U.S. CLS. 1, 4, 6, 50, 51 AND 52).

SUSAN HAYASH, EXAMINING ATTORNEY

SN 78-494,454. ECO HOLDINGS, LLC, MIAMI, FL. FILED 10-5-2004.



THE COLOR(S) GREEN IS/ARE CLAIMED AS A FEATURE OF THE MARK.

THE COLOR(S) GREEN APPEARS IN VARIOUS SHADES THROUGHOUT THE WHOLE MARK.

THE MARK CONSISTS OF THREE RINGS CONNECTED BY A SWIRL. ALL OF THE RINGS AND THE SWIRL HAVE DIFFERENT SHADES OF GREEN.

FOR ALL PURPOSE CLEANERS; ALL PURPOSE CLEANERS AND DEGREASERS; AND ALL PURPOSE DEGREASERS NOT USED IN MANUFACTURING PROCESSES (U.S. CLS. 1, 4, 6, 50, 51 AND 52).

SUSAN HAYASH, EXAMINING ATTORNEY

CLASS 3—(Continued).

SN 78-495,191. DENESE, ADRIENNE, NEW YORK, NY. FILED 10-6-2004.

DR. DENESE NEW YORK

THE MARK CONSISTS OF STANDARD CHARACTERS WITHOUT CLAIM TO ANY PARTICULAR FONT, STYLE, SIZE, OR COLOR.

NO CLAIM IS MADE TO THE EXCLUSIVE RIGHT TO USE NEW YORK, APART FROM THE MARK AS SHOWN.

THE NAME DR. DENESE IDENTIFIES A LIVING INDIVIDUAL WHOSE CONSENT IS OF RECORD.

FOR SKIN CARE PREPARATIONS, NAMELY, CREAMS, LOTIONS, NON-MEDICATED SERUMS FOR ANTI-WRINKLE EFFECTS TO TONE SKIN; NON-MEDICATED SKIN CARE PRODUCTS, NAMELY, SKIN FIRING PREPARATIONS, DRY SKIN LOTIONS AND GELS, SKIN HYDRATORS, TONERS, AND NON-MEDICAL FIRING SERUM FOR FACE, EYES, NECK AND BODY; COSMETIC PADS AND FACIAL MASKS, LIGHT PEELS, SKIN FADING LOTIONS, MOISTURIZERS, AND COSMETICS, NAMELY, LIPSTICKS, LIP GLOSS, FOUNDATION, CONCEALERS, TONERS AND LIP LINER PENCILS (U.S. CLS. 1, 4, 6, 50, 51 AND 52).

FIRST USE 11-1-2003; IN COMMERCE 11-1-2003.

MICHAEL KAZAZIAN, EXAMINING ATTORNEY

SN 78-495,339. PHILOSOPHY, INC., PHOENIX, AZ. FILED 10-6-2004.

SHOWER FOR THE CURE

THE MARK CONSISTS OF STANDARD CHARACTERS WITHOUT CLAIM TO ANY PARTICULAR FONT, STYLE, SIZE, OR COLOR.

NO CLAIM IS MADE TO THE EXCLUSIVE RIGHT TO USE "SHOWER", APART FROM THE MARK AS SHOWN.

FOR SCENTED HEAD-TO-TOE BODY WASH (U.S. CLS. 1, 4, 6, 50, 51 AND 52).

BARBARA A. LOUGHRAN, EXAMINING ATTORNEY

CLASS 3—(Continued).

SN 78-495,831. PERRY, WAYNE, J., GUILDERLAND, NY. FILED 10-6-2004.

CLASS 3—(Continued).

SN 78-496,763. VARN INTERNATIONAL, INC., DAYTON, OH. FILED 10-8-2004.

PepperCare

THE MARK CONSISTS OF STANDARD CHARACTERS WITHOUT CLAIM TO ANY PARTICULAR FONT, STYLE, SIZE, OR COLOR.

FOR NON-BURNING SKIN CONDITIONING CREAM MADE WITH NATURAL HOT PEPPER EXTRACT, NAMELY CAPSAICIN (U.S. CLS. 1, 4, 6, 50, 51 AND 52).
KIMBERLY PERRY, EXAMINING ATTORNEY

ECOLO-WASH

THE MARK CONSISTS OF STANDARD CHARACTERS WITHOUT CLAIM TO ANY PARTICULAR FONT, STYLE, SIZE, OR COLOR.

OWNER OF U.S. REG. NO. 2,571,445.
FOR CLEANING PREPARATIONS FOR ROLLERS AND BLANKETS FOR PRINTING PRESSES (U.S. CLS. 1, 4, 6, 50, 51 AND 52).
FIRST USE 2-0-1992; IN COMMERCE 2-0-1992.
MARCIE MILONE, EXAMINING ATTORNEY

SN 78-497,253. BASKETT, AUSTIN H., LAFAYETTE, CO. FILED 10-8-2004.

SN 78-496,235. HOEHN, JENNY, LASALLE, IL. FILED 10-7-2004.

In Kristine's Shower

THE MARK CONSISTS OF STANDARD CHARACTERS WITHOUT CLAIM TO ANY PARTICULAR FONT, STYLE, SIZE, OR COLOR.

FOR SOAPS, BODY LOTIONS, BODY EXFOLIATING SCRUBS, NON-MEDICATED BATH BOMBS CONTAINING FRAGRANCES AND OILS, AND LIP GLOSSES (U.S. CLS. 1, 4, 6, 50, 51 AND 52).
FIRST USE 5-31-2002; IN COMMERCE 7-15-2002.
LINDA M. KING, EXAMINING ATTORNEY

Union Jack brilliant men's grooming

THE MARK CONSISTS OF STANDARD CHARACTERS WITHOUT CLAIM TO ANY PARTICULAR FONT, STYLE, SIZE, OR COLOR.

NO CLAIM IS MADE TO THE EXCLUSIVE RIGHT TO USE MEN'S GROOMING, APART FROM THE MARK AS SHOWN.

FOR AFTER SUN CREAMS, AFTER-SHAVE BALMS, AFTER-SHAVE EMULSIONS, AFTER-SHAVE GEL, AFTER-SHAVE LOTIONS, AFTER-SUN LOTIONS, ANTI-BACTERIAL SKIN SOAPS, ANTIPERSPIRANTS, ANTI-PERSPIRANTS FOR PERSONAL USE, ANTI-AGING CREAM, ANTI-BACTERIAL SOAP, ANTI-WRINKLE CREAM, ANTI-WRINKLE CREAMS, BABY HAIR CONDITIONER, BABY LOTION, BABY SHAMPOO, BATH FOAM, BATH FOAMS, BATH GEL, BATH GELS, BATH LOTION, BATHING LOTIONS, BEAUTY CREAMS, BEAUTY CREAMS FOR BODY CARE, BEAUTY GELS, BEAUTY LOTIONS, BEAUTY MASKS, BEAUTY SERUMS, BODY AND BEAUTY CARE PREPARATIONS, BODY CREAM, BODY CREAM SOAP, BODY CREAMS, BODY EMULSIONS, BODY LOTION, BODY LOTIONS, BODY SCRUB, BODY SPRAY USED AS A PERSONAL DEODORANT AND AS FRAGRANCE, BODY SPRAYS, COLOGNE, COLOGNE WATER, COSMETIC CREAMS FOR SKIN CARE, COSMETIC SOAPS, COSMETIC SUN-PROTECTING PREPARATIONS, DEODORANT SOAP, DEODORANTS AND ANTIPERSPIRANTS, DEODORANTS FOR BODY CARE, EAU DE COLOGNE, EAU DE COLOGNE, EAU DE TOILETTE, EAU-DE-TOILETTE, ESSENTIAL OILS FOR PERSONAL USE, EXFOLIANT CREAMS, EYE COMPRESSES FOR COSMETIC PURPOSES, EYE CREAM, EYE GELS, FACE AND BODY BEAUTY CREAMS, FACE AND BODY CREAMS, FACE

CLASS 3—(Continued).

AND BODY LOTIONS, FACE CREAMS, FACIAL CREAM, FACIAL CREAMS, FACIAL EMULSIONS, FACIAL LOTION, FACIAL SCRUBS, FACIAL WASHES, FAIR COMPLEXION CREAM, FRAGRANCES FOR PERSONAL USE, HAIR GEL; HAIR BLEACH, HAIR BLEACHES, HAIR BLEACHING PREPARATIONS, HAIR CARE CREAMS, HAIR CARE LOTIONS, HAIR CARE PREPARATIONS, HAIR CLEANING PREPARATIONS, HAIR COLOR, HAIR CONDITIONER, HAIR CONDITIONERS, HAIR CONDITIONERS FOR BABIES, HAIR CREAMS, HAIR DRESSINGS FOR MEN, HAIR DYE, HAIR DYES, HAIR EMOLLIENTS, HAIR FIXERS, HAIR GEL, HAIR GELS, HAIR LIGHTENERS, HAIR LOTIONS, HAIR MOUSSE, HAIR MOUSSES, HAIR NOURISHERS, HAIR OILS, HAIR POMADES, HAIR REMOVING CREAM, HAIR RINSES, HAIR RINSES, HAIR SHAMPOO, HAIR SPRAY, HAIR STRAIGHTENING PREPARATIONS, HAIR STYLING GEL, HAIR STYLING PREPARATIONS, HAIR STYLING SPRAY, HAIR TONIC, HAIR TONICS, LIP BALM, LIQUID SOAP, LIQUID SOAPS, LIQUID SOAPS FOR HANDS, FACE AND BODY, LIQUID SOAPS FOR HANDS AND FACE, HAIR LOTIONS, LOTIONS FOR FACE AND BODY CARE, MEDICATED SOAP, MEDICATED SOAPS, HAIR AND FACIAL MOUSSE, PERSONAL DEODORANTS, POMADES, POMADES, PRE-MOISTENED COSMETIC TISSUES, PRE-MOISTENED COSMETIC TOWELETTES, PRE-SHAVE CREAMS, SCENTED BODY SPRAY, SHAMPOOS [BODY, HAIR], SHAMPOOS FOR BABIES, SHAMPOO-CONDITIONERS, SHAVING BALM, SHAVING CREAM, SHAVING CREAMS, SHAVING FOAM, SHAVING GEL, SHAVING GELS, SHAVING LOTION, SHAVING LOTIONS, SHAVING MOUSSE, SHAVING PREPARATIONS, SHAVING SOAP, SHOWER AND BATH FOAM, SHOWER AND BATH GEL, SHOWER CREAMS, SHOWER GEL, SHOWER GELS, SKIN CLARIFIERS, SKIN CLEANSERS, SKIN CLEANSING CREAM, SKIN CLEANSING LOTION, SKIN CONDITIONERS, SKIN CREAM, SKIN CREAMS, SKIN CREAMS IN LIQUID AND IN SOLID FORM, SKIN CREAMS IN LIQUID AND SOLID, SKIN CREAMS IN LIQUID AND SOLID FORM, SKIN EMOLLIENTS, SKIN GELS FOR ACCELERATING, ENHANCING OR EXTENDING TANS, SKIN LOTION, SKIN LOTIONS, SKIN MOISTURIZER, SKIN SOAP, SOAPS FOR PERSONAL USE, STYLING GELS, STYLING LOTIONS, STYLING MOUSSE, SUN CARE LOTIONS, SUN CREAMS, SUN SCREEN, SUN TAN LOTION, SUNSCREEN CREAM, SUNSCREEN CREAMS, SELF-TANNING CREAMS, TALCUM POWDER, TALCUM POWDERS, TONING LOTION FOR THE FACE, BODY AND HANDS, UNDER-EYE ENHANCERS, AND WATERLESS SOAP (U.S. CLS. 1, 4, 6, 50, 51 AND 52).

REBECCA GAN, EXAMINING ATTORNEY

CLASS 3—(Continued).

SN 78-497,291. GUTHY-RENKER CORPORATION, PALM DESERT, CA. FILED 10-8-2004.

TRUESHADE TECHNOLOGY

THE MARK CONSISTS OF STANDARD CHARACTERS WITHOUT CLAIM TO ANY PARTICULAR FONT, STYLE, SIZE, OR COLOR.

NO CLAIM IS MADE TO THE EXCLUSIVE RIGHT TO USE TECHNOLOGY, APART FROM THE MARK AS SHOWN.

FOR SKIN AND BODY CARE PREPARATIONS NAMELY, SKIN CLEANSERS, SKIN MOISTURIZERS, SKIN LOTIONS, SKIN SOAPS, SUN SCREEN PREPARATIONS, COSMETICS, NON-MEDICATED HAIR CARE PREPARATIONS, NAIL CARE PREPARATIONS, NON-MEDICATED SKIN CARE PREPARATIONS, COLOGNES, PERFUMES AND TOOTH WHITENING PREPARATIONS (U.S. CLS. 1, 4, 6, 50, 51 AND 52).

MICHAEL SOUDERS, EXAMINING ATTORNEY

SN 78-497,455. MOTHERS POLISHES WAXES CLEANERS, HUNTINGTON BEACH, CA. FILED 10-10-2004.

MOTHERS FX

THE MARK CONSISTS OF STANDARD CHARACTERS WITHOUT CLAIM TO ANY PARTICULAR FONT, STYLE, SIZE, OR COLOR.

OWNER OF U.S. REG. NOS. 1,021,824, 2,899,846 AND OTHERS.

FOR CLEANING AND WAX PREPARATIONS FOR AUTOMOBILES, MOTORCYCLES, RECREATIONAL VEHICLES, TRUCKS, AIRPLANES AND BOATS (U.S. CLS. 1, 4, 6, 50, 51 AND 52).

FIRST USE 12-17-2004; IN COMMERCE 12-17-2004.

MICHAEL SOUDERS, EXAMINING ATTORNEY

CLASS 3—(Continued).

SN 78-497,524. STRENGTH OF NATURE, LLC, ATLANTA, GA. FILED 10-11-2004.

CLASS 3—(Continued).

SN 78-498,210. OLI-CO, LLC, GOODLETTSVILLE, TN. FILED 10-12-2004.

MEGA GROWTH

NO CLAIM IS MADE TO THE EXCLUSIVE RIGHT TO USE "GROWTH", APART FROM THE MARK AS SHOWN.
THE COLOR(S) BLACK, YELLOW, AND WHITE IS/ARE CLAIMED AS A FEATURE OF THE MARK.
THE COLOR BLACK APPEARS IN THE WORDING MEGA AND GROWTH. THE COLOR YELLOW SURROUNDS THE WORDING MEGA AND IS IN THE OUTLINE OF THE RECTANGLE. THE COLOR WHITE SURROUNDS THE WORDING GROWTH.
FOR HAIR CARE PREPARATIONS (U.S. CLS. 1, 4, 6, 50, 51 AND 52).
FIRST USE 7-1-2000; IN COMMERCE 7-1-2000.
BRIAN PINO, EXAMINING ATTORNEY

Pene-Fusion 8

SN 78-498,128. LOVING, CYNTHIA, GREENSBORO, NC. FILED 10-12-2004.

LovingScents

THE MARK CONSISTS OF STANDARD CHARACTERS WITHOUT CLAIM TO ANY PARTICULAR FONT, STYLE, SIZE, OR COLOR.
FOR ESSENTIAL OILS FOR USE IN AROMATHERAPY (U.S. CLS. 1, 4, 6, 50, 51 AND 52).
FIRST USE 1-1-1995; IN COMMERCE 1-1-1995.
ESTHER BELENKER, EXAMINING ATTORNEY

THE MARK CONSISTS OF STANDARD CHARACTERS WITHOUT CLAIM TO ANY PARTICULAR FONT, STYLE, SIZE, OR COLOR.
FOR SKIN CARE PREPARATIONS, NAMELY, FACIAL TONERS/CLARIFIERS, FACIAL MOISTURIZERS, FOAMING FACIAL WASH, AND SKIN HYDRATING FORMULATIONS (U.S. CLS. 1, 4, 6, 50, 51 AND 52).
HEATHER THOMPSON, EXAMINING ATTORNEY

CLASS 3—(Continued).

SN 78-498,437. FRENCH CONNECTION LIMITED, LONDON, UNITED KINGDOM, FILED 10-12-2004.

FCUK

THE MARK CONSISTS OF STANDARD CHARACTERS WITHOUT CLAIM TO ANY PARTICULAR FONT, STYLE, SIZE, OR COLOR.

OWNER OF ERPN CMNTY TM OFC REG. NO. 000945584, DATED 2-9-2000, EXPIRES 9-25-2008.

OWNER OF U.S. REG. NOS. 2,520,614, 2,772,903 AND OTHERS.

FOR SOAPS; LIQUID SOAPS; SHOWER AND BATH GEL, OILS, SALTS AND CREAMS; SHOWER AND BATH ADDITIVES, NAMELY, BEADS, CRYSTALS, GELS AND BUBBLE BATHS; PERFUMES; COSMETICS; ESSENTIAL OILS FOR PERSONAL USE, NON-MEDICATED PREPARATIONS FOR THE CARE OF THE SKIN AND HAIR; SHAMPOOS; DENTIFRICES; TOILET WATER; COLOGNE; DEODORANTS AND ANTI-PERSPIRANTS FOR PERSONAL USE; TALCUM POWDER; PREPARATIONS FOR USE BEFORE, DURING, AND AFTER SHAVING; COSMETIC SUN-TANNING AND AFTER-SUN PREPARATIONS; NAIL-POLISH, NAIL-VANISH FOR COSMETIC PURPOSES; FACIAL CLEANSERS AND SCRUBS; SKIN MOISTURIZERS; NON-MEDICATED SCALP TREATMENT CREAM; HAIR COLOR; HAIR CONDITIONERS; HAIR DYES; NON-MEDIATED MASSAGE OILS, DEPILATORIES; COTTON-STICKS FOR COSMETIC PURPOSES, COTTON WOOL FOR NON-MEDICAL PURPOSES; AND SCENTED ARTICLES ALL FOR PERFUMERY PURPOSES, NAMELY, SACHETS AND SCENTED CERAMIC STONES (U.S. CLS. 1, 4, 6, 50, 51 AND 52).

JOHN GARTNER, EXAMINING ATTORNEY

SN 78-498,895. PHILOSOPHY, INC., PHOENIX, AZ. FILED 10-13-2004.

BATHE FOR THE CURE

THE MARK CONSISTS OF STANDARD CHARACTERS WITHOUT CLAIM TO ANY PARTICULAR FONT, STYLE, SIZE, OR COLOR.

NO CLAIM IS MADE TO THE EXCLUSIVE RIGHT TO USE "BATHE", APART FROM THE MARK AS SHOWN.

FOR NON-MEDICATED BATH CARE PREPARATIONS, NAMELY, SOAP, SALTS, CRYSTALS, BEADS, GEL, OIL, POWDER, AND BUBBLE BATH; SCENTED HEAD-TO-TOE BODY WASH (U.S. CLS. 1, 4, 6, 50, 51 AND 52).

BARBARA A. LOUGHRAN, EXAMINING ATTORNEY

CLASS 3—(Continued).

SN 78-498,900. PHILOSOPHY, INC., PHOENIX, AZ. FILED 10-13-2004.

SHAMPOO FOR THE CURE

THE MARK CONSISTS OF STANDARD CHARACTERS WITHOUT CLAIM TO ANY PARTICULAR FONT, STYLE, SIZE, OR COLOR.

NO CLAIM IS MADE TO THE EXCLUSIVE RIGHT TO USE "SHAMPOO", APART FROM THE MARK AS SHOWN.

FOR HAIR CARE PREPARATIONS, NAMELY, SHAMPOO, CONDITIONER, RINSE; SCENTED HEAD-TO-TOE BODY WASH (U.S. CLS. 1, 4, 6, 50, 51 AND 52).

BARBARA A. LOUGHRAN, EXAMINING ATTORNEY

SN 78-498,991. NATURAL THOUGHTS, INC., SAN DIEGO, CA. FILED 10-13-2004.

BIOTONE SPA

THE MARK CONSISTS OF STANDARD CHARACTERS WITHOUT CLAIM TO ANY PARTICULAR FONT, STYLE, SIZE, OR COLOR.

OWNER OF U.S. REG. NOS. 2,159,105, 2,817,330 AND 2,857,992.

FOR SKIN PREPARATIONS, NAMELY, EXFOLIATION BODY SCRUBS, BODY MUDS, HYDRATING LOTIONS AND CREMES; MASSAGE PREPARATIONS, NAMELY, OILS, LOTIONS AND CREMES; ESSENTIAL OILS FOR PERSONAL USE; AND FRAGRANCES (U.S. CLS. 1, 4, 6, 50, 51 AND 52).

FIRST USE 1-14-2003; IN COMMERCE 1-14-2003.

JOHN WILKE, EXAMINING ATTORNEY

CLASS 3—(Continued).

SN 78-499,312. MUSGRAVE, CATHERINE, CLOVIS, CA.
FILED 10-13-2004.

CLASS 3—(Continued).

SN 78-500,289. NEDBOY, ROBIN L, NEW YORK, NY. FILED
10-15-2004.

Love That Tail

THE MARK CONSISTS OF STANDARD CHARACTERS
WITHOUT CLAIM TO ANY PARTICULAR FONT, STYLE,
SIZE, OR COLOR.

FOR EQUINE SHAMPOO AND CONDITIONER (U.S.
CLS. 1, 4, 6, 50, 51 AND 52).

FIRST USE 10-1-2000; IN COMMERCE 10-1-2000.
SALLY SHIH, EXAMINING ATTORNEY

GARDEN CLUB

SN 78-499,578. COLGATE-PALMOLIVE COMPANY, NEW
YORK, NY. FILED 10-14-2004.

FLUORIGARD

THE MARK CONSISTS OF STANDARD CHARACTERS
WITHOUT CLAIM TO ANY PARTICULAR FONT, STYLE,
SIZE, OR COLOR.

OWNER OF U.S. REG. NO. 1,354,922.
FOR DENTIFRICES (U.S. CLS. 1, 4, 6, 50, 51 AND 52).
MONTIA G. PRESSEY, EXAMINING ATTORNEY

THE MARK CONSISTS OF STANDARD CHARACTERS
WITHOUT CLAIM TO ANY PARTICULAR FONT, STYLE,
SIZE, OR COLOR.

FOR NON-MEDICATED SKIN CARE PREPARATIONS,
NAMELY, ANTI-AGING CREAM, ANTI-WRINKLE
CREAM, ASTRINGENT FOR COSMETIC PURPOSES,
BODY CREAM, BODY EMULSION, BODY LOTION,
BODY MILK, BODY OIL, BODY SCRUB, BODY SPRAY,
EXFOLIANTS FOR SKIN, EYE CREAM, EYE GEL,
FACIAL CLEANSER, FACIAL CREAM, FACIAL EMUL-
SIONS, FACIAL MASKS, FACIAL SCRUB, HAND
CREAM, HAND LOTION, HAND SOAP, MOISTURIZING
MILKS, NON-MEDICATED BODY SOAK, NON-MEDI-
CATED FOOT CREAM, SHOWER GEL, SKIN CLARI-
FIERS, SKIN CLEANSERS, SKIN CLEANSING CREAM,
SKIN CLEANSING LOTION, SKIN CONDITIONERS,
SKIN CREAM, SKIN EMOLLIENTS, SKIN LOTION,
SKIN MASKS, SKIN MOISTURIZER, SKIN SOAP, SKIN
TONER, SOAP FOR COSMETIC PURPOSES; SHAVING
PREPARATIONS, NAMELY, SHAVING BALM, SHAV-
ING CREAM, SHAVING FOAM, SHAVING GEL, SHAV-
ING LOTION, SHAVING SOAP, AFTER-SHAVE GEL,
AFTER-SHAVE LOTION; BATH ADDITIVES, NAMELY,
BATH BEADS, BATH CRYSTALS, BATH FOAMS, BATH
GELS, BATH MILK, BATH OILS, BATH PEARLS, BUB-
BLE BATH, NON-MEDICATED BATH SALTS; FRA-
GRANCES, NAMELY, ESSENTIAL OILS FOR
PERSONAL USE, POTPOURRI, SCENTED LINEN
SPRAYS, SCENTED ROOM SPRAYS, PERFUME, EAU
DE TOILETTE; NON-MEDICATED HAIR CARE PRE-
PARATIONS, NAMELY, HAIR CONDITIONERS, HAIR
DRESSINGS FOR MEN, HAIR EMOLLIENTS, HAIR
GEL, HAIR MOUSSE, HAIR POMADES, HAIR RINSES,
HAIR SHAMPOO, HAIR SPRAY, HAIR STYLING PRE-
PARATIONS; HOUSEHOLD CLEANING PREPARA-
TIONS, NAMELY, DISH DETERGENTS, LAUNDRY
DETERGENTS, GLASS CLEANING PREPARATIONS
(U.S. CLS. 1, 4, 6, 50, 51 AND 52).

FIRST USE 10-1-2001; IN COMMERCE 10-1-2001.
RUSS HERMAN, EXAMINING ATTORNEY

SN 78-500,149. WELLA PERSONAL CARE OF NORTH
AMERICA, INC., STAMFORD, CT. FILED 10-14-2004.

gentletreatment

OWNER OF U.S. REG. NOS. 1,277,666 AND 1,376,790.
THE MARK CONSISTS OF THE WORDS GENTLE
TREATMENT IN STYLIZED FORM.

FOR HAIR CARE PRODUCTS, NAMELY, HEAT
MANAGER PROTECTANT SPRAY, CREAM MOISTUR-
IZER, CONDITIONERS, SHAMPOOS AND SEMI-PER-
MANENT HAIR COLOR (U.S. CLS. 1, 4, 6, 50, 51 AND
52).

FIRST USE 5-1-2002; IN COMMERCE 5-1-2002.
DEBRA LEE, EXAMINING ATTORNEY

CLASS 3—(Continued).

SN 78-500,303. THE GILLETTE COMPANY, BOSTON, MA.
FILED 10-15-2004.

COOL SPRAY

THE MARK CONSISTS OF STANDARD CHARACTERS WITHOUT CLAIM TO ANY PARTICULAR FONT, STYLE, SIZE, OR COLOR.

NO CLAIM IS MADE TO THE EXCLUSIVE RIGHT TO USE "SPRAY", APART FROM THE MARK AS SHOWN.

FOR ANTIPERSPIRANT AND DEODORANT (U.S. CLS. 1, 4, 6, 50, 51 AND 52).

FIRST USE 3-0-2004; IN COMMERCE 5-0-2004.
TANYA AMOS, EXAMINING ATTORNEY

CLASS 3—(Continued).

SN 78-501,731. ST. TROPEZ, INC., SANTA CLARITA, CA.
FILED 10-18-2004.



ST. TROPEZ

THE MARK CONSISTS OF THE WORDS "ST. TROPEZ" SURMOUNTED BY A FAN DESIGN.

FOR SELF TANNING SPRAY; SELF TANNING MOUSSE, SELF TANNING LOTION, SELF TAN STAIN REMOVER, SKIN MOISTURIZERS, SELF TANNING ACCELERATOR, EXFOLIANTS, AND SELF TAN POWDERS (U.S. CLS. 1, 4, 6, 50, 51 AND 52).

FIRST USE 1-15-1993; IN COMMERCE 1-15-1993.
DAWN FELDMAN, EXAMINING ATTORNEY

SN 78-502,771. APPLIED GENETICS INCORPORATED DERMATICS, FREEPORT, NY. FILED 10-20-2004.

SN 78-500,536. GARRETT, TENAYA, PLEASANT HILL, CA.
FILED 10-15-2004.

CONSCIOUS
COOKIEASE

THE MARK CONSISTS OF STANDARD CHARACTERS WITHOUT CLAIM TO ANY PARTICULAR FONT, STYLE, SIZE, OR COLOR.

FOR BATH AND BODY PRODUCTS, NAMELY, BATH BOMBS (U.S. CLS. 1, 4, 6, 50, 51 AND 52).

FIRST USE 10-0-2003; IN COMMERCE 10-0-2003.
DANIEL CAPSHAW, EXAMINING ATTORNEY

EVODIOX

THE MARK CONSISTS OF STANDARD CHARACTERS WITHOUT CLAIM TO ANY PARTICULAR FONT, STYLE, SIZE, OR COLOR.

FOR BIOLOGICALLY ACTIVE INGREDIENT FOR USE IN THE PREPARATION OF CREAMS, LOTIONS OR GELS FOR THE HANDS, FACE OR BODY BY MANUFACTURERS OF COSMETICS OR PERSONAL CARE PRODUCTS (U.S. CLS. 1, 4, 6, 50, 51 AND 52).

FIRST USE 7-13-2004; IN COMMERCE 7-13-2004.
TEJBIR SINGH, EXAMINING ATTORNEY

CLASS 3—(Continued).

SN 78-504,230. ECOLAB INC., ST. PAUL, MN. FILED 10-22-2004.

CLASS 3—(Continued).

SN 78-508,220. BIOSYN INC., HARRAHAN, LA. FILED 10-29-2004.

MULTI 25

Nanolucent

THE MARK CONSISTS OF STANDARD CHARACTERS WITHOUT CLAIM TO ANY PARTICULAR FONT, STYLE, SIZE, OR COLOR.
FOR FLOOR FINISHING PREPARATIONS (U.S. CLS. 1, 4, 6, 50, 51 AND 52).
FIRST USE 4-20-2004; IN COMMERCE 4-20-2004.
MAUREEN DALL, EXAMINING ATTORNEY

THE MARK CONSISTS OF STANDARD CHARACTERS WITHOUT CLAIM TO ANY PARTICULAR FONT, STYLE, SIZE, OR COLOR.
FOR COSMETIC PREPARATIONS FOR SKIN RENEWAL (U.S. CLS. 1, 4, 6, 50, 51 AND 52).
FIRST USE 10-28-2004; IN COMMERCE 10-28-2004.
LANA PHAM, EXAMINING ATTORNEY

SN 78-510,392. WINSTON COMPANY, INC., TULSA, OK. FILED 11-3-2004.

SN 78-506,963. DEL LABORATORIES, INC., UNIONDALE, NY. FILED 10-27-2004.

AIRBRUSH SUN

OXY-KEM

THE MARK CONSISTS OF STANDARD CHARACTERS WITHOUT CLAIM TO ANY PARTICULAR FONT, STYLE, SIZE, OR COLOR.
OWNER OF U.S. REG. NO. 2,927,032.
NO CLAIM IS MADE TO THE EXCLUSIVE RIGHT TO USE "AIRBRUSH", APART FROM THE MARK AS SHOWN.
FOR COSMETICS (U.S. CLS. 1, 4, 6, 50, 51 AND 52).
RAUL CORDOVA, EXAMINING ATTORNEY

THE MARK CONSISTS OF STANDARD CHARACTERS WITHOUT CLAIM TO ANY PARTICULAR FONT, STYLE, SIZE, OR COLOR.
FOR OXYGENATED ENZYME CLEANER WITH DEODORANT FOR WASTE WATER HOLDING TANKS AND PORTABLE TOILETS (U.S. CLS. 1, 4, 6, 50, 51 AND 52).
MELISSA VALLILLO, EXAMINING ATTORNEY

CLASS 3—(Continued).

SN 78-511,388. PHILOSOPHY, INC., PHOENIX, AZ. FILED 11-4-2004.

SHAVE FOR THE CURE

THE MARK CONSISTS OF STANDARD CHARACTERS WITHOUT CLAIM TO ANY PARTICULAR FONT, STYLE, SIZE, OR COLOR.

NO CLAIM IS MADE TO THE EXCLUSIVE RIGHT TO USE "SHAVE", APART FROM THE MARK AS SHOWN.

FOR COSMETICS, NAMELY, LIPSTICK, LIP GLOSS, LIP LINER, LIP BALM, BLUSH, FOUNDATION, EYE SHADOW, EYE LINER, MASCARA, CONCEALER, COSMETIC PENCILS, AND FACIAL POWDER; FRAGRANCES, NAMELY, PERFUME, COLOGNE, AND AFTER-SHAVE LOTION AND GEL; NON-MEDICATED SKIN CARE PREPARATIONS, NAMELY, SOAP, SCRUBS, TONER, CONDITIONER, EXFOLIANTS, SKIN CLARIFIER, WRINKLE REMOVING SKIN CARE PREPARATIONS, AND MOISTURIZER; FACE AND BODY LOTION, CREAM, OIL, GEL AND SPRAY; SUN SCREEN PREPARATIONS, NAMELY, LOTION, CREAM, GEL AND SPRAY; NON-MEDICATED FACE AND BODY SKIN LIGHTENER; HAIR CARE PREPARATIONS, NAMELY, SHAMPOO, CONDITIONER, RINSE, GEL, MOUSSE, SPRAY AND TONIC; BATH CARE PREPARATIONS, NAMELY, SOAP, SALTS, CRYSTALS, BEADS, GEL, OIL, POWDER, AND BUBBLE BATH; SCENTED HEAD-TO-TOE BODY WASH; NAIL CARE PREPARATIONS, NAMELY, CUTICLE CREAM, CUTICLE REMOVING PREPARATIONS, NAIL ENAMEL, NAIL POLISH, NAIL POLISH REMOVER, NAIL POLISH BASE COAT, NAIL POLISH TOP COAT, AND NAIL STRENGTHENERS; PERSONAL DEODORANT; TOOTH WHITENING GELS, CREAMS, AND PASTES; NON-MEDICATED FOOT CARE PREPARATIONS, NAMELY SCRUBS, LOTIONS, CREAMS, DEODORANT, AND EXFOLIANTS; MEN'S TOILETRIES, NAMELY COLOGNE, AFTER-SHAVE LOTION AND GEL, SKIN CLEANSER, SKIN SCRUBS, SKIN TONER, SKIN CREAM, SHAVING GEL, SHAVING CREAM, TOILET WATER, PERSONAL DEODORANT, SHAMPOO, BODY LOTION, BODY TALC, AND SKIN MOISTURIZER; NON-MEDICATED BABY CARE PREPARATIONS, NAMELY, LOTIONS, CREAMS, OINTMENTS, SOAPS, POWDERS, AND SHAMPOO; FACIAL AND BODY HAIR DEPILATORY WAXES, CREAMS, LOTIONS, BLEACHING AND COLORING PREPARATIONS; MAKE-UP KITS AND GIFT SETS COMPRISED OF ONE OR MORE OF LIPSTICK, LIP GLOSS, LIP LINER, LIP BALM, BLUSH, FOUNDATION, EYE SHADOW, EYE LINER, MASCARA, CONCEALER, COSMETIC PENCILS, AND FACIAL POWDER, FRAGRANCES, NAMELY, PERFUME, COLOGNE, AND AFTER-SHAVE LOTION AND GEL, NON-MEDICATED SKIN CARE PREPARATIONS, NAMELY, SOAP, SCRUBS, TONER, CONDITIONER, EXFOLIATORS, SKIN CLARIFIER, WRINKLE REMOVING SKIN CARE PREPARATIONS, AND MOISTURIZER, FACE AND BODY LOTION, CREAM, OIL, GEL AND SPRAY, SUN SCREEN PREPARATIONS, NAMELY, LOTION, CREAM, GEL, AND SPRAY, NON-MEDICATED FACE AND BODY SKIN LIGHTENER, HAIR CARE PREPARATIONS, NAMELY, SHAMPOO, CONDITIONER, RINSE, GEL, MOUSSE, SPRAY AND TONIC, BATH CARE PREPARATIONS, NAMELY, SOAP, SALTS, CRYSTALS, BEADS, GEL OIL, POWDER, AND BUBBLE BATH, SCENTED HEAD-TO-TOE BODY WASH, NAIL CARE PREPARATIONS, NAMELY, CUTICLE CREAM, CUTICLE REMOVING PREPARATIONS, NAIL ENAMEL, NAIL POLISH, NAIL POLISH REMOVER, NAIL POLISH BASE COAT, NAIL POLISH TOP COAT, AND NAIL STRENGTHENERS, PERSONAL DEODORANT, TOOTH WHITENING GELS, CREAMS, AND PASTES, NON-MEDICATED FOOT CARE PREPARATIONS, NAMELY, SCRUBS, LOTIONS, CREAMS, DEODORANT, AND EX-

CLASS 3—(Continued).

FOLIATORS, MEN'S TOILETRIES, NAMELY, COLOGNE, AFTER-SHAVE LOTION AND GEL, SKIN CLEANSER, SKIN SCRUBS, SKIN TONER, SKIN CREAM, SHAVING GEL, SHAVING CREAM, TOILET WATER, PERSONAL DEODORANT, SHAMPOO, BODY LOTION, BODY TALC AND SKIN MOISTURIZER, NON-MEDICATED BABY CARE PREPARATIONS, NAMELY, LOTIONS, CREAMS, OINTMENTS, SOAPS, POWDERS AND SHAMPOO, FACIAL AND BODY HAIR DEPILATORY WAXES, CREAMS, LOTIONS, BLEACHING AND COLORING PREPARATIONS (U.S. CLS. 1, 4, 6, 50, 51 AND 52).

BARBARA A. LOUGHRAN, EXAMINING ATTORNEY

SN 78-511,391. THE PROCTER & GAMBLE COMPANY, CINCINNATI, OH. FILED 11-4-2004.

SIMPLY FRESH

THE MARK CONSISTS OF STANDARD CHARACTERS WITHOUT CLAIM TO ANY PARTICULAR FONT, STYLE, SIZE, OR COLOR.

OWNER OF U.S. REG. NO. 2,528,658.

FOR LAUNDRY DETERGENT AND FABRIC SOFTENER (U.S. CLS. 1, 4, 6, 50, 51 AND 52).

BRIAN PINO, EXAMINING ATTORNEY

SN 78-511,392. PHILOSOPHY, INC., PHOENIX, AZ. FILED 11-4-2004.

WASH FOR THE CURE

THE MARK CONSISTS OF STANDARD CHARACTERS WITHOUT CLAIM TO ANY PARTICULAR FONT, STYLE, SIZE, OR COLOR.

NO CLAIM IS MADE TO THE EXCLUSIVE RIGHT TO USE "WASH", APART FROM THE MARK AS SHOWN.

FOR COSMETICS, NAMELY, LIPSTICK, LIP GLOSS, LIP LINER, LIP BALM, BLUSH, FOUNDATION, EYE SHADOW, EYE LINER, MASCARA, CONCEALER, COSMETIC PENCILS, AND FACIAL POWDER; FRAGRANCES, NAMELY, PERFUME, COLOGNE, AND AFTER-SHAVE LOTION AND GEL; NON-MEDICATED SKIN CARE PREPARATIONS, NAMELY, SOAP, SCRUBS, TONER, CONDITIONER, EXFOLIANTS, SKIN CLARIFIER, WRINKLE REMOVING SKIN CARE PREPARATIONS, AND MOISTURIZER; FACE AND BODY LOTION, CREAM, OIL, GEL AND SPRAY; SUN SCREEN PREPARATIONS, NAMELY, LOTION, CREAM, GEL AND SPRAY; NON-MEDICATED FACE AND BODY SKIN LIGHTENER; HAIR CARE PREPARATIONS, NAMELY, SHAMPOO, CONDITIONER, RINSE, GEL, MOUSSE, SPRAY AND TONIC; BATH CARE PREPARATIONS, NAMELY, SOAP, SALTS, CRYSTALS, BEADS, GEL, OIL, POWDER, AND BUBBLE BATH; SCENTED HEAD-TO-TOE BODY WASH; NAIL CARE PREPARATIONS, NAMELY, CUTICLE CREAM, CUTICLE REMOVING PREPARATIONS, NAIL ENAMEL, NAIL

CLASS 3—(Continued).

POLISH, NAIL POLISH REMOVER, NAIL POLISH BASE COAT, NAIL POLISH TOP COAT, AND NAIL STRENGTHENERS; PERSONAL DEODORANT; TOOTH WHITENING GELS, CREAMS, AND PASTES; NON-MEDICATED FOOT CARE PREPARATIONS, NAMELY SCRUBS, LOTIONS, CREAMS, DEODORANT, AND EXFOLIANTS; MEN'S TOILETRIES, NAMELY COLOGNE, AFTER-SHAVE LOTION AND GEL, SKIN CLEANSER, SKIN SCRUBS, SKIN TONER, SKIN CREAM, SHAVING GEL, SHAVING CREAM, TOILET WATER, PERSONAL DEODORANT, SHAMPOO, BODY LOTION, BODY TALC, AND SKIN MOISTURIZER; NON-MEDICATED BABY CARE PREPARATIONS, NAMELY, LOTIONS, CREAMS, OINTMENTS, SOAPS, POWDERS, AND SHAMPOO; FACIAL AND BODY HAIR DEPILATORY WAXES, CREAMS, LOTIONS, BLEACHING AND COLORING PREPARATIONS; MAKE-UP KITS AND GIFT SETS COMPRISED OF ONE OR MORE OF LIPSTICK, LIP GLOSS, LIP LINER, LIP BALM, BLUSH, FOUNDATION, EYE SHADOW, EYE LINER, MASCARA, CONCEALER, COSMETIC PENCILS, AND FACIAL POWDER, FRAGRANCES, NAMELY, PERFUME, COLOGNE, AND AFTER-SHAVE LOTION AND GEL, NON-MEDICATED SKIN CARE PREPARATIONS, NAMELY, SOAP, SCRUBS, TONER, CONDITIONER, EXFOLIATORS, SKIN CLARIFIER, WRINKLE REMOVING SKIN CARE PREPARATIONS, AND MOISTURIZER, FACE AND BODY LOTION, CREAM, OIL, GEL AND SPRAY, SUN SCREEN PREPARATIONS, NAMELY, LOTION, CREAM, GEL, AND SPRAY, NON-MEDICATED FACE AND BODY SKIN LIGHTENER, HAIR CARE PREPARATIONS, NAMELY, SHAMPOO, CONDITIONER, RINSE, GEL MOUSSE, SPRAY AND TONIC, BATH CARE PREPARATIONS, NAMELY, SOAP, SALTS, CRYSTALS, BEADS, GEL OIL, POWDER, AND BUBBLE BATH, SCENTED HEAD-TO-TOE BODY WASH, NAIL CARE PREPARATIONS, NAMELY, CUTICLE CREAM, CUTICLE REMOVING PREPARATIONS, NAIL ENAMEL, NAIL POLISH, NAIL POLISH REMOVER, NAIL POLISH BASE COAT, NAIL POLISH TOP COAT, AND NAIL STRENGTHENERS, PERSONAL DEODORANT, TOOTH WHITENING GELS, CREAMS, AND PASTES, NON-MEDICATED FOOT CARE PREPARATIONS, NAMELY, SCRUBS, LOTIONS, CREAMS, DEODORANT, AND EXFOLIATORS, MEN'S TOILETRIES, NAMELY, COLOGNE, AFTER-SHAVE LOTION AND GEL, SKIN CLEANSER, SKIN SCRUBS, SKIN TONER, SKIN CREAM, SHAVING GEL, SHAVING CREAM, TOILET WATER, PERSONAL DEODORANT, SHAMPOO, BODY LOTION, BODY TALC AND SKIN MOISTURIZER, NON-MEDICATED BABY CARE PREPARATIONS, NAMELY, LOTIONS, CREAMS, OINTMENTS, SOAPS, POWDERS AND SHAMPOO, FACIAL AND BODY HAIR DEPILATORY WAXES, CREAMS, LOTIONS, BLEACHING AND COLORING PREPARATIONS (U.S. CLS. 1, 4, 6, 50, 51 AND 52).

BARBARA A. LOUGHRAN, EXAMINING ATTORNEY

CLASS 3—(Continued).

SN 78-511,397. PHILOSOPHY, INC., PHOENIX, AZ. FILED 11-4-2004.

BLUSH FOR THE CURE

THE MARK CONSISTS OF STANDARD CHARACTERS WITHOUT CLAIM TO ANY PARTICULAR FONT, STYLE, SIZE, OR COLOR.

NO CLAIM IS MADE TO THE EXCLUSIVE RIGHT TO USE "BLUSH", APART FROM THE MARK AS SHOWN.

FOR COSMETICS, NAMELY, LIPSTICK, LIP GLOSS, LIP LINER, LIP BALM, BLUSH, FOUNDATION, EYE SHADOW, EYE LINER, MASCARA, CONCEALER, COSMETIC PENCILS, AND FACIAL POWDER; FRAGRANCES, NAMELY, PERFUME, COLOGNE, AND AFTER-SHAVE LOTION AND GEL; NON-MEDICATED SKIN CARE PREPARATIONS, NAMELY, SOAP, SCRUBS, TONER, CONDITIONER, EXFOLIANTS, SKIN CLARIFIER, WRINKLE REMOVING SKIN CARE PREPARATIONS, AND MOISTURIZER; FACE AND BODY LOTION, CREAM, OIL, GEL AND SPRAY; SUN SCREEN PREPARATIONS, NAMELY, LOTION, CREAM, GEL AND SPRAY; NON-MEDICATED FACE AND BODY SKIN LIGHTENER; HAIR CARE PREPARATIONS, NAMELY, SHAMPOO, CONDITIONER, RINSE, GEL, MOUSSE, SPRAY AND TONIC; BATH CARE PREPARATIONS, NAMELY, SOAP, SALTS, CRYSTALS, BEADS, GEL, OIL, POWDER, AND BUBBLE BATH; SCENTED HEAD-TO-TOE BODY WASH; NAIL CARE PREPARATIONS, NAMELY, CUTICLE CREAM, CUTICLE REMOVING PREPARATIONS, NAIL ENAMEL, NAIL POLISH, NAIL POLISH REMOVER, NAIL POLISH BASE COAT, NAIL POLISH TOP COAT, AND NAIL STRENGTHENERS; PERSONAL DEODORANT; TOOTH WHITENING GELS, CREAMS, AND PASTES; NON-MEDICATED FOOT CARE PREPARATIONS, NAMELY SCRUBS, LOTIONS, CREAMS, DEODORANT, AND EXFOLIANTS; MEN'S TOILETRIES, NAMELY COLOGNE, AFTER-SHAVE LOTION AND GEL, SKIN CLEANSER, SKIN SCRUBS, SKIN TONER, SKIN CREAM, SHAVING GEL, SHAVING CREAM, TOILET WATER, PERSONAL DEODORANT, SHAMPOO, BODY LOTION, BODY TALC, AND SKIN MOISTURIZER; NON-MEDICATED BABY CARE PREPARATIONS, NAMELY, LOTIONS, CREAMS, OINTMENTS, SOAPS, POWDERS, AND SHAMPOO; FACIAL AND BODY HAIR DEPILATORY WAXES, CREAMS, LOTIONS, BLEACHING AND COLORING PREPARATIONS; MAKE-UP KITS AND GIFT SETS COMPRISED OF ONE OR MORE OF LIPSTICK, LIP GLOSS, LIP LINER, LIP BALM, BLUSH, FOUNDATION, EYE SHADOW, EYE LINER, MASCARA, CONCEALER, COSMETIC PENCILS, AND FACIAL POWDER, FRAGRANCES, NAMELY, PERFUME, COLOGNE, AND AFTER-SHAVE LOTION AND GEL, NON-MEDICATED SKIN CARE PREPARATIONS, NAMELY, SOAP, SCRUBS, TONER, CONDITIONER, EXFOLIATORS, SKIN CLARIFIER, WRINKLE REMOVING SKIN CARE PREPARATIONS, AND MOISTURIZER, FACE AND BODY LOTION, CREAM, OIL, GEL AND SPRAY, SUN SCREEN PREPARATIONS, NAMELY, LOTION, CREAM, GEL, AND SPRAY, NON-MEDICATED FACE AND BODY SKIN LIGHTENER, HAIR CARE PREPARATIONS, NAMELY, SHAMPOO, CONDITIONER, RINSE, GEL MOUSSE, SPRAY AND TONIC, BATH CARE PREPARATIONS, NAMELY, SOAP, SALTS, CRYSTALS, BEADS, GEL OIL, POWDER, AND BUBBLE BATH, SCENTED HEAD-TO-TOE BODY WASH, NAIL CARE PREPARATIONS, NAMELY, CUTICLE CREAM, CUTICLE REMOVING PREPARATIONS, NAIL ENAMEL, NAIL POLISH, NAIL POLISH REMOVER, NAIL POLISH BASE COAT, NAIL POLISH TOP COAT, AND NAIL STRENGTHENERS, PERSONAL DEODORANT, TOOTH WHITENING GELS, CREAMS, AND PASTES, NON-MEDICATED FOOT CARE PREPARATIONS, NAMELY, SCRUBS, LOTIONS, CREAMS, DEODORANT, AND EX-

CLASS 3—(Continued).

FOLIATORS, MEN'S TOILETRIES, NAMELY, COLOGNE, AFTER-SHAVE LOTION AND GEL, SKIN CLEANSER, SKIN SCRUBS, SKIN TONER, SKIN CREAM, SHAVING GEL, SHAVING CREAM, TOILET WATER, PERSONAL DEODORANT, SHAMPOO, BODY LOTION, BODY TALC AND SKIN MOISTURIZER, NON-MEDICATED BABY CARE PREPARATIONS, NAMELY, LOTIONS, CREAMS, OINTMENTS, SOAPS, POWDERS AND SHAMPOO, FACIAL AND BODY HAIR DEPILATORY WAXES, CREAMS, LOTIONS, BLEACHING AND COLORING PREPARATIONS (U.S. CLS. 1, 4, 6, 50, 51 AND 52).

BARBARA A. LOUGHRAN, EXAMINING ATTORNEY

SN 78-511,403. PHILOSOPHY, INC., PHOENIX, AZ. FILED 11-4-2004.

GLOSS FOR THE CURE

THE MARK CONSISTS OF STANDARD CHARACTERS WITHOUT CLAIM TO ANY PARTICULAR FONT, STYLE, SIZE, OR COLOR.

NO CLAIM IS MADE TO THE EXCLUSIVE RIGHT TO USE "GLOSS", APART FROM THE MARK AS SHOWN.

FOR COSMETICS, NAMELY, LIPSTICK, LIP GLOSS, LIP LINER, LIP BALM, BLUSH, FOUNDATION, EYE SHADOW, EYE LINER, MASCARA, CONCEALER, COSMETIC PENCILS, AND FACIAL POWDER; FRAGRANCES, NAMELY, PERFUME, COLOGNE, AND AFTER-SHAVE LOTION AND GEL; NON-MEDICATED SKIN CARE PREPARATIONS, NAMELY, SOAP, SCRUBS, TONER, CONDITIONER, EXFOLIANTS, SKIN CLARIFIER, WRINKLE REMOVING SKIN CARE PREPARATIONS, AND MOISTURIZER; FACE AND BODY LOTION, CREAM, OIL, GEL AND SPRAY; SUN SCREEN PREPARATIONS, NAMELY, LOTION, CREAM, GEL AND SPRAY; NON-MEDICATED FACE AND BODY SKIN LIGHTENER; HAIR CARE PREPARATIONS, NAMELY, SHAMPOO, CONDITIONER, RINSE, GEL, MOUSSE, SPRAY AND TONIC; BATH CARE PREPARATIONS, NAMELY, SOAP, SALTS, CRYSTALS, BEADS, GEL, OIL, POWDER, AND BUBBLE BATH; SCENTED HEAD-TO-TOE BODY WASH; NAIL CARE PREPARATIONS, NAMELY, CUTICLE CREAM, CUTICLE REMOVING PREPARATIONS, NAIL ENAMEL, NAIL POLISH, NAIL POLISH REMOVER, NAIL POLISH BASE COAT, NAIL POLISH TOP COAT, AND NAIL STRENGTHENERS; PERSONAL DEODORANT; TOOTH WHITENING GELS, CREAMS, AND PASTES; NON-MEDICATED FOOT CARE PREPARATIONS, NAMELY, SCRUBS, LOTIONS, CREAMS, DEODORANT, AND EXFOLIANTS; MEN'S TOILETRIES, NAMELY COLOGNE, AFTER-SHAVE LOTION AND GEL, SKIN CLEANSER, SKIN SCRUBS, SKIN TONER, SKIN CREAM, SHAVING GEL, SHAVING CREAM, TOILET WATER, PERSONAL DEODORANT, SHAMPOO, BODY LOTION, BODY TALC, AND SKIN MOISTURIZER; NON-MEDICATED BABY CARE PREPARATIONS, NAMELY, LOTIONS, CREAMS, OINTMENTS, SOAPS, POWDERS, AND SHAMPOO; FACIAL AND BODY HAIR DEPILATORY WAXES, CREAMS, LOTIONS, BLEACHING AND COLORING PREPARATIONS; MAKE-UP KITS AND GIFT SETS COMPRISED OF ONE OR MORE OF LIPSTICK, LIP GLOSS, LIP LINER, LIP BALM, BLUSH, FOUNDATION, EYE SHADOW, EYE LINER, MASCARA, CONCEALER, COSMETIC PENCILS, AND FACIAL POWDER, FRAGRANCES, NAMELY, PERFUME, COLOGNE, AND AFTER-SHAVE LOTION AND GEL, NON-MEDICATED SKIN CARE PREPARATIONS, NAMELY, SOAP, SCRUBS, TONER, CONDITIONER, EXFOLIATORS, SKIN CLARIFIER, WRINKLE REMOVING SKIN CARE PREPARATIONS, AND MOISTURIZER, FACE AND BODY LOTION, CREAM, OIL, GEL AND SPRAY, SUN SCREEN PREPARATIONS, NAMELY, LOTION, CREAM,

CLASS 3—(Continued).

GEL, AND SPRAY, NON-MEDICATED FACE AND BODY SKIN LIGHTENER, HAIR CARE PREPARATIONS, NAMELY, SHAMPOO, CONDITIONER, RINSE, GEL MOUSSE, SPRAY AND TONIC, BATH CARE PREPARATIONS, NAMELY, SOAP, SALTS, CRYSTALS, BEADS, GEL OIL, POWDER, AND BUBBLE BATH, SCENTED HEAD-TO-TOE BODY WASH, NAIL CARE PREPARATIONS, NAMELY, CUTICLE CREAM, CUTICLE REMOVING PREPARATIONS, NAIL ENAMEL, NAIL POLISH, NAIL POLISH REMOVER, NAIL POLISH BASE COAT, NAIL POLISH TOP COAT, AND NAIL STRENGTHENERS, PERSONAL DEODORANT, TOOTH WHITENING GELS, CREAMS, AND PASTES, NON-MEDICATED FOOT CARE PREPARATIONS, NAMELY, SCRUBS, LOTIONS, CREAMS, DEODORANT, AND EXFOLIATORS, MEN'S TOILETRIES, NAMELY, COLOGNE, AFTER-SHAVE LOTION AND GEL, SKIN CLEANSER, SKIN SCRUBS, SKIN TONER, SKIN CREAM, SHAVING GEL, SHAVING CREAM, TOILET WATER, PERSONAL DEODORANT, SHAMPOO, BODY LOTION, BODY TALC AND SKIN MOISTURIZER, NON-MEDICATED BABY CARE PREPARATIONS, NAMELY, LOTIONS, CREAMS, OINTMENTS, SOAPS, POWDERS AND SHAMPOO, FACIAL AND BODY HAIR DEPILATORY WAXES, CREAMS, LOTIONS, BLEACHING AND COLORING PREPARATIONS (U.S. CLS. 1, 4, 6, 50, 51 AND 52).

BARBARA A. LOUGHRAN, EXAMINING ATTORNEY

SN 78-515,070. THE PROCTER & GAMBLE COMPANY, CINCINNATI, OH. FILED 11-11-2004.

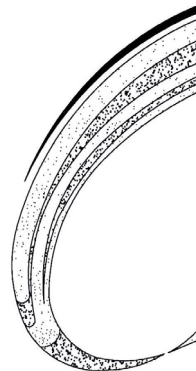

THE STIPPLING IS FOR SHADING PURPOSES ONLY. THE MARK CONSISTS OF A PARTIAL C CURVE THAT IS WIDER AT THE TOP COMING TO A POINT AT THE BOTTOM OF THE CURVE.

FOR HAIR CARE PREPARATIONS (U.S. CLS. 1, 4, 6, 50, 51 AND 52).

ELLEN PERKINS, EXAMINING ATTORNEY

CLASS 3—(Continued).

SN 78-516,193. ESTEE LAUDER INC., NEW YORK, NY. FILED 11-12-2004.

GRAPHIC COLOR

THE MARK CONSISTS OF STANDARD CHARACTERS WITHOUT CLAIM TO ANY PARTICULAR FONT, STYLE, SIZE, OR COLOR.

NO CLAIM IS MADE TO THE EXCLUSIVE RIGHT TO USE "COLOR". APART FROM THE MARK AS SHOWN. FOR COSMETICS (U.S. CLS. 1, 4, 6, 50, 51 AND 52).
DEBRA LEE, EXAMINING ATTORNEY

SN 78-516,326. ORANGE GLO INTERNATIONAL, INC., GREENWOOD VILLAGE, CO. FILED 11-12-2004.

OXI CLEAN

THE MARK CONSISTS OF STANDARD CHARACTERS WITHOUT CLAIM TO ANY PARTICULAR FONT, STYLE, SIZE, OR COLOR.

OWNER OF U.S. REG. NO. 2,430,077.
NO CLAIM IS MADE TO THE EXCLUSIVE RIGHT TO USE "CLEAN", APART FROM THE MARK AS SHOWN. FOR HOUSEHOLD CLEANING PRODUCTS, NAMELY DISHWASHING DETERGENT, LAUNDRY DETERGENT, AND DISPOSABLE WIPES IMPREGNATED WITH CHEMICALS OR COMPOUNDS FOR HOUSEHOLD USE (U.S. CLS. 1, 4, 6, 50, 51 AND 52).
FIRST USE 8-0-1999; IN COMMERCE 8-0-1999.
AMY HELLA, EXAMINING ATTORNEY

SN 78-517,939. ILACQUA, GLEN, SCITUATE, MA. FILED 11-16-2004.



NO CLAIM IS MADE TO THE EXCLUSIVE RIGHT TO USE "BOSTON SOAPWORKS", APART FROM THE MARK AS SHOWN.

FOR PREPARATIONS FOR CLEANING, PROTECTING AND PRESERVING VEHICLE SURFACES (U.S. CLS. 1, 4, 6, 50, 51 AND 52).

MITCHELL FRONT, EXAMINING ATTORNEY

CLASS 3—(Continued).

SN 78-518,539. AB LABS INC, BROOKLYN, NY. FILED 11-17-2004.

TRIM STRIPS

THE MARK CONSISTS OF STANDARD CHARACTERS WITHOUT CLAIM TO ANY PARTICULAR FONT, STYLE, SIZE, OR COLOR.

NO CLAIM IS MADE TO THE EXCLUSIVE RIGHT TO USE "STRIPS", APART FROM THE MARK AS SHOWN. FOR NON-MEDICATED, OVER-THE-COUNTER, BREATH-FRESHENING STRIPS CONTAINING CAFFEINE AND CHROMIUM (U.S. CLS. 1, 4, 6, 50, 51 AND 52).

ALINA MORRIS, EXAMINING ATTORNEY

SN 78-518,607. FRESH INC, BOSTON, MA. FILED 11-17-2004.

SUGAR

THE MARK CONSISTS OF STANDARD CHARACTERS WITHOUT CLAIM TO ANY PARTICULAR FONT, STYLE, SIZE, OR COLOR.

OWNER OF U.S. REG. NOS. 2,234,297 AND 2,537,616. FOR FRAGRANCES FOR PERSONAL USE, EAU DE PARFUM AND EAU DE TOILETTE (U.S. CLS. 1, 4, 6, 50, 51 AND 52).

FIRST USE 1-14-1998; IN COMMERCE 1-14-1998.

MARK T. MULLEN, EXAMINING ATTORNEY

CLASS 3—(Continued).

SN 78-518,693. BONNE BELL, INC., LAKEWOOD, OH. FILED 11-17-2004.

CLASS 3—(Continued).

SN 78-524,391. SARBEZ, LLC, SARASOTA, FL. FILED 11-30-2004.

EYE POD

SARBEZ

THE MARK CONSISTS OF STANDARD CHARACTERS WITHOUT CLAIM TO ANY PARTICULAR FONT, STYLE, SIZE, OR COLOR.

NO CLAIM IS MADE TO THE EXCLUSIVE RIGHT TO USE "EYE", APART FROM THE MARK AS SHOWN.

FOR EYE COSMETICS, NAMELY MASCARA, EYE-SHADOW, EYE LINER AND EYEBROW PENCIL (U.S. CLS. 1, 4, 6, 50, 51 AND 52).

LINDA M. KING, EXAMINING ATTORNEY

THE MARK CONSISTS OF STANDARD CHARACTERS WITHOUT CLAIM TO ANY PARTICULAR FONT, STYLE, SIZE, OR COLOR.

FOR PERFUME (U.S. CLS. 1, 4, 6, 50, 51 AND 52).

ZHALEH DELANEY, EXAMINING ATTORNEY

SN 78-525,219. WORLD MARKETING GROUP, INC., NEW YORK, NY. FILED 12-1-2004.

SN 78-520,791. CHASE PRODUCTS COMPANY, BROADVIEW, IL. FILED 11-22-2004.

Men's Formula 1000

I'M TOO SEXY FOR THE SUN

THE MARK CONSISTS OF STANDARD CHARACTERS WITHOUT CLAIM TO ANY PARTICULAR FONT, STYLE, SIZE, OR COLOR.

FOR SUNLESS TANNING SPRAYS (U.S. CLS. 1, 4, 6, 50, 51 AND 52).

FIRST USE 4-30-2004; IN COMMERCE 11-12-2004.

GEORGE LORENZO, EXAMINING ATTORNEY

THE MARK CONSISTS OF STANDARD CHARACTERS WITHOUT CLAIM TO ANY PARTICULAR FONT, STYLE, SIZE, OR COLOR.

NO CLAIM IS MADE TO THE EXCLUSIVE RIGHT TO USE MEN'S FORMULA, APART FROM THE MARK AS SHOWN.

FOR SCENTED BODY OIL (U.S. CLS. 1, 4, 6, 50, 51 AND 52).

FIRST USE 8-16-2004; IN COMMERCE 8-16-2004.

KAREN K. BUSH, EXAMINING ATTORNEY

CLASS 3—(Continued).

SN 78-525,740. MAKE-UP ART COSMETICS INC., NEW YORK, NY. FILED 12-2-2004.

CLASS 3—(Continued).

SN 78-526,127. ORANGE-MATE, INC., WALDPOR, OR. FILED 12-2-2004.

TURQUATIC

TREAT & FRESH

THE MARK CONSISTS OF STANDARD CHARACTERS WITHOUT CLAIM TO ANY PARTICULAR FONT, STYLE, SIZE, OR COLOR.

FOR PERFUMES, FRAGRANCES FOR PERSONAL USE AND COLOGNES (U.S. CLS. 1, 4, 6, 50, 51 AND 52).
MATTHEW KLINE, EXAMINING ATTORNEY

THE MARK CONSISTS OF STANDARD CHARACTERS WITHOUT CLAIM TO ANY PARTICULAR FONT, STYLE, SIZE, OR COLOR.

FOR FABRIC CLEANSER WITH ODOR REMOVER; LAUNDRY PRODUCTS, NAMELY, LAUNDRY DETERGENT, LAUNDRY PRESPOTTER, STAIN REMOVER, AND SPOT REMOVER (U.S. CLS. 1, 4, 6, 50, 51 AND 52).
ALICIA COLLINS, EXAMINING ATTORNEY

SN 78-526,075. JAFER LIMITED, HAMILTON HM12, BERMUDA, FILED 12-2-2004.

SN 78-526,132. AVON PRODUCTS, INC., NEW YORK, NY. FILED 12-2-2004.

UNIQUECIL

REAL HERO

THE MARK CONSISTS OF STANDARD CHARACTERS WITHOUT CLAIM TO ANY PARTICULAR FONT, STYLE, SIZE, OR COLOR.

OWNER OF U.S. REG. NO. 2,950,055.
FOR MAKEUP, EYELINER PENCIL, EYE SHADOWS WITH APPLICATOR, MASCARA, EYE LINERS, EYE PENCILS, EYELASH PENCILS (U.S. CLS. 1, 4, 6, 50, 51 AND 52).

FIRST USE 10-12-1993; IN COMMERCE 8-31-2004.
GEORGE LORENZO, EXAMINING ATTORNEY

THE MARK CONSISTS OF STANDARD CHARACTERS WITHOUT CLAIM TO ANY PARTICULAR FONT, STYLE, SIZE, OR COLOR.

FOR FRAGRANCE AND TOILETRY PRODUCTS, NAMELY, EAU DE TOILETTE, HAIR AND BODY WASH, AFTER SHAVE CONDITIONER, AND PERSONAL DEODORANT (U.S. CLS. 1, 4, 6, 50, 51 AND 52).

ALICIA COLLINS, EXAMINING ATTORNEY

CLASS 3—(Continued).

SN 78-527,410. INTIMATE BEAUTY CORPORATION, DBA VICTORIA'S SECRET BEAUTY, NEW YORK, NY. FILED 12-6-2004.

PEAR GLACÉ

THE MARK CONSISTS OF STANDARD CHARACTERS WITHOUT CLAIM TO ANY PARTICULAR FONT, STYLE, SIZE, OR COLOR.

NO CLAIM IS MADE TO THE EXCLUSIVE RIGHT TO USE "PEAR", APART FROM THE MARK AS SHOWN.

FOR PERSONAL CARE PRODUCTS, NAMELY, BODY SCRUB, BUBBLE BATH, COLOGNE, CREAM FOR THE BODY, CREAM FOR THE HANDS, EXFOLIATORS FOR THE SKIN, FACE SCRUB, FRAGRANT BODY SPLASH, FRAGRANT BODY MIST, HAIR CONDITIONER, HAIR SHAMPOO, HAIR SPRAY, HAIR STYLING GEL, HAIR STYLING MOUSSE, LOTION FOR THE BODY, PERFUME, POWDER FOR THE BODY, SHOWER GEL, SOAP FOR THE BODY, SOAP FOR THE FACE AND SOAP FOR THE HANDS (U.S. CLS. 1, 4, 6, 50, 51 AND 52).

FIRST USE 9-30-1993; IN COMMERCE 9-30-1993.
WENDY GOODMAN, EXAMINING ATTORNEY

SN 78-533,388. MOLECULAR RESEARCH CENTER, INC., CINCINNATI, OH. FILED 12-16-2004.

NOREDOL

THE MARK CONSISTS OF STANDARD CHARACTERS WITHOUT CLAIM TO ANY PARTICULAR FONT, STYLE, SIZE, OR COLOR.

FOR NON-MEDICATED SKIN CREAMS AND LOTIONS (U.S. CLS. 1, 4, 6, 50, 51 AND 52).

FIRST USE 5-26-2005; IN COMMERCE 5-26-2005.
STEVEN R. FINE, EXAMINING ATTORNEY

CLASS 3—(Continued).

SN 78-534,342. VITAQUEST INTERNATIONAL, INC., WEST CALDWELL, NJ. FILED 12-17-2004.

Youth Factors

THE MARK CONSISTS OF STANDARD CHARACTERS WITHOUT CLAIM TO ANY PARTICULAR FONT, STYLE, SIZE, OR COLOR.

FOR SKIN CREAMS AND SKIN LOTIONS (U.S. CLS. 1, 4, 6, 50, 51 AND 52).

JENNIFER WILLISTON, EXAMINING ATTORNEY

SN 78-536,018. SPURRIER CHEMICAL COMPANIES, INC., WICHITA, KS. FILED 12-21-2004.

ENZYO-BRITE

THE MARK CONSISTS OF STANDARD CHARACTERS WITHOUT CLAIM TO ANY PARTICULAR FONT, STYLE, SIZE, OR COLOR.

FOR INSTITUTIONAL AND INDUSTRIAL LAUNDRY DETERGENT (U.S. CLS. 1, 4, 6, 50, 51 AND 52).

FIRST USE 10-0-1998; IN COMMERCE 10-0-1998.

GIANCARLO CASTRO, EXAMINING ATTORNEY

SN 78-536,569. JESSICA COSMETICS INTERNATIONAL, INC., NORTH HOLLYWOOD, CA. FILED 12-21-2004.

UNBREAKABLE

THE MARK CONSISTS OF STANDARD CHARACTERS WITHOUT CLAIM TO ANY PARTICULAR FONT, STYLE, SIZE, OR COLOR.

FOR NAIL CARE PRODUCTS, NAMELY, NAIL HARDENERS AND NAIL STRENGTHENERS (U.S. CLS. 1, 4, 6, 50, 51 AND 52).

FIRST USE 9-15-2004; IN COMMERCE 9-15-2004.

DOUGLAS LEE, EXAMINING ATTORNEY

CLASS 3—(Continued).

SN 78-537,778. NEDBOY, ROBIN L, NEW YORK, NY. FILED 12-23-2004.

CLASS 3—(Continued).

SN 78-537,788. TURTLE WAX, INC., CHICAGO, IL. FILED 12-23-2004.

TURTLE WAX

IL LABORATORIO DI BELLEZZA

THE MARK CONSISTS OF STANDARD CHARACTERS WITHOUT CLAIM TO ANY PARTICULAR FONT, STYLE, SIZE, OR COLOR.
NO CLAIM IS MADE TO THE EXCLUSIVE RIGHT TO USE WAX, APART FROM THE MARK AS SHOWN.
FOR SHOE POLISH AND SHOE CLEANING PREPARATIONS (U.S. CLS. 1, 4, 6, 50, 51 AND 52).
ZHALEH DELANEY, EXAMINING ATTORNEY

THE MARK CONSISTS OF STANDARD CHARACTERS WITHOUT CLAIM TO ANY PARTICULAR FONT, STYLE, SIZE, OR COLOR.

NO CLAIM IS MADE TO THE EXCLUSIVE RIGHT TO USE BEAUTY, APART FROM THE MARK AS SHOWN.
THE ENGLISH TRANSLATION OF IL LABORATORIO DI BELLEZZA IS THE LABORATORY OF BEAUTY.

FOR NON-MEDICATED SKIN CARE PREPARATIONS, NAMELY, ANTI-AGING CREAM, ANTI-WRINKLE CREAM, ASTRINGENT FOR COSMETIC PURPOSES, BODY CREAM, BODY EMULSION, BODY LOTION, BODY MILK, BODY OIL, BODY SCRUB, BODY SPRAY, EXFOLIANTS FOR SKIN, EYE CREAM, EYE GEL, FACIAL CLEANSER, FACIAL CREAM, FACIAL EMULSIONS, FACIAL MASKS, FACIAL SCRUB, HAND CREAM, HAND LOTION, HAND SOAP, MOISTURIZING MILKS, NON-MEDICATED BODY SOAK, NON-MEDICATED FOOT CREAM, SHOWER GEL, SKIN CLARIFIERS, SKIN CLEANSERS, SKIN CLEANSING CREAM, SKIN CLEANSING LOTION, SKIN CONDITIONERS, SKIN CREAM, SKIN EMOLLIENTS, SKIN LOTION, SKIN MASKS, SKIN MOISTURIZER, SKIN SOAP, SKIN TONER, SOAP FOR COSMETIC PURPOSES; SHAVING PREPARATIONS, NAMELY, SHAVING BALM, SHAVING CREAM, SHAVING FOAM, SHAVING GEL, SHAVING LOTION, SHAVING SOAP, AFTER-SHAVE GEL, AFTER-SHAVE LOTION; BATH ADDITIVES, NAMELY, BATH BEADS, BATH CRYSTALS, BATH FOAMS, BATH GELS, BATH MILK, BATH OILS, BATH PEARLS, BUBBLE BATH, NON-MEDICATED BATH SALTS; FRAGRANCES, NAMELY, ESSENTIAL OILS FOR PERSONAL USE, POTPOURRI, SCENTED LINEN SPRAYS, SCENTED ROOM SPRAYS, PERFUME, EAU DE TOILETTE; NON-MEDICATED HAIR CARE PREPARATIONS, NAMELY, HAIR CONDITIONERS, HAIR DRESSINGS FOR MEN, HAIR EMOLLIENTS, HAIR GEL, HAIR MOUSSE, HAIR POMADES, HAIR RINSES, HAIR SHAMPOO, HAIR SPRAY, HAIR STYLING PREPARATIONS; HOUSEHOLD CLEANING PREPARATIONS, NAMELY, DISH DETERGENTS, LAUNDRY DETERGENTS, GLASS CLEANING PREPARATIONS, CLEANER FOR USE ON COUNTERTOPS (U.S. CLS. 1, 4, 6, 50, 51 AND 52).

FIRST USE 2-1-2002; IN COMMERCE 2-1-2002.
MICHELE SWAIN, EXAMINING ATTORNEY

SN 78-537,870. TURTLE WAX, INC., CHICAGO, IL. FILED 12-23-2004.

LIQUID CRYSTAL

THE MARK CONSISTS OF STANDARD CHARACTERS WITHOUT CLAIM TO ANY PARTICULAR FONT, STYLE, SIZE, OR COLOR.

OWNER OF U.S. REG. NOS. 1,311,884, 1,667,122 AND 1,676,297.

NO CLAIM IS MADE TO THE EXCLUSIVE RIGHT TO USE LIQUID, APART FROM THE MARK AS SHOWN.

FOR PREPARATIONS FOR CLEANING, WASHING, WAXING, POLISHING, PROTECTING AND RESTORING SURFACES OF VEHICLES (U.S. CLS. 1, 4, 6, 50, 51 AND 52).

AMY GEARIN, EXAMINING ATTORNEY

CLASS 3—(Continued).

SN 78-537,881. CLIENLE, INC, SUNRISE, FL. FILED 12-23-2004.

CLASS 3—(Continued).

SN 78-538,165. SYSCO CORPORATION, HOUSTON, TX. FILED 12-23-2004.

InvisiPore

SOFTOUCH

THE MARK CONSISTS OF STANDARD CHARACTERS WITHOUT CLAIM TO ANY PARTICULAR FONT, STYLE, SIZE, OR COLOR.

FOR NON-MEDICATED COSMETICS, NAMELY, SKIN CARE MOISTURIZERS, ANTI-WRINKLE CREAMS, ANTIOXIDANT SKIN LOTIONS, SUNSCREENS, LIP CREAM, NIGHT SKIN CREAMS, HAND AND BODY LOTIONS (U.S. CLS. 1, 4, 6, 50, 51 AND 52).

FIRST USE 7-0-2004; IN COMMERCE 7-0-2004.
JOHN WILKE, EXAMINING ATTORNEY

THE MARK CONSISTS OF STANDARD CHARACTERS WITHOUT CLAIM TO ANY PARTICULAR FONT, STYLE, SIZE, OR COLOR.

OWNER OF U.S. REG. NOS. 1,855,187 AND 1,893,523. FOR PREMOISTENED ADULT AND BABY WIPES (U.S. CLS. 1, 4, 6, 50, 51 AND 52).

FIRST USE 12-22-1998; IN COMMERCE 12-22-1998.
JEFF DEFORD, EXAMINING ATTORNEY

SN 78-538,054. MALKA, ERIC, MIAMI, CA. FILED 12-23-2004.

SN 78-538,617. ESTEE LAUDER INC., NEW YORK, NY. FILED 12-27-2004.

ONE GREAT SHAVE

MAXIMUM COVER

THE MARK CONSISTS OF STANDARD CHARACTERS WITHOUT CLAIM TO ANY PARTICULAR FONT, STYLE, SIZE, OR COLOR.

FOR COSMETIC PREPARATIONS FOR MALE SKIN CARE (U.S. CLS. 1, 4, 6, 50, 51 AND 52).
FIRST USE 4-30-1999; IN COMMERCE 4-30-1999.
DANIEL CAPSHAW, EXAMINING ATTORNEY

THE MARK CONSISTS OF STANDARD CHARACTERS WITHOUT CLAIM TO ANY PARTICULAR FONT, STYLE, SIZE, OR COLOR.

FOR COSMETICS (U.S. CLS. 1, 4, 6, 50, 51 AND 52).
FIRST USE 4-15-1994; IN COMMERCE 4-15-1994.
BARBARA RUTLAND, EXAMINING ATTORNEY

CLASS 3—(Continued).

SN 78-539,032. CRC INDUSTRIES HOLDINGS, INC., WILMINGTON, DE. FILED 12-28-2004.

CLASS 3—(Continued).

SN 78-539,260. BATH BY BETTIJO, LLC, GLENDALE, AZ. FILED 12-28-2004.

PRECISION PLUS

THE MARK CONSISTS OF STANDARD CHARACTERS WITHOUT CLAIM TO ANY PARTICULAR FONT, STYLE, SIZE, OR COLOR.

FOR CLEANING PREPARATIONS FOR ELECTRICAL CONNECTORS AND EQUIPMENT (U.S. CLS. 1, 4, 6, 50, 51 AND 52).

FIRST USE 2-1-1996; IN COMMERCE 2-1-1996.
ALICE BENMAMAN, EXAMINING ATTORNEY

SN 78-539,033. CRC INDUSTRIES HOLDINGS, INC., WILMINGTON, DE. FILED 12-28-2004.

Bath By Bettijo

THE MARK CONSISTS OF STANDARD CHARACTERS WITHOUT CLAIM TO ANY PARTICULAR FONT, STYLE, SIZE, OR COLOR.

NO CLAIM IS MADE TO THE EXCLUSIVE RIGHT TO USE BATH, APART FROM THE MARK AS SHOWN.

FOR PERSONAL CARE PRODUCTS, NAMELY, SOAP FOR THE BODY, SOAP FOR THE FACE, SOAP FOR THE HANDS, BATH TEAS, BATH OIL, BATH SALTS, SHEA BUTTER HAND CREAMS, CREAM FOR THE BODY, CREAM FOR THE FACE, CREAM FOR THE HANDS, BODY SCRUB, SCRUBS FOR THE SKIN, EXFOLIATORS FOR THE SKIN, BODY OIL, ESSENTIAL OILS FOR PERSONAL USE, LOTION FOR THE BODY, LOTION FOR THE HANDS, LOTION FOR THE FACE, LIP BALM, LIP GLOSS, NON-MEDICATED CLEANSER FOR THE FACE, NON-MEDICATED MASSAGE OINTMENT, MASSAGE BALM, MASSAGE OIL, POWDER FOR THE BODY, SHAVING OIL, AFTERSHAVE, PUMICE STONES FOR PERSONAL USE, AND BABY PERSONAL CARE PRODUCTS NAMELY BABY SOAP, BABY OIL, MASSAGE OIL FOR BABIES, NON-MEDICATED DIAPER OINTMENT, NON-MEDICATED DIAPER CREAMS, BABY LOTION, BABY POWDER, NON-MEDICATED BABY BODY SOAKS (U.S. CLS. 1, 4, 6, 50, 51 AND 52).

FIRST USE 12-1-2002; IN COMMERCE 12-1-2002.
ALICE BENMAMAN, EXAMINING ATTORNEY

SN 78-539,929. GRAYSON O. COMPANY, KANNAPOLIS, NC. FILED 12-30-2004.

QD

THE MARK CONSISTS OF STANDARD CHARACTERS WITHOUT CLAIM TO ANY PARTICULAR FONT, STYLE, SIZE, OR COLOR.

FOR CLEANING PREPARATIONS FOR ELECTRICAL EQUIPMENT (U.S. CLS. 1, 4, 6, 50, 51 AND 52).
FIRST USE 12-1-1991; IN COMMERCE 12-1-1991.
ALICE BENMAMAN, EXAMINING ATTORNEY

TAC

THE MARK CONSISTS OF STANDARD CHARACTERS WITHOUT CLAIM TO ANY PARTICULAR FONT, STYLE, SIZE, OR COLOR.

FOR HAIR CARE PREPARATIONS, NAMELY, STYLING TAFFY (U.S. CLS. 1, 4, 6, 50, 51 AND 52).
FIRST USE 9-0-2000; IN COMMERCE 9-0-2000.
DORITT L. CARROLL, EXAMINING ATTORNEY

CLASS 3—(Continued).

SN 78-539,944. GRAYSON O. COMPANY, KANNAPOLIS, NC. FILED 12-30-2004.

ESCULPT

THE MARK CONSISTS OF STANDARD CHARACTERS WITHOUT CLAIM TO ANY PARTICULAR FONT, STYLE, SIZE, OR COLOR.

FOR HAIR CARE PREPARATIONS, NAMELY, HAIR GELS (U.S. CLS. 1, 4, 6, 50, 51 AND 52).

FIRST USE 9-29-1994; IN COMMERCE 9-29-1994.

DORITT L. CARROLL, EXAMINING ATTORNEY

CLASS 3—(Continued).

SN 78-550,227. PERFORMANCE BRANDS, INC., SUNRISE, FL. FILED 1-19-2005.

APPLE TINI

THE MARK CONSISTS OF STANDARD CHARACTERS WITHOUT CLAIM TO ANY PARTICULAR FONT, STYLE, SIZE, OR COLOR.

NO CLAIM IS MADE TO THE EXCLUSIVE RIGHT TO USE "APPLE", APART FROM THE MARK AS SHOWN.

FOR LIP MOISTURIZER, NAMELY A SUN PROTECTION BALM FOR APPLICATION ON THE LIPS (U.S. CLS. 1, 4, 6, 50, 51 AND 52).

FIRST USE 7-2-2003; IN COMMERCE 11-17-2003.

ROBIN CHOSID, EXAMINING ATTORNEY

SN 78-541,409. POLLEY, TAMMIE T., SAN JOSE, CA. FILED 1-3-2005.

TAM organics

NO CLAIM IS MADE TO THE EXCLUSIVE RIGHT TO USE "ORGANICS", APART FROM THE MARK AS SHOWN.

FOR PERSONAL CARE PRODUCTS; NAMELY, SHAMPOOS, HAIR CONDITIONERS, RINSES, TONERS, CLEANSERS, MASKS, MOISTURIZERS, OILS, LOTIONS, DEODORANTS MOUTHWASHES, NON-MEDICATED LIP BALMS, SALVES AND SOAPS (U.S. CLS. 1, 4, 6, 50, 51 AND 52).

FIRST USE 9-7-2004; IN COMMERCE 12-3-2004.

CAROLINE WEIMER, EXAMINING ATTORNEY

SN 78-551,757. REVLON CONSUMER PRODUCTS CORPORATION, NEW YORK, NY. FILED 1-21-2005.

COLORSTAY ACTIVE

THE MARK CONSISTS OF STANDARD CHARACTERS WITHOUT CLAIM TO ANY PARTICULAR FONT, STYLE, SIZE, OR COLOR.

OWNER OF U.S. REG. NOS. 1,912,134, 2,102,325 AND OTHERS.

FOR MAKEUP (U.S. CLS. 1, 4, 6, 50, 51 AND 52).

ANDREA K. NADELMAN, EXAMINING ATTORNEY

CLASS 3—(Continued).

SN 78-571,683. PRODUCERS ENVIRONMENTAL PRODUCTS, DBA ENVIRONMENTAL SOLUTIONS INTERNATIONAL, BATAVIA, IL. FILED 2-21-2005.

CHOMP PRO

THE MARK CONSISTS OF STANDARD CHARACTERS WITHOUT CLAIM TO ANY PARTICULAR FONT, STYLE, SIZE, OR COLOR.

OWNER OF U.S. REG. NO. 2,628,162.

NO CLAIM IS MADE TO THE EXCLUSIVE RIGHT TO USE "PRO", APART FROM THE MARK AS SHOWN.

FOR MULTIPURPOSE CLEANING PREPARATIONS IN THE NATURE OF DRIED LATEX PAINT REMOVER AND DEGREASING PREPARATIONS FOR FIBERGLASS, ALUMINUM, HARD SURFACES, APPLIANCES, CONCRETE, BRICK, METAL, CHROME, VINYL, GLASS, LAMINATED COUNTERTOPS, VINYL FLOORS, BASEBOARDS, WALKWAYS, PLASTIC, GROUT, AND POLYURETHANE (U.S. CLS. 1, 4, 6, 50, 51 AND 52).

FIRST USE 2-12-2005; IN COMMERCE 2-12-2005.
SUNG IN, EXAMINING ATTORNEY

SN 79-000,055. PROVEA, CH-1000 LAUSANNE, SWITZERLAND, FILED 11-14-2003.

PROVEA

THE MARK CONSISTS OF STANDARD CHARACTERS WITHOUT CLAIM TO ANY PARTICULAR FONT, STYLE, SIZE, OR COLOR.

OWNER OF INTERNATIONAL REGISTRATION 0802244 DATED 4-17-2003, EXPIRES 4-17-2013.

FOR BLEACHING PREPARATIONS FOR LAUNDRY; PREPARATIONS FOR LAUNDRY USE, NAMELY PRE-SOAK, DETERGENT, STARCH; GENERAL PURPOSE CLEANING, POLISHING AND ABRASIVE LIQUIDS AND POWDERS; CLEANING PREPARATIONS, NAMELY, GREASE REMOVERS; HAND, SKIN, AND DETERGENT SOAPS; PERFUME; ESSENTIAL OILS FOR PERSONAL USE; COSMETICS, HAIR LOTIONS, DENTIFRICES (U.S. CLS. 1, 4, 6, 50, 51 AND 52).

TONI HICKEY, EXAMINING ATTORNEY

CLASS 3—(Continued).

SN 79-000,114. BURBERRY LIMITED, UNITED KINGDOM, FILED 11-11-2003.

BURBERRY BRIT

THE MARK CONSISTS OF STANDARD CHARACTERS WITHOUT CLAIM TO ANY PARTICULAR FONT, STYLE, SIZE, OR COLOR.

PRIORITY DATE OF 10-31-2003 IS CLAIMED.

OWNER OF INTERNATIONAL REGISTRATION 0814807 DATED 11-11-2003, EXPIRES 11-11-2013.

OWNER OF U.S. REG. NOS. 2,624,684, 2,634,190 AND OTHERS.

FOR NON-MEDICATED TOILET PREPARATIONS, NAMELY, PERFUMES, EAU DE COLOGNE, AND TOILET WATER, ESSENTIAL OILS FOR PERSONAL USE, COSMETIC PREPARATIONS FOR THE TEETH AND FOR THE HAIR, NAMELY, TOOTHPASTES, SHAMPOOS, CONDITIONERS, HAIR SPRAYS, HAIR GELS, SOAPS FOR THE BODY, SHOWER GELS AND BATH GELS AND BATH FOAMS; ANTIPERSPIRANTS AND DEODORANTS; SHAVING PREPARATIONS AND POTPOURRI (U.S. CLS. 1, 4, 6, 50, 51 AND 52).

LESLEY LAMOTHE, EXAMINING ATTORNEY

SN 79-002,274. SCANDINAVIAN REGULATORY SERVICES AKTIEBOLAG, SWEDEN, FILED 4-2-2004.

LACTIM

THE MARK CONSISTS OF STANDARD CHARACTERS WITHOUT CLAIM TO ANY PARTICULAR FONT, STYLE, SIZE, OR COLOR.

PRIORITY DATE OF 1-15-2004 IS CLAIMED.

OWNER OF INTERNATIONAL REGISTRATION 0823855 DATED 4-2-2004, EXPIRES 4-2-2014.

FOR NON-MEDICATED TOILETRY PREPARATION NAMELY, ESSENTIAL OILS FOR PERSONAL USE (U.S. CLS. 1, 4, 6, 50, 51 AND 52).

KAREN K. BUSH, EXAMINING ATTORNEY

SN 79-002,854. MICHEL KUITEMS, NETHERLANDS, FILED 4-2-2004.

AERODENT

THE MARK CONSISTS OF STANDARD CHARACTERS WITHOUT CLAIM TO ANY PARTICULAR FONT, STYLE, SIZE, OR COLOR.

PRIORITY DATE OF 10-6-2003 IS CLAIMED.

OWNER OF INTERNATIONAL REGISTRATION 0825764 DATED 4-2-2004, EXPIRES 4-2-2014.

FOR DENTIFRICES (U.S. CLS. 1, 4, 6, 50, 51 AND 52).

GIANCARLO CASTRO, EXAMINING ATTORNEY

CLASS 3—(Continued).

SN 79-003,180. PARFUMS CINDY C., F-75116 PARIS, FRANCE, FILED 5-14-2004.

CINDY .C

THE MARK CONSISTS OF STANDARD CHARACTERS WITHOUT CLAIM TO ANY PARTICULAR FONT, STYLE, SIZE, OR COLOR.

OWNER OF INTERNATIONAL REGISTRATION 0700871 DATED 6-17-1998, EXPIRES 6-17-2008.

OWNER OF U.S. REG. NO. 2,405,097.

FOR SOAPS; PERFUMERY ARTICLES, NAMELY, TOILET WATER, PERFUMED WATER, PERFUMES, ESSENTIAL OILS FOR PERSONAL USE, ESSENTIAL OILS FOR USE IN THE MANUFACTURE OF SCENTED PRODUCTS; COSMETICS; HAIR LOTIONS; DENTIFRICES (U.S. CLS. 1, 4, 6, 50, 51 AND 52).

BRENDAN REGAN, EXAMINING ATTORNEY

SN 79-004,596. LIDL STIFTUNG & CO. KG, FED REP GERMANY, FILED 6-29-2004.

Suddenly

THE MARK CONSISTS OF STANDARD CHARACTERS WITHOUT CLAIM TO ANY PARTICULAR FONT, STYLE, SIZE, OR COLOR.

OWNER OF INTERNATIONAL REGISTRATION 0831195 DATED 6-29-2004, EXPIRES 6-29-2014.

FOR BLEACHING PREPARATIONS AND OTHER SUBSTANCES FOR LAUNDRY USE, NAMELY; LAUNDRY BLEACH, LAUNDRY DETERGENT, FABRIC SOFTENERS, LAUNDRY STARCH; CLEANING, POLISHING, SCOURING AND ABRASIVE PREPARATIONS; SOAPS; PERFUMERY; ESSENTIAL OILS FOR PERSONAL USE; COSMETICS; HAIR LOTIONS; DENITRIFIES (U.S. CLS. 1, 4, 6, 50, 51 AND 52).

GRETTA YAO, EXAMINING ATTORNEY

SN 79-005,064. WELLA AKTIENGESELLSCHAFT, FED REP GERMANY, FILED 7-20-2004.

NUYA

THE MARK CONSISTS OF STANDARD CHARACTERS WITHOUT CLAIM TO ANY PARTICULAR FONT, STYLE, SIZE, OR COLOR.

PRIORITY DATE OF 2-18-2004 IS CLAIMED.

OWNER OF INTERNATIONAL REGISTRATION 0832446 DATED 7-20-2004, EXPIRES 7-20-2014.

FOR HAIR CARE PREPARATIONS, NAMELY SHAMPOOS AND HAIR CONDITIONERS; HAIR STYLING AND FINISHING PRODUCTS, NAMELY HAIR SPRAYS, SPRAY GELS, GELS, MOUSSES, CREAMS, LOTIONS, POMADES AND WAXES, AND HAIR AND SCALP TREATMENTS, NAMELY RESTRUCTURIZERS AND SCALP CONDITIONERS (U.S. CLS. 1, 4, 6, 50, 51 AND 52).

LAURA KOVAISKY, EXAMINING ATTORNEY

CLASS 3—(Continued).

SN 79-005,214. MÜLHENS GMBH & CO. KG, FED REP GERMANY, FILED 6-17-2004.

OOH LA LOVE

THE MARK CONSISTS OF STANDARD CHARACTERS WITHOUT CLAIM TO ANY PARTICULAR FONT, STYLE, SIZE, OR COLOR.

PRIORITY DATE OF 2-19-2004 IS CLAIMED.

OWNER OF INTERNATIONAL REGISTRATION 0833048 DATED 6-17-2004, EXPIRES 6-17-2014.

FOR PERFUMERIES, ESSENTIAL OILS FOR PERSONAL USE, COSMETICS, NAMELY EYE MAKE-UP AND FACIAL MAKE-UP, NON-MEDICATED SKIN CARE PREPARATIONS, NAMELY, CREAMS, LOTIONS, MOISTURIZERS, TEXTURIZERS AND TONERS; BATH GEL, SHOWER GEL, FOAM BATH AND PERSONAL DEODORANTS; HAIR LOTIONS, DENTIFRICES, TOILET SOAPS (U.S. CLS. 1, 4, 6, 50, 51 AND 52).

RUSS HERMAN, EXAMINING ATTORNEY

SN 79-005,215. MÜLHENS GMBH & CO. KG, FED REP GERMANY, FILED 6-16-2004.

INDIVIDUEL

THE MARK CONSISTS OF STANDARD CHARACTERS WITHOUT CLAIM TO ANY PARTICULAR FONT, STYLE, SIZE, OR COLOR.

PRIORITY DATE OF 1-13-2004 IS CLAIMED.

OWNER OF INTERNATIONAL REGISTRATION 0833049 DATED 6-16-2004, EXPIRES 6-16-2014.

FOR PERFUMERIES, ESSENTIAL OILS FOR PERSONAL USE, COSMETICS, NAMELY EYE MAKE-UP AND FACIAL MAKE-UP, SKIN CARE PREPARATIONS, NAMELY, CREAMS, LOTIONS, MOISTURIZERS, TEXTURIZERS AND TONERS; BATH GEL, SHOWER GEL, FOAM BATH AND PERSONAL DEODORANTS; HAIR LOTIONS, DENTIFRICES, TOILET SOAPS (U.S. CLS. 1, 4, 6, 50, 51 AND 52).

HOWARD SMIGA, EXAMINING ATTORNEY

CLASS 3—(Continued).

SN 79-005,743. XIAMEN POWE BUILDING MATERIAL; INDUSTRIAL CO., LTD, TIYU ROAD; XIAMEN 361012, CHINA, FILED 5-12-2004.



OWNER OF INTERNATIONAL REGISTRATION 0834402 DATED 5-12-2004, EXPIRES 5-12-2014.

THE MARK CONSIST OF LETTERS POWE, WITH THE "O" SHOWN AS DIAMOND IN A GEAR.

THE NON-LATIN CHARACTERS IN THE MARK TRANSLATE TO "BAO YIN POWE" AND THIS MEANS "POWER" IN ENGLISH.

FOR ABRASIVE MADE OF CORUNDUM FOR SHAPING AND SMOOTHING BY GRINDING AND RUBBING AGAINST STONES AND METALS; ABRASIVES MADE OF SILICON CARBIDE FOR SHAPING AND SMOOTHING BY GRINDING AND RUBBING AGAINST STONES AND METALS; GRINDING PREPARATIONS, NAMELY DIAMOND CHIPS AND POWDERS, PARTICULATE BORON, PARTICULATE BORON CARBIDE ALL FOR SHAPING AND SMOOTHING STONES AND METALS BY RUBBING THEREAGAINST; EMERY PAPERS; MAKE-UP; PERFUMERY FOR INDUSTRIAL USE; POLISHING PREPARATIONS; COSMETICS FOR ANIMALS (U.S. CLS. 1, 4, 6, 50, 51 AND 52).

KATHRYN COWARD, EXAMINING ATTORNEY

SN 79-006,198. LORENZO VILLORESI, ITALY, FILED 3-25-2004.

IPERBOREA

THE MARK CONSISTS OF STANDARD CHARACTERS WITHOUT CLAIM TO ANY PARTICULAR FONT, STYLE, SIZE, OR COLOR.

OWNER OF INTERNATIONAL REGISTRATION 0835676 DATED 3-25-2004, EXPIRES 3-25-2014.

THE ENGLISH TRANSLATION OF IPERBOREA IS "HYPERBOREAN."

FOR SOAPS FOR PERSONAL USE, SHAVING CREAMS, AFTER-SHAVE LOTIONS AND CREAMS; FOAM BATH, NON-MEDICATED HAIR SHAMPOOS; HAND, BODY, HAIR LOTIONS; ESSENTIAL OILS FOR PERSONAL USE; PERFUMES IN LIQUID, SOLID AND CREAM FORMS; PERFUMED BATH OILS, EAU DE TOILETTE AND EAU DE COLOGNE, PERFUMES AND AROMATIC WATERS FOR AROMATHERAPY; PERSONAL DEODORANTS, INCENSE (U.S. CLS. 1, 4, 6, 50, 51 AND 52).

ALLISON SCHRODY, EXAMINING ATTORNEY

CLASS 3—(Continued).

SN 79-008,450. ZULIANI DARIO, ITALY, FILED 9-20-2004.

ACQUA DI FIRENZE

THE MARK CONSISTS OF STANDARD CHARACTERS WITHOUT CLAIM TO ANY PARTICULAR FONT, STYLE, SIZE, OR COLOR.

OWNER OF INTERNATIONAL REGISTRATION 0842046 DATED 9-20-2004, EXPIRES 9-20-2014.

NO CLAIM IS MADE TO THE EXCLUSIVE RIGHT TO USE "FIRENZE", APART FROM THE MARK AS SHOWN.

THE ENGLISH TRANSLATION OF THE WORDING IN THE MARK IS WATER OF FLORENCE.

FOR BLEACHING PREPARATIONS AND OTHER SUBSTANCES NAMELY LAUNDRY SOAPS, FABRIC SOFTENERS AND ESSENTIAL OILS AS PERFUME FOR LAUNDRY USE; CLEANING AND POLISHING PREPARATIONS FOR HOUSEHOLD PURPOSES; SCOURING LIQUIDS AND ABRASIVE POWDERS FOR HOUSEHOLD PURPOSES; SOAPS FOR PERSONAL USE; PERFUMERY, ESSENTIAL OILS FOR PERSONAL USE; COSMETICS, HAIR LOTIONS. (U.S. CLS. 1, 4, 6, 50, 51 AND 52).

RENEE MCCRAY, EXAMINING ATTORNEY

SN 79-011,249. MÜLHENS GMBH & CO. KG, FED REP GERMANY, FILED 12-30-2004.

SHEER SUMMER

THE MARK CONSISTS OF STANDARD CHARACTERS WITHOUT CLAIM TO ANY PARTICULAR FONT, STYLE, SIZE, OR COLOR.

PRIORITY DATE OF 7-15-2004 IS CLAIMED.

OWNER OF INTERNATIONAL REGISTRATION 0850603 DATED 12-30-2004, EXPIRES 12-30-2014.

FOR PERFUMERIES, ESSENTIAL OILS FOR PERSONAL USE, COSMETICS, NAMELY EYE MAKE-UP AND FACIAL MAKE-UP, NON-MEDICATED SKIN CARE PREPARATIONS, NAMELY, CREAMS, LOTIONS, MOISTURIZERS, TEXTURIZERS AND TONERS; BATH GEL, SHOWER GEL, FOAM BATH AND PERSONAL DEODORANTS; HAIR LOTIONS, DENTIFRICES, TOILET SOAPS (U.S. CLS. 1, 4, 6, 50, 51 AND 52).

FRED MANDIR, EXAMINING ATTORNEY

CLASS 4—LUBRICANTS AND FUELS

SN 76-579,660. INERGY GAS, LLC, KANSAS CITY, MO.
FILED 3-8-2004.

MAINGAS

THE MARK CONSISTS OF STANDARD CHARACTERS
WITHOUT CLAIM TO ANY PARTICULAR FONT, STYLE,
SIZE, OR COLOR.

SEC. 2(F).
FOR LIQUID PROPANE GAS FOR USE WITH GAS
APPLIANCES (U.S. CLS. 1, 6 AND 15).
FIRST USE 0-0-1970; IN COMMERCE 0-0-1970.
ANDREA SAUNDERS, EXAMINING ATTORNEY

SN 76-610,550. VOTIVO, LTD., SEATTLE, WA. FILED 9-9-
2004.



OWNER OF U.S. REG. NOS. 1,932,316, 2,932,538 AND
OTHERS.

NO CLAIM IS MADE TO THE EXCLUSIVE RIGHT TO
USE "AROMATIC CANDLES" AND "GINGERSNAP",
APART FROM THE MARK AS SHOWN.

THE COLOR(S) BROWN, SILVER, COPPER AND GRAY
IS/ARE CLAIMED AS A FEATURE OF THE MARK.

THE COLOR BROWN APPEARS AS THE PRIMARY
COLOR OF THE BOX. THE COLOR SILVER APPEARS AS
THE PRIMARY COLOR OF THE INNER RECTANGULAR
LABEL, THE METALLIC BRACKETS AND TWINE. THE
COLOR COPPER APPEARS AS THE PRIMARY COLOR OF
OUTER RECTANGULAR BORDER OF THE LABEL AND
THE COLOR GRAY APPEARS AS THE PRIMARY COLOR
OF THE "V-VOTIVO" SEAL.

THE MARK CONSISTS OF A RIGID RECTANGULAR
CARDBOARD BOX AND LID WITH FOUR CHROME
DECORATIVE METAL CORNERS. THE MARK CONSISTS,
IN PART, OF THE CONFIGURATION OF THE PACKA-
GING OF THE GOODS. THE BOX CONTAINS A LABEL ON
THE FRONT OF THE BOX IDENTIFYING THE VOTIVO
NAME ALONG WITH THE AROMATIC SCENT, GINGERS-
NAP, SURROUNDED BY A RECTANGULAR BORDER.
THE BOX LID IS TOPPED WITH TWINE THAT PASSES,
BOB STYLE, THROUGH A METAL "V-VOTIVO" SEAL AND
INTO THE LID OF THE BOX. THE REPRESENTATION OF
A BOX SHOWN IN DASHED LINING FORMS NO PART OF
THE MARK AND MERELY SERVES TO SHOW THE
POSITION OF THESE ITEMS ON THE MARK.

SEC. 2(F) AS TO THE PORTION OF THE MARK THAT
CONSISTS OF THE CONFIGURATION OF THE PACKA-
GING FOR THE GOODS.

FOR CANDLES AND TAPERS (U.S. CLS. 1, 6 AND 15).
FIRST USE 9-0-2003; IN COMMERCE 9-0-2003.
TARAH HARDY, EXAMINING ATTORNEY

CLASS 4—(Continued).

SN 76-613,561. SCENT-SATIONS, INC., WILKES-BARRE, PA.
FILED 9-24-2004.

MIA BELLA

THE MARK CONSISTS OF STANDARD CHARACTERS
WITHOUT CLAIM TO ANY PARTICULAR FONT, STYLE,
SIZE, OR COLOR.

THE ENGLISH TRANSLATION OF "MIA BELLA" IS "MY
BEAUTIFUL".

FOR CANDLES, VOTIVE CANDLES (U.S. CLS. 1, 6
AND 15).

FIRST USE 10-1-2000; IN COMMERCE 10-1-2000.
ASMAT KHAN, EXAMINING ATTORNEY

SN 76-615,902. REMET CORPORATION, UTICA, NY. FILED
10-14-2004.

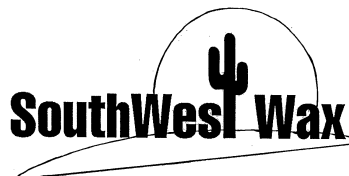

NO CLAIM IS MADE TO THE EXCLUSIVE RIGHT TO
USE "WAX", APART FROM THE MARK AS SHOWN.

FOR WAX, NAMELY, PARAFFIN WAX; BEESWAX;
CARNAUBA WAX; RAW MATERIAL WAXES; WAX FOR
CANDLES; WAX FOR WINE AND WAX FOR CHEESE
(U.S. CLS. 1, 6 AND 15).

FIRST USE 5-23-2005; IN COMMERCE 5-23-2005.
ADA HAN, EXAMINING ATTORNEY

SN 78-197,267. WORTHINGTON GROUP LLC, THE, BEV-
ERLY HILLS, CA. FILED 12-23-2002.

OOOHLALA

OWNER OF U.S. REG. NO. 2,706,833.

FOR WAX FOR USE IN THE MANUFACTURE OF
CANDLES (U.S. CLS. 1, 6 AND 15).

FIRST USE 7-31-2001; IN COMMERCE 7-31-2001.
ELISSA GARBER KON, EXAMINING ATTORNEY

SN 78-305,159. CALUMET WOOD PRODUCTS, INC., HAM-
MOND, IN. FILED 9-25-2003.

**HAPPY PAPPY'S GOURMET
WOODCHIPS**

NO CLAIM IS MADE TO THE EXCLUSIVE RIGHT TO
USE "GOURMET WOODCHIPS", APART FROM THE
MARK AS SHOWN.

FOR WOODCHIPS FOR SMOKING AND FLAVORING
FOOD (U.S. CLS. 1, 6 AND 15).

CHARLES L. JENKINS, EXAMINING ATTORNEY

CLASS 4—(Continued).

SN 78-310,114. ENERGEX PROPERTIES, LTD., WILMINGTON, DE. FILED 10-7-2003.



NO CLAIM IS MADE TO THE EXCLUSIVE RIGHT TO USE "AMERICAN", APART FROM THE MARK AS SHOWN. FOR WOOD PELLETS FOR USE AS FUEL (U.S. CLS. 1, 6 AND 15).
FIRST USE 10-0-1999; IN COMMERCE 10-0-1999.
G. MAYERSCHOFF, EXAMINING ATTORNEY

CLASS 4—(Continued).

SN 78-475,639. THE YANKEE CANDLE COMPANY, INC., SOUTH DEERFIELD, MA. FILED 8-30-2004.

RAIN WASHED

THE MARK CONSISTS OF STANDARD CHARACTERS WITHOUT CLAIM TO ANY PARTICULAR FONT, STYLE, SIZE, OR COLOR.
FOR CANDLES; FRAGRANT WAX FOR USE IN POTPOURRI BURNERS (U.S. CLS. 1, 6 AND 15).
FIRST USE 12-11-2004; IN COMMERCE 12-11-2004.
LAURA KOVAISKY, EXAMINING ATTORNEY

SN 78-320,730. CANDLE CORPORATION OF AMERICA, DES PLAINES, IL. FILED 10-30-2003.

HOLIDAY SPARKLE

FOR CANDLES (U.S. CLS. 1, 6 AND 15).
FIRST USE 6-0-2003; IN COMMERCE 6-0-2003.
JOHN E. MICHOS, EXAMINING ATTORNEY

SN 78-489,775. BOEHME FILATEX, INC., REIDSVILLE, NC. FILED 9-27-2004.

SN 78-420,981. THE YANKEE CANDLE COMPANY, INC., SOUTH DEERFIELD, MA. FILED 5-18-2004.

LUBROL

PUMPKIN FEST

THE MARK CONSISTS OF STANDARD CHARACTERS WITHOUT CLAIM TO ANY PARTICULAR FONT, STYLE, SIZE, OR COLOR.
NO CLAIM IS MADE TO THE EXCLUSIVE RIGHT TO USE "PUMPKIN", APART FROM THE MARK AS SHOWN. FOR CANDLES (U.S. CLS. 1, 6 AND 15).
FIRST USE 8-9-2004; IN COMMERCE 8-9-2004.
KATHRYN COWARD, EXAMINING ATTORNEY

THE MARK CONSISTS OF STANDARD CHARACTERS WITHOUT CLAIM TO ANY PARTICULAR FONT, STYLE, SIZE, OR COLOR.
OWNER OF U.S. REG. NO. 1,858,332.
FOR TEXTILE LUBRICANTS (U.S. CLS. 1, 6 AND 15).
FIRST USE 10-0-1990; IN COMMERCE 10-0-1990.
MARLENE BELL, EXAMINING ATTORNEY

CLASS 4—(Continued).

SN 78-496,001. K GEE'S PRODUCTS, LLC, UPLAND, CA.
FILED 10-7-2004.

K GEE'S

THE MARK CONSISTS OF STANDARD CHARACTERS
WITHOUT CLAIM TO ANY PARTICULAR FONT, STYLE,
SIZE, OR COLOR.

FOR BARBEQUE KITS CONTAINING WOOD CHAR-
COAL, COOKING OIL, AND PAPER (U.S. CLS. 1, 6 AND
15).

JOHN SCHUYLER YARD, EXAMINING ATTORNEY

SN 78-500,742. THE YANKEE CANDLE COMPANY, INC.,
SOUTH DEERFIELD, MA. FILED 10-15-2004.

SUNWASHED LINEN

THE MARK CONSISTS OF STANDARD CHARACTERS
WITHOUT CLAIM TO ANY PARTICULAR FONT, STYLE,
SIZE, OR COLOR.

FOR CANDLES; FRAGRANT WAX FOR USE IN
POTPOURRI BURNERS (U.S. CLS. 1, 6 AND 15).

FIRST USE 12-20-2003; IN COMMERCE 12-30-2003.

DAWN FELDMAN, EXAMINING ATTORNEY

SN 78-512,876. STONE, CHARLES THOMAS, KANNAPOLIS,
NC. FILED 11-8-2004.

STONE'S WHITE LIGHTNING

THE MARK CONSISTS OF STANDARD CHARACTERS
WITHOUT CLAIM TO ANY PARTICULAR FONT, STYLE,
SIZE, OR COLOR.

FOR GRANULAR ABSORBENT COMPOSITION FOR
ABSORBING SPILLS (U.S. CLS. 1, 6 AND 15).

JULIE GUTTADAURO, EXAMINING ATTORNEY

CLASS 4—(Continued).

SN 78-536,961. RAY, BROOKE R., PATASKALA, OH. FILED
12-22-2004.

SHADETREE CANDLE

THE MARK CONSISTS OF STANDARD CHARACTERS
WITHOUT CLAIM TO ANY PARTICULAR FONT, STYLE,
SIZE, OR COLOR.

NO CLAIM IS MADE TO THE EXCLUSIVE RIGHT TO
USE "CANDLE", APART FROM THE MARK AS SHOWN.

FOR CANDLES (U.S. CLS. 1, 6 AND 15).

FIRST USE 11-1-2004; IN COMMERCE 11-1-2004.

JUDITH HELFMAN, EXAMINING ATTORNEY

SN 78-537,694. 1429030 ONTARIO INC., DBA BLOOMING
ROSE, CONCORD, ONTARIO, CANADA, FILED 12-23-
2004.

SISI

THE MARK CONSISTS OF STANDARD CHARACTERS
WITHOUT CLAIM TO ANY PARTICULAR FONT, STYLE,
SIZE, OR COLOR.

FOR CANDLES (U.S. CLS. 1, 6 AND 15).

FIRST USE 1-30-2002; IN COMMERCE 1-30-2002.

JOHN DWYER, EXAMINING ATTORNEY

CLASS 4—(Continued).

SN 78-538,146. THE YANKEE CANDLE COMPANY, INC., SOUTH DEERFIELD, MA. FILED 12-23-2004.

CLASS 4—(Continued).

SN 78-539,043. CRC INDUSTRIES HOLDINGS, INC., WILMINGTON, DE. FILED 12-28-2004.

SNOW ANGELS

6-56

THE MARK CONSISTS OF STANDARD CHARACTERS WITHOUT CLAIM TO ANY PARTICULAR FONT, STYLE, SIZE, OR COLOR.

THE LITERAL ELEMENT OF THE MARK CONSISTS OF SNOW ANGELS

FOR CANDLES; FRAGRANT WAX FOR USE IN POTPOURRI BURNERS (U.S. CLS. 1, 6 AND 15).

FIRST USE 5-29-2001; IN COMMERCE 6-1-2001.

DAVID H. STINE, EXAMINING ATTORNEY

THE MARK CONSISTS OF STANDARD CHARACTERS WITHOUT CLAIM TO ANY PARTICULAR FONT, STYLE, SIZE, OR COLOR.

FOR ALL PURPOSE LUBRICANTS (U.S. CLS. 1, 6 AND 15).

FIRST USE 3-1-1991; IN COMMERCE 3-1-1991.

JAMES GRIFFIN, EXAMINING ATTORNEY

SN 78-539,041. CRC INDUSTRIES HOLDINGS, INC., WILMINGTON, DE. FILED 12-28-2004.

SN 78-539,065. CRC INDUSTRIES HOLDINGS, INC., WILMINGTON, DE. FILED 12-28-2004.

SYN-GO

STA-PLEX

THE MARK CONSISTS OF STANDARD CHARACTERS WITHOUT CLAIM TO ANY PARTICULAR FONT, STYLE, SIZE, OR COLOR.

FOR AUTOMOTIVE GEAR OIL (U.S. CLS. 1, 6 AND 15).

FIRST USE 1-4-2002; IN COMMERCE 1-4-2002.

JAMES GRIFFIN, EXAMINING ATTORNEY

THE MARK CONSISTS OF STANDARD CHARACTERS WITHOUT CLAIM TO ANY PARTICULAR FONT, STYLE, SIZE, OR COLOR.

FOR AUTOMOTIVE AND GENERAL PURPOSE GREASES (U.S. CLS. 1, 6 AND 15).

FIRST USE 3-1-1993; IN COMMERCE 3-1-1993.

CHARLES JOYNER, EXAMINING ATTORNEY

CLASS 5—PHARMACEUTICALS

SN 75-892,540. GREEN POWER HEALTH PRODUCTS INTERNATIONAL CO. LTD., MONGKOK, KOWLOON, HONG KONG, FILED 1-7-2000.

ENHANVOL

OWNER OF HONG KONG REG. NO. 05373, DATED 5-9-2002, EXPIRES 10-8-2008.
FOR DIETARY AND NUTRITIONAL SUPPLEMENTS (U.S. CLS. 6, 18, 44, 46, 51 AND 52).
ALICIA COLLINS, EXAMINING ATTORNEY

SN 76-029,374. NITRO US TRADEMARK LTD., MISSISSAUGA, CANADA, FILED 4-19-2000.

NITROXEN

PRIORITY CLAIMED UNDER SEC. 44(D) ON CANADA APPLICATION NO. 1032915, FILED 10-19-1999, REG. NO. TMA570948, DATED 11-20-2002, EXPIRES 11-20-2017.
FOR FOOD AND SPORT NUTRITIONAL SUPPLEMENTS FOR STRENGTH AND PERFORMANCE ENHANCEMENT (U.S. CLS. 6, 18, 44, 46, 51 AND 52).
IRA J. GOODSaid, EXAMINING ATTORNEY

SN 76-524,656. HUMCO HOLDING GROUP, INC., TEXARKANA, TX. FILED 6-19-2003.

CONSUMERS FIRST

FOR THEREFORE-OVER THE COUNTER PHARMACEUTICAL PREPARATIONS NAMELY FIRST AID ANTISEPTICS (U.S. CLS. 6, 18, 44, 46, 51 AND 52).
FIRST USE 10-24-2003; IN COMMERCE 10-24-2003.
KELLY BOULTON, EXAMINING ATTORNEY

SN 76-588,750. NATIONAL ENZYME COMPANY, INC., FORSYTH, MO. FILED 4-26-2004.

N•ZIMESPA-L

THE MARK CONSISTS OF STANDARD CHARACTERS WITHOUT CLAIM TO ANY PARTICULAR FONT, STYLE, SIZE, OR COLOR.
OWNER OF U.S. REG. NOS. 1,856,145 AND 2,760,237.
FOR NUTRICEUTICALS FOR USE AS DIETARY SUPPLEMENTS (U.S. CLS. 6, 18, 44, 46, 51 AND 52).
FIRST USE 11-0-2001; IN COMMERCE 11-0-2001.
TERESA M. RUPP, EXAMINING ATTORNEY

CLASS 5—(Continued).

SN 76-588,755. NATIONAL ENZYME COMPANY, INC., FORSYTH, MO. FILED 4-26-2004.

CERECALASE

THE MARK CONSISTS OF STANDARD CHARACTERS WITHOUT CLAIM TO ANY PARTICULAR FONT, STYLE, SIZE, OR COLOR.

FOR UNIQUE ENZYME COMPOSITION INGREDIENT FOR BREAKING DOWN PHYTIC ACID AND BETA GLUCANS FOR HUMAN CONSUMPTION SOLD AS A COMPONENT OF DIETARY SUPPLEMENTS (U.S. CLS. 6, 18, 44, 46, 51 AND 52).

FIRST USE 9-0-1999; IN COMMERCE 9-0-1999.
MARK SPARACINO, EXAMINING ATTORNEY

SN 76-589,150. INSERT THERAPEUTICS, INC., PASADENA, CA. FILED 4-28-2004.

NANORX

THE MARK CONSISTS OF STANDARD CHARACTERS WITHOUT CLAIM TO ANY PARTICULAR FONT, STYLE, SIZE, OR COLOR.

FOR FULL LINE OF PHARMACEUTICAL PREPARATIONS (U.S. CLS. 6, 18, 44, 46, 51 AND 52).

SUSAN STIGLITZ, EXAMINING ATTORNEY

SN 76-593,572. WALLCUR, INC., SAN DIEGO, CA. FILED 5-24-2004.

PRACTI-POWDER

THE MARK CONSISTS OF STANDARD CHARACTERS WITHOUT CLAIM TO ANY PARTICULAR FONT, STYLE, SIZE, OR COLOR.

FOR SIMULATED NON-MEDICATED PREPARATIONS FOR USE IN MEDICAL TRAINING (U.S. CLS. 6, 18, 44, 46, 51 AND 52).

FIRST USE 5-0-1986; IN COMMERCE 5-0-1986.
GEOFFREY FOSDICK, EXAMINING ATTORNEY

CLASS 5—(Continued).

SN 76-593,573. WALLCUR, INC., SAN DIEGO, CA. FILED 5-24-2004.

WALLCUR

THE MARK CONSISTS OF STANDARD CHARACTERS WITHOUT CLAIM TO ANY PARTICULAR FONT, STYLE, SIZE, OR COLOR.

FOR SIMULATED NON-MEDICATED PILLS AND PREPARATIONS FOR USE IN MEDICAL TRAINING (U.S. CLS. 6, 18, 44, 46, 51 AND 52).

FIRST USE 4-17-2004; IN COMMERCE 4-17-2004.
GEOFFREY FOSDICK, EXAMINING ATTORNEY

SN 76-594,410. WALLCUR, INC., SAN DIEGO, CA. FILED 5-27-2004.

PRACTI-COUMA

THE MARK CONSISTS OF STANDARD CHARACTERS WITHOUT CLAIM TO ANY PARTICULAR FONT, STYLE, SIZE, OR COLOR.

FOR SIMULATED NON-MEDICATED PILLS FOR USE IN MEDICAL TRAINING (U.S. CLS. 6, 18, 44, 46, 51 AND 52).

FIRST USE 10-0-1993; IN COMMERCE 10-0-1993.
GEOFFREY FOSDICK, EXAMINING ATTORNEY

SN 76-594,411. WALLCUR, INC., SAN DIEGO, CA. FILED 5-27-2004.

PRACTI-LASX

THE MARK CONSISTS OF STANDARD CHARACTERS WITHOUT CLAIM TO ANY PARTICULAR FONT, STYLE, SIZE, OR COLOR.

FOR SIMULATED NON-MEDICATED PILLS FOR USE IN MEDICAL TRAINING (U.S. CLS. 6, 18, 44, 46, 51 AND 52).

FIRST USE 8-0-2003; IN COMMERCE 8-0-2003.
GEOFFREY FOSDICK, EXAMINING ATTORNEY

CLASS 5—(Continued).

SN 76-595,701. GLYCOMINDS LTD., LOD 71291, ISRAEL, FILED 6-4-2004.

GLYCOMINDS

THE MARK CONSISTS OF STANDARD CHARACTERS WITHOUT CLAIM TO ANY PARTICULAR FONT, STYLE, SIZE, OR COLOR.

FOR BIOMARKERS, NAMELY, BIOCHEMICALS FOR MEDICAL OR VETERINARY USE IN THE FIELD OF AUTOIMMUNE AND INFLAMMATORY DISEASES (U.S. CLS. 6, 18, 44, 46, 51 AND 52).

SUSAN STIGLITZ, EXAMINING ATTORNEY

SN 76-599,219. AMERIDEN INTERNATIONAL LLC, FALL-BROOK, CA. FILED 6-21-2004.

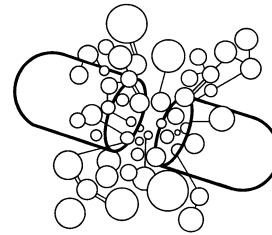

FOR DIETARY FOOD SUPPLEMENTS (U.S. CLS. 6, 18, 44, 46, 51 AND 52).

FIRST USE 1-1-2002; IN COMMERCE 1-1-2002.
CAROLYN CATALDO, EXAMINING ATTORNEY

SN 76-602,620. OTSUKA PHARMACEUTICAL CO., LTD., CHIYODA-KU, TOKYO, JAPAN, FILED 7-16-2004.

MUCOSTA

THE MARK CONSISTS OF STANDARD CHARACTERS WITHOUT CLAIM TO ANY PARTICULAR FONT, STYLE, SIZE, OR COLOR.

OWNER OF JAPAN REG. NO. 2330327, DATED 8-30-1991, EXPIRES 8-30-2011.

OWNER OF U.S. REG. NO. 2,648,223.
FOR PHARMACEUTICAL PREPARATIONS FOR THE TREATMENT OF OPHTHALMIC DISORDER (U.S. CLS. 6, 18, 44, 46, 51 AND 52).

THEODORE MCBRIDE, EXAMINING ATTORNEY

CLASS 5—(Continued).

SN 76-603,367. LEINER HEALTH SERVICES CORP., CARSON, CA. FILED 7-22-2004.

CARDIO DISCOVERY

THE MARK CONSISTS OF STANDARD CHARACTERS WITHOUT CLAIM TO ANY PARTICULAR FONT, STYLE, SIZE, OR COLOR.

NO CLAIM IS MADE TO THE EXCLUSIVE RIGHT TO USE CARDIO, APART FROM THE MARK AS SHOWN, FOR VITAMINS AND DIETARY FOOD SUPPLEMENTS (U.S. CLS. 6, 18, 44, 46, 51 AND 52).

FIRST USE 9-13-2004; IN COMMERCE 9-13-2004.

C. DIONNE CLYBURN, EXAMINING ATTORNEY

SN 76-604,176. CEDARCIDE CALIFORNIA, INC., FRESNO, CA. FILED 7-26-2004.

MANE DEFENSE

THE MARK CONSISTS OF STANDARD CHARACTERS WITHOUT CLAIM TO ANY PARTICULAR FONT, STYLE, SIZE, OR COLOR.

NO CLAIM IS MADE TO THE EXCLUSIVE RIGHT TO USE "MANE", APART FROM THE MARK AS SHOWN.

FOR INSECT REPELLENTS FOR USE ON HORSES (U.S. CLS. 6, 18, 44, 46, 51 AND 52).

FIRST USE 5-15-2004; IN COMMERCE 5-15-2004.

MICHAEL TANNER, EXAMINING ATTORNEY

SN 76-605,288. AERO PHARMACEUTICALS, INC., BOCA RATON, FL. FILED 7-30-2004.

FOR PHARMACEUTICALS, NAMELY, ANTIHISTAMINES AND DECONGESTANTS FOR THE RELIEF OF UPPER RESPIRATORY SYMPTOMS ASSOCIATED WITH ALLERGIES AND THE COMMON COLD (U.S. CLS. 6, 18, 44, 46, 51 AND 52).

FIRST USE 10-10-2002; IN COMMERCE 10-10-2002.

LAURA KOVAISKY, EXAMINING ATTORNEY

SN 76-607,302. KENPAL FARM PRODUCTS INC., CENTRALIA, ONTARIO, N0M 1K0, CANADA, FILED 8-17-2004.

OWNER OF U.S. REG. NO. 2,927,657.
FOR MEDICATED ANIMAL FEED (U.S. CLS. 6, 18, 44, 46, 51 AND 52).
FIRST USE 7-1-2004; IN COMMERCE 7-1-2004.
STEVEN JACKSON, EXAMINING ATTORNEY

CLASS 5—(Continued).

SN 76-612,516. NANOCARRIER CO., LTD., KASHIWA CHI-BA, JAPAN, FILED 9-22-2004.

NANOPLATIN

THE MARK CONSISTS OF STANDARD CHARACTERS WITHOUT CLAIM TO ANY PARTICULAR FONT, STYLE, SIZE, OR COLOR.

OWNER OF JAPAN REG. NO. 4774528, DATED 5-28-2004, EXPIRES 5-28-2014.

FOR MEDICINES AND DRUGS FOR THE TREATMENT OF CANCER (U.S. CLS. 6, 18, 44, 46, 51 AND 52).
BRIAN NEVILLE, EXAMINING ATTORNEY

SN 76-612,946. PRIMARY INVESTMENTS GROUP LIMITED, ROAD TOWN, TORTOLA, BR.VIRGIN ISLANDS, FILED 9-27-2004.

DIET SYSTEM 6

THE MARK CONSISTS OF STANDARD CHARACTERS WITHOUT CLAIM TO ANY PARTICULAR FONT, STYLE, SIZE, OR COLOR.

NO CLAIM IS MADE TO THE EXCLUSIVE RIGHT TO USE "DIET SYSTEM", APART FROM THE MARK AS SHOWN.

FOR VITAMINS AND NUTRITIONAL SUPPLEMENTS (U.S. CLS. 6, 18, 44, 46, 51 AND 52).

FIRST USE 4-10-2002; IN COMMERCE 4-10-2002.

ANNE E. GUSTASON, EXAMINING ATTORNEY

SN 76-613,248. KENPAL FARM PRODUCTS INC., CENTRALIA, ONTARIO, N0M 1K0, CANADA, FILED 9-22-2004.

OWNER OF U.S. REG. NOS. 2,755,995, 2,771,271 AND OTHERS.

FOR MEDICATED ANIMAL FEED (U.S. CLS. 6, 18, 44, 46, 51 AND 52).

FIRST USE 9-1-2004; IN COMMERCE 9-1-2004.

KELLY BOULTON, EXAMINING ATTORNEY

CLASS 5—(Continued).

SN 76-613,249. KENPAL FARM PRODUCTS INC., CENTRALIA, ONTARIO, N0M 1K0, CANADA, FILED 9-22-2004.

TRIMSTART

THE MARK CONSISTS OF STANDARD CHARACTERS WITHOUT CLAIM TO ANY PARTICULAR FONT, STYLE, SIZE, OR COLOR.

OWNER OF U.S. REG. NOS. 2,755,995, 2,771,271 AND OTHERS.

FOR MEDICATED ANIMAL FEED (U.S. CLS. 6, 18, 44, 46, 51 AND 52).

FIRST USE 9-1-2004; IN COMMERCE 9-1-2004.

KELLY BOULTON, EXAMINING ATTORNEY

SN 76-614,798. L. PERRIGO COMPANY, ALLEGAN, MI. FILED 10-4-2004.

SOUR BURST

THE MARK CONSISTS OF STANDARD CHARACTERS WITHOUT CLAIM TO ANY PARTICULAR FONT, STYLE, SIZE, OR COLOR.

NO CLAIM IS MADE TO THE EXCLUSIVE RIGHT TO USE "SOUR", APART FROM THE MARK AS SHOWN.

FOR DIETARY SUPPLEMENTS (U.S. CLS. 6, 18, 44, 46, 51 AND 52).

CHRISTOPHER ADKINS, EXAMINING ATTORNEY

SN 76-615,003. GOLF NUTRITION SCIENCES, INC., ARVADA, CO. FILED 10-7-2004.

SLIM SEDUCTION

THE MARK CONSISTS OF STANDARD CHARACTERS WITHOUT CLAIM TO ANY PARTICULAR FONT, STYLE, SIZE, OR COLOR.

FOR DIETARY SUPPLEMENTS FOR WEIGHT LOSS (U.S. CLS. 6, 18, 44, 46, 51 AND 52).

FIRST USE 7-14-2004; IN COMMERCE 7-14-2004.

TEJBIR SINGH, EXAMINING ATTORNEY

CLASS 5—(Continued).

SN 76-615,218. WEIDER HEALTH AND FITNESS, WOODLAND HILLS, CA. FILED 10-12-2004.

MASTER BLASTER

THE MARK CONSISTS OF STANDARD CHARACTERS WITHOUT CLAIM TO ANY PARTICULAR FONT, STYLE, SIZE, OR COLOR.

FOR VITAMINS; MEAL REPLACEMENT DRINKS, POWDERS AND PILLS; DIETARY SUPPLEMENTS; SINUS PILLOWS, EYE PILLOWS CONTAINING AROMATIC SUBSTANCES FOR RELIEF FROM HEADACHES, INSOMNIA AND SINUS DISCOMFORT; MUSCLE RELAXANTS AND SOAKS; HERB TEAS FOR MEDICINAL PURPOSES (U.S. CLS. 6, 18, 44, 46, 51 AND 52).

HEATHER THOMPSON, EXAMINING ATTORNEY

SN 76-617,338. ALOE VERA OF AMERICA, INC., DALLAS, TX. FILED 10-22-2004.

FOREVER VISION

THE MARK CONSISTS OF STANDARD CHARACTERS WITHOUT CLAIM TO ANY PARTICULAR FONT, STYLE, SIZE, OR COLOR.

OWNER OF U.S. REG. NOS. 1,724,910, 2,751,559 AND OTHERS.

NO CLAIM IS MADE TO THE EXCLUSIVE RIGHT TO USE "VISION", APART FROM THE MARK AS SHOWN.

FOR DIETARY SUPPLEMENT WITH BILBERRY, LUTEIN, ZEAXANTHIN, PLUS SUPER ANTIOXIDANTS AND OTHER NUTRIENTS (U.S. CLS. 6, 18, 44, 46, 51 AND 52).

FIRST USE 8-9-2004; IN COMMERCE 8-9-2004.

LINDA M. KING, EXAMINING ATTORNEY

SN 76-617,340. ALOE VERA OF AMERICA, INC., DALLAS, TX. FILED 10-22-2004.

FOREVER LITE ULTRA

THE MARK CONSISTS OF STANDARD CHARACTERS WITHOUT CLAIM TO ANY PARTICULAR FONT, STYLE, SIZE, OR COLOR.

OWNER OF U.S. REG. NOS. 1,724,910, 2,018,119 AND OTHERS.

NO CLAIM IS MADE TO THE EXCLUSIVE RIGHT TO USE "LITE", APART FROM THE MARK AS SHOWN.

FOR NUTRITIONAL SUPPLEMENTS, NAMELY, A NUTRITIONAL SHAKE MIX FOR WEIGHT CONTROL (U.S. CLS. 6, 18, 44, 46, 51 AND 52).

FIRST USE 8-9-2004; IN COMMERCE 8-9-2004.

MONTIA G. PRESSEY, EXAMINING ATTORNEY

CLASS 5—(Continued).

SN 76-618,222. THORN, JAMES, CERRITOS, CA. FILED 10-26-2004.

REGENEFLEX

THE MARK CONSISTS OF STANDARD CHARACTERS WITHOUT CLAIM TO ANY PARTICULAR FONT, STYLE, SIZE, OR COLOR.

FOR TOPICAL ANALGESIC PREPARATION, NAMELY, ANTI-INFLAMMATORY TOPICAL ROLL-ON DELIVERED BY WAY OF CREAM, PASTE AND LIQUID FORM, ADHESIVE PATCHES CONTAINING ANALGESIC PREPARATION FOR PAIN RELIEF; NATURAL ANTI-INFLAMMATORY NUTRITIONAL SUPPLEMENTS (U.S. CLS. 6, 18, 44, 46, 51 AND 52).

FIRST USE 9-1-2004; IN COMMERCE 9-1-2004.
WILLIAM P. SHANAHAN, EXAMINING ATTORNEY

CLASS 5—(Continued).

SN 76-620,142. VET SOLUTIONS, L.P., FORT WORTH, TX. FILED 11-12-2004.

OSTEO-3

THE MARK CONSISTS OF STANDARD CHARACTERS WITHOUT CLAIM TO ANY PARTICULAR FONT, STYLE, SIZE, OR COLOR.

FOR ANIMAL FEED ADDITIVES FOR USE AS NUTRITIONAL SUPPLEMENTS (U.S. CLS. 6, 18, 44, 46, 51 AND 52).

FIRST USE 9-0-2003; IN COMMERCE 9-0-2003.
PAULA MAHONEY, EXAMINING ATTORNEY

SN 76-618,529. F-MATIC OF AMERICA, LEHI, UT. FILED 10-25-2004.

ORCHARD PEACH

THE MARK CONSISTS OF STANDARD CHARACTERS WITHOUT CLAIM TO ANY PARTICULAR FONT, STYLE, SIZE, OR COLOR.

NO CLAIM IS MADE TO THE EXCLUSIVE RIGHT TO USE PEACH, APART FROM THE MARK AS SHOWN.

FOR AIR FRESHENER CARTRIDGE (U.S. CLS. 6, 18, 44, 46, 51 AND 52).

FIRST USE 11-1-1990; IN COMMERCE 11-1-1990.
JOHN DALIER, EXAMINING ATTORNEY

SN 76-625,166. PURE TANGO, INC., SAN FRANCISCO, CA. FILED 12-20-2004.

FEMMEPHASE

THE MARK CONSISTS OF STANDARD CHARACTERS WITHOUT CLAIM TO ANY PARTICULAR FONT, STYLE, SIZE, OR COLOR.

FOR DIETARY, HERBAL AND NUTRITIONAL SUPPLEMENTS (U.S. CLS. 6, 18, 44, 46, 51 AND 52).

FIRST USE 11-1-2004; IN COMMERCE 12-8-2004.
MARGERY A. TIERNEY, EXAMINING ATTORNEY

SN 76-619,269. PET-AG, INC., HAMPSHIRE, IL. FILED 11-4-2004.

ENTERALCARE

THE MARK CONSISTS OF STANDARD CHARACTERS WITHOUT CLAIM TO ANY PARTICULAR FONT, STYLE, SIZE, OR COLOR.

FOR FOOD SUPPLEMENTS FOR ANIMALS (U.S. CLS. 6, 18, 44, 46, 51 AND 52).

FIRST USE 1-28-2005; IN COMMERCE 1-28-2005.
LINDA ESTRADA, EXAMINING ATTORNEY

SN 76-625,167. PURE TANGO, INC., SAN FRANCISCO, CA. FILED 12-20-2004.

ALLERPHASE

THE MARK CONSISTS OF STANDARD CHARACTERS WITHOUT CLAIM TO ANY PARTICULAR FONT, STYLE, SIZE, OR COLOR.

FOR DIETARY, HERBAL AND NUTRITIONAL SUPPLEMENTS (U.S. CLS. 6, 18, 44, 46, 51 AND 52).

FIRST USE 6-16-2004; IN COMMERCE 7-26-2004.
MARGERY A. TIERNEY, EXAMINING ATTORNEY

CLASS 5—(Continued).

SN 76-625,168. PURE TANGO, INC., SAN FRANCISCO, CA. FILED 12-20-2004.

OSTEOPHASE

THE MARK CONSISTS OF STANDARD CHARACTERS WITHOUT CLAIM TO ANY PARTICULAR FONT, STYLE, SIZE, OR COLOR.
FOR DIETARY, HERBAL AND NUTRITIONAL SUPPLEMENTS (U.S. CLS. 6, 18, 44, 46, 51 AND 52).
FIRST USE 9-29-2004; IN COMMERCE 12-8-2004.
MARGERY A. TIERNEY, EXAMINING ATTORNEY

SN 76-625,647. LEINER HEALTH SERVICES CORP., CARSON, CA. FILED 12-27-2004.

SHORT CUTS

THE MARK CONSISTS OF STANDARD CHARACTERS WITHOUT CLAIM TO ANY PARTICULAR FONT, STYLE, SIZE, OR COLOR.
FOR VITAMINS AND DIETARY FOOD SUPPLEMENTS (U.S. CLS. 6, 18, 44, 46, 51 AND 52).
ESTHER A. BORSUK, EXAMINING ATTORNEY

SN 76-626,423. ENZYMATIC THERAPY, INC., GREEN BAY, WI. FILED 12-28-2004.

FANTASTIC FIBER

THE MARK CONSISTS OF STANDARD CHARACTERS WITHOUT CLAIM TO ANY PARTICULAR FONT, STYLE, SIZE, OR COLOR.
NO CLAIM IS MADE TO THE EXCLUSIVE RIGHT TO USE FIBER, APART FROM THE MARK AS SHOWN.
FOR DIETARY AND NUTRITIONAL SUPPLEMENTS (U.S. CLS. 6, 18, 44, 46, 51 AND 52).
ALEXANDER L. POWERS, EXAMINING ATTORNEY

CLASS 5—(Continued).

SN 76-626,446. VEDCO, INC., ST. JOSEPH, MO. FILED 12-28-2004.

DURAPEN

THE MARK CONSISTS OF STANDARD CHARACTERS WITHOUT CLAIM TO ANY PARTICULAR FONT, STYLE, SIZE, OR COLOR.
FOR VETERINARY ANTIBIOTICS FOR LIVESTOCK AND DOMESTIC ANIMALS (U.S. CLS. 6, 18, 44, 46, 51 AND 52).
FIRST USE 0-0-1984; IN COMMERCE 0-0-1984.
SANI KHOURI, EXAMINING ATTORNEY

SN 76-626,486. RIOWELL, LLC, HOUSTON, TX. FILED 12-29-2004.

CHOC-O-LIFE

THE MARK CONSISTS OF STANDARD CHARACTERS WITHOUT CLAIM TO ANY PARTICULAR FONT, STYLE, SIZE, OR COLOR.
FOR DIETARY SUPPLEMENTS (U.S. CLS. 6, 18, 44, 46, 51 AND 52).
FIRST USE 8-21-2002; IN COMMERCE 8-21-2002.
KEVIN DINALLO, EXAMINING ATTORNEY

SN 76-626,487. RIOWELL, LLC, HOUSTON, TX. FILED 12-29-2004.

ORAFLOW PLUS

THE MARK CONSISTS OF STANDARD CHARACTERS WITHOUT CLAIM TO ANY PARTICULAR FONT, STYLE, SIZE, OR COLOR.
FOR DIETARY FOOD SUPPLEMENTS; VITAMIN AND MINERAL SUPPLEMENTS (U.S. CLS. 6, 18, 44, 46, 51 AND 52).
FIRST USE 7-26-1989; IN COMMERCE 7-26-1989.
KEVIN DINALLO, EXAMINING ATTORNEY

CLASS 5—(Continued).

SN 76-626,488. RIOWELL, LLC, HOUSTON, TX. FILED 12-29-2004.

PHYTO-PHAMILY

THE MARK CONSISTS OF STANDARD CHARACTERS WITHOUT CLAIM TO ANY PARTICULAR FONT, STYLE, SIZE, OR COLOR.

FOR DIETARY SUPPLEMENTS (U.S. CLS. 6, 18, 44, 46, 51 AND 52).

KEVIN DINALLO, EXAMINING ATTORNEY

SN 76-626,489. RIOWELL, LLC, HOUSTON, TX. FILED 12-29-2004.

ITCHBUSTER

THE MARK CONSISTS OF STANDARD CHARACTERS WITHOUT CLAIM TO ANY PARTICULAR FONT, STYLE, SIZE, OR COLOR.

FOR TOPICAL PREPARATIONS FOR THE RELIEF OF ITCHING (U.S. CLS. 6, 18, 44, 46, 51 AND 52).

KEVIN DINALLO, EXAMINING ATTORNEY

SN 76-626,729. VIDERS, DANIEL E., SOUTHBRIDGE, MA. FILED 12-30-2004.



FOR LIP DERMATOLOGICAL PRODUCTS, NAMELY, MEDICATED LIP BALM (U.S. CLS. 6, 18, 44, 46, 51 AND 52).

FIRST USE 6-4-1999; IN COMMERCE 6-4-1999.
SUSAN HAYASH, EXAMINING ATTORNEY

SN 76-977,664. DADE BEHRING INC., DEERFIELD, IL. FILED 1-17-2001.

DIMENSION

OWNER OF U.S. REG. NO. 1,456,333.
FOR REAGENTS AND REAGENT CARTRIDGES FOR CLINICAL AND MEDICAL LABORATORY USE (U.S. CLS. 6, 18, 44, 46, 51 AND 52).

FIRST USE 12-8-1986; IN COMMERCE 12-8-1986.
KAREN K. BUSH, EXAMINING ATTORNEY

CLASS 5—(Continued).

SN 78-049,514. WETH, BOHEMIA, NY. FILED 2-21-2001.

SOLOVITE

FOR DIETARY AND NUTRITIONAL SUPPLEMENTS (U.S. CLS. 6, 18, 44, 46, 51 AND 52).

FIRST USE 0-0-1973; IN COMMERCE 0-0-1973.
CHERYL CLAYTON, EXAMINING ATTORNEY

SN 78-211,831. ARK THERAPEUTICS LIMITED, LONDON, ENGLAND, FILED 2-6-2003.

TRONAL

THE MARK CONSISTS OF STANDARD CHARACTERS WITHOUT CLAIM TO ANY PARTICULAR FONT, STYLE, SIZE, OR COLOR.

OWNER OF ERPN CMNTY TM OFC REG. NO. 3036589, DATED 3-12-2004, EXPIRES 3-12-2014.

FOR PHARMACEUTICAL PREPARATIONS AND THERAPEUTIC AGENTS FOR TREATING MUSCLE WASTING; PHARMACEUTICAL PREPARATIONS AND THERAPEUTIC AGENTS FOR TREATING CANCER AND MUSCLE WASTING IN CANCER; PHARMACEUTICAL PREPARATIONS AND THERAPEUTIC AGENTS FOR TREATING LIPODYSTROPHY AND OTHER METABOLIC CONDITIONS ASSOCIATED WITH THE USE OF ANTI-HIV THERAPY; PHARMACEUTICAL PREPARATIONS AND THERAPEUTIC AGENTS FOR INCREASING THE EFFICIENCY OF MUSCLE CELL ENERGY PRODUCTION (U.S. CLS. 6, 18, 44, 46, 51 AND 52).

RON FAIRBANKS, EXAMINING ATTORNEY

SN 78-278,228. WYETH, MADISON, NJ. FILED 7-24-2003.

"DR. MOM"

FOR COUGH AND COLD TREATMENT PREPARATIONS (U.S. CLS. 6, 18, 44, 46, 51 AND 52).

FIRST USE 1-31-1986; IN COMMERCE 1-31-1986.
SONYA STEPHENS, EXAMINING ATTORNEY

CLASS 5—(Continued).

SN 78-280,284. NISSHIN SEIFUN GROUP INC., TOKYO, JAPAN, FILED 7-29-2003.

NISSHIN INITIO

PRIORITY CLAIMED UNDER SEC. 44(D) ON JAPAN APPLICATION NO. 049759/2003, FILED 6-16-2003, REG. NO. 4753293, DATED 3-5-2004, EXPIRES 3-5-2014.

THE ENGLISH TRANSLATION OF THE WORD NISSHIN IN THE MARK IS PURE WATER OF THE DAY.

FOR MEDICINES AND HEALTH SUPPLEMENTS ALL FOR HUMAN CONSUMPTION, NAMELY, VITAMIN PREPARATIONS; MINERAL WATER FOR MEDICAL PURPOSES FOR THE TREATMENT OF METABOLIC CONDITIONS; FLOUR FOR PHARMACEUTICAL PURPOSES TO AID DIGESTION; MEAL FOR PHARMACEUTICAL PURPOSES TO AID DIGESTION; MALTED MILK BEVERAGES FOR MEDICAL PURPOSES TO AID DIGESTION; CHEWING GUM FOR MEDICAL PURPOSES FOR THE TREATMENT OF DENTAL CONDITIONS; MINT FOR PHARMACEUTICAL PURPOSES FOR THE TREATMENT OF BRONCHITIS; MALT FOR PHARMACEUTICAL PURPOSES TO AID DIGESTION; LOZENGES FOR PHARMACEUTICAL PURPOSE FOR THE TREATMENT OF BRONCHITIS; GELATIN CAPSULES SOLD EMPTY FOR PHARMACEUTICALS; EDIBLE PLANT FIBERS FOR THE TREATMENT OF CONSTIPATION; AND MINERAL FOOD SUPPLEMENTS (U.S. CLS. 6, 18, 44, 46, 51 AND 52).

MARY BOAGNI, EXAMINING ATTORNEY

SN 78-297,765. MYUNG-JA HA, WAYNE, NJ. FILED 9-9-2003.

VIROX GOLD

THE MARK CONSISTS OF STANDARD CHARACTERS WITHOUT CLAIM TO ANY PARTICULAR FONT, STYLE, SIZE, OR COLOR.

FOR VITAMIN AND MINERAL SUPPLEMENT (U.S. CLS. 6, 18, 44, 46, 51 AND 52).

FIRST USE 2-1-2003; IN COMMERCE 2-1-2003.

RON FAIRBANKS, EXAMINING ATTORNEY

SN 78-317,983. NATURAL FACTORS NUTRITIONAL PRODUCTS LTD., COQUITLAM, BRITISH COLUMBIA, CANADA, FILED 10-23-2003.

**THE REVOLUTIONARY
APPETITE & BLOOD SUGAR
REGULATOR PROGRAM**

PRIORITY CLAIMED UNDER SEC. 44(D) ON CANADA APPLICATION NO. 1193847, FILED 10-23-2003, REG. NO. TMA623333, DATED 10-25-2004, EXPIRES 10-25-2019.

NO CLAIM IS MADE TO THE EXCLUSIVE RIGHT TO USE "APPETITE & BLOOD SUGAR REGULATOR PROGRAM", APART FROM THE MARK AS SHOWN.

FOR DIETARY AND NUTRITIONAL SUPPLEMENTS, NAMELY, VITAMINS, MINERALS, HERBS, BEE POLLEN, GREEN TEA, PROTEIN LECITHIN, HEALTHY FAT AND DIETARY FIBERS (U.S. CLS. 6, 18, 44, 46, 51 AND 52).

BRENDAN MCCAULEY, EXAMINING ATTORNEY

CLASS 5—(Continued).

SN 78-322,930. COVEX FARMA, S.L., MADRID, SPAIN, FILED 11-4-2003.



OWNER OF U.S. REG. NO. 2,170,799.
THE COLOR(S) BLUE IS/ARE CLAIMED AS A FEATURE OF THE MARK.

THE MARK CONSISTS OF THE COLOR DARK BLUE AS IT APPEARS IN THE LEFT RECTANGULAR PORTION OF THE MARK SURROUNDING THE CRESCENT OR ARC DESIGN. THE MARK ALSO COMPRISES OF THE COLOR LIGHT BLUE AS IT APPEARS IN SHADED FORM IN THE RIGHT RECTANGULAR PORTION OF THE MARK.

FOR DIETARY SUPPLEMENTS, NAMELY, PILLS TO ENHANCE MEMORY (U.S. CLS. 6, 18, 44, 46, 51 AND 52).
FIRST USE 7-29-1999; IN COMMERCE 7-23-2003.

MICHAEL HALL, EXAMINING ATTORNEY

SN 78-325,306. GLAXO GROUP LIMITED, MIDDLESEX, UNITED KINGDOM, FILED 11-10-2003.

PARTEMPO

THE MARK CONSISTS OF STANDARD CHARACTERS WITHOUT CLAIM TO ANY PARTICULAR FONT, STYLE, SIZE, OR COLOR.

OWNER OF UNITED KINGDOM REG. NO. 2332235, DATED 5-16-2003, EXPIRES 5-16-2013.

FOR PHARMACEUTICAL PREPARATIONS FOR THE TREATMENT OF CANCER (U.S. CLS. 6, 18, 44, 46, 51 AND 52).

MICHELLE S. WISEMAN, EXAMINING ATTORNEY

CLASS 5—(Continued).

SN 78-325,309. GLAXO GROUP LIMITED, MIDDLESEX, UNITED KINGDOM, FILED 11-10-2003.

PIBONAR

THE MARK CONSISTS OF STANDARD CHARACTERS WITHOUT CLAIM TO ANY PARTICULAR FONT, STYLE, SIZE, OR COLOR.

OWNER OF UNITED KINGDOM REG. NO. 2332234, DATED 5-16-2003, EXPIRES 5-16-2013.

FOR PHARMACEUTICAL PREPARATIONS FOR THE TREATMENT OF CANCER (U.S. CLS. 6, 18, 44, 46, 51 AND 52).

MICHELLE S. WISEMAN, EXAMINING ATTORNEY

CLASS 5—(Continued).

SN 78-332,640. LUEN YICK PHARMACEUTICAL CO LTD, TSUEN WAN N.T., HONG KONG, FILED 11-25-2003.

仁
濟
堂

Yan Chai Tong

THE ENGLISH TRANSLATION OF THE WORD YAN CHAI TONG IN THE MARK IS IDEAL OF CONFUCIUS GIVE.

THE NON-LATIN CHARACTER(S) IN THE MARK TRANSLITERATES INTO YAN CHAI TONG, AND THIS MEANS THE IDEAL OF CONFUCIUS, GIVE IN ENGLISH.

FOR DIETARY AND HERBAL SUPPLEMENTS, NAMELY, REISHI MUSHROOM POWDER CAPSULES, BAK FOONG HERBAL PILLS, PLASTER CORDYCEPS HERBAL CAPSULES, AND CHINESE HERBAL PREPARATIONS (U.S. CLS. 6, 18, 44, 46, 51 AND 52).

FIRST USE 2-1-1995; IN COMMERCE 9-1-2003.
MARK T. MULLEN, EXAMINING ATTORNEY

SN 78-325,896. BIOGENETICS, INC., NASSAU, BAHAMAS, FILED 11-11-2003.

One Life

THE MARK CONSISTS OF STANDARD CHARACTERS WITHOUT CLAIM TO ANY PARTICULAR FONT, STYLE, SIZE, OR COLOR.

FOR MULTI-NUTRITIONAL SUPPLEMENTS (U.S. CLS. 6, 18, 44, 46, 51 AND 52).

CHRISIE B. KING, EXAMINING ATTORNEY

SN 78-349,893. C.B. MEDICAL, LLC, COLLINSVILLE, CT, FILED 1-9-2004.

DISPENS-IT

THE MARK CONSISTS OF STANDARD CHARACTERS WITHOUT CLAIM TO ANY PARTICULAR FONT, STYLE, SIZE, OR COLOR.

FOR MEDICAL AND PERSONAL CARE BANDAGES, NAMELY, ADHESIVE BANDAGES, BANDAGES FOR DRESSING, AND BANDAGES FOR SKIN APPLICATIONS, NAMELY BANDAGES FOR SKIN INJURIES; AND APPARATUS FOR DISPENSING MEDICAL AND PERSONAL CARE BANDAGES, NAMELY, ADHESIVE BANDAGES, BANDAGES FOR DRESSING, AND BANDAGES FOR SKIN APPLICATIONS. (U.S. CLS. 6, 18, 44, 46, 51 AND 52).

MARLENE BELL, EXAMINING ATTORNEY

CLASS 5—(Continued).

SN 78-354,205. KRAMER LABORATORIES INC., MIAMI, FL. FILED 1-20-2004.

CLASS 5—(Continued).

SN 78-360,073. NOVARTIS AG, BASEL, SWITZERLAND, FILED 1-30-2004.

SANDOGLOBULIN

Cough Eze

THE MARK CONSISTS OF STANDARD CHARACTERS WITHOUT CLAIM TO ANY PARTICULAR FONT, STYLE, SIZE, OR COLOR.

OWNER OF SWITZERLAND REG. NO. 294019, DATED 4-14-1998, EXPIRES 4-14-2008.

OWNER OF U.S. REG. NO. 1,265,559.

FOR MEDICINAL PREPARATION USED AS AN ANTI-BODY SUPPLEMENT (U.S. CLS. 6, 18, 44, 46, 51 AND 52).
DAWN FELDMAN, EXAMINING ATTORNEY

THE MARK CONSISTS OF STANDARD CHARACTERS WITHOUT CLAIM TO ANY PARTICULAR FONT, STYLE, SIZE, OR COLOR.

NO CLAIM IS MADE TO THE EXCLUSIVE RIGHT TO USE "COUGH", APART FROM THE MARK AS SHOWN.

FOR COUGH SUPPRESSANT, COUGH EXPECTORANT, COUGH SYRUP (U.S. CLS. 6, 18, 44, 46, 51 AND 52).
ELLEN B. AWRICH, EXAMINING ATTORNEY

SN 78-363,433. UNICITY PROPERTIES, INC., OREM, UT. FILED 2-5-2004.

SN 78-359,672. PREFERRED NUTRITION INC., ACTON, ONTARIO, CANADA, FILED 1-29-2004.



ARTHRITISENSE

THE COLORS (1) PROCESS BLACK AND (2) PMS 284 BLUE ARE CLAIMED AS A FEATURE OF THE MARK.

THE MARK CONSISTS OF (1) STYLIZED MAKE LIFE BETTER WORDS IN PROCESS BLACK COLOR, AND (2) A PICTOGRAM COMPRISING A STYLIZED IMAGE OF TWO HUMAN PERSONS, VISIBLE FROM THEIR WAISTS UP, ONE OF THEM REACHING DOWN WITH HER HELPING HANDS OUT OF A ROUND WINDOW TO HELP UP ANOTHER PERSON REACHING UP TO THE FIRST PERSON WITH BOTH HER HANDS AND HOLDING THE HANDS OF THE FIRST PERSON. THE PERSON REACHING DOWN IS LOCATED OVER THE WORD "LIFE", AND THE PERSON REACHING UP IS LOCATED BETWEEN THE WORDS "MAKE" AND "LIFE". THIS PICTOGRAM IS IN PMS 284 BLUE COLOR.

FOR MEDICATED HAIR LOTIONS; PHARMACEUTICAL, VETERINARY AND SANITARY SUBSTANCES, NAMELY, INFANTS' AND INVALIDS' FOODS, HERBAL TEAS FOR MEDICINAL PURPOSES, DIURETIC PREPARATIONS, WOUND DRESSINGS, BURN DRESSINGS, PREPARATIONS FOR TREATING COLDS, POLLEN FOR USE AS A DIETARY SUPPLEMENT, DIETARY SUPPLEMENTS, NUTRITIONAL SUPPLEMENTS, AND VITAMIN AND MINERAL SUPPLEMENTS (U.S. CLS. 6, 18, 44, 46, 51 AND 52).
DAVID MURRAY, EXAMINING ATTORNEY

THE MARK CONSISTS OF STANDARD CHARACTERS WITHOUT CLAIM TO ANY PARTICULAR FONT, STYLE, SIZE, OR COLOR.

PRIORITY CLAIMED UNDER SEC. 44(D) ON CANADA APPLICATION NO. 1198226, FILED 12-2-2003, REG. NO. TMA638426, DATED 4-27-2005, EXPIRES 4-27-2020.

FOR DIETARY SUPPLEMENT AND MEDICATED HERBAL GEL, LIQUID, LOTION AND CREAM (U.S. CLS. 6, 18, 44, 46, 51 AND 52).

JOHN WILKE, EXAMINING ATTORNEY

CLASS 5—(Continued).

SN 78-376,542. GRASSEL, MARK, ENGLEWOOD, CO. FILED 3-1-2004.

FUNK FREE

THE MARK CONSISTS OF STANDARD CHARACTERS WITHOUT CLAIM TO ANY PARTICULAR FONT, STYLE, SIZE, OR COLOR.

FOR DEODORIZERS, ODOR ELIMINATORS AND ODOR NEUTRALIZERS FOR USE ON ATHLETIC EQUIPMENT AND ATHLETIC APPAREL (U.S. CLS. 6, 18, 44, 46, 51 AND 52).

FIRST USE 6-0-2004; IN COMMERCE 6-0-2004.
NANCY CLARKE, EXAMINING ATTORNEY

CLASS 5—(Continued).

SN 78-381,039. UNITEL PHARMEX, INC., MT. PROSPECT, IL. FILED 3-9-2004.

A LA VIE

THE MARK CONSISTS OF STANDARD CHARACTERS WITHOUT CLAIM TO ANY PARTICULAR FONT, STYLE, SIZE, OR COLOR.

THE FOREIGN WORDING IN THE MARK TRANSLATES INTO ENGLISH AS TO LIFE.

FOR NUTRACEUTICALS FOR USE AS A DIETARY SUPPLEMENT (U.S. CLS. 6, 18, 44, 46, 51 AND 52).

YONG KIM, EXAMINING ATTORNEY

SN 78-382,106. INSTONE, LLC, IRVINE, CA. FILED 3-10-2004.

SN 78-376,717. JOHNSON & JOHNSON, NEW BRUNSWICK, NJ. FILED 3-2-2004.

BETHOGUARD

FORZA-T

THE MARK CONSISTS OF STANDARD CHARACTERS WITHOUT CLAIM TO ANY PARTICULAR FONT, STYLE, SIZE, OR COLOR.

FOR FUNGICIDES AND ALGICIDES FOR DOMESTIC USE (U.S. CLS. 6, 18, 44, 46, 51 AND 52).

ASMAT KHAN, EXAMINING ATTORNEY

THE MARK CONSISTS OF STANDARD CHARACTERS WITHOUT CLAIM TO ANY PARTICULAR FONT, STYLE, SIZE, OR COLOR.

THE FOREIGN WORDING IN THE MARK TRANSLATES INTO ENGLISH AS "FORCE", "STRENGTH", OR "VIGOUR".

FOR DIETARY AND NUTRITIONAL SUPPLEMENTS (U.S. CLS. 6, 18, 44, 46, 51 AND 52).

MARGERIE A. TIERNEY, EXAMINING ATTORNEY

CLASS 5—(Continued).

SN 78-388,583. P.T. KALBE FARMA TBK., BEKASI, INDONESIA, FILED 3-22-2004.

KALSOLAC

THE MARK CONSISTS OF STANDARD CHARACTERS WITHOUT CLAIM TO ANY PARTICULAR FONT, STYLE, SIZE, OR COLOR.

FOR PHARMACEUTICAL PREPARATIONS FOR THE TREATMENT OF BRAIN TRAUMA, STROKES AND FLUID RESUSCITATION; SANITARY PREPARATIONS FOR MEDICAL USE. (U.S. CLS. 6, 18, 44, 46, 51 AND 52).
ANDREA SAUNDERS, EXAMINING ATTORNEY

CLASS 5—(Continued).

SN 78-391,371. XTREME TECHNOLOGIES, INC., DBA BIO2 PET LABS, COEUR D'ALENE, ID. FILED 3-26-2004.

HERMIT GLUB

THE MARK CONSISTS OF STANDARD CHARACTERS WITHOUT CLAIM TO ANY PARTICULAR FONT, STYLE, SIZE, OR COLOR.

NO CLAIM IS MADE TO THE EXCLUSIVE RIGHT TO USE "HERMIT", APART FROM THE MARK AS SHOWN. FOR NUTRITIONAL WATER SUPPLEMENT FOR HERMIT CRABS, CRABS, AND OTHER SMALL AMPHIBIANS AND CRUSTACEANS (U.S. CLS. 6, 18, 44, 46, 51 AND 52).

FIRST USE 1-24-2004; IN COMMERCE 2-24-2004.
KAREN BRACEY, EXAMINING ATTORNEY

SN 78-395,204. CREATIVE BEAUTY INNOVATIONS, INC., CARROLLTON, TX. FILED 4-2-2004.

SN 78-389,361. MORNINGSTAR MINERALS CORPORATION, FARMINGTON, NM. FILED 3-23-2004.



NO CLAIM IS MADE TO THE EXCLUSIVE RIGHT TO USE "MINERALS", "ENERGY", AND "MINERAL SUPPLEMENTS", APART FROM THE MARK AS SHOWN.

FOR MINERAL SUPPLEMENTS (U.S. CLS. 6, 18, 44, 46, 51 AND 52).
FIRST USE 1-15-2000; IN COMMERCE 1-15-2000.
STANLEY I. OSBORNE, EXAMINING ATTORNEY

OPUDERM

THE MARK CONSISTS OF STANDARD CHARACTERS WITHOUT CLAIM TO ANY PARTICULAR FONT, STYLE, SIZE, OR COLOR.

FOR COSMECEUTICALS IN THE NATURE OF MEDICATED SKIN CARE PREPARATIONS FOR PROFESSIONAL USE (U.S. CLS. 6, 18, 44, 46, 51 AND 52).
YONG KIM, EXAMINING ATTORNEY

CLASS 5—(Continued).

SN 78-397,836. ABBOTT LABORATORIES, ABBOTT PARK, IL. FILED 4-7-2004.

CLASS 5—(Continued).

SN 78-401,411. BODY DYNAMICS, INC., CARMEL, IN. FILED 4-14-2004.

MINI THIN 25/50 EF

CLIVARIN

THE MARK CONSISTS OF STANDARD CHARACTERS WITHOUT CLAIM TO ANY PARTICULAR FONT, STYLE, SIZE, OR COLOR.
FOR PHARMACEUTICAL PREPARATIONS, NAMELY ANTICOAGULANTS (U.S. CLS. 6, 18, 44, 46, 51 AND 52).
RAMONA ORTIGA, EXAMINING ATTORNEY

THE MARK CONSISTS OF STANDARD CHARACTERS WITHOUT CLAIM TO ANY PARTICULAR FONT, STYLE, SIZE, OR COLOR.
OWNER OF U.S. REG. NOS. 2,226,143, 2,887,818 AND OTHERS.
FOR DIETARY SUPPLEMENTS (U.S. CLS. 6, 18, 44, 46, 51 AND 52).
FIRST USE 9-17-2003; IN COMMERCE 9-17-2003.
RENEE MCCRAY, EXAMINING ATTORNEY

SN 78-401,855. MARIPOSA, INC., NEW HYDE PARK, NY. FILED 4-14-2004.

SN 78-398,969. BDY ACQUISITION CORP., FAIRFIELD, NJ. FILED 4-8-2004.

**ADOXA DOXYCYCLINE
TABLETS SMALL.
EASY TO SWALLOW.**

HX

THE MARK CONSISTS OF STANDARD CHARACTERS WITHOUT CLAIM TO ANY PARTICULAR FONT, STYLE, SIZE, OR COLOR.
OWNER OF U.S. REG. NO. 2,725,852.
NO CLAIM IS MADE TO THE EXCLUSIVE RIGHT TO USE "TABLETS SMALL. EASY TO SWALLOW.", APART FROM THE MARK AS SHOWN.
FOR ORAL ANTIBIOTICS FOR DERMATOLOGICAL USE (U.S. CLS. 6, 18, 44, 46, 51 AND 52).
FIRST USE 3-1-2002; IN COMMERCE 5-1-2003.
FLORENTINA BLANDU, EXAMINING ATTORNEY

THE MARK CONSISTS OF STANDARD CHARACTERS WITHOUT CLAIM TO ANY PARTICULAR FONT, STYLE, SIZE, OR COLOR.
FOR HERBAL PREPARATIONS, NAMELY, HERBAL SUPPLEMENTS; HOMEOPATHIC REMEDIES, NAMELY, SUPPLEMENTS; DIETARY AND NUTRITIONAL SUPPLEMENTS; VITAMIN COMPOUNDS; MINERAL SUPPLEMENTS; VITAMIN AND MINERAL SUPPLEMENTS (U.S. CLS. 6, 18, 44, 46, 51 AND 52).
MATTHEW KLINE, EXAMINING ATTORNEY

CLASS 5—(Continued).

SN 78-408,545. BASF AKTIENGESELLSCHAFT, LUDWIG-SHAFEN AM RHEIN, FED REP GERMANY, FILED 4-27-2004.

EXCISE

THE MARK CONSISTS OF STANDARD CHARACTERS WITHOUT CLAIM TO ANY PARTICULAR FONT, STYLE, SIZE, OR COLOR.

FOR PESTICIDES, INSECTICIDES AND HERBICIDES FOR AGRICULTURAL, COMMERCIAL AND DOMESTIC USE; FUNGICIDES; AND PREPARATIONS FOR DESTROYING VERMIN (U.S. CLS. 6, 18, 44, 46, 51 AND 52).

CHRISTOPHER ADKINS, EXAMINING ATTORNEY

CLASS 5—(Continued).

SN 78-408,812. INTEGRACLICK, INC., SARASOTA, FL. FILED 4-27-2004.

Carbodrine

THE MARK CONSISTS OF STANDARD CHARACTERS WITHOUT CLAIM TO ANY PARTICULAR FONT, STYLE, SIZE, OR COLOR.

FOR CARBOHYDRATE-BLOCKING DIETARY SUPPLEMENT (U.S. CLS. 6, 18, 44, 46, 51 AND 52).

FIRST USE 1-5-2004; IN COMMERCE 2-20-2004.

TRACY CROSS, EXAMINING ATTORNEY

SN 78-408,549. BASF AKTIENGESELLSCHAFT, LUDWIG-SHAFEN AM RHEIN, FED REP GERMANY, FILED 4-27-2004.

EXTENSIVE

THE MARK CONSISTS OF STANDARD CHARACTERS WITHOUT CLAIM TO ANY PARTICULAR FONT, STYLE, SIZE, OR COLOR.

FOR PESTICIDES, INSECTICIDES AND HERBICIDES FOR AGRICULTURAL, COMMERCIAL AND DOMESTIC USE; FUNGICIDES; AND PREPARATIONS FOR DESTROYING VERMIN (U.S. CLS. 6, 18, 44, 46, 51 AND 52).

LEIGH LOWRY, EXAMINING ATTORNEY

SN 78-411,405. THE ULTIMATE LIFE, SANTA BARBARA, CA. FILED 4-30-2004.

THE ULTIMATE MEAL

THE MARK CONSISTS OF STANDARD CHARACTERS WITHOUT CLAIM TO ANY PARTICULAR FONT, STYLE, SIZE, OR COLOR.

OWNER OF U.S. REG. NOS. 2,028,215, 2,074,462 AND OTHERS.

NO CLAIM IS MADE TO THE EXCLUSIVE RIGHT TO USE "MEAL", APART FROM THE MARK AS SHOWN.

SEC. 2(F).

FOR DIETARY NUTRITIONAL DRINK MIX FOR USE AS A MEAL REPLACEMENT (U.S. CLS. 6, 18, 44, 46, 51 AND 52).

FIRST USE 2-0-1982; IN COMMERCE 2-0-1983.

ELIZABETH J. WINTER, EXAMINING ATTORNEY

CLASS 5—(Continued).

SN 78-412,449. ENAMELITE LLC, CLARKSVILLE, TN.
FILED 5-3-2004.



The logo for Enamelite features the word "enamelite" in a bold, lowercase, sans-serif font. The letter "e" is stylized with a thick, curved line arching over it, resembling a protective coating or a dental arch. The rest of the letters are in a standard, bold font.

OWNER OF U.S. REG. NO. 2,898,045.
FOR SPRAY-ON DRY OR WET POWDER FOR APPLI-
CATION TO SOLID SURFACES FOR USE IN THE
DENTAL RESTORATION FIELD (U.S. CLS. 6, 18, 44, 46,
51 AND 52).
FIRST USE 9-30-2002; IN COMMERCE 9-30-2002.
DAVID MURRAY, EXAMINING ATTORNEY

SN 78-412,534. OFFICE OF THE PRESIDING BISHOP OF
THE TEMPLE OF HEALTH AND ECSTASY AFTER THE
ORDER OF MELCHIZEDEK, THE, BEVERLY HILLS, CA.
FILED 5-3-2004.

ECSTASY

THE MARK CONSISTS OF STANDARD CHARACTERS
WITHOUT CLAIM TO ANY PARTICULAR FONT, STYLE,
SIZE, OR COLOR.
FOR DIETARY SUPPLEMENTS, NAMELY HERBAL
FORMULATIONS (U.S. CLS. 6, 18, 44, 46, 51 AND 52).
FIRST USE 1-1-1993; IN COMMERCE 1-1-1993.
SHAUNIA WALLACE, EXAMINING ATTORNEY

CLASS 5—(Continued).

SN 78-415,219. SIGMA-TAU INDUSTRIE FARMACEUTICHE
RIUNITE S.P.A., ROMA, ITALY, FILED 5-7-2004.

CARNYDYN

THE MARK CONSISTS OF STANDARD CHARACTERS
WITHOUT CLAIM TO ANY PARTICULAR FONT, STYLE,
SIZE, OR COLOR.

OWNER OF ITALY REG. NO. 331.115, DATED 3-24-1982,
RENEWED AS REG. NO. 956366, DATED 2-18-2005, EXPIRES
3-24-2012.

FOR PHARMACEUTICAL PREPARATIONS FOR USE
IN TREATING CARDIAC DISEASES AND OTHER CON-
DITIONS REQUIRING ENERGY SUPPLEMENTATION;
DIETARY FOOD SUPPLEMENTS (U.S. CLS. 6, 18, 44, 46,
51 AND 52).

KARLA PERKINS, EXAMINING ATTORNEY

SN 78-415,487. ALFARO DE MARON, ANA ELOISA, SAN
SALVADOR, EL SALVADOR, FILED 5-8-2004.

NEURO FOSFATON

THE MARK CONSISTS OF STANDARD CHARACTERS
WITHOUT CLAIM TO ANY PARTICULAR FONT, STYLE,
SIZE, OR COLOR.

FOR NUTRITIONAL SUPPLEMENT FOR HUMAN
CONSUMPTION FOR THE BRAIN AND NERVOUS
SYSTEM WITH GLUTAMIC ACID AND PHOSPHORUS,
WHICH OXYGENATES THE METABOLISM OF THE
CEREBRAL CORTEX AND RECONSTITUTES THE
BRAIN CELLS. IN LIQUID FORM, CAPSULE FORM
AND DRINKABLE VIALS FORM (U.S. CLS. 6, 18, 44, 46,
51 AND 52).

FIRST USE 10-31-1996; IN COMMERCE 0-0-1997.
MICHAEL KEATING, EXAMINING ATTORNEY

CLASS 5—(Continued).

SN 78-417,010. CREATIVE GENETICS OF CALIFORNIA, INC., OAKDALE, CA. FILED 5-11-2004.



NO CLAIM IS MADE TO THE EXCLUSIVE RIGHT TO USE "GENETICS OF CALIFORNIA INC", APART FROM THE MARK AS SHOWN.

THE COLOR(S) BURGUNDY AND GOLD IS/ARE CLAIMED AS A FEATURE OF THE MARK.

THE MARK CONSISTS OF A VERTICAL OVAL-SHAPED BACKGROUND IN THE COLOR BURGUNDY, WITH A VERY FINE RIM OF GOLD COLOR JUST INSIDE THE PERIMETER OF THE OVAL SHAPE. WITHIN THE GOLD RIM AT THE TOP OF THE OVAL ARE OVERLAPPING STYLIZED LETTERS C AND G IN GOLD COLOR. BELOW THE STYLIZED LETTERS C AND G ARE THE WORDS "CREATIVE GENETICS OF CALIFORNIA INC". ALSO WITHIN THE PERIMETER, TOWARD THE BOTTOM OF THE OVAL, ARE TWO VERTICAL HALF-ROWS OF GOLD COINS.

FOR BULL SEMEN (U.S. CLS. 6, 18, 44, 46, 51 AND 52).
FIRST USE 2-25-2004; IN COMMERCE 2-25-2004.
SUSAN LESLIE DUBOIS, EXAMINING ATTORNEY

SN 78-417,341. TORRENT PHARMACEUTICALS LIMITED, AHMEDABAD 380009, GUJARAT, INDIA, FILED 5-12-2004.



THE MARK CONSISTS OF A SQUARE ADJACENT TO A HORIZONTAL RECTANGLE. EACH SHAPE WITH CLIPPED CORNERS; THE SQUARE CONTAINS FIVE SMALLER SQUARES ARRANGED IN AN X-SHAPED PATTERN; THE RECTANGLE CONTAINS THE WORD TORRENT.

FOR HOUSE MARK FOR A FULL LINE OF PHARMACEUTICALS (U.S. CLS. 6, 18, 44, 46, 51 AND 52).
ANNE MADDEN, EXAMINING ATTORNEY

CLASS 5—(Continued).

SN 78-417,344. TORRENT PHARMACEUTICALS LIMITED, AHMEDABAD 380009, INDIA, FILED 5-12-2004.

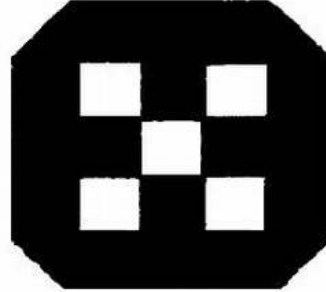

THE MARK CONSISTS OF A SQUARE WITH CLIPPED CORNERS AND CONTAINING FIVE SMALLER SQUARES ARRANGED IN AN X-SHAPED PATTERN.

FOR HOUSE MARK FOR A FULL LINE OF PHARMACEUTICALS (U.S. CLS. 6, 18, 44, 46, 51 AND 52).
WARREN L. OLANDRIA, EXAMINING ATTORNEY

SN 78-417,345. TORRENT PHARMACEUTICALS LIMITED, AHMEDABAD 380009, INDIA, FILED 5-12-2004.



THE MARK CONSISTS OF A HORIZONTAL RECTANGLE WITH CLIPPED CORNERS AND CONTAINING THE WORD TORRENT.

FOR HOUSE MARK FOR A FULL LINE OF PHARMACEUTICALS (U.S. CLS. 6, 18, 44, 46, 51 AND 52).
ANNE MADDEN, EXAMINING ATTORNEY

SN 78-419,635. FITNESS QUEST INC., CANTON, OH. FILED 5-17-2004.

Healthy Dose

THE MARK CONSISTS OF STANDARD CHARACTERS WITHOUT CLAIM TO ANY PARTICULAR FONT, STYLE, SIZE, OR COLOR.

FOR VITAMIN AND MINERAL SUPPLEMENTS (U.S. CLS. 6, 18, 44, 46, 51 AND 52).
MICHAEL KAZAZIAN, EXAMINING ATTORNEY

CLASS 5—(Continued).

SN 78-421,135. CYVEX NUTRITION, INC., IRVINE, CA.
FILED 5-18-2004.

CLASS 5—(Continued).

SN 78-424,949. WEIGHT LOSS BY DESIGN THE DOCTOR'S
CHOICE INC., HUNTINGDON VALLEY, PA. FILED 5-25-
2004.

AVOVIDA

LIPID-LO

THE MARK CONSISTS OF STANDARD CHARACTERS
WITHOUT CLAIM TO ANY PARTICULAR FONT, STYLE,
SIZE, OR COLOR.

FOR NUTRITIONAL AND FOOD SUPPLEMENTS (U.S.
CLS. 6, 18, 44, 46, 51 AND 52).
FIRST USE 5-31-2003; IN COMMERCE 5-31-2003.
ANN LINNEHAN, EXAMINING ATTORNEY

THE MARK CONSISTS OF STANDARD CHARACTERS
WITHOUT CLAIM TO ANY PARTICULAR FONT, STYLE,
SIZE, OR COLOR.

FOR NUTRITIONAL SUPPLEMENTS (U.S. CLS. 6, 18,
44, 46, 51 AND 52).
FIRST USE 0-0-2002; IN COMMERCE 0-0-2002.
RUDY R. SINGLETON, EXAMINING ATTORNEY

SN 78-421,236. SINOVAC BIOTECH CO., LTD., BEIJING,
CHINA, FILED 5-19-2004.

SN 78-426,829. NOVARTIS AG, BASEL, SWITZERLAND,
FILED 5-28-2004.

sinovac

OCTREOTHER

OWNER OF CHINA REG. NO. 3030750, DATED 1-7-2003,
EXPIRES 1-6-2013.
FOR VACCINES (U.S. CLS. 6, 18, 44, 46, 51 AND 52).
BRENDAN REGAN, EXAMINING ATTORNEY

THE MARK CONSISTS OF STANDARD CHARACTERS
WITHOUT CLAIM TO ANY PARTICULAR FONT, STYLE,
SIZE, OR COLOR.

OWNER OF SWITZERLAND REG. NO. 482592, DATED 3-
12-2001, EXPIRES 2-16-2011.
FOR PHARMACEUTICAL PREPARATIONS FOR USE
IN THE FIELD OF ONCOLOGY (U.S. CLS. 6, 18, 44, 46, 51
AND 52).
SALLY SHIH, EXAMINING ATTORNEY

CLASS 5—(Continued).

SN 78-428,771. PH DPI, LLC, POTOMAC, MD. FILED 6-2-2004.

PROSTATE SOLUTIONS

THE MARK CONSISTS OF STANDARD CHARACTERS WITHOUT CLAIM TO ANY PARTICULAR FONT, STYLE, SIZE, OR COLOR.
SEC. 2(F).
FOR NUTRITIONAL SUPPLEMENTS (U.S. CLS. 6, 18, 44, 46, 51 AND 52).
FIRST USE 10-0-1999; IN COMMERCE 10-0-1999.
JAMES GRIFFIN, EXAMINING ATTORNEY

SN 78-431,625. AOKI BIO CO., LTD., ACTON, MA. FILED 6-8-2004.

GOLDBIO

THE MARK CONSISTS OF STANDARD CHARACTERS WITHOUT CLAIM TO ANY PARTICULAR FONT, STYLE, SIZE, OR COLOR.
FOR PHARMACEUTICALS FOR THE TREATMENT OF INFLAMMATORY CONDITIONS AND SARCOMA (U.S. CLS. 6, 18, 44, 46, 51 AND 52).
JOHN E. MICHOS, EXAMINING ATTORNEY

CLASS 5—(Continued).

SN 78-433,785. NOVARTIS AG, BASEL, SWITZERLAND, FILED 6-11-2004.



OWNER OF SWITZERLAND REG. NO. 509923, DATED 4-22-2004, EXPIRES 4-22-2014.
FOR HOUSE MARK FOR A FULL LINE OF PHARMACEUTICAL PREPARATIONS FOR HUMAN USE (U.S. CLS. 6, 18, 44, 46, 51 AND 52).
JAMES A. RAUEN, EXAMINING ATTORNEY

SN 78-433,992. SCHERING CORPORATION, KENILWORTH, NJ. FILED 6-11-2004.

PEG-REBETRON

THE MARK CONSISTS OF STANDARD CHARACTERS WITHOUT CLAIM TO ANY PARTICULAR FONT, STYLE, SIZE, OR COLOR.
OWNER OF U.S. REG. NOS. 2,504,912 AND 2,747,045.
"PEG-REBETRON" DOES NOT IDENTIFY A LIVING INDIVIDUAL.
FOR ANTIVIRAL PREPARATIONS (U.S. CLS. 6, 18, 44, 46, 51 AND 52).
STEVEN R. FOSTER, EXAMINING ATTORNEY

CLASS 5—(Continued).

SN 78-434,784. NOVARTIS AG, BASEL, SWITZERLAND, FILED 6-14-2004.

FEPAXIM

THE MARK CONSISTS OF STANDARD CHARACTERS WITHOUT CLAIM TO ANY PARTICULAR FONT, STYLE, SIZE, OR COLOR.

PRIORITY CLAIMED UNDER SEC. 44(D) ON SWITZERLAND APPLICATION NO. 1524/2004, FILED 4-28-2004, REG. NO. 521385, DATED 5-11-2004, EXPIRES 5-11-2014.

FOR PHARMACEUTICAL PREPARATIONS FOR THE PREVENTION AND TREATMENT OF DISORDERS OF THE NERVOUS SYSTEM, THE IMMUNE SYSTEM, THE CARDIOVASCULAR SYSTEM, THE RESPIRATORY SYSTEM, THE MUSCULOSKELETAL SYSTEM, THE GENITOURINARY SYSTEM, FOR THE TREATMENT OF INFLAMMATORY DISORDERS, FOR USE IN DERMATOLOGY, IN ONCOLOGY, IN HEMATOLOGY, IN OPHTHALMOLOGY, FOR USE IN THE GASTROENTEROLOGICAL AREA AND THE PREVENTION AND TREATMENT OF OCULAR DISORDERS OR DISEASES; ANTI-INFECTIVES, PHARMACEUTICAL PREPARATIONS TREATING BACTERIA-BASED DISEASES, ANTIVIRALS, ANTI-BIOTICS, ANTI-FUNGALS (U.S. CLS. 6, 18, 44, 46, 51 AND 52).

ROBIN CHOSID, EXAMINING ATTORNEY

SN 78-434,845. POLYMEDCO, INC., CORTLANDT MANOR, NY. FILED 6-14-2004.

SED-CHEK

THE MARK CONSISTS OF STANDARD CHARACTERS WITHOUT CLAIM TO ANY PARTICULAR FONT, STYLE, SIZE, OR COLOR.

FOR DIAGNOSTIC REAGENTS FOR CLINICAL MEDICAL LABORATORY USE IN THE FIELD OF HEMATOLOGY (U.S. CLS. 6, 18, 44, 46, 51 AND 52).

FIRST USE 3-28-1996; IN COMMERCE 3-28-1996.
DAWN FELDMAN, EXAMINING ATTORNEY

CLASS 5—(Continued).

SN 78-435,454. ELAN PHARMA INTERNATIONAL LIMITED, SHANNON COUNTY CLARE, IRELAND, FILED 6-15-2004.

ANTERAGREN

THE MARK CONSISTS OF STANDARD CHARACTERS WITHOUT CLAIM TO ANY PARTICULAR FONT, STYLE, SIZE, OR COLOR.

FOR PHARMACEUTICAL PREPARATIONS FOR THE PREVENTION, TREATMENT AND DIAGNOSIS OF INFLAMMATORY DISORDERS, DISEASES AND CONDITIONS, AND FOR THE PREVENTION, TREATMENT AND DIAGNOSIS OF PHYSIOLOGICAL CONDITIONS RELATING TO CELL ADHESION, SIGNALING AND MIGRATION (U.S. CLS. 6, 18, 44, 46, 51 AND 52).

MARY CRAWFORD, EXAMINING ATTORNEY

SN 78-435,465. ELAN PHARMA INTERNATIONAL LIMITED, SHANNON COUNTY CLARE, IRELAND, FILED 6-15-2004.

VANTEGRAC

THE MARK CONSISTS OF STANDARD CHARACTERS WITHOUT CLAIM TO ANY PARTICULAR FONT, STYLE, SIZE, OR COLOR.

FOR PHARMACEUTICAL PREPARATIONS FOR THE PREVENTION, TREATMENT AND DIAGNOSIS OF INFLAMMATORY DISORDERS, DISEASES AND CONDITIONS, AND FOR THE PREVENTION, TREATMENT AND DIAGNOSIS OF PHYSIOLOGICAL CONDITIONS RELATING TO CELL ADHESION, SIGNALING AND MIGRATION (U.S. CLS. 6, 18, 44, 46, 51 AND 52).

MARY CRAWFORD, EXAMINING ATTORNEY

CLASS 5—(Continued).

SN 78-446,823. AGRI BEEF CO., NAMPA, ID. FILED 7-7-2004.

RUMAX

THE MARK CONSISTS OF STANDARD CHARACTERS WITHOUT CLAIM TO ANY PARTICULAR FONT, STYLE, SIZE, OR COLOR.

FOR LIQUID LIVESTOCK FEED SUPPLEMENT EITHER SOLD IN BULK AND DELIVERED BY TANKER OR AS A COMPONENT OF A MECHANIZED FEED SUPPLEMENT DELIVERY SYSTEM (U.S. CLS. 6, 18, 44, 46, 51 AND 52).

FIRST USE 12-31-1987; IN COMMERCE 12-31-1987.
KAREN K. BUSH, EXAMINING ATTORNEY

CLASS 5—(Continued).

SN 78-449,239. MEHARG, ROBERT LEE, STEVENSVILLE, MT. FILED 7-12-2004.



THE MARK CONSISTS OF MASK-A-SCENT, IN NEW WESTMINSTER FONT, AND BORDERED BY A "APPROPRIATE WIDTH" LINE/RECTANGLE WITH SMALL ROUNDED CORNERS.

FOR ODOR-NEUTRALIZING PREPARATION STRIP/ COUPON, CONTAINING AN AROMA/SCENT ON THE "USER" SIDE AND AN ADHESIVE SIDE TO AFFIX TO PAPER, CLOTH, PLASTIC OR RUBBER MASKS, COMMONLY USED IN MEDICINE, NURSING, NURSING HOMES, CONSTRUCTION TRADES, RESTAURANTS AND/OR SIMILAR OCCUPATIONS WHERE UNPLEASANT ODORS CAN BE MINIMIZED WITH THIS PRODUCT IN THE MASK (U.S. CLS. 6, 18, 44, 46, 51 AND 52).

ALEX KEAM, EXAMINING ATTORNEY

SN 78-447,635. KLEARSEN CORPORATION, BOULDER, CO. FILED 7-8-2004.

Healing Rain

THE MARK CONSISTS OF STANDARD CHARACTERS WITHOUT CLAIM TO ANY PARTICULAR FONT, STYLE, SIZE, OR COLOR.

NO CLAIM IS MADE TO THE EXCLUSIVE RIGHT TO USE "HEALING", APART FROM THE MARK AS SHOWN.

FOR TOPICAL SKIN TREATMENTS, NAMELY MEDICATED SKIN CARE PREPARATIONS (U.S. CLS. 6, 18, 44, 46, 51 AND 52).

FIRST USE 4-1-2004; IN COMMERCE 5-1-2004.
WON TEAK OH, EXAMINING ATTORNEY

SN 78-449,866. INTARCIA THERAPEUTICS, INC., EMERYVILLE, CA. FILED 7-13-2004.

INTARCIA

THE MARK CONSISTS OF STANDARD CHARACTERS WITHOUT CLAIM TO ANY PARTICULAR FONT, STYLE, SIZE, OR COLOR.

FOR PHARMACEUTICAL PREPARATIONS FOR THE TREATMENT OF CANCER; ANTIVIRALS (U.S. CLS. 6, 18, 44, 46, 51 AND 52).

SUE LAWRENCE, EXAMINING ATTORNEY

CLASS 5—(Continued).

SN 78-450,654. GLAXO GROUP LIMITED, GREENFORD, MIDDLESEX, UNITED KINGDOM, FILED 7-14-2004.

ALLERMIST

THE MARK CONSISTS OF STANDARD CHARACTERS WITHOUT CLAIM TO ANY PARTICULAR FONT, STYLE, SIZE, OR COLOR.

PRIORITY CLAIMED UNDER SEC. 44(D) ON UNITED KINGDOM APPLICATION NO. 2367455, FILED 7-5-2004, REG. NO. 2367455, DATED 7-5-2004, EXPIRES 7-5-2014.

FOR PHARMACEUTICAL PREPARATIONS AND SUBSTANCES FOR THE TREATMENT OF INFECTIOUS DISEASES, PAIN, INFLAMMATION, SEPSIS, ALOPECIA AND OBESITY, AND FOR THE TREATMENT OF VIRAL, METABOLIC, MUSCULOSKELETAL, CARDIO-PULMONARY, GENITOURINARY, ONCOLOGICAL, RESPIRATORY, NEUROLOGICAL, GASTROINTESTINAL, HORMONAL, DERMATOLOGICAL AND PSYCHIATRIC RELATED DISEASES AND DISORDERS AND SKIN AND TISSUE REPAIR PREPARATIONS (U.S. CLS. 6, 18, 44, 46, 51 AND 52).

JOHN DALIER, EXAMINING ATTORNEY

CLASS 5—(Continued).

SN 78-451,742. PFIZER INC., NEW YORK, NY. FILED 7-16-2004.

TRAVASERT

THE MARK CONSISTS OF STANDARD CHARACTERS WITHOUT CLAIM TO ANY PARTICULAR FONT, STYLE, SIZE, OR COLOR.

FOR VETERINARY PREPARATIONS AND SUBSTANCES FOR THE PREVENTION AND TREATMENT OF OCULAR DISORDERS, ORAL DISEASES, DISORDERS OF THE NERVOUS SYSTEM, THE BLOOD AND IMMUNE SYSTEM, THE CARDIO-VASCULAR SYSTEM, THE RESPIRATORY SYSTEM, THE MUSCULO-SKELETAL SYSTEM, THE DIGESTIVE SYSTEM, THE GENITOURINARY SYSTEM, AND THE REPRODUCTIVE SYSTEM; VETERINARY PREPARATIONS AND SUBSTANCES FOR THE TREATMENT AND PREVENTION OF INFECTIOUS DISEASES, OBESITY, BEHAVIORAL DISORDERS AND INFLAMMATORY DISORDERS; VETERINARY PREPARATIONS AND SUBSTANCES FOR USE IN DERMATOLOGY, ONCOLOGY, HEMATOLOGY, OPHTHALMOLOGY, AND GASTROENTEROLOGY; NUTRITIONAL ADDITIVES AND FOOD SUPPLEMENTS; DENTAL CARE PREPARATIONS; ANTI-INFECTIVES; ANTI-BACTERIALS; ANTIVIRALS; ANTIBIOTICS; ANTIFUNGALS; ANTHELMINTICS; PARASITICIDES; ANALGESICS AND ANTI-ALLERGENS; ALL OF THE FOREGOING FOR TREATING FELINES, CANINES, BOVINES, PORCINES, EQUINES, RABBITS, POULTRY, GOATS AND SHEEP (U.S. CLS. 6, 18, 44, 46, 51 AND 52).

ZACHARY BELLO, EXAMINING ATTORNEY

SN 78-452,466. AOKI BIO CO., LTD, ACTON, MA. FILED 7-19-2004.

SN 78-451,427. SILVERMAN, JAMES, DAVIE, FL. FILED 7-15-2004.

YGSRS



FOR NUTRITIONAL SUPPLEMENTS (U.S. CLS. 6, 18, 44, 46, 51 AND 52).

KATHERINE STOIDES, EXAMINING ATTORNEY

THE MARK CONSISTS OF STANDARD CHARACTERS WITHOUT CLAIM TO ANY PARTICULAR FONT, STYLE, SIZE, OR COLOR.

FOR PHARMACEUTICALS FOR THE TREATMENT OF INFLAMMATORY CONDITIONS AND SARCOMA (U.S. CLS. 6, 18, 44, 46, 51 AND 52).

JOHN E. MICHOS, EXAMINING ATTORNEY

CLASS 5—(Continued).

SN 78-458,572. GRUBER, EDWARD R., BROOKLYN, NY.
FILED 7-29-2004.



NO CLAIM IS MADE TO THE EXCLUSIVE RIGHT TO USE "RESEARCH", APART FROM THE MARK AS SHOWN. FOR VITAMIN/MINERAL/HERBAL SUPPLEMENTS (U.S. CLS. 6, 18, 44, 46, 51 AND 52). FIRST USE 8-28-2002; IN COMMERCE 8-28-2002. ELLEN BURNS, EXAMINING ATTORNEY

SN 78-458,759. GLAXO GROUP LIMITED, GREENFORD, MIDDLESEX, UNITED KINGDOM, FILED 7-29-2004.

CLASS 5—(Continued).

SN 78-468,506. AGRI BEEF CO., NAMPA, ID. FILED 8-17-2004.

CAF BOOST

THE MARK CONSISTS OF STANDARD CHARACTERS WITHOUT CLAIM TO ANY PARTICULAR FONT, STYLE, SIZE, OR COLOR.

NO CLAIM IS MADE TO THE EXCLUSIVE RIGHT TO USE "CALF", APART FROM THE MARK AS SHOWN.

FOR FEED SUPPLEMENTS FOR LIVESTOCK (U.S. CLS. 6, 18, 44, 46, 51 AND 52).

FIRST USE 5-21-2004; IN COMMERCE 5-21-2004. GWEN STOKOLS, EXAMINING ATTORNEY

SN 78-468,699. DENTON, ROBERT M., FELTON, CA. FILED 8-17-2004.

PANEROF

THE MARK CONSISTS OF STANDARD CHARACTERS WITHOUT CLAIM TO ANY PARTICULAR FONT, STYLE, SIZE, OR COLOR.

PRIORITY CLAIMED UNDER SEC. 44(D) ON UNITED KINGDOM APPLICATION NO. 2368653, FILED 7-21-2004, REG. NO. 2368653, DATED 7-21-2004, EXPIRES 7-21-2014.

FOR PHARMACEUTICAL PREPARATIONS AND SUBSTANCES FOR THE TREATMENT OF INFECTIOUS DISEASES, PAIN, INFLAMMATION, SEPSIS, ALOPECIA AND OBESITY, AND FOR THE TREATMENT OF VIRAL, METABOLIC, MUSCULOSKELETAL, CARDIOPULMONARY, GENITOURINARY, ONCOLOGICAL, RESPIRATORY, NEUROLOGICAL, GASTROINTESTINAL, HORMONAL, DERMATOLOGICAL AND PSYCHIATRIC RELATED DISEASES AND DISORDERS AND SKIN AND TISSUE REPAIR PREPARATIONS (U.S. CLS. 6, 18, 44, 46, 51 AND 52).

KIMBERLY FRYE, EXAMINING ATTORNEY



THE MARK CONSISTS OF SINK THE STINK IS IN A CARTOON FONT.

FOR DEODORIZERS FOR USE IN MARINE AND AQUATIC APPLICATIONS NAMELY, DEODORIZING WET SUITS, LIFE JACKETS, SCUBA EQUIPMENT, HEADS, BAIT WELLS, BOOTIES, AQUARIUMS AND NON-MARINE RELATED APPLICATIONS NAMELY, HOCKEY PADS AND OTHER SPORTING EQUIPMENT, RUNNING SHOES, PET ACCIDENTS AND CAMPING EQUIPMENT (U.S. CLS. 6, 18, 44, 46, 51 AND 52).

FIRST USE 5-5-1994; IN COMMERCE 5-5-1994. JASON TURNER, EXAMINING ATTORNEY

CLASS 5—(Continued).

SN 78-469,697. VNS INNOVATIONS, NOVI, MI. FILED 8-18-2004.



THE COLOR(S) GREEN, WHITE AND YELLOW IS/ARE CLAIMED AS A FEATURE OF THE MARK.

THE MARK CONTAINS WHITE LETTERS WITH YELLOW KEY LINING ON A GREEN BANNER.

FOR DISPOSABLE DRESS LINERS IMPREGNATED WITH CHEMICALS OR COMPOUNDS FOR PERSONAL USE (U.S. CLS. 6, 18, 44, 46, 51 AND 52).

CHARLES JOYNER, EXAMINING ATTORNEY

SN 78-471,675. NOVARTIS AG, BASEL, SWITZERLAND, FILED 8-23-2004.

SANDOGLOBULIN

THE MARK CONSISTS OF STANDARD CHARACTERS WITHOUT CLAIM TO ANY PARTICULAR FONT, STYLE, SIZE, OR COLOR.

OWNER OF SWITZERLAND REG. NO. 294019, DATED 4-14-1978, EXPIRES 4-14-2008.

FOR PHARMACEUTICAL PREPARATIONS FOR THE PREVENTION AND TREATMENT OF DISORDERS OF THE NERVOUS SYSTEM, THE IMMUNE SYSTEM, THE CARDIO-VASCULAR SYSTEM, THE RESPIRATORY SYSTEM, THE MUSCULO-SKELETAL SYSTEM, THE GENITOURINARY SYSTEM, FOR THE TREATMENT OF INFLAMMATORY DISORDERS, FOR USE IN DERMATOLOGY, IN ONCOLOGY, IN HEMATOLOGY, IN TRANSPLANTATION, IN OPHTHALMOLOGY, FOR USE IN THE GASTROENTEROLOGICAL AREA AND THE PREVENTION AND TREATMENT OF OCULAR DISORDERS OR DISEASES; ANTI-INFECTIVES, ANTI-BACTERIALS, ANTIVIRALS, ANTI-BIOTICS, ANTI-FUNGALS (U.S. CLS. 6, 18, 44, 46, 51 AND 52).

ZACHARY BELLO, EXAMINING ATTORNEY

CLASS 5—(Continued).

SN 78-472,057. ADVANCED PROTEIN SYSTEMS, LLC, PHOENIX, AZ. FILED 8-23-2004.

Immulox

THE MARK CONSISTS OF STANDARD CHARACTERS WITHOUT CLAIM TO ANY PARTICULAR FONT, STYLE, SIZE, OR COLOR.

FOR NATURAL HEALTH PRODUCT, NAMELY, A DIETARY SUPPLEMENT EXTRACTED FROM BOVINE COLOSTRUM USED TO ENHANCE IMMUNITY (U.S. CLS. 6, 18, 44, 46, 51 AND 52).

MELISSA VALLILLO, EXAMINING ATTORNEY

SN 78-472,609. KUSTOMER KINETICS, INC., ARCADIA, CA. AND SENSUOUS SOLUTIONS, LLC, ARCADIA, CA. FILED 8-24-2004.

**Chloro-Clear
Whirlpool
Antiseptic Additive**

THE MARK CONSISTS OF STANDARD CHARACTERS WITHOUT CLAIM TO ANY PARTICULAR FONT, STYLE, SIZE, OR COLOR.

NO CLAIM IS MADE TO THE EXCLUSIVE RIGHT TO USE "WHIRLPOOL ANTISEPTIC ADDITIVE", APART FROM THE MARK AS SHOWN.

FOR DISINFECTANTS FOR HYGIENIC PURPOSES, NAMELY A WHIRLPOOL ANTISEPTIC ADDITIVE CONTAINING 100% CHLORAMINE-T IN A WATER-SOLUBLE POUCH (U.S. CLS. 6, 18, 44, 46, 51 AND 52).

FIRST USE 1-15-1997; IN COMMERCE 2-20-1997.

TIMOTHY FINNEGAN, EXAMINING ATTORNEY

CLASS 5—(Continued).

SN 78-472,660. PHYSIOGARD LLC, PALM SPRINGS, CA. FILED 8-24-2004.

CLASS 5—(Continued).

SN 78-473,193. CAMBRIDGE DIAGNOSTIC PRODUCTS, INC., FORT LAUDERDALE, FL. FILED 8-25-2004.

PHYSIOGARD

POLY-TET

THE MARK CONSISTS OF STANDARD CHARACTERS WITHOUT CLAIM TO ANY PARTICULAR FONT, STYLE, SIZE, OR COLOR.

FOR PHARMACEUTICALS USED TO TREAT ACUTE ADVERSE HEALTH EVENTS, NAMELY, CARDIOPULMONARY EMERGENCIES, ABDOMINAL EMERGENCIES, NERVOUS SYSTEM EMERGENCIES, ENDOCRINE AND METABOLIC EMERGENCIES, AND IMMUNOLOGICAL EMERGENCIES (U.S. CLS. 6, 18, 44, 46, 51 AND 52).

MELISSA VALLILLO, EXAMINING ATTORNEY

THE MARK CONSISTS OF STANDARD CHARACTERS WITHOUT CLAIM TO ANY PARTICULAR FONT, STYLE, SIZE, OR COLOR.

FOR HEMATOLOGICAL STAIN FOR USE IN MEDICAL LABORATORY BLOOD ANALYSIS, NAMELY, DIAGNOSTIC PREPARATIONS FOR MEDICAL LABORATORY USE (U.S. CLS. 6, 18, 44, 46, 51 AND 52).

FIRST USE 2-26-1990; IN COMMERCE 2-26-1990.

JOHN DWYER, EXAMINING ATTORNEY

SN 78-473,077. TROUW NUTRITION USA, LLC, HIGHLAND, IL. FILED 8-25-2004.

SN 78-476,769. SENSUOUS SOLUTIONS, LLC, ARCADIA, CA. FILED 8-31-2004.

PROGENOS

SOFT SOAK SANITIZING MANICURE TABLETS

THE MARK CONSISTS OF STANDARD CHARACTERS WITHOUT CLAIM TO ANY PARTICULAR FONT, STYLE, SIZE, OR COLOR.

FOR FEED ADDITIVE FOR LIVESTOCK, POULTRY AND COMPANION ANIMALS (U.S. CLS. 6, 18, 44, 46, 51 AND 52).

FIRST USE 7-30-2004; IN COMMERCE 7-30-2004.

BRIAN NEVILLE, EXAMINING ATTORNEY

THE MARK CONSISTS OF STANDARD CHARACTERS WITHOUT CLAIM TO ANY PARTICULAR FONT, STYLE, SIZE, OR COLOR.

NO CLAIM IS MADE TO THE EXCLUSIVE RIGHT TO USE "SOAK SANITIZING MANICURE TABLET", APART FROM THE MARK AS SHOWN.

FOR SANITIZING MANICURE TABLET CONTAINING TRICLOSAN, CONDITIONERS AND MOISTURIZERS TO TREAT SKIN, CUTICLES AND FINGERNAILS (U.S. CLS. 6, 18, 44, 46, 51 AND 52).

FIRST USE 12-19-2001; IN COMMERCE 1-2-2002.

BARBARA BROWN, EXAMINING ATTORNEY

CLASS 5—(Continued).

SN 78-477,771. NUANGEL, INC., ATHENS, AL. FILED 9-2-2004.



OWNER OF U.S. REG. NO. 1,796,325.
 THE MARK CONSISTS OF STYLIZED LETTERING FOR THE WORD "NUANGEL" IN THE FOREGROUND, A SET OF HEAVENLY WINGS IN THE BACKGROUND, AND A HALO POSITIONED IN THE CENTER ABOVE THE WINGS.
 FOR NURSING BRA PADS (U.S. CLS. 6, 18, 44, 46, 51 AND 52).
 FIRST USE 12-31-2003; IN COMMERCE 12-31-2003.
 SHARON MEIER, EXAMINING ATTORNEY

CLASS 5—(Continued).

SN 78-487,910. AMPHASTAR PHARMACEUTICALS, INC., RANCHO CUCAMONGA, CA. FILED 9-22-2004.

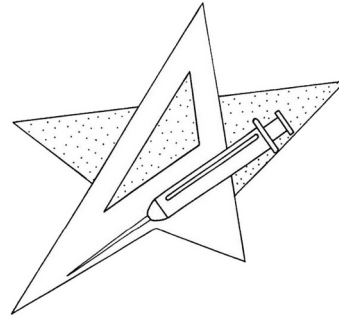

OWNER OF U.S. REG. NO. 2,849,356.
 THE STIPPLING IN THE DRAWING IS FOR SHADING PURPOSES ONLY.
 THE MARK CONSISTS OF A STYLIZED LETTER A, A STAR AND A SYRINGE.
 FOR PHARMACEUTICAL, NAMELY, ANALGESICS (U.S. CLS. 6, 18, 44, 46, 51 AND 52).
 FIRST USE 10-6-2003; IN COMMERCE 10-6-2003.
 JOHN DALIER, EXAMINING ATTORNEY

SN 78-478,511. STELLA PHARMACEUTICAL COMPANY INC., DAYTON, NJ. FILED 9-3-2004.



OWNER OF U.S. REG. NO. 2,848,734.
 NO CLAIM IS MADE TO THE EXCLUSIVE RIGHT TO USE "LITE ON CARBS", APART FROM THE MARK AS SHOWN.
 FOR MEAL REPLACEMENT AND NUTRITIONAL BARS (U.S. CLS. 6, 18, 44, 46, 51 AND 52).
 FIRST USE 2-25-2004; IN COMMERCE 2-25-2004.
 ELLEN BURNS, EXAMINING ATTORNEY

SN 78-491,849. CEMINES, INC., GOLDEN, CO. FILED 9-29-2004.

SN 78-486,075. GLAXOSMITHKLINE CONSUMER HEALTH-CARE L.P., WILMINGTON, DE. FILED 9-20-2004.

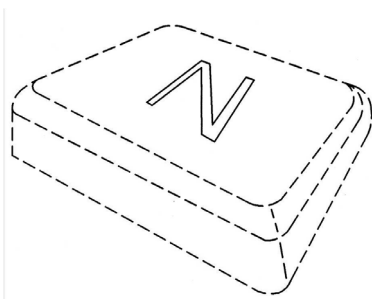

OWNER OF U.S. REG. NOS. 992,648 AND 1,186,363.
 THE MARK CONSISTS OF A PIECE OF GUM WITH THE LETTER N ON THE TOP; NO CLAIM IS MADE TO THE MATTER APPEARING IN THE DOTTED LINES; IT SERVES MERELY TO SHOW THE PLACEMENT OF THE MARK.
 FOR PHARMACEUTICAL PREPARATIONS, NAMELY, MEDICATIONS FOR SUPPRESSING, REDUCING OR ELIMINATING SMOKING AND THE URGE TO SMOKE (U.S. CLS. 6, 18, 44, 46, 51 AND 52).
 ROBERT LAVACHE, EXAMINING ATTORNEY

TRIAL VIAL

THE MARK CONSISTS OF STANDARD CHARACTERS WITHOUT CLAIM TO ANY PARTICULAR FONT, STYLE, SIZE, OR COLOR.
 FOR DIAGNOSTIC AND THERAPEUTIC ANTIBODY PREPARATIONS FOR CLINICAL AND MEDICAL RESEARCH LABORATORY USE (U.S. CLS. 6, 18, 44, 46, 51 AND 52).
 FIRST USE 9-15-2004; IN COMMERCE 9-15-2004.
 TEJBIR SINGH, EXAMINING ATTORNEY

CLASS 5—(Continued).

SN 78-493,038. ANIMAL HEALTHCARE PRODUCTS, INC./
PRODUITS DE SOINS ET SANTE ANIMALS, INC.,
BEACONSFIELD, QUEBEC, CANADA, FILED 10-1-2004.

CLASS 5—(Continued).

SN 78-494,950. JARROW FORMULAS, INC., LOS ANGELES,
CA. FILED 10-5-2004.

Predict-A-Foal

MITYQONDRIA

THE MARK CONSISTS OF STANDARD CHARACTERS
WITHOUT CLAIM TO ANY PARTICULAR FONT, STYLE,
SIZE, OR COLOR.

SEC. 2(F).
FOR IN VITRO DIAGNOSTIC PREGNANCY TEST
KITS TO ASSIST IN DETERMINING THE TIME WHEN
A MARE WILL FOAL (U.S. CLS. 6, 18, 44, 46, 51 AND 52).
FIRST USE 9-5-1986; IN COMMERCE 9-5-1986.
DAWN HAN, EXAMINING ATTORNEY

THE MARK CONSISTS OF STANDARD CHARACTERS
WITHOUT CLAIM TO ANY PARTICULAR FONT, STYLE,
SIZE, OR COLOR.

FOR DIETARY AND NUTRITIONAL SUPPLEMENTS
(U.S. CLS. 6, 18, 44, 46, 51 AND 52).
WON TEAK OH, EXAMINING ATTORNEY

SN 78-493,047. BRISTOL-MYERS SQUIBB MEDICAL IMA-
GING, INC., NEW YORK, NY. FILED 10-1-2004.

SN 78-495,337. HEALTHPOINT, LTD., SAN ANTONIO, TX.
FILED 10-6-2004.

HARMODENE

ACTOGEN

THE MARK CONSISTS OF STANDARD CHARACTERS
WITHOUT CLAIM TO ANY PARTICULAR FONT, STYLE,
SIZE, OR COLOR.

FOR PHARMACEUTICAL PREPARATIONS FOR THE
TREATMENT AND PREVENTION OF DIABETES, IN-
CONTINENCE, CARDIOVASCULAR DISEASES, CENTRAL
NERVOUS SYSTEM DISEASES AND
DISORDERS, STROKE, CANCER, INFLAMMATION
AND INFLAMMATORY DISEASES, RESPIRATORY
AND INFECTIOUS DISEASES, AUTO-IMMUNE DIS-
EASES, SOLID ORGAN TRANSPLANT REJECTION;
PHARMACEUTICAL PREPARATIONS, NAMELY, ANTI-
BIOTICS, ANTIFUNGALS AND IMMUNOSUPPRES-
SANTS; DIAGNOSTIC IMAGING AND ULTRASOUND
CONTRAST AGENTS; PHARMACEUTICAL PREPARA-
TIONS FOR IDENTIFYING AND DIAGNOSING CARDI-
OVASCULAR DISEASES AND CONDITIONS (U.S. CLS.
6, 18, 44, 46, 51 AND 52).
RAMONA ORTIGA, EXAMINING ATTORNEY

THE MARK CONSISTS OF STANDARD CHARACTERS
WITHOUT CLAIM TO ANY PARTICULAR FONT, STYLE,
SIZE, OR COLOR.

FOR CHEMICAL STERILANT AND DISINFECTANT
FOR STERILIZATION OR HIGH LEVEL DISINFECTING
OF MEDICAL EQUIPMENT (U.S. CLS. 6, 18, 44, 46, 51
AND 52).
BARBARA A. LOUGHRAN, EXAMINING ATTORNEY

CLASS 5—(Continued).

SN 78-495,803. WESTERN HOLDINGS, LLC, CHEYENNE, WY. FILED 10-6-2004.

CLASS 5—(Continued).

SN 78-496,127. PFIZER INC., NEW YORK, NY. FILED 10-7-2004.

STIM-FREE

THE MARK CONSISTS OF STANDARD CHARACTERS WITHOUT CLAIM TO ANY PARTICULAR FONT, STYLE, SIZE, OR COLOR.
FOR DIETARY SUPPLEMENTS (U.S. CLS. 6, 18, 44, 46, 51 AND 52).
CATHERINE FAINT, EXAMINING ATTORNEY

SN 78-495,819. POLICH, NANCY J, NAPERVILLE, IL. FILED 10-6-2004.

Injurease

THE MARK CONSISTS OF STANDARD CHARACTERS WITHOUT CLAIM TO ANY PARTICULAR FONT, STYLE, SIZE, OR COLOR.
FOR HOMEOPATHIC PHARMACEUTICALS FOR USE IN THE TREATMENT OF MUSCULO-SKELETAL INJURIES (U.S. CLS. 6, 18, 44, 46, 51 AND 52).
MELVIN AXILBUND, EXAMINING ATTORNEY

ATUBRI

THE MARK CONSISTS OF STANDARD CHARACTERS WITHOUT CLAIM TO ANY PARTICULAR FONT, STYLE, SIZE, OR COLOR.

FOR PHARMACEUTICAL PREPARATIONS FOR THE TREATMENT OF CARDIOVASCULAR DISEASES AND DISORDERS, CENTRAL NERVOUS SYSTEM AND NEUROLOGICAL DISEASES AND DISORDERS, UROLOGICAL AND UROGENITAL DISEASES AND DISORDERS, GASTROINTESTINAL DISEASES AND DISORDERS, MUSCULOSKELETAL DISEASES AND DISORDERS, MIGRAINES, PAIN, HYPERTENSION, INFLAMMATION AND INFLAMMATORY DISEASES AND DISORDERS, METABOLIC DISEASES AND DISORDERS, RESPIRATORY AND INFECTIOUS DISEASES AND DISORDERS, IMMUNOLOGICAL, BACTERIAL, VIRAL AND FUNGAL DISEASES AND DISORDERS, PSYCHIATRIC DISEASES AND DISORDERS, ALLERGIES, DIABETES, OBESITY, STROKE, ERECTILE AND SEXUAL DYSFUNCTION, AND HEMOLYTIC DISEASES AND DISORDERS, PHARMACEUTICAL PREPARATIONS, NAMELY, CHOLESTEROL PREPARATIONS, OSTEOPOROSIS PREPARATIONS, ONCOLOGICAL PREPARATIONS, DERMATOLOGICAL PREPARATIONS, OPHTHALMOLOGIC PREPARATIONS, SMOKING CESSATION PREPARATIONS, TISSUE AND SKIN REPAIR PREPARATIONS AND GYNECOLOGICAL PREPARATIONS (U.S. CLS. 6, 18, 44, 46, 51 AND 52).
JASON TURNER, EXAMINING ATTORNEY

SN 78-496,665. OSMOPHARM, USA, POMPANO BEACH, FL. FILED 10-8-2004.

GREEN-CO-FEX

THE MARK CONSISTS OF STANDARD CHARACTERS WITHOUT CLAIM TO ANY PARTICULAR FONT, STYLE, SIZE, OR COLOR.
FOR NUTRITIONAL SUPPLEMENTS (U.S. CLS. 6, 18, 44, 46, 51 AND 52).
LANA PHAM, EXAMINING ATTORNEY

CLASS 5—(Continued).

SN 78-497,211. NEXT PROTEINS, INC., CARLSBAD, CA. FILED 10-8-2004.

CLASS 5—(Continued).

SN 78-498,096. HEALTH FOOD ASSOCIATES, INC., TULSA, OK. FILED 10-12-2004.

NonStop

ALL-WELL

THE MARK CONSISTS OF STANDARD CHARACTERS WITHOUT CLAIM TO ANY PARTICULAR FONT, STYLE, SIZE, OR COLOR.
FOR DIETARY SUPPLEMENT DRINK CONSISTING OF WHEY PROTEIN (U.S. CLS. 6, 18, 44, 46, 51 AND 52).
TRACY FLETCHER, EXAMINING ATTORNEY

THE MARK CONSISTS OF STANDARD CHARACTERS WITHOUT CLAIM TO ANY PARTICULAR FONT, STYLE, SIZE, OR COLOR.
FOR VITAMIN, MINERAL, AND HERBAL EXTRACTS (U.S. CLS. 6, 18, 44, 46, 51 AND 52).
FIRST USE 12-30-1996; IN COMMERCE 12-30-1996.
PAULA MAYS, EXAMINING ATTORNEY

SN 78-498,004. BARLEAN'S ORGANIC OILS, FERNDALE, WA. FILED 10-11-2004.

SN 78-498,360. AHG, LLC, CHESTNUT HILL, MA. FILED 10-12-2004.

FRESH CATCH

SIMREG

THE MARK CONSISTS OF STANDARD CHARACTERS WITHOUT CLAIM TO ANY PARTICULAR FONT, STYLE, SIZE, OR COLOR.
FOR FISH OIL DIETARY SUPPLEMENTS, SOLD IN CAPSULE AND LIQUID FORM (U.S. CLS. 6, 18, 44, 46, 51 AND 52).
DAVID H. STINE, EXAMINING ATTORNEY

THE MARK CONSISTS OF STANDARD CHARACTERS WITHOUT CLAIM TO ANY PARTICULAR FONT, STYLE, SIZE, OR COLOR.
OWNER OF U.S. REG. NO. 1,327,940.
FOR SMALL MOLECULAR WEIGHT SUBSTANCES USED TO TREAT DISORDERS OF THE HUMAN IMMUNE SYSTEM (U.S. CLS. 6, 18, 44, 46, 51 AND 52).
DAVID MURRAY, EXAMINING ATTORNEY

CLASS 5—(Continued).

SN 78-498,592. DURHAM'S BEE FARM, INC., WALLS, MS. FILED 10-12-2004.

CLASS 5—(Continued).

SN 78-499,675. GENE BIOTECHNOLOGY CORPORATION, LOS ANGELES, CA. FILED 10-14-2004.

Blister-Rid

THE MARK CONSISTS OF STANDARD CHARACTERS WITHOUT CLAIM TO ANY PARTICULAR FONT, STYLE, SIZE, OR COLOR.

FOR HONEYBEE PROPOLIS FOR SUPPLEMENT USE FOR MEDICINAL OR THERAPEUTIC PURPOSES (U.S. CLS. 6, 18, 44, 46, 51 AND 52).

FIRST USE 9-29-2003; IN COMMERCE 9-29-2003.
RUSS HERMAN, EXAMINING ATTORNEY

INCONTI-CARE

THE MARK CONSISTS OF STANDARD CHARACTERS WITHOUT CLAIM TO ANY PARTICULAR FONT, STYLE, SIZE, OR COLOR.

FOR DIETARY AND NUTRITIONAL FOOD SUPPLEMENT FOR BLADDER CONTROL (U.S. CLS. 6, 18, 44, 46, 51 AND 52).

ALICIA COLLINS, EXAMINING ATTORNEY

SN 78-499,800. MYAIRAIDE.COM, MICHIGAN CITY, IN. FILED 10-14-2004.

SN 78-499,320. GENE BIOTECHNOLOGY CORPORATION, LOS ANGELES, CA. FILED 10-13-2004.

YOUNG BONES

myairaide.com

THE MARK CONSISTS OF STANDARD CHARACTERS WITHOUT CLAIM TO ANY PARTICULAR FONT, STYLE, SIZE, OR COLOR.

FOR DIETARY AND NUTRITIONAL FOOD SUPPLEMENT FOR BONE STRENGTHENING (U.S. CLS. 6, 18, 44, 46, 51 AND 52).

FIRST USE 7-14-2000; IN COMMERCE 7-14-2000.
KARLA PERKINS, EXAMINING ATTORNEY

THE MARK CONSISTS OF MYAIRAIDE.COM STYLIZED.

FOR BOTANICALS FOR USE AS A DIETARY FOOD SUPPLEMENT (U.S. CLS. 6, 18, 44, 46, 51 AND 52).

FIRST USE 10-10-2004; IN COMMERCE 10-10-2004.
VIVIAN MICZNIK FIRST, EXAMINING ATTORNEY

CLASS 5—(Continued).

SN 78-500,322. BIO-NUTRA TECHNOLOGIES, LLC, VENICE, FL. FILED 10-15-2004.

CLASS 5—(Continued).

SN 78-501,197. BAYER HEALTHCARE LLC, PITTSBURGH, PA. FILED 10-18-2004.

BLACK-MAX

**TAKE THE BITE OUT
OF FLEAS, TICKS &
MOSQUITOES**

THE MARK CONSISTS OF STANDARD CHARACTERS WITHOUT CLAIM TO ANY PARTICULAR FONT, STYLE, SIZE, OR COLOR.

FOR NIGELLA SALIVA OIL FOR USE AS AN INGREDIENT IN NUTRITIONAL SUPPLEMENTS PREPARED FROM DARK-COLORED FRUITS IN CONCENTRATE, EXTRACT, JUICE POWDER, OR FIBER FORM (U.S. CLS. 6, 18, 44, 46, 51 AND 52).

FIRST USE 5-31-2003; IN COMMERCE 5-31-2003.
KRISTINA KLOIBER, EXAMINING ATTORNEY

THE MARK CONSISTS OF STANDARD CHARACTERS WITHOUT CLAIM TO ANY PARTICULAR FONT, STYLE, SIZE, OR COLOR.

OWNER OF U.S. REG. NO. 2,880,320.
FOR VETERINARY PARASITICIDES AND INSECTICIDES; INSECT CONTROL PREPARATIONS FOR PETS (U.S. CLS. 6, 18, 44, 46, 51 AND 52).

FIRST USE 4-1-2004; IN COMMERCE 4-1-2004.
ALLISON HOLTZ, EXAMINING ATTORNEY

SN 78-500,733. GAMMA ENTERPRISES, LLC, MELVILLE, NY. FILED 10-15-2004.

SN 78-501,607. BIONEURIX CORP., SAN FRANCISCO, CA. FILED 10-18-2004.

GAMMA-O

Seredyn

THE MARK CONSISTS OF STANDARD CHARACTERS WITHOUT CLAIM TO ANY PARTICULAR FONT, STYLE, SIZE, OR COLOR.

FOR FOOD SUPPLEMENTS, VITAMINS, MINERAL SUPPLEMENTS, NUTRITIONAL SUPPLEMENTS, DIETARY SUPPLEMENTS, HERBAL SUPPLEMENTS, MEAL REPLACEMENT BARS; MEAL REPLACEMENT DRINK MIX; MEAL REPLACEMENT DRINKS (U.S. CLS. 6, 18, 44, 46, 51 AND 52).

INGA ERVIN, EXAMINING ATTORNEY

THE MARK CONSISTS OF STANDARD CHARACTERS WITHOUT CLAIM TO ANY PARTICULAR FONT, STYLE, SIZE, OR COLOR.

FOR NATURAL DIETARY SUPPLEMENTS FOR MOOD BALANCE (U.S. CLS. 6, 18, 44, 46, 51 AND 52).

FIRST USE 7-27-2004; IN COMMERCE 7-27-2004.
CAROLINE WOOD, EXAMINING ATTORNEY

CLASS 5—(Continued).

SN 78-501,799. ECKELBERRY, NICHOLAS, LOS ANGELES, CA. FILED 10-19-2004.

CLASS 5—(Continued).

SN 78-502,811. MILL, RITA A., PLAINS, MT. FILED 10-20-2004.

Nano-Cal

Never Bite!

THE MARK CONSISTS OF STANDARD CHARACTERS WITHOUT CLAIM TO ANY PARTICULAR FONT, STYLE, SIZE, OR COLOR.

FOR NUTRITIONAL SUPPLEMENT CONTAINING CALCIUM (U.S. CLS. 6, 18, 44, 46, 51 AND 52).
FIRST USE 1-20-2002; IN COMMERCE 5-4-2003.
MICHAEL KEATING, EXAMINING ATTORNEY

THE MARK CONSISTS OF STANDARD CHARACTERS WITHOUT CLAIM TO ANY PARTICULAR FONT, STYLE, SIZE, OR COLOR.

FOR NATURAL INSECT REPELLENT (U.S. CLS. 6, 18, 44, 46, 51 AND 52).
FIRST USE 10-1-2004; IN COMMERCE 10-1-2004.
SUE LAWRENCE, EXAMINING ATTORNEY

SN 78-502,757. TIDI PRODUCTS, LLC, NEENAH, WI. FILED 10-20-2004.

SN 78-503,888. HEATHY PETS, INC., HAYWARD, CA. FILED 10-21-2004.

VENTURE

DERM-TABS

THE MARK CONSISTS OF STANDARD CHARACTERS WITHOUT CLAIM TO ANY PARTICULAR FONT, STYLE, SIZE, OR COLOR.

FOR COTTON ROLLS FOR MEDICAL AND DENTAL PURPOSES (U.S. CLS. 6, 18, 44, 46, 51 AND 52).
FIRST USE 1-31-2005; IN COMMERCE 1-31-2005.
MARK RADEMACHER, EXAMINING ATTORNEY

THE MARK CONSISTS OF STANDARD CHARACTERS WITHOUT CLAIM TO ANY PARTICULAR FONT, STYLE, SIZE, OR COLOR.

FOR NUTRITIONAL SUPPLEMENTS FOR ANIMALS (U.S. CLS. 6, 18, 44, 46, 51 AND 52).
FIRST USE 10-18-2004; IN COMMERCE 10-18-2004.
TRACY WHITAKER-BOWN, EXAMINING ATTORNEY

CLASS 5—(Continued).

SN 78-504,607. CONSAC INDUSTRIES, INC., DBA IRON-TEK, HAUPPAUGE, NY. FILED 10-22-2004.

CLASS 5—(Continued).

SN 78-505,086. IMPROVITA HEALTH PRODUCTS INC., CLEVELAND, OH. FILED 10-25-2004.

OPTICARN

Improvax

THE MARK CONSISTS OF STANDARD CHARACTERS WITHOUT CLAIM TO ANY PARTICULAR FONT, STYLE, SIZE, OR COLOR.

FOR VITAMINS, NUTRITIONAL SUPPLEMENTS, AND DIETARY SUPPLEMENTS (U.S. CLS. 6, 18, 44, 46, 51 AND 52).

FIRST USE 10-22-2004; IN COMMERCE 10-22-2004.
DANIEL CAPSHAW, EXAMINING ATTORNEY

THE MARK CONSISTS OF STANDARD CHARACTERS WITHOUT CLAIM TO ANY PARTICULAR FONT, STYLE, SIZE, OR COLOR.

FOR HOMEOPATHIC PHARMACEUTICALS FOR THE TREATMENT OF INFLUENZA (U.S. CLS. 6, 18, 44, 46, 51 AND 52).

FIRST USE 5-1-2004; IN COMMERCE 7-1-2004.
IRA J. GOODSaid, EXAMINING ATTORNEY

SN 78-504,692. DAIWA PHARMACEUTICAL CO., LTD., TOKYO, JAPAN, FILED 10-22-2004.

SN 78-505,985. MED FIVE, INC., KANEOHE, HI. FILED 10-26-2004.



**THE REJUVETATE
LIFE SYSTEM**

FOR NUTRACEUTICALS FOR USE AS A DIETARY SUPPLEMENT; NUTRITIONAL AND DIETARY SUPPLEMENTS; FUNCTIONAL FOOD ADDITIVE, NAMELY, NATURAL DIGESTIVE AID CONSISTING OF LACTOBACILLUS CULTURE FOR USE AS A DIETARY SUPPLEMENT. (U.S. CLS. 6, 18, 44, 46, 51 AND 52).
APRIL L. RADEMACHER, EXAMINING ATTORNEY

THE MARK CONSISTS OF STANDARD CHARACTERS WITHOUT CLAIM TO ANY PARTICULAR FONT, STYLE, SIZE, OR COLOR.

NO CLAIM IS MADE TO THE EXCLUSIVE RIGHT TO USE SYSTEM, APART FROM THE MARK AS SHOWN. FOR NUTRITIONAL SUPPLEMENTS IN MOUTHWASH AND ORAL DOSAGE FORMS (U.S. CLS. 6, 18, 44, 46, 51 AND 52).

FIRST USE 4-0-2004; IN COMMERCE 4-0-2004.
SUSAN LESLIE DUBOIS, EXAMINING ATTORNEY

CLASS 5—(Continued).

SN 78-506,251. PAC NATURAL SALES & MARKETING, LLC, DBA NATURAL-EDGE, SALT LAKE CITY, UT. FILED 10-26-2004.

TRANS-PLEX NATURAL

THE MARK CONSISTS OF STANDARD CHARACTERS WITHOUT CLAIM TO ANY PARTICULAR FONT, STYLE, SIZE, OR COLOR.

NO CLAIM IS MADE TO THE EXCLUSIVE RIGHT TO USE "NATURAL", APART FROM THE MARK AS SHOWN. FOR DIETARY DRINK MIX FOR USE AS A MEAL REPLACEMENT (U.S. CLS. 6, 18, 44, 46, 51 AND 52). FIRST USE 5-1-2001; IN COMMERCE 7-1-2001. IRA J. GOODSARD, EXAMINING ATTORNEY

SN 78-509,722. ISI BRANDS, INC., GRAND RAPIDS, MI. FILED 11-2-2004.

MAXILIFE CARDIO PROTECTOR

THE MARK CONSISTS OF STANDARD CHARACTERS WITHOUT CLAIM TO ANY PARTICULAR FONT, STYLE, SIZE, OR COLOR.

OWNER OF U.S. REG. NO. 1,321,725. NO CLAIM IS MADE TO THE EXCLUSIVE RIGHT TO USE CARDIO PROTECTOR, APART FROM THE MARK AS SHOWN. FOR DIETARY SUPPLEMENTS (U.S. CLS. 6, 18, 44, 46, 51 AND 52). FIRST USE 10-18-1996; IN COMMERCE 10-18-1996. DEZMONA MIZELLE, EXAMINING ATTORNEY

SN 78-510,668. BRADLEY PHARMACEUTICALS, INC., FAIRFIELD, NJ. FILED 11-3-2004.

ADOXA Dose Pak

OWNER OF U.S. REG. NO. 2,725,852. NO CLAIM IS MADE TO THE EXCLUSIVE RIGHT TO USE "DOSE PAK", APART FROM THE MARK AS SHOWN. THE MARK CONSISTS OF THE WORD "ADOXA" WITH A STYLIZED LETTER "O" FOLLOWED BY THE WORDS "DOSE PAK".

FOR ORAL ANTIBIOTIC (U.S. CLS. 6, 18, 44, 46, 51 AND 52). JIM RINGLE, EXAMINING ATTORNEY

CLASS 5—(Continued).

SN 78-510,722. GLOBAL COLLEGE OF NATURAL MEDICINE, INC., SANTA CRUZ, CA. FILED 11-3-2004.

NiteDetox

THE MARK CONSISTS OF STANDARD CHARACTERS WITHOUT CLAIM TO ANY PARTICULAR FONT, STYLE, SIZE, OR COLOR.

FOR HERBAL TEA AND DIETARY SUPPLEMENT FOR DETOXIFICATION AND REGULARITY (U.S. CLS. 6, 18, 44, 46, 51 AND 52). FIRST USE 5-1-2004; IN COMMERCE 11-3-2004. TARAH HARDY, EXAMINING ATTORNEY

SN 78-514,465. VITA LICENSING, INC., WILMINGTON, DE. FILED 11-10-2004.

CONFORM

THE MARK CONSISTS OF STANDARD CHARACTERS WITHOUT CLAIM TO ANY PARTICULAR FONT, STYLE, SIZE, OR COLOR.

FOR SURGICAL IMPLANT, NAMELY, BIOLOGICAL TISSUE INTENDED FOR SUBSEQUENT IMPLANTATION AS A SUBSTITUTE TO REPAIR THE DURA, THE MEMBRANE SURROUNDING THE SPINAL CORD OR THE BRAIN (U.S. CLS. 6, 18, 44, 46, 51 AND 52). ELISSA GARBER KON, EXAMINING ATTORNEY

CLASS 5—(Continued).

SN 78-515,338. WYETH HOLDINGS CORPORATION, MADISON, NJ. FILED 11-11-2004.

CLASS 5—(Continued).

SN 78-517,082. WINFUEL, INC., CEDAR KNOLLS, NJ. FILED 11-15-2004.

**THERE'S MORE IN IT
FOR KIDS**

THE MARK CONSISTS OF STANDARD CHARACTERS WITHOUT CLAIM TO ANY PARTICULAR FONT, STYLE, SIZE, OR COLOR.

FOR PHARMACEUTICAL PREPARATIONS, NAMELY DIETARY AND NUTRITIONAL SUPPLEMENTS (U.S. CLS. 6, 18, 44, 46, 51 AND 52).

CHRIS WELLS, EXAMINING ATTORNEY

**First Multi
VitaWin**

SN 78-516,764. PHARMACIA & UPJOHN COMPANY LLC, PEAPACK, NJ. FILED 11-15-2004.

THE MARK CONSISTS OF STANDARD CHARACTERS WITHOUT CLAIM TO ANY PARTICULAR FONT, STYLE, SIZE, OR COLOR.

NO CLAIM IS MADE TO THE EXCLUSIVE RIGHT TO USE "MULTI", APART FROM THE MARK AS SHOWN.

FOR MULTI-VITAMINS; DIETARY AND NUTRITIONAL SUPPLEMENTS (U.S. CLS. 6, 18, 44, 46, 51 AND 52).

JASON LOTT, EXAMINING ATTORNEY

XAPTEK

SN 78-517,086. WINFUEL, INC., CEDAR KNOLLS, NJ. FILED 11-15-2004.

THE MARK CONSISTS OF STANDARD CHARACTERS WITHOUT CLAIM TO ANY PARTICULAR FONT, STYLE, SIZE, OR COLOR.

FOR PHARMACEUTICAL PREPARATIONS FOR THE TREATMENT OF CARDIOVASCULAR DISEASES AND DISORDERS, CENTRAL NERVOUS SYSTEM AND NEUROLOGICAL DISEASES AND DISORDERS, UROLOGICAL DISEASES AND DISORDERS, GASTROINTESTINAL DISEASES AND DISORDERS, MUSCULOSKELETAL DISEASES AND DISORDERS, MIGRAINES, PAIN, INFLAMMATION AND INFLAMMATORY DISEASES AND DISORDERS, METABOLIC DISEASES AND DISORDERS, RESPIRATORY AND INFECTIOUS DISEASES AND DISORDERS, IMMUNOLOGICAL, BACTERIAL, VIRAL AND FUNGAL DISEASES AND DISORDERS, PSYCHIATRIC DISEASES AND DISORDERS, ALLERGIES, DIABETES, OBESITY, STROKE, ERECTILE AND SEXUAL DYSFUNCTION, AND HEMOLYTIC DISEASES AND DISORDERS; PHARMACEUTICAL PREPARATIONS, NAMELY, OSTEOPOROSIS PREPARATIONS, ONCOLOGICAL PREPARATIONS, DERMATOLOGICAL PREPARATIONS, OPHTHALMOLOGIC PREPARATIONS, SMOKING CESSATION PREPARATIONS, TISSUE AND SKIN REPAIR PREPARATIONS AND GYNECOLOGICAL PREPARATIONS (U.S. CLS. 6, 18, 44, 46, 51 AND 52).

CARRIE ACHEN, EXAMINING ATTORNEY

1st Multi VitaWin

THE MARK CONSISTS OF STANDARD CHARACTERS WITHOUT CLAIM TO ANY PARTICULAR FONT, STYLE, SIZE, OR COLOR.

NO CLAIM IS MADE TO THE EXCLUSIVE RIGHT TO USE "MULTI", APART FROM THE MARK AS SHOWN.

FOR MULTI-VITAMINS; DIETARY AND NUTRITIONAL SUPPLEMENTS (U.S. CLS. 6, 18, 44, 46, 51 AND 52).

JASON LOTT, EXAMINING ATTORNEY

CLASS 5—(Continued).

SN 78-517,327. SOLSTICE NEUROSCIENCES, INC., SAN DIEGO, CA. FILED 11-15-2004.

 The logo for MYO)BLOC features the word "MYO" in a bold, sans-serif font, followed by a closing parenthesis symbol ")", and then the word "BLOC" in the same font. The parenthesis is positioned between "MYO" and "BLOC".

OWNER OF U.S. REG. NOS. 2,628,983 AND 2,639,583.
FOR PHARMACEUTICAL PREPARATIONS FOR THE
TREATMENT OF NEUROMUSCULAR DISORDERS
(U.S. CLS. 6, 18, 44, 46, 51 AND 52).
JOHN GARTNER, EXAMINING ATTORNEY

CLASS 5—(Continued).

SN 78-517,872. FMC CORPORATION, PHILADELPHIA, PA.
FILED 11-16-2004.

CLEANFIELDS

THE MARK CONSISTS OF STANDARD CHARACTERS
WITHOUT CLAIM TO ANY PARTICULAR FONT, STYLE,
SIZE, OR COLOR.

FOR PREPARATIONS FOR THE DESTRUCTION OF
VERMIN AND WEEDS; AGRICULTURAL PESTICIDES,
DOMESTIC PESTICIDES, COMMERCIAL PESTICIDES,
INDUSTRIAL PESTICIDES; AGRICULTURAL HERBI-
CIDES, DOMESTIC HERBICIDES; FUNGICIDES (U.S.
CLS. 6, 18, 44, 46, 51 AND 52).
TANYA AMOS, EXAMINING ATTORNEY

SN 78-517,746. NUTRAMAX LABORATORIES, INC., EDGE-
WOOD, MD. FILED 11-16-2004.

G-FORCE

THE MARK CONSISTS OF STANDARD CHARACTERS
WITHOUT CLAIM TO ANY PARTICULAR FONT, STYLE,
SIZE, OR COLOR.
FOR DIETARY AND NUTRITIONAL SUPPLEMENT
FOR ANIMALS (U.S. CLS. 6, 18, 44, 46, 51 AND 52).
JULIE GUTTADAURO, EXAMINING ATTORNEY

SN 78-521,271. MYOGEN, INC., WESTMINSTER, CO. FILED
11-22-2004.

ELIBREZE

THE MARK CONSISTS OF STANDARD CHARACTERS
WITHOUT CLAIM TO ANY PARTICULAR FONT, STYLE,
SIZE, OR COLOR.
FOR PHARMACEUTICAL PREPARATIONS FOR THE
TREATMENT OF DISEASES AND DISORDERS IN THE
CARDIOVASCULAR, CARDIAC, VASCULAR AND HE-
MATOLOGY FIELDS (U.S. CLS. 6, 18, 44, 46, 51 AND 52).
LINDA E. BLOHM, EXAMINING ATTORNEY

CLASS 5—(Continued).

SN 78-524,370. STIEFEL LABORATORIES, INC., CORAL GABLES, FL. FILED 11-30-2004.

MIMYX

THE MARK CONSISTS OF STANDARD CHARACTERS WITHOUT CLAIM TO ANY PARTICULAR FONT, STYLE, SIZE, OR COLOR.
FOR TOPICAL PHARMACEUTICAL PREPARATION FOR TREATMENT OF DERMATOLOGICAL DISEASES, DISORDERS, AND CONDITIONS (U.S. CLS. 6, 18, 44, 46, 51 AND 52).
JUDITH HELFMAN, EXAMINING ATTORNEY

SN 78-524,409. GRUPO OMILIFE S.A. DE C.V., ZAPOPAN, JALISCO, MEXICO, FILED 11-30-2004.

CAFETINO DE OLLA

THE MARK CONSISTS OF STANDARD CHARACTERS WITHOUT CLAIM TO ANY PARTICULAR FONT, STYLE, SIZE, OR COLOR.
OWNER OF U.S. REG. NO. 2,216,109.
THE ENGLISH TRANSLATION OF "DE OLLA" IS "OF POT".
FOR DIETARY SUPPLEMENT DRINK IN THE NATURE OF THERMOGENIC COFFEE (U.S. CLS. 6, 18, 44, 46, 51 AND 52).
FIRST USE 12-13-2001; IN COMMERCE 12-13-2001.
BARBARA GAYNOR, EXAMINING ATTORNEY

CLASS 5—(Continued).

SN 78-524,418. GRUPO OMILIFE S.A. DE C.V., ZAPOPAN, JALISCO, MEXICO, FILED 11-30-2004.

CAFETINO AMARETTO

THE MARK CONSISTS OF STANDARD CHARACTERS WITHOUT CLAIM TO ANY PARTICULAR FONT, STYLE, SIZE, OR COLOR.
OWNER OF U.S. REG. NO. 2,216,109.
NO CLAIM IS MADE TO THE EXCLUSIVE RIGHT TO USE "AMARETTO", APART FROM THE MARK AS SHOWN.
FOR DIETARY SUPPLEMENT IN THE NATURE OF A COFFEE DRINK (U.S. CLS. 6, 18, 44, 46, 51 AND 52).
FIRST USE 12-4-2001; IN COMMERCE 12-4-2001.
GEORGIA CARTY, EXAMINING ATTORNEY

SN 78-526,150. SCHERING-PLOUGH VETERINARY CORPORATION, RENO, NV. FILED 12-2-2004.

EMUSPAN

THE MARK CONSISTS OF STANDARD CHARACTERS WITHOUT CLAIM TO ANY PARTICULAR FONT, STYLE, SIZE, OR COLOR.
FOR VETERINARY ADJUVANT FOR VACCINES TO TREAT LIVESTOCK (U.S. CLS. 6, 18, 44, 46, 51 AND 52).
JOHN SCHUYLER YARD, EXAMINING ATTORNEY

SN 78-526,220. UNITED PHOSPHORUS, INC., TRENTON, NJ. FILED 12-2-2004.

WEEVIL-CIDE

OWNER OF U.S. REG. NO. 1,540,036.
FOR AGRICULTURAL PESTICIDE (U.S. CLS. 6, 18, 44, 46, 51 AND 52).
FIRST USE 4-28-1997; IN COMMERCE 4-28-1997.
NELSON SNYDER, EXAMINING ATTORNEY

CLASS 5—(Continued).

SN 78-526,460. UNITED PHOSPHORUS, INC., TRENTON, NJ.
FILED 12-3-2004.

PERM-UP 25 WP

THE MARK CONSISTS OF STANDARD CHARACTERS WITHOUT CLAIM TO ANY PARTICULAR FONT, STYLE, SIZE, OR COLOR.

NO CLAIM IS MADE TO THE EXCLUSIVE RIGHT TO USE "25 WP", APART FROM THE MARK AS SHOWN.

FOR AGRICULTURAL INSECTICIDE (U.S. CLS. 6, 18, 44, 46, 51 AND 52).

DOMINIC J. FERRAIUOLO, EXAMINING ATTORNEY

CLASS 5—(Continued).

SN 78-528,387. ORTHO MOLECULAR PRODUCTS, INC., STEVENS POINT, WI. FILED 12-7-2004.

TRIPLICHOL

THE MARK CONSISTS OF STANDARD CHARACTERS WITHOUT CLAIM TO ANY PARTICULAR FONT, STYLE, SIZE, OR COLOR.

FOR NUTRACEUTICALS FOR USE AS A DIETARY SUPPLEMENT (U.S. CLS. 6, 18, 44, 46, 51 AND 52).

MATTHEW PAPPAS, EXAMINING ATTORNEY

SN 78-528,314. DAIWA PHARMACEUTICAL CO. LTD., TOKYO, JAPAN, FILED 12-7-2004.

BRM4

THE MARK CONSISTS OF STANDARD CHARACTERS WITHOUT CLAIM TO ANY PARTICULAR FONT, STYLE, SIZE, OR COLOR.

FOR NUTRACEUTICALS FOR USE AS A DIETARY SUPPLEMENT; NUTRITIONAL AND DIETARY SUPPLEMENTS; FUNCTIONAL FOODS AND FUNCTIONAL FOOD ADDITIVES, NAMELY, DIETARY FIBER FOR USE AS A DIETARY FOOD SUPPLEMENT (U.S. CLS. 6, 18, 44, 46, 51 AND 52).

MARY CRAWFORD, EXAMINING ATTORNEY

SN 78-530,822. NUTRAMARKS, INC., PARK CITY, UT. FILED 12-10-2004.

FOOD SOURCE

THE MARK CONSISTS OF STANDARD CHARACTERS WITHOUT CLAIM TO ANY PARTICULAR FONT, STYLE, SIZE, OR COLOR.

NO CLAIM IS MADE TO THE EXCLUSIVE RIGHT TO USE "FOOD", APART FROM THE MARK AS SHOWN.

FOR NUTRITIONAL SUPPLEMENTS; HERBAL SUPPLEMENTS; MINERAL SUPPLEMENTS; VITAMINS; VITAMIN SUPPLEMENTS; NUTRITIONAL DRINK MIX FOR USE AS A MEAL SUPPLEMENT; NUTRITIONAL FOOD BARS FOR USE AS A MEAL SUPPLEMENT; NUTRITIONAL MEAL SUPPLEMENT POWDERS; AND DIETARY FOOD SUPPLEMENTS (U.S. CLS. 6, 18, 44, 46, 51 AND 52).

FIRST USE 4-15-2004; IN COMMERCE 4-15-2004.

WON TEAK OH, EXAMINING ATTORNEY

CLASS 5—(Continued).

SN 78-532,296. BRECKENRIDGE PHARMACEUTICAL, INC., BOCA RATON, FL. FILED 12-14-2004.

CLASS 5—(Continued).

SN 78-532,632. REGINAL MEDICAL SOLUTIONS, INC., PALO ALTO, CA. FILED 12-15-2004.

V-TANN

BLOODSTOP

THE MARK CONSISTS OF STANDARD CHARACTERS WITHOUT CLAIM TO ANY PARTICULAR FONT, STYLE, SIZE, OR COLOR.

FOR PRESCRIPTION PHARMACEUTICAL PREPARATION USED AS AN ANTIHISTAMINE AND NASAL DECONGESTANT (U.S. CLS. 6, 18, 44, 46, 51 AND 52). FIRST USE 9-11-2003; IN COMMERCE 9-11-2003. G. MAYERSCHOFF, EXAMINING ATTORNEY

THE MARK CONSISTS OF STANDARD CHARACTERS WITHOUT CLAIM TO ANY PARTICULAR FONT, STYLE, SIZE, OR COLOR.

FOR BANDAGES FOR SKIN WOUNDS AND DRESSINGS; HEMOSTATIC PRODUCTS, NAMELY STERILE COMPRESSION DRESSING FOR PUNCTURE OF THE VASCULAR ACCESS SITES; SURGICAL DRESSINGS AND ADHESIVE BANDAGES IMPREGNATED WITH HEMOSTATIC AGENTS; GAUZE FOR DRESSINGS (U.S. CLS. 6, 18, 44, 46, 51 AND 52). JACQUELINE A. LAVINE, EXAMINING ATTORNEY

SN 78-534,677. CHEMCO INDUSTRIES, INC., LOS ANGELES, CA. FILED 12-17-2004.

SN 78-532,508. MCLAUGHLIN GORMLEY KING COMPANY, MINNEAPOLIS, MN. FILED 12-14-2004.

EVERCIDE

POSINOL

OWNER OF U.S. REG. NO. 425,664. THE COLOR(S) RED AND GRAY IS/ARE CLAIMED AS A FEATURE OF THE MARK.

THE MARK CONSISTS OF DISTINCTIVE STYLIZATION OF THE EVERCIDE MARK WITH THE EVER PREFIX IN THE COLOR RED AND THE CIDE SUFFIX IN THE COLOR GRAY.

FOR INSECTICIDES (U.S. CLS. 6, 18, 44, 46, 51 AND 52). MATTHEW PAPPAS, EXAMINING ATTORNEY

THE MARK CONSISTS OF STANDARD CHARACTERS WITHOUT CLAIM TO ANY PARTICULAR FONT, STYLE, SIZE, OR COLOR.

FOR DIETARY AND NUTRITIONAL SUPPLEMENTS (U.S. CLS. 6, 18, 44, 46, 51 AND 52). MATTHEW PAPPAS, EXAMINING ATTORNEY

CLASS 5—(Continued).

SN 78-535,757. MYOGEN, INC., WESTMINSTER, CO. FILED 12-20-2004.

CLASS 5—(Continued).

SN 78-535,765. MYOGEN, INC., WESTMINSTER, CO. FILED 12-20-2004.

REZIRIS

VALLIX

THE MARK CONSISTS OF STANDARD CHARACTERS WITHOUT CLAIM TO ANY PARTICULAR FONT, STYLE, SIZE, OR COLOR.
FOR PHARMACEUTICALS IN THE CARDIOVASCULAR, CARDIAC, VASCULAR AND HEMATOLOGY FIELDS (U.S. CLS. 6, 18, 44, 46, 51 AND 52).
TARAH HARDY, EXAMINING ATTORNEY

THE MARK CONSISTS OF STANDARD CHARACTERS WITHOUT CLAIM TO ANY PARTICULAR FONT, STYLE, SIZE, OR COLOR.
FOR PHARMACEUTICALS IN THE CARDIOVASCULAR, CARDIAC, VASCULAR AND HEMATOLOGY FIELDS (U.S. CLS. 6, 18, 44, 46, 51 AND 52).
TARAH HARDY, EXAMINING ATTORNEY

SN 78-535,761. MYOGEN, INC., WESTMINSTER, CO. FILED 12-20-2004.

SN 78-535,766. MYOGEN, INC., WESTMINSTER, CO. FILED 12-20-2004.

TRACIRA

XONEER

THE MARK CONSISTS OF STANDARD CHARACTERS WITHOUT CLAIM TO ANY PARTICULAR FONT, STYLE, SIZE, OR COLOR.
FOR PHARMACEUTICALS IN THE CARDIOVASCULAR, CARDIAC, VASCULAR AND HEMATOLOGY FIELDS (U.S. CLS. 6, 18, 44, 46, 51 AND 52).
TARAH HARDY, EXAMINING ATTORNEY

THE MARK CONSISTS OF STANDARD CHARACTERS WITHOUT CLAIM TO ANY PARTICULAR FONT, STYLE, SIZE, OR COLOR.
FOR PHARMACEUTICALS IN THE CARDIOVASCULAR, CARDIAC, VASCULAR AND HEMATOLOGY FIELDS (U.S. CLS. 6, 18, 44, 46, 51 AND 52).
TARAH HARDY, EXAMINING ATTORNEY

CLASS 5—(Continued).

SN 78-535,976. BETA PHARMACEUTICAL, WESTON, FL.
FILED 12-21-2004.

CLASS 5—(Continued).

SN 78-537,353. ENN ENVIRONMENTAL NUTRITION NET-
WORK CORP., VANCOUVER, BRITISH COLUMBIA,
CANADA, FILED 12-22-2004.

Coldenz

SKINNEES

THE MARK CONSISTS OF STANDARD CHARACTERS
WITHOUT CLAIM TO ANY PARTICULAR FONT, STYLE,
SIZE, OR COLOR.
FOR VITAMIN & MINERAL SUPPLEMENTS (U.S.
CLS. 6, 18, 44, 46, 51 AND 52).
JENNIFER WILLISTON, EXAMINING ATTORNEY

THE MARK CONSISTS OF STANDARD CHARACTERS
WITHOUT CLAIM TO ANY PARTICULAR FONT, STYLE,
SIZE, OR COLOR.
FOR DIETARY SUPPLEMENTS IN TABLET FORM
(U.S. CLS. 6, 18, 44, 46, 51 AND 52).
FIRST USE 11-30-2004; IN COMMERCE 11-30-2004.
APRIL L. RADEMACHER, EXAMINING ATTORNEY

SN 78-536,588. VITAQUEST INTERNATIONAL, INC., WEST
CALDWELL, NJ. FILED 12-21-2004.

SN 78-537,418. WINNERS BEE POLLEN CO., PHOENIX, AZ.
FILED 12-22-2004.

Cold Avert

Hema Flex

THE MARK CONSISTS OF STANDARD CHARACTERS
WITHOUT CLAIM TO ANY PARTICULAR FONT, STYLE,
SIZE, OR COLOR.
NO CLAIM IS MADE TO THE EXCLUSIVE RIGHT TO
USE "COLD", APART FROM THE MARK AS SHOWN.
FOR DIETARY SUPPLEMENT (U.S. CLS. 6, 18, 44, 46,
51 AND 52).
SANI KHOURI, EXAMINING ATTORNEY

THE MARK CONSISTS OF STANDARD CHARACTERS
WITHOUT CLAIM TO ANY PARTICULAR FONT, STYLE,
SIZE, OR COLOR.
NO CLAIM IS MADE TO THE EXCLUSIVE RIGHT TO
USE "HEMA", APART FROM THE MARK AS SHOWN.
FOR NUTRITIONAL FOOD SUPPLEMENT FOR
HORSES (U.S. CLS. 6, 18, 44, 46, 51 AND 52).
ALLISON SCHRODY, EXAMINING ATTORNEY

CLASS 5—(Continued).

SN 78-537,988. SANOFI-AVENTIS, PARIS, FRANCE, FILED 12-23-2004.

CLASS 5—(Continued).

SN 78-538,002. SANOFI-AVENTIS, PARIS, FRANCE, FILED 12-23-2004.

AKOMPLIA

AKAMPLIA

THE MARK CONSISTS OF STANDARD CHARACTERS WITHOUT CLAIM TO ANY PARTICULAR FONT, STYLE, SIZE, OR COLOR.
FOR PHARMACEUTICAL PREPARATIONS FOR THE PREVENTION OF CARDIOVASCULAR DISEASES, FOR SMOKING CESSATION AND OBESITY (U.S. CLS. 6, 18, 44, 46, 51 AND 52).
JENNIFER CHICOSKI, EXAMINING ATTORNEY

THE MARK CONSISTS OF STANDARD CHARACTERS WITHOUT CLAIM TO ANY PARTICULAR FONT, STYLE, SIZE, OR COLOR.
FOR PHARMACEUTICAL PREPARATIONS FOR THE PREVENTION OF CARDIOVASCULAR DISEASES, FOR SMOKING CESSATION AND OBESITY (U.S. CLS. 6, 18, 44, 46, 51 AND 52).
JENNIFER CHICOSKI, EXAMINING ATTORNEY

SN 78-537,996. SANOFI-AVENTIS, PARIS, FRANCE, FILED 12-23-2004.

SN 78-538,008. SANOFI-AVENTIS, PARIS, FRANCE, FILED 12-23-2004.

ACAMPLIA

OCOMPLIA

THE MARK CONSISTS OF STANDARD CHARACTERS WITHOUT CLAIM TO ANY PARTICULAR FONT, STYLE, SIZE, OR COLOR.
FOR PHARMACEUTICAL PREPARATIONS FOR THE PREVENTION OF CARDIOVASCULAR DISEASES, FOR SMOKING CESSATION AND OBESITY (U.S. CLS. 6, 18, 44, 46, 51 AND 52).
JENNIFER CHICOSKI, EXAMINING ATTORNEY

THE MARK CONSISTS OF STANDARD CHARACTERS WITHOUT CLAIM TO ANY PARTICULAR FONT, STYLE, SIZE, OR COLOR.
FOR PHARMACEUTICAL PREPARATIONS FOR THE PREVENTION OF CARDIOVASCULAR DISEASES, FOR SMOKING CESSATION AND OBESITY (U.S. CLS. 6, 18, 44, 46, 51 AND 52).
JENNIFER CHICOSKI, EXAMINING ATTORNEY

CLASS 5—(Continued).

SN 78-538,576. WILSON ENTERPRISES INC, DISPUTANTA, VA. FILED 12-27-2004.

CLASS 5—(Continued).

SN 78-539,483. MEDIAPOWER, INC., PORTLAND, ME. FILED 12-29-2004.

EQUI-CHOICE

Nutranetics

THE MARK CONSISTS OF STANDARD CHARACTERS WITHOUT CLAIM TO ANY PARTICULAR FONT, STYLE, SIZE, OR COLOR.

FOR EQUINE FREE CHOICE MINERAL SUPPLEMENT (U.S. CLS. 6, 18, 44, 46, 51 AND 52).
FIRST USE 0-0-1985; IN COMMERCE 0-0-1985.
VERNA BETH RIRIE, EXAMINING ATTORNEY

THE MARK CONSISTS OF STANDARD CHARACTERS WITHOUT CLAIM TO ANY PARTICULAR FONT, STYLE, SIZE, OR COLOR.

FOR NUTRITIONAL AND DIETARY SUPPLEMENT (U.S. CLS. 6, 18, 44, 46, 51 AND 52).
FIRST USE 6-19-2004; IN COMMERCE 6-19-2004.
JILL PRATER, EXAMINING ATTORNEY

SN 78-539,095. KUSTOMER KINETICS, INC., ARCADIA, CA. FILED 12-28-2004.

SN 78-549,768. TRIMSPA, INC., CEDAR KNOLLS, NJ. FILED 1-19-2005.

Lido-Gel

Sé Envidiado.

THE MARK CONSISTS OF STANDARD CHARACTERS WITHOUT CLAIM TO ANY PARTICULAR FONT, STYLE, SIZE, OR COLOR.

FOR NON-TOXIC LOCAL ANESTHETIC GEL IN A NON-STAINING TRANSDERMAL BASE FOR USE IN RELIEF OF ITCHING, PAIN, SORENESS, AND AS AN ANTI-INFLAMMATORY; MAY BE USED IN CONJUNCTION WITH ULTRASOUND (PHONOPHORESIS) AND/OR ION TRANSFER (IONTOPHORESIS) (U.S. CLS. 6, 18, 44, 46, 51 AND 52).
FIRST USE 8-20-1992; IN COMMERCE 11-15-1992.
KAREN BRACEY, EXAMINING ATTORNEY

THE MARK CONSISTS OF STANDARD CHARACTERS WITHOUT CLAIM TO ANY PARTICULAR FONT, STYLE, SIZE, OR COLOR.

OWNER OF U.S. REG. NO. 2,823,337.
THE FOREIGN WORDING IN THE MARK TRANSLATES INTO ENGLISH AS BE ENVIED.
FOR DIETARY AND NUTRITIONAL SUPPLEMENTS (U.S. CLS. 6, 18, 44, 46, 51 AND 52).
EVELYN BRADLEY, EXAMINING ATTORNEY

CLASS 5—(Continued).

SN 78-549,769. TRIMSPA, INC., CEDAR KNOLLS, NJ. FILED 1-19-2005.

Soyez Envié.

THE MARK CONSISTS OF STANDARD CHARACTERS WITHOUT CLAIM TO ANY PARTICULAR FONT, STYLE, SIZE, OR COLOR.

OWNER OF U.S. REG. NO. 2,823,337.

THE FOREIGN WORDING IN THE MARK TRANSLATES INTO ENGLISH AS BE ENVIED.

FOR DIETARY AND NUTRITIONAL SUPPLEMENTS (U.S. CLS. 6, 18, 44, 46, 51 AND 52).

EVELYN BRADLEY, EXAMINING ATTORNEY

SN 78-567,531. REVLOX CONSUMER PRODUCTS CORPORATION, NEW YORK, NY. FILED 2-15-2005.

COLORSTAY

THE MARK CONSISTS OF STANDARD CHARACTERS WITHOUT CLAIM TO ANY PARTICULAR FONT, STYLE, SIZE, OR COLOR.

OWNER OF U.S. REG. NOS. 1,912,134, 2,102,325 AND OTHERS.

FOR MEDICATED SKIN CARE PREPARATIONS (U.S. CLS. 6, 18, 44, 46, 51 AND 52).

ANDREA K. NADELMAN, EXAMINING ATTORNEY

CLASS 5—(Continued).

SN 79-000,264. HAGER & WERKEN GMBH & CO. KG, FED REP GERMANY, FILED 11-4-2003.

BIOPAQUE

OWNER OF INTERNATIONAL REGISTRATION 0520265 DATED 1-29-1988, EXPIRES 1-29-2008.

FOR CHEMICAL PREPARATIONS FOR DENTISTRY AND DENTAL LABORATORY TECHNIQUES, NAMELY, PASTE FOR MAKING DENTAL CERAMICS (U.S. CLS. 6, 18, 44, 46, 51 AND 52).

SHAUNIA WALLACE, EXAMINING ATTORNEY

SN 79-002,268. LIDL STIFTUNG & CO. KG, NECKARSULM, FED REP GERMANY, FILED 3-26-2004.

SENSIPLAST

THE MARK CONSISTS OF STANDARD CHARACTERS WITHOUT CLAIM TO ANY PARTICULAR FONT, STYLE, SIZE, OR COLOR.

PRIORITY DATE OF 9-30-2003 IS CLAIMED.

OWNER OF INTERNATIONAL REGISTRATION 0823849 DATED 3-26-2004, EXPIRES 3-26-2014.

FOR MATERIALS FOR DRESSINGS, NAMELY, BANDAGES FOR DRESSINGS, BURN DRESSINGS, GAUZE FOR DRESSINGS, SELF-ADHESIVE DRESSINGS, SURGICAL DRESSINGS AND WOUND DRESSINGS; MEDICAL PLASTERS, STICKING PLASTERS FOR MEDICAL USE (U.S. CLS. 6, 18, 44, 46, 51 AND 52).

JOHN KELLY, EXAMINING ATTORNEY

SN 79-003,072. DROUJESTVO S OGRANICHENA; OTGOVORNOST "NANO KOM", BULGARIA, FILED 5-15-2004.

**NOROTEN
HOPOTEH**

THE MARK CONSISTS OF STANDARD CHARACTERS WITHOUT CLAIM TO ANY PARTICULAR FONT, STYLE, SIZE, OR COLOR.

PRIORITY DATE OF 12-30-2003 IS CLAIMED.

OWNER OF INTERNATIONAL REGISTRATION 0826439 DATED 5-15-2004, EXPIRES 5-15-2014.

FOR VITAMIN PREPARATIONS, NUTRITIONAL ADDITIVES FOR MEDICAL PURPOSES FOR USE IN FOODS AND DIETARY SUPPLEMENTS FOR HUMAN CONSUMPTION (U.S. CLS. 6, 18, 44, 46, 51 AND 52).

RONALD MCMORROW, EXAMINING ATTORNEY

CLASS 5—(Continued).

SN 79-003,464. LIMONOV VICTOR L'VOVICH, RUSSIAN FED., FILED 2-13-2004.

ЦЕФАБОЛ

OWNER OF INTERNATIONAL REGISTRATION 0812039 DATED 5-28-2003, EXPIRES 5-28-2013.

CEFABOL
FOR ANTIBIOTICS (U.S. CLS. 6, 18, 44, 46, 51 AND 52).
CHRISTOPHER BUONGIORNO, EXAMINING ATTORNEY

SN 79-003,727. LIMONOV VICTOR L'VOVICH, RUSSIAN FED., FILED 2-13-2004.

ЦЕФТРИАБОЛ

OWNER OF INTERNATIONAL REGISTRATION 0812050 DATED 5-28-2003, EXPIRES 5-28-2013.

CEFTRIABOL
FOR ANTIBIOTICS, BACTERIAL AND BACTERIOLOGICAL PREPARATIONS FOR MEDICAL OR VETERINARY PURPOSES, PHARMACEUTICAL ANTITUSSIVE-COLD PREPARATIONS, PHARMACEUTICAL ANTI-ALLERGIC PREPARATIONS AND SUBSTANCES, PHARMACEUTICAL FOR THE TREATMENT OF ERECTILE DYSFUNCTION, PHARMACEUTICAL PREPARATIONS FOR USE IN CHEMOTHERAPY, PHARMACEUTICAL PREPARATION FOR THE TREATMENT OF GOUT, PHARMACEUTICAL PREPARATIONS FOR THE TREATMENT OF HEART RHYTHM DISORDERS, PHARMACEUTICAL PREPARATIONS FOR THE TREATMENT OF INFECTIOUS DISEASES PHARMACEUTICAL PREPARATIONS ACTING ON THE CENTRAL NERVOUS SYSTEM, PHARMACEUTICAL PREPARATIONS AND SUBSTANCES FOR THE TREATMENT OF GASTRO-INTESTINAL DISEASES, PHARMACEUTICAL PREPARATIONS FOR ANIMAL SKINCARE, PHARMACEUTICAL PREPARATIONS FOR INHALATION FOR THE TREATMENT OF PULMONARY HYPERTENSION, PHARMACEUTICAL PREPARATIONS FOR OCULAR OR INTRAOCULAR SURGERY, PHARMACEUTICAL PREPARATIONS FOR THE TREATMENT OF HORMONAL DISORDERS AND THE PREVENTION OF OSTEOPOROSIS, PHARMACEUTICAL PREPARATIONS FOR TREATING ALLERGIC RHINITIS AND ASTHMA, PHARMACEUTICAL PREPARATIONS FOR TREATING DIABETES, PHARMACEUTICAL PREPARATIONS FOR TREATING SKIN DISORDERS, PHARMACEUTICAL PREPARATIONS FOR USE IN DERMATOLOGY, PHARMACEUTICAL PREPARATIONS FOR WOUNDS, PHARMACEUTICAL PRODUCTS AND PREPARATIONS AGAINST DRY SKIN CAUSED BY PREGNANCY, PHARMACEUTICAL PRODUCTS AND PREPARATIONS FOR CHLOASMA, PHARMACEUTICAL PRODUCTS AND PREPARATIONS FOR HYDRATING THE SKIN DURING PREGNANCY, PHARMACEUTICAL PRODUCTS AND PREPARATIONS FOR PREGNANCY BLEMISHES, PHARMACEUTICAL PRODUCTS AND PREPARATIONS FOR PREVENTING SKIN BLEMISHES DURING PREGNANCY, PHARMACEUTICAL PRODUCTS AND PREPARATIONS TO PREVENT STRETCH MARKS, PHARMACEUTICAL PRODUCTS AND PREPARATIONS TO PREVENT SWELLING IN THE LEGS, PHARMACEUTICAL PRODUCTS FOR OPHTHALMOLOGICAL USE, PHARMACEUTICAL PRODUCTS FOR SKIN CARE FOR ANIMALS, PHARMACEUTICAL PRODUCTS FOR THE TREATMENT OF BONE DISEASES, PHARMACEUTICAL PRODUCTS FOR THE TREATMENT OF VIRAL AND INFECTIOUS DIS-

CLASS 5—(Continued).

EASES, FOR THE TREATMENT OF CANCER, PHARMACEUTICAL PRODUCTS FOR TREATING RESPIRATORY DISEASES AND ASTHMA, PHARMACEUTICAL SKIN LOTIONS PHARMACEUTICAL SOLUTIONS USED IN DIALYSIS, PHARMACEUTICALS FOR THE TREATMENT OF ERECTILE DYSFUNCTION, ANTIBACTERIAL PHARMACEUTICALS, ANTI-DIABETIC PHARMACEUTICALS, ASTRINGENTS [PHARMACEUTICAL], CARDIOVASCULAR PHARMACEUTICALS, DERMATOLOGICAL PHARMACEUTICAL PRODUCTS; ANESTHETICS FOR NON-SURGICAL USE, ANESTHETICS FOR SURGICAL AND NON-SURGICAL USE, BIOLOGICAL PREPARATIONS FOR MEDICAL PURPOSES, BIOLOGICAL AND CHEMICAL PREPARATIONS AND REAGENTS FOR MEDICAL OR VETERINARY USE, FERMENTS FOR MEDICAL OR VETERINARY USE, TOPICAL ANESTHETICS, SANITARY STERILIZING PREPARATIONS, PHARMACEUTICAL PREPARATIONS FOR USE IN CHEMOTHERAPY, VETERINARY VACCINES (U.S. CLS. 6, 18, 44, 46, 51 AND 52).

LINDA M. KING, EXAMINING ATTORNEY

SN 79-003,939. COLTÈNE AG, SWITZERLAND, FILED 6-4-2004.

PARACEM

THE MARK CONSISTS OF STANDARD CHARACTERS WITHOUT CLAIM TO ANY PARTICULAR FONT, STYLE, SIZE, OR COLOR.

PRIORITY DATE OF 4-8-2004 IS CLAIMED.

OWNER OF INTERNATIONAL REGISTRATION 0829203 DATED 6-4-2004, EXPIRES 6-4-2014.

FOR FIXING CEMENT FOR DENTAL USE (U.S. CLS. 6, 18, 44, 46, 51 AND 52).

ELIZABETH PIGNATELLO, EXAMINING ATTORNEY

SN 79-003,968. COLTÈNE AG, SWITZERLAND, FILED 6-4-2004.

PARABOND

THE MARK CONSISTS OF STANDARD CHARACTERS WITHOUT CLAIM TO ANY PARTICULAR FONT, STYLE, SIZE, OR COLOR.

PRIORITY DATE OF 4-8-2004 IS CLAIMED.

OWNER OF INTERNATIONAL REGISTRATION 0829309 DATED 6-4-2004, EXPIRES 6-4-2014.

FOR DENTAL ADHESIVE (U.S. CLS. 6, 18, 44, 46, 51 AND 52).

ELIZABETH PIGNATELLO, EXAMINING ATTORNEY

CLASS 5—(Continued).

SN 79-004,031. LIMONOV VICTOR L'VOVICH, RUSSIAN FED., FILED 2-13-2004.

ЦЕФУРАБОЛ

OWNER OF INTERNATIONAL REGISTRATION 0812043 DATED 5-28-2003, EXPIRES 5-28-2013.

CEFURABOL

FOR ANTIBIOTICS, BACTERIAL AND BACTERIOLOGICAL PREPARATIONS FOR MEDICAL OR VETERINARY PURPOSES, PHARMACEUTICAL ANTITUSSIVE-COLD PREPARATIONS, PHARMACEUTICAL ANTI-ALLERGIC PREPARATIONS AND SUBSTANCES, PHARMACEUTICAL FOR THE TREATMENT OF ERECTILE DYSFUNCTION, PHARMACEUTICAL PREPARATIONS FOR USE IN CHEMOTHERAPY, PHARMACEUTICAL PREPARATION FOR THE TREATMENT OF GOUT, PHARMACEUTICAL PREPARATIONS FOR THE TREATMENT OF HEART RHYTHM DISORDERS, PHARMACEUTICAL PREPARATIONS FOR THE TREATMENT OF INFECTIOUS DISEASES PHARMACEUTICAL PREPARATIONS ACTING ON THE CENTRAL NERVOUS SYSTEM, PHARMACEUTICAL PREPARATIONS AND SUBSTANCES FOR THE TREATMENT OF GASTRO-INTESTINAL DISEASES, PHARMACEUTICAL PREPARATIONS FOR ANIMAL SKINCARE, PHARMACEUTICAL PREPARATIONS FOR INHALATION FOR THE TREATMENT OF PULMONARY HYPERTENSION, PHARMACEUTICAL PREPARATIONS FOR OCULAR OR INTRAOCULAR SURGERY, PHARMACEUTICAL PREPARATIONS FOR THE TREATMENT OF HORMONAL DISORDERS AND THE PREVENTION OF OSTEOPOROSIS, PHARMACEUTICAL PREPARATIONS FOR TREATING ALLERGIC RHINITIS AND ASTHMA, PHARMACEUTICAL PREPARATIONS FOR TREATING DIABETES, PHARMACEUTICAL PREPARATIONS FOR TREATING SKIN DISORDERS, PHARMACEUTICAL PREPARATIONS FOR USE IN DERMATOLOGY, PHARMACEUTICAL PREPARATIONS FOR WOUNDS, PHARMACEUTICAL PRODUCTS AND PREPARATIONS AGAINST DRY SKIN CAUSED BY PREGNANCY, PHARMACEUTICAL PRODUCTS AND PREPARATIONS FOR CHLOASMA, PHARMACEUTICAL PRODUCTS AND PREPARATIONS FOR HYDRATING THE SKIN DURING PREGNANCY, PHARMACEUTICAL PRODUCTS AND PREPARATIONS FOR PREGNANCY BLEMISHES, PHARMACEUTICAL PRODUCTS AND PREPARATIONS FOR PREVENTING SKIN BLEMISHES DURING PREGNANCY, PHARMACEUTICAL PRODUCTS AND PREPARATIONS TO PREVENT STRETCH MARKS, PHARMACEUTICAL PRODUCTS AND PREPARATIONS TO PREVENT SWELLING IN THE LEGS, PHARMACEUTICAL PRODUCTS FOR OPHTHALMOLOGICAL USE, PHARMACEUTICAL PRODUCTS FOR SKIN CARE FOR ANIMALS, PHARMACEUTICAL PRODUCTS FOR THE TREATMENT OF BONE DISEASES, PHARMACEUTICAL PRODUCTS FOR THE TREATMENT OF VIRAL AND INFECTIOUS DISEASES, FOR THE TREATMENT OF CANCER, PHARMACEUTICAL PRODUCTS FOR TREATING RESPIRATORY DISEASES AND ASTHMA, PHARMACEUTICAL SKIN LOTIONS PHARMACEUTICAL SOLUTIONS USED IN DIALYSIS, PHARMACEUTICALS FOR THE TREATMENT OF ERECTILE DYSFUNCTION, ANTIBACTERIAL PHARMACEUTICALS, ANTI-DIABETIC PHARMACEUTICALS, ASTRINGENTS [PHARMACEUTICAL], CARDIOVASCULAR PHARMACEUTICALS, DERMATOLOGICAL PHARMACEUTICAL PRODUCTS; ANESTHETICS FOR NON-SURGICAL USE, ANESTHETICS FOR SURGICAL AND NON-SURGICAL USE, BIOLOGICAL PREPARATIONS FOR MEDICAL PURPOSES, BIOLOGICAL AND CHEMICAL PREPARATIONS AND REAGENTS FOR MEDICAL OR VETERINARY USE, FERMENTS FOR MEDICAL OR VETERINARY USE, TOPICAL ANESTHETICS, SANITARY STERILIZING PREPARATIONS, PHARMACEUTICAL PREPARATIONS FOR USE IN CHEMOTHERAPY, VETERINARY VACCINES (U.S. CLS. 6, 18, 44, 46, 51 AND 52).

LINDA M. KING, EXAMINING ATTORNEY

CLASS 5—(Continued).

SN 79-004,062. NEGMA-L.E.R.A.D.S., FRANCE, FILED 4-7-2004.

ART 40 m

THE MARK CONSISTS OF STANDARD CHARACTERS WITHOUT CLAIM TO ANY PARTICULAR FONT, STYLE, SIZE, OR COLOR.

OWNER OF INTERNATIONAL REGISTRATION 0829548 DATED 4-7-2004, EXPIRES 4-7-2014.

OWNER OF U.S. REG. NO. 2,664,933.

NO CLAIM IS MADE TO THE EXCLUSIVE RIGHT TO USE "40", APART FROM THE MARK AS SHOWN.

FOR PHARMACEUTICAL PREPARATION IN THE FIELD OF ARTHROSIS OR ARTHRITIS (U.S. CLS. 6, 18, 44, 46, 51 AND 52).

CHRIS WELLS, EXAMINING ATTORNEY

SN 79-004,363. SANOFI-AVENTIS, FRANCE, FILED 6-4-2004.

SYVITAL

THE MARK CONSISTS OF STANDARD CHARACTERS WITHOUT CLAIM TO ANY PARTICULAR FONT, STYLE, SIZE, OR COLOR.

PRIORITY DATE OF 12-30-2003 IS CLAIMED.

OWNER OF INTERNATIONAL REGISTRATION 0830543 DATED 6-4-2004, EXPIRES 6-4-2014.

FOR PHARMACEUTICAL PREPARATIONS FOR SMOKING CESSATION, FOR THE PREVENTION OF CARDIOVASCULAR DISEASES AND FOR THE TREATMENT OF OBESITY (U.S. CLS. 6, 18, 44, 46, 51 AND 52).

ELIZABETH PIGNATELLO, EXAMINING ATTORNEY

SN 79-004,449. BOEHRINGER INGELHEIM PHARMA; GMBH & CO. KG, FED REP GERMANY, FILED 6-30-2004.

CLEDACTO

THE MARK CONSISTS OF STANDARD CHARACTERS WITHOUT CLAIM TO ANY PARTICULAR FONT, STYLE, SIZE, OR COLOR.

OWNER OF INTERNATIONAL REGISTRATION 0830772 DATED 6-30-2004, EXPIRES 6-30-2014.

FOR PHARMACEUTICAL PREPARATIONS AND SUBSTANCES FOR THE TREATMENT OF DISEASES OF THE ALIMENTARY TRACT AND METABOLISM, BLOOD AND BLOOD FORMING ORGANS, THE CARDIOVASCULAR SYSTEM, THE MUSCULOSKELETAL SYSTEM, THE CENTRAL NERVOUS SYSTEM, THE PERIPHERAL NERVOUS SYSTEM, THE GENITO-URINARY SYSTEM, THE RESPIRATORY SYSTEM; HORMONES FOR MEDICAL PURPOSES; ANTI-INFECTIVE PREPARATIONS; ANTIVIRAL PREPARATIONS; CYTOSTATIC PREPARATIONS FOR USE IN THE TREATMENT OF CANCER (U.S. CLS. 6, 18, 44, 46, 51 AND 52).

BRIDGETT SMITH, EXAMINING ATTORNEY

CLASS 5—(Continued).

SN 79-004,519. SOLVAY PHARMACEUTICALS B.V., NETHERLANDS, FILED 6-10-2004.

SAVANDRA

THE MARK CONSISTS OF STANDARD CHARACTERS WITHOUT CLAIM TO ANY PARTICULAR FONT, STYLE, SIZE, OR COLOR.

PRIORITY DATE OF 12-22-2003 IS CLAIMED.

OWNER OF INTERNATIONAL REGISTRATION 0830982 DATED 6-10-2004, EXPIRES 6-10-2014.

FOR PHARMACEUTICAL PREPARATIONS AND SUBSTANCES FOR THE TREATMENT OF DISEASES OF THE CENTRAL NERVOUS SYSTEM, GASTRO-INTESTINAL DISEASES, GYNECOLOGICAL DISEASES AND CARDIOVASCULAR DISEASES (U.S. CLS. 6, 18, 44, 46, 51 AND 52).

VIVIAN MICZNIK FIRST, EXAMINING ATTORNEY

SN 79-005,473. SHAN XI GUANG YU YUAN LIMITED; COMPANY OF CHINESE MEDICINE, TAIGU COUNTY; SHANXI, CHINA, FILED 7-15-2004.



OWNER OF INTERNATIONAL REGISTRATION 0833629 DATED 7-15-2004, EXPIRES 7-15-2014.

THE FIRST CHINESE CHARACTER MEANS "VAST", THE SECOND CHINESE CHARACTER MEANS "REPUTATION", THE LAST CHINESE CHARACTER MEANS "FAR", THE COMBINATION OF THE THREE CHINESE CHARACTERS HAS NO MEANING.

FIRST CHINESE CHARACTER IS "GUANG", SECOND CHINESE CHARACTER IS "YU", THE LAST CHINESE CHARACTER IS "YUAN".

FOR PHARMACIST-PREPARED TRADITIONAL CHINESE MEDICINE FOR USE IN THE TREATMENT OF SEXUAL DISORDER, IMPOTENCE, MALE STERILITY, GYNAECOLOGICAL DISEASE, NERVOUS SYSTEM, DIGESTIVE SYSTEM, RESPIRATORY SYSTEM, COLD, COUGH; MEDICINAL LIQUOR FOR USE IN THE TREATMENT OF SEXUAL DISORDER, IMPOTENCE, MALE STERILITY, GYNAECOLOGICAL DISEASE, NERVOUS SYSTEM, DIGESTIVE SYSTEM, RESPIRATORY SYSTEM, COLD, COUGH (U.S. CLS. 6, 18, 44, 46, 51 AND 52).

RICHARD WHITE, EXAMINING ATTORNEY

CLASS 5—(Continued).

SN 79-005,587. UCB FARCHIM SA, CHEMIN DE CROIX-BLANCHE 10, SWITZERLAND, FILED 8-17-2004.



PRIORITY DATE OF 4-1-2004 IS CLAIMED.

OWNER OF INTERNATIONAL REGISTRATION 0833883 DATED 8-17-2004, EXPIRES 8-17-2014.

OWNER OF U.S. REG. NO. 2,479,307.

THE COLOR(S) BLUE, WHITE, YELLOW, BLACK IS/ARE CLAIMED AS A FEATURE OF THE MARK.

THE COLOR BLUE APPEARS IN THE DESIGN OF THE TWO "Y" LETTERS THAT FORM AN "X" AND IN THE LETTERS "Y" AND "Z" IN THE MARK. THE COLOR YELLOW APPEARS IN THE LETTERS "A" AND "I" IN THE MARK. HOWEVER, THE COLOR WHITE APPEARS IN A BAND IN THE MIDDLE PORTION OF EACH LETTER AND IN THE BACKGROUND. THE COLOR BLACK APPEARS IN THE RIGHT EDGES OF THE TWO "Y" LETTERS FORMING AN "X" AND THE RIGHT EDGES OF THE LETTERS "Y" AND "Z" IN THE MARK.

FOR PHARMACEUTICAL PRODUCTS FOR THE TREATMENT OF RESPIRATORY DISEASES, NAMELY ANTI-ALLERGIC AND ANTI-ASTHMATIC DECONGESTANTS (U.S. CLS. 6, 18, 44, 46, 51 AND 52).

MAUREEN DALL, EXAMINING ATTORNEY

SN 79-006,232. RICHTER GEDEON VEGYÉSZETI GYÁR RT., HUNGARY, FILED 8-2-2004.

ESCURION

THE MARK CONSISTS OF STANDARD CHARACTERS WITHOUT CLAIM TO ANY PARTICULAR FONT, STYLE, SIZE, OR COLOR.

PRIORITY DATE OF 2-4-2004 IS CLAIMED.

OWNER OF INTERNATIONAL REGISTRATION 0835790 DATED 8-2-2004, EXPIRES 8-2-2014.

FOR PHARMACEUTICAL PREPARATIONS FOR DERMATOLOGICAL USE (U.S. CLS. 6, 18, 44, 46, 51 AND 52).

GEORGIA CARTY, EXAMINING ATTORNEY

SN 79-006,233. RICHTER GEDEON VEGYÉSZETI GYÁR RT., HUNGARY, FILED 8-2-2004.

CURIOSCAR

THE MARK CONSISTS OF STANDARD CHARACTERS WITHOUT CLAIM TO ANY PARTICULAR FONT, STYLE, SIZE, OR COLOR.

PRIORITY DATE OF 2-4-2004 IS CLAIMED.

OWNER OF INTERNATIONAL REGISTRATION 0835791 DATED 8-2-2004, EXPIRES 8-2-2014.

FOR PHARMACEUTICAL PREPARATIONS FOR DERMATOLOGICAL USE (U.S. CLS. 6, 18, 44, 46, 51 AND 52).

GEORGIA CARTY, EXAMINING ATTORNEY

CLASS 5—(Continued).

SN 79-006,234. RICHTER GEDEON VEGYÉSZETI GYÁR RT., HUNGARY, FILED 8-2-2004.

CURIOSA

THE MARK CONSISTS OF STANDARD CHARACTERS WITHOUT CLAIM TO ANY PARTICULAR FONT, STYLE, SIZE, OR COLOR.

PRIORITY DATE OF 2-4-2004 IS CLAIMED.
OWNER OF INTERNATIONAL REGISTRATION 0835792 DATED 8-2-2004, EXPIRES 8-2-2014.

FOR PHARMACEUTICAL PREPARATIONS FOR DERMATOLOGICAL USE (U.S. CLS. 6, 18, 44, 46, 51 AND 52).
GEORGIA CARTY, EXAMINING ATTORNEY

CLASS 5—(Continued).

SN 79-007,397. BOEHRINGER INGELHEIM INTERNATIONAL GMBH, FED REP GERMANY, FILED 9-16-2004.

PILAVY

THE MARK CONSISTS OF STANDARD CHARACTERS WITHOUT CLAIM TO ANY PARTICULAR FONT, STYLE, SIZE, OR COLOR.

PRIORITY DATE OF 3-18-2004 IS CLAIMED.
OWNER OF INTERNATIONAL REGISTRATION 0839154 DATED 9-16-2004, EXPIRES 9-16-2014.

FOR PHARMACEUTICAL PREPARATIONS AND SUBSTANCES FOR THE TREATMENT OF DISEASES AND DISORDERS OF THE ALIMENTARY TRACT AND METABOLISM, BLOOD AND BLOOD FORMING ORGANS, THE CARDIOVASCULAR SYSTEM, THE MUSCULOSKELETAL SYSTEM, THE CENTRAL NERVOUS SYSTEM, THE PERIPHERAL NERVOUS SYSTEM, THE GENITOURINARY SYSTEM, THE RESPIRATORY SYSTEM, AND DERMATOLOGICAL DISORDERS; HORMONES FOR MEDICAL PURPOSES; ANTI-INFECTIVE PREPARATIONS; ANTI-VIRAL PREPARATIONS; CYTOSTATIC PREPARATIONS FOR USE IN THE TREATMENT OF CANCER (U.S. CLS. 6, 18, 44, 46, 51 AND 52).
SUSAN STIGLITZ, EXAMINING ATTORNEY

SN 79-007,119. BOEHRINGER INGELHEIM PHARMA; GMBH & CO. KG, FED REP GERMANY, FILED 10-21-2004.

JETARO

THE MARK CONSISTS OF STANDARD CHARACTERS WITHOUT CLAIM TO ANY PARTICULAR FONT, STYLE, SIZE, OR COLOR.

PRIORITY DATE OF 5-11-2004 IS CLAIMED.
OWNER OF INTERNATIONAL REGISTRATION 0838374 DATED 10-21-2004, EXPIRES 10-21-2014.

FOR PHARMACEUTICAL PREPARATIONS AND SUBSTANCES FOR THE TREATMENT OF DISEASES AND DISORDERS OF THE ALIMENTARY TRACT AND METABOLISM, BLOOD AND BLOOD FORMING ORGANS, THE CARDIOVASCULAR SYSTEM, THE MUSCULOSKELETAL SYSTEM, THE CENTRAL NERVOUS SYSTEM, THE PERIPHERAL NERVOUS SYSTEM, THE GENITOURINARY SYSTEM, THE RESPIRATORY SYSTEM, AND DERMATOLOGICAL DISORDERS; HORMONES FOR MEDICAL PURPOSES; ANTI-INFECTIVE PREPARATIONS; ANTI-VIRAL PREPARATIONS; CYTOSTATIC PREPARATIONS FOR USE IN THE TREATMENT OF CANCER (U.S. CLS. 6, 18, 44, 46, 51 AND 52).
SEAN DWYER, EXAMINING ATTORNEY

SN 79-008,105. IVOCLAR VIVADENT AG, LIECHTENSTEIN, FILED 7-5-2004.

APEXCAL

THE MARK CONSISTS OF STANDARD CHARACTERS WITHOUT CLAIM TO ANY PARTICULAR FONT, STYLE, SIZE, OR COLOR.

PRIORITY DATE OF 3-30-2004 IS CLAIMED.
OWNER OF INTERNATIONAL REGISTRATION 0840987 DATED 7-5-2004, EXPIRES 7-5-2014.

FOR MATERIALS FOR USE IN DENTISTRY, PARTICULARLY MATERIALS AND ACCESSORIES FOR MAKING DENTAL IMPRESSIONS, MODELS, MATERIALS FOR TOOTH CROWNS AND BRIDGES, ARTIFICIAL TEETH AND INLAYS, TOOTH FILLING MATERIALS, PULP PROTECTION MATERIALS; ADHESIVE AGENTS, PROTECTIVE VARNISHES FOR TEETH, DENTAL COMPOSITE MATERIALS, DENTAL PREPARATION FOR USE IN TREATING CARIES AND PERIODONTOSIS, DENTAL ADHESIVES, CAVITY LINING MATERIALS, MATERIALS FOR ROOT TREATMENT AND FILLING (U.S. CLS. 6, 18, 44, 46, 51 AND 52).

DANIEL CAPSHAW, EXAMINING ATTORNEY

CLASS 5—(Continued).

SN 79-009,439. PIETRASANTA PHARMA S.P.A., ITALY,
FILED 10-18-2004.

STERIBLOCK

THE MARK CONSISTS OF STANDARD CHARACTERS WITHOUT CLAIM TO ANY PARTICULAR FONT, STYLE, SIZE, OR COLOR.

OWNER OF INTERNATIONAL REGISTRATION 0845052 DATED 10-18-2004, EXPIRES 10-18-2014.

FOR PLASTERS FOR MEDICAL PURPOSES, BANDAGES FOR DRESSINGS, ADHESIVE BANDS FOR MEDICAL PURPOSES (U.S. CLS. 6, 18, 44, 46, 51 AND 52).
CHRISTOPHER BUONGIORNO, EXAMINING ATTORNEY

CLASS 6—METAL GOODS

SN 76-541,488. COMPUMERIC ENGINEERING, INC., ONTARIO, CA. FILED 8-28-2003.

BEARSAVER

FOR METAL BOXES, NAMELY, ANIMAL-PROOF STORAGE CONTAINERS, NOT REFRIGERATED, FOR CAMPSITE, RESIDENTIAL, OR COMMERCIAL USE; ANIMAL-PROOF, HANDICAPPED ACCESSIBLE TRASH AND RECYCLING METAL BOXES FOR CAMPING, COMMERCIAL AND RESIDENTIAL USES; METAL ANIMAL-PROOF CONTAINERS FOR RECEIVING, TRANSPORTING AND DUMPING MATERIAL OF VARIOUS KINDS, NAMELY, REFUSE, TRASH, GARBAGE, OR SCRAP (U.S. CLS. 2, 12, 13, 14, 23, 25 AND 50).

FIRST USE 2-1-2002; IN COMMERCE 2-1-2002.
LEIGH CAROLINE CASE, EXAMINING ATTORNEY

SN 79-009,798. REGULON A.E., GREECE, FILED 10-26-2004.

LipoVIL12

PRIORITY DATE OF 6-11-2004 IS CLAIMED.
OWNER OF INTERNATIONAL REGISTRATION 0846086 DATED 10-26-2004, EXPIRES 10-26-2014.

FOR PHARMACEUTICAL PREPARATIONS AND FORMULATIONS FOR USE IN THE TREATMENT OF CANCER AND FOR ANTIFUNGAL, ANTIVIRAL AND ANTIPROTOZOAN USE (U.S. CLS. 6, 18, 44, 46, 51 AND 52).

HEATHER THOMPSON, EXAMINING ATTORNEY

SN 76-566,817. KINETIK, LLC, MIAMI, FL. FILED 12-12-2003.

HEXLOBE

FOR METAL FASTENERS, NAMELY BOLTS AND SCREWS, FOR USE IN FASTENING AFTER-MARKET WHEELS TO AUTOMOBILES (U.S. CLS. 2, 12, 13, 14, 23, 25 AND 50).

RONALD AIKENS, EXAMINING ATTORNEY

SN 79-009,800. SOLVAY PHARMACEUTICALS B.V., NETHERLANDS, FILED 10-26-2004.

RITOBA

THE MARK CONSISTS OF STANDARD CHARACTERS WITHOUT CLAIM TO ANY PARTICULAR FONT, STYLE, SIZE, OR COLOR.

PRIORITY DATE OF 4-28-2004 IS CLAIMED.
OWNER OF INTERNATIONAL REGISTRATION 0846088 DATED 10-26-2004, EXPIRES 10-26-2014.

FOR PHARMACEUTICAL PREPARATIONS AND SUBSTANCES FOR THE TREATMENT OF DISEASES OF THE CENTRAL NERVOUS SYSTEM, NAMELY PSYCHIATRIC DISEASES AND DISORDERS (U.S. CLS. 6, 18, 44, 46, 51 AND 52).

HEATHER THOMPSON, EXAMINING ATTORNEY

SN 76-589,653. AMERICAN PRESTO CORPORATION, ONTARIO, CA. FILED 4-23-2004.

HUGHES

THE MARK CONSISTS OF STANDARD CHARACTERS WITHOUT CLAIM TO ANY PARTICULAR FONT, STYLE, SIZE, OR COLOR.

SEC. 2(F).

FOR METAL ENGINE STANDS, METAL JACK STANDS, METAL ENGINE HOISTS, METAL ENGINE HOLDERS, METAL UNDER HOIST STANDS, METAL HOOKS, METAL HANGERS, METAL QUICK LINKS, METAL SAFETY SPRING HOOKS, METAL ANCHOR SHACKLES, METAL TURNBUCKLES, METAL WIRE ROPE CLIPS, METAL CHAINS, METAL SWIVEL SNAPS, STEEL HITCH BALLS AND COUPLERS, BOLTS AND NUTS, METAL CLIPS, RIVETS AND ROLL PINS, SNAP RINGS, WASHERS, SPRINGS, TOOL BOXES, AND STEEL ANVILS (U.S. CLS. 2, 12, 13, 14, 23, 25 AND 50).

FIRST USE 1-1-1988; IN COMMERCE 1-1-1988.

HENRY S. ZAK, EXAMINING ATTORNEY

CLASS 6—(Continued).

SN 76-591,820. SPAGNOLA, EUGENE, NEWTOWN, CT.
FILED 5-12-2004.

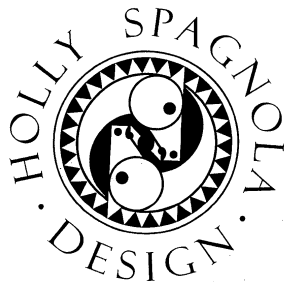

NO CLAIM IS MADE TO THE EXCLUSIVE RIGHT TO USE "DESIGN", APART FROM THE MARK AS SHOWN.

THE NAME(S), PORTRAIT(S), AND/OR SIGNATURE(S) SHOWN IN THE MARK IDENTIFIES HOLLY SPAGNOLA, WHOSE CONSENT(S) TO REGISTER IS SUBMITTED.

FOR SPURS AND STIRRUPS OF METAL (U.S. CLS. 2, 12, 13, 14, 23, 25 AND 50).

TARAH HARDY, EXAMINING ATTORNEY

CLASS 6—(Continued).

SN 76-596,322. ELTRAK INTERNATIONAL & STAFF PTY. LTD., SOUTH AUSTRALIA, AUSTRALIA, FILED 6-8-2004.

ELTRAK

THE MARK CONSISTS OF STANDARD CHARACTERS WITHOUT CLAIM TO ANY PARTICULAR FONT, STYLE, SIZE, OR COLOR.

FOR METAL BUILDING MATERIALS, NAMELY, METAL GATES AND FENCES; IRONMONGERY, PIPES AND TUBES OF METAL; SMALL ITEMS OF METAL HARDWARE, NAMELY SLIDING DOOR TRACKS, SUPPORT BRACKETS FOR GATES AND FENCES, FRAME MATERIAL FOR DOORS, NUTS, BOLTS, FASTENERS, CLAMPS, CONNECTORS, LATCHES, HINGES, FLANGES AND METAL CAPS FOR GATES AND FENCES; ALL OF THE AFORESAID GOODS NOT INCLUDING METAL RACKS OR METAL CASES OF ANY TYPE (U.S. CLS. 2, 12, 13, 14, 23, 25 AND 50).

FIRST USE 4-0-2002; IN COMMERCE 4-0-2002.

JOHN DALIER, EXAMINING ATTORNEY

SN 76-598,620. WEATHER SHIELD MFG., INC., MEDFORD, WI. FILED 6-22-2004.

LIFE GUARD

THE MARK CONSISTS OF STANDARD CHARACTERS WITHOUT CLAIM TO ANY PARTICULAR FONT, STYLE, SIZE, OR COLOR.

OWNER OF U.S. REG. NO. 2,916,583.

FOR METAL WINDOWS AND METAL DOORS (U.S. CLS. 2, 12, 13, 14, 23, 25 AND 50).

FIRST USE 5-31-2002; IN COMMERCE 5-31-2002.

INGRID C. EULIN, EXAMINING ATTORNEY

SN 76-595,303. SHARIFY, AMIR, HAYWARD, CA. FILED 6-1-2004.

SPIRAMIR

SN 76-598,994. THE OSBORNE COINAGE COMPANY, CINCINNATI, OH. FILED 6-23-2004.

TOKENSDIRECT

THE MARK CONSISTS OF STANDARD CHARACTERS WITHOUT CLAIM TO ANY PARTICULAR FONT, STYLE, SIZE, OR COLOR.

FOR METAL AIR DUCTS FOR HEATING/VENTILATING/AIR CONDITIONING (HVAC) SYSTEMS AND FOR HVAC ACCESSORIES (U.S. CLS. 2, 12, 13, 14, 23, 25 AND 50).

FIRST USE 6-30-2000; IN COMMERCE 6-30-2000.

BRENDAN REGAN, EXAMINING ATTORNEY

THE MARK CONSISTS OF STANDARD CHARACTERS WITHOUT CLAIM TO ANY PARTICULAR FONT, STYLE, SIZE, OR COLOR.

FOR NON-MONETARY METAL TOKENS FOR USE IN AMUSEMENT PARK GAMES, VENDING MACHINES AND COIN-OPERATED DEVICES (U.S. CLS. 2, 12, 13, 14, 23, 25 AND 50).

FIRST USE 10-15-2002; IN COMMERCE 10-15-2002.

KAREN K. BUSH, EXAMINING ATTORNEY

CLASS 6—(Continued).

SN 76-603,468. ATRIUM COMPANIES, INC., DALLAS, TX.
FILED 7-22-2004.

ATRIUM

THE MARK CONSISTS OF STANDARD CHARACTERS WITHOUT CLAIM TO ANY PARTICULAR FONT, STYLE, SIZE, OR COLOR.

OWNER OF U.S. REG. NOS. 2,497,433, 2,497,434 AND 2,859,535.

SEC. 2(F).
FOR METAL DOORS AND WINDOWS (U.S. CLS. 2, 12, 13, 14, 23, 25 AND 50).

FIRST USE 5-12-1975; IN COMMERCE 5-12-1975.
MICHAEL TANNER, EXAMINING ATTORNEY

CLASS 6—(Continued).

SN 76-619,664. WINDSONG COATINGS, LLC, ROUND POND, ME. FILED 11-8-2004.

CAPE MAY

THE MARK CONSISTS OF STANDARD CHARACTERS WITHOUT CLAIM TO ANY PARTICULAR FONT, STYLE, SIZE, OR COLOR.

FOR METAL BELLS (U.S. CLS. 2, 12, 13, 14, 23, 25 AND 50).

FIRST USE 1-2-2004; IN COMMERCE 1-2-2004.
JENNIFER CHICOSKI, EXAMINING ATTORNEY

SN 76-606,015. NORRIS, WILLIAM G., JR., JACKSONVILLE, FL. FILED 8-9-2004.

SN 76-624,908. RADIUS TRACK CORPORATION, BLAINE, MN. FILED 12-16-2004.



READY-ANGLE

OWNER OF U.S. REG. NO. 2,681,963.
NO CLAIM IS MADE TO THE EXCLUSIVE RIGHT TO USE MINI'S, APART FROM THE MARK AS SHOWN.

FOR PORTABLE, TOWABLE, LIFTABLE, RACKABLE, STACKABLE AND WATERPROOF METAL STORAGE CONTAINERS (U.S. CLS. 2, 12, 13, 14, 23, 25 AND 50).

FIRST USE 1-1-2002; IN COMMERCE 1-1-2002.
CHERYL CLAYTON, EXAMINING ATTORNEY

THE MARK CONSISTS OF STANDARD CHARACTERS WITHOUT CLAIM TO ANY PARTICULAR FONT, STYLE, SIZE, OR COLOR.

FOR METAL FRAMING SUPPORT RAILS FOR USE IN THE CONSTRUCTION OF CURVED STRUCTURES (U.S. CLS. 2, 12, 13, 14, 23, 25 AND 50).

FIRST USE 10-15-2003; IN COMMERCE 10-15-2003.
ADA HAN, EXAMINING ATTORNEY

SN 76-614,810. TEXTRON INC., DBA TEXTRON FASTENING SYSTEMS, INC., PROVIDENCE, RI. FILED 10-7-2004.

SN 76-625,109. BERGER BROS CO., FEASTERVILLE, PA. FILED 12-20-2004.

CONFLEX

E-RAIL

THE MARK CONSISTS OF STANDARD CHARACTERS WITHOUT CLAIM TO ANY PARTICULAR FONT, STYLE, SIZE, OR COLOR.

OWNER OF U.S. REG. NO. 2,050,784.
FOR METAL THREADED FASTENERS (U.S. CLS. 2, 12, 13, 14, 23, 25 AND 50).

JASON TURNER, EXAMINING ATTORNEY

THE MARK CONSISTS OF STANDARD CHARACTERS WITHOUT CLAIM TO ANY PARTICULAR FONT, STYLE, SIZE, OR COLOR.

FOR METAL SNOW RETENTION APPARATUS, NAMELY, SNOW BARS, SNOW FENCES AND SNOW RAILS FOR ROOFS (U.S. CLS. 2, 12, 13, 14, 23, 25 AND 50).

FIRST USE 11-0-2004; IN COMMERCE 12-8-2004.
JEAN IM, EXAMINING ATTORNEY

CLASS 6—(Continued).

SN 78-167,876. CREATIVE TENT INTERNATIONAL, LAKE HAVASU CITY, AZ. FILED 9-25-2002.

CLASS 6—(Continued).

SN 78-332,150. T.D. WILLIAMSON, INC., TULSA, OK. FILED 11-24-2003.

SHASTA SHELTER

THE MARK CONSISTS OF STANDARD CHARACTERS WITHOUT CLAIM TO ANY PARTICULAR FONT, STYLE, SIZE, OR COLOR.

NO CLAIM IS MADE TO THE EXCLUSIVE RIGHT TO USE "SHELTER", APART FROM THE MARK AS SHOWN.

FOR METAL PREFABRICATED BUILDING MATERIALS NAMELY STRUCTURAL BEAMS (U.S. CLS. 2, 12, 13, 14, 23, 25 AND 50).

FIRST USE 10-18-2002; IN COMMERCE 10-18-2002.

RON FAIRBANKS, EXAMINING ATTORNEY

V-JET

THE MARK CONSISTS OF STANDARD CHARACTERS WITHOUT CLAIM TO ANY PARTICULAR FONT, STYLE, SIZE, OR COLOR.

FOR METAL PIGS POWERED BY INTERNAL PIPELINE PRESSURE FOR APPLYING CONDITIONERS AND/OR INHIBITORS TO INTERIOR SURFACES OF PIPELINES (U.S. CLS. 2, 12, 13, 14, 23, 25 AND 50).

JOHN LINCOSKI, EXAMINING ATTORNEY

SN 78-185,054. OUTOKUMPU OYJ, ESPOO, FINLAND, FILED 11-14-2002.

NORDIC BROWN

PRIORITY CLAIMED UNDER SEC. 44(D) ON FINLAND APPLICATION NO. T200201494, FILED 5-17-2002, REG. NO. 226698, DATED 3-14-2003, EXPIRES 3-14-2013.

NO CLAIM IS MADE TO THE EXCLUSIVE RIGHT TO USE "BROWN", APART FROM THE MARK AS SHOWN.

FOR COPPER SHEETS, PLATES, FOILS AND STRIPS (U.S. CLS. 2, 12, 13, 14, 23, 25 AND 50).

SUELLEN HICKEY, EXAMINING ATTORNEY

SN 78-342,417. KNAACK MANUFACTURING COMPANY, CRYSTAL LAKE, IL. FILED 12-17-2003.

SN 78-185,102. OUTOKUMPU OYJ, ESPOO, FINLAND, FILED 11-14-2002.

NORDIC DECOR

PRIORITY CLAIMED UNDER SEC. 44(D) ON FINLAND APPLICATION NO. T200201495, FILED 5-17-2002, REG. NO. 226782, DATED 3-31-2003, EXPIRES 3-31-2013.

FOR COPPER SHEETS, PLATES, FOILS AND STRIPS (U.S. CLS. 2, 12, 13, 14, 23, 25 AND 50).

SUELLEN HICKEY, EXAMINING ATTORNEY



FOR JOBSITE STORAGE UNITS, NAMELY, METAL CHESTS FOR STORING TOOLS AND OTHER EQUIPMENT AND PROVIDING AN ELECTRICAL PLUG PASS-THROUGH FEATURE (U.S. CLS. 2, 12, 13, 14, 23, 25 AND 50).

BARNEY CHARLON, EXAMINING ATTORNEY

CLASS 6—(Continued).

SN 78-354,976. SCHLAGE LOCK COMPANY, CARMEL, IN. FILED 1-21-2004.

CLASS 6—(Continued).

SN 78-381,361. J.R. CLANCY, INC., SYRACUSE, NY. FILED 3-10-2004.

ACCENTS

SURELOCK

THE MARK CONSISTS OF STANDARD CHARACTERS WITHOUT CLAIM TO ANY PARTICULAR FONT, STYLE, SIZE, OR COLOR.

FOR METAL DOOR HARDWARE, NAMELY DOOR LOCKS COMPRISED OF DEADBOLTS, LEVERS, KNOBS AND HANDLE SETS, DOOR KICK PLATES, DOOR PUSH PLATES, DOOR PULLS, DOOR STOPS, DOOR KNOCKERS, DOOR MAIL SLOTS, DOOR HOUSE NUMBERS, DOOR VIEWERS, DOOR MORTISE BOLTS, DOOR CHAIN GUARDS, DOOR SURFACE BOLTS, DOOR PULLS, DOOR LATCHES, DOOR CATCHES AND DOOR HINGES; METAL BUILDERS HARDWARE, NAMELY WINDOW LOCKS, WINDOW LIFTS, HANDRAIL BRACKETS, SWITCH PLATE COVERS AND OUTLET PLATE COVERS, WARDROBE HOOKS, COAT AND HAT HOOKS; METAL CABINET HARDWARE, NAMELY, CABINET KNOBS AND HANDLE SETS, CABINET PULLS, CABINET STOPS, CABINET LATCHES, CABINET CATCHES AND CABINET HINGES (U.S. CLS. 2, 12, 13, 14, 23, 25 AND 50).

RONALD AIKENS, EXAMINING ATTORNEY

THE MARK CONSISTS OF STANDARD CHARACTERS WITHOUT CLAIM TO ANY PARTICULAR FONT, STYLE, SIZE, OR COLOR.

OWNER OF U.S. REG. NO. 1,308,612.
FOR APPARATUS AND RIGGING FOR THEATRICAL AND STAGE PRODUCTIONS, NAMELY, MANUALLY OPERATED METAL ROPE LOCKS (U.S. CLS. 2, 12, 13, 14, 23, 25 AND 50).

GLENN CLARK, EXAMINING ATTORNEY

SN 78-395,025. J. MITTON & ASSOCIATES, INC., NEW HOLLAND, PA. FILED 4-1-2004.

SN 78-365,093. CONTINUOUS COATING CORP., ORANGE, CA. FILED 2-9-2004.

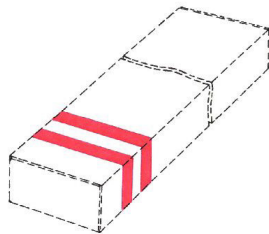

Foot Free

THE COLOR(S) RED IS/ARE CLAIMED AS A FEATURE OF THE MARK.

THE MARK CONSISTS OF TWO PARALLEL TRANSVERSE RED STRIPES APPLIED ADJACENT ONE END OF THE ELONGATED PACKAGING FOR THE GOODS.

SEC. 2(F).
FOR BUILDING MATERIAL, NAMELY DRYWALL TRIM AND CORNER BEADS FOR USE WITH DRYWALL, MADE PRIMARILY OF METAL (U.S. CLS. 2, 12, 13, 14, 23, 25 AND 50).

FIRST USE 0-0-1969; IN COMMERCE 0-0-1969.
SHAUNIA WALLACE, EXAMINING ATTORNEY

THE MARK CONSISTS OF STANDARD CHARACTERS WITHOUT CLAIM TO ANY PARTICULAR FONT, STYLE, SIZE, OR COLOR.

FOR STIRRUPS OF METAL (U.S. CLS. 2, 12, 13, 14, 23, 25 AND 50).

FIRST USE 4-1-1993; IN COMMERCE 4-1-1993.
GEORGE LORENZO, EXAMINING ATTORNEY

CLASS 6—(Continued).

SN 78-409,690. ALGOMA STEEL INC., SAULT STE. MARIE, ONTARI, CANADA, FILED 4-28-2004.

CLASS 6—(Continued).

SN 78-428,929. ILLINOIS TOOL WORKS INC., GLENVIEW, IL. FILED 6-2-2004.

DSPC-80F

EYE HOOK

THE MARK CONSISTS OF STANDARD CHARACTERS WITHOUT CLAIM TO ANY PARTICULAR FONT, STYLE, SIZE, OR COLOR.

PRIORITY CLAIMED UNDER SEC. 44(D) ON CANADA APPLICATION NO. 1,211,399, FILED 3-29-2004, REG. NO. TMA635907, DATED 3-22-2005, EXPIRES 3-22-2020.

OWNER OF U.S. REG. NOS. 2,258,392 AND 2,258,398. FOR STEEL (U.S. CLS. 2, 12, 13, 14, 23, 25 AND 50). FIRST USE 4-0-2003; IN COMMERCE 4-0-2003. ANDREA SAUNDERS, EXAMINING ATTORNEY

THE MARK CONSISTS OF STANDARD CHARACTERS WITHOUT CLAIM TO ANY PARTICULAR FONT, STYLE, SIZE, OR COLOR.

FOR METAL SEAM PLATE FOR COMMERCIAL ROOF FASTENING (U.S. CLS. 2, 12, 13, 14, 23, 25 AND 50).

FIRST USE 1-1-2004; IN COMMERCE 1-1-2004. MICHAEL TANNER, EXAMINING ATTORNEY

SN 78-418,732. LEO INTERNATIONAL, INC., BROOKLYN, NY. FILED 5-14-2004.

SN 78-429,801. LOK-MOR, INC., MANSFIELD, TX. FILED 6-3-2004.

FITLOK

TRI-LOC

THE COLOR(S) ORANGE IS/ARE CLAIMED AS A FEATURE OF THE MARK.

THE MARK CONSISTS OF THE LETTERS FITLOK WITH ALL OF THE LETTERS APPEARING IN THE COLOR ORANGE.

FOR METAL PIPE FITTINGS, METAL PIPE GROOVED FITTINGS, GASKETED METAL PIPE GROOVED FITTINGS, GASKETED COUPLINGS, METAL PIPE CONNECTORS, METAL PIPE STRAINERS TO FILTER FOREIGN MATERIALS, METAL CHECK VALVES FOR MANUAL INSPECTION, ALL USED WITH METAL TUBES AND PIPES (U.S. CLS. 2, 12, 13, 14, 23, 25 AND 50). JEFF DEFORD, EXAMINING ATTORNEY

THE MARK CONSISTS OF STANDARD CHARACTERS WITHOUT CLAIM TO ANY PARTICULAR FONT, STYLE, SIZE, OR COLOR.

FOR INDUSTRIAL SELF LOCKING NUTS (U.S. CLS. 2, 12, 13, 14, 23, 25 AND 50). CIMMERIAN COLEMAN, EXAMINING ATTORNEY

CLASS 6—(Continued).

SN 78-430,028. SEXTON, INC., LULING, TX. FILED 6-4-2004.

CLASS 6—(Continued).

SN 78-444,026. STAR PIPE PRODUCTS, LTD., HOUSTON, TX. FILED 6-30-2004.



STAR

NO CLAIM IS MADE TO THE EXCLUSIVE RIGHT TO USE "GATES", APART FROM THE MARK AS SHOWN.
THE MARK CONSISTS OF A COW HEAD INSIDE THE STATE OF TEXAS.
FOR METAL GATES AND FENCING PANELS (U.S. CLS. 2, 12, 13, 14, 23, 25 AND 50).
FIRST USE 4-1-2004; IN COMMERCE 5-1-2004.
STEPHANIE DAVIS, EXAMINING ATTORNEY

THE MARK CONSISTS OF STANDARD CHARACTERS WITHOUT CLAIM TO ANY PARTICULAR FONT, STYLE, SIZE, OR COLOR.
OWNER OF U.S. REG. NO. 1,726,996.
FOR PIPE FITTINGS, PIPE FLANGES, PIPE GLANDS, RETAINER GLANDS IN THE NATURE OF PIPE CONNECTORS, ADAPTER FLANGES, JOINT RESTRAINING DEVICES, NAMELY, PIPE FITTINGS, PIPE CONNECTORS, PIPE ADAPTERS, CASTINGS AND VALVE BOXES ALL MADE PRIMARILY OF METAL. (U.S. CLS. 2, 12, 13, 14, 23, 25 AND 50).
FIRST USE 6-30-1986; IN COMMERCE 6-30-1986.
YSA DEJESUS, EXAMINING ATTORNEY

SN 78-442,964. TEMTCO STEEL, INC., LOUISVILLE, MS. FILED 6-29-2004.

SN 78-444,585. THORO'BRED RACING PLATE CO., INC, ANAHEIM, CA. FILED 7-1-2004.

Omega Armor

TURBO

THE MARK CONSISTS OF STANDARD CHARACTERS WITHOUT CLAIM TO ANY PARTICULAR FONT, STYLE, SIZE, OR COLOR.
NO CLAIM IS MADE TO THE EXCLUSIVE RIGHT TO USE "ARMOR", APART FROM THE MARK AS SHOWN.
FOR STEEL (U.S. CLS. 2, 12, 13, 14, 23, 25 AND 50).
FIRST USE 6-22-2001; IN COMMERCE 6-22-2001.
WINSTON FOLMAR, EXAMINING ATTORNEY

THE MARK CONSISTS OF STANDARD CHARACTERS WITHOUT CLAIM TO ANY PARTICULAR FONT, STYLE, SIZE, OR COLOR.
FOR METAL HORSESHOES (U.S. CLS. 2, 12, 13, 14, 23, 25 AND 50).
FIRST USE 6-14-2004; IN COMMERCE 6-14-2004.
BARBARA GAYNOR, EXAMINING ATTORNEY

CLASS 6—(Continued).

SN 78-460,926. FLAIM, DONALD, HAZLETON, PA. FILED 8-3-2004.

**Clean Gutters ...
NEVER!**

THE MARK CONSISTS OF STANDARD CHARACTERS WITHOUT CLAIM TO ANY PARTICULAR FONT, STYLE, SIZE, OR COLOR.

NO CLAIM IS MADE TO THE EXCLUSIVE RIGHT TO USE "GUTTERS", APART FROM THE MARK AS SHOWN.

FOR METAL RAIN GUTTERS; METAL RAIN GUTTERS WITH DEBRIS PROTECTION; AND METAL DEBRIS PROTECTION FOR RAIN GUTTERS (U.S. CLS. 2, 12, 13, 14, 23, 25 AND 50).

FIRST USE 4-1-2003; IN COMMERCE 4-1-2003.
ALICE BENMAMAN, EXAMINING ATTORNEY

CLASS 6—(Continued).

SN 78-463,187. DELGALLO, FRANK, SCHENECTADY, NY. FILED 8-6-2004.



NO CLAIM IS MADE TO THE EXCLUSIVE RIGHT TO USE "COUNTRY POOLS INC.", APART FROM THE MARK AS SHOWN.

THE COLOR(S) YELLOW IS/ARE CLAIMED AS A FEATURE OF THE MARK.

THE COLOR YELLOW APPEARS IN THE DESIGN OF THE SUN.

FOR METAL INGROUND POOLS AND ABOVE GROUND POOLS (U.S. CLS. 2, 12, 13, 14, 23, 25 AND 50).

WENDY GOODMAN, EXAMINING ATTORNEY

SN 78-468,488. ATI PROPERTIES, INC., ALBANY, OR. FILED 8-17-2004.

SN 78-462,546. BROWNING, MORGAN, UT. FILED 8-5-2004.

**409 ALMZ
GOLD**

THE MARK CONSISTS OF STANDARD CHARACTERS WITHOUT CLAIM TO ANY PARTICULAR FONT, STYLE, SIZE, OR COLOR.

FOR METAL SAFES FOR STORAGE OF FIREARMS AND OTHER VALUABLES (U.S. CLS. 2, 12, 13, 14, 23, 25 AND 50).

FIRST USE 1-1-1993; IN COMMERCE 1-1-1993.
LINDA E. BLOHM, EXAMINING ATTORNEY

THE MARK CONSISTS OF STANDARD CHARACTERS WITHOUT CLAIM TO ANY PARTICULAR FONT, STYLE, SIZE, OR COLOR.

NO CLAIM IS MADE TO THE EXCLUSIVE RIGHT TO USE "409", APART FROM THE MARK AS SHOWN.

THE MARK IS PRESENTED IN STANDARD CHARACTERS, WITHOUT CLAIM TO ANY PARTICULAR FONT, STYLE, SIZE OR COLOR.

FOR ALUMINUM COATED FLAT-ROLLED STAINLESS STEEL SHEET AND STRIP (U.S. CLS. 2, 12, 13, 14, 23, 25 AND 50).

FIRST USE 12-1-2003; IN COMMERCE 12-1-2003.
CAROL SPILS, EXAMINING ATTORNEY

CLASS 6—(Continued).

SN 78-473,606. HARD AND FAST METALWARE FACTORY LTD., TSUEN WAN, HONG KONG, FILED 8-25-2004.



THE MARK CONSISTS OF STYLIZED WORDING ECLAT AND TRANGULAR DESIGN.
FOR METAL LOCKS AND KEYS FOR METAL LOCKS (U.S. CLS. 2, 12, 13, 14, 23, 25 AND 50).
FIRST USE 12-1-2003; IN COMMERCE 12-1-2003.
SUSAN STIGLITZ, EXAMINING ATTORNEY

SN 78-483,887. PRECISION POST TENSION, LP, SEAGOVILLE, TX. FILED 9-15-2004.

SURE-LOCK

THE MARK CONSISTS OF STANDARD CHARACTERS WITHOUT CLAIM TO ANY PARTICULAR FONT, STYLE, SIZE, OR COLOR.
OWNER OF U.S. REG. NO. 2,536,752.
FOR CONSTRUCTION ELEMENTS MADE OF METAL USED IN CONCRETE AND OTHER ANCHORING SYSTEMS, NAMELY, WEDGES, ANCHORS, CHUCKS, DONUTS, AND COUPLERS (U.S. CLS. 2, 12, 13, 14, 23, 25 AND 50).
FIRST USE 8-0-2002; IN COMMERCE 8-0-2002.
DAWN HAN, EXAMINING ATTORNEY

CLASS 6—(Continued).

SN 78-491,700. DELAWARE CAPITAL FORMATION, INC., WILMINGTON, DE. FILED 9-29-2004.

EZ FLEX

THE MARK CONSISTS OF STANDARD CHARACTERS WITHOUT CLAIM TO ANY PARTICULAR FONT, STYLE, SIZE, OR COLOR.
NO CLAIM IS MADE TO THE EXCLUSIVE RIGHT TO USE "FLEX", APART FROM THE MARK AS SHOWN.
FOR FLUID FUELING COMPONENTS MADE PRIMARILY OF METAL, NAMELY, SWIVELS (U.S. CLS. 2, 12, 13, 14, 23, 25 AND 50).
KAREN K. BUSH, EXAMINING ATTORNEY

SN 78-493,409. SAFETY BY DESIGN, LLC, CHESTERFIELD, MO. FILED 10-1-2004.

SAFETY BY DESIGN

THE MARK CONSISTS OF STANDARD CHARACTERS WITHOUT CLAIM TO ANY PARTICULAR FONT, STYLE, SIZE, OR COLOR.
FOR HOME SECURITY PRODUCTS, NAMELY, METAL DEAD BOLT DOOR LOCKS (U.S. CLS. 2, 12, 13, 14, 23, 25 AND 50).
JIM RINGLE, EXAMINING ATTORNEY

CLASS 6—(Continued).

SN 78-495,258. SUNWIN ENTERPRISES INC., CALGARY, ALBERTA, CANADA, FILED 10-6-2004.

SUNWIN

THE MARK CONSISTS OF STANDARD CHARACTERS WITHOUT CLAIM TO ANY PARTICULAR FONT, STYLE, SIZE, OR COLOR.
FOR METAL NAME BADGES (U.S. CLS. 2, 12, 13, 14, 23, 25 AND 50).
JENNIFER MARTIN, EXAMINING ATTORNEY

CLASS 6—(Continued).

SN 78-496,495. TRUFAST CORPORATION, BRYAN, OH. FILED 10-7-2004.

TIMBERFAST

THE MARK CONSISTS OF STANDARD CHARACTERS WITHOUT CLAIM TO ANY PARTICULAR FONT, STYLE, SIZE, OR COLOR.
FOR METAL SCREWS (U.S. CLS. 2, 12, 13, 14, 23, 25 AND 50).
TIMOTHY FINNEGAN, EXAMINING ATTORNEY

SN 78-496,125. TRISTAR PRODUCTS, INC., FAIRFIELD, NJ. FILED 10-7-2004.

SQV

THE MARK CONSISTS OF STANDARD CHARACTERS WITHOUT CLAIM TO ANY PARTICULAR FONT, STYLE, SIZE, OR COLOR.
FOR LADDERS MADE OF METAL (U.S. CLS. 2, 12, 13, 14, 23, 25 AND 50).
JASON TURNER, EXAMINING ATTORNEY

SN 78-514,285. CIMBERIO VALVE CO. INC., MALVERN, PA. FILED 11-10-2004.

CIMPRESS

THE MARK CONSISTS OF STANDARD CHARACTERS WITHOUT CLAIM TO ANY PARTICULAR FONT, STYLE, SIZE, OR COLOR.
FOR MANUALLY OPERATED METAL VALVES (U.S. CLS. 2, 12, 13, 14, 23, 25 AND 50).
FIRST USE 2-5-2004; IN COMMERCE 2-5-2004.
CAROLINE WOOD, EXAMINING ATTORNEY

CLASS 6—(Continued).

SN 78-517,375. UNITED STATES POSTAL SERVICE, WASHINGTON, DC. FILED 11-16-2004.



OWNER OF U.S. REG. NOS. 2,213,699 AND 2,900,954.
 THE MARK CONSISTS OF AN OVAL CONTAINING THE WORDS "PONY EXPRESS UNITED STATES MAIL" AND A HORSE AND RIDER DESIGN.
 FOR METAL MONEY CLIPS, KEY HOLDERS, AND KEY CHAINS (U.S. CLS. 2, 12, 13, 14, 23, 25 AND 50).
 JEFFERY COWARD, EXAMINING ATTORNEY

CLASS 6—(Continued).

SN 78-522,764. GOODYEAR TIRE & RUBBER COMPANY, THE, AKRON, OH. FILED 11-24-2004.

UNI-CRIMP

THE MARK CONSISTS OF STANDARD CHARACTERS WITHOUT CLAIM TO ANY PARTICULAR FONT, STYLE, SIZE, OR COLOR.
 FOR METAL FITTINGS FOR HYDRAULIC HOSE (U.S. CLS. 2, 12, 13, 14, 23, 25 AND 50).
 ANNE FARRELL, EXAMINING ATTORNEY

SN 78-517,590. SEQUA CORPORATION, ST. LOUIS, MO. FILED 11-16-2004.

KASSELWOOD

THE MARK CONSISTS OF STANDARD CHARACTERS WITHOUT CLAIM TO ANY PARTICULAR FONT, STYLE, SIZE, OR COLOR.
 FOR METAL SHINGLES (U.S. CLS. 2, 12, 13, 14, 23, 25 AND 50).
 MICHELE SWAIN, EXAMINING ATTORNEY

SN 78-530,767. HOMER TLC, INC., CLAYMONT, DE. FILED 12-10-2004.

TrafficMaster

SN 78-520,962. RIVERS, ALBERT A.SR., TICONDEROGA, NY. FILED 11-22-2004.

HI-TECH MAILBOXES

THE MARK CONSISTS OF STANDARD CHARACTERS WITHOUT CLAIM TO ANY PARTICULAR FONT, STYLE, SIZE, OR COLOR.
 NO CLAIM IS MADE TO THE EXCLUSIVE RIGHT TO USE "MAILBOXES", APART FROM THE MARK AS SHOWN.
 FOR METAL MAIL BOXES HAVING INCOMING AND OUTGOING MAIL FLAGS (U.S. CLS. 2, 12, 13, 14, 23, 25 AND 50).
 KATHY DE JONGE, EXAMINING ATTORNEY

THE MARK CONSISTS OF STANDARD CHARACTERS WITHOUT CLAIM TO ANY PARTICULAR FONT, STYLE, SIZE, OR COLOR.
 OWNER OF U.S. REG. NOS. 2,321,766 AND 2,730,350.
 FOR METAL CASTING FORMS FOR CONCRETE, WINDOWS, LADDERS AND DECORATIVE HARDWARE (U.S. CLS. 2, 12, 13, 14, 23, 25 AND 50).
 WON TEAK OH, EXAMINING ATTORNEY

CLASS 6—(Continued).

SN 78-535,269. U-HAUL INTERNATIONAL, INC., PHOENIX, AZ. FILED 12-20-2004.

U-HAUL

THE MARK CONSISTS OF STANDARD CHARACTERS WITHOUT CLAIM TO ANY PARTICULAR FONT, STYLE, SIZE, OR COLOR.

OWNER OF U.S. REG. NOS. 746,034, 893,891 AND OTHERS.

FOR METAL LOCKS (U.S. CLS. 2, 12, 13, 14, 23, 25 AND 50).

FIRST USE 5-1-1997; IN COMMERCE 5-1-1997.

THEODORE MCBRIDE, EXAMINING ATTORNEY

SN 78-537,700. COXWELLS, INC., TEMPE, AZ. FILED 12-23-2004.

ALUMI-PRO

THE MARK CONSISTS OF STANDARD CHARACTERS WITHOUT CLAIM TO ANY PARTICULAR FONT, STYLE, SIZE, OR COLOR.

FOR HAND OPERATED METAL REELS FOR FLEXIBLE HOSE (U.S. CLS. 2, 12, 13, 14, 23, 25 AND 50).

FIRST USE 12-21-2004; IN COMMERCE 12-21-2004.

JOHN GARTNER, EXAMINING ATTORNEY

CLASS 6—(Continued).

SN 78-537,760. BUFFETT, JIMMY, KEY WEST, FL. FILED 12-23-2004.

MARGARITAVILLE

THE MARK CONSISTS OF STANDARD CHARACTERS WITHOUT CLAIM TO ANY PARTICULAR FONT, STYLE, SIZE, OR COLOR.

OWNER OF U.S. REG. NOS. 1,642,132, 1,877,860 AND OTHERS.

FOR METAL KEY RINGS, METAL LICENSE PLATES (U.S. CLS. 2, 12, 13, 14, 23, 25 AND 50).

FIRST USE 5-1-1992; IN COMMERCE 5-1-1992.

BARBARA RUTLAND, EXAMINING ATTORNEY

SN 78-540,198. MORTON BUILDINGS, INC., MORTON, IL. FILED 12-30-2004.

FIBERSTEEL

THE MARK CONSISTS OF STANDARD CHARACTERS WITHOUT CLAIM TO ANY PARTICULAR FONT, STYLE, SIZE, OR COLOR.

FOR PRE-HUNG METAL DOORS (U.S. CLS. 2, 12, 13, 14, 23, 25 AND 50).

FIRST USE 1-27-2003; IN COMMERCE 10-11-2004.

SAMUEL E. SHARPER JR., EXAMINING ATTORNEY

CLASS 6—(Continued).

SN 78-541,308. TREK BICYCLE CORPORATION, WATER-
LOO, WI. FILED 1-3-2005.

VeloGlide

THE MARK CONSISTS OF STANDARD CHARACTERS
WITHOUT CLAIM TO ANY PARTICULAR FONT, STYLE,
SIZE, OR COLOR.

FOR METAL BICYCLE STORAGE RACK (U.S. CLS. 2,
12, 13, 14, 23, 25 AND 50).

FIRST USE 8-1-2004; IN COMMERCE 8-1-2004.

CAROLINE WEIMER, EXAMINING ATTORNEY

SN 79-001,719. TRAFILERIE DI CITTADELLA S.P.A., I-35013
CITTADELLA (PADOVA), ITALY, FILED 1-21-2004.

FILEUR

THE MARK CONSISTS OF STANDARD CHARACTERS
WITHOUT CLAIM TO ANY PARTICULAR FONT, STYLE,
SIZE, OR COLOR.

PRIORITY DATE OF 12-30-2003 IS CLAIMED.

OWNER OF INTERNATIONAL REGISTRATION 0821813
DATED 1-21-2004, EXPIRES 1-21-2014.

THE ENGLISH TRANSLATION OF THE WORD FILEUR,
IN THE MARK, IS SPINNER.

FOR WELDING WIRES OF METAL; NON-ELECTRIC
CABLES AND WIRES OF COMMON METAL (U.S. CLS.
2, 12, 13, 14, 23, 25 AND 50).

CURTIS FRENCH, EXAMINING ATTORNEY

SN 79-005,020. NINGBO YONGFA (GROUP) CO., LTD.,
CHINA, FILED 7-23-2004.



OWNER OF INTERNATIONAL REGISTRATION 0733777
DATED 4-20-2000, EXPIRES 4-20-2010.

THE NON-LATIN CHARACTERS IN THE MARK TRANS-
LITERATE TO YONG FA AND THIS MEANS FOREVER
ISSUE IN ENGLISH.

FOR METAL SAFES, COMMON METAL BOXES (U.S.
CLS. 2, 12, 13, 14, 23, 25 AND 50).

ANN LINNEHAN, EXAMINING ATTORNEY

CLASS 6—(Continued).

SN 79-006,429. GALLY S.P.A., ITALY, FILED 8-6-2004.



OWNER OF INTERNATIONAL REGISTRATION 0483530
DATED 2-20-1984, EXPIRES 2-20-2014.

FOR SELF-LOCKING NUTS AND SCREWS (U.S. CLS.
2, 12, 13, 14, 23, 25 AND 50).

MICHAEL KEATING, EXAMINING ATTORNEY

SN 79-007,233. NINGBO DONG YING HE; ELECTRONIC
CO., LTD., NINGBO CITY, ZHEJIANG PROVINCE 315040,
CHINA, FILED 6-7-2004.



OWNER OF INTERNATIONAL REGISTRATION 0838710
DATED 6-7-2004, EXPIRES 6-7-2014.

THE COLOR(S) BLUE IS/ARE CLAIMED AS A FEATURE
OF THE MARK.

SECOND LETTER "S" IS IN BLUE.

FOR SAFES, NAMELY METAL STRONG BOXES,
METAL SAFETY CASHBOXES; SAFES OF METAL;
CHESTS OF METAL FOR DOCUMENTS; NON-ELEC-
TRIC METAL SAFETY LOCKS; NON-ELECTRIC METAL
LOCKS (U.S. CLS. 2, 12, 13, 14, 23, 25 AND 50).

JENNIFER MARTIN, EXAMINING ATTORNEY

CLASS 7—MACHINERY

SN 76-501,432. LEYBOLD OPTICS GMBH, D-63755 ALZE-
NAU, FED REP GERMANY, FILED 3-27-2003.

HELIOS

OWNER OF FED REP GERMANY REG. NO. 395004403,
DATED 6-12-1995, EXPIRES 1-31-2015.

OWNER OF U.S. REG. NO. 2,052,165.

HELIOS TRANSLATED INTO ENGLISH MEANS "SUN".

FOR MACHINES FOR COATING OF SUBSTRATES
MADE OF ORGANIC OR MINERAL MATERIALS WITH
TRANSPARENT, WEAR RESISTANCE OR OPTICAL
COATINGS (U.S. CLS. 13, 19, 21, 23, 31, 34 AND 35).

ROBERT LORENZO, EXAMINING ATTORNEY

CLASS 7—(Continued).

SN 76-508,455. QUICKCORNER, INC., CORONA, CA. FILED 4-7-2003.

QUICKCORNER

OWNER OF U.S. REG. NO. 1,439,815.
FOR INDUSTRIAL MACHINES FOR INSTALLING
CORNER PROTECTORS ON FRAMES USED TO HOLD
FLAT ARTICLES (U.S. CLS. 13, 19, 21, 23, 31, 34 AND 35).
FIRST USE 9-30-2000; IN COMMERCE 9-30-2000.
SAMUEL E. SHARPER JR., EXAMINING ATTORNEY

SN 76-543,200. JOHN CRANE INC., MORTON GROVE, IL.
FILED 9-8-2003.

SEALIDE

OWNER OF U.S. REG. NO. 2,117,517.
FOR SILICON CARBIDE FACE MATERIAL SOLD AS
AN INTEGRAL COMPONENT OF ROTARY MECHANICAL
SEALS AND AS A REPLACEMENT PART FOR
SUCH SEALS (U.S. CLS. 13, 19, 21, 23, 31, 34 AND 35).
FIRST USE 10-0-1972; IN COMMERCE 10-0-1972.
TRACY FLETCHER, EXAMINING ATTORNEY

SN 76-561,125. STEIN SEAL COMPANY, KULPSVILLE, PA.
FILED 11-20-2003.

HYDROLOAD

THE MARK CONSISTS OF STANDARD CHARACTERS
WITHOUT CLAIM TO ANY PARTICULAR FONT, STYLE,
SIZE, OR COLOR.
FOR SEALS AND SEALING ASSEMBLIES COM-
PRISED OF SEALS AND THEIR STRUCTURAL PARTS,
FOR LIMITING FLUID LEAKAGE IN MECHANICAL
EQUIPMENT FOR USE IN TURBO-MACHINERY (U.S.
CLS. 13, 19, 21, 23, 31, 34 AND 35).
FIRST USE 0-0-1998; IN COMMERCE 0-0-1998.
JENNIFER MARTIN, EXAMINING ATTORNEY

SN 76-564,369. RACE ENGINEERING, INC., LAKE WORTH,
FL. FILED 11-28-2003.

ALL-AMERICAN

THE MARK CONSISTS OF STANDARD CHARACTERS
WITHOUT CLAIM TO ANY PARTICULAR FONT, STYLE,
SIZE, OR COLOR.
FOR RACE CAR ENGINE COMPONENTS, NAMELY
CRANKSHAFTS NOT SOLD IN AUTO PARTS STORES
(U.S. CLS. 13, 19, 21, 23, 31, 34 AND 35).
FIRST USE 12-0-2002; IN COMMERCE 12-0-2002.
STEVEN R. FINE, EXAMINING ATTORNEY

CLASS 7—(Continued).

SN 76-571,546. TRUMPF GMBH + CO. KG, D-71254,
DITZINGEN, FED REP GERMANY, FILED 1-22-2004.

LASERCELL

THE MARK CONSISTS OF STANDARD CHARACTERS
WITHOUT CLAIM TO ANY PARTICULAR FONT, STYLE,
SIZE, OR COLOR.

FOR LASER INSTALLATIONS INCLUDING A MULTI-
AXIS LASER PROCESSING MACHINE FOR CUTTING,
WELDING AND SURFACE TREATING WORKPIECES
(U.S. CLS. 13, 19, 21, 23, 31, 34 AND 35).
FIRST USE 1-1-1998; IN COMMERCE 1-1-1998.
STEPHANIE DAVIS, EXAMINING ATTORNEY

SN 76-581,434. CHICK WORKHOLDING SOLUTIONS, INC.,
WARRENDALE, PA. FILED 3-17-2004.

PNEU-DEX

THE MARK CONSISTS OF STANDARD CHARACTERS
WITHOUT CLAIM TO ANY PARTICULAR FONT, STYLE,
SIZE, OR COLOR.

FOR TOOLHOLDING AND WORKHOLDING FIX-
TURES FOR PRECISION MACHINING APPLICATIONS
(U.S. CLS. 13, 19, 21, 23, 31, 34 AND 35).
FIRST USE 9-0-1996; IN COMMERCE 9-0-1996.
DOUGLAS LEE, EXAMINING ATTORNEY

SN 76-584,417. ROTOCHOPPER, INC., ST. MARTIN, MN.
FILED 4-1-2004.

PERFECT IN ONE PASS

THE MARK CONSISTS OF STANDARD CHARACTERS
WITHOUT CLAIM TO ANY PARTICULAR FONT, STYLE,
SIZE, OR COLOR.

FOR WASTE HANDLING AND RECYCLING MA-
CHINES USED TO SHRED WASTE (U.S. CLS. 13, 19, 21,
23, 31, 34 AND 35).
FIRST USE 2-1-2003; IN COMMERCE 2-1-2003.
MELISSA SHELLA, EXAMINING ATTORNEY

CLASS 7—(Continued).

SN 76-584,760. KELLER, WILHELM A., SALEM, NH. FILED 4-5-2004.

STATOMIX

OWNER OF U.S. REG. NO. 1,328,016.
THE MARK IS NOT LINED FOR COLOR.
FOR PROCESS MACHINERY, NAMELY, CONTINUOUS MIXERS FOR MIXING AND HOMOGENIZING SOLID, LIQUID AND GASEOUS MATERIALS (U.S. CLS. 13, 19, 21, 23, 31, 34 AND 35).
FIRST USE 9-13-1983; IN COMMERCE 9-13-1983.
JEFF DEFORD, EXAMINING ATTORNEY

SN 76-585,013. FUJI CHEMICAL INDUSTRY CO., LTD., TOYAMA-KEN, JAPAN, FILED 4-5-2004.

BIODOME

THE MARK CONSISTS OF STANDARD CHARACTERS WITHOUT CLAIM TO ANY PARTICULAR FONT, STYLE, SIZE, OR COLOR.
FOR CHEMICAL PROCESSING MACHINES AND APPARATUS FOR INDUSTRIAL USE, NAMELY, ALGAE CULTURE APPARATUS, MICROALGAE CULTURE APPARATUS, BLUE GREEN ALGAE CULTURE APPARATUS, YEAST CULTURE APPARATUS, BACTERIA CULTURE APPARATUS, FUNGUS CULTURE APPARATUS, KOJI MOLD CULTURE APPARATUS (U.S. CLS. 13, 19, 21, 23, 31, 34 AND 35).
CURTIS FRENCH, EXAMINING ATTORNEY

SN 76-586,088. COLFAX CORPORATION, LAWRENCEVILLE, NJ. FILED 4-12-2004.

DELROYD

THE MARK CONSISTS OF STANDARD CHARACTERS WITHOUT CLAIM TO ANY PARTICULAR FONT, STYLE, SIZE, OR COLOR.
FOR MACHINE PARTS, NAMELY, SPEED REDUCERS, GEARS, WORM GEARS, DRIVES AND TRANSMISSIONS, GEAR DRIVES, DRIVE CHAINS, MECHANICAL DRIVES, VERTICAL AND HORIZONTAL DRIVES, SPEED INCREASERS, GEAR HOUSINGS, GEAR MOTORS, BED PLATES, COUPLINGS, COUPLING GUARDS, AND SHOE AND DISC BRAKES FOR INDUSTRIAL APPLICATIONS (U.S. CLS. 13, 19, 21, 23, 31, 34 AND 35).
FIRST USE 1-0-1951; IN COMMERCE 1-0-1951.
MATTHEW PAPPAS, EXAMINING ATTORNEY

CLASS 7—(Continued).

SN 76-587,302. MID-ATLANTIC SCAFFOLD, INC., ATLANTA, GA. FILED 4-19-2004.

HYDEK

THE MARK CONSISTS OF STANDARD CHARACTERS WITHOUT CLAIM TO ANY PARTICULAR FONT, STYLE, SIZE, OR COLOR.
FOR HYDRAULICALLY POWERED LIFT PLATFORMS (U.S. CLS. 13, 19, 21, 23, 31, 34 AND 35).
MARCIE MILONE, EXAMINING ATTORNEY

SN 76-589,331. SPIEL ASSOCIATES, INC., LONG ISLAND CITY, NY. FILED 4-28-2004.

DIGIBINDER

THE MARK CONSISTS OF STANDARD CHARACTERS WITHOUT CLAIM TO ANY PARTICULAR FONT, STYLE, SIZE, OR COLOR.
FOR MACHINERY AND EQUIPMENT USED IN THE BOOKBINDING AND PAPER CONVERTING INDUSTRY, NAMELY BINDERS (U.S. CLS. 13, 19, 21, 23, 31, 34 AND 35).
FIRST USE 10-1-2003; IN COMMERCE 10-1-2003.
ALLISON HOLTZ, EXAMINING ATTORNEY

SN 76-597,625. H&L TOOTH COMPANY, TULSA, OK. FILED 6-16-2004.

DELTA WING

THE MARK CONSISTS OF STANDARD CHARACTERS WITHOUT CLAIM TO ANY PARTICULAR FONT, STYLE, SIZE, OR COLOR.
FOR GROUND ENGAGING EQUIPMENT, NAMELY, GROUND ENGAGING TEETH ATTACHABLE TO EARTH EXCAVATING AND DIGGING MACHINERY (U.S. CLS. 13, 19, 21, 23, 31, 34 AND 35).
FIRST USE 11-4-2004; IN COMMERCE 11-4-2004.
GEORGIA CARTY, EXAMINING ATTORNEY

CLASS 7—(Continued).

SN 76-600,352. SHAFFER, JOHN D. III, SHELL KNOB, MO. FILED 6-30-2004.

FOR NAUTICAL APPARATUS, NAMELY POWER OPERATED BOAT LIFTS (U.S. CLS. 13, 19, 21, 23, 31, 34 AND 35).

FIRST USE 3-1-1997; IN COMMERCE 3-1-1997.
DOMINIC J. FERRAIUOLO, EXAMINING ATTORNEY

SN 76-601,848. SCHWARZE INDUSTRIES, INC., HUNTSVILLE, AL. FILED 7-9-2004.

**NEW IDEAS FROM THE COMPANY THAT'S SWEEPING
THE EARTH**

THE MARK CONSISTS OF STANDARD CHARACTERS WITHOUT CLAIM TO ANY PARTICULAR FONT, STYLE, SIZE, OR COLOR.

FOR LAND VEHICLES, NAMELY, INDUSTRIAL SIZE GROUND AND STREET VACUUMS AND SWEEPERS AND STRUCTURAL PARTS THEREFOR (U.S. CLS. 13, 19, 21, 23, 31, 34 AND 35).

GEORGE LORENZO, EXAMINING ATTORNEY

SN 76-601,849. SCHWARZE INDUSTRIES, INC., HUNTSVILLE, AL. FILED 7-9-2004.

**NEW IDEAS FROM THE COMPANY THAT'S SWEEPING
THE WORLD**

THE MARK CONSISTS OF STANDARD CHARACTERS WITHOUT CLAIM TO ANY PARTICULAR FONT, STYLE, SIZE, OR COLOR.

FOR LAND VEHICLES, NAMELY, INDUSTRIAL SIZE GROUND AND STREET VACUUMS AND SWEEPERS AND STRUCTURAL PARTS THEREFOR (U.S. CLS. 13, 19, 21, 23, 31, 34 AND 35).

GEORGE LORENZO, EXAMINING ATTORNEY

SN 76-607,117. STEVENS INDUSTRIES, L.L.C., POINT PLEASANT, NJ. FILED 8-16-2004.

RAPID COATER

THE MARK CONSISTS OF STANDARD CHARACTERS WITHOUT CLAIM TO ANY PARTICULAR FONT, STYLE, SIZE, OR COLOR.

NO CLAIM IS MADE TO THE EXCLUSIVE RIGHT TO USE COATER, APART FROM THE MARK AS SHOWN.

FOR MACHINES FOR APPLYING COATING MATERIALS ON TABLETS IN THE FIELD OF PHARMACEUTICALS AND CONFECTIONERY (U.S. CLS. 13, 19, 21, 23, 31, 34 AND 35).

FIRST USE 8-5-2004; IN COMMERCE 8-5-2004.
KELLY CHOE, EXAMINING ATTORNEY

CLASS 7—(Continued).

SN 76-607,242. IGE SOLUTIONS, INC., JUPITER, FL. FILED 8-12-2004.

IGE'S ELITE

THE MARK CONSISTS OF STANDARD CHARACTERS WITHOUT CLAIM TO ANY PARTICULAR FONT, STYLE, SIZE, OR COLOR.

FOR ABRASIVE DIAMOND GRINDING AND POLISHING WHEELS, BITS AND BLADES FOR USE ON AUTOMATIC, NON-CONSUMER INDUSTRIAL GRADE, GLASS AND STONE POLISHING MACHINES AND STONE CUTTING SAWS (U.S. CLS. 13, 19, 21, 23, 31, 34 AND 35).

FIRST USE 1-1-2004; IN COMMERCE 1-30-2004.
WILLIAM VERHOSEK, EXAMINING ATTORNEY

SN 76-610,564. HOPKINS, WALTER, MCGAHEYSVILLE, VA. FILED 9-9-2004.



FOR IMPACT INERTIAL COLLECTOR MACHINE TO GATHER DEBRIS FROM A HIGHWAY SURFACE SUCH AS DISCARDED TIRE TREADS (U.S. CLS. 13, 19, 21, 23, 31, 34 AND 35).

FIRST USE 6-6-2003; IN COMMERCE 7-18-2003.
TARAH HARDY, EXAMINING ATTORNEY

SN 76-611,658. PACKAGING TECHNOLOGIES, INC., DAVENPORT, IA. FILED 9-16-2004.

Opti-fil

THE MARK CONSISTS OF STANDARD CHARACTERS WITHOUT CLAIM TO ANY PARTICULAR FONT, STYLE, SIZE, OR COLOR.

OWNER OF U.S. REG. NO. 2,052,567.

FOR MACHINES FOR FILLING, CAPPING AND SEALING FOOD CONTAINERS (U.S. CLS. 13, 19, 21, 23, 31, 34 AND 35).

FIRST USE 11-30-1995; IN COMMERCE 11-30-1995.
RAMONA ORTIGA, EXAMINING ATTORNEY

CLASS 7—(Continued).

SN 76-611,709. BOLDSTAR TECHNICAL, LLC, BOCA RATON, FL. FILED 9-13-2004.

SAFE HANDS

THE MARK CONSISTS OF STANDARD CHARACTERS WITHOUT CLAIM TO ANY PARTICULAR FONT, STYLE, SIZE, OR COLOR.
 FOR POWER-OPERATED SAWS AND COMPONENTS, NAMELY, POWER SAW BLADES (U.S. CLS. 13, 19, 21, 23, 31, 34 AND 35).
 FIRST USE 8-20-2004; IN COMMERCE 8-20-2004.
 ROBERT LORENZO, EXAMINING ATTORNEY

SN 76-612,020. VICKI MACK AND CARYL MACMASTER, DBA MERIT-TEX, PALOS VERDES ESTATES, CA. FILED 9-13-2004.

MERIT-TEX

THE MARK CONSISTS OF STANDARD CHARACTERS WITHOUT CLAIM TO ANY PARTICULAR FONT, STYLE, SIZE, OR COLOR.
 FOR PRINTING PLATES FOR PRINTING TEXTURED PHOTOGRAPHS (U.S. CLS. 13, 19, 21, 23, 31, 34 AND 35).
 FIRST USE 0-0-1984; IN COMMERCE 0-0-1984.
 KELLY CHOE, EXAMINING ATTORNEY

SN 76-613,510. SOBER, RONALD J., NEW BROWNFELS, TX. FILED 9-23-2004.



NO CLAIM IS MADE TO THE EXCLUSIVE RIGHT TO USE SKEGGARD, APART FROM THE MARK AS SHOWN.
 FOR MARINE ENGINE COVER KITS FOR PROTECTING SKEGS COMPRISED OF A PREFORMED COVER MEMBER DESIGNED TO FIT OVER THE SKEG AND PERMANENTLY ATTACH TO THE LOWER UNIT OF THE MARINE ENGINE (U.S. CLS. 13, 19, 21, 23, 31, 34 AND 35).
 FIRST USE 1-0-1991; IN COMMERCE 1-0-1991.
 JOHN DALIER, EXAMINING ATTORNEY

CLASS 7—(Continued).

SN 76-614,482. AMERICAN FLOOR DISCOUNT, INC., LAWRENCEVILLE, GA. FILED 10-1-2004.



NO CLAIM IS MADE TO THE EXCLUSIVE RIGHT TO USE "AMERICAN FLOOR", APART FROM THE MARK AS SHOWN.
 FOR FLOORING INSTALLATION EQUIPMENT, NAMELY, BUFFERS, EDGERS, POLISHING MACHINES, SANDERS, SLABBING MACHINES AND WASHING MACHINES (U.S. CLS. 13, 19, 21, 23, 31, 34 AND 35).
 FIRST USE 4-4-1999; IN COMMERCE 4-15-2002.
 JENNIFER WILLISTON, EXAMINING ATTORNEY

SN 76-615,217. WEIDER HEALTH AND FITNESS, WOODLAND HILLS, CA. FILED 10-12-2004.

MASTER BLASTER

THE MARK CONSISTS OF STANDARD CHARACTERS WITHOUT CLAIM TO ANY PARTICULAR FONT, STYLE, SIZE, OR COLOR.
 FOR ELECTRIC FOOD BLENDERS AND ELECTRIC JUICERS (U.S. CLS. 13, 19, 21, 23, 31, 34 AND 35).
 HEATHER THOMPSON, EXAMINING ATTORNEY

SN 76-617,019. THE CP PRODUCTS COMPANY, INC., TEMPE, AZ. FILED 10-19-2004.



THE MARK CONSISTS OF STANDARD CHARACTERS WITHOUT CLAIM TO ANY PARTICULAR FONT, STYLE, SIZE, OR COLOR.
 FOR NOZZLES AND CHECK VALVES FOR POWER OPERATED AGRICULTURAL SPRAYERS (U.S. CLS. 13, 19, 21, 23, 31, 34 AND 35).
 FIRST USE 5-0-1982; IN COMMERCE 5-0-1982.
 DAVID MURRAY, EXAMINING ATTORNEY

CLASS 7—(Continued).

SN 76-617,417. FANIMATION, INC., ZIONSVILLE, IL. FILED 10-25-2004.

ZANZIBAR

THE MARK CONSISTS OF STANDARD CHARACTERS WITHOUT CLAIM TO ANY PARTICULAR FONT, STYLE, SIZE, OR COLOR.

FOR MOTOR HOUSINGS FOR ELECTRIC CEILING FANS (U.S. CLS. 13, 19, 21, 23, 31, 34 AND 35).
FIRST USE 6-0-2004; IN COMMERCE 6-0-2004.
EVELYN BRADLEY, EXAMINING ATTORNEY

CLASS 7—(Continued).

SN 76-626,314. IGE SOLUTIONS, INC., JUPITER, FL. FILED 12-28-2004.

LINE BREAKER

THE MARK CONSISTS OF STANDARD CHARACTERS WITHOUT CLAIM TO ANY PARTICULAR FONT, STYLE, SIZE, OR COLOR.

FOR ABRASIVE DIAMOND GRINDING AND POLISHING WHEELS, BITS AND BLADES FOR USE ON AUTOMATIC, INDUSTRIAL, NON-CONSUMER GRADE, GLASS AND STONE POLISHING MACHINES FOR REMOVAL OF LINES IN GRANITE, MARBLE, OR OTHER SOFT OR HARD STONE (U.S. CLS. 13, 19, 21, 23, 31, 34 AND 35).

FIRST USE 3-0-2004; IN COMMERCE 3-0-2004.
AMY GEARIN, EXAMINING ATTORNEY

SN 76-617,760. MERLIN GLOW PLUGS, INC., WESTERN SPRINGS, IL. FILED 10-26-2004.

GOLDEN GLOW

THE MARK CONSISTS OF STANDARD CHARACTERS WITHOUT CLAIM TO ANY PARTICULAR FONT, STYLE, SIZE, OR COLOR.

NO CLAIM IS MADE TO THE EXCLUSIVE RIGHT TO USE "GLOW", APART FROM THE MARK AS SHOWN, FOR MODEL CAR AND AIRCRAFT ENGINE COMPONENTS, NAMELY, GLOW PLUGS (U.S. CLS. 13, 19, 21, 23, 31, 34 AND 35).

FIRST USE 10-31-2003; IN COMMERCE 10-31-2003.
TRACY WHITAKER-BOWN, EXAMINING ATTORNEY

SN 76-626,726. UNION PROCESS, INC., AKRON, OH. FILED 12-27-2004.

DMQ-MILL

THE MARK CONSISTS OF STANDARD CHARACTERS WITHOUT CLAIM TO ANY PARTICULAR FONT, STYLE, SIZE, OR COLOR.

FOR WET AND DRY GRINDING PARTICLE SIZE REDUCTION MILLS (U.S. CLS. 13, 19, 21, 23, 31, 34 AND 35).

FIRST USE 12-17-2004; IN COMMERCE 12-17-2004.
ELLEN BURNS, EXAMINING ATTORNEY

SN 76-625,696. PRECISION METALSMITHS, INC., CLEVELAND, OH. FILED 12-21-2004.

eQUICK-TOOL

FOR NON-METALLIC INJECTION DIES USED TO MAKE INVESTMENT CASTING PATTERNS AND THE LIKE (U.S. CLS. 13, 19, 21, 23, 31, 34 AND 35).

RONALD MCMORROW, EXAMINING ATTORNEY

SN 76-628,963. IGE SOLUTIONS, INC., JUPITER, FL. FILED 1-24-2005.

LINE BUSTER

THE MARK CONSISTS OF STANDARD CHARACTERS WITHOUT CLAIM TO ANY PARTICULAR FONT, STYLE, SIZE, OR COLOR.

FOR ABRASIVE DIAMOND GRINDING AND POLISHING WHEELS, BITS AND BLADES FOR USE ON AUTOMATIC, INDUSTRIAL, NON-CONSUMER GRADE, GLASS AND STONE POLISHING MACHINES FOR REMOVAL OF LINES IN GRANITE, MARBLE, OR OTHER SOFT OR HARD STONE (U.S. CLS. 13, 19, 21, 23, 31, 34 AND 35).

FIRST USE 3-0-2004; IN COMMERCE 3-0-2004.
AMY GEARIN, EXAMINING ATTORNEY

CLASS 7—(Continued).

SN 78-089,184. SMITH INTERNATIONAL, INC., HOUSTON, TX. FILED S.R. 10-19-2001; AM. P.R. 8-23-2002.

SMITH BITS

OWNER OF U.S. REG. NOS. 964,649 AND 1,252,730.
NO CLAIM IS MADE TO THE EXCLUSIVE RIGHT TO USE "BITS", APART FROM THE MARK AS SHOWN.
SEC. 2(F) AS TO "SMITH".
FOR ROCK BITS FOR DRILLING BORE HOLES IN THE EARTH. (U.S. CLS. 13, 19, 21, 23, 31, 34 AND 35).
FIRST USE 9-1-1998; IN COMMERCE 9-1-1998.
SUELLEN HICKEY, EXAMINING ATTORNEY

SN 78-161,010. INTEGRATED FLOW SOLUTIONS, LLC, HOUSTON, TX. FILED 9-5-2002.

INTEGRATED FLOW SOLUTIONS

NO CLAIM IS MADE TO THE EXCLUSIVE RIGHT TO USE "FLOW", APART FROM THE MARK AS SHOWN.
FOR MODULAR PUMPING SYSTEMS USED FOR PUMPING LIQUIDS OR GASES COMPRISED OF PUMPS WITH BLOWERS, MOTORS, ENGINES, VALVES, PIPING, MIXERS, ELECTRIC HEATERS AND CONTROLS FOR THE PUMPS, NAMELY, INSTRUMENTATION, PROGRAMMABLE LOGIC CONTROLLERS, STARTERS, MICROPROCESSORS ALL MOUNTED ON STRUCTURAL STEEL BASES AND SOLD AS A UNIT FOR USE IN THE OIL AND GAS PRODUCTION, OIL REFINING, CHEMICAL PROCESSING, POWER GENERATION, NOX REDUCTION, GENERAL INDUSTRIAL, PULP AND PAPER AND PHARMACEUTICALS INDUSTRIES (U.S. CLS. 13, 19, 21, 23, 31, 34 AND 35).
EUGENIA MARTIN, EXAMINING ATTORNEY

SN 78-185,790. RISLEY ENTERPRISES LTD., GRANDE PRAIRIE, ALBERTA, CANADA, FILED 11-15-2002.

RISLEY

PRIORITY CLAIMED UNDER SEC. 44(D) ON CANADA APPLICATION NO. 1141326, FILED 5-17-2002, REG. NO. TMA631777, DATED 2-2-2005, EXPIRES 2-2-2020.
SEC. 2(F).
FOR FORESTRY MACHINERY, NAMELY, TREE FALLING HEADS, TREE HARVESTING MACHINES, TREE DELIMBERS, TOPPING SAWS, HIGH SPEED SAWS, BUTT SAWS, TRIM SAWS, TREE PROCESSING HEADS AND RELATED PARTS FOR THE FOREGOING GOODS (U.S. CLS. 13, 19, 21, 23, 31, 34 AND 35).
FIRST USE 12-31-1990; IN COMMERCE 12-31-1995.
HOWARD SMIGA, EXAMINING ATTORNEY

CLASS 7—(Continued).

SN 78-227,068. BROWN BOGGS FOUNDRY AND MACHINE COMPANY LIMITED, ANCASTER, ONTARIO, CANADA, FILED 3-18-2003.

BROWN BOGGS

PRIORITY CLAIMED UNDER SEC. 44(D) ON CANADA APPLICATION NO. 1153164, FILED 9-25-2002, REG. NO. TMA617793, DATED 8-26-2004, EXPIRES 8-26-2019.
FOR SHEET METAL MACHINE WORKING TOOLS AND MACHINERY (U.S. CLS. 13, 19, 21, 23, 31, 34 AND 35).
FIRST USE 4-0-1890; IN COMMERCE 3-0-1978.
ANNE MADDEN, EXAMINING ATTORNEY

SN 78-302,004. DANSK INDUSTRI SYNDIKAT A/S, 2730 HERLEV, DENMARK, FILED 9-18-2003.

DISA

PRIORITY CLAIMED UNDER SEC. 44(D) ON DENMARK APPLICATION NO. VA200301663, FILED 4-29-2003, REG. NO. VR200302337, DATED 7-4-2003, EXPIRES 7-4-2013.
OWNER OF U.S. REG. NO. 2,653,269.
FOR MACHINES AND MACHINE TOOLS, NAMELY FOUNDRY MACHINES AND MOLD HANDLING EQUIPMENT; MACHINES FOR DIE CASTING; INDUSTRIAL ROBOTS; FOUNDRY SAND HANDLING EQUIPMENT; MACHINERY FOR CONTROLLING AND TESTING THE FOUNDRY PROCESS; ROTARY DRUMS FOR SAND CASTINGS SEPARATION, SAND AND CASTING COOLING AND SAND HOMOGENIZING; HIGH SPEED MIXERS; POURING MACHINES; CORE MAKING MACHINES; CORE HANDLING MACHINES; SHOT BLAST CLEANING MACHINES; MACHINERY FOR THE FETTLING OF CASTINGS; MACHINERY FOR THE TRIMMING OF CASTING; GRINDING MACHINERY; MACHINERY FOR DUST COLLECTING AND FILTERING; CONVEYERS; CONVERTER FOUNDRY MACHINERY FOR STEEL MANUFACTURE (U.S. CLS. 13, 19, 21, 23, 31, 34 AND 35).
PAM WILLIS, EXAMINING ATTORNEY

SN 78-302,507. DESIGN CORP, GOSHEN, IN. FILED 9-18-2003.



Automatic Mulch Coloring System

NO CLAIM IS MADE TO THE EXCLUSIVE RIGHT TO USE "AUTOMATIC MULCH COLORING SYSTEM", APART FROM THE MARK AS SHOWN.
FOR MACHINES FOR DISPENSING WOOD MULCH COLORANT (U.S. CLS. 13, 19, 21, 23, 31, 34 AND 35).
FIRST USE 9-1-2003; IN COMMERCE 9-15-2003.
DOMINICK J. SALEMI, EXAMINING ATTORNEY

CLASS 7—(Continued).

SN 78-303,627. REGAL-BELOIT CORPORATION, BELOIT, WI. FILED 9-22-2003.

WASH-THRU

FOR INDUSTRIAL ELECTRIC MOTORS FOR EQUIPMENT IN HARSH ENVIRONMENTS (U.S. CLS. 13, 19, 21, 23, 31, 34 AND 35).

FIRST USE 5-1-1998; IN COMMERCE 5-1-1998.
GIANCARLO CASTRO, EXAMINING ATTORNEY

SN 78-316,929. WESTERBEKE CORPORATION, TAUNTON, MA. FILED 10-22-2003.

SAFE CO

NO CLAIM IS MADE TO THE EXCLUSIVE RIGHT TO USE "CO", APART FROM THE MARK AS SHOWN.

FOR BOAT ENGINES; CATALYTIC CONVERTERS FOR MOTORS AND ENGINES; DIESEL ENGINES FOR MARINE PROPULSION AND POWER GENERATION; DIESEL ENGINES FOR MACHINES; DIESEL ENGINES NOT FOR LAND VEHICLES; EMISSION REDUCTION UNITS FOR MOTORS AND ENGINES, NAMELY CATALYTIC CONVERTERS; ENGINES NOT FOR LAND VEHICLES; INTERNAL COMBUSTION ENGINES FOR BOATS; INTERNAL COMBUSTION ENGINES FOR MACHINE OPERATION AND REPLACEMENT PARTS THEREFORE; INTERNAL COMBUSTION ENGINES FOR POWER GENERATION; DIESEL ENGINES FOR PROPULSION AND POWER GENERATION; ELECTRIC GENERATORS; GENERATORS FOR LAND VEHICLES; BOAT MOTORS; INTERNAL COMBUSTION ENGINE WITH INTEGRATED ELECTRONIC CONTROLS FOR REDUCTION OF CO EMISSIONS FOR BOATS; MARINE PROPULSION ENGINES; MARINE ENGINES FOR ELECTRIC POWER GENERATION; ENGINE DRIVEN GENERATORS FOR POWER GENERATION IN MINING APPLICATIONS (U.S. CLS. 13, 19, 21, 23, 31, 34 AND 35).
RUSS HERMAN, EXAMINING ATTORNEY

CLASS 7—(Continued).

SN 78-317,210. ZHEJIANG HUALIAN PACKAGING MACHINERY CO., LTD., ZHEJIANG PROVINCE, CHINA, FILED 10-22-2003.



FOR PACKAGING MACHINES; MACHINES FOR WRAPPING GOODS FOR PACKAGING; SEALING MACHINES FOR USE IN SEALING PLASTIC BAGS FOR INDUSTRIAL PURPOSES; SHEAF-BINDING MACHINES FOR USE IN BINDING PACKAGES; BOTTLE SEALING MACHINES; FILLING MACHINES FOR USE IN FILLING BOTTLES WITH LIQUIDS; HOT-STAMPING MACHINES, NAMELY, PRESSES FOR HOT-STAMPING NUMBERS AND LABELS; PRINTING MACHINES, NAMELY, PRINTING PRESSES; OFF-SET PRESSES, NAMELY, INDUSTRIAL MACHINE PRESSES; FOLDING MACHINES, NAMELY, MACHINES FOR USE IN FOLDING GARMENTS FOR INDUSTRIAL USE; FOOD PACKAGING MACHINES; COLLOID MILLS LABELING MACHINES USED IN FOODSTUFFS INDUSTRY, CHEMICAL INDUSTRY AND EVERYDAY CHEMICAL INDUSTRY (U.S. CLS. 13, 19, 21, 23, 31, 34 AND 35).
MARY CRAWFORD, EXAMINING ATTORNEY

SN 78-328,082. ENVIRO-PADS CONTAINMENT SYSTEMS INC., RED DEER, ALBERTA, CANADA, FILED 11-14-2003.

ENVIRO-PADS

THE MARK CONSISTS OF STANDARD CHARACTERS WITHOUT CLAIM TO ANY PARTICULAR FONT, STYLE, SIZE, OR COLOR.

PRIORITY CLAIMED UNDER SEC. 44(D) ON CANADA APPLICATION NO. 1192715, FILED 10-2-2003, REG. NO. TMA625017, DATED 11-9-2004, EXPIRES 11-9-2019.

FOR PORTABLE WASH STATIONS, PORTABLE REFUELING STATIONS AND CONTAINMENT STRUCTURES, NAMELY, FLAT STRUCTURES OR PADS CAPABLE OF BEING TRANSPORTED TO VARIOUS WORK SITES ONTO WHICH VEHICLES ARE DRIVEN AND WASHED OR REFUELED ALLOWING SPILLED LIQUIDS TO BE COLLECTED IN THE PAD AND THEN DRAINED INTO CONTAINMENT STRUCTURES OR TANKS FOR PROPER DISPOSAL (U.S. CLS. 13, 19, 21, 23, 31, 34 AND 35).

FIRST USE 8-6-2004; IN COMMERCE 8-6-2004.
LOURDES AYALA, EXAMINING ATTORNEY

CLASS 7—(Continued).

SN 78-342,795. TRI-MOTION INDUSTRIES, INC., TAMPA, FL. FILED 12-18-2003.

DROP STOP

THE MARK CONSISTS OF STANDARD CHARACTERS WITHOUT CLAIM TO ANY PARTICULAR FONT, STYLE, SIZE, OR COLOR.

FOR OVERHEAD HOIST AND TACKLE BLOCK FOR HANDLING MATERIALS (U.S. CLS. 13, 19, 21, 23, 31, 34 AND 35).

FIRST USE 4-5-1971; IN COMMERCE 4-15-1971.
RICHARD WHITE, EXAMINING ATTORNEY

SN 78-359,741. GL&V MANAGEMENT HUNGARY KFT., EGRESSY UT 26, HUNGARY, FILED 1-29-2004.

DEEP CONE

THE MARK CONSISTS OF STANDARD CHARACTERS WITHOUT CLAIM TO ANY PARTICULAR FONT, STYLE, SIZE, OR COLOR.

FOR MACHINES, NAMELY, THICKENERS, FOR USE IN THE MINING AND INDUSTRIAL PROCESSING INDUSTRIES; INSTALLATIONS, NAMELY, PASTE THICKENER UNITS FOR THICKENING PROCESS FLOW STREAMS (U.S. CLS. 13, 19, 21, 23, 31, 34 AND 35).

FIRST USE 5-1-1998; IN COMMERCE 5-1-1998.
MARLENE BELL, EXAMINING ATTORNEY

CLASS 7—(Continued).

SN 78-390,605. NATIONAL AUTOMOTIVE PARTS ASSOCIATION, ATLANTA, GA. FILED 3-25-2004.



NO CLAIM IS MADE TO THE EXCLUSIVE RIGHT TO USE "PERFORMANCE", APART FROM THE MARK AS SHOWN.

THE STIPPLING IS FOR SHADING PURPOSES.

THE ENGLISH TRANSLATION OF HYOSHI IS BEAT, RHYTHM, TEMPO.

FOR PARTS FOR VEHICLE MOTORS AND ENGINES, NAMELY TIMING BELTS, TIMING GEARS, SERPENTINE BELTS, IDLERS, TENSIONERS, AND KITS CONTAINING SAME; AND RADIATOR HOSES AND HOSE CLAMPS (U.S. CLS. 13, 19, 21, 23, 31, 34 AND 35).

FIRST USE 5-1-2004; IN COMMERCE 5-1-2004.
LINDA ESTRADA, EXAMINING ATTORNEY

SN 78-393,183. FULTON, STEVE, CORTE MADERA, CA. FILED 3-30-2004.

Modern Linear

THE MARK CONSISTS OF STANDARD CHARACTERS WITHOUT CLAIM TO ANY PARTICULAR FONT, STYLE, SIZE, OR COLOR.

NO CLAIM IS MADE TO THE EXCLUSIVE RIGHT TO USE "LINEAR", APART FROM THE MARK AS SHOWN. FOR LINEAR ACTUATORS (U.S. CLS. 13, 19, 21, 23, 31, 34 AND 35).

FIRST USE 5-15-2003; IN COMMERCE 5-15-2003.
MARY CRAWFORD, EXAMINING ATTORNEY

CLASS 7—(Continued).

SN 78-399,045. AIRTRAX, INC., HAMMONTON, NJ. FILED 4-8-2004.

AIRTRAX

THE MARK CONSISTS OF STANDARD CHARACTERS WITHOUT CLAIM TO ANY PARTICULAR FONT, STYLE, SIZE, OR COLOR.

FOR POWER-OPERATED LIFT USED TO TRANSPORT, PLACE AND/OR ELEVATE GOODS AND MATERIALS (U.S. CLS. 13, 19, 21, 23, 31, 34 AND 35).

FIRST USE 2-28-1999; IN COMMERCE 2-28-1999.
KATHERINE STOIDES, EXAMINING ATTORNEY

CLASS 7—(Continued).

SN 78-405,621. SUMAKE INDUSTRIAL CO., LTD., TAIPEI, TAIWAN, FILED 4-21-2004.



FOR IMPACT WRENCHES, POWER-OPERATED SCREWDRIVERS, POWER ELECTRIC AND FLOOR SANDERS, POWER NAIL GUNS, POWER STAPLERS, POWER DRILLS, HAND HELD POWER DRIVEN GRINDERS, POWER-OPERATED RIVET GUNS, POWER-OPERATED HAMMERS, AIR COMPRESSORS, PNEUMATIC GREASE GUNS, POWER-OPERATED SPRAYERS, PAINT SPRAY GUNS, AND POWER ELECTRIC SCREWDRIVERS (U.S. CLS. 13, 19, 21, 23, 31, 34 AND 35).

LOURDES AYALA, EXAMINING ATTORNEY

SN 78-407,113. TECHNICAL DEVELOPMENT (HK) LIMITED, SHEUNG WAN, HONG KONG, FILED 4-23-2004.

SN 78-403,849. SUN AUTOMATION INC., SPARKS, MD. FILED 4-19-2004.



OWNER OF U.S. REG. NO. 2,618,203.
NO CLAIM IS MADE TO THE EXCLUSIVE RIGHT TO USE "AUTOMATION GROUP", APART FROM THE MARK AS SHOWN.

FOR COMPONENTS OF BOX-MAKING MACHINES, NAMELY, CONVEYORS, DIE CUTTERS, AND PRINT AND DWELL UNITS (U.S. CLS. 13, 19, 21, 23, 31, 34 AND 35).

FIRST USE 4-16-2004; IN COMMERCE 4-16-2004.
CIMMERIAN COLEMAN, EXAMINING ATTORNEY



FOR POWER OPERATED HAND HELD KITCHEN APPLIANCES IN THE NATURE OF A WHISK; POWER OPERATED HAND HELD KITCHEN APPLIANCES, NAMELY, BEATERS, WHISKS, GRATERS, PEELERS; HOLDERS, AND STRUCTURAL AND REPLACEMENT PARTS FOR ALL THE AFORESAID GOODS (U.S. CLS. 13, 19, 21, 23, 31, 34 AND 35).

FIRST USE 1-31-2002; IN COMMERCE 1-31-2002.
KAREN BRACEY, EXAMINING ATTORNEY

CLASS 7—(Continued).

SN 78-408,699. BLACK & DECKER CORPORATION, THE, TOWSON, MD. FILED 4-27-2004.

CLASS 7—(Continued).

SN 78-415,258. ANNUGAS COMPRESSION CONSULTING LTD., RED DEER, ALBERTA, CANADA, FILED 5-7-2004.



ANNUGAS PRODUCTION
ENHANCER

OWNER OF U.S. REG. NOS. 517,319, 747,179 AND OTHERS.

FOR PAINTING SYSTEMS, NAMELY: POWER-OPERATED AIRLESS PAINT SPRAYERS, POWER-OPERATED PAINT ROLLERS, POWER-OPERATED STAIN AND SEALANT APPLICATORS (U.S. CLS. 13, 19, 21, 23, 31, 34 AND 35).

ANN LINNEHAN, EXAMINING ATTORNEY

THE MARK CONSISTS OF STANDARD CHARACTERS WITHOUT CLAIM TO ANY PARTICULAR FONT, STYLE, SIZE, OR COLOR.

PRIORITY CLAIMED UNDER SEC. 44(D) ON CANADA APPLICATION NO. 1,198,438, FILED 12-4-2003, REG. NO. TMA627,969, DATED 12-8-2004, EXPIRES 12-8-2019.

NO CLAIM IS MADE TO THE EXCLUSIVE RIGHT TO USE "PRODUCTION ENHANCER", APART FROM THE MARK AS SHOWN.

FOR GAS COMPRESSORS (U.S. CLS. 13, 19, 21, 23, 31, 34 AND 35).

FIRST USE 3-21-1995; IN COMMERCE 7-15-1998.
BILL DAWE, EXAMINING ATTORNEY

SN 78-414,643. TEGAL CORPORATION, SAN FRANCISCO, CA. FILED 5-6-2004.

SN 78-425,213. VESTERGAARD COMPANY, INC., MCHENRY, IL. FILED 5-26-2004.

SIMPLUS

FREEZEPOINT+

THE MARK CONSISTS OF STANDARD CHARACTERS WITHOUT CLAIM TO ANY PARTICULAR FONT, STYLE, SIZE, OR COLOR.

FOR SEMICONDUCTOR WAFER PROCESSING MACHINES (U.S. CLS. 13, 19, 21, 23, 31, 34 AND 35).

FIRST USE 8-0-2001; IN COMMERCE 8-0-2001.
CATHERINE CAIN, EXAMINING ATTORNEY

FOR TRUCK MOUNTED FLUID MIXING MACHINE FOR USE WITH AIRCRAFT DEICING MACHINERY TO PREPARE HEATED DEICING FLUID AND WATER IN VARIABLE PERCENTAGES FOR THE AIRCRAFT INDUSTRY (U.S. CLS. 13, 19, 21, 23, 31, 34 AND 35).

JOHN HWANG, EXAMINING ATTORNEY

CLASS 7—(Continued).

SN 78-430,350. ILLINOIS TOOL WORKS INC., GLENVIEW, IL. FILED 6-4-2004.

CLASS 7—(Continued).

SN 78-445,189. MILLENNIUM INDUSTRIES CORPORATION, CASS CITY, MI. FILED 7-2-2004.

DEVILBISS

SDR

THE MARK CONSISTS OF STANDARD CHARACTERS WITHOUT CLAIM TO ANY PARTICULAR FONT, STYLE, SIZE, OR COLOR.

OWNER OF U.S. REG. NOS. 166,404 AND 771,830. SEC. 2(F).

FOR MULTIPLE COMPONENT REACTIVE LIQUID CATALYST SYSTEMS COMPRISED OF SPRAY GUNS, FILTERS, REGULATORS, GAUGES AND VALVES; AIR COMPRESSORS; DRYING AND FINISHING EQUIPMENT OF THE CONVECTION AND RADIANT TYPE (U.S. CLS. 13, 19, 21, 23, 31, 34 AND 35).

CURTIS FRENCH, EXAMINING ATTORNEY

THE MARK CONSISTS OF STANDARD CHARACTERS WITHOUT CLAIM TO ANY PARTICULAR FONT, STYLE, SIZE, OR COLOR.

FOR INTERNAL COMBUSTION ENGINE PARTS NAMELY FUEL INTAKE MANIFOLDS (U.S. CLS. 13, 19, 21, 23, 31, 34 AND 35).

BILL DAWE, EXAMINING ATTORNEY

SN 78-446,510. MITSUBISHI CATERPILLAR FORKLIFT AMERICA INC., HOUSTON, TX. FILED 7-6-2004.

SN 78-430,981. IRWIN INDUSTRIAL TOOL COMPANY, FREEPORT, IL. FILED 6-7-2004.

POWER-GRIP

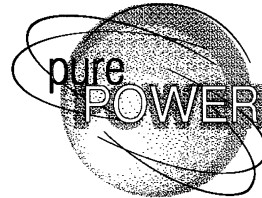

THE MARK CONSISTS OF STANDARD CHARACTERS WITHOUT CLAIM TO ANY PARTICULAR FONT, STYLE, SIZE, OR COLOR.

FOR POWER TOOL ACCESSORIES; NAMELY, FASTENER EXTRACTORS (U.S. CLS. 13, 19, 21, 23, 31, 34 AND 35).

FIRST USE 12-1-2004; IN COMMERCE 12-1-2004. FRED MANDIR, EXAMINING ATTORNEY

THE STIPPLING IS FOR SHADING PURPOSES ONLY. THE DRAWING CONSISTS OF A SHADED SPHERE AS INDICATED BY STIPPLING WHICH IS SURROUNDED BY CIRCLES IN AN ORBITING FASHION.

FOR INTERNAL COMBUSTION ENGINE FOR USE IN FORKLIFT TRUCKS (U.S. CLS. 13, 19, 21, 23, 31, 34 AND 35).

FIRST USE 2-0-2004; IN COMMERCE 2-0-2004. INGA ERVIN, EXAMINING ATTORNEY

CLASS 7—(Continued).

SN 78-446,515. MITSUBISHI CATERPILLAR FORKLIFT AMERICA INC., HOUSTON, TX. FILED 7-6-2004.

CLASS 7—(Continued).

SN 78-448,304. BOSSES, MARK D., BOCA RATON, FL. FILED 7-9-2004.

SONIC SYSTEMS

enviro2 engines

THE MARK CONSISTS OF STANDARD CHARACTERS WITHOUT CLAIM TO ANY PARTICULAR FONT, STYLE, SIZE, OR COLOR.

NO CLAIM IS MADE TO THE EXCLUSIVE RIGHT TO USE SYSTEMS, APART FROM THE MARK AS SHOWN.

FOR VACUUM CLEANERS (U.S. CLS. 13, 19, 21, 23, 31, 34 AND 35).

KAREN K. BUSH, EXAMINING ATTORNEY

THE MARK CONSISTS OF STANDARD CHARACTERS WITHOUT CLAIM TO ANY PARTICULAR FONT, STYLE, SIZE, OR COLOR.

NO CLAIM IS MADE TO THE EXCLUSIVE RIGHT TO USE "ENGINES", APART FROM THE MARK AS SHOWN.

FOR INTERNAL COMBUSTION ENGINE FOR USE IN FORKLIFT TRUCKS (U.S. CLS. 13, 19, 21, 23, 31, 34 AND 35).

FIRST USE 2-0-2004; IN COMMERCE 2-0-2004.
ANNE E. GUSTASON, EXAMINING ATTORNEY

SN 78-448,570. SMARTPOOL INC., LAKEWOOD, NJ. FILED 7-9-2004.



SN 78-446,521. MITSUBISHI CATERPILLAR FORKLIFT AMERICA INC., HOUSTON, TX. FILED 7-6-2004.

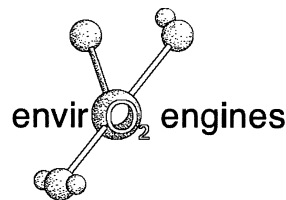

THE MARK CONSISTS OF THE STYLIZED WORD "POOLHOG" WITH A MISCELLANEOUS DESIGN OF A HOG WITHIN THE "O" IN "HOG".

FOR COMMERCIAL AND INDUSTRIAL AS WELL AS RESIDENTIAL ROBOTS FOR CLEANING SWIMMING POOLS (U.S. CLS. 13, 19, 21, 23, 31, 34 AND 35).

FIRST USE 11-15-2004; IN COMMERCE 11-15-2004.
SKYE YOUNG, EXAMINING ATTORNEY

SN 78-455,230. CHAE, WALTER C., ANAHEIM, CA. FILED 7-22-2004.

MARATHON JUICER

NO CLAIM IS MADE TO THE EXCLUSIVE RIGHT TO USE "ENGINES", APART FROM THE MARK AS SHOWN.

THE STIPPLING IS FOR SHADING PURPOSES ONLY.

THE DRAWING CONSISTS OF A MAIN SPHERE WITH THREE SURROUNDING SPHERES CONNECTED BY RODS. ALL SPHERES AND THE ROD IN THE 11 O'CLOCK POSITION ARE SHADED AS INDICATED BY STIPPLING. THE MIDDLE SPHERE IS CUT OUT BY THE TERM "02".

FOR INTERNAL COMBUSTION ENGINE FOR USE IN FORKLIFT TRUCKS (U.S. CLS. 13, 19, 21, 23, 31, 34 AND 35).

FIRST USE 2-0-2004; IN COMMERCE 2-0-2004.
ALEXANDER L. POWERS, EXAMINING ATTORNEY

THE MARK CONSISTS OF STANDARD CHARACTERS WITHOUT CLAIM TO ANY PARTICULAR FONT, STYLE, SIZE, OR COLOR.

NO CLAIM IS MADE TO THE EXCLUSIVE RIGHT TO USE "JUICER", APART FROM THE MARK AS SHOWN.

FOR JUICE EXTRACTOR (U.S. CLS. 13, 19, 21, 23, 31, 34 AND 35).

FIRST USE 3-15-2004; IN COMMERCE 7-15-2004.
JOANNA DUKOVIC, EXAMINING ATTORNEY

CLASS 7—(Continued).

SN 78-455,662. SCOCCIMARO, MARIO, LAWRENCEVILLE, GA. FILED 7-23-2004.



NO CLAIM IS MADE TO THE EXCLUSIVE RIGHT TO USE "ESPRESSO SOUTHEAST", APART FROM THE MARK AS SHOWN.

THE MARK CONSISTS OF THE WORDS "ESPRESSO SOUTHEAST, WITH THE FIRST "S" IN ESPRESSO IN A LARGER FONT EXTENDING BELOW THE WORD ESPRESSO TO FORM THE FIRST "S" IN THE WORD "SOUTHEAST".

FOR COFFEE EXTRACTING MACHINES (U.S. CLS. 13, 19, 21, 23, 31, 34 AND 35).

FIRST USE 6-30-2002; IN COMMERCE 6-30-2002.

RUDY R. SINGLETON, EXAMINING ATTORNEY

CLASS 7—(Continued).

SN 78-464,151. UNIVERSAL ENGRAVING, INC., OVERLAND PARK, KS. FILED 8-9-2004.

UNILOCK-UP

THE MARK CONSISTS OF STANDARD CHARACTERS WITHOUT CLAIM TO ANY PARTICULAR FONT, STYLE, SIZE, OR COLOR.

FOR ENGRAVED DIE ASSEMBLIES FOR USE IN THE GRAPHIC ARTS INDUSTRY, NAMELY METAL STAMPING AND EMBOSSING DIES AND A SUPPORT PLATE SOLD AS A UNIT (U.S. CLS. 13, 19, 21, 23, 31, 34 AND 35).

FIRST USE 5-21-2004; IN COMMERCE 5-21-2004.

SALLY SHIH, EXAMINING ATTORNEY

SN 78-464,114. DEMARCO MAXVAC CORPORATION, MCHENRY, IL. FILED 8-9-2004.

SILENCER BASE

THE MARK CONSISTS OF STANDARD CHARACTERS WITHOUT CLAIM TO ANY PARTICULAR FONT, STYLE, SIZE, OR COLOR.

FOR MUFFLERS FOR VACUUM PUMPS AND BLOWERS (U.S. CLS. 13, 19, 21, 23, 31, 34 AND 35).

FIRST USE 12-16-1986; IN COMMERCE 12-16-1986.

MICHAEL TANNER, EXAMINING ATTORNEY

SN 78-466,259. AGRI-FAB, INC., SULLIVAN, IL. FILED 8-12-2004.

MOW-N-VAC

THE MARK CONSISTS OF STANDARD CHARACTERS WITHOUT CLAIM TO ANY PARTICULAR FONT, STYLE, SIZE, OR COLOR.

FOR LAWN VACUUMS (U.S. CLS. 13, 19, 21, 23, 31, 34 AND 35).

FIRST USE 12-31-1987; IN COMMERCE 12-31-1987.

KHANH LE, EXAMINING ATTORNEY

CLASS 7—(Continued).

SN 78-472,555. NORTHEAST ISUZU ENGINES, INC., EAST HADDAM, CT. FILED 8-24-2004.

CLASS 7—(Continued).

SN 78-475,403. KEATON, JAMES E., DOSWELL, VA. FILED 8-29-2004.

Aqua Shield

THE MARK CONSISTS OF STANDARD CHARACTERS WITHOUT CLAIM TO ANY PARTICULAR FONT, STYLE, SIZE, OR COLOR.

NO CLAIM IS MADE TO THE EXCLUSIVE RIGHT TO USE "AQUA", APART FROM THE MARK AS SHOWN.

FOR ENGINE PARTS SOLD AS COMPONENTS OF ENGINES FOR INDUSTRIAL MACHINES, LAND AND MARINE VEHICLES, NAMELY, DEVICES THAT INTERCEPT AND DISSIPATE THE HEAT WHICH RADIATES FROM THE EXHAUST SYSTEM (U.S. CLS. 13, 19, 21, 23, 31, 34 AND 35).

FIRST USE 1-1-2003; IN COMMERCE 1-1-2003.
VERNA BETH RIRIE, EXAMINING ATTORNEY

AMCAN SOLUTIONS

THE MARK CONSISTS OF STANDARD CHARACTERS WITHOUT CLAIM TO ANY PARTICULAR FONT, STYLE, SIZE, OR COLOR.

FOR CAN MANUFACTURING MACHINERY, NAMELY KITS FOR UPGRADING EXISTING MACHINERY (U.S. CLS. 13, 19, 21, 23, 31, 34 AND 35).

FLORENTINA BLANDU, EXAMINING ATTORNEY

SN 78-479,878. LONG CHANG MACHINERY CO. LTD., TAIPING CITY, TAICHUNG, TAIWAN, FILED 9-7-2004.

SN 78-474,301. DIAMOND PRODUCTIONS LTD., MONTREAL, QUEBEC, CANADA, FILED 8-26-2004.



Sure-Shape

THE MARK CONSISTS OF STANDARD CHARACTERS WITHOUT CLAIM TO ANY PARTICULAR FONT, STYLE, SIZE, OR COLOR.

FOR DIAMOND-POINTED METAL-CUTTING TOOLS; DIAMOND TIPPED SAW-BLADES AND CORE BITS; POWER-OPERATED GRINDING WHEELS (U.S. CLS. 13, 19, 21, 23, 31, 34 AND 35).

GWEN STOKOLS, EXAMINING ATTORNEY

OWNER OF U.S. REG. NO. 1,437,750.
THE COLOR(S) RED AND BLACK IS/ARE CLAIMED AS A FEATURE OF THE MARK.

THE MARK CONSISTS OF THE WORD FIRST IN STYLIZED LETTERS WITH THE WORD FIRST IN BLACK LETTERING, HOWEVER, THE DOT OVER THE I IS IN THE COLOR RED.

FOR LATHES; MILLING MACHINES; METAL WORKING MACHINES, NAMELY, MACHINING CENTERS; ELECTRIC PLANERS; DRILLING MACHINES FOR METALWORKING; MILLING-DRILLING MACHINES; PUNCHING PRESSES FOR METALWORKING; MACHINE TOOLS FOR THE CUTTING AND FORMING OF MATERIALS (U.S. CLS. 13, 19, 21, 23, 31, 34 AND 35).

FIRST USE 9-23-1994; IN COMMERCE 2-11-1995.
ALEXANDER L. POWERS, EXAMINING ATTORNEY

CLASS 7—(Continued).

SN 78-480,703. VOONER FLOGARD CORPORATION, CHARLOTTE, NC. FILED 9-9-2004.

CLASS 7—(Continued).

SN 78-492,123. LIFESTYLE CUSTOM CYCLES, LLC, VILLA PARK, CA. FILED 9-30-2004.

SHENANDOAH

SFP'S

THE MARK CONSISTS OF STANDARD CHARACTERS WITHOUT CLAIM TO ANY PARTICULAR FONT, STYLE, SIZE, OR COLOR.

FOR POWER OPERATED SPRAYERS FOR DISTRIBUTING AND SPRAYING LIQUIDS FOR INDUSTRIAL PURPOSES; PAPER MAKING MACHINE PARTS, NAMELY, SPRAYERS (U.S. CLS. 13, 19, 21, 23, 31, 34 AND 35).
SHAUNIA WALLACE, EXAMINING ATTORNEY

THE MARK CONSISTS OF STANDARD CHARACTERS WITHOUT CLAIM TO ANY PARTICULAR FONT, STYLE, SIZE, OR COLOR.

FOR AUTOMOTIVE AND MOTORCYCLE EXHAUST PIPES (U.S. CLS. 13, 19, 21, 23, 31, 34 AND 35).
FIRST USE 8-16-2004; IN COMMERCE 8-16-2004.
INGA ERVIN, EXAMINING ATTORNEY

SN 78-480,809. NEXICOR, LLC, LOVELAND, OH. FILED 9-9-2004.

SN 78-492,127. LIFESTYLE CUSTOM CYCLES, LLC, VILLA PARK, CA. FILED 9-30-2004.

KOOLGLIDE

CRUSHER ONE-ELEVEN

THE MARK CONSISTS OF STANDARD CHARACTERS WITHOUT CLAIM TO ANY PARTICULAR FONT, STYLE, SIZE, OR COLOR.

FOR ELECTROMAGNETIC MACHINE TOOLS, NAMELY, INDUCTION HEATING DEVICES (U.S. CLS. 13, 19, 21, 23, 31, 34 AND 35).
FIRST USE 10-31-2003; IN COMMERCE 10-31-2003.
G. MAYERSCHOFF, EXAMINING ATTORNEY

THE MARK CONSISTS OF STANDARD CHARACTERS WITHOUT CLAIM TO ANY PARTICULAR FONT, STYLE, SIZE, OR COLOR.

NO CLAIM IS MADE TO THE EXCLUSIVE RIGHT TO USE "ONE-ELEVEN", APART FROM THE MARK AS SHOWN.
FOR MOTORCYCLE ENGINES (U.S. CLS. 13, 19, 21, 23, 31, 34 AND 35).
FIRST USE 6-18-2004; IN COMMERCE 6-18-2004.
ANGELA M. MICHELI, EXAMINING ATTORNEY

CLASS 7—(Continued).

SN 78-493,856. PROTEAM, INC., BOISE, ID. FILED 10-4-2004.

CLASS 7—(Continued).

SN 78-496,805. SCHILLER-PFEIFFER, INC., SOUTHAMP-
TON, PA. FILED 10-8-2004.

INTERCEPT MICRO

CLEAN UP WITH LITTLE WONDER

THE MARK CONSISTS OF STANDARD CHARACTERS WITHOUT CLAIM TO ANY PARTICULAR FONT, STYLE, SIZE, OR COLOR.

OWNER OF U.S. REG. NO. 2,898,674.

FOR VACUUM CLEANERS AND STRUCTURAL PARTS THEREOF; VACUUM CLEANER ACCESSORIES, NAMELY, VACUUM CLEANER FILTERS, SUCTION NOZZLES, HOSES, WANDS, UPHOLSTERY KITS CONSISTING OF CREVICE TOOLS AND DUST BRUSHES (U.S. CLS. 13, 19, 21, 23, 31, 34 AND 35).

TRICIA SONNEBORN, EXAMINING ATTORNEY

THE MARK CONSISTS OF STANDARD CHARACTERS WITHOUT CLAIM TO ANY PARTICULAR FONT, STYLE, SIZE, OR COLOR.

FOR POWER OPERATED LAWN, GARDEN AND GOLF COURSE CARE TOOLS AND MACHINES, NAMELY, LOG AND WOOD SPLITTERS, CHIPPERS, SHREDDERS, CREVICE CLEANERS, LAWN AERATORS, TRUCKLOADERS, BLOWERS, VACUUMS, EDGERS, SPRAYERS, HEDGE TRIMMERS, TILLERS, CULTIVATORS, SWEEPERS, AND PARTS FOR THE FOREGOING POWER OPERATED TOOLS AND MACHINES (U.S. CLS. 13, 19, 21, 23, 31, 34 AND 35).

FIRST USE 9-6-2004; IN COMMERCE 9-6-2004.

MONIQUE MILLER, EXAMINING ATTORNEY

SN 78-495,291. PRODUCT-WORX, INC., NORTH HAVEN, CT. FILED 10-6-2004.

SN 78-500,451. FREE-FLOW PACKAGING INTERNATIONAL, INC., REDWOOD CITY, CA. FILED 10-15-2004.

LINTEATER

PILLOW PAK'R

THE MARK CONSISTS OF STANDARD CHARACTERS WITHOUT CLAIM TO ANY PARTICULAR FONT, STYLE, SIZE, OR COLOR.

FOR POWER TOOLS, NAMELY, ROTARY DUCT CLEANING TOOLS AND ATTACHMENTS FOR USE THEREWITH (U.S. CLS. 13, 19, 21, 23, 31, 34 AND 35).

DAVID MURRAY, EXAMINING ATTORNEY

THE MARK CONSISTS OF STANDARD CHARACTERS WITHOUT CLAIM TO ANY PARTICULAR FONT, STYLE, SIZE, OR COLOR.

OWNER OF U.S. REG. NO. 2,179,792.

NO CLAIM IS MADE TO THE EXCLUSIVE RIGHT TO USE "PACKER", APART FROM THE MARK AS SHOWN.

FOR MACHINES FOR INFLATING AND SEALING AIR-FILLED PACKING AND CUSHIONING MATERIALS (U.S. CLS. 13, 19, 21, 23, 31, 34 AND 35).

FIRST USE 10-6-2004; IN COMMERCE 10-6-2004.

JOHN DWYER, EXAMINING ATTORNEY

CLASS 7—(Continued).

SN 78-502,286. TRUE COLORS OF THE AMERICA'S, LTD., CHARLOTTE, NC. FILED 10-19-2004.

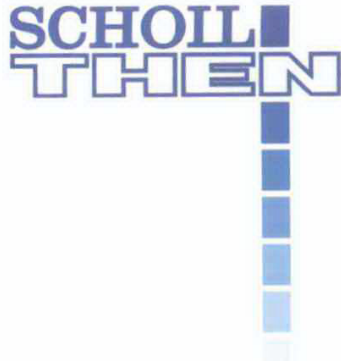

THE COLOR(S) BLUE AND WHITE IS/ARE CLAIMED AS A FEATURE OF THE MARK.

THE COLOR BLUE APPEARS IN THE LETTERING SCHOLL AND THE OUTLINING OF THEN; THE COLOR WHITE APPEARS IN THE INTERIOR OF THE LETTERING THEN; THE RECTANGLES APPEAR IN VARYING SHADES OF BLUE WITH THE TOP RECTANGLE IN DARK BLUE AND THE LAST RECTANGLE IN LIGHT BLUE.

FOR TEXTILE MACHINES AND REPLACEMENT PARTS THEREFORE (U.S. CLS. 13, 19, 21, 23, 31, 34 AND 35).

FIRST USE 2-1-2002; IN COMMERCE 2-1-2002.
KAREN K. BUSH, EXAMINING ATTORNEY

CLASS 7—(Continued).

SN 78-503,515. RUGGEDBILT-USA, INC., BARAGA, MI. FILED 10-21-2004.

TRAILLIFT

THE MARK CONSISTS OF STANDARD CHARACTERS WITHOUT CLAIM TO ANY PARTICULAR FONT, STYLE, SIZE, OR COLOR.

FOR ELEVATED AERIAL PLATFORM, HYDRAULIC LIFT TABLE (U.S. CLS. 13, 19, 21, 23, 31, 34 AND 35).

FIRST USE 8-10-2003; IN COMMERCE 8-10-2003.
MARGERY A. TIERNEY, EXAMINING ATTORNEY

SN 78-502,358. J-STAR MOTOR INDUSTRIAL CO., LTD., TAIPEI, TAIWAN, FILED 10-19-2004.

J'STAR

FOR ELECTRIC MOTORS FOR MACHINES AND ELECTRIC MOTOR APPARATUS, NAMELY LINEAR ACTUATORS COMPRISING MOTOR; LINEAR ACTUATORS, LINEAR MOTORS (U.S. CLS. 13, 19, 21, 23, 31, 34 AND 35).

FIRST USE 6-0-2004; IN COMMERCE 6-0-2004.
BRIAN PINO, EXAMINING ATTORNEY

SN 78-505,368. MITSUI MACHINERY DISTRIBUTING INC., SWEDESBORO, NJ. FILED 10-25-2004.



OWNER OF U.S. REG. NO. 2,876,277.
NO CLAIM IS MADE TO THE EXCLUSIVE RIGHT TO USE "EQUIPMENT", APART FROM THE MARK AS SHOWN.

FOR CONSTRUCTION EQUIPMENT, NAMELY, WHEEL LOADERS, ELECTRIC GENERATORS, COMPACT EXCAVATORS, AND AIR COMPRESSORS (U.S. CLS. 13, 19, 21, 23, 31, 34 AND 35).

FIRST USE 1-2-2003; IN COMMERCE 1-2-2003.
MARC LEIPZIG, EXAMINING ATTORNEY

CLASS 7—(Continued).

SN 78-505,824. PULSEWAVE, LLC, CENTENNIAL, CO. FILED 10-26-2004.

CLASS 7—(Continued).

SN 78-515,102. THOMAS ENERGY SERVICES, INC., NEW IBERIA, LA. FILED 11-11-2004.

PULSEWAVE

GUARDIAN

THE MARK CONSISTS OF STANDARD CHARACTERS WITHOUT CLAIM TO ANY PARTICULAR FONT, STYLE, SIZE, OR COLOR.
FOR MILLING AND COMMINUTION MACHINES USING SOUND AND RESONANCE DISINTEGRATION (U.S. CLS. 13, 19, 21, 23, 31, 34 AND 35).
ALEX KEAM, EXAMINING ATTORNEY

THE MARK CONSISTS OF STANDARD CHARACTERS WITHOUT CLAIM TO ANY PARTICULAR FONT, STYLE, SIZE, OR COLOR.
FOR OILFIELD DRILLING EQUIPMENT, NAMELY MONITORING TOOLS USED DURING REMOVAL OF OILFIELD TUBING OR PIPE (U.S. CLS. 13, 19, 21, 23, 31, 34 AND 35).
ALICE SUE CARRUTHERS, EXAMINING ATTORNEY

SN 78-512,984. NOLOGY ENGINEERING, INC., SAN MARCOS, CA. FILED 11-8-2004.

SN 78-516,409. CONTINENTAL D.I.A. DIAMOND PRODUCTS, INC., SAN CARLOS, CA. FILED 11-12-2004.

COOLWIRES

TERMINATOR XTREME

THE MARK CONSISTS OF STANDARD CHARACTERS WITHOUT CLAIM TO ANY PARTICULAR FONT, STYLE, SIZE, OR COLOR.
OWNER OF U.S. REG. NO. 2,071,219.
FOR SPARK PLUG IGNITION WIRES (U.S. CLS. 13, 19, 21, 23, 31, 34 AND 35).
KHANH LE, EXAMINING ATTORNEY

THE MARK CONSISTS OF STANDARD CHARACTERS WITHOUT CLAIM TO ANY PARTICULAR FONT, STYLE, SIZE, OR COLOR.
OWNER OF U.S. REG. NO. 2,497,482.
FOR POWER SAW BLADES CONTAINING DIAMONDS, BITS FOR POWER DRILLS CONTAINING DIAMONDS, POWER GRINDING WHEELS CONTAINING DIAMONDS AND POLISHING PADS CONTAINING DIAMONDS, ALL FOR USE IN THE MARBLE, GRANITE, CONCRETE, ASPHALT, ROOFING AND TILE INDUSTRY (U.S. CLS. 13, 19, 21, 23, 31, 34 AND 35).
FIRST USE 9-13-2004; IN COMMERCE 9-13-2004.
GIANCARLO CASTRO, EXAMINING ATTORNEY

CLASS 7—(Continued).

SN 78-519,273. OMS INVESTMENTS, INC., LOS ANGELES, CA. FILED 11-18-2004.

LAWN PRO

THE MARK CONSISTS OF STANDARD CHARACTERS WITHOUT CLAIM TO ANY PARTICULAR FONT, STYLE, SIZE, OR COLOR.

OWNER OF U.S. REG. NOS. 757,264 AND 1,135,940.
NO CLAIM IS MADE TO THE EXCLUSIVE RIGHT TO USE "LAWN", APART FROM THE MARK AS SHOWN, FOR MECHANICAL SPREADERS (U.S. CLS. 13, 19, 21, 23, 31, 34 AND 35).
MIDGE BUTLER, EXAMINING ATTORNEY

CLASS 7—(Continued).

SN 78-524,316. TELEDYNE TECHNOLOGIES INCORPORATED, LOS ANGELES, CA. FILED 11-30-2004.

TOPCARE

THE MARK CONSISTS OF STANDARD CHARACTERS WITHOUT CLAIM TO ANY PARTICULAR FONT, STYLE, SIZE, OR COLOR.

OWNER OF U.S. REG. NO. 2,473,557.
FOR AIRCRAFT ENGINES AND CYLINDERS (U.S. CLS. 13, 19, 21, 23, 31, 34 AND 35).
FIRST USE 2-17-1997; IN COMMERCE 2-17-1997.
DAWN HAN, EXAMINING ATTORNEY

SN 78-524,600. T.D. WILLIAMSON, INC., TULSA, OK. FILED 11-30-2004.

SN 78-521,606. BBA NONWOVENS SIMPSONVILLE, INC., SIMPSONVILLE, SC. FILED 11-23-2004.

Red•1

THE MARK CONSISTS OF STANDARD CHARACTERS WITHOUT CLAIM TO ANY PARTICULAR FONT, STYLE, SIZE, OR COLOR.

OWNER OF U.S. REG. NOS. 2,160,296 AND 2,210,426.
NO CLAIM IS MADE TO THE EXCLUSIVE RIGHT TO USE "RED", APART FROM THE MARK AS SHOWN.
FOR TUBULAR COVER FOR MACHINE PARTS, NAMELY, TUBULAR COVER FOR LITHOGRAPHIC DAMPENERS ROLLS (U.S. CLS. 13, 19, 21, 23, 31, 34 AND 35).

FIRST USE 11-20-1998; IN COMMERCE 11-20-1998.
ANDREW RHIM, EXAMINING ATTORNEY

FinalSTOPP

THE MARK CONSISTS OF STANDARD CHARACTERS WITHOUT CLAIM TO ANY PARTICULAR FONT, STYLE, SIZE, OR COLOR.

FOR MACHINES FOR INHIBITING FLOW IN A FLUID CONDUIT FOR THE PURPOSE OF ISOLATING A SECTION OF A FLOW CONDUIT FOR INSPECTION, SERVICE OR REPAIR (U.S. CLS. 13, 19, 21, 23, 31, 34 AND 35).

MATTHEW KLINE, EXAMINING ATTORNEY

CLASS 7—(Continued).

SN 78-525,164. ACTION EQUIPMENT COMPANY, INC., NEWBERG, OR. FILED 12-1-2004.

CLASS 7—(Continued).

SN 78-531,632. STANLEY LOGISTICS, INC, NEW BRITAIN, CT. FILED 12-13-2004.

DENSE-OUT

THE MARK CONSISTS OF STANDARD CHARACTERS WITHOUT CLAIM TO ANY PARTICULAR FONT, STYLE, SIZE, OR COLOR.

FOR VIBRATORY SEPARATORS AND CONVEYORS FOR SEPARATION AND CLASSIFICATION OF MIXED MATERIALS (U.S. CLS. 13, 19, 21, 23, 31, 34 AND 35).

JOHN DWYER, EXAMINING ATTORNEY

COBOTICS

SN 78-525,419. ADVANCED VAPOR TECHNOLOGIES, LLC, EDMONDS, WA. FILED 12-1-2004.

TANCS

THE MARK CONSISTS OF STANDARD CHARACTERS WITHOUT CLAIM TO ANY PARTICULAR FONT, STYLE, SIZE, OR COLOR.

FOR CYLINDERS SOLD AS AN INTEGRAL COMPONENT OF STEAM CLEANING MACHINE UTILIZING THERMAL ACCELERATED NANO CRYSTAL SANITATION WATER TREATMENT PROCESS (U.S. CLS. 13, 19, 21, 23, 31, 34 AND 35).

BARBARA RUTLAND, EXAMINING ATTORNEY

THE MARK CONSISTS OF STANDARD CHARACTERS WITHOUT CLAIM TO ANY PARTICULAR FONT, STYLE, SIZE, OR COLOR.

FOR CONVEYING MACHINES, NAMELY A HIGH PERFORMANCE ELECTRICALLY POWERED CONVEYING MACHINE FOR TRANSPORTING MATERIALS ON AN OVERHEAD RAIL SYSTEM USED IN MANUFACTURING, WAREHOUSING, AND ASSEMBLY ENVIRONMENTS; HOISTS, NAMELY A HIGH PERFORMANCE HOIST FOR RAISING AND LOWERING A LOAD FOR USE IN MANUFACTURING, DISTRIBUTION, AND ASSEMBLY ENVIRONMENTS (U.S. CLS. 13, 19, 21, 23, 31, 34 AND 35).

FIRST USE 2-12-2001; IN COMMERCE 2-12-2001.

MARK SPARACINO, EXAMINING ATTORNEY

CLASS 7—(Continued).

SN 78-537,584. GARDNER DENVER, INC., QUINCY, IL.
FILED 12-23-2004.

AQUALINE

THE MARK CONSISTS OF STANDARD CHARACTERS WITHOUT CLAIM TO ANY PARTICULAR FONT, STYLE, SIZE, OR COLOR.

FOR LIQUID RING VACUUM PUMPS FOR USE IN INDUSTRIAL MOBILE AND STATIONARY AIR AND GAS APPLICATIONS; LIQUID RING VACUUM PUMPS FOR CREATING AIR SUCTION FOR USE IN MOVING LIQUID AND SLUDGE WASTE MATERIALS; LIQUID RING VACUUM PUMPS FOR USE IN INDUSTRIAL MOBILE AND STATIONARY AIR AND GAS APPLICATIONS, AND ACCOMPANYING PRINTED OPERATING INSTRUCTIONS SOLD THEREWITH; LIQUID RING VACUUM PUMPS FOR CREATING AIR SUCTION FOR USE IN MOVING LIQUID AND SLUDGE WASTE MATERIALS, AND ACCOMPANYING PRINTED OPERATING INSTRUCTIONS SOLD THEREWITH (U.S. CLS. 13, 19, 21, 23, 31, 34 AND 35).

FIRST USE 1-0-1999; IN COMMERCE 1-0-1999.
AMY HELLA, EXAMINING ATTORNEY

SN 78-538,160. SINOCHEN NINGBO LTD., NINGBO, ZHEJIANG, CHINA, FILED 12-23-2004.

CARSTECH

THE MARK CONSISTS OF THE WORD CARSTECH WHICH IS AN INVENTED WORD AND HAS NO MEANING OR SIGNIFICANCE IN THE RELEVANT TRADE OR IN ANY LANGUAGES.

FOR WASHING MACHINES FOR HOUSEHOLD PURPOSES; VEHICLE WASHING INSTALLATIONS; ELECTRIC WASHING MACHINES FOR INDUSTRIAL PURPOSES; STEAM CLEANING MACHINES; DUST SEPARATORS; MULTI-PURPOSE HIGH PRESSURE WASHERS; POWER-OPERATED WAX POLISHERS; VACUUM CLEANERS; ELECTRIC WAX-POLISHING MACHINES FOR HOUSEHOLD PURPOSES; ELECTRIC WAX-POLISHING MACHINES FOR INDUSTRIAL PURPOSES (U.S. CLS. 13, 19, 21, 23, 31, 34 AND 35).

FIRST USE 8-1-2002; IN COMMERCE 11-30-2003.
JEFF DEFORD, EXAMINING ATTORNEY

CLASS 7—(Continued).

SN 78-539,651. ASTEC UNDERGROUND, INC., LOUDON, TN. FILED 12-29-2004.

QUIK TRAC

THE MARK CONSISTS OF STANDARD CHARACTERS WITHOUT CLAIM TO ANY PARTICULAR FONT, STYLE, SIZE, OR COLOR.

FOR HORIZONTAL BORING MACHINES (U.S. CLS. 13, 19, 21, 23, 31, 34 AND 35).

FIRST USE 11-1-2004; IN COMMERCE 11-1-2004.
CHRISIE B. KING, EXAMINING ATTORNEY

SN 78-540,217. FLEXIBLE CUTTING SYSTEMS, L.L.C., HIGH RIDGE, MO. FILED 12-30-2004.

FCS

THE MARK CONSISTS OF STANDARD CHARACTERS WITHOUT CLAIM TO ANY PARTICULAR FONT, STYLE, SIZE, OR COLOR.

FOR ROTARY CUTTING DIES FOR USE WITH PRESSURE SENSITIVE MATERIALS IN THE FLEXOGRAPHIC PRINTING AND CONVERTING INDUSTRY FOR MAKING PERFORATED AND CUT PRODUCTS (U.S. CLS. 13, 19, 21, 23, 31, 34 AND 35).

FIRST USE 4-0-2003; IN COMMERCE 4-0-2003.
DORITT L. CARROLL, EXAMINING ATTORNEY

CLASS 7—(Continued).

SN 79-000,583. APPLIED FILMS GMBH & CO. KG, FED REP GERMANY, FILED 12-2-2003.

ATON

THE MARK CONSISTS OF STANDARD CHARACTERS WITHOUT CLAIM TO ANY PARTICULAR FONT, STYLE, SIZE, OR COLOR.

PRIORITY DATE OF 7-25-2003 IS CLAIMED.
OWNER OF INTERNATIONAL REGISTRATION 0817328 DATED 12-2-2003, EXPIRES 12-2-2013.

FOR MACHINES FOR DEPOSITING THIN LAYERS UNDER VACUUM, NAMELY FOR THE COATING OF FLAT WORKPIECES, WHEREBY THE LAYERS ARE COMPOSED OF ORGANIC, DIELECTRIC AND/OR METALLIC MATERIALS (U.S. CLS. 13, 19, 21, 23, 31, 34 AND 35).

STANLEY I. OSBORNE, EXAMINING ATTORNEY

CLASS 7—(Continued).

SN 79-003,116. DYSTAR TEXTILFARBEN GMBH & CO. DEUTSCHLAND KG, FED REP GERMANY, FILED 5-21-2004.

DENCON

THE MARK CONSISTS OF STANDARD CHARACTERS WITHOUT CLAIM TO ANY PARTICULAR FONT, STYLE, SIZE, OR COLOR.

PRIORITY DATE OF 4-1-2004 IS CLAIMED.
OWNER OF INTERNATIONAL REGISTRATION 0826636 DATED 5-21-2004, EXPIRES 5-21-2014.

FOR TEXTILE-DYEING MACHINES AND PARTS THEREOF (U.S. CLS. 13, 19, 21, 23, 31, 34 AND 35).

MARY ROSSMAN, EXAMINING ATTORNEY

SN 79-003,265. NEXTURN CO., LTD., REPUBLIC OF KOREA, FILED 4-22-2004.

NEXTURN

THE MARK CONSISTS OF STANDARD CHARACTERS WITHOUT CLAIM TO ANY PARTICULAR FONT, STYLE, SIZE, OR COLOR.

PRIORITY DATE OF 4-12-2004 IS CLAIMED.
OWNER OF INTERNATIONAL REGISTRATION 0827029 DATED 4-22-2004, EXPIRES 4-22-2014.

FOR MACHINE TOOLS NOT FOR WOODWORKING, NAMELY, LATHES (U.S. CLS. 13, 19, 21, 23, 31, 34 AND 35).

HEATHER THOMPSON, EXAMINING ATTORNEY

SN 79-002,982. KBA-GIORI S.A., CH-1003 LAUSANNE, SWITZERLAND, FILED 4-20-2004.

CUTPAK

OWNER OF INTERNATIONAL REGISTRATION 0383913 DATED 11-17-1971, EXPIRES 11-17-2011.
FOR MACHINES FOR MANUFACTURING BANK-NOTES (U.S. CLS. 13, 19, 21, 23, 31, 34 AND 35).

JIM RINGLE, EXAMINING ATTORNEY

SN 79-003,669. AVDEL VERBINDUNGSELEMENTE GMBH, D-30851 LANGENHAGEN, FED REP GERMANY, FILED 2-27-2004.

AVIMAT

THE MARK CONSISTS OF STANDARD CHARACTERS WITHOUT CLAIM TO ANY PARTICULAR FONT, STYLE, SIZE, OR COLOR.

PRIORITY DATE OF 10-28-2003 IS CLAIMED.
OWNER OF INTERNATIONAL REGISTRATION 0828329 DATED 2-27-2004, EXPIRES 2-27-2014.

FOR METAL WORKING MACHINES, NAMELY, MACHINING CENTERS; MACHINES FOR THE WORKING AND SETTING OF RIVETS; MECHANICAL DEVICES FOR WORKING AND SETTING OF RIVETS, NAMELY, AUTOMATED ASSEMBLY MACHINES FOR BREAK-STEM RIVETS OR HOLLOW CORE RIVETS; MECHANICAL RIVETING TOOLS, NAMELY, POWER OPERATED RIVET GUNS; MECHANICAL DEVICES AND TOOLS AS PARTS OR AS ACCESSORIES FOR THE ABOVE-MENTIONED GOODS FOR USE IN FEEDING RIVETS AND SETTING RIVETS, NAMELY, MOUTH PIECES FOR RIVETING MACHINES, PNEUMATIC CYLINDERS FOR ACTUATING RIVETING MACHINES, AND RIVET FEEDERS FOR RIVETING MACHINES (U.S. CLS. 13, 19, 21, 23, 31, 34 AND 35).

JOHN GARTNER, EXAMINING ATTORNEY

SN 79-002,998. HABASIT AG, CH-4153 REINACH, SWITZERLAND, FILED 5-17-2004.

Habasit HyGUARD

THE MARK CONSISTS OF STANDARD CHARACTERS WITHOUT CLAIM TO ANY PARTICULAR FONT, STYLE, SIZE, OR COLOR.

OWNER OF INTERNATIONAL REGISTRATION 0676650 DATED 3-25-1997, EXPIRES 3-25-2007.

FOR CONVEYING BELTS AND CONVEYING BELTS FOR USE DURING MANUFACTURING PROCESSES (U.S. CLS. 13, 19, 21, 23, 31, 34 AND 35).

STEVEN R. FINE, EXAMINING ATTORNEY

CLASS 7—(Continued).

SN 79-003,898. PIV DRIVES GMBH, FED REP GERMANY,
FILED 6-15-2004.

POSIREX

THE MARK CONSISTS OF STANDARD CHARACTERS
WITHOUT CLAIM TO ANY PARTICULAR FONT, STYLE,
SIZE, OR COLOR.

OWNER OF INTERNATIONAL REGISTRATION 0829048
DATED 6-15-2004, EXPIRES 6-15-2014.

FOR EXTRUSION GEARS FOR PLASTICS PROCES-
SING MACHINES (U.S. CLS. 13, 19, 21, 23, 31, 34 AND
35).

JAMES A. RAUEN, EXAMINING ATTORNEY

CLASS 7—(Continued).

SN 79-005,948. SANOVO ENGINEERING A/S, DK-5210
ODENSE NV, DENMARK, FILED 4-27-2004.



SN 79-005,127. CI XING GROUP CO., LTD., CIXI CITY,
ZHEJIANG PROVINCE 315300, CHINA, FILED 6-14-2004.

CWBR

OWNER OF INTERNATIONAL REGISTRATION 0832652
DATED 6-14-2004, EXPIRES 6-14-2014.

FOR MACHINE PARTS, NAMELY, BEARINGS (U.S.
CLS. 13, 19, 21, 23, 31, 34 AND 35).

REBECCA GILBERT, EXAMINING ATTORNEY

PRIORITY DATE OF 10-31-2003 IS CLAIMED.
OWNER OF INTERNATIONAL REGISTRATION 0834970
DATED 4-27-2004, EXPIRES 4-27-2014.

NO CLAIM IS MADE TO THE EXCLUSIVE RIGHT TO
USE "ENGINEERING", APART FROM THE MARK AS
SHOWN.

THE MARK CONSISTS OF A GLOBE IN A CRACKED
EGGSHELL.

FOR MACHINES FOR TREATMENT, MANUFACTUR-
ING AND PACKAGING OF FOODSTUFFS; MACHINES
FOR TREATMENT, MANUFACTURING AND PACKA-
GING OF GOODS MADE OF EGG (U.S. CLS. 13, 19, 21,
23, 31, 34 AND 35).

MARGERY A. TIERNEY, EXAMINING ATTORNEY

SN 79-005,432. LIEBHERR-EMTEC GMBH, FED REP GER-
MANY, FILED 7-20-2004.

LIKUFIX

THE MARK CONSISTS OF STANDARD CHARACTERS
WITHOUT CLAIM TO ANY PARTICULAR FONT, STYLE,
SIZE, OR COLOR.

PRIORITY DATE OF 1-20-2004 IS CLAIMED.

OWNER OF INTERNATIONAL REGISTRATION 0833576
DATED 7-20-2004, EXPIRES 7-20-2014.

FOR MECHANICAL AND HYDRAULIC QUICK
CHANGE ADAPTERS FOR USE IN EARTH MOVERS
AND MATERIAL LOADING AND UNLOADING MA-
CHINES; HYDRAULIC COUPLING DEVICES AND SUS-
PENSIONS FOR WORKING TOOLS FOR
CONSTRUCTION MACHINES, NAMELY EARTH
MOVERS AND MATERIAL LOADING AND UNLOAD-
ING MACHINES (U.S. CLS. 13, 19, 21, 23, 31, 34 AND 35).

LAURA KOVAISKY, EXAMINING ATTORNEY

SN 79-007,322. ARGAL SRL, ITALY, FILED 8-13-2004.

PRIORITY DATE OF 6-28-2004 IS CLAIMED.
OWNER OF INTERNATIONAL REGISTRATION 0838970
DATED 8-13-2004, EXPIRES 8-13-2014.

THE COLOR(S) BLUE IS/ARE CLAIMED AS A FEATURE
OF THE MARK.

THE MARK CONSISTS OF THE WORD "ARGAL" WRIT-
TEN IN CAPITAL AND FANCIFUL LETTERS. THE COLOR
BLUE APPEARS IN THE OUTLINE OF THE WORD ARGAL
FOR CENTRIFUGAL PUMPS; CENTRIFUGAL CHEM-
ICAL PUMPS; CENTRIFUGAL PUMPS FOR CHEMI-
CAL AND PHARMACEUTICAL INDUSTRIES (U.S. CLS.
13, 19, 21, 23, 31, 34 AND 35).

SOPHIA S. KIM, EXAMINING ATTORNEY

CLASS 7—(Continued).

SN 79-008,595. SANCASSIANO SPA, ITALY, FILED 12-20-2004.

SANCASSIANO

THE MARK CONSISTS OF STANDARD CHARACTERS WITHOUT CLAIM TO ANY PARTICULAR FONT, STYLE, SIZE, OR COLOR.

PRIORITY DATE OF 11-3-2004 IS CLAIMED.

OWNER OF INTERNATIONAL REGISTRATION 0842410 DATED 12-20-2004, EXPIRES 12-20-2014.

THE MARK CONSISTS OF THE WORDING SANCASSIANO CORRESPONDING TO THE APPLICANT'S NAME.

FOR MACHINES FOR THE FOOD INDUSTRY, NAMELY MIXERS, KNEADING MACHINES AND BOWL ELEVATORS THEREFOR, PORTIONING HOPPERS (U.S. CLS. 13, 19, 21, 23, 31, 34 AND 35).

STEVEN JACKSON, EXAMINING ATTORNEY

CLASS 8—(Continued).

SN 76-587,176. RIKENKAKI KOGYO KABUSHIKI KAISHA, SAITAMA, JAPAN, FILED 4-16-2004.



PRIORITY CLAIMED UNDER SEC. 44(D) ON JAPAN APPLICATION NO. 2004-011325, FILED 2-10-2004, REG. NO. 4764695, DATED 8-13-2004, EXPIRES 8-13-2014.

FOR HAND-OPERATED TOOLS, NAMELY, WRENCHES, SPANNERS AND SCREWDRIVERS, AND HAND-OPERATED LIFTING JACKS (U.S. CLS. 23, 28 AND 44).

RAUL CORDOVA, EXAMINING ATTORNEY

CLASS 8—HAND TOOLS

SN 76-271,814. 655685 ONTARIO LIMITED, DBA INTERNATIONAL SPECIALTY ITEMS, HAMILTON, ONTARIO, CANADA, FILED 6-15-2001.

ONE SECOND PLUMBER

PRIORITY CLAIMED UNDER SEC. 44(D) ON CANADA APPLICATION NO. 1100110, FILED 4-17-2001, REG. NO. TMA609697, DATED 5-7-2004, EXPIRES 5-7-2019.

FOR HAND OPERATED DRAIN CLEARING TOOLS OPERABLE TO APPLY FLUID PRESSURE TO A BLOCKED DRAIN (U.S. CLS. 23, 28 AND 44).

ANNE MADDEN, EXAMINING ATTORNEY

SN 76-588,736. CARMOUCHE, JAMES M., HOUSTON, TX, FILED 4-26-2004.

INDUSTRIAL INNOVATIONS

THE MARK CONSISTS OF STANDARD CHARACTERS WITHOUT CLAIM TO ANY PARTICULAR FONT, STYLE, SIZE, OR COLOR.

NO CLAIM IS MADE TO THE EXCLUSIVE RIGHT TO USE "INDUSTRIAL", APART FROM THE MARK AS SHOWN.

FOR HAND TOOLS, NAMELY, CONSTRUCTION TOOLS FOR DISASSEMBLING AND REMOVING CONSTRUCTION FORMS AND CONSTRUCTION FORM INSTALLATION MATERIALS (U.S. CLS. 23, 28 AND 44).

TINA L. SNAPP, EXAMINING ATTORNEY

SN 76-584,925. MILLER, MICHAEL D., WICHITA, KS. FILED 4-1-2004.

**REVOLUTIONIZING
OVER 1000 YEARS OF
DINING**

THE MARK CONSISTS OF STANDARD CHARACTERS WITHOUT CLAIM TO ANY PARTICULAR FONT, STYLE, SIZE, OR COLOR.

FOR EATING UTENSILS AND CUTLERY, NAMELY FORKS, KNIVES AND SPOONS, AND FORKS AND SPOONS HAVING BEVELED AND SHARPENED SIDE EDGES (U.S. CLS. 23, 28 AND 44).

FIRST USE 10-1-2001; IN COMMERCE 12-10-2002.

KATHY DE JONGE, EXAMINING ATTORNEY

SN 76-588,868. BUD K WORLDWIDE, INC., MOULTRIE, GA, FILED 4-23-2004.

GET THE EDGE

THE MARK CONSISTS OF STANDARD CHARACTERS WITHOUT CLAIM TO ANY PARTICULAR FONT, STYLE, SIZE, OR COLOR.

FOR POCKET KNIVES (U.S. CLS. 23, 28 AND 44).

FIRST USE 9-1-2003; IN COMMERCE 9-1-2003.

CHARLES JOYNER, EXAMINING ATTORNEY

CLASS 8—(Continued).

SN 76-609,870. SNAP-ON INCORPORATED, PLEASANT PRAIRIE, WI. FILED 8-30-2004.

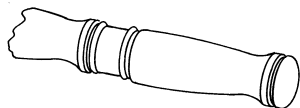

OWNER OF U.S. REG. NOS. 2,689,961, 2,717,021 AND OTHERS.

THE MARK CONSISTS OF THE CONFIGURATION OF THE HANDLE OF A SOCKET DRIVER WITH ONE CIRCUMFERENTIAL GROOVE NEAR THE FREE END OF THE HANDLE AND THREE SPACED CIRCUMFERENTIAL GROOVES NEAR THE MIDDLE OF THE HANDLE.

SEC. 2(F).

FOR HAND TOOLS, NAMELY, SOCKET DRIVERS, NAMELY, RATCHETS, BREAKER BARS AND SPEEDERS (U.S. CLS. 23, 28 AND 44).

FIRST USE 0-0-1979; IN COMMERCE 0-0-1979.

BRIAN PINO, EXAMINING ATTORNEY

SN 76-612,349. FINGER SPA, INC., CORAL SPRINGS, FL. FILED 9-16-2004.

Medi Soakers

THE MARK CONSISTS OF STANDARD CHARACTERS WITHOUT CLAIM TO ANY PARTICULAR FONT, STYLE, SIZE, OR COLOR.

NO CLAIM IS MADE TO THE EXCLUSIVE RIGHT TO USE "SOAKERS", APART FROM THE MARK AS SHOWN.

FOR NON-POWER OPERATED FINGERNAIL TOOL FOR SOAKING FINGERNAILS IN LIQUIDS AND TO REMOVE ARTIFICIAL FINGERNAILS THAT ALSO GIVE CLIENTS FINGER MOBILITY, NAMELY, WEARABLE FINGERNAIL SOAKERS THAT CONNECT TO EACH FINGERTIP (U.S. CLS. 23, 28 AND 44).

KEVIN DINALLO, EXAMINING ATTORNEY

SN 76-626,282. GLOVER, CHARLES, LENOIR, NC. FILED 12-30-2004.

ARRESTOR

THE MARK CONSISTS OF STANDARD CHARACTERS WITHOUT CLAIM TO ANY PARTICULAR FONT, STYLE, SIZE, OR COLOR.

FOR PERSONAL DEFENSE BATON (U.S. CLS. 23, 28 AND 44).

FIRST USE 5-1-2004; IN COMMERCE 5-1-2004.

JANICE L. MCMORROW, EXAMINING ATTORNEY

CLASS 8—(Continued).

SN 78-240,642. LEE, TAE WOO, DBA 9 PLUS AMERICA, LITTLETON, CO. AND F.S. KOREA IND. INC., SEOUL, REPUBLIC OF KOREA, FILED 4-22-2003.

9 PLUS

FOR COSMETIC PRODUCTS, NAMELY, NAIL FILES, NAIL CLIPPERS, CUTICLE PUSHERS, CUTICLE CLIPPERS, TWEEZERS, AND EYELASH CURLERS (U.S. CLS. 23, 28 AND 44).

FIRST USE 1-1-2003; IN COMMERCE 1-1-2003.

JILL C. ALT, EXAMINING ATTORNEY

SN 78-313,263. SPELLBOUND DEVELOPMENT GROUP, INC., NEWPORT BEACH, CA. FILED 10-14-2003.

ERGOFLOW

FOR HAND TOOLS FOR HOME, OFFICE, KITCHEN, GARDEN, INDUSTRIAL AND COMMERCIAL USE, NAMELY, UTILITY KNIVES (U.S. CLS. 23, 28 AND 44).

FIRST USE 7-31-2002; IN COMMERCE 1-31-2003.

ANDREW BENZMILLER, EXAMINING ATTORNEY

SN 78-342,702. NEUMAN, RANDALL L, JENISON, MI. FILED 12-18-2003.



FOR MANUALLY OPERATED HAND TOOL IN THE NATURE OF A POLE WITH A HEAD THAT ADAPTS TO AN AWNING RAFTER KNOB FOR ADJUSTING AWNINGS (U.S. CLS. 23, 28 AND 44).

FIRST USE 12-10-2003; IN COMMERCE 1-15-2004.

WON TEAK OH, EXAMINING ATTORNEY

SN 78-388,318. EARNSHAW, THOMAS L., DALLAS, TX. FILED 3-22-2004.



THE COLOR(S) GRAY IS/ARE CLAIMED AS A FEATURE OF THE MARK.

THE COLOR GRAY APPEARS IN THE NUT, INSIDE THE "K".

THE MARK CONSISTS OF STYLIZED LETTERING, THE K IS PORTRAYING A WRENCH THAT IS LOCKED AROUND A NUT.

FOR HAND TOOLS NAMELY, WRENCHES (U.S. CLS. 23, 28 AND 44).

GINA HAYES, EXAMINING ATTORNEY

CLASS 8—(Continued).

SN 78-402,735. AMERICAN HAND TOOL, ALISO VIEJO, CA. FILED 4-15-2004.



THE COLOR(S) RED AND BLACK IS/ARE CLAIMED AS A FEATURE OF THE MARK.

THE MARK CONSISTS OF THE LETTERS LOC IN RED AND THE LETTERS KEY IN BLACK.

FOR HAND TOOLS, NAMELY, WRENCHES FOR USE BY ELECTRICIANS AND ELECTRICAL CONTRACTORS IN ELECTRICAL, LANDSCAPING AND FIRE SYSTEM INSTALLATIONS (U.S. CLS. 23, 28 AND 44).

FIRST USE 12-15-2002; IN COMMERCE 2-15-2003.
AMY GEARIN, EXAMINING ATTORNEY

CLASS 8—(Continued).

SN 78-409,287. REACH-ALL PRODUCTS, LLC, NAPLES, FL. FILED 4-28-2004.

REACH-ALL

THE MARK CONSISTS OF STANDARD CHARACTERS WITHOUT CLAIM TO ANY PARTICULAR FONT, STYLE, SIZE, OR COLOR.

FOR HAND TOOLS, NAMELY, TOOLS FOR USE IN ACCESSING DIFFICULT TO REACH AREAS VIA TELESCOPING ADJUSTABLE POLE AND ATTACHMENTS; TOOLS FOR ACCESSING DIFFICULT TO REACH AREAS VIA A TELESCOPING POLE (U.S. CLS. 23, 28 AND 44).

FIRST USE 1-1-1995; IN COMMERCE 1-1-1995.
JAMES GRIFFIN, EXAMINING ATTORNEY

SN 78-407,342. HI-FIVE PRODUCTS DEVELOPING CO., LTD., TAICHUNG, TAIWAN, FILED 4-23-2004.

GEARFLEX WRENCH

THE MARK CONSISTS OF STANDARD CHARACTERS WITHOUT CLAIM TO ANY PARTICULAR FONT, STYLE, SIZE, OR COLOR.

NO CLAIM IS MADE TO THE EXCLUSIVE RIGHT TO USE "WRENCH", APART FROM THE MARK AS SHOWN.

FOR HAND TOOLS, NAMELY, BOX WRENCHES, SPOKE WRENCHES, SOCKET WRENCHES, PLIERS, AXES, HATCHETS, WRENCHES, NON-ELECTRIC CAN OPENERS, NAIL FILES, SCREWDRIVERS, HAMMERS, TWEEZERS, COMPOSITION WRENCHES, SOCKET SETS, LOCKING WRENCHES, ADJUSTABLE WRENCHES, AND HOOK SCREWDRIVERS; HANDLES FOR HEX KEY WRENCHES; HAND-OPERATED DECORICATING TOOLS, NAMELY, CRIMPING AND WIRE STRIPPING TOOLS FOR ELECTRIC WIRES; AND EXTENSION BARS FOR WRENCHES (U.S. CLS. 23, 28 AND 44).

FIRST USE 10-8-2003; IN COMMERCE 10-8-2003.
JOHN DALIER, EXAMINING ATTORNEY

SN 78-421,785. EVEREADY BATTERY COMPANY, INC., ST. LOUIS, MO. FILED 5-19-2004.



OWNER OF U.S. REG. NO. 2,813,551.

THE STIPPLING IS FOR SHADING PURPOSES ONLY.

THE FOREIGN WORDING IN THE MARK TRANSLATES INTO ENGLISH AS FOUR.

FOR RAZORS AND RAZOR BLADES (U.S. CLS. 23, 28 AND 44).

FIRST USE 9-11-2003; IN COMMERCE 9-11-2003.
CHERYL CLAYTON, EXAMINING ATTORNEY

CLASS 8—(Continued).

SN 78-424,971. INVENTIONS UNLIMITED, INCORPORATED, YUCCA VALLEY, CA. FILED 5-25-2004.

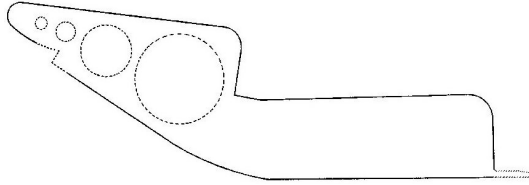

THE MARK CONSISTS OF A CONFIGURATION OF A MANUALLY-OPERATED HAND TOOL CONSISTING OF A SLOPING LEFT END, WHICH CONTAINS FOUR CIRCULAR HOLES, RANGING FROM SMALLEST TO THE LARGEST FROM LEFT TO RIGHT. TO THE RIGHT OF THE FOURTH AND LARGEST HOLE IS A FLAT, HORIZONTAL BASE THAT LEADS TO A DROP DOWN POINTED TIP.

SEC. 2(F).

FOR MANUALLY-OPERATED HAND TOOLS, NAMELY, LIFTER FOR CONSTRUCTION MATERIALS AND AUTOMOBILE TIRES AND RASPS FOR DRY-WALL MATERIALS (U.S. CLS. 23, 28 AND 44).

FIRST USE 1-1-1987; IN COMMERCE 1-1-1997.

KARANENDRA S. CHHINA, EXAMINING ATTORNEY

SN 78-428,339. JIANG, WEIZHONG, GUANGZHOU, CHINA, FILED 6-2-2004.



OWNER OF CHINA REG. NO. 3174384, DATED 6-7-2003, EXPIRES 6-6-2013.

THE MARK CONSISTS OF STYLIZED WORD GET-WIN AND HEAD PORTRAIT OF A HAWK WITH TRIANGLE BACKGROUND.

FOR PENKNIVES; HUNTING KNIVES; MACHETES; KNIVES, NAMELY, BUTCHER KNIVES, CARPET KNIVES, CHEF KNIVES, FISHING KNIVES, SPORT KNIVES, WHITTILING KNIVES, KNIVES FOR HOBBY USE, AND KNIVES MADE OF PRECIOUS METAL; BAYONETS; DAGGERS; SWORDS; SABERS; HAND-OPERATED CHOPPERS; KNIFE SHEATHS (U.S. CLS. 23, 28 AND 44).

LINDA POWELL, EXAMINING ATTORNEY

CLASS 8—(Continued).

SN 78-432,150. MALCO PRODUCTS, INC., ANNANDALE, MN. FILED 6-9-2004.

TURBOSHEAR

THE MARK CONSISTS OF STANDARD CHARACTERS WITHOUT CLAIM TO ANY PARTICULAR FONT, STYLE, SIZE, OR COLOR.

FOR SHEAR ATTACHMENT FOR HAND-HELD DRILLS (U.S. CLS. 23, 28 AND 44).

FIRST USE 2-2-2004; IN COMMERCE 2-2-2004.

SCOTT OSLICK, EXAMINING ATTORNEY

SN 78-441,282. REVLON CONSUMER PRODUCTS CORPORATION, NEW YORK, NY. FILED 6-25-2004.

SHAPE 'N' BUFF

THE MARK CONSISTS OF STANDARD CHARACTERS WITHOUT CLAIM TO ANY PARTICULAR FONT, STYLE, SIZE, OR COLOR.

SEC. 2(F).

FOR NAIL CARE IMPLEMENTS, NAMELY NAIL FILES AND NAIL BUFFERS (U.S. CLS. 23, 28 AND 44).

FIRST USE 7-7-1999; IN COMMERCE 7-7-1999.

ANDREA SAUNDERS, EXAMINING ATTORNEY

SN 78-453,925. MAYFIELD, TREVIS, CHANUTE, KS. FILED 7-21-2004.

MULTI-HOLD-IT TOOL HOLDING SYSTEM

THE MARK CONSISTS OF STANDARD CHARACTERS WITHOUT CLAIM TO ANY PARTICULAR FONT, STYLE, SIZE, OR COLOR.

NO CLAIM IS MADE TO THE EXCLUSIVE RIGHT TO USE "TOOL HOLDING SYSTEM", APART FROM THE MARK AS SHOWN.

FOR TOOL HOLDERS IN THE NATURE OF TOOL BELTS (U.S. CLS. 23, 28 AND 44).

FIRST USE 0-0-2003; IN COMMERCE 0-0-2003.

SCOTT OSLICK, EXAMINING ATTORNEY

CLASS 8—(Continued).

SN 78-484,600. BURKE, WILLIAM C., THOUSAND OAKS, CA. FILED 9-16-2004.

TRENCHFOOT

THE MARK CONSISTS OF STANDARD CHARACTERS WITHOUT CLAIM TO ANY PARTICULAR FONT, STYLE, SIZE, OR COLOR.

FOR HAND TOOL ATTACHMENT IN THE NATURE OF A FOOT PLATE TO BE MOUNTED ON A DIGGING TOOL TO ASSIST IN DIGGING OPERATIONS (U.S. CLS. 23, 28 AND 44).

FIRST USE 5-7-2005; IN COMMERCE 6-18-2005.
KIMBERLY FRYE, EXAMINING ATTORNEY

SN 78-495,221. DIVERSITECH HOLDINGS, LTD., CENTRAL HONG KONG, HONG KONG, FILED 10-6-2004.

MR SEVEN HANDS

THE MARK CONSISTS OF STANDARD CHARACTERS WITHOUT CLAIM TO ANY PARTICULAR FONT, STYLE, SIZE, OR COLOR.

FOR MULTI-FUNCTION HAND TOOLS COMPRISED OF SCREWDRIVERS, KNIVES AND WRENCHES, WITH OR WITHOUT A BUILT-IN FLASHLIGHT (U.S. CLS. 23, 28 AND 44).

MITCHELL FRONT, EXAMINING ATTORNEY

CLASS 8—(Continued).

SN 78-497,600. MENARD, INC., EAU CLAIRE, WI. FILED 10-11-2004.



THE COLORS BEIGE AND BROWN ARE CLAIMED AS A FEATURE OF THE MARK.

THE MARK CONSISTS OF A COMPASS DESIGN WITH THE WORD GUIDESMAN WRITTEN ACROSS THE CENTER. THE TERM GUIDESMAN APPEARS IN BEIGE AGAINST A RECTANGULAR BROWN BACKGROUND WITH A BEIGE BORDER. THE CIRCULAR BACKGROUND APPEARS IN BEIGE WITH A BROWN BORDER. THE RAYS OF THE CENTRAL STAR DESIGN ARE ALTERNATELY BROWN AND BEIGE.

FOR KNIVES; MULTI-FUNCTION HAND TOOLS COMPRISED OF PLIERS, WIRE CUTTERS, HOOK REMOVERS, FISH SCALERS, RULERS, FILES, KNIVES, KNIFE BLADES, AWLS, SCREWDRIVERS, SCREW FASTENING TOOLS, BOTTLE OPENERS, SAWS, AND CAN OPENERS (U.S. CLS. 23, 28 AND 44).

FIRST USE 6-0-2002; IN COMMERCE 6-0-2002.
STEVEN PEREZ, EXAMINING ATTORNEY

SN 78-497,601. MENARD, INC., EAU CLAIRE, WI. FILED 10-11-2004.

GUIDESMAN

THE MARK CONSISTS OF STANDARD CHARACTERS WITHOUT CLAIM TO ANY PARTICULAR FONT, STYLE, SIZE, OR COLOR.

FOR KNIVES; MULTI-FUNCTION HAND TOOLS COMPRISED OF PLIERS, WIRE CUTTERS, HOOK REMOVERS, FISH SCALERS, RULERS, FILES, KNIVES, KNIFE BLADES, AWLS, SCREWDRIVERS, SCREW FASTENING TOOLS, BOTTLE OPENERS, SAWS, AND CAN OPENERS (U.S. CLS. 23, 28 AND 44).

FIRST USE 6-0-2002; IN COMMERCE 6-0-2002.
STEVEN PEREZ, EXAMINING ATTORNEY

CLASS 8—(Continued).

SN 78-497,901. ALLSTAR MARKETING GROUP, LLC, HAWTHORNE, NY. FILED 10-11-2004.

CLASS 8—(Continued).

SN 78-498,639. LEATHERMAN TOOL GROUP, INC., PORTLAND, OR. FILED 10-12-2004.

GRIP'N'TOSS

THE MARK CONSISTS OF STANDARD CHARACTERS WITHOUT CLAIM TO ANY PARTICULAR FONT, STYLE, SIZE, OR COLOR.
FOR LAWN AND GARDEN TOOLS, NAMELY, RAKES (U.S. CLS. 23, 28 AND 44).
BARBARA A. LOUGHRAN, EXAMINING ATTORNEY

CORE

THE MARK CONSISTS OF STANDARD CHARACTERS WITHOUT CLAIM TO ANY PARTICULAR FONT, STYLE, SIZE, OR COLOR.
FOR MULTI-FUNCTION HAND TOOLS COMPRISED OF TWO OR MORE OF THE FOLLOWING ELEMENTS—PLIERS, KNIVES, SCREWDRIVERS, WIRE CUTTER, CRIMPER, FILE AND SAW (U.S. CLS. 23, 28 AND 44).
BARBARA A. LOUGHRAN, EXAMINING ATTORNEY

SN 78-499,249. GROBET FILE COMPANY OF AMERICA, INC., CARLSTADT, NJ. FILED 10-13-2004.

SN 78-498,610. SEARS BRANDS, LLC, HOFFMAN ESTATES, IL. FILED 10-12-2004.

TEBORG

EXTREME GRIP

THE MARK CONSISTS OF STANDARD CHARACTERS WITHOUT CLAIM TO ANY PARTICULAR FONT, STYLE, SIZE, OR COLOR.
FOR WRENCHES (U.S. CLS. 23, 28 AND 44).
KEVON CHISOLM, EXAMINING ATTORNEY

THE MARK CONSISTS OF STANDARD CHARACTERS WITHOUT CLAIM TO ANY PARTICULAR FONT, STYLE, SIZE, OR COLOR.
FOR HAND-OPERATED JEWELER'S TOOLS; NAMELY, PLIERS AND CUTTERS (U.S. CLS. 23, 28 AND 44).
FIRST USE 1-31-2005; IN COMMERCE 1-31-2005.
SUNG IN, EXAMINING ATTORNEY

CLASS 8—(Continued).

SN 78-501,307. JANLEANN, INC., STILWELL, KS. FILED 10-18-2004.

CLASS 8—(Continued).

SN 78-507,739. FISKARS BRANDS, INC., MADISON, WI. FILED 10-28-2004.

Intimate Shave

ASPECT

THE MARK CONSISTS OF STANDARD CHARACTERS WITHOUT CLAIM TO ANY PARTICULAR FONT, STYLE, SIZE, OR COLOR.

NO CLAIM IS MADE TO THE EXCLUSIVE RIGHT TO USE "SHAVE", APART FROM THE MARK AS SHOWN. FOR ELECTRIC RAZOR (U.S. CLS. 23, 28 AND 44). FIRST USE 9-26-2004; IN COMMERCE 9-26-2004. PAUL F. GAST, EXAMINING ATTORNEY

THE MARK CONSISTS OF STANDARD CHARACTERS WITHOUT CLAIM TO ANY PARTICULAR FONT, STYLE, SIZE, OR COLOR.

FOR SPORT, HUNTING AND FISHING KNIVES; MULTI-FUNCTION HAND TOOLS COMPRISING ALL OR A COMBINATION OF THE FOLLOWING - PLIERS, SCREWDRIVERS, BOTTLE OPENERS, KNIFE BLADE, CAN OPENER, FILE, SAW, SCISSORS AND TWEEZERS (U.S. CLS. 23, 28 AND 44). FIRST USE 4-1-2005; IN COMMERCE 4-1-2005. JEFF DEFORD, EXAMINING ATTORNEY

SN 78-515,535. HI-FIVE PRODUCTS DEVELOPING CO., LTD., TAICHUNG, TAIWAN, FILED 11-11-2004.

SN 78-507,736. FISKARS BRANDS, INC., MADISON, WI. FILED 10-28-2004.

DuoGear

FATTY

THE MARK CONSISTS OF STANDARD CHARACTERS WITHOUT CLAIM TO ANY PARTICULAR FONT, STYLE, SIZE, OR COLOR.

FOR HAND TOOLS, NAMELY, BOX WRENCHES, SPOKE WRENCHES, SOCKET WRENCHES, PLIERS, AXES, HATCHETS, WRENCHES, NON-ELECTRIC CAN OPENERS, NAIL FILES, SCREWDRIVERS, HAMMERS, TWEEZERS, COMPOSITION WRENCHES, SOCKET SETS, LOCKING WRENCHES, ADJUSTABLE WRENCHES, AND HOOK SCREWDRIVERS; HANDLES FOR HEX KEY WRENCHES; HAND-OPERATED DECORICATING TOOLS, NAMELY, CRIMPING AND WIRE STRIPPING TOOLS FOR ELECTRIC WIRES; AND EXTENSION BARS FOR WRENCHES (U.S. CLS. 23, 28 AND 44). FIRST USE 10-15-2004; IN COMMERCE 10-15-2004. MICHAEL KEATING, EXAMINING ATTORNEY

THE MARK CONSISTS OF STANDARD CHARACTERS WITHOUT CLAIM TO ANY PARTICULAR FONT, STYLE, SIZE, OR COLOR.

FOR SPORT, HUNTING AND FISHING KNIVES (U.S. CLS. 23, 28 AND 44). FIRST USE 4-1-2005; IN COMMERCE 4-1-2005. JEFF DEFORD, EXAMINING ATTORNEY

CLASS 8—(Continued).

SN 78-521,499. OLYMPIA GROUP, INC., CITY OF INDUSTRY, CA. FILED 11-23-2004.

CLASS 8—(Continued).

SN 78-522,606. CAMILLUS CUTLERY CO., CAMILLUS, NY. FILED 11-24-2004.

HOE-MATIC

GRANPA

THE MARK CONSISTS OF STANDARD CHARACTERS WITHOUT CLAIM TO ANY PARTICULAR FONT, STYLE, SIZE, OR COLOR.

FOR HAND-HELD GARDEN TOOLS, NAMELY, RAKES, HOES, SHOVELS, SAWS AND PRUNING SHEARS (U.S. CLS. 23, 28 AND 44).

FIRST USE 7-0-1984; IN COMMERCE 7-0-1984.
JOHN WILKE, EXAMINING ATTORNEY

THE MARK CONSISTS OF STANDARD CHARACTERS WITHOUT CLAIM TO ANY PARTICULAR FONT, STYLE, SIZE, OR COLOR.

FOR CUTLERY, NAMELY POCKET KNIVES (U.S. CLS. 23, 28 AND 44).

FIRST USE 10-28-2004; IN COMMERCE 10-28-2004.
RONALD MCMORROW, EXAMINING ATTORNEY

SN 78-521,502. OLYMPIA GROUP, INC., CITY OF INDUSTRY, CA. FILED 11-23-2004.

SN 78-533,210. MUSLAND, PETER K., EDMONDS, WA. FILED 12-15-2004.

ROUGHNECK

GUT GUARD

THE MARK CONSISTS OF STANDARD CHARACTERS WITHOUT CLAIM TO ANY PARTICULAR FONT, STYLE, SIZE, OR COLOR.

OWNER OF U.S. REG. NO. 1,178,879.
FOR HAND OPERATED STRIKING AND STRUCK TOOLS, NAMELY, SLEDGE HAMMERS, AXES, MAULS, WEDGES AND SPLITTERS, AND STRIKING TOOL HANDLES (U.S. CLS. 23, 28 AND 44).

FIRST USE 2-0-1992; IN COMMERCE 2-0-1992.
JOHN WILKE, EXAMINING ATTORNEY

THE MARK CONSISTS OF STANDARD CHARACTERS WITHOUT CLAIM TO ANY PARTICULAR FONT, STYLE, SIZE, OR COLOR.

NO CLAIM IS MADE TO THE EXCLUSIVE RIGHT TO USE "GUARD", APART FROM THE MARK AS SHOWN.

FOR BUTCHERING IMPLEMENT, NAMELY, A PLASTIC PROTECTIVE SHEATH FOR COVERING A PORTION OF THE CUTTING EDGE OF A KNIFE DURING USE (U.S. CLS. 23, 28 AND 44).

FIRST USE 10-29-2004; IN COMMERCE 10-29-2004.
BARBARA A. GOLD, EXAMINING ATTORNEY

CLASS 8—(Continued).

SN 79-006,966. ZHEJIANG SANDING TOOL CO., LTD., CHINA, FILED 9-14-2004.



OWNER OF INTERNATIONAL REGISTRATION 0830131 DATED 5-14-2004, EXPIRES 5-14-2014. FOR SCREWDRIVERS (U.S. CLS. 23, 28 AND 44). LEIGH LOWRY, EXAMINING ATTORNEY

CLASS 9—(Continued).

SN 75-758,120. TUT SYSTEMS, INC., PLEASANT HILL, CA. FILED 7-22-1999.



TUT SYSTEMS

CLASS 9—ELECTRICAL AND SCIENTIFIC APPARATUS

SN 75-480,702. SYMMETRICS MARKETING CORPORATION, SCOTTSDALE, AZ. FILED 5-7-1998.

CIMETRY

FOR COMPUTER PROGRAMS FOR FACILITATING DIRECT MARKETING, NAMELY, COMPUTER PROGRAMS FOR MEASURING AND IMPROVING THE EFFECTIVENESS OF DIRECT MARKETING TO CONSUMERS AND BUSINESS OVER NETWORKS AND THE GLOBAL COMPUTER NETWORK (U.S. CLS. 21, 23, 26 AND 38). SCOTT BALDWIN, EXAMINING ATTORNEY

OWNER OF U.S. REG. NO. 1,916,130. FOR COMPUTER AND ELECTRONIC HARDWARE, NAMELY NETWORK INTERFACE CARDS, ASYNCHRONOUS TRANSFER MODES AND VIDEO ON DEMAND TRANSCEIVERS; COMPUTER OPERATING SOFTWARE UTILIZING THE ABOVE HARDWARE FOR USE ON TELECOMMUNICATION AND COMMUNICATION APPLICATIONS AND ETHERNET LOCAL AREA NETWORKS; COMMUNICATIONS NETWORKING EQUIPMENTS, NAMELY, HIGH-SPEED MODEM, WIRELESS AND CABLE ACCESS UNITS AND CONCENTRATORS, NETWORK INTERFACE CARDS, AND IP TELEPHONES (U.S. CLS. 21, 23, 26, 36 AND 38). FIRST USE 11-1-1993; IN COMMERCE 11-1-1993. MICHELE SWAIN, EXAMINING ATTORNEY

SN 75-554,522. EVANS & SUTHERLAND COMPUTER CORPORATION, SALT LAKE CITY, UT. FILED 9-17-1998.

SYMPHONY STRATEGY

FOR COMPUTER HARDWARE AND COMPUTER SOFTWARE FOR USE IN GENERATING REALTIME GRAPHIC IMAGES (U.S. CLS. 21, 23, 26, 36 AND 38). FIRST USE 11-25-1997; IN COMMERCE 11-25-1997. HOWARD SMIGA, EXAMINING ATTORNEY

SN 75-778,635. STARLOGIC CC, KWAZULU NATAL, SOUTH AFRICA, FILED 8-18-1999.

FRAMIT

SN 75-637,713. E-DIALOG, INC., LEXINGTON, MA. FILED 2-10-1999.

E-DIALOG

SEC. 2(F). FOR COMPUTER SOFTWARE FOR PURPOSES OF ELECTRONIC DIRECT-RESPONSE MARKETING VIA AN ON-LINE GLOBAL COMPUTER NETWORK (U.S. CLS. 21, 23, 26, 36 AND 38). FIRST USE 8-31-1998; IN COMMERCE 8-31-1998. IRENE D. WILLIAMS, EXAMINING ATTORNEY

FOR COMPUTER HARDWARE AND SOFTWARE USED FOR PERFORMING FREQUENCY RESPONSE ANALYSIS (FRA) TESTS ON THE WINDING STRUCTURES OF TRANSFORMERS, REGULATORS AND MOTORS; BROCHURES AND USER MANUALS SOLD AS A UNIT THEREWITH (U.S. CLS. 21, 23, 26, 36 AND 38). FIRST USE 4-6-1995; IN COMMERCE 6-11-1997. HEATHER THOMPSON, EXAMINING ATTORNEY

CLASS 9—(Continued).

SN 75-788,768. KABUSHIKI KAISHA SONY COMPUTER ENTERTAINMENT, TA SONY COMPUTER ENTERTAINMENT INC., TOKYO, 107-0052, JAPAN, FILED 8-31-1999.



PlayStation 2

OWNER OF JAPAN REG. NO. 4336803, DATED 11-19-1999, EXPIRES 11-19-2009.

THE MARK CONSISTS OF THE STYLIZED LETTERS AND NUMERALS "P S 2".

FOR ELECTRIC SWITCHES; ELECTRIC RELAYS; CIRCUIT BREAKERS; POWER CONTROLLERS; CURRENT RECTIFIERS; ELECTRIC CONNECTORS; ELECTRIC CIRCUIT CLOSERS; ELECTRIC CAPACITOR; ELECTRIC RESISTORS; LOCAL SWITCHES; POWER DISTRIBUTING BOXES; SWITCHBOARDS; FUSES FOR ELECTRIC CURRENT; LIGHTNING ARRESTERS; ELECTRIC TRANSFORMERS; INDUCTION VOLTAGE REGULATORS; ROTARY INVERTORS; DRY CELL BATTERIES; WET CELL BATTERIES; ACCUMULATORS; PHOTOVOLTAIC CELLS; ELECTRIC WIRES; ELECTRIC CABLES; PHOTOGRAPHIC APPARATUS AND INSTRUMENTS, NAMELY PHOTOGRAPHIC CAMERAS, PHOTOGRAPHIC PROJECTORS, AND PHOTOGRAPHIC SLIDE TRANSPARENCIES; CINEMATOGRAPHIC APPARATUS, NAMELY MOTION PICTURE CAMERAS AND VIDEO RECORDERS; OPTICAL APPARATUS AND INSTRUMENTS, NAMELY OPTICAL INSPECTION APPARATUS FOR INDUSTRIAL USE, OPTICAL LENS SIGHTS, OPTICAL MIRRORS AND CONTACT LENSES; TELEPHONE ANSWERING MACHINES OR TELEPHONES; TELETYPEWRITERS; FACSIMILE MACHINES; AUDIO FREQUENCY TRANSMISSION APPARATUS, BROADCASTING APPARATUS, NAMELY TRANSMITTERS AND RECEIVERS, RADIO BEACON APPARATUS, REMOTE CONTROL TELEMETERING UNITS; AUDIO FREQUENCY APPARATUS, NAMELY, TAPE RECORDERS, DISC RECORDERS, RECORD PLAYERS, AND COMPACT DISC PLAYERS; AUDIO FREQUENCY APPARATUS, NAMELY, TAPE RECORDERS, DISC RECORDERS, RECORD PLAYERS, AND VIDEO FREQUENCY APPARATUS, NAMELY, VIDEO CAMERAS; ANTENNAS; LOUDSPEAKERS; PHONOGRAPHIC RECORDS FEATURING MUSIC; PRERECORDED COMPACT DISCS FEATURING MUSIC; PRERECORDED MAGNETIC TAPES FEATURING MUSIC; METRONOMES; JACKETS FOR COMPUTER DISCS; ELECTROSTATIC COPYING MACHINES; COMPUTERS; COMPUTER PERIPHERALS; SOFTWARE FOR DATABASE MANAGEMENT; SOFTWARE FOR MAKING AND RETRIEVING DOCUMENTS, ELECTRON MICROSCOPES; ELECTRONIC DESK CALCULATORS; WORD PROCESSORS; VACUUM TUBES; RECTIFIER TUBES; CATHODE RAY TUBES; DISCHARGE TUBES; THERMISTORS; DIODES; TRANSISTORS; INTEGRATED CIRCUITS; LARGE SCALE INTEGRATED CIRCUITS; SLOT MACHINES; MAGNETIC CORES; ELECTRICAL WIRES, NAMELY, RESISTANCE WIRES; EXPOSED CINEMATOGRAPHIC FILMS; EXPOSED SLIDE FILMS FEATURING ENTERTAINMENT PROGRAMS; PHOTOGRAPHIC SLIDE TRANSPARENCIES; SLIDE FILM MOUNTS; COMPACT DISCS, OPTICAL DISCS AND MAGNETIC DISCS ALL FEATURING NEWS, SPORTS, MUSIC AND ENTERTAINMENT (U.S. CLS. 21, 23, 26, 36 AND 38).

PRISCILLA MILTON, EXAMINING ATTORNEY

CLASS 9—(Continued).

SN 75-826,166. IMANAGE, INC., SAN MATEO, CA. FILED 10-18-1999.

IMANAGE INFOCOMMERCE

FOR COMPUTER SOFTWARE FOR MANAGING DOCUMENTS, AUDIO, VIDEO, EMAIL, TEXT, DATA, GRAPHICS AND FACSIMILES FOR APPLICATION WITHIN DOCUMENT MANAGEMENT, KNOWLEDGE MANAGEMENT AND BUSINESS-TO-BUSINESS INFORMATION APPLICATIONS VIA LOCAL, WIDE AREA AND GLOBAL NETWORKS (U.S. CLS. 21, 23, 26, 36 AND 38).

PAULA MAYS, EXAMINING ATTORNEY

SN 75-866,907. SUMITOMO ELECTRIC INDUSTRIES, LTD., OSAKA 541-0041, JAPAN, FILED 12-9-1999.

GIGASTREAM

OWNER OF JAPAN REG. NO. 4233555, DATED 1-22-1999, EXPIRES 1-22-2009.

FOR ELECTRONIC COMMUNICATIONS APPARATUS AND INSTRUMENTS, NAMELY, AUTO-NAVIGATION ROUTING SWITCHES, ADAPTERS FOR COMMUNICATION, CABLE MODEMS, CONNECTORS, TRANSFORMERS AND ELECTRIC WIRES AND CABLES FOR SETTING UP COMPUTER NETWORKS SUCH AS LOCAL AREA NETWORKS (U.S. CLS. 21, 23, 26, 36 AND 38).

ESTHER A. BORSUK, EXAMINING ATTORNEY

SN 76-017,628. GENERAL CABLE TECHNOLOGIES CORPORATION, HIGHLAND HEIGHTS, KY. FILED 4-4-2000.

ENERGYGUARD

OWNER OF U.S. REG. NOS. 1,015,700, 1,232,543 AND 1,868,119.

FOR POWER CABLES USED IN THE TELECOMMUNICATIONS INDUSTRY (U.S. CLS. 21, 23, 26, 36 AND 38).

HEATHER THOMPSON, EXAMINING ATTORNEY

SN 76-184,083. MEMLINK LTD., 46733 HERZELIA PITUACH, ISRAEL, FILED 12-20-2000.

MEMLINK

FOR OPTICAL COMPONENTS AND SYSTEMS CONSISTING OF OPTICAL SWITCHES, OPTICAL CROSS CONNECTIONS, OPTICAL ATTENUATORS, OPTICAL SELECTORS AND OPTICAL SPLITTERS (U.S. CLS. 21, 23, 26, 36 AND 38).

RONALD AIKENS, EXAMINING ATTORNEY

CLASS 9—(Continued).

SN 76-270,509. SCHLUMBERGER TECHNOLOGIES, INC., SAN JOSE, CA. FILED 6-12-2001.

Helix

FOR COMPUTER HARDWARE AND SOFTWARE TO MONITOR, DIAGNOSE, ANALYZE AND TROUBLE-SHOOT TELECOMMUNICATION NETWORKS AND ELEMENTS THAT DELIVERY VOICE, VIDEO, PROTOCOLS AND DATA SIGNALS (U.S. CLS. 21, 23, 26, 36 AND 38).

FIRST USE 5-0-2000; IN COMMERCE 5-0-2000.
KATHLEEN M. VANSTON, EXAMINING ATTORNEY

SN 76-315,105. SIERRA DESIGN GROUP, RENO, NV. FILED 9-20-2001.



FOR GAMING EQUIPMENT NAMELY INTERACTIVE KIOSKS FOR THE REDEMPTION OF PRIZES WON IN CONJUNCTION WITH CASINO GAMING MACHINES (U.S. CLS. 21, 23, 26, 36 AND 38).

FIRST USE 2-13-2001; IN COMMERCE 2-13-2001.
LESLEY LAMOTHE, EXAMINING ATTORNEY

SN 76-333,417. PROTECTION TECHNOLOGY CO, 5 MOSCOW, RUSSIAN FED., FILED 11-2-2001.

STARFORCE

PRIORITY CLAIMED UNDER SEC. 44(D) ON CANADA APPLICATION NO. 1,116,974, FILED 9-28-2001.

FOR SOFTWARE USED TO PREVENT INSTALLATION OF ILLEGALLY COPIED OPTICAL DISKS; SOFTWARE USED TO PREVENT UNAUTHORIZED COPYING AND UNAUTHORIZED MODIFICATION OF SOFTWARE APPLICATIONS; COPYRIGHT PROTECTION SOFTWARE FEATURING DIGITAL SOFTWARE LOCKS USED TO PREVENT INSTALLATION OF ILLEGALLY COPIED OPTICAL DISKS AND CD KEYS USED TO PREVENT INSTALLATION OF ILLEGALLY COPIED OPTICAL DISKS (U.S. CLS. 21, 23, 26, 36 AND 38).

JANICE L. MCMORROW, EXAMINING ATTORNEY

CLASS 9—(Continued).

SN 76-338,280. MATSUSHITA ELECTRIC INDUSTRIAL CO., LTD., OSAKA-FU, JAPAN, FILED 11-14-2001.

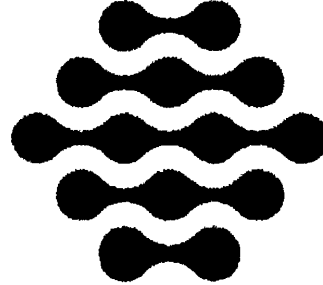

OWNER OF JAPAN REG. NO. 4613635, DATED 10-18-2002, EXPIRES 10-18-2012.

FOR APPARATUS FOR DETECTION AND MEASUREMENT OF MICROBES; PARTS AND FITTINGS FOR USE WITH THE AFORESAID APPARATUS, NAMELY TIPS, MANIFOLDS AND SUCTION TUBES FOR FILTERING, AND RUBBER STOPPERS (U.S. CLS. 21, 23, 26, 36 AND 38).

ELISSA GARBER KON, EXAMINING ATTORNEY

SN 76-345,300. INFINEON TECHNOLOGIES AG, MUNICH, FED REP GERMANY, FILED 12-5-2001.



PRIORITY CLAIMED UNDER SEC. 44(D) ON FED REP GERMANY APPLICATION NO. 30134412.4/0, FILED 6-5-2001, REG. NO. 30134412, DATED 8-27-2002, EXPIRES 6-30-2011.

NO CLAIM IS MADE TO THE EXCLUSIVE RIGHT TO USE "CARD", APART FROM THE MARK AS SHOWN.

THE MARK CONSISTS OF THE WORD "FINGER CARD" AND A DESIGN WHICH INCORPORATES A STYLIZED RECTANGLE AND REPRESENTATION OF A FINGER-PRINT.

FOR PLASTIC CARDS WITH INTEGRATED BIOMETRIC INFORMATION ELECTRONIC COMPONENTS THAT ARE NOT USED IN CREDIT OR FINANCIAL TRANSACTIONS IN THE RETAIL INDUSTRY, AND ELECTRONIC COMPONENTS, NAMELY, DYNAMIC RANDOM ACCESS MEMORY; RANDOM ACCESS MEMORY; READ ONLY MEMORY; DUAL IN-LINE MEMORY MODULE; SINGLE IN-LINE MEMORY MODULE; SEMICONDUCTOR CHIPS; SEMICONDUCTOR MEMORY DEVICES; INTEGRATED CIRCUITS; MICROCONTROLLERS; DIGITAL SIGNAL PROCESSORS; CODERS; TRANSCIEVERS FOR COMMUNICATION; FILTERS; DECODERS; EQUALIZERS; FUSES; INTERFACE DEVICES FOR MULTICHANNEL SUBSCRIBER LINE TO BE USED IN THE FIELD OF TELECOMMUNICATION; BUS CONTROLLERS FOR COMMUNICATION; REDUNDANT MEMORY CELLS USED IN THE DYNAMIC RANDOM ACCESS MEMORY; DIODES; SEMICONDUCTORS; WAFERS; THERMISTORS; TRANSISTORS; MICROPROCESSORS; PRINTED CIRCUITS; AUTOMATIC SOLAR RAY PURSUIT SENSORS; COMPUTER STORAGE UNITS; TRANSMITTERS OF ELECTRONIC SIGNALS (U.S. CLS. 21, 23, 26, 36 AND 38).

MELVIN AXILBUND, EXAMINING ATTORNEY

CLASS 9—(Continued).

SN 76-358,534. DEMAND MANAGEMENT, INC., CLAYTON, MO. FILED 1-14-2002.

DSS&OP

FOR COMPUTER PROGRAMS ON DISCS AND INSTRUCTION MANUALS SOLD AS A UNIT THEREWITH FOR USE IN BUSINESS PLANNING; NAMELY FORECASTING, INVENTORY MANAGEMENT AND SHORT AND LONG TERM PLANNING (U.S. CLS. 21, 23, 26, 36 AND 38).

FIRST USE 0-0-1994; IN COMMERCE 0-0-1994.
KATHERINE STOIDES, EXAMINING ATTORNEY

SN 76-365,874. PREMITECH A/S, DK-2840 HOLTE, DENMARK, FILED 2-1-2002.

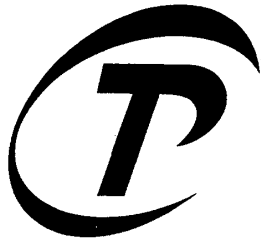

OWNER OF DENMARK REG. NO. VR200103935, DATED 9-25-2001, EXPIRES 9-25-2011.

FOR COMPUTER SOFTWARE USED TO MONITOR COMPUTER SYSTEM PERFORMANCE AND ENHANCE THE PERFORMANCE OF DATABASE SOFTWARE APPLICATIONS OR NETWORK SOFTWARE APPLICATIONS (U.S. CLS. 21, 23, 26, 36 AND 38).

CHERYL STEPLIGHT, EXAMINING ATTORNEY

SN 76-384,617. TELEFONICA, S.A., 28013 MADRID, SPAIN, FILED 3-15-2002.

TELEFONICA MOVISTAR

OWNER OF SPAIN REG. NO. 2,291,408, DATED 7-20-2000, EXPIRES 2-16-2010.

OWNER OF U.S. REG. NOS. 2,692,008, 2,790,106 AND 2,806,932.

THE ENGLISH TRANSLATION OF "TELEFONICA" IS "TELEPHONIC."

SEC. 2(F) AS TO THE TERM "TELEFONICA".

FOR TELEPHONES, TELEGRAPHS, TELEPHONE SYSTEMS, NAMELY, TELEPHONES, TELEPHONE SWITCHERS, PRIVATE BRANCH EXCHANGES, TELEPHONE ANSWERING MACHINES, RADIO TELEPHONES, DIGITAL TELEPHONE SWITCHING EQUIPMENT, AND PARTS THEREOF, FOR HOME AND OFFICE USE AND FOR USE IN CONJUNCTION WITH COMPUTERS, COMPUTER MODEMS AND TELEFACSIMILES (U.S. CLS. 21, 23, 26, 36 AND 38).

STEPHANIE DAVIS, EXAMINING ATTORNEY

CLASS 9—(Continued).

SN 76-386,631. SUMITOMO ELECTRIC INDUSTRIES, LTD., OSAKA, 541-0041, JAPAN, FILED 3-22-2002.

MEMCROS

PRIORITY CLAIMED UNDER SEC. 44(D) ON JAPAN APPLICATION NO. 2001-116058, FILED 12-28-2001.

FOR OPTICAL COMPONENT FOR USE IN FIBER OPTIC COMMUNICATIONS NETWORKS, NAMELY, OPTICAL SWITCHES NOT FOR USE IN RADIO COMMUNICATION (U.S. CLS. 21, 23, 26, 36 AND 38).

FIRST USE 11-0-2002; IN COMMERCE 1-0-2003.
BRIAN PINO, EXAMINING ATTORNEY

SN 76-391,656. VAN ESSEN INSTRUMENTS B.V., 2628 XII DELFT, NETHERLANDS, FILED 4-4-2002.

DIVER

FOR MEASURING INSTRUMENT, NAMELY, A DEVICE USED FOR MEASURING AND MONITORING WATER RESERVOIR CHARACTERISTICS, PARTICULARLY GROUND WATER AND SURFACE WATER DEPTH, LEVEL, TEMPERATURE, PRESSURE, CONDUCTIVITY AND OXYGEN CONCENTRATION (U.S. CLS. 21, 23, 26, 36 AND 38).

FIRST USE 11-0-1995; IN COMMERCE 1-0-2001.
MICHELE SWAIN, EXAMINING ATTORNEY

SN 76-413,353. COMPLEX SYSTEMS, INC., NEW YORK, NY, FILED 5-23-2002.

CLIENTRADE

FOR COMPUTER SOFTWARE, NAMELY, A DOWNLOADABLE INTERNET BASED BANKING SOLUTION FOR USE BY BANKS AND THEIR CUSTOMERS FOR THE ADMINISTRATION OF INTERNATIONAL TRADE TRANSACTIONS, NAMELY, THE PREPARATION AND MANAGEMENT OF LETTERS OF CREDIT, STAND-BY LETTERS OF CREDIT, GUARANTEES, IMPORT/EXPORT DOCUMENTS AND FUNDS COLLECTION (U.S. CLS. 21, 23, 26, 36 AND 38).

FIRST USE 11-12-2001; IN COMMERCE 11-12-2001.
JENNIFER WILLISTON, EXAMINING ATTORNEY

SN 76-416,390. BEAVER MACHINE CORPORATION, NEW-MARKET, ONTARIO, CANADA, FILED 6-3-2002.

FLAT-PAK

PRIORITY CLAIMED UNDER SEC. 44(D) ON CANADA APPLICATION NO. 1128748, FILED 1-25-2002, REG. NO. TMA607937, DATED 4-19-2004, EXPIRES 4-19-2019.

FOR VENDING MACHINES, AND PARTS AND FITTINGS FOR VENDING MACHINES (U.S. CLS. 21, 23, 26, 36 AND 38).

ANDREA SAUNDERS, EXAMINING ATTORNEY

CLASS 9—(Continued).

SN 76-421,172. SHIMADZU CORPORATION, KYOTO, JAPAN, FILED 6-12-2002.

DeNOVA

PRIORITY CLAIMED UNDER SEC. 44(D) ON JAPAN APPLICATION NO. 2002029463, FILED 4-11-2002, REG. NO. 4658540, DATED 4-4-2003, EXPIRES 4-4-2013.

FOR DNA SEQUENCERS, SOMATIC HYBRIDIZERS, PROTEIN SEQUENCERS AND APPARATUS FOR TRANSFERRING GENES FROM OUTSIDE OF THE CELL INTO THE CELL, NAMELY, GENE TRANSFER INSTRUMENTS (U.S. CLS. 21, 23, 26, 36 AND 38).
ADA HAN, EXAMINING ATTORNEY

SN 76-430,101. ZENIMAX MEDIA INC., ROCKVILLE, MD. FILED 7-10-2002.

BETHESDA SOFTWAREWORKS

OWNER OF U.S. REG. NOS. 2,584,383 AND 2,689,683. NO CLAIM IS MADE TO THE EXCLUSIVE RIGHT TO USE "BETHESDA", APART FROM THE MARK AS SHOWN.

FOR COMPUTER GAME PROGRAMS; COMPUTER GAME PROGRAMS DOWNLOADABLE FROM A GLOBAL COMPUTER NETWORK (U.S. CLS. 21, 23, 26, 36 AND 38).
FIRST USE 6-0-1981; IN COMMERCE 0-0-1985.
STACY WAHLBERG, EXAMINING ATTORNEY

SN 76-436,687. TUVOX INCORPORATED, MOUNTAIN VIEW, CA. FILED 8-1-2002.



FOR COMPUTER HARDWARE AND SOFTWARE FOR SPEECH AUTOMATION, SPEECH RECOGNITION, HOSTING SERVICES, MANAGING INFRASTRUCTURE FOR SPEECH APPLICATIONS AND SPEECH SYSTEMS, VOICE RECOGNITION AND CALL AUTOMATION (U.S. CLS. 21, 23, 26, 36 AND 38).
FIRST USE 12-30-2000; IN COMMERCE 12-30-2000.
KATHLEEN M. VANSTON, EXAMINING ATTORNEY

CLASS 9—(Continued).

SN 76-436,782. TUVOX INCORPORATED, MOUNTAIN VIEW, CA. FILED 8-2-2002.

TUVOX

FOR COMPUTER HARDWARE AND SOFTWARE FOR SPEECH AUTOMATION, SPEECH RECOGNITION, HOSTING SERVICES, MANAGING INFRASTRUCTURE FOR SPEECH APPLICATIONS AND SPEECH SYSTEMS, VOICE RECOGNITION AND CALL AUTOMATION (U.S. CLS. 21, 23, 26, 36 AND 38).
FIRST USE 12-0-2000; IN COMMERCE 12-0-2000.
KATHLEEN M. VANSTON, EXAMINING ATTORNEY

SN 76-448,041. A & F MARKETING, INC., GURNEE, IL. FILED 9-9-2002.

SWING STUDIO

NO CLAIM IS MADE TO THE EXCLUSIVE RIGHT TO USE SWING, APART FROM THE MARK AS SHOWN.
FOR ELECTRONIC GOLF SWING TRAINING DEVICE COMPRISING CAMERAS AND SPECIALIZED SOFTWARE TO ALLOW GOLFERS TO SEE IMAGES OF THEIR PRACTICE SWINGS FROM MULTIPLE ANGLES (U.S. CLS. 21, 23, 26, 36 AND 38).
FIRST USE 11-15-2003; IN COMMERCE 11-15-2003.
SOPHIA S. KIM, EXAMINING ATTORNEY

SN 76-476,251. WIBU-SYSTEMS USA INC., SEATTLE, WA. FILED 12-18-2002.

SMARTSHELTER

FOR COMPUTER SECURITY PRODUCTS, NAMELY COMPUTER HARDWARE AND COMPUTER ENCRYPTION SOFTWARE USED IN THE FIELD OF DOCUMENT PROTECTION (U.S. CLS. 21, 23, 26, 36 AND 38).
STEPHANIE DAVIS, EXAMINING ATTORNEY

SN 76-478,861. ARISTOCRAT TECHNOLOGIES AUSTRALIA PTY LTD, LANE COVE, 2066, NSW, AUSTRALIA, FILED 12-26-2002.

TOP FORM

PRIORITY CLAIMED UNDER SEC. 44(D) ON AUSTRALIA APPLICATION NO. 918411, FILED 7-2-2002, REG. NO. 918411, DATED 7-2-2002, EXPIRES 7-2-2012.
FOR GAMING DEVICES, NAMELY, GAMING MACHINES (U.S. CLS. 21, 23, 26, 36 AND 38).
SONYA STEPHENS, EXAMINING ATTORNEY

CLASS 9—(Continued).

SN 76-484,842. BERTHOLD TYPES LIMITED, CHICAGO, IL.
FILED 1-27-2003.

WHITTINGHAM

SEC. 2(F).

FOR TYPEFACE FONTS, NAMELY, ALPHABET SYMBOLS AND GRAPHIC FONTS, RECORDED ON MAGNETIC MEDIA FOR REPRODUCTION AND DUPLICATION FOR THE CREATION OF TEXTS USING GRAPHIC TECHNIQUES; DIGITALLY STORED TYPEFACES, IN PARTICULAR ON ELECTRIC AND/OR MAGNETIC DATA CARRIERS, MAGNETIC DISCS, CD ROMS AND DISKETTES; COMPUTER SOFTWARE IN THE FIELD OF DESKTOP PUBLISHING; COMPUTER SOFTWARE DOWNLOADABLE FROM GLOBAL COMPUTER INFORMATION NETWORKS FOR GENERATION OF TYPEFACES AND FONTS (U.S. CLS. 21, 23, 26, 36 AND 38).

FIRST USE 3-18-2000; IN COMMERCE 3-18-2000.
RUSS HERMAN, EXAMINING ATTORNEY

SN 76-487,907. SENNHEISER ELECTRONIC GMBH & CO.
KG, 30900 WEDEMARK, FED REP GERMANY, FILED 2-6-2003.

HiDyn plus

PRIORITY CLAIMED UNDER SEC. 44(D) ON FED REP GERMANY APPLICATION NO. 30257921.4, FILED 11-26-2002, REG. NO. 30257921, DATED 12-19-2002, EXPIRES 12-19-2012.

FOR ELECTRIC, ELECTRONIC AND OPTICAL MEASURING, SIGNALLING, CHECKING APPARATUS AND INSTRUMENTS SPECIFICALLY, ELECTRIC APPARATUS AND INSTRUMENTS FOR ELECTRO-ACOUSTICS, NAMELY SPEAKERS, EQUALIZERS, AUDIO SYNTHESIZERS, AUDIO TRANSMITTERS, HIGH-FREQUENCY AUDIO RECEIVERS, HIGH-FREQUENCY INPUT MODULES FOR PROVIDING A HARMONIOUS SOUND BALANCE, PARTS FOR THE AFORESAID GOODS; ACTIVE INTERFERING NOISE SUPPRESSION DEVICES, FOR USE WITH OTHER AUDIO AND AUDIO VISUAL SYSTEMS; ANALOG AND DIGITAL ELECTRO-ACOUSTIC SYSTEMS AND APPARATUS, NAMELY ELECTRO-ACOUSTIC SYSTEMS COMPRISED OF DIGITAL SOUND FILTERS, COMPUTERS, ANALOG-TO-DIGITAL SOUND CONVERTERS, POCKET AUDIO TRANSMITTERS AND POCKET AUDIO RECEIVERS FOR THE UHF AND VHF RANGES, AND PARTS THEREOF, DIVERSITY AUDIO RECEIVERS, SMALL AUDIO RECEIVERS, LIVE NEWS COVERAGE APPARATUS, NAMELY BROADBAND AUDIO TRANSMITTERS WITH COMMAND AUDIO RECEIVERS, BACKWARD CHANNEL AUDIO TRANSMITTERS, DIVERSITY PROGRAM AUDIO RECEIVERS, COMMAND AUDIO TRANSMITTERS, FOR RECORDING, TRANSMITTING AND REPRODUCING AUDIO SIGNALS; AUDIO FILTERS, AUDIO AMPLIFIERS, ELECTRICAL VOLUME CONTROLS, LOUDSPEAKERS, HEADSETS, MICROPHONES, NAMELY MICROPHONES WITH INTEGRATED TRANSMITTERS, NAMELY CONDENSER MICROPHONES WITH BUILT-IN HIGH FREQUENCY TRANSMITTERS, SOLOIST MICROPHONES, PRESSURE MICROPHONES, SWITCHABLE MICROPHONES, INTERFACE MICROPHONES, ELECTRET MICROPHONES, HEADSET MICROPHONES, GOOSENECK MICROPHONES, DIRECTIONAL TUBE MICROPHONES, WIRELESS MICROPHONES, CLIP-ON MICROPHONES; MICROPHONE PARTS, NAMELY MICROPHONE DIAPHRAGMA CAPSULES, OMNI-DIRECTIONAL ELECTRET MICROPHONE CAPSULES, OMNI-

CLASS 9—(Continued).

DIRECTIONAL FOIL ELETRET CAPSULES, MICROPHONE MODULES EFFECTED THROUGH COMPUTER AIDED ACOUSTIC DESIGN AND LASER INTERFEROMETRY TECHNIQUES, MICROPHONE TERMINAL DISTRIBUTORS, MICROPHONE SLEEVES; AERIALS, ACCUMULATOR PLUGS, PLUG BATTERY CHARGERS, LISTENER CABLES, TRANSDUCERS AND PARTS THEREFOR; APPARATUS FOR THE WIRELESS TRANSMISSION, TRANSFER AND RECEPTION OF SOUND OR VIDEO SIGNALS, NAMELY, MULTI-CHANNEL TRANSMITTERS AND SINGLE-CHANNEL TRANSMITTERS AND SIGNALS, NAMELY, MULTI-CHANNEL TRANSMITTERS AND SINGLE-CHANNEL TRANSMITTERS AND INFRARED TRANSMITTERS AND RECEIVERS; ELECTRIC, ELECTRONIC AND ELECTRO-ACOUSTIC APPARATUS AND INSTRUMENTS FOR COMMUNICATIONS TECHNOLOGY, NAMELY, TELEPHONES, HEARING AND SPEECH ATTACHMENTS AUGMENTERS, AND PRE-RECORDED FLOPPY DISCS, TAPES AND DISCS FEATURING OPERATING SYSTEM SOFTWARE (U.S. CLS. 21, 23, 26, 36 AND 38).

RONALD AIKENS, EXAMINING ATTORNEY

SN 76-501,817. MY FIRST SHADES, GREAT NECK, NY.
FILED 3-27-2003.



NO CLAIM IS MADE TO THE EXCLUSIVE RIGHT TO USE "SHADES", APART FROM THE MARK AS SHOWN.

FOR SUNGLASSES AND COMPONENT PARTS THEREOF AND ACCESSORIES, NAMELY, EARSTEMS, NOSE PIECES, FOAM STRIPS, SHIELDS AND LENSES (U.S. CLS. 21, 23, 26, 36 AND 38).

FIRST USE 9-0-2002; IN COMMERCE 9-0-2002.
ESTHER A. BORSUK, EXAMINING ATTORNEY

SN 76-512,569. SANCHEZ, LUIS MANUEL RODRIGUEZ,
COLONIA CENTRO C.P. 06000, MEXICO, FILED 5-8-2003.



OWNER OF MEXICO REG. NO. 722350, DATED 10-31-2001, EXPIRES 8-3-2011.

FOR BURGLAR ALARMS, AUDIO SYSTEMS AND COMPONENTS NAMELY, RADIOS, EQUALIZERS, AMPLIFIERS, SPEAKERS, COMPACT DISC PLAYERS, VIDEO DISC PLAYERS, CASSETTE PLAYERS AND HEADPHONE SPEAKERS (U.S. CLS. 21, 23, 26, 36 AND 38).

TINA L. SNAPP, EXAMINING ATTORNEY

CLASS 9—(Continued).

SN 76-514,478. INDUSTRIAL MAGNETICS, INC., BOYNE CITY, MI. FILED 5-15-2003.

JIT CLEAN-FLOW

OWNER OF U.S. REG. NO. 1,255,960.
 NO CLAIM IS MADE TO THE EXCLUSIVE RIGHT TO USE "JIT", APART FROM THE MARK AS SHOWN.
 FOR MAGNETS (U.S. CLS. 21, 23, 26, 36 AND 38).
 FIRST USE 1-2-2001; IN COMMERCE 1-2-2001.
 ROBERT LAVACHE, EXAMINING ATTORNEY

CLASS 9—(Continued).

SN 76-548,748. XITRON, INC., ANN ARBOR, MI. FILED 10-2-2003.

XITRON

OWNER OF U.S. REG. NO. 1,475,668.
 FOR COMPUTER HARDWARE; PERIPHERALS, AND SOFTWARE FOR CONVERSION OF DIGITAL INFORMATION, FOR PRE-PRESS WORKFLOW FOR USE IN THE FIELD OF GRAPHIC ARTS (U.S. CLS. 21, 23, 26, 36 AND 38).
 FIRST USE 8-30-1978; IN COMMERCE 8-30-1978.
 EUGENIA MARTIN, EXAMINING ATTORNEY

SN 76-521,433. FLASHLINE PRODUCTS LLC, CARLSBAD, CA. FILED 6-6-2003.

WALLETTREADERX

THE MARK CONSISTS OF STANDARD CHARACTERS WITHOUT CLAIM TO ANY PARTICULAR FONT, STYLE, SIZE, OR COLOR.
 FOR OPTICS RELATED CONVENIENCE PRODUCT, COMPRISED OF READING-GLASSES WITH A CREDIT-CARD SIZED ENVELOPE-HOLDER, WHICH ARE SOLD AS A UNIT, FOR READY CARRYING WITHIN ONES WALLET (U.S. CLS. 21, 23, 26, 36 AND 38).
 FIRST USE 5-25-2003; IN COMMERCE 5-25-2003.
 MATTHEW KLINE, EXAMINING ATTORNEY

SN 76-553,494. OLD WORLD INDUSTRIES, INC., NORTH-BROOK, IL. FILED 10-23-2003.

SN 76-524,971. SLEEPMED, INCORPORATED, PEABODY, MA. FILED 6-23-2003.

DIGIVIEW

FOR SOFTWARE USED TO COLLECT AND PRESENT BRAIN AND SLEEP DATA FOR REVIEW BY RESEARCHERS, PHYSICIANS, TECHNOLOGISTS AND OTHER HEALTH CARE PROVIDERS (U.S. CLS. 21, 23, 26, 36 AND 38).
 FIRST USE 12-30-2002; IN COMMERCE 3-18-2003.
 ZHALEH DELANEY, EXAMINING ATTORNEY



SN 76-537,142. E.E. MULTIMEDIA, INC., CHATSWORTH, CA. FILED 8-13-2003.



FOR HOUSE MARK FOR MULTIMEDIA PRODUCTS FOR ADULT ENTERTAINMENT, NAMELY, VIDEO TAPES, AND DVD'S (U.S. CLS. 21, 23, 26, 36 AND 38).
 FIRST USE 5-19-2003; IN COMMERCE 5-19-2003.
 PAM WILLIS, EXAMINING ATTORNEY

OWNER OF U.S. REG. NOS. 759,028, 2,239,194 AND OTHERS.
 NO CLAIM IS MADE TO THE EXCLUSIVE RIGHT TO USE "PERFORMANCE PRODUCTS", APART FROM THE MARK AS SHOWN.
 THE MARK CONSISTS OF A MOUNTAIN PEAK.
 FOR BATTERY CHARGERS, BATTERY JUMP STARTERS AND POWER INVERTERS THAT CHANGE DC CURRENT TO AC CURRENT (U.S. CLS. 21, 23, 26, 36 AND 38).
 FIRST USE 8-20-2001; IN COMMERCE 8-20-2001.
 SCOTT BALDWIN, EXAMINING ATTORNEY

CLASS 9—(Continued).

SN 76-558,976. TAI-AI UNITED TRADING CO., LTD.,
TAICHUNG HSIEN, TAIWAN, FILED 11-12-2003.

MITSUCA

THE MARK CONSISTS OF STANDARD CHARACTERS WITHOUT CLAIM TO ANY PARTICULAR FONT, STYLE, SIZE, OR COLOR.

FOR PERSONAL STEREOs, PORTABLE TELEPHONES, COMPUTERS, COMPUTER CARRYING CASES, GAMING EQUIPMENT, NAMELY, SLOT MACHINES WITH OR WITHOUT VIDEO OUTPUT, LABORATORY APPARATUS, NAMELY, CENTRIFUGES, REMOTE CURSOR CONTROLS FOR COMPUTERS, VIDEO OUTPUT GAME MACHINES FOR USE WITH TELEVISIONS, COMPUTERIZED VIDEO TABLE GAMES FOR GAMING PURPOSES, GAMBLING MACHINES, GAMING MACHINES, MACHINES FOR PLAYING GAMES OF CHANCE, COMPUTER COMMUNICATIONS SERVERS, COMPUTER MEMORY CARDS, COMPUTER MICROCHIPS, COMPUTER MICROPROCESSORS, SOUND RECORDING FEATURING MUSIC AND SELF IMPROVEMENT, VIDEO RECORDING FEATURING MUSIC AND SELF-IMPROVEMENT, MECHANICAL SIGNS, BLANK OPTICAL DISCS, OPTICAL GLASSES, BLANK ELECTRONIC CHIP CARDS, BLANK SMART CARDS, BLANK INTEGRATED CIRCUIT CARDS, ELECTROPLATING MACHINES, ADDING MACHINES, GARMENT STEAMERS, 35 MM CAMERAS, ANTI-INTRUSION ALARMS, AUDIO CASSETTE RECORDERS, AUDIO TAPE RECORDERS, BATTERIES, BATTERIES FOR VEHICLES, BATTERY CHARGERS, BINOCULARS, BLANK AUDIO CASSETTES, BLANK AUDIO TAPES, BLANK DISCS FOR COMPUTERS, BLANK HARD COMPUTER DISCS, BLANK VIDEO CASSETTES, BLANK VIDEOTAPES, BURGLAR ALARMS, CALCULATORS, CAMERA CASES, CASH REGISTERS, CELLULAR TELEPHONES, COMPUTER HARDWARE, COMPUTER MONITORS, COMPUTER MEMORIES, COMPUTER KEYBOARDS, COMPUTER OPERATING PROGRAMS, COMPUTER OPERATING SYSTEMS, COMPUTER PERIPHERALS, COMPUTERS AND INSTRUCTIONAL MANUALS SOLD AS A UNIT, DIVING HELMETS, DIVING SUITS, DIVING GLOVES, ELECTRIC DEVICES FOR ATTRACTING AND KILLING INSECTS, EMERGENCY WARNING LIGHTS, EPIDIASCOPIES, FACSIMILE MACHINES, FIRE ALARMS, FIRE EXTINGUISHERS, HARD DISCS FOR COMPUTERS, ELECTRIC IRONS, FLAT IRONS, STEAM IRONS, LABORATORY EQUIPMENT AND SUPPLIES NAMELY, CALIPERS, LABORATORY EQUIPMENT AND SUPPLIES, NAMELY TEST TUBES, LABORATORY EQUIPMENT AND SUPPLIES, NAMELY CRUCIBLES, LABORATORY EQUIPMENT AND SUPPLIES, NAMELY CUPELS, LABORATORY GLASSWARE, MAGNIFYING GLASSES, MICROCOMPUTERS, MAGNIFYING PEEPHOLES FOR DOORS, MICRO-PROCESSORS, MINICOMPUTERS, MOTION PICTURE CAMERAS, MOVIE PROJECTORS, PHOTOCOPYING MACHINES, PRISMS FOR SCIENTIFIC PURPOSES, PHOTOGRAPHIC CAMERAS, PHOTOGRAPHIC PROJECTORS, RADIOS, RADIOS FOR VEHICLES, SAFETY GOGGLES, SIRENS, SIRENS FOR VEHICLES, SLIDE PROJECTORS, SLOT MACHINES, SUPERCOMPUTERS, TELEPHONES, TELESCOPES, TELEVISION ANTENNAS, TELEVISION SETS, THEFT ALARMS, VIDEO CAMERAS, VIDEO CASSETTE RECORDERS, VIDEO TAPE RECORDERS, BREATHING APPARATUS FOR DIVERS, NAMELY COMPRESSED AIR BAILOUT UNITS, BREATHING APPARATUS FOR DIVERS, NAMELY, BUOYANCE BLADDERS, CAMCORDERS, CORDLESS TELEPHONES, DIGITAL PHONES, DIGITAL CAMERAS, ELECTRONIC AND ELECTRO-MECHANICAL GAMING TABLES WITH VIDEO OUTPUT, HAND-HELD PERSONAL COMPUTERS, IRON PRESSING MACHINES, MOBILE TELEPHONES, MOUNTING RACKS FOR COMPUTER HARDWARE, NOTEBOOK COMPUTERS, COMPUTER CAMERAS, PHOTOCOPIERS, AUTOMATIC TELLER MACHINES, RIFLE SCOPES, COMPUTER GAME DISCS, COMPUTER GAME CASSETTES, COMPUTER GAME PROGRAMS, VIDEO GAME CARTRIDGES, VIDEO GAME SOFTWARE, VIDEO GAME DISCS, VIDEO GAME TAPE CASSETTES AND VENDING MACHINES (U.S. CLS. 21, 23, 26, 36 AND 38).

CLASS 9—(Continued).

CAL GAMING TABLES WITH VIDEO OUTPUT, HAND-HELD PERSONAL COMPUTERS, IRON PRESSING MACHINES, MOBILE TELEPHONES, MOUNTING RACKS FOR COMPUTER HARDWARE, NOTEBOOK COMPUTERS, COMPUTER CAMERAS, PHOTOCOPIERS, AUTOMATIC TELLER MACHINES, RIFLE SCOPES, COMPUTER GAME DISCS, COMPUTER GAME CASSETTES, COMPUTER GAME PROGRAMS, VIDEO GAME CARTRIDGES, VIDEO GAME SOFTWARE, VIDEO GAME DISCS, VIDEO GAME TAPE CASSETTES AND VENDING MACHINES (U.S. CLS. 21, 23, 26, 36 AND 38).

FIRST USE 7-1-2002; IN COMMERCE 7-1-2002.
ODESSA BIBBINS, EXAMINING ATTORNEY

SN 76-559,815. NATIONAL CATHODE CORP., HACKENSACK, NJ. FILED 10-30-2003.

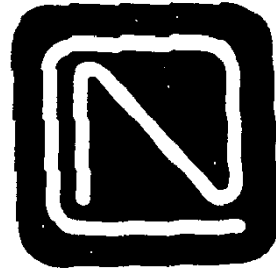

THE MARK CONSISTS OF THE LETTERS "NC".
FOR ELECTRICAL TRANSFORMERS, TRANSFORMER PARTS AND TRANSFORMER FITTINGS (U.S. CLS. 21, 23, 26, 36 AND 38).

FIRST USE 0-0-1969; IN COMMERCE 0-0-1969.
WON TEAK OH, EXAMINING ATTORNEY

CLASS 9—(Continued).

SN 76-560,775. PASCO SCIENTIFIC, ROSEVILLE, CA. FILED 11-20-2003.

CLASS 9—(Continued).

SN 76-563,529. AHG LICENSING, INC., NEW YORK, NY. FILED 11-20-2003.

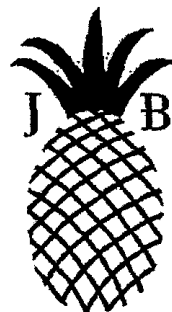

OWNER OF U.S. REG. NOS. 1,880,156, 1,994,301 AND OTHERS.

NO CLAIM IS MADE TO THE EXCLUSIVE RIGHT TO USE SCIENTIFIC, APART FROM THE MARK AS SHOWN.

FOR SCIENTIFIC AND EDUCATIONAL LABORATORY APPARATUSES AND INSTRUMENTS AND EQUIPMENT BEING USED FOR TEACHING— OPTICS, ELECTROSTATICS, WAVE THEORY, MECHANICS, THERMODYNAMICS, SOUND, ELECTRICITY AND MAGNETISM, NUCLEAR AND ATOMIC PHYSICS, AND X-RAY TECHNOLOGY; NAMELY, LASERS NOT FOR MEDICAL USE, PROBES, NAMELY, PRESSURE PROBES, TEMPERATURE PROBES, VOLTAGE PROBES AND ELECTRIC CURRENT PROBES; SENSORS, NAMELY, ROTARY MOTION SENSORS, LINEAR MOTION SENSORS, STRAIN GAUGE FORCE SENSORS, ACCELERATION SENSORS, PRESSURE SENSORS, LIGHT SENSORS, MAGNETIC FIELD SENSORS, INFRARED SENSORS, TEMPERATURE SENSORS, SOUND INTENSITY SENSORS, SOUND SPEED SENSORS, VOLTAGE SENSORS, ELECTRIC CURRENT SENSORS, ELECTROSTATIC CHARGE SENSORS, BETA RADIATION SENSORS, GENERAL PURPOSE NUCLEAR SENSORS, PH SENSORS, COLOR IMAGERY SENSORS, HEART RATE SENSORS NOT FOR MEDICAL USE, EKG SENSORS NOT FOR MEDICAL USE, RESPIRATION RATE SENSORS NOT FOR MEDICAL PURPOSES, BAROMETRIC SENSORS, RELATIVE HUMIDITY SENSORS, CONDUCTIVITY SENSORS, CARBON DIOXIDE SENSORS, OXYGEN GAS SENSORS, DISSOLVED GAS SENSORS; ALTIMETERS, MOTION VISUALIZER SYSTEMS, COMPRISED OF 3D PROCESSOR, COMPUTER SOFTWARE FOR VIEWING MOTION IN GRAPH FORM, CABLES, POWER SOURCES, AND CAMERA ALIGNMENT TOOL; COLORIMETERS, OPTICAL MIRRORS, AND MICROSCOPES (U.S. CLS. 21, 23, 26, 36 AND 38).

FIRST USE 6-15-1964; IN COMMERCE 6-15-1964.

KATHRYN COWARD, EXAMINING ATTORNEY

FOR PROTECTIVE EYEWEAR; SUNGLASSES; EYEGLASSES; EYEGLASS FRAMES; EYEGLASS, SUNGLASS AND SPECTACLE CASES; EYEGLASS, SUNGLASS AND SPECTACLE STRAPS; EYEGLASS, SUNGLASS AND SPECTACLE CHAINS; EYEGLASS, SUNGLASS AND SPECTACLE CLEANING CLOTHS; MAGNETS; DECORATIVE MAGNETS; REFRIGERATOR MAGNETS; NOVELTY MAGNETS; MOUSE PADS; COMPACT DISC CASES; COMPUTER CARRYING CASES; WRIST RESTS AND SUPPORTS FOR COMPUTER MOUSE USERS; WRIST RESTS FOR COMPUTER PRODUCTS; COMPUTER KEYBOARD WRIST PADS (U.S. CLS. 21, 23, 26, 36 AND 38).

MARY CRAWFORD, EXAMINING ATTORNEY

CLASS 9—(Continued).

SN 76-564,119. APLUS TECHNICS CO., LTD, CHUNG-HO, TAIPEI, TAIWAN, FILED 12-8-2003.



THE COLOR(S) RED, ORANGE, YELLOW, GREEN, BLUE, INDIGO AND VIOLET IS/ARE CLAIMED AS A FEATURE OF THE MARK.

THE MARK INCLUDES A HIGHLY STYLIZED "A" IN RAINBOW CONFIGURATION WITH THE COLOR OF THE RAINBOW PASSING FROM RED AT THE UPPER PORTION OF THE MARK THROUGH THE COLOR VIOLET AT THE LOWER PORTION OF THE CONTOURED "A".

FOR LIQUID CRYSTAL DISPLAY MONITOR SCREEN; TELEVISION SET; SIGNAL CONVERTER FOR SATELLITE TELEVISION; VIDEO RECEIVER; VIDEO SIGNAL MAGNIFIER; CAR STEREO; CABLE TELEVISION BOX; AUDIO/VIDEO RECEIVER; AUDIO/VIDEO SELECTOR; DIGITAL AUDIO/VIDEO MIXER; LIQUID CRYSTAL DISPLAY TELEVISION; AUDIO/VIDEO RECORDER; THIN FILM TRANSISTOR LIQUID CRYSTAL DISPLAY TELEVISION; THIN FILM TRANSISTOR LIQUID CRYSTAL DISPLAY HIGH-DEFINITION TELEVISION; DIGITAL IMAGE STORAGE, NAMELY CARD READER FOR LIQUID CRYSTAL DISPLAY; HI-FI STEREO EQUIPMENT, NAMELY STEREO AMPLIFIERS, STEREO RECEIVERS, STEREO TUNERS; SET TOP BOX (U.S. CLS. 21, 23, 26, 36 AND 38).

FIRST USE 7-29-2003; IN COMMERCE 7-29-2003.
DOMINIC J. FERRAIUOLO, EXAMINING ATTORNEY

SN 76-564,371. INMEDIATA CORPORATION, SAN JUAN, PUERTO RICO, FILED 11-28-2003.



FOR COMPUTER E-COMMERCE SOFTWARE TO ALLOW USERS TO PERFORM ELECTRONIC BUSINESS TRANSACTIONS VIA A GLOBAL COMPUTER NETWORK (U.S. CLS. 21, 23, 26, 36 AND 38).

FIRST USE 5-0-2003; IN COMMERCE 5-0-2003.
RENEE MCCRAY, EXAMINING ATTORNEY

CLASS 9—(Continued).

SN 76-568,217. ULTRALINK PRODUCTS, INC., MARKHAM, ONTARIO L3R 3W7, CANADA, FILED 1-2-2004.

ULTRALINK

THE MARK CONSISTS OF STANDARD CHARACTERS WITHOUT CLAIM TO ANY PARTICULAR FONT, STYLE, SIZE, OR COLOR.

FOR AUDIO SIGNAL CABLE AND CONNECTORS, VIDEO SIGNAL CABLE AND CONNECTORS, ELECTRICAL SIGNAL TRANSMITTING CABLE AND CONNECTORS, AND ELECTRICAL CABLES FOR AUDIO EQUIPMENT; ALL FOR USE WITH HIGH PERFORMANCE HOME THEATER, AUDIO AND VIDEO SYSTEMS FOR HOME USE (U.S. CLS. 21, 23, 26, 36 AND 38).

FIRST USE 9-0-1996; IN COMMERCE 9-0-1996.
JILL C. ALT, EXAMINING ATTORNEY

SN 76-569,182. SOKOL PACKAGING GROUP, INC., NEW YORK, NY. FILED 12-18-2003.



NO CLAIM IS MADE TO THE EXCLUSIVE RIGHT TO USE PACKAGING GROUP, APART FROM THE MARK AS SHOWN.

FOR CDS AND CD-ROMS FEATURING MUSIC, GAMES AND PROMOTIONAL MATERIAL DISTRIBUTED IN CONNECTION WITH OTHER RETAIL GOODS (U.S. CLS. 21, 23, 26, 36 AND 38).

ALICE BENMAMAN, EXAMINING ATTORNEY

SN 76-572,843. SECURICOM INC., HILLSIDE, IL. FILED 1-30-2004.

INVISOLINK 2000

THE MARK CONSISTS OF STANDARD CHARACTERS WITHOUT CLAIM TO ANY PARTICULAR FONT, STYLE, SIZE, OR COLOR.

FOR SECURITY MONITORING SYSTEM COMPRISING COMPUTER HARDWARE AND VIDEO CAMERA (U.S. CLS. 21, 23, 26, 36 AND 38).

FIRST USE 2-1-2002; IN COMMERCE 2-1-2002.
SOPHIA S. KIM, EXAMINING ATTORNEY

CLASS 9—(Continued).

SN 76-575,567. STONE TECHNOLOGIES CORPORATION,
AUSTIN, TX. FILED 2-13-2004.



OWNER OF U.S. REG. NO. 1,758,067.
FOR ELECTRONIC ANTI-INTRUSION ALARMS AND
REPLACEMENT PARTS THEREOF (U.S. CLS. 21, 23, 26,
36 AND 38).
FIRST USE 5-15-1991; IN COMMERCE 5-15-1991.
BERYL GARDNER, EXAMINING ATTORNEY

SN 76-575,829. CARL ZEISS AG, 73447 OBERKOCHEN, FED
REP GERMANY, FILED 2-17-2004.

CORONA

THE MARK CONSISTS OF STANDARD CHARACTERS
WITHOUT CLAIM TO ANY PARTICULAR FONT, STYLE,
SIZE, OR COLOR.

OWNER OF FED REP GERMANY REG. NO. 39973325,
DATED 12-21-1999, EXPIRES 11-30-2009.

FOR SPECTROMETERS; SPECTRUM SENSORS USED
TO DETERMINE, EVALUATE OR MEASURE THE CON-
TENTS, COLORS, MOISTURE AND OTHER PROPER-
TIES OF VARIOUS PRODUCTS AND MATERIALS (U.S.
CLS. 21, 23, 26, 36 AND 38).

FIRST USE 9-0-1999; IN COMMERCE 9-0-1999.
KELLY BOULTON, EXAMINING ATTORNEY

CLASS 9—(Continued).

SN 76-577,324. SOLICORE, INC., LAKELAND, FL. FILED 2-9-
2004.



THE STIPPLING IS FOR SHADING PURPOSES ONLY.
THE MARK CONSISTS OF THE WORDING "SOLICORE",
WITH DESIGN, INCLUDING DISPLAY OF THE SECOND
LETTER "O" AS A BLUE SPHERE SURROUNDED BY A
BLACK CIRCLE, WHICH ITSELF IS PARTIALLY SUR-
ROUNDED BY A LARGER LETTER "C". THE STIPPLED
SPHERE DESIGN, NOT INCLUDING THE SURROUNDING
BLACK CIRCLE, IS BLUE COLOR, WHICH IS CLAIMED AS
A FEATURE OF THE MARK. THE COLOR BLUE IS
CLAIMED AS PART OF THE MARK.

FOR BATTERIES; SOLID-STATE ELECTROLYTE BAT-
TERIES; FUEL CELLS; SOLID-STATE FUEL CELLS;
BATTERY POWERED MAGNETICALLY OR MICRO-
CHIP ENCODEABLE CREDIT CARDS, DEBIT CARDS,
IDENTIFICATION CARDS, CONDITIONAL ACCESS
CARDS AND OTHER ELECTRICAL POWERED MAG-
NETICALLY OR MICROCHIP ENCODEABLE SMART
CARDS, TAGS AND FOBS, SOLD PARTIALLY EN-
CODED FOR COMPLETION OF ENCODING BY THE
CUSTOMER; COMPONENT CORES OF BATTERY POW-
ERED MAGNETICALLY OR MICROCHIP ENCODE-
ABLE CREDIT CARDS, DEBIT CARDS,
IDENTIFICATION CARDS, CONDITIONAL ACCESS
CARDS AND OTHER ELECTRICAL POWERED MAG-
NETICALLY OR MICROCHIP ENCODEABLE SMART
CARDS, TAGS AND FOBS, SOLD PARTIALLY EN-
CODED FOR COMPLETION OF ENCODING AND AP-
PLICATION OF PRINTED OVERLAYS BY THE
CUSTOMER; PROTECTIVE SLEEVES WITH BATTERIES
FOR RECHARGING OTHER BATTERIES; AND PRO-
TECTIVE SLEEVES WITH BATTERIES FOR STORING
AND RECHARGING BATTERY POWERED CREDIT
CARDS, DEBIT CARDS, IDENTIFICATION CARDS,
CONDITIONAL ACCESS CARDS AND OTHER ELEC-
TRICAL POWERED SMART CARDS, TAGS AND FOBS
(U.S. CLS. 21, 23, 26, 36 AND 38).

FIRST USE 9-1-2001; IN COMMERCE 9-1-2001.
LINDA MICKLEBURGH, EXAMINING ATTORNEY

SN 76-578,662. POWER BY HAND, LLC, FRANKLIN, TN.
FILED 3-1-2004.

STREAMLYNC

FOR COMPUTER SOFTWARE FOR TRANSFERRING
DIGITAL CONTENT TO HANDHELD COMPUTERS
AND WIRELESS PHONES (U.S. CLS. 21, 23, 26, 36 AND
38).

FIRST USE 1-31-2003; IN COMMERCE 2-8-2003.
WILLIAM P. SHANAHAN, EXAMINING ATTORNEY

CLASS 9—(Continued).

SN 76-580,892. ANDERSON, ROSS MARTIN, SAN DIEGO, CA. FILED 3-15-2004.

HANG AND HEAR

THE MARK CONSISTS OF STANDARD CHARACTERS WITHOUT CLAIM TO ANY PARTICULAR FONT, STYLE, SIZE, OR COLOR.

FOR BRACKETS USED IN MOUNTING AUDIO SPEAKERS TO A SURFACE (U.S. CLS. 21, 23, 26, 36 AND 38).

FIRST USE 1-13-2003; IN COMMERCE 1-13-2003.
STEVEN JACKSON, EXAMINING ATTORNEY

CLASS 9—(Continued).

SN 76-583,052. STRATECISION, INC., NEEDHAM, MA. FILED 3-24-2004.

LTC QUOTE

THE MARK CONSISTS OF STANDARD CHARACTERS WITHOUT CLAIM TO ANY PARTICULAR FONT, STYLE, SIZE, OR COLOR.

OWNER OF U.S. REG. NOS. 2,098,879 AND 2,454,295.
SEC. 2(F).

FOR COMPUTER SOFTWARE DESIGNED TO PROVIDE SINGLE OR COMPARATIVE PROPOSALS FOR THE PURCHASE OF INSURANCE (U.S. CLS. 21, 23, 26, 36 AND 38).

FIRST USE 12-16-1998; IN COMMERCE 12-16-1998.
JOANNA DUKOVIC, EXAMINING ATTORNEY

SN 76-581,467. WOVEN ELECTRONICS CORPORATION, GREENVILLE, SC. FILED 3-17-2004.

LIGHTLOC

THE MARK CONSISTS OF STANDARD CHARACTERS WITHOUT CLAIM TO ANY PARTICULAR FONT, STYLE, SIZE, OR COLOR.

FOR FIBER OPTIC SECURITY SYSTEMS COMPRISED OF FIBER OPTIC SENSORS FOR FIBER OPTIC CABLES AND NETWORKS, FIBER OPTIC BARRIER CABLES, AND COMPUTER PROGRAMS FOR DETECTING INTRUSION OF MANHOLE COVERS, HATCHES, UTILITY TUNNEL DOORS, SECURITY DOORS, AND CRITICAL EQUIPMENT ACCESS LIDS, AND INTRUSION OF PERIMETERS OF SECURED AREAS (U.S. CLS. 21, 23, 26, 36 AND 38).

FIRST USE 9-15-2003; IN COMMERCE 9-15-2003.
KATHRYN COWARD, EXAMINING ATTORNEY

SN 76-583,852. THOMAS, MATTHEW G., ESSEXVILLE, MI. FILED 3-26-2004.

SN 76-582,351. TOTAL RESOURCES INTERNATIONAL, WALNUT, CA. FILED 3-22-2004.

BRIGHTSTICK

THE MARK CONSISTS OF STANDARD CHARACTERS WITHOUT CLAIM TO ANY PARTICULAR FONT, STYLE, SIZE, OR COLOR.

FOR NON-ELECTRIC, CHEMILUMINESCENT LIGHTS IN THE FORM OF STICKS TO BE USED OUT OF DOORS TO PROVIDE A VISUAL WARNING OF AN ACCIDENT OR EMERGENCY CONDITION (U.S. CLS. 21, 23, 26, 36 AND 38).

FIRST USE 3-1-2004; IN COMMERCE 3-1-2004.
TRACY CROSS, EXAMINING ATTORNEY

**B
L
O
C
K
C
K**

NO CLAIM IS MADE TO THE EXCLUSIVE RIGHT TO USE BLOCK, APART FROM THE MARK AS SHOWN.

FOR AUDIO MIXERS (U.S. CLS. 21, 23, 26, 36 AND 38).

FIRST USE 2-27-2004; IN COMMERCE 2-27-2004.

TRACY WHITAKER-BOWN, EXAMINING ATTORNEY

CLASS 9—(Continued).

SN 76-584,192. TMIO, LLC, CLEVELAND, OH. FILED 3-31-2004.



FOR COMPUTER SOFTWARE, NAMELY, SOFTWARE THAT ACTS AS A CONTROL SYSTEM FOR A COMBINATION HEATING AND REFRIGERATING UNIT FOR FOOD (U.S. CLS. 21, 23, 26, 36 AND 38).
FIRST USE 5-0-2002; IN COMMERCE 5-0-2002.
RONALD MCMORROW, EXAMINING ATTORNEY

SN 76-584,207. GRABER PRODUCTS, INC., MADISON, WI. FILED 3-31-2004.

FITNESSLINK

THE MARK CONSISTS OF STANDARD CHARACTERS WITHOUT CLAIM TO ANY PARTICULAR FONT, STYLE, SIZE, OR COLOR.
FOR COMPUTER SOFTWARE FOR TRACKING, DISPLAYING AND ANALYZING PERFORMANCE DATA AND STATISTICS FOR USE IN FITNESS AND ATHLETIC TRAINING (U.S. CLS. 21, 23, 26, 36 AND 38).
SKYE YOUNG, EXAMINING ATTORNEY

SN 76-584,208. GRABER PRODUCTS, INC., MADISON, WI. FILED 3-31-2004.

HEARTLINK

THE MARK CONSISTS OF STANDARD CHARACTERS WITHOUT CLAIM TO ANY PARTICULAR FONT, STYLE, SIZE, OR COLOR.
FOR COMPUTER SOFTWARE FOR TRACKING, DISPLAYING AND ANALYZING PERFORMANCE DATA AND STATISTICS FOR USE IN FITNESS AND ATHLETIC TRAINING (U.S. CLS. 21, 23, 26, 36 AND 38).
SKYE YOUNG, EXAMINING ATTORNEY

CLASS 9—(Continued).

SN 76-584,209. GRABER PRODUCTS, INC., MADISON, WI. FILED 3-31-2004.

CYCLELINK

THE MARK CONSISTS OF STANDARD CHARACTERS WITHOUT CLAIM TO ANY PARTICULAR FONT, STYLE, SIZE, OR COLOR.
FOR COMPUTER SOFTWARE FOR TRACKING, DISPLAYING AND ANALYZING PERFORMANCE DATA AND STATISTICS FOR USE IN FITNESS AND ATHLETIC TRAINING (U.S. CLS. 21, 23, 26, 36 AND 38).
SKYE YOUNG, EXAMINING ATTORNEY

SN 76-584,260. SPORTBRAIN HOLDINGS, INC., NAPLES, FL. FILED 3-29-2004.

SPORTBRAIN

THE MARK CONSISTS OF STANDARD CHARACTERS WITHOUT CLAIM TO ANY PARTICULAR FONT, STYLE, SIZE, OR COLOR.
FOR PERSONAL DATA CAPTURE AND MONITORING DEVICES COMPRISED OF COMPUTER HARDWARE AND SOFTWARE USED TO MONITOR MOVEMENT AND PHYSICAL ACTIVITY INCORPORATING TECHNOLOGY FOR ACCESSING AND MANIPULATING INFORMATION ON AN INTERACTIVE PERSONAL WEB SITE (U.S. CLS. 21, 23, 26, 36 AND 38).
FIRST USE 9-14-2002; IN COMMERCE 9-14-2002.
ERNEST SHOSHO, EXAMINING ATTORNEY

SN 76-584,346. CYBERLINK CORP., TAIPEI, TAIWAN, FILED 4-1-2004.

PHOTONOW

THE MARK CONSISTS OF STANDARD CHARACTERS WITHOUT CLAIM TO ANY PARTICULAR FONT, STYLE, SIZE, OR COLOR.
FOR COMPUTER SOFTWARE AND FIRMWARE PROGRAMS FOR EDITING PHOTOS OR IMAGES ON A COMPUTER (U.S. CLS. 21, 23, 26, 36 AND 38).
WON TEAK OH, EXAMINING ATTORNEY

CLASS 9—(Continued).

SN 76-584,347. CYBERLINK CORP., TAIPEI, TAIWAN,
FILED 4-1-2004.

POWERSTARTER

THE MARK CONSISTS OF STANDARD CHARACTERS WITHOUT CLAIM TO ANY PARTICULAR FONT, STYLE, SIZE, OR COLOR.

FOR COMPUTER SOFTWARE AND FIRMWARE PROGRAMS FOR INITIATING OTHER COMPUTER PROGRAMS ON A COMPUTER (U.S. CLS. 21, 23, 26, 36 AND 38).

WON TEAK OH, EXAMINING ATTORNEY

SN 76-584,511. LIGHTING WORLD, INC., OCEAN, NJ.
FILED 3-31-2004.

i-WIRE

FOR ELECTRIC WIRE FOR SUPPORTING LIGHTING FIXTURES; ELECTRICAL SUSPENSION CABLES FOR LIGHTING FIXTURES CONTAINING CURRENT-CARRYING WIRE; ELECTRIFIED SUSPENSION CABLES FOR LIGHTING FIXTURES (U.S. CLS. 21, 23, 26, 36 AND 38).

STACY WAHLBERG, EXAMINING ATTORNEY

SN 76-585,666. STORM COMMERCE, INC., NEW YORK, NY.
FILED 4-5-2004.

Storm Server

THE MARK CONSISTS OF STANDARD CHARACTERS WITHOUT CLAIM TO ANY PARTICULAR FONT, STYLE, SIZE, OR COLOR.

NO CLAIM IS MADE TO THE EXCLUSIVE RIGHT TO USE "SERVER", APART FROM THE MARK AS SHOWN.

FOR COMPUTER SOFTWARE FOR PROGRAMMING AND SOFTWARE DEVELOPMENT; COMPUTER SOFTWARE FOR CREATING, MANAGING AND INTEGRATING ONLINE COMMERCIAL EXCHANGES AND FOR SUPPLY CHAIN MANAGEMENT; COMPUTER SOFTWARE FOR INTEGRATION AND SHARED USE OF INFORMATION FROM DIFFERENT SOFTWARE APPLICATIONS, PLATFORMS, OPERATING SYSTEMS OR DATABASES; SOFTWARE FOR DEVELOPING, DEPLOYING, MANAGING, PUBLISHING, AND INTEGRATING ONLINE BUSINESS TRANSACTIONS, AND FOR ONLINE TRANSACTION PROCESSING (U.S. CLS. 21, 23, 26, 36 AND 38).

KELLEY WELLS, EXAMINING ATTORNEY

CLASS 9—(Continued).

SN 76-585,668. STORM COMMERCE, INC., NEW YORK, NY.
FILED 4-5-2004.

Storm Technology

THE MARK CONSISTS OF STANDARD CHARACTERS WITHOUT CLAIM TO ANY PARTICULAR FONT, STYLE, SIZE, OR COLOR.

NO CLAIM IS MADE TO THE EXCLUSIVE RIGHT TO USE "TECHNOLOGY", APART FROM THE MARK AS SHOWN.

FOR COMPUTER SOFTWARE FOR PROGRAMMING AND SOFTWARE DEVELOPMENT; COMPUTER SOFTWARE FOR CREATING, MANAGING AND INTEGRATING ONLINE COMMERCIAL EXCHANGES AND FOR SUPPLY CHAIN MANAGEMENT; COMPUTER SOFTWARE FOR INTEGRATION AND SHARED USE OF INFORMATION FROM DIFFERENT SOFTWARE APPLICATIONS, PLATFORMS, OPERATING SYSTEMS OR DATABASES; SOFTWARE FOR DEVELOPING, DEPLOYING, MANAGING, PUBLISHING, AND INTEGRATING ONLINE BUSINESS TRANSACTIONS, AND FOR ONLINE TRANSACTION PROCESSING (U.S. CLS. 21, 23, 26, 36 AND 38).

KELLEY WELLS, EXAMINING ATTORNEY

SN 76-585,739. ABDO, NASSER ABO, BREA, CA. FILED 4-8-2004.

DA

THE MARK CONSISTS OF STANDARD CHARACTERS WITHOUT CLAIM TO ANY PARTICULAR FONT, STYLE, SIZE, OR COLOR.

FOR MOBILE AUDIO SYSTEMS AND COMPONENTS, NAMELY, SPEAKERS, WOOFERS, TWEETERS, AMPLIFIERS, CAPACITORS, ENCLOSURES FOR SPEAKERS, DVD PLAYERS, CD PLAYERS, AUDIO RECEIVERS, AM-FM TUNERS, DVD CHANGERS, CD CHANGERS, CABLE CONNECTORS, SIGNAL PROCESSORS, AUDIO SOUND EQUALIZERS, REMOTE CONTROLS FOR MOBILE AUDIO SYSTEMS THAT CONTROL SOUND, VOLUME, DIRECTION OF SOUND, BASS AND TREBLE, ELECTRICAL AND POWER CABLES, ADAPTERS CHANGING VOLTAGE, DIGITAL VOLTAGE METERS, ELECTRIC DISTRIBUTION CONSOLES, NAMELY DISTRIBUTION BLOCKS TO DISTRIBUTE POWER TO THE COMPONENTS, AND FUSE DISTRIBUTION BLOCKS TO PREVENT SYSTEMS FROM LOSING POWER, LINE DRIVERS TO BOOST THE SIGNAL, PHASE SHIFTERS TO DELAY THE SIGNAL, ELECTRONIC CROSS OVERS TO CHANGE THE FREQUENCY OF SOUND, BASS DRIVERS TO BOOST THE SIGNAL AT LOW FREQUENCIES, ELECTRIC WIRES, SPEAKER GRILLES TO COVER FANS, HOLES FOR ENCLOSURES, AND FOR COSMETIC PURPOSES, AMPLIFIER INSTALLATION KITS COMPRISED OF WIRE, FUSES, AUDIO CABLES, DISTRIBUTION BLOCKS AND CONNECTORS AND RADIOS (U.S. CLS. 21, 23, 26, 36 AND 38).

FIRST USE 10-15-2001; IN COMMERCE 10-15-2001.
STANLEY I. OSBORNE, EXAMINING ATTORNEY

CLASS 9—(Continued).

SN 76-586,641. AUDIO PRODUCTS INTERNATIONAL CORP., SCARBOROUGH, ONTARIO, CANADA, FILED 4-14-2004.



PRIORITY CLAIMED UNDER SEC. 44(D) ON CANADA APPLICATION NO. 1,212,723, FILED 4-8-2004, REG. NO. TMA636242, DATED 3-29-2005, EXPIRES 3-29-2020.
 OWNER OF U.S. REG. NOS. 2,285,660 AND 2,710,330.
 NO CLAIM IS MADE TO THE EXCLUSIVE RIGHT TO USE "TECHNOLOGIES", APART FROM THE MARK AS SHOWN.
 FOR SOUND EQUIPMENT NAMED LOUD SPEAKERS (U.S. CLS. 21, 23, 26, 36 AND 38).
 C. DIONNE CLYBURN, EXAMINING ATTORNEY

SN 76-587,043. SOTTI RECORDS, LLC, NEW YORK, NY. FILED 4-13-2004.

SOTTI RECORDS

THE MARK CONSISTS OF STANDARD CHARACTERS WITHOUT CLAIM TO ANY PARTICULAR FONT, STYLE, SIZE, OR COLOR.
 NO CLAIM IS MADE TO THE EXCLUSIVE RIGHT TO USE "RECORDS", APART FROM THE MARK AS SHOWN.
 FOR SOUND AND VIDEO RECORDINGS, FEATURING MUSICAL, LITERARY AND DRAMATIC WORKS (U.S. CLS. 21, 23, 26, 36 AND 38).
 FIRST USE 4-0-2003; IN COMMERCE 4-0-2003.
 DOUGLAS LEE, EXAMINING ATTORNEY

CLASS 9—(Continued).

SN 76-587,557. KENDRO LABORATORY PRODUCTS, L.P., ASHEVILLE, NC. FILED 4-20-2004.

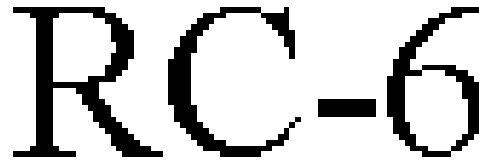

THE MARK CONSISTS OF STANDARD CHARACTERS WITHOUT CLAIM TO ANY PARTICULAR FONT, STYLE, SIZE, OR COLOR.
 FOR LABORATORY APPARATUS, NAMED, CENTRIFUGES (U.S. CLS. 21, 23, 26, 36 AND 38).
 FIRST USE 5-11-2004; IN COMMERCE 5-11-2004.
 BARBARA BROWN, EXAMINING ATTORNEY

SN 76-588,206. MIDWEST MEDICAL RECORD ASSOCIATION, INC., SCHAUMBURG, IL. FILED 4-16-2004.

INFOQUEST

THE MARK CONSISTS OF STANDARD CHARACTERS WITHOUT CLAIM TO ANY PARTICULAR FONT, STYLE, SIZE, OR COLOR.
 FOR COMPUTER PROGRAMS FOR USE IN TRACKING HEALTH INFORMATION ON PC BASED COMPUTER SYSTEMS (U.S. CLS. 21, 23, 26, 36 AND 38).
 FIRST USE 12-1-1999; IN COMMERCE 12-1-1999.
 HEATHER THOMPSON, EXAMINING ATTORNEY

SN 76-588,483. RAINBOW SYMPHONY, INC., RESEDA, CA. FILED 4-23-2004.

FIREWORKS GLASSES

THE MARK CONSISTS OF STANDARD CHARACTERS WITHOUT CLAIM TO ANY PARTICULAR FONT, STYLE, SIZE, OR COLOR.
 NO CLAIM IS MADE TO THE EXCLUSIVE RIGHT TO USE "GLASSES", APART FROM THE MARK AS SHOWN.
 FOR 3-D GLASSES (U.S. CLS. 21, 23, 26, 36 AND 38).
 FIRST USE 1-1-1984; IN COMMERCE 1-1-1984.
 SHAUNIA WALLACE, EXAMINING ATTORNEY

CLASS 9—(Continued).

SN 76-588,628. RAINBOW SYMPHONY, INC., RESEDA, CA.
FILED 4-26-2004.

RAINBOW GLASSES

THE MARK CONSISTS OF STANDARD CHARACTERS WITHOUT CLAIM TO ANY PARTICULAR FONT, STYLE, SIZE, OR COLOR.

NO CLAIM IS MADE TO THE EXCLUSIVE RIGHT TO USE "GLASSES", APART FROM THE MARK AS SHOWN.
FOR 3-D GLASSES (U.S. CLS. 21, 23, 26, 36 AND 38).
FIRST USE 1-1-1984; IN COMMERCE 1-1-1984.
JIM RINGLE, EXAMINING ATTORNEY

CLASS 9—(Continued).

SN 76-591,613. TRIPOD GURU INTERNATIONAL INC.,
BABYLON, NY. FILED 5-11-2004.

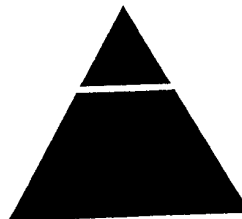

SN 76-589,283. GENERAL-TECH HOLDINGS LIMITED,
KWAI CHUNG, HONG KONG, FILED 4-29-2004.

NEONTRAC

THE MARK CONSISTS OF STANDARD CHARACTERS WITHOUT CLAIM TO ANY PARTICULAR FONT, STYLE, SIZE, OR COLOR.

FOR NEON LIGHT DISPLAYS AND NEON SIGNS (U.S. CLS. 21, 23, 26, 36 AND 38).
DOUGLAS LEE, EXAMINING ATTORNEY

THE LINING IS A FEATURE OF THE MARK AND DOES NOT INDICATE COLOR.

FOR TRIPODS FOR CAMERAS; BAGS FOR CAMERAS AND PHOTOGRAPHIC EQUIPMENT, NAMELY, BAGS FOR HOLDING CAMERAS, CAMERA ACCESSORIES AND VIDEOS; COMPUTER CARRYING CASES (U.S. CLS. 21, 23, 26, 36 AND 38).
MICHAEL ENGEL, EXAMINING ATTORNEY

SN 76-590,398. AKASA (TAIWAN) CORPORATION, TAIPEI
COUNTY 241, TAIWAN, FILED 5-4-2004.

PAX.mate

FOR COMPUTER HARDWARE; COMPUTER PERIPHERALS, NAMELY, ACOUSTIC ABSORPTION MATS ATTACHED TO COMPUTER FRAMES; ELECTRIC NOISE REDUCTION UNITS FOR COMPUTERS (U.S. CLS. 21, 23, 26, 36 AND 38).

FIRST USE 11-0-2001; IN COMMERCE 12-0-2001.
SUE LAWRENCE, EXAMINING ATTORNEY

SN 76-591,786. KABUSHIKI KAISHA SEGA, DBA SEGA CORPORATION, OHTA-KU, TOKYO, JAPAN, FILED 5-12-2004.

SystemSP

THE MARK CONSISTS OF STANDARD CHARACTERS WITHOUT CLAIM TO ANY PARTICULAR FONT, STYLE, SIZE, OR COLOR.

PRIORITY CLAIMED UNDER SEC. 44(D) ON JAPAN APPLICATION NO. 2004042602, FILED 5-10-2004, REG. NO. 4834438, DATED 1-21-2005, EXPIRES 1-21-2015.

FOR MOTHERBOARDS FOR USE WITH ARCADE VIDEO GAME MACHINES (U.S. CLS. 21, 23, 26, 36 AND 38).

ANDREW BENZMILLER, EXAMINING ATTORNEY

CLASS 9—(Continued).

SN 76-593,973. MEDICO INDUSTRIES, INC., WILKES-BARRE, PA. FILED 5-25-2004.



NO CLAIM IS MADE TO THE EXCLUSIVE RIGHT TO USE "TALKING CONE", APART FROM THE MARK AS SHOWN.

FOR WARNING AND SAFETY EQUIPMENT, NAMELY, SAFETY CONES AND ELECTRONIC SAFETY SIGNS INCORPORATING SOUND DEVICES (U.S. CLS. 21, 23, 26, 36 AND 38).

FIRST USE 9-8-2003; IN COMMERCE 9-8-2003.
TINA L. SNAPP, EXAMINING ATTORNEY

SN 76-593,979. FUJITSU LIMITED, KAWASAKI-SHI, KANAGAWA-KEN, JAPAN, FILED 5-26-2004.

ColorDoctor

THE MARK CONSISTS OF STANDARD CHARACTERS WITHOUT CLAIM TO ANY PARTICULAR FONT, STYLE, SIZE, OR COLOR.

PRIORITY CLAIMED UNDER SEC. 44(D) ON JAPAN APPLICATION NO. 2004-17641, FILED 2-26-2004, REG. NO. 4797658, DATED 8-27-2004, EXPIRES 8-27-2014.

FOR COMPUTER SOFTWARE SIMULATING AND DISPLAYING HOW PERSONS WITH CERTAIN COLOR PERCEPTION CONDITIONS SEE (U.S. CLS. 21, 23, 26, 36 AND 38).

MICHAEL ENGEL, EXAMINING ATTORNEY

SN 76-594,591. RHINE ELECTRONIC CO., LTD., TAICHUNG CITY 404, TAIWAN, FILED 5-27-2004.



FOR ELECTRIC SWITCHES; ELECTRIC SWITCH CONTACTS; ELECTRONIC MOTOR CONTROLLERS; REMOTE CONTROL APPARATUS, NAMELY, ELECTRONIC CONTROLLERS FOR OPENING AND CLOSING DOORS; UNINTERRUPTIBLE ELECTRICAL POWER SUPPLIES; ELECTRIC DOOR CLOSERS; ELECTRIC DOOR OPENERS; AUTOMATIC SEQUENCE CONTROLS FOR OPENING AND CLOSING DOORS; ELECTRIC ALARM BELLS; ELECTRIC BURGLAR ALARMS; AND ELECTRIC WARNING BUZZERS (U.S. CLS. 21, 23, 26, 36 AND 38).

FIRST USE 4-1-2004; IN COMMERCE 4-1-2004.
STEVEN JACKSON, EXAMINING ATTORNEY

CLASS 9—(Continued).

SN 76-595,525. AVID TECHNOLOGY, INC., TEWKSBURY, MA. FILED 6-3-2004.

PROSESSIONS

THE MARK CONSISTS OF STANDARD CHARACTERS WITHOUT CLAIM TO ANY PARTICULAR FONT, STYLE, SIZE, OR COLOR.

FOR PRERECORDED CDS AND DVDS FEATURING SOUND AND MUSIC LIBRARIES FOR USE IN COMPOSING MUSIC (U.S. CLS. 21, 23, 26, 36 AND 38).

FIRST USE 10-13-2003; IN COMMERCE 10-13-2003.
CHRISIE B. KING, EXAMINING ATTORNEY

SN 76-595,974. STRATASYS, INC., EDEN PRAIRIE, MN. FILED 4-23-2004.

DIMENSION SST

THE MARK CONSISTS OF STANDARD CHARACTERS WITHOUT CLAIM TO ANY PARTICULAR FONT, STYLE, SIZE, OR COLOR.

FOR COMPUTER HARDWARE AND COMPUTER SOFTWARE FOR THE CREATION OF THREE DIMENSIONAL MODELS AND IMAGES IN PLASTIC, WAX AND OTHER MATERIALS AND CREATED USING A COMPUTER AIDED DESIGN COMPUTER FILE AND BY A MATERIAL DEPOSITION PROCESS (U.S. CLS. 21, 23, 26, 36 AND 38).

FIRST USE 3-1-2004; IN COMMERCE 3-1-2004.
DAWN FELDMAN, EXAMINING ATTORNEY

SN 76-597,005. LITEL INSTRUMENTS, SAN DIEGO, CA. FILED 6-14-2004.

HIGH ACCURACY INSPECSTEP INTERFEROMETER (HA-ISI)

THE MARK CONSISTS OF STANDARD CHARACTERS WITHOUT CLAIM TO ANY PARTICULAR FONT, STYLE, SIZE, OR COLOR.

NO CLAIM IS MADE TO THE EXCLUSIVE RIGHT TO USE "HIGH ACCURACY" AND "INTERFEROMETER", APART FROM THE MARK AS SHOWN.

FOR INTERFEROMETER AND SOFTWARE PACKAGE FOR ANALYZING SEMICONDUCTOR CHIP OPTICAL TEST STRUCTURE DATA RECEIVED FROM AN OVERLAY TOOL, SOLD AS A UNIT (U.S. CLS. 21, 23, 26, 36 AND 38).

JASON LOTT, EXAMINING ATTORNEY

CLASS 9—(Continued).

SN 76-597,279. ZAPPA FAMILY TRUST, STUDIO CITY, CA.
FILED 6-14-2004.

BEAT THE BOOTS!

THE MARK CONSISTS OF STANDARD CHARACTERS WITHOUT CLAIM TO ANY PARTICULAR FONT, STYLE, SIZE, OR COLOR.

FOR CDS AND CASSETTES FEATURING MUSICAL SOUND RECORDINGS (U.S. CLS. 21, 23, 26, 36 AND 38).

FIRST USE 7-0-1991; IN COMMERCE 7-0-1991.
CAROLINE WOOD, EXAMINING ATTORNEY

SN 76-598,168. FRONTIER FASHION, INC., EL MONTE, CA.
FILED 6-18-2004.

ELLSIE

THE MARK CONSISTS OF STANDARD CHARACTERS WITHOUT CLAIM TO ANY PARTICULAR FONT, STYLE, SIZE, OR COLOR.

FOR EYEWEAR, NAMELY, SUNGLASSES, SPECTACLES AND EYE GLASSES; ACCESSORIES OF GLASSES, SPECTACLES OR SUNGLASSES, NAMELY, LENSES, FRAMES AND CASES (U.S. CLS. 21, 23, 26, 36 AND 38).

FIRST USE 6-12-2003; IN COMMERCE 6-12-2003.
KAREN K. BUSH, EXAMINING ATTORNEY

SN 76-598,444. AIRTIME MANAGEMENT, INC., MORRISTOWN, NJ. FILED 6-21-2004.

A4P

THE MARK CONSISTS OF STANDARD CHARACTERS WITHOUT CLAIM TO ANY PARTICULAR FONT, STYLE, SIZE, OR COLOR.

FOR COMPUTER SOFTWARE USED TO MANAGE WIRELESS TELEPHONE USAGE AND CALL PROGRAM INFORMATION AND USER AND INSTALLATION GUIDES SOLD AS A UNIT THEREWITH; COMPUTER SOFTWARE IN THE NATURE OF A PERSONAL INFORMATION MANAGER AND USER AND INSTALLATION GUIDES SOLD AS A UNIT THEREWITH (U.S. CLS. 21, 23, 26, 36 AND 38).

ALICE SUE CARRUTHERS, EXAMINING ATTORNEY

CLASS 9—(Continued).

SN 76-598,658. TOPCODER, INC., GLASTONBURY, CT.
FILED 6-18-2004.

[TOPCODER] SOFTWARE

THE MARK CONSISTS OF STANDARD CHARACTERS WITHOUT CLAIM TO ANY PARTICULAR FONT, STYLE, SIZE, OR COLOR.

OWNER OF U.S. REG. NOS. 2,764,034, 2,764,035 AND 2,813,438.

NO CLAIM IS MADE TO THE EXCLUSIVE RIGHT TO USE "SOFTWARE", APART FROM THE MARK AS SHOWN.

FOR DOWNLOADABLE COMPUTER SOFTWARE COMPONENTS FOR DEVELOPING OTHER COMPUTER SOFTWARE; CUSTOM COMPUTER SOFTWARE COMPONENTS FOR NUMERICAL AND TEXT ANALYSIS, SOFTWARE APPLICATION MANAGEMENT, NETWORK COMMUNICATION, DATA ORGANIZATION AND MANAGEMENT, DATA OBJECT MANAGEMENT, ELECTRONIC COMMERCE, DEVELOPMENT OF SOFTWARE, SECURITY AUTHORIZATION AND AUTHENTICATION, AND DOCUMENT MANAGEMENT; AND SOFTWARE APPLICATIONS FOR ENTERPRISE BUSINESS MANAGEMENT, ELECTRONIC COMMERCE, AND DELIVERY OF INFORMATION OVER THE INTERNET (U.S. CLS. 21, 23, 26, 36 AND 38).

FIRST USE 10-14-2002; IN COMMERCE 10-14-2002.
WINSTON FOLMAR, EXAMINING ATTORNEY

SN 76-598,661. TOPCODER, INC., GLASTONBURY, CT.
FILED 6-18-2004.

[TOPCODER]

THE MARK CONSISTS OF STANDARD CHARACTERS WITHOUT CLAIM TO ANY PARTICULAR FONT, STYLE, SIZE, OR COLOR.

OWNER OF U.S. REG. NOS. 2,764,034, 2,764,035 AND 2,813,438.

FOR DOWNLOADABLE COMPUTER SOFTWARE COMPONENTS FOR DEVELOPING OTHER COMPUTER SOFTWARE; CUSTOM COMPUTER SOFTWARE COMPONENTS FOR NUMERICAL AND TEXT ANALYSIS, SOFTWARE APPLICATION MANAGEMENT, NETWORK COMMUNICATION, DATA ORGANIZATION AND MANAGEMENT, DATA OBJECT MANAGEMENT, ELECTRONIC COMMERCE, DEVELOPMENT OF SOFTWARE, SECURITY AUTHORIZATION AND AUTHENTICATION, AND DOCUMENT MANAGEMENT; AND SOFTWARE APPLICATIONS FOR ENTERPRISE BUSINESS MANAGEMENT, ELECTRONIC COMMERCE, AND DELIVERY OF INFORMATION OVER THE INTERNET (U.S. CLS. 21, 23, 26, 36 AND 38).

FIRST USE 10-14-2002; IN COMMERCE 10-14-2002.
WINSTON FOLMAR, EXAMINING ATTORNEY

CLASS 9—(Continued).

SN 76-599,839. TAPE EASE LLC, SANTA FE, NM. FILED 6-28-2004.

TAPE-EASE

THE MARK CONSISTS OF STANDARD CHARACTERS WITHOUT CLAIM TO ANY PARTICULAR FONT, STYLE, SIZE, OR COLOR.

FOR TAPE MEASURE ACCESSORY, NAMELY, A HOOK-END BRACE THAT ATTACHES TO THE TAPE MEASURE AND TEMPORARILY HOLDS ON TO THE PIECE TO BE MEASURED (U.S. CLS. 21, 23, 26, 36 AND 38).

FIRST USE 6-11-2004; IN COMMERCE 6-11-2004.
SAMUEL E. SHARPER JR., EXAMINING ATTORNEY

SN 76-600,564. BASS WALK, INC., COAL GABLES, FL. FILED 7-2-2004.



FOR PRERECORDED AUDIO CASSETTE TAPES, COMPACT AND LASER DISCS AND PHONOGRAPH RECORDS FEATURING MUSIC (U.S. CLS. 21, 23, 26, 36 AND 38).

FIRST USE 4-29-2003; IN COMMERCE 4-29-2003.
PAULA MAHONEY, EXAMINING ATTORNEY

SN 76-600,789. QINGHAI MICRO MEASURING TECHNOLOGY CO.,LTD., XINING, QINGHAI PROVINCE, CHINA, FILED 7-6-2004.



FOR MEASURING INSTRUMENTS, NAMELY, OUTSIDE MICROMETER, DIGITAL MICROMETER, ELECTRONIC MICROMETER, AND INSIDE MICROMETER (U.S. CLS. 21, 23, 26, 36 AND 38).

FIRST USE 1-1-1999; IN COMMERCE 1-1-1999.
DAVID H. STINE, EXAMINING ATTORNEY

CLASS 9—(Continued).

SN 76-602,139. BUS-TECH, INC., BURLINGTON, MA. FILED 7-13-2004.

MAINFRAME APPLIANCE FOR NETWORKING

THE MARK CONSISTS OF STANDARD CHARACTERS WITHOUT CLAIM TO ANY PARTICULAR FONT, STYLE, SIZE, OR COLOR.

OWNER OF U.S. REG. NO. 2,650,825.
SEC. 2(F).
FOR COMPUTER HARDWARE, NAMELY INTRANET TO MAINFRAME CONNECTIVITY HARDWARE (U.S. CLS. 21, 23, 26, 36 AND 38).

FIRST USE 9-16-1999; IN COMMERCE 9-16-1999.
MARIA-VICTORIA SUAREZ, EXAMINING ATTORNEY

SN 76-602,574. DESPERTT, KEVIN, WASHINGTON, DC. FILED 7-16-2004.

Loose Cannons

THE MARK CONSISTS OF STANDARD CHARACTERS WITHOUT CLAIM TO ANY PARTICULAR FONT, STYLE, SIZE, OR COLOR.

OWNER OF U.S. REG. NO. 2,430,096.
FOR MUSICAL RECORDINGS NAMELY, PRE-RECORDED DVD'S, CD'S, AUDIO AND VIDEO CASSETTES (U.S. CLS. 21, 23, 26, 36 AND 38).

FIRST USE 2-24-2000; IN COMMERCE 2-24-2000.
LESLEY LAMOTHE, EXAMINING ATTORNEY

SN 76-603,216. DIABLOSPORT, LLC, BOCA RATON, FL. FILED 7-19-2004.



FOR HANDHELD ELECTRONIC AUTOMOTIVE DIAGNOSTIC APPARATUS, NAMELY ELECTRONIC DIAGNOSTIC DEVICE FOR VEHICLES WHICH ANALYZE THE ENGINE PARAMETERS AND UPLOAD REVISED PARAMETERS TO ENHANCE ENGINE PERFORMANCE (U.S. CLS. 21, 23, 26, 36 AND 38).

FIRST USE 9-1-2001; IN COMMERCE 9-1-2001.
NORA BUCHANAN WILL, EXAMINING ATTORNEY

CLASS 9—(Continued).

SN 76-604,391. EKSIGENT TECHNOLOGIES LLC, LIVERMORE, CA. FILED 7-26-2004.

EXPRESSLC

THE MARK CONSISTS OF STANDARD CHARACTERS WITHOUT CLAIM TO ANY PARTICULAR FONT, STYLE, SIZE, OR COLOR.

FOR AUTOMATIC LIQUID CHROMATOGRAPHY APPARATUS (U.S. CLS. 21, 23, 26, 36 AND 38).

FIRST USE 5-0-2004; IN COMMERCE 5-0-2004.
ANDREA SAUNDERS, EXAMINING ATTORNEY

SN 76-604,653. HELEN OF TROY LIMITED, BRIDGETOWN, BARBADOS, FILED 7-29-2004.

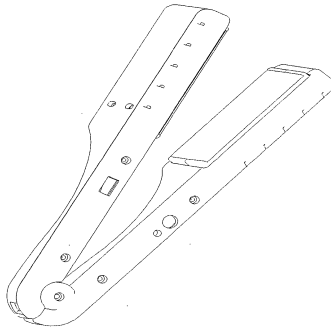

THE MARK CONSISTS OF THE CONFIGURATION OF AN ORNAMENTAL HAND-HELD HAIR STRAIGHTENER. SEC. 2(F).

FOR ELECTRIC HAND-HELD FLAT IRONS (U.S. CLS. 21, 23, 26, 36 AND 38).

FIRST USE 3-0-1997; IN COMMERCE 3-0-1997.
SUSAN HAYASH, EXAMINING ATTORNEY

SN 76-604,850. CYBERLOGIC TECHNOLOGIES, INC., TROY, MI. FILED 7-30-2004.

INTELLIGENT POWERFUL RELIABLE

THE MARK CONSISTS OF STANDARD CHARACTERS WITHOUT CLAIM TO ANY PARTICULAR FONT, STYLE, SIZE, OR COLOR.

FOR COMPUTER PROGRAMS, NAMELY, CONTROL AND MONITORING COMPUTER SOFTWARE FOR USE WITH AUTOMATED INDUSTRIAL AND MANUFACTURING MACHINERY (U.S. CLS. 21, 23, 26, 36 AND 38).

FIRST USE 9-30-2001; IN COMMERCE 9-30-2001.
JASON TURNER, EXAMINING ATTORNEY

CLASS 9—(Continued).

SN 76-605,943. D-LINK SYSTEMS, INC., FOUNTAIN VALLEY, CA. FILED 8-6-2004.

 **Pocket Router**

NO CLAIM IS MADE TO THE EXCLUSIVE RIGHT TO USE "POCKET ROUTER", APART FROM THE MARK AS SHOWN.

THE MARK CONSISTS IN PART OF THREE CURVED LINES ON TOP OF A ROUNDED SQUARE. A SINGLE STRAIGHT LINE ATTACHES TO THE LEFT TOP CORNER OF THE ROUNDED SQUARE, AND THE LETTER "D" OVERLAID ON THE ROUNDED SQUARE.

FOR ELECTRONIC APPARATUS FOR WIRELESS AND WIRED ETHERNET-BASED NETWORKS, NAMELY, ACCESS POINTS, UNIVERSAL REPEATERS, ADAPTERS, BRIDGES, AND ROUTERS (U.S. CLS. 21, 23, 26, 36 AND 38).

FIRST USE 7-29-2004; IN COMMERCE 7-29-2004.
GINNY ISAACSON, EXAMINING ATTORNEY

SN 76-605,944. D-LINK SYSTEMS, INC., FOUNTAIN VALLEY, CA. FILED 8-6-2004.

 **Pocket Router/AP**

NO CLAIM IS MADE TO THE EXCLUSIVE RIGHT TO USE "POCKET ROUTER/AP", APART FROM THE MARK AS SHOWN.

THE MARK CONSISTS IN PART OF A DESIGN WITH TWO PARTS. ON THE LEFT: THREE CURVED LINES ON TOP OF THE SMALL ROUNDED SQUARE, A SINGLE STRAIGHT LINE ATTACHES TO THE RIGHT TOP CORNER OF THE ROUNDED SQUARE, AND THE LETTER "D" OVERLAID ON THE ROUNDED SQUARE. ON THE RIGHT: THREE CURVED LINES ON TOP OF THE LARGE ROUNDED SQUARE, A SINGLE STRAIGHT LINE ATTACHES TO THE LEFT TOP CORNER OF THE ROUNDED SQUARE, AND THE LETTER "D" OVERLAID ON THE ROUNDED SQUARE.

FOR ELECTRONIC APPARATUS FOR WIRELESS AND WIRED ETHERNET-BASED NETWORKS, NAMELY, ACCESS POINTS, UNIVERSAL REPEATERS, ADAPTERS, BRIDGES, AND ROUTERS (U.S. CLS. 21, 23, 26, 36 AND 38).

FIRST USE 7-29-2004; IN COMMERCE 7-29-2004.
GINNY ISAACSON, EXAMINING ATTORNEY

CLASS 9—(Continued).

SN 76-605,945. D-LINK SYSTEMS, INC., FOUNTAIN VALLEY, CA. FILED 8-6-2004.



NO CLAIM IS MADE TO THE EXCLUSIVE RIGHT TO USE "POCKET AP", APART FROM THE MARK AS SHOWN.

THE MARK CONSISTS OF THREE CURVE LINES ON TOP OF THE ROUNDED SQUARE, A SINGLE STRAIGHT LINE ATTACHES TO THE RIGHT TOP CORNER OF THE ROUNDED SQUARE, A LETTER OF D OVERLAID ON THE ROUNDED SQUARE.

FOR ELECTRONIC APPARATUS FOR WIRELESS AND WIRED ETHERNET-BASED NETWORKS, NAMELY, ACCESS POINTS, UNIVERSAL REPEATERS, ADAPTERS, BRIDGES, AND ROUTERS (U.S. CLS. 21, 23, 26, 36 AND 38).

FIRST USE 7-29-2004; IN COMMERCE 7-29-2004.
MICHAEL KEATING, EXAMINING ATTORNEY

CLASS 9—(Continued).

SN 76-606,968. DIGITAL IDENTIFICATION SOLUTIONS GMBH, DBA DIGITAL IDENTIFICATION SOLUTIONS, LLC, ESSLINGEN, FED REP GERMANY, FILED 8-11-2004.



THE MARK CONSISTS OF STANDARD CHARACTERS WITHOUT CLAIM TO ANY PARTICULAR FONT, STYLE, SIZE, OR COLOR.

FOR IDENTIFICATION SYSTEM HARDWARE, NAMELY- DIGITAL CAMERAS, COMPUTER PRINTER AND COMPUTER COLOR PRINTER USING HEAT SENSITIVE DRY PRINTING PROCESS; IDENTIFICATION AND SECURITY CARD SUPPLIES, NAMELY- MAGNETIC CARDS, MAGNETIC CODED CARDS FOR ACCESS CONTROL SYSTEMS AND PAYMENTS, MAGNETIC IDENTIFYING CARDS, ENCODED ELECTRONIC CHIP CARDS AND INTEGRATED CIRCUIT CARDS (SMART CARDS) FOR USE IN PHYSICAL AND LOGICAL (COMPUTER) ACCESS CONTROL APPLICATIONS, BLANK ELECTRONIC CHIP AND INTEGRATED CIRCUIT (SMART) CARDS; IDENTIFICATION AND SECURITY SOFTWARE, NAMELY- COMPUTER SOFTWARE FOR PRODUCING IDENTIFICATION CARDS AND MANAGEMENT OF CARDHOLDER DATABASES, SOFTWARE FOR THE OPERATIONAL MANAGEMENT OF PORTABLE MAGNETIC AND ELECTRONIC CARDS, AND FACILITIES MANAGEMENT SOFTWARE, NAMELY, SOFTWARE TO PRODUCE IDENTIFICATION CREDENTIALS AND USED TO CONTROL BUILDING ACCESS AND COMPUTER SYSTEM ACCESS; ALSO, COMPUTER SOFTWARE DEVELOPMENT TOOLS AND COMPUTER SOFTWARE FOR APPLICATION AND DATABASE INTEGRATION (U.S. CLS. 21, 23, 26, 36 AND 38).

FIRST USE 3-3-2004; IN COMMERCE 3-3-2004.
BARBARA BROWN, EXAMINING ATTORNEY

SN 76-606,053. SWITCHCRAFT, INC., CHICAGO, IL. FILED 8-9-2004.

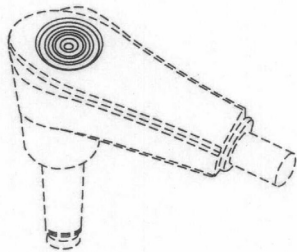

SN 76-607,501. KASPAR WIRE WORKS, INC., SHINER, TX. FILED 8-18-2004.



THE MARK CONSISTS OF CONCENTRIC CIRCULAR RIBS AND INTERMEDIATE GROOVES FORMED IN A SURFACE OF THE GOODS. THE DOTTED OUTLINE OF THE GOODS FORMS NO PART OF THE MARK AND IS INCLUDED MERELY TO ILLUSTRATE THE POSITION OF THE MARK ON THE GOODS.

SEC. 2(F).
FOR CIRCUIT COMPONENTS, NAMELY CONNECTORS (U.S. CLS. 21, 23, 26, 36 AND 38).
FIRST USE 10-10-1957; IN COMMERCE 10-10-1957.
ELISSA GARBER KON, EXAMINING ATTORNEY

FOR TELESCOPE MOUNTING STOCK (U.S. CLS. 21, 23, 26, 36 AND 38).
FIRST USE 7-30-2004; IN COMMERCE 7-30-2004.
HOWARD B. LEVINE, EXAMINING ATTORNEY

CLASS 9—(Continued).

SN 76-608,064. NAMCO LTD., TOKYO, JAPAN, FILED 8-20-2004.

TAIKO CONTROLLER

THE MARK CONSISTS OF STANDARD CHARACTERS WITHOUT CLAIM TO ANY PARTICULAR FONT, STYLE, SIZE, OR COLOR.

NO CLAIM IS MADE TO THE EXCLUSIVE RIGHT TO USE "CONTROLLER", APART FROM THE MARK AS SHOWN.

THE ENGLISH TRANSLATION OF THE FOREIGN WORDING IN THE MARK IS "DRUM".

FOR VIDEO GAME CARTRIDGES, COMPUTER GAME PROGRAMS AND VIDEO GAME CONTROLLERS (U.S. CLS. 21, 23, 26, 36 AND 38).

MATTHEW PAPPAS, EXAMINING ATTORNEY

SN 76-608,197. UNIVERSITY OF SOUTHERN CALIFORNIA, LOS ANGELES, CA. FILED 8-18-2004.



NO CLAIM IS MADE TO THE EXCLUSIVE RIGHT TO USE "RECORDS", APART FROM THE MARK AS SHOWN.

THE MARK CONSISTS OF A STYLIZED LETTER "F" INSIDE A CIRCLE WITH THE WORDING "FLORA RECORDS" UNDERNEATH AND OUTSIDE THE CIRCLE.

FOR COMPACT DISCS FEATURING MUSICAL SOUND RECORDINGS (U.S. CLS. 21, 23, 26, 36 AND 38).

FIRST USE 7-0-2004; IN COMMERCE 7-0-2004.

ANNE MADDEN, EXAMINING ATTORNEY

SN 76-608,324. PAISANO PUBLICATIONS, LLC, AGOURA HILLS, CA. FILED 8-24-2004.

HiBeamZ

THE MARK CONSISTS OF STANDARD CHARACTERS WITHOUT CLAIM TO ANY PARTICULAR FONT, STYLE, SIZE, OR COLOR.

OWNER OF U.S. REG. NO. 2,768,295.

FOR DOWNLOADABLE ELECTRONIC PUBLICATIONS IN THE NATURE OF MAGAZINES FEATURING TEXT AND IMAGES, DIRECTED TO READERS AND VIEWERS INTERESTED IN THE CUSTOMIZATION OF IMPORTED VEHICLES (U.S. CLS. 21, 23, 26, 36 AND 38).

FIRST USE 4-20-2004; IN COMMERCE 4-20-2004.

THEODORE MCBRIDE, EXAMINING ATTORNEY

CLASS 9—(Continued).

SN 76-608,520. CONTROL MODULE, INC., ENFIELD, CT. FILED 8-25-2004.

BIOSCAN EXPRESS

THE MARK CONSISTS OF STANDARD CHARACTERS WITHOUT CLAIM TO ANY PARTICULAR FONT, STYLE, SIZE, OR COLOR.

OWNER OF U.S. REG. NO. 2,355,212.

NO CLAIM IS MADE TO THE EXCLUSIVE RIGHT TO USE "EXPRESS", APART FROM THE MARK AS SHOWN.

FOR SCIENTIFIC INSTRUMENTS; NAMELY, BIOMETRIC IDENTIFICATION TERMINALS (U.S. CLS. 21, 23, 26, 36 AND 38).

FIRST USE 9-0-2004; IN COMMERCE 9-0-2004.

SCOTT OSLICK, EXAMINING ATTORNEY

SN 76-608,743. DAYMEN PHOTO MARKETING LP, MARKHAM, ONTARIO, CANADA, FILED 8-26-2004.

THE PACK JACK

THE MARK CONSISTS OF STANDARD CHARACTERS WITHOUT CLAIM TO ANY PARTICULAR FONT, STYLE, SIZE, OR COLOR.

FOR HARNESS ADJUSTMENT DEVICE SOLD AS A COMPONENT OF BAGS, HARD AND SOFT COVERED CASES, RUCKSACKS, BACKPACKS WITH ROLLING WHEELS, BACKPACKS WITHOUT ROLLING WHEELS AND BELT PACKS, ALL DESIGNED FOR CARRYING PHOTOGRAPHIC, CINEMATOGRAPHIC, VIDEO GRAPHIC, OPTICAL, AUDIO, ELECTRONIC AND COMPUTER EQUIPMENT (U.S. CLS. 21, 23, 26, 36 AND 38).

FIRST USE 12-15-2002; IN COMMERCE 2-15-2003.

LINDA ESTRADA, EXAMINING ATTORNEY

SN 76-608,939. HELEN OF TROY LIMITED, BRIDGETOWN, BARBADOS, FILED 8-27-2004.

GETS HOT ... STAYS HOT

THE MARK CONSISTS OF STANDARD CHARACTERS WITHOUT CLAIM TO ANY PARTICULAR FONT, STYLE, SIZE, OR COLOR.

SEC. 2(F).

FOR ELECTRIC HAND HELD STYLING IRONS, NAMELY, ELECTRIC HAND HELD CURLING IRONS, ELECTRIC HAND HELD FLAT IRONS; AND ELECTRIC HAND HELD CRIMPING AND WAVING IRONS (U.S. CLS. 21, 23, 26, 36 AND 38).

FIRST USE 10-0-1995; IN COMMERCE 10-0-1995.

BRIAN NEVILLE, EXAMINING ATTORNEY

CLASS 9—(Continued).

SN 76-609,610. U.S. DEPT. OF LABOR, WASHINGTON, DC.
FILED 8-27-2004.

WORKFORCE CONNECTIONS

THE MARK CONSISTS OF STANDARD CHARACTERS WITHOUT CLAIM TO ANY PARTICULAR FONT, STYLE, SIZE, OR COLOR.

NO CLAIM IS MADE TO THE EXCLUSIVE RIGHT TO USE "WORKFORCE", APART FROM THE MARK AS SHOWN.

FOR COMPUTER SOFTWARE, USED TO CREATE AND MANAGE ONLINE CONTENT, THAT MAY BE DOWNLOADED FROM A GLOBAL COMPUTER NETWORK (U.S. CLS. 21, 23, 26, 36 AND 38).

FIRST USE 11-30-2003; IN COMMERCE 12-24-2003.
ALLISON HOLTZ, EXAMINING ATTORNEY

CLASS 9—(Continued).

SN 76-611,290. ZEMERICK SOFTWARE INC., OAK HILL, WV. FILED 9-14-2004.

Chat Watch

THE MARK CONSISTS OF STANDARD CHARACTERS WITHOUT CLAIM TO ANY PARTICULAR FONT, STYLE, SIZE, OR COLOR.

NO CLAIM IS MADE TO THE EXCLUSIVE RIGHT TO USE "CHAT", APART FROM THE MARK AS SHOWN.

FOR COMPUTER SOFTWARE DESIGNED TO MONITOR AND LOG ONLINE INSTANT MESSAGES (U.S. CLS. 21, 23, 26, 36 AND 38).

FIRST USE 1-0-2002; IN COMMERCE 1-0-2002.
MARTHA FROMM, EXAMINING ATTORNEY

SN 76-610,310. SUNGLASS DESIGNS, INC., SCOTTSDALE, AZ. FILED 9-7-2004.

DOGGIE

THE MARK CONSISTS OF STANDARD CHARACTERS WITHOUT CLAIM TO ANY PARTICULAR FONT, STYLE, SIZE, OR COLOR.

FOR EYEGLASSES, SUNGLASSES, GOGGLES FOR SPORTS, DIVING GOGGLES, SKI GOGGLES, SNOW GOGGLES, SWIMMING GOGGLES, AND SAFETY GOGGLES AND ACCESSORIES THEREFOR, NAMELY CASES, NECK STRAPS, NECK CORDS, AND NECK CHAINS (U.S. CLS. 21, 23, 26, 36 AND 38).

MICHAEL ENGEL, EXAMINING ATTORNEY

SN 76-611,682. SHOPPING SOLUTIONS, LLC, MILFORD, OH. FILED 9-9-2004.

KIDDIETAINER

THE MARK CONSISTS OF STANDARD CHARACTERS WITHOUT CLAIM TO ANY PARTICULAR FONT, STYLE, SIZE, OR COLOR.

FOR PORTABLE CARRYING CASES FOR ELECTRONIC EQUIPMENT, NAMELY, DIGITAL VIDEO PLAYERS, VIDEO GAME UNITS AND VIDEOTAPE PLAYERS, THAT ATTACH TO CHILD CARRIERS, SHOPPING CARTS AND STROLLERS (U.S. CLS. 21, 23, 26, 36 AND 38).

LEIGH LOWRY, EXAMINING ATTORNEY

SN 76-610,949. PLUSTEK INC., TAIPEI, TAIWAN, FILED 9-10-2004.

OpticBook

THE MARK CONSISTS OF STANDARD CHARACTERS WITHOUT CLAIM TO ANY PARTICULAR FONT, STYLE, SIZE, OR COLOR.

FOR SCANNERS, COMPUTER SOFTWARE AND CD-ROM DRIVES FOR USE IN THE OPERATION OF SCANNERS; INSTRUCTION MANUALS SOLD THEREWITH (U.S. CLS. 21, 23, 26, 36 AND 38).

FIRST USE 1-5-2004; IN COMMERCE 1-5-2004.
MELISSA VALLILLO, EXAMINING ATTORNEY

SN 76-611,698. NORELLS SWEDEN AB, S-721 30 VASTERAS, SWEDEN, FILED 9-10-2004.

NORELLS

THE MARK CONSISTS OF STANDARD CHARACTERS WITHOUT CLAIM TO ANY PARTICULAR FONT, STYLE, SIZE, OR COLOR.

SEC. 2(F).
FOR FOIL ELEMENTS, NAMELY CIRCUITS FOR HEATING (U.S. CLS. 21, 23, 26, 36 AND 38).

FIRST USE 0-0-1973; IN COMMERCE 0-0-1992.
TANYA AMOS, EXAMINING ATTORNEY

CLASS 9—(Continued).

SN 76-612,336. NEW CONCEPTS DEVELOPMENT CORPORATION, WOODSTOCK, IL. FILED 9-16-2004.

ROAD TRIP

THE MARK CONSISTS OF STANDARD CHARACTERS WITHOUT CLAIM TO ANY PARTICULAR FONT, STYLE, SIZE, OR COLOR.

FOR FM MODULATOR FOR USE WITH AN AUDIO PLAYER, NAMELY, AN FM MODULATOR WHICH TRANSMITS A SIGNAL FROM AN AUDIO PLAYER TO AN FM RADIO WHICH THEN REPRODUCES THE AUDIO INFORMATION RECORDED ON THE AUDIO PLAYER (U.S. CLS. 21, 23, 26, 36 AND 38).

FIRST USE 8-7-2004; IN COMMERCE 8-7-2004.

KARANENDRA S. CHHINA, EXAMINING ATTORNEY

SN 76-612,555. BOA (UK) LIMITED, CROYDON CR0 9UG, ENGLAND, FILED 9-23-2004.

BOA STRATUM

THE MARK CONSISTS OF STANDARD CHARACTERS WITHOUT CLAIM TO ANY PARTICULAR FONT, STYLE, SIZE, OR COLOR.

OWNER OF U.S. REG. NOS. 2,466,165 AND 2,919,446.

FOR CARPENTER'S LEVELS, SPIRIT LEVEL INDICATORS AND PLUMB BOBS; APPARATUS FOR SURVEYING, NAMELY, SURVEYORS' LEVELS AND LEVELING RODS; AND WALL MOUNTERS CONSISTING OF MEASURING APPARATUS FOR ASSESSING HEIGHT AND LEVEL OF PICTURES AND OTHER OBJECTS TO BE MOUNTED ON WALLS (U.S. CLS. 21, 23, 26, 36 AND 38).

FIRST USE 7-0-2003; IN COMMERCE 7-0-2003.

VERNA BETH RIRIE, EXAMINING ATTORNEY

SN 76-613,114. VIRTUAL TELEMETRY CORPORATION, NEW YORK, NY. FILED 9-28-2004.



a **DriverAssistanceDevice**

NO CLAIM IS MADE TO THE EXCLUSIVE RIGHT TO USE "AUTO" AND "DRIVER ASSISTANCE DEVICE", APART FROM THE MARK AS SHOWN.

FOR HAND-HELD ELECTRONIC DEVICE, NAMELY, TELEMATIC APPARATUS FOR INTERPRETING DATA GENERATED BY A MOTOR VEHICLES'S COMPUTER (U.S. CLS. 21, 23, 26, 36 AND 38).

ROBERT LORENZO, EXAMINING ATTORNEY

CLASS 9—(Continued).

SN 76-614,224. EASY STREET, INC., LENEXA, KS. FILED 10-1-2004.

TOTAL OFFICE MANAGER

THE MARK CONSISTS OF STANDARD CHARACTERS WITHOUT CLAIM TO ANY PARTICULAR FONT, STYLE, SIZE, OR COLOR.

NO CLAIM IS MADE TO THE EXCLUSIVE RIGHT TO USE OFFICE MANAGER, APART FROM THE MARK AS SHOWN.

FOR COMPUTER SOFTWARE FOR USE IN THE FIELD OF PERSONAL AND BUSINESS FINANCE FOR ACCOUNTING, PROJECT COSTING MANAGEMENT, TAX MANAGEMENT, PAYROLL PREPARATION, PAYROLL TAX CALCULATION, PAYROLL TAX FILING, EMPLOYEE BENEFIT PLANNING, SALES COMMISSIONS, COMPENSATION, BANK RECONCILIATION, RECEIVABLES MANAGEMENT, SALES ORDER, WORK ORDER, INVOICE PROCESSING, PAYABLE MANAGEMENT, PURCHASE ORDER PROCESSING, INVENTORY CONTROL, PAYROLL AND FINANCIAL REPORTS, BILL PAYING, COLLECTIONS, MESSAGING, ASSET MANAGEMENT, SERVICE AGREEMENTS, PLANNED MAINTENANCE, DISPATCHING, SCHEDULING, AND MANUALS SOLD AS A UNIT THEREWITH (U.S. CLS. 21, 23, 26, 36 AND 38).

FIRST USE 8-1-2004; IN COMMERCE 8-1-2004.

JOHN E. MICHOS, EXAMINING ATTORNEY

SN 76-614,287. DATAVIZ, INC., MILFORD, CT. FILED 9-29-2004.

ROADSYNC

THE MARK CONSISTS OF STANDARD CHARACTERS WITHOUT CLAIM TO ANY PARTICULAR FONT, STYLE, SIZE, OR COLOR.

FOR COMPUTER SOFTWARE FOR TRANSFER AND EXCHANGE OF ELECTRONIC MESSAGES AND OTHER DATA BETWEEN STATIONARY COMPUTERS AND/OR SERVERS AND PORTABLE, WIRELESS COMPUTERS AND TELEPHONES (U.S. CLS. 21, 23, 26, 36 AND 38).

RONALD AIKENS, EXAMINING ATTORNEY

SN 76-614,559. HARMONIC VISION, INC., CHICAGO, IL. FILED 10-4-2004.

MAESTRO MAX

THE MARK CONSISTS OF STANDARD CHARACTERS WITHOUT CLAIM TO ANY PARTICULAR FONT, STYLE, SIZE, OR COLOR.

FOR COMPUTER SOFTWARE FOR MUSIC INSTRUCTION (U.S. CLS. 21, 23, 26, 36 AND 38).

FIRST USE 6-7-1994; IN COMMERCE 6-17-1994.

MARK T. MULLEN, EXAMINING ATTORNEY

CLASS 9—(Continued).

SN 76-614,601. PREDATOR PERFORMANCE PADDLE-SPORTS LTD., VANCOUVER, BRITISH COLUMBIA, CANADA, FILED 10-6-2004.



FOR SPORTS HELMETS (U.S. CLS. 21, 23, 26, 36 AND 38).

FIRST USE 5-20-2003; IN COMMERCE 5-20-2003.
ALICE BENMAMAN, EXAMINING ATTORNEY

SN 76-614,762. MEDICAL DIGITAL DEVELOPERS, LLC, NEW YORK, NY. FILED 10-7-2004.

D-SCOPE

THE MARK CONSISTS OF STANDARD CHARACTERS WITHOUT CLAIM TO ANY PARTICULAR FONT, STYLE, SIZE, OR COLOR.

FOR COMPUTER HARDWARE, PERIPHERALS AND SOFTWARE, WHICH MAY BE INTEGRATED AS A HANDS-FREE SYSTEM, USED FOR RECORDING AUDIO AND VIDEO DATA, FOR ANNOTATING, REPORTING, FILING AND EXPORTING PATIENT EXAMINATION DATA, AND FOR CREATING INTEGRATED MULTIMEDIA REPORTS AND WRITING MEDICAL PRESCRIPTIONS; FILE MANAGEMENT COMPUTER SOFTWARE USED FOR MANAGING MEDICAL PATIENT RECORDS; AND ELECTRONIC DATABASES RECORDED ON COMPUTER MEDIA FEATURING MEDICAL PATIENT RECORDS AND DATA (U.S. CLS. 21, 23, 26, 36 AND 38).

KATRINA EDGE, EXAMINING ATTORNEY

SN 76-615,224. BOSE CORPORATION, FRAMINGHAM, MA. FILED 10-12-2004.



THE MARK CONSISTS OF STANDARD CHARACTERS WITHOUT CLAIM TO ANY PARTICULAR FONT, STYLE, SIZE, OR COLOR.

OWNER OF U.S. REG. NO. 2,734,489.
FOR LOUDSPEAKER SYSTEMS (U.S. CLS. 21, 23, 26, 36 AND 38).

FIRST USE 6-1-2004; IN COMMERCE 6-1-2004.
SHARON MEIER, EXAMINING ATTORNEY

CLASS 9—(Continued).

SN 76-615,388. PHOENIX TECHNOLOGIES LTD., MILPITAS, CA. FILED 10-6-2004.

PHOENIX

THE MARK CONSISTS OF STANDARD CHARACTERS WITHOUT CLAIM TO ANY PARTICULAR FONT, STYLE, SIZE, OR COLOR.

OWNER OF U.S. REG. NOS. 2,484,133, 2,625,542 AND OTHERS.

FOR COMPUTER SOFTWARE, NAMELY, COMPUTER APPLICATION SOFTWARE FOR USE IN PROVIDING SECURE, AUTHENTICATED PRE-OPERATING SYSTEM PROTECTED APPLICATIONS, SECURE MEMORY FUNCTIONS, APPLICATIONS AND DELIVERY OF SYSTEMS SOFTWARE SECURITY SERVICES THROUGHOUT A DEVICE AND/OR NETWORK; BASIC INPUT/OUTPUT SYSTEM SOFTWARE FOR USE IN PROVIDING SECURE, AUTHENTICATED PRE-OPERATING SYSTEM PROTECTED APPLICATIONS, SECURE MEMORY FUNCTIONS, APPLICATIONS AND DELIVERY OF SYSTEMS SOFTWARE SECURITY SERVICES THROUGHOUT A DEVICE AND/OR NETWORK; COMPUTER SOFTWARE FOR DATA STORAGE MANAGEMENT AND DISASTER RECOVERY, NAMELY, DATA RECOVERY; COMPUTER SOFTWARE FOR USE IN OPERATING SECURE SYSTEM APPLICATIONS, SECURE MEMORY SYSTEMS, SECURE COMPUTER AND NETWORK SYSTEMS (U.S. CLS. 21, 23, 26, 36 AND 38).

FIRST USE 9-13-1979; IN COMMERCE 9-13-1979.

PAM WILLIS, EXAMINING ATTORNEY

SN 76-615,563. PEAK PERFORMANCE TECHNOLOGIES, INC., CENTENNIAL, CO. FILED 10-13-2004.

VOLANT

THE MARK CONSISTS OF STANDARD CHARACTERS WITHOUT CLAIM TO ANY PARTICULAR FONT, STYLE, SIZE, OR COLOR.

THE ENGLISH TRANSLATION OF THE FRENCH WORDING "VOLANT" IS "FLYING".
FOR DIGITAL CAMERA (U.S. CLS. 21, 23, 26, 36 AND 38).

FIRST USE 8-1-2004; IN COMMERCE 8-1-2004.
SUELLEN HICKEY, EXAMINING ATTORNEY

CLASS 9—(Continued).

SN 76-615,633. SUPERCHIPS, INC., SANFORD, FL. FILED 10-13-2004.

SUPERCHIPS INC.

THE MARK CONSISTS OF STANDARD CHARACTERS WITHOUT CLAIM TO ANY PARTICULAR FONT, STYLE, SIZE, OR COLOR.

OWNER OF U.S. REG. NO. 1,876,383.

NO CLAIM IS MADE TO THE EXCLUSIVE RIGHT TO USE "INC.", APART FROM THE MARK AS SHOWN.

FOR HAND-HELD ELECTRONIC COMPUTERS FOR USE IN PROGRAMMING AUTOMOTIVE COMPUTERS (U.S. CLS. 21, 23, 26, 36 AND 38).

FIRST USE 2-0-1998; IN COMMERCE 2-0-1998.

KARANENDRA S. CHHINA, EXAMINING ATTORNEY

SN 76-615,743. SUN HING OPTICAL MANUFACTORY LIMITED, KOWLOON, HONG KONG, FILED 10-14-2004.

PUBLIC +

FOR SPECTACLES; SUNGLASSES; CONTACT LENSES; OPTICAL LENSES; SPECTACLE FRAMES; CASES AND HOLDERS FOR SPECTACLE AND GLASSES; SPECTACLE CHAINS; SPECTACLE CORDS (U.S. CLS. 21, 23, 26, 36 AND 38).

JUDITH HELFMAN, EXAMINING ATTORNEY

SN 76-616,011. LEGACY ELECTRONICS, INC., SAN CLEMENTE, CA. FILED 10-15-2004.

POINT SEVEN

THE MARK CONSISTS OF STANDARD CHARACTERS WITHOUT CLAIM TO ANY PARTICULAR FONT, STYLE, SIZE, OR COLOR.

FOR COMPUTER PRINTED CIRCUIT BOARDS, COMPUTER MEMORY MODULES, SEMICONDUCTOR COMPONENTS, CENTRAL PROCESSING UNITS AND SOFTWARE FOR CONTROLLING SAME (U.S. CLS. 21, 23, 26, 36 AND 38).

VIVIAN MICZNIK FIRST, EXAMINING ATTORNEY

CLASS 9—(Continued).

SN 76-616,123. RITRON, INC., CARMEL, IN. FILED 10-14-2004.

RADIONEXUS

THE MARK CONSISTS OF STANDARD CHARACTERS WITHOUT CLAIM TO ANY PARTICULAR FONT, STYLE, SIZE, OR COLOR.

FOR TWO-WAY RADIOS (U.S. CLS. 21, 23, 26, 36 AND 38).

RICHARD A. STRASER, EXAMINING ATTORNEY

SN 76-616,620. TIME TRAX TECHNOLOGIES CORPORATION, NORTH POTOMAC, MD. FILED 10-20-2004.

TIMETRAX

THE MARK CONSISTS OF STANDARD CHARACTERS WITHOUT CLAIM TO ANY PARTICULAR FONT, STYLE, SIZE, OR COLOR.

FOR COMPUTER SOFTWARE FOR USE IN A COMPUTER TO CAPTURE SATELLITE RADIO BROADCASTS TO THE COMPUTER (U.S. CLS. 21, 23, 26, 36 AND 38).

FIRST USE 7-0-2004; IN COMMERCE 7-0-2004.

KATHLEEN M. VANSTON, EXAMINING ATTORNEY

CLASS 9—(Continued).

SN 76-616,655. MOBILE ACTION TECHNOLOGY INC., SINDIAN CITY, TAIPEI COUNTY, TAIWAN, FILED 10-15-2004.



FOR COMPUTER SOFTWARE FOR USE IN MANAGING MOBILE TELEPHONES, TELEPHONE HEADSETS AND CELLULAR TELEPHONE FEATURES, NAMELY PHONE BOOK, CALENDAR, RING TONE, SHORT MESSAGE SERVICE AND PICTURE; ELECTRICAL CABLES FOR USE IN TRANSMITTING DATA BETWEEN AND AMONG PERSONAL COMPUTERS AND MOBILE TELEPHONES; INFRARED TRANSCEIVERS FOR USE IN TRANSMITTING DATA BETWEEN AND AMONG PERSONAL COMPUTERS AND MOBILE TELEPHONES; ADAPTERS FOR TELECOMMUNICATION AND COMPUTER EQUIPMENT INCLUDING RADIO MODEMS, NAMELY TRANSCEIVERS FOR USE IN TRANSMITTING DATA BETWEEN AND AMONG PERSONAL COMPUTERS AND MOBILE TELEPHONES; COMPUTER SOFTWARE FOR USE IN DEVELOPING OTHER COMPUTER SOFTWARE; COMPUTER SOFTWARE FOR MANAGING WIRELESS CONTENT DELIVERY; COMPUTER SOFTWARE TO ENABLE TRANSMISSION OF PHOTOGRAPHS AND VIDEO VIA MOBILE TELEPHONES; COMPUTER TELEPHONY SOFTWARE FOR USE IN ENABLING TELEPHONE ACTIVITIES TO BE PERFORMED THROUGH A COMPUTER; CONNECTING ELECTRICAL CABLES (U.S. CLS. 21, 23, 26, 36 AND 38).

FIRST USE 11-1-2000; IN COMMERCE 11-1-2000.
TARAH HARDY, EXAMINING ATTORNEY

SN 76-616,666. SHALLCO, INC., SMITHFIELD, NC. FILED 10-15-2004.

DUTYSAFE

THE MARK CONSISTS OF STANDARD CHARACTERS WITHOUT CLAIM TO ANY PARTICULAR FONT, STYLE, SIZE, OR COLOR.

FOR SWITCHES, NAMELY, THERMAL SAFETY BREAKERS (U.S. CLS. 21, 23, 26, 36 AND 38).
FIRST USE 9-28-2004; IN COMMERCE 9-28-2004.
APRIL L. RADEMACHER, EXAMINING ATTORNEY

CLASS 9—(Continued).

SN 76-616,853. MEDICAL INFORMATICS ENGINEERING, INCORPORATED, FORT WAYNE, IN. FILED 10-21-2004.

ALTERNATIFF

THE MARK CONSISTS OF STANDARD CHARACTERS WITHOUT CLAIM TO ANY PARTICULAR FONT, STYLE, SIZE, OR COLOR.

FOR SOFTWARE AND DOWNLOADABLE SOFTWARE FOR IMAGE VIEWING AND MANIPULATION (U.S. CLS. 21, 23, 26, 36 AND 38).

FIRST USE 8-0-1998; IN COMMERCE 8-0-1998.

ELIZABETH HUGHITT, EXAMINING ATTORNEY

SN 76-617,077. TRANQUILITY SOLUTIONS, INC., PLYMOUTH, IN. FILED 10-18-2004.

CLARITY

THE MARK CONSISTS OF STANDARD CHARACTERS WITHOUT CLAIM TO ANY PARTICULAR FONT, STYLE, SIZE, OR COLOR.

FOR COMPUTER SOFTWARE FOR PROCESS MANAGEMENT AND DOCUMENT GENERATION IN THE AREA OF K-12 EDUCATION SPECIAL POPULATIONS PROGRAMS (U.S. CLS. 21, 23, 26, 36 AND 38).

FIRST USE 2-0-2004; IN COMMERCE 2-0-2004.

JENNIFER MARTIN, EXAMINING ATTORNEY

SN 76-617,192. ENGIUS LLC, STILLWATER, OK. FILED 10-19-2004.

INTELLIROCK

THE MARK CONSISTS OF STANDARD CHARACTERS WITHOUT CLAIM TO ANY PARTICULAR FONT, STYLE, SIZE, OR COLOR.

FOR CONCRETE TESTING SYSTEM COMPRISED OF ELECTRONIC SENSORS AND A HAND-HELD READER USED TO SENSE AND MONITOR THE PHYSICAL CONDITION OF CONCRETE (U.S. CLS. 21, 23, 26, 36 AND 38).

FIRST USE 2-0-2002; IN COMMERCE 2-0-2002.

KATHRYN COWARD, EXAMINING ATTORNEY

CLASS 9—(Continued).

SN 76-617,714. PAUL W. MARINO GAGES, INC., WARREN, MI. FILED 10-25-2004.



FOR COORDINATE MEASURING MACHINES AND FIXTURING AND MEASURING TOOL PARTS THEREOF; MEASURING INSTRUMENTS FOR CALIBRATION AND DIMENSIONAL CERTIFICATION OF TO-BE-MANUFACTURED PARTS (U.S. CLS. 21, 23, 26, 36 AND 38).
FIRST USE 12-31-1991; IN COMMERCE 12-31-1991.
RICHARD A. STRASER, EXAMINING ATTORNEY

SN 76-617,743. PARKER, JOHN F., JR., HOUSTON, TX. FILED 10-26-2004.



THE COLOR(S) BROWN, GOLD, BLACK AND WHITE IS/ARE CLAIMED AS A FEATURE OF THE MARK.

ALL LETTERS ARE WHITE IN COLOR THE SHADOWED BACKGROUND IS MADE UP OF BROWN, BLACK AND GOLD.

"TOO MUCH BOOTY TRAPP": THE WORDS "TOO MUCH BOOTY" IN UPPER AND LOWER CASE LETTERS APPEARING OVER THE WORD "TRAPP" WHICH IS IN ALL CAPITAL LETTERS. ALL LETTERS HAVE A SHADOWED BACKGROUND.

FOR MOTION PICTURE FILM ABOUT A COMEDY BASED ON A BIKINI CONTEST (U.S. CLS. 21, 23, 26, 36 AND 38).

FIRST USE 4-3-1999; IN COMMERCE 4-1-2000.

ANNE E. GUSTASON, EXAMINING ATTORNEY

SN 76-617,768. CHENBRO MICOM CO., LTD., CHUNG HO CITY, TAIPEI HSIEN, TAIWAN, FILED 10-26-2004.



FOR COMPUTER MAINFRAME; MAINFRAME OF PERSONAL COMPUTER (U.S. CLS. 21, 23, 26, 36 AND 38).

FIRST USE 10-10-2003; IN COMMERCE 10-10-2003.

RICHARD A. STRASER, EXAMINING ATTORNEY

CLASS 9—(Continued).

SN 76-617,963. UECHI, KATSUYA, STUDIO CITY, CA. FILED 10-27-2004.

KATSU

THE MARK CONSISTS OF STANDARD CHARACTERS WITHOUT CLAIM TO ANY PARTICULAR FONT, STYLE, SIZE, OR COLOR.

FOR VIDEO TAPES FEATURING COOKING INSTRUCTIONS (U.S. CLS. 21, 23, 26, 36 AND 38).
MICHAEL WEBSTER, EXAMINING ATTORNEY

SN 76-617,966. UECHI, KATSUYA, STUDIO CITY, CA. FILED 10-27-2004.

KATSU-YA

THE MARK CONSISTS OF STANDARD CHARACTERS WITHOUT CLAIM TO ANY PARTICULAR FONT, STYLE, SIZE, OR COLOR.

FOR VIDEO TAPES FEATURING COOKING INSTRUCTIONS (U.S. CLS. 21, 23, 26, 36 AND 38).

MICHAEL WEBSTER, EXAMINING ATTORNEY

SN 76-617,987. QUALITY VISION INTERNATIONAL, INC., ROCHESTER, NY. FILED 10-27-2004.

HI-EYE

THE MARK CONSISTS OF STANDARD CHARACTERS WITHOUT CLAIM TO ANY PARTICULAR FONT, STYLE, SIZE, OR COLOR.

FOR VIDEO MAGNIFIER FOR INSPECTION MEASUREMENT, AND ASSEMBLY (U.S. CLS. 21, 23, 26, 36 AND 38).

FIRST USE 9-8-2004; IN COMMERCE 9-8-2004.

JOHN DALIER, EXAMINING ATTORNEY

CLASS 9—(Continued).

SN 76-617,999. ELK PRODUCTS, INC., HILDEBRAN, NC. FILED 10-27-2004.



THE MARK CONSISTS OF AN OBLONG SHAPE CONTAINING THE WORD M1 AGAINST A DARK BACKGROUND.

FOR ELECTRIC CONTROL PANEL FOR A BUILDING THAT IS UNIVERSALLY ADAPTABLE TO CONTROL ANY ELECTRONIC FUNCTION (U.S. CLS. 21, 23, 26, 36 AND 38).

FIRST USE 9-5-2003; IN COMMERCE 9-5-2003.
DORITT L. CARROLL, EXAMINING ATTORNEY

CLASS 9—(Continued).

SN 76-619,180. MAPTECH, INC., AMESBURY, MA. FILED 11-3-2004.



THE MARK CONSISTS OF STANDARD CHARACTERS WITHOUT CLAIM TO ANY PARTICULAR FONT, STYLE, SIZE, OR COLOR.

FOR FILE FORMAT SOFTWARE FOR DIGITAL NAUTICAL CHARTS (U.S. CLS. 21, 23, 26, 36 AND 38).

FIRST USE 5-0-1995; IN COMMERCE 5-0-1995.
ROBERT LORENZO, EXAMINING ATTORNEY

SN 76-618,110. STAR HEADLIGHT & LANTERN CO., INC., AVON, NY. FILED 10-25-2004.



THE MARK CONSISTS OF STANDARD CHARACTERS WITHOUT CLAIM TO ANY PARTICULAR FONT, STYLE, SIZE, OR COLOR.

OWNER OF U.S. REG. NOS. 1,276,812, 2,881,175 AND OTHERS.

FOR WARNING LIGHTS FOR USE ON VEHICLES (U.S. CLS. 21, 23, 26, 36 AND 38).

FIRST USE 10-21-2003; IN COMMERCE 6-15-2004.
KEVIN DINALLO, EXAMINING ATTORNEY

SN 76-619,273. ELECTEC LIMITED, NEPEAN, ONTARIO L2H 7Z1, CANADA, FILED 11-4-2004.



FOR ELECTRICAL POWER CONTROL AND INTERCONNECTING WIRING SYSTEM CONFIGURATIONS COMPRISED OF SOME OR ALL OF THE FOLLOWING COMPONENTS, NAMELY, CABLES, INTERCEPTORS, RECEPTACLES, ADAPTERS, SWITCHES, ENCLOSURES, COVER PLATES, SENSORS, BRACKETS, BAR HANGERS, BOXES, PLUGS (U.S. CLS. 21, 23, 26, 36 AND 38).

FIRST USE 1-0-1998; IN COMMERCE 1-0-1998.
LINDA ESTRADA, EXAMINING ATTORNEY

SN 76-618,668. HASBRO, INC., PAWTUCKET, RI. FILED 11-1-2004.



THE MARK CONSISTS OF STANDARD CHARACTERS WITHOUT CLAIM TO ANY PARTICULAR FONT, STYLE, SIZE, OR COLOR.

FOR DIGITAL CAMERAS, WALKIE-TALKIES, ELECTRONIC TEXT MESSAGING DEVICES, NAMELY, WALKIE-TALKIES AND ACCESSORIES FOR USE THEREWITH (U.S. CLS. 21, 23, 26, 36 AND 38).

MARLENE BELL, EXAMINING ATTORNEY

SN 76-619,601. POLARLAKE LIMITED, DUBLIN 3, IRELAND, FILED 11-5-2004.



THE MARK CONSISTS OF STANDARD CHARACTERS WITHOUT CLAIM TO ANY PARTICULAR FONT, STYLE, SIZE, OR COLOR.

FOR COMPUTER SOFTWARE FOR USE IN MANAGING SYSTEM-TO-SYSTEM INTEGRATION, APPLICATION INTEGRATION AND BUSINESS-TO-BUSINESS INTEGRATION, THAT MAY BE DOWNLOADED FROM A GLOBAL COMPUTER NETWORK (U.S. CLS. 21, 23, 26, 36 AND 38).

FIRST USE 2-7-2002; IN COMMERCE 2-7-2002.
CURTIS FRENCH, EXAMINING ATTORNEY

CLASS 9—(Continued).

SN 76-619,871. HARMAN INTERNATIONAL INDUSTRIES, INCORPORATED, NORTHRIDGE, CA. FILED 11-8-2004.



on tour

OWNER OF U.S. REG. NOS. 782,327, 2,921,042 AND OTHERS.

FOR AUDIO EQUIPMENT, NAMELY, AMPLIFIERS AND SPEAKERS (U.S. CLS. 21, 23, 26, 36 AND 38).

FIRST USE 7-11-2004; IN COMMERCE 7-11-2004.
ANDREA SAUNDERS, EXAMINING ATTORNEY

CLASS 9—(Continued).

SN 76-620,800. SHIN CHIN INDUSTRIAL CO., LTD., TAINAN HSIEN, TAIWAN, FILED 11-16-2004.

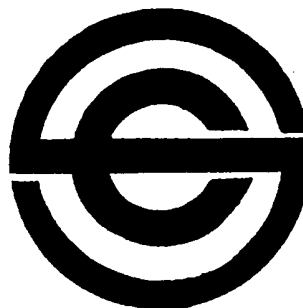

FOR ELECTRIC SWITCHES; ELECTRIC PLUGS; ELECTRICAL SOCKETS; ELECTRICAL TERMINALS; CIRCUIT BREAKERS; SWITCH BOXES; FUSE HOLDERS; POWER PANEL SWITCHES; AC/DC ADAPTORS; ELECTRICAL MOTOR CONTROLLERS; ELECTRICAL POWER SUPPLIES; UNINTERRUPTIBLE POWER SUPPLIES; POWER DISTRIBUTION UNITS; ELECTRICAL PUSH SWITCHES; ELECTRIC CONTROL PANELS; ELECTRICAL SWITCH COVERS; BATTERY CHARGERS; ELECTRICAL SWITCH HOUSING (U.S. CLS. 21, 23, 26, 36 AND 38).

FIRST USE 6-30-1984; IN COMMERCE 6-30-1984.
PAM WILLIS, EXAMINING ATTORNEY

SN 76-620,355. CONCORD RECORDS, INC., BEVERLY HILLS, CA. FILED 11-12-2004.

JAZZ MOODS

THE MARK CONSISTS OF STANDARD CHARACTERS WITHOUT CLAIM TO ANY PARTICULAR FONT, STYLE, SIZE, OR COLOR.

NO CLAIM IS MADE TO THE EXCLUSIVE RIGHT TO USE "JAZZ", APART FROM THE MARK AS SHOWN.

FOR SERIES OF MUSICAL SOUND RECORDINGS (U.S. CLS. 21, 23, 26, 36 AND 38).

FIRST USE 3-16-1999; IN COMMERCE 3-16-1999.
LA TONIA FISHER, EXAMINING ATTORNEY

SN 76-623,254. THERMOTUX, INC., ROCK SPRINGS, WY. FILED 12-6-2004.

THERMOTUX

THE MARK CONSISTS OF STANDARD CHARACTERS WITHOUT CLAIM TO ANY PARTICULAR FONT, STYLE, SIZE, OR COLOR.

OWNER OF U.S. REG. NO. 2,374,921.

FOR HELMET INSERTS, HELMET LINERS, AND SWEAT BANDS FOR HELMETS (U.S. CLS. 21, 23, 26, 36 AND 38).

FIRST USE 9-0-2003; IN COMMERCE 9-0-2003.

ANNE E. GUSTASON, EXAMINING ATTORNEY

CLASS 9—(Continued).

SN 76-623,307. WIND-UP ENTERTAINMENT, INC., NEW YORK, NY. FILED 12-6-2004.

WIND-UP

THE MARK CONSISTS OF STANDARD CHARACTERS WITHOUT CLAIM TO ANY PARTICULAR FONT, STYLE, SIZE, OR COLOR.

OWNER OF U.S. REG. NO. 2,202,060.

FOR MUSICAL SOUND RECORDINGS; RECORDED PRODUCT, NAMELY, COMPACT DISCS, DVDS, PHONOGRAPH RECORDS, PRERECORDED AUDIO CASSETTE TAPES, VIDEO TAPES AND VIDEO CASSETTES, ALL FEATURING MUSIC (U.S. CLS. 21, 23, 26, 36 AND 38).

FIRST USE 3-25-1997; IN COMMERCE 3-25-1997.

RONALD MCMORROW, EXAMINING ATTORNEY

SN 76-623,316. LOGIC DREAM PRODUCTIONS, INC., EL PRADO, NM. FILED 12-6-2004.

SUBE

THE MARK CONSISTS OF STANDARD CHARACTERS WITHOUT CLAIM TO ANY PARTICULAR FONT, STYLE, SIZE, OR COLOR.

THE ENGLISH TRANSLATION OF SUBE IS "HE/SHE GOES UP".

FOR PRE-RECORDED VIDEO TAPES AND CDS FEATURING EDUCATIONAL AND LANGUAGE INSTRUCTION FOR CHILDREN (U.S. CLS. 21, 23, 26, 36 AND 38).

FIRST USE 10-15-1996; IN COMMERCE 10-15-1996.

RONALD MCMORROW, EXAMINING ATTORNEY

SN 76-623,646. CCM CELLULAR CONNECTION OF MIAMI, INC., MIAMI, FL. FILED 12-8-2004.

NO CLAIM IS MADE TO THE EXCLUSIVE RIGHT TO USE "BLUE", APART FROM THE MARK AS SHOWN.

THE STIPPLING IN THE DRAWING IS FOR SHADING PURPOSES ONLY.

FOR CELLULAR ACCESSORIES, NAMELY, WIRE FREE HEADSETS AND HANDS FREE DEVICES FOR MOBILE PHONES (U.S. CLS. 21, 23, 26, 36 AND 38).

FIRST USE 1-0-2004; IN COMMERCE 1-0-2004.

RONALD MCMORROW, EXAMINING ATTORNEY

CLASS 9—(Continued).

SN 76-624,684. LTB AUDIO SYSTEMS, INC., TETERBORO, NJ. FILED 12-15-2004.

FOR HEADPHONES, HEADSETS AND RELATED ACCESSORIES, NAMELY, PLUG ADAPTERS, REPLACEMENT CUSHION SETS, COILED EXTENSION CORDS, SPEAKER SWITCHES, EXTENSION CABLES, ADAPTERS AND CONNECTOR BOXES (U.S. CLS. 21, 23, 26, 36 AND 38).

FIRST USE 7-28-2004; IN COMMERCE 7-28-2004.

KIMBERLY PERRY, EXAMINING ATTORNEY

SN 76-625,548. GRIND GAMES, INC., AUSTIN, TX. FILED 12-27-2004.

GRIND GAMES

THE MARK CONSISTS OF STANDARD CHARACTERS WITHOUT CLAIM TO ANY PARTICULAR FONT, STYLE, SIZE, OR COLOR.

NO CLAIM IS MADE TO THE EXCLUSIVE RIGHT TO USE "GAMES", APART FROM THE MARK AS SHOWN.

FOR DOWNLOADABLE WIRELESS GAME SOFTWARE; DOWNLOADABLE WIRELESS ENTERTAINMENT, NAMELY, RING TONES, SCREEN SAVERS AND IMAGES, WALLPAPER; AND COMPUTER SOFTWARE FOR USE IN THE DESIGN, DEVELOPMENT AND EXECUTION OF WIRELESS GAME AND ENTERTAINMENT PROGRAMS AND APPLICATIONS (U.S. CLS. 21, 23, 26, 36 AND 38).

FIRST USE 8-20-2003; IN COMMERCE 8-20-2003.

PAUL F. GAST, EXAMINING ATTORNEY

CLASS 9—(Continued).

SN 76-625,775. PAXAR AMERICAS, INC., MIAMISBURG, OH. FILED 12-22-2004.

9416

THE MARK CONSISTS OF STANDARD CHARACTERS WITHOUT CLAIM TO ANY PARTICULAR FONT, STYLE, SIZE, OR COLOR.

OWNER OF U.S. REG. NOS. 1,652,164, 1,654,745 AND 2,214,391.

FOR ELECTRONIC PRINTER FOR PRINTING TAGS, LABELS AND RECEIPTS (U.S. CLS. 21, 23, 26, 36 AND 38).

FIRST USE 3-1-2004; IN COMMERCE 3-1-2004.
SUSAN HAYASH, EXAMINING ATTORNEY

SN 76-626,034. EBTRON, INC., LORIS, SC. FILED 12-27-2004.

EBTRON

FOR ELECTRONIC HEATING, VENTILATION, AND AIR CONDITIONING CONTROLLERS; TEMPERATURE PROBES AND SENSORS; PRESSURE PROBES AND SENSORS; AIRFLOW PROBES AND SENSORS; VELOCITY PROBES AND SENSORS (U.S. CLS. 21, 23, 26, 36 AND 38).

FIRST USE 4-1-2001; IN COMMERCE 4-1-2001.
WILLIAM VERHOSEK, EXAMINING ATTORNEY

SN 76-626,035. EBTRON, INC., LORIS, SC. FILED 12-27-2004.

EBTRON

THE MARK CONSISTS OF STANDARD CHARACTERS WITHOUT CLAIM TO ANY PARTICULAR FONT, STYLE, SIZE, OR COLOR.

FOR ELECTRONIC HEATING, VENTILATION, AND AIR CONDITIONING CONTROLLERS; TEMPERATURE PROBES AND SENSORS; PRESSURE PROBES AND SENSORS; AIRFLOW PROBES AND SENSORS; VELOCITY PROBES AND SENSORS (U.S. CLS. 21, 23, 26, 36 AND 38).

FIRST USE 0-0-1984; IN COMMERCE 0-0-1984.
WILLIAM VERHOSEK, EXAMINING ATTORNEY

CLASS 9—(Continued).

SN 76-626,310. FOOD QUALITY SENSOR INTERNATIONAL, INC., CAMBRIDGE, MA. FILED 12-23-2004.

FQSI

THE MARK CONSISTS OF STANDARD CHARACTERS WITHOUT CLAIM TO ANY PARTICULAR FONT, STYLE, SIZE, OR COLOR.

FOR FOOD QUALITY SENSORS (U.S. CLS. 21, 23, 26, 36 AND 38).

MARK RADEMACHER, EXAMINING ATTORNEY

SN 76-637,218. J.A. WOOLLAM CO. INC., LINCOLN, NE. FILED 4-27-2005.

GENOSC-PREFIT

THE MARK CONSISTS OF STANDARD CHARACTERS WITHOUT CLAIM TO ANY PARTICULAR FONT, STYLE, SIZE, OR COLOR.

FOR EQUIPMENT, NAMELY ELLIPSOMETER BASED APPARATUS FOR MEASURING THICKNESS AND OPTICAL PROPERTIES OF SEMICONDUCTOR, DISK DRIVE, MAGNETIC DATA STORAGE MEDIA, OPTICAL DATA STORAGE MEDIA, THIN FILMS AND MULTIPLE LAYER FILMS ON SUBSTRATES AND COATINGS, INCLUDING TEMPERATURE CAUSED EFFECTS, AND COMPUTER PROGRAMS NECESSARY FOR CONTROLLING THE ELLIPSOMETER BASED APPARATUS AND FOR ANALYZING ACQUIRED ELLIPSOMETRIC DATA (U.S. CLS. 21, 23, 26, 36 AND 38).

ANNE MADDEN, EXAMINING ATTORNEY

SN 76-637,220. J.A. WOOLLAM CO. INC., LINCOLN, NE. FILED 4-27-2005.

GENOSC-GLOBAL FIT

THE MARK CONSISTS OF STANDARD CHARACTERS WITHOUT CLAIM TO ANY PARTICULAR FONT, STYLE, SIZE, OR COLOR.

FOR EQUIPMENT, NAMELY ELLIPSOMETER BASED APPARATUS FOR MEASURING THICKNESS AND OPTICAL PROPERTIES OF SEMICONDUCTOR, DISK DRIVE, MAGNETIC DATA STORAGE MEDIA, OPTICAL DATA STORAGE MEDIA, THIN FILMS AND MULTIPLE LAYER FILMS ON SUBSTRATES AND COATINGS, INCLUDING TEMPERATURE CAUSED EFFECTS, AND COMPUTER PROGRAMS NECESSARY FOR CONTROLLING THE ELLIPSOMETER BASED APPARATUS AND FOR ANALYZING ACQUIRED ELLIPSOMETRIC DATA (U.S. CLS. 21, 23, 26, 36 AND 38).

ANNE MADDEN, EXAMINING ATTORNEY

CLASS 9—(Continued).

SN 78-002,369. SEEBEYOND TECHNOLOGY CORPORATION, MONROVIA, CA. FILED 4-3-2000.

E*XCHANGE

FOR COMPUTER SOFTWARE FOR ENABLING BUSINESS TO BUSINESS COMMUNICATIONS INTEGRATION BETWEEN VARIOUS SOFTWARE APPLICATIONS AND HARDWARE PLATFORMS IN THE NATURE OF ELECTRONIC DATA INTERCHANGE USED TO MODEL AND MANAGE BUSINESS TO BUSINESS PROCESSES AS WELL AS TRADING PARTNER PROFILES (U.S. CLS. 21, 23, 26, 36 AND 38).

FIRST USE 2-17-2000; IN COMMERCE 3-31-2000.
CHARLES JOYNER, EXAMINING ATTORNEY

SN 78-025,658. TARCO ENGINEERING INC., CALGARY, ALBERTA, CANADA, FILED 9-13-2000.

MOTIV

PRIORITY CLAIMED UNDER SEC. 44(D) ON CANADA APPLICATION NO. 1063895, FILED 6-23-2000, REG. NO. TMA637,928, DATED 4-20-2005, EXPIRES 4-20-2020.

FOR COMPUTER HARDWARE, NAMELY ELECTRONIC CONTROL MODULES USED FOR CONTROL SYSTEMS IN INDUSTRIAL AUTOMATION EQUIPMENT; COMPUTER SOFTWARE USED FOR CONTROLLING, MONITORING, DIAGNOSING, TRENDING AND REPORTING IN INDUSTRIAL AUTOMATION EQUIPMENT (U.S. CLS. 21, 23, 26, 36 AND 38).

MICHAEL TANNER, EXAMINING ATTORNEY

SN 78-029,668. BLUEPOINT LINUX SOFTWARE CORP., SHENZHEN, CHINA, FILED 10-8-2000.

BLUEPOINT

FOR COMPUTER OPERATING SYSTEMS (U.S. CLS. 21, 23, 26, 36 AND 38).

FIRST USE 7-0-1999; IN COMMERCE 7-0-1999.
NANCY CLARKE, EXAMINING ATTORNEY

SN 78-141,791. INFINEON TECHNOLOGIES AG, MUNICH, FED REP GERMANY, FILED 7-8-2002.

TRICORE

OWNER OF FED REP GERMANY REG. NO. 39741852, DATED 10-10-1997, EXPIRES 9-30-2007.

OWNER OF U.S. REG. NO. 2,422,705.
FOR MICROCONTROLLERS (U.S. CLS. 21, 23, 26, 36 AND 38).

FIRST USE 11-30-1999; IN COMMERCE 11-30-1999.
ALICE BENMAMAN, EXAMINING ATTORNEY

CLASS 9—(Continued).

SN 78-155,548. MAILFRONTIER, INC., PALO ALTO, CA. FILED 8-19-2002.

MATADOR

FOR COMPUTER SOFTWARE FOR THE DETECTION, BLOCKING, FILTERING AND MODIFICATION OF UNSOLICITED, BULK, AND JUNK ELECTRONIC MESSAGES; COMPUTER SOFTWARE FOR NETWORK MANAGEMENT, PROTECTION AND RECOVERY FROM COMPUTER VIRUSES, COPY PROTECTION, TRANSFERRING DATA BETWEEN PORTABLE COMPUTER DEVICES AND DESKTOP AND NETWORKED COMPUTERS, AND FOR LINKING TEXT RECORDS WITH ELECTRONIC IMAGES; COMPUTER UTILITY AND ANTIVIRUS SOFTWARE; COMPUTER COMMUNICATIONS SOFTWARE FOR ALLOWING ELECTRONIC MAIL AND ONLINE COMMUNICATIONS AND MESSAGING; COMPUTER COMMUNICATIONS SOFTWARE FOR CONNECTING LOCAL AREA NETWORKS, INTERNAL CORPORATE NETWORKS, AND FILE AND PROXY SERVERS (U.S. CLS. 21, 23, 26, 36 AND 38).

FIRST USE 7-30-2002; IN COMMERCE 8-26-2002.
TONJA GASKINS, EXAMINING ATTORNEY

SN 78-174,839. DYNAVOX SYSTEMS LLC, PITTSBURGH, PA. FILED 10-16-2002.

VRT

FOR FEATURE FOR A COMMUNICATIONS DEVICE FOR THE SPEECH IMPAIRED, NAMELY, A MEMORY FOR STORING SPOKEN WORDS FROM A HUMAN VOICE AND SOFTWARE RESPONSIVE TO INFORMATION ENTERED THROUGH A KEYBOARD OR A TOUCH SCREEN FOR CAUSING THE DEVICE TO PRODUCE SPEECH FROM THE STORED SPOKEN WORDS (U.S. CLS. 21, 23, 26, 36 AND 38).

FIRST USE 4-9-2003; IN COMMERCE 4-9-2003.
TONI HICKEY, EXAMINING ATTORNEY

SN 78-212,063. PIONEER MAGNETICS, INC., SANTA MONICA, CA. FILED 2-7-2003.



OWNER OF U.S. REG. NOS. 1,916,004 AND 2,749,388.
NO CLAIM IS MADE TO THE EXCLUSIVE RIGHT TO USE "POWER DELIVERY SYSTEM" AND "INC.", APART FROM THE MARK AS SHOWN.

FOR SWITCHING POWER SUPPLY SYSTEM COMPRISED OF INDUSTRIAL POWER REGULATORS, TRANSFORMERS, DISTRIBUTORS, AND RECTIFIERS THAT MONITORS, CONTROLS, PROGRAMS, STORES AND DELIVERS ELECTRIC POWER (U.S. CLS. 21, 23, 26, 36 AND 38).

FIRST USE 4-0-2000; IN COMMERCE 4-0-2000.
ALICIA COLLINS, EXAMINING ATTORNEY

CLASS 9—(Continued).

SN 78-238,027. OGREN, WAYNE STUART, REPUBLIC, WA.
FILED 4-15-2003.

CLASS 9—(Continued).

SN 78-248,095. ATOMATE CORPORATION, SANTA BARBARA, CA. FILED 5-9-2003.

SOLAR SMART

NO CLAIM IS MADE TO THE EXCLUSIVE RIGHT TO USE "SOLAR", APART FROM THE MARK AS SHOWN.

FOR APPARATUS FOR CONVERTING ELECTRONIC RADIATION TO ELECTRICAL ENERGY, NAMELY, PHOTOVOLTAIC SOLAR MODULES, PHOTOVOLTAIC SOLAR THERMAL HYBRID MODULES (U.S. CLS. 21, 23, 26, 36 AND 38).

FIRST USE 11-1-2001; IN COMMERCE 11-1-2001.
MARK T. MULLEN, EXAMINING ATTORNEY



SN 78-239,641. CTI ELECTRONICS CORPORATION, STRATFORD, CT. FILED 4-18-2003.

ORBITALMOUSE

FOR BUTTON STYLE COMPUTER MOUSE (U.S. CLS. 21, 23, 26, 36 AND 38).

KAREN K. BUSH, EXAMINING ATTORNEY

FOR SEMICONDUCTORS; ELECTRONIC COMPONENTS AND SUBSYSTEMS, NAMELY ELECTRONIC CABLES, ELECTRIC ACCUMULATORS, ELECTRIC COILS, ELECTRIC CURRENT CONVERTERS, ELECTRIC CORDS, ELECTRIC FUSES, ELECTRONIC IGNITORS, ELECTRONIC DIMMERS AND SWITCHES, ELECTRIC PLUGS, ELECTRIC WIRES, ELECTRIC BATTERIES, TRANSISTORS, DIODES, VOLTAGE REGULATORS FOR ELECTRIC POWER, BLANK ELECTRONIC CHIP CARDS, ELECTRONIC ENCRYPTION UNITS, ELECTRONIC TESTING EQUIPMENT USING OR USED IN THE PROCESSING OF NANOMATERIALS AND NANOCOMPOSITIES, ELECTRICAL TRANSFORMERS, APPARATUS FOR CONVERTING RADIATION TO ELECTRICAL ENERGY, SOLAR COLLECTORS; LIGHT EMITTING DIODES; LASERS FOR NON-MEDICAL USE; COMPUTER HARDWARE; TELECOMMUNICATIONS AND COMMUNICATIONS HARDWARE, NAMELY PHONES, ROUTERS, SERVERS, HUBS, MODEMS, FILTERS, FRAMES AND CIRCUITS; DATA STORAGE HARDWARE, NAMELY DISK DRIVES, HARD DRIVES; CIRCUIT BOARDS; VISUAL DISPLAYS, NAMELY VIDEO MONITORS, TELEVISIONS, LIQUID CRYSTAL DISPLAYS, LIGHT EMITTING DIODE VISUAL DISPLAYS, ELECTRIC LUMINESCENT DISPLAY PANELS, COMPUTER MONITORS AND FRAMES, LUMINOUS SIGNS; PHOTOVOLTAICS, NAMELY PHOTO VOLTAIC CELLS; PHOTO VOLTAIC SOLAR MODULES, PHOTO VOLTAIC CLADDING PANELS; SOLAR CELLS; BIOSENSORS FOR SENSING RADIATION, LIGHT, ELECTRICITY, GASES, LIQUIDS, SOLIDS AND AIR; CHEMICAL SENSORS; ENERGY CONVERSION DEVICES, NAMELY RELAYS, ELECTRIC CONVERTERS, OVERCURRENT DEVICES, INVERTERS, TRANSFER SWITCHES (U.S. CLS. 21, 23, 26, 36 AND 38).

FIRST USE 12-22-2003; IN COMMERCE 12-22-2003.

KARLA PERKINS, EXAMINING ATTORNEY

CLASS 9—(Continued).

SN 78-252,327. VERITAS OPERATING CORPORATION, MOUNTAIN VIEW, CA. FILED 5-20-2003.

VERITAS I3

FOR COMPUTER SOFTWARE FOR MONITORING, ANALYZING, REPORTING AND SOLVING PERFORMANCE ISSUES OF WEB SERVICES, APPLICATION SOFTWARE, DATABASES, NETWORK, STORAGE, AND OTHER COMPUTER COMPONENTS AND PROGRAMS; INSTRUCTION MANUALS SUPPLIED AS A UNIT WITH THE FOREGOING; PUBLICATIONS IN ELECTRONIC FORM, ON MAGNETIC AND OPTICAL COMPUTER-READABLE MEDIA OR DOWNLOADABLE VIA COMPUTER AND COMMUNICATION NETWORKS, INCLUDING THE INTERNET, NAMELY, WORK BOOKS, QUICK REFERENCE GUIDES, TECHNICAL REFERENCE MANUALS, USER MANUALS, AND EVALUATION GUIDES IN THE FIELD OF COMPUTERS, COMPUTER SOFTWARE, COMPUTER PERIPHERALS, AND COMPUTER NETWORKS (U.S. CLS. 21, 23, 26, 36 AND 38).

MELVIN AXILBUND, EXAMINING ATTORNEY

SN 78-253,601. INTERNATIONAL DATA GROUP, INC., FRAMINGHAM, MA. FILED 5-23-2003.

SPAM CALCULATOR

NO CLAIM IS MADE TO THE EXCLUSIVE RIGHT TO USE "SPAM", APART FROM THE MARK AS SHOWN.

FOR COMPUTER SOFTWARE, NAMELY, SOFTWARE THAT ENABLE AN ORGANIZATION TO ESTABLISH THE COST OF UNSOLICITED ELECTRONIC MAIL TO THEIR ORGANIZATION (U.S. CLS. 21, 23, 26, 36 AND 38).

FIRST USE 5-31-2003; IN COMMERCE 5-31-2003.
WANDA KAY PRICE, EXAMINING ATTORNEY

SN 78-261,755. SUNCADDY CANDA INC., REGINA, SACKATCHEWAN, CANADA, FILED 6-12-2003.

SUNCATCHER

PRIORITY CLAIMED UNDER SEC. 44(D) ON CANADA APPLICATION NO. 1168691, FILED 2-19-2003, REG. NO. TMA610435, DATED 5-14-2004, EXPIRES 5-14-2019.

FOR SOLAR COLLECTOR BATTERY CHARGERS FOR GOLF CARTS AND UTILITY VEHICLES (U.S. CLS. 21, 23, 26, 36 AND 38).

MICHELE SWAIN, EXAMINING ATTORNEY

CLASS 9—(Continued).

SN 78-267,150. NETOPIA, INC., EMERYVILLE, CA. FILED 6-25-2003.

BROADBAND WITHOUT BOUNDARIES

FOR COMPUTER HARDWARE AND SOFTWARE FOR USE IN ESTABLISHING, MAINTAINING, SECURING AND MANAGING WIDE AREA AND LOCAL AREA COMPUTER NETWORKS AND COMPUTER NETWORK CONNECTIONS, INCLUDING GLOBAL COMPUTER NETWORK CONNECTIONS; COMPUTER HARDWARE AND COMMUNICATIONS SOFTWARE FOR ELECTRONIC FILE TRANSFER, REMOTE COMPUTER ACCESS AND REMOTE NETWORK ACCESS, ALL IN THE FIELDS OF WIDE AREA AND LOCAL AREA NETWORKS, INCLUDING GLOBAL COMPUTER NETWORKS; USER MANUALS SUPPLIED AS A UNIT WITH THE FOREGOING (U.S. CLS. 21, 23, 26, 36 AND 38).

FIRST USE 10-9-2003; IN COMMERCE 10-9-2003.
VIVIAN MICZNIK FIRST, EXAMINING ATTORNEY

SN 78-268,891. TATUNG COMPANY, TAIPEI, TAIWAN, FILED 6-30-2003.

TATUNG

OWNER OF U.S. REG. NOS. 1,321,881 AND 1,619,640.
THE ENGLISH TRANSLATION OF THE MARK IS "HARMONY; AN IDEAL WORLD; UTOPIA".

FOR PERSONAL COMPUTERS, COMPUTER MONITORS, STEREO TUNERS, STEREO AMPLIFIERS, STEREO PRE-AMPLIFIERS, STEREO CASSETTE DECKS, RECORD PLAYERS, SPEAKERS, VIDEO CASSETTE PLAYERS/RECORDERS, DVD PLAYERS/RECORDERS, CD PLAYERS AND TELEVISIONS (U.S. CLS. 21, 23, 26, 36 AND 38).

FIRST USE 1-1-1972; IN COMMERCE 1-1-1972.
RICHARD WHITE, EXAMINING ATTORNEY

SN 78-271,685. BRAND, KIM J, GREENFIELD, IN. FILED 7-8-2003.



OWNER OF U.S. REG. NO. 2,741,757.
FOR FILE SERVER ACCESSIBLE FROM A LOCAL AREA NETWORK FOR THE STORAGE AND RETRIEVAL OF FILES (U.S. CLS. 21, 23, 26, 36 AND 38).
FIRST USE 4-13-2000; IN COMMERCE 4-13-2000.
KELLEY WELLS, EXAMINING ATTORNEY

CLASS 9—(Continued).

SN 78-277,915. THOMSON, BOULOGNE-BILLANCOURT, FRANCE, FILED 7-23-2003.



PRIORITY CLAIMED UNDER SEC. 44(D) ON FRANCE APPLICATION NO. 033209901, FILED 2-17-2003, REG. NO. 033209901, DATED 2-17-2003, EXPIRES 2-17-2013. THE STIPPLING IS FOR SHADING PURPOSES ONLY. FOR HEADPHONES (U.S. CLS. 21, 23, 26, 36 AND 38). PAULA MAHONEY, EXAMINING ATTORNEY

SN 78-283,511. INTERNATIONAL LOTTERY & TOTALIZATION SYSTEMS, INC. CARLSBAD, CA. FILED 8-5-2003.

INTELMARKFLX

FOR COMPUTER HARDWARE, COMPUTER PRINTER, COMPUTER MONITOR, COMPUTER PERIPHERALS AND OPERATING SOFTWARE FOR AN ON-LINE LOTTERY TERMINAL (U.S. CLS. 21, 23, 26, 36 AND 38).

FIRST USE 10-12-2001; IN COMMERCE 10-12-2001. GEOFFREY FOSDICK, EXAMINING ATTORNEY

SN 78-283,629. ZHEJIANG KAN BATTERY CO., LTD., MIAOGAO TOWN, SUICHANG 323300, ZHEJIANG, CHINA, FILED 8-6-2003.



THE MARK ITSELF IS A LONG "C" WITH THE LETTERS "KAN" INSIDE THE "C".

FOR ACCUMULATORS, NAMELY, ELECTRIC ACCUMULATORS, ACCUMULATOR BOXES, ELECTRIC ACCUMULATORS FOR VEHICLES; GALVANIC CELLS, NAMELY, PHOTOVOLTAIC CELLS; BATTERY CHARGERS; BATTERIES, CAPACITORS, ELECTRIC SOCKETS, ELECTRIC PLUGS AND OTHER CONTACTS, NAMELY, ELECTRICAL CONNECTORS, CABLE CONNECTORS, INSULATED ELECTRICAL CONNECTORS; MATERIAL FOR USE WITH ELECTRICITY MAINS, NAMELY, WIRES AND CABLES, ELECTRIC WIRES, POWER WIRES, ELECTRICAL WIRES, BATTERY CABLES, COAXIAL CABLES, ELECTRICAL CABLES, POWER CABLES; STABLE ELECTRIC SOURCE, NAMELY, POWER LINE CONDITIONERS, VOLTAGE REGULATORS; COUPLINGS; NAMELY, ELECTRIC COUPLINGS, COUPLINGS FOR METERS, MAINS COUPLINGS; LOW VOLTAGE ELECTRICAL POWER SUPPLIES (U.S. CLS. 21, 23, 26, 36 AND 38).

FIRST USE 12-1-1996; IN COMMERCE 12-1-2002. HOWARD SMIGA, EXAMINING ATTORNEY

CLASS 9—(Continued).

SN 78-289,129. STRIX SYSTEMS, INC., WESTLAKE VILLAGE, CA. FILED 8-19-2003.

MANAGER/ONE

FOR COMPUTER SOFTWARE FOR MANAGEMENT OF A WIRELESS LAN NETWORK (U.S. CLS. 21, 23, 26, 36 AND 38).

FIRST USE 7-21-2003; IN COMMERCE 7-21-2003. ELLEN B. AWRICH, EXAMINING ATTORNEY

SN 78-297,065. CHUN, CONNIE L., CUPERTINO, CA. FILED 9-8-2003.

CALM - COMPUTER ASSISTED LEGAL MANAGEMENT

NO CLAIM IS MADE TO THE EXCLUSIVE RIGHT TO USE "COMPUTER ASSISTED LEGAL MANAGEMENT", APART FROM THE MARK AS SHOWN.

FOR COMPUTER SOFTWARE FOR USE IN THE FIELD OF DOCUMENT MANAGEMENT FOR LEGAL PROFESSIONALS (U.S. CLS. 21, 23, 26, 36 AND 38).

FIRST USE 6-1-2003; IN COMMERCE 7-3-2003. ADA HAN, EXAMINING ATTORNEY

SN 78-298,362. HYPERTAC SA, SAINT AUBIN LES ELBEUF, FRANCE, FILED 9-10-2003.

HYPERSTAC

PRIORITY CLAIMED UNDER SEC. 44(D) ON FRANCE APPLICATION NO. 033214778, FILED 3-12-2003, REG. NO. 033214778, DATED 3-12-2003, EXPIRES 3-12-2013.

FOR ELECTRIC AND ELECTRONIC CONNECTORS (U.S. CLS. 21, 23, 26, 36 AND 38).

TRICIA SONNEBORN, EXAMINING ATTORNEY

SN 78-299,943. APPLE COMPUTER, INC., CUPERTINO, CA. FILED 9-12-2003.

LIVETYPE

PRIORITY CLAIMED UNDER SEC. 44(D) ON SINGAPORE APPLICATION NO. T03/03605A, FILED 3-19-2003, REG. NO. T03/03605A, DATED 3-19-2003, EXPIRES 3-19-2013.

FOR COMPUTER SOFTWARE FOR USE IN VIDEO EDITING; COMPUTER SOFTWARE FOR USE IN CREATING FONTS AND TITLES FOR FILM, VIDEO AND MULTIMEDIA CONTENT (U.S. CLS. 21, 23, 26, 36 AND 38).

FIRST USE 6-30-2003; IN COMMERCE 6-30-2003. DOMINIC J. FERRAIUOLO, EXAMINING ATTORNEY

CLASS 9—(Continued).

SN 78-305,410. LPE S.P.A., BOLLATE (MILANO), ITALY, FILED 9-25-2003.

Powering the future

PRIORITY CLAIMED UNDER SEC. 44(D) ON ITALY APPLICATION NO. MI2003C00713, FILED 7-11-2003, REG. NO. 00908016, DATED 9-17-2003, EXPIRES 7-11-2013.

FOR EPITAXIAL REACTORS AND PARTS THEREFOR FOR USE IN DEPOSITING LAYERS OF SEMICONDUCTOR MATERIAL ONTO SEMICONDUCTOR WAFER SURFACES IN THE PRODUCTION OF ELECTRONIC COMPONENTS, SUCH AS TRANSISTORS, DIODES, AND INTEGRATED CIRCUITS, OPERATIONAL SOFTWARE FOR EPITAXIAL REACTORS (U.S. CLS. 21, 23, 26, 36 AND 38).

GEOFFREY FOSDICK, EXAMINING ATTORNEY

SN 78-309,188. OPAL-RT INC., MONTREAL, CANADA, FILED 10-3-2003.

RT-LAB

OWNER OF CANADA REG. NO. TMA550075, DATED 8-23-2001, EXPIRES 8-23-2016. SEC. 2(F).

FOR COMPUTER SOFTWARE ENGINEERED TO ACCELERATE THE SIMULATION AND IMPLEMENTATION OF CONTROL SYSTEMS THROUGH THE DISTRIBUTION OF CODES, EXECUTED ON ONE OR SEVERAL PROCESSORS FOR APPLICATIONS IN ENERGY, AVIATION, NAVAL, AEROSPACE, AUTOMOTIVE, COMMUNICATION, ENGINEERING, ELECTRICITY AND ROBOTICS (U.S. CLS. 21, 23, 26, 36 AND 38).

FIRST USE 9-1-1997; IN COMMERCE 12-21-1998. FLORENTINA BLANDU, EXAMINING ATTORNEY

SN 78-310,333. STORACTIVE, INC., MARINA DEL REY, CA. FILED 10-7-2003.

OpenDelta

FOR COMPUTER SOFTWARE FOR DATA BACKUP AND RECOVERY (U.S. CLS. 21, 23, 26, 36 AND 38). JENNIFER MARTIN, EXAMINING ATTORNEY

SN 78-312,496. ATLANTIC DIVING EQUIPMENT, INC., BOWIE, MD. FILED 10-11-2003.

CRAFTSWELD

FOR DIVING HELMETS (U.S. CLS. 21, 23, 26, 36 AND 38). FIRST USE 2-0-2000; IN COMMERCE 2-0-2000. MARIA-VICTORIA SUAREZ, EXAMINING ATTORNEY

CLASS 9—(Continued).

SN 78-312,814. RED CHIP COMPANY LTD., ROAD TOWN, TORTOLA, BR.VIRGIN ISLANDS, FILED 10-13-2003.

VIRTUALIZER PRO

NO CLAIM IS MADE TO THE EXCLUSIVE RIGHT TO USE "PRO", APART FROM THE MARK AS SHOWN.

FOR AUDIO EQUIPMENT, NAMELY, MULTI-EFFECTS PROCESSORS (U.S. CLS. 21, 23, 26, 36 AND 38). FIRST USE 2-2-1998; IN COMMERCE 2-2-1998. ANDREA K. NADELMAN, EXAMINING ATTORNEY

SN 78-316,848. GENERAL CABLE TECHNOLOGIES CORPORATION, HIGHLAND HEIGHTS, KY. FILED 10-22-2003.



OWNER OF U.S. REG. NO. 2,110,077. THE MARK CONSISTS OF A VIBRANT, FLUORESCENT LIME GREEN COLOR USED OVER THE ENTIRE SURFACE OF THE CORD AND THE COLOR BLACK USED OVER THE ENTIRE SURFACE OF THE RECEPTACLE AT EITHER END OF THE CORD. THE MARK IS LINED FOR THE COLOR GREEN. THE MATTER SHOWN IN BROKEN LINES SERVES TO SHOW POSITIONING OF THE MARK AND NO CLAIM IS MADE TO IT.

SEC. 2(F). FOR ELECTRICAL EXTENSION CORDS (U.S. CLS. 21, 23, 26, 36 AND 38). FIRST USE 12-1-1995; IN COMMERCE 12-1-1995. RUSS HERMAN, EXAMINING ATTORNEY

SN 78-318,063. CLAREOS, INC., HERNDON, VA. FILED 10-24-2003.

clareos|crosscut

OWNER OF U.S. REG. NOS. 2,431,828 AND 2,433,684. THE COLOR(S) BLACK AND BLUE IS/ARE CLAIMED AS A FEATURE OF THE MARK.

THE COLOR BLACK APPEARS IN THE WORD CLAREOS AND THE COLOR BLUE IN THE WORD CROSSCUT. FOR SOFTWARE FOR THE QUERY, REPORTING, AND ANALYSIS OF DATA FROM DATABASE AND OPERATIONAL DATA SOURCES (U.S. CLS. 21, 23, 26, 36 AND 38).

FIRST USE 3-1-2000; IN COMMERCE 10-10-2003. CAROL SPILS, EXAMINING ATTORNEY

CLASS 9—(Continued).

SN 78-318,085. TABULA, INC., SANTA CLARA, CA. FILED 10-24-2003.

EVERYWARE

FOR COMPUTER SOFTWARE USED TO PROGRAM AND CONFIGURE COMPUTER CHIPS, ELECTRONIC CIRCUITS, SEMICONDUCTOR DEVICES AND INTEGRATED CIRCUITS, AND ELECTRONIC AND PRINT MANUALS SOLD THEREWITH (U.S. CLS. 21, 23, 26, 36 AND 38).

MATTHEW KLINE, EXAMINING ATTORNEY

SN 78-319,297. OMNI DEVELOPMENT, INC., SEATTLE, WA. FILED 10-27-2003.

OMNIGRAFFLE

FOR COMPUTER SOFTWARE FOR USE IN CREATING, EDITING AND MANAGING DIAGRAMS, CHARTS, DRAWINGS AND IMAGES (U.S. CLS. 21, 23, 26, 36 AND 38).

FIRST USE 3-25-2001; IN COMMERCE 3-25-2001.
GEORGIA CARTY, EXAMINING ATTORNEY

SN 78-325,190. BISEPS, INC., MONROE, WA. FILED 11-9-2003.

IsoKrom

THE MARK CONSISTS OF STANDARD CHARACTERS WITHOUT CLAIM TO ANY PARTICULAR FONT, STYLE, SIZE, OR COLOR.

FOR LABORATORY EQUIPMENT, NAMELY, LOW PRESSURE LIQUID CHROMATOGRAPHY COLUMNS FOR BIOMEDICAL RESEARCH (U.S. CLS. 21, 23, 26, 36 AND 38).

FIRST USE 7-2-2003; IN COMMERCE 7-2-2003.
LESLEY LAMOTHE, EXAMINING ATTORNEY

CLASS 9—(Continued).

SN 78-325,609. MITITECH, LLC, KENSINGTON, MD. FILED 11-10-2003.



NO CLAIM IS MADE TO THE EXCLUSIVE RIGHT TO USE SAFETYDRAPE, APART FROM THE MARK AS SHOWN.

SEC. 2(F) AS TO "SAFETYDRAPE".

FOR SAFETY PRODUCTS, NAMELY, DRAPES FOR BLAST PROTECTION (U.S. CLS. 21, 23, 26, 36 AND 38).

FIRST USE 8-29-2003; IN COMMERCE 8-29-2003.

JOSETTE BEVERLY, EXAMINING ATTORNEY

SN 78-327,283. T L JONES LIMITED, CHRISTCHURCH, NEW ZEALAND, FILED 11-13-2003.

REDZONE

THE MARK CONSISTS OF STANDARD CHARACTERS WITHOUT CLAIM TO ANY PARTICULAR FONT, STYLE, SIZE, OR COLOR.

PRIORITY CLAIMED UNDER SEC. 44(D) ON NEW ZEALAND APPLICATION NO. 703865, FILED 11-3-2003, REG. NO. 703865, DATED 5-6-2004, EXPIRES 11-3-2013.

FOR WATCHMAN'S TIME RECORDERS, NAMELY, A DEVICE FOR RECORDING THE ACTIVITIES OF SECURITY GUARDS TO INSURE THAT THE SECURITY GUARD ARRIVES AT SCHEDULED CHECKPOINTS; SIGNALING BUOYS; SCALES; GAS SENSORS FOR MEASURING GAS CONCENTRATION; LASERS FOR MEASURING PURPOSES; MEASURING APPARATUS, NAMELY, BEVELS; POCKET CALIPERS FOR MEASURING; RADIATION-MEASURING INSTRUMENTS; ELECTRICITY CONDUITS; ELECTRICAL TRANSFORMERS; ELECTRIC SWITCHES; ELECTRIC SWITCH PLATES; VOLTAGE REGULATORS FOR ELECTRIC POWER; ELECTRIC CONTROLLERS (U.S. CLS. 21, 23, 26, 36 AND 38).

CHRISTOPHER ADKINS, EXAMINING ATTORNEY

SN 78-327,780. PERSONAL COMPUTER MEMORY CARD INTERNATIONAL ASSOCIATION, SAN JOSE, CA. FILED 11-13-2003.



FOR MODULAR PERIPHERALS FOR MOBILE AND DESKTOP COMPUTERS AND ADD IN STORAGE AND COMMUNICATIONS CARDS FOR COMPUTERS (U.S. CLS. 21, 23, 26, 36 AND 38).

HOWARD B. LEVINE, EXAMINING ATTORNEY

CLASS 9—(Continued).

SN 78-330,456. VISTA GAMING CORP., GOLDEN, CO. FILED 11-19-2003.

CLASS 9—(Continued).

SN 78-333,930. MONSTER CABLE PRODUCTS, INC., BRISBANE, CA. FILED 11-26-2003.

TICKLED PINK

THE MARK CONSISTS OF STANDARD CHARACTERS WITHOUT CLAIM TO ANY PARTICULAR FONT, STYLE, SIZE, OR COLOR.

FOR CURRENCY AND CREDIT OPERATING GAMING DEVICES, NAMELY SLOT MACHINES AND COMPUTER GAME SOFTWARE THEREFOR (U.S. CLS. 21, 23, 26, 36 AND 38).

ELIZABETH J. WINTER, EXAMINING ATTORNEY

MONSTEROUS

THE MARK CONSISTS OF STANDARD CHARACTERS WITHOUT CLAIM TO ANY PARTICULAR FONT, STYLE, SIZE, OR COLOR.

FOR ELECTRICAL AND ELECTRONIC CONTROL DEVICES, NAMELY ELECTRICAL AND ELECTROMAGNETIC SIGNAL TRANSMITTING AMPLIFYING, RECEIVING, AND CONVERTING DEVICES, NAMELY CABLES, WIRES, CONNECTORS, FOR USE WITH ELECTRICAL, ELECTRONIC, AND COMPUTER DEVICES, NAMELY ELECTRICAL AND ELECTRONIC SIGNAL SWITCHES, ELECTRICAL AND ELECTRONIC SIGNAL SPLITTERS, ELECTRICAL AND ELECTRONIC SIGNAL MULTIPLEXERS, ELECTRICAL AND ELECTRONIC SIGNAL WIRELESS REMOTE CONTROLLERS, AND ELECTRICAL AND ELECTRONIC SIGNAL CONTROLLERS; COMPUTER COMPONENTS AND ACCESSORIES, NAMELY, COMPUTER PERIPHERALS, CD-ROM, AND CONNECTORS, DATA PROCESSING EQUIPMENT, AND ELECTRICAL AND ELECTRONIC CONTROL COMPONENTS AND ACCESSORIES, NAMELY, ELECTRICAL POWER CONDITIONING DEVICES, POWER AMPLIFIERS, VOLTAGE STABILIZING DEVICES, CURRENT STABILIZING DEVICES, ELECTRICAL SURGE PROTECTORS, CIRCUIT CHARGERS, AND CIRCUIT BREAKERS; AUDIO EQUIPMENT AND ACCESSORIES, NAMELY, STEREOS, SPEAKERS, SUB-WOOFERS, POWER AMPLIFIERS, AUDIO SIGNAL EQUALIZERS, DIGITAL MEDIA RECORDERS, AND DIGITAL MEDIA PLAYERS; VIDEO EQUIPMENT AND ACCESSORIES, NAMELY, DIGITAL MEDIA RECORDERS AND DIGITAL MEDIA PLAYERS; AND ELECTRICAL POWER CONTROL COMPONENTS AND ACCESSORIES, NAMELY, POWER CONDITIONERS, POWER CELL RECHARGERS, POWER AMPLIFIERS, VOLTAGE STABILIZERS, CURRENT STABILIZERS, ELECTRICAL SURGE PROTECTORS, CIRCUIT CHARGERS AND CIRCUIT BREAKERS (U.S. CLS. 21, 23, 26, 36 AND 38).

FIRST USE 11-10-1997; IN COMMERCE 11-10-1997.
FLORENTINA BLANDU, EXAMINING ATTORNEY

SN 78-333,218. WORLD EMBLEM INTERNATIONAL, INC., MIAMI, FL. FILED 11-25-2003.

Perfect Print

THE MARK CONSISTS OF STANDARD CHARACTERS WITHOUT CLAIM TO ANY PARTICULAR FONT, STYLE, SIZE, OR COLOR.

NO CLAIM IS MADE TO THE EXCLUSIVE RIGHT TO USE PRINT, APART FROM THE MARK AS SHOWN.

FOR COMPUTER SYSTEM OF COMPUTER HARDWARE AND SOFTWARE FOR COMPUTER AIDED DESIGN AND PRODUCTION OF PATTERNS TO BE APPLIED TO FABRIC FOR USE AS EMBLEMS (U.S. CLS. 21, 23, 26, 36 AND 38).

FIRST USE 9-1-2001; IN COMMERCE 9-1-2001.
ANDREA SAUNDERS, EXAMINING ATTORNEY

CLASS 9—(Continued).

SN 78-337,197. MICROSTRATEGY INCORPORATED, MCLEAN, VA. FILED 12-5-2003.

**MICROSTRATEGY
OFFICE**

THE MARK CONSISTS OF STANDARD CHARACTERS WITHOUT CLAIM TO ANY PARTICULAR FONT, STYLE, SIZE, OR COLOR.

OWNER OF U.S. REG. NOS. 1,908,974 AND 1,959,945.

NO CLAIM IS MADE TO THE EXCLUSIVE RIGHT TO USE OFFICE, APART FROM THE MARK AS SHOWN.

FOR COMPUTER PROGRAMS FOR USE IN ONLINE ANALYTIC PROCESSING, DATA ANALYSIS, REPORTING, AND INFORMATION DELIVERY (U.S. CLS. 21, 23, 26, 36 AND 38).

FIRST USE 12-10-2003; IN COMMERCE 12-10-2003.
SUELLEN HICKEY, EXAMINING ATTORNEY

CLASS 9—(Continued).

SN 78-338,093. KONCEPT INTERNATIONAL, INC., LOS ANGELES, CA. FILED 12-8-2003.



THE COLOR(S) YELLOW AND BLACK IS/ARE CLAIMED AS A FEATURE OF THE MARK.

THE MARK CONSISTS OF A DESIGN AND LETTERS. THE DESIGN IS A STYLIZED LETTER K WITH THE LEFT ERECT LINE AND THE RIGHTWARD STROKE IN BLACK AND THE OTHER LEFTWARD STROKE IN YELLOW. THE LETTERS ARE KONCEPT IN BLACK.

FOR TELEPHONE APPARATUS, NAMELY COMPUTER TELEPHONY SOFTWARE THAT ENABLES TELEPHONE ACTIVITIES TO BE PERFORMED THROUGH A COMPUTER OR DIRECTLY TO INTERNET CONNECTION (U.S. CLS. 21, 23, 26, 36 AND 38).

FIRST USE 1-0-2003; IN COMMERCE 1-0-2003.
JAMES A. RAUEN, EXAMINING ATTORNEY

SN 78-337,201. MICROSTRATEGY INCORPORATED, MCLEAN, VA. FILED 12-5-2003.

MICROSTRATEGY REPORT SERVICES

THE MARK CONSISTS OF STANDARD CHARACTERS WITHOUT CLAIM TO ANY PARTICULAR FONT, STYLE, SIZE, OR COLOR.

OWNER OF U.S. REG. NOS. 1,908,974 AND 1,959,945.

NO CLAIM IS MADE TO THE EXCLUSIVE RIGHT TO USE "REPORT SERVICES", APART FROM THE MARK AS SHOWN.

FOR COMPUTER PROGRAMS FOR USE IN ONLINE ANALYTIC PROCESSING, DATA ANALYSIS, REPORTING, AND INFORMATION DELIVERY (U.S. CLS. 21, 23, 26, 36 AND 38).

FIRST USE 12-10-2003; IN COMMERCE 12-10-2003.
SUELLEN HICKEY, EXAMINING ATTORNEY

SN 78-338,972. FISHER SCIENTIFIC COMPANY L.L.C., HAMPTON, NH. FILED 12-10-2003.

POWERGEN

THE MARK CONSISTS OF STANDARD CHARACTERS WITHOUT CLAIM TO ANY PARTICULAR FONT, STYLE, SIZE, OR COLOR.

FOR LABORATORY EQUIPMENT, NAMELY, HOMOGENIZERS, FOR CHEMICALLY OR PHYSICALLY DISPERSING SUBSTANCES, FOR CELL DISRUPTION AND FOR TISSUE HOMOGENIZATION, SOLD TOGETHER AS A UNIT WITH PROBES THEREFOR (U.S. CLS. 21, 23, 26, 36 AND 38).

FIRST USE 0-0-1995; IN COMMERCE 0-0-1995.
MARY BOAGNI, EXAMINING ATTORNEY

CLASS 9—(Continued).

SN 78-339,329. PAR NUCLEAR, INC., SHOREVIEW, MN. FILED 12-11-2003.

CLASS 9—(Continued).

SN 78-340,194. INSTITUE FOR HUMAN AND MACHINE COGNITION BY AND ON BEHALF OF THE UNIVERSITY OF WEST FLORIDA BOARD OF TRUSTEES, PENSACOLA, FL. FILED 12-12-2003.

FUELNET

CMAP TOOLS

THE MARK CONSISTS OF STANDARD CHARACTERS WITHOUT CLAIM TO ANY PARTICULAR FONT, STYLE, SIZE, OR COLOR.

FOR AUTOMATED NUCLEAR FUEL MACHINE FOR MONITORING AND FACILITATING REFUELING OF NUCLEAR FUEL DURING REFUELING OUTAGES (U.S. CLS. 21, 23, 26, 36 AND 38).

FIRST USE 12-3-2003; IN COMMERCE 12-3-2003.
TONI HICKEY, EXAMINING ATTORNEY

THE MARK CONSISTS OF STANDARD CHARACTERS WITHOUT CLAIM TO ANY PARTICULAR FONT, STYLE, SIZE, OR COLOR.

NO CLAIM IS MADE TO THE EXCLUSIVE RIGHT TO USE "TOOLS", APART FROM THE MARK AS SHOWN, FOR SOFTWARE, NAMELY SOFTWARE FOR CONSTRUCTING AND MANIPULATING KNOWLEDGE MODELS (U.S. CLS. 21, 23, 26, 36 AND 38).

FIRST USE 9-1-1998; IN COMMERCE 6-1-2001.
INGA ERVIN, EXAMINING ATTORNEY

SN 78-340,042. COMPUTRONIX (OVERSEAS) LIMITED, LARNACA, CYPRUS, FILED 12-12-2003.

SN 78-343,768. KIWI-TEK,LLC, CARMEL, IN. FILED 12-19-2003.

SUPERCLASS

CODEREADY

THE MARK CONSISTS OF STANDARD CHARACTERS WITHOUT CLAIM TO ANY PARTICULAR FONT, STYLE, SIZE, OR COLOR.

FOR COMPUTER SOFTWARE, NAMELY, SOFTWARE TOOLS AND OBJECTS LIBRARIES USED TO CREATE COMPUTER APPLICATIONS (U.S. CLS. 21, 23, 26, 36 AND 38).

KAREN K. BUSH, EXAMINING ATTORNEY

THE MARK CONSISTS OF STANDARD CHARACTERS WITHOUT CLAIM TO ANY PARTICULAR FONT, STYLE, SIZE, OR COLOR.

FOR COMPUTER SOFTWARE DEVICE FOR READING ELECTRONIC TEXT OF PATIENT MEDICAL RECORDS, INTERPRETING ELECTRONIC TEXT OF MEDICAL RECORDS, AND ASSIGNING MEDICAL CODES TO PATIENT RECORDS (U.S. CLS. 21, 23, 26, 36 AND 38).

FIRST USE 3-1-2004; IN COMMERCE 3-1-2004.
BERYL GARDNER, EXAMINING ATTORNEY

CLASS 9—(Continued).

SN 78-344,177. ASN, INC., WESTMONT, IL. FILED 12-22-2003.

LynxIT Solution

THE MARK CONSISTS OF STANDARD CHARACTERS WITHOUT CLAIM TO ANY PARTICULAR FONT, STYLE, SIZE, OR COLOR.

FOR COMPUTER SOFTWARE PRODUCTS, NAMELY, COMPUTER SOFTWARE FOR MEDICAL BILLING (U.S. CLS. 21, 23, 26, 36 AND 38).

FIRST USE 12-22-2003; IN COMMERCE 12-22-2003.
NANCY CLARKE, EXAMINING ATTORNEY



SN 78-352,672. INJURY SCIENCES LLC, SAN ANTONIO, TX. FILED 1-15-2004.

EDR INSIGHT

THE MARK CONSISTS OF STANDARD CHARACTERS WITHOUT CLAIM TO ANY PARTICULAR FONT, STYLE, SIZE, OR COLOR.

NO CLAIM IS MADE TO THE EXCLUSIVE RIGHT TO USE "EDR", APART FROM THE MARK AS SHOWN.

FOR COMPUTER SOFTWARE FOR HARVESTING RESOURCES AND ENGINEERING ANALYSIS OF VEHICULAR ACCIDENT EVENT DATA RECORDED FROM PASSENGER AND COMMERCIAL VEHICLES TO AID IN THE EVALUATION AND INVESTIGATION OF THE ACCIDENT (U.S. CLS. 21, 23, 26, 36 AND 38).

FIRST USE 1-13-2004; IN COMMERCE 1-13-2004.
ZACHARY BELLO, EXAMINING ATTORNEY

CLASS 9—(Continued).

SN 78-354,340. LIEBLEIN, COREY, PORT WASHINGTON, NY. FILED 1-20-2004.

IT.

THE MARK CONSISTS OF STANDARD CHARACTERS WITHOUT CLAIM TO ANY PARTICULAR FONT, STYLE, SIZE, OR COLOR.

FOR CONSUMER ELECTRONICS, NAMELY AUDIO AND VIDEO DEVICES IN THE NATURE OF TELEVISIONS, HOME THEATRE SYSTEMS COMPRISING OF RADIOS, CD PLAYERS, DVD PLAYERS, CASSETTE PLAYERS; DVD PLAYERS, DIGITAL AND PORTABLE AUDIO DEVICES, NAMELY, STEREO, CD PLAYERS, RADIOS, TV WITH ATTACHED LANTERN, RADIO, COMPASS, AND THERMOMETER; TABLETOP AUDIO AND VIDEO DEVICES, NAMELY RADIOS, CASSETTE PLAYERS AND CD PLAYERS (U.S. CLS. 21, 23, 26, 36 AND 38).

FIRST USE 1-1-2004; IN COMMERCE 6-1-2004.
ANN E. SAPPENFIELD, EXAMINING ATTORNEY



SN 78-355,293. V, INC., FOUNTAIN VALLEY, CA. FILED 1-21-2004.



THE MARK CONSISTS OF A STYLIZED LETTER V. FOR TELEVISIONS, LCD TELEVISIONS, PLASMA TELEVISIONS, COMPUTER MONITORS AND DVD PLAYERS (U.S. CLS. 21, 23, 26, 36 AND 38).

FIRST USE 11-1-2003; IN COMMERCE 11-1-2003.
BRIDGETT SMITH, EXAMINING ATTORNEY

CLASS 9—(Continued).

SN 78-358,914. PENTEK, UPPER SADDLE RIVER, NJ. FILED 1-28-2004.

RTS

THE MARK CONSISTS OF STANDARD CHARACTERS WITHOUT CLAIM TO ANY PARTICULAR FONT, STYLE, SIZE, OR COLOR.

FOR COMPUTER SYSTEMS COMPRISED OF COMPUTER HARDWARE AND SOFTWARE FEATURING A LIBRARY OF C-LANGUAGE COMPUTER PROGRAMMING FUNCTIONS FOR USE BY SOFTWARE DEVELOPERS TO IMPROVE DIGITAL SIGNAL PROCESSING AND DATA ACQUISITION COMPUTER SYSTEM DEVELOPMENT TIME (U.S. CLS. 21, 23, 26, 36 AND 38).

FIRST USE 8-1-2003; IN COMMERCE 8-1-2003.
LAURA KOVAISKY, EXAMINING ATTORNEY

CLASS 9—(Continued).

SN 78-362,668. SIERRA INSTRUMENTS, INC., MONTEREY, CA. FILED 2-4-2004.

**SIERRA
INSTRUMENTS, INC.
THE MASS FLOW
COMPANY**

THE MARK CONSISTS OF STANDARD CHARACTERS WITHOUT CLAIM TO ANY PARTICULAR FONT, STYLE, SIZE, OR COLOR.

NO CLAIM IS MADE TO THE EXCLUSIVE RIGHT TO USE "INSTRUMENTS, INC." AND "THE MASS FLOW COMPANY", APART FROM THE MARK AS SHOWN.

FOR MASS FLOW METERS AND ELECTRIC CONTROLLERS FOR MEASURING AIR AND GAS (U.S. CLS. 21, 23, 26, 36 AND 38).

FIRST USE 1-31-1998; IN COMMERCE 1-31-1998.
LINDA M. KING, EXAMINING ATTORNEY

SN 78-361,729. LITTLE CEDAR STUDIO, INC., WEST BEND, WI. FILED 2-3-2004.



NO CLAIM IS MADE TO THE EXCLUSIVE RIGHT TO USE NATURE SERIES, APART FROM THE MARK AS SHOWN.

FOR PRE-RECORDED CDS, DVDS, AND VIDEO TAPES FEATURING MUSIC AND RELAXATION SOUND RECORDINGS (U.S. CLS. 21, 23, 26, 36 AND 38).

FIRST USE 1-3-2004; IN COMMERCE 1-20-2004.
JIM RINGLE, EXAMINING ATTORNEY

SN 78-364,960. SONICCOMFORT LTD., DALLAS, TX. FILED 2-9-2004.

SONICCOMFORT

THE MARK CONSISTS OF STANDARD CHARACTERS WITHOUT CLAIM TO ANY PARTICULAR FONT, STYLE, SIZE, OR COLOR.

FOR WIRELESS AUDIO SPEAKER SYSTEMS COMPRISED OF A TRANSMITTER, RECEIVER, AND SPEAKERS (U.S. CLS. 21, 23, 26, 36 AND 38).

STEPHANIE DAVIS, EXAMINING ATTORNEY

CLASS 9—(Continued).

SN 78-365,160. AMITY SYSTEMS, INC., SAN JOSE, CA.
FILED 2-9-2004.

CLASS 9—(Continued).

SN 78-368,652. CHINA UNIONPAY CO., LTD., SHANGHAI,
CHINA, FILED 2-16-2004.

MARS

THE MARK CONSISTS OF STANDARD CHARACTERS WITHOUT CLAIM TO ANY PARTICULAR FONT, STYLE, SIZE, OR COLOR.

FOR SOFTWARE FOR STREAMING VOICE-OVER IP WEB, VIDEO, AND AUDIO CONFERENCING SOFTWARE FOR USE WITH DESK TOP COMPUTERS (U.S. CLS. 21, 23, 26, 36 AND 38).

RONALD AIKENS, EXAMINING ATTORNEY

SN 78-366,289. INDUSTRIAL LOGIC CORPORATION, DBA ILC, ATLANTA, GA. FILED 2-11-2004.

DOMINION

THE MARK CONSISTS OF STANDARD CHARACTERS WITHOUT CLAIM TO ANY PARTICULAR FONT, STYLE, SIZE, OR COLOR.

OWNER OF U.S. REG. NO. 2,832,082.

FOR COMPUTER HARDWARE AND COMPUTER SOFTWARE FOR MONITORING, SCHEDULING AND CONTROLLING NETWORK TELECOMMUNICATIONS EQUIPMENT, NAMELY, BROADCAST, CABLE AND SATELLITE NETWORK TELECOMMUNICATIONS EQUIPMENT (U.S. CLS. 21, 23, 26, 36 AND 38).

FIRST USE 11-0-2001; IN COMMERCE 11-0-2001.

ANN LINNEHAN, EXAMINING ATTORNEY

CUP

THE MARK CONSISTS OF STANDARD CHARACTERS WITHOUT CLAIM TO ANY PARTICULAR FONT, STYLE, SIZE, OR COLOR.

FOR COMPUTER SOFTWARE, NAMELY, DATA ENCRYPTION SOFTWARE FOR SECURE DATA STORAGE AND RETRIEVAL AND TRANSMISSION OF CONFIDENTIAL CUSTOMER INFORMATION USED BY INDIVIDUALS, BANKING AND FINANCIAL INSTITUTIONS; BANKING SOFTWARE FOR USE IN INTER-BANK BANK CARD INFORMATION SWITCH AND INTERCHANGE SYSTEMS; BANKING SOFTWARE FOR USE IN ENABLING BANK CARDS OR SMART CARDS TO INTERACT WITH TERMINALS AND CARD READERS; ELECTRONIC DEVICES, NAMELY, COMPUTER HARDWARE IN THE NATURE OF ENCRYPTION KEYS FOR USE IN CREATING DIGITAL CERTIFICATES AND DIGITAL SIGNATURES; DEVICES, NAMELY, CARD READERS FOR READING CARDS AND READING INFORMATION STORED IN COMPUTER CHIPS; DOWNLOADABLE ELECTRONIC PUBLICATIONS IN THE NATURE OF PAMPHLETS, BROCHURES, NEWSLETTERS, JOURNALS AND MAGAZINES FEATURING INFORMATION ABOUT FINANCIAL AND BANKING SERVICES; MAGNETICALLY ENCODED CHARGE CARDS, BANK CARDS, CREDIT CARDS, DEBIT CARDS, PAYMENT CARDS, INTEGRATED CIRCUIT CARDS, NAMELY, BLANK SMART CARDS AND MAGNETIC IDENTITY CARDS AND CARD READERS AND OTHER ELECTRONIC APPARATUS, NAMELY, COMPUTER DIAL TERMINALS, FOR VERIFYING THE AUTHENTICITY OF SUCH CARDS FOR USE THEREWITH; CASH REGISTERS; AUTOMATIC VENDING MACHINES; AUTOMATIC TICKET DISPENSERS; AUTOMATED TELLER MACHINES; COMPUTERIZED POINT-OF-SALE MACHINES FOR USE AS STAND ALONE UNITS TO TALLY SALES; MONEY COUNTING AND AUTOMATED PAPER MONEY SORTING MACHINES; AND FALSE COIN DETECTORS (U.S. CLS. 21, 23, 26, 36 AND 38).

AMOS T. MATTHEWS, JR., EXAMINING ATTORNEY

CLASS 9—(Continued).

SN 78-370,863. PORVAIR SCIENCES LIMITED, SHEPPER-
TON, MIDDLESEX, UNITED KINGDOM, FILED 2-19-
2004.

TRISEAL

THE MARK CONSISTS OF STANDARD CHARACTERS
WITHOUT CLAIM TO ANY PARTICULAR FONT, STYLE,
SIZE, OR COLOR.

PRIORITY CLAIMED UNDER SEC. 44(D) ON UNITED
KINGDOM APPLICATION NO. 2356335, FILED 2-19-2004,
REG. NO. 2356335, DATED 7-16-2004, EXPIRES 2-19-2014.

FOR HEAT SEALING MACHINES WHICH HEAT
SEAL FILM OR FOIL TO A MICROPLATE, LABORA-
TORY HEAT SEALING EQUIPMENT, NAMELY, HEAT
SEALING MACHINES FOR HEAT SEALING FILM OR
FOIL TO A MICROPLATE, GOODS FOR HEAT-SEAL-
ING FILM TO MICROPLATES, NAMELY HEAT SEAL-
ING MACHINES WHICH HEAT SEAL FILM OR FOIL TO
A MICROPLATE (U.S. CLS. 21, 23, 26, 36 AND 38).

KATHRYN COWARD, EXAMINING ATTORNEY

CLASS 9—(Continued).

SN 78-372,655. JABLONSKI, XAVIER ANDREW, NEWPORT,
VICTORIA 3015, AUSTRALIA, FILED 2-23-2004.

i.FOS

THE MARK CONSISTS OF STANDARD CHARACTERS
WITHOUT CLAIM TO ANY PARTICULAR FONT, STYLE,
SIZE, OR COLOR.

FOR CONTROLLERS AND LIGHT GUIDE TUBING
FOR NOVELTY DEVICES, NAMELY ILLUMINATED
BAND, STRAPS AND STRIPS FOR AUDIO ENTERTAIN-
MENT; PLAY ARTICLES, NAMELY, SOUND SENSITIVE
ILLUMINATED BANDS, STRAPS AND STRIPS (U.S.
CLS. 21, 23, 26, 36 AND 38).

EVELYN BRADLEY, EXAMINING ATTORNEY

SN 78-371,467. CORNERSTONE INFORMATION SYSTEMS,
INC., BLOOMINGTON, IN. FILED 2-20-2004.

IQCX

THE MARK CONSISTS OF STANDARD CHARACTERS
WITHOUT CLAIM TO ANY PARTICULAR FONT, STYLE,
SIZE, OR COLOR.

OWNER OF U.S. REG. NO. 2,282,411.

FOR COMPUTER SOFTWARE FOR THE TRAVEL
INDUSTRY, NAMELY, AUTOMATED QUALITY CON-
TROL AND PRODUCTIVITY ENHANCEMENT SOFT-
WARE (U.S. CLS. 21, 23, 26, 36 AND 38).

MICHAEL HALL, EXAMINING ATTORNEY

SN 78-374,230. MOORE, JAMES S., FORT COLLINS, CO.
FILED 2-25-2004.

Rhythm Rulz

THE MARK CONSISTS OF STANDARD CHARACTERS
WITHOUT CLAIM TO ANY PARTICULAR FONT, STYLE,
SIZE, OR COLOR.

NO CLAIM IS MADE TO THE EXCLUSIVE RIGHT TO
USE "RHYTHM", APART FROM THE MARK AS SHOWN.

FOR COMPUTER SOFTWARE FOR MUSIC EDUCA-
TION (U.S. CLS. 21, 23, 26, 36 AND 38).

NAKWAMA ANKRAH, EXAMINING ATTORNEY

CLASS 9—(Continued).

SN 78-375,267. NEXANS, PARIS, FRANCE, FILED 2-27-2004.

XGLAN

THE MARK CONSISTS OF STANDARD CHARACTERS WITHOUT CLAIM TO ANY PARTICULAR FONT, STYLE, SIZE, OR COLOR.

FOR COPPER AND OPTICAL FIBER CABLES, COPPER AND OPTICAL FIBER CONNECTING DEVICES, NAMELY, CONNECTORS, PATCH CORDS, OPTICAL FIBER TERMINATION DEVICES; AND CABLING SYSTEMS FOR TRANSMITTING DATA ON LOCAL AREA NETWORKS, NAMELY, TWISTED PAIR LOCAL AREA NETWORK CABLES, OPTICAL FIBER LOCAL AREA NETWORK CABLES, CONNECTORS, PATCH CORDS AND OPTICAL FIBER TERMINATION DEVICES (U.S. CLS. 21, 23, 26, 36 AND 38).

CURTIS FRENCH, EXAMINING ATTORNEY

SN 78-376,162. ELECTRONICS FOR IMAGING, INC., FOSTER CITY, CA. FILED 3-1-2004.

efi

FOR COMPUTER SOFTWARE FOR IMAGE PROCESSING AND IMAGE EDITING, COMPUTER SOFTWARE FOR CREATING GRAPHICS, COMPUTER SOFTWARE FOR NETWORKED PRINTING, COMPUTER SOFTWARE FOR PRINTING SERVICES, COMPUTER SOFTWARE FOR ACCOUNTING; COMPUTER SOFTWARE TO CONTROL PRINTING SYSTEMS; COMPUTER SOFTWARE FOR RENDING ACCURATE COLOR TRANSFER AND REPRODUCTION IN THE FIELD OF PRINTING AND PUBLISHING; COMMUNICATIONS NETWORK SERVERS, RASTER IMAGE PROCESSORS, PRINTERS; PRINTER CONTROLLERS AND INTERPRETERS, PHOTOCOPIERS AND ADD-ON CONTROLLERS FOR PHOTOCOPIERS, SCANNERS, SCANNER CONTROLLERS, COMPUTER HARDWARE, COMPUTER FIRMWARE FOR PRINTING SERVICES, AND COMPUTER PERIPHERALS (U.S. CLS. 21, 23, 26, 36 AND 38).

DEZMONA MIZELLE, EXAMINING ATTORNEY

CLASS 9—(Continued).

SN 78-376,334. MAKIBILITY USA LLC., MORRISVILLE, NC. FILED 3-1-2004.



X-SHIELD
Xtreme Auto Protection

NO CLAIM IS MADE TO THE EXCLUSIVE RIGHT TO USE "AUTO PROTECTION", APART FROM THE MARK AS SHOWN.

THE MARK CONSISTS OF A SHIELD WITH A ARMOR SIGN.

FOR SECURITY SYSTEM AND PARTS FOR AUTOMOTIVE USE, NAMELY, CAR ALARM, AND/OR MOTORCYCLE ALARM AND TRANSPONDER BYPASS KIT (U.S. CLS. 21, 23, 26, 36 AND 38).

FIRST USE 1-12-2004; IN COMMERCE 1-12-2004.

PAULA MAYS, EXAMINING ATTORNEY

SN 78-378,464. COMPUTER ASSOCIATES THINK, INC., ISLANDIA, NY. FILED 3-4-2004.

ETRUST EZ ANTI-SPAM

THE MARK CONSISTS OF STANDARD CHARACTERS WITHOUT CLAIM TO ANY PARTICULAR FONT, STYLE, SIZE, OR COLOR.

OWNER OF U.S. REG. NOS. 2,637,917, 2,775,966 AND 2,900,582.

NO CLAIM IS MADE TO THE EXCLUSIVE RIGHT TO USE "EZ" AND "ANTI-SPAM", APART FROM THE MARK AS SHOWN.

FOR COMPUTER SOFTWARE THAT FILTERS, SEGREGATES AND MANAGES INCOMING ELECTRONIC MAIL (U.S. CLS. 21, 23, 26, 36 AND 38).

HEATHER THOMPSON, EXAMINING ATTORNEY

CLASS 9—(Continued).

SN 78-378,555. DYNAMIC IMAGING, INC., ALLENDALE, NJ. FILED 3-4-2004.

CLASS 9—(Continued).

SN 78-379,454. INTERCIM, INC., BURNSVILLE, MN. FILED 3-5-2004.

INTEGRADWEB



THE MARK CONSISTS OF STANDARD CHARACTERS WITHOUT CLAIM TO ANY PARTICULAR FONT, STYLE, SIZE, OR COLOR.

FOR COMPUTER HARDWARE, NAMELY, INTERNET SERVERS; COMPUTER SOFTWARE, NAMELY, DATABASE MANAGEMENT SOFTWARE, IMAGE COMPRESSION SOFTWARE AND DATA TRANSFER SOFTWARE FOR USE IN RADIOLOGY IMAGE MANAGEMENT AND DISTRIBUTION (U.S. CLS. 21, 23, 26, 36 AND 38).
RONALD AIKENS, EXAMINING ATTORNEY

FOR COMPUTER SOFTWARE FOR THE ELECTRONIC DELIVERY OF WORK INSTRUCTIONS, PROCEDURAL CONTROL AND PROCESS EXECUTION OF WORK ORDERS FOR PRE-FIELD FAILURE QUALITY MANAGEMENT, STATISTICAL PROCESS CONTROL AND NON-CONFORMANCE MANAGEMENT (U.S. CLS. 21, 23, 26, 36 AND 38).
ANDREA SAUNDERS, EXAMINING ATTORNEY

SN 78-378,675. GEOVARIANCES, 77212 AVON CEDEX, FRANCE, FILED 3-4-2004.

SN 78-379,733. TRACEABILITY SYSTEM ARCHITECTS, INC., NEWTON, MA. FILED 3-5-2004.

GEOVARIANCES

PRODUCT GENOME

THE MARK CONSISTS OF STANDARD CHARACTERS WITHOUT CLAIM TO ANY PARTICULAR FONT, STYLE, SIZE, OR COLOR.

FOR COMPUTER SOFTWARE IN THE FIELD OF GEOSTATISTICS FOR USE BY THE OIL, GAS AND MINING INDUSTRIES FOR RESOURCE EVALUATION, NAMELY, RECORDING, PROCESSING, AND ANALYZING DATA RELATING TO THE QUALITY, QUANTITY AND LOCATION OF NATURAL RESOURCES, AUTOMATIC CARTOGRAPHY, AND RISK ANALYSIS, NAMELY, RECORDING, PROCESSING AND ANALYZING DATA RELATING TO COSTS, PROBABLE RETURNS, AND FEASIBILITY OF PROSPECTIVE OIL, GAS AND MINING OPERATIONS, AND COMPUTER SOFTWARE FOR USE BY THE OIL, GAS AND MINING INDUSTRIES FOR ENVIRONMENTAL STUDIES, NAMELY, RECORDING, PROCESSING AND ANALYZING DATA RELATING TO THE EFFECTS OF OIL, GAS AND MINING OPERATIONS ON THE ENVIRONMENT AND POTENTIAL POLLUTION AND RESOURCE DEPLETION CAUSED BY SUCH OPERATIONS; INSTRUCTIONAL COMPUTER SOFTWARE IN THE FIELD OF GEOSTATISTICS (U.S. CLS. 21, 23, 26, 36 AND 38).
CHRISIE B. KING, EXAMINING ATTORNEY

THE MARK CONSISTS OF STANDARD CHARACTERS WITHOUT CLAIM TO ANY PARTICULAR FONT, STYLE, SIZE, OR COLOR.
NO CLAIM IS MADE TO THE EXCLUSIVE RIGHT TO USE "PRODUCT", APART FROM THE MARK AS SHOWN.
FOR COMPUTER PROGRAMS FOR USE IN COLLECTING, MANAGING AND MONITORING GOODS THROUGHOUT THE STAGES OF ENGINEERING, MANUFACTURING, DISTRIBUTION, INSTALLATION AND USAGE (U.S. CLS. 21, 23, 26, 36 AND 38).
MELVIN AXILBUND, EXAMINING ATTORNEY

CLASS 9—(Continued).

SN 78-380,801. ADC INCORPORATED, CENTENNIAL, CO. FILED 3-9-2004.



THE COLOR(S) RED, BLACK AND WHITE IS/ARE CLAIMED AS A FEATURE OF THE MARK.

THE LETTERS CU APPEAR IN WHITE WITHIN A RED BACKGROUND OUTLINED IN BLACK NEXT TO THE NUMERAL 10 IN BLACK.

FOR ELECTRICAL WIRE, ELECTRICAL CABLE, AND ELECTRICAL CONNECTORS. (U.S. CLS. 21, 23, 26, 36 AND 38).

BRETT J. GOLDEN, EXAMINING ATTORNEY

CLASS 9—(Continued).

SN 78-382,718. LAUNCHLAB, LOS ANGELES, CA. FILED 3-11-2004.



FOR FILM AND VIDEO CAMERA ACCESSORIES, NAMELY, CARRYING CASES, LENS SHADES, FILTER HOLDERS (U.S. CLS. 21, 23, 26, 36 AND 38).

AMY GEARIN, EXAMINING ATTORNEY

SN 78-382,864. STEIGER, DEAN, NEW HAVEN, MO. FILED 3-11-2004.

SN 78-381,481. MARGIN MAXIMIZER GROUP, INC., DBA "US BANKING ALLIANCE", ATLANTA, GA. FILED 3-10-2004.

RelationshipManage
r

THE MARK CONSISTS OF STANDARD CHARACTERS WITHOUT CLAIM TO ANY PARTICULAR FONT, STYLE, SIZE, OR COLOR.

FOR COMPUTER SOFTWARE TO ASSIST LENDERS IN PRICING CONSUMER, COMMERCIAL, COMMERCIAL REAL ESTATE, COMMERCIAL AND RESIDENTIAL CONSTRUCTION, AND AGRICULTURAL LOANS AND LINES OF CREDIT (U.S. CLS. 21, 23, 26, 36 AND 38).

FIRST USE 7-1-2001; IN COMMERCE 7-1-2001.
IRA J. GOODSaid, EXAMINING ATTORNEY

EngineMaxx

THE MARK CONSISTS OF STANDARD CHARACTERS WITHOUT CLAIM TO ANY PARTICULAR FONT, STYLE, SIZE, OR COLOR.

FOR FUEL RAIL CONTROLS FOR DIESEL ENGINES IN THE NATURE OF CHECK VALVES AND PRESSURE VALVES FOR CONTROLLING FUEL (U.S. CLS. 21, 23, 26, 36 AND 38).

HENRY S. ZAK, EXAMINING ATTORNEY

CLASS 9—(Continued).

SN 78-385,030. CALLPOD, INC., CHICAGO, IL. FILED 3-16-2004.



THE COLOR(S) GREEN AND BLACK IS/ARE CLAIMED AS A FEATURE OF THE MARK.

THE COLOR GREEN APPEARS IN THE LETTER "O" AND THE COLOR BLACK APPEARS IN THE LETTERS "CALLP" AND "D" IN THE MARK.

FOR WIRELESS AND CELLULAR TELEPHONE CONFERENCING DEVICE, NAMELY, WIRELESS AUDIO AND VIDEO TRANSMITTER AND RECEIVER THAT ENABLES WIRELESS AND CELLULAR TELEPHONES TO CONDUCT CONFERENCE CALLS WITH MORE THAN ONE CALLER AT A TIME (U.S. CLS. 21, 23, 26, 36 AND 38).

FIRST USE 6-7-2001; IN COMMERCE 6-7-2001.
ANDREA K. NADELMAN, EXAMINING ATTORNEY

CLASS 9—(Continued).

SN 78-388,213. HENDERSON, BARBARA, TORONTO, ONTARIO, CANADA, FILED 3-22-2004.

SUITESCRIPTS

THE MARK CONSISTS OF STANDARD CHARACTERS WITHOUT CLAIM TO ANY PARTICULAR FONT, STYLE, SIZE, OR COLOR.

PRIORITY CLAIMED UNDER SEC. 44(D) ON CANADA APPLICATION NO. 1191369, FILED 9-22-2003, REG. NO. TMA639179, DATED 5-5-2005, EXPIRES 5-5-2020.

FOR COMPUTER SOFTWARE, NAMELY SOFTWARE FOR USE IN THE MANAGEMENT OF WEB-SITE CONTENT AND DATABASES ON THE WEB-SITE, AND SOFTWARE WHICH ENABLES USERS TO MANAGE DATA AND INFORMATION; WEB-SITE PAGE TEMPLATES, NAMELY SOFTWARE APPLICATIONS WHICH ENABLE USERS TO ENTER, STORE, ACCESS, SHARE, SAVE, AND MANAGE DATA AND INFORMATION ON A WEB-SITE (U.S. CLS. 21, 23, 26, 36 AND 38).

BARBARA A. LOUGHRAN, EXAMINING ATTORNEY

SN 78-385,103. LASH'S LESSONS, LLC, SCIENCE HILL, KY. FILED 3-16-2004.

CAPTAIN DOODLE DOO

THE MARK CONSISTS OF STANDARD CHARACTERS WITHOUT CLAIM TO ANY PARTICULAR FONT, STYLE, SIZE, OR COLOR.

FOR SOUND, VIDEO AND DATA RECORDINGS, NAMELY, PRE-RECORDED CHILDREN'S AUDIO CASSETTE TAPES, VIDEO TAPES, DVDS, COMPACT DISCS, SOUND RECORDINGS AND VIDEO RECORDINGS (U.S. CLS. 21, 23, 26, 36 AND 38).

DAWN HAN, EXAMINING ATTORNEY

SN 78-389,575. TWENTIETH CENTURY FOX FILM CORPORATION, LOS ANGELES, CA. FILED 3-23-2004.

SN 78-387,870. ATMOS PICTURES, INC, LOS ANGELES, CA. FILED 3-19-2004.



FOR PRERECORDED DVDS, CD-ROMS, DIGITAL AUDIO, VIDEO TAPES AND DISCS FEATURING MUSIC, STILL OR MOVING GRAPHIC IMAGES AND COLOR, DESIGNED TO CREATE ATMOSPHERE OR PROMOTE RELAXATION OR WELL BEING (U.S. CLS. 21, 23, 26, 36 AND 38).

FIRST USE 9-5-2004; IN COMMERCE 9-5-2004.
DAVID TAYLOR, EXAMINING ATTORNEY



FOR COMPUTER MOUSE PADS (U.S. CLS. 21, 23, 26, 36 AND 38).

MARY ROSSMAN, EXAMINING ATTORNEY

CLASS 9—(Continued).

SN 78-391,178. BAEDER CORPORATION, PROVIDENCE, RI. FILED 3-26-2004.

CLASS 9—(Continued).

SN 78-391,681. LEVITON MANUFACTURING CO., INC., LITTLE NECK, NY. FILED 3-26-2004.

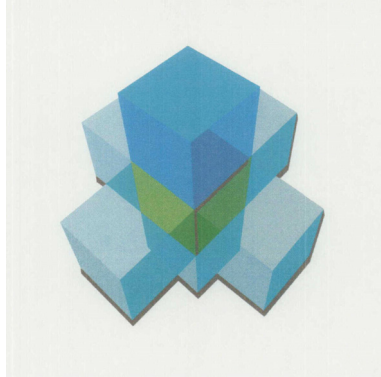

THE COLORS BLUE AND GREEN ARE CLAIMED AS A FEATURE OF THE MARK.

THE COLOR GREEN APPEARS ON THE FACES OF A RECTANGULAR PRISM IN THE CENTER OF THE MARK. THE COLOR BLUE APPEARS ON THE FACES OF OTHER RECTANGULAR PRISMS SURROUNDING THE GREEN RECTANGULAR PRISM.

THE MARK CONSISTS OF A DESIGN OF OVERLAPPING BOXES.

FOR ENTERPRISE SOFTWARE FOR DATABASE MANAGEMENT, WORK FLOW, INTEGRATION AND COMMUNICATIONS (U.S. CLS. 21, 23, 26, 36 AND 38).

FIRST USE 6-27-2002; IN COMMERCE 6-27-2002.

STEVEN R. FINE, EXAMINING ATTORNEY

DIMENSIONS

SN 78-391,181. BAEDER CORPORATION, PROVIDENCE, RI. FILED 3-26-2004.

OpenBOX

THE MARK CONSISTS OF STANDARD CHARACTERS WITHOUT CLAIM TO ANY PARTICULAR FONT, STYLE, SIZE, OR COLOR.

FOR ENTERPRISE SOFTWARE FOR DATABASE MANAGEMENT, WORK FLOW, INTEGRATION AND COMMUNICATIONS (U.S. CLS. 21, 23, 26, 36 AND 38).

FIRST USE 6-27-2002; IN COMMERCE 6-27-2002.

STEVEN R. FINE, EXAMINING ATTORNEY

THE MARK CONSISTS OF STANDARD CHARACTERS WITHOUT CLAIM TO ANY PARTICULAR FONT, STYLE, SIZE, OR COLOR.

OWNER OF U.S. REG. NO. 2,790,312.

FOR ELECTRIC SWITCH BOARDS AND PANELS, BUILT-IN LIQUID CRYSTAL LIGHTING CONTROL DISPLAYS AND ELECTRIC CONSOLES, ALL FOR CONTROLLING LIGHTING LEVELS FROM INCANDESCENT AND DISCHARGE LIGHTING SOURCES IN THEATER, TELEVISION, MOTION PICTURE, ARCHITECTURAL, COMMERCIAL AND INDUSTRIAL APPLICATIONS AND PROGRAMMABLE ELECTRIC CONTROLLERS AND WIRELESS REMOTE CONTROLS THEREFOR; AND COMPUTER NETWORK WIRING HARDWARE, NAMELY, ELECTRIC SWITCHES, JACKS AND ELECTRIC LIGHTING CONTROLS, ALL FOR CONTROLLING LIGHTING LEVELS FROM INCANDESCENT AND DISCHARGE LIGHTING SOURCES IN THEATER, TELEVISION, MOTION PICTURE, ARCHITECTURAL, COMMERCIAL AND INDUSTRIAL APPLICATIONS (U.S. CLS. 21, 23, 26, 36 AND 38).

FIRST USE 12-7-1984; IN COMMERCE 12-7-1984.

MARC LEIPZIG, EXAMINING ATTORNEY

CLASS 9—(Continued).

SN 78-392,347. INTELLITOOLS, INC., PETALUMA, CA. FILED 3-29-2004.

CLASS 9—(Continued).

SN 78-393,231. INFINEER, LTD., BANGOR, NORTHERN IRELAND, FILED 3-30-2004.

INTELLITOOLS

CHIPNET3

THE MARK CONSISTS OF STANDARD CHARACTERS WITHOUT CLAIM TO ANY PARTICULAR FONT, STYLE, SIZE, OR COLOR.

OWNER OF U.S. REG. NO. 1,838,992.

FOR EDUCATIONAL COMPUTER SOFTWARE FOR USE IN CONNECTION WITH K-6 STUDENTS AND SEVERELY PHYSICALLY CHALLENGED COMPUTER USERS, NAMELY, COMPUTER SOFTWARE FOR CREATING CUSTOM KEYBOARD CONFIGURATIONS, COMPUTER SOFTWARE FOR CREATING GRAPHIC WORKS, COMPUTER SOFTWARE FOR WORD PROCESSING WITH VOICE OUTPUT CAPABILITY, COMPUTER SOFTWARE FOR USE IN TEACHING MULTIPLE LANGUAGES, EDUCATIONAL COMPUTER SOFTWARE FEATURING ACTIVITIES FOR CHILDREN, COMPUTER SOFTWARE PROGRAMS ESPECIALLY ADAPTED FOR SEVERELY PHYSICALLY CHALLENGED COMPUTER USERS OPERATING AN ON/OFF DEVICE FOR ACTIVATION AND SELECTION, EDUCATIONAL SOFTWARE FOR TEACHING K-6 LEVEL READING, MATHEMATICS AND PROBLEM SOLVING, COMPUTER SOFTWARE UTILITY PROGRAM FOR USE IN MAKING OVERLAYS FOR COMPUTER INPUT DEVICES, COMPUTER SOFTWARE WHICH ALLOWS BOTH TEACHERS AND STUDENTS TO AUTHOR LEARNING ACTIVITIES, CREATE ANIMATION, IMPORT PICTURES, IMPORT MOVIES, AND IMPORT WEB CONTENT (U.S. CLS. 21, 23, 26, 36 AND 38).

FIRST USE 4-2-2001; IN COMMERCE 4-2-2001.

CHRISTOPHER ADKINS, EXAMINING ATTORNEY

THE MARK CONSISTS OF STANDARD CHARACTERS WITHOUT CLAIM TO ANY PARTICULAR FONT, STYLE, SIZE, OR COLOR.

FOR COMPUTER HARDWARE AND SOFTWARE FOR CONTROLLING, MONITORING, RECORDING AND REPORTING PURCHASES OF GOODS AND SERVICES; MAGNETIC CODED STORED-VALUE CARDS WHICH ALLOW USERS TO ADD CASH VALUE AND WHEN PURCHASES ARE MADE THE COST IS DEDUCTED FROM THE VALUE OF THE CARD; COMPUTER HARDWARE AND SOFTWARE FOR ENCODING STORED-VALUE CARDS; AND CARD READERS FOR STORED-VALUE CARDS FOR USE IN PURCHASING GOODS AND SERVICES (U.S. CLS. 21, 23, 26, 36 AND 38).

FIRST USE 5-30-2003; IN COMMERCE 5-30-2003.

ANDREW RHIM, EXAMINING ATTORNEY

CLASS 9—(Continued).

SN 78-393,660. JEFFREY M VOLK, SAN LUIS OBISPO, CA.
FILED 3-31-2004.

CLASS 9—(Continued).

SN 78-394,310. METAFUSE, INC., IRVINE, CA. FILED 3-31-
2004.

Project Insight

Express

THE MARK CONSISTS OF STANDARD CHARACTERS WITHOUT CLAIM TO ANY PARTICULAR FONT, STYLE, SIZE, OR COLOR.

NO CLAIM IS MADE TO THE EXCLUSIVE RIGHT TO USE "PROJECT", APART FROM THE MARK AS SHOWN.

FOR COMPUTER SOFTWARE USED FOR TRACKING TIME AND THE COST OF HUMAN RESOURCES AND MATERIALS, FOR USE IN THE FIELD OF PROJECT MANAGEMENT (U.S. CLS. 21, 23, 26, 36 AND 38).

RICHARD WHITE, EXAMINING ATTORNEY

SN 78-394,603. ALFLEX CORPORATION, CARROLLTON, GA. FILED 4-1-2004.

THE MARK CONSISTS OF STANDARD CHARACTERS WITHOUT CLAIM TO ANY PARTICULAR FONT, STYLE, SIZE, OR COLOR.

FOR APPARATUS FOR PRODUCING SOUND, IMAGES OR AUDIO, VIDEO AND DATA COMMUNICATIONS SYSTEMS, NAMELY, ELECTRONIC AND OPTICAL INSTRUMENTS AND COMPONENTS IN THE FORM OF DIGITAL AND ANALOG SIGNAL TRANSMITTERS, RECEIVERS AND CONVERTERS, RADIO AND TELEPHONE TRANSMITTERS, RECEIVERS AND COMMUNICATIONS SERVERS; TELEPHONES, WIRELESS AND CELLULAR TELEPHONES AND ANSWERING MACHINES, TELECOMMUNICATION TRANSMISSION, RECEIVING, AND STORAGE APPARATUS, NAMELY, TELECOMMUNICATION TRANSCIEVERS, DATA TRANSMITTERS, FACSIMILE MACHINES, ELECTRONIC MAIL APPARATUS FOR ELECTRONIC EXCHANGE OF DATA IMAGES AND MESSAGES, PAGERS, PAGING EQUIPMENT, FACSIMILE TRANSMITTERS AND RECEIVERS, WIRELESS FAX MACHINES, CELLULAR TELEPHONE ACCESSORIES, NAMELY, PROTECTIVE LEATHER CASES FOR CELLULAR TELEPHONES, SPECIALTY HOLSTERS FOR CARRYING CELLULAR TELEPHONES, CELLULAR TELEPHONE HOUSINGS, HANDS-FREE HEAD SETS FOR CELLULAR TELEPHONES (U.S. CLS. 21, 23, 26, 36 AND 38).

FIRST USE 6-1-1991; IN COMMERCE 12-13-1992.

ANDREW RHIM, EXAMINING ATTORNEY

MC SMART

THE MARK CONSISTS OF STANDARD CHARACTERS WITHOUT CLAIM TO ANY PARTICULAR FONT, STYLE, SIZE, OR COLOR.

NO CLAIM IS MADE TO THE EXCLUSIVE RIGHT TO USE "MC", APART FROM THE MARK AS SHOWN.

FOR ELECTRICAL CABLE; ELECTRICAL ARMORED CABLE AND METAL-CLAD CABLE; WIRING SYSTEMS COMPRISED OF ELECTRICAL WIRES, ELECTRICAL CABLES, AND ELECTRICAL CONNECTORS; AND PRE-ASSEMBLED ELECTRICAL CABLE (U.S. CLS. 21, 23, 26, 36 AND 38).

STACY WAHLBERG, EXAMINING ATTORNEY

CLASS 9—(Continued).

SN 78-394,757. JAKKS PACIFIC, INC., MALIBU, CA. FILED 4-1-2004.



NO CLAIM IS MADE TO THE EXCLUSIVE RIGHT TO USE "GAMES", APART FROM THE MARK AS SHOWN.

THE COLOR(S) BLUE, GREEN, RED, GOLD, YELLOW, ORANGE, PURPLE, BLUE IS/ARE CLAIMED AS A FEATURE OF THE MARK.

THE MARK CONSIST OF THE WORD CHILD IN BLUE, IN WHICH THERE IS A GREEN DOT ON THE "I" AND WITH 3 GOLD STARBURSTS, BENEATH WHICH IS A GREEN LINE, BENEATH WHICH IS THE WORD GUIDANCE IN RED LETTERS, BENEATH WHICH IS THE WORD GAMES IN WHICH THE G IS GREEN WITH DARK GREEN SQUIGGLES, THE LETTER A IS YELLOW WITH ORANGE STRIPES, THE LETTER M IS PURPLE WITH PURPLE SQUIGGLES, THE LETTER E IS BLUE WITH BLUE SQUIGGLES AND THE LETTER S IS YELLOW WITH ORANGE STRIPES. THE WORDS ARE ON A YELLOW BACKGROUND THAT IS OUTLINED IN BLUE.

FOR VIDEO GAME MACHINES FOR USE WITH TELEVISIONS (U.S. CLS. 21, 23, 26, 36 AND 38).
MICHAEL ENGEL, EXAMINING ATTORNEY

CLASS 9—(Continued).

SN 78-395,305. OPTA SYSTEMS, LLC, SCOTTSDALE, AZ. FILED 4-2-2004.

GoVideo

THE MARK CONSISTS OF STANDARD CHARACTERS WITHOUT CLAIM TO ANY PARTICULAR FONT, STYLE, SIZE, OR COLOR.

OWNER OF U.S. REG. NO. 1,667,512.

FOR CONSUMER ELECTRONIC DEVICES, NAMELY—CELL PHONES; MP3 PLAYERS AND RECORDERS; DVD PLAYERS AND RECORDERS; PORTABLE AUDIO AND VIDEO PLAYERS; COMBINATION UNITS, WHICH INCLUDE A SINGLE UNIT WITH BOTH A DVD PLAYER AND A VCR PLAYER-RECORDER; DVD COMBINATION UNITS, WHICH INCLUDE A DVD PLAYER, OR PLAYER-RECORDER, AND A HARD DRIVE; AUDIO PLAYERS; AUDIO PLAYER-RECORDERS; TELEVISION SETS; PRERECORDED DVD DISKS AND CD-ROM DISKS FEATURING MOVIES, MUSIC AND VIDEOS; BLANK DVD DISKS AND CD-ROM DISKS; AND APPARATUS FOR RECORDING, TRANSCRIBING, REPRODUCING AND VIEWING SOUND AND IMAGES; AND ACCESSORIES FOR ALL LISTED GOODS, NAMELY, HEADPHONES, BATTERIES, POWER SUPPLIES, ELECTRIC CABLES, AND CARRYING CASES (U.S. CLS. 21, 23, 26, 36 AND 38).

CATHERINE CAIN, EXAMINING ATTORNEY

SN 78-395,190. ASPEN TOUCH SOLUTIONS, INC., EVERGREEN, CO. FILED 4-2-2004.

THE MARK CONSISTS OF A SINGLE WORD AND A DESIGN ELEMENT. THE WORD "ASPEN" IS THE FOCAL POINT AND IS DONE IN LARGE TYPE WITH A CAPITAL "A"; WITH THE OTHER LETTERS IN LOWER CASE. A STYLIZED ASPEN LEAF IS POSITIONED JUST TO THE LEFT OF THE WORD ASPEN; THE STEM OF THE LEAF EXTENDS TO THE RIGHT UNDER THE "A". THE LEAF'S BODY POINTS TO THE LEFT AND IS ROUGHLY THE SAME HEIGHT AS THE "A".

FOR COMPUTER TOUCHSCREENS; COMPUTER DISPLAY MONITORS EQUIPPED WITH TOUCHSCREENS AND ELECTRONIC CONTROLLERS FOR COMPUTER TOUCHSCREENS (U.S. CLS. 21, 23, 26, 36 AND 38).

AMY ALFIERI, EXAMINING ATTORNEY

SN 78-396,384. SIEGER, ARLETTE GREENFIELD, PORT WASHINGTON, NY. FILED 4-5-2004.

TRAPEZE

THE MARK CONSISTS OF STANDARD CHARACTERS WITHOUT CLAIM TO ANY PARTICULAR FONT, STYLE, SIZE, OR COLOR.

FOR NECKLACES, CHAINS, CORDS, AND CLIPS FOR HOLDING AND SECURING EYEGLASSES AND SUNGLASSES (U.S. CLS. 21, 23, 26, 36 AND 38).

EVELYN BRADLEY, EXAMINING ATTORNEY

CLASS 9—(Continued).

SN 78-396,387. DC COMICS, NEW YORK, NY. FILED 4-5-2004.

KRYPTO THE SUPERDOG

THE MARK CONSISTS OF STANDARD CHARACTERS WITHOUT CLAIM TO ANY PARTICULAR FONT, STYLE, SIZE, OR COLOR.

FOR MOTION PICTURE FILMS FEATURING COMEDY, DRAMA, ACTION, ADVENTURE AND/OR ANIMATION, AND MOTION PICTURE FILMS FOR BROADCAST ON TELEVISION FEATURING COMEDY, DRAMA, ACTION, ADVENTURE AND/OR ANIMATION; PRERECORDED VINYL RECORDS, AUDIO TAPES, AUDIO-VIDEO TAPES, AUDIO VIDEO CASSETTES, AUDIO VIDEO DISCS, AND DIGITAL VERSATILE DISCS FEATURING MUSIC, COMEDY, DRAMA, ACTION, ADVENTURE, AND/OR ANIMATION; STEREO HEADPHONES; BATTERIES; CORDLESS TELEPHONES; HAND-HELD CALCULATORS; PRE-RECORDED AUDIO CASSETTES FEATURING COMEDY, DRAMA, ACTION, ADVENTURE AND/OR ANIMATION, AND CD PLAYERS; CD ROM COMPUTER GAME DISCS; HAND-HELD KARAOKE PLAYERS, TELEPHONE AND/OR RADIO PAGERS; SHORT MOTION PICTURE FILM CASSETTES FEATURING COMEDY, DRAMA, ACTION, ADVENTURE AND/OR ANIMATION TO BE USED WITH HAND-HELD VIEWERS OR PROJECTORS; VIDEO CASSETTE RECORDERS AND PLAYERS, COMPACT DISC PLAYERS, DIGITAL AUDIO TAPE RECORDERS AND PLAYERS, ELECTRONIC DIARIES; RADIOS; MOUSE PADS; EYEGASSES, SUNGLASSES AND CASES THEREFORE; AUDIO TAPES AND BOOKLETS SOLD AS A UNIT FEATURING COMEDY, DRAMA, ACTION, ADVENTURE, ANIMATION AND MUSIC INFORMATION; COMPUTER PROGRAMS, NAMELY SOFTWARE LINKING DIGITIZED VIDEO AND AUDIO MEDIA TO A GLOBAL COMPUTER INFORMATION NETWORK; GAME EQUIPMENT SOLD AS A UNIT FOR PLAYING A PARLOR-TYPE COMPUTER GAME; VIDEO AND COMPUTER GAME PROGRAMS; VIDEO GAME CARTRIDGES AND CASSETTES; CELLULAR TELEPHONE ACCESSORIES, NAMELY HANDS-FREE ACCESSORIES, CELLULAR TELEPHONE COVERS AND CELLULAR TELEPHONE FACE COVERS; ENCODED MAGNETIC CARDS, NAMELY, PHONE CARDS, CREDIT CARDS, CASH CARDS, DEBIT CARDS AND MAGNETIC KEY CARDS; AND DECORATIVE MAGNETS (U.S. CLS. 21, 23, 26, 36 AND 38).

CHERYL STEPLIGHT, EXAMINING ATTORNEY

CLASS 9—(Continued).

SN 78-396,691. APROPOS RETAIL MANAGEMENT SYSTEMS, INC., LYNNWOOD, WA. FILED 4-5-2004.

DATA NINJA

THE MARK CONSISTS OF STANDARD CHARACTERS WITHOUT CLAIM TO ANY PARTICULAR FONT, STYLE, SIZE, OR COLOR.

NO CLAIM IS MADE TO THE EXCLUSIVE RIGHT TO USE "DATA", APART FROM THE MARK AS SHOWN.

FOR COMPUTER SOFTWARE, NAMELY COMPUTER SOFTWARE FOR ACCESSING, SEARCHING, AND CREATING DYNAMIC LINKED VIEWS OF SQL DATABASES; QUERY PROCESSING AND QUERY ARCHIVING SOFTWARE FOR DATA RETRIEVAL, CREATING VIEWS OF DATA, AND PERFORMING OPERATIONS ON DATA (U.S. CLS. 21, 23, 26, 36 AND 38).

FIRST USE 2-27-2004; IN COMMERCE 2-27-2004.

CIMMERIAN COLEMAN, EXAMINING ATTORNEY

SN 78-397,265. EMS TECHNOLOGIES, INC., NORCROSS, GA. FILED 4-6-2004.

RFTerm

THE MARK CONSISTS OF STANDARD CHARACTERS WITHOUT CLAIM TO ANY PARTICULAR FONT, STYLE, SIZE, OR COLOR.

FOR SOFTWARE FOR USE IN RADIO FREQUENCY NETWORK COMPUTERS AND MOBILE COMPUTERS TO ALLOW FOR COMMUNICATION BETWEEN A MOBILE COMPUTER AND A HOST APPLICATION OR A HOST COMPUTER (U.S. CLS. 21, 23, 26, 36 AND 38).

FIRST USE 8-19-2002; IN COMMERCE 8-19-2002.

BRENDAN REGAN, EXAMINING ATTORNEY

CLASS 9—(Continued).

SN 78-397,476. DESKTILES, LLC, DALLAS, TX. FILED 4-6-2004.

DESKTILES

THE MARK CONSISTS OF STANDARD CHARACTERS WITHOUT CLAIM TO ANY PARTICULAR FONT, STYLE, SIZE, OR COLOR.

FOR COMPUTER SOFTWARE FOR ORGANIZING AND MANAGING COMPUTER FILES. (U.S. CLS. 21, 23, 26, 36 AND 38).

CHRISTOPHER ADKINS, EXAMINING ATTORNEY

CLASS 9—(Continued).

SN 78-399,158. THE CREATIVE DEVELOPMENT GROUP, INC., DBA HORSES 123, MARIETTA, GA. FILED 4-9-2004.



NO CLAIM IS MADE TO THE EXCLUSIVE RIGHT TO USE "HORSES", APART FROM THE MARK AS SHOWN.

THE COLOR(S) WHITE, GREY AND BROWN IS/ARE CLAIMED AS A FEATURE OF THE MARK.

THE MARK CONSISTS OF THE COLOR WHITE APPEARS IN THE WORDING "EVERYTHING HORSES"; THE COLOR GREY APPEARS IN THE HORSE SHOES AND THE BUST OF THE HORSE ADJACENT TO THE LETTER "S"; AND THE COLOR BROWN APPEARS IN THE BUST OF THE HORSE ADJACENT TO THE LETTER "E," AS WELL AS THE COLOR OF THE BACKGROUND BOARD.

FOR PRE-RECORDED CD-ROMS, DVDS, AND CASSETTE TAPES FEATURING EQUESTRIAN-RELATED PROGRAMS; AND VIDEO GAME SOFTWARE (U.S. CLS. 21, 23, 26, 36 AND 38).

FIRST USE 4-1-2004; IN COMMERCE 4-1-2004.

MITCHELL FRONT, EXAMINING ATTORNEY

SN 78-398,278. ALTIVATION, INC., CHICO, CA. FILED 4-7-2004.

Hemasphere

THE MARK CONSISTS OF STANDARD CHARACTERS WITHOUT CLAIM TO ANY PARTICULAR FONT, STYLE, SIZE, OR COLOR.

FOR COMPUTER SOFTWARE FOR MANAGEMENT OF BLOOD CENTERS FOR ACCOUNT/SPONSOR INFORMATION, CONTACT MANAGEMENT, BLOOD DRIVE MANAGEMENT, LOGISTICS AND STAFF SCHEDULING (U.S. CLS. 21, 23, 26, 36 AND 38).

FIRST USE 2-27-2004; IN COMMERCE 2-27-2004.

WON TEAK OH, EXAMINING ATTORNEY

SN 78-399,200. COHEN, GREGG A., DALLAS, TX. FILED 4-9-2004.

CellNorth Electronics, Corp.

THE MARK CONSISTS OF STANDARD CHARACTERS WITHOUT CLAIM TO ANY PARTICULAR FONT, STYLE, SIZE, OR COLOR.

NO CLAIM IS MADE TO THE EXCLUSIVE RIGHT TO USE "ELECTRONICS, CORP", APART FROM THE MARK AS SHOWN.

FOR ELECTRONIC ACCESSORIES FOR WIRELESS PHONES AND PDA'S, NAMELY BATTERIES, BATTERY CHARGERS, HANDS-FREE AUDIO SPEAKERS, HOLDERS, ANTENNAS, ANTENNA CONNECTORS AND ANTENNA CABLES (U.S. CLS. 21, 23, 26, 36 AND 38).

FIRST USE 1-1-2004; IN COMMERCE 1-1-2004.

ASMAT KHAN, EXAMINING ATTORNEY

CLASS 9—(Continued).

SN 78-399,517. GENISYS SOFTWARE INC., BROOKLYN PARK, MN. FILED 4-9-2004.



NO CLAIM IS MADE TO THE EXCLUSIVE RIGHT TO USE "SOFTWARE INC.", APART FROM THE MARK AS SHOWN.

THE MARK CONSISTS OF THE WORDS GENISYS SOFTWARE INC. AND MOUNTAIN PEAK LOGO.

FOR COMPUTER SOFTWARE; NAMELY, RENTAL AND POINT OF SALE SOFTWARE FOR THE EQUIPMENT, TOOL, PARTY, SPECIAL EVENTS, MOUNTAIN SPORTS AND VIDEO RETAIL RENTAL BUSINESS (U.S. CLS. 21, 23, 26, 36 AND 38).

FIRST USE 3-13-1995; IN COMMERCE 3-13-1995.
CHARLES L. JENKINS, EXAMINING ATTORNEY

SN 78-399,901. DAS DISTRIBUTORS, INC., PALMYRA, PA. FILED 4-11-2004.



OWNER OF U.S. REG. NO. 2,808,042.
NO CLAIM IS MADE TO THE EXCLUSIVE RIGHT TO USE "SERIES", APART FROM THE MARK AS SHOWN.

THE COLOR(S) GREEN, ORANGE, BLACK, AND GRAY IS/ARE CLAIMED AS A FEATURE OF THE MARK.

THE MARK CONSISTS OF THE WORDS "PRO" AND "ICE" IN GREEN ACROSS A BLACK OVAL. A LARGE ORANGE "X" IS BETWEEN THE WORDS "PRO" AND "ICE". THE WORD "SERIES" IS IN GRAY BELOW THE WORD "ICE".

FOR ELECTRICAL CONNECTORS AND ELECTRICAL CABLES (U.S. CLS. 21, 23, 26, 36 AND 38).

FIRST USE 1-0-2004; IN COMMERCE 1-0-2004.
GRETTA YAO, EXAMINING ATTORNEY

CLASS 9—(Continued).

SN 78-399,999. WELDING, CUTTING, TOOLS & ACCESSORIES, LLC, CLEVELAND, OH. FILED 4-12-2004.



THE LINING IS A FEATURE OF THE MARK AND DOES NOT INDICATE COLOR.

FOR WELDING EQUIPMENT AND ACCESSORIES THEREFOR, NAMELY ELECTRIC ARC WELDERS AND STRUCTURAL PARTS THEREFOR, POWER SUPPLIES FOR ELECTRIC ARC WELDERS, WELDING ELECTRODES, ELECTRICAL CONTROLLERS FOR ELECTRIC ARC WELDERS, WELDING HEADS FOR ELECTRIC ARC WELDERS, TRANSFORMERS FOR ELECTRIC ARC WELDERS, PRESSURE REGULATORS AND GAS FLOW CONTROL VALVES FOR WELDING EQUIPMENT, WIRE FEEDERS FOR ELECTRIC ARC WELDERS, ENGINE DRIVEN ELECTRIC ARC WELDERS, COMPUTER SOFTWARE FOR CONTROL OF ARC WELDING SYSTEMS, WELDING TORCHES FOR ELECTRIC ARC WELDERS, TIPS FOR ELECTRIC ARC WELDERS, CUTTING ATTACHMENTS FOR WELDING TORCHES, ELECTRICAL CONNECTORS AND ADAPTORS FOR ELECTRIC ARC WELDERS, SPOOL GUNS FOR ELECTRIC ARC WELDERS, NOZZLES FOR ELECTRIC ARC WELDERS, ELECTRODE HOLDERS FOR ELECTRIC ARC WELDERS, ELECTRICITY CONDUITS FOR ELECTRIC ARC WELDERS, ELECTRICAL CABLES FOR ELECTRIC ARC WELDERS, WELDING CLAMPS FOR ELECTRIC ARC WELDERS, ELECTRODE SPOOLS FOR ELECTRIC ARC WELDERS; WELDING SAFETY EQUIPMENT NAMELY, SAFETY FACE PROTECTION SHIELDS FOR USE WITH ELECTRIC ARC WELDERS, SAFETY EYEGLASSES AND SAFETY GOGGLES; FUEL GAS-AIR POWERED WELDING AND BRAZING TORCHES FOR LOW TEMPERATURE BRAZING AND WELDING; PRESSURE AND FLOW REGULATORS FOR PLASMA ARC CUTTERS, POWER SUPPLIES FOR PLASMA ARC CUTTERS, HIGH FREQUENCY POWER SUPPLIES FOR ARC STRIKING, CONTROLLERS FOR PLASMA ARC CUTTERS (U.S. CLS. 21, 23, 26, 36 AND 38).

FIRST USE 1-31-2004; IN COMMERCE 1-31-2004.
MELISSA SHELLA, EXAMINING ATTORNEY

SN 78-400,492. NET ENDEAVOR, INC., PLEASANT GROVE, UT. FILED 4-12-2004.



FOR COMPUTER SOFTWARE FOR USE IN COLLECTING, ANALYZING, AND REPORTING DATA FOR SURVEYS AND ASSESSMENTS (U.S. CLS. 21, 23, 26, 36 AND 38).

REBECCA GILBERT, EXAMINING ATTORNEY

CLASS 9—(Continued).

SN 78-401,285. MAXWELL TECHNOLOGIES, INC., SAN DIEGO, CA. FILED 4-13-2004.

CLASS 9—(Continued).

SN 78-401,629. TERADYNE, INC., BOSTON, MA. FILED 4-14-2004.

D CELL

THE MARK CONSISTS OF STANDARD CHARACTERS WITHOUT CLAIM TO ANY PARTICULAR FONT, STYLE, SIZE, OR COLOR.
FOR ELECTRICAL CAPACITORS (U.S. CLS. 21, 23, 26, 36 AND 38).
CATHERINE CAIN, EXAMINING ATTORNEY

VICTORY

THE MARK CONSISTS OF STANDARD CHARACTERS WITHOUT CLAIM TO ANY PARTICULAR FONT, STYLE, SIZE, OR COLOR.
FOR COMPUTER SOFTWARE USED IN CONNECTION WITH THE TESTING AND FAULT ANALYSIS OF ASSEMBLIES CONTAINING MODULES WITH SCAN CHAINS (U.S. CLS. 21, 23, 26, 36 AND 38).
FIRST USE 12-0-1991; IN COMMERCE 12-0-1991.
PRISCILLA MILTON, EXAMINING ATTORNEY

SN 78-401,682. NEXTEST SYSTEMS CORPORATION, SAN JOSE, CA. FILED 4-14-2004.

SN 78-401,385. HOMER TLC, INC., CLAYMONT, DE. FILED 4-14-2004.

**NO ONE BACKS YOU
UP LONGER**

THE MARK CONSISTS OF STANDARD CHARACTERS WITHOUT CLAIM TO ANY PARTICULAR FONT, STYLE, SIZE, OR COLOR.
FOR VOLTAGE SURGE PROTECTORS AND UNINTERRUPTED POWER SUPPLY SYSTEMS COMPRISED OF BATTERIES AND BATTERY CHARGERS (U.S. CLS. 21, 23, 26, 36 AND 38).
MICHAEL ENGEL, EXAMINING ATTORNEY

NEXTEST

THE MARK CONSISTS OF STANDARD CHARACTERS WITHOUT CLAIM TO ANY PARTICULAR FONT, STYLE, SIZE, OR COLOR.
FOR AUTOMATIC TEST EQUIPMENT FOR SEMICONDUCTORS; CIRCUIT BOARD CABLES; SEMICONDUCTOR CIRCUIT BOARDS; AND SOCKET CARDS (U.S. CLS. 21, 23, 26, 36 AND 38).
FIRST USE 11-0-1997; IN COMMERCE 11-0-1997.
MICHAEL SOUDERS, EXAMINING ATTORNEY

CLASS 9—(Continued).

SN 78-401,867. OPTA SYSTEMS, LLC, SCOTTSDALE, AZ.
FILED 4-14-2004.

CLASS 9—(Continued).

SN 78-402,165. DATABUILDER, INC., DES MOINES, IA.
FILED 4-15-2004.

OFF-ROAD

ECC

THE MARK CONSISTS OF STANDARD CHARACTERS WITHOUT CLAIM TO ANY PARTICULAR FONT, STYLE, SIZE, OR COLOR.

FOR CONSUMER ELECTRONIC DEVICES, NAMELY: CELL PHONES; MP3 PLAYERS AND RECORDERS; DVD PLAYERS AND RECORDERS; DIGITAL VIDEO RECORDERS; PORTABLE MEDIA PLAYERS, NAMELY AUDIO AND VIDEO PLAYERS; COMBINATION VIDEO PLAYERS AND RECORDERS; TELEVISION SETS; AND CAMERAS (U.S. CLS. 21, 23, 26, 36 AND 38).

TIMOTHY FINNEGAN, EXAMINING ATTORNEY

THE MARK CONSISTS OF STANDARD CHARACTERS WITHOUT CLAIM TO ANY PARTICULAR FONT, STYLE, SIZE, OR COLOR.

FOR SOFTWARE FOR USE IN DATABASE, SPREADSHEET, WORD PROCESSING, GRAPHIC, BLUEPRINT AND DOCUMENT MANAGEMENT FOR PROJECT CLOSE-OUT IN THE CONSTRUCTION INDUSTRY (U.S. CLS. 21, 23, 26, 36 AND 38).

FIRST USE 12-1-2003; IN COMMERCE 12-1-2003.
GRETTA YAO, EXAMINING ATTORNEY

SN 78-401,969. OPTA SYSTEMS, LLC, SCOTTSDALE, AZ.
FILED 4-14-2004.

SN 78-402,169. WAIFE & ASSOCIATES, INC., NEEDHAM, MA. FILED 4-15-2004.

GOJr.

PIVOTAL TECHNOLOGY

THE MARK CONSISTS OF STANDARD CHARACTERS WITHOUT CLAIM TO ANY PARTICULAR FONT, STYLE, SIZE, OR COLOR.

FOR CONSUMER ELECTRONIC DEVICES, NAMELY—DVD PLAYERS AND KARAOKE PLAYERS (U.S. CLS. 21, 23, 26, 36 AND 38).

FIRST USE 10-27-2003; IN COMMERCE 10-27-2003.
GLENN CLARK, EXAMINING ATTORNEY

THE MARK CONSISTS OF STANDARD CHARACTERS WITHOUT CLAIM TO ANY PARTICULAR FONT, STYLE, SIZE, OR COLOR.

NO CLAIM IS MADE TO THE EXCLUSIVE RIGHT TO USE "TECHNOLOGY", APART FROM THE MARK AS SHOWN.

FOR COMPUTER SOFTWARE CONSISTING OF A DATABASE AND WORKFLOW ENGINE, USED FOR MANAGING CLINICAL RESEARCH (U.S. CLS. 21, 23, 26, 36 AND 38).

FIRST USE 1-15-1997; IN COMMERCE 1-15-1997.
GRETTA YAO, EXAMINING ATTORNEY

CLASS 9—(Continued).

SN 78-402,816. ANABOLIC VIDEO PRODUCTIONS, INC., CHATSWORTH, CA. FILED 4-15-2004.

CLASS 9—(Continued).

SN 78-405,287. CANADIAN DATA SOFTWARE, TORONTO, CANADA, FILED 4-20-2004.

ARTCORE

ARTMACS

THE MARK CONSISTS OF STANDARD CHARACTERS WITHOUT CLAIM TO ANY PARTICULAR FONT, STYLE, SIZE, OR COLOR.

FOR SERIES OF PRERECORDED VIDEO TAPES AND DVDS FEATURING ADULT ENTERTAINMENT (U.S. CLS. 21, 23, 26, 36 AND 38).

WENDY GOODMAN, EXAMINING ATTORNEY

THE MARK CONSISTS OF STANDARD CHARACTERS WITHOUT CLAIM TO ANY PARTICULAR FONT, STYLE, SIZE, OR COLOR.

FOR COMPUTER SOFTWARE FOR AIR TRAFFIC CONTROL SIMULATION (U.S. CLS. 21, 23, 26, 36 AND 38).

FIRST USE 8-26-2002; IN COMMERCE 8-26-2002.
ADA HAN, EXAMINING ATTORNEY

SN 78-403,774. ROSS GORDON SYMONS, MELBOURNE, VICTORIA, AUSTRALIA, FILED 4-19-2004.

Street Luge

SN 78-405,411. CURLY PRODUCTIONS, INC., MILL VALLEY, CA. FILED 4-21-2004.

THE MARK CONSISTS OF STANDARD CHARACTERS WITHOUT CLAIM TO ANY PARTICULAR FONT, STYLE, SIZE, OR COLOR.

NO CLAIM IS MADE TO THE EXCLUSIVE RIGHT TO USE "LUGE", APART FROM THE MARK AS SHOWN.

FOR COMPUTER GAME SOFTWARE AND VIDEO GAME SOFTWARE; COMPUTER HARDWARE FOR COMPUTER GAMES; VIDEO GAMES HARDWARE, NAMELY, VIDEO GAME MACHINES FOR USE WITH TELEVISIONS; COMPUTER SOFTWARE, OBJECTS, AND LIBRARIES, COMPRISED OF ENABLE VIDEO, AUDIO, AND TEXT, FOR USE IN CREATING OTHER COMPUTER; COMPUTER TELECOMMUNICATION SOFTWARE AND COMPUTER HARDWARE FOR USE IN ACCESSING GLOBAL COMPUTER NETWORKS AND FOR USE IN CONNECTING TO CELLULAR PHONES, PAGERS, PERSONAL DATA ASSISTANTS (U.S. CLS. 21, 23, 26, 36 AND 38).

FIRST USE 1-1-2002; IN COMMERCE 1-1-2002.
RONALD AIKENS, EXAMINING ATTORNEY

THE MARK CONSISTS OF STANDARD CHARACTERS WITHOUT CLAIM TO ANY PARTICULAR FONT, STYLE, SIZE, OR COLOR.

FOR PRERECORDED VIDEO SERIES FEATURING ADULT-ORIENTED ENTERTAINMENT DISTRIBUTED ON VIDEOTAPE, DVD VIDEO, VIDEO DISK, AND FILM (U.S. CLS. 21, 23, 26, 36 AND 38).

FIRST USE 4-15-2003; IN COMMERCE 9-3-2003.
SUSAN LESLIE DUBOIS, EXAMINING ATTORNEY

CRACK HER JACK

CLASS 9—(Continued).

SN 78-406,767. RUIZ, JOSE HERRERA, SOUTH GATE, CA. FILED 4-22-2004.



NO CLAIM IS MADE TO THE EXCLUSIVE RIGHT TO USE "NORTENA", APART FROM THE MARK AS SHOWN. THE COLORS BLACK, YELLOW AND RED ARE CLAIMED AS A FEATURE OF THE MARK.

ALSO CLAIMED ARE THE COLORS RED, YELLOW AND BLACK THAT APPEARS IN THE WORDING GENERACION, AND THE COLORS RED AND BLACK APPEARING IN THE WORDING NORTENA.

THE FOREIGN WORDING IN THE MARK TRANSLATES INTO ENGLISH AS GENERATION OF THE NORTH.

FOR PRE-RECORDED CD'S, AUDIO CASSETTES, DVD'S, AND MINI-DISCS FEATURING MEXICAN MUSIC (U.S. CLS. 21, 23, 26, 36 AND 38).

FIRST USE 1-1-2004; IN COMMERCE 1-1-2004.

ANNE E. GUSTASON, EXAMINING ATTORNEY

SN 78-407,185. KONAMI CORPORATION, TOKYO, JAPAN, FILED 4-23-2004.

**7 DAYS OF DUELISTS
WORLD
CHAMPIONSHIP
TOURNAMENT**

THE MARK CONSISTS OF STANDARD CHARACTERS WITHOUT CLAIM TO ANY PARTICULAR FONT, STYLE, SIZE, OR COLOR.

OWNER OF U.S. REG. NOS. 2,773,926, 2,884,830 AND OTHERS.

NO CLAIM IS MADE TO THE EXCLUSIVE RIGHT TO USE "TOURNAMENT", APART FROM THE MARK AS SHOWN.

FOR VIDEO GAME SOFTWARE, VIDEO GAME PROGRAMS, VIDEO GAME CD-ROMS, VIDEO GAME DIGITAL VERSATILE DISC-ROMS, COMPUTER GAME PROGRAMS, COMPUTER GAME CD-ROMS, COMPUTER GAME DIGITAL VERSATILE DISC-ROMS, ELECTRONIC GAME PROGRAMS, ELECTRONIC GAME CD-ROMS, ELECTRONIC GAME DIGITAL VERSATILE DISC-ROMS, CARTRIDGES AND CASSETTES FOR USE WITH HAND-HELD VIDEO GAME MACHINES, CIRCUIT BOARDS CONTAINING GAME PROGRAMS FOR USE WITH HAND-HELD VIDEO GAME MACHINES, VIDEO OUTPUT GAME MACHINES, DOWNLOADABLE ELECTRONIC GAME SOFTWARE, DOWNLOADABLE COMPUTER GAME SOFTWARE, AND DOWNLOADABLE VIDEO GAME SOFTWARE (U.S. CLS. 21, 23, 26, 36 AND 38).

ALICE SUE CARRUTHERS, EXAMINING ATTORNEY

CLASS 9—(Continued).

SN 78-407,808. GENERAL ELECTRIC COMPANY, SCHECTADY, NY. FILED 4-26-2004.

HEAT SENTINEL

THE MARK CONSISTS OF STANDARD CHARACTERS WITHOUT CLAIM TO ANY PARTICULAR FONT, STYLE, SIZE, OR COLOR.

NO CLAIM IS MADE TO THE EXCLUSIVE RIGHT TO USE "HEAT", APART FROM THE MARK AS SHOWN.

FOR ELECTRONIC SENSORS FOR SENSING TEMPERATURE FOR USE IN AIR CONDITIONING UNITS (U.S. CLS. 21, 23, 26, 36 AND 38).

CATHERINE CAIN, EXAMINING ATTORNEY

SN 78-409,568. ELLUSIONIST.COM, LLC, SAN RAFAEL, CA. FILED 4-28-2004.

Revolution

THE MARK CONSISTS OF STANDARD CHARACTERS WITHOUT CLAIM TO ANY PARTICULAR FONT, STYLE, SIZE, OR COLOR.

FOR PROVIDING INSTRUCTIONAL VIDEO OF MAGIC TRICKS FOR DOWNLOAD FROM WEB SITE (U.S. CLS. 21, 23, 26, 36 AND 38).

FIRST USE 3-8-2004; IN COMMERCE 3-8-2004.

DEZMONA MIZELLE, EXAMINING ATTORNEY

CLASS 9—(Continued).

SN 78-409,796. PROCEDE SOFTWARE, LP, SAN DIEGO, CA. FILED 4-28-2004.

CLASS 9—(Continued).

SN 78-410,151. NOVOSEL, JOHN M., SR, LEAWOOD, KS. FILED 4-29-2004.

EXCEDE

21/7

THE MARK CONSISTS OF STANDARD CHARACTERS WITHOUT CLAIM TO ANY PARTICULAR FONT, STYLE, SIZE, OR COLOR.

FOR COMPUTER SOFTWARE FOR AUTOMOBILE AND TRUCK DEALERSHIP MANAGEMENT, NAMELY, INTEGRATED ACCOUNTING OF VEHICLE SALES, PARTS AND SERVICE DEPARTMENTS, INVENTORY MANAGEMENT FOR VEHICLES, PARTS AND SERVICE LABOR, PROCESSING VEHICLE SALES AND PURCHASE ORDERS, PROCESSING RETAIL AND WHOLESALE PARTS SALES AND PURCHASES, PROCESS RETAIL AND INTERNAL SERVICE REPAIR ORDERS, MANAGING EMPLOYEE TIME ENTRIES FOR PAYROLL, MANAGING DATABASES FOR CURRENT AND PROSPECTIVE CUSTOMERS, AND MANAGING DATABASES FOR EMPLOYEE PAYROLL AND HUMAN RESOURCE INFORMATION (U.S. CLS. 21, 23, 26, 36 AND 38).

MARK SPARACINO, EXAMINING ATTORNEY

THE MARK CONSISTS OF STANDARD CHARACTERS WITHOUT CLAIM TO ANY PARTICULAR FONT, STYLE, SIZE, OR COLOR.

FOR SERIES OF COMPACT DISCS FEATURING MUSIC AND INSTRUCTION IN GOLF (U.S. CLS. 21, 23, 26, 36 AND 38).

FIRST USE 4-26-2004; IN COMMERCE 4-29-2004.

ELIZABETH PIGNATELLO, EXAMINING ATTORNEY

SN 78-409,952. HK-CHINA ENTERPRISES LIMITED, CENTRAL, HONG KONG, FILED 4-29-2004.

SN 78-410,174. NOVOSEL, JOHN M., SR, LEAWOOD, KS. FILED 4-29-2004.

 **Livstar**

24/8

THE MARK CONSISTS OF THE WORD LIVSTAR, A STAR AND A DESIGN OF LETTERS LS.

FOR ELECTRICAL ADAPTORS; ELECTRICAL ADAPTORS, NAMELY, CABLE ADAPTORS; MUSICAL INSTRUMENT ADAPTORS, NAMELY, AUDIO AND VIDEO ADAPTORS; BATTERIES; PHOTOGRAPHIC CAMERAS; DIGITAL CAMERAS; VIDEO CAMERAS; COMPUTER CAMERAS; TELEPHONES; RADIOS INCORPORATING CLOCKS; BATHROOM SCALES; KITCHEN SCALES; ELECTRIC CIGARETTE LIGHTERS FOR LAND VEHICLES; EMERGENCY SIGNAL TRANSMITTERS; CALCULATORS (U.S. CLS. 21, 23, 26, 36 AND 38).

TRACY WHITAKER-BOWN, EXAMINING ATTORNEY

THE MARK CONSISTS OF STANDARD CHARACTERS WITHOUT CLAIM TO ANY PARTICULAR FONT, STYLE, SIZE, OR COLOR.

FOR SERIES OF COMPACT DISCS FEATURING MUSIC AND INSTRUCTION IN GOLF (U.S. CLS. 21, 23, 26, 36 AND 38).

FIRST USE 4-26-2004; IN COMMERCE 4-29-2004.

ELIZABETH PIGNATELLO, EXAMINING ATTORNEY

CLASS 9—(Continued).

SN 78-410,392. CLICKN' KIDS, INC., AGOURA HILLS, CA. FILED 4-29-2004.



NO CLAIM IS MADE TO THE EXCLUSIVE RIGHT TO USE "KIDS", APART FROM THE MARK AS SHOWN. FOR CHILDREN'S EDUCATIONAL SOFTWARE; EDUCATIONAL SOFTWARE FEATURING INSTRUCTION IN READING (U.S. CLS. 21, 23, 26, 36 AND 38). FIRST USE 4-29-2004; IN COMMERCE 4-29-2004. EVELYN BRADLEY, EXAMINING ATTORNEY

SN 78-412,023. ANDERSON, MARK L., SPRING VALLEY, WI. FILED 5-3-2004.

EEZYTRAC

THE MARK CONSISTS OF STANDARD CHARACTERS WITHOUT CLAIM TO ANY PARTICULAR FONT, STYLE, SIZE, OR COLOR. FOR INSERTABLE COMPUTER CHIP USED TO LOCATE AND IDENTIFY LOST, MISSING OR STOLEN CHATTEL (U.S. CLS. 21, 23, 26, 36 AND 38). FIRST USE 4-0-2000; IN COMMERCE 4-0-2000. LESLEY LAMOTHE, EXAMINING ATTORNEY

CLASS 9—(Continued).

SN 78-412,272. FUTURE SYSTEMS, INC., SEOUL, REPUBLIC OF KOREA, FILED 5-3-2004.

Villian

PRIORITY CLAIMED UNDER SEC. 44(D) ON REPUBLIC OF KOREA APPLICATION NO. 2003-0049543, FILED 11-10-2003, REG. NO. 0597507, DATED 10-29-2004, EXPIRES 10-29-2014.

FOR COMPUTER GATEWAY SYSTEM FOR HOME NETWORKS, CONSISTING OF COMPUTER NETWORK HUBS, SWITCHES AND ROUTERS; ELECTRICAL CONTROLLERS, NAMELY, WIRED AND WIRELESS CONTROLLERS FOR USE IN CONTROLLING NETWORKED, HOUSEHOLD COOLING AND HEATING SYSTEMS AND FOR HOUSEHOLD APPLIANCES; ELECTRONIC HOME SECURITY SYSTEMS COMPRISING ANTENNAS, MOTION SENSITIVE SECURITY LIGHTS, AND COMPUTER-CONTROLLED ALARMS; DOWNLOADABLE COMPUTER PROGRAMS FOR ACCESSING CONTROL PANELS FOR HOME SECURITY SYSTEMS AND FOR OPERATING HOME SECURITY SYSTEMS (U.S. CLS. 21, 23, 26, 36 AND 38).

JOANNA DUKOVIC, EXAMINING ATTORNEY

SN 78-412,960. SYMPHONIA SYSTEMS, INC., ARLINGTON, VA. FILED 5-4-2004.

DIANE 
Digital Analysis Environment

NO CLAIM IS MADE TO THE EXCLUSIVE RIGHT TO USE "DIGITAL ANALYSIS ENVIRONMENT", APART FROM THE MARK AS SHOWN.

THE COLOR(S) BLUE, RED, ORANGE, AND GOLD IS/ARE CLAIMED AS A FEATURE OF THE MARK.

THE MARK CONSISTS OF THE WORD "DIANE" IN CAPITAL LETTERS, THE WORDS "DIGITAL ANALYSIS ENGINE" IN UPPER AND LOWER CASE LETTERS AND A GRAPHIC ELEMENT CONSISTING OF 16 OVALS IN BLUE, RED, ORANGE AND GOLD.

FOR COMPUTER SOFTWARE FOR INFORMATION COLLECTION, STORAGE, EXTRACTION, ANALYSIS AND DISPLAY OF DATA AND IMAGES FOR THE PURPOSE OF TRACKING GLOBAL TRENDS AND IDEAS FROM VARIOUS SOURCES FOR USE IN KNOWLEDGE ACCRETION AND MANAGEMENT (U.S. CLS. 21, 23, 26, 36 AND 38).

FIRST USE 2-1-2004; IN COMMERCE 2-1-2004. MICHELE SWAIN, EXAMINING ATTORNEY

CLASS 9—(Continued).

SN 78-414,036. DC COMICS, NEW YORK, NY. FILED 5-6-2004.



FOR MOTION PICTURE FILMS FEATURING COMEDY, DRAMA, ACTION, ADVENTURE AND/OR ANIMATION, AND MOTION PICTURE FILMS FOR BROADCAST ON TELEVISION FEATURING COMEDY, DRAM, ACTION, ADVENTURE AND/OR ANIMATION; PRERECORDED VINYL RECORDS, AUDIO TAPES, AUDIO-VIDEO TAPES, AUDIO VIDEO CASSETTES, AUDIO VIDEO DISCS, AND DIGITAL VERSATILE DISCS FEATURING MUSIC, COMEDY, DRAMA, ACTION, ADVENTURE, AND/OR ANIMATION; STEREO HEADPHONES; BATTERIES; CORDLESS TELEPHONES; HAND-HELD CALCULATORS; PRE-RECORDED AUDIO CASSETTES FEATURING COMEDY, DRAMA, ACTION, ADVENTURE AND/OR ANIMATION, AND CD PLAYERS; CD ROM COMPUTER GAME DISCS; HAND-HELD KARAOKE PLAYERS, TELEPHONE AND/OR RADIO PAGERS; SHORT MOTION PICTURE FILM CASSETTES FEATURING COMEDY, DRAMA, ACTION, ADVENTURE AND/OR ANIMATION TO BE USED WITH HAND-HELD VIEWERS OR PROJECTORS; VIDEO CASSETTE RECORDERS AND PLAYERS, COMPACT DISC PLAYERS, DIGITAL AUDIO TAPE RECORDERS AND PLAYERS, ELECTRONIC DIARIES; RADIOS; MOUSE PADS; EYEGASSES, SUNGLASSES AND CASES THEREFORE; AUDIO TAPES AND BOOKLETS SOLD AS A UNIT FEATURING COMEDY, DRAMA, ACTION, ADVENTURE, ANIMATION AND MUSIC INFORMATION; COMPUTER PROGRAMS, NAMELY SOFTWARE LINKING DIGITIZED VIDEO AND AUDIO MEDIA TO A GLOBAL COMPUTER INFORMATION NETWORK; GAME EQUIPMENT SOLD AS A UNIT FOR PLAYING A PARLOR-TYPE COMPUTER GAME; VIDEO AND COMPUTER GAME PROGRAMS; VIDEO GAME CARTRIDGES AND CASSETTES; CELLULAR TELEPHONE ACCESSORIES, NAMELY HANDS-FREE ACCESSORIES, CELLULAR TELEPHONE COVERS AND CELLULAR TELEPHONE FACE COVERS; ENCODED MAGNETIC CARDS, NAMELY, PHONE CARDS, CREDIT CARDS, CASH CARDS, DEBIT CARDS AND MAGNETIC KEY CARDS; AND DECORATIVE MAGNETS (U.S. CLS. 21, 23, 26, 36 AND 38).

CHERYL STEPLIGHT, EXAMINING ATTORNEY

CLASS 9—(Continued).

SN 78-414,324. ANALOG DEVICES, INC., NORWOOD, MA. FILED 5-6-2004.

ICMOS

THE MARK CONSISTS OF STANDARD CHARACTERS WITHOUT CLAIM TO ANY PARTICULAR FONT, STYLE, SIZE, OR COLOR.

FOR INTEGRATED CIRCUITS (U.S. CLS. 21, 23, 26, 36 AND 38).

DAVID MURRAY, EXAMINING ATTORNEY

SN 78-414,594. A P PRODUCTS GMBH, WEIL IM SCHOENBUCH, FED REP GERMANY, FILED 5-6-2004.

A P PRODUCTS

THE MARK CONSISTS OF STANDARD CHARACTERS WITHOUT CLAIM TO ANY PARTICULAR FONT, STYLE, SIZE, OR COLOR.

NO CLAIM IS MADE TO THE EXCLUSIVE RIGHT TO USE "PRODUCTS", APART FROM THE MARK AS SHOWN.

FOR ELECTRICAL CONNECTORS, ELECTRICAL CABLES, ELECTRICAL CABLE ASSEMBLIES, ELECTRICAL SWITCHES, CIRCUIT BOARDS, TEST CLIP CONNECTORS FOR TESTING OF ELECTRICAL CIRCUITS AND COMPONENTS, ELECTRICAL CONNECTORS, NAMELY, ELECTRICAL HEADERS FOR ELECTRICAL AND ELECTRONIC CIRCUITS, ELECTRICAL JUMPER CONNECTORS, ELECTRICAL POLARITY TAB KEYS TO FACILITATE CORRECT ALIGNMENT OF MALE AND FEMALE CONNECTORS, SOLDERLESS BREADBOARD CIRCUIT BUILDING COMPONENTS, NAMELY, ELECTRICAL TERMINALS, CONNECTORS, WIRES AND ELECTRICAL POWER SUPPLIES, ELECTRICAL TERMINALS, ELECTRICAL BREADBOARD UNITS, ELECTRICAL SIGNAL TRANSMITTERS, ELECTRICAL PATCH CORDS AND TELECOMMUNICATION PATCH CORDS (U.S. CLS. 21, 23, 26, 36 AND 38).

LEIGH LOWRY, EXAMINING ATTORNEY

CLASS 9—(Continued).

SN 78-416,440. WORLD GOLF FOUNDATION, INC., ST. AUGUSTINE, FL. FILED 5-11-2004.



OWNER OF U.S. REG. NO. 2,190,342.
FOR MAGNETS, MAGNETICALLY ENCODED, PRE-PAID GASOLINE CARDS (U.S. CLS. 21, 23, 26, 36 AND 38).
FIRST USE 5-19-1998; IN COMMERCE 5-19-1998.
CAROL SPILS, EXAMINING ATTORNEY

SN 78-416,778. PROPERTY AUTOMATION SOFTWARE CORPORATION, RICHARDSON, TX. FILED 5-11-2004.

TENANT PRO

THE MARK CONSISTS OF STANDARD CHARACTERS WITHOUT CLAIM TO ANY PARTICULAR FONT, STYLE, SIZE, OR COLOR.
NO CLAIM IS MADE TO THE EXCLUSIVE RIGHT TO USE "TENANT", APART FROM THE MARK AS SHOWN.
FOR COMPUTER SOFTWARE IN THE FIELD OF PROPERTY MANAGEMENT FOR USE IN TRACKING AND STORING FINANCIAL AND ACCOUNTING INFORMATION PERTAINING TO OWNERS, PROPERTIES, UNITS, TENANTS, AND VENDORS (U.S. CLS. 21, 23, 26, 36 AND 38).
FIRST USE 2-1-1995; IN COMMERCE 2-1-1995.
NAAKWAMA ANKRAH, EXAMINING ATTORNEY

CLASS 9—(Continued).

SN 78-416,934. BOSON SOFTWARE, INC., TAMPA, FL. FILED 5-11-2004.

BOSON VIRTUAL PACKET TECHNOLOGY

THE MARK CONSISTS OF STANDARD CHARACTERS WITHOUT CLAIM TO ANY PARTICULAR FONT, STYLE, SIZE, OR COLOR.
OWNER OF U.S. REG. NOS. 2,675,662, 2,788,883 AND OTHERS.
NO CLAIM IS MADE TO THE EXCLUSIVE RIGHT TO USE "VIRTUAL PACKET TECHNOLOGY", APART FROM THE MARK AS SHOWN.
FOR COMPUTER SOFTWARE FOR USE IN STUDENT TRAINING AND STUDENT TEST PREPARATION IN THE FIELD OF COMPUTER NETWORKING AND INFORMATION TECHNOLOGY (U.S. CLS. 21, 23, 26, 36 AND 38).
FIRST USE 7-6-2003; IN COMMERCE 7-6-2003.
ANDREA SAUNDERS, EXAMINING ATTORNEY

SN 78-416,949. BOSON SOFTWARE, INC., TAMPA, FL. FILED 5-11-2004.

BOSON NETWORKSIM

THE MARK CONSISTS OF STANDARD CHARACTERS WITHOUT CLAIM TO ANY PARTICULAR FONT, STYLE, SIZE, OR COLOR.
OWNER OF U.S. REG. NOS. 2,675,662, 2,788,883 AND OTHERS.
FOR COMPUTER SOFTWARE FOR USE IN STUDENT TRAINING AND STUDENT TEST PREPARATION IN THE FIELD OF COMPUTER NETWORKING AND INFORMATION TECHNOLOGY (U.S. CLS. 21, 23, 26, 36 AND 38).
FIRST USE 1-16-2004; IN COMMERCE 1-16-2004.
ANDREA SAUNDERS, EXAMINING ATTORNEY

CLASS 9—(Continued).

SN 78-417,463. ENCRYPTX CORPORATION, LONGMONT, CO. FILED 5-12-2004.

CLASS 9—(Continued).

SN 78-417,891. ABS GLOBAL, INC., DEFOREST, WI. FILED 5-13-2004.

BeCompliant

VALID

THE MARK CONSISTS OF STANDARD CHARACTERS WITHOUT CLAIM TO ANY PARTICULAR FONT, STYLE, SIZE, OR COLOR.

FOR AUTOMATED EMAIL AND DATA SECURITY SOFTWARE SYSTEM THAT PROVIDES COMPLIANCE WITH GOVERNMENT AND INDUSTRY REGULATIONS. (U.S. CLS. 21, 23, 26, 36 AND 38).

ROBIN CHOSID, EXAMINING ATTORNEY

THE MARK CONSISTS OF STANDARD CHARACTERS WITHOUT CLAIM TO ANY PARTICULAR FONT, STYLE, SIZE, OR COLOR.

FOR ANIMAL LOCATOR DEVICE USING HANDHELD DATA COLLECTION DEVICE AND RFID ANIMAL IDENTIFICATION TECHNOLOGY (U.S. CLS. 21, 23, 26, 36 AND 38).

PAULA MAHONEY, EXAMINING ATTORNEY

SN 78-417,821. TESLA ELECTRONICS, INC., SANTA MONICA, CA. FILED 5-13-2004.

SN 78-418,802. PERCEPTIVE VISION, INC., SHAWNEE, KS. FILED 5-14-2004.

GTECH

CAPTURENOW

THE MARK CONSISTS OF STANDARD CHARACTERS WITHOUT CLAIM TO ANY PARTICULAR FONT, STYLE, SIZE, OR COLOR.

FOR AUTOMOTIVE GAUGES, NAMELY AUTOMOTIVE PERFORMANCE METERS, AUTOMOTIVE PERFORMANCE GAUGES, AUTOMOTIVE RPM GAUGES, AND GAUGES FOR OIL PRESSURE, BOOST PRESSURE, VOLTAGE, TIRE PRESSURE, GAS LEVEL, AND OIL, WATER AND AIR TEMPERATURE; ELECTRONIC SENSORS FOR LAND VEHICLES USED FOR DATA ACQUISITION; ELECTRONIC DEVICES USED TO MEASURE AND PROCESS SIGNALS FOR LAND VEHICLES; AND PERFORMANCE ANALYSIS AND ENHANCEMENT DEVICES FOR LAND VEHICLES IN THE NATURE OF SPEEDOMETERS AND RADAR DETECTORS (U.S. CLS. 21, 23, 26, 36 AND 38).

FIRST USE 8-0-1995; IN COMMERCE 8-0-1995.
JAMES GRIFFIN, EXAMINING ATTORNEY

THE MARK CONSISTS OF STANDARD CHARACTERS WITHOUT CLAIM TO ANY PARTICULAR FONT, STYLE, SIZE, OR COLOR.

FOR DOWNLOADABLE COMPUTER SOFTWARE FOR ADDING SCANNING FUNCTION TO EXISTING ELECTRONIC IMAGING PROGRAM TO ENABLE INTRANET AND INTERNET TRANSMISSION OF DOCUMENTS AND IMAGES (U.S. CLS. 21, 23, 26, 36 AND 38).

FIRST USE 5-1-1998; IN COMMERCE 5-1-1998.
MICHAEL HALL, EXAMINING ATTORNEY

CLASS 9—(Continued).

SN 78-418,803. KONTRON EMBEDDED MODULES GMBH, D-94469 DEGGENDORF, FED REP GERMANY, FILED 5-14-2004.

ETXexpress

THE MARK CONSISTS OF STANDARD CHARACTERS WITHOUT CLAIM TO ANY PARTICULAR FONT, STYLE, SIZE, OR COLOR.

PRIORITY CLAIMED UNDER SEC. 44(D) ON ERP N CMNTY TM OFC APPLICATION NO. 003539277, FILED 11-14-2003.

FOR DATA PROCESSING EQUIPMENT, NAMELY COMPUTER HARDWARE; COMPUTERS; CIRCUIT BOARDS PROVIDED WITH INTEGRATED CIRCUITS; CIRCUIT BOARDS; PRINTED CIRCUIT BOARDS; INDUSTRIAL PCS; EMBEDDED PCS; EMBEDDED PC BOARDS; MEMORY BOARDS; COMPUTER CHIPS CONTAINING FLASH MEMORY AND DISK MEMORIES FEATURING FLASH MEMORY; ELECTRONIC CIRCUIT BOARDS; MOTHERBOARDS; CPU; INTEGRATED CIRCUITS, NAMELY, LCD DRIVERS; MONITORS FOR COMPUTERS (U.S. CLS. 21, 23, 26, 36 AND 38).

JOANNA DUKOVIC, EXAMINING ATTORNEY

SN 78-419,295. REVOLUTION EYEWEAR, INC., SIMI VALLEY, CA. FILED 5-14-2004.

INNOVATIVE M/F TECHNOLOGY

THE MARK CONSISTS OF STANDARD CHARACTERS WITHOUT CLAIM TO ANY PARTICULAR FONT, STYLE, SIZE, OR COLOR.

NO CLAIM IS MADE TO THE EXCLUSIVE RIGHT TO USE "TECHNOLOGY", APART FROM THE MARK AS SHOWN.

FOR EYEWEAR, NAMELY EYEGLASSES, SUNGLASSES, EYEGLASS FRAMES, SUNGLASS FRAMES, EYEGLASS LENSES, SUNGLASS LENSES, INTERCHANGEABLE EYEGLASS FRAMES, INTERCHANGEABLE SUNGLASS FRAMES, INTERCHANGEABLE EYEGLASS LENSES, INTERCHANGEABLE SUNGLASS LENSES (U.S. CLS. 21, 23, 26, 36 AND 38).

FIRST USE 8-0-1998; IN COMMERCE 8-0-1998.
JAMES A. RAUEN, EXAMINING ATTORNEY

CLASS 9—(Continued).

SN 78-419,894. WATERS INVESTMENTS LIMITED, MILFORD, MA. FILED 5-17-2004.

NANO UPLC

THE MARK CONSISTS OF STANDARD CHARACTERS WITHOUT CLAIM TO ANY PARTICULAR FONT, STYLE, SIZE, OR COLOR.

FOR ANALYTICAL EQUIPMENT FOR PERFORMING BIOLOGICAL AND CHEMICAL SEPARATION, PURIFICATION, SCREENING AND IDENTIFICATION; NAMELY CHROMATOGRAPHIC SYSTEMS COMPRISING PUMPS, DETECTORS, INJECTORS, AUTOSAMPLERS, GRADIENT CONTROLLERS, MIXING CHAMBERS, COLUMNS, RECORDERS, PRINTERS, FRACTION COLLECTORS AND OPERATING SOFTWARE, AND REPLACEMENT PARTS AND SOFTWARE UPDATES (U.S. CLS. 21, 23, 26, 36 AND 38).

RON FAIRBANKS, EXAMINING ATTORNEY

SN 78-420,492. KONTRON EMBEDDED MODULES GMBH, 94469 DEGGENDORF, FED REP GERMANY, FILED 5-18-2004.



The logo features the letters 'ET' in a bold, black, sans-serif font. A large, black, stylized 'X' is superimposed over the 'ET', with the word 'express' written in a white, lowercase, sans-serif font across the middle of the 'X'.

PRIORITY CLAIMED UNDER SEC. 44(D) ON ERP N CMNTY TM OFC APPLICATION NO. 003548765, FILED 11-19-2003.

FOR DATA PROCESSING EQUIPMENT, NAMELY COMPUTER HARDWARE; COMPUTERS; CIRCUIT BOARDS PROVIDED WITH INTEGRATED CIRCUITS; CIRCUIT BOARDS; PRINTED CIRCUIT BOARDS; INDUSTRIAL PCS; EMBEDDED PCS; EMBEDDED PC BOARDS; MEMORY BOARDS; COMPUTER CHIPS CONTAINING FLASH MEMORY AND DISK MEMORIES FEATURING FLASH MEMORY; ELECTRONIC CIRCUIT BOARDS; MOTHERBOARDS; CPU; INTEGRATED CIRCUITS, NAMELY, LCD DRIVERS; MONITORS FOR COMPUTERS (U.S. CLS. 21, 23, 26, 36 AND 38).

JOANNA DUKOVIC, EXAMINING ATTORNEY

CLASS 9—(Continued).

SN 78-420,549. VIACOM INTERNATIONAL INC., NEW YORK, NY. FILED 5-18-2004.

BLUE'S ROOM DOODLE BOARD

THE MARK CONSISTS OF STANDARD CHARACTERS WITHOUT CLAIM TO ANY PARTICULAR FONT, STYLE, SIZE, OR COLOR.

FOR THEATRICAL OR MUSICAL SOUND RECORDINGS OR VIDEO RECORDINGS; SUNGLASSES; MAGNETS; ALL TYPES OF WIRELESS MOBILE PHONE EQUIPMENT AND ACCESSORIES, NAMELY TELEPHONES, CHARGERS, CASES, HEADSETS, AND HOLDERS; MOBILE PHONE FACE PLATES; DOWNLOADABLE RING TONES, MUSIC, MP3S, GRAPHIC, GAMES, AND VIDEO IMAGES FOR WIRELESS MOBILE COMMUNICATION DEVICES (U.S. CLS. 21, 23, 26, 36 AND 38).

PATRICIA EVANKO, EXAMINING ATTORNEY

CLASS 9—(Continued).

SN 78-421,778. CHENOWETH, LYNN, DBA PULLTARPS MANUFACTURING, EL CAJON, CA. FILED 5-19-2004.



The logo for 'SLOPE DETECTOR' features the word 'SLOPE' in a bold, italicized, sans-serif font, slanted upwards to the right. A thick horizontal line is positioned below 'SLOPE', and the word 'DETECTOR' is written in a bold, blocky, sans-serif font directly beneath this line.

THE MARK CONSISTS OF THE WORDS SLOPE AND DETECTOR SEPARATED BY A GENERALLY HORIZONTAL V-SHAPED LINE, WITH THE POINT OF THE V FACING TO THE LEFT, AND WITH THE WORD SLOPE ABOVE THE V-SHAPED LINE AND THE WORD DETECTOR BELOW THE V-SHAPED LINE.

SEC. 2(F).

FOR SYSTEM COMPRISED OF A TILT SENSOR AND MEASURING UNIT, A LIGHTED DISPLAY INDICATING TILT ANGLE AND AN ALARM FOR INDICATING EXCESSIVE TILT, FOR USE IN THE DETECTION AND WARNING OF EXCESSIVE TILT IN DUMP TRUCKS AND THE LIKE (U.S. CLS. 21, 23, 26, 36 AND 38).

FIRST USE 10-28-1994; IN COMMERCE 10-28-1994. GENE MACIOL, EXAMINING ATTORNEY

SN 78-420,569. AMINO HOLDINGS LIMITED, CAMBRIDGE, UNITED KINGDOM, FILED 5-18-2004.

AMINET

THE MARK CONSISTS OF STANDARD CHARACTERS WITHOUT CLAIM TO ANY PARTICULAR FONT, STYLE, SIZE, OR COLOR.

FOR COMPUTER HARDWARE, MIDDLEWARE AND SOFTWARE FOR THE DISTRIBUTION OF SOUND, IMAGE OR DATA FOR USE WITH IP-TV, SET-TOP BOXES, IP-TV, CABLE AND/OR SATELLITE DECODERS AND RECEIVERS, COMPUTER SERVERS FOR USE WITH IP-TV, COMPUTER ROUTERS FOR USE WITH IP-TV (U.S. CLS. 21, 23, 26, 36 AND 38).

BRIAN PINO, EXAMINING ATTORNEY

SN 78-421,953. MULTIMUSIC INC., CULVER CITY, CA. FILED 5-20-2004.



The logo for 'Multi Karaoke Canta Como' features the words 'Multi Karaoke' in a stylized, bubbly, italicized font with a drop shadow effect. Below this, the words 'Canta Como' are written in a smaller, simpler, sans-serif font.

OWNER OF U.S. REG. NO. 2,558,460.

NO CLAIM IS MADE TO THE EXCLUSIVE RIGHT TO USE "MULTI KARAOKE", APART FROM THE MARK AS SHOWN.

THE COLORS BLACK AND GRAY ARE CLAIMED AS A FEATURE OF THE MARK.

THE COLOR BLACK IS USED ON THE WORDING CANTA COMO AND USED ON THE OUTLINES OF THE WORDING MULTI KARAOKE. THE COLOR GRAY IS USED ON THE WORDING MULTI KARAOKE.

THE MARK CONSISTS OF THE WORDS "MULTI" AND "KARAOKE" SUPERIMPOSED OVER A DRAWING OF A MUSICAL STAFF, WITH THE WORDS "CANTA COMO" BENEATH.

THE FOREIGN WORDING IN THE MARK TRANSLATES INTO ENGLISH AS SING LIKE.

FOR AUDIO TAPES AND COMPACT DISCS FEATURING MUSICAL ENTERTAINMENT (U.S. CLS. 21, 23, 26, 36 AND 38).

FIRST USE 11-29-2000; IN COMMERCE 11-29-2000. CURTIS FRENCH, EXAMINING ATTORNEY

CLASS 9—(Continued).

SN 78-421,954. MULTIMUSIC INC., CULVER CITY, CA.
FILED 5-20-2004.



CANTA COMO

NO CLAIM IS MADE TO THE EXCLUSIVE RIGHT TO USE "100% KARAOKE", APART FROM THE MARK AS SHOWN.

THE COLORS GRAY, WHITE AND BLACK ARE CLAIMED AS A FEATURE OF THE MARK.

THE MARK CONSISTS OF SUPER-IMPOSED ON DOUBLE HORIZONTAL BLACK BARS ARE A SILHOUETTE OF A MAN, WITH HIS ARM RAISED HOLDING A STAR, THE WORDS "100% KARAOKE", AND 5 STARS POSITIONED ON THE UPPER RIGHT OF THE WORDS. THE WORDS "CANTA COMO" APPEAR DIRECTLY UNDERNEATH. ON TOP OF THE NUMBER "1" IS A WHITE SUN SHAPE. THE COLOR GRAY APPEARS IN THE SHADOW OUTLINES ALONG THE LEFT SIDES AND BOTTOMS OF THE 5 STARS, IN THE SHADOW OUTLINES ALONG THE SIDES AND BOTTOMS OF THE WORDS "100% KARAOKE", AND IN THE SHADOW BOX OUTLINES THAT APPEAR TO THE LEFT AND RIGHT OF THE HORIZONTAL BLACK BARS. THE COLOR BLACK IS USED ON THE WORDING CANTA COMO, AND ON THE HUMAN FIGURE, AND USED ON THE OUTLINES OF THE WORDING 100% KARAOKE, STAR DESIGNS, AS WELL AS ON THE DESIGN OF THE RECTANGLE. WHITE IS ALSO USED ON THE RECTANGLE DESIGN, BETWEEN THE BLACK LINES. WHITE IS USED TO THE INTERIOR OF THE WORDING 100% KARAOKE AND THE STAR DESIGNS. THE COLOR GRAY IS USED ON THE OUTLINE OF THE WORDING 100% KARAOKE, STAR DESIGN AND AS THE BACKGROUND.

THE FOREIGN WORDING IN THE MARK TRANSLATES INTO ENGLISH AS SING LIKE.

FOR PRE-RECORDED AUDIO TAPES, COMPACT DISCS, VIDEOTAPES AND DVD'S FEATURING MUSICAL ENTERTAINMENT (U.S. CLS. 21, 23, 26, 36 AND 38).

FIRST USE 10-17-2003; IN COMMERCE 10-17-2003.
CURTIS FRENCH, EXAMINING ATTORNEY

CLASS 9—(Continued).

SN 78-423,270. RAMP CORPORATION, NEW YORK, NY.
FILED 5-21-2004.

**HEALTHRAMP
CAREGIVER**

SN 78-423,073. CLARKSON EYECARE INC., ELLISVILLE, MO. FILED 5-21-2004.



THE COLOR(S) BLUE IS/ARE CLAIMED AS A FEATURE OF THE MARK.

THE MARK CONSISTS OF ROUNDED SQUARE PAIR OF GLASSES IN BLUE WITH BLACK OUTLINE WITH WORD 'DARSANA' UNDERNEATH IN BLACK.

FOR EYEGLASSES, SUNGLASSES (U.S. CLS. 21, 23, 26, 36 AND 38).

FIRST USE 1-1-2004; IN COMMERCE 4-1-2004.
JOHN SCHUYLER YARD, EXAMINING ATTORNEY

THE MARK CONSISTS OF STANDARD CHARACTERS WITHOUT CLAIM TO ANY PARTICULAR FONT, STYLE, SIZE, OR COLOR.

NO CLAIM IS MADE TO THE EXCLUSIVE RIGHT TO USE "CAREGIVER", APART FROM THE MARK AS SHOWN.

FOR SOFTWARE FOR USE IN THE NURSING HOME AND ASSISTED LIVING INDUSTRY BY LONG TERM CARE FACILITY MEDICAL AND ADMINISTRATIVE STAFF FOR ELECTRONIC ORDERING AND REORDERING OF PRESCRIPTION DRUGS, NON-PRESCRIPTION DRUGS, TREATMENT ORDERS, AND MEDICAL SUPPLIES, ORDERING LABORATORY TESTS AND RESULTS, MAINTAINING ELECTRONIC MEDICATION AND TREATMENT HISTORY RECORDS, FACILITATING RESIDENT ADMISSIONS, DISCHARGES AND TRANSFERS, INTEGRATING RESIDENT INFORMATION AND PRESCRIPTION DATA, COORDINATING PRESCRIPTION INFORMATION WITH PATIENTS' INSURANCE POLICIES, AND ALERTING PHYSICIANS TO ALLERGIES AND POTENTIAL TREATMENT CONFLICTS BETWEEN SIMULTANEOUS PRESCRIPTIONS, VIA A WIRELESS HANDHELD DEVICE OR WEB BROWSER ON THE GLOBAL COMPUTER NETWORK (U.S. CLS. 21, 23, 26, 36 AND 38).

SUSAN STIGLITZ, EXAMINING ATTORNEY

CLASS 9—(Continued).

SN 78-423,820. OMNILALA, INC., NEWTON CENTER, MA. FILED 5-24-2004.

LALA

THE MARK CONSISTS OF STANDARD CHARACTERS WITHOUT CLAIM TO ANY PARTICULAR FONT, STYLE, SIZE, OR COLOR.

FOR COMPUTERS; DIGITAL AUDIO PLAYERS; PORTABLE MEDIA PLAYERS; ELECTRONIC CONTROL SYSTEMS FOR AUDIO PLAYERS; WIRELESS INTERNET APPARATUS WHICH PROVIDES CONTROL OVER AUDIO AND VIDEO PLAYERS; COMPUTER HARDWARE; COMPUTER MEMORY HARDWARE; DISC MEMORIES; SYSTEM BOARDS AND PROCESSORS; AUDIO CIRCUIT BOARDS; DIGITAL DISC DRIVES; MOTHERBOARDS; COMPUTER NETWORKING HARDWARE; COMPUTER PERIPHERALS; CD-ROM DRIVES; CD PLAYERS; WIRELESS COMPUTER PERIPHERALS; FLASH MEMORY CARDS; COMPUTER OPERATING SOFTWARE; COMMUNICATIONS SOFTWARE FOR CONNECTING COMPUTER NETWORK USERS; COMPUTER SOFTWARE FOR COLLECTING, STORING, ORGANIZING, BOOK-MARKING, MODIFYING, PROCESSING, RETRIEVING, SHARING, TRANSMITTING AND PLAYING DATA, INFORMATION, IMAGES, SOUND AND VIDEO; COMPUTER SOFTWARE FOR CONTROLLING AND MANAGING MUSIC SERVER APPLICATIONS; COMPUTER SOFTWARE FOR CONTROLLING PORTABLE LISTENING DEVICES, NAMELY MP3 PLAYERS; NETWORK ACCESS SERVER OPERATING SOFTWARE (U.S. CLS. 21, 23, 26, 36 AND 38).

FIRST USE 12-16-2003; IN COMMERCE 12-16-2003. LESLEY LAMOTHE, EXAMINING ATTORNEY

CLASS 9—(Continued).

SN 78-424,117. OPNET TECHNOLOGIES, INC., BETHESDA, MD. FILED 5-24-2004.

3DNV

THE MARK CONSISTS OF STANDARD CHARACTERS WITHOUT CLAIM TO ANY PARTICULAR FONT, STYLE, SIZE, OR COLOR.

FOR COMPUTER SOFTWARE THAT ENABLES THREE DIMENSIONAL DISPLAYS OF COMMUNICATION NETWORKS AND THEIR PERFORMANCE, INCORPORATING TOPOLOGY, NODE RELATIONSHIPS AND PERFORMANCE STATISTICS OVERLAID ON REALISTICALLY RENDERED TERRAIN; THE SOFTWARE PROVIDES THE ABILITY TO VISUALIZE LINE-OF-SIGHT, TRANSMISSION QUALITY, THROUGHPUT, DELAY, AND MESSAGE STATUS INFORMATION; THE SOFTWARE INCLUDES AN APPLICATION PROGRAMMING INTERFACE FOR CREATING CUSTOM THREE DIMENSIONAL NETWORK VISUALIZATION GRAPHICS (U.S. CLS. 21, 23, 26, 36 AND 38).

KAREN K. BUSH, EXAMINING ATTORNEY

SN 78-424,181. HOWARD, KEVIN, NORWOOD, MA. FILED 5-24-2004.

Ruining Tomorrow

FOR COMPACT DISCS AND AUDIO TAPES FEATURING MUSICAL RECORDINGS (U.S. CLS. 21, 23, 26, 36 AND 38).

RUDY R. SINGLETON, EXAMINING ATTORNEY

CLASS 9—(Continued).

SN 78-424,255. ANABOLIC VIDEO PRODUCTIONS, INC., CHATSWORTH, CA. FILED 5-25-2004.

T-GIRLS

THE MARK CONSISTS OF STANDARD CHARACTERS WITHOUT CLAIM TO ANY PARTICULAR FONT, STYLE, SIZE, OR COLOR.

FOR SERIES OF PRERECORDED VIDEO TAPES AND DVDS FEATURING ADULT ENTERTAINMENT (U.S. CLS. 21, 23, 26, 36 AND 38).

WENDY GOODMAN, EXAMINING ATTORNEY

SN 78-424,625. BHV SOFTWARE GMBH&CO.KG, KAARST, FED REP GERMANY, FILED 5-25-2004.

X-oom

THE MARK CONSISTS OF STANDARD CHARACTERS WITHOUT CLAIM TO ANY PARTICULAR FONT, STYLE, SIZE, OR COLOR.

FOR COMPUTER SOFTWARE TO EDIT, MANAGE AND ARCHIVE DIGITAL MEDIA, NAMELY PHOTOS, VIDEOS, MUSIC AND MOVIES; COMPUTER GAMES SOFTWARE (U.S. CLS. 21, 23, 26, 36 AND 38).

ELIZABETH J. WINTER, EXAMINING ATTORNEY

CLASS 9—(Continued).

SN 78-425,622. DYADEM INTERNATIONAL LTD., RICHMOND HILL, ONTARIO, CANADA, FILED 5-26-2004.

SVA-Pro

THE MARK CONSISTS OF STANDARD CHARACTERS WITHOUT CLAIM TO ANY PARTICULAR FONT, STYLE, SIZE, OR COLOR.

FOR COMPUTER SOFTWARE FOR USE IN IMPROVING SECURITY SYSTEMS THROUGH DETAILED SECURITY VULNERABILITY ANALYSIS STUDIES (U.S. CLS. 21, 23, 26, 36 AND 38).

FIRST USE 9-16-2002; IN COMMERCE 9-16-2002.
SALLY SHIH, EXAMINING ATTORNEY

SN 78-425,669. VIRAGE LOGIC CORPORATION, FREMONT, CA. FILED 5-26-2004.

IPRIMA AUTOMOTIVE

THE MARK CONSISTS OF STANDARD CHARACTERS WITHOUT CLAIM TO ANY PARTICULAR FONT, STYLE, SIZE, OR COLOR.

NO CLAIM IS MADE TO THE EXCLUSIVE RIGHT TO USE "AUTOMOTIVE", APART FROM THE MARK AS SHOWN.

FOR COMPUTER SOFTWARE FOR DESIGN AND MANUFACTURE OF INTEGRATED CIRCUITS, AND MANUALS PACKAGED AS A UNIT (U.S. CLS. 21, 23, 26, 36 AND 38).

ANN E. SAPPENFIELD, EXAMINING ATTORNEY

CLASS 9—(Continued).

SN 78-425,671. VIRAGE LOGIC CORPORATION, FREMONT, CA. FILED 5-26-2004.

CLASS 9—(Continued).

SN 78-426,364. CHANGETOOLS INC., HUNTSVILLE, AL. FILED 5-27-2004.

IPRIMA GRAPHICS

ChangeTools

THE MARK CONSISTS OF STANDARD CHARACTERS WITHOUT CLAIM TO ANY PARTICULAR FONT, STYLE, SIZE, OR COLOR.

NO CLAIM IS MADE TO THE EXCLUSIVE RIGHT TO USE "GRAPHICS", APART FROM THE MARK AS SHOWN.

FOR COMPUTER SOFTWARE FOR DESIGN AND MANUFACTURE OF INTEGRATED CIRCUITS, AND MANUALS PACKAGED AS A UNIT (U.S. CLS. 21, 23, 26, 36 AND 38).

ANN E. SAPPENFIELD, EXAMINING ATTORNEY

THE MARK CONSISTS OF STANDARD CHARACTERS WITHOUT CLAIM TO ANY PARTICULAR FONT, STYLE, SIZE, OR COLOR.

FOR GRAPHICAL USER INTERFACE SOFTWARE AND ASSOCIATED SOFTWARE DEVELOPMENT TOOLS (U.S. CLS. 21, 23, 26, 36 AND 38).

FIRST USE 8-28-2001; IN COMMERCE 8-28-2001.
DOUGLAS LEE, EXAMINING ATTORNEY

SN 78-425,763. ORTIZ, JEFFREY, NEW YORK, NY. FILED 5-26-2004.

SN 78-426,499. LONSDALE, ANTHONY, OXFORDSHIRE, UNITED KINGDOM, AND LONSDALE, BRYAN, OXFORDSHIRE, UNITED KINGDOM, FILED 5-27-2004.



FOR PRE RECORDED COMPACT DISCS, AUDIO CASSETTE TAPES AND VIDEO CASSETTE TAPES FEATURING MUSIC AND SPOKEN WORDS (U.S. CLS. 21, 23, 26, 36 AND 38).

FIRST USE 5-0-2001; IN COMMERCE 5-0-2001.
KATHY DE JONGE, EXAMINING ATTORNEY

FOR ELECTRIC OR ELECTRONIC TRANSDUCERS FOR PROVIDING AN OUTPUT INDICATIVE OF TORQUE— ELECTRIC OR ELECTRONIC SENSORS FOR SENSING TORQUE (U.S. CLS. 21, 23, 26, 36 AND 38).

FIRST USE 2-25-2000; IN COMMERCE 2-25-2000.
APRIL L. RADEMACHER, EXAMINING ATTORNEY

CLASS 9—(Continued).

SN 78-427,385. WALTER E ST.JONES, MARLBOROUGH, MA. FILED 5-29-2004.

Pay Cash Now

THE MARK CONSISTS OF STANDARD CHARACTERS WITHOUT CLAIM TO ANY PARTICULAR FONT, STYLE, SIZE, OR COLOR.

FOR MAGNETIC CARD THAT ALLOWS USERS TO LOAD MONEY ONTO THE CARD FOR LATER USE AS A DEBIT OR ATM CARD (U.S. CLS. 21, 23, 26, 36 AND 38).

FIRST USE 1-1-2003; IN COMMERCE 1-1-2004.
KEVON CHISOLM, EXAMINING ATTORNEY

CLASS 9—(Continued).

SN 78-428,988. SPIRIT-LED RECORDS, LLC, FRANKLIN, TN. FILED 6-2-2004.

**ABSOLUTE
SMASH
HITS**

NO CLAIM IS MADE TO THE EXCLUSIVE RIGHT TO USE HITS, APART FROM THE MARK AS SHOWN.

THE MARK IS NOT IN COLOR.

FOR PRE-RECORDED AUDIO COMPACT DISCS FEATURING MUSIC (U.S. CLS. 21, 23, 26, 36 AND 38).

FIRST USE 4-23-2004; IN COMMERCE 4-23-2004.
ANNE E. GUSTASON, EXAMINING ATTORNEY

SN 78-429,673. KABUSHIKI KAISHA TOPCON, TOKYO, JAPAN, FILED 6-3-2004.

SN 78-427,960. SARIN TECHNOLOGIES, LTD., RAMATGAN, ISRAEL, FILED 6-1-2004.

SARIN
SARIN TECHNOLOGIES LTD.

NO CLAIM IS MADE TO THE EXCLUSIVE RIGHT TO USE "TECHNOLOGIES LTD.", APART FROM THE MARK AS SHOWN.

THE MARK CONSISTS OF THE STYLIZED WORD SARIN, ABOVE THE WORDS SARIN TECHNOLOGIES LTD., WITH AN ARC ABOVE.

FOR COMPUTER HARDWARE, OPTICAL HARDWARE AND COMPUTER SOFTWARE FOR MEASURING, SCANNING, PLANNING, MARKING, INSCRIBING, RECORDING, ANALYZING, VISUALLY REPRESENTING, EVALUATING AND REPORTING DIAMOND AND GEMSTONES (U.S. CLS. 21, 23, 26, 36 AND 38).

FIRST USE 7-31-1997; IN COMMERCE 7-31-1997.
TIMOTHY FINNEGAN, EXAMINING ATTORNEY

mmGPS

THE MARK CONSISTS OF STANDARD CHARACTERS WITHOUT CLAIM TO ANY PARTICULAR FONT, STYLE, SIZE, OR COLOR.

FOR POSITIONING AND SURVEYING INSTRUMENTS, NAMELY GLOBAL POSITIONING SYSTEMS CONSISTING OF RECEIVERS, TRANSCIVERS, ANTENNAS, CASINGS, RECHARGEABLE BATTERIES, AND PLATFORMS; COMPUTER SOFTWARE FOR COMPUTING AN X, Y AND Z COORDINATE ON THE EARTH AND ASSIGNING AN ATTRIBUTE OR DESCRIPTION TO THAT COORDINATE FOR MAPPING PURPOSES AND FOR COMPUTING A USERS CURRENT LOCATION AND NAVIGATING TO A DESIRED OR PREVIOUSLY FIXED LOCATION, IN THE FIELDS OF SURVEYING, CONSTRUCTION, COMMERCIAL MAPPING, CIVIL ENGINEERING, PRECISION AGRICULTURE, PHOTOGRAMMETRY MAPPING, AND HYDROGRAPHY MEASURING APPARATUS FOR USE IN PREPARING SURVEYS OF COSTAL LAND FORMA-

CLASS 9—(Continued).

TIONS AND DEPTH OF HARBORS AND SEAWAYS, APPARATUS AND INSTRUMENTS FOR THE SURVEYING AND LOCATING TERRESTRIAL FEATURES AND STRUCTURES; LASER SURVEYING INSTRUMENTS, NAMED LASERS FOR USE IN MEASURING THE RANGE TO, HEIGHT, AND WEIGHT OF, AND OTHER DIMENSIONS RELATING TO OBJECTS AND TERRAIN AND CREATING TWO OR THREE DIMENSIONAL REPRESENTATIONS OF THE OBJECTS OR TERRAIN; ROTATING LASER SURVEYING INSTRUMENTS FOR SURVEYING THE POSITION OF LAND FORMATIONS AND TERRESTRIAL FEATURES AND STRUCTURES ON A HORIZONTAL AND VERTICAL PLANE BY ILLUMINATING LASERS AND SWIVELING LASERS HORIZONTALLY AND VERTICALLY; LASER AND GPS SYSTEMS, NAMED RECEIVERS, ELECTRONIC TOTAL STATIONS, ROTATING LASERS, PIPE LASERS FOR USE IN THE FIELD OF AGRICULTURE, CONSTRUCTION, MACHINE CONTROL, SURVEYING, MAPPING AND POSITIONING (U.S. CLS. 21, 23, 26, 36 AND 38).

CAROLYN CATALDO, EXAMINING ATTORNEY

CLASS 9—(Continued).

SN 78-431,187. THE AIMBRIDGE GROUP, DENVER, CO. FILED 6-7-2004.

APPLINE

THE MARK CONSISTS OF STANDARD CHARACTERS WITHOUT CLAIM TO ANY PARTICULAR FONT, STYLE, SIZE, OR COLOR.

FOR DOWNLOADABLE INTERACTIVE FINANCIAL DATA SOFTWARE FOR COLLECTING, ANALYZING, MONITORING AND REPORTING THE STATUS OF LOAN FINANCING, MORTGAGE LENDING AND FINANCIAL INFORMATION SERVICES (U.S. CLS. 21, 23, 26, 36 AND 38).

ASMAT KHAN, EXAMINING ATTORNEY

SN 78-430,844. DIAS, L. M., CONCORD, CA. FILED 6-7-2004.

SN 78-432,864. DAVIS, ROBERT KENT, ANNA MARIA, FL. FILED 6-10-2004.

posanywhere

MAN VS. MACHINE

THE MARK CONSISTS OF STANDARD CHARACTERS WITHOUT CLAIM TO ANY PARTICULAR FONT, STYLE, SIZE, OR COLOR.

FOR CINEMATOGRAPHIC FILMS CONCERNING DEMONSTRATIONS AND SHOWS FEATURING FIGHTS BETWEEN HUMAN AND ROBOT PERFORMERS; MOTION PICTURE FILMS MADE FOR TELEVISION CONCERNING DEMONSTRATIONS AND SHOWS FEATURING FIGHTS BETWEEN HUMAN AND ROBOT PERFORMERS; AMUSEMENT GAMING MACHINES; COMPUTER AND VIDEO GAMES IN THE FORM OF CARTRIDGES, TAPES, SOFTWARE, GAME DISCS; PRE-RECORDED VIDEO TAPES OR COMPACT DISCS CONCERNING DEMONSTRATIONS AND SHOWS FEATURING FIGHTS BETWEEN HUMAN AND ROBOT PERFORMERS, MAGNETS AND MOUSE PADS (U.S. CLS. 21, 23, 26, 36 AND 38).

CHRIS WELLS, EXAMINING ATTORNEY

THE MARK CONSISTS OF STANDARD CHARACTERS WITHOUT CLAIM TO ANY PARTICULAR FONT, STYLE, SIZE, OR COLOR.

FOR COMPUTER SOFTWARE FOR APPLICATION AND DATABASE INTEGRATION (U.S. CLS. 21, 23, 26, 36 AND 38).

FIRST USE 12-15-2003; IN COMMERCE 12-15-2003.

DOMINIC J. FERRAIUOLO, EXAMINING ATTORNEY

CLASS 9—(Continued).

SN 78-434,242. HITACHI SOFTWARE ENGINEERING AMERICA, LTD., SOUTH SAN FRANCISCO, CA. FILED 6-11-2004.

CLASS 9—(Continued).

SN 78-434,931. CAVIUM NETWORKS, SANTA CLARA, CA. FILED 6-14-2004.

MasterPlex

THE MARK CONSISTS OF STANDARD CHARACTERS WITHOUT CLAIM TO ANY PARTICULAR FONT, STYLE, SIZE, OR COLOR.

FOR SOFTWARE FOR THE SCIENTIFIC DATA ANALYSIS OF MULTIPLEX ASSAYS FOR MULTI-ANALYTES PROFILING SYSTEMS FOR ACADEMIC AND COMMERCIAL RESEARCH AND DEVELOPMENT IN THE LIFE SCIENCE FIELD (U.S. CLS. 21, 23, 26, 36 AND 38).

FIRST USE 12-27-2001; IN COMMERCE 12-27-2001.
ZHALEH DELANEY, EXAMINING ATTORNEY

OCTIAN

THE MARK CONSISTS OF STANDARD CHARACTERS WITHOUT CLAIM TO ANY PARTICULAR FONT, STYLE, SIZE, OR COLOR.

FOR SEMICONDUCTORS, SEMICONDUCTOR CHIP SETS, MICROPROCESSORS, CUSTOMIZED MICROPROCESSORS AND RELATED SOFTWARE FOR USE IN SWITCHES, ROUTERS AND COMPUTER SERVERS FOR MANAGING, OPERATING, AND SECURING LOCAL AND WIDE AREA COMPUTER NETWORKS AND NETWORK PRODUCTS; APPLICATION SPECIFIC INTEGRATED CIRCUITS, COMPUTER BOARDS, AND COMPUTER PROCESSORS USED IN, AND FOR OPERATING AND SECURING, COMPUTER HARDWARE, NAMELY, COMPUTER NETWORK SERVERS, WORKSTATION, DESKTOP, AND LAPTOP COMPUTERS, AND PDA'S. (U.S. CLS. 21, 23, 26, 36 AND 38).

JAMES GRIFFIN, EXAMINING ATTORNEY

SN 78-434,930. CLUSTER RESOURCES, INC., SPANISH FORK, UT. FILED 6-14-2004.

SN 78-435,146. CLUSTER RESOURCES, INC., SPANISH FORK, UT. FILED 6-15-2004.

MOAB ACCESS PORTAL

THE MARK CONSISTS OF STANDARD CHARACTERS WITHOUT CLAIM TO ANY PARTICULAR FONT, STYLE, SIZE, OR COLOR.

NO CLAIM IS MADE TO THE EXCLUSIVE RIGHT TO USE "ACCESS PORTAL", APART FROM THE MARK AS SHOWN.

FOR COMPUTER SOFTWARE, NAMELY, PLATFORM INDEPENDENT DOWNLOADABLE SOFTWARE FOR SECURE JOB SUBMISSION, MANAGEMENT AND STATUS RETRIEVAL WITH AN INTERNET WEB BROWSER; COMPUTER SOFTWARE, NAMELY, DOWNLOADABLE SOFTWARE FOR ENABLING REMOTE ACCESS TO A RESOURCE MANAGER AND SCHEDULER FOR A GROUP OF NETWORKED COMPUTERS KNOWN AS A CLUSTER, A GROUP OF COMPUTER CLUSTERS KNOWN AS A GRID OR GRIDS, DATA-CENTERS AND UTILITY-BASED COMPUTING SYSTEMS AND HETEROGENEOUS NETWORK ENVIRONMENTS (U.S. CLS. 21, 23, 26, 36 AND 38).

FIRST USE 2-1-2004; IN COMMERCE 6-1-2004.
JAMES GRIFFIN, EXAMINING ATTORNEY

MOAB CLUSTER SUITE

THE MARK CONSISTS OF STANDARD CHARACTERS WITHOUT CLAIM TO ANY PARTICULAR FONT, STYLE, SIZE, OR COLOR.

NO CLAIM IS MADE TO THE EXCLUSIVE RIGHT TO USE "CLUSTER SUITE", APART FROM THE MARK AS SHOWN.

FOR DISTRIBUTION JOB MANAGEMENT TOOLS FOR A CLUSTER OF COMPUTERS, A GROUP OF COMPUTER CLUSTERS KNOWN AS A GRID AND GRIDS, DATA-CENTERS, UTILITY-BASED COMPUTING SYSTEMS AND HETEROGENEOUS NETWORK ENVIRONMENTS, IN THE NATURE OF DOWNLOADABLE COMPUTER SOFTWARE WHICH PROVIDES A SINGLE, SECURE INTERFACE TO ALL OF THE CLUSTER OR GRID COMPUTING RESOURCES FOR WORKLOAD MANAGEMENT BY ADMINISTRATORS, MANAGERS AND END-USERS IN THE NATURE OF ALLOCATION OF COMPUTER RESOURCES, ANALYSIS OF COMPUTING RESOURCE AVAILABILITY AND STATUS INFORMATION, INSTALLATION OF SOFTWARE AND SOFTWARE UPGRADES MANAGEMENT, ACCOUNTING AND USAGE MANAGEMENT FOR REPORTING AND BILLING, 3RD PARTY APPLICATION INTEGRATION MANAGEMENT, WORKLOAD POLICY MANAGEMENT, AND JOB SCHEDULING FOR BOTH BATCH AND INTERACTIVE JOBS; DOWNLOADABLE COMPUTER SOFTWARE FOR MONITORING, MANA-

CLASS 9—(Continued).

GING, PROFILING AND INDICATING AVAILABLE COMPUTING RESOURCES, NAMELY, FOR INTELLIGENT MULTIPLE RESOURCE MANAGEMENT, SCHEDULING AND COMPUTING RESOURCE POLICY IMPLEMENTATION THAT ENABLES ADMINISTRATORS, MANAGERS AND END-USERS TO CONTROL AND UTILIZE MULTIPLE COMPUTING RESOURCES ACROSS HETEROGENEOUS COMPUTERS AND CLUSTERS AND FOR PROVIDING DATA IN THE FIELD OF COMPUTER RESOURCES ON EITHER A CLUSTER OR GRID OR GRIDS; DOWNLOADABLE COMPUTER SOFTWARE FOR STATISTICAL DIAGNOSTIC AND PERFORMANCE MONITORING, NAMELY, UTILIZATION OF COMPUTING RESOURCES, ANALYSIS OF EFFICIENT USE OF COMPUTER RESOURCES, ANALYSIS OF OPTIMIZATION OF COMPUTING RESOURCES, ANALYSIS OF FAIR SHARING OF COMPUTING RESOURCES, ANALYSIS OF LOAD-BALANCING OF COMPUTER SYSTEMS, ANALYSIS OF ORGANIZATIONS, ENTITIES, INDIVIDUALS, CLASSIFICATIONS OF QUALITY OF SERVICE, QUEUES AND COMPUTING NODES; DOWNLOADABLE COMPUTER SOFTWARE FOR PROVIDING A QUALITY OF SERVICE FOR SUBMITTED JOBS, SCHEDULING GUARANTEES AND JOB RESERVATIONS FOR USERS, GROUPS, CLASSES, ACCOUNTS AND LEVELS OF QUALITY OF SERVICE; DOWNLOADABLE COMPUTER SOFTWARE FOR COMMAND-LINE AND GRAPHICAL RESOURCE AND WORKLOAD SIMULATION, INCLUDING SIMULATION OF SIMULTANEOUS INSTANCES TO EXPLORE THE EFFECTS OF CONFIGURATIONS AND POLICIES ON CLUSTERS OR GRIDS; DOWNLOADABLE COMPUTER SOFTWARE FOR DYNAMIC COMMAND-LINE AND GRAPHICAL MANAGEMENT OF COMPUTER RESOURCES, NAMELY MANAGEMENT OF SOFTWARE LICENSES WITHIN A SINGLE COMPUTER ADMINISTRATIVE DOMAIN OR ACROSS MULTIPLE HETEROGENEOUS COMPUTER ADMINISTRATIVE DOMAINS, FILE SPACE, NETWORK-ATTACHED STORAGE MEDIA, TAPE DRIVES, PROCESSORS, MEMORY, DISK, NETWORK BANDWIDTH, AND OTHER HARDWARE RESOURCES; DOWNLOADABLE COMPUTER SOFTWARE FOR INTERFACE AND COLLECTION OF END USER COMMANDS FOR JOB, QUEUE AND SYSTEM MANAGEMENT, INTERNAL DIAGNOSTIC AND LOGGING FACILITIES, INTEGRATION OF PROVISIONING MANAGERS, BILLING SYSTEMS, IDENTITY AND SECURITY MANAGERS AND DATABASES, AND TRANSFER OF RESOURCE MANAGER JOB SUBMISSIONS; DOWNLOADABLE COMPUTER SOFTWARE FOR PEER-TO-PEER COLLABORATION OF MULTIPLE INSTANCES TO PROVIDE DOMAIN-SPECIFIC POLICIES AND TO PROVIDE NATIVE RESOURCE MANAGEMENT SUPPORT (U.S. CLS. 21, 23, 26, 36 AND 38).

FIRST USE 3-1-2001; IN COMMERCE 5-1-2003.
 JAMES GRIFFIN, EXAMINING ATTORNEY

CLASS 9—(Continued).

SN 78-435,147. CLUSTER RESOURCES, INC., SPANISH FORK, UT. FILED 6-15-2004.

MOAB GRID SUITE

THE MARK CONSISTS OF STANDARD CHARACTERS WITHOUT CLAIM TO ANY PARTICULAR FONT, STYLE, SIZE, OR COLOR.

NO CLAIM IS MADE TO THE EXCLUSIVE RIGHT TO USE "GRID SUITE", APART FROM THE MARK AS SHOWN.

FOR DISTRIBUTION JOB MANAGEMENT TOOLS FOR A CLUSTER OF COMPUTERS, A GROUP OF COMPUTER CLUSTERS KNOWN AS A GRID AND GRIDS, DATA-CENTERS, UTILITY-BASED COMPUTING SYSTEMS AND HETEROGENEOUS NETWORK ENVIRONMENTS, IN THE NATURE OF DOWNLOADABLE COMPUTER SOFTWARE WHICH PROVIDES A SINGLE, SECURE INTERFACE TO ALL OF THE CLUSTER OR GRID COMPUTING RESOURCES FOR WORKLOAD MANAGEMENT BY ADMINISTRATORS, MANAGERS AND END-USERS IN THE NATURE OF ALLOCATION OF COMPUTER RESOURCES, ANALYSIS OF COMPUTING RESOURCE AVAILABILITY AND STATUS INFORMATION, INSTALLATION OF SOFTWARE AND SOFTWARE UPGRADES MANAGEMENT, ACCOUNTING AND USAGE MANAGEMENT FOR REPORTING AND BILLING, 3RD PARTY APPLICATION INTEGRATION MANAGEMENT, WORKLOAD POLICY MANAGEMENT, AND JOB SCHEDULING FOR BOTH BATCH AND INTERACTIVE JOBS; DOWNLOADABLE COMPUTER SOFTWARE FOR MONITORING, MANAGING, PROFILING AND INDICATING AVAILABLE COMPUTING RESOURCES, NAMELY, FOR INTELLIGENT MULTIPLE RESOURCE MANAGEMENT, SCHEDULING AND COMPUTING RESOURCE POLICY IMPLEMENTATION THAT ENABLES ADMINISTRATORS, MANAGERS AND END-USERS TO CONTROL AND UTILIZE MULTIPLE COMPUTING RESOURCES ACROSS HETEROGENEOUS COMPUTERS AND CLUSTERS AND FOR PROVIDING DATA IN THE FIELD OF COMPUTER RESOURCES ON EITHER A CLUSTER OR GRID OR GRIDS; DOWNLOADABLE COMPUTER SOFTWARE FOR STATISTICAL DIAGNOSTIC AND PERFORMANCE MONITORING, NAMELY, UTILIZATION OF COMPUTING RESOURCES, ANALYSIS OF EFFICIENT USE OF COMPUTER RESOURCES, ANALYSIS OF OPTIMIZATION OF COMPUTING RESOURCES, ANALYSIS OF FAIR SHARING OF COMPUTING RESOURCES, ANALYSIS OF LOAD-BALANCING OF COMPUTER SYSTEMS, ANALYSIS OF ORGANIZATIONS, ENTITIES, INDIVIDUALS, CLASSIFICATIONS OF QUALITY OF SERVICE, QUEUES AND COMPUTING NODES; DOWNLOADABLE COMPUTER SOFTWARE FOR PROVIDING A QUALITY OF SERVICE FOR SUBMITTED JOBS, SCHEDULING GUARANTEES AND JOB RESERVATIONS FOR USERS, GROUPS, CLASSES, ACCOUNTS AND LEVELS OF QUALITY OF SERVICE; DOWNLOADABLE COMPUTER SOFTWARE FOR COMMAND-LINE AND GRAPHICAL RESOURCE AND WORKLOAD SIMULATION, INCLUDING SIMULATION OF SIMULTANEOUS INSTANCES TO EXPLORE THE EFFECTS OF CONFIGURATIONS AND POLICIES ON CLUSTERS OR GRIDS; DOWNLOADABLE COMPUTER SOFTWARE FOR DYNAMIC COMMAND-LINE AND GRAPHICAL MANAGEMENT OF COMPUTER RESOURCES, NAMELY MANAGEMENT OF SOFTWARE LICENSES WITHIN A SINGLE COMPUTER ADMINISTRATIVE DOMAIN OR ACROSS MULTIPLE HETEROGENEOUS COMPUTER ADMINISTRATIVE DOMAINS, FILE SPACE, NETWORK-ATTACHED STORAGE MEDIA, TAPE DRIVES, PROCESSORS, MEMORY, DISK, NETWORK BANDWIDTH, AND OTHER HARDWARE RESOURCES; DOWNLOADABLE COMPUTER SOFTWARE FOR INTERFACE AND COLLECTION OF END USER COMMANDS FOR JOB, QUEUE AND SYSTEM MANAGEMENT, INTERNAL DIAGNOSTIC AND LOGGING FACILITIES, INTEGRATION OF PROVISIONING MANAGERS, BILLING SYSTEMS, IDENTITY AND SECURITY MANAGERS AND DATABASES, AND TRANSFER OF RESOURCE MANAGER JOB SUBMISSIONS; DOWNLOADABLE COMPUTER SOFTWARE FOR PEER-TO-PEER COLLABORATION OF MULTIPLE INSTANCES TO PROVIDE DOMAIN-SPECIFIC POLICIES AND TO PROVIDE NATIVE RESOURCE MANAGEMENT SUPPORT (U.S. CLS. 21, 23, 26, 36 AND 38).

CLASS 9—(Continued).

WARE FOR INTERFACE AND COLLECTION OF END USER COMMANDS FOR JOB, QUEUE AND SYSTEM MANAGEMENT, INTERNAL DIAGNOSTIC AND LOGGING FACILITIES, INTEGRATION OF PROVISIONING MANAGERS, BILLING SYSTEMS, IDENTITY AND SECURITY MANAGERS AND DATABASES, AND TRANSLOCATION OF RESOURCE MANAGER JOB SUBMISSIONS; DOWNLOADABLE COMPUTER SOFTWARE FOR PEER-TO-PEER COLLABORATION OF MULTIPLE INSTANCES TO PROVIDE DOMAIN-SPECIFIC POLICIES AND TO PROVIDE NATIVE RESOURCE MANAGEMENT SUPPORT (U.S. CLS. 21, 23, 26, 36 AND 38).

FIRST USE 5-1-2004; IN COMMERCE 5-1-2004.
JAMES GRIFFIN, EXAMINING ATTORNEY

CLASS 9—(Continued).

SN 78-435,729. ATOM LIGHTING, INC., TEMPE, AZ. FILED 6-15-2004.

CURRENT

SN 78-435,430. CABOT SAFETY INTERMEDIATE CORPORATION, NEWARK, DE. FILED 6-15-2004.

THE MARK CONSISTS OF STANDARD CHARACTERS WITHOUT CLAIM TO ANY PARTICULAR FONT, STYLE, SIZE, OR COLOR.

FOR ELECTRIC CABLES, NAMELY, LOW-VOLTAGE DIRECT BURIAL CABLES FOR EXTERIOR LANDSCAPE LIGHTING (U.S. CLS. 21, 23, 26, 36 AND 38).

FIRST USE 8-0-2003; IN COMMERCE 8-0-2003.
BILL DAWE, EXAMINING ATTORNEY

SN 78-436,380. APPLIED BIOSYSTEMS/MDS SCIEX INSTRUMENTS, CONCORD, ONTARIO, CANADA, FILED 6-16-2004.

LR50**OPTI-TOF**

THE MARK CONSISTS OF STANDARD CHARACTERS WITHOUT CLAIM TO ANY PARTICULAR FONT, STYLE, SIZE, OR COLOR.

FOR PROTECTIVE HEADGEAR, NAMELY, HARD HATS AND HARD HAT LINERS THEREFOR (U.S. CLS. 21, 23, 26, 36 AND 38).

STEVEN JACKSON, EXAMINING ATTORNEY

THE MARK CONSISTS OF STANDARD CHARACTERS WITHOUT CLAIM TO ANY PARTICULAR FONT, STYLE, SIZE, OR COLOR.

OWNER OF U.S. REG. NO. 2,593,108.

FOR LABORATORY EQUIPMENT AND SUPPLIES, NAMELY, HOLDERS, INSERTS AND PLATES (U.S. CLS. 21, 23, 26, 36 AND 38).

FIRST USE 2-12-2004; IN COMMERCE 2-12-2004.
IRENE D. WILLIAMS, EXAMINING ATTORNEY

CLASS 9—(Continued).

SN 78-437,250. NEXTEP, RENO, NV. FILED 6-17-2004.

CLASS 9—(Continued).

SN 78-441,576. BUDGETEXT CORPORATION, FAYETTEVILLE, AR. FILED 6-25-2004.

BENCH MATE

ComText

THE MARK CONSISTS OF STANDARD CHARACTERS WITHOUT CLAIM TO ANY PARTICULAR FONT, STYLE, SIZE, OR COLOR.

NO CLAIM IS MADE TO THE EXCLUSIVE RIGHT TO USE BENCH, APART FROM THE MARK AS SHOWN.

FOR ELECTRICAL POWER DISTRIBUTION CORDS (U.S. CLS. 21, 23, 26, 36 AND 38).

FIRST USE 6-2-2004; IN COMMERCE 6-2-2004.
BRIDGETT SMITH, EXAMINING ATTORNEY

THE MARK CONSISTS OF STANDARD CHARACTERS WITHOUT CLAIM TO ANY PARTICULAR FONT, STYLE, SIZE, OR COLOR.

FOR COMPUTER SOFTWARE FOR MANAGEMENT OF BUYING AND SELLING OF BOOKS (U.S. CLS. 21, 23, 26, 36 AND 38).

FIRST USE 4-1-1985; IN COMMERCE 4-1-1985.
ANN LINNEHAN, EXAMINING ATTORNEY

SN 78-442,005. ADVANCED BIOLOGIC CORP., TORONTO ONTARIO, CANADA, FILED 6-27-2004.

SN 78-439,542. TRS QUALITY, INC., FORT WORTH, TX. FILED 6-22-2004.

ROADSIDE COMPANION

Galileo

THE MARK CONSISTS OF STANDARD CHARACTERS WITHOUT CLAIM TO ANY PARTICULAR FONT, STYLE, SIZE, OR COLOR.

NO CLAIM IS MADE TO THE EXCLUSIVE RIGHT TO USE "ROADSIDE", APART FROM THE MARK AS SHOWN.

FOR NAVIGATIONAL SYSTEM, COMPRISING ELECTRONIC TRANSMITTERS, RECEIVERS, CIRCUITRY, MICROPROCESSORS, CELLULAR TELEPHONE AND COMPUTER SOFTWARE ALL FOR USE IN NAVIGATION AND ALL INCORPORATED INTO A MOTOR VEHICLE (U.S. CLS. 21, 23, 26, 36 AND 38).

MATTHEW PAPPAS, EXAMINING ATTORNEY

THE MARK CONSISTS OF STANDARD CHARACTERS WITHOUT CLAIM TO ANY PARTICULAR FONT, STYLE, SIZE, OR COLOR.

PRIORITY CLAIMED UNDER SEC. 44(D) ON CANADA APPLICATION NO. 1200497, FILED 12-31-2003, REG. NO. TMA633912, DATED 2-28-2005, EXPIRES 2-28-2019.

FOR MEDICAL IMAGING SOFTWARE AND MEDICAL IMAGE CO-REGISTRATION SOFTWARE (U.S. CLS. 21, 23, 26, 36 AND 38).

DANIEL BRODY, EXAMINING ATTORNEY

CLASS 9—(Continued).

SN 78-443,680. DANSKIN, INC., NEW YORK, NY. FILED 6-30-2004.

DANSKIN NOW

THE MARK CONSISTS OF STANDARD CHARACTERS WITHOUT CLAIM TO ANY PARTICULAR FONT, STYLE, SIZE, OR COLOR.

OWNER OF U.S. REG. NOS. 772,356, 2,017,878 AND OTHERS.

FOR EYEGLASSES; SUNGLASSES; PRE-RECORDED CD'S, VIDEO TAPES, LASER DISKS AND DVD'S ALL RELATING TO HEALTH, NUTRITION, FITNESS, EXERCISE, AND AN ACTIVE LIFE STYLE NOT RELATING TO SOFTWARE OR MUSIC (U.S. CLS. 21, 23, 26, 36 AND 38).

PRISCILLA MILTON, EXAMINING ATTORNEY

SN 78-443,692. DANSKIN, INC., NEW YORK, NY. FILED 6-30-2004.

NOW

THE MARK CONSISTS OF STANDARD CHARACTERS WITHOUT CLAIM TO ANY PARTICULAR FONT, STYLE, SIZE, OR COLOR.

FOR EYEGLASSES; SUNGLASSES; PRE-RECORDED CDS, VIDEO TAPES, LASER DISKS, AND DVDS, ALL RELATING TO HEALTH, NUTRITION, FITNESS, EXERCISE, AND AN ACTIVE LIFESTYLE, NOT RELATING TO SOFTWARE OR MUSIC (U.S. CLS. 21, 23, 26, 36 AND 38).

PRISCILLA MILTON, EXAMINING ATTORNEY

CLASS 9—(Continued).

SN 78-444,262. AEROCOOL ADVANCED TECHNOLOGIES CORP., TAIPEI CITY, TAIWAN, FILED 7-1-2004.



NO CLAIM IS MADE TO THE EXCLUSIVE RIGHT TO USE "COOL", APART FROM THE MARK AS SHOWN.

FOR COMPUTER HARDWARE; COMPUTER KEYBOARDS; MOUSE PADS; HEAT SINKS FOR CENTRAL PROCESSING UNITS; TEMPERATURE CONTROLLERS; COMPUTER HARDWARE NAMELY, COMPUTER CASINGS, COOLING FANS FOR CONDUCTING HEAT AWAY FROM COMPUTER HARDWARE, HEAT SINKS; STEREO APPARATUS, NAMELY, PERSONAL STEREO, STEREO RECEIVERS, AND STEREO AMPLIFIERS (U.S. CLS. 21, 23, 26, 36 AND 38).

FIRST USE 4-16-2004; IN COMMERCE 4-16-2004.

KIM SAITO, EXAMINING ATTORNEY

SN 78-444,480. VICTOR DATA SYSTEMS CO., LTD., TOKYO, JAPAN, FILED 7-1-2004.



THE MARK CONSISTS OF THE LETTERS VDS IN STYLIZED FORM.

FOR MAGNETIC TAPE DRIVES; VIDEO DISPLAY MONITORS; LCD DISPLAY MONITORS; COMPUTER DISPLAY MONITORS; CARD PRINTERS (U.S. CLS. 21, 23, 26, 36 AND 38).

FIRST USE 12-20-1981; IN COMMERCE 12-20-1996.

JACQUELINE A. LAVINE, EXAMINING ATTORNEY

CLASS 9—(Continued).

SN 78-445,764. ANSUL, INCORPORATED, MARINETTE, WI. FILED 7-3-2004.



THE COLOR(S) RED IS/ARE CLAIMED AS A FEATURE OF THE MARK.
THE MARK CONSISTS OF RED FLAMES WITH THE WORD "CORDOVA" IN RED.
FOR COMPONENT PARTS OF FIRE EXTINGUISHING SYSTEMS, NAMELY, NOZZLES AND CONTROL VALVES WHICH TRANSPORT WATER, FOAM, AND GEL (U.S. CLS. 21, 23, 26, 36 AND 38).
FIRST USE 1-31-1990; IN COMMERCE 1-31-1990.
ANDREA SAUNDERS, EXAMINING ATTORNEY

CLASS 9—(Continued).

SN 78-448,497. XSYNTHESIS, LLC, LEESBURG, VA. FILED 7-9-2004.



SN 78-447,568. RICHEY ELECTRONICS LIMITED, KAOHSIUNG, TAIWAN, FILED 7-8-2004.



THE MARK CONSISTS OF STANDARD CHARACTERS WITHOUT CLAIM TO ANY PARTICULAR FONT, STYLE, SIZE, OR COLOR.
SEC. 2(F).
FOR CAPACITORS, ELECTROLYTIC CAPACITORS, CERAMIC CAPACITORS, PLASTIC CAPACITORS, AND FIXED ALUMINUM ELECTROLYTIC CAPACITORS (U.S. CLS. 21, 23, 26, 36 AND 38).
FIRST USE 12-23-1991; IN COMMERCE 1-16-1998.
VIVIAN MICZNIK FIRST, EXAMINING ATTORNEY

FOR COMPUTER APPLICATIONS, SOFTWARE AND PROGRAMS IN THE FIELDS OF BUSINESS OPERATIONS AND GENERAL OFFICE FUNCTIONS, NAMELY, MEMBERSHIP RECORDS MANAGEMENT SOFTWARE, CUSTOMER RECORDS MANAGEMENT SOFTWARE, ORDER ENTRY AND RETURNS PROCESSING SOFTWARE, MARKETING PRESENCE WEB SITE SOFTWARE, INTERACTIVE WEB SITE SOFTWARE, E-COMMERCE WEB SITE SOFTWARE, EMAIL CAMPAIGN MANAGEMENT SOFTWARE, EVENTS MANAGEMENT SOFTWARE, MEETING PLANNING SOFTWARE, WEB SITE AND INTRANET SOFTWARE CONTENT MANAGEMENT SOFTWARE, KNOWLEDGE BASE SEARCH SOFTWARE, DOCUMENT MANAGEMENT SOFTWARE, CONTENT ROTATION ENGINE SOFTWARE, BILLING AND INVOICING SOFTWARE, CREDIT CARD PROCESSING SOFTWARE, SHIPPING MANAGEMENT SOFTWARE; ACCOUNTING SOFTWARE, NAMELY, GENERAL LEDGER, ACCOUNTS RECEIVABLE, ACCOUNTS PAYABLE, BANK ACCOUNTS AND ASSETS, PURCHASING AND RECEIVING SOFTWARE, VENDOR MANAGEMENT SOFTWARE, INVENTORY MANAGEMENT SOFTWARE, INTERACTIVE ONLINE SURVEY SOFTWARE, DOCUMENTATION, MANUALS, CATALOGS AND INSTRUCTIONS DISTRIBUTED THEREWITH (U.S. CLS. 21, 23, 26, 36 AND 38).
FIRST USE 4-4-2004; IN COMMERCE 4-4-2004.
MELVIN AXILBUND, EXAMINING ATTORNEY

CLASS 9—(Continued).

SN 78-448,738. CAVIUM NETWORKS, SANTA CLARA, CA.
FILED 7-9-2004.

CLASS 9—(Continued).

SN 78-448,788. TAMURA TAIKO HOLDINGS CO., INC.,
TOKYO, JAPAN, FILED 7-9-2004.

OCTEON

THE MARK CONSISTS OF STANDARD CHARACTERS WITHOUT CLAIM TO ANY PARTICULAR FONT, STYLE, SIZE, OR COLOR.

PRIORITY CLAIMED UNDER SEC. 44(D) ON JAPAN APPLICATION NO. 2004-2229, FILED 1-14-2004, REG. NO. 000003632, DATED 3-24-2005, EXPIRES 3-24-2015.

FOR TELECOMMUNICATION TRANSMITTERS; TRANSMITTERS OF ELECTRONIC SIGNALS, NAMELY, RADIO, TELEVISION AND HIGH DEFINITION TELEVISION SIGNALS; PUBLIC TELEPHONES; TELEPHONES FOR COMMERCIAL USE; TELEPHONES FOR DOMESTIC USE; RADIO COMMUNICATION TELEPHONE SETS; COMMUNICATION TERMINALS UTILIZING INTEGRATED CIRCUIT CARDS; INTEGRATED CIRCUIT CARD READERS; INTEGRATED CIRCUIT CARD WRITERS; MAGNETIC CARD READERS; MAGNETIC CARD WRITERS; TAPE COUNTERS; ELECTROMAGNETIC COUNTERS. (U.S. CLS. 21, 23, 26, 36 AND 38).

RONALD AIKENS, EXAMINING ATTORNEY

SN 78-449,139. HOME BOX OFFICE, INC., NEW YORK, NY.
FILED 7-12-2004.

The Sopranos

THE MARK CONSISTS OF STANDARD CHARACTERS WITHOUT CLAIM TO ANY PARTICULAR FONT, STYLE, SIZE, OR COLOR.

FOR SEMICONDUCTORS, SEMICONDUCTOR CHIP SETS, MICROPROCESSORS, CUSTOMIZED MICROPROCESSORS AND RELATED SOFTWARE FOR USE IN SWITCHES, ROUTERS AND COMPUTER SERVERS FOR MANAGING, OPERATING, AND SECURING LOCAL AND WIDE AREA COMPUTER NETWORKS AND NETWORK PRODUCTS; APPLICATION SPECIFIC INTEGRATED CIRCUITS, COMPUTER BOARDS, AND COMPUTER PROCESSORS USED IN, AND FOR OPERATING AND SECURING, COMPUTER HARDWARE, NAMELY, COMPUTER NETWORK SERVERS, WORKSTATION, DESKTOP, AND LAPTOP COMPUTERS, AND PDA'S. (U.S. CLS. 21, 23, 26, 36 AND 38).

JAMES GRIFFIN, EXAMINING ATTORNEY

OWNER OF U.S. REG. NOS. 2,366,388, 2,916,578 AND OTHERS.

FOR PRERECORDED AUDIOTAPES, VIDEOTAPES, COMPACT DISCS, DVDS AND MULTIMEDIA SOFTWARE RECORDED ON CD-ROM FEATURING CONTENT FROM OR RELATING TO APPLICANT'S DRAMATIC TELEVISION SERIES OF THE SAME NAME (U.S. CLS. 21, 23, 26, 36 AND 38).

FIRST USE 0-0-1999; IN COMMERCE 0-0-1999.

ERNEST SHOSHO, EXAMINING ATTORNEY

CLASS 9—(Continued).

SN 78-449,146. PTW-NEW YORK CORPORATION, HICKS-VILLE, NY. FILED 7-12-2004.

TRUFIX

THE MARK CONSISTS OF STANDARD CHARACTERS WITHOUT CLAIM TO ANY PARTICULAR FONT, STYLE, SIZE, OR COLOR.

FOR ION CHAMBER HOLDER, NAMELY, A MECHANICAL DEVICE USED TO ACCURATELY POSITION SEVERAL DIFFERENT TYPES OF ION CHAMBERS BY ALIGNING THE EFFECTIVE MEASUREMENT POINTS OF THE CHAMBERS IN THE RADIATION BEAM (U.S. CLS. 21, 23, 26, 36 AND 38).

FIRST USE 6-25-2004; IN COMMERCE 6-25-2004.
DOUGLAS LEE, EXAMINING ATTORNEY

CLASS 9—(Continued).

SN 78-451,491. CIRQUE CORPORATION, SALT LAKE CITY, UT. FILED 7-15-2004.

GLIDEPOINT

THE MARK CONSISTS OF STANDARD CHARACTERS WITHOUT CLAIM TO ANY PARTICULAR FONT, STYLE, SIZE, OR COLOR.

OWNER OF U.S. REG. NO. 1,917,722.

FOR COMPUTER INPUT DEVICE IN THE NATURE OF A PAD WHICH IS SENSITIVE TO THE PROXIMITY OF AN OBJECT SO AS TO INPUT DATA TO DEVICES; NAMELY, COMPUTERS, FOR USE IN THE COMPUTER FIELD (U.S. CLS. 21, 23, 26, 36 AND 38).

FIRST USE 7-14-1992; IN COMMERCE 7-14-1992.
ERNEST SHOSHO, EXAMINING ATTORNEY

SN 78-451,925. CLARION CO., LTD., TOKYO, JAPAN, FILED 7-16-2004.



SN 78-450,372. BUNZL DISTRIBUTION USA, INC., ST. LOUIS, MO. FILED 7-14-2004.

BIG RED

THE MARK CONSISTS OF STANDARD CHARACTERS WITHOUT CLAIM TO ANY PARTICULAR FONT, STYLE, SIZE, OR COLOR.

FOR THERMOMETERS NOT FOR MEDICAL USE (U.S. CLS. 21, 23, 26, 36 AND 38).

FIRST USE 8-31-2003; IN COMMERCE 6-1-2004.
MITCHELL FRONT, EXAMINING ATTORNEY

FOR CAR RADIOS, CAR STEREOS, CB TRANSMITTERS (TRANSCIEVERS), RADIO TUNERS AND RECEIVERS, TAPE PLAYERS AND RECORDERS (TAPE DECKS), RECORD PLAYERS, AMPLIFIERS, SPEAKERS, ANTENNAS, MICROPHONES; ROTATING ELECTRICAL MACHINES, NAMELY, PHASE MODIFIERS AND ROTARY CONVERTERS; ELECTRICAL DISTRIBUTION OR CONTROL MACHINES AND APPARATUS, NAMELY, RECTIFIERS, TRANSFORMERS, INDUCTION VOLTAGE REGULATORS, SWITCHBOARDS, RELAYS, SWITCHES, DISCONNECTING SWITCHES, CIRCUIT BREAKERS, CONTROLLERS, STARTERS, RESISTORS, STATIC CONDENSERS, LIGHTING ARRESTERS, LIGHTNING ARRESTERS, REACTORS, LOCAL SWITCHES, LAMP HOLDERS, CONNECTORS, DISTRIBUTING BOXES AND FUSES; SAFETY MINE LIGHT LAMPS; BATTERIES, NAMELY, DRY CELLS, WET CELLS AND STORAGE BATTERIES; ELECTRICAL AND MAGNETIC MEASURING INSTRUMENTS, NAMELY, AMMETERS, VOLTMETERS, WATT METERS, WATT HOUR METERS, PHASE METERS, FREQUENCY METERS, RADIO WAVE METERS, ANTENNA

CLASS 9—(Continued).

MEASURING APPARATUS, RESISTANCE MEASURING APPARATUS, CAPACITANCE MEASURING APPARATUS, VACUUM TUBE CHARACTERISTICS MEASURING APPARATUS, GENERATORS AND OSCILLATORS, DETECTORS, MAGNETIC MEASURING APPARATUS, ELECTRICAL CIRCUIT TESTERS AND OSCILLOGRAPH; ELECTRIC WIRES, NAMELY, UNCOVERED WIRES, RUBBER COVERED WIRES, PLASTIC COVERED WIRES, MAGNETIC WIRES AND SPECIAL COVERED WIRES; CABLES, NAMELY, POWER CABLES, COMMUNICATION CABLES, CONNECTION BOXES, TERMINAL BOXES AND CONNECTING SLEEVES; HOUSEHOLD ELECTRIC APPLIANCES, NAMELY, ELECTRIC IRONS, ELECTRIC HAIR CURLERS, ELECTRIC DOOR BELLS; DATA PROCESSORS; COMPUTERS; DATA PROCESSING EQUIPMENT AND COMPUTERS, NAMELY, BLACK BOXES WHICH CONTROL IN-VEHICLE NAVIGATION AND ENTERTAINMENT SYSTEMS; LCD MONITORS, DVD PLAYERS, CD PLAYERS, DVD CHANGERS, IN-DASH DISPLAY SCREENS, SUBWOOFER CONTROLS (U.S. CLS. 21, 23, 26, 36 AND 38).

TONI HICKEY, EXAMINING ATTORNEY

SN 78-452,811. VERTICAL SYSTEMS, INC., EDEN PRAIRIE, MN. FILED 7-19-2004.

KNOWWIRE

THE MARK CONSISTS OF STANDARD CHARACTERS WITHOUT CLAIM TO ANY PARTICULAR FONT, STYLE, SIZE, OR COLOR.

FOR COMPUTER SOFTWARE FOR MOBILE DATA COLLECTION, NAMELY, SURVEY DATA COLLECTION USING MOBILE DEVICES (U.S. CLS. 21, 23, 26, 36 AND 38).

FIRST USE 12-0-2003; IN COMMERCE 12-0-2003.
PATRICIA EVANKO, EXAMINING ATTORNEY

CLASS 9—(Continued).

SN 78-453,249. IN SITU INC., LARAMIE, WY. FILED 7-20-2004.

RDO

THE MARK CONSISTS OF STANDARD CHARACTERS WITHOUT CLAIM TO ANY PARTICULAR FONT, STYLE, SIZE, OR COLOR.

FOR INSTRUMENTATION FOR USE IN THE FIELD OF HYDROLOGY FOR ON-SITE MONITORING OF WATER SUPPLIES AND BODIES OF WATER, NAMELY, MONITORS, METERS, AND PROBES FOR SENSING AND COLLECTING HYDROLOGIC DATA AND PROVIDING DISSOLVED-OXYGEN MEASUREMENT (U.S. CLS. 21, 23, 26, 36 AND 38).

FIRST USE 5-28-2004; IN COMMERCE 5-28-2004.
LAURIE MAYES, EXAMINING ATTORNEY

SN 78-454,257. HOLY HIP HOP HOLDINGS, INC., PINE LAKE, GA. FILED 7-21-2004.

**HOLY HIP HOP
"TAKING THE GOSPEL
TO THE STREETS"**

THE MARK CONSISTS OF STANDARD CHARACTERS WITHOUT CLAIM TO ANY PARTICULAR FONT, STYLE, SIZE, OR COLOR.

OWNER OF U.S. REG. NO. 2,363,376.

NO CLAIM IS MADE TO THE EXCLUSIVE RIGHT TO USE "HOLY HIP HOP", APART FROM THE MARK AS SHOWN.

FOR SERIES OF MUSICAL SOUND RECORDINGS FEATURING INSPIRATIONAL SPIRITUAL HIP HOP (U.S. CLS. 21, 23, 26, 36 AND 38).

FIRST USE 4-2-2004; IN COMMERCE 6-29-2004.
AMY HELLA, EXAMINING ATTORNEY

CLASS 9—(Continued).

SN 78-454,994. PACIFIC LINK TRADE USA, INC., DALTON, GA. FILED 7-22-2004.

CLASS 9—(Continued).

SN 78-455,186. NAVICARE SYSTEMS, INC., ST. PAUL, MN. FILED 7-22-2004.



FAMILYVUE

NO CLAIM IS MADE TO THE EXCLUSIVE RIGHT TO USE "VISION", APART FROM THE MARK AS SHOWN.
 THE MARK CONSISTS OF A STYLIZED LETTER V OVERLAYING A STYLIZED LETTER C, CENTERED ABOVE THE WORDS CITY VISION.
 FOR EYEGLASSES, SUNGLASSES, EYEGLASS FRAMES, EYEGLASS CASES (U.S. CLS. 21, 23, 26, 36 AND 38).
 DANIEL CAPSHAW, EXAMINING ATTORNEY

THE MARK CONSISTS OF STANDARD CHARACTERS WITHOUT CLAIM TO ANY PARTICULAR FONT, STYLE, SIZE, OR COLOR.
 FOR COMPUTER SOFTWARE AND COMPUTER HARDWARE FOR USE IN HEALTHCARE FACILITIES TO MONITOR AND DISPLAY PATIENT STATUS AND LOCATION (U.S. CLS. 21, 23, 26, 36 AND 38).
 FIRST USE 0-0-1997; IN COMMERCE 0-0-1997.
 ALICE BENMAMAN, EXAMINING ATTORNEY

SN 78-455,174. DRS ELECTRONIC SYSTEMS, INC., GAITHERSBURG, MD. FILED 7-22-2004.

SN 78-455,256. JORDAN VALLEY APPLIED RADIATION LTD., MIGDAL HA'EMEK, ISRAEL, FILED 7-22-2004.

CBAAR

JVX

THE MARK CONSISTS OF STANDARD CHARACTERS WITHOUT CLAIM TO ANY PARTICULAR FONT, STYLE, SIZE, OR COLOR.
 FOR FIXED OR ROTATING ACTIVE ARRAY RADAR FOR DETECTION PURPOSES (U.S. CLS. 21, 23, 26, 36 AND 38).
 ELLEN B. AWRICH, EXAMINING ATTORNEY

THE MARK CONSISTS OF STANDARD CHARACTERS WITHOUT CLAIM TO ANY PARTICULAR FONT, STYLE, SIZE, OR COLOR.
 FOR INSTRUMENTS FOR ANALYSIS OF MATERIALS AND FOR CHARACTERIZATION AND METROLOGY OF THIN FILMS, NAMELY, INSTRUMENTS BASED ON X-RAYS, AND SOFTWARE FOR OPERATING SUCH INSTRUMENTS (U.S. CLS. 21, 23, 26, 36 AND 38).
 FIRST USE 5-0-2000; IN COMMERCE 5-0-2000.
 AMY HELLA, EXAMINING ATTORNEY

CLASS 9—(Continued).

SN 78-455,402. VIACOM INTERNATIONAL INC., NEW YORK, NY. FILED 7-23-2004.

MTV PILATES MIX

THE MARK CONSISTS OF STANDARD CHARACTERS WITHOUT CLAIM TO ANY PARTICULAR FONT, STYLE, SIZE, OR COLOR.

NO CLAIM IS MADE TO THE EXCLUSIVE RIGHT TO USE "PILATES MIX", APART FROM THE MARK AS SHOWN.

FOR PRE-RECORDED VIDEO TAPES AND VIDEO DISCS FEATURING TOPICS RELATED TO HEALTH, WELLNESS AND PILATES EXERCISE PROGRAMS (U.S. CLS. 21, 23, 26, 36 AND 38).

WILLIAM BRECKENFELD, EXAMINING ATTORNEY

SN 78-456,455. BELKIN CORPORATION, COMPTON, CA. FILED 7-26-2004.

TUNEPower

THE MARK CONSISTS OF STANDARD CHARACTERS WITHOUT CLAIM TO ANY PARTICULAR FONT, STYLE, SIZE, OR COLOR.

FOR BATTERY CHARGERS, BATTERIES, AND ELECTRICAL POWER SUPPLIES (U.S. CLS. 21, 23, 26, 36 AND 38).

REBECCA SMITH, EXAMINING ATTORNEY

CLASS 9—(Continued).

SN 78-457,282. TORAND PRODUCTIONS INC., LOS ANGELES, CA. FILED 7-27-2004.



OWNER OF U.S. REG. NO. 2,510,281.

THE STIPPLING IS A FEATURE OF THE MARK.

THE MARK CONSISTS OF A CIRCLE WITH THE MARK BEVERLY HILLS 90210.

FOR PRERECORDED VIDEOCASSETTES AND DVDS FEATURING A TELEVISION DRAMA SERIES (U.S. CLS. 21, 23, 26, 36 AND 38).

FIRST USE 1-21-1992; IN COMMERCE 1-21-1992.

SAMUEL E. SHARPER JR., EXAMINING ATTORNEY

SN 78-457,373. EXECUCOMM LLC, LA JOLLA, CA. FILED 7-27-2004.

EXECUTIVE VOCABULARY

THE MARK CONSISTS OF STANDARD CHARACTERS WITHOUT CLAIM TO ANY PARTICULAR FONT, STYLE, SIZE, OR COLOR.

NO CLAIM IS MADE TO THE EXCLUSIVE RIGHT TO USE "VOCABULARY", APART FROM THE MARK AS SHOWN.

FOR PRE-RECORDED AUDIO TAPES AND CDS AND EDUCATIONAL COMPUTER SOFTWARE FEATURING LANGUAGE TRAINING REGARDING ENGLISH VOCABULARY AND GRAMMAR (U.S. CLS. 21, 23, 26, 36 AND 38).

FIRST USE 10-1-2001; IN COMMERCE 3-26-2002.

WILLIAM VERHOSEK, EXAMINING ATTORNEY

CLASS 9—(Continued).

SN 78-457,760. SPORTSOFT, RENTON, WA. FILED 7-28-2004.

CLASS 9—(Continued).

SN 78-458,191. ACTIVEWAVE INC., BOCA RATON, FL. FILED 7-28-2004.

SPORTSOFT

ActiveWave

THE MARK CONSISTS OF STANDARD CHARACTERS WITHOUT CLAIM TO ANY PARTICULAR FONT, STYLE, SIZE, OR COLOR.

FOR ATHLETIC EQUIPMENT BAR CODE INVENTORY SYSTEM, NAMELY, COMPUTERS, BAR CODES, COMPUTER APPLICATION SOFTWARE, BAR CODE INPUT DEVICES, BAR CODE OUPUT DEVICES (U.S. CLS. 21, 23, 26, 36 AND 38).

FIRST USE 1-4-1996; IN COMMERCE 10-23-1996.
KIMBERLY PERRY, EXAMINING ATTORNEY

THE MARK CONSISTS OF STANDARD CHARACTERS WITHOUT CLAIM TO ANY PARTICULAR FONT, STYLE, SIZE, OR COLOR.

FOR RADIO FREQUENCY IDENTIFICATION AND TRACKING DEVICES, NAMELY, HANDHELD AND STATIONARY READERS AND TRANSPONDERS USING RADIO FREQUENCY TECHNOLOGY FOR THE EXCHANGE OF INFORMATION. (U.S. CLS. 21, 23, 26, 36 AND 38).

AMOS T. MATTHEWS, JR., EXAMINING ATTORNEY

SN 78-460,202. GRAND HALL ENTERPRISE CO., LTD., TAIPEI, TAIWAN, FILED 8-2-2004.

SN 78-458,003. HARMAN INTERNATIONAL INDUSTRIES, INCORPORATED, NORTHRIDGE, CA. FILED 7-28-2004.

Quick Check



on stage

OWNER OF U.S. REG. NOS. 782,327, 2,853,443 AND OTHERS.

FOR AUDIO EQUIPMENT, NAMELY, AMPLIFIERS AND SPEAKERS (U.S. CLS. 21, 23, 26, 36 AND 38).

FIRST USE 7-11-2004; IN COMMERCE 7-11-2004.
ANDREA SAUNDERS, EXAMINING ATTORNEY

THE MARK CONSISTS OF STANDARD CHARACTERS WITHOUT CLAIM TO ANY PARTICULAR FONT, STYLE, SIZE, OR COLOR.

NO CLAIM IS MADE TO THE EXCLUSIVE RIGHT TO USE "CHECK", APART FROM THE MARK AS SHOWN.

FOR FUEL LEVEL GAUGES (U.S. CLS. 21, 23, 26, 36 AND 38).

FIRST USE 7-8-2004; IN COMMERCE 7-8-2004.
MAUREEN DALL, EXAMINING ATTORNEY

CLASS 9—(Continued).

SN 78-461,427. FLYING LAB SOFTWARE, LLC, SEATTLE, WA. FILED 8-4-2004.

**FLYING LAB
SOFTWARE**

THE MARK CONSISTS OF STANDARD CHARACTERS WITHOUT CLAIM TO ANY PARTICULAR FONT, STYLE, SIZE, OR COLOR.

NO CLAIM IS MADE TO THE EXCLUSIVE RIGHT TO USE "SOFTWARE", APART FROM THE MARK AS SHOWN. FOR COMPUTER GAME SOFTWARE (U.S. CLS. 21, 23, 26, 36 AND 38).

FIRST USE 9-11-1987; IN COMMERCE 9-19-2001.
LINDA MICKLEBURGH, EXAMINING ATTORNEY

SN 78-462,567. XENTRIS LLC, ADDISON, IL. FILED 8-5-2004.

XENTRIS

THE MARK CONSISTS OF STANDARD CHARACTERS WITHOUT CLAIM TO ANY PARTICULAR FONT, STYLE, SIZE, OR COLOR.

XENTRIS IS A GREEK WORD WHICH TRANSLATES AS "A NEW BEGINNING".

FOR WIRELESS PHONE ACCESSORIES, NAMELY, CARRYING CASES, TRAVEL CHARGERS, VEHICLE POWER ADAPTERS, HEADSETS, FACE PLATES, DATA CABLES, BELT CLIPS, HOLSTERS, PHONE CORD KEEPERS, PHONE COVERS NOT MADE OF PAPER (U.S. CLS. 21, 23, 26, 36 AND 38).

FIRST USE 1-27-2003; IN COMMERCE 1-27-2003.
KIMBERLY PERRY, EXAMINING ATTORNEY

CLASS 9—(Continued).

SN 78-462,678. JONSA TECHNOLOGIES CO., LTD., NAN KANG INDUSTRIAL PARK, NANTOU CITY, TAIWAN, FILED 8-5-2004.

 **JONSA**

OWNER OF U.S. REG. NOS. 1,820,486, 2,329,436 AND 2,357,229.

THE MARK CONSISTS OF THE STYLIZED WORDS "JONSA" WITH A MISCELLANEOUS DESIGN. FOR ANTENNAS; SATELLITE DISH ANTENNAS; TELEVISION ANTENNAS (U.S. CLS. 21, 23, 26, 36 AND 38).

FIRST USE 4-1-2004; IN COMMERCE 4-1-2004.
RONALD MCMORROW, EXAMINING ATTORNEY

SN 78-463,064. JASON ANTHONY CASATELLI, SEATTLE, WA. FILED 8-6-2004.

CIVILIZED ANIMALS

THE MARK CONSISTS OF STANDARD CHARACTERS WITHOUT CLAIM TO ANY PARTICULAR FONT, STYLE, SIZE, OR COLOR.

FOR PRE-RECORDED CD'S FEATURING MUSIC, PHONOGRAPH RECORDS FEATURING MUSIC (U.S. CLS. 21, 23, 26, 36 AND 38).

FIRST USE 12-1-1995; IN COMMERCE 1-31-2003.
LAURIE MAYES, EXAMINING ATTORNEY

CLASS 9—(Continued).

SN 78-464,175. GREGORY QUIST AND DAVID DRAKE, DBA THE LXT GROUP, ESCONDIDO, CA. FILED 8-9-2004.

CLASS 9—(Continued).

SN 78-464,391. PARKER-HANNIFIN CORPORATION, CLEVELAND, OH. FILED 8-9-2004.

BIOSENTRY

UNI-STAT

THE MARK CONSISTS OF STANDARD CHARACTERS WITHOUT CLAIM TO ANY PARTICULAR FONT, STYLE, SIZE, OR COLOR.

FOR SCIENTIFIC APPARATUS FOR DETECTING AND IDENTIFYING PATHOGENS IN FLUIDS AND AIR (U.S. CLS. 21, 23, 26, 36 AND 38).

FIRST USE 3-31-2005; IN COMMERCE 3-31-2005.
ODESSA BIBBINS, EXAMINING ATTORNEY

THE MARK CONSISTS OF STANDARD CHARACTERS WITHOUT CLAIM TO ANY PARTICULAR FONT, STYLE, SIZE, OR COLOR.

FOR ELECTRONIC CONTROLLERS FOR REFRIGERATION AND AIR CONDITIONING EQUIPMENT (U.S. CLS. 21, 23, 26, 36 AND 38).

FIRST USE 12-9-2002; IN COMMERCE 12-9-2002.
CHERYL CLAYTON, EXAMINING ATTORNEY

SN 78-464,300. EXAVIO, INC., SANTA CLARA, CA. FILED 8-9-2004.

SN 78-464,830. CALVIN, GIORDANO & ASSOCIATES, INC., FORT LAUDERDALE, FL. FILED 8-10-2004.

ExaVault

INKFORCE

THE MARK CONSISTS OF STANDARD CHARACTERS WITHOUT CLAIM TO ANY PARTICULAR FONT, STYLE, SIZE, OR COLOR.

FOR DIGITAL STORAGE OF ELECTRONIC DATA, SUCH AS IMAGES, TEXT, AUDIO OR VISUAL DATA AND OTHER COMPUTER DATA WITH EXTERNAL COMMUNICATION INTERFACE, WHICH CAN BE CONNECTED TO DATA NETWORKS, NAMELY, ELECTRONIC DIGITAL STORAGE SYSTEMS COMPRISING COMPUTER HARDWARE AND SOFTWARE (U.S. CLS. 21, 23, 26, 36 AND 38).

FIRST USE 6-1-2003; IN COMMERCE 6-1-2003.
KELLY BOULTON, EXAMINING ATTORNEY

THE MARK CONSISTS OF STANDARD CHARACTERS WITHOUT CLAIM TO ANY PARTICULAR FONT, STYLE, SIZE, OR COLOR.

FOR ON-SITE CODE ENFORCEMENT CITATION EQUIPMENT, NAMELY, HAND-HELD WIRELESS COMMUNICATION TRANSCEIVERS, PRINTERS, TABLET PERSONAL COMPUTERS, PERSONAL DIGITAL ASSISTANTS, AND LAPTOP COMPUTING DEVICES HAVING WIRELESS COMMUNICATION CAPABILITIES IN THE NATURE OF MOBILE COMPUTING AND OPERATING PLATFORMS CONSISTING OF DATA TRANSCEIVERS, WIRELESS NETWORKS AND GATEWAYS FOR COLLECTION AND MANAGEMENT OF DATA; AND ON-SITE ENFORCEMENT SOFTWARE FOR ENTERING, ISSUING, TRACKING, AND MONITORING COMPLAINTS AND VIOLATIONS IN THE FIELD OF CODE ENFORCEMENT (U.S. CLS. 21, 23, 26, 36 AND 38).

TONI HICKEY, EXAMINING ATTORNEY

CLASS 9—(Continued).

SN 78-465,047. 3DM INNOVATIONS, INC., CINCINNATI, OH. FILED 8-10-2004.

CLASS 9—(Continued).

SN 78-465,119. ELSEVIER INC, NEW YORK, NY. FILED 8-10-2004.

DINING U-CONTROL

EVOLVE

THE MARK CONSISTS OF STANDARD CHARACTERS WITHOUT CLAIM TO ANY PARTICULAR FONT, STYLE, SIZE, OR COLOR.

NO CLAIM IS MADE TO THE EXCLUSIVE RIGHT TO USE "DINING", APART FROM THE MARK AS SHOWN.

FOR COMPUTER SOFTWARE FOR USE IN THE RESTAURANT INDUSTRY, NAMELY FOR ALLOWING CUTOMERS TO PLACE ORDERS, PAY BILLS, DISPLAY MENUS, DISPLAY CALORIC INFORMATION, AND PLAY GAMES (U.S. CLS. 21, 23, 26, 36 AND 38).

FIRST USE 2-29-2004; IN COMMERCE 2-29-2004.
DOMINIC J. FERRAIUOLO, EXAMINING ATTORNEY

THE MARK CONSISTS OF STANDARD CHARACTERS WITHOUT CLAIM TO ANY PARTICULAR FONT, STYLE, SIZE, OR COLOR.

OWNER OF U.S. REG. NOS. 2,851,612, 2,857,314 AND 2,857,315.

FOR DOWNLOADABLE AND PRINTABLE ELECTRONIC PUBLICATIONS FOR AN EDUCATIONAL COURSE MANAGEMENT SYSTEM PROVIDING EDUCATIONAL CONTENT, TOOLS AND MATERIALS, NAMELY, SYLLABI, CLASS LECTURE NOTES, HOMEWORK ASSIGNMENTS, GRADES, TEST QUESTIONS, QUIZZES, TUTORIALS, SELF-STUDY GUIDES, WORKBOOKS AND TEXTBOOKS IN THE FIELDS OF SCIENCE, MEDICINE AND OTHER HEALTH RELATED PROFESSIONS (U.S. CLS. 21, 23, 26, 36 AND 38).

FIRST USE 11-1-2002; IN COMMERCE 11-1-2002.
CAROLINE WOOD, EXAMINING ATTORNEY

SN 78-465,093. 3DM INNOVATIONS, INC., CINCINNATI, OH. FILED 8-10-2004.

SN 78-465,729. INTERACTIVE SUPERCOMPUTING LLC, ACTON, MA. FILED 8-11-2004.



***P**

FOR COMPUTER SOFTWARE FOR USE IN THE RESTAURANT INDUSTRY, NAMELY FOR ALLOWING CUTOMERS TO PLACE ORDERS, PAY BILLS, DISPLAY MENUS, DISPLAY CALORIC INFORMATION, AND PLAY GAMES (U.S. CLS. 21, 23, 26, 36 AND 38).

FIRST USE 2-29-2004; IN COMMERCE 2-29-2004.
INGRID C. EULIN, EXAMINING ATTORNEY

THE MARK CONSISTS OF STANDARD CHARACTERS WITHOUT CLAIM TO ANY PARTICULAR FONT, STYLE, SIZE, OR COLOR.

FOR COMPUTER SOFTWARE, NAMELY PROGRAMMING SOFTWARE FOR PARALLEL, DISTRIBUTED OR HIGH PERFORMANCE COMPUTERS, CLUSTERS OR PROCESSORS (U.S. CLS. 21, 23, 26, 36 AND 38).

ALEX KEAM, EXAMINING ATTORNEY

CLASS 9—(Continued).

SN 78-466,016. HOMESTEAD MUSIC, LLC, NASHVILLE, TN. FILED 8-11-2004.

Homestead Music

THE MARK CONSISTS OF STANDARD CHARACTERS WITHOUT CLAIM TO ANY PARTICULAR FONT, STYLE, SIZE, OR COLOR.

NO CLAIM IS MADE TO THE EXCLUSIVE RIGHT TO USE MUSIC, APART FROM THE MARK AS SHOWN.

FOR PHONOGRAPH RECORDS FEATURING VARIOUS ARTISTS AND TYPES OF MUSIC (U.S. CLS. 21, 23, 26, 36 AND 38).

FIRST USE 4-1-2005; IN COMMERCE 5-1-2005.
RON FAIRBANKS, EXAMINING ATTORNEY

CLASS 9—(Continued).

SN 78-467,456. XENOMORPH SOFTWARE LIMITED, LONDON, UNITED KINGDOM, FILED 8-13-2004.

DEAL-TIME TECHNOLOGY

THE MARK CONSISTS OF STANDARD CHARACTERS WITHOUT CLAIM TO ANY PARTICULAR FONT, STYLE, SIZE, OR COLOR.

NO CLAIM IS MADE TO THE EXCLUSIVE RIGHT TO USE "TECHNOLOGY", APART FROM THE MARK AS SHOWN.

FOR COMPUTER SOFTWARE PROVIDING FLEXIBLE DATA WAREHOUSING SOLUTIONS FOR THE MANAGEMENT AND ANALYSIS OF PRICE HISTORIES, YIELD CURVES AND DERIVATIVE INSTRUMENTS IN THE FINANCIAL MARKETS INDUSTRY; COMPUTER SOFTWARE FOR ACQUIRING AND ANALYZING FINANCIAL DATA; AND COMPUTER SOFTWARE FOR TRADING AND RISK MANAGEMENT IN HEDGE FUNDS (U.S. CLS. 21, 23, 26, 36 AND 38).
INGA ERVIN, EXAMINING ATTORNEY

SN 78-467,914. MCELROY, RALPH, KINGSLAND, TX. FILED 8-16-2004.

SN 78-467,122. BELKIN CORPORATION, COMPTON, CA. FILED 8-13-2004.

MEDIAPILOT

THE MARK CONSISTS OF STANDARD CHARACTERS WITHOUT CLAIM TO ANY PARTICULAR FONT, STYLE, SIZE, OR COLOR.

FOR COMPUTER HARDWARE AND PERIPHERALS, NAMELY, WIRELESS KEYBOARDS AND MICE, AND INFRARED UNIVERSAL REMOTE CONTROL APPARATUS (U.S. CLS. 21, 23, 26, 36 AND 38).
JOHN LINCOSKI, EXAMINING ATTORNEY

TRIP TRAP

THE MARK CONSISTS OF STANDARD CHARACTERS WITHOUT CLAIM TO ANY PARTICULAR FONT, STYLE, SIZE, OR COLOR.

NO CLAIM IS MADE TO THE EXCLUSIVE RIGHT TO USE TRIP, APART FROM THE MARK AS SHOWN.

FOR INTERLOCK ACTUATION INDICATORS FOR USE WITH ELECTRICAL INTERLOCK PROTECTED MACHINERY TO INDICATE WHICH INTERLOCK CAUSED SHUTDOWN OF THE MACHINERY (U.S. CLS. 21, 23, 26, 36 AND 38).

FIRST USE 3-13-1975; IN COMMERCE 3-13-1975.
ROBERT C. CLARK JR., EXAMINING ATTORNEY

CLASS 9—(Continued).

SN 78-468,407. SHANGHAI ELEMFG. CORP., SHANGHAI, CHINA, FILED 8-17-2004.



NO CLAIM IS MADE TO THE EXCLUSIVE RIGHT TO USE "ELE MFG", APART FROM THE MARK AS SHOWN. FOR ELECTRIC SWITCHES; ELECTRIC PLUGS; ELECTRIC SOCKETS; ELECTRICAL OUTLET PLATES; VOLTAGE SURGE PROTECTORS; AUTOMATIC ELECTRIC SWITCHES; ELECTRIC LIGHT SWITCHES; BLANK INTEGRATED CIRCUIT CARDS BEING BLANK SMART CARDS; SAFETY EQUIPMENT, NAMELY, BEACON LIGHTS; TRAFFIC LIGHTS; EMERGENCY WARNING LIGHTS; ELECTRICAL INDUCTORS; BATTERIES; WARNING BELLS; COMMUTATORS (U.S. CLS. 21, 23, 26, 36 AND 38).

ALEXANDER L. POWERS, EXAMINING ATTORNEY

SN 78-469,336. JUNIPER RECORDS LLC, HAMDEN, CT. FILED 8-18-2004.



NO CLAIM IS MADE TO THE EXCLUSIVE RIGHT TO USE "RECORDS", APART FROM THE MARK AS SHOWN. THE MARK CONSISTS OF THE WORDS "JUNIPER RECORDS" SUPERIMPOSED OVER AN IMAGE OF AN OUTLINE OF A RESTING CAT IN PROFILE.

FOR COMPACT DISCS AND VIDEO DISCS FEATURING MUSICAL RECORDINGS; DOWNLOADABLE AUDIO AND VIDEO RECORDINGS FEATURING MUSICAL PERFORMANCES (U.S. CLS. 21, 23, 26, 36 AND 38).

FIRST USE 1-1-1997; IN COMMERCE 1-1-1997.
STEVEN PEREZ, EXAMINING ATTORNEY

CLASS 9—(Continued).

SN 78-469,575. GRAPHLOGIC INC., BRANFORD, CT. FILED 8-18-2004.



THE MARK CONSISTS OF A STYLIZED DEPICTION OF GRAPH LINES AND NODES IN THE FORM OF THE LETTERS "GL" AND THE WORKING "GRAPHLOGIC".

FOR COMPUTER SOFTWARE FOR PROCESS AND DATA MANAGEMENT (U.S. CLS. 21, 23, 26, 36 AND 38). FIRST USE 6-1-2003; IN COMMERCE 7-1-2003.
CHARLES JOYNER, EXAMINING ATTORNEY

SN 78-469,628. DENTISTS MANAGEMENT CORPORATION, PORTLAND, OR. FILED 8-18-2004.

DAISY CHART

THE MARK CONSISTS OF STANDARD CHARACTERS WITHOUT CLAIM TO ANY PARTICULAR FONT, STYLE, SIZE, OR COLOR.

OWNER OF U.S. REG. NOS. 2,315,420 AND 2,317,775.

NO CLAIM IS MADE TO THE EXCLUSIVE RIGHT TO USE "CHART", APART FROM THE MARK AS SHOWN.

FOR COMPUTER SOFTWARE FOR USE BY DENTAL OFFICES IN MANAGING THEIR DENTAL PRACTICES, NAMELY, COMPUTER SOFTWARE FOR PATIENT AND INSURANCE BILLING, RECORDING AND TRACKING PATIENT TREATMENTS, PROPOSED TREATMENTS AND TREATMENT AND MEDICAL HISTORIES, PATIENT SCHEDULING, ACCOUNTS RECEIVABLE, PATIENT PRESCRIPTION PRINTING AND PRESCRIPTION HISTORY, WORD PROCESSING, RECORDING PATIENT INSURANCE INFORMATION, AND RECORDING AND TRACKING DENTISTS' AND DENTAL ASSISTANTS' TIME, SCHEDULES AND APPOINTMENTS (U.S. CLS. 21, 23, 26, 36 AND 38).

FIRST USE 4-1-2004; IN COMMERCE 4-1-2004.
STEVEN JACKSON, EXAMINING ATTORNEY

CLASS 9—(Continued).

SN 78-469,782. MICROSTRAIN, INC., WILLISTON, VT. FILED 8-18-2004.

CLASS 9—(Continued).

SN 78-470,980. DAVIS, SUE CAROL, HICKORY, NC. FILED 8-20-2004.

RELIABLE SOURCES

TC-LINK

THE MARK CONSISTS OF STANDARD CHARACTERS WITHOUT CLAIM TO ANY PARTICULAR FONT, STYLE, SIZE, OR COLOR.
FOR A SERIES OF MUSICAL SOUND RECORDINGS (U.S. CLS. 21, 23, 26, 36 AND 38).
FIRST USE 3-15-2003; IN COMMERCE 3-15-2003.
MICHAEL TANNER, EXAMINING ATTORNEY

SN 78-471,603. THE TRUSTEES OF SMG TRUST, WASHINGTON, DC. FILED 8-23-2004.

THE MARK CONSISTS OF STANDARD CHARACTERS WITHOUT CLAIM TO ANY PARTICULAR FONT, STYLE, SIZE, OR COLOR.
OWNER OF U.S. REG. NO. 2,711,435.
FOR ANALOG AND DIGITAL MEASURING DEVICES CONSISTING OF THERMOCOUPLES FOR USE IN WIRELESS SENSOR NETWORKS (U.S. CLS. 21, 23, 26, 36 AND 38).
FIRST USE 10-28-2002; IN COMMERCE 10-28-2002.
TONJA GASKINS, EXAMINING ATTORNEY

IT'S ABOUT BEING THERE

THE MARK CONSISTS OF STANDARD CHARACTERS WITHOUT CLAIM TO ANY PARTICULAR FONT, STYLE, SIZE, OR COLOR.
FOR SURROUND SOUND EQUIPMENT, NAMELY AMPLIFIERS AND RECEIVERS (U.S. CLS. 21, 23, 26, 36 AND 38).
ALINA MORRIS, EXAMINING ATTORNEY

SN 78-470,080. CLARKE POWER PRODUCTS, INC., PERRYSBURG, OH. FILED 8-19-2004.

SN 78-472,771. HELMER LABS INC., NOBLESVILLE, IN. FILED 8-24-2004.

HOT SHOT

LABSPIN

THE MARK CONSISTS OF STANDARD CHARACTERS WITHOUT CLAIM TO ANY PARTICULAR FONT, STYLE, SIZE, OR COLOR.
FOR ELECTRIC ARC WELDERS (U.S. CLS. 21, 23, 26, 36 AND 38).
FIRST USE 10-21-2004; IN COMMERCE 10-21-2004.
ANGELA M. MICHELI, EXAMINING ATTORNEY

THE MARK CONSISTS OF STANDARD CHARACTERS WITHOUT CLAIM TO ANY PARTICULAR FONT, STYLE, SIZE, OR COLOR.
FOR CENTRIFUGE USED FOR SPINNING SPECIMEN TUBES (U.S. CLS. 21, 23, 26, 36 AND 38).
FIRST USE 4-15-2003; IN COMMERCE 4-15-2003.
ALINA MORRIS, EXAMINING ATTORNEY

CLASS 9—(Continued).

SN 78-473,219. ONCOLOGY NURSING SOCIETY, PITTSBURGH, PA. FILED 8-25-2004.

CLASS 9—(Continued).

SN 78-475,229. LINEAR TECHNOLOGY CORPORATION, MILPITAS, CA. FILED 8-28-2004.

Knowledgy

LTM

THE MARK CONSISTS OF STANDARD CHARACTERS WITHOUT CLAIM TO ANY PARTICULAR FONT, STYLE, SIZE, OR COLOR.

FOR ELECTRONIC EDUCATIONAL GAME PROGRAMS FOR ONCOLOGY NURSES; MULTIMEDIA SOFTWARE RECORDED ON CD-ROMS FEATURING EDUCATIONAL ACTIVITIES FOR ONCOLOGY NURSES, IN CLASS 9. (U.S. CLS. 21, 23, 26, 36 AND 38).

FIRST USE 4-29-2004; IN COMMERCE 4-29-2004.
GINA FINK, EXAMINING ATTORNEY

THE MARK CONSISTS OF STANDARD CHARACTERS WITHOUT CLAIM TO ANY PARTICULAR FONT, STYLE, SIZE, OR COLOR.

FOR INTEGRATED CIRCUITS, EXCLUDING COMPONENTS OF GAS CHROMATOGRAPH SYSTEMS (U.S. CLS. 21, 23, 26, 36 AND 38).

TRACY CROSS, EXAMINING ATTORNEY

SN 78-473,965. DUALITE, INC., WILLIAMSBURG, OH. FILED 8-26-2004.

SN 78-476,942. FUJINON CORPORATION, SAITAMA-SHI, SAITAMA-KEN, JAPAN, FILED 9-1-2004.



OWNER OF U.S. REG. NOS. 647,381, 1,821,122 AND OTHERS.

FOR ELECTRICAL, LUMINOUS SIGNS AND DISPLAYS (U.S. CLS. 21, 23, 26, 36 AND 38).

FIRST USE 3-13-1973; IN COMMERCE 3-13-1973.
PRISCILLA MILTON, EXAMINING ATTORNEY

FOR LENSES FOR TELEVISION CAMERAS, TELEVISION CAMERAS, LENSES FOR CAMERAS, LENSES FOR DIGITAL CAMERAS (U.S. CLS. 21, 23, 26, 36 AND 38).

TRICIA SONNEBORN, EXAMINING ATTORNEY

CLASS 9—(Continued).

SN 78-477,834. EARTHLINK, INC., ATLANTA, GA. FILED 9-2-2004.



NO CLAIM IS MADE TO THE EXCLUSIVE RIGHT TO USE "SCAMBLOCKER", APART FROM THE MARK AS SHOWN.

FOR COMPUTER SOFTWARE THAT FILTERS AND BLOCKS/QUARANTINES WEBSITES THAT ATTEMPT TO FRAUDULENTLY OBTAIN CREDIT CARD INFORMATION AND PERSONAL INFORMATION FOR ILLEGAL USES (U.S. CLS. 21, 23, 26, 36 AND 38).

FIRST USE 4-0-2004; IN COMMERCE 4-0-2004.
TRACY CROSS, EXAMINING ATTORNEY

CLASS 9—(Continued).

SN 78-479,744. DIGIUM, INC., HUNTSVILLE, AL. FILED 9-7-2004.



THE MARK CONSISTS OF THE WORD ASTERISK WITH AN ASTERISK ENCIRCLED IN A CONVERSATION BUBBLE ABOVE THE WORD.

FOR OPEN SOURCE COMPUTER SOFTWARE TO CREATE A PUBLIC BRANCH EXCHANGE TELEPHONE NETWORK THAT MAY BE DOWNLOADED FROM A GLOBAL COMPUTER NETWORK (U.S. CLS. 21, 23, 26, 36 AND 38).

FIRST USE 5-15-2004; IN COMMERCE 5-15-2004.
RUSS HERMAN, EXAMINING ATTORNEY

SN 78-480,752. 1ST PORT O'CALL, INC., CHICAGO, IL. FILED 9-9-2004.

SN 78-478,843. ADP, INC., HOFFMAN ESTATES, IL. FILED 9-3-2004.

LASERSTATION



THE MARK CONSISTS OF STANDARD CHARACTERS WITHOUT CLAIM TO ANY PARTICULAR FONT, STYLE, SIZE, OR COLOR.

FOR COMPUTER HARDWARE FOR LASER PRINTERS AND COMPUTER SOFTWARE FOR THE OPERATION OF LASER PRINTERS (U.S. CLS. 21, 23, 26, 36 AND 38).

SCOTT OSLICK, EXAMINING ATTORNEY

NO CLAIM IS MADE TO THE EXCLUSIVE RIGHT TO USE "PC" AND "PORT OF CALL", APART FROM THE MARK AS SHOWN.

THE MARK CONSISTS OF A GLOBE WORLD DESIGN AND THE WORDING PC 1ST PORT O' CALL.

FOR PREPROGRAMMED COMPUTER SOFTWARE FOR USE IN SHIP LOG DATABASE MANAGEMENT AND IN THE FIELD OF RECREATIONAL BOATING. (U.S. CLS. 21, 23, 26, 36 AND 38).

ANDREW RHIM, EXAMINING ATTORNEY

CLASS 9—(Continued).

SN 78-482,380. FOUNTAINHEAD INTERNATIONAL LLC,
MOUNT PROSPECT, IL. FILED 9-13-2004.

FreightPath

THE MARK CONSISTS OF STANDARD CHARACTERS
WITHOUT CLAIM TO ANY PARTICULAR FONT, STYLE,
SIZE, OR COLOR.

SEC. 2(F).

FOR SOFTWARE PROGRAMS FOR FACILITATING
THE TRANSPORTATION OF AIR CARGO (U.S. CLS. 21,
23, 26, 36 AND 38).

FIRST USE 9-10-1999; IN COMMERCE 9-10-1999.
STACY WAHLBERG, EXAMINING ATTORNEY

CLASS 9—(Continued).

SN 78-483,274. PRECISION POURS, INC., PLYMOUTH, MN.
FILED 9-14-2004.

PRECISION POUR

THE MARK CONSISTS OF STANDARD CHARACTERS
WITHOUT CLAIM TO ANY PARTICULAR FONT, STYLE,
SIZE, OR COLOR.

OWNER OF U.S. REG. NO. 2,434,367.

SEC. 2(F).

FOR MEASURED LIQUID POURER THAT PORTIONS
OUT A MEASURED AMOUNT OF LIQUID FROM A
BOTTLE (U.S. CLS. 21, 23, 26, 36 AND 38).

FIRST USE 4-1-1999; IN COMMERCE 4-1-1999.

JIM RINGLE, EXAMINING ATTORNEY

SN 78-482,897. DONAHUE, WILLIAM JOHN, LAHAINA, HI.
FILED 9-13-2004.

lonopono

THE MARK CONSISTS OF STANDARD CHARACTERS
WITHOUT CLAIM TO ANY PARTICULAR FONT, STYLE,
SIZE, OR COLOR.

LONOPONO IS NOT A FOREIGN WORD, BUT LONO
AND PONO ARE HAWAIIAN WORDS. LONO MEANS
'NEWS' AND PONO MEANS 'GOODNESS'.

FOR COMPUTER SOFTWARE FOR THE COLLEC-
TION, EDITING, ORGANIZING, MODIFYING, BOOK-
MARKING, TRANSMISSION, STORAGE, AND
SHARING OF DATA AND INFORMATION (U.S. CLS.
21, 23, 26, 36 AND 38).

KENNETH D. BATTLE, EXAMINING ATTORNEY

SN 78-483,639. SCIENCE WITH ME LLC, PRINCETON, NJ.
FILED 9-14-2004.

French With Me!

THE MARK CONSISTS OF STANDARD CHARACTERS
WITHOUT CLAIM TO ANY PARTICULAR FONT, STYLE,
SIZE, OR COLOR.

NO CLAIM IS MADE TO THE EXCLUSIVE RIGHT TO
USE "FRENCH", APART FROM THE MARK AS SHOWN.

FOR SERIES OF PRE-RECORDED VIDEOTAPES,
DVDS, CD'S, LASER DISCS AND DOWNLOADABLE
VIDEO RECORDINGS FEATURING EDUCATIONAL
MATERIALS IN THE FIELD OF FRENCH (U.S. CLS.
21, 23, 26, 36 AND 38).

SCOTT OSCLICK, EXAMINING ATTORNEY

CLASS 9—(Continued).

SN 78-483,642. SCIENCE WITH ME, LLC, PRINCETON, NJ. FILED 9-14-2004.

CLASS 9—(Continued).

SN 78-484,261. THE WORLD COMPANY, LAWRENCE, KS. FILED 9-15-2004.

**LAWRENCE JOURNAL-
WORLD**

German With Me!

THE MARK CONSISTS OF STANDARD CHARACTERS WITHOUT CLAIM TO ANY PARTICULAR FONT, STYLE, SIZE, OR COLOR.

NO CLAIM IS MADE TO THE EXCLUSIVE RIGHT TO USE "GERMAN", APART FROM THE MARK AS SHOWN.

FOR SERIES OF PRE-RECORDED VIDEOTAPES, DVDS, CD'S, LASER DISCS AND DOWNLOADABLE VIDEO RECORDINGS FEATURING EDUCATIONAL MATERIALS IN THE FIELD OF GERMAN (U.S. CLS. 21, 23, 26, 36 AND 38).

SCOTT OSCLICK, EXAMINING ATTORNEY

THE MARK CONSISTS OF STANDARD CHARACTERS WITHOUT CLAIM TO ANY PARTICULAR FONT, STYLE, SIZE, OR COLOR.

OWNER OF U.S. REG. NOS. 2,383,130 AND 2,468,984.

NO CLAIM IS MADE TO THE EXCLUSIVE RIGHT TO USE "LAWRENCE", APART FROM THE MARK AS SHOWN.

FOR CONTENT MANAGEMENT SOFTWARE FOR ENABLING THE ENTRY OF NEWS, MEDIA AND OTHER CONTENT INTO A DATABASE THROUGH A WEB-BASED INTERFACE, FACILITATING THE DISPLAY OF CONTENT FROM THE DATABASE OVER A WEB SERVER BASED ON URL REQUESTS AND RENDERING CONTENT INTO HTML USING A TEMPLATE SYSTEM (U.S. CLS. 21, 23, 26, 36 AND 38).

GINNY ISAACSON, EXAMINING ATTORNEY

SN 78-485,054. CASINO SYSTEMS, INC., LAS VEGAS, NV. FILED 9-16-2004.

SN 78-483,901. WELKER ENGINEERING COMPANY, SU-GARLAND, TX. FILED 9-15-2004.



OWNER OF U.S. REG. NOS. 1,439,624, 2,267,068 AND OTHERS.

NO CLAIM IS MADE TO THE EXCLUSIVE RIGHT TO USE "SCOPE", APART FROM THE MARK AS SHOWN. SEC. 2(F).

FOR OPTICAL INSPECTION APPARATUS FOR INDUSTRIAL USE, NAMELY, SCOPE USED FOR INSPECTION OF PIPELINES, VESSELS, AND VARIOUS OTHER CAVITIES (U.S. CLS. 21, 23, 26, 36 AND 38).

FIRST USE 5-1-1995; IN COMMERCE 5-1-1995.

MARIAM MAHMOUDI, EXAMINING ATTORNEY

Penny Millionaire

THE MARK CONSISTS OF STANDARD CHARACTERS WITHOUT CLAIM TO ANY PARTICULAR FONT, STYLE, SIZE, OR COLOR.

NO CLAIM IS MADE TO THE EXCLUSIVE RIGHT TO USE "PENNY", APART FROM THE MARK AS SHOWN.

FOR GAMING EQUIPMENT FOR PLAYING ELECTRONIC GAMES OF CHANCE, NAMELY, SLOT MACHINES WITH OR WITHOUT VIDEO OUTPUT, VIDEO PULL-TAB GAMING TERMINALS, AUTOMATED VIDEO PULL-TAB DISPENSERS, AND VIDEO BINGO TERMINALS (U.S. CLS. 21, 23, 26, 36 AND 38).

FIRST USE 1-1-2003; IN COMMERCE 3-1-2003.

KIMBERLY FRYE, EXAMINING ATTORNEY

CLASS 9—(Continued).

SN 78-485,364. WORLD TRIATHLON CORPORATION, TARPON SPRINGS, FL. FILED 9-17-2004.



OWNER OF U.S. REG. NOS. 1,353,313, 1,375,270 AND 2,325,508.

FOR BODY WEIGHT SCALES WITH BODY FAT ANALYZER; BATHROOM SCALES (U.S. CLS. 21, 23, 26, 36 AND 38).

LINDA ESTRADA, EXAMINING ATTORNEY

SN 78-485,545. MGA ENTERTAINMENT, INC., VAN NUYS, CA. FILED 9-17-2004.

ULTROX

THE MARK CONSISTS OF STANDARD CHARACTERS WITHOUT CLAIM TO ANY PARTICULAR FONT, STYLE, SIZE, OR COLOR.

FOR CALCULATORS; CASES FOR EYEGLASSES; CELLULAR TELEPHONES; COMPACT DISC PLAYERS; DIGITAL CAMERAS; FIBER OPTIC LIGHT AND IMAGE CONDUITS; KARAOKE MACHINES; MOBILE RADIO SETS SOLD AS A UNIT; MOTION PICTURE FILMS FEATURING ANIMATED AND NON-ANIMATED CHARACTERS; MP3 PLAYERS; PHOTOGRAPHIC CAMERAS; PROTECTIVE HELMETS; PRE-RECORDED COMPACT DISCS, DVDS AND VIDEOCASSETTES FEATURING ANIMATED AND/OR NON-ANIMATED CHARACTERS AND MUSIC; RADIOS; SUNGLASSES; SWIM GOGGLES; AND VIDEO GAME SOFTWARE (U.S. CLS. 21, 23, 26, 36 AND 38).

MICHAEL WEBSTER, EXAMINING ATTORNEY

CLASS 9—(Continued).

SN 78-485,630. SCIENCE WITH ME, LLC, PRINCETON, NJ. FILED 9-17-2004.

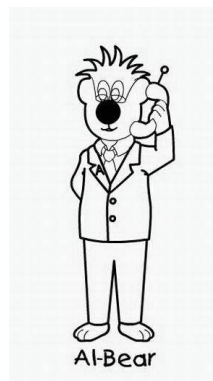

THE MARK CONSISTS OF A STYLIZED REPRESENTATION OF A BEAR HOLDING A PHONE TO HIS EAR, ABOVE THE WORDING AL-BEAR.

FOR PRE-RECORDED VIDEOTAPES, CDS, LASER DISKS AND DOWNLOADABLE VIDEO RECORDINGS FEATURING EDUCATIONAL MATERIALS IN THE FIELD OF SCIENCE (U.S. CLS. 21, 23, 26, 36 AND 38).

FIRST USE 9-16-2004; IN COMMERCE 9-16-2004.

AMY ALFIERI, EXAMINING ATTORNEY

SN 78-486,605. AVIATION COMMUNICATION & SURVEILLANCE SYSTEMS, PHOENIX, AZ. FILED 9-20-2004.

CORE HYPER-SOFT

THE MARK CONSISTS OF STANDARD CHARACTERS WITHOUT CLAIM TO ANY PARTICULAR FONT, STYLE, SIZE, OR COLOR.

FOR COMPUTER SOFTWARE FOR USE IN BUSINESS MANAGEMENT, EXPORT COMPLIANCE, WARRANTY MANAGEMENT, CONTRACT MANAGEMENT, BUDGET MANAGEMENT, LABOR MANAGEMENT, REPAIR AND OVERHAUL MANAGEMENT, FIXED ASSETS MANAGEMENT (U.S. CLS. 21, 23, 26, 36 AND 38).

JOHN E. MICHOS, EXAMINING ATTORNEY

CLASS 9—(Continued).

SN 78-487,630. IGT, RENO, NV. FILED 9-22-2004.



OWNER OF U.S. REG. NOS. 1,194,245 AND 1,208,011.
FOR COMPUTER HARDWARE AND SOFTWARE FOR THE GAMING INDUSTRY FOR SLOT MACHINE ACCOUNTING, PATRON MANAGEMENT, GAMING MACHINE ACCOUNTING, MANAGEMENT OF CAGE ACCOUNTING, VISUAL EVALUATION OF SLOT MACHINE PERFORMANCE, AND DETERMINING BONUS GAMES FOR MACHINES, AND MOBILE DATA ACCESS TO ALL THE FOREGOING INFORMATION; COMPUTER SOFTWARE THAT SUPPORTS DEVICES THAT ACCEPT A WAGER AND DISPLAY GAME OUTCOMES (U.S. CLS. 21, 23, 26, 36 AND 38).
LINDA POWELL, EXAMINING ATTORNEY

CLASS 9—(Continued).

SN 78-489,835. SIMONTON, ROBERT B., JR., NEW YORK, NY. FILED 9-27-2004.

DJ Renegade

THE MARK CONSISTS OF STANDARD CHARACTERS WITHOUT CLAIM TO ANY PARTICULAR FONT, STYLE, SIZE, OR COLOR.
NO CLAIM IS MADE TO THE EXCLUSIVE RIGHT TO USE "DJ", APART FROM THE MARK AS SHOWN.
FOR PHONOGRAPH RECORDS FEATURING MUSIC; PRE-RECORDED AUDIO CASSETTES AND COMPACT DISCS FEATURING MUSIC; PRE-RECORDED VIDEO TAPES FEATURING MUSIC PERFORMANCES (U.S. CLS. 21, 23, 26, 36 AND 38).
FIRST USE 8-17-1999; IN COMMERCE 8-17-1999.
KAREN BRACEY, EXAMINING ATTORNEY

SN 78-487,633. LOLLAR, JASON, VASHON ISLAND, WA. AND LOLLAR, STEPHANIE, VASHON ISLAND, WA. FILED 9-22-2004.

CHICAGO STEEL

THE MARK CONSISTS OF STANDARD CHARACTERS WITHOUT CLAIM TO ANY PARTICULAR FONT, STYLE, SIZE, OR COLOR.
NO CLAIM IS MADE TO THE EXCLUSIVE RIGHT TO USE "STEEL", APART FROM THE MARK AS SHOWN.
FOR ELECTRONIC SOUND PICKUP FOR GUITARS AND BASSES (U.S. CLS. 21, 23, 26, 36 AND 38).
FIRST USE 9-8-2004; IN COMMERCE 9-8-2004.
ANDREA K. NADELMAN, EXAMINING ATTORNEY

SN 78-490,323. SHERMAN, STEVEN K., MARLBOROUGH, MA. FILED 9-27-2004.

SpeciFyr

THE MARK CONSISTS OF STANDARD CHARACTERS WITHOUT CLAIM TO ANY PARTICULAR FONT, STYLE, SIZE, OR COLOR.
FOR COMPUTER PROGRAMS FOR FILE AND USER INPUT PROCESSING RECORDED ON DATA MEDIA DESIGNED FOR USE IN CONSTRUCTION AND AUTOMATED MANUFACTURING (U.S. CLS. 21, 23, 26, 36 AND 38).
RICHARD WHITE, EXAMINING ATTORNEY

CLASS 9—(Continued).

SN 78-491,205. STREAM2PEERS INC, IRVING, TX. FILED 9-29-2004.

StreamJobs

THE MARK CONSISTS OF STANDARD CHARACTERS WITHOUT CLAIM TO ANY PARTICULAR FONT, STYLE, SIZE, OR COLOR.

FOR COMPUTER E-COMMERCE SOFTWARE TO ALLOW USERS TO PERFORM ELECTRONIC BUSINESS TRANSACTIONS VIA A GLOBAL COMPUTER NETWORK (U.S. CLS. 21, 23, 26, 36 AND 38).

ELIZABETH J. WINTER, EXAMINING ATTORNEY

CLASS 9—(Continued).

SN 78-491,785. WEBB, SCOTT & QUINN, INC., WESTMINSTER, CO. FILED 9-29-2004.

Power Frontier

THE MARK CONSISTS OF STANDARD CHARACTERS WITHOUT CLAIM TO ANY PARTICULAR FONT, STYLE, SIZE, OR COLOR.

NO CLAIM IS MADE TO THE EXCLUSIVE RIGHT TO USE "POWER", APART FROM THE MARK AS SHOWN.

FOR COMPUTER SOFTWARE FOR POWER MARKET ANALYSIS; THE SOFTWARE WILL CALCULATE THE RISK VS RETURN FOR ENERGY ASSET PORTFOLIOS (U.S. CLS. 21, 23, 26, 36 AND 38).

MARK RADEMACHER, EXAMINING ATTORNEY

SN 78-492,000. CALYPSO PRODUCTIONS, INC., TARZANA, CA. FILED 9-30-2004.

SN 78-491,390. SERAT, WILLIAM, MORENO VALLEY, CA. FILED 9-29-2004.

COINS-2-CASH

THE MARK CONSISTS OF STANDARD CHARACTERS WITHOUT CLAIM TO ANY PARTICULAR FONT, STYLE, SIZE, OR COLOR.

FOR PORTABLE DEVICE THAT CONVERTS COINS TO DOLLAR BILLS (U.S. CLS. 21, 23, 26, 36 AND 38).

FIRST USE 1-1-2004; IN COMMERCE 1-1-2004.
SHARI SHEFFIELD, EXAMINING ATTORNEY

DR. STEEL

THE MARK CONSISTS OF STANDARD CHARACTERS WITHOUT CLAIM TO ANY PARTICULAR FONT, STYLE, SIZE, OR COLOR.

FOR MUSICAL RECORDINGS ON CDS, DVDS, VIDEO TAPES AND AUDIO CASSETTES (U.S. CLS. 21, 23, 26, 36 AND 38).

FIRST USE 0-0-1999; IN COMMERCE 0-0-1999.
KIMBERLY PERRY, EXAMINING ATTORNEY

CLASS 9—(Continued).

SN 78-492,130. EDSA MICRO CORPORATION, SAN DIEGO, CA. FILED 9-30-2004.



OWNER OF U.S. REG. NO. 2,096,997.
FOR COMPUTER SOFTWARE FOR USE AS ONLINE REAL TIME HEALTH MONITORING AND PREDICTIVE CONTROL OF ELECTRICAL POWER SYSTEMS (U.S. CLS. 21, 23, 26, 36 AND 38).
FIRST USE 4-21-2004; IN COMMERCE 4-21-2004.
ANGELA M. MICHELI, EXAMINING ATTORNEY

CLASS 9—(Continued).

SN 78-492,284. BERGLY, LISA T., CHANAHASSEN, MN. FILED 9-30-2004.

YOGA BONDING

THE MARK CONSISTS OF STANDARD CHARACTERS WITHOUT CLAIM TO ANY PARTICULAR FONT, STYLE, SIZE, OR COLOR.

NO CLAIM IS MADE TO THE EXCLUSIVE RIGHT TO USE "YOGA", APART FROM THE MARK AS SHOWN.

FOR DVDS FEATURING INSTRUCTION AND INFORMATION IN THE FIELD OF YOGA, EXERCISE, HEALTH, AND WELLNESS (U.S. CLS. 21, 23, 26, 36 AND 38).

DEBRA LEE, EXAMINING ATTORNEY

SN 78-493,130. SMART STRUCTURES LLC, RANTOUL, IL. FILED 10-1-2004.

SN 78-492,223. OAKLEY, INC., FOOTHILL RANCH, CA. FILED 9-30-2004.

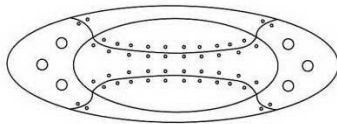

OWNER OF U.S. REG. NO. 2,702,378.
FOR SPORTING GOODS, NAMELY GOGGLES AND REPLACEMENT PARTS FOR GOGGLES FOR SKIING, SNOWBOARDING AND MOTOCROSS (U.S. CLS. 21, 23, 26, 36 AND 38).
FIRST USE 11-14-2002; IN COMMERCE 11-14-2002.
TINA L. SNAPP, EXAMINING ATTORNEY

SensID

THE MARK CONSISTS OF STANDARD CHARACTERS WITHOUT CLAIM TO ANY PARTICULAR FONT, STYLE, SIZE, OR COLOR.

FOR VEHICLE AND BRIDGE MONITORING SYSTEM COMPRISED OF CAMERAS AND COMPUTER SOFTWARE WHICH ANALYZES THE PICTURES TO OBTAIN LICENSE PLATE NUMBERS FOR VEHICLE IDENTIFICATION FOR TOLL COLLECTION (U.S. CLS. 21, 23, 26, 36 AND 38).

TRICIA SONNEBORN, EXAMINING ATTORNEY

CLASS 9—(Continued).

SN 78-493,143. BLUE LOUNGE, LLC, PASADENA, CA.
FILED 10-1-2004.

CABLEYOYO

THE MARK CONSISTS OF STANDARD CHARACTERS WITHOUT CLAIM TO ANY PARTICULAR FONT, STYLE, SIZE, OR COLOR.

FOR PLASTIC, WOOD OR OTHER SYNTHETIC SPOOL DEVICES FOR WRAPPING AND/OR HOLDING CORDS, WIRES AND CABLES (U.S. CLS. 21, 23, 26, 36 AND 38).

MICHAEL SOUDERS, EXAMINING ATTORNEY

SN 78-493,154. CASINO SYSTEMS, INC., LAS VEGAS, NV.
FILED 10-1-2004.

Million Coin Magic

THE MARK CONSISTS OF STANDARD CHARACTERS WITHOUT CLAIM TO ANY PARTICULAR FONT, STYLE, SIZE, OR COLOR.

NO CLAIM IS MADE TO THE EXCLUSIVE RIGHT TO USE "MILLION COIN", APART FROM THE MARK AS SHOWN.

FOR GAMING EQUIPMENT FOR PLAYING ELECTRONIC GAMES OF CHANCE; GAMING EQUIPMENT, NAMELY, SLOT MACHINES WITH OR WITHOUT VIDEO OUTPUT; VIDEO PULL-TAB GAMING TERMINALS FEATURING TECHNOLOGICAL AID TO THE GAME OF PULL TAB; VIDEO PULL-TAB DISPENSERS; VIDEO BINGO TERMINALS FEATURING TECHNOLOGICAL AID TO THE GAME OF BINGO (U.S. CLS. 21, 23, 26, 36 AND 38).

FIRST USE 1-13-2003; IN COMMERCE 8-1-2004.
JUDITH HELFMAN, EXAMINING ATTORNEY

CLASS 9—(Continued).

SN 78-493,318. DEUTSCHE TELEKOM AG, BONN, FED REP GERMANY, FILED 10-1-2004.

T-Mobile multimedia experience

THE MARK CONSISTS OF STANDARD CHARACTERS WITHOUT CLAIM TO ANY PARTICULAR FONT, STYLE, SIZE, OR COLOR.

PRIORITY CLAIMED UNDER SEC. 44(D) ON FED REP GERMANY APPLICATION NO. 30418510838, FILED 4-2-2004, REG. NO. 30418510, DATED 4-22-2004, EXPIRES 4-22-2014.

OWNER OF U.S. REG. NO. 2,282,432.

NO CLAIM IS MADE TO THE EXCLUSIVE RIGHT TO USE "MULTIMEDIA", APART FROM THE MARK AS SHOWN.

FOR ELECTRIC, ELECTRONIC, OPTICAL, MEASURING, SIGNALING, CONTROLLING AND TEACHING APPARATUS AND INSTRUMENTS, ALL FOR USE WITH TELECOMMUNICATIONS, NAMELY, APPARATUS FOR PRODUCING SOUND, IMAGES OR DATA, NAMELY, BLANK MAGNETIC AND OPTICAL DATA CARRIERS; DATA PROCESSORS; COMPUTERS, NAMELY, MICROCOMPUTERS, MINICOMPUTERS, COMPUTER CENTRAL PROCESSORS, COMPUTER MONITORS, COMPUTER KEYBOARDS, COMPUTER TERMINALS, COMPUTER MEMORIES, COMPUTER LASER PRINTERS, COMPUTER IMPACT PRINTERS, COMPUTER DOT MATRIX PRINTERS, COMPUTERS AND INSTRUCTIONAL MANUALS SOLD AS A UNIT; COMPUTER MEMORY HARDWARE; COMPUTER INTERFACE APPARATUS, NAMELY, COMPUTER INTERFACE BOARDS, COMPUTER MOUSE AND MOUSE PAD, COMPUTER PERIPHERALS AND PARTS THEREOF; COMPUTER SOFTWARE PROGRAMS FOR USE IN OPERATING TELECOMMUNICATIONS AND BUSINESS MANAGEMENT SYSTEMS AND RELATED INSTRUCTION MANUALS SOLD AS A UNIT; COMPUTER SOFTWARE FOR FINANCIAL ACCOUNTING, FOR THE PROVISION OF ONLINE INFORMATION SERVICES IN THE FIELD OF NEWS, SPORTS, ENTERTAINMENT, CULTURE, BUSINESS AND FINANCE, WEATHER AND TRAVEL, NETWORK MANAGEMENT, COMPUTER PROXY SOFTWARE FOR USE WITH OTHER SOFTWARE PROGRAMS, FOR CONTROLLING ACCESS AND ALARM MONITORING OF HOMES, APARTMENTS, BUILDINGS AND OTHER PROPERTIES, BILLING ANALYSIS, NETWORK ACCESS CONTROL AND FOR CREATING AND MAINTAINING FIREWALLS; COMPUTER SOFTWARE PROGRAMS FOR ACCESSING A GLOBAL COMPUTER NETWORK AND INTERACTIVE COMPUTER COMMUNICATIONS NETWORKS; OPTICAL FIBERS SOLD AS A COMPONENT OF FIBER OPTICAL CABLES; FIBER OPTIC CABLES; OPTICAL SCANNERS; OPTICAL CHARACTER READERS; OPTICAL BLANK DISCS; OPTICAL GLASS FOR SIGNAL TRANSMISSION; OPTIC TRANSMITTERS FOR RADIO, TELEPHONE; OPTIC RECEIVERS FOR TELEPHONE, AUDIO, VIDEO; OPTICAL SIGNAL PROCESSORS; OPTIC TELECOMMUNICATIONS SWITCHES; OPTICAL ATTENUATORS; OPTICAL AMPLIFIERS; OPTICAL CHARACTER RECOGNITION APPARATUS, FOR USE IN THE TELECOMMUNICATIONS FIELD, AND PARTS THEREOF; TELEPHONE LOCAL AREA NETWORKS; TELECOMMUNICATION AUDIO, VIDEO AND DATA COMMUNICATIONS SYSTEMS, NAMELY, DIGITAL AND ANALOGUE SIGNAL TRANSMITTERS; RECEI-

CLASS 9—(Continued).

VERS AND CONVERTERS FOR USE WITH TELEPHONE, AUDIO, VIDEO; RADIO AND TELEPHONE TRANSMITTERS; COMMUNICATION RECEIVERS AND SERVERS FOR TELEPHONE, AUDIO, VIDEO; TELEPHONE ANSWERING MACHINES; TELEPROMPTERS; TELETYPEWRITERS AND PARTS THEREOF, NAMELY, CALLER IDENTIFICATION BOXES, DIALING ASSEMBLIES, TELEPHONE UNITS, AUDIO OPERATED RELAYS, AUDIO/VIDEO SIGNAL AND OPTICAL FILTERS, PROTECTORS AND AUTOMATIC SIGNALING AND CONTROL EQUIPMENT, TELEMETERS, WIRELESS AND CELLULAR TELEPHONES, AND RADIO PAGERS; INTERCOMS; FACSIMILE MACHINE; ELECTRONIC MAIL APPARATUS FOR ELECTRONIC EXCHANGE OF DATA, IMAGES AND MESSAGES; ELECTRICAL WIRE; ELECTRICAL WIRE CONNECTORS; INTEGRATED CIRCUITS; PRINTED CIRCUITS; ELECTRIC CIRCUITS; CIRCUIT BREAKERS; PRINTED CIRCUIT BOARDS; CIRCUIT CONNECTORS; ELECTRICAL CONTROLLERS; ELECTRICAL CONVERTERS; ELECTRICAL CONDUCTORS; ELECTRICAL FUSES; ELECTRIC LUMINESCENT DISPLAY PANELS; ELECTRICAL SWITCH PLATES; ELECTRIC PLUGS; ELECTRIC COILS; ANTENNAS; ELECTRICAL CABLES; COMPUTER CABLES; COMPUTER CHIPS; SILICON CHIPS; CHRONOGRAPHS FOR USE AS SPECIALIZED TIME RECORDING APPARATUS; COMPUTER BUFFERS; BLANK COMPUTER DISCS; BLANK COMPUTER FLOPPY DISKS; COMPUTER HARD DISCS; ACOUSTIC CONDUITS; ELECTRICAL CONDUITS; FIBER OPTIC CONDUITS AND PARTS THEREOF; COMPACT DISC PLAYERS; AUDIO AND VIDEO TAPE RECORDERS; AUDIO AND VIDEOTAPE PLAYERS; AUDIO AND VIDEOCASSETTE RECORDERS; AUDIO AND VIDEOCASSETTE PLAYERS; BLANK AUDIO AND VIDEOTAPES, CASSETTES, DISCS AND MICROFICHE; AUDIO AND VIDEO TAPES, CASSETTES, DISCS AND MICROFICHE FEATURING INFORMATION CONCERNING TELECOMMUNICATIONS, AND CONCERNING PERSONAL AND BUSINESS MANAGEMENT SYSTEMS; AUDIO AND VIDEO RECORDINGS IN THE FIELD OF TELECOMMUNICATIONS, INFORMATION TECHNOLOGY AND SAFETY; TELEVISION AND TELEVISION PERIPHERAL EQUIPMENT, NAMELY, CAMERAS, SET TOP BOXES, REMOTE CONTROL UNITS FOR INTERACTIVE AND NON-INTERACTIVE USE; VIDEO MONITORS; AUTOMATIC VENDING MACHINES AND TIMING MECHANISMS THEREFOR AND PARTS THEREOF; MACHINE READABLE, MAGNETICALLY ENCODED CARDS, NAMELY, PREPAID TELEPHONE CALLING CARDS AND CREDIT CARDS; BLANK SMART CARDS; MAGNETIC CODED CARD READERS; DATA PROCESSORS AND READERS; WORD PROCESSORS; MICROPROCESSORS; ELECTRONIC ENCRYPTION UNITS; DEMAGNETIZERS FOR MAGNETIC TAPES AND PARTS THEREOF; LASERS NOT FOR MEDICAL USE; LIGHT EMITTING DIODES; LIGHT EMITTING DIODE DISPLAYS; COMPUTER, DATA AND VIDEO NETWORKING AND CONFERENCING EQUIPMENT, NAMELY, TELECONFERENCING EQUIPMENT AND AUDIOVISUAL TEACHING EQUIPMENT IN THE NATURE OF OVERHEAD FILM, PHOTOGRAPHIC AND SLIDE PROJECTORS; PROJECTION SCREENS; COMPUTER BASED INFORMATION DISPLAY EQUIPMENT, NAMELY, COMPUTERS WHICH DISPLAY INFORMATION ON AN OVERHEAD SCREEN; PORTABLE DEVICES, NAMELY, LAPTOPS, HANDHELD AND POCKET COMPUTERS, WIRELESS FAX MACHINES; PERSONAL COMMUNICATIONS EQUIPMENT, NAMELY, PERSONAL DIGITAL ASSISTANTS; CALCULATORS AND RELATED PERIPHERALS; SATELLITE PROCESSORS, SATELLITE AND SATELLITE COMMUNICATION EARTH STATIONS BOTH STATIONARY AND MOVEABLE; COMPUTER GAME PROGRAMS FOR CHILDREN AND ADULTS; VIDEO AND COMPUTER GAME CARTRIDGES; AUDIO AND VIDEO RECORDINGS IN THE FIELD OF NEWS, SPORTS, ENTERTAINMENT, CULTURE, BUSINESS AND FINANCE, WEATHER AND TRAVEL; PRERECORDED COMPACT DISCS, AUDIOCASSETTE TAPES, VIDEOCASSETTE TAPES, DIGITAL AUDIOTAPES AND DIGITAL VIDEO DISCS FEATURING MUSICAL, VARIETY, NEWS AND COMEDY SHOWS; CARRYING CASES FOR POCKET CALCULATORS AND CELLPHONES (U.S. CLS. 21, 23, 26, 36 AND 38).

FLORENTINA BLANDU, EXAMINING ATTORNEY

CLASS 9—(Continued).

SN 78-493,406. LAY, JOHNNY T, RANCHO CUCAMONGA, CA. FILED 10-1-2004.

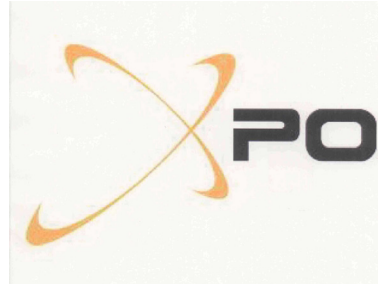

THE COLOR(S) YELLOW X IS/ARE CLAIMED AS A FEATURE OF THE MARK.

THE X IN THE MARK APPEARS IN THE COLOR YELLOW.

THE MARK CONSISTS OF "A STYLIZED LETTER X". FOR POLARIZED EYEWEAR, NAMELY, SUNGLASSES (U.S. CLS. 21, 23, 26, 36 AND 38).

FIRST USE 5-12-2004; IN COMMERCE 5-12-2004.

BARBARA BROWN, EXAMINING ATTORNEY

SN 78-493,785. ADVANCE INNOVATIVE SOLUTIONS, INC., OAK BROOK, IL. FILED 10-4-2004.

RXCALL

THE MARK CONSISTS OF STANDARD CHARACTERS WITHOUT CLAIM TO ANY PARTICULAR FONT, STYLE, SIZE, OR COLOR.

FOR COMPUTER HARDWARE AND SOFTWARE WHICH PROVIDES AUTOMATED OUTBOUND TELEPHONE AND PAGER COMMUNICATIONS TO PHARMACY CUSTOMERS REGARDING PHARMACY INFORMATION AND SERVICES, INCLUDING THE STATUS OF PRESCRIPTION ORDERS (U.S. CLS. 21, 23, 26, 36 AND 38).

SHARON MEIER, EXAMINING ATTORNEY

CLASS 9—(Continued).

SN 78-493,863. NASHMAN, LAURA, TORONTO, ONTARIO, CANADA, FILED 10-4-2004.

SPA-LA-LA

THE MARK CONSISTS OF STANDARD CHARACTERS WITHOUT CLAIM TO ANY PARTICULAR FONT, STYLE, SIZE, OR COLOR.

FOR PRE-RECORDED SOUND RECORDINGS ON COMPACT DISCS AND CASSETTE TAPES FEATURING MUSIC (U.S. CLS. 21, 23, 26, 36 AND 38).

ALLISON SCHRODY, EXAMINING ATTORNEY

SN 78-493,984. DEUTSCHE TELEKOM AG, BONN, FED REP GERMANY, FILED 10-4-2004.

T-Mobile mms&messaging

THE MARK CONSISTS OF STANDARD CHARACTERS WITHOUT CLAIM TO ANY PARTICULAR FONT, STYLE, SIZE, OR COLOR.

PRIORITY CLAIMED UNDER SEC. 44(D) ON FED REP GERMANY APPLICATION NO. 30418512438, FILED 4-2-2004, REG. NO. 30418512, DATED 4-22-2004, EXPIRES 4-30-2014.

OWNER OF U.S. REG. NO. 2,282,432.

NO CLAIM IS MADE TO THE EXCLUSIVE RIGHT TO USE "MMS&MESSAGING", APART FROM THE MARK AS SHOWN.

FOR ELECTRIC, ELECTRONIC, OPTICAL, MEASURING, SIGNALING, CONTROLLING AND TEACHING APPARATUS AND INSTRUMENTS, ALL FOR USE WITH TELECOMMUNICATIONS, NAMELY, APPARATUS FOR PRODUCING SOUND, IMAGES OR DATA, NAMELY, BLANK MAGNETIC AND OPTICAL DATA CARRIERS; DATA PROCESSORS; COMPUTERS, NAMELY, MICROCOMPUTERS, MINICOMPUTERS, COMPUTER CENTRAL PROCESSORS, COMPUTER MONITORS, COMPUTER KEYBOARDS, COMPUTER TERMINALS, COMPUTER MEMORIES, COMPUTER LASER PRINTERS, COMPUTER IMPACT PRINTERS, COMPUTER DOT MATRIX PRINTERS, COMPUTERS AND INSTRUCTIONAL MANUALS SOLD AS A UNIT; COMPUTER MEMORY HARDWARE; COMPUTER INTERFACE APPARATUS, NAMELY, COMPUTER INTERFACE BOARDS, COMPUTER MOUSE AND MOUSE PAD, COMPUTER PERIPHERALS AND PARTS THEREOF; COMPUTER SOFTWARE PROGRAMS FOR USE IN OPERATING TELECOMMUNICATIONS AND BUSINESS MANAGEMENT SYSTEMS AND RELATED INSTRUC-

CLASS 9—(Continued).

TION MANUALS SOLD AS A UNIT; COMPUTER SOFTWARE FOR FINANCIAL ACCOUNTING, FOR THE PROVISION OF ONLINE INFORMATION SERVICES IN THE FIELD OF NEWS, SPORTS, ENTERTAINMENT, CULTURE, BUSINESS AND FINANCE, WEATHER AND TRAVEL, NETWORK MANAGEMENT, COMPUTER PROXY SOFTWARE FOR USE WITH OTHER SOFTWARE PROGRAMS, FOR CONTROLLING ACCESS AND ALARM MONITORING OF HOMES, APARTMENTS, BUILDINGS AND OTHER PROPERTIES, BILLING ANALYSIS, NETWORK ACCESS CONTROL AND FOR CREATING AND MAINTAINING FIREWALLS; COMPUTER SOFTWARE PROGRAMS FOR ACCESSING A GLOBAL COMPUTER NETWORK AND INTERACTIVE COMPUTER COMMUNICATIONS NETWORKS; OPTICAL FIBERS SOLD AS A COMPONENT OF FIBER OPTICAL CABLES; FIBER OPTIC CABLES; OPTICAL SCANNERS; OPTICAL CHARACTER READERS; OPTICAL BLANK DISCS; OPTICAL GLASS FOR SIGNAL TRANSMISSION; OPTIC TRANSMITTERS FOR RADIO, TELEPHONE; OPTIC RECEIVERS FOR TELEPHONE, AUDIO, VIDEO; OPTICAL SIGNAL PROCESSORS; OPTIC TELECOMMUNICATIONS SWITCHES; OPTICAL ATTENUATORS; OPTICAL AMPLIFIERS; OPTICAL CHARACTER RECOGNITION APPARATUS, FOR USE IN THE TELECOMMUNICATIONS FIELD, AND PARTS THEREOF; TELEPHONE LOCAL AREA NETWORKS; TELECOMMUNICATION AUDIO, VIDEO AND DATA COMMUNICATIONS SYSTEMS, NAMELY, DIGITAL AND ANALOGUE SIGNAL TRANSMITTERS; RECEIVERS AND CONVERTERS FOR USE WITH TELEPHONE, AUDIO, VIDEO; RADIO AND TELEPHONE TRANSMITTERS; COMMUNICATION RECEIVERS AND SERVERS FOR TELEPHONE, AUDIO, VIDEO; TELEPHONE ANSWERING MACHINES; TELEPROMPTERS; TELETYPEWRITERS AND PARTS THEREOF, NAMELY, CALLER IDENTIFICATION BOXES, DIALING ASSEMBLIES, TELEPHONE UNITS, AUDIO OPERATED RELAYS, AUDIO/VIDEO SIGNAL AND OPTICAL FILTERS, PROTECTORS AND AUTOMATIC SIGNALING AND CONTROL EQUIPMENT, TELEMETERS, WIRELESS AND CELLULAR TELEPHONES, AND RADIO PAGERS; INTERCOMS; FACSIMILE MACHINE; ELECTRONIC MAIL APPARATUS FOR ELECTRONIC EXCHANGE OF DATA, IMAGES AND MESSAGES; ELECTRICAL WIRE; ELECTRICAL WIRE CONNECTORS; INTEGRATED CIRCUITS; PRINTED CIRCUITS; ELECTRIC CIRCUITS; CIRCUIT BREAKERS; PRINTED CIRCUIT BOARDS; CIRCUIT CONNECTORS; ELECTRICAL CONTROLLERS; ELECTRICAL CONVERTERS; ELECTRICAL CONDUCTORS; ELECTRICAL FUSES; ELECTRIC LUMINESCENT DISPLAY PANELS; ELECTRICAL SWITCH PLATES; ELECTRIC PLUGS; ELECTRIC COILS; ANTENNAS; ELECTRICAL CABLES; COMPUTER CABLES; COMPUTER CHIPS; SILICON CHIPS; CHRONOGRAPHS FOR USE AS SPECIALIZED TIME RECORDING APPARATUS; COMPUTER BUFFERS; BLANK COMPUTER DISCS; BLANK COMPUTER FLOPPY DISKS; COMPUTER HARD DISCS; ACOUSTIC CONDUITS; ELECTRICAL CONDUITS; FIBER OPTIC CONDUITS AND PARTS THEREOF; COMPACT DISC PLAYERS; AUDIO AND VIDEO TAPE RECORDERS; AUDIO AND VIDEOTAPE PLAYERS; AUDIO AND VIDEOCASSETTE RECORDERS; AUDIO AND VIDEOCASSETTE PLAYERS; BLANK AUDIO AND VIDEOTAPE, CASSETTES, DISCS AND MICROFICHE; AUDIO AND VIDEO TAPES, CASSETTES, DISCS AND MICROFICHE FEATURING INFORMATION CONCERNING TELECOMMUNICATIONS, AND CONCERNING PERSONAL AND BUSINESS MANAGEMENT SYSTEMS; AUDIO AND VIDEO RECORDINGS IN THE FIELD OF TELECOMMUNICATIONS, INFORMATION TECHNOLOGY AND SAFETY; TELEVISION AND TELEVISION PERIPHERAL EQUIPMENT, NAMELY, CAMERAS, SET TOP BOXES, REMOTE CONTROL UNITS FOR INTERACTIVE AND NON-INTERACTIVE USE; VIDEO MONITORS; AUTOMATIC VENDING MACHINES AND TIMING MECHANISMS THEREFOR AND PARTS THEREOF; MACHINE READABLE, MAGNETICALLY ENCODED CARDS, NAMELY, PREPAID TELEPHONE CALLING CARDS AND CREDIT CARDS; BLANK SMART CARDS; MAGNETIC CODED CARD READERS; DATA PROCESSORS AND READERS; WORD PROCESSORS; MICROPROCESSORS; ELECTRONIC ENCRYPTION UNITS; DEMAGNETIZERS FOR MAGNETIC TAPES AND PARTS THEREOF; LASERS NOT FOR MEDICAL USE; LIGHT EMITTING DIODES; LIGHT

CLASS 9—(Continued).

EMITTING DIODE DISPLAYS; COMPUTER, DATA AND VIDEO NETWORKING AND CONFERENCING EQUIPMENT, NAMELY, TELECONFERENCING EQUIPMENT AND AUDIOVISUAL TEACHING EQUIPMENT IN THE NATURE OF OVERHEAD FILM, PHOTOGRAPHIC AND SLIDE PROJECTORS; PROJECTION SCREENS; COMPUTER BASED INFORMATION DISPLAY EQUIPMENT, NAMELY, COMPUTERS WHICH DISPLAY INFORMATION ON AN OVERHEAD SCREEN; PORTABLE DEVICES, NAMELY, LAPTOPS, HANDHELD AND POCKET COMPUTERS, WIRELESS FAX MACHINES; PERSONAL COMMUNICATIONS EQUIPMENT, NAMELY, PERSONAL DIGITAL ASSISTANTS; CALCULATORS AND RELATED PERIPHERALS; SATELLITE PROCESSORS, SATELLITE AND SATELLITE COMMUNICATION EARTH STATIONS BOTH STATIONARY AND MOVEABLE; COMPUTER GAME PROGRAMS FOR CHILDREN AND ADULTS; VIDEO AND COMPUTER GAME CARTRIDGES; AUDIO AND VIDEO RECORDINGS IN THE FIELD OF NEWS, SPORTS, ENTERTAINMENT, CULTURE, BUSINESS AND FINANCE, WEATHER AND TRAVEL; PRERECORDED COMPACT DISCS, AUDIOCASSETTE TAPES, VIDEOCASSETTE TAPES, DIGITAL AUDIOTAPES AND DIGITAL VIDEO DISCS FEATURING MUSICAL, VARIETY, NEWS AND COMEDY SHOWS; CARRYING CASES FOR POCKET CALCULATORS AND CELLPHONES (U.S. CLS. 21, 23, 26, 36 AND 38).

FLORENTINA BLANDU, EXAMINING ATTORNEY

SN 78-494,141. DEUTSCHE TELEKOM AG, BONN, FED REP GERMANY, FILED 10-4-2004.

T-Mobile instant email

THE MARK CONSISTS OF STANDARD CHARACTERS WITHOUT CLAIM TO ANY PARTICULAR FONT, STYLE, SIZE, OR COLOR.

PRIORITY CLAIMED UNDER SEC. 44(D) ON FED REP GERMANY APPLICATION NO. 30418511638, FILED 4-2-2004, REG. NO. 30418511, DATED 4-22-2004, EXPIRES 4-30-2014.

OWNER OF U.S. REG. NO. 2,282,432.

NO CLAIM IS MADE TO THE EXCLUSIVE RIGHT TO USE "INSTANT MAIL", APART FROM THE MARK AS SHOWN.

FOR ELECTRIC, ELECTRONIC, OPTICAL, MEASURING, SIGNALING, CONTROLLING AND TEACHING APPARATUS AND INSTRUMENTS, ALL FOR USE WITH TELECOMMUNICATIONS, NAMELY, APPARATUS FOR PRODUCING SOUND, IMAGES OR DATA, NAMELY, BLANK MAGNETIC AND OPTICAL DATA CARRIERS; DATA PROCESSORS; COMPUTERS, NAMELY, MICROCOMPUTERS, MINICOMPUTERS, COMPUTER CENTRAL PROCESSORS, COMPUTER MONITORS, COMPUTER KEYBOARDS, COMPUTER TERMINALS, COMPUTER MEMORIES, COMPUTER LASER PRINTERS, COMPUTER IMPACT PRINTERS, COMPUTER DOT MATRIX PRINTERS, COMPUTERS AND INSTRUCTIONAL MANUALS SOLD AS A UNIT; COMPUTER MEMORY HARDWARE; COMPUTER INTERFACE APPARATUS, NAMELY, COMPUTER INTERFACE BOARDS, COMPUTER MOUSE AND MOUSE PAD, COMPUTER PERIPHERALS AND PARTS THEREOF; COMPUTER SOFTWARE PROGRAMS FOR USE IN OPERATING TELECOMMUNICATIONS AND BUSINESS MANAGEMENT SYSTEMS AND RELATED INSTRUCTION MANUALS SOLD AS A UNIT; COMPUTER SOFTWARE FOR FINANCIAL ACCOUNTING, FOR THE PROVISION OF ONLINE INFORMATION SERVICES IN

CLASS 9—(Continued).

THE FIELD OF NEWS, SPORTS, ENTERTAINMENT, CULTURE, BUSINESS AND FINANCE, WEATHER AND TRAVEL, NETWORK MANAGEMENT, COMPUTER PROXY SOFTWARE FOR USE WITH OTHER SOFTWARE PROGRAMS, FOR CONTROLLING ACCESS AND ALARM MONITORING OF HOMES, APARTMENTS, BUILDINGS AND OTHER PROPERTIES, BILLING ANALYSIS, NETWORK ACCESS CONTROL AND FOR CREATING AND MAINTAINING FIREWALLS; COMPUTER SOFTWARE PROGRAMS FOR ACCESSING A GLOBAL COMPUTER NETWORK AND INTERACTIVE COMPUTER COMMUNICATIONS NETWORKS; OPTICAL FIBERS SOLD AS A COMPONENT OF FIBER OPTICAL CABLES; FIBER OPTIC CABLES; OPTICAL SCANNERS; OPTICAL CHARACTER READERS; OPTICAL BLANK DISCS; OPTICAL GLASS FOR SIGNAL TRANSMISSION; OPTIC TRANSMITTERS FOR RADIO, TELEPHONE; OPTIC RECEIVERS FOR TELEPHONE, AUDIO, VIDEO; OPTICAL SIGNAL PROCESSORS; OPTIC TELECOMMUNICATIONS SWITCHES; OPTICAL ATTENUATORS; OPTICAL AMPLIFIERS; OPTICAL CHARACTER RECOGNITION APPARATUS, FOR USE IN THE TELECOMMUNICATIONS FIELD, AND PARTS THEREOF; TELEPHONE LOCAL AREA NETWORKS; TELECOMMUNICATION AUDIO, VIDEO AND DATA COMMUNICATIONS SYSTEMS, NAMELY, DIGITAL AND ANALOGUE SIGNAL TRANSMITTERS; RECEIVERS AND CONVERTERS FOR USE WITH TELEPHONE, AUDIO, VIDEO; RADIO AND TELEPHONE TRANSMITTERS; COMMUNICATION RECEIVERS AND SERVERS FOR TELEPHONE, AUDIO, VIDEO; TELEPHONE ANSWERING MACHINES; TELEPROMPTERS; TELETYPEWRITERS AND PARTS THEREOF, NAMELY, CALLER IDENTIFICATION BOXES, DIALING ASSEMBLIES, TELEPHONE UNITS, AUDIO OPERATED RELAYS, AUDIO/VIDEO SIGNAL AND OPTICAL FILTERS, PROTECTORS AND AUTOMATIC SIGNALING AND CONTROL EQUIPMENT, TELEMETERS, WIRELESS AND CELLULAR TELEPHONES, AND RADIO PAGERS; INTERCOMS; FACSIMILE MACHINE; ELECTRONIC MAIL APPARATUS FOR ELECTRONIC EXCHANGE OF DATA, IMAGES AND MESSAGES; ELECTRICAL WIRE; ELECTRICAL WIRE CONNECTORS; INTEGRATED CIRCUITS; PRINTED CIRCUITS; ELECTRIC CIRCUITS; CIRCUIT BREAKERS; PRINTED CIRCUIT BOARDS; CIRCUIT CONNECTORS; ELECTRICAL CONTROLLERS; ELECTRICAL CONVERTERS; ELECTRICAL CONDUCTORS; ELECTRICAL FUSES; ELECTRIC LUMINESCENT DISPLAY PANELS; ELECTRICAL SWITCH PLATES; ELECTRIC PLUGS; ELECTRIC COILS; ANTENNAS; ELECTRICAL CABLES; COMPUTER CABLES; COMPUTER CHIPS; SILICON CHIPS; CHRONOGRAPHS FOR USE AS SPECIALIZED TIME RECORDING APPARATUS; COMPUTER BUFFERS; BLANK COMPUTER DISCS; BLANK COMPUTER FLOPPY DISKS; COMPUTER HARD DISCS; ACOUSTIC CONDUITS; ELECTRICAL CONDUITS; FIBER OPTIC CONDUITS AND PARTS THEREOF; COMPACT DISC PLAYERS; AUDIO AND VIDEO TAPE RECORDERS; AUDIO AND VIDEOTAPE PLAYERS; AUDIO AND VIDEOCASSETTE RECORDERS; AUDIO AND VIDEOCASSETTE PLAYERS; BLANK AUDIO AND VIDEOTAPES, CASSETTES, DISCS AND MICROFICHE; AUDIO AND VIDEO TAPES, CASSETTES, DISCS AND MICROFICHE FEATURING INFORMATION CONCERNING TELECOMMUNICATIONS, AND CONCERNING PERSONAL AND BUSINESS MANAGEMENT SYSTEMS; AUDIO AND VIDEO RECORDINGS IN THE FIELD OF TELECOMMUNICATIONS, INFORMATION TECHNOLOGY AND SAFETY; TELEVISION AND TELEVISION PERIPHERAL EQUIPMENT, NAMELY, CAMERAS, SET TOP BOXES, REMOTE CONTROL UNITS FOR INTERACTIVE AND NON-INTERACTIVE USE; VIDEO MONITORS; AUTOMATIC VENDING MACHINES AND TIMING MECHANISMS THEREFOR AND PARTS THEREOF; MACHINE READABLE, MAGNETICALLY ENCODED CARDS, NAMELY, PREPAID TELEPHONE CALLING CARDS AND CREDIT CARDS; BLANK SMART CARDS; MAGNETIC CODED CARD READERS; DATA PROCESSORS AND READERS; WORD PROCESSORS; MICROPROCESSORS; ELECTRONIC ENCRYPTION UNITS; DEMAGNETIZERS FOR MAGNETIC TAPES AND PARTS THEREOF; LASERS NOT FOR MEDICAL USE; LIGHT EMITTING DIODES; LIGHT EMITTING DIODE DISPLAYS; COMPUTER, DATA AND VIDEO NETWORKING AND CONFERENCING EQUIPMENT, NAMELY, TELECONFERENCING EQUIP-

CLASS 9—(Continued).

MENT AND AUDIOVISUAL TEACHING EQUIPMENT IN THE NATURE OF OVERHEAD FILM, PHOTOGRAPHIC AND SLIDE PROJECTORS; PROJECTION SCREENS; COMPUTER BASED INFORMATION DISPLAY EQUIPMENT, NAMELY, COMPUTERS WHICH DISPLAY INFORMATION ON AN OVERHEAD SCREEN; PORTABLE DEVICES, NAMELY, LAPTOPS, HANDHELD AND POCKET COMPUTERS, WIRELESS FAX MACHINES; PERSONAL COMMUNICATIONS EQUIPMENT, NAMELY, PERSONAL DIGITAL ASSISTANTS; CALCULATORS AND RELATED PERIPHERALS; SATELLITE PROCESSORS, SATELLITE AND SATELLITE COMMUNICATION EARTH STATIONS BOTH STATIONARY AND MOVEABLE; COMPUTER GAME PROGRAMS FOR CHILDREN AND ADULTS; VIDEO AND COMPUTER GAME CARTRIDGES; AUDIO AND VIDEO RECORDINGS IN THE FIELD OF NEWS, SPORTS, ENTERTAINMENT, CULTURE, BUSINESS AND FINANCE, WEATHER AND TRAVEL; PRERECORDED COMPACT DISCS, AUDIOCASSETTE TAPES, VIDEOCASSETTE TAPES, DIGITAL AUDIOTAPES AND DIGITAL VIDEO DISCS FEATURING MUSICAL, VARIETY, NEWS AND COMEDY SHOWS; CARRYING CASES FOR POCKET CALCULATORS AND CELLPHONES (U.S. CLS. 21, 23, 26, 36 AND 38).

FLORENTINA BLANDU, EXAMINING ATTORNEY

SN 78-494,142. ACHIEVIA DIRECT, INC., DAYTONA BEACH, FL. FILED 10-4-2004.

Caribbean Sun

THE MARK CONSISTS OF STANDARD CHARACTERS WITHOUT CLAIM TO ANY PARTICULAR FONT, STYLE, SIZE, OR COLOR.

FOR SUNGLASSES (U.S. CLS. 21, 23, 26, 36 AND 38).
BRENDAN REGAN, EXAMINING ATTORNEY

CLASS 9—(Continued).

SN 78-494,166. DEUTSCHE TELEKOM AG, BONN, FED REP GERMANY, FILED 10-4-2004.

T-Mobile screen styles

THE MARK CONSISTS OF STANDARD CHARACTERS WITHOUT CLAIM TO ANY PARTICULAR FONT, STYLE, SIZE, OR COLOR.

PRIORITY CLAIMED UNDER SEC. 44(D) ON FED REP GERMANY APPLICATION NO. 30418515938, FILED 4-2-2004, REG. NO. 30418515, DATED 4-22-2004, EXPIRES 4-30-2014.

OWNER OF U.S. REG. NO. 2,282,432.

NO CLAIM IS MADE TO THE EXCLUSIVE RIGHT TO USE "SCREEN STYLES", APART FROM THE MARK AS SHOWN.

FOR ELECTRIC, ELECTRONIC, OPTICAL, MEASURING, SIGNALING, CONTROLLING AND TEACHING APPARATUS AND INSTRUMENTS, ALL FOR USE WITH TELECOMMUNICATIONS, NAMELY, APPARATUS FOR PRODUCING SOUND, IMAGES OR DATA, NAMELY, BLANK MAGNETIC AND OPTICAL DATA CARRIERS; DATA PROCESSORS; COMPUTERS, NAMELY, MICROCOMPUTERS, MINICOMPUTERS, COMPUTER CENTRAL PROCESSORS, COMPUTER MONITORS, COMPUTER KEYBOARDS, COMPUTER TERMINALS, COMPUTER MEMORIES, COMPUTER LASER PRINTERS, COMPUTER IMPACT PRINTERS, COMPUTER DOT MATRIX PRINTERS, COMPUTERS AND INSTRUCTIONAL MANUALS SOLD AS A UNIT; COMPUTER MEMORY HARDWARE; COMPUTER INTERFACE APPARATUS, NAMELY, COMPUTER INTERFACE BOARDS, COMPUTER MOUSE AND MOUSE PAD, COMPUTER PERIPHERALS AND PARTS THEREOF; COMPUTER SOFTWARE PROGRAMS FOR USE IN OPERATING TELECOMMUNICATIONS AND BUSINESS MANAGEMENT SYSTEMS AND RELATED INSTRUCTION MANUALS SOLD AS A UNIT; COMPUTER SOFTWARE FOR FINANCIAL ACCOUNTING, FOR THE PROVISION OF ONLINE INFORMATION SERVICES IN THE FIELD OF NEWS, SPORTS, ENTERTAINMENT, CULTURE, BUSINESS AND FINANCE, WEATHER AND TRAVEL, NETWORK MANAGEMENT, COMPUTER PROXY SOFTWARE FOR USE WITH OTHER SOFTWARE PROGRAMS, FOR CONTROLLING ACCESS AND ALARM MONITORING OF HOMES, APARTMENTS, BUILDINGS AND OTHER PROPERTIES, BILLING ANALYSIS, NETWORK ACCESS CONTROL AND FOR CREATING AND MAINTAINING FIREWALLS; COMPUTER SOFTWARE PROGRAMS FOR ACCESSING A GLOBAL COMPUTER NETWORK AND INTERACTIVE COMPUTER COMMUNICATIONS NETWORKS; OPTICAL FIBERS SOLD AS A COMPONENT OF FIBER OPTICAL CABLES; FIBER OPTIC CABLES; OPTICAL SCANNERS; OPTICAL CHARACTER READERS; OPTICAL BLANK DISCS; OPTICAL GLASS FOR SIGNAL TRANSMISSION; OPTIC TRANSMITTERS FOR RADIO, TELEPHONE; OPTIC RECEIVERS FOR TELEPHONE, AUDIO, VIDEO; OPTICAL SIGNAL PROCESSORS; OPTIC TELECOMMUNICATIONS SWITCHES; OPTICAL ATTENUATORS; OPTICAL AMPLIFIERS; OPTICAL CHARACTER RECOGNITION APPARATUS, FOR USE IN THE TELECOMMUNICATIONS FIELD, AND PARTS THEREOF; TELEPHONE LOCAL AREA NETWORKS; TELECOMMUNICATION AUDIO, VIDEO AND DATA COMMUNICATIONS SYSTEMS, NAMELY, DIGITAL AND ANALOGUE SIGNAL TRANSMITTERS; RECEIVERS AND CONVERTERS FOR USE WITH TELEPHONE, AUDIO, VIDEO; RADIO AND TELEPHONE TRANSMITTERS; COMMUNICATION RECEIVERS AND SERVERS FOR TELEPHONE, AUDIO, VIDEO; TELEPHONE ANSWERING MACHINES; TELEPROMPTERS; TELETYPEWRITERS AND PARTS THEREOF,

CLASS 9—(Continued).

NAMELY, CALLER IDENTIFICATION BOXES, DIALING ASSEMBLIES, TELEPHONE UNITS, AUDIO OPERATED RELAYS, AUDIO/VIDEO SIGNAL AND OPTICAL FILTERS, PROTECTORS AND AUTOMATIC SIGNALING AND CONTROL EQUIPMENT, TELEMETERS, WIRELESS AND CELLULAR TELEPHONES, AND RADIO PAGERS; INTERCOMS; FACSIMILE MACHINE; ELECTRONIC MAIL APPARATUS FOR ELECTRONIC EXCHANGE OF DATA, IMAGES AND MESSAGES; ELECTRICAL WIRE; ELECTRICAL WIRE CONNECTORS; INTEGRATED CIRCUITS; PRINTED CIRCUITS; ELECTRIC CIRCUITS; CIRCUIT BREAKERS; PRINTED CIRCUIT BOARDS; CIRCUIT CONNECTORS; ELECTRICAL CONTROLLERS; ELECTRICAL CONVERTERS; ELECTRICAL CONDUCTORS; ELECTRICAL FUSES; ELECTRIC LUMINESCENT DISPLAY PANELS; ELECTRICAL SWITCH PLATES; ELECTRIC PLUGS; ELECTRIC COILS; ANTENNAS; ELECTRICAL CABLES; COMPUTER CABLES; COMPUTER CHIPS; SILICON CHIPS; CHRONOGRAPHS FOR USE AS SPECIALIZED TIME RECORDING APPARATUS; COMPUTER BUFFERS; BLANK COMPUTER DISCS; BLANK COMPUTER FLOPPY DISKS; COMPUTER HARD DISCS; ACOUSTIC CONDUITS; ELECTRICAL CONDUITS; FIBER OPTIC CONDUITS AND PARTS THEREOF; COMPACT DISC PLAYERS; AUDIO AND VIDEO TAPE RECORDERS; AUDIO AND VIDEOTAPE PLAYERS; AUDIO AND VIDEOCASSETTE RECORDERS; AUDIO AND VIDEOCASSETTE PLAYERS; BLANK AUDIO AND VIDEOTAPES, CASSETTES, DISCS AND MICROFICHE; AUDIO AND VIDEO TAPES, CASSETTES, DISCS AND MICROFICHE FEATURING INFORMATION CONCERNING TELECOMMUNICATIONS, AND CONCERNING PERSONAL AND BUSINESS MANAGEMENT SYSTEMS; AUDIO AND VIDEO RECORDINGS IN THE FIELD OF TELECOMMUNICATIONS, INFORMATION TECHNOLOGY AND SAFETY; TELEVISION AND TELEVISION PERIPHERAL EQUIPMENT, NAMELY, CAMERAS, SET TOP BOXES, REMOTE CONTROL UNITS FOR INTERACTIVE AND NON-INTERACTIVE USE; VIDEO MONITORS; AUTOMATIC VENDING MACHINES AND TIMING MECHANISMS THEREFOR AND PARTS THEREOF; MACHINE READABLE, MAGNETICALLY ENCODED CARDS, NAMELY, PREPAID TELEPHONE CALLING CARDS AND CREDIT CARDS; BLANK SMART CARDS; MAGNETIC CODED CARD READERS; DATA PROCESSORS AND READERS; WORD PROCESSORS; MICROPROCESSORS; ELECTRONIC ENCRYPTION UNITS; DEMAGNETIZERS FOR MAGNETIC TAPES AND PARTS THEREOF; LASERS NOT FOR MEDICAL USE; LIGHT EMITTING DIODES; LIGHT EMITTING DIODE DISPLAYS; COMPUTER, DATA AND VIDEO NETWORKING AND CONFERENCING EQUIPMENT, NAMELY, TELECONFERENCING EQUIPMENT AND AUDIOVISUAL TEACHING EQUIPMENT IN THE NATURE OF OVERHEAD FILM, PHOTOGRAPHIC AND SLIDE PROJECTORS; PROJECTION SCREENS; COMPUTER BASED INFORMATION DISPLAY EQUIPMENT, NAMELY, COMPUTERS WHICH DISPLAY INFORMATION ON AN OVERHEAD SCREEN; PORTABLE DEVICES, NAMELY, LAPTOPS, HANDHELD AND POCKET COMPUTERS, WIRELESS FAX MACHINES; PERSONAL COMMUNICATIONS EQUIPMENT, NAMELY, PERSONAL DIGITAL ASSISTANTS; CALCULATORS AND RELATED PERIPHERALS; SATELLITE PROCESSORS, SATELLITE AND SATELLITE COMMUNICATION EARTH STATIONS BOTH STATIONARY AND MOVEABLE; COMPUTER GAME PROGRAMS FOR CHILDREN AND ADULTS; VIDEO AND COMPUTER GAME CARTRIDGES; AUDIO AND VIDEO RECORDINGS IN THE FIELD OF NEWS, SPORTS, ENTERTAINMENT, CULTURE, BUSINESS AND FINANCE, WEATHER AND TRAVEL; PRERECORDED COMPACT DISCS, AUDIOCASSETTE TAPES, VIDEOCASSETTE TAPES, DIGITAL AUDIOTAPES AND DIGITAL VIDEO DISCS FEATURING MUSICAL, VARIETY, NEWS AND COMEDY SHOWS; CARRYING CASES FOR POCKET CALCULATORS AND CELLPHONES (U.S. CLS. 21, 23, 26, 36 AND 38).

FLORENTINA BLANDU, EXAMINING ATTORNEY

CLASS 9—(Continued).

SN 78-494,425. GAMEWORKS INTERNATIONAL PTY LTD, COOGEE, AUSTRALIA, FILED 10-5-2004.

HEART OF AFRICA

THE MARK CONSISTS OF STANDARD CHARACTERS WITHOUT CLAIM TO ANY PARTICULAR FONT, STYLE, SIZE, OR COLOR.

FOR GAMING EQUIPMENT, NAMELY SLOT MACHINES WITH OR WITHOUT VIDEO INPUT (U.S. CLS. 21, 23, 26, 36 AND 38).

STACY WAHLBERG, EXAMINING ATTORNEY

SN 78-494,472. LIFESTYLE ESSENTIALS, INC., WESTON, FL. FILED 10-5-2004.

ESSENTIALS FOR THE MIND

THE MARK CONSISTS OF STANDARD CHARACTERS WITHOUT CLAIM TO ANY PARTICULAR FONT, STYLE, SIZE, OR COLOR.

FOR PRE-RECORDED CD'S, VIDEO TAPES, LASER DISKS AND DVD'S FEATURING HEALTH AND WELLNESS INFORMATION (U.S. CLS. 21, 23, 26, 36 AND 38).

MICHELLE DUBOIS, EXAMINING ATTORNEY

SN 78-494,834. CARPENTER, WILLIAM N JR., AUBURN, CA. FILED 10-5-2004.

POWERSTRIP SAVER

THE MARK CONSISTS OF STANDARD CHARACTERS WITHOUT CLAIM TO ANY PARTICULAR FONT, STYLE, SIZE, OR COLOR.

NO CLAIM IS MADE TO THE EXCLUSIVE RIGHT TO USE "SAVER", APART FROM THE MARK AS SHOWN.

FOR ELECTRICAL POWER ADAPTER (U.S. CLS. 21, 23, 26, 36 AND 38).

FIRST USE 1-1-2001; IN COMMERCE 1-1-2002.

INGA ERVIN, EXAMINING ATTORNEY

CLASS 9—(Continued).

SN 78-495,165. ZENITH PRODUCTS CORPORATION, NEW CASTLE, DE. FILED 10-6-2004.

PEAK PERFORMANCE

THE MARK CONSISTS OF STANDARD CHARACTERS WITHOUT CLAIM TO ANY PARTICULAR FONT, STYLE, SIZE, OR COLOR.

FOR BODY WEIGHT AND FAT MEASURING DEVICES (U.S. CLS. 21, 23, 26, 36 AND 38).
SUE LAWRENCE, EXAMINING ATTORNEY

SN 78-495,167. TREGASKISS LTD., OLD CASTLE (WINDSOR), ONTARIO, CANADA, FILED 10-6-2004.

TGX

THE MARK CONSISTS OF STANDARD CHARACTERS WITHOUT CLAIM TO ANY PARTICULAR FONT, STYLE, SIZE, OR COLOR.

OWNER OF U.S. REG. NO. 2,923,888.
FOR WELDING EQUIPMENT, NAMELY, WELDING TORCHES AND REPLACEMENT PARTS THEREFOR (U.S. CLS. 21, 23, 26, 36 AND 38).
FIRST USE 4-1-2003; IN COMMERCE 4-1-2003.
SUE LAWRENCE, EXAMINING ATTORNEY

CLASS 9—(Continued).

SN 78-495,445. RLJ BASKETBALL, LLC, CHARLOTTE, NC. FILED 10-6-2004.



THE MARK CONSISTS OF THE HEAD OF A BOBCAT OVER A BASKETBALL.

FOR AUDIO RECORDINGS AND VIDEO RECORDINGS IN THE FIELD OF BASKETBALL; AUDIO, VIDEO, COMPUTER AND LASER DISCS, PRE-RECORDED AUDIO AND VIDEO CASSETTES, PRE-RECORDED AUDIO AND VIDEO TAPES, PRE-RECORDED COMPACT DISCS, PRE-RECORDED COMPUTER DISCS, ALL RELATED TO BASKETBALL; COMPUTER ACCESSORIES, NAMELY MOUSE PADS, MICE, DISC CASES, COMPUTER CARRY-ON CASES, KEYBOARD WRIST PADS, COMPUTER MONITOR CARDBOARD FRAMES, ALL RELATED TO BASKETBALL; COMPUTER PROGRAMS FOR VIEWING INFORMATION, STATISTICS AND TRIVIA ABOUT BASKETBALL; COMPUTER SOFTWARE, NAMELY SCREEN SAVERS FEATURING BASKETBALL THEMES, COMPUTER SOFTWARE TO ACCESS AND VIEW COMPUTER WALLPAPER, COMPUTER BROWSERS, COMPUTER SKINS AND COMPUTER CURSORS; COMPUTER GAME SOFTWARE; VIDEO GAME SOFTWARE, VIDEO GAME CARTRIDGES AND VIDEO GAME MACHINES FOR USE WITH TELEVISIONS; RADIOS, TELEPHONES, AND CELL PHONE ACCESSORIES, NAMELY FACE PLATES AND CELL PHONE COVERS; BINOCULARS; SUNGLASSES; EYEGLASS FRAMES; EYEWEAR STRAPS AND CHAINS; EYEGLASS AND SUNGLASS CASES; MAGNETS; DISPOSABLE CAMERAS; CREDIT CARDS AND PRE-PAID TELEPHONE CALLING CARDS MAGNETICALLY ENCODED, DOWNLOADABLE VIDEO RECORDINGS, VIDEO STREAM RECORDINGS, AND AUDIO RECORDINGS IN THE FIELD OF BASKETBALL PROVIDED OVER THE INTERNET; DOWNLOADABLE COMPUTER SOFTWARE FOR VIEWING DATABASES OF INFORMATION, STATISTICAL INFORMATION, TRIVIA, POLLING INFORMATION, AND INTERACTIVE POLLING IN THE FIELD OF BASKETBALL PROVIDED OVER THE INTERNET; DOWNLOADABLE COMPUTER GAME SOFTWARE; DOWNLOADABLE VIDEO GAME PROGRAMS, DOWNLOADABLE INTERACTIVE VIDEO GAMES AND DOWNLOADABLE TRIVIA GAME SOFTWARE, ALL PROVIDED OVER THE INTERNET; DOWNLOADABLE COMPUTER SOFTWARE FOR USE AS SCREENSAVERS, WALLPAPER, BROWSERS, SKINS, AVATARS AND CURSORS OVER THE INTERNET; DOWNLOADABLE ELECTRONIC PUBLICATIONS IN THE NATURE OF MAGAZINES, NEWSLETTERS, COLORING BOOKS, GAME SCHEDULES ALL IN THE FIELD OF BASKETBALL PROVIDED OVER THE INTERNET; DOWNLOADABLE CATALOGS PROVIDED OVER THE INTERNET FEATURING AN ARRAY OF BASKETBALL-THEMED PRODUCTS; DOWNLOADABLE GREETING CARDS PROVIDED OVER THE INTERNET (U.S. CLS. 21, 23, 26, 36 AND 38).
AMOS T. MATTHEWS, JR., EXAMINING ATTORNEY

CLASS 9—(Continued).

SN 78-495,510. ZEOMI, INC., CENTER POINT, AL. FILED 10-6-2004.

ZTAB

THE MARK CONSISTS OF STANDARD CHARACTERS WITHOUT CLAIM TO ANY PARTICULAR FONT, STYLE, SIZE, OR COLOR.

FOR COMPUTER KEYBOARDS (U.S. CLS. 21, 23, 26, 36 AND 38).

CHRIS WELLS, EXAMINING ATTORNEY

CLASS 9—(Continued).

SN 78-495,727. BRONCHICK, WILLIAM, AURORA, CO. FILED 10-6-2004.

LEGALWIZ

THE MARK CONSISTS OF STANDARD CHARACTERS WITHOUT CLAIM TO ANY PARTICULAR FONT, STYLE, SIZE, OR COLOR.

OWNER OF U.S. REG. NO. 2,878,191.

FOR COMPUTER SOFTWARE FOR USE IN CREATING AND PREPARING LEGAL FORMS CONTAINING BLANKS FOR USE BY NON-LAWYERS AND LAWYERS; AND COMPUTER SOFTWARE FOR USE IN COORDINATING THE END-TO-END CREATION AND PREPARATION OF LEGAL, BUSINESS AND GOVERNMENT DOCUMENTS, INCLUDING DATA COLLECTION AND DOCUMENT PREPARATION (U.S. CLS. 21, 23, 26, 36 AND 38).

FIRST USE 10-0-2001; IN COMMERCE 10-0-2001.

MARK T. MULLEN, EXAMINING ATTORNEY

SN 78-495,671. CACAO RECORDS, INC., BRONX, NY. FILED 10-6-2004.

SN 78-495,763. LEFT FIELD PRODUCTIONS, INC, WESTLAKE VILLAGE, CA. FILED 10-6-2004.



Impulse Games

THE MARK CONSISTS OF STANDARD CHARACTERS WITHOUT CLAIM TO ANY PARTICULAR FONT, STYLE, SIZE, OR COLOR.

NO CLAIM IS MADE TO THE EXCLUSIVE RIGHT TO USE "GAMES", APART FROM THE MARK AS SHOWN.

FOR VIDEO GAMES FOR PERSONAL COMPUTERS AND VIDEO GAME CONSOLES (U.S. CLS. 21, 23, 26, 36 AND 38).

FIRST USE 4-12-2004; IN COMMERCE 4-12-2004.

LINDA MICKLEBURGH, EXAMINING ATTORNEY

FOR AUDIO-VISUAL RECORDINGS, NAMELY CD-'S FEATURING MUSIC (U.S. CLS. 21, 23, 26, 36 AND 38).

FIRST USE 4-15-2004; IN COMMERCE 5-15-2004.

TEJBIR SINGH, EXAMINING ATTORNEY

CLASS 9—(Continued).

SN 78-495,783. SORRISO, INC., WEST BOYLSTON, MA.
FILED 10-6-2004.

Giona

THE MARK CONSISTS OF STANDARD CHARACTERS
WITHOUT CLAIM TO ANY PARTICULAR FONT, STYLE,
SIZE, OR COLOR.
FOR CAMERA CASES (U.S. CLS. 21, 23, 26, 36 AND 38).
WENDY GOODMAN, EXAMINING ATTORNEY

SN 78-496,189. GUILLEMOT, INC., NEW YORK, NY. FILED
10-7-2004.

SPRUNG

THE MARK CONSISTS OF STANDARD CHARACTERS
WITHOUT CLAIM TO ANY PARTICULAR FONT, STYLE,
SIZE, OR COLOR.

FOR SOFTWARE AND ELECTRONIC GAMES,
NAMELY SOFTWARE GAMES RECORDED ON CD-
ROM AND DIGITAL VIDEO DISCS FOR COMPUTERS;
SOFTWARE GAMES RECORDED ON CD-ROMS, DIGI-
TAL VIDEO DISCS, AND CARTRIDGES FOR CONSOLE
AND INDIVIDUAL, PORTABLE GAMING SYSTEMS;
SOFTWARE GAMES THAT ARE DOWNLOADABLE
FROM A REMOTE COMPUTER SITES; AND SOFT-
WARE GAMES FOR MOBILE PHONES, PERSONAL
DIGITAL ASSISTANTS, AND HANDHELD COMPUTERS
(U.S. CLS. 21, 23, 26, 36 AND 38).

GENE MACIOL, EXAMINING ATTORNEY

CLASS 9—(Continued).

SN 78-496,322. C. R. BARD, INC., MURRAY HILL, NJ. FILED
10-7-2004.

CLEARSIGN

THE MARK CONSISTS OF STANDARD CHARACTERS
WITHOUT CLAIM TO ANY PARTICULAR FONT, STYLE,
SIZE, OR COLOR.

FOR COMPUTER AND SOFTWARE DATA ACQUI-
SITION AND ANALYSIS SYSTEM DESIGNED TO FACI-
LITATE THE GATHERING, DISPLAY, ANALYSIS, PACE
MAPPING AND STORAGE OF CARDIAC ELECTRO-
PHYSIOLOGICAL DATA (U.S. CLS. 21, 23, 26, 36 AND
38).

ROBERT LAVACHE, EXAMINING ATTORNEY

SN 78-496,380. INTERLINK ELECTRONICS, INC., CAMAR-
ILLO, CA. FILED 10-7-2004.

PRESENTATION PILOT

THE MARK CONSISTS OF STANDARD CHARACTERS
WITHOUT CLAIM TO ANY PARTICULAR FONT, STYLE,
SIZE, OR COLOR.

NO CLAIM IS MADE TO THE EXCLUSIVE RIGHT TO
USE "PRESENTATION", APART FROM THE MARK AS
SHOWN.

FOR REMOTE CONTROLS FOR USE WITH COMPU-
TERS AND TELEVISIONS. (U.S. CLS. 21, 23, 26, 36 AND
38).

MITCHELL FRONT, EXAMINING ATTORNEY

CLASS 9—(Continued).

SN 78-496,702. INTRAGLOBAL PARTNERS US, INC., ATLANTA, GA. FILED 10-8-2004.

CLASS 9—(Continued).

SN 78-496,726. VISTASCAPE SECURITY SYSTEMS CORP., ATLANTA, GA. FILED 10-8-2004.

MicroSite

SITEIQ

THE MARK CONSISTS OF STANDARD CHARACTERS WITHOUT CLAIM TO ANY PARTICULAR FONT, STYLE, SIZE, OR COLOR.

FOR MICROELECTRONICS PACKAGING, NAMELY, ELECTRICAL CONDUCTION INTERFACES FOR SEMI-CONDUCTORS (U.S. CLS. 21, 23, 26, 36 AND 38).
FIRST USE 8-11-1999; IN COMMERCE 8-11-1999.
PAULA MAHONEY, EXAMINING ATTORNEY

THE MARK CONSISTS OF STANDARD CHARACTERS WITHOUT CLAIM TO ANY PARTICULAR FONT, STYLE, SIZE, OR COLOR.

FOR COMPUTER SOFTWARE TO CORRELATE AND VISUALIZE MONITORING AND SAFETY SYSTEM POLICIES ALONG WITH DATA FROM SENSORS, NAMELY, VISUAL IMAGERY, CHEMICAL SENSING, BIOLOGICAL SENSING, RADAR TRANSDUCERS, SONAR TRANSDUCERS, MICROWAVE TRANSDUCERS AND RADIO FREQUENCY IDENTIFICATION RECEIVERS, ON A SINGLE VISUAL DISPLAY FOR AT-RISK FACILITIES SUCH AS BORDERS, PORTS, AND AIRPORTS (U.S. CLS. 21, 23, 26, 36 AND 38).
GINA FINK, EXAMINING ATTORNEY

SN 78-496,706. SARA LEE GLOBAL FINANCE, L.L.C., WINSTON-SALEM, NC. FILED 10-8-2004.

SN 78-496,926. PROVISIO, INC., CHICAGO, IL. FILED 10-8-2004.

Champion

APPRENTICESHIP
ACCELERATOR

OWNER OF U.S. REG. NOS. 1,323,337, 1,860,938 AND OTHERS.

FOR PEDOMETERS AND TIME CLOCKS (U.S. CLS. 21, 23, 26, 36 AND 38).
LANA PHAM, EXAMINING ATTORNEY

THE MARK CONSISTS OF STANDARD CHARACTERS WITHOUT CLAIM TO ANY PARTICULAR FONT, STYLE, SIZE, OR COLOR.

NO CLAIM IS MADE TO THE EXCLUSIVE RIGHT TO USE "APPRENTICESHIP", APART FROM THE MARK AS SHOWN.

FOR SOFTWARE FOR IMPLEMENTATION OF ON-THE-JOB LEARNING PROGRAMS FOR INDIVIDUALS AND FOR WORKFORCE DEVELOPMENT (U.S. CLS. 21, 23, 26, 36 AND 38).
FIRST USE 11-30-2003; IN COMMERCE 11-30-2003.
ADA HAN, EXAMINING ATTORNEY

CLASS 9—(Continued).

SN 78-497,183. MACROSYSTEM DIGITAL VIDEO AG, 58300 WETTER, FED REP GERMANY, FILED 10-8-2004.

CASABLANCA SOLITAIRE

THE MARK CONSISTS OF STANDARD CHARACTERS WITHOUT CLAIM TO ANY PARTICULAR FONT, STYLE, SIZE, OR COLOR.

OWNER OF U.S. REG. NOS. 2,352,235, 2,865,054 AND OTHERS.

FOR ELECTRONIC DEVICES, NAMELY ELECTRONIC DEVICES FOR EDITING, PROCESSING AND REPRODUCTION OF VIDEO DATA, VIDEO EDITING EQUIPMENT IN ANALOG AND DIGITAL FORMAT, CONTAINING COMPUTER SOFTWARE FOR THE STORAGE, PROCESSING, ISOLATION, REPRODUCTION, TRANSMISSION AND SUBSEQUENT TRANSLATION OF VIDEO TO DIGITAL VERSATILE DISK (DVD) FORMAT, COMPRESSION OF VIDEO MATERIAL, SYSTEMS CONTROL OF SPECIAL HARDWARE FOR TRANSLATING VIDEO MATERIAL TO DIGITAL VERSATILE DISK FORMAT, AND INCREASING AND IMPROVING THE COMPATIBILITY OF VIDEO MATERIAL AND DIGITAL VERSATILE DISK FORMAT, STORAGE MEDIA FOR RECORDING VIDEO DATA ON HARD DISCS AND DIGITAL VERSATILE DISKS (U.S. CLS. 21, 23, 26, 36 AND 38).

FIRST USE 4-19-2004; IN COMMERCE 9-2-2004.
KEVIN DINALLO, EXAMINING ATTORNEY

SN 78-497,252. MARANTEC AMERICA CORPORATION, LINCOLNSHIRE, IL. FILED 10-8-2004.

ENERGIE-PAC

THE MARK CONSISTS OF STANDARD CHARACTERS WITHOUT CLAIM TO ANY PARTICULAR FONT, STYLE, SIZE, OR COLOR.

FOR BATTERY BACKUP SYSTEM CONSISTING OF BATTERY, ELECTRONIC CONTROL, CURRENT SENSING CIRCUIT, INVERTER CIRCUIT, AND DIAGNOSTIC CIRCUIT FOR GARAGE DOOR OPENERS (U.S. CLS. 21, 23, 26, 36 AND 38).

FIRST USE 7-1-2004; IN COMMERCE 7-1-2004.
ZACHARY BELLO, EXAMINING ATTORNEY

CLASS 9—(Continued).

SN 78-497,379. GOLDENSOURCE CORPORATION, NEW YORK, NY. FILED 10-9-2004.

GOLDENSOURCE

THE MARK CONSISTS OF STANDARD CHARACTERS WITHOUT CLAIM TO ANY PARTICULAR FONT, STYLE, SIZE, OR COLOR.

FOR COMPUTER SOFTWARE FOR ENABLING THE PROCESSING AND STORING OF HIGH VOLUME MARKET DATA FOR INTEGRATION OR CONSOLIDATION OF ALL GLOBAL FINANCIAL REFERENCE DATA INTO FIRM WIDE REPOSITORIES, FOR USE BY FINANCIAL COMPANIES; COMPUTER SOFTWARE FOR REAL TIME AND BATCH INTEGRATION OF ENTERPRISE BUSINESS PROCESSING OF SECURITIES TRANSACTIONS, FOR USE BY FINANCIAL COMPANIES; COMPUTER SOFTWARE FOR PROCESSING FINANCIAL DATA FOR STORING, FILTERING, MANIPULATING AND ACCESSING SUCH DATA, FOR USE BY FINANCIAL COMPANIES; COMPUTER SOFTWARE FOR ENABLING THE MANAGEMENT AND TRACKING OF FINANCIAL TRANSACTIONS THROUGHOUT THEIR LIFE CYCLE, FOR USE BY FINANCIAL COMPANIES; COMPUTER SOFTWARE FOR ENABLING THE WORKFLOW BASED PROCESSING OF GLOBAL CORPORATE MESSAGING, NAMELY ELECTION, NOTIFICATION, ENTITLEMENT TRACKING AND PROCESSING OF CORPORATE ACTION TRANSACTIONS, FOR USE BY FINANCIAL COMPANIES; COMPUTER SOFTWARE FOR ENABLING THE MANAGEMENT OF GLOBAL FINANCIAL DATA, WITH AN INDUSTRY RECOGNIZED DATA MODEL, FOR USE BY FINANCIAL COMPANIES; COMPUTER SOFTWARE FOR FINANCIAL DATA PROCESSING, NAMELY, EXTRACTING, CONSOLIDATING, STORING AND ANALYZING FINANCIAL AND INVESTMENT DATA RELEVANT TO CUSTOMER TRANSACTIONS, FOR USE BY FINANCIAL COMPANIES (U.S. CLS. 21, 23, 26, 36 AND 38).

FIRST USE 9-29-2004; IN COMMERCE 9-29-2004.
RONALD MCMORROW, EXAMINING ATTORNEY

SN 78-497,465. PANG, UNSONG MARCUS, ORINDA, CA. FILED 10-10-2004.

Serenifinity RECORDS

NO CLAIM IS MADE TO THE EXCLUSIVE RIGHT TO USE "RECORDS", APART FROM THE MARK AS SHOWN.

FOR PRERECORDED AUDIO CASSETTES, TAPES AND COMPACT DISCS FEATURING MUSIC AND MUSICAL PERFORMANCES (U.S. CLS. 21, 23, 26, 36 AND 38).

JOHN WILKE, EXAMINING ATTORNEY

CLASS 9—(Continued).

SN 78-497,810. CONVERGYS CMG UTAH INC., SOUTH JORDAN, UT. FILED 10-11-2004.

CLASS 9—(Continued).

SN 78-497,920. BAKER, ANGIE, DBA JAWBONE, EDMONDS, WA. FILED 10-11-2004.

INFINYS

JAWBONE

THE MARK CONSISTS OF STANDARD CHARACTERS WITHOUT CLAIM TO ANY PARTICULAR FONT, STYLE, SIZE, OR COLOR.

OWNER OF U.S. REG. NOS. 2,795,221 AND 2,901,832.
FOR COMPUTER SOFTWARE AND HARDWARE FOR BILLING SERVICES FOR TELECOMMUNICATION, CABLE, BROADBAND, SATELLITE, INTERNET SERVICE PROVIDERS, HEALTHCARE PROVIDERS, INSURANCE PROVIDERS, FINANCIAL PROVIDERS, CORPORATIONS, AND GOVERNMENT ENTITIES; COMPUTER HARDWARE AND SOFTWARE FOR PROVIDING OUTSOURCED CUSTOMER SUPPORT SERVICES FOR TELECOMMUNICATIONS, CABLE, BROADBAND, SATELLITE, INTERNET SERVICE PROVIDERS, HEALTHCARE PROVIDERS, INSURANCE PROVIDERS, FINANCIAL SERVICE PROVIDERS, CORPORATIONS, AND GOVERNMENT ENTITIES (U.S. CLS. 21, 23, 26, 36 AND 38).

FIRST USE 6-30-2000; IN COMMERCE 6-30-2000.
BARBARA RUTLAND, EXAMINING ATTORNEY

THE MARK CONSISTS OF STANDARD CHARACTERS WITHOUT CLAIM TO ANY PARTICULAR FONT, STYLE, SIZE, OR COLOR.

FOR COMPUTER SOFTWARE FOR USE IN VOICE RECOGNITION AND SYNTHESIZED VOICE OUTPUT APPLICATIONS; VOICE RECOGNITION AND SYNTHESIZED VOICE OUTPUT SOFTWARE FOR USE WITH ELECTRONIC DEVICES, NAMELY, COMPUTERS, PDA'S, TELEVISIONS, RADIOS, PHONES, APPLIANCES AND TABLETS; VOICE RECOGNITION AND SYNTHESIZED VOICE OUTPUT HARDWARE AND SOFTWARE THAT IS RESPONSIVE TO VOICE COMMANDS, INSTRUCTIONS, DICTATION AND INTERACTIVE COMMUNICATIONS (U.S. CLS. 21, 23, 26, 36 AND 38).

FIRST USE 6-1-1999; IN COMMERCE 6-1-1999.
SUSAN HAYASH, EXAMINING ATTORNEY

SN 78-497,856. E-ONE, INC., OCALA, FL. FILED 10-11-2004.

SN 78-498,000. INNOTEK, INC., GARRETT, IN. FILED 10-11-2004.

S300

ULTRASMART

THE MARK CONSISTS OF STANDARD CHARACTERS WITHOUT CLAIM TO ANY PARTICULAR FONT, STYLE, SIZE, OR COLOR.

FOR FIRE TRUCKS (U.S. CLS. 21, 23, 26, 36 AND 38).
GINA HAYES, EXAMINING ATTORNEY

THE MARK CONSISTS OF STANDARD CHARACTERS WITHOUT CLAIM TO ANY PARTICULAR FONT, STYLE, SIZE, OR COLOR.

FOR ELECTRONIC ANIMAL CONFINEMENT UNIT COMPRISING TRANSMITTERS, ELECTRICAL TRANSFORMERS, WIRES, AND RECEIVER COLLARS (U.S. CLS. 21, 23, 26, 36 AND 38).

ANN E. SAPPENFIELD, EXAMINING ATTORNEY

CLASS 9—(Continued).

SN 78-498,135. WENTWORTH-DOUGLASS HOSPITAL, DOVER, NH. FILED 10-12-2004.

Wentworth-Douglas Hospital - The Seacoast's Leading Medical Center
The Doctors Health Partnership
Physicians - Patients - Community

OWNER OF U.S. REG. NO. 2,777,606.
 NO CLAIM IS MADE TO THE EXCLUSIVE RIGHT TO USE "HOSPITAL" "THE SEACOSTS LEADING MEDICAL CENTER" "DOCTORS HEALTH" "PHYSICIANS" "PATIENTS", APART FROM THE MARK AS SHOWN.

FOR COMPUTER SOFTWARE FOR THE COLLECTION, EDITING, ORGANIZING, MODIFYING, BOOK MARKING, TRANSMISSION, STORAGE, AND SHARING OF MEDICAL CENTER INFORMATION FOR PHYSICIANS/CLINICIANS AND PATIENTS (U.S. CLS. 21, 23, 26, 36 AND 38).

FIRST USE 2-28-2004; IN COMMERCE 2-28-2004.
 TARAH HARDY, EXAMINING ATTORNEY

CLASS 9—(Continued).

SN 78-498,212. SONIC SOLUTIONS, NOVATO, CA. FILED 10-12-2004.

POPCORN

THE MARK CONSISTS OF STANDARD CHARACTERS WITHOUT CLAIM TO ANY PARTICULAR FONT, STYLE, SIZE, OR COLOR.

FOR COMPUTER SOFTWARE FOR PRODUCING AND STORING DIGITAL INFORMATION, NAMELY, AUDIO, VIDEO AND TEXT DATA; COMPUTER SOFTWARE FOR CONVERTING AND STORING ANALOG AUDIO DATA INTO DIGITAL AUDIO DATA ON OPTICAL MEDIA; COMPUTER SOFTWARE FOR USE IN THE CONVERSION TO AND STORAGE OF AUDIO, VIDEO AND TEXT DATA ON OPTICAL MEDIA AND USER MANUALS SOLD THEREWITH AS A UNIT (U.S. CLS. 21, 23, 26, 36 AND 38).

HEATHER THOMPSON, EXAMINING ATTORNEY

SN 78-498,143. TVS S.P.A., 61020 TRASANNI, URBINO, ITALY, FILED 10-12-2004.

TControl

OWNER OF ITALY REG. NO. 00882864, DATED 2-6-2003, EXPIRES 12-18-2012.

OWNER OF U.S. REG. NO. 2,866,609.
 THE MARK CONSISTS OF THE TERM TCONTROL WITH THE LETTER C IN SPECIAL FORM AND FOLLOWED BY THREE ARROW DESIGNS.

FOR TEMPERATURE DETECTOR INSERTED IN THE HANDLES OF SAUCEPANS, CASSEROLES, PANS AND OTHER KITCHEN TOOLS, NAMELY POTS, KETTLES, MILK BOILERS (U.S. CLS. 21, 23, 26, 36 AND 38).

TARAH HARDY, EXAMINING ATTORNEY

SN 78-498,251. TIMEWORKS, INC., PHOENIX, AZ. FILED 10-12-2004.

T:MEWORKS

SN 78-498,151. MINEAR, MARK, LINCOLN, MA. FILED 10-12-2004.

HOG

THE COLOR(S) ORANGE, YELLOW, AND PINK IS/ARE CLAIMED AS A FEATURE OF THE MARK.

THE MARK CONSISTS OF THE WORD HOG IN ORANGE, TRAILED BY ORANGE, YELLOW AND PINK FLAMES.

FOR SUNGLASSES (U.S. CLS. 21, 23, 26, 36 AND 38).
 FIRST USE 9-1-2004; IN COMMERCE 9-1-2004.
 TARAH HARDY, EXAMINING ATTORNEY

THE MARK CONSISTS OF STANDARD CHARACTERS WITHOUT CLAIM TO ANY PARTICULAR FONT, STYLE, SIZE, OR COLOR.

FOR COMPUTER SOFTWARE FOR USE IN TRACKING TIME AND ATTENDANCE OF EMPLOYEES AND GENERATING RESULTING PAYROLL AND TIME RECORD REPORTS (U.S. CLS. 21, 23, 26, 36 AND 38).

FIRST USE 10-21-1999; IN COMMERCE 10-21-1999.
 WINSTON FOLMAR, EXAMINING ATTORNEY

CLASS 9—(Continued).

SN 78-498,666. DIGITAL PRAISE, INC., FREMONT, CA. FILED 10-12-2004.

CLASS 9—(Continued).

SN 78-499,064. AMETEK, INC., PAOLI, PA. FILED 10-13-2004.

FUNWARE

AMTUNE

THE MARK CONSISTS OF STANDARD CHARACTERS WITHOUT CLAIM TO ANY PARTICULAR FONT, STYLE, SIZE, OR COLOR.

FOR INTERACTIVE MULTIMEDIA COMPUTER GAME PROGRAMS (U.S. CLS. 21, 23, 26, 36 AND 38). FIRST USE 9-14-2004; IN COMMERCE 9-14-2004. SCOTT OSCLICK, EXAMINING ATTORNEY

THE MARK CONSISTS OF STANDARD CHARACTERS WITHOUT CLAIM TO ANY PARTICULAR FONT, STYLE, SIZE, OR COLOR.

OWNER OF U.S. REG. NOS. 744,348, 1,330,323 AND 1,388,557.

FOR COMPUTER SOFTWARE FOR USE IN MONITORING, ANALYZING AND RECORDING COMBUSTION MEASUREMENTS AND FOR CONTROLLING COMBUSTION MONITORS AND DEVICES, AND DOCUMENTATION THEREFOR WHEN SOLD AS A UNIT (U.S. CLS. 21, 23, 26, 36 AND 38).

PAULA MAHONEY, EXAMINING ATTORNEY

SN 78-498,715. DIGITAL PRAISE, INC., FREMONT, CA. FILED 10-12-2004.

SN 78-499,328. ZORAN CORPORATION, SUNNYVALE, CA. FILED 10-13-2004.



APPROACH

THE MARK CONSISTS OF A DRAWING OF A ROCKET SHIP POINTING UPWARD, WITHIN A CIRCLE, WITH THE STYLIZED WORDS POWERED BY FUNWARE TO THE RIGHT.

FOR INTERACTIVE MULTIMEDIA COMPUTER GAME PROGRAMS (U.S. CLS. 21, 23, 26, 36 AND 38). FIRST USE 9-14-2004; IN COMMERCE 9-14-2004. NORA BUCHANAN WILL, EXAMINING ATTORNEY

THE MARK CONSISTS OF STANDARD CHARACTERS WITHOUT CLAIM TO ANY PARTICULAR FONT, STYLE, SIZE, OR COLOR.

FOR INTEGRATED CIRCUITS; MICROPROCESSORS (U.S. CLS. 21, 23, 26, 36 AND 38).

BRIAN NEVILLE, EXAMINING ATTORNEY

CLASS 9—(Continued).

SN 78-499,485. WEISS, GLEN/H, WHITE HOUSE, TN. FILED 10-14-2004.

Thong Girl

THE MARK CONSISTS OF STANDARD CHARACTERS WITHOUT CLAIM TO ANY PARTICULAR FONT, STYLE, SIZE, OR COLOR.

FOR PRE-RECORDED VIDEOTAPES AND DVDS FEATURING LIVE ACTION AND ANIMATED ENTERTAINMENT (U.S. CLS. 21, 23, 26, 36 AND 38).

GEOFFREY FOSDICK, EXAMINING ATTORNEY

CLASS 9—(Continued).

SN 78-499,783. ULTRA-OPTIX, INC., EAST HAVEN, CT. FILED 10-14-2004.

ULTRA-LOUPE

THE MARK CONSISTS OF STANDARD CHARACTERS WITHOUT CLAIM TO ANY PARTICULAR FONT, STYLE, SIZE, OR COLOR.

FOR MAGNIFIERS (U.S. CLS. 21, 23, 26, 36 AND 38).

FIRST USE 9-23-2004; IN COMMERCE 9-23-2004.

KELLY BOULTON, EXAMINING ATTORNEY

SN 78-499,568. KOLPIN OUTDOORS, INC., FOX LAKE, WI. FILED 10-14-2004.

WILDLIFE EYE

THE MARK CONSISTS OF STANDARD CHARACTERS WITHOUT CLAIM TO ANY PARTICULAR FONT, STYLE, SIZE, OR COLOR.

NO CLAIM IS MADE TO THE EXCLUSIVE RIGHT TO USE "WILDLIFE", APART FROM THE MARK AS SHOWN.

FOR CAMERAS AND RECORDING DEVICES FOR MONITORING AND CAPTURING SOUNDS AND IMAGES OF ANIMALS AND FOR MONITORING AND CAPTURING SOUNDS AND IMAGES FOR SECURITY PURPOSES (U.S. CLS. 21, 23, 26, 36 AND 38).

INGA ERVIN, EXAMINING ATTORNEY

SN 78-499,810. ALLERGYZONE, LLC, LOUISVILLE, KY. FILED 10-14-2004.

BREATHXCHANGE

THE MARK CONSISTS OF STANDARD CHARACTERS WITHOUT CLAIM TO ANY PARTICULAR FONT, STYLE, SIZE, OR COLOR.

FOR PERSONAL RESPIRATORY HEAT EXCHANGER MASKS (U.S. CLS. 21, 23, 26, 36 AND 38).

FIRST USE 12-1-2004; IN COMMERCE 12-1-2004.

DOMINIC J. FERRAIUOLO, EXAMINING ATTORNEY

CLASS 9—(Continued).

SN 78-500,061. KYJAC INC., NESQUEHONING, PA. FILED 10-14-2004.

CLASS 9—(Continued).

SN 78-500,175. SAND CODEX LLC, SEATTLE, WA. FILED 10-14-2004.

SuperBowl

seadragon

THE MARK CONSISTS OF STANDARD CHARACTERS WITHOUT CLAIM TO ANY PARTICULAR FONT, STYLE, SIZE, OR COLOR.

FOR AUTOMATED DISPENSER FOR DILUTING AND DISPENSING EITHER POWDER OR SOLID CHEMICALS (U.S. CLS. 21, 23, 26, 36 AND 38).

FIRST USE 7-0-1984; IN COMMERCE 7-0-1984.
TANYA AMOS, EXAMINING ATTORNEY

THE MARK CONSISTS OF STANDARD CHARACTERS WITHOUT CLAIM TO ANY PARTICULAR FONT, STYLE, SIZE, OR COLOR.

FOR CLIENT AND SERVER COMPUTER TECHNOLOGY SOFTWARE FOR DISTRIBUTING VISUAL CONTENT, ESPECIALLY LARGE OR NUMEROUS IMAGES AND TEXTS VIA GLOBAL COMPUTER NETWORKS; SOFTWARE DEVELOPMENT KIT COMPRISING COMPUTER SOFTWARE DEVELOPMENT TOOLS ALLOWING THIRD PARTIES TO DEVELOP SOFTWARE THAT CREATES VISUAL CONTENT, ESPECIALLY LARGE OR NUMEROUS IMAGES AND TEXTS VIA GLOBAL COMPUTER NETWORKS (U.S. CLS. 21, 23, 26, 36 AND 38).
WILLIAM VERHOSEK, EXAMINING ATTORNEY

SN 78-500,083. CHEMSW, INC., FAIRFIELD, CA. FILED 10-14-2004.

SN 78-500,443. EBSCO INDUSTRIES, INC., BIRMINGHAM, AL. FILED 10-15-2004.

CISPRO

GAME SPY

THE MARK CONSISTS OF STANDARD CHARACTERS WITHOUT CLAIM TO ANY PARTICULAR FONT, STYLE, SIZE, OR COLOR.

OWNER OF U.S. REG. NO. 2,245,096.
FOR COMPUTER PROGRAMS FOR MANAGING CHEMICAL INVENTORY AND SAFETY INFORMATION (U.S. CLS. 21, 23, 26, 36 AND 38).

FIRST USE 3-10-1999; IN COMMERCE 3-10-1999.
ELISSA GARBER KON, EXAMINING ATTORNEY

THE MARK CONSISTS OF STANDARD CHARACTERS WITHOUT CLAIM TO ANY PARTICULAR FONT, STYLE, SIZE, OR COLOR.

NO CLAIM IS MADE TO THE EXCLUSIVE RIGHT TO USE "GAME", APART FROM THE MARK AS SHOWN.
FOR WILDLIFE SURVEILLANCE EQUIPMENT, NAMELY MOTION ACTUATED CAMERAS (U.S. CLS. 21, 23, 26, 36 AND 38).

FIRST USE 10-0-2003; IN COMMERCE 6-0-2004.
JOHN GARTNER, EXAMINING ATTORNEY

CLASS 9—(Continued).

SN 78-500,448. EBSCO INDUSTRIES, INC., BIRMINGHAM, AL. FILED 10-15-2004.

GAME WATCHER

THE MARK CONSISTS OF STANDARD CHARACTERS WITHOUT CLAIM TO ANY PARTICULAR FONT, STYLE, SIZE, OR COLOR.
NO CLAIM IS MADE TO THE EXCLUSIVE RIGHT TO USE "GAME", APART FROM THE MARK AS SHOWN.
FOR WILDLIFE SURVEILLANCE EQUIPMENT, NAMELY MOTION ACTUATED CAMERAS (U.S. CLS. 21, 23, 26, 36 AND 38).
FIRST USE 6-0-2003; IN COMMERCE 6-0-2004.
JOHN DWYER, EXAMINING ATTORNEY

CLASS 9—(Continued).

SN 78-500,833. WMO GLOBAL, INC., ENCINITAS, CA. FILED 10-15-2004.

WMO1

THE MARK CONSISTS OF THE LITERAL ELEMENT WMO WHERE THE NUMBER 1 IS CONTAINED WITHIN THE LETTER O.
FOR MAGNETICALLY ENCODED PREPAID OR RELOADABLE STORED VALUE CARDS (U.S. CLS. 21, 23, 26, 36 AND 38).
ALLISON HOLTZ, EXAMINING ATTORNEY

SN 78-500,738. FLASHLAW, LLC, DALLAS, TX. FILED 10-15-2004.

FLASHLAW

THE MARK CONSISTS OF STANDARD CHARACTERS WITHOUT CLAIM TO ANY PARTICULAR FONT, STYLE, SIZE, OR COLOR.
FOR COMPUTER SOFTWARE FOR LEGAL PROFESSIONALS AND LAW STUDENTS THAT PERFORMS LEGAL DATA MANAGEMENT (U.S. CLS. 21, 23, 26, 36 AND 38).
FIRST USE 6-14-2001; IN COMMERCE 8-31-2004.
CARRIE ACHEN, EXAMINING ATTORNEY

SN 78-501,103. CANTO NOVO, LLC, SANTA MONICA, CA. FILED 10-17-2004.

CHIPOTLE

THE MARK CONSISTS OF STANDARD CHARACTERS WITHOUT CLAIM TO ANY PARTICULAR FONT, STYLE, SIZE, OR COLOR.
FOR COMPACT DISCS, DVD'S AND VIDEOS CONTAINING PRE-RECORDED MUSIC (U.S. CLS. 21, 23, 26, 36 AND 38).
REBECCA GAN, EXAMINING ATTORNEY

CLASS 9—(Continued).

SN 78-501,569. CORD COMMUNICATIONS, INC., WACO, TX. FILED 10-18-2004.

CLASS 9—(Continued).

SN 78-501,697. LOAN MASTERS INC, BOCA RATON, FL. FILED 10-18-2004.

MATH AT WORK

Final Conclusion

THE MARK CONSISTS OF STANDARD CHARACTERS WITHOUT CLAIM TO ANY PARTICULAR FONT, STYLE, SIZE, OR COLOR.

OWNER OF U.S. REG. NO. 2,210,641. SEC. 2(F).

FOR SERIES OF INTERACTIVE EDUCATIONAL SOFTWARE FOR USE IN TEACHING MATHEMATICS (U.S. CLS. 21, 23, 26, 36 AND 38).

FIRST USE 2-1-1997; IN COMMERCE 2-1-1997. ESTHER BELENKER, EXAMINING ATTORNEY

THE MARK CONSISTS OF STANDARD CHARACTERS WITHOUT CLAIM TO ANY PARTICULAR FONT, STYLE, SIZE, OR COLOR.

FOR COMPUTER SOFTWARE FOR EVALUATING REAL ESTATE FINANCING AND INSTRUCTION MANUALS SOLD AS A UNIT (U.S. CLS. 21, 23, 26, 36 AND 38).

FIRST USE 7-0-1997; IN COMMERCE 7-21-1997. IRA J. GOODSАID, EXAMINING ATTORNEY

SN 78-501,871. WISPI.NET, INC., ATLANTA, GA. FILED 10-19-2004.

SN 78-501,579. CORD COMMUNICATIONS, INC., WACO, TX. FILED 10-18-2004.

WISPI.NET

CYBER SNACKS

THE MARK CONSISTS OF STANDARD CHARACTERS WITHOUT CLAIM TO ANY PARTICULAR FONT, STYLE, SIZE, OR COLOR.

OWNER OF U.S. REG. NO. 2,206,947.

FOR SERIES OF EDUCATIONAL INTERACTIVE EDUCATIONAL SOFTWARE PERTAINING TO MATHEMATICS FOR STUDENTS (U.S. CLS. 21, 23, 26, 36 AND 38).

FIRST USE 2-1-1997; IN COMMERCE 2-1-1997. CHRISTOPHER BUONGIORNO, EXAMINING ATTORNEY

THE MARK CONSISTS OF STANDARD CHARACTERS WITHOUT CLAIM TO ANY PARTICULAR FONT, STYLE, SIZE, OR COLOR.

FOR WIRELESS MONITORING, CONTROL AND COMMUNICATIONS DEVICES, NAMELY TEMPERATURE, HUMIDITY, VIBRATION, AND ENVIRONMENTAL SENSORS, ELECTRICAL ON/OFF SWITCHES, ELECTRONIC INPUT AND OUTPUT (I/O) INDICATORS, ELECTRIC CURRENT MONITORS, AND ELECTRONIC SECURITY SYSTEM SENSORS, FOR COMMERCIAL, INDUSTRIAL, HEALTH CARE, CONSUMER AND MILITARY MARKETS (U.S. CLS. 21, 23, 26, 36 AND 38).

STEVEN JACKSON, EXAMINING ATTORNEY

CLASS 9—(Continued).

SN 78-501,875. DARATA, RONALD L., MIAMI, FL. FILED 10-19-2004.

COTTON CLUB

THE MARK CONSISTS OF STANDARD CHARACTERS WITHOUT CLAIM TO ANY PARTICULAR FONT, STYLE, SIZE, OR COLOR.

FOR EYEWEAR, NAMELY, OPHTHALMIC FRAMES, SPECTACLES, SUNGLASSES, PRIMARY FRAMES AND AUXILIARY SUNGLASSES ATTACHMENTS TO ATTACH FRAMES TO EYEGLASSES, GLASSES CASES, AND GLASSES CHAINS (U.S. CLS. 21, 23, 26, 36 AND 38).

FIRST USE 6-11-2004; IN COMMERCE 10-18-2004.
AMY HELLA, EXAMINING ATTORNEY

CLASS 9—(Continued).

SN 78-502,194. HANLEY-WOOD, LLC, WASHINGTON, DC. FILED 10-19-2004.

RESIDENTIAL PRO

THE MARK CONSISTS OF STANDARD CHARACTERS WITHOUT CLAIM TO ANY PARTICULAR FONT, STYLE, SIZE, OR COLOR.

NO CLAIM IS MADE TO THE EXCLUSIVE RIGHT TO USE "RESIDENTIAL", APART FROM THE MARK AS SHOWN.

FOR COMPUTER SOFTWARE FOR EVALUATING RESIDENTIAL REAL ESTATE (U.S. CLS. 21, 23, 26, 36 AND 38).

FIRST USE 0-0-1995; IN COMMERCE 0-0-1995.
ESTHER BELENKER, EXAMINING ATTORNEY

SN 78-501,995. ELECTRONIC ARTS INC., REDWOOD CITY, CA. FILED 10-19-2004.

MVP BASEBALL

THE MARK CONSISTS OF STANDARD CHARACTERS WITHOUT CLAIM TO ANY PARTICULAR FONT, STYLE, SIZE, OR COLOR.

NO CLAIM IS MADE TO THE EXCLUSIVE RIGHT TO USE "BASEBALL", APART FROM THE MARK AS SHOWN.

FOR COMPUTER GAME SOFTWARE AND RELATED INSTRUCTION MANUALS SOLD TOGETHER AS A UNIT (U.S. CLS. 21, 23, 26, 36 AND 38).

FIRST USE 3-11-2003; IN COMMERCE 3-11-2003.
TANYA AMOS, EXAMINING ATTORNEY

SN 78-502,333. MANLEY LABORATORIES INCORPORATED, CHINO, CA. FILED 10-19-2004.

STINGRAY

THE MARK CONSISTS OF STANDARD CHARACTERS WITHOUT CLAIM TO ANY PARTICULAR FONT, STYLE, SIZE, OR COLOR.

FOR STEREO AMPLIFIER FOR HI-FI AUDIO SYSTEMS (U.S. CLS. 21, 23, 26, 36 AND 38).

FIRST USE 1-19-1998; IN COMMERCE 1-19-1998.
G. MAYERSCHOFF, EXAMINING ATTORNEY

CLASS 9—(Continued).

SN 78-502,439. COMMUNICATION INTELLIGENCE CORPORATION, REDWOOD SHORES, CA. FILED 10-19-2004.

SIGN-ON

THE MARK CONSISTS OF STANDARD CHARACTERS WITHOUT CLAIM TO ANY PARTICULAR FONT, STYLE, SIZE, OR COLOR.

OWNER OF U.S. REG. NO. 2,728,260.
SEC. 2(F).

FOR COMPUTER APPLICATION SOFTWARE FOR HANDWRITING RECOGNITION FOR GENERAL USE AND FOR COMPUTER SECURITY, NAMELY, THE PREVENTION OF UNAUTHORIZED COPYING, USE, AND ACCESS TO COMPUTER DATABASES AND OTHER COMPUTER SOFTWARE PROGRAMS (U.S. CLS. 21, 23, 26, 36 AND 38).

FIRST USE 10-7-1999; IN COMMERCE 10-7-1999.
ESTHER A. BORSUK, EXAMINING ATTORNEY

CLASS 9—(Continued).

SN 78-502,498. BLUDAMAN ENTERTAINMENT INC., BALTIMORE, MD. FILED 10-19-2004.

Picture Me Bad

THE MARK CONSISTS OF STANDARD CHARACTERS WITHOUT CLAIM TO ANY PARTICULAR FONT, STYLE, SIZE, OR COLOR.

FOR PRERECORDED VIDEOCASSETTE TAPES, COMPACT DISC-READ ONLY MEMORY (CD-ROM), DIGITAL VIDEO DISC (DVD), FEATURING ADULT ENTERTAINMENT AND MUSIC (U.S. CLS. 21, 23, 26, 36 AND 38).

FIRST USE 10-25-2003; IN COMMERCE 11-1-2003.
LOURDES AYALA, EXAMINING ATTORNEY

SN 78-502,465. IDISPLAY.TV CORPORATION, GARDENA, CA. FILED 10-19-2004.

IDISPLAY

THE MARK CONSISTS OF STANDARD CHARACTERS WITHOUT CLAIM TO ANY PARTICULAR FONT, STYLE, SIZE, OR COLOR.

FOR CABLE TELEVISION CONVERTERS, CAR TELEVISIONS, PROGRAMMABLE DIGITAL TELEVISION RECORDERS, RECEIVERS FOR RECEIVING CABLE TELEVISION, REMOTE CONTROLS FOR TELEVISIONS, TELEVISION ANTENNAS, TELEVISION MONITORS, TELEVISION RECEIVERS, TELEVISION SETS, COMPUTER MONITORS, HOME THEATER PRODUCTS, NAMELY, LIQUID CRYSTAL DISPLAY, LIQUID CRYSTAL DISPLAY LARGE-SCREEN DISPLAYS, LIQUID CRYSTAL DISPLAY PANELS, LIQUID CRYSTAL DISPLAY PROJECTORS, PLASMA TELEVISIONS AND PLASMA MONITORS (U.S. CLS. 21, 23, 26, 36 AND 38).

FIRST USE 3-30-2003; IN COMMERCE 5-31-2003.
JOHN DWYER, EXAMINING ATTORNEY

SN 78-502,501. DIGITAL MEDIA MANAGEMENT, INC., FORT LAUDERDALE, FL. FILED 10-19-2004.

CURVES

THE MARK CONSISTS OF STANDARD CHARACTERS WITHOUT CLAIM TO ANY PARTICULAR FONT, STYLE, SIZE, OR COLOR.

FOR PRE-RECORDED VIDEOTAPES AND DIGITAL VIDEO DISKS, DVD'S, IN THE FIELD OF ADULT ENTERTAINMENT (U.S. CLS. 21, 23, 26, 36 AND 38).

FIRST USE 6-1-1992; IN COMMERCE 6-1-1992.
LOURDES AYALA, EXAMINING ATTORNEY

CLASS 9—(Continued).

SN 78-502,570. CITADEL SECURITY SOFTWARE INC., DALLAS, TX. FILED 10-20-2004.

CLASS 9—(Continued).

SN 78-502,703. APPLIED MINDS, INC., GLENDALE, CA. FILED 10-20-2004.

NETOFF

TouchTable

THE MARK CONSISTS OF STANDARD CHARACTERS WITHOUT CLAIM TO ANY PARTICULAR FONT, STYLE, SIZE, OR COLOR.

FOR COMPUTER SOFTWARE, NAMELY, SOFTWARE FOR COMPUTER NETWORK SECURITY FOR AUTOMATICALLY PASSWORD LOCKING, LOGGING OFF, AND POWERING DOWN UNATTENDED COMPUTERS WITH MEASURES TO PRESERVE DATA AND STATE OF THE LOCKED DOWN COMPUTER (U.S. CLS. 21, 23, 26, 36 AND 38).

FIRST USE 2-0-2000; IN COMMERCE 2-0-2000.
KELLEY WELLS, EXAMINING ATTORNEY

THE MARK CONSISTS OF STANDARD CHARACTERS WITHOUT CLAIM TO ANY PARTICULAR FONT, STYLE, SIZE, OR COLOR.

FOR INTERACTIVE DISPLAY FOR DISPLAYING HIGH RESOLUTION GEOGRAPHIC INFORMATION SYSTEMS IMAGERY, CONTROLLED BY USER GESTURES IDENTIFIED ON A TOUCH DETECTING DISPLAY SURFACE (U.S. CLS. 21, 23, 26, 36 AND 38).

FIRST USE 3-24-2004; IN COMMERCE 8-9-2004.
KAREN K. BUSH, EXAMINING ATTORNEY

SN 78-502,598. COVARIANT SOFTWARE CORPORATION, WELLESLEY, MA. FILED 10-20-2004.

SN 78-502,707. CONTECH ELECTRONICS, INC., SAANICHTON, BRITISH COLUMBIA, CANADA, FILED 10-20-2004.

DIPLOMAT

SQUIRRELSTOP

THE MARK CONSISTS OF STANDARD CHARACTERS WITHOUT CLAIM TO ANY PARTICULAR FONT, STYLE, SIZE, OR COLOR.

FOR COMPUTER SOFTWARE FOR MANAGEMENT OF SECURE FILE TRANSFERS (U.S. CLS. 21, 23, 26, 36 AND 38).

FIRST USE 6-19-2003; IN COMMERCE 11-21-2003.
KELLEY WELLS, EXAMINING ATTORNEY

THE MARK CONSISTS OF STANDARD CHARACTERS WITHOUT CLAIM TO ANY PARTICULAR FONT, STYLE, SIZE, OR COLOR.

FOR ELECTROMECHANICAL DEVICES FOR PREVENTING SQUIRRELS AND OTHER ANIMALS FROM ACCESSING BIRD SEED IN FEEDERS (U.S. CLS. 21, 23, 26, 36 AND 38).

FIRST USE 10-1-2004; IN COMMERCE 10-1-2004.
KAREN K. BUSH, EXAMINING ATTORNEY

CLASS 9—(Continued).

SN 78-502,758. TEXAS CALCULATEM, LLC, LUTZ, FL.
FILED 10-20-2004.

GET THE EDGE BY
KNOWING THE ODDS

THE MARK CONSISTS OF STANDARD CHARACTERS
WITHOUT CLAIM TO ANY PARTICULAR FONT, STYLE,
SIZE, OR COLOR.

FOR COMPUTER SOFTWARE PROGRAMS FOR USE
IN PREDICTING THE PROBABILITY OF OUTCOMES IN
ON-LINE GAMES OF CHANCE AND SKILL (U.S. CLS.
21, 23, 26, 36 AND 38).

FIRST USE 12-6-2004; IN COMMERCE 12-6-2004.
MARGERY A. TIERNEY, EXAMINING ATTORNEY

CLASS 9—(Continued).

SN 78-503,747. IP3 NETWORKS, INC., CARLSBAD, CA.
FILED 10-21-2004.



THE MARK CONSISTS OF THE LETTERS I AND P AND
A STYLIZED NUMERAL 3.

FOR COMPUTER NETWORKING HARDWARE; COM-
MUNICATIONS SOFTWARE FOR CONNECTING COM-
PUTER NETWORK USERS; COMPUTER SOFTWARE
EMBEDDED IN NETWORKING HARDWARE FOR CON-
TROLLING BROADBAND ACCESS TO THE INTERNET,
AND FOR BILLING AND SUBSCRIBER MANAGEMENT
(U.S. CLS. 21, 23, 26, 36 AND 38).

FIRST USE 1-0-2002; IN COMMERCE 1-0-2002.
STEVEN R. FOSTER, EXAMINING ATTORNEY

SN 78-503,779. IP3 NETWORKS, INC., CARLSBAD, CA.
FILED 10-21-2004.

SN 78-503,646. SPIRIT-LED RECORDS, LLC, FRANKLIN,
TN. FILED 10-21-2004.



NO CLAIM IS MADE TO THE EXCLUSIVE RIGHT TO
USE "HYMNS", APART FROM THE MARK AS SHOWN.

FOR PRE-RECORDED AUDIO AND AUDIO-VISUAL
CASSETTE TAPES, DVD'S, COMPACT DISCS, CD-ROMS
AND ENHANCED CD'S, ALL FEATURING MUSIC (U.S.
CLS. 21, 23, 26, 36 AND 38).

KATRINA EDGE, EXAMINING ATTORNEY



THE MARK CONSISTS OF STANDARD CHARACTERS
WITHOUT CLAIM TO ANY PARTICULAR FONT, STYLE,
SIZE, OR COLOR.

FOR COMPUTER NETWORKING HARDWARE; COM-
MUNICATIONS SOFTWARE FOR CONNECTING COM-
PUTER NETWORK USERS; COMPUTER SOFTWARE
EMBEDDED IN NETWORKING HARDWARE FOR CON-
TROLLING BROADBAND ACCESS TO THE INTERNET,
AND FOR BILLING AND SUBSCRIBER MANAGEMENT
(U.S. CLS. 21, 23, 26, 36 AND 38).

FIRST USE 11-0-2001; IN COMMERCE 11-0-2001.
GRETTA YAO, EXAMINING ATTORNEY

CLASS 9—(Continued).

SN 78-503,880. BMC PLAYERS, INC., WILMINGTON, DE. FILED 10-21-2004.

CLASS 9—(Continued).

SN 78-504,970. SEAN CONWAY, INC., TIVERTON, RI. FILED 10-25-2004.

AND 1

CULTIVATING LIFE

THE MARK CONSISTS OF STANDARD CHARACTERS WITHOUT CLAIM TO ANY PARTICULAR FONT, STYLE, SIZE, OR COLOR.

OWNER OF U.S. REG. NOS. 1,898,164, 2,969,524 AND OTHERS.

FOR SOFTWARE AND ELECTRONIC GAMES, NAMELY VIDEO AND COMPUTER GAME SOFTWARE RECORDED ON CD-ROMS AND DIGITAL VIDEO DISCS (U.S. CLS. 21, 23, 26, 36 AND 38).

FIRST USE 9-1-2002; IN COMMERCE 9-1-2002.
MICHAEL TANNER, EXAMINING ATTORNEY

THE MARK CONSISTS OF STANDARD CHARACTERS WITHOUT CLAIM TO ANY PARTICULAR FONT, STYLE, SIZE, OR COLOR.

FOR COMPUTER SOFTWARE, DISKS, CD-ROMS AND VIDEO CASSETTES ALL FEATURING EDUCATIONAL MATERIAL AND INFORMATION IN THE FIELDS OF HORTICULTURE AND GARDENING (U.S. CLS. 21, 23, 26, 36 AND 38).
JULIE WATSON, EXAMINING ATTORNEY

SN 78-505,095. INFO-HOLD, INC., CINCINNATI, OH. FILED 10-25-2004.

SN 78-503,928. JEAN CO., LTD., TAIPEI, TAIWAN, FILED 10-21-2004.

YusmaRT

Info-Hold, Inc.

THE MARK CONSISTS OF STANDARD CHARACTERS WITHOUT CLAIM TO ANY PARTICULAR FONT, STYLE, SIZE, OR COLOR.

FOR LCD COMPUTER MONITORS; COMPUTER MONITORS; COMPUTER KEYBOARDS; COMPUTER MICE; PERSONAL COMPUTERS; COMPUTER CASES; NOTEBOOK COMPUTERS; PROJECTION SCREENS; SLIDE PROJECTORS; VIDEO PROJECTORS; LCD PROJECTORS; TELEVISION SETS; REAR PROJECTION TELEVISIONS; LCD TELEVISIONS; REAR PROJECTION TELEVISIONS; PLASMA DISPLAY TELEVISIONS; AND DVD RECORDERS AND PLAYERS (U.S. CLS. 21, 23, 26, 36 AND 38).

FIRST USE 8-20-2004; IN COMMERCE 8-20-2004.
DOMINICK J. SALEMI, EXAMINING ATTORNEY

THE MARK CONSISTS OF STANDARD CHARACTERS WITHOUT CLAIM TO ANY PARTICULAR FONT, STYLE, SIZE, OR COLOR.

NO CLAIM IS MADE TO THE EXCLUSIVE RIGHT TO USE "INC", APART FROM THE MARK AS SHOWN.

FOR COMPACT DISC FEATURING MESSAGES TO BE PLAYED WHILE CALLERS PLACED ON HOLD (U.S. CLS. 21, 23, 26, 36 AND 38).

FIRST USE 1-1-1990; IN COMMERCE 1-1-1990.
SHAUNIA WALLACE, EXAMINING ATTORNEY

CLASS 9—(Continued).

SN 78-505,513. WILES, WILIAM A, PHOENIX, AZ. FILED 10-25-2004.

CLASS 9—(Continued).

SN 78-507,689. CADLINK TECHNOLOGY CORPORATION, OTTAWA, ONTARIO, CANADA, FILED 10-28-2004.

XTREME COMFORT

PROFILELAB

THE MARK CONSISTS OF STANDARD CHARACTERS WITHOUT CLAIM TO ANY PARTICULAR FONT, STYLE, SIZE, OR COLOR.

FOR PROTECTIVE HEADWEAR LINERS, NAMELY, SWEAT BANDS SOLD AS A COMPONENT OF PROTECTIVE HELMETS AND PROTECTIVE HEADWEAR; REMOVABLE CUSHIONS SOLD AS A COMPONENT OF PROTECTIVE HELMETS AND PROTECTIVE HEADWEAR (U.S. CLS. 21, 23, 26, 36 AND 38).

FIRST USE 2-1-2005; IN COMMERCE 2-1-2005.
DAVID MURRAY, EXAMINING ATTORNEY

THE MARK CONSISTS OF STANDARD CHARACTERS WITHOUT CLAIM TO ANY PARTICULAR FONT, STYLE, SIZE, OR COLOR.

FOR COMPUTER SOFTWARE FOR GENERATING GRAPHICS TO BE PROCESSED BY ROUTERS AND PROFILE CUTTERS (U.S. CLS. 21, 23, 26, 36 AND 38).

FIRST USE 6-1-2000; IN COMMERCE 6-1-2000.
HOWARD B. LEVINE, EXAMINING ATTORNEY

SN 78-506,867. WIZSOFT, INC., SYOSSET, NY. FILED 10-27-2004.

SN 78-507,704. TELCEL COMMUNICATIONS, INC., LAKE-
LAND, FL. FILED 10-28-2004.

WIZCOUNT

MixFone

THE MARK CONSISTS OF STANDARD CHARACTERS WITHOUT CLAIM TO ANY PARTICULAR FONT, STYLE, SIZE, OR COLOR.

OWNER OF U.S. REG. NOS. 2,103,346, 2,865,277 AND OTHERS.

FOR COMPUTER SOFTWARE, NAMELY, BANK RECONCILIATION SOFTWARE (U.S. CLS. 21, 23, 26, 36 AND 38).

FIRST USE 1-1-2003; IN COMMERCE 1-1-2004.
H. M. FISHER, EXAMINING ATTORNEY

THE MARK CONSISTS OF STANDARD CHARACTERS WITHOUT CLAIM TO ANY PARTICULAR FONT, STYLE, SIZE, OR COLOR.

FOR DOWNLOADABLE INTERNET TELEPHONY SOFTWARE (U.S. CLS. 21, 23, 26, 36 AND 38).

FIRST USE 1-15-2004; IN COMMERCE 3-15-2004.
CAROLINE WEIMER, EXAMINING ATTORNEY

CLASS 9—(Continued).

SN 78-510,370. INPATIENT MANAGEMENT PARTNERS, INC., HOUSTON, TX. FILED 11-3-2004.



NO CLAIM IS MADE TO THE EXCLUSIVE RIGHT TO USE "ORDER OPTIMIZER; MERGED ORDER SET GENERATION SOFTWARE", APART FROM THE MARK AS SHOWN.

THE COLOR(S) BLUE, LIGHT BLUE, WHITE, AND BLACK IS/ARE CLAIMED AS A FEATURE OF THE MARK. THE MARK CONSISTS OF TWO INTERLOCKING WHITE AND LIGHT BLUE LETTER O'S WITH A ROUND BLUE SHADOW BEHIND THEM.

FOR COMPUTER SOFTWARE FOR MEDICAL PURPOSES, SPECIFICALLY THE CREATION OF PATIENT ORDERS AND PLANS OF CARE (U.S. CLS. 21, 23, 26, 36 AND 38).

HENRY S. ZAK, EXAMINING ATTORNEY

CLASS 9—(Continued).

SN 78-511,144. ANCHOR BAY ENTERTAINMENT, TROY, MI. FILED 11-4-2004.



FOR PRERECORDED VIDEOS, DVDS, CDS, AND CD-ROMS FEATURING CONTENT IN THE FIELD OF DANCE AND FITNESS (U.S. CLS. 21, 23, 26, 36 AND 38).
DAVID MURRAY, EXAMINING ATTORNEY

SN 78-510,815. RAINTREE ESSIX INC., WILMINGTON, DE. FILED 11-3-2004.

MARS

THE MARK CONSISTS OF STANDARD CHARACTERS WITHOUT CLAIM TO ANY PARTICULAR FONT, STYLE, SIZE, OR COLOR.

FOR COMPUTER SOFTWARE FOR ARCHIVAL AND MANAGEMENT OF INVENTORY FOR DENTAL PROFESSIONALS (U.S. CLS. 21, 23, 26, 36 AND 38).

FIRST USE 6-11-1999; IN COMMERCE 6-11-1999.
BARBARA RUTLAND, EXAMINING ATTORNEY

SN 78-511,155. VIRTUOSOWORKS, INC., GREENSBORO, NC. FILED 11-4-2004.

**NOTION REALIZE
MUSIC**

THE MARK CONSISTS OF STANDARD CHARACTERS WITHOUT CLAIM TO ANY PARTICULAR FONT, STYLE, SIZE, OR COLOR.

NO CLAIM IS MADE TO THE EXCLUSIVE RIGHT TO USE MUSIC, APART FROM THE MARK AS SHOWN.

FOR INTERACTIVE EDUCATIONAL SOFTWARE FOR TEACHING AND LEARNING MUSICAL COMPOSITION, FEATURING MUSIC NOTATION AND MUSICAL COMPOSITION GENERATION TECHNOLOGY (U.S. CLS. 21, 23, 26, 36 AND 38).

ANN LINNEHAN, EXAMINING ATTORNEY

CLASS 9—(Continued).

SN 78-511,426. JSCAPE LLC, MESA, AZ. FILED 11-4-2004.

CLASS 9—(Continued).

SN 78-512,901. DELORME PUBLISHING COMPANY, INC., YARMOUTH, ME. FILED 11-8-2004.

iNet Factory

TopoWorld

THE MARK CONSISTS OF STANDARD CHARACTERS WITHOUT CLAIM TO ANY PARTICULAR FONT, STYLE, SIZE, OR COLOR.

NO CLAIM IS MADE TO THE EXCLUSIVE RIGHT TO USE "INET", APART FROM THE MARK AS SHOWN.

FOR DOWNLOADABLE COMPUTER SOFTWARE FOR USE IN DEVELOPING NETWORK CAPABLE APPLICATIONS FOR USE IN EMAILING, FILE TRANSFERS AND WEB BROWSING (U.S. CLS. 21, 23, 26, 36 AND 38).

FIRST USE 8-30-2001; IN COMMERCE 8-30-2001.
JOHN WILKE, EXAMINING ATTORNEY

THE MARK CONSISTS OF STANDARD CHARACTERS WITHOUT CLAIM TO ANY PARTICULAR FONT, STYLE, SIZE, OR COLOR.

FOR COMPUTER SOFTWARE AND HARDWARE FOR THE RETRIEVAL AND DISPLAY OF GEOGRAPHIC DATA AND MAPS, NAMELY, WORLD-WIDE COLOR SATELLITE IMAGERY AND ELEVATION DATA FOR THREE DIMENSIONAL VIEWING, AND PRE-RECORDED DISCS FEATURING MAPS FOR THE USE OF REGIONAL OR GLOBAL PLANNING AND ESTIMATION TASKS (U.S. CLS. 21, 23, 26, 36 AND 38).

FIRST USE 9-1-1998; IN COMMERCE 9-1-1998.
JAMES A. RAUEN, EXAMINING ATTORNEY

SN 78-512,888. CLINICS OF NORTH TEXAS, L.L.P., WICHITA FALLS, TX. FILED 11-8-2004.

SN 78-513,249. KABUSHIKI KAISHA SATO, TOKYO, JAPAN, FILED 11-8-2004.

epChart

RWG

THE MARK CONSISTS OF STANDARD CHARACTERS WITHOUT CLAIM TO ANY PARTICULAR FONT, STYLE, SIZE, OR COLOR.

FOR COMPUTER SOFTWARE FOR COLLECTING AND PROCESSING PATIENT MEDICAL DATA AND CHARTS (U.S. CLS. 21, 23, 26, 36 AND 38).

ROBERT LAVACHE, EXAMINING ATTORNEY

THE MARK CONSISTS OF STANDARD CHARACTERS WITHOUT CLAIM TO ANY PARTICULAR FONT, STYLE, SIZE, OR COLOR.

FOR LABEL REWINDERS (U.S. CLS. 21, 23, 26, 36 AND 38).

ADA HAN, EXAMINING ATTORNEY

CLASS 9—(Continued).

SN 78-513,482. TWIN VISION CORPORATION, CAMARILLO, CA. FILED 11-8-2004.

CLASS 9—(Continued).

SN 78-514,095. ALISTA TECHNOLOGIES, INC., BELLEVUE, WA. FILED 11-9-2004.

APEX

THE MARK CONSISTS OF STANDARD CHARACTERS WITHOUT CLAIM TO ANY PARTICULAR FONT, STYLE, SIZE, OR COLOR.

FOR AUTOMATED COMMUNICATIONS CALL PROCESSING AND ROUTING SYSTEMS COMPRISED OF COMPUTER HARDWARE AND SOFTWARE FOR ROUTING, SWITCHING, CONTROLLING AND MANAGING VOICE AND DATA TRAFFIC OVER NETWORKS (U.S. CLS. 21, 23, 26, 36 AND 38).

FIRST USE 4-1-1985; IN COMMERCE 4-1-1985.
GINA FINK, EXAMINING ATTORNEY

ALISTA TECHNOLOGIES

SN 78-513,853. CATALYTIC, INC., PALO ALTO, CA. FILED 11-9-2004.

DELTAFOX

THE MARK CONSISTS OF STANDARD CHARACTERS WITHOUT CLAIM TO ANY PARTICULAR FONT, STYLE, SIZE, OR COLOR.

FOR SOFTWARE FOR INTEGRATED CIRCUIT DESIGN AUTOMATION (U.S. CLS. 21, 23, 26, 36 AND 38).
FIRST USE 11-9-2004; IN COMMERCE 11-9-2004.
JEFF DEFORD, EXAMINING ATTORNEY

THE MARK CONSISTS OF STANDARD CHARACTERS WITHOUT CLAIM TO ANY PARTICULAR FONT, STYLE, SIZE, OR COLOR.

NO CLAIM IS MADE TO THE EXCLUSIVE RIGHT TO USE TECHNOLOGIES, APART FROM THE MARK AS SHOWN.

FOR COMPUTER SOFTWARE FOR USE IN ASSISTING INDIVIDUALS AND BUSINESSES TO TRANSFER DATA AND SETTINGS FROM ONE ELECTRONIC DEVICE TO ANOTHER, BY MEANS OF A GLOBAL COMPUTER NETWORK (U.S. CLS. 21, 23, 26, 36 AND 38).

FIRST USE 10-1-2004; IN COMMERCE 10-1-2004.
KAREN K. BUSH, EXAMINING ATTORNEY

CLASS 9—(Continued).

SN 78-514,366. DISNEY ENTERPRISES, INC., BURBANK, CA. FILED 11-10-2004.

CLASS 9—(Continued).

SN 78-514,644. GEIST MANUFACTURING, INC., LINCOLN, NE. FILED 11-10-2004.

RacSense

QUINCY

THE MARK CONSISTS OF STANDARD CHARACTERS WITHOUT CLAIM TO ANY PARTICULAR FONT, STYLE, SIZE, OR COLOR.

FOR ELECTRICAL POWER DISTRIBUTION BOXES WITH COMBINATIONS OF TEMPERATURE, HUMIDITY, AIRFLOW, LIGHTLEVEL, SOUND LEVEL, EXTERNAL INPUT/OUTPUT, RESISTANCE, VOLTAGE AND/OR CURRENT SENSING CIRCUITS, AND COMPATIBLE COMPUTER SOFTWARE DESIGNED TO-(1) INTERPRET THE SENSOR VALUES; (2) REPORT THE SENSOR VALUES THROUGH LOCAL DISPLAY, WEB PAGE ACCESSED THROUGH INTERNET PROTOCOL, OR CLIENT SOFTWARE THAT ACCESSES THE DATA FROM THE BOXES THROUGH STANDARD REPORTING PROTOCOLS SUCH AS EXTENSIBLE MARKUP LANGUAGE AND SIMPLE NETWORK MANAGEMENT PROTOCOL; AND (3) ALLOW FOR ALARMS BASED ON DATA VALUES AT USER DEFINED SET-POINTS TO BE TRIGGERED TO LOCAL ALARM, SIMPLE NETWORK MANAGEMENT PROTOCOL AND/OR E-MAIL (U.S. CLS. 21, 23, 26, 36 AND 38).

FIRST USE 12-30-2004; IN COMMERCE 12-30-2004.
JIM RINGLE, EXAMINING ATTORNEY

THE MARK CONSISTS OF STANDARD CHARACTERS WITHOUT CLAIM TO ANY PARTICULAR FONT, STYLE, SIZE, OR COLOR.

FOR AUDIO AND VISUAL RECORDINGS IN ALL MEDIA, NAMELY, PRE-RECORDED VIDEOTAPES, VIDEO DISCS, DVDS, CD-ROMS, AUDIO CASSETTES, AND AUDIO CDS, ALL FEATURING MUSIC, STORIES, GAMES AND ANIMATED ENTERTAINMENT FOR CHILDREN; COMPUTER GAME PROGRAMS AND COMPUTER SOFTWARE FEATURING LEARNING ACTIVITIES FOR CHILDREN; MOTION PICTURE FILMS IN THE FIELD OF ANIMATED CHILDREN'S COMEDY AND ADVENTURE; EYEGLASSES; SUNGLASSES; CONSUMER ELECTRONIC GOODS, NAMELY, PORTABLE COMPACT DISC PLAYERS, DIGITAL COMPACT DISC PLAYERS, PORTABLE SOLID STATE DIGITAL DEVICES IN THE NATURE OF DIGITAL AUDIO PLAYERS, DIGITAL AUDIO TAPE PLAYERS, DIGITAL AUDIO TAPE RECORDERS, DIGITAL CAMERAS, DIGITAL CELLULAR PHONES, AND DIGITAL VIDEO DISC DRIVES, TV AND DVD COMBINATION MACHINES, TV AND VCR COMBINATION MACHINES, TV AND DVD AND VCR COMBINATION MACHINES, DVD PLAYERS, VCR RECORDER AND PLAYERS, DVD AND VCR COMBINATION PLAYERS, TELEVISION SETS, DESKTOP PERSONAL COMPUTERS, PORTABLE PERSONAL COMPUTERS, CONVERGENT TV/PC UNITS, HANDHELD COMPUTERS, TWO-WAY RADIO PAGERS, PORTABLE RADIOS, WALKIE-TALKIES, CORDLESS TELEPHONES, TELEPHONES, STILL 35 MM CAMERAS, VIDEO CAMERAS, VIDEO GAME INTERACTIVE HAND HELD REMOTE CONTROLS IN THE NATURE OF CONSOLES FOR PLAYING ELECTRONIC GAMES, AND COMPUTER HARDWARE AND PERIPHERALS (U.S. CLS. 21, 23, 26, 36 AND 38).

GEOFFREY FOSDICK, EXAMINING ATTORNEY

SN 78-514,774. BEI TECHNOLOGIES, INC., SAN FRANCISCO, CA. FILED 11-10-2004.



THE MARK CONSISTS OF THE LETTERS GRO IN COMBINATION WITH A FANCIFUL DESIGN OF A TUNING FORK, WHICH APPEARS BETWEEN THE "G" AND THE "R," AND THE GREEK LETTER "MU," WHICH APPEARS BEFORE THE "G" AND IS USED TO REPRESENT THE TERM "MICRO" IN THE RELEVANT INDUSTRY.

FOR ANGULAR RATE SENSORS (U.S. CLS. 21, 23, 26, 36 AND 38).
ROBERT LAVACHE, EXAMINING ATTORNEY

CLASS 9—(Continued).

SN 78-515,080. DATACOLOR HOLDING AG, LUZERN, SWITZERLAND, FILED 11-11-2004.

CLASS 9—(Continued).

SN 78-515,398. HOFFMAN ENCLOSURES INC., ANOKA, MN. FILED 11-11-2004.

DATACOLOR MONITOR

THE MARK CONSISTS OF STANDARD CHARACTERS WITHOUT CLAIM TO ANY PARTICULAR FONT, STYLE, SIZE, OR COLOR.

OWNER OF U.S. REG. NO. 1,423,732.

NO CLAIM IS MADE TO THE EXCLUSIVE RIGHT TO USE "MONITOR", APART FROM THE MARK AS SHOWN.

FOR COLOR MEASUREMENT SYSTEM COMPRISED OF COLOR MEASURING APPARATUS AND COLOR MEASURING COMPUTER SOFTWARE FOR DETERMINING COLOR DEVIATIONS WITHIN A UNITARY PIECE OF MATERIAL SUCH AS A FABRIC AND REPORTING THE AMOUNT AND LOCATIONS OF THE COLOR DEVIATIONS (U.S. CLS. 21, 23, 26, 36 AND 38).

ANNE FARRELL, EXAMINING ATTORNEY

INTERSAFE

THE MARK CONSISTS OF STANDARD CHARACTERS WITHOUT CLAIM TO ANY PARTICULAR FONT, STYLE, SIZE, OR COLOR.

FOR DATA INTERFACE PANEL ASSEMBLY FOR USE WITH METAL ENCLOSURES, NAMELY, A DOOR PROVIDING ACCESS TO A PANEL HAVING PROGRAMMABLE CONTROLS AND EXTERNAL DATABUS CONNECTORS FOR EQUIPMENT MOUNTED WITHIN THE METAL ENCLOSURES (U.S. CLS. 21, 23, 26, 36 AND 38).

KRISTINA KLOIBER, EXAMINING ATTORNEY

SN 78-515,183. ENCIRQ CORPORATION, BURLINGAME, CA. FILED 11-11-2004.

SN 78-515,758. ISO CLAIMS SERVICES, INC., COLUMBIA, SC. FILED 11-12-2004.

SensorFusion

THE MARK CONSISTS OF STANDARD CHARACTERS WITHOUT CLAIM TO ANY PARTICULAR FONT, STYLE, SIZE, OR COLOR.

FOR COMPUTER SOFTWARE FOR USE IN DATA MANAGEMENT OF EMBEDDED COMPUTER SYSTEMS, INCLUDING BUT NOT LIMITED TO WIRELESS DATA COMMUNICATIONS SYSTEMS, AUTOMOTIVE COMPUTER SYSTEMS, CONSUMER ELECTRONICS DEVICES, INDUSTRIAL AUTOMATION SYSTEMS, TELECOMMUNICATION SYSTEMS, THAT PROVIDES INTEGRATION AND COMMUNICATION OF DATA ACROSS AND WITHIN SYSTEMS AND SENSORS (U.S. CLS. 21, 23, 26, 36 AND 38).

HENRY S. ZAK, EXAMINING ATTORNEY

SPOT

THE MARK CONSISTS OF STANDARD CHARACTERS WITHOUT CLAIM TO ANY PARTICULAR FONT, STYLE, SIZE, OR COLOR.

FOR COMPUTER SOFTWARE FOR USE IN THE MORTGAGE SERVICES INDUSTRY, NAMELY, APPLICATIONS PROGRAMS THAT CONVERT AND TRANSLATE PORTABLE DOCUMENT FORMAT (PDF) FILES INTO DATA STREAMS, EXTRACT THE DATA IN THOSE PDF FILES, AND USE THAT DATA TO CREATE XML DATA FILES OR TO POPULATE OTHER FORMS USING OTHER TECHNOLOGIES AND IN OTHER DOCUMENT FORMATS (U.S. CLS. 21, 23, 26, 36 AND 38).

CHRISTOPHER ADKINS, EXAMINING ATTORNEY

CLASS 9—(Continued).

SN 78-516,947. EDGEWALKER ENTERPRISES, INC. DBA FUNDRAISER SOFTWARE, WEST PLAINS, MO. FILED 11-15-2004.

Fundraiser Jr

THE MARK CONSISTS OF STANDARD CHARACTERS WITHOUT CLAIM TO ANY PARTICULAR FONT, STYLE, SIZE, OR COLOR.

OWNER OF U.S. REG. NO. 2,874,806.

NO CLAIM IS MADE TO THE EXCLUSIVE RIGHT TO USE "FUNDRAISER", APART FROM THE MARK AS SHOWN.

FOR DATABASE MANAGEMENT SOFTWARE FOR USE IN FUNDRAISING (U.S. CLS. 21, 23, 26, 36 AND 38).

FIRST USE 8-1-1996; IN COMMERCE 8-1-1996.
KIMBERLY FRYE, EXAMINING ATTORNEY

CLASS 9—(Continued).

SN 78-517,069. ANSR AUDIO INC., CLARKSVILLE, TX. FILED 11-15-2004.

ANSR AUDIO

THE MARK CONSISTS OF STANDARD CHARACTERS WITHOUT CLAIM TO ANY PARTICULAR FONT, STYLE, SIZE, OR COLOR.

NO CLAIM IS MADE TO THE EXCLUSIVE RIGHT TO USE "AUDIO", APART FROM THE MARK AS SHOWN.

FOR AUDIO EQUIPMENT, NAMELY, WIRELESS RECEIVERS AND TRANSMITTERS, MICROPHONES (U.S. CLS. 21, 23, 26, 36 AND 38).

FIRST USE 4-1-2004; IN COMMERCE 4-1-2004.

THEODORE MCBRIDE, EXAMINING ATTORNEY

SN 78-516,982. EDGEWALKER ENTERPRISES, INC. DBA FUNDRAISER SOFTWARE, WEST PLAINS, MO. FILED 11-15-2004.

Fundraiser Basic

THE MARK CONSISTS OF STANDARD CHARACTERS WITHOUT CLAIM TO ANY PARTICULAR FONT, STYLE, SIZE, OR COLOR.

OWNER OF U.S. REG. NO. 2,874,806.

NO CLAIM IS MADE TO THE EXCLUSIVE RIGHT TO USE "FUNDRAISER", APART FROM THE MARK AS SHOWN.

FOR DATABASE MANAGEMENT SOFTWARE FOR USE IN FUNDRAISING (U.S. CLS. 21, 23, 26, 36 AND 38).

FIRST USE 3-30-1994; IN COMMERCE 3-30-1994.
KIMBERLY FRYE, EXAMINING ATTORNEY

SN 78-517,693. ELECTRIC MOBILITY CORPORATION, SEWELL, NJ. FILED 11-16-2004.

NiMHble Battery

THE MARK CONSISTS OF STANDARD CHARACTERS WITHOUT CLAIM TO ANY PARTICULAR FONT, STYLE, SIZE, OR COLOR.

NO CLAIM IS MADE TO THE EXCLUSIVE RIGHT TO USE BATTERY, APART FROM THE MARK AS SHOWN.

FOR NICKEL METAL HYDRIDE (NIMH) BATTERIES (U.S. CLS. 21, 23, 26, 36 AND 38).

AMY HELLA, EXAMINING ATTORNEY

CLASS 9—(Continued).

SN 78-517,759. DIEBOLD, INCORPORATED, NORTH CANTON, OH. FILED 11-16-2004.

EZROSTER

THE MARK CONSISTS OF STANDARD CHARACTERS WITHOUT CLAIM TO ANY PARTICULAR FONT, STYLE, SIZE, OR COLOR.

FOR ELECTRONIC DATABASE FEATURING A ROSTER OF REGISTERED VOTERS, RECORDED ON COMPUTER MEDIA (U.S. CLS. 21, 23, 26, 36 AND 38).

ANNE FARRELL, EXAMINING ATTORNEY

CLASS 9—(Continued).

SN 78-518,279. ACUNETIX LTD., ROAD TOWN, TORTOLA, BR. VIRGIN ISLANDS, FILED 11-17-2004.

ACUNETIX

THE MARK CONSISTS OF STANDARD CHARACTERS WITHOUT CLAIM TO ANY PARTICULAR FONT, STYLE, SIZE, OR COLOR.

FOR COMPUTER SOFTWARE FOR NETWORKING AND SECURITY; COMPUTER SOFTWARE USED FOR ANALYZING AND DETERMINING WHETHER NETWORKS, COMPUTERS AND WEBSITES ARE SECURE (U.S. CLS. 21, 23, 26, 36 AND 38).

ASMAT KHAN, EXAMINING ATTORNEY

SN 78-518,683. SIREN, INC., MENLO PARK, CA. FILED 11-17-2004.

SIREN

SN 78-518,275. SAMTEC, INC., NEW ALBANY, IN. FILED 11-17-2004.

GOLDEN STANDARD

THE MARK CONSISTS OF STANDARD CHARACTERS WITHOUT CLAIM TO ANY PARTICULAR FONT, STYLE, SIZE, OR COLOR.

FOR ELECTRONIC CIRCUITRY BOARDS (U.S. CLS. 21, 23, 26, 36 AND 38).

BRIAN NEVILLE, EXAMINING ATTORNEY

THE MARK CONSISTS OF STANDARD CHARACTERS WITHOUT CLAIM TO ANY PARTICULAR FONT, STYLE, SIZE, OR COLOR.

FOR PORTABLE AND HANDHELD DIGITAL ELECTRONIC DEVICES FOR RECORDING, ORGANIZING, TRANSMITTING, MANIPULATING, AND REVIEWING AUDIO, VIDEO, AND DIGITAL IMAGE FILES; COMPUTER SOFTWARE FOR USE IN ORGANIZING, TRANSMITTING, MANIPULATING, AND REVIEWING AUDIO, VIDEO, AND DIGITAL IMAGE FILES ON PORTABLE AND HANDHELD DIGITAL ELECTRONIC DEVICES (U.S. CLS. 21, 23, 26, 36 AND 38).

LINDA M. KING, EXAMINING ATTORNEY

CLASS 9—(Continued).

SN 78-519,656. PHOTOFLEX, INC., WATSONVILLE, CA. FILED 11-18-2004.

CLASS 9—(Continued).

SN 78-519,873. LEPLEY, LEWIS F., TUCSON, AZ. FILED 11-19-2004.

SILVERDOME

MetroCaller

THE MARK CONSISTS OF STANDARD CHARACTERS WITHOUT CLAIM TO ANY PARTICULAR FONT, STYLE, SIZE, OR COLOR.

OWNER OF U.S. REG. NO. 2,675,072.
FOR COLLAPSIBLE LIGHT DIRECTORS AND DIFFUSERS FOR USE WITH PHOTOGRAPHIC LIGHTING EQUIPMENT FOR PROFESSIONAL AND HIGH-END PHOTOGRAPHY (U.S. CLS. 21, 23, 26, 36 AND 38).
FIRST USE 12-31-1995; IN COMMERCE 12-31-1995.
G. MAYERSCHÖFF, EXAMINING ATTORNEY

THE MARK CONSISTS OF STANDARD CHARACTERS WITHOUT CLAIM TO ANY PARTICULAR FONT, STYLE, SIZE, OR COLOR.

FOR COMPUTER TELEPHONY SOFTWARE (U.S. CLS. 21, 23, 26, 36 AND 38).
FIRST USE 7-9-2004; IN COMMERCE 7-9-2004.
FLORENTINA BLANDU, EXAMINING ATTORNEY

SN 78-519,758. TRUSTGENIX, INC., SANTA CLARA, CA. FILED 11-18-2004.

SN 78-520,076. OMNIVISION TECHNOLOGIES, INC., SUNNYVALE, CA. FILED 11-19-2004.

Trustgenix

VARIOISO

THE MARK CONSISTS OF STANDARD CHARACTERS WITHOUT CLAIM TO ANY PARTICULAR FONT, STYLE, SIZE, OR COLOR.

FOR COMPUTER HARDWARE, SOFTWARE AND PERIPHERALS FOR USE IN SECURING TRANSMISSION; COMPUTER SECURITY SOFTWARE TO ENABLE SECURE PROVISION, TRANSMISSION AND SHARING OF PERSONAL IDENTIFICATION AND AUTHENTICATION INFORMATION OVER GLOBAL COMPUTER NETWORKS (U.S. CLS. 21, 23, 26, 36 AND 38).
FIRST USE 9-10-2002; IN COMMERCE 9-10-2002.
ZACHARY BELLO, EXAMINING ATTORNEY

THE MARK CONSISTS OF STANDARD CHARACTERS WITHOUT CLAIM TO ANY PARTICULAR FONT, STYLE, SIZE, OR COLOR.

FOR SOFTWARE, NAMELY, CAMERA TOOLS AND MIDDLEWARE FOR DIGITAL STILL CAMERAS, DIGITAL VIDEO AND MEDICAL APPLICATIONS; INTEGRATED CIRCUITS (U.S. CLS. 21, 23, 26, 36 AND 38).
JOHN E. MICHOS, EXAMINING ATTORNEY

CLASS 9—(Continued).

SN 78-520,696. GRANT, JOHN D., ALBUQUERQUE, NM. FILED 11-21-2004.

Ticklefish

THE MARK CONSISTS OF STANDARD CHARACTERS WITHOUT CLAIM TO ANY PARTICULAR FONT, STYLE, SIZE, OR COLOR.

FOR MUSICAL SOUND RECORDINGS AND MUSICAL VIDEO RECORDINGS FEATURING MUSIC ENTERTAINMENT FOR CHILDREN (U.S. CLS. 21, 23, 26, 36 AND 38).

RENEE MCCRAY, EXAMINING ATTORNEY

CLASS 9—(Continued).

SN 78-521,712. CENTRAL PURCHASING, LLC, CAMARILLO, CA. FILED 11-23-2004.

THUNDERBOLT MAGNUM

THE MARK CONSISTS OF STANDARD CHARACTERS WITHOUT CLAIM TO ANY PARTICULAR FONT, STYLE, SIZE, OR COLOR.

FOR INVERTERS USED IN AUTOMOBILES, GENERATORS AND SOLAR LIGHTS (U.S. CLS. 21, 23, 26, 36 AND 38).

BRIAN PINO, EXAMINING ATTORNEY

SN 78-521,778. CORONADO INSTRUMENTS, INC., IRVINE, CA. FILED 11-23-2004.

SN 78-521,538. GLOBESTAR SYSTEMS INC., TORONTO, ONTARIO, CANADA, FILED 11-23-2004.

CONNEXALL

THE MARK CONSISTS OF STANDARD CHARACTERS WITHOUT CLAIM TO ANY PARTICULAR FONT, STYLE, SIZE, OR COLOR.

FOR COMPUTER SOFTWARE FOR BUSINESS INTEGRATION AND TO FACILITATE COMMUNICATION BETWEEN DIFFERENT TYPES OF COMMUNICATION DEVICES (U.S. CLS. 21, 23, 26, 36 AND 38).

FIRST USE 11-0-2001; IN COMMERCE 11-0-2001.
ANNE FARRELL, EXAMINING ATTORNEY

CORONADO

THE MARK CONSISTS OF STANDARD CHARACTERS WITHOUT CLAIM TO ANY PARTICULAR FONT, STYLE, SIZE, OR COLOR.

FOR TELESCOPES AND OPTICAL FILTERS (U.S. CLS. 21, 23, 26, 36 AND 38).

FIRST USE 2-28-1998; IN COMMERCE 2-28-1998.
CHRIS DONINGER, EXAMINING ATTORNEY

CLASS 9—(Continued).

SN 78-522,168. MOTOROLA, INC., SCHAUMBURG, IL.
FILED 11-23-2004.

CLASS 9—(Continued).

SN 78-522,573. JAMMIN' SUNSHAYDES, LLC, WIXOM, MI.
FILED 11-24-2004.

MAG ONE

THE MARK CONSISTS OF STANDARD CHARACTERS WITHOUT CLAIM TO ANY PARTICULAR FONT, STYLE, SIZE, OR COLOR.

FOR TWO-WAY RADIOS AND ACCESSORIES FOR TWO-WAY RADIOS, NAMELY HEADSETS, CHARGERS, BATTERIES, BELT CLIPS, CARRYING CASES, ANTENNAS (U.S. CLS. 21, 23, 26, 36 AND 38).

FIRST USE 1-14-1998; IN COMMERCE 1-14-1998.
JOHN WILKE, EXAMINING ATTORNEY

KIDZ BRIMZ

THE MARK CONSISTS OF STANDARD CHARACTERS WITHOUT CLAIM TO ANY PARTICULAR FONT, STYLE, SIZE, OR COLOR.

OWNER OF U.S. REG. NO. 2,747,884.
NO CLAIM IS MADE TO THE EXCLUSIVE RIGHT TO USE "KIDS", APART FROM THE MARK AS SHOWN.
FOR SUNGLASSES, SAFETY SHIELDS, NAMELY, FACE SHIELDS (U.S. CLS. 21, 23, 26, 36 AND 38).

MARIA-VICTORIA SUAREZ, EXAMINING ATTORNEY

SN 78-522,963. DRAGON OPTICAL, INC., CARLSBAD, CA.
FILED 11-24-2004.

SN 78-522,485. THEGLOBE.COM, INC., FT. LAUDERDALE, FL.
FILED 11-24-2004.

GLOGREET

THE MARK CONSISTS OF STANDARD CHARACTERS WITHOUT CLAIM TO ANY PARTICULAR FONT, STYLE, SIZE, OR COLOR.

FOR COMPUTER SOFTWARE THAT ENABLES USERS TO LEAVE FANCIFUL VOICE MESSAGES AND SOUND CLIPS FOR OTHERS (U.S. CLS. 21, 23, 26, 36 AND 38).

BRIAN PINO, EXAMINING ATTORNEY

GALORE

THE MARK CONSISTS OF STANDARD CHARACTERS WITHOUT CLAIM TO ANY PARTICULAR FONT, STYLE, SIZE, OR COLOR.

FOR PROTECTIVE AND/OR ANTI-GLARE EYEWEAR, NAMELY, SUNGLASSES, GOGGLES AND PARTS AND ACCESSORIES THEREFORE, NAMELY, REPLACEMENT LENSES, EAR STEMS, FRAMES, NOSE PIECES AND FOAM STRIPS; AND CASES SPECIALLY ADAPTED FOR PROTECTIVE AND/OR ANTI-GLARE EYEWEAR (U.S. CLS. 21, 23, 26, 36 AND 38).

FIRST USE 1-28-2005; IN COMMERCE 1-28-2005.
JOHN WILKE, EXAMINING ATTORNEY

CLASS 9—(Continued).

SN 78-523,713. PHOENIX INTANGIBLES HOLDING COMPANY, GREENVILLE, DE. FILED 11-29-2004.



FOR EYEWEAR, NAMELY, EYEGLASSES; SUNGLASSES; AND FRAMES FOR EYEGLASSES AND SUNGLASSES (U.S. CLS. 21, 23, 26, 36 AND 38).
ANNE MADDEN, EXAMINING ATTORNEY

SN 78-523,757. BRADLEY, RANDALL E., PARADISE VALLEY, AZ. FILED 11-29-2004.

myDirectory

THE MARK CONSISTS OF STANDARD CHARACTERS WITHOUT CLAIM TO ANY PARTICULAR FONT, STYLE, SIZE, OR COLOR.

FOR COMPUTER SOFTWARE FOR LOCATING, ACCESSING AND UPDATING INFORMATION STORED IN DATABASES (U.S. CLS. 21, 23, 26, 36 AND 38).
BRENDAN MCCAULEY, EXAMINING ATTORNEY

CLASS 9—(Continued).

SN 78-523,823. TRS QUALITY, INC., FORT WORTH, TX. FILED 11-29-2004.

VEX

THE MARK CONSISTS OF STANDARD CHARACTERS WITHOUT CLAIM TO ANY PARTICULAR FONT, STYLE, SIZE, OR COLOR.

FOR EDUCATIONAL ROBOTIC KITS COMPRISING ALL OF THE FOLLOWING (1) ROBOT CONSTRUCTION BUILDING ELEMENTS, PROGRAMMABLE ON-BOARD ELECTRONIC CONTROL, MOTORS AND SENSORS, REMOTE CONTROLLER, ALL FOR BUILDING MOTORIZED ROBOTS, (2) COMPUTER SOFTWARE AND MANUAL FOR DESIGNING AND REMOTELY CONTROLLING MOTORIZED ROBOTS (3) ELECTRONIC COMPUTER INTERFACE FOR CONTROLLING MOTORIZED ROBOTS, AND (4) ELECTRICAL POWER TRANSFORMER FOR MOTORIZED ROBOTS (U.S. CLS. 21, 23, 26, 36 AND 38).

GLENN CLARK, EXAMINING ATTORNEY

SN 78-524,694. MARK PAUL CONFORTI, UNION, NJ. FILED 11-30-2004.

TEACH ME TIGER

THE MARK CONSISTS OF STANDARD CHARACTERS WITHOUT CLAIM TO ANY PARTICULAR FONT, STYLE, SIZE, OR COLOR.

FOR CD'S FEATURING MUSIC (U.S. CLS. 21, 23, 26, 36 AND 38).

ELLEN B. AWRICH, EXAMINING ATTORNEY

CLASS 9—(Continued).

SN 78-524,754. CREATIVE TECHNOLOGY LTD., SINGAPORE, SINGAPORE, FILED 11-30-2004.

CLASS 9—(Continued).

SN 78-524,759. CREATIVE TECHNOLOGY LTD., SINGAPORE, SINGAPORE, FILED 11-30-2004.

NEOTITANIUM

NEEON

THE MARK CONSISTS OF STANDARD CHARACTERS WITHOUT CLAIM TO ANY PARTICULAR FONT, STYLE, SIZE, OR COLOR.

FOR COMPUTER HARDWARE; COMPUTER SOFTWARE TO CONTROL AND IMPROVE COMPUTER AND AUDIO EQUIPMENT SOUND QUALITY; COMPUTER SOFTWARE FOR THE STORAGE, REPRODUCTION, TRANSMISSION AND EDITING OF SOUND, DATA, TEXT, IMAGES, AND VIDEO IN COMPUTER HARDWARE; COMPUTER PERIPHERALS; DIGITAL AUDIO PLAYERS AND RECORDERS; DIGITAL VIDEO PLAYERS AND RECORDERS; DIGITAL IMAGE RECORDERS AND VIEWERS; ELECTRONIC AUDIO AND VIDEO COMPONENTS, NAMELY, SOUND SYSTEMS COMPRISED OF RECEIVERS, AMPLIFIERS, TUNERS, SOUND MIXERS, EQUALIZERS, AUDIO AND VIDEO RECORDERS AND PLAYERS, RADIOS, AND REMOTE CONTROLS USED IN CONNECTION THEREWITH; NETWORK INTERFACE AND COMMUNICATION DEVICES, NAMELY, MODEMS, TELEPHONES, SWITCHES, ROUTERS, HUBS AND ADAPTERS; LOUDSPEAKERS; AND MANUALS DISTRIBUTED THEREWITH (U.S. CLS. 21, 23, 26, 36 AND 38).

JUDITH HELFMAN, EXAMINING ATTORNEY

THE MARK CONSISTS OF STANDARD CHARACTERS WITHOUT CLAIM TO ANY PARTICULAR FONT, STYLE, SIZE, OR COLOR.

FOR COMPUTER HARDWARE; COMPUTER SOFTWARE TO CONTROL AND IMPROVE COMPUTER AND AUDIO EQUIPMENT SOUND QUALITY; COMPUTER SOFTWARE FOR THE STORAGE, REPRODUCTION, TRANSMISSION AND EDITING OF SOUND, DATA, TEXT, IMAGES, AND VIDEO IN COMPUTER HARDWARE; COMPUTER PERIPHERALS; DIGITAL AUDIO PLAYERS AND RECORDERS; DIGITAL VIDEO PLAYERS AND RECORDERS; DIGITAL IMAGE RECORDERS AND VIEWERS; ELECTRONIC AUDIO AND VIDEO COMPONENTS, NAMELY, SOUND SYSTEMS COMPRISED OF RECEIVERS, AMPLIFIERS, TUNERS, SOUND MIXERS, EQUALIZERS, AUDIO AND VIDEO RECORDERS AND PLAYERS, RADIOS, AND REMOTE CONTROLS USED IN CONNECTION THEREWITH; NETWORK INTERFACE AND COMMUNICATION DEVICES, NAMELY, MODEMS, TELEPHONES, SWITCHES, ROUTERS, HUBS AND ADAPTERS; LOUDSPEAKERS; AND MANUALS DISTRIBUTED THEREWITH (U.S. CLS. 21, 23, 26, 36 AND 38).

JUDITH HELFMAN, EXAMINING ATTORNEY

CLASS 9—(Continued).

SN 78-524,768. CREATIVE TECHNOLOGY LTD., SINGAPORE, SINGAPORE, FILED 11-30-2004.

NAGISA

THE MARK CONSISTS OF STANDARD CHARACTERS WITHOUT CLAIM TO ANY PARTICULAR FONT, STYLE, SIZE, OR COLOR.

FOR COMPUTER HARDWARE; COMPUTER SOFTWARE TO CONTROL AND IMPROVE COMPUTER AND AUDIO EQUIPMENT SOUND QUALITY; COMPUTER SOFTWARE FOR THE STORAGE, REPRODUCTION, TRANSMISSION AND EDITING OF SOUND, DATA, TEXT, IMAGES, AND VIDEO IN COMPUTER HARDWARE; COMPUTER PERIPHERALS; DIGITAL AUDIO PLAYERS AND RECORDERS; DIGITAL VIDEO PLAYERS AND RECORDERS; DIGITAL IMAGE RECORDERS AND VIEWERS; ELECTRONIC AUDIO AND VIDEO COMPONENTS, NAMELY, SOUND SYSTEMS COMPRISED OF RECEIVERS, AMPLIFIERS, TUNERS, SOUND MIXERS, EQUALIZERS, AUDIO AND VIDEO RECORDERS AND PLAYERS, AND RADIOS; NETWORK INTERFACE AND COMMUNICATION DEVICES, NAMELY, MODEMS, TELEPHONES, SWITCHES, ROUTERS, HUBS AND ADAPTERS; LOUDSPEAKERS; REMOTE CONTROLS FOR DIGITAL AUDIO PLAYERS AND RECORDERS, DIGITAL VIDEO PLAYERS AND RECORDERS, DIGITAL IMAGE RECORDERS AND VIEWERS, ELECTRONIC AUDIO AND VIDEO COMPONENTS, NAMELY, SOUND SYSTEMS COMPRISED OF RECEIVERS, AMPLIFIERS, TUNERS, SOUND MIXERS, EQUALIZERS, AUDIO AND VIDEO RECORDERS AND PLAYERS, AND RADIOS, LOUDSPEAKERS; AND MANUALS DISTRIBUTED THEREWITH (U.S. CLS. 21, 23, 26, 36 AND 38).

JEAN IM, EXAMINING ATTORNEY

CLASS 9—(Continued).

SN 78-524,823. BINAURA AUDIO RESEARCH CORPORATION, LAWNSDALE, CA. FILED 11-30-2004.



FOR COMPUTER HARDWARE; COMPUTER SOFTWARE TO CONTROL AND IMPROVE COMPUTER AND AUDIO EQUIPMENT SOUND QUALITY AND COMPUTER SOFTWARE FOR THE STORAGE, REPRODUCTION, TRANSMISSION AND EDITING OF SOUND; ELECTRONIC AUDIO COMPONENTS, NAMELY, SOUND SYSTEMS COMPRISED OF RECEIVERS, AMPLIFIERS, AUDIO RECORDERS, AUDIO CASSETTE DECKS, CD PLAYERS AND RECORDERS, AND DIGITAL AUDIO PLAYERS AND RECORDERS AND STEREO LOUDSPEAKERS (U.S. CLS. 21, 23, 26, 36 AND 38).

BILL DAWE, EXAMINING ATTORNEY

SN 78-525,254. THE COVENANT CONSORTIUM, INC., DALLAS, TX. FILED 12-1-2004.

IDFEND

THE MARK CONSISTS OF STANDARD CHARACTERS WITHOUT CLAIM TO ANY PARTICULAR FONT, STYLE, SIZE, OR COLOR.

FOR COMPUTER SOFTWARE USED TO PROVIDE FACIAL RECOGNITION FOR PHYSICAL AND LOGICAL SECURITY (U.S. CLS. 21, 23, 26, 36 AND 38).

JOHN DWYER, EXAMINING ATTORNEY

CLASS 9—(Continued).

SN 78-525,539. ATHEROS COMMUNICATIONS, INC., SUNNYVALE, CA. FILED 12-1-2004.

CLASS 9—(Continued).

SN 78-527,935. MULTIMEDIA GAMES, INC., AUSTIN, TX. FILED 12-6-2004.

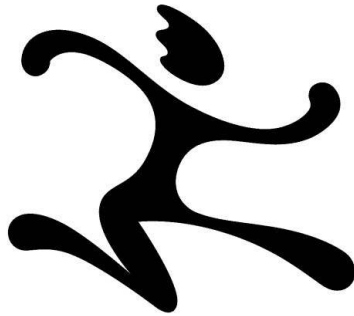

Penny Colada

THE MARK CONSISTS OF A STYLIZED DRAWING OF A PERSON IN A HURDLING POSITION WITH ARMS OUTSTRETCHED AND LEGS BENT.

FOR COMPUTER HARDWARE, NAMELY, COMPUTER CHIPS AND MODULES FOR WIRELESS COMMUNICATIONS, DATA COMMUNICATIONS, AND VOICE COMMUNICATIONS; COMPUTER SOFTWARE FOR CONTROLLING, OPERATING, AND INTERFACING WITH WIRELESS COMMUNICATIONS SYSTEMS (U.S. CLS. 21, 23, 26, 36 AND 38).

CHRISTOPHER ADKINS, EXAMINING ATTORNEY

THE MARK CONSISTS OF STANDARD CHARACTERS WITHOUT CLAIM TO ANY PARTICULAR FONT, STYLE, SIZE, OR COLOR.

FOR GAMING MACHINES, NAMELY ELECTRONIC BINGO MACHINES; SLOT MACHINES; VIDEO LOTTERY TERMINALS (U.S. CLS. 21, 23, 26, 36 AND 38).

REBECCA GAN, EXAMINING ATTORNEY

SN 78-526,144. MULTIMEDIACARD ASSOCIATION, SUNOL, CA. FILED 12-2-2004.

SN 78-528,320. DGA ENTERPRISES, LLC, BOSTON, MA. FILED 12-7-2004.

MMCMICRO

SCENTSOR

THE MARK CONSISTS OF STANDARD CHARACTERS WITHOUT CLAIM TO ANY PARTICULAR FONT, STYLE, SIZE, OR COLOR.

FOR CARDS CONTAINING AN INTEGRATED CIRCUIT MEMORY COMPONENT FOR STORING DIGITAL DATA THAT INTERFACES WITH TELECOMMUNICATION DEVICES, TESTERS, INTEGRATED CIRCUITS, HOST HANDHELD DEVICES SUCH AS PERSONAL DIGITAL ASSISTANTS WHICH CONTAIN, ACCEPT, READ, RECOGNIZE AND/OR UTILIZE SUCH CARDS AS ALL OR PART OF THEIR FUNCTION (U.S. CLS. 21, 23, 26, 36 AND 38).

GIANCARLO CASTRO, EXAMINING ATTORNEY

THE MARK CONSISTS OF STANDARD CHARACTERS WITHOUT CLAIM TO ANY PARTICULAR FONT, STYLE, SIZE, OR COLOR.

FOR INDICATOR FOR INDICATING A PARTICULAR TIME PERIOD OR THE DEPLETION OF AIR TREATING MATERIAL (U.S. CLS. 21, 23, 26, 36 AND 38).

FIRST USE 1-25-2005; IN COMMERCE 1-25-2005.

REBECCA GAN, EXAMINING ATTORNEY

CLASS 9—(Continued).

SN 78-528,551. MARY LEE FERRIN, CULLEOKA, TN. FILED 12-7-2004.



THE COLORS GOLD, PLUM, BLACK, WHITE, RED, GRAY, BROWN, ORANGE, AND GREEN ARE CLAIMED AS A FEATURE OF THE MARK.

THE MARK CONSISTS OF A PLACEMAT WITH SCALLOPED EDGES THAT IS HALF GOLD AND HALF PLUM. THE WORD "DINNER AND" APPEARS IN THE UPPER LEFT HAND CORNER OF THE PLACEMAT IN BLACK AND THE WORDS "A MURDER" APPEAR IN THE BOTTOM LEFT HAND CORNER OF THE PLACEMAT IN BLACK. A FORK AND BLOODY NAPKIN, A SMOKING GUN AND BULLET ON TOP OF A PLATE, AND A STONE-ENCRUSTED DAGGER APPEAR BETWEEN THE WORDING ON THE PLACEMAT. THE NAPKIN IS WHITE AND OUTLINED IN BLACK WITH RED BLOOD ON THE TOP CORNER. THE FORK OVERLAPS THE NAPKIN AND IS IN BLACK AND WHITE. THE PLATE IS BLACK AND WHITE WITH RED BLOOD ON THE BOTTOM RIGHT CORNER. THE BULLET IS GRAY WITH RED BLOOD ON THE TIP AND APPEARS ON THE RIGHT HAND SIDE OF THE PLATE. THE BROWN AND GOLD GUN APPEARS WITH GRAY SMOKE IN THE CENTER OF THE PLATE. TO THE RIGHT OF THE PLATE IS A GRAY STONE DAGGER ENCRUSTED WITH WHITE, RED, ORANGE AND GREEN STONES ON THE HANDLE".

FOR DOWNLOADABLE ELECTRONIC PUBLICATIONS IN THE NATURE OF MURDER MYSTERY ROLE PLAYING PARTY GAMES (U.S. CLS. 21, 23, 26, 36 AND 38).

FIRST USE 10-21-2002; IN COMMERCE 12-8-2002.
JENNIFER WILLISTON, EXAMINING ATTORNEY

SN 78-529,316. ENERGY SOLUTIONS INTERNATIONAL, INC., HOUSTON, TX. FILED 12-8-2004.

VISUALPIPELINE

THE MARK CONSISTS OF STANDARD CHARACTERS WITHOUT CLAIM TO ANY PARTICULAR FONT, STYLE, SIZE, OR COLOR.

FOR COMPUTER SOFTWARE, NAMELY SOFTWARE FOR PROVIDING GRAPHICAL OPERATOR INTERFACE WITH OTHER COMPUTER PROGRAMS USED FOR PIPELINE OPERATION AND CONTROL IN THE ENERGY INDUSTRY (U.S. CLS. 21, 23, 26, 36 AND 38).

FIRST USE 5-26-2004; IN COMMERCE 8-18-2004.
TIMOTHY FINNEGAN, EXAMINING ATTORNEY

CLASS 9—(Continued).

SN 78-529,416. LOGICUBE, INC., CHATSWORTH, CA. FILED 12-8-2004.

OmniClone

THE MARK CONSISTS OF STANDARD CHARACTERS WITHOUT CLAIM TO ANY PARTICULAR FONT, STYLE, SIZE, OR COLOR.

FOR HARD DISK DRIVE DUPLICATION DEVICES (U.S. CLS. 21, 23, 26, 36 AND 38).

FIRST USE 1-2-2001; IN COMMERCE 1-2-2001.
REBECCA GAN, EXAMINING ATTORNEY

SN 78-530,614. MOHON INTERNATIONAL, INC., PARIS, TN. FILED 12-10-2004.



NO CLAIM IS MADE TO THE EXCLUSIVE RIGHT TO USE ADAPTABLE LAB SYSTEMS, APART FROM THE MARK AS SHOWN.

THE COLOR(S) KOBALT BLUE, SILVER AND BLACK IS/ARE CLAIMED AS A FEATURE OF THE MARK.

THE MARK CONSISTS OF THE WORD "APOGEE" IN KOBALT BLUE AND SILVER OUTLINED LETTERING WITH THE LEFT SIDE AND APEX OF THE LETTER "A" EXTENDING OVER THE LETTERS "POGE" ENDING IN AN EXPANDING STAR DESIGN OVER THE LETTER "G" AND A POINT OVER THE LETTER "E". THE ENTIRE WORD "APOGEE" SITS ATOP THE WORDS "ADAPTABLE LAB SYSTEMS" WHICH ALL APPEAR IN SOLID BLACK LETTERING.

FOR SELF CONTAINED MOVABLE AND ADAPTABLE LABORATORY FURNITURE WITH LABORATORY FIXTURES (U.S. CLS. 21, 23, 26, 36 AND 38).

FIRST USE 3-1-2005; IN COMMERCE 3-1-2005.
SUE LAWRENCE, EXAMINING ATTORNEY

CLASS 9—(Continued).

SN 78-530,795. WHIRLWIND CONCEPTS, INC., SPOKANE, WA. FILED 12-10-2004.

BIG RED

THE MARK CONSISTS OF STANDARD CHARACTERS WITHOUT CLAIM TO ANY PARTICULAR FONT, STYLE, SIZE, OR COLOR.

FOR VENDING MACHINES; AUTOMATED WINDSHIELD WASHING FLUID DISPENSERS (U.S. CLS. 21, 23, 26, 36 AND 38).

WON TEAK OH, EXAMINING ATTORNEY



SN 78-531,742. MICRO MEMORY, LLC, CHATSWORTH, CA. FILED 12-13-2004.

UMEM

THE MARK CONSISTS OF STANDARD CHARACTERS WITHOUT CLAIM TO ANY PARTICULAR FONT, STYLE, SIZE, OR COLOR.

FOR NVRAM CIRCUIT CARD ASSEMBLIES (U.S. CLS. 21, 23, 26, 36 AND 38).

FIRST USE 6-30-2001; IN COMMERCE 6-30-2001.
AISHA CLARKE, EXAMINING ATTORNEY

CLASS 9—(Continued).

SN 78-532,439. KCI COMMUNICATIONS, INC., LAKE ZURICH, IL. FILED 12-14-2004.



NO CLAIM IS MADE TO THE EXCLUSIVE RIGHT TO USE "MOBILE VEHICLE", APART FROM THE MARK AS SHOWN.

THE MARK CONSISTS OF THE LETTERS "MVP" ENCLOSED IN AN OVAL WITH THE WORDS "MOBILE VEHICLE PROSECUTOR".

FOR DIGITAL VIDEO RECORDER (U.S. CLS. 21, 23, 26, 36 AND 38).

FIRST USE 11-20-2004; IN COMMERCE 12-1-2004.
DAVID C. REIHNER, EXAMINING ATTORNEY



SN 78-532,505. FINDBASE, LLC, TWAIN HARTE, CA. FILED 12-14-2004.



FOR COMPUTER SOFTWARE AND DOWNLOADABLE COMPUTER SOFTWARE FOR RESTRICTING ACCESS TO NETWORK DATA REPOSITORIES AND KEEPING A RECORD OF INDIVIDUALS AND ENTITY SOURCES THAT ATTEMPT TO ACCESS THE NETWORK DATA REPOSITORIES (U.S. CLS. 21, 23, 26, 36 AND 38).

FIRST USE 11-1-2001; IN COMMERCE 11-1-2001.
LAURIE MAYES, EXAMINING ATTORNEY

CLASS 9—(Continued).

SN 78-532,646. PEOPLENET COMMUNICATIONS CORPORATION, CHASKA, MN. FILED 12-15-2004.

CLASS 9—(Continued).

SN 78-533,358. DATA IMPACT SOFTWARE, LLC, ANN ARBOR, MI. FILED 12-15-2004.

PEOPLENET

THE MARK CONSISTS OF STANDARD CHARACTERS WITHOUT CLAIM TO ANY PARTICULAR FONT, STYLE, SIZE, OR COLOR.

OWNER OF U.S. REG. NOS. 2,186,388 AND 2,194,078.
FOR ELECTRONIC TELEMONTORING SYSTEMS CONSISTING OF COMPUTER HARDWARE AND COMPUTER SOFTWARE PROGRAMS USED FOR THE PURPOSE OF MONITORING, TRACKING, AND COMMUNICATING WITH TRANSPORT VEHICLES, PERSONS, PACKAGES AND FREIGHT IN TRANSIT (U.S. CLS. 21, 23, 26, 36 AND 38).

FIRST USE 5-31-1996; IN COMMERCE 6-30-1996.
TANYA AMOS, EXAMINING ATTORNEY

Accommodate Pro

THE MARK CONSISTS OF STANDARD CHARACTERS WITHOUT CLAIM TO ANY PARTICULAR FONT, STYLE, SIZE, OR COLOR.

FOR COMPUTER SOFTWARE FOR THE CREATION OF SEARCHABLE DATABASES OF INFORMATION AND DATA RELATED TO STUDENTS WITH LEARNING DIFFICULTIES AND BEHAVIORAL PROBLEMS; COMPUTER SOFTWARE FOR APPLICATION, DATABASE INTEGRATION AND MANAGEMENT IN THE FIELD OF STUDENT LEARNING DIFFICULTIES; COMPUTER SOFTWARE FOR SPREADSHEETS, WORD PROCESSING AND THE CREATION OF FORMS COMPLIANT WITH GOVERNMENTAL REGULATIONS IN THE FIELD OF STUDENT LEARNING DIFFICULTIES AND BEHAVIORAL PROBLEMS; COMPUTER SOFTWARE FOR THE COLLECTION, EDITING, ORGANIZING, MODIFYING, BOOK MARKING, TRANSMISSION, STORAGE AND SHARING OF DATA AND INFORMATION IN THE FIELD OF STUDENT LEARNING DIFFICULTIES AND BEHAVIORAL PROBLEMS; COMPUTER SOFTWARE FOR THE CREATION AND COMMUNICATION OF STRATEGIC INTERVENTION AND REMEDIAL PLANS FOR STUDENTS WITH LEARNING DIFFICULTIES AND BEHAVIORAL PROBLEMS; COMPUTER SOFTWARE FOR THE EVALUATION, MONITORING AND REPORTING OF PERFORMANCE OF STUDENTS WITH LEARNING DIFFICULTIES AND BEHAVIORAL PROBLEMS; AND EDUCATIONAL SOFTWARE FEATURING INSTRUCTION IN AND OVERVIEW OF FEDERAL GUIDELINES FOR STUDENTS WITH PHYSICAL AND MENTAL DISABILITIES (U.S. CLS. 21, 23, 26, 36 AND 38).

FIRST USE 3-15-2004; IN COMMERCE 9-1-2004.
APRIL L. RADEMACHER, EXAMINING ATTORNEY

SN 78-533,329. US DATAWORKS, INC., HOUSTON, TX. FILED 12-15-2004.

CREDIT PUSH

THE MARK CONSISTS OF STANDARD CHARACTERS WITHOUT CLAIM TO ANY PARTICULAR FONT, STYLE, SIZE, OR COLOR.

NO CLAIM IS MADE TO THE EXCLUSIVE RIGHT TO USE "CREDIT", APART FROM THE MARK AS SHOWN.

FOR COMPUTER SOFTWARE FOR ELECTRONIC TRANSACTION PROCESSING (U.S. CLS. 21, 23, 26, 36 AND 38).

ANN LINNEHAN, EXAMINING ATTORNEY

CLASS 9—(Continued).

SN 78-533,408. GAMING LABORATORIES INTERNATIONAL, INC., LAKEWOOD, NJ. FILED 12-16-2004.

CLASS 9—(Continued).

SN 78-533,738. CARBON STEEL INSPECTION, INC., PITTSBURGH, PA. FILED 12-16-2004.

CDCK

TRIAx

THE MARK CONSISTS OF STANDARD CHARACTERS WITHOUT CLAIM TO ANY PARTICULAR FONT, STYLE, SIZE, OR COLOR.

FOR COMPUTER SOFTWARE FOR USE IN SECURING AND VERIFYING THE IDENTITY AND INTEGRITY OF GAMING DEVICES AND THEIR PLATFORMS (U.S. CLS. 21, 23, 26, 36 AND 38).

FIRST USE 7-8-1999; IN COMMERCE 7-8-1999.
LEIGH CAROLINE CASE, EXAMINING ATTORNEY

THE MARK CONSISTS OF STANDARD CHARACTERS WITHOUT CLAIM TO ANY PARTICULAR FONT, STYLE, SIZE, OR COLOR.

FOR COMPUTER SOFTWARE, NAMELY, SOFTWARE FOR MAINTAINING, ANALYZING, DISPLAYING, IMPORTING AND EXPORTING AND PRINTING RECORDS AND DATA CONCERNING THE CONDITION, AGE, RELIABILITY AND REMAINING USEFUL LIFE OF HEAT EXCHANGE EQUIPMENT, NAMELY, HEATERS, BOILERS, COOLERS, EVAPORATORS, CONDENSERS AND RELATED TUBES, TUBESHEETS, HEADERS AND APPURTENANT PIPING (U.S. CLS. 21, 23, 26, 36 AND 38).

FIRST USE 10-31-2003; IN COMMERCE 9-30-2004.
JILL PRATER, EXAMINING ATTORNEY

SN 78-533,494. WILCOX ASSOCIATES, INC., DANVILLE, CA. FILED 12-16-2004.

SN 78-534,580. ENERGY SOLUTIONS INTERNATIONAL, INC., HOUSTON, TX. FILED 12-17-2004.

EMS

TLNET

THE MARK CONSISTS OF STANDARD CHARACTERS WITHOUT CLAIM TO ANY PARTICULAR FONT, STYLE, SIZE, OR COLOR.

FOR COMPUTER SOFTWARE FOR PROVIDING AN INTERFACE BETWEEN MEASURING SOFTWARE AND A MEASUREMENT DEVICE (U.S. CLS. 21, 23, 26, 36 AND 38).

FIRST USE 9-1-2003; IN COMMERCE 4-1-2004.
LEIGH CAROLINE CASE, EXAMINING ATTORNEY

THE MARK CONSISTS OF STANDARD CHARACTERS WITHOUT CLAIM TO ANY PARTICULAR FONT, STYLE, SIZE, OR COLOR.

FOR COMPUTER PROGRAMS, NAMELY SOFTWARE FOR SIMULATING LIQUID PIPELINE NETWORKS FOR DESIGN AND MODELING (U.S. CLS. 21, 23, 26, 36 AND 38).

FIRST USE 9-0-1982; IN COMMERCE 9-0-1982.
FLORENTINA BLANDU, EXAMINING ATTORNEY

CLASS 9—(Continued).

SN 78-534,687. GENTEX CORPORATION, CARBONDALE, PA. FILED 12-17-2004.

CLASS 9—(Continued).

SN 78-535,384. ADC TELECOMMUNICATIONS, INC., EDEN PRAIRIE, MN. FILED 12-20-2004.

X Liner

OPTENET

THE MARK CONSISTS OF STANDARD CHARACTERS WITHOUT CLAIM TO ANY PARTICULAR FONT, STYLE, SIZE, OR COLOR.

NO CLAIM IS MADE TO THE EXCLUSIVE RIGHT TO USE "LINER", APART FROM THE MARK AS SHOWN.

FOR LINERS FOR PROTECTIVE HELMETS (U.S. CLS. 21, 23, 26, 36 AND 38).

SANI KHOURI, EXAMINING ATTORNEY

THE MARK CONSISTS OF STANDARD CHARACTERS WITHOUT CLAIM TO ANY PARTICULAR FONT, STYLE, SIZE, OR COLOR.

FOR TELECOMMUNICATIONS EQUIPMENT, NAMELY, MEDIA CONVERTERS USED TO CONVERT TELECOM AND DATA SIGNALS FROM OPTICAL TO ELECTRICAL MEDIA AND TO MANAGE NETWORK MEDIA TRANSITIONS (U.S. CLS. 21, 23, 26, 36 AND 38).

FIRST USE 4-0-2003; IN COMMERCE 7-30-2003.
JASON ROTH, EXAMINING ATTORNEY

SN 78-534,726. IGG SOFTWARE, LLC, PUTNEY, VT. FILED 12-17-2004.

SN 78-535,385. MEYER SOUND LABORATORIES, INCORPORATED, BERKELEY, CA. FILED 12-20-2004.

iBiz

M'ELODIE

THE MARK CONSISTS OF STANDARD CHARACTERS WITHOUT CLAIM TO ANY PARTICULAR FONT, STYLE, SIZE, OR COLOR.

FOR COMPUTER SOFTWARE FOR PROJECT AND CLIENT MANAGEMENT, TIME TRACKING AND INVOICING (U.S. CLS. 21, 23, 26, 36 AND 38).

KIMBERLY PERRY, EXAMINING ATTORNEY

THE MARK CONSISTS OF STANDARD CHARACTERS WITHOUT CLAIM TO ANY PARTICULAR FONT, STYLE, SIZE, OR COLOR.

FOR LOUDSPEAKERS WITH BUILT IN AMPLIFIERS (U.S. CLS. 21, 23, 26, 36 AND 38).

JASON ROTH, EXAMINING ATTORNEY

CLASS 9—(Continued).

SN 78-535,549. ATTENEX CORPORATION, SEATTLE, WA. FILED 12-20-2004.

CLASS 9—(Continued).

SN 78-535,760. RADIATION DYNAMICS, INC., EDGEWOOD, NY. FILED 12-20-2004.



OWNER OF U.S. REG. NO. 2,766,309.
THE MARK CONSISTS OF THREE CIRCLES CONNECTED WITH STRAIGHT LINES AND THE WORD ATTENEX.

FOR COMPUTER SOFTWARE FOR USE IN THE MANAGEMENT, ANALYSIS AND REVIEW OF ELECTRONIC DOCUMENTS FOR LITIGATION READINESS, LITIGATION RESPONSE AND REGULATORY COMPLIANCE; COMPUTER SOFTWARE FOR THE VISUALIZATION OF LARGE DOCUMENT COLLECTIONS AND DATA SETS; COMPUTER SOFTWARE FOR USE IN THE DRAFTING AND DISTRIBUTION OF COMPLEX DOCUMENTS; COMPUTER SOFTWARE FOR THE ANALYSIS AND REVIEW OF ELECTRONIC DATA AND DOCUMENTS FOR FORENSIC ACCOUNTING AND INVESTIGATION (U.S. CLS. 21, 23, 26, 36 AND 38).

FIRST USE 10-6-2004; IN COMMERCE 10-6-2004.
LINDA E. BLOHM, EXAMINING ATTORNEY

RDI

THE MARK CONSISTS OF STANDARD CHARACTERS WITHOUT CLAIM TO ANY PARTICULAR FONT, STYLE, SIZE, OR COLOR.

FOR ION SOURCES, POWER SUPPLIES AND CHARGED PARTICLE ACCELERATORS (U.S. CLS. 21, 23, 26, 36 AND 38).

FIRST USE 11-9-1960; IN COMMERCE 11-9-1960.
TARAH HARDY, EXAMINING ATTORNEY

SN 78-535,693. SHERPA SOFTWARE GROUP, INC., BRIDGEVILLE, PA. FILED 12-20-2004.

SN 78-536,103. COE NEWNES/MCGEHEE ULC, SALMON ARM, BRITISH COLUMBIA, CANADA, FILED 12-21-2004.

DISCLAIMER
ATTENDER

THE MARK CONSISTS OF STANDARD CHARACTERS WITHOUT CLAIM TO ANY PARTICULAR FONT, STYLE, SIZE, OR COLOR.

NO CLAIM IS MADE TO THE EXCLUSIVE RIGHT TO USE "DISCLAIMER", APART FROM THE MARK AS SHOWN.

FOR COMPUTER SOFTWARE FOR USE IN THE COORDINATION AND ADMINISTRATION OF ELECTRONIC COMMUNICATIONS AND THE DATA RELATED THERETO (U.S. CLS. 21, 23, 26, 36 AND 38).

GEOFFREY FOSDICK, EXAMINING ATTORNEY

LHG

THE MARK CONSISTS OF STANDARD CHARACTERS WITHOUT CLAIM TO ANY PARTICULAR FONT, STYLE, SIZE, OR COLOR.

PRIORITY CLAIMED UNDER SEC. 44(D) ON CANADA APPLICATION NO. 1,241,310, FILED 12-20-2004.

FOR LUMBER GRADING MACHINES (U.S. CLS. 21, 23, 26, 36 AND 38).

FIRST USE 12-31-2001; IN COMMERCE 7-31-2002.
ANDREA K. NADELMAN, EXAMINING ATTORNEY

CLASS 9—(Continued).

SN 78-536,171. MANAGERASSISTANT.COM, LLC, TARPON SPRINGS, FL. FILED 12-21-2004.

MANAGERASSISTANT

THE MARK CONSISTS OF STANDARD CHARACTERS WITHOUT CLAIM TO ANY PARTICULAR FONT, STYLE, SIZE, OR COLOR.

FOR SOFTWARE FOR LOGGING AND TRACKING TIME OFF, TRAINING, REVIEWS, PERFORMANCE, INCIDENTS, RECRUITMENT AND EXPENSES (U.S. CLS. 21, 23, 26, 36 AND 38).

FIRST USE 8-16-2004; IN COMMERCE 8-16-2004.
LEIGH CAROLINE CASE, EXAMINING ATTORNEY

SN 78-536,274. ASK JEEVES, INC., OAKLAND, CA. FILED 12-21-2004.

ASK JEEVES

THE MARK CONSISTS OF STANDARD CHARACTERS WITHOUT CLAIM TO ANY PARTICULAR FONT, STYLE, SIZE, OR COLOR.

FOR DOWNLOADABLE COMPUTER SOFTWARE FOR USE IN PROVIDING SEARCH ENGINE SERVICES WHICH IS PROVIDED THROUGH A BROWSER TOOLBAR (U.S. CLS. 21, 23, 26, 36 AND 38).

FIRST USE 2-0-2003; IN COMMERCE 2-0-2003.
ZHALEH DELANEY, EXAMINING ATTORNEY

CLASS 9—(Continued).

SN 78-536,412. MONARCH COMPUTER SYSTEMS, INC., TUCKER, GA. FILED 12-21-2004.

Empro

THE MARK CONSISTS OF STANDARD CHARACTERS WITHOUT CLAIM TO ANY PARTICULAR FONT, STYLE, SIZE, OR COLOR.

FOR PERSONAL BASE COMPUTER SYSTEM, NAMELY, COMPUTERS, COMPUTER MONITORS, AND COMPUTER PERIPHERALS (U.S. CLS. 21, 23, 26, 36 AND 38).

FIRST USE 11-15-2004; IN COMMERCE 11-15-2004.
LEIGH CAROLINE CASE, EXAMINING ATTORNEY

SN 78-537,138. U. S. GOVERNMENT, DEPARTMENT OF THE NAVY, WASHINGTON, DC. FILED 12-22-2004.

BARS

THE MARK CONSISTS OF STANDARD CHARACTERS WITHOUT CLAIM TO ANY PARTICULAR FONT, STYLE, SIZE, OR COLOR.

FOR BATTLEFIELD SIMULATION SYSTEM INCLUDING A WEARABLE COMPUTER, A WIRELESS NETWORK, A SEE-THROUGH, HEAD-MOUNTED DISPLAY, A CAMERA, AND SENSORS TO TRACK THE USERS POSITION AND HEAD ORIENTATION (U.S. CLS. 21, 23, 26, 36 AND 38).

RAUL CORDOVA, EXAMINING ATTORNEY

CLASS 9—(Continued).

SN 78-537,142. TRANSWITCH CORPORATION, SHELTON, CT. FILED 12-22-2004.

CELLBUS

THE MARK CONSISTS OF STANDARD CHARACTERS WITHOUT CLAIM TO ANY PARTICULAR FONT, STYLE, SIZE, OR COLOR.

OWNER OF U.S. REG. NO. 2,177,641. SEC. 2(F).

FOR TELECOMMUNICATIONS HARDWARE AND SOFTWARE, NAMELY, INTEGRATED CIRCUIT CHIPS FEATURING ASYNCHRONOUS DATA TRANSFER AND SOURCE TRAFFIC CONTROL SYSTEMS (U.S. CLS. 21, 23, 26, 36 AND 38).

FIRST USE 8-10-1995; IN COMMERCE 8-11-1995. RAUL CORDOVA, EXAMINING ATTORNEY

CLASS 9—(Continued).

SN 78-537,455. EXPERIENCE LEARNING COMMUNITY, SEATTLE, WA. FILED 12-22-2004.



THE MARK CONSISTS OF A THREE-LEGGED WINGED CREATURE CENTERED ABOVE THE STYLIZED LETTERS SFM.

FOR ELECTRONIC BOOKS, NAMELY COMPUTER DISCS AND COMPACT DISCS, FEATURING, SCIENCE FICTION, POPULAR CULTURE, ART, PERSONALITIES, HISTORY, MEMORABILIA, EDUCATION, TELEVISION, MOTION PICTURES AND ENTERTAINMENT; COMPUTER SOFTWARE FEATURING SCIENCE FICTION, POPULAR CULTURE, ART, PERSONALITIES, HISTORY, MEMORABILIA, EDUCATION, TELEVISION, MOTION PICTURES AND ENTERTAINMENT; INTERACTIVE COMPUTER PROGRAMS FEATURING SCIENCE FICTION, POPULAR CULTURE, ART, PERSONALITIES, HISTORY, MEMORABILIA, EDUCATION, TELEVISION, MOTION PICTURES AND ENTERTAINMENT; CD-ROMS FEATURING SCIENCE FICTION, POPULAR CULTURE, ART, PERSONALITIES, HISTORY, MEMORABILIA, EDUCATION, TELEVISION, MOTION PICTURES AND ENTERTAINMENT; AND MULTIMEDIA PROGRAMS FEATURING SCIENCE FICTION, POPULAR CULTURE, ART, PERSONALITIES, HISTORY, MEMORABILIA, EDUCATION, TELEVISION, MOTION PICTURES AND ENTERTAINMENT; ALL DISTRIBUTED BY, IN PROMOTION OF, OR IN CONJUNCTION WITH A MUSEUM (U.S. CLS. 21, 23, 26, 36 AND 38).

FIRST USE 6-18-2004; IN COMMERCE 6-18-2004. ROBERT LORENZO, EXAMINING ATTORNEY

SN 78-537,362. SILVACO INTERNATIONAL, INC., SANTA CLARA, CA. FILED 12-22-2004.



THE MARK CONSISTS OF TWO STYLIZED ARROWS FORMING AN OVAL SHAPE, WHERE THE TIP OF EACH ARROW POINTS TO THE END OF THE OTHER ARROW.

FOR COMPUTER PROGRAMS FOR USE IN DESIGN AND SIMULATION TESTING OF SEMICONDUCTOR DEVICES (U.S. CLS. 21, 23, 26, 36 AND 38).

FIRST USE 12-22-2004; IN COMMERCE 12-22-2004. KATHRYN COWARD, EXAMINING ATTORNEY

SN 78-537,496. OLSON, JAMES TODD, MADISON, TN. FILED 12-22-2004.

**Trailer Trash
Pedalboards**

THE MARK CONSISTS OF STANDARD CHARACTERS WITHOUT CLAIM TO ANY PARTICULAR FONT, STYLE, SIZE, OR COLOR.

NO CLAIM IS MADE TO THE EXCLUSIVE RIGHT TO USE "PEDALBOARDS", APART FROM THE MARK AS SHOWN.

FOR GUITAR PEDALBOARD, NAMELY, ELECTRONIC EFFECT PEDALS FOR USE WITH SOUND AMPLIFIERS (U.S. CLS. 21, 23, 26, 36 AND 38).

FIRST USE 12-1-2003; IN COMMERCE 6-1-2004. ROBERT LORENZO, EXAMINING ATTORNEY

CLASS 9—(Continued).

SN 78-537,592. HARMONY LINE, INC., WALTHAM, MA.
FILED 12-23-2004.

HYPERSCORE

THE MARK CONSISTS OF STANDARD CHARACTERS WITHOUT CLAIM TO ANY PARTICULAR FONT, STYLE, SIZE, OR COLOR.

FOR COMPUTER SOFTWARE, NAMELY, A SOFTWARE APPLICATION THAT ENABLES ONE TO COMPOSE ORIGINAL MUSIC (U.S. CLS. 21, 23, 26, 36 AND 38).

FIRST USE 5-1-2002; IN COMMERCE 5-1-2002.
WON TEAK OH, EXAMINING ATTORNEY

CLASS 9—(Continued).

SN 78-537,674. TENEBRIL INCORPORATED, BOSTON, MA.
FILED 12-23-2004.

GHOSTSURF

THE MARK CONSISTS OF STANDARD CHARACTERS WITHOUT CLAIM TO ANY PARTICULAR FONT, STYLE, SIZE, OR COLOR.

FOR COMPUTER SOFTWARE, NAMELY, COMPUTER SOFTWARE FOR MAINTAINING THE PRIVACY AND SECURITY OF PERSONAL INFORMATION BY PROVIDING AN ANONYMOUS, SECURE, AND ENCRYPTED CONNECTION TO THE INTERNET, REMOVING SPYWARE AND OTHER MALICIOUS SOFTWARE, SECURELY DELETING TRACES OF INTERNET USE, AND ENCRYPTING FILES (U.S. CLS. 21, 23, 26, 36 AND 38).

FIRST USE 7-1-2002; IN COMMERCE 7-1-2002.
EVELYN BRADLEY, EXAMINING ATTORNEY

SN 78-537,666. SESMA SOLUTIONS, INC., IRVINE, CA.
FILED 12-23-2004.

JCOM

THE MARK CONSISTS OF STANDARD CHARACTERS WITHOUT CLAIM TO ANY PARTICULAR FONT, STYLE, SIZE, OR COLOR.

FOR COMPUTER SOFTWARE FOR USE IN THE DEVELOPMENT, INTEGRATION AND TRANSFER OF INFORMATION USING BI-DIRECTIONAL COMMUNICATION WITH OTHER COMPUTER SOFTWARE PROGRAMS (U.S. CLS. 21, 23, 26, 36 AND 38).

FIRST USE 11-15-2003; IN COMMERCE 1-1-2004.
WILLIAM VERHOSEK, EXAMINING ATTORNEY

SN 78-537,677. TENEBRIL INCORPORATED, BOSTON, MA.
FILED 12-23-2004.

TENEBRIL

THE MARK CONSISTS OF STANDARD CHARACTERS WITHOUT CLAIM TO ANY PARTICULAR FONT, STYLE, SIZE, OR COLOR.

FOR COMPUTER SOFTWARE, NAMELY, COMPUTER SOFTWARE FOR MAINTAINING THE PRIVACY AND SECURITY OF PERSONAL INFORMATION INCLUDING ENCRYPTION, ACCESS RESTRICTION, REMOTE MONITORING AND RECORDING, SPYWARE AND AD-BLOCKING SOFTWARE, DATA BLOCKING AND DATA STORAGE SOFTWARE; COMPUTER SOFTWARE FOR USE IN IMPROVING COMPUTER PERFORMANCE INCLUDING SYSTEM OPTIMIZATION, DATA RECOVERY AND DATA BACK-UP SOFTWARE (U.S. CLS. 21, 23, 26, 36 AND 38).

FIRST USE 8-1-1998; IN COMMERCE 8-1-1998.
WILLIAM VERHOSEK, EXAMINING ATTORNEY

CLASS 9—(Continued).

SN 78-537,678. MICROBOARDS TECHNOLOGY LLC, CHAN-HASSEN, MN. FILED 12-23-2004.

CLASS 9—(Continued).

SN 78-537,911. NEON SOFTWARE, INC., LAFAYETTE, CA. FILED 12-23-2004.

PF-2

NetMinder

THE MARK CONSISTS OF STANDARD CHARACTERS WITHOUT CLAIM TO ANY PARTICULAR FONT, STYLE, SIZE, OR COLOR.

FOR AUTOMATIC LOADING, GRAVITY FED, BELT DRIVEN INKJET PRINTER, WHICH LABELS CDS, DVDS, AND OTHER DIGITAL MEDIA (U.S. CLS. 21, 23, 26, 36 AND 38).

FIRST USE 12-15-2004; IN COMMERCE 12-15-2004.
WILLIAM VERHOSEK, EXAMINING ATTORNEY

THE MARK CONSISTS OF STANDARD CHARACTERS WITHOUT CLAIM TO ANY PARTICULAR FONT, STYLE, SIZE, OR COLOR.

OWNER OF U.S. REG. NO. 2,311,217.
FOR COMPUTER SOFTWARE FOR LOCAL AREA NETWORK MONITORING (U.S. CLS. 21, 23, 26, 36 AND 38).

FIRST USE 1-8-1989; IN COMMERCE 2-27-1990.
ESTHER BELENKER, EXAMINING ATTORNEY

SN 78-537,866. IDEAL INDUSTRIES, INC., SYCAMORE, IL. FILED 12-23-2004.

SN 78-538,177. MOBILE AGENT TECHNOLOGIES, STATEN ISLAND, NY. FILED 12-23-2004.

12

AgentOS

THE MARK CONSISTS OF STANDARD CHARACTERS WITHOUT CLAIM TO ANY PARTICULAR FONT, STYLE, SIZE, OR COLOR.

FOR ELECTRICAL WIRE CONNECTORS (U.S. CLS. 21, 23, 26, 36 AND 38).

AMY GEARIN, EXAMINING ATTORNEY

THE MARK CONSISTS OF STANDARD CHARACTERS WITHOUT CLAIM TO ANY PARTICULAR FONT, STYLE, SIZE, OR COLOR.

FOR COMPUTER SOFTWARE THAT ASSISTS COMPUTERS IN DEPLOYING PARALLEL APPLICATIONS AND PERFORMING PARALLEL COMPUTATIONS (U.S. CLS. 21, 23, 26, 36 AND 38).

JEFF DEFORD, EXAMINING ATTORNEY

CLASS 9—(Continued).

SN 78-538,209. TRAINING EDUCATION DEVELOPMENT SOLUTIONS, LLC, ATKINS, VA. FILED 12-24-2004.

TEDS WORKFORCE MANAGEMENT

THE MARK CONSISTS OF STANDARD CHARACTERS WITHOUT CLAIM TO ANY PARTICULAR FONT, STYLE, SIZE, OR COLOR.

OWNER OF U.S. REG. NO. 1,852,297.

NO CLAIM IS MADE TO THE EXCLUSIVE RIGHT TO USE WORKFORCE MANAGEMENT, APART FROM THE MARK AS SHOWN.

FOR COMPUTER SOFTWARE IN THE NATURE OF A LEARNING MANAGEMENT SYSTEM, NAMELY, SOFTWARE FOR MANAGING PROFESSIONAL AND EMPLOYEE TRAINING, AND COMPUTER SOFTWARE FOR PREPARING AND CONDUCTING AUTOMATED TRAINING AND TESTING ACTIVITIES, ALL FOR USE PRIMARILY BY BUSINESS ORGANIZATIONS AND THEIR EMPLOYEES TO FACILITATE THE ACQUISITION AND EVALUATION OF WORKPLACE SKILLS; AND USER MANUALS PACKAGED AS A UNIT WITH THE FOREGOING GOODS (U.S. CLS. 21, 23, 26, 36 AND 38).

DORITT L. CARROLL, EXAMINING ATTORNEY

CLASS 9—(Continued).

SN 78-538,416. CAUSEKEEPERS, INC., RAMSEUR, NC. FILED 12-27-2004.

MAKE YOUR PASSION KNOWN

THE MARK CONSISTS OF STANDARD CHARACTERS WITHOUT CLAIM TO ANY PARTICULAR FONT, STYLE, SIZE, OR COLOR.

FOR DECORATIVE MAGNETS (U.S. CLS. 21, 23, 26, 36 AND 38).

FIRST USE 5-1-2004; IN COMMERCE 5-1-2004.

CHARLES JOYNER, EXAMINING ATTORNEY

SN 78-538,466. ONSITE PRO INC., TRABUCO CANYON, CA. FILED 12-27-2004.

AquaManager

THE MARK CONSISTS OF STANDARD CHARACTERS WITHOUT CLAIM TO ANY PARTICULAR FONT, STYLE, SIZE, OR COLOR.

FOR LEAK DETECTING DEVICE FOR WATER SUPPLIED HOME APPLIANCES, CONSISTING OF WATER SENSOR, CONTROL UNIT WITH AUDIBLE ALARM AND WATER VALVES (U.S. CLS. 21, 23, 26, 36 AND 38).

JOHN DWYER, EXAMINING ATTORNEY

SN 78-538,486. SDI TECHNOLOGIES, INC., RAHWAY, NJ. FILED 12-27-2004.



THE MARK CONSISTS OF THE PLANET EARTH, WITH OUTLINES OF THE CONTINENTS, HELD BY A PAIR OF STYLIZED HANDS.

FOR DECORATIVE MAGNETS (U.S. CLS. 21, 23, 26, 36 AND 38).

FIRST USE 5-1-2004; IN COMMERCE 5-1-2004.

CHARLES JOYNER, EXAMINING ATTORNEY

THE MARK CONSISTS OF STANDARD CHARACTERS WITHOUT CLAIM TO ANY PARTICULAR FONT, STYLE, SIZE, OR COLOR.

FOR DIGITAL TIMERS (U.S. CLS. 21, 23, 26, 36 AND 38).

ELLEN BURNS, EXAMINING ATTORNEY

SINGLE-STEP

CLASS 9—(Continued).

SN 78-538,899. J&J ACQUISITION CORP, DBA S&S FIRE APPARATUS CO., FAIRMOUNT, IN. FILED 12-28-2004.

CLASS 9—(Continued).

SN 78-539,784. RELIASOFT CORPORATION, TUCSON, AZ. FILED 12-29-2004.

ULTRA XT

RG A

THE MARK CONSISTS OF STANDARD CHARACTERS WITHOUT CLAIM TO ANY PARTICULAR FONT, STYLE, SIZE, OR COLOR.
FOR FIRE TRUCKS (U.S. CLS. 21, 23, 26, 36 AND 38).
FIRST USE 4-18-2003; IN COMMERCE 4-18-2003.
EUGENIA MARTIN, EXAMINING ATTORNEY

THE MARK CONSISTS OF STANDARD CHARACTERS WITHOUT CLAIM TO ANY PARTICULAR FONT, STYLE, SIZE, OR COLOR.
FOR COMPUTER SOFTWARE FOR RELIABILITY ANALYSIS, NAMELY RELIABILITY GROWTH ANALYSIS AND REPAIRABLE SYSTEMS ANALYSIS AS IT APPLIES TO THE FIELD OF RELIABILITY ENGINEERING (U.S. CLS. 21, 23, 26, 36 AND 38).
FIRST USE 10-0-2001; IN COMMERCE 12-15-2003.
YSA DEJESUS, EXAMINING ATTORNEY

SN 78-539,141. CMH UNITED CORP., MIAMI, FL. FILED 12-28-2004.

SN 78-540,203. REBORN PRODUCTS CO., INC., DBA THE AMERICAN BELT COMPANY, BENSALEM, PA. FILED 12-30-2004.

BAREFOOT

SHOT TENDER

THE MARK CONSISTS OF STANDARD CHARACTERS WITHOUT CLAIM TO ANY PARTICULAR FONT, STYLE, SIZE, OR COLOR.
FOR CELLULAR PHONE ACCESSORIES, NAMELY, CASES, CHARGERS, HOUSINGS AND HOLSTERS (U.S. CLS. 21, 23, 26, 36 AND 38).
FIRST USE 1-9-2004; IN COMMERCE 1-9-2004.
MITCHELL FRONT, EXAMINING ATTORNEY

THE MARK CONSISTS OF STANDARD CHARACTERS WITHOUT CLAIM TO ANY PARTICULAR FONT, STYLE, SIZE, OR COLOR.
NO CLAIM IS MADE TO THE EXCLUSIVE RIGHT TO USE "SHOT", APART FROM THE MARK AS SHOWN.
FOR BEVERAGE DISPENSERS CAPABLE OF PRODUCING PRECISELY MEASURED BEVERAGES, INCLUDING AN ATTACHED CONTAINER FOR HOLDING SUCH BEVERAGES (U.S. CLS. 21, 23, 26, 36 AND 38).
FIRST USE 2-13-2003; IN COMMERCE 2-13-2003.
AISHA CLARKE, EXAMINING ATTORNEY

CLASS 9—(Continued).

SN 78-541,225. SAF-T-GARD INTERNATIONAL, INC.,
NORTHBROOK, IL. FILED 1-3-2005.

ERGOFLEX

THE MARK CONSISTS OF STANDARD CHARACTERS
WITHOUT CLAIM TO ANY PARTICULAR FONT, STYLE,
SIZE, OR COLOR.

FOR PROTECTIVE GLOVES AND OTHER PERSONAL
PROTECTIVE EQUIPMENT, NAMELY PROTECTIVE
CLOTHING (U.S. CLS. 21, 23, 26, 36 AND 38).

FIRST USE 2-1-2002; IN COMMERCE 3-25-2002.
ALLISON SCHRODY, EXAMINING ATTORNEY

CLASS 9—(Continued).

SN 78-543,461. TRS QUALITY, INC., FORT WORTH, TX.
FILED 1-6-2005.

VEX

THE MARK CONSISTS OF STANDARD CHARACTERS
WITHOUT CLAIM TO ANY PARTICULAR FONT, STYLE,
SIZE, OR COLOR.

FOR EDUCATIONAL PERSONAL ROBOTS, EACH
WITH A PROGRAMMABLE MICROCONTROLLER
AND SENSOR ARRAY FOR THE DETECTION AND
NAVIGATION OF THE SURROUNDING ENVIRON-
MENT, FOR EDUCATIONAL, HOBBY OR PERSONAL
USE; EDUCATIONAL COMPUTER PROGRAMS FOR
DESIGNING AND REMOTELY CONTROLLING MO-
TORIZED TOYS (U.S. CLS. 21, 23, 26, 36 AND 38).

GLENN CLARK, EXAMINING ATTORNEY

SN 78-541,492. GUANGZHOU HONRISE PLASTIC & HARD-
WARE CO., LTD., GUANGZHOU, CHINA, FILED 1-3-2005.

EZChoice

FOR DISC STORAGE CONTAINERS; CARRYING
CASES, BAGS, POUCHES, HOLDERS AND JACKETS
DESIGNED FOR STORING OPTICAL DISCS, COMPU-
TER DISCS OR MAGNETIC DISKS; BLANK OPTICAL
DISCS; BLANK COMPUTER DISCS; COMPUTER GAME
DISCS; COMPUTER PERIPHERALS; KEYBOARD COV-
ERS; KEYBOARDS; NOTEBOOK COMPUTER CARRY-
ING CASES; BAGS FOR CAMERAS AND
PHOTOGRAPHIC EQUIPMENT (U.S. CLS. 21, 23, 26, 36
AND 38).

FIRST USE 7-1-2001; IN COMMERCE 6-8-2002.
MICHAEL KEATING, EXAMINING ATTORNEY

SN 78-574,273. MONARCH COMPUTER SYSTEMS, INC.,
TUCKER, GA. FILED 2-24-2005.

Empro

THE MARK CONSISTS OF STANDARD CHARACTERS
WITHOUT CLAIM TO ANY PARTICULAR FONT, STYLE,
SIZE, OR COLOR.

FOR PERSONAL COMPUTERS, COMPUTER WORK
STATIONS CONSISTING OF COMPUTERS AND COM-
PUTER MONITORS, AND PERIPHERALS THEREOF
(U.S. CLS. 21, 23, 26, 36 AND 38).

FIRST USE 11-15-2004; IN COMMERCE 11-15-2004.
LEIGH CAROLINE CASE, EXAMINING ATTORNEY

CLASS 9—(Continued).

SN 78-621,405. MAKEMUSIC! INC., EDEN PRAIRIE, MN.
FILED 5-2-2005.

finale

OWNER OF U.S. REG. NOS. 1,470,685, 1,931,995 AND OTHERS.

FOR COMPUTER SOFTWARE FOR COMPOSING, PERFORMING, PUBLISHING AND ARRANGING AND PRINTING MUSIC (U.S. CLS. 21, 23, 26, 36 AND 38).

Laurie Mayes, Examining Attorney

CLASS 9—(Continued).

SN 79-001,821. TALLCOMPONENTS B.V., NETHERLANDS,
FILED 1-30-2004.



SN 78-975,842. SIGMA-ALDRICH BIOTECHNOLOGY L.P.,
ST. LOUIS, MO. FILED 9-11-2003.

ILAP

FOR GAS CHROMATOGRAPHY APPARATUS FOR USE IN PROTEIN DETECTION, SEPARATION, PURIFICATION AND ANALYSIS PROCEDURES, NAMELY, CHROMATOGRAPHY CARTRIDGES, CHROMATOGRAPHY COLUMNS, SPIN COLUMNS, SLIDES AND MULTIWELL PLATES; GAS CHROMATOGRAPHY APPARATUS KITS COMPRISED OF CHROMATOGRAPHY CARTRIDGES, CHROMATOGRAPHY COLUMNS, SPIN COLUMNS, SLIDES AND MULTIWELL PLATES (U.S. CLS. 21, 23, 26, 36 AND 38).

FIRST USE 7-31-2003; IN COMMERCE 7-31-2003.

Linda M. King, Examining Attorney

PRIORITY DATE OF 8-22-2003 IS CLAIMED.
OWNER OF INTERNATIONAL REGISTRATION 0822056
DATED 1-30-2004, EXPIRES 1-30-2014.

NO CLAIM IS MADE TO THE EXCLUSIVE RIGHT TO USE PDF KIT.NET, APART FROM THE MARK AS SHOWN. THE COLOR(S) YELLOW, BLACK, WHITE IS/ARE CLAIMED AS A FEATURE OF THE MARK.

THE COLOR YELLOW APPEARS IN THE TOP PORTION AND RIGHT SIDE OF THE DESIGN ELEMENT IN THE MARK AND THE WORDING KIT.NET, THE COLOR WHITE APPEARS AS OUTLINING AND THE WORD PDF, AND THE COLOR BLACK APPEARS IN THE BACKGROUND AND DESIGN ELEMENT.

FOR COMPUTER SOFTWARE FOR READING, CREATING AND MANIPULATING ELECTRONIC DOCUMENTS AND FORMS (U.S. CLS. 21, 23, 26, 36 AND 38).

Kelly Boulton, Examining Attorney

SN 78-975,978. CATERPILLAR INC., PEORIA, IL. FILED 2-17-2003.

POINTGUARD

FOR ELECTRONIC MONITORS FOR USE WITH UNINTERRUPTIBLE POWER SYSTEMS AND GENERATOR SETS FOR ENABLING REMOTE CONTROL AND COMMUNICATION OF ALARMS, FAULTS, AND DIAGNOSTIC CODES FROM SAID POWER SYSTEMS AND GENERATOR SETS (U.S. CLS. 21, 23, 26, 36 AND 38).

Ada Han, Examining Attorney

SN 79-002,072. KONINKLIJKE PHILIPS ELECTRONICS N.V.,
NETHERLANDS, FILED 3-31-2004.

STENTBOOST

THE MARK CONSISTS OF STANDARD CHARACTERS WITHOUT CLAIM TO ANY PARTICULAR FONT, STYLE, SIZE, OR COLOR.

PRIORITY DATE OF 11-26-2003 IS CLAIMED.

OWNER OF INTERNATIONAL REGISTRATION 0823122
DATED 3-31-2004, EXPIRES 3-31-2014.

FOR SOFTWARE FOR ANALYZING AND DIAGNOSING MEDICAL CONDITIONS AND DISEASES FOR USE BY MEDICAL STAFF AND SOFTWARE FOR IMPROVING VISUALIZATION OF STENTS IN THE CORONARY ARTERIES DURING INTERVENTIONS. (U.S. CLS. 21, 23, 26, 36 AND 38).

Kelly Choe, Examining Attorney

CLASS 9—(Continued).

SN 79-002,100. HANGZHOU JINLI PU ELECTRICAL CO., LTD., CHINA, FILED 3-10-2004.



OWNER OF INTERNATIONAL REGISTRATION 0823240 DATED 3-10-2004, EXPIRES 3-10-2014.

THE NON-LATIN CHARACTER(S) IN THE MARK TRANSLITERATES INTO JIN LI PU, AND THIS MEANS GOLD, GAINS AND GENERAL IN ENGLISH.

FOR AUDIO AND VIDEO RECEIVERS; CABINETS FOR LOUDSPEAKERS; RADIOS; TELEVISION SETS; TELEVISION MONITORS; TELEVISION ANTENNAS; TELEVISION TRANSMITTERS OF ELECTRONIC SIGNALS; TELECOMMUNICATION OPTICAL FIBER CABLES USED FOR TRANSMISSION OF TELEVISION SIGNALS; OPTICAL COMMUNICATIONS INSTRUMENTS AND COMPONENTS, NAMELY, OPTICAL TRANSMITTERS, OPTICAL RECEIVERS, OPTICAL TRANSCEIVERS AND OPTICAL DATA LINKS; TELECOMMUNICATION RADIO TRANSMITTERS; TELEPHONE APPARATUS; FACSIMILE MACHINES; TELEGRAPHS; LUMINOUS SIGNS FOR ROAD TRAFFIC; VIDEOTAPE RECORDERS, LOUDSPEAKERS (U.S. CLS. 21, 23, 26, 36 AND 38).

AMY HELLA, EXAMINING ATTORNEY

SN 79-002,178. ALCATEL, FRANCE, FILED 1-30-2004.

IP TOUCH

THE MARK CONSISTS OF STANDARD CHARACTERS WITHOUT CLAIM TO ANY PARTICULAR FONT, STYLE, SIZE, OR COLOR.

PRIORITY DATE OF 8-5-2003 IS CLAIMED.

OWNER OF INTERNATIONAL REGISTRATION 0823534 DATED 1-30-2004, EXPIRES 1-30-2014.

OWNER OF U.S. REG. NOS. 2,411,798, 2,590,013 AND OTHERS.

NO CLAIM IS MADE TO THE EXCLUSIVE RIGHT TO USE IP, APART FROM THE MARK AS SHOWN.

FOR TELEPHONES (U.S. CLS. 21, 23, 26, 36 AND 38).
KELLY BOULTON, EXAMINING ATTORNEY

SN 79-002,543. MIKROMASCH EESTI OÜ, ESTONIA, FILED 4-7-2004.

STING

PRIORITY DATE OF 10-10-2003 IS CLAIMED.

OWNER OF INTERNATIONAL REGISTRATION 0824772 DATED 4-7-2004, EXPIRES 4-7-2014.

FOR CANTILEVERS FOR MICROSCOPES (U.S. CLS. 21, 23, 26, 36 AND 38).

MICHAEL KEATING, EXAMINING ATTORNEY

CLASS 9—(Continued).

SN 79-002,583. GS YUASA CORPORATION, SHIMOGYO-KU, KYOTO-SHI, KYOTO 600-8007, JAPAN, FILED 4-26-2004.

Y T X

THE MARK CONSISTS OF STANDARD CHARACTERS WITHOUT CLAIM TO ANY PARTICULAR FONT, STYLE, SIZE, OR COLOR.

PRIORITY DATE OF 10-28-2003 IS CLAIMED.

OWNER OF INTERNATIONAL REGISTRATION 0824979 DATED 4-26-2004, EXPIRES 4-26-2014.

FOR BATTERIES; VEHICLE BATTERIES; MOTORCYCLE BATTERIES; DRY CELLS; ELECTRICAL CELLS; ELECTRIC ACCUMULATOR BATTERIES; BATTERY JARS; AND ACCUMULATOR JARS (U.S. CLS. 21, 23, 26, 36 AND 38).

ANDREA SAUNDERS, EXAMINING ATTORNEY

SN 79-002,731. DR. MED. LAURENCE MEER-SCHERRER, SWITZERLAND, FILED 4-22-2004.

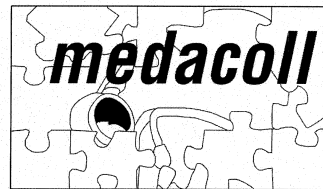

PRIORITY DATE OF 10-28-2003 IS CLAIMED.

OWNER OF INTERNATIONAL REGISTRATION 0825441 DATED 4-22-2004, EXPIRES 4-22-2014.

THE MARK CONSISTS OF THE WORD MEDACOLL AND A STETHOSCOPE.

FOR COMPUTER SOFTWARE FOR CREATING DATABASES OF MEDICAL INFORMATION AND DATA; COMPACT DISCS FEATURING COMPUTER PROGRAMS AND DATABASES FOR MEDICAL INFORMATION AND DATA (U.S. CLS. 21, 23, 26, 36 AND 38).

HENRY S. ZAK, EXAMINING ATTORNEY

SN 79-002,814. KOMAX AG, SWITZERLAND, FILED 2-12-2004.

TOPTOUCH

THE MARK CONSISTS OF STANDARD CHARACTERS WITHOUT CLAIM TO ANY PARTICULAR FONT, STYLE, SIZE, OR COLOR.

PRIORITY DATE OF 11-10-2003 IS CLAIMED.

OWNER OF INTERNATIONAL REGISTRATION 0825743 DATED 2-12-2004, EXPIRES 2-12-2014.

OWNER OF U.S. REG. NO. 2,829,226.

FOR COMPUTER SOFTWARE FOR CABLE, CRIMP AND HOSE PROCESSING MACHINES; PRE-RECORDED MAGNETIC AND DIGITAL DATA MEDIA, NAMELY COMPUTER DISKS, COMPACT DISKS, CD-ROM, VIDEO TAPES, AUDIO TAPES CONTAINING SOFTWARE FOR CABLE, CRIMP AND HOSE PROCESSING MACHINES. (U.S. CLS. 21, 23, 26, 36 AND 38).

MICHELLE S. WISEMAN, EXAMINING ATTORNEY

CLASS 9—(Continued).

SN 79-003,428. UNIVERS SONS, FRANCE, FILED 4-29-2004.

UVI ENGINE

THE MARK CONSISTS OF STANDARD CHARACTERS WITHOUT CLAIM TO ANY PARTICULAR FONT, STYLE, SIZE, OR COLOR.

OWNER OF INTERNATIONAL REGISTRATION 0827672 DATED 4-29-2004, EXPIRES 4-29-2014.

NO CLAIM IS MADE TO THE EXCLUSIVE RIGHT TO USE "ENGINE", APART FROM THE MARK AS SHOWN.

FOR SOFTWARE AND COMPUTER INSTRUMENTS FOR PROFESSIONAL MUSICIANS, NAMELY, COMPUTER PROGRAMS FOR EDITING IMAGES, SOUND AND VIDEO, FOR PROCESSING DIGITAL MUSIC FILES, AND FOR COLLECTION, EDITING, ORGANIZING, MODIFYING, BOOK MARKING, TRANSMISSION, STORAGE AND SHARING OF DATA AND INFORMATION, COMPUTER CENTRAL PROCESSING UNITS, CHIPS, PERIPHERALS, KEYBOARDS AND KEYPADS; SOFTWARE FOR CREATING AND PRODUCING SOUNDS OR DATA BANKS CONTAINING SOUNDS NAMELY AUDIO RECORDINGS OF EXISTING INSTRUMENTS ENABLING THE SOFTWARE TO RECREATE THE RECORDED INSTRUMENT, SOUND CREATION SOFTWARE, TECHNOLOGY SOFTWARE FOR MUSICAL CREATION, MUSICAL SOFTWARE, VIRTUAL MUSICAL INSTRUMENT CREATED BY SOFTWARE (U.S. CLS. 21, 23, 26, 36 AND 38).

GINA HAYES, EXAMINING ATTORNEY

CLASS 9—(Continued).

SN 79-003,882. SHENYANG BT-DIRECTION GROUP CO., LTD, YUHONG DISTRICT; SHENYANG, CHINA, FILED 5-18-2004.

direction

OWNER OF INTERNATIONAL REGISTRATION 0828996 DATED 5-18-2004, EXPIRES 5-18-2014.

FOR COMPUTERS; CALCULATING MACHINES IN THE NATURE OF CALCULATORS; LAPTOP COMPUTERS; COMPUTER KEYBOARDS; COMPUTER PERIPHERAL DEVICES; COMPUTER MOUSE; COMPUTER MONITORS; ELECTRONIC POCKET TRANSLATORS; ELECTRONIC DICTIONARIES; NOTEBOOK COMPUTERS; SCANNERS (U.S. CLS. 21, 23, 26, 36 AND 38).

MARC LEIPZIG, EXAMINING ATTORNEY

SN 79-003,927. ACG ADVANCED COMPONENT GROUP; AKTIENGESELLSCHAFT, WIESBADEN, FED REP GERMANY, FILED 4-5-2004.

SN 79-003,630. INFOVISTA SA, FRANCE, FILED 2-24-2004.

VistaTroubleshooter

THE MARK CONSISTS OF STANDARD CHARACTERS WITHOUT CLAIM TO ANY PARTICULAR FONT, STYLE, SIZE, OR COLOR.

PRIORITY DATE OF 9-23-2003 IS CLAIMED.

OWNER OF INTERNATIONAL REGISTRATION 0828130 DATED 2-24-2004, EXPIRES 2-24-2014.

NO CLAIM IS MADE TO THE EXCLUSIVE RIGHT TO USE "TROUBLESHOOTER", APART FROM THE MARK AS SHOWN.

FOR SOFTWARE FOR LAUNCHING REAL-TIME AUDIT REPORTS ON THE INFORMATION SYSTEM; BLANK MAGNETIC DATA CARRIERS; BLANK OPTICAL DATA DISCS; DATA PROCESSORS; AND ALL OF THE AFORESAID GOODS NOT FOR USE IN THE FIELDS OF SURVEILLANCE OF GOODS AND PERSONS, SECURITY, OR TRESPASS DETECTION (U.S. CLS. 21, 23, 26, 36 AND 38).

SCOTT BALDWIN, EXAMINING ATTORNEY

AZEGO

THE MARK CONSISTS OF STANDARD CHARACTERS WITHOUT CLAIM TO ANY PARTICULAR FONT, STYLE, SIZE, OR COLOR.

PRIORITY DATE OF 12-4-2003 IS CLAIMED.

OWNER OF INTERNATIONAL REGISTRATION 0829177 DATED 4-5-2004, EXPIRES 4-5-2014.

FOR ELECTRIC AND ELECTRONIC COMPONENTS, NAMELY, SEMICONDUCTORS, CAPACITORS, CENTRAL PROCESSING UNITS, DIODES, ELECTRONIC MEMORIES, FLASH MEMORY CARDS, SEMI-CONDUCTOR MEMORIES, ELECTRICAL FUSES, ELECTRICAL SOCKETS, ELECTRICAL INDUCTORS, INTEGRATED CIRCUITS, ELECTRONIC CONTROLLERS FOR COMPUTERS, MICRO-PROCESSORS, OSCILLATORS, ELECTRIC RELAYS, ELECTRIC RESISTORS, ELECTRIC SWITCHES, TRANSISTORS, DYNAMIC RANDOM ACCESS MEMORIES, SYNCHRONOUS DYNAMIC RANDOM ACCESS MEMORIES, CERAMIC CONDENSERS, SUB D CONNECTORS, ELECTRONIC CONNECTORS (U.S. CLS. 21, 23, 26, 36 AND 38).

CHRIS WELLS, EXAMINING ATTORNEY

CLASS 9—(Continued).

SN 79-004,094. TIXI.COM GMBH TELECOMMUNICATION SYSTEMS, D-13465 BERLIN, FED REP GERMANY, FILED 5-17-2004.

TILA

THE MARK CONSISTS OF STANDARD CHARACTERS WITHOUT CLAIM TO ANY PARTICULAR FONT, STYLE, SIZE, OR COLOR.

PRIORITY DATE OF 11-17-2003 IS CLAIMED.

OWNER OF INTERNATIONAL REGISTRATION 0829695 DATED 5-17-2004, EXPIRES 5-17-2014.

FOR COMPUTER PROGRAMS FOR TRANSMISSION OF ELECTRONIC MAIL, NAMELY; SOFTWARE FOR ALARM AND MESSAGE MODEMS; ANALOGUE AND DIGITAL MODEMS, ISDN-MODEMS, GSM/GPRS-MODEMS, AND E-MAIL SERVERS; SOFTWARE FOR ACCESSING THE WORLD-WIDE-WEB; SOFTWARE FOR THE CONFIGURATION OF PROGRAMMABLE LOGIC CONTROLLERS (PLC) COMMUNICATION, ENTRY OF ALARM MESSAGES, LINKING OF ALARMS TO INPUT/OUTPUT PORTS AND PLC VARIABLES, COMPUTER PROGRAMS ON MACHINE READABLE MEDIA, NAMELY, TEXT EDITOR SOFTWARE FOR MESSAGE TEXTS AND ADDRESSES (U.S. CLS. 21, 23, 26, 36 AND 38).

DAWN FELDMAN, EXAMINING ATTORNEY

SN 79-004,122. SATISH WADHUMAL RAISINGHANI; RAISINGHANI, SPAIN, FILED 3-29-2004.

PANACELL

THE MARK CONSISTS OF STANDARD CHARACTERS WITHOUT CLAIM TO ANY PARTICULAR FONT, STYLE, SIZE, OR COLOR.

OWNER OF INTERNATIONAL REGISTRATION 0656269 DATED 4-17-1996, EXPIRES 4-17-2016.

FOR ELECTRIC BATTERIES (U.S. CLS. 21, 23, 26, 36 AND 38).

JASON LOTT, EXAMINING ATTORNEY

CLASS 9—(Continued).

SN 79-004,606. SIEMENS AKTIENGESELLSCHAFT, FED REP GERMANY, FILED 6-17-2004.

SCALANCE

THE MARK CONSISTS OF STANDARD CHARACTERS WITHOUT CLAIM TO ANY PARTICULAR FONT, STYLE, SIZE, OR COLOR.

PRIORITY DATE OF 1-26-2004 IS CLAIMED.

OWNER OF INTERNATIONAL REGISTRATION 0831232 DATED 6-17-2004, EXPIRES 6-17-2014.

FOR ELECTRICAL AND ELECTRONIC APPARATUS, DEVICES AND INSTRUMENTS, NAMELY, PROGRAMMERS AND CONTROLLERS FOR AUTOMATION OF MANUFACTURING PROCESSES AND CONTROL OF INDUSTRIAL MACHINES; OPEN AND CLOSED-LOOP CONTROL AND SWITCHING DEVICES, NAMELY, SWITCHES FOR INDUSTRIAL ETHERNETS, ACCESS CONTROLS FOR INDUSTRIAL WIRELESS LANS, AND SECURITY MODULES FOR THE CONNECTION OF ETHERNET NODES; ELECTRICAL SWITCHGEAR FOR LOW AND HIGH AC AND DC VOLTAGE; CONTROL CABINETS MADE SPECIFICALLY FOR SWITCHGEAR; CABINETS FOR CONTAINING ELECTRIC SWITCHGEAR AND VOLTAGE CONTROL DEVICES, CONSISTING OF CONTROL GEAR SUPPORTS, PROFILED STRUTS AND MOUNTING RACKS COMPRISED OF SIDE PANELS, CONNECTING BARS, LOCKING BARS, SUPPORT BARS AND GUIDE RAILS, ALL SOLD AS A UNIT; PLUG-IN MODULES COMPRISED OF DEVICES TO LOCATE AND/OR INTEGRATE PRINTED CIRCUIT BOARDS; THERMOSTATS; LASERS FOR SCIENTIFIC PURPOSES (U.S. CLS. 21, 23, 26, 36 AND 38).

RUSS HERMAN, EXAMINING ATTORNEY

SN 79-004,706. SAIP&SCHYLLER S.R.L., ITALY, FILED 4-6-2004.

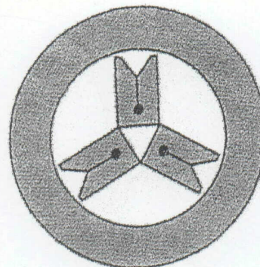

PRIORITY DATE OF 12-19-2003 IS CLAIMED.
OWNER OF INTERNATIONAL REGISTRATION 0831682 DATED 4-6-2004, EXPIRES 4-6-2014.

THIS TRADEMARK CONSISTS OF THE GRAPHIC REPRESENTATION OF A CIRCULAR CROWN WITH A CONTRASTING TONALITY BACKGROUND INSIDE OF WHICH THREE RADIAL IRREGULAR GEOMETRIC SHAPES WITH DOVETAIL ENDS ARE PLACED. FROM SUCH DOVETAIL ENDS MIDPOINT A LINE TERMINATING WITH A SMALL RING WITHIN A FULL BACKGROUND; THE UNION OF EVERY SINGLE VERTEX OF THE MORE INTERNAL SIDES OF THESE SHAPES CREATES AN EMPTY TRIANGLE, IN THE MIDDLE OF THE WHOLE OF THE GRAPHIC REPRESENTATION.

FOR ELECTRIC OUTLET, ELECTRIC CONTROL PANELS, ELECTRIC CABLES (U.S. CLS. 21, 23, 26, 36 AND 38).

JAMES A. RAUEN, EXAMINING ATTORNEY

CLASS 9—(Continued).

SN 79-004,708. OSRAM; GESELLSCHAFT MIT BESCHRÄNKTER HAFTUNG, D-81543 MÜNCHEN, FED REP GERMANY, FILED 6-17-2004.

DRAGONtape

THE MARK CONSISTS OF STANDARD CHARACTERS WITHOUT CLAIM TO ANY PARTICULAR FONT, STYLE, SIZE, OR COLOR.

OWNER OF INTERNATIONAL REGISTRATION 0831796 DATED 6-17-2004, EXPIRES 6-17-2014.

FOR LIGHT EMITTING DIODES (LEDS) AND LED MODULES; PARTS OF THE AFOREMENTIONED GOODS (U.S. CLS. 21, 23, 26, 36 AND 38).

RUSS HERMAN, EXAMINING ATTORNEY

SN 79-004,816. SWISSQUAL HOLDING AG, POSTFACH 117; CH-6301 ZUG, SWITZERLAND, FILED 8-3-2004.

NetQual

OWNER OF INTERNATIONAL REGISTRATION 0808447 DATED 7-22-2003, EXPIRES 7-22-2013.

FOR COMPUTERS AND COMPUTER PROGRAMS USED IN OPERATING INSTRUMENTS USED FOR MEASURING AND TESTING THE QUALITY OF WIRED AND WIRELESS TRANSMISSIONS (U.S. CLS. 21, 23, 26, 36 AND 38).

ALICIA COLLINS, EXAMINING ATTORNEY

SN 79-004,954. ADWEB PTY LTD, AUSTRALIA, FILED 6-16-2004.



OWNER OF INTERNATIONAL REGISTRATION 0832204 DATED 6-16-2004, EXPIRES 6-16-2014.

NO CLAIM IS MADE TO THE EXCLUSIVE RIGHT TO USE INTRANET DASHBOARD, APART FROM THE MARK AS SHOWN.

FOR COMPUTER SOFTWARE FOR DESIGNING, CREATING, MAINTAINING AND ACCESSING CUSTOMIZED INTERNAL NETWORK SITES (U.S. CLS. 21, 23, 26, 36 AND 38).

HOWARD SMIGA, EXAMINING ATTORNEY

CLASS 9—(Continued).

SN 79-004,979. MICHAEL COYLE, SOUTHAMPTON, SO15 1JJ, UNITED KINGDOM, FILED 5-13-2004.

SPORTING GLORY

THE MARK CONSISTS OF STANDARD CHARACTERS WITHOUT CLAIM TO ANY PARTICULAR FONT, STYLE, SIZE, OR COLOR.

OWNER OF INTERNATIONAL REGISTRATION 0832254 DATED 5-13-2004, EXPIRES 5-13-2014.

NO CLAIM IS MADE TO THE EXCLUSIVE RIGHT TO USE "SPORTING", APART FROM THE MARK AS SHOWN.

FOR CDS BEARING SPORTING COMMENTARY FOR THE PURPOSES OF ENTERTAINMENT (U.S. CLS. 21, 23, 26, 36 AND 38).

DAVID TAYLOR, EXAMINING ATTORNEY

SN 79-005,330. CONTEC CO., LTD., JAPAN, FILED 6-25-2004.



OWNER OF INTERNATIONAL REGISTRATION 0833345 DATED 6-25-2004, EXPIRES 6-25-2014.

FOR COMPUTERS; COMPUTER MONITORS; PRINTED CIRCUIT BOARDS FOR COMPUTERS; COMPUTER PROGRAMS USED FOR AUTOMATED PROCESS CONTROL, NAMELY ANALYSIS, MONITORING, DATA ACQUISITION, DATA PROCESSING, OFFICE AUTOMATION, AND RESEARCH AND DEVELOPMENT LABORATORY AUTOMATION, FOR USE IN MANUFACTURING, DISTRIBUTION, TELECOMMUNICATIONS, TRANSPORTATION, COMPUTER HARDWARE AND SOFTWARE, WAREHOUSING AND STORAGE, UTILITY, POLLUTION AND ENVIRONMENTAL MANAGEMENT INDUSTRIES; COMPUTER SOFTWARE FOR USE IN DESIGNING DISPLAY SCREENS AND COMPUTER GRAPHICS SOFTWARE (U.S. CLS. 21, 23, 26, 36 AND 38).

TIMOTHY FINNEGAN, EXAMINING ATTORNEY

SN 79-005,963. ENDRESS + HAUSER GMBH + CO. KG, FED REP GERMANY, FILED 7-12-2004.

LIQUICAP

THE MARK CONSISTS OF STANDARD CHARACTERS WITHOUT CLAIM TO ANY PARTICULAR FONT, STYLE, SIZE, OR COLOR.

PRIORITY DATE OF 1-14-2004 IS CLAIMED.

OWNER OF INTERNATIONAL REGISTRATION 0835008 DATED 7-12-2004, EXPIRES 7-12-2014.

FOR MEASURING APPARATUS, NAMELY, LEVEL TRANSMITTERS FOR MEASURING PRESSURE, FILLING LEVEL, AND FLOW RATE, AND ELECTRIC AND HYDROSTATIC PROBES, SENSORS AND RADIO TRANSMITTERS FOR MEASURING THE FILLING LEVEL OF FLUIDS OR BULK MATERIALS IN A CONTAINER OR TANK AND TRANSMITTING THE SAME; SOFTWARE FOR USE IN PROCESSING MEASURING SIGNALS BY LEVEL TRANSMITTERS OR PROCESS CONTROL COMPUTERS (U.S. CLS. 21, 23, 26, 36 AND 38).

JENNIFER MARTIN, EXAMINING ATTORNEY

CLASS 9—(Continued).

SN 79-005,978. DIGITAL ILLUSIONS CE AB, SWEDEN, FILED 9-13-2004.

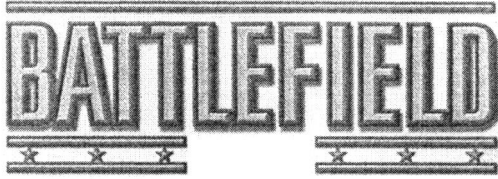

PRIORITY DATE OF 7-5-2004 IS CLAIMED.
OWNER OF INTERNATIONAL REGISTRATION 0835035 DATED 9-13-2004, EXPIRES 9-13-2014.
THE STIPPLING IS FOR SHADING PURPOSES.
THE COLOR(S) GRAY IS/ARE CLAIMED AS A FEATURE OF THE MARK.
THE LETTERS, STARS AND LINES ARE IN LIGHT GRAY BUT ARE OUTLINED IN DARK GRAY.
FOR COMPUTER GAME PROGRAMS (U.S. CLS. 21, 23, 26, 36 AND 38).
TRACY WHITAKER-BOWN, EXAMINING ATTORNEY

SN 79-006,043. SHANGHAI MINGYUE OPTICAL; GLASSES CO. LTD., CHINA, FILED 7-28-2004.

BERG
明月贝格

OWNER OF INTERNATIONAL REGISTRATION 0835242 DATED 7-28-2004, EXPIRES 7-28-2014.
THE NON-LATIN CHARACTERS IN THE MARK TRANSLITERATE TO "MING YUE BEI GE", AND EVERY SINGLE CHARACTER AND THE PHRASE IS MEANINGLESS IN CHINESE AND IN ENGLISH.
FOR GOGGLES FOR SPORTS; CORRECTING OPTICAL LENSES; SPECTACLE CASES; SPECTACLES FOR OPTICAL PURPOSES; SPECTACLE GLASSES; SPECTACLE FRAMES; READING GLASSES FOR WEARING ON THE NOSE; CONTACT LENSES; SUN GLASSES; SPECTACLE FRAMES (U.S. CLS. 21, 23, 26, 36 AND 38).
SUE LAWRENCE, EXAMINING ATTORNEY

SN 79-006,144. ABB ENTRELEC, FRANCE, FILED 8-26-2004.

ADO system

THE MARK CONSISTS OF STANDARD CHARACTERS WITHOUT CLAIM TO ANY PARTICULAR FONT, STYLE, SIZE, OR COLOR.
PRIORITY DATE OF 2-26-2004 IS CLAIMED.
OWNER OF INTERNATIONAL REGISTRATION 0835484 DATED 8-26-2004, EXPIRES 8-26-2014.
OWNER OF U.S. REG. NO. 1,999,258.
NO CLAIM IS MADE TO THE EXCLUSIVE RIGHT TO USE SYSTEM, APART FROM THE MARK AS SHOWN.
FOR ELECTRIC TERMINAL BLOCKS; TERMINAL SCREWS FOR ELECTRICAL EQUIPMENT (U.S. CLS. 21, 23, 26, 36 AND 38).
FLORENTINA BLANDU, EXAMINING ATTORNEY

CLASS 9—(Continued).

SN 79-006,364. ARISTIDE & CO; ANTIQUAIRE DE MARQUES, FRANCE, FILED 6-14-2004.

VECTREX

THE MARK CONSISTS OF STANDARD CHARACTERS WITHOUT CLAIM TO ANY PARTICULAR FONT, STYLE, SIZE, OR COLOR.

PRIORITY DATE OF 1-9-2004 IS CLAIMED.
OWNER OF INTERNATIONAL REGISTRATION 0836158 DATED 6-14-2004, EXPIRES 6-14-2014.
FOR COMPUTER GAME SOFTWARE; WEB CONSOLES FOR ELECTRONIC GAMES; PLAYER OPERATED ELECTRONIC CONTROLLERS FOR ELECTRONIC VIDEO GAMES MACHINES; APPLICATIONS FOR GAMES INTENDED FOR TELEVISION USE, NAMELY JOYSTICKS AND CONTROLLERS FOR GAMES INTENDED FOR TELEVISION USE; CD-ROMS CONTAINING COMPUTER GAMES; COMPUTER GAME CARTRIDGES; ARCADE GAMES; MULTIMEDIA APPARATUS AND INSTRUMENTS NAMELY VIDEO GAME MACHINES FOR USE WITH TELEVISIONS (U.S. CLS. 21, 23, 26, 36 AND 38).
REBECCA GILBERT, EXAMINING ATTORNEY

SN 79-006,504. DREAM TECHNOLOGIES CO. LTD., JAPAN, FILED 9-16-2004.

ZOOMA

THE MARK CONSISTS OF STANDARD CHARACTERS WITHOUT CLAIM TO ANY PARTICULAR FONT, STYLE, SIZE, OR COLOR.

PRIORITY DATE OF 3-16-2004 IS CLAIMED.
OWNER OF INTERNATIONAL REGISTRATION 0836510 DATED 9-16-2004, EXPIRES 9-16-2014.
FOR COMPUTER SOFTWARE FOR DOCUMENT IMAGE CONVERSION FROM PRINT TO COMPUTER, FOR HIGH QUALITY IMAGE TRANSFER OVER THE INTERNET OR INTRANET, AND FOR DOCUMENT INTEGRATION, FOR BUSINESS, PROFESSIONAL, AND NON-PROFESSIONAL USE; READ-ONLY MEMORY COMPACT DISCS FEATURING THE AFORESAID COMPUTER SOFTWARE (U.S. CLS. 21, 23, 26, 36 AND 38).
JACQUELINE A. LAVINE, EXAMINING ATTORNEY

SN 79-006,701. SIEMENS AKTIENGESELLSCHAFT, FED REP GERMANY, FILED 6-8-2004.

PockServ

THE MARK CONSISTS OF STANDARD CHARACTERS WITHOUT CLAIM TO ANY PARTICULAR FONT, STYLE, SIZE, OR COLOR.

PRIORITY DATE OF 3-19-2004 IS CLAIMED.
OWNER OF INTERNATIONAL REGISTRATION 0837089 DATED 6-8-2004, EXPIRES 6-8-2014.
FOR ELECTRONIC COMPONENTS, NAMELY, MEMORY EXPANSION MODULES FOR CELLULAR TELEPHONES AND PDAS CONTAINING A HARD DISC AND A USB COMPUTER INTERFACE. (U.S. CLS. 21, 23, 26, 36 AND 38).
PAULA MAHONEY, EXAMINING ATTORNEY

CLASS 9—(Continued).

SN 79-006,877. SIEMENS AKTIENGESELLSCHAFT, D-80333 MÜNCHEN, FED REP GERMANY, FILED 4-16-2004.

Bubble Boost

THE MARK CONSISTS OF STANDARD CHARACTERS WITHOUT CLAIM TO ANY PARTICULAR FONT, STYLE, SIZE, OR COLOR.

PRIORITY DATE OF 11-20-2003 IS CLAIMED.

OWNER OF INTERNATIONAL REGISTRATION 0837584 DATED 4-16-2004, EXPIRES 4-16-2014.

FOR SOFTWARE-BASED GAMES FOR MOBILE TELEPHONES (U.S. CLS. 21, 23, 26, 36 AND 38).

MELVIN AXILBUND, EXAMINING ATTORNEY

SN 79-007,876. BOWLTECH INTERNATIONAL HOLDING B.V., NETHERLANDS, FILED 8-10-2004.

Sweep Talk

THE MARK CONSISTS OF STANDARD CHARACTERS WITHOUT CLAIM TO ANY PARTICULAR FONT, STYLE, SIZE, OR COLOR.

PRIORITY DATE OF 5-7-2004 IS CLAIMED.

OWNER OF INTERNATIONAL REGISTRATION 0840350 DATED 8-10-2004, EXPIRES 8-10-2014.

FOR COMPUTERS; COMPUTER PERIPHERAL; COMPUTER MONITORS; COMPUTER KEYBOARDS; COMPUTER SOFTWARE AND HARDWARE FOR USE IN RUNNING A BOWLING BUSINESS, NAMELY CONTROL OF THE BOWLING GAME AND UPDATING OF THE SCORES; COMPUTER SOFTWARE AND COMMUNICATION DEVICES IN THE NATURE OF RADIO PAGERS WHICH THE USERS OF BOWLING CONDUITS CAN USE TO SEND AND RECEIVE MESSAGES WITH THEIR OWN SCOREBOARDS TO THE SCOREBOARDS OF USERS OF OTHER BOWLING CONDUITS (U.S. CLS. 21, 23, 26, 36 AND 38).

LAURA KOVAISKY, EXAMINING ATTORNEY

SN 79-007,904. SIEMENS AKTIENGESELLSCHAFT, FED REP GERMANY, FILED 9-23-2004.

Emoty

THE MARK CONSISTS OF STANDARD CHARACTERS WITHOUT CLAIM TO ANY PARTICULAR FONT, STYLE, SIZE, OR COLOR.

PRIORITY DATE OF 6-1-2004 IS CLAIMED.

OWNER OF INTERNATIONAL REGISTRATION 0840427 DATED 9-23-2004, EXPIRES 9-23-2014.

FOR TELEPHONES, MOBILE TELEPHONES; ACCUMULATORS, BATTERIES; SENSORS; ACCESSORIES FOR MOBILE TELEPHONES, NAMELY SUPPORTS, HANDS-FREE SETS, CHARGING CABLES, CHARGING UNITS, CHARGING STATIONS, HEADSETS, FLIP COVERS, GAME DECKS, KEYBOARDS, KEYPADS, COMPUTER MICE, CHIP CARDS; SOFTWARE FOR USE IN ENABLING WIRELESS TELEPHONES; SCANNERS; CAMERAS; CAMERA FLASH ATTACHMENTS AND FLASHBULBS (U.S. CLS. 21, 23, 26, 36 AND 38).

JILL C. ALT, EXAMINING ATTORNEY

CLASS 9—(Continued).

SN 79-008,414. SOURIAU, FRANCE, FILED 9-24-2004.

TRIM TRIO

THE MARK CONSISTS OF STANDARD CHARACTERS WITHOUT CLAIM TO ANY PARTICULAR FONT, STYLE, SIZE, OR COLOR.

PRIORITY DATE OF 4-1-2004 IS CLAIMED.

OWNER OF INTERNATIONAL REGISTRATION 0841919 DATED 9-24-2004, EXPIRES 9-24-2014.

FOR ELECTRIC, ELECTRONIC, OPTO-ELECTRONIC AND OPTICAL CONNECTORS; WIRE HARNESS COMPRISING ELECTRIC, ELECTRONIC, OPTO-ELECTRONIC OR OPTICAL CABLES AND CONNECTORS; COMPONENTS OF SUCH CONNECTORS, NAMELY ELECTRIC CONTACTS, CLIP AND JACK CONTACTS, CONTACT FERULES, CONTACT TERMINALS, CONNECTOR HOUSINGS (U.S. CLS. 21, 23, 26, 36 AND 38).

SKYE YOUNG, EXAMINING ATTORNEY

CLASS 10—MEDICAL APPARATUS

SN 76-218,269. AMERICAN BLOSSOM CORPORATION, HAYWARD, CA. FILED 2-28-2001.

HORIZON

FOR LATEX, VINYL, AND NITRILE EXAMINATION GLOVES FOR MEDICAL USE (U.S. CLS. 26, 39 AND 44).

YONG KIM, EXAMINING ATTORNEY

SN 76-368,310. JOTEC GMBH, 72379 HECHINGEN, FED REP GERMANY, FILED 2-7-2002.

FLOW

OWNER OF ERPN CMNTY TM OFC REG. NO. 002542652, DATED 3-22-2005, EXPIRES 1-21-2012.

FOR SURGICAL, MEDICAL, DENTAL AND VETERINARY APPARATUS AND INSTRUMENTS, NAMELY, ARTIFICIAL LIMBS, EYES AND TEETH; IMPLANTS, NAMELY VESSEL IMPLANTS, STENTS, PATCHES, GUIDE RAIL SUPPORTS FOR NERVES, VEIN-VALVE PROSTHESIS; ORTHOPEDIC ARTICLES IN THE NATURE OF JOINT IMPLANTS; SUTURES; CATHETERS (U.S. CLS. 26, 39 AND 44).

LEIGH CAROLINE CASE, EXAMINING ATTORNEY

SN 76-516,121. ADVANCED NEUROMODULATION SYSTEMS, INC., PLANO, TX. FILED 5-21-2003.

PLACER

FOR MEDICAL DEVICE, NAMELY, A STEERABLE STYLET (U.S. CLS. 26, 39 AND 44).

ROBERT LAVACHE, EXAMINING ATTORNEY

CLASS 10—(Continued).

SN 76-537,412. EMBO-OPTICS, LLC, GLOUCESTER, MA.
FILED 8-14-2003.

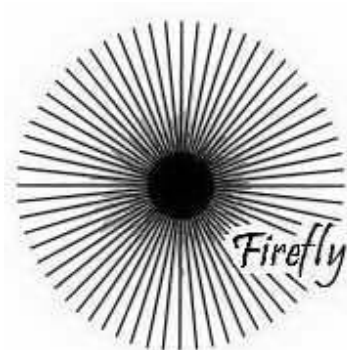

THE MARK CONSISTS OF THE WORDING FIREFLY SUPERIMPOSED OVER THE LOWER RIGHT PORTION OF A SUN. THE RAYS RADIATING FROM THE SUN ARE JAGGED RAYS.

FOR LIGHTING FIXTURES FOR USE IN MEDICAL APPLICATIONS, NAMELY, LIGHTING FIXTURES FOR ILLUMINATION OF DRIP CHAMBERS OF INTRAVENOUS DRIP SOLUTION BAGS (U.S. CLS. 26, 39 AND 44).

FIRST USE 6-1-2003; IN COMMERCE 6-1-2003.
LINDA POWELL, EXAMINING ATTORNEY

SN 76-556,923. NICOLAY GMBH & CO. KG, D-72202
NAGOLD, FED REP GERMANY, FILED 11-5-2003.

NICOLAY

THE MARK CONSISTS OF STANDARD CHARACTERS WITHOUT CLAIM TO ANY PARTICULAR FONT, STYLE, SIZE, OR COLOR.

OWNER OF FED REP GERMANY REG. NO. 39522981, DATED 10-29-1996, RENEWED AS REG. NO. 39522981, DATED 6-30-2005, EXPIRES 6-30-2015.

OWNER OF U.S. REG. NO. 2,082,598 AND OTHERS.
SEC. 2(F).

FOR ELECTRICAL CONNECTORS AND TRANSDUCERS FOR MEASUREMENT OF PHYSIOLOGICAL PARAMETERS OF HUMANS; CABLES AND TRANSDUCERS FOR MEDICAL APPLIANCES (U.S. CLS. 26, 39 AND 44).

FIRST USE 11-0-1972; IN COMMERCE 9-0-1977.
RICHARD A. STRASER, EXAMINING ATTORNEY

CLASS 10—(Continued).

SN 76-561,104. KROW S.A., BUENOS AIRES, ARGENTINA,
FILED 11-3-2003.



OWNER OF ARGENTINA REG. NO. 761704, DATED 7-19-2002, EXPIRES 7-19-2012.

THE COLOR(S) GRAY IS/ARE CLAIMED AS A FEATURE OF THE MARK.

THE COLOR GRAY APPEARS IN THE SHAPE ABOVE THE WORK SHARK.

FOR LATEX CONDOM (U.S. CLS. 26, 39 AND 44).
SUSAN STIGLITZ, EXAMINING ATTORNEY

SN 76-568,469. PERCARDIA INC., MERRIMACK, NH. FILED
1-6-2004.

VCONDUIT

THE MARK CONSISTS OF STANDARD CHARACTERS WITHOUT CLAIM TO ANY PARTICULAR FONT, STYLE, SIZE, OR COLOR.

FOR MEDICAL INSTRUMENTS AND DEVICES, NAMELY, STENTS, STENT-GRAFTS, GUIDEWIRES, CATHETERS, CANNULAS, AND VASCULAR SHUNTS (U.S. CLS. 26, 39 AND 44).

BRIDGETT SMITH, EXAMINING ATTORNEY

SN 76-568,472. PERCARDIA INC., MERRIMACK, NH. FILED
1-6-2004.

VPLASTY

THE MARK CONSISTS OF STANDARD CHARACTERS WITHOUT CLAIM TO ANY PARTICULAR FONT, STYLE, SIZE, OR COLOR.

FOR MEDICAL INSTRUMENTS AND DEVICES, NAMELY, STENTS, STENT-GRAFTS, GUIDEWIRES, CATHETERS, CANNULAS, VASCULAR SHUNTS, AND INTRODUCERS FOR USE WITH CATHETERS, STENTS, AND STENT-GRAFTS (U.S. CLS. 26, 39 AND 44).

BRIDGETT SMITH, EXAMINING ATTORNEY

CLASS 10—(Continued).

SN 76-588,593. CRUZ, JOSEPH, LA MESA, CA. FILED 4-26-2004.



FOR THERAPEUTIC EXERCISE DEVICES, NAMELY STRETCHING, STRENGTHENING AND MASSAGE APPARATUS. (U.S. CLS. 26, 39 AND 44).
ANDREA SAUNDERS, EXAMINING ATTORNEY

CLASS 10—(Continued).

SN 76-594,353. NUGA USA, INC., DALLAS, TX. FILED 5-27-2004.

NUGA BEST

NO CLAIM IS MADE TO THE EXCLUSIVE RIGHT TO USE BEST, APART FROM THE MARK AS SHOWN.
FOR ELECTRIC MASSAGE APPARATUS, NAMELY A THERAPEUTIC CHAIR PROVIDING MASSAGE AND HEAT TREATMENTS (U.S. CLS. 26, 39 AND 44).
FIRST USE 5-1-2004; IN COMMERCE 5-1-2004.
TIMOTHY FINNEGAN, EXAMINING ATTORNEY

SN 76-591,035. EMBO-OPTICS, LLC, GLOUCESTER, MA. FILED 5-7-2004.

FLUSH-LITE

THE MARK CONSISTS OF STANDARD CHARACTERS WITHOUT CLAIM TO ANY PARTICULAR FONT, STYLE, SIZE, OR COLOR.
FOR LIGHTS FOR USE IN MEDICAL APPLICATIONS, NAMELY, CHEMICALLY-ACTIVATED LIGHT STICKS FOR MARKING AND HIGHLIGHTING OF INTRAVENOUS FLUIDS AND WITHDRAWAL LINES (U.S. CLS. 26, 39 AND 44).
BARBARA GAYNOR, EXAMINING ATTORNEY

SN 76-596,458. AMBIT CORPORATION, GAINESVILLE, GA. FILED 6-9-2004.

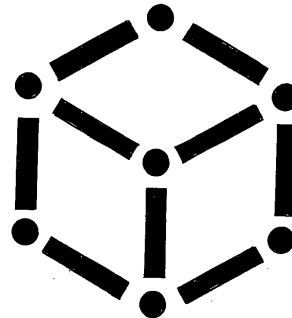

FOR HEARING AIDS (U.S. CLS. 26, 39 AND 44).
DEZMONA MIZELLE, EXAMINING ATTORNEY

SN 76-592,853. WILLIAMS HEALTHCARE SYSTEMS LLC, ELGIN, IL. FILED 5-18-2004.

TERMINAL POINT

THE MARK CONSISTS OF STANDARD CHARACTERS WITHOUT CLAIM TO ANY PARTICULAR FONT, STYLE, SIZE, OR COLOR.
SEC. 2(F).
FOR CHIROPRACTIC TABLES WITH AIR OR MECHANICALLY ACTIVATED DROPS (U.S. CLS. 26, 39 AND 44).
FIRST USE 1-0-1964; IN COMMERCE 1-0-1964.
ANDREW BENZMILLER, EXAMINING ATTORNEY

SN 76-604,863. PRECIMED S.A., 2534 ORVIN, SWITZERLAND, FILED 7-30-2004.

NO-PLAY

THE MARK CONSISTS OF STANDARD CHARACTERS WITHOUT CLAIM TO ANY PARTICULAR FONT, STYLE, SIZE, OR COLOR.
FOR COUPLINGS FOR SURGICAL INSTRUMENTS AND MEDICAL DEVICES (U.S. CLS. 26, 39 AND 44).
FIRST USE 9-0-2002; IN COMMERCE 9-0-2002.
HOWARD B. LEVINE, EXAMINING ATTORNEY

CLASS 10—(Continued).

SN 76-612,694. SAEBO, INC., CHARLOTTE, NC. FILED 9-17-2004.

NO PLATEAU IN SIGHT

THE MARK CONSISTS OF STANDARD CHARACTERS WITHOUT CLAIM TO ANY PARTICULAR FONT, STYLE, SIZE, OR COLOR.

FOR EXERCISE DEVICES FOR REHABILITATIVE AND THERAPEUTIC PURPOSES (U.S. CLS. 26, 39 AND 44).

FIRST USE 8-13-2004; IN COMMERCE 8-13-2004.
BARBARA RUTLAND, EXAMINING ATTORNEY

SN 76-614,045. MEDICAL COMPONENTS, INC., HARLEYSVILLE, PA. FILED 9-28-2004.

HEMO-FLOW

OWNER OF U.S. REG. NO. 2,872,926.
SEC. 2(F).

FOR CATHETERS AND CATHETER KITS CONSISTING OF MEDICAL GUIDE WIRE BULB INTRODUCERS AND MEDICAL GUIDE WIRES, CATHETER INTRODUCERS, CATHETER INSERTION TRAYS, INTRODUCER SHEATHS AND DILATORS, SCALPELS, NEEDLES, SUTURES, SYRINGES, GLOVES, SPONGES, IODINE SWABSTICKS AND OINTMENT, AND CAPS FOR MEDICAL OR SURGICAL PURPOSES (U.S. CLS. 26, 39 AND 44).

FIRST USE 8-0-1999; IN COMMERCE 8-0-1999.
HOWARD SMIGA, EXAMINING ATTORNEY

SN 76-614,865. TELEFLEX INCORPORATED, LIMERICK, PA. FILED 10-4-2004.

ORTHOSPECIALTIES BY KMEDIC

THE MARK CONSISTS OF STANDARD CHARACTERS WITHOUT CLAIM TO ANY PARTICULAR FONT, STYLE, SIZE, OR COLOR.

OWNER OF U.S. REG. NOS. 1,940,595 AND 1,966,576.

FOR FULL LINE OF SURGICAL INSTRUMENTS FOR ORTHOPEDIC, SPINAL, TRAUMA, SPORTS MEDICINE, AND IMAGE-GUIDED SURGICAL PROCEDURES; STERILIZATION AND STORAGE RACKS FOR MEDICAL INSTRUMENTS (U.S. CLS. 26, 39 AND 44).

CHRISTOPHER ADKINS, EXAMINING ATTORNEY

CLASS 10—(Continued).

SN 76-616,292. SILVI SYSTEMS, LLC, HOUSTON, TX. FILED 10-18-2004.

STICKARETTE

THE MARK CONSISTS OF STANDARD CHARACTERS WITHOUT CLAIM TO ANY PARTICULAR FONT, STYLE, SIZE, OR COLOR.

FOR SIMULATED CIGARETTE WHICH DOES NOT CONTAIN TOBACCO MADE OF WOOD TO ASSIST PEOPLE IN QUITTING SMOKING (U.S. CLS. 26, 39 AND 44).

JENNIFER MARTIN, EXAMINING ATTORNEY

SN 76-617,902. INNOVATIVE HEALTH PRODUCTS, INC., EL CAJON, CA. FILED 10-26-2004.

Geleez

THE MARK CONSISTS OF STANDARD CHARACTERS WITHOUT CLAIM TO ANY PARTICULAR FONT, STYLE, SIZE, OR COLOR.

FOR CAPS AND MASKS FOR MEDICAL ICE PACKS TO BE WORN AFTER FACIAL OR DENTAL SURGERY THAT HOLD GEL PACKS NEAR THE SKIN TO PROVIDE RELIEF TO THE WEARER (U.S. CLS. 26, 39 AND 44).

FIRST USE 5-1-2003; IN COMMERCE 5-1-2003.
ANGELA M. MICHELI, EXAMINING ATTORNEY

SN 76-622,438. TP ORTHODONTICS, INC., LAPORTE, IN. FILED 11-26-2004.

Readi-Base

FOR ORTHODONTIC APPLIANCES, IN THE NATURE OF BRACKETS WITH OR WITHOUT POSITIONING JIGS AND MOLAR TUBES, SOLD INDIVIDUALLY AND IN KIT FORM (U.S. CLS. 26, 39 AND 44).

FIRST USE 11-1-2004; IN COMMERCE 11-1-2004.
JOHN WILKE, EXAMINING ATTORNEY

CLASS 10—(Continued).

SN 76-626,738. AESCULAP AG & CO. KG, TUTTLINGEN, FED REP GERMANY, FILED 1-3-2005.

PLASMAPORE

OWNER OF FED REP GERMANY REG. NO. 1131935, DATED 12-12-1988, EXPIRES 11-30-2006.
FOR ENDO JOINT PROSTHESIS (U.S. CLS. 26, 39 AND 44).
INGA ERVIN, EXAMINING ATTORNEY

CLASS 10—(Continued).

SN 78-254,582. FLAEM NUOVA S.P.A., S. MARTINO DELLA BATTAGLIA (BRESCIA), ITALY, FILED 5-27-2003.

RHINO CLEAR

PRIORITY CLAIMED UNDER SEC. 44(D) ON ITALY APPLICATION NO. BS2002C00048, FILED 11-28-2002, REG. NO. 00893662, DATED 5-23-2003, EXPIRES 11-28-2012.
FOR MEDICAL APPLIANCES, NAMELY WATER SPRAYERS AND MEDICINE SPRAYERS FOR WASHING NASAL CAVITIES (U.S. CLS. 26, 39 AND 44).
BRIAN NEVILLE, EXAMINING ATTORNEY

SN 78-218,614. C-MIX CORP., DELRAY BEACH, FL. FILED 2-25-2003.



FOR DENTAL PORCELAIN (U.S. CLS. 26, 39 AND 44).
FIRST USE 2-26-2003; IN COMMERCE 2-26-2003.
KAREN K. BUSH, EXAMINING ATTORNEY

SN 78-233,271. AEROGEN, INC., MOUNTAIN VIEW, CA. FILED 4-2-2003.

GO

FOR NEBULIZERS FOR RESPIRATION THERAPY (U.S. CLS. 26, 39 AND 44).
KIM SAITO, EXAMINING ATTORNEY

SN 78-242,231. VITALITEC INTERNATIONAL, INC., PLYMOUTH, MA. FILED 4-25-2003.

GUIDETROCAR

FOR SURGICAL INSTRUMENTS, NAMELY, SURGICAL TROCARS AND CANNULAS (U.S. CLS. 26, 39 AND 44).
JOHN LINCOSKI, EXAMINING ATTORNEY

SN 78-270,403. REMEL INC., LENEXA, KS. FILED 7-3-2003.

MICRO TEST

NO CLAIM IS MADE TO THE EXCLUSIVE RIGHT TO USE "MICRO", APART FROM THE MARK AS SHOWN.
FOR COLLECTION AND TRANSPORT KITS FOR MICROORGANISMS FROM FLUID AND SWAB SAMPLES FOR IN VITRO DIAGNOSTIC USE CONSISTING PRIMARILY OF DISPOSABLE PLASTIC TUBES WITH CLOSURES CONTAINING TRANSPORT MEDIA WITH OR WITHOUT GLASS BEADS (U.S. CLS. 26, 39 AND 44).
FIRST USE 0-0-1990; IN COMMERCE 0-0-1990.
KATHERINE STOIDES, EXAMINING ATTORNEY

SN 78-348,138. THERAGEN INTERNATIONAL, INC., CAPE CORAL, FL. FILED 1-6-2004.

BACK-IN ACTION

THE MARK CONSISTS OF STANDARD CHARACTERS WITHOUT CLAIM TO ANY PARTICULAR FONT, STYLE, SIZE, OR COLOR.
FOR ORTHOPEDIC SUPPORT BANDAGES, WRAPS, AND BRACES (U.S. CLS. 26, 39 AND 44).
DAVID MURRAY, EXAMINING ATTORNEY

CLASS 10—(Continued).

SN 78-353,603. NOVARTIS AG, BASEL, SWITZERLAND,
FILED 1-19-2004.

EASY LATCH

THE MARK CONSISTS OF STANDARD CHARACTERS
WITHOUT CLAIM TO ANY PARTICULAR FONT, STYLE,
SIZE, OR COLOR.

NO CLAIM IS MADE TO THE EXCLUSIVE RIGHT TO
USE "LATCH", APART FROM THE MARK AS SHOWN.

FOR BABY BOTTLES, BABY BOTTLE NIPPLES AND
CUPS ADAPTED FOR FEEDING BABIES AND CHILDREN
(U.S. CLS. 26, 39 AND 44).

SHARI SHEFFIELD, EXAMINING ATTORNEY

SN 78-364,755. FAIRMONT MEDICAL PRODUCTS PTY LTD,
BAYSWATER, VICTORIA, AUSTRALIA, FILED 2-9-2004.

TELEPAC

THE MARK CONSISTS OF STANDARD CHARACTERS
WITHOUT CLAIM TO ANY PARTICULAR FONT, STYLE,
SIZE, OR COLOR.

PRIORITY CLAIMED UNDER SEC. 44(D) ON AUSTRALIA
APPLICATION NO. 986093, FILED 1-23-2004, REG. NO.
986093, DATED 1-23-2004, EXPIRES 1-23-2014.

FOR CONTAINERS FOR USE IN STERILIZING MEDICAL
EQUIPMENT; CONTAINERS FOR USE IN STERILIZING
OPERATING TELESCOPES; ARTHROSCOPES;
LAPAROSCOPES (U.S. CLS. 26, 39 AND 44).

JENNIFER MARTIN, EXAMINING ATTORNEY

CLASS 10—(Continued).

SN 78-369,730. OTICON A/S, 2900 HELLERUP, DENMARK,
FILED 2-18-2004.

GO

THE MARK CONSISTS OF STANDARD CHARACTERS
WITHOUT CLAIM TO ANY PARTICULAR FONT, STYLE,
SIZE, OR COLOR.

PRIORITY CLAIMED UNDER SEC. 44(D) ON DENMARK
APPLICATION NO. VA200303677, FILED 10-10-2003, REG.
NO. VR200303574, DATED 10-24-2003, EXPIRES 10-24-2013.

FOR HEARING AIDS AND PARTS THEREFOR (U.S.
CLS. 26, 39 AND 44).

AMOS T. MATTHEWS, JR., EXAMINING ATTORNEY

SN 78-379,653. HOMEDICS, INC., COMMERCE TOWNSHIP,
MI. FILED 3-5-2004.

COZY CUBE

THE MARK CONSISTS OF STANDARD CHARACTERS
WITHOUT CLAIM TO ANY PARTICULAR FONT, STYLE,
SIZE, OR COLOR.

NO CLAIM IS MADE TO THE EXCLUSIVE RIGHT TO
USE CUBE, APART FROM THE MARK AS SHOWN.

FOR MASSAGING OTTOMAN (U.S. CLS. 26, 39 AND
44).

ANGELA M. MICHELI, EXAMINING ATTORNEY

CLASS 10—(Continued).

SN 78-388,688. VISIONQUEST INDUSTRIES, INC., DBA VQ ORTHOCARE, ALISO VIEJO, CA. FILED 3-22-2004.



FOR ORTHOPEDIC BRACES NAMELY KNEE BRACES, WRIST BRACES AND BACK BRACES (U.S. CLS. 26, 39 AND 44).

BARBARA A. LOUGHRAN, EXAMINING ATTORNEY

CLASS 10—(Continued).

SN 78-393,206. JOINT REPLACEMENT INSTRUMENTATION LIMITED, LONDON, UNITED KINGDOM, FILED 3-30-2004.

FURLONG ACTIVE HIP REPLACEMENT

THE MARK CONSISTS OF STANDARD CHARACTERS WITHOUT CLAIM TO ANY PARTICULAR FONT, STYLE, SIZE, OR COLOR.

PRIORITY CLAIMED UNDER SEC. 44(D) ON UNITED KINGDOM APPLICATION NO. GB2346098, FILED 10-16-2003, REG. NO. 2346098, DATED 3-26-2004, EXPIRES 10-16-2013.

NO CLAIM IS MADE TO THE EXCLUSIVE RIGHT TO USE "HIP REPLACEMENT", APART FROM THE MARK AS SHOWN.

FOR SURGICAL IMPLANTS COMPRISING ARTIFICIAL MATERIAL; PROSTHESES, NAMELY HIP PROSTHESES, KNEE JOINT PROSTHESES, BONE IMPLANTS COMPOSED OF ARTIFICIAL MATERIALS AND ORTHOPEDIC JOINT IMPLANTS; ORTHOPEDIC BRACES AND SUPPORTS FOR JOINTS; BONE AND CARTILAGE IMPLANTS COMPRISING ARTIFICIAL MATERIAL; PARTS AND FITTINGS THEREFORE FOR ALL OF THE AFORESAID GOODS; SUTURES (U.S. CLS. 26, 39 AND 44).

LANA PHAM, EXAMINING ATTORNEY

SN 78-390,091. HARRIS, JAMES A., DENVER, CO. FILED 3-24-2004.

SN 78-395,719. PROMEX TECHNOLOGIES, LLC, FRANKLIN, IN. FILED 4-2-2004.

SAFE SCRIBE

THE MARK CONSISTS OF STANDARD CHARACTERS WITHOUT CLAIM TO ANY PARTICULAR FONT, STYLE, SIZE, OR COLOR.

FOR INSTRUMENTS FOR USE IN HAIR TRANSPLANTATION, NAMELY, BIOPSY PUNCHES, DISSECTING PUNCHES AND FORCEPS (U.S. CLS. 26, 39 AND 44).

ANDREW RHIM, EXAMINING ATTORNEY

TLAB

THE MARK CONSISTS OF STANDARD CHARACTERS WITHOUT CLAIM TO ANY PARTICULAR FONT, STYLE, SIZE, OR COLOR.

FOR MEDICAL DEVICES, NAMELY, TISSUE EXTRACTION DEVICES, TISSUE AND ORGAN ACCESS DEVICES, BIOPSY GUNS, BIOPSY NEEDLES, BIOPSY KITS COMPRISING INTRODUCERS, GUIDE CATHETERS AND SINGLE ACTION BIOPSY DEVICES AND TISSUE EXTRACTION DEVICES FOR MEDICAL USE; AND TRANSJUGULAR LIVER ACCESS BIOPSY KITS CONSISTING PRIMARILY OF SINGLE ACTION BIOPSY DEVICES, CATHETERS, CANNULAE AND TISSUE SAMPLE REMOVAL SWAB (U.S. CLS. 26, 39 AND 44).

FIRST USE 12-1-2004; IN COMMERCE 12-1-2004.
MARLENE BELL, EXAMINING ATTORNEY

CLASS 10—(Continued).

SN 78-402,139. M.T.R.E. ADVANCED TECHNOLOGIES LTD., CAESARIA, ISRAEL, FILED 4-15-2004.

CRITICOOL

THE MARK CONSISTS OF STANDARD CHARACTERS WITHOUT CLAIM TO ANY PARTICULAR FONT, STYLE, SIZE, OR COLOR.

PRIORITY CLAIMED UNDER SEC. 44(D) ON ISRAEL APPLICATION NO. 171102, FILED 3-18-2004, REG. NO. 171102, DATED 5-8-2005, EXPIRES 3-18-2011.

FOR MEDICAL INSTRUMENTS, APPARATUS AND SYSTEMS FOR CONTROLLING OF BODY TEMPERATURE OF HUMAN AND ANIMALS, NAMELY, DEVICES PRIMARILY COMPRISED OF THERMOELECTRIC-BASED HEATING/COOLING UNITS, ELECTRONIC TEMPERATURE CONTROLLERS, A WATER CIRCULATING PUMP, A POWER SOURCE, THERMAL SENSORS, TUBING AND HOSES, WHICH CONTROL OR REGULATE BODY TEMPERATURE BY SUPPLYING COOLING OR HEATING LIQUID TO A HEAT EXCHANGER GARMENT; AND HEAT EXCHANGER GARMENTS FOR APPLICATION ONTO AN INDIVIDUAL'S BODY FOR HEATING OR COOLING THEREOF (U.S. CLS. 26, 39 AND 44).

SEAN DWYER, EXAMINING ATTORNEY

SN 78-402,252. SCIENT'X USA, INC., MAITLAND, FL. FILED 4-15-2004.

ISOBAR TTL

THE MARK CONSISTS OF STANDARD CHARACTERS WITHOUT CLAIM TO ANY PARTICULAR FONT, STYLE, SIZE, OR COLOR.

FOR IMPLANTS AND TOOLS, NAMELY, RIGID AND SEMI-RIGID RODS, PEDICULAR SCREWS, NUTS, CLAMPS AND HOOKS FOR STABILIZING THE SPINE; VERTEBRAL BODY REPLACEMENT OR FUSION IMPLANTS (U.S. CLS. 26, 39 AND 44).

FIRST USE 12-0-2000; IN COMMERCE 12-0-2000.

KELLY CHOE, EXAMINING ATTORNEY

CLASS 10—(Continued).

SN 78-403,143. HILL, MARKUSS, AZUSA, CA. FILED 4-16-2004.



NO CLAIM IS MADE TO THE EXCLUSIVE RIGHT TO USE "HOT AIR EXTRACTION SYSTEM", APART FROM THE MARK AS SHOWN.

THE MARK CONSISTS OF A STYLIZED REPRESENTATION OF THE WORD "VAPRO".

FOR MEDICAL APPARATUS, NAMELY, ELECTRIC VAPORIZER THAT EMITS PHARMACEUTICALS IN VAPOROUS FORM TO THE THROAT AND LUNGS DIRECTLY FOR THE TREATMENT OF A VARIETY OF MEDICAL CONDITIONS (U.S. CLS. 26, 39 AND 44).

FIRST USE 5-1-2004; IN COMMERCE 5-16-2004.

BARBARA BROWN, EXAMINING ATTORNEY

SN 78-403,872. INSERBO, S.L., TORREFARRERA, LLEIDA, SPAIN, FILED 4-19-2004.



FOR VETERINARY APPARATUS AND INSTRUMENTS, NAMELY SYRINGES AND NEEDLES (U.S. CLS. 26, 39 AND 44).

MARTHA FROMM, EXAMINING ATTORNEY

SN 78-418,655. CONMED CORPORATION, UTICA, NY. FILED 5-14-2004.

EXCALIBUR PLUS PC

THE MARK CONSISTS OF STANDARD CHARACTERS WITHOUT CLAIM TO ANY PARTICULAR FONT, STYLE, SIZE, OR COLOR.

FOR MEDICAL EQUIPMENT, NAMELY, ELECTROSURGICAL POWER GENERATORS FOR USE WITH ELECTROSURGICAL SCALPELS AND ELECTRODES (U.S. CLS. 26, 39 AND 44).

FIRST USE 1-17-1996; IN COMMERCE 1-17-1996.

RICHARD WHITE, EXAMINING ATTORNEY

CLASS 10—(Continued).

SN 78-420,873. NORTHGATE TECHNOLOGIES INC., ELGIN, IL. FILED 5-18-2004.

CLASS 10—(Continued).

SN 78-430,265. DRAEGER MEDICAL SYSTEMS, INC., DANVERS, MA. FILED 6-4-2004.

FLO-ASSIST

INTERACTIVE INTERGRATION

THE MARK CONSISTS OF STANDARD CHARACTERS WITHOUT CLAIM TO ANY PARTICULAR FONT, STYLE, SIZE, OR COLOR.

SEC. 2(F).
FOR MEDICAL APPARATUS, NAMELY, ENDO-SCOPIC EQUIPMENT, NAMELY, TUBING SETS AND IRRIGATION PUMPS (U.S. CLS. 26, 39 AND 44).
FIRST USE 7-15-1996; IN COMMERCE 7-15-1996.
MICHAEL TANNER, EXAMINING ATTORNEY

THE MARK CONSISTS OF STANDARD CHARACTERS WITHOUT CLAIM TO ANY PARTICULAR FONT, STYLE, SIZE, OR COLOR.

NO CLAIM IS MADE TO THE EXCLUSIVE RIGHT TO USE "INTERACTIVE", APART FROM THE MARK AS SHOWN.

FOR MEDICAL EQUIPMENT NAMELY A PATIENT MONITOR FOR DISPLAYING BOTH REAL TIME AND PATIENT SPECIFIC DATA IN THE NATURE OF LABORATORY RESULTS, MEASURED AND CALCULATED CARDIOLOGICAL PARAMETERS, MEASURED AND CALCULATED HEMODYNAMIC PARAMETERS, MEASURED AND CALCULATED VENTILATION PARAMETERS AND MEASURED AND CALCULATED NEUROLOGICAL PARAMETERS (U.S. CLS. 26, 39 AND 44).
FIRST USE 11-1-2003; IN COMMERCE 11-1-2003.
KIM SAITO, EXAMINING ATTORNEY

SN 78-428,454. AIRWAYS DEVELOPMENT, LLC, KENILWORTH, NJ. FILED 6-2-2004.

SN 78-430,379. DRAEGER MEDICAL SYSTEMS, INC., DANVERS, MA. FILED 6-4-2004.

Neo-Spa

CLINICAL VISION

THE MARK CONSISTS OF STANDARD CHARACTERS WITHOUT CLAIM TO ANY PARTICULAR FONT, STYLE, SIZE, OR COLOR.

FOR NEONATAL UNITS WITH CONTROLLED ENVIRONMENT (U.S. CLS. 26, 39 AND 44).
FIRST USE 5-18-2004; IN COMMERCE 5-18-2004.
RAUL CORDOVA, EXAMINING ATTORNEY

THE MARK CONSISTS OF STANDARD CHARACTERS WITHOUT CLAIM TO ANY PARTICULAR FONT, STYLE, SIZE, OR COLOR.

NO CLAIM IS MADE TO THE EXCLUSIVE RIGHT TO USE "CLINICAL", APART FROM THE MARK AS SHOWN.
FOR MEDICAL EQUIPMENT, NAMELY, A PATIENT MONITOR FOR DISPLAYING BOTH REAL TIME AND PATIENT SPECIFIC DATA (U.S. CLS. 26, 39 AND 44).
FIRST USE 4-1-2004; IN COMMERCE 4-1-2004.

WANDA KAY PRICE, EXAMINING ATTORNEY

CLASS 10—(Continued).

SN 78-431,476. TYCO HEALTHCARE GROUP LP, MANSFIELD, MA. FILED 6-8-2004.

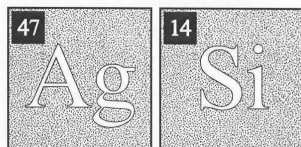

THE STIPPLING SHOWN IN THE DRAWING IS A FEATURE OF THE MARK.

THE MARK CONSISTS OF 47 AG, THE SYMBOL FOR SILVER IN THE CHEMICAL PERIODIC TABLE AND 14 SI, THE SYMBOL FOR SILICONE IN THE CHEMICAL PERIODIC TABLE.

FOR MEDICAL DEVICES, NAMELY, URINE METERS AND NEEDLELESS SAMPLING PORTS; UROLOGICAL CATHETERS; UROLOGICAL CARE KITS, PACKS AND TRAYS COMPRISED OF CATHETERS, URINE METERS AND COLLECTION BAGS; MEDICAL TUBING; URINE COLLECTION DEVICES (U.S. CLS. 26, 39 AND 44).

CHARLES L. JENKINS, EXAMINING ATTORNEY

SN 78-438,056. I-FLOW CORPORATION, LAKE FOREST, CA. FILED 6-18-2004.

SOAKER

THE MARK CONSISTS OF STANDARD CHARACTERS WITHOUT CLAIM TO ANY PARTICULAR FONT, STYLE, SIZE, OR COLOR.

FOR MEDICAL DEVICES, NAMELY, CATHETERS (U.S. CLS. 26, 39 AND 44).

FIRST USE 3-16-2000; IN COMMERCE 3-16-2000.

CIMMERIAN COLEMAN, EXAMINING ATTORNEY

CLASS 10—(Continued).

SN 78-444,794. GLAXO GROUP LIMITED, GREENFORD, MIDDLESEX UB6 ONN, UNITED KINGDOM, FILED 7-1-2004.

ACCUPLUME

THE MARK CONSISTS OF STANDARD CHARACTERS WITHOUT CLAIM TO ANY PARTICULAR FONT, STYLE, SIZE, OR COLOR.

PRIORITY CLAIMED UNDER SEC. 44(D) ON UNITED KINGDOM APPLICATION NO. 2366269, FILED 6-21-2004.

FOR MEDICAL AND SURGICAL INSTRUMENTS, NAMELY INHALERS SOLD EMPTY BUT USED FOR THE TREATMENT AND/OR ALLEVIATION OF RESPIRATORY DISORDERS (U.S. CLS. 26, 39 AND 44).

FLORENTINA BLANDU, EXAMINING ATTORNEY

SN 78-461,263. NEOTECH PRODUCTS, INC., CHATSWORTH, CA. FILED 8-3-2004.

SECURE-ET

THE MARK CONSISTS OF STANDARD CHARACTERS WITHOUT CLAIM TO ANY PARTICULAR FONT, STYLE, SIZE, OR COLOR.

FOR WING SHAPED ADHESIVE BANDING, WITH ORIENTING ELEMENT FOR APPLICATION TO ENDOTRACHEAL TUBE (U.S. CLS. 26, 39 AND 44).

FIRST USE 9-27-2002; IN COMMERCE 9-27-2002.

ROBIN CHOSID, EXAMINING ATTORNEY

CLASS 10—(Continued).

SN 78-468,103. BOSTON BRACE INTERNATIONAL, INC., AVON, MA. FILED 8-16-2004.

CLASS 10—(Continued).

SN 78-480,023. DIACHEMIX, LLC, MILWAUKEE, WI. FILED 9-8-2004.

BOSTON BODY JACKET

THE MARK CONSISTS OF STANDARD CHARACTERS WITHOUT CLAIM TO ANY PARTICULAR FONT, STYLE, SIZE, OR COLOR.

OWNER OF U.S. REG. NOS. 1,850,464 AND 1,850,465.

NO CLAIM IS MADE TO THE EXCLUSIVE RIGHT TO USE "BODY JACKET", APART FROM THE MARK AS SHOWN.

SEC. 2(F).

FOR ORTHOPEDIC APPLIANCES, NAMELY, BODY JACKETS (U.S. CLS. 26, 39 AND 44).

FIRST USE 7-31-1992; IN COMMERCE 7-31-1992.

THEODORE MCBRIDE, EXAMINING ATTORNEY

SENTRY

THE MARK CONSISTS OF STANDARD CHARACTERS WITHOUT CLAIM TO ANY PARTICULAR FONT, STYLE, SIZE, OR COLOR.

FOR APPARATUS FOR CLINICAL DIAGNOSIS, NAMELY, ELECTRONIC APPARATUS FOR CONDUCTING DIAGNOSTIC TESTS FOR IDENTIFYING PATHOGENS, ANTIBODIES, TOXINS, ANALYTES, CHEMICAL RESIDUES, FOOD INGREDIENTS, AND DNA SEQUENCES (U.S. CLS. 26, 39 AND 44).

FIRST USE 8-0-1999; IN COMMERCE 8-0-1999.

DAVID C. REIHNER, EXAMINING ATTORNEY

SN 78-468,134. BOSTON BRACE INTERNATIONAL, INC., AVON, MA. FILED 8-16-2004.

SN 78-486,587. CRUZ, DAVID, DAVIS, CA. FILED 9-20-2004.

BOSTON SOFT BODY JACKET

THE MARK CONSISTS OF STANDARD CHARACTERS WITHOUT CLAIM TO ANY PARTICULAR FONT, STYLE, SIZE, OR COLOR.

OWNER OF U.S. REG. NOS. 1,850,464 AND 1,850,465.

NO CLAIM IS MADE TO THE EXCLUSIVE RIGHT TO USE "SOFT BODY JACKET", APART FROM THE MARK AS SHOWN.

SEC. 2(F).

FOR ORTHOPEDIC APPLIANCES, NAMELY, BODY JACKETS (U.S. CLS. 26, 39 AND 44).

FIRST USE 7-31-1992; IN COMMERCE 7-31-1992.

THEODORE MCBRIDE, EXAMINING ATTORNEY

TACTICAL EXTRICATION DEVICE

THE MARK CONSISTS OF STANDARD CHARACTERS WITHOUT CLAIM TO ANY PARTICULAR FONT, STYLE, SIZE, OR COLOR.

NO CLAIM IS MADE TO THE EXCLUSIVE RIGHT TO USE "DEVICE", APART FROM THE MARK AS SHOWN.

FOR EMERGENCY STRETCHER DESIGNED FOR TWO PEOPLE TO CARRY AN INJURED PATIENT (U.S. CLS. 26, 39 AND 44).

FIRST USE 9-4-1999; IN COMMERCE 9-4-1999.

CAROLYN GRAY, EXAMINING ATTORNEY

CLASS 10—(Continued).

SN 78-487,140. ORTHOHELIX SURGICAL DESIGNS, INC., AKRON, OH. FILED 9-21-2004.

MAXLOCK

THE MARK CONSISTS OF STANDARD CHARACTERS WITHOUT CLAIM TO ANY PARTICULAR FONT, STYLE, SIZE, OR COLOR.

FOR ORTHOPEDIC PLATES AND ORTHOPEDIC SCREWS; ORTHOPEDIC INSTRUMENTS FOR USE IN ORTHOPEDIC SURGERY (U.S. CLS. 26, 39 AND 44).
KHANH LE, EXAMINING ATTORNEY

SN 78-490,700. ARTHREX INC., NAPLES, FL. FILED 9-28-2004.

HATRIC

THE MARK CONSISTS OF STANDARD CHARACTERS WITHOUT CLAIM TO ANY PARTICULAR FONT, STYLE, SIZE, OR COLOR.

FOR PROSTHETIC AND FILLING MATERIALS, NAMELY ARTIFICIAL BIO-ABSORBABLE MATERIAL FOR USE IN BONE GRAFTING TYPE MEDICAL PROCEDURES (U.S. CLS. 26, 39 AND 44).
MICHELLE DUBOIS, EXAMINING ATTORNEY

CLASS 10—(Continued).

SN 78-491,525. CONOR MEDSYSTEMS, INC., MENLO PARK, CA. FILED 9-29-2004.

RENAISSANCE

THE MARK CONSISTS OF STANDARD CHARACTERS WITHOUT CLAIM TO ANY PARTICULAR FONT, STYLE, SIZE, OR COLOR.

FOR MEDICAL DEVICES, NAMELY STENTS AND CATHETERS (U.S. CLS. 26, 39 AND 44).
AMY ALFIERI, EXAMINING ATTORNEY

SN 78-493,053. SHERWOOD SERVICES AG, SCHAFFHAUSEN, SWITZERLAND, FILED 10-1-2004.

PROTECT POINT

THE MARK CONSISTS OF STANDARD CHARACTERS WITHOUT CLAIM TO ANY PARTICULAR FONT, STYLE, SIZE, OR COLOR.

FOR SUTURE MATERIALS AND SURGICAL SUTURES (U.S. CLS. 26, 39 AND 44).
FIRST USE 0-0-1992; IN COMMERCE 0-0-1992.
JENNIFER KRISP, EXAMINING ATTORNEY

SN 78-494,415. MERRICK, JAMES WILLIAM, JR., KERRVILLE, TX. FILED 10-5-2004.

WAKE UP DROPS

THE MARK CONSISTS OF STANDARD CHARACTERS WITHOUT CLAIM TO ANY PARTICULAR FONT, STYLE, SIZE, OR COLOR.

NO CLAIM IS MADE TO THE EXCLUSIVE RIGHT TO USE "DROPS", APART FROM THE MARK AS SHOWN.
FOR EYE DROPPERS (U.S. CLS. 26, 39 AND 44).
KEVIN DINALLO, EXAMINING ATTORNEY

CLASS 10—(Continued).

SN 78-494,702. ARBIOS TECHNOLOGIES, INC., LOS ANGELES, CA. FILED 10-5-2004.

CLASS 10—(Continued).

SN 78-497,331. DEPUY, INC., WARSAW, IN. FILED 10-8-2004.

SEPET

THE MARK CONSISTS OF STANDARD CHARACTERS WITHOUT CLAIM TO ANY PARTICULAR FONT, STYLE, SIZE, OR COLOR.

FOR MEDICAL DEVICE, NAMELY, A CARTRIDGE USED FOR BLOOD AND PLASMA FILTRATION IN PROVIDING TEMPORARY LIVER AND RENAL SUPPORT (U.S. CLS. 26, 39 AND 44).

ALICE SUE CARRUTHERS, EXAMINING ATTORNEY

MOUNTAINEER

THE MARK CONSISTS OF STANDARD CHARACTERS WITHOUT CLAIM TO ANY PARTICULAR FONT, STYLE, SIZE, OR COLOR.

FOR SPINAL IMPLANTS COMPRISED OF ARTIFICIAL MATERIALS; SURGICAL INSTRUMENTS FOR USE WITH SPINAL IMPLANTS (U.S. CLS. 26, 39 AND 44).

FIRST USE 3-21-2005; IN COMMERCE 3-21-2005.
DANIEL BRODY, EXAMINING ATTORNEY

SN 78-496,315. MAJESTIC DRUG CO., INC., SOUTH FALLS-BURG, NY. FILED 10-7-2004.

SN 78-497,713. BRINSTON, CHARLES, PEARL, MS. FILED 10-11-2004.

D.O.C.

THE MARK CONSISTS OF STANDARD CHARACTERS WITHOUT CLAIM TO ANY PARTICULAR FONT, STYLE, SIZE, OR COLOR.

OWNER OF U.S. REG. NO. 670,367.
FOR DENTURE REPAIR KITS CONSISTING PRIMARILY OF EPOXY, A MIXING TRAY AND A MIXING SPATULA (U.S. CLS. 26, 39 AND 44).

FIRST USE 0-0-2002; IN COMMERCE 0-0-2002.
RON FAIRBANKS, EXAMINING ATTORNEY

SLIM BOSS

THE MARK CONSISTS OF STANDARD CHARACTERS WITHOUT CLAIM TO ANY PARTICULAR FONT, STYLE, SIZE, OR COLOR.

FOR ELECTRICAL WEIGHT LOSS BODY BELT (U.S. CLS. 26, 39 AND 44).

KELLEY WELLS, EXAMINING ATTORNEY

CLASS 10—(Continued).

SN 78-499,887. ENDOMED INC., PHOENIX, AZ. FILED 10-14-2004.

ENDOMED

THE MARK CONSISTS OF STANDARD CHARACTERS WITHOUT CLAIM TO ANY PARTICULAR FONT, STYLE, SIZE, OR COLOR.

FOR MEDICAL STENTS, STENT GRAFTS AND OCCLUDERS (U.S. CLS. 26, 39 AND 44).

FIRST USE 11-1-1993; IN COMMERCE 11-1-1993.

CIMMERIAN COLEMAN, EXAMINING ATTORNEY

SN 78-499,985. INNOVATIVE SPINAL TECHNOLOGIES, INC., BOULDER, CO. FILED 10-14-2004.

MAX-LIF

THE MARK CONSISTS OF STANDARD CHARACTERS WITHOUT CLAIM TO ANY PARTICULAR FONT, STYLE, SIZE, OR COLOR.

FOR MEDICAL AND SURGICAL APPARATUS AND INSTRUMENTS, NAMELY, SURGICAL IMPLANTS COMPOSED OF ARTIFICIAL MATERIALS FOR THE TREATMENT OF DISEASES OF THE SPINE; VERTEBRAL DISCECTOMY APPARATUS AND INSTRUMENTS; VERTEBRAL ORTHOPEDIC APPARATUS AND INSTRUMENTS; ORTHOPEDIC FIXATION DEVICES USED IN VERTEBRAL IMPLANT SURGERY; PEDICLE SCREWS AND CONNECTING RODS USED IN VERTEBRAL SURGERY; SURGICAL INTERBODY SPACERS, CAGES, AND ASSOCIATED INSTRUMENTS, NAMELY, SURGICAL CUTTERS FOR IMPLANT SITE PREPARATION, IMPLANT TRIALS FOR VERIFYING A FIT BETWEEN THE SURGICAL SITE SIZE AND THE IMPLANT SIZE, AND IMPLANT HOLDERS AND INSERTION TOOLS FOR HOLDING AND INSERTING THE IMPLANT INTO THE SITE; AND PARTS AND FITTINGS FOR MEDICAL IMAGING APPARATUS PROVIDING PATIENT AND INSTRUMENT POSITIONING DATA IN SPINAL SURGERY (U.S. CLS. 26, 39 AND 44).

RAUL CORDOVA, EXAMINING ATTORNEY

CLASS 10—(Continued).

SN 78-501,654. THE SEABERG COMPANY, INC., NEWPORT, OR. FILED 10-18-2004.

WE CLOSE THE BOOK ON PELVIC FRACTURES

THE MARK CONSISTS OF STANDARD CHARACTERS WITHOUT CLAIM TO ANY PARTICULAR FONT, STYLE, SIZE, OR COLOR.

FOR MEDICAL DEVICES, NAMELY, DEVICES FOR IMMOBILIZATION OF PELVIC FRACTURES (U.S. CLS. 26, 39 AND 44).

FIRST USE 9-30-2004; IN COMMERCE 9-30-2004.

ATTIYA MALIK, EXAMINING ATTORNEY

SN 78-502,413. INNOVATION SPORTS, INC., FOOTHILL RANCH, CA. FILED 10-19-2004.

ACCUTRAC

THE MARK CONSISTS OF STANDARD CHARACTERS WITHOUT CLAIM TO ANY PARTICULAR FONT, STYLE, SIZE, OR COLOR.

FOR ORTHOPEDIC APPLIANCE HINGES SOLD AS AN INTEGRAL COMPONENT OF MEDICAL BRACES (U.S. CLS. 26, 39 AND 44).

FIRST USE 6-1-1991; IN COMMERCE 6-1-1991.

MARIA-VICTORIA SUAREZ, EXAMINING ATTORNEY

CLASS 10—(Continued).

SN 78-502,766. TIDI PRODUCTS, LLC, NEENAH, WI. FILED 10-20-2004.

CLASS 10—(Continued).

SN 78-504,675. DIGIRAD CORPORATION, POWAY, CA. FILED 10-22-2004.

SPECTPAK PLUS

VENTURE

THE MARK CONSISTS OF STANDARD CHARACTERS WITHOUT CLAIM TO ANY PARTICULAR FONT, STYLE, SIZE, OR COLOR.

FOR COMPONENTS OF A DIAGNOSTIC INSTRUMENT FOR NUCLEAR MEDICINE USE, NAMELY, A ROTATING PLATFORM CHAIR AND A SOLID STATE GAMMA CAMERA (U.S. CLS. 26, 39 AND 44).

FIRST USE 7-25-2000; IN COMMERCE 7-25-2000.
MARIA-VICTORIA SUAREZ, EXAMINING ATTORNEY

SN 78-505,087. RHYTHMLINK INTERNATIONAL, LLC, COLUMBIA, SC. FILED 10-25-2004.

THE MARK CONSISTS OF STANDARD CHARACTERS WITHOUT CLAIM TO ANY PARTICULAR FONT, STYLE, SIZE, OR COLOR.

FOR SPONGES FOR MEDICAL AND DENTAL PURPOSES (U.S. CLS. 26, 39 AND 44).

FIRST USE 6-20-1997; IN COMMERCE 6-20-1997.
MARGERY A. TIERNEY, EXAMINING ATTORNEY

RHYTHMLINK

SN 78-504,352. OSMETECH INC., ROSWELL, GA. FILED 10-22-2004.

THE MARK CONSISTS OF STANDARD CHARACTERS WITHOUT CLAIM TO ANY PARTICULAR FONT, STYLE, SIZE, OR COLOR.

FOR MEDICAL DIAGNOSTIC ELECTRODES (U.S. CLS. 26, 39 AND 44).

FIRST USE 4-29-2003; IN COMMERCE 4-29-2003.
IRA J. GOODSaid, EXAMINING ATTORNEY

SN 78-508,256. ARROW INTERNATIONAL INVESTEMENT CORP., WILMINGTON, PA. FILED 10-29-2004.

COMFORTSAMPLER

SUPER ARROW-FLEX

THE MARK CONSISTS OF STANDARD CHARACTERS WITHOUT CLAIM TO ANY PARTICULAR FONT, STYLE, SIZE, OR COLOR.

FOR ARTERIAL BLOOD COLLECTION DEVICE FOR THE DETERMINATION OF PH, BLOOD GAS, ELECTROLYTES, AND METABOLITES (U.S. CLS. 26, 39 AND 44).

FIRST USE 7-21-2004; IN COMMERCE 7-21-2004.
JILL C. ALT, EXAMINING ATTORNEY

THE MARK CONSISTS OF STANDARD CHARACTERS WITHOUT CLAIM TO ANY PARTICULAR FONT, STYLE, SIZE, OR COLOR.

OWNER OF U.S. REG. NOS. 1,315,592, 1,837,796 AND 2,176,791.

NO CLAIM IS MADE TO THE EXCLUSIVE RIGHT TO USE "SUPER", APART FROM THE MARK AS SHOWN.

FOR PERCUTANEOUS SHEATH INTRODUCER USED WITH CATHETERS (U.S. CLS. 26, 39 AND 44).

FIRST USE 6-30-1994; IN COMMERCE 6-30-1994.
NELSON SNYDER, EXAMINING ATTORNEY

CLASS 10—(Continued).

SN 78-509,470. TING, DARREN T.C., MALIBU, CA. FILED 11-1-2004.

MDF

THE MARK CONSISTS OF STANDARD CHARACTERS WITHOUT CLAIM TO ANY PARTICULAR FONT, STYLE, SIZE, OR COLOR.

FOR MEDICAL AND SURGICAL APPARATUS AND INSTRUMENTS, NAMELY, STETHOSCOPES, SPHYGMOMANOMETER AND NEUROLOGICAL HAMMERS (U.S. CLS. 26, 39 AND 44).

FIRST USE 1-1-1994; IN COMMERCE 1-1-1994.
DAVID TAYLOR, EXAMINING ATTORNEY

SN 78-509,741. AMERICAN MEDICAL TECHNOLOGIES, INC., CORPUS CHRISTI, TX. FILED 11-2-2004.

VALUECAM

THE MARK CONSISTS OF STANDARD CHARACTERS WITHOUT CLAIM TO ANY PARTICULAR FONT, STYLE, SIZE, OR COLOR.

FOR INTRAORAL CAMERA FOR MEDICAL USE (U.S. CLS. 26, 39 AND 44).

AMOS T. MATTHEWS, JR., EXAMINING ATTORNEY

CLASS 10—(Continued).

SN 78-514,482. AA ADVANCED TECHNOLOGY INC., CHICAGO, IL. FILED 11-10-2004.

MESOPORATION

THE MARK CONSISTS OF STANDARD CHARACTERS WITHOUT CLAIM TO ANY PARTICULAR FONT, STYLE, SIZE, OR COLOR.

FOR MEDICAL DEVICES, NAMELY, A TRANSDERMAL DRUG DELIVERY DEVICE USING ELECTROPORATION (U.S. CLS. 26, 39 AND 44).

DEBRA LEE, EXAMINING ATTORNEY

SN 78-514,974. ADVANCED MEDICAL TECHNOLOGIES, LLC., LOS ANGELES, CA. FILED 11-10-2004.



FOR BLOOD GLUCOSE MONITORING DEVICES (U.S. CLS. 26, 39 AND 44).

FIRST USE 11-1-2004; IN COMMERCE 11-1-2004.
KAREN K. BUSH, EXAMINING ATTORNEY

SN 78-515,135. ACTIVE ANKLE SYSTEMS, INC., JEFFERSONVILLE, IN. FILED 11-11-2004.

MULTI-PHASE

THE MARK CONSISTS OF STANDARD CHARACTERS WITHOUT CLAIM TO ANY PARTICULAR FONT, STYLE, SIZE, OR COLOR.

FOR EXERCISE CUSHION INSERT FOR ANKLE AND FOOT ORTHOTIC PURPOSES (U.S. CLS. 26, 39 AND 44).

MELISSA VALLILLO, EXAMINING ATTORNEY

CLASS 10—(Continued).

SN 78-515,763. OTOVATION, LLC, LEDERACH, PA. FILED 11-12-2004.

CLASS 10—(Continued).

SN 78-518,232. INTEGRAL TECHNOLOGIES, INC., BELLINGHAM, WA. FILED 11-17-2004.

AMPLITUDE

PlastiShock

THE MARK CONSISTS OF STANDARD CHARACTERS WITHOUT CLAIM TO ANY PARTICULAR FONT, STYLE, SIZE, OR COLOR.

FOR MEDICAL EQUIPMENT FOR USE IN DIAGNOSING AND ASSESSING HEARING LOSS, NAMELY, AUDIOMETERS (U.S. CLS. 26, 39 AND 44).

PRISCILLA MILTON, EXAMINING ATTORNEY

THE MARK CONSISTS OF STANDARD CHARACTERS WITHOUT CLAIM TO ANY PARTICULAR FONT, STYLE, SIZE, OR COLOR.

FOR MOLDABLE ELECTRICAL SHOCK OR ELECTRO THERAPY STIMULATION CONTACTS, PADDLES OR PADS (U.S. CLS. 26, 39 AND 44).

REBECCA SMITH, EXAMINING ATTORNEY

SN 78-515,865. INNOMED TECHNOLOGIES, INC., BOCA RATON, FL. FILED 11-12-2004.

SN 78-519,235. WILSON-COOK MEDICAL INC., WINSTON-SALEM, NC. FILED 11-18-2004.

RESPCARE

SONNET

THE MARK CONSISTS OF STANDARD CHARACTERS WITHOUT CLAIM TO ANY PARTICULAR FONT, STYLE, SIZE, OR COLOR.

FOR NASAL VENTILATION INTERFACE AND RESPIRATORS FOR MEDICAL PURPOSES; CONTINUOUS POSITIVE AIRWAY PRESSURE (CPAP) COMPRESSORS AND MONITORS FOR MEDICAL USE; BILEVEL POSITIVE AIRWAY PRESSURE COMPRESSORS AND MONITORS FOR MEDICAL USE; AND HUMIDIFIERS FOR USE IN CONNECTION WITH MEDICAL RESPIRATORY DEVICES (U.S. CLS. 26, 39 AND 44).

MARY ROSSMAN, EXAMINING ATTORNEY

THE MARK CONSISTS OF STANDARD CHARACTERS WITHOUT CLAIM TO ANY PARTICULAR FONT, STYLE, SIZE, OR COLOR.

FOR DISPOSABLE ENDOSCOPIC POLYPECTOMY SHORT-THROW SNARE (U.S. CLS. 26, 39 AND 44).

BARBARA A. GOLD, EXAMINING ATTORNEY

CLASS 10—(Continued).

SN 78-524,363. SOCIETE POUR LA CONCEPTION DES APPLICATIONS DES TECHNIQUES ELECTRONIQUES - SATELEC, MERIGNAC, FRANCE, FILED 11-30-2004.

CRUISE CONTROL

THE MARK CONSISTS OF STANDARD CHARACTERS WITHOUT CLAIM TO ANY PARTICULAR FONT, STYLE, SIZE, OR COLOR.

FOR ULTRASONIC APPARATUS FOR DENTAL USE, NAMELY ELECTRONIC GENERATOR CONTROL MODULES FOR USE IN PERIODONTICS, ENDODONTICS AND SCALING DENTAL PROCEDURES; DENTAL HANDPIECE ATTACHMENT FOR CLEANING OR POLISHING TEETH (U.S. CLS. 26, 39 AND 44).

LOURDES AYALA, EXAMINING ATTORNEY

SN 78-528,348. INNOMED TECHNOLOGIES, INC., BOCA RATON, FL. FILED 12-7-2004.

NIRVANA

THE MARK CONSISTS OF STANDARD CHARACTERS WITHOUT CLAIM TO ANY PARTICULAR FONT, STYLE, SIZE, OR COLOR.

FOR NASAL VENTILATION INTERFACE AND RESPIRATORS FOR MEDICAL PURPOSES; CONTINUOUS POSITIVE AIRWAY PRESSURE (CPAP) COMPRESSORS AND MONITORS; BILEVEL POSITIVE AIRWAY PRESSURE COMPRESSORS AND MONITORS; HUMIDIFIERS FOR USE IN CONNECTION WITH MEDICAL RESPIRATORY DEVICES; FACIAL MASKS FOR USE IN CONNECTION WITH NASAL VENTILATION INTERFACE AND RESPIRATORS, CONTINUOUS POSITIVE AIRWAY PRESSURE (CPAP) COMPRESSORS BILEVEL POSITIVE AIRWAY PRESSURE COMPRESSORS (U.S. CLS. 26, 39 AND 44).

MATTHEW PAPPAS, EXAMINING ATTORNEY

CLASS 10—(Continued).

SN 78-529,267. PATIENT FIRST TESTING, INC., FREMONT, NE. FILED 12-8-2004.

**SUREMIST
ULTRASONIC
NEBULIZER**

THE MARK CONSISTS OF STANDARD CHARACTERS WITHOUT CLAIM TO ANY PARTICULAR FONT, STYLE, SIZE, OR COLOR.

NO CLAIM IS MADE TO THE EXCLUSIVE RIGHT TO USE "ULTRASONIC NEBULIZER", APART FROM THE MARK AS SHOWN.

FOR RESPIRATORY MEDICAL PRODUCTS, NAMELY NEBULIZERS (U.S. CLS. 26, 39 AND 44).

FIRST USE 10-15-2004; IN COMMERCE 10-15-2004.

KATRINA EDGE, EXAMINING ATTORNEY

SN 78-533,299. RICHARD, PATRICIA A., WESTPORT, CT. FILED 12-15-2004.

HUG-A-LEG

THE MARK CONSISTS OF STANDARD CHARACTERS WITHOUT CLAIM TO ANY PARTICULAR FONT, STYLE, SIZE, OR COLOR.

FOR MEDICAL APPARATUS, NAMELY, BRACES FOR LIMBS OR JOINTS, ORTHOPEDIC BRACES FOR IMMOBILIZING ORTHOPEDIC CASTS, CASTS FOR ORTHOPEDIC PURPOSES, AND ORTHOPEDIC BRACES (U.S. CLS. 26, 39 AND 44).

FIRST USE 7-9-2004; IN COMMERCE 7-9-2004.

EVELYN BRADLEY, EXAMINING ATTORNEY

CLASS 10—(Continued).

SN 78-533,538. AESCULAP, INC., CENTER VALLEY, PA.
FILED 12-16-2004.

EXCIA

THE MARK CONSISTS OF STANDARD CHARACTERS WITHOUT CLAIM TO ANY PARTICULAR FONT, STYLE, SIZE, OR COLOR.
FOR ORTHOPEDIC IMPLANTS, NAMELY, HIP STEMS COMPOSED OF ARTIFICIAL MATERIAL (U.S. CLS. 26, 39 AND 44).
JACQUELINE A. LAVINE, EXAMINING ATTORNEY

CLASS 10—(Continued).

SN 78-540,053. USGI MEDICAL, INC., SAN CLEMENTE, CA.
FILED 12-30-2004.



OWNER OF U.S. REG. NO. 2,910,918.
NO CLAIM IS MADE TO THE EXCLUSIVE RIGHT TO USE MEDICAL, APART FROM THE MARK AS SHOWN.
THE COLOR(S) DARK BLUE, LIGHT BLUE, BLACK IS/ ARE CLAIMED AS A FEATURE OF THE MARK.
THE LETTERS US IN DARK BLUE AND THE LETTERS GI IN LIGHT BLUE, THE WORD MEDICAL IN BLACK.
THE MARK CONSISTS OF THE LETTERS USGI IN STYLIZED LETTERING WITH THE LETTER G BEING PROMINENTLY DISPLAYED.
SEC. 2(F).
FOR MEDICAL DEVICES, NAMELY, SURGICAL INSTRUMENTS FOR LAPAROSCOPIC SURGERY (U.S. CLS. 26, 39 AND 44).
FIRST USE 4-1-2001; IN COMMERCE 10-1-2001.
YSA DEJESUS, EXAMINING ATTORNEY

SN 78-976,193. PROMEX TECHNOLOGIES, LLC, FRANKLIN, IN. FILED 5-1-2004.

**HELPING ANSWER
LIFE'S MOST
IMPORTANT
QUESTIONS**

SN 78-534,183. TYCO PLASTICS SERVICES AG, SCHAFFHAUSEN, SWITZERLAND, FILED 12-17-2004.

MEDI-TUFF

THE MARK CONSISTS OF STANDARD CHARACTERS WITHOUT CLAIM TO ANY PARTICULAR FONT, STYLE, SIZE, OR COLOR.
FOR INFECTIOUS WASTE BAGS (U.S. CLS. 26, 39 AND 44).
FIRST USE 7-2-1993; IN COMMERCE 7-2-1993.
NORA BUCHANAN WILL, EXAMINING ATTORNEY

THE MARK CONSISTS OF STANDARD CHARACTERS WITHOUT CLAIM TO ANY PARTICULAR FONT, STYLE, SIZE, OR COLOR.
FOR MEDICAL, SURGICAL AND VETERINARIAN DEVICES, NAMELY BIOPSY NEEDLES, BIOPSY GUNS, FINE NEEDLE ASPIRATION DEVICES, TISSUE LESION LOCALIZATION NEEDLES, CORE BIOPSY NEEDLES, BONE MARROW BIOPSY AND ACCESS DEVICES FOR MEDICAL USE, SINGLE ACTION BIOPSY DEVICES, TISSUE EXTRACTION DEVICES, ORTHOPEDIC PENS, AND BIOPSY KITS COMPRISING INTRODUCERS, GUIDE CATHETERS AND SINGLE ACTION BIOPSY DEVICES (U.S. CLS. 26, 39 AND 44).
FIRST USE 12-1-2004; IN COMMERCE 12-1-2004.
JANICE L. MCMORROW, EXAMINING ATTORNEY

CLASS 10—(Continued).

SN 79-000,292. HAGER & WERKEN GMBH & CO. KG, FED REP GERMANY, FILED 11-4-2003.

MIRAJECT

THE MARK CONSISTS OF STANDARD CHARACTERS WITHOUT CLAIM TO ANY PARTICULAR FONT, STYLE, SIZE, OR COLOR.

OWNER OF INTERNATIONAL REGISTRATION 0808414 DATED 7-14-2003, EXPIRES 7-14-2013.

FOR CANNULAE FOR INJECTIONS (U.S. CLS. 26, 39 AND 44).

SHAUNIA WALLACE, EXAMINING ATTORNEY

SN 79-000,296. HAGER & WERKEN GMBH & CO. KG, FED REP GERMANY, FILED 11-4-2003.

SPANDEX

THE MARK CONSISTS OF STANDARD CHARACTERS WITHOUT CLAIM TO ANY PARTICULAR FONT, STYLE, SIZE, OR COLOR.

OWNER OF INTERNATIONAL REGISTRATION 0810219 DATED 7-31-2003, EXPIRES 7-31-2013.

FOR CHEEK AND LIP EXPANDERS FOR DENTAL AND SURGICAL PURPOSES (U.S. CLS. 26, 39 AND 44).

SHAUNIA WALLACE, EXAMINING ATTORNEY

SN 79-002,629. H.S. HOSPITAL SERVICES S.P.A., ITALY, FILED 3-18-2004.

TRAP AUTOMATIC SYSTEM

THE MARK CONSISTS OF STANDARD CHARACTERS WITHOUT CLAIM TO ANY PARTICULAR FONT, STYLE, SIZE, OR COLOR.

PRIORITY DATE OF 10-1-2003 IS CLAIMED.

OWNER OF INTERNATIONAL REGISTRATION 0815111 DATED 10-9-2003, EXPIRES 10-9-2013.

OWNER OF U.S. REG. NO. 2,039,584.

NO CLAIM IS MADE TO THE EXCLUSIVE RIGHT TO USE AUTOMATIC SYSTEM, APART FROM THE MARK AS SHOWN.

FOR SURGICAL INSTRUMENTS IN PARTICULAR SURGICAL INSTRUMENTS FOR BIOPSY (U.S. CLS. 26, 39 AND 44).

STEVEN JACKSON, EXAMINING ATTORNEY

CLASS 10—(Continued).

SN 79-002,696. H.S. HOSPITAL SERVICE S.P.A., ITALY, FILED 3-18-2004.

TRAP MATIC SYSTEM

THE MARK CONSISTS OF STANDARD CHARACTERS WITHOUT CLAIM TO ANY PARTICULAR FONT, STYLE, SIZE, OR COLOR.

PRIORITY DATE OF 10-1-2003 IS CLAIMED.

OWNER OF INTERNATIONAL REGISTRATION 0815027 DATED 10-9-2003, EXPIRES 10-9-2013.

OWNER OF U.S. REG. NO. 2,039,584.

NO CLAIM IS MADE TO THE EXCLUSIVE RIGHT TO USE SYSTEM, APART FROM THE MARK AS SHOWN.

FOR SURGICAL INSTRUMENTS IN PARTICULAR SURGICAL INSTRUMENTS FOR BIOPSY (U.S. CLS. 26, 39 AND 44).

STEVEN JACKSON, EXAMINING ATTORNEY

SN 79-003,438. FOURNITURES HOSPITALIERES INDUSTRIE, 6 RUE NOBEL; F-29000 QUIMPER, FRANCE, FILED 6-11-2004.

TENOLIG

OWNER OF INTERNATIONAL REGISTRATION 0615801 DATED 2-18-1994, EXPIRES 2-18-2014.

FOR LIGAMENT REINFORCEMENT IMPLANT, NAMELY, SURGICAL DEVICE FOR SUTURING ACHILLES TENDON IN PERCUTANEOUS SURGERY (U.S. CLS. 26, 39 AND 44).

KELLY CHOE, EXAMINING ATTORNEY

SN 79-004,022. ARION INTERNATIONAL B.V., NETHERLANDS, FILED 6-30-2004.



OWNER OF INTERNATIONAL REGISTRATION 0714168 DATED 6-3-1999, EXPIRES 6-3-2009.

NO CLAIM IS MADE TO THE EXCLUSIVE RIGHT TO USE "EASY SLIDE", APART FROM THE MARK AS SHOWN.

THE COLOR(S) BLUE AND GREY IS/ARE CLAIMED AS A FEATURE OF THE MARK.

BLUE IS RELATED TO THE TRIANGLE, WHICH IS THE BACKGROUND OF THE TRADEMARK; GREY IS RELATED TO THE TYPEFACES OF THE WORD EASY-SLIDE.

FOR MEDICAL APPLICATION AID FOR PUTTING ON ELASTIC COMPRESSION STOCKINGS, TIGHTS AND ANKLE BANDAGES, NAMELY, A SOCK MADE OF A SMOOTH AND SHINY MATERIAL (U.S. CLS. 26, 39 AND 44).

MELVIN AXILBUND, EXAMINING ATTORNEY

CLASS 10—(Continued).

SN 79-006,636. IMPELLA CARDIOSYSTEMS AG, FED REP GERMANY, FILED 8-10-2004.

impella recover

OWNER OF INTERNATIONAL REGISTRATION 0836915 DATED 8-10-2004, EXPIRES 8-10-2014.
OWNER OF U.S. REG. NO. 2,443,683.
FOR BLOOD PUMPS (U.S. CLS. 26, 39 AND 44).
LAURA KOVAISKY, EXAMINING ATTORNEY

CLASS 11—ENVIRONMENTAL CONTROL APPARATUS

SN 76-429,477. CCI THERMAL TECHNOLOGIES INC., EDMONTON, ALBERTA, CANADA, FILED 7-9-2002.

QUIKLITE

PRIORITY CLAIMED UNDER SEC. 44(D) ON CANADA APPLICATION NO. 1131622, FILED 2-25-2002, REG. NO. TMA635307, DATED 3-15-2005, EXPIRES 3-15-2020.
FOR INFRARED ELECTRIC OVEN FOR INDUSTRIAL APPLICATIONS (U.S. CLS. 13, 21, 23, 31 AND 34).
WILLIAM VERHOSEK, EXAMINING ATTORNEY

SN 76-509,496. BAINS ULTRA INC., SAINT-NICOLAS, QUEBEC, G7A 2N1, CANADA, FILED 4-25-2003.

THERMOMASSEUR

OWNER OF CANADA REG. NO. TMA626324, DATED 3-30-2005, EXPIRES 3-30-2020.
FOR APPARATUS AND INSTALLATIONS FOR WATER SUPPLY AND SANITARY PURPOSES, NAMELY, BATHTUBS AND SHOWERS (U.S. CLS. 13, 21, 23, 31 AND 34).
GENE MACIOL, EXAMINING ATTORNEY

SN 76-511,558. CONVEC A/S, DK-3050 HUMBLEBAEK, DENMARK, FILED 4-18-2003.

CONVEC

FOR FAN ASSISTED INDOOR HEATING AND COOLING SYSTEMS, NAMELY VENTILATORS, AIR CONDITIONERS AND EMITTERS (U.S. CLS. 13, 21, 23, 31 AND 34).
FIRST USE 12-0-2003; IN COMMERCE 12-0-2003.
LEIGH CAROLINE CASE, EXAMINING ATTORNEY

CLASS 11—(Continued).

SN 76-534,151. BSH BOSCH UND SIEMENS HAUSGERATE GMBH, MUNICH, FED REP GERMANY, FILED 8-4-2003.

EASYSTORE

PRIORITY CLAIMED UNDER SEC. 44(D) ON FED REP GERMANY APPLICATION NO. 30303161107, FILED 1-22-2003, REG. NO. 30303161, DATED 2-20-2003, EXPIRES 1-31-2013.

FOR COOLING MACHINES, NAMELY, REFRIGERATORS, FREEZERS, ICE MAKING MACHINES, AND PARTS THEREFORE (U.S. CLS. 13, 21, 23, 31 AND 34).
STEPHANIE DAVIS, EXAMINING ATTORNEY

SN 76-551,445. EAGLE INDUSTRY CO., LTD., MINATO-KU, TOKYO, JAPAN, FILED 10-15-2003.

HEATED WALL

PRIORITY CLAIMED UNDER SEC. 44(D) ON JAPAN APPLICATION NO. 2003079611, FILED 9-12-2003, REG. NO. 4787288, DATED 7-16-2004, EXPIRES 7-16-2014.

FOR HEATERS FOR SEMICONDUCTOR MANUFACTURING MACHINES AND SYSTEMS; SUPER HEATERS FOR INDUSTRIAL USE, NAMELY, IN THE MANUFACTURING OF SEMICONDUCTORS; HEATERS FOR CHEMICAL PROCESSING MACHINES AND APPARATUS (U.S. CLS. 13, 21, 23, 31 AND 34).
SOPHIA S. KIM, EXAMINING ATTORNEY

SN 76-553,249. RATIONAL AG, 86899 LANDSBERG/LECH, FED REP GERMANY, FILED 10-22-2003.

SELFCOOKINGCONTROL

OWNER OF FED REP GERMANY REG. NO. 30327498, DATED 9-5-2003, EXPIRES 5-31-2013.

FOR ELECTRIC FOOD COOKERS FOR COMMERCIAL USE; ELECTRIC FOOD STEAMERS FOR COMMERCIAL USE; AND COMMERCIAL COOKING OVENS (U.S. CLS. 13, 21, 23, 31 AND 34).
CAROLINE WOOD, EXAMINING ATTORNEY

SN 76-562,435. HAMILTON BEACH/PROCTOR-SILEX, INC., GLEN ALLEN, VA. FILED 11-14-2003.

BREWSTATION

THE MARK CONSISTS OF STANDARD CHARACTERS WITHOUT CLAIM TO ANY PARTICULAR FONT, STYLE, SIZE, OR COLOR.

FOR ELECTRIC COFFEE MAKERS (U.S. CLS. 13, 21, 23, 31 AND 34).
FIRST USE 1-0-2003; IN COMMERCE 1-0-2003.
KATHERINE STOIDES, EXAMINING ATTORNEY

CLASS 11—(Continued).

SN 76-563,951. VOGELZANG INTERNATIONAL CORPORATION, HOLLAND, MI. FILED 12-8-2003.

THE SHEEPHERDER

THE MARK CONSISTS OF STANDARD CHARACTERS WITHOUT CLAIM TO ANY PARTICULAR FONT, STYLE, SIZE, OR COLOR.

FOR WOOD OR COAL BURNING STOVES (U.S. CLS. 13, 21, 23, 31 AND 34).

KIMBERLY FRYE, EXAMINING ATTORNEY

CLASS 11—(Continued).

SN 76-566,461. SPA ACQUISITION CORP., ANAHEIM, CA. FILED 12-22-2003.



NO CLAIM IS MADE TO THE EXCLUSIVE RIGHT TO USE "CLEAN FILTRATION SYSTEM", APART FROM THE MARK AS SHOWN.

THE STIPPLING IS FOR SHADING PURPOSES. FOR WATER FILTERS FOR SPAS (U.S. CLS. 13, 21, 23, 31 AND 34).

FIRST USE 10-24-2003; IN COMMERCE 10-24-2003. GWEN STOKOLS, EXAMINING ATTORNEY

SN 76-571,067. SOUTHERN MARKETING AND MANUFACTURING, INC., SPARTANBURG, SC. FILED 1-21-2004.

HERBIEPAC'S

THE MARK CONSISTS OF STANDARD CHARACTERS WITHOUT CLAIM TO ANY PARTICULAR FONT, STYLE, SIZE, OR COLOR.

OWNER OF U.S. REG. NO. 2,755,993. FOR MICROWAVEABLE HEATING PADS NOT FOR MEDICAL USE FILLED WITH ORGANIC MATERIALS (U.S. CLS. 13, 21, 23, 31 AND 34).

FIRST USE 7-31-2003; IN COMMERCE 7-31-2003. BRIDGETT SMITH, EXAMINING ATTORNEY

SN 76-575,550. LIQUID SOLUTIONS INC., OAKVILLE, ONTARIO, L6M 3G1, CANADA, FILED 2-13-2004.

OIL LIMINATOR

PRIORITY CLAIMED UNDER SEC. 44(D) ON CANADA APPLICATION NO. 1191156, FILED 9-18-2003, REG. NO. TMA627633, DATED 12-6-2004, EXPIRES 12-6-2019.

THE LINING SHOWN THE DRAWING IS A FEATURE OF THE MARK.

FOR WATER PURIFYING APPARATUS, NAMELY HYDROCLONES; AND WATER FILTERS (U.S. CLS. 13, 21, 23, 31 AND 34).

TONI HICKEY, EXAMINING ATTORNEY

SN 76-565,161. SIDNEY FRANK IMPORTING CO., INC., NEW ROCHELLE, NY. FILED 12-2-2003.

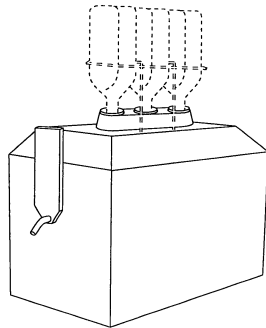

THE MARK CONSISTS OF THE THREE-DIMENSIONAL OVERALL APPEARANCE OF A COMPACT DISPENSING-CHILLING UNIT HAVING A PARALLELEPIPED LOWER PORTION AND A TRUNCATED PYRAMIDAL UPPER PORTION WITH A LARGE PADDLE SPIGOT AT THE FRONT AND A BOTTLE COLLAR ON TOP. THE MATTER SHOWN BY DOTTED LINES IN THE DRAWING IS NOT A PART OF THE MARK AND SERVES ONLY TO SHOW THE POSITIONING OF INVERTED BOTTLES OF LIQUID TO BE DISPENSED.

SEC. 2(F). FOR COMPACT REFRIGERATED BEVERAGE CHILLING AND DISPENSING UNITS (U.S. CLS. 13, 21, 23, 31 AND 34).

FIRST USE 0-0-1995; IN COMMERCE 0-0-1995. JENNIFER MARTIN, EXAMINING ATTORNEY

CLASS 11—(Continued).

SN 76-575,949. STREAMLIGHT, INC., EAGLEVILLE, PA. FILED 2-17-2004.

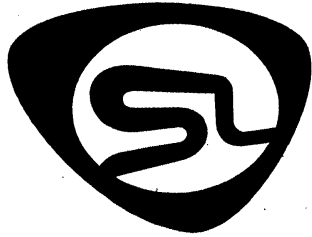

OWNER OF U.S. REG. NOS. 1,486,053, 1,486,054 AND 1,486,058.

FOR FLASHLIGHTS AND PARTS THEREOF AND FLASHLIGHT ACCESSORIES, NAMELY FLASHLIGHT CHARGERS AND FLASHLIGHT HOLSTERS (U.S. CLS. 13, 21, 23, 31 AND 34).

MICHAEL HALL, EXAMINING ATTORNEY

SN 76-576,393. GEA INTEGRATED COOLING TECHNOLOGIES, INC., LAKEWOOD, CO. FILED 2-17-2004.

PANORAMA

THE MARK CONSISTS OF STANDARD CHARACTERS WITHOUT CLAIM TO ANY PARTICULAR FONT, STYLE, SIZE, OR COLOR.

FOR COOLING TOWERS (U.S. CLS. 13, 21, 23, 31 AND 34).

FIRST USE 12-1-2003; IN COMMERCE 12-1-2003.

MICHELLE S. WISEMAN, EXAMINING ATTORNEY

SN 76-584,981. THE BASIC SOURCE, INC., ROHNERT PARK, CA. FILED 3-30-2004.

Condor Lighting

THE MARK CONSISTS OF STANDARD CHARACTERS WITHOUT CLAIM TO ANY PARTICULAR FONT, STYLE, SIZE, OR COLOR.

NO CLAIM IS MADE TO THE EXCLUSIVE RIGHT TO USE "LIGHTING", APART FROM THE MARK AS SHOWN. FOR ELECTRIC LIGHTING FIXTURES (U.S. CLS. 13, 21, 23, 31 AND 34).

FIRST USE 1-31-1994; IN COMMERCE 1-31-1994.

ROBIN CHOSID, EXAMINING ATTORNEY

CLASS 11—(Continued).

SN 76-586,162. AMERICAN AUTO ACCESSORIES INCORPORATION, CORONA, NY. FILED 4-12-2004.

NEKOI TOKYO

THE MARK CONSISTS OF STANDARD CHARACTERS WITHOUT CLAIM TO ANY PARTICULAR FONT, STYLE, SIZE, OR COLOR.

NO CLAIM IS MADE TO THE EXCLUSIVE RIGHT TO USE "TOKYO", APART FROM THE MARK AS SHOWN.

FOR AUTOMOBILE LIGHTING, NAMELY, HEADLIGHTS, INTERIOR LIGHTS, AND INTERIOR AND EXTERIOR DECORATIVE NEON LIGHTS (U.S. CLS. 13, 21, 23, 31 AND 34).

FIRST USE 1-31-2004; IN COMMERCE 1-31-2004.

SCOTT OSLICK, EXAMINING ATTORNEY

SN 76-589,130. HUBBELL INCORPORATED, ORANGE, CT. FILED 4-28-2004.

LAREDO

THE MARK CONSISTS OF STANDARD CHARACTERS WITHOUT CLAIM TO ANY PARTICULAR FONT, STYLE, SIZE, OR COLOR.

FOR ELECTRICAL LIGHTING FIXTURES (U.S. CLS. 13, 21, 23, 31 AND 34).

CHARLES L. JENKINS, EXAMINING ATTORNEY

SN 76-590,648. BARBER, CHARLES, COLORADO SPRINGS, CO. FILED 5-3-2004.



NO CLAIM IS MADE TO THE EXCLUSIVE RIGHT TO USE "VALVE", APART FROM THE MARK AS SHOWN.

THE MARK CONSISTS OF A BLACK AND WHITE DESIGN IN THREE PARTS: A. THE TOPMOST PART BEING A REPRESENTATION OF AN EFFLUENT LINE WITH A BACKWATER VALVE RESTRICTING WASTE-WATER FROM ENTERING A BUILDING. B. THE MIDDLE PART BEING THE WORDS "CHECK VALVE SALES", AND C. THE LOWER PART BEING A BLACK LINE IN WHICH ARE WHITE LETTERS SPELLING, "ICK- EOU", "KEEP THAT STUFF OUT OF MY BASEMENT".

FOR PLUMBING PRODUCTS, NAMELY UNIDIRECTIONAL AUTOMATIC WATER FLOW CONTROL VALVES (U.S. CLS. 13, 21, 23, 31 AND 34).

FIRST USE 4-28-2004; IN COMMERCE 4-28-2004.

C. DIONNE CLYBURN, EXAMINING ATTORNEY

CLASS 11—(Continued).

SN 76-591,447. THE MEYER COMPANY, CLEVELAND, OH. FILED 5-10-2004.

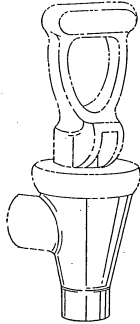

OWNER OF U.S. REG. NOS. 1,261,623 AND 2,058,539.
 THE MARK CONSISTS OF A CONFIGURATION OF A LIQUID DISPENSING FAUCET. THE DOTTED PORTION OF THE MARK IS NOT CLAIMED AND IS USED TO IDENTIFY THE RELATIVE POSITION OF THE MARK. THE LINING IN THE MARK IS USED TO INDICATE THAT THE MARK IS THREE DIMENSIONAL.
 SEC. 2(F).
 FOR FAUCETS (U.S. CLS. 13, 21, 23, 31 AND 34).
 FIRST USE 0-0-1955; IN COMMERCE 0-0-1955.
 RAMONA ORTIGA, EXAMINING ATTORNEY

SN 76-591,448. THE MEYER COMPANY, CLEVELAND, OH. FILED 5-10-2004.

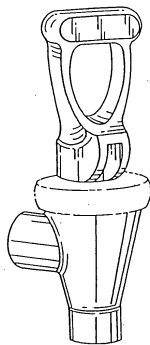

OWNER OF U.S. REG. NOS. 1,261,623 AND 2,058,539.
 THE MARK CONSISTS OF A CONFIGURATION OF A LIQUID DISPENSING FAUCET. THE DOTTED PORTION OF THE MARK IS NOT CLAIMED AND IS USED TO IDENTIFY THE RELATIVE POSITION OF THE MARK. THE LINING IN THE MARK IS USED TO INDICATE THAT THE MARK IS THREE DIMENSIONAL.
 SEC. 2(F).
 FOR FAUCETS (U.S. CLS. 13, 21, 23, 31 AND 34).
 FIRST USE 0-0-1955; IN COMMERCE 0-0-1955.
 RAMONA ORTIGA, EXAMINING ATTORNEY

CLASS 11—(Continued).

SN 76-591,925. THE SY-KLONE COMPANY, INC., JACKSONVILLE, FL. FILED 5-13-2004.

OPTIMAX

THE MARK CONSISTS OF STANDARD CHARACTERS WITHOUT CLAIM TO ANY PARTICULAR FONT, STYLE, SIZE, OR COLOR.
 FOR DUAL STAGE AIR INTAKE SYSTEMS FOR THE AIR INTAKE OF ENGINES, VENTILATION SYSTEMS AND OTHER APPARATUS THAT DRAW IN AIR LADEN WITH DEBRIS CONSISTING OF TWO STAGES THE FIRST OF WHICH IS COMPRISED OF A HOUSING AND IMPELLER ROTATABLY MOUNTED WITHIN THE HOUSING FOR CLEANING INTAKE AIR BY SPINNING THE INTAKE AIR AT HIGH SPEED TO SEPARATE HEAVIER-THAN-AIR CONTAMINATES THERE FROM BY CENTRIFUGAL FORCE, WITH THE IMPELLER BEING DRIVEN BY THE AIR DRAWN INTO THE SYSTEM, THE SECOND STAGE BEING AN EVACUATED VORTEX CHAMBER (U.S. CLS. 13, 21, 23, 31 AND 34).
 FIRST USE 10-0-2002; IN COMMERCE 10-0-2002.
 MARY CRAWFORD, EXAMINING ATTORNEY

SN 76-594,254. TOTO U.S.A., INC., MORROW, GA. FILED 5-21-2004.

CLAYTON

THE MARK CONSISTS OF STANDARD CHARACTERS WITHOUT CLAIM TO ANY PARTICULAR FONT, STYLE, SIZE, OR COLOR.
 FOR TOILETS, BIDETS, SHOWERS, BATHTUBS, SINKS, FAUCETS, AND LIGHTING FIXTURES (U.S. CLS. 13, 21, 23, 31 AND 34).
 RONALD AIKENS, EXAMINING ATTORNEY

SN 76-598,197. TOPAIR RANGE HOOD CORP., EL MONTE, CA. FILED 6-18-2004.

合家歡 TOPAIR

THE NON-LATIN CHARACTERS IN THE MARK TRANSLITERATE TO "HAP-KA-FOON," WHICH WHEN READ TOGETHER TRANSLATE IN ENGLISH TO "THE ENTIRE FAMILY IS HAPPY."
 FOR RANGE HOOD (U.S. CLS. 13, 21, 23, 31 AND 34).
 FIRST USE 2-7-2004; IN COMMERCE 2-7-2004.
 WINSTON FOLMAR, EXAMINING ATTORNEY

CLASS 11—(Continued).

SN 76-607,322. EIKO.LTD., SHAWNEE, KS. FILED 8-11-2004.

RAIN FRESH AIR

THE MARK CONSISTS OF STANDARD CHARACTERS WITHOUT CLAIM TO ANY PARTICULAR FONT, STYLE, SIZE, OR COLOR.

NO CLAIM IS MADE TO THE EXCLUSIVE RIGHT TO USE AIR, APART FROM THE MARK AS SHOWN.

FOR PORTABLE AIR CLEANING AND FILTRATION SYSTEMS CONSISTING OF AIR CLEANING UNITS WITH FILTERS (U.S. CLS. 13, 21, 23, 31 AND 34).

FIRST USE 3-1-2005; IN COMMERCE 3-1-2005.
ANDREA SAUNDERS, EXAMINING ATTORNEY

SN 76-608,264. SAVIO ENGINEERING, INC., SANTA FE, NM. FILED 8-23-2004.

SAVIO

THE MARK CONSISTS OF STANDARD CHARACTERS WITHOUT CLAIM TO ANY PARTICULAR FONT, STYLE, SIZE, OR COLOR.

FOR POND PRODUCTS, NAMELY, POND-MAKING PACKAGES COMPRISING WATER FILTERS, WATER PUMPS, BIOLOGICAL FILTERS, WATER CLARIFIERS, WATER SOLUTIONS, POND LINERS (U.S. CLS. 13, 21, 23, 31 AND 34).

FIRST USE 9-0-2002; IN COMMERCE 9-0-2002.
STEVEN JACKSON, EXAMINING ATTORNEY

SN 76-612,000. SEVERN TRENT WATER PURIFICATION, INC., COLMAR, PA. FILED 9-20-2004.

ClorTab

THE MARK CONSISTS OF STANDARD CHARACTERS WITHOUT CLAIM TO ANY PARTICULAR FONT, STYLE, SIZE, OR COLOR.

FOR WATER PURIFICATION APPARATUS THAT DISSOLVES DISINFECTANT AND DE-CHLORINATION TABLETS FOR DOSING POTABLE WATER AND WASTE WATER (U.S. CLS. 13, 21, 23, 31 AND 34).

FIRST USE 10-1-2003; IN COMMERCE 10-1-2003.
JIM RINGLE, EXAMINING ATTORNEY

CLASS 11—(Continued).

SN 76-613,058. DIMENSION ONE SPAS, INC., VISTA, CA. FILED 9-20-2004.

@HOME

THE MARK CONSISTS OF STANDARD CHARACTERS WITHOUT CLAIM TO ANY PARTICULAR FONT, STYLE, SIZE, OR COLOR.

FOR SPAS IN THE NATURE OF HEATED POOLS, WHIRLPOOLS, BATHTUBS, HOT TUBS, WHIRLPOOL BATHS, AND RECREATIONAL SWIMMING POOLS (U.S. CLS. 13, 21, 23, 31 AND 34).

FIRST USE 7-31-2004; IN COMMERCE 7-31-2004.
WILLIAM VERHOSEK, EXAMINING ATTORNEY

SN 76-613,443. ROONEY, KEVIN, SACRAMENTO, CA. FILED 9-29-2004.

KEV CATCHER

THE MARK CONSISTS OF STANDARD CHARACTERS WITHOUT CLAIM TO ANY PARTICULAR FONT, STYLE, SIZE, OR COLOR.

FOR STRAINERS FOR PLUMBING DRAINS (U.S. CLS. 13, 21, 23, 31 AND 34).

DAWN HAN, EXAMINING ATTORNEY

SN 76-616,467. DES-CASE CORPORATION, WHITE HOUSE, TN. FILED 10-13-2004.

HELPING INDUSTRY BREATHE BETTER

THE MARK CONSISTS OF STANDARD CHARACTERS WITHOUT CLAIM TO ANY PARTICULAR FONT, STYLE, SIZE, OR COLOR.

FOR HYGROSCOPIC FILTERS AND HYGROSCOPIC BREATHERS FOR CONTAMINATION CONTROL OF FLUID SYSTEMS (U.S. CLS. 13, 21, 23, 31 AND 34).

FIRST USE 1-0-2001; IN COMMERCE 1-0-2001.
DARRYL SPRUILL, EXAMINING ATTORNEY

CLASS 11—(Continued).

SN 76-616,577. LSI INDUSTRIES INC., CINCINNATI, OH.
FILED 10-18-2004.

SUPERKIT

THE MARK CONSISTS OF STANDARD CHARACTERS
WITHOUT CLAIM TO ANY PARTICULAR FONT, STYLE,
SIZE, OR COLOR.
OWNER OF U.S. REG. NO. 2,235,523.
SEC. 2(F).
FOR ELECTRICAL LIGHTING FIXTURES (U.S. CLS.
13, 21, 23, 31 AND 34).
FIRST USE 11-11-1997; IN COMMERCE 11-11-1997.
ALICE BENMAMAN, EXAMINING ATTORNEY

SN 76-617,028. ON THE GO PORTABLE WATER SOFTENER,
LLC, FORT WAYNE, IN. FILED 10-18-2004.

ON THE GO

THE MARK CONSISTS OF STANDARD CHARACTERS
WITHOUT CLAIM TO ANY PARTICULAR FONT, STYLE,
SIZE, OR COLOR.
FOR WATER SOFTENING UNITS (U.S. CLS. 13, 21, 23,
31 AND 34).
FIRST USE 1-26-2004; IN COMMERCE 1-26-2004.
SUSAN STIGLITZ, EXAMINING ATTORNEY

SN 76-617,834. CONSOLIDATED PLUMBING INDUSTRIES,
KNOXVILLE, TN. FILED 10-27-2004.

GRAND SLAM MANIFOLD

THE MARK CONSISTS OF STANDARD CHARACTERS
WITHOUT CLAIM TO ANY PARTICULAR FONT, STYLE,
SIZE, OR COLOR.
NO CLAIM IS MADE TO THE EXCLUSIVE RIGHT TO
USE MANIFOLD, APART FROM THE MARK AS SHOWN.
FOR POTABLE WATER MANIFOLD SYSTEM FOR
RESIDENTIAL USE AND PARTS THEREFORE (U.S.
CLS. 13, 21, 23, 31 AND 34).
FIRST USE 10-5-2004; IN COMMERCE 10-5-2004.
HOWARD B. LEVINE, EXAMINING ATTORNEY

CLASS 11—(Continued).

SN 76-622,151. MINKA LIGHTING, INC., CORONA, CA.
FILED 11-24-2004.

BALBOA BEACH

THE MARK CONSISTS OF STANDARD CHARACTERS
WITHOUT CLAIM TO ANY PARTICULAR FONT, STYLE,
SIZE, OR COLOR.
FOR CEILING FANS (U.S. CLS. 13, 21, 23, 31 AND 34).
STACY WAHLBERG, EXAMINING ATTORNEY

SN 76-622,152. MINKA LIGHTING, INC., CORONA, CA.
FILED 11-24-2004.

SEMILLON

THE MARK CONSISTS OF STANDARD CHARACTERS
WITHOUT CLAIM TO ANY PARTICULAR FONT, STYLE,
SIZE, OR COLOR.
FOR CEILING FANS (U.S. CLS. 13, 21, 23, 31 AND 34).
STACY WAHLBERG, EXAMINING ATTORNEY

SN 76-625,192. TOTO U.S.A., INC., MORROW, GA. FILED 12-
20-2004.

VESPIN

THE MARK CONSISTS OF STANDARD CHARACTERS
WITHOUT CLAIM TO ANY PARTICULAR FONT, STYLE,
SIZE, OR COLOR.
FOR PLUMBING FIXTURES, NAMELY, TOILETS,
BIDETS, BATHTUBS, SHOWERS, SINKS, FAUCETS
(U.S. CLS. 13, 21, 23, 31 AND 34).
FIRST USE 6-1-1999; IN COMMERCE 6-1-1999.
GEORGE LORENZO, EXAMINING ATTORNEY

CLASS 11—(Continued).

SN 76-625,672. TOTO U.S.A., INC., MORROW, GA. FILED 12-20-2004.

CARROLLTON

THE MARK CONSISTS OF STANDARD CHARACTERS WITHOUT CLAIM TO ANY PARTICULAR FONT, STYLE, SIZE, OR COLOR.

FOR PLUMBING FIXTURES, NAMELY, TOILETS, BIDETS, BATHTUBS, SHOWERS, SINKS, FAUCETS (U.S. CLS. 13, 21, 23, 31 AND 34).

FIRST USE 4-27-2001; IN COMMERCE 4-27-2001.
GEORGE LORENZO, EXAMINING ATTORNEY

CLASS 11—(Continued).

SN 76-625,678. TOTO U.S.A., INC., MORROW, GA. FILED 12-20-2004.

DORIAN

THE MARK CONSISTS OF STANDARD CHARACTERS WITHOUT CLAIM TO ANY PARTICULAR FONT, STYLE, SIZE, OR COLOR.

FOR PLUMBING FIXTURES, NAMELY, TOILETS, BIDETS, BATHTUBS, SHOWERS, SINKS, FAUCETS (U.S. CLS. 13, 21, 23, 31 AND 34).

FIRST USE 4-7-2000; IN COMMERCE 4-7-2000.
KIMBERLY PERRY, EXAMINING ATTORNEY

SN 76-625,675. TOTO U.S.A., INC., MORROW, GA. FILED 12-20-2004.

CARUSOE

THE MARK CONSISTS OF STANDARD CHARACTERS WITHOUT CLAIM TO ANY PARTICULAR FONT, STYLE, SIZE, OR COLOR.

FOR PLUMBING FIXTURES, NAMELY, TOILETS, BIDETS, BATHTUBS, SHOWERS, SINKS, FAUCETS (U.S. CLS. 13, 21, 23, 31 AND 34).

FIRST USE 4-1-1998; IN COMMERCE 4-1-1998.
KIMBERLY PERRY, EXAMINING ATTORNEY

SN 76-625,764. METROPOLITAN VACUUM CLEANER, CO., INC., SUFFERN, NY. FILED 12-21-2004.

STEALTH

THE MARK CONSISTS OF STANDARD CHARACTERS WITHOUT CLAIM TO ANY PARTICULAR FONT, STYLE, SIZE, OR COLOR.

FOR PORTABLE ELECTRIC AIR POWER BLOWER FOR USE IN DRYING PETS (U.S. CLS. 13, 21, 23, 31 AND 34).

FIRST USE 8-14-2003; IN COMMERCE 8-14-2003.
SUELLEN HICKEY, EXAMINING ATTORNEY

SN 76-625,677. TOTO U.S.A., INC., MORROW, GA. FILED 12-20-2004.

DARTMOUTH

THE MARK CONSISTS OF STANDARD CHARACTERS WITHOUT CLAIM TO ANY PARTICULAR FONT, STYLE, SIZE, OR COLOR.

FOR PLUMBING FIXTURES, NAMELY, TOILETS, BIDETS, BATHTUBS, SHOWERS, SINKS, FAUCETS (U.S. CLS. 13, 21, 23, 31 AND 34).

FIRST USE 8-15-2001; IN COMMERCE 10-1-2001.
KIMBERLY PERRY, EXAMINING ATTORNEY

SN 76-626,109. MINKA LIGHTING, INC., CORONA, CA. FILED 12-29-2004.

CRUISER

THE MARK CONSISTS OF STANDARD CHARACTERS WITHOUT CLAIM TO ANY PARTICULAR FONT, STYLE, SIZE, OR COLOR.

FOR CEILING FANS (U.S. CLS. 13, 21, 23, 31 AND 34).

FIRST USE 4-0-2002; IN COMMERCE 4-0-2002.
ALLISON HOLTZ, EXAMINING ATTORNEY

CLASS 11—(Continued).

SN 76-626,170. MINKA LIGHTING, INC., CORONA, CA.
FILED 12-28-2004.

VALLEJO

THE MARK CONSISTS OF STANDARD CHARACTERS
WITHOUT CLAIM TO ANY PARTICULAR FONT, STYLE,
SIZE, OR COLOR.
FOR CEILING FANS (U.S. CLS. 13, 21, 23, 31 AND 34).
FIRST USE 1-0-2004; IN COMMERCE 1-0-2004.
GEORGE LORENZO, EXAMINING ATTORNEY

SN 76-626,171. MINKA LIGHTING, INC., CORONA, CA.
FILED 12-28-2004.

ESCAPE

THE MARK CONSISTS OF STANDARD CHARACTERS
WITHOUT CLAIM TO ANY PARTICULAR FONT, STYLE,
SIZE, OR COLOR.
FOR CEILING FANS (U.S. CLS. 13, 21, 23, 31 AND 34).
FIRST USE 1-0-2004; IN COMMERCE 1-0-2004.
SOPHIA S. KIM, EXAMINING ATTORNEY

SN 76-633,771. ACUITY BRANDS, INC., ATLANTA, GA.
FILED 3-18-2005.

INTELLIBAY

THE MARK CONSISTS OF STANDARD CHARACTERS
WITHOUT CLAIM TO ANY PARTICULAR FONT, STYLE,
SIZE, OR COLOR.
FOR ELECTRIC LIGHTING FIXTURES (U.S. CLS. 13,
21, 23, 31 AND 34).
KIMBERLY FRYE, EXAMINING ATTORNEY

CLASS 11—(Continued).

SN 76-633,772. ACUITY BRANDS, INC., ATLANTA, GA.
FILED 3-18-2005.

INTELLIVUE

THE MARK CONSISTS OF STANDARD CHARACTERS
WITHOUT CLAIM TO ANY PARTICULAR FONT, STYLE,
SIZE, OR COLOR.
FOR ELECTRIC LIGHTING FIXTURES (U.S. CLS. 13,
21, 23, 31 AND 34).
KIMBERLY FRYE, EXAMINING ATTORNEY

SN 78-085,902. CCI THERMAL TECHNOLOGIES INC.,
EDMONTON, ALBERTA, CANADA, FILED 9-27-2001.

TRITON

PRIORITY CLAIMED UNDER SEC. 44(D) ON CANADA
APPLICATION NO. 1097578, FILED 3-28-2001, REG. NO.
TMA623,106, DATED 10-21-2004, EXPIRES 10-21-2019.
FOR HEATERS, NAMELY ELECTRIC HEATERS FOR
INDUSTRIAL USE AND PARTS THEREFOR (U.S. CLS.
13, 21, 23, 31 AND 34).
DAVID TAYLOR, EXAMINING ATTORNEY

SN 78-293,159. WATKINS MANUFACTURING CORPORA-
TION, VISTA, CA. FILED 8-27-2003.

LIFESPRINGS SPAS

NO CLAIM IS MADE TO THE EXCLUSIVE RIGHT TO
USE SPAS, APART FROM THE MARK AS SHOWN.
FOR PORTABLE SPAS IN THE NATURE OF HEATED
POOLS (U.S. CLS. 13, 21, 23, 31 AND 34).
FIRST USE 6-21-1997; IN COMMERCE 6-21-1997.
TRACY WHITAKER-BOWN, EXAMINING ATTORNEY

SN 78-311,681. WATKINS MANUFACTURING CORPORA-
TION, VISTA, CA. FILED 10-9-2003.

PALOMAR

FOR HOT TUBS AND SPAS IN THE NATURE OF
HEATED WHIRLPOOLS (U.S. CLS. 13, 21, 23, 31 AND 34).
SCOTT OSLICK, EXAMINING ATTORNEY

CLASS 11—(Continued).

SN 78-339,576. KX INDUSTRIES, L.P., ORANGE, CT. FILED 12-11-2003.

**MATRIKX
MICROBIOLOGICAL
BARRIER**

THE MARK CONSISTS OF STANDARD CHARACTERS WITHOUT CLAIM TO ANY PARTICULAR FONT, STYLE, SIZE, OR COLOR.

OWNER OF U.S. REG. NOS. 1,827,380 AND 2,027,085.
NO CLAIM IS MADE TO THE EXCLUSIVE RIGHT TO USE "MICROBIOLOGICAL BARRIER", APART FROM THE MARK AS SHOWN.

FOR AIR AND WATER FILTERS FOR DOMESTIC, COMMERCIAL AND INDUSTRIAL USE (U.S. CLS. 13, 21, 23, 31 AND 34).

JAMES GRIFFIN, EXAMINING ATTORNEY

CLASS 11—(Continued).

SN 78-361,159. MODERN EQUIPMENT COMPANY, INC., PORT WASHINGTON, WI. FILED 2-2-2004.

MICRO JET MELTER

THE MARK CONSISTS OF STANDARD CHARACTERS WITHOUT CLAIM TO ANY PARTICULAR FONT, STYLE, SIZE, OR COLOR.

NO CLAIM IS MADE TO THE EXCLUSIVE RIGHT TO USE "MELTER", APART FROM THE MARK AS SHOWN.
FOR GAS FIRED ALUMINUM MELTING FURNACE (U.S. CLS. 13, 21, 23, 31 AND 34).

FIRST USE 8-0-2003; IN COMMERCE 8-0-2003.

CHERYL CLAYTON, EXAMINING ATTORNEY

SN 78-354,981. SOUTHWEST WATER SOLUTIONS, L.L.C., SAN DIEGO, CA. FILED 1-21-2004.

Shower to Flower

THE MARK CONSISTS OF STANDARD CHARACTERS WITHOUT CLAIM TO ANY PARTICULAR FONT, STYLE, SIZE, OR COLOR.

FOR GRAY WATER RECLAMATION SYSTEM COMPRISING COLLECTION VALVE, WATER PUMP, FILTER, AND STORAGE TANK, AND IRRIGATION FIXTURES SOLD IN CONNECTION THEREWITH (U.S. CLS. 13, 21, 23, 31 AND 34).

STEVEN JACKSON, EXAMINING ATTORNEY

SN 78-371,939. CREWS, LEWIS JEREMY, RICHMOND, VA. FILED 2-22-2004.



NO CLAIM IS MADE TO THE EXCLUSIVE RIGHT TO USE "INDUSTRIES LTD.", APART FROM THE MARK AS SHOWN.

THE MARK CONSISTS OF PART OF THE DESIGN OF AN ANVIL.

FOR SPECIALTY COOLING AND HEATING PRODUCTS, NAMELY AIR CONDITIONING UNITS AND HEATING UNITS FOR USE IN OPERATOR'S CABS ON LARGE MOBILE INDUSTRIAL MACHINERY (U.S. CLS. 13, 21, 23, 31 AND 34).

FIRST USE 12-31-1993; IN COMMERCE 12-31-1993.

JIM RINGLE, EXAMINING ATTORNEY

CLASS 11—(Continued).

SN 78-380,389. PERMLIGHT PRODUCTS, INC., TUSTIN, CA. FILED 3-8-2004.

TWISTE-R

THE MARK CONSISTS OF STANDARD CHARACTERS WITHOUT CLAIM TO ANY PARTICULAR FONT, STYLE, SIZE, OR COLOR.

FOR ILLUMINATION DEVICES, NAMELY, INTERCONNECTED LIGHT FIXTURES FOR USE IN ILLUMINATED SIGNAGE AND DISPLAY LIGHTING (U.S. CLS. 13, 21, 23, 31 AND 34).

KIMBERLY FRYE, EXAMINING ATTORNEY

SN 78-380,398. PERMLIGHT PRODUCTS, INC., TUSTIN, CA. FILED 3-8-2004.

MONSTER-LIGHT

THE MARK CONSISTS OF STANDARD CHARACTERS WITHOUT CLAIM TO ANY PARTICULAR FONT, STYLE, SIZE, OR COLOR.

FOR ILLUMINATION DEVICES, NAMELY, LIGHTING FIXTURES CONTAINING LIGHT EMITTING DIODES (U.S. CLS. 13, 21, 23, 31 AND 34).

KIMBERLY FRYE, EXAMINING ATTORNEY

CLASS 11—(Continued).

SN 78-383,966. ENGINEERING FLUID SOLUTIONS, LLC, LAKEWOOD, CO. FILED 3-13-2004.



THE COLORS BLACK, GRAY AND AQUA BLUE ARE CLAIMED AS A FEATURE OF THE MARK.

THE COLORS BLACK AND GRAY APPEAR IN THE ACRONYM "CF" AND THE COLOR AQUA BLUE APPEARS IN THE WORD "CLARIFLO" IMBEDDED IN THE "CF".

THE MARK CONSISTS OF 3-D ACRONYM "CF" WITH "CLARIFLO" NAME IMBEDDED IN THE "CF".

FOR INDUSTRIAL WATER CLARIFICATION SYSTEM COMPRISED OF TANKS, SETTLING MEDIA, PUMPS, CONTROLS, AND PIPING, SOLD AS A UNIT (U.S. CLS. 13, 21, 23, 31 AND 34).

FIRST USE 5-15-2002; IN COMMERCE 5-15-2002.

ASMAT KHAN, EXAMINING ATTORNEY

SN 78-386,222. ENVIRO LABS, LP, VALENCIA, CA. FILED 3-17-2004.

MICROPURE

THE MARK CONSISTS OF STANDARD CHARACTERS WITHOUT CLAIM TO ANY PARTICULAR FONT, STYLE, SIZE, OR COLOR.

FOR AIR FILTERS, AIR CLEANERS, AND ULTRAVIOLET DISINFECTION UNITS/REACTORS FOR RESIDENTIAL HEATING, VENTILATION AND COOLING SYSTEMS; PHOTOCATALYTIC OXIDATION (PCO) FILTERS (U.S. CLS. 13, 21, 23, 31 AND 34).

KIMBERLY PERRY, EXAMINING ATTORNEY

CLASS 11—(Continued).

SN 78-388,574. MEDICLINICS, S. A., BARCELONA, SPAIN, FILED 3-22-2004.

CLASS 11—(Continued).

SN 78-393,549. PHASYC, INC., PARK CITY, UT. FILED 3-30-2004.

SANIFLOW

THE MARK CONSISTS OF STANDARD CHARACTERS WITHOUT CLAIM TO ANY PARTICULAR FONT, STYLE, SIZE, OR COLOR.

FOR WALL-MOUNTED AND HAND-HELD ELECTRIC HOT AIR DRYERS FOR THE HANDS, FACE AND HAIR (U.S. CLS. 13, 21, 23, 31 AND 34).

RAUL CORDOVA, EXAMINING ATTORNEY

PERMACLEAN

THE MARK CONSISTS OF STANDARD CHARACTERS WITHOUT CLAIM TO ANY PARTICULAR FONT, STYLE, SIZE, OR COLOR.

FOR AIRFLOW FILTER SYSTEMS COMPRISING ONE OR MORE COLD CATHODE ULTRA-VIOLET LAMPS IN A CHAMBER THAT CAN INCLUDE BAFFLING OR ONE OR MORE FILTERS, FOR USE IN CONNECTION WITH CENTRAL HEATING AND AIR CONDITIONING SYSTEMS; COMPONENT PARTS FOR SAID AIRFLOW FILTER SYSTEMS (U.S. CLS. 13, 21, 23, 31 AND 34).

FIRST USE 4-1-2000; IN COMMERCE 4-1-2000.

ANN E. SAPPENFIELD, EXAMINING ATTORNEY

SN 78-392,542. WORLD FACTORY, INC., SOUTHLAKE, TX. FILED 3-29-2004.

SN 78-396,021. HELENOWSKI, JACEK, STONE PARK, IL. FILED 4-4-2004.

SUNERGY

THE MARK CONSISTS OF STANDARD CHARACTERS WITHOUT CLAIM TO ANY PARTICULAR FONT, STYLE, SIZE, OR COLOR.

FOR SOLAR POWERED LAWN AND GARDEN LIGHTS (U.S. CLS. 13, 21, 23, 31 AND 34).

FIRST USE 8-1-2001; IN COMMERCE 8-1-2001.

ANDREW BENZMILLER, EXAMINING ATTORNEY

TOTAL COLOR LIGHTING

THE MARK CONSISTS OF STANDARD CHARACTERS WITHOUT CLAIM TO ANY PARTICULAR FONT, STYLE, SIZE, OR COLOR.

NO CLAIM IS MADE TO THE EXCLUSIVE RIGHT TO USE "COLOR LIGHTING", APART FROM THE MARK AS SHOWN.

FOR LUMINOUS TUBES FOR USE IN GENERAL AND ACCENT LIGHTING, NAMELY, EXPOSED ILLUMINATION, BACKLIGHTING, COVE LIGHTING, LIGHTING BOXES, SIGNAGE, AUTOMATIC LIGHTING CONTROL SYSTEMS, AND MANUAL LIGHTING CONTROL SYSTEMS (U.S. CLS. 13, 21, 23, 31 AND 34).

FIRST USE 5-1-1988; IN COMMERCE 10-1-1995.

WINSTON FOLMAR, EXAMINING ATTORNEY

CLASS 11—(Continued).

SN 78-400,669. ASHBROOK CORPORATION, HOUSTON, TX.
FILED 4-13-2004.

ECO-THERM

THE MARK CONSISTS OF STANDARD CHARACTERS WITHOUT CLAIM TO ANY PARTICULAR FONT, STYLE, SIZE, OR COLOR.

FOR SLUDGE PASTEURIZATION PROCESS SYSTEM COMPRISING A BIO-REACTOR AND HEAT EXCHANGER FOR PRODUCING CLASS "A" BIOSOLIDS (U.S. CLS. 13, 21, 23, 31 AND 34).

FIRST USE 2-19-2001; IN COMMERCE 2-19-2001.
ASMAT KHAN, EXAMINING ATTORNEY

CLASS 11—(Continued).

SN 78-403,326. MUG MASTER, INC., ROCHESTER, MN.
FILED 4-16-2004.

SOUP MASTER

THE MARK CONSISTS OF STANDARD CHARACTERS WITHOUT CLAIM TO ANY PARTICULAR FONT, STYLE, SIZE, OR COLOR.

NO CLAIM IS MADE TO THE EXCLUSIVE RIGHT TO USE "SOUP", APART FROM THE MARK AS SHOWN.

FOR THERMOELECTRIC AND ELECTRIC BEVERAGE MUG BASE FOR WARMING OR COOLING THE MUG AND ITS CONTENTS (U.S. CLS. 13, 21, 23, 31 AND 34).

MARK SPARACINO, EXAMINING ATTORNEY

SN 78-401,579. FRIGEL FIRENZE S.P.A., SCANDICCI, FLORENCE, ITALY, FILED 4-14-2004.

FRIGEL

THE MARK CONSISTS OF STANDARD CHARACTERS WITHOUT CLAIM TO ANY PARTICULAR FONT, STYLE, SIZE, OR COLOR.

FOR AIR AND/OR WATER BASED COOLING SYSTEMS COMPRISING OF HEAT EXCHANGERS AND FANS (U.S. CLS. 13, 21, 23, 31 AND 34).

FIRST USE 4-1-1998; IN COMMERCE 4-1-1998.
BRIDGETT SMITH, EXAMINING ATTORNEY

SN 78-409,017. ASTHMA FREEDOM, INC., EAST AMHERST, NY, FILED 4-27-2004.

**The Peaceful
Breeze Air Purifier
System**

THE MARK CONSISTS OF STANDARD CHARACTERS WITHOUT CLAIM TO ANY PARTICULAR FONT, STYLE, SIZE, OR COLOR.

NO CLAIM IS MADE TO THE EXCLUSIVE RIGHT TO USE "AIR PURIFIER SYSTEM", APART FROM THE MARK AS SHOWN.

FOR AIR PURIFIERS (U.S. CLS. 13, 21, 23, 31 AND 34).
JAMES A. RAUEN, EXAMINING ATTORNEY

CLASS 11—(Continued).

SN 78-412,216. Q LIGHTING, INC., LEXINGTON, KY. FILED 5-3-2004.

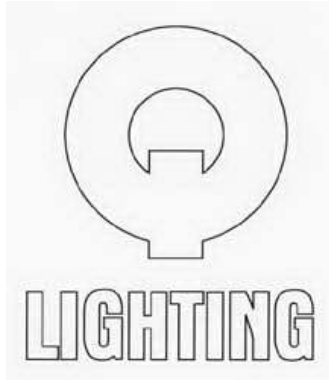

NO CLAIM IS MADE TO THE EXCLUSIVE RIGHT TO USE "LIGHTING", APART FROM THE MARK AS SHOWN. FOR PERSONAL HEADLIGHT WITH CLIP FOR HANDS FREE MOUNTING; MUSIC STAND LIGHT (U.S. CLS. 13, 21, 23, 31 AND 34).
 FIRST USE 7-1-2002; IN COMMERCE 7-1-2002.
 JOHN E. MICHOS, EXAMINING ATTORNEY

CLASS 11—(Continued).

SN 78-435,879. COOL CANDELA INC, ATLANTA, GA. FILED 6-16-2004.

Cool Candela

THE MARK CONSISTS OF STANDARD CHARACTERS WITHOUT CLAIM TO ANY PARTICULAR FONT, STYLE, SIZE, OR COLOR.
 NO CLAIM IS MADE TO THE EXCLUSIVE RIGHT TO USE "CANDELA", APART FROM THE MARK AS SHOWN. FOR ELECTRIC LUMINAIRES (U.S. CLS. 13, 21, 23, 31 AND 34).
 DAVID TAYLOR, EXAMINING ATTORNEY

SN 78-419,017. ISLAND SKY CORPORATION, NORTH MIAMI BEACH, FL. FILED 5-14-2004.

Island Sky

THE MARK CONSISTS OF STANDARD CHARACTERS WITHOUT CLAIM TO ANY PARTICULAR FONT, STYLE, SIZE, OR COLOR.
 FOR WATER TREATMENT SYSTEM AND DESALINATION DEVICES, NAMELY A REFRIGERANT GAS BASED REFRIGERATION SYSTEM COMPRISED OF HEAT EXCHANGER, COMPRESSORS, EVAPORATORS AND FANS THAT COLLECTS AND CONDENSES MOISTURE FROM THE ATMOSPHERE TO PRODUCE FRESH WATER (U.S. CLS. 13, 21, 23, 31 AND 34).
 SHARI SHEFFIELD, EXAMINING ATTORNEY

SN 78-436,489. HUNTER FAN COMPANY, MEMPHIS, TN. FILED 6-16-2004.

SANTORINI

THE MARK CONSISTS OF STANDARD CHARACTERS WITHOUT CLAIM TO ANY PARTICULAR FONT, STYLE, SIZE, OR COLOR.
 FOR CEILING FANS (U.S. CLS. 13, 21, 23, 31 AND 34).
 FIRST USE 4-30-2004; IN COMMERCE 4-30-2004.
 MICHAEL WEBSTER, EXAMINING ATTORNEY

CLASS 11—(Continued).

SN 78-443,637. BEMIS MANUFACTURING COMPANY, SHEBOYGAN FALLS, WI. FILED 6-30-2004.

CLASS 11—(Continued).

SN 78-457,815. OPTO TECH CORPORATION, HSINCHU CITY, TAIWAN, FILED 7-28-2004.

MY OWN POTTY

IRISin

THE MARK CONSISTS OF STANDARD CHARACTERS WITHOUT CLAIM TO ANY PARTICULAR FONT, STYLE, SIZE, OR COLOR.

SEC. 2(F) AS TO POTTY.
FOR TOILET SEATS (U.S. CLS. 13, 21, 23, 31 AND 34).
FIRST USE 9-0-1997; IN COMMERCE 11-0-1997.
TIMOTHY FINNEGAN, EXAMINING ATTORNEY

THE COLOR(S) BLUE IS/ARE CLAIMED AS A FEATURE OF THE MARK.

THE MARK CONSISTS OF THE WORD IRISIN IN BLUE LETTERING. THE DESIGN OVER THE "IN" IS THREE SLANTED RECTANGLES OF DIFFERING SIZES IN 3 GRADUATED SHADES OF BLUE.

FOR ELECTRONIC LIGHTING FIXTURES (U.S. CLS. 13, 21, 23, 31 AND 34).
FIRST USE 4-15-2004; IN COMMERCE 4-15-2004.
INGA ERVIN, EXAMINING ATTORNEY

SN 78-457,489. BOU-MATIC TECHNOLOGIES CORPORATION, HOUSTON, TX. FILED 7-27-2004.

SN 78-459,291. GRAND HALL ENTERPRISE CO., LTD., TAIPEI, TAIWAN, FILED 7-30-2004.



THE MARK CONSISTS OF A DESIGN INDICATING A BIRD.

FOR DEHUMIDIFIERS, AXIAL AIR MOVERS, FANS AND AIR BLOWERS FOR MOVING AIR AND PROMOTING DRYING AND POSITIVE OR NEGATIVE PRESSURIZATION OF SPACES (U.S. CLS. 13, 21, 23, 31 AND 34).
FIRST USE 4-1-1994; IN COMMERCE 4-1-1994.
ODESSA BIBBINS, EXAMINING ATTORNEY

THE STIPPLING IS A FEATURE OF THE MARK AND SHADING PURPOSES ONLY.

FOR GAS BARBECUE GRILLS (U.S. CLS. 13, 21, 23, 31 AND 34).
FIRST USE 3-31-1994; IN COMMERCE 6-30-1995.
DARRYL SPRUILL, EXAMINING ATTORNEY

CLASS 11—(Continued).

SN 78-460,643. ADVANCED PROPULSION TECHNOLOGIES, INC., GOLETA, CA. FILED 8-2-2004.

CLASS 11—(Continued).

SN 78-496,284. NUAIRE, INC., PLYMOUTH, MN. FILED 10-7-2004.

microsol

LABGARD

THE MARK CONSISTS OF STANDARD CHARACTERS WITHOUT CLAIM TO ANY PARTICULAR FONT, STYLE, SIZE, OR COLOR.

FOR FUEL BURNING RADIANT HEATERS, NAMELY FUEL BURNING PATIO HEATERS, FUEL BURNING SPACE HEATERS, FIREPLACE INSERTS, HEAT EXCHANGES AND FUEL BURNING FOOD COOKERS. (U.S. CLS. 13, 21, 23, 31 AND 34).

CHERYL CLAYTON, EXAMINING ATTORNEY

THE MARK CONSISTS OF STANDARD CHARACTERS WITHOUT CLAIM TO ANY PARTICULAR FONT, STYLE, SIZE, OR COLOR.

FOR AIR FILTRATION UNITS FOR USE IN WORKING SPACES (U.S. CLS. 13, 21, 23, 31 AND 34).

FIRST USE 0-0-1973; IN COMMERCE 0-0-1973.
SCOTT OSLICK, EXAMINING ATTORNEY

SN 78-470,706. CHAUVET & SONS, INC., HOLLYWOOD, FL. FILED 8-20-2004.

SN 78-496,339. SEARS BRANDS, LLC, HOFFMAN ESTATES, IL. FILED 10-7-2004.



ACCELER-ICE

NO CLAIM IS MADE TO THE EXCLUSIVE RIGHT TO USE INTEGRATED LIGHTING SYSTEM, APART FROM THE MARK AS SHOWN.

THE MARK CONSISTS OF THE LETTERS ILS WITHIN A SIX-SIDED GRAPHICAL DESIGN WITH THE WORDS INTEGRATED LIGHTING SYSTEM UNDERNEATH.

FOR COMMERCIAL ENTERTAINMENT LIGHTING SYSTEMS CONSISTING OF ELECTRIC LIGHTING FIXTURES, ELECTRICAL STAGE THEATRICAL LIGHTS, ELECTRIC STROBE LIGHTS, ELECTRONIC DISCO AND MOBILE DISC JOCKEY LIGHTS COMPRISED OF LASERS AND ELECTRONIC EFFECTS LIGHTING, WITH DMX CONTROL COMPATIBILITY (U.S. CLS. 13, 21, 23, 31 AND 34).

JOHN LINCOSKI, EXAMINING ATTORNEY

THE MARK CONSISTS OF STANDARD CHARACTERS WITHOUT CLAIM TO ANY PARTICULAR FONT, STYLE, SIZE, OR COLOR.

FOR ICE PRODUCTION CONTROL FEATURE AS A COMPONENT PART IN REFRIGERATORS (U.S. CLS. 13, 21, 23, 31 AND 34).

FIRST USE 1-0-2000; IN COMMERCE 1-0-2000.
MARLENE BELL, EXAMINING ATTORNEY

CLASS 11—(Continued).

SN 78-496,607. FIBERSTARS, INC., FREMONT, CA. FILED 10-7-2004.

CLASS 11—(Continued).

SN 78-496,707. AAF-MCQUAY INC., LOUISVILLE, KY. FILED 10-8-2004.

LIGHTLY EXPRESSED

THE MARK CONSISTS OF STANDARD CHARACTERS WITHOUT CLAIM TO ANY PARTICULAR FONT, STYLE, SIZE, OR COLOR.

FOR ELECTRIC LIGHTING FIXTURES ESPECIALLY LIGHTS AND LIGHTING FIXTURES THAT INCLUDE FIBEROPTICS (U.S. CLS. 13, 21, 23, 31 AND 34).

FIRST USE 5-0-1995; IN COMMERCE 5-0-1995.

JULIA HARDY COFIELD, EXAMINING ATTORNEY

INNSAVER

THE MARK CONSISTS OF STANDARD CHARACTERS WITHOUT CLAIM TO ANY PARTICULAR FONT, STYLE, SIZE, OR COLOR.

FOR PACKAGED TERMINAL AIR CONDITIONING UNITS AND PARTS THEREOF; COMMERCIAL AND RESIDENTIAL AIR CONDITIONING UNITS, AND PARTS THEREOF (U.S. CLS. 13, 21, 23, 31 AND 34).

ANNE MADDEN, EXAMINING ATTORNEY

SN 78-496,610. JME, INC., DBA TMB, PACOIMA, CA. FILED 10-7-2004.

SN 78-497,225. VERDI INC., BROOKLYN, NY. FILED 10-8-2004.

POWERPAR

THE MARK CONSISTS OF STANDARD CHARACTERS WITHOUT CLAIM TO ANY PARTICULAR FONT, STYLE, SIZE, OR COLOR.

FOR PORTABLE STAGE LIGHTING (U.S. CLS. 13, 21, 23, 31 AND 34).

FIRST USE 11-9-2000; IN COMMERCE 11-9-2000.

JULIA HARDY COFIELD, EXAMINING ATTORNEY

VERDI LIGHTING

THE MARK CONSISTS OF STANDARD CHARACTERS WITHOUT CLAIM TO ANY PARTICULAR FONT, STYLE, SIZE, OR COLOR.

NO CLAIM IS MADE TO THE EXCLUSIVE RIGHT TO USE "LIGHTING", APART FROM THE MARK AS SHOWN.

FOR LIGHTING FIXTURES SOLD TO RETAILERS (U.S. CLS. 13, 21, 23, 31 AND 34).

IRA J. GOODSaid, EXAMINING ATTORNEY

CLASS 11—(Continued).

SN 78-497,445. MORRIS, DAVID L., SAN ANTONIO, TX.
FILED 10-10-2004.

CLASS 11—(Continued).

SN 78-497,800. BEAD FILTERS INTERNATIONAL, LLC,
BATON ROUGE, LA. FILED 10-11-2004.

Sir-Q

POLYGEYSER

THE MARK CONSISTS OF STANDARD CHARACTERS
WITHOUT CLAIM TO ANY PARTICULAR FONT, STYLE,
SIZE, OR COLOR.
FOR ON-REQUEST HOT WATER CIRCULATOR (U.S.
CLS. 13, 21, 23, 31 AND 34).
KHANH LE, EXAMINING ATTORNEY

THE MARK CONSISTS OF STANDARD CHARACTERS
WITHOUT CLAIM TO ANY PARTICULAR FONT, STYLE,
SIZE, OR COLOR.
FOR WATER FILTRATION UNITS FOR FILTERING
FISH PONDS AND AQUARIA (U.S. CLS. 13, 21, 23, 31
AND 34).
FIRST USE 10-1-2004; IN COMMERCE 10-1-2004.
JENNIFER MARTIN, EXAMINING ATTORNEY

SN 78-497,533. BSH HOME APPLIANCES CORPORATION,
HUNTINGTON BEACH, CA. FILED 10-11-2004.

SN 78-498,433. HUNTER FAN COMPANY, MEMPHIS, TN.
FILED 10-12-2004.

AROMASWIRL

ZOE

THE MARK CONSISTS OF STANDARD CHARACTERS
WITHOUT CLAIM TO ANY PARTICULAR FONT, STYLE,
SIZE, OR COLOR.
FOR DOMESTIC ELECTRIC COFFEE MAKERS,
NAMELY ESPRESSO MACHINES AND PARTS THERE-
FORE (U.S. CLS. 13, 21, 23, 31 AND 34).
LINDA ESTRADA, EXAMINING ATTORNEY

THE MARK CONSISTS OF STANDARD CHARACTERS
WITHOUT CLAIM TO ANY PARTICULAR FONT, STYLE,
SIZE, OR COLOR.
FOR CEILING FANS (U.S. CLS. 13, 21, 23, 31 AND 34).
HEATHER THOMPSON, EXAMINING ATTORNEY

CLASS 11—(Continued).

SN 78-498,939. SEARS BRANDS, LLC, HOFFMAN ESTATES, IL. FILED 10-13-2004.

SUPRA FRESH

THE MARK CONSISTS OF STANDARD CHARACTERS WITHOUT CLAIM TO ANY PARTICULAR FONT, STYLE, SIZE, OR COLOR.

NO CLAIM IS MADE TO THE EXCLUSIVE RIGHT TO USE "FRESH", APART FROM THE MARK AS SHOWN.

FOR REFRIGERATOR PARTS, NAMELY, DRAWERS WITH HUMIDITY CONTROL (U.S. CLS. 13, 21, 23, 31 AND 34).

FIRST USE 4-0-2003; IN COMMERCE 4-0-2003.
ESTHER BELENKER, EXAMINING ATTORNEY

CLASS 11—(Continued).

SN 78-500,567. A & B LIGHT STAND, LLC, SWANVILLE, MN. FILED 10-15-2004.

Above and Beyond

THE MARK CONSISTS OF STANDARD CHARACTERS WITHOUT CLAIM TO ANY PARTICULAR FONT, STYLE, SIZE, OR COLOR.

FOR UTILITY ELECTRIC LIGHT STAND FOR THE PLACEMENT OF ELECTRIC LIGHTS AND WHICH IS ADJUSTABLE TO ALLOW BETTER POSITIONING OF THE TROUBLE LIGHT DURING ITS USE (U.S. CLS. 13, 21, 23, 31 AND 34).

FIRST USE 7-1-2004; IN COMMERCE 8-17-2004.
WILLIAM VERHOSEK, EXAMINING ATTORNEY

SN 78-498,971. SEARS BRANDS, LLC, HOFFMAN ESTATES, IL. FILED 10-13-2004.

FRONT CHILL

THE MARK CONSISTS OF STANDARD CHARACTERS WITHOUT CLAIM TO ANY PARTICULAR FONT, STYLE, SIZE, OR COLOR.

NO CLAIM IS MADE TO THE EXCLUSIVE RIGHT TO USE CHILL, APART FROM THE MARK AS SHOWN.

FOR COMPONENT PARTS OF REFRIGERATORS NAMELY COOLING AIR DUCTS (U.S. CLS. 13, 21, 23, 31 AND 34).

FIRST USE 4-0-2003; IN COMMERCE 4-0-2003.
JOHN HWANG, EXAMINING ATTORNEY

SN 78-501,287. CASY POTTERY COMPANY, L.L.P., MARSHALL, TX. FILED 10-18-2004.

LA-TEE-DA!

THE MARK CONSISTS OF STANDARD CHARACTERS WITHOUT CLAIM TO ANY PARTICULAR FONT, STYLE, SIZE, OR COLOR.

FOR OIL FRAGRANCE LAMPS (U.S. CLS. 13, 21, 23, 31 AND 34).

FIRST USE 3-1-2004; IN COMMERCE 3-1-2004.
CAROLYN GRAY, EXAMINING ATTORNEY

CLASS 11—(Continued).

SN 78-501,874. GUILD ASSOCIATES, INC., DUBLIN, OH.
FILED 10-19-2004.

CLASS 11—(Continued).

SN 78-502,101. HUNTER FAN COMPANY, MEMPHIS, TN.
FILED 10-19-2004.

TRINITY

MONACO

THE MARK CONSISTS OF STANDARD CHARACTERS WITHOUT CLAIM TO ANY PARTICULAR FONT, STYLE, SIZE, OR COLOR.

FOR EMISSION CONTROL AND ABATEMENT EQUIPMENT, NAMELY, MACHINES TO DESTROY VOLATILE ORGANIC COMPOUNDS (U.S. CLS. 13, 21, 23, 31 AND 34).

FIRST USE 9-18-2002; IN COMMERCE 9-18-2002.
AMY HELLA, EXAMINING ATTORNEY

THE MARK CONSISTS OF STANDARD CHARACTERS WITHOUT CLAIM TO ANY PARTICULAR FONT, STYLE, SIZE, OR COLOR.

FOR CEILING FANS (U.S. CLS. 13, 21, 23, 31 AND 34).
FIRST USE 4-30-2004; IN COMMERCE 4-30-2004.
AMY ALFIERI, EXAMINING ATTORNEY

SN 78-501,900. APEX VALVES LIMITED, ROSEBANK, AUCKLAND, NEW ZEALAND, FILED 10-19-2004.

SN 78-511,581. LAERA, VITO ANTONIO, FORT LAUDERDALE, FL. FILED 11-4-2004.

XTRAFLO

C-TECH-I

THE MARK CONSISTS OF STANDARD CHARACTERS WITHOUT CLAIM TO ANY PARTICULAR FONT, STYLE, SIZE, OR COLOR.

FOR WATER CONTROL VALVES (U.S. CLS. 13, 21, 23, 31 AND 34).

FIRST USE 5-1-1998; IN COMMERCE 2-14-2002.
STEVEN R. FINE, EXAMINING ATTORNEY

THE MARK CONSISTS OF STANDARD CHARACTERS WITHOUT CLAIM TO ANY PARTICULAR FONT, STYLE, SIZE, OR COLOR.

FOR SINKS AND FAUCETS (U.S. CLS. 13, 21, 23, 31 AND 34).

FIRST USE 8-15-2002; IN COMMERCE 8-15-2002.
KARLA PERKINS, EXAMINING ATTORNEY

CLASS 11—(Continued).

SN 78-511,989. ORECK HOLDINGS, LLC, CHEYENNE, WY.
FILED 11-5-2004.

**NOTHING GETS BY AN
ORECK**

THE MARK CONSISTS OF STANDARD CHARACTERS
WITHOUT CLAIM TO ANY PARTICULAR FONT, STYLE,
SIZE, OR COLOR.

OWNER OF U.S. REG. NO. 1,860,794.
FOR AIR PURIFIERS, PARTS AND ACCESSORIES
THEREOF (U.S. CLS. 13, 21, 23, 31 AND 34).
FIRST USE 7-31-2004; IN COMMERCE 7-31-2004.
APRIL L. RADEMACHER, EXAMINING ATTORNEY

CLASS 11—(Continued).

SN 78-514,636. HUNTER FAN COMPANY, MEMPHIS, TN.
FILED 11-10-2004.

VALHALLA

THE MARK CONSISTS OF STANDARD CHARACTERS
WITHOUT CLAIM TO ANY PARTICULAR FONT, STYLE,
SIZE, OR COLOR.

FOR CEILING FANS (U.S. CLS. 13, 21, 23, 31 AND 34).
ROBERT LAVACHE, EXAMINING ATTORNEY

SN 78-512,178. AKTIEBOLAGET ELECTROLUX, SE-105 45
STOCKHOLM, SWEDEN, FILED 11-5-2004.

 Electrolux | ICON

OWNER OF U.S. REG. NOS. 2,704,689, 2,794,522 AND
2,854,144.

THE MARK CONSISTS OF STYLIZED E AND OTHER
STYLIZED LETTERS AS SHOWN.

FOR DOMESTIC AND COMMERCIAL OUTDOOR
ELECTRIC AND GAS GRILLS AND WINE COOLERS,
NAMELY, REFRIGERATED CABINETS CONTAINING
RACKS FOR WINE BOTTLES AND STORAGE SHELVES
(U.S. CLS. 13, 21, 23, 31 AND 34).

CATHERINE CAIN, EXAMINING ATTORNEY

SN 78-514,906. CATALYTIC GENERATORS, INC., NOR-
FOLK, VA. FILED 11-10-2004.

SN 78-513,891. ETS, INC., INDIANAPOLIS, IN. FILED 11-9-
2004.

STAR

THE MARK CONSISTS OF STANDARD CHARACTERS
WITHOUT CLAIM TO ANY PARTICULAR FONT, STYLE,
SIZE, OR COLOR.

FOR TANNING BEDS AND TANNING BOOTHS (U.S.
CLS. 13, 21, 23, 31 AND 34).

HEATHER THOMPSON, EXAMINING ATTORNEY

SMART-RIPE

THE MARK CONSISTS OF STANDARD CHARACTERS
WITHOUT CLAIM TO ANY PARTICULAR FONT, STYLE,
SIZE, OR COLOR.

FOR ETHYLENE GAS GENERATOR FOR RIPENING
FRUIT (U.S. CLS. 13, 21, 23, 31 AND 34).

REBECCA GAN, EXAMINING ATTORNEY

CLASS 11—(Continued).

SN 78-514,987. INASCENTS LLC, PLEASANT VIEW, UT.
FILED 11-10-2004.

Candlebracelet

THE MARK CONSISTS OF STANDARD CHARACTERS WITHOUT CLAIM TO ANY PARTICULAR FONT, STYLE, SIZE, OR COLOR.
FOR ELECTRIC WARMER THAT CAN BE PLACED AROUND A CANDLE AT ANY LEVEL FOR USE AS A CANDLE MELTER (U.S. CLS. 13, 21, 23, 31 AND 34).
FIRST USE 11-10-2004; IN COMMERCE 11-10-2004.
ELLEN PERKINS, EXAMINING ATTORNEY

SN 78-518,333. EURO-PRO OPERATING LLC, WEST NEWTON, MA. FILED 11-17-2004.

EURO-PRO

THE MARK CONSISTS OF STANDARD CHARACTERS WITHOUT CLAIM TO ANY PARTICULAR FONT, STYLE, SIZE, OR COLOR.
OWNER OF U.S. REG. NOS. 1,373,148, 2,053,143 AND OTHERS.
FOR AIR PURIFIERS AND HUMIDIFIERS FOR DOMESTIC USE (U.S. CLS. 13, 21, 23, 31 AND 34).
REBECCA GILBERT, EXAMINING ATTORNEY

CLASS 11—(Continued).

SN 78-520,674. PROCESS 4, INC., CHAGRIN FALLS, OH.
FILED 11-21-2004.

TOWEL TOASTER

THE MARK CONSISTS OF STANDARD CHARACTERS WITHOUT CLAIM TO ANY PARTICULAR FONT, STYLE, SIZE, OR COLOR.
NO CLAIM IS MADE TO THE EXCLUSIVE RIGHT TO USE "TOWEL", APART FROM THE MARK AS SHOWN.
FOR ELECTRIC DEVICES FOR WARMING TOWELS (U.S. CLS. 13, 21, 23, 31 AND 34).
ANNE FARRELL, EXAMINING ATTORNEY

SN 78-525,179. ENSOLVE BIOSYSTEMS, INC, RALEIGH, NC.
FILED 12-1-2004.

ENSOLVE

THE MARK CONSISTS OF STANDARD CHARACTERS WITHOUT CLAIM TO ANY PARTICULAR FONT, STYLE, SIZE, OR COLOR.
FOR WASTE STREAM PURIFICATION UNITS COMPRISING OF BIOFILTERS, BIOREACTORS, MEDIA AND MICROORGANISMS ASSOCIATED WITH THESE DEVICES (U.S. CLS. 13, 21, 23, 31 AND 34).
FIRST USE 12-19-1995; IN COMMERCE 12-19-1995.
ELLEN PERKINS, EXAMINING ATTORNEY

CLASS 11—(Continued).

SN 78-528,140. EVAC OY, ESPOO, FINLAND, FILED 12-7-2004.

INSHINE

THE MARK CONSISTS OF STANDARD CHARACTERS WITHOUT CLAIM TO ANY PARTICULAR FONT, STYLE, SIZE, OR COLOR.

FOR TOILETS; REPLACEMENT AND COMPONENT PARTS THEREFOR (U.S. CLS. 13, 21, 23, 31 AND 34).
FRED MANDIR, EXAMINING ATTORNEY

CLASS 11—(Continued).

SN 78-533,743. BLANCO GMBH + CO KG, OBERDERDINGEN, FED REP GERMANY, FILED 12-16-2004.

PRECISION

THE MARK CONSISTS OF STANDARD CHARACTERS WITHOUT CLAIM TO ANY PARTICULAR FONT, STYLE, SIZE, OR COLOR.

FOR PLUMBING FIXTURES AND ACCESSORIES, NAMELY SINKS (U.S. CLS. 13, 21, 23, 31 AND 34).
FIRST USE 4-2-2004; IN COMMERCE 4-2-2004.
ROBERT LAVACHE, EXAMINING ATTORNEY

SN 78-528,866. ARCHISTORIC PRODUCTS, LLC, CHICAGO, IL. FILED 12-8-2004.



NO CLAIM IS MADE TO THE EXCLUSIVE RIGHT TO USE "COLLECTION", APART FROM THE MARK AS SHOWN.

THE COLOR(S) GRAY IS/ARE CLAIMED AS A FEATURE OF THE MARK.

GRAY APPEARS ON THE LETTER H WHICH SHADOWS THE LETTER A IN THE STYLIZED DESIGN.

THE MARK CONSISTS OF A STYLIZED A ABOVE A STYLIZED H TO THE LEFT OF THE WORD ARCHIVE AND THE WORD COLLECTION WHICH APPEARS BELOW THE WORD ARCHIVE, THE LETTERS ARCH APPEARING IN BOLD.

FOR LIGHTING FIXTURES (U.S. CLS. 13, 21, 23, 31 AND 34).

FIRST USE 10-18-2004; IN COMMERCE 10-18-2004.
JOHN HWANG, EXAMINING ATTORNEY

SN 78-535,274. U-HAUL INTERNATIONAL, INC., PHOENIX, AZ. FILED 12-20-2004.

U-HAUL

THE MARK CONSISTS OF STANDARD CHARACTERS WITHOUT CLAIM TO ANY PARTICULAR FONT, STYLE, SIZE, OR COLOR.

OWNER OF U.S. REG. NOS. 746,034, 893,891 AND OTHERS.

FOR TRAILER LIGHTS FOR VEHICLES AND BOATS; LIGHTS FOR VEHICLES, NAMELY, TAIL LIGHTS (U.S. CLS. 13, 21, 23, 31 AND 34).

FIRST USE 3-1-1991; IN COMMERCE 3-1-1991.
THEODORE MCBRIDE, EXAMINING ATTORNEY

CLASS 11—(Continued).

SN 78-538,122. YANKEE CANDLE COMPANY, INC., THE, SOUTH DEERFIELD, MA. FILED 12-23-2004.

CLASS 11—(Continued).

SN 78-538,737. ADAGIO TEAS, CLIFTON, NJ. FILED 12-27-2004.

FRUIT SMOOTHIE

utiliTEA

THE MARK CONSISTS OF STANDARD CHARACTERS WITHOUT CLAIM TO ANY PARTICULAR FONT, STYLE, SIZE, OR COLOR.

FOR ELECTRIC FRAGRANCE DISPENSERS (U.S. CLS. 13, 21, 23, 31 AND 34).
DEBRA LEE, EXAMINING ATTORNEY

THE MARK CONSISTS OF STANDARD CHARACTERS WITHOUT CLAIM TO ANY PARTICULAR FONT, STYLE, SIZE, OR COLOR.

FOR ELECTRIC KETTLE (U.S. CLS. 13, 21, 23, 31 AND 34).
FIRST USE 11-15-2004; IN COMMERCE 11-15-2004.
JAMES A. RAUEN, EXAMINING ATTORNEY

SN 78-538,130. THE YANKEE CANDLE COMPANY, INC., SOUTH DEERFIELD, MA. FILED 12-23-2004.

SN 79-001,877. HERBERT SILDERHUIS, NETHERLANDS, FILED 2-18-2004.

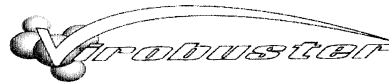

JACK FROST

PRIORITY DATE OF 11-26-2003 IS CLAIMED.
OWNER OF INTERNATIONAL REGISTRATION 0822307 DATED 2-18-2004, EXPIRES 2-18-2014.

THE COLOR GRAY IS CLAIMED AS A FEATURE OF THE MARK.

THE COLOR GRAY APPEARS IN THE BUBBLES IN THE MARK.

FOR AIR CONDITIONING APPARATUS AND CENTRAL AIR CONDITIONING INSTALLATIONS FOR DOMESTIC AND INDUSTRIAL PURPOSES; AIR CONDITIONERS FOR DOMESTIC AND INDUSTRIAL PURPOSES; VENTILATION APPARATUS AND INSTALLATIONS FOR DOMESTIC AND INDUSTRIAL PURPOSES; HOT AIR APPARATUS AND INSTALLATIONS, NAMELY, AIR PURIFIERS; HEATING AND COOLING APPLIANCES, NAMELY, HEAT PUMPS AND THEIR FILTERS; REPLACEMENT PARTS OF THE AFOREMENTIONED GOODS (U.S. CLS. 13, 21, 23, 31 AND 34).
GINA FINK, EXAMINING ATTORNEY

THE MARK CONSISTS OF STANDARD CHARACTERS WITHOUT CLAIM TO ANY PARTICULAR FONT, STYLE, SIZE, OR COLOR.

FOR ELECTRIC FRAGRANCE DISPENSERS (U.S. CLS. 13, 21, 23, 31 AND 34).
DAVID ELTON, EXAMINING ATTORNEY

CLASS 11—(Continued).

SN 79-002,575. HOTSET HEIZPATRONEN U. ZUBEHÖR GMBH, FED REP GERMANY, FILED 1-30-2004.

hotspring

THE MARK CONSISTS OF STANDARD CHARACTERS WITHOUT CLAIM TO ANY PARTICULAR FONT, STYLE, SIZE, OR COLOR.

PRIORITY DATE OF 10-15-2003 IS CLAIMED.

OWNER OF INTERNATIONAL REGISTRATION 0824917 DATED 1-30-2004, EXPIRES 1-30-2014.

FOR ELECTRIC HEATING DEVICES FOR INDUSTRIAL PURPOSES, NAMELY, FOR PROCESSING, SHAPING, SPRAYING AND MOLDING OF PLASTICS, RUBBERS AND SILICONES, FOR HEATING OF MANIFOLDS, NOZZLES, CHANNELS, DYES, FOR HEATING OF LIQUIDS INCLUDING OILS, FOR HEATING OF ROLLS, WELDERS AND MACHINE PARTS AND PIPING; ELECTRIC HEATING CARTRIDGES FOR INDUSTRIAL PURPOSES, NAMELY, THE PROCESSING, SHAPING, SPRAYING AND MOLDING OF PLASTICS, RUBBERS AND SILICONES (U.S. CLS. 13, 21, 23, 31 AND 34).

KELLY BOULTON, EXAMINING ATTORNEY

CLASS 11—(Continued).

SN 79-003,158. NICHIA CORPORATION, JAPAN, FILED 4-22-2004.



OWNER OF INTERNATIONAL REGISTRATION 0826807 DATED 4-22-2004, EXPIRES 4-22-2014.

OWNER OF U.S. REG. NOS. 1,485,803 AND 2,020,899.

NO CLAIM IS MADE TO THE EXCLUSIVE RIGHT TO USE "GENUINE" AND "LED", APART FROM THE MARK AS SHOWN.

FOR LIGHT-EMITTING DIODE PENLIGHTS AND LIGHT-EMITTING DIODE PENLIGHTS WITH KEYRINGS; LIGHT-EMITTING DIODE AUTOMOTIVE HEADLAMPS; LIGHT-EMITTING DIODE READING LAMPS FOR VEHICLES OR HOUSEHOLD PURPOSES; LIGHT-EMITTING DIODE HEADLIGHTS FOR VEHICLES; AND LIGHT-EMITTING DIODE AUTOMOTIVE INTERIOR DOME LIGHTS (U.S. CLS. 13, 21, 23, 31 AND 34).

STEVEN JACKSON, EXAMINING ATTORNEY

SN 79-002,860. BECKER GANSER EDMUND, FRANCE, FILED 2-17-2004.

Wine  Sceptre

OWNER OF INTERNATIONAL REGISTRATION 0825792 DATED 2-17-2004, EXPIRES 2-17-2014.

NO CLAIM IS MADE TO THE EXCLUSIVE RIGHT TO USE "WINE", APART FROM THE MARK AS SHOWN.

FOR REFRIGERATING APPARATUS AND COOLING INSTALLATIONS FOR LIQUIDS, NAMELY A COOLED BODY DIMENSIONED TO BE DISPOSED IN A BOTTLE, NAMELY REFRIGERATED DISPENSING UNITS FOR BEVERAGES (U.S. CLS. 13, 21, 23, 31 AND 34).

MARLENE BELL, EXAMINING ATTORNEY

SN 79-003,515. TANGSHAN MONOPY CERAMIC CO., LTD., CHINA, FILED 3-8-2004.

monopy

OWNER OF INTERNATIONAL REGISTRATION 0827888 DATED 3-8-2004, EXPIRES 3-8-2014.

THE MARK CONSIST OF THE CHARACTERS "MONOPY".

FOR BIDETS, BATHTUBS, TOILETS, TOILET BOWLS, WATER CLOSETS, SHOWERS, LAVATORIES, TOILET SEATS, WASHING SINKS; SANITATION FIXTURES, NAMELY URINALS, WASH BASINS, PLUMBING FITTINGS, NAMELY, VALVES FOR WATER LEVEL CONTROL (U.S. CLS. 13, 21, 23, 31 AND 34).

TIMOTHY FINNEGAN, EXAMINING ATTORNEY

CLASS 11—(Continued).

SN 79-003,627. TACMINA CORPORATION, JAPAN, FILED 12-8-2003.



OWNER OF INTERNATIONAL REGISTRATION 0828123 DATED 12-8-2003, EXPIRES 12-8-2013.

THE COLOR(S) COMBINATION OF GREEN AND BLUE IS/ARE CLAIMED AS A FEATURE OF THE MARK.

THE COLOR GREEN APPEARS IN THE HALF CIRCLE PORTION OF THE MARK AND ALL REMAINING PORTIONS OF THE MARK ARE BLUE.

FOR CHLORINE STERILIZING APPARATUS FOR SWIMMING POOLS; HEAT EXCHANGERS; BATH-WATER STERILIZING APPARATUS FOR INDUSTRIAL USE, FOOD STERILIZING APPARATUS; WATER-PURIFYING APPARATUS FOR HOT SPRINGS OR SWIMMING POOLS; WATER-PURIFYING APPARATUS FOR OTHER PURPOSE; ELECTRIC BATH-WATER PURIFYING APPARATUS FOR HOUSEHOLD; EVAPORATORS; DISTILLERS; MILK STERILIZERS; INDUSTRIAL FURNACES; INDUSTRIAL BOILERS; FREEZING MACHINES AND APPARATUS; CLOTHS DRYERS FOR INDUSTRIAL PURPOSES; HAIR DRYING APPARATUS FOR BEAUTY SALON USE; INDUSTRIAL DISH DRYERS; DISH DISINFECTANT APPARATUS FOR INDUSTRIAL USE; TAP WATER FAUCETS; LEVEL CONTROLLING PLUMBING VALVES FOR TANKS; GARBAGE INCINERATORS; SOLAR WATER HEATERS; WATER PURIFYING APPARATUS; WASHERS FOR WATER TAPS; KITCHEN SINKS; ICE CHESTS; HOUSEHOLD TAP-WATER FILTERS; GAS LAMPS; OIL LAMPS; LAMP CHIMNEYS; TOILET STOOL UNITS WITH A WASHING WATER SQUIRTER; DISINFECTANT DISPENSERS FOR TOILETS; TOILET BOWLS; WASTE WATER TREATMENT TANKS FOR HOUSEHOLD PURPOSES; SEPTIC TANKS FOR HOUSEHOLD PURPOSES (U.S. CLS. 13, 21, 23, 31 AND 34).

CHERYL CLAYTON, EXAMINING ATTORNEY

SN 79-004,002. UNOX S.P.A., ITALY, FILED 5-7-2004.



PRIORITY DATE OF 4-28-2004 IS CLAIMED.
OWNER OF INTERNATIONAL REGISTRATION 0829404 DATED 5-7-2004, EXPIRES 5-7-2014.

THE MARK CONSISTS OF THE FANCY WORDING "KOLDAX" WRITTEN IN FANCY CHARACTERS INSIDE TWO CONCENTRIC ELLIPSES, WHERE THE INNER ONE

CLASS 11—(Continued).

IS CHARACTERIZED BY A BACKGROUND HAVING A CONTRASTING SHADE WITH THAT OF THE EXTERIOR ELLIPSE, IN PARTICULAR, THE INITIAL LETTER "K" IS BIGGER THAN THE REMAINING VERBAL PORTION, WHICH IS WRITTEN IN CONTRASTING SHADES WITH THE BACKGROUND, WITH THE EXCEPTION OF THE FINAL LETTER "X" WHICH HAS THE SAME SHADE AS THE BACKGROUND OF THE INTERNAL ELLIPSE AND IS CHARACTERIZED BY A BOLD OUTLINE IN CONTRAST WITH THE SAME BACKGROUND.

FOR APPARATUS FOR REFRIGERATING, NAMELY REFRIGERATORS; APPARATUS FOR VENTILATING, NAMELY VENTILATING FANS FOR COMMERCIAL AND INDUSTRIAL USE; APPARATUS FOR PROFESSIONAL REFRIGERATING, NAMELY REFRIGERATING MACHINES; FOOD AND BEVERAGE CHILLING UNITS IN THE NATURE OF BLAST CHILLERS, FREEZERS, SHOCK FREEZERS, REFRIGERATING COUNTERS, REFRIGERATED TABLES; REFRIGERATED RETARDER-PROVER APPARATUS, NAMELY REFRIGERATING AND HEATING MACHINES FOR THE CONTROL OF LEAVENING PROCESSES (U.S. CLS. 13, 21, 23, 31 AND 34).

LINDA ESTRADA, EXAMINING ATTORNEY

SN 79-004,722. MK ILLUMINATION HANDELS GMBH, AUSTRIA, FILED 6-22-2004.

G WIRE

THE MARK CONSISTS OF STANDARD CHARACTERS WITHOUT CLAIM TO ANY PARTICULAR FONT, STYLE, SIZE, OR COLOR.

PRIORITY DATE OF 1-30-2004 IS CLAIMED.

OWNER OF INTERNATIONAL REGISTRATION 0831829 DATED 6-22-2004, EXPIRES 6-22-2014.

FOR LIGHT TUBES OF ELECTRO-LUMINESCENT MATERIAL (U.S. CLS. 13, 21, 23, 31 AND 34).

RENEE MCCRAY, EXAMINING ATTORNEY

SN 79-004,838. STAYL MEDIZINTECHNIK GMBH, FED REP GERMANY, FILED 6-17-2004.

freeSTAYL

PRIORITY DATE OF 2-27-2004 IS CLAIMED.

OWNER OF INTERNATIONAL REGISTRATION 0831891 DATED 6-17-2004, EXPIRES 6-17-2014.

FOR TANNING MACHINES, NAMELY, TANNING BEDS AND TANNING LAMPS; UV ILLUMINANTS, NAMELY, TANNING LAMPS FOR SUNBATHING OR THERAPEUTIC EXPOSURE TO LIGHT (U.S. CLS. 13, 21, 23, 31 AND 34).

FRED MANDIR, EXAMINING ATTORNEY

CLASS 11—(Continued).

SN 79-005,140. ELICA S.P.A., ITALY, FILED 4-30-2004.



PRIORITY DATE OF 2-5-2004 IS CLAIMED.
OWNER OF INTERNATIONAL REGISTRATION 0832713
DATED 4-30-2004, EXPIRES 4-30-2014.

TRADEMARK CONSISTING OF THE LETTER "E" HAVING A TAIL COMPOSED OF MANY STRIPES AS TO LOOK LIKE A WAKE.

FOR EXHAUST HOODS FOR KITCHENS, VENTILATING EXHAUST FANS AND DEVICES FOR EXHAUSTING, FILTERING, DEPURATING, REGENERATING, HEATING, COOLING AND CONDITIONING THE AIR NAMELY, ELECTRIC HEATING FANS (U.S. CLS. 13, 21, 23, 31 AND 34).

FLORENTINA BLANDU, EXAMINING ATTORNEY

CLASS 12—(Continued).

SN 76-421,724. FREESTYLE PROMOTIONS-99, S.L., 36214 VIGO (PONTEVEDRA), SPAIN, FILED 6-17-2002.



OWNER OF SPAIN REG. NO. 2.363.845, DATED 6-5-2001, EXPIRES 12-11-2010.

FOR BICYCLES (U.S. CLS. 19, 21, 23, 31, 35 AND 44).
JANICE L. MCMORROW, EXAMINING ATTORNEY

CLASS 12—VEHICLES

SN 76-254,620. TONG YANG MOOLSAN CO., LTD., YONG SAN-KU, SEOUL, REPUBLIC OF KOREA, FILED 5-10-2001.

TYM

FOR TRACTORS (U.S. CLS. 19, 21, 23, 31, 35 AND 44).
FIRST USE 1-1-1999; IN COMMERCE 1-1-1999.
TANYA AMOS, EXAMINING ATTORNEY

SN 76-431,006. PRIDE MOBILITY PRODUCTS CORPORATION, EXETER, PA. FILED 7-15-2002.

JET

FOR SEATS, LAP BELTS, CUP HOLDERS, DUST COVERS, REAR BASKETS, OXYGEN TANK HOLDERS, CANE/CRUTCH HOLDERS, WALKER HOLDERS, LEG RESTS AND HEEL LOOPS, ALL SOLD AS INTEGRAL COMPONENTS OF AND/OR AS REPLACEMENT AND ADD-ON PARTS FOR POWERED MID-WHEEL DRIVE PERSONAL MOBILITY VEHICLES IN THE NATURE OF POWER CHAIRS AND POWERED WHEELCHAIRS, USED PRIMARILY BY THE ELDERLY, DISABLED AND INFIRM (U.S. CLS. 19, 21, 23, 31, 35 AND 44).
FIRST USE 0-0-2001; IN COMMERCE 0-0-2001.
TANYA AMOS, EXAMINING ATTORNEY

SN 76-462,807. RECARO AIRCRAFT SEATING GMBH & CO., 74523 SCHWABISCH HALL, FED REP GERMANY, FILED 10-25-2002.

COCOON

SN 76-258,227. CHANG STAR CORPORATION, CHANGHUA, TAIWAN, FILED 5-17-2001.



FOR BICYCLE PARTS, NAMELY, BRAKES, BRAKE LEVERS, HANDLE BARS, STEMS, SEAT POSTS, AND PEDALS (U.S. CLS. 19, 21, 23, 31, 35 AND 44).
VIVIAN MICZNIK FIRST, EXAMINING ATTORNEY

PRIORITY CLAIMED UNDER SEC. 44(D) ON ERPNTY TM OFC APPLICATION NO. 002859510, FILED 9-19-2002, REG. NO. 002859510, DATED 9-19-2002, EXPIRES 9-19-2012.

FOR VEHICLES SEATS, SEATS FOR AIR PASSENGERS, SEATS, ARM RESTS, SAFETY SEAT BELTS, HEAD RESTS, RAILS, RODS AND FRAMES FOR FASTENING HEAD RESTS, RAILS, RODS AND FRAMES FOR FASTENING THE AFORESAID PARTS TOGETHER AND/OR TO THE VEHICLE; SHOCK ABSORBERS FOR SAFETY BELTS, SEATS AND HEAD RESTS; VEHICLE PARTS, NAMELY PLASTIC MOLDABLE PARTS AND ELASTIC PARTS FOR SEATS AND DASHBOARDS IN THE NATURE OF SEPARATION WALLS, TABLE DIVIDERS AND COVERING SHELTERS, PLASTIC MOLDABLE HEAD RESTS; FITTINGS FOR THE AFORESAID GOODS, NAMELY, MECHANICAL ADJUSTERS (U.S. CLS. 19, 21, 23, 31, 35 AND 44).
BRIDGETT SMITH, EXAMINING ATTORNEY

CLASS 12—(Continued).

SN 76-511,168. GROUPE PROCYCLE INC. / PROCYCLE GROUP INC., DBA ROCKY MOUNTAIN BICYCLES, SAINT-GEORGES, BEAUCE, QUEBEC, CANADA, FILED 5-2-2003.

RMX

PRIORITY CLAIMED UNDER SEC. 44(D) ON CANADA APPLICATION NO. 1,172,505, FILED 3-25-2003, REG. NO. TMA624506, DATED 11-3-2004, EXPIRES 11-3-2019.

FOR BICYCLES, BICYCLE FRAMES AND PARTS THEREFOR (U.S. CLS. 19, 21, 23, 31, 35 AND 44).
RUSS HERMAN, EXAMINING ATTORNEY

SN 76-525,590. PROCOMPETITION TIRE AND WHEEL COMPANY, INC., COMPTON, CA. FILED 6-26-2003.

STREET LOCK

FOR VEHICLE PARTS, NAMELY WHEELS (U.S. CLS. 19, 21, 23, 31, 35 AND 44).

FIRST USE 11-0-2000; IN COMMERCE 11-0-2000.
HOWARD B. LEVINE, EXAMINING ATTORNEY

SN 76-549,058. EXCEL TIRE & WHEEL CORP., WALNUT, CA. FILED 10-6-2003.

DIAMONDTRAK 

FOR TIRES ESPECIALLY DESIGNED FOR ALL TERRAIN VEHICLES (U.S. CLS. 19, 21, 23, 31, 35 AND 44).
FIRST USE 3-1-2003; IN COMMERCE 3-1-2003.
LINDA MICKLEBURGH, EXAMINING ATTORNEY

SN 76-571,586. PEWAG AUSTRIA GMBH, GRAZ, AUSTRIA, FILED 1-16-2004.

TITANGRIP

THE MARK CONSISTS OF STANDARD CHARACTERS WITHOUT CLAIM TO ANY PARTICULAR FONT, STYLE, SIZE, OR COLOR.

OWNER OF AUSTRIA REG. NO. 001194513, DATED 7-31-2001, EXPIRES 5-26-2009.

FOR LAND VEHICLE PARTS, NAMELY, ANTI-SKID CHAINS, TIRE PROTECTION CHAINS, AND SNOW CHAINS (U.S. CLS. 19, 21, 23, 31, 35 AND 44).

FIRST USE 8-1-1999; IN COMMERCE 11-1-2000.
PAULA MAYS, EXAMINING ATTORNEY

CLASS 12—(Continued).

SN 76-584,471. INNOTEC CORPORATION, ZEELAND, MI. FILED 4-1-2004.



FOR AUTOMOTIVE INTERIOR COMPONENTS, NAMELY VISORS, HEADLINERS AND DOOR PANELS (U.S. CLS. 19, 21, 23, 31, 35 AND 44).

APRIL L. RADEMÄCHER, EXAMINING ATTORNEY

SN 76-585,677. SUNPROS CO., LTD., TOKYO 169-8588, JAPAN, FILED 4-7-2004.



NO CLAIM IS MADE TO THE EXCLUSIVE RIGHT TO USE "PROFESSIONAL DRIFT GRAND PRIX SERIES", APART FROM THE MARK AS SHOWN.

THE COLOR(S) ORANGE IS/ARE CLAIMED AS A FEATURE OF THE MARK.

THE BACKGROUND OF THE MARK IS ORANGE WITH THE WRITING IN BLACK. A WHITE FLAME OVERLAPS "D1".

FOR AUTOMOBILES; AUTOMOBILE BODIES; AUTOMOBILE BUMPERS; AUTOMOBILE CHASSIS; AUTOMOBILE HOODS; BRAKES FOR LAND VEHICLES; BRAKE LININGS FOR LAND VEHICLES; BRAKE SHOES FOR LAND VEHICLES; CHILD SAFETY HARNESSSES FOR VEHICLE SEATS; CLUTCHES FOR LAND VEHICLES; DIRECTIONAL SIGNALS FOR VEHICLES; DRIVE SHAFTS FOR LAND VEHICLES; GAS CAPS FOR LAND VEHICLES; LAND VEHICLE PARTS, NAMELY, FENDERS; LAND VEHICLE PARTS, NAMELY, DRIVE GEARS; LAND VEHICLE PARTS, NAMELY, WHEELS; LAND VEHICLE SUSPENSION PARTS, NAMELY, COIL SPRINGS; LAND VEHICLE SUSPENSION PARTS, NAMELY, LEAF SPRINGS; LAND VEHICLE SUSPENSION PARTS, NAMELY, TORSION/SWAY BARS; SEAT BELTS FOR USE IN VEHICLES; SPOILERS FOR VEHICLE; TIRES; TIRES FOR LAND VEHICLES; TORQUE CONVERTERS FOR LAND VEHICLES; TURBINES FOR LAND VEHICLES; VALVES FOR VEHICLE TIRES; VEHICLE PARTS, NAMELY, REARVIEW MIRRORS; VEHICLE PARTS, NAMELY, SHOCK ABSORBERS; SUSPENSION SHOCK ABSORBER FOR VEHICLE; VEHICLE PARTS, NAMELY, STEERING WHEELS; VEHICLE PARTS, NAMELY, TRANSMISSIONS; VEHICLE PARTS, NAMELY, WINDSHIELD WIPERS; VEHICLE SEAT COVERS; VEHICLE SEATS; WHEEL HUBS FOR BICYCLES, MOTORCYCLES, AND AUTOMOBILES; WHEEL RIMS FOR VEHICLES (U.S. CLS. 19, 21, 23, 31, 35 AND 44).

SHARI SHEFFIELD, EXAMINING ATTORNEY

CLASS 12—(Continued).

SN 76-586,535. ACUMEN INC., STERLING, VA. FILED 4-13-2004.

PASSO

THE MARK CONSISTS OF STANDARD CHARACTERS WITHOUT CLAIM TO ANY PARTICULAR FONT, STYLE, SIZE, OR COLOR.

THE ENGLISH TRANSLATION OF THE WORD PASSO IN THE MARK IS "PACE".

FOR BICYCLE SADDLES (U.S. CLS. 19, 21, 23, 31, 35 AND 44).

FIRST USE 4-1-2002; IN COMMERCE 6-1-2002.
MICHELE SWAIN, EXAMINING ATTORNEY

SN 76-586,536. ACUMEN INC., STERLING, VA. FILED 4-13-2004.

VOLO

THE MARK CONSISTS OF STANDARD CHARACTERS WITHOUT CLAIM TO ANY PARTICULAR FONT, STYLE, SIZE, OR COLOR.

THE ENGLISH TRANSLATION OF THE WORD VOLO IN THE MARK IS "FLY".

FOR BICYCLE SADDLES (U.S. CLS. 19, 21, 23, 31, 35 AND 44).

FIRST USE 4-1-2002; IN COMMERCE 6-1-2002.
MICHELE SWAIN, EXAMINING ATTORNEY

SN 76-587,890. NUDO PRODUCTS INC., SPRINGFIELD, IL. FILED 4-21-2004.

NU-FOAM

THE MARK CONSISTS OF STANDARD CHARACTERS WITHOUT CLAIM TO ANY PARTICULAR FONT, STYLE, SIZE, OR COLOR.

OWNER OF U.S. REG. NOS. 1,264,252, 2,717,138 AND 2,799,956.

FOR CARGO TRAILER PARTS, NAMELY, FREIGHT PANELS MADE OF ALUMINUM AND POLYSTYRENE FOAM (U.S. CLS. 19, 21, 23, 31, 35 AND 44).

FIRST USE 7-26-2003; IN COMMERCE 7-26-2003.
KATHERINE STOIDES, EXAMINING ATTORNEY

CLASS 12—(Continued).

SN 76-588,504. DAIMLERCHRYSLER AG, 70567 STUTTGART, FED REP GERMANY, FILED 4-23-2004.

ARTICO

THE MARK CONSISTS OF STANDARD CHARACTERS WITHOUT CLAIM TO ANY PARTICULAR FONT, STYLE, SIZE, OR COLOR.

PRIORITY CLAIMED UNDER SEC. 44(D) ON FED REP GERMANY APPLICATION NO. 30365178.412, FILED 12-10-2003, REG. NO. 30365178, DATED 2-3-2004, EXPIRES 2-3-2014.

FOR MOTOR VEHICLE INTERIOR FURNISHINGS AND TRIM MADE OF LEATHER AND IMITATION LEATHER, NAMELY, SEATS, SEAT CUSHIONS, SEAT COVERS, ARM RESTS, STEERING WHEELS, CEILINGS, DOOR AND ROOF PANELS, HANDLES AND STRAPS FOR CEILINGS AND DOORS, FITTED LINERS FOR CARGO AREA, HEAD RESTS, DASHBOARDS AND GEAR SHIFT LEVERS (U.S. CLS. 19, 21, 23, 31, 35 AND 44).

DEZMONA MIZELLE, EXAMINING ATTORNEY

SN 76-590,841. SHIUE, BA-SHIUAN, TIEN WEI HSIANG, CHANGHUA, TAIWAN, FILED 5-7-2004.



FOR BICYCLES, MOTORCYCLES AND MOTORBIKES AND PARTS FOR THESE GOODS, NAMELY, BIKE PEDALS, BIKE HANDLE COVERS, BIKE FRONT FORK SLEEVES, BIKE RINGS, BIKE SADDLES, BIKE HANDLEBARS, FRONT FORKS, BIKE FLYWHEELS, BIKE FRAMES, BIKE BRAKES, BACK BRAKES, FRONT BRAKES, BIKE CRANKS, BIKE CHAINS, BIKE RIMS, BRAKE HANDLES, BIKE DERAILLEURS AND BIKE GEARS (U.S. CLS. 19, 21, 23, 31, 35 AND 44).

PRISCILLA MILTON, EXAMINING ATTORNEY

SN 76-591,901. NORTHSTAR INDUSTRIES, L.C., DBA NORTHSTAR TRAILERS, AMERICAN FORK, UT. FILED 5-12-2004.

NORTH STAR

THE MARK CONSISTS OF STANDARD CHARACTERS WITHOUT CLAIM TO ANY PARTICULAR FONT, STYLE, SIZE, OR COLOR.

FOR UTILITY TRAILERS AND ATV TRAILERS (U.S. CLS. 19, 21, 23, 31, 35 AND 44).

FIRST USE 2-0-2003; IN COMMERCE 2-0-2003.

RUDY R. SINGLETON, EXAMINING ATTORNEY

CLASS 12—(Continued).

SN 76-594,096. C.Q.S. TECHNOLOGIES INC., JUNGHE, TAIPEI 235, TAIWAN, FILED 5-26-2004.



FOR VEHICLE PARTS, NAMELY, CONNECTING RODS FOR VEHICLE OTHER THAN PARTS OF MOTORS OR ENGINES, CUSHIONS, SHOCK ABSORBERS, PROPELLER SHAFTS; MOTORCYCLES; MOTORIZED SCOOTERS; MOTORIZED GOLF CARTS; MOTORIZED BIKES; MOTORIZED CARTS; WHEELCHAIRS; ELECTRIC WHEELCHAIRS (U.S. CLS. 19, 21, 23, 31, 35 AND 44).

FIRST USE 9-15-2003; IN COMMERCE 9-15-2003.
NORA BUCHANAN WILL, EXAMINING ATTORNEY

SN 76-596,020. MICHELIN NORTH AMERICA, INC., GREENVILLE, SC. FILED 6-7-2004.

TRACTION T/A

THE MARK CONSISTS OF STANDARD CHARACTERS WITHOUT CLAIM TO ANY PARTICULAR FONT, STYLE, SIZE, OR COLOR.

OWNER OF U.S. REG. NOS. 1,185,677, 1,239,297 AND OTHERS.

NO CLAIM IS MADE TO THE EXCLUSIVE RIGHT TO USE "TRACTION", APART FROM THE MARK AS SHOWN, FOR PNEUMATIC TIRES FOR VEHICLE WHEELS (U.S. CLS. 19, 21, 23, 31, 35 AND 44).

FIRST USE 10-1-2003, THE MARK WAS FIRST USED ANYWHERE IN A DIFFERENT FORM OTHER THAN THAT SOUGHT TO BE REGISTERED ON 08/07/1970.; IN COMMERCE 10-1-2003, THE MARK WAS FIRST USED IN COMMERCE IN A DIFFERENT FORM OTHER THAN THAT SOUGHT TO BE REGISTERED ON 08/07/1970..

HEATHER THOMPSON, EXAMINING ATTORNEY

SN 76-608,518. DAIMLERCHRYSLER AG, 70567 STUTTGART, FED REP GERMANY, FILED 8-25-2004.

TAF

THE MARK CONSISTS OF STANDARD CHARACTERS WITHOUT CLAIM TO ANY PARTICULAR FONT, STYLE, SIZE, OR COLOR.

PRIORITY CLAIMED UNDER SEC. 44(D) ON FED REP GERMANY APPLICATION NO. 30439564.1/1, FILED 7-9-2004, REG. NO. 30439564, DATED 8-3-2004, EXPIRES 8-3-2014.

FOR AUTOMOBILES AND THEIR STRUCTURAL PARTS (U.S. CLS. 19, 21, 23, 31, 35 AND 44).

WILLIAM P. SHANAHAN, EXAMINING ATTORNEY

CLASS 12—(Continued).

SN 76-612,797. UNIVERSAL MFG., CO., ALGONA, IA. FILED 9-24-2004.

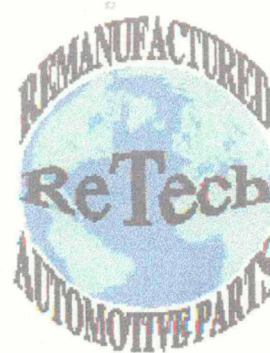

NO CLAIM IS MADE TO THE EXCLUSIVE RIGHT TO USE "REMANUFACTURED AUTOMOTIVE PARTS", APART FROM THE MARK AS SHOWN.

THE COLOR(S) BLUE AND GREEN IS/ARE CLAIMED AS A FEATURE OF THE MARK.

THE COLOR BLUE AND GREEN APPEAR IN THE GLOBE IN THE CENTER OF THE MARK.

FOR REMANUFACTURED PARTS FOR GENERAL PRODUCT LINES IN THE AUTOMOTIVE INDUSTRY, NAMELY ELECTRONIC FUEL PUMPS, TRANSFER CASES, TRANSFER CASE ENGAGEMENT MOTORS AND CALIPERS (U.S. CLS. 19, 21, 23, 31, 35 AND 44).

FIRST USE 6-0-2000; IN COMMERCE 6-0-2000.
MARGERY A. TIERNEY, EXAMINING ATTORNEY

SN 76-614,055. FRASER, WILLIAM THOMAS, AUSTIN, TX. FILED 9-30-2004.



FOR VEHICLE SEAT COVERS AND SEAT BELT SLEEVES (U.S. CLS. 19, 21, 23, 31, 35 AND 44).

KHANH LE, EXAMINING ATTORNEY

SN 76-614,120. FRASER, WILLIAM THOMAS, AUSTIN, TX. FILED 9-30-2004.

IGOACTIVE

THE MARK CONSISTS OF STANDARD CHARACTERS WITHOUT CLAIM TO ANY PARTICULAR FONT, STYLE, SIZE, OR COLOR.

FOR VEHICLE SEAT COVERS AND SEAT BELT SLEEVES (U.S. CLS. 19, 21, 23, 31, 35 AND 44).

JASON LOTT, EXAMINING ATTORNEY

CLASS 12—(Continued).

SN 76-614,395. SUMITOMO RUBBER INDUSTRIES, LTD.,
CHUO-KU, KOBE-SHI, HYOGO, JAPAN, FILED 10-1-2004.

FALKEN

THE MARK CONSISTS OF STANDARD CHARACTERS
WITHOUT CLAIM TO ANY PARTICULAR FONT, STYLE,
SIZE, OR COLOR.

OWNER OF U.S. REG. NO. 2,741,524.
FOR WHEELS FOR AUTOMOBILES (U.S. CLS. 19, 21,
23, 31, 35 AND 44).
FIRST USE 3-1-2003; IN COMMERCE 3-1-2003.
SUSAN LESLIE DUBOIS, EXAMINING ATTORNEY

SN 76-614,976. GREAT AMERICAN BICYCLE, LLC, SARA-
TOGA SPRINGS, NY. FILED 10-7-2004.

TORSIONCORE

FOR BICYCLE FRAMES AND TUBES (U.S. CLS. 19, 21,
23, 31, 35 AND 44).
NICHOLAS ALTREE, EXAMINING ATTORNEY

SN 76-615,109. AUTOLIGN MANUFACTURING GROUP,
INC., MILAN, MI. FILED 10-6-2004.

Original Fit by Autolign

THE MARK CONSISTS OF STANDARD CHARACTERS
WITHOUT CLAIM TO ANY PARTICULAR FONT, STYLE,
SIZE, OR COLOR.

OWNER OF U.S. REG. NOS. 2,293,441, 2,488,321 AND
2,937,316.

FOR AUTOMOTIVE COLLISION REPAIR PARTS,
NAMELY, REBARS, LAMPS AND LAMP ASSEMBLIES,
WHEELS, BUMPER FASCIA, STEEL BUMPERS AND
GRILLES (U.S. CLS. 19, 21, 23, 31, 35 AND 44).
H. M. FISHER, EXAMINING ATTORNEY

CLASS 12—(Continued).

SN 76-615,808. HURRICANE POWER, INC., MIAMI, FL.
FILED 10-12-2004.

SPECIAL FORM DRAWING WITH SHADING. THE
MARK CONSISTS OF STYLIZED LETTERS "HP DESIGN"
WITH BLACK OUTER BORDERS AND INTERIOR SHAD-
ING, PROGRESSIVELY INCREASING IN SHADE FROM
TOP TO BOTTOM. THE LETTERS "HP" ARE DEPICTED
ABOVE THE WORD "DESIGN" IN THE MARK.

FOR RACING AND PERFORMANCE AUTOMOBILE
PARTS, NAMELY, STEERING WHEELS, SHIFT KNOBS,
BRAKE AND GAS PEDAL PADS, SHOCK ABSORBERS,
TIRES, HUB CAPS, WHEEL RIMS, VEHICLE STRUC-
TURAL WOOD KITS CONSISTING OF WOOD VEHICLE
PANELS AND ADHESIVES (U.S. CLS. 19, 21, 23, 31, 35
AND 44).

FIRST USE 7-10-2000; IN COMMERCE 1-10-2001.
PAULA MAYS, EXAMINING ATTORNEY

SN 76-615,837. HURRICANE POWER, INC., MIAMI, FL.
FILED 10-12-2004.

THE MARK CONSISTS OF STYLIZED LETTERS "HP
DESIGN" WITH BLACK OUTER BORDERS AND INTER-
IOR SHADING, PROGRESSIVELY INCREASING IN SHADE
FROM TOP TO BOTTOM. THE LETTERS "DESIGN" ARE IN
LINE WITH AND TO THE LEFT OF THE LETTERS "HP".

FOR RACING AND PERFORMANCE AUTOMOBILE
PARTS, NAMELY, STEERING WHEELS, SHIFT KNOBS,
BRAKE AND GAS PEDAL PADS, SHOCK ABSORBERS,
TIRES, HUB CAPS, WHEEL RIMS, VEHICLE STRUC-
TURAL WOOD KITS CONSISTING OF WOOD VEHICLE
PANELS AND ADHESIVES (U.S. CLS. 19, 21, 23, 31, 35
AND 44).

FIRST USE 7-10-2000; IN COMMERCE 1-10-2001.
KENNETH D. BATTLE, EXAMINING ATTORNEY

CLASS 12—(Continued).

SN 76-621,101. CHADCO ENTERPRISES, INC., DBA HARMAR MOBILITY, SARASOTA, FL. FILED 11-18-2004.

POWER TOTE

THE MARK CONSISTS OF STANDARD CHARACTERS WITHOUT CLAIM TO ANY PARTICULAR FONT, STYLE, SIZE, OR COLOR.

NO CLAIM IS MADE TO THE EXCLUSIVE RIGHT TO USE TOTE, APART FROM THE MARK AS SHOWN.

FOR WHEELCHAIR LIFTS FOR USE WITH VEHICLES (U.S. CLS. 19, 21, 23, 31, 35 AND 44).

FIRST USE 7-0-2001; IN COMMERCE 7-0-2001.

RONALD MCMORROW, EXAMINING ATTORNEY

SN 76-621,499. POLYBILT BODY COMPANY, LLC, OCALA, FL. FILED 11-19-2004.

POLYBILT

THE MARK CONSISTS OF STANDARD CHARACTERS WITHOUT CLAIM TO ANY PARTICULAR FONT, STYLE, SIZE, OR COLOR.

FOR TRUCK BODIES MADE OF POLYMER BASED MATERIALS WITH INTEGRATED COMPARTMENTS FOR COMMERCIAL USE (U.S. CLS. 19, 21, 23, 31, 35 AND 44).

FIRST USE 1-0-2000; IN COMMERCE 1-0-2000.

WILLIAM BRECKENFELD, EXAMINING ATTORNEY

SN 76-622,986. DAIMLERCHRYSLER AG, 70567 STUTTGART, FED REP GERMANY, FILED 12-2-2004.

NECK PRO

THE MARK CONSISTS OF STANDARD CHARACTERS WITHOUT CLAIM TO ANY PARTICULAR FONT, STYLE, SIZE, OR COLOR.

PRIORITY CLAIMED UNDER SEC. 44(D) ON FED REP GERMANY APPLICATION NO. 304570583/12, FILED 10-5-2004, REG. NO. 30457058, DATED 11-8-2004, EXPIRES 10-31-2014.

FOR AUTOMOBILES AND THEIR STRUCTURAL PARTS (U.S. CLS. 19, 21, 23, 31, 35 AND 44).

KEVIN DINALLO, EXAMINING ATTORNEY

CLASS 12—(Continued).

SN 76-625,867. VALENCIA SPORT GROUP, LLC, VALENCIA, CA. FILED 12-27-2004.

SUNLINE

THE MARK CONSISTS OF STANDARD CHARACTERS WITHOUT CLAIM TO ANY PARTICULAR FONT, STYLE, SIZE, OR COLOR.

FOR PARTS FOR MOTORCYCLES, NAMELY, CONTROL LEVERS, PERCHES, CLUTCH ASSEMBLIES, ROTATOR CLAMPS, BRAKE LEVERS, CLUTCH FLEX LEVERS, BRAKE FLEX LEVERS WITH BALL BEARING PIVOT, ADJUSTABLE CLUTCH LEVER/BILLET PERCHES, ARC CNC PERCHES, FORGED FLEX LEVERS, COMPLETE CLUTCH SETS, COMPLETE CLUTCH LEVER/PERCH SETS (U.S. CLS. 19, 21, 23, 31, 35 AND 44).

FIRST USE 8-28-1978; IN COMMERCE 8-28-1978.

DORITT L. CARROLL, EXAMINING ATTORNEY

SN 76-626,092. RELAXT TRADING CO., PTY. LTD., WAHROONGA N.S.W., AUSTRALIA, FILED 12-27-2004.

RELAXt

FOR MOTORIZED AND COMPUTERIZED GOLF CARTS; MOTORIZED GOLF CARTS; MOTORIZED LUGGAGE CARTS; MOTORIZED SCOOTERS; MOTORIZED VEHICLES, NAMELY, GO-CARTS (U.S. CLS. 19, 21, 23, 31, 35 AND 44).

FIRST USE 0-0-1999; IN COMMERCE 0-0-1999.

JOHN WILKE, EXAMINING ATTORNEY

SN 78-131,555. THE ECONO-RACK GROUP INC., MISSISSAUGA, ONTARIO, CANADA, FILED 5-28-2002.

PALLET RUNNER

PRIORITY CLAIMED UNDER SEC. 44(D) ON CANADA APPLICATION NO. 1141671, FILED 5-24-2002, REG. NO. TMA643,491, DATED 7-4-2005, EXPIRES 7-4-2020.

NO CLAIM IS MADE TO THE EXCLUSIVE RIGHT TO USE "PALLET", APART FROM THE MARK AS SHOWN.

FOR BATTERY-POWERED REMOTE CONTROLLED CART WHICH RUNS INSIDE HIGH DENSITY PALLET STORAGE RACKS TO DELIVER AND RETRIEVE PALLETS (U.S. CLS. 19, 21, 23, 31, 35 AND 44).

DAVID H. STINE, EXAMINING ATTORNEY

CLASS 12—(Continued).

SN 78-163,701. CONWAY, RICHARD P., WILLIAMSVILLE, NY. FILED 9-13-2002.

BALANCE BUDDY

NO CLAIM IS MADE TO THE EXCLUSIVE RIGHT TO USE "BALANCE", APART FROM THE MARK AS SHOWN. FOR BICYCLE PARTS, NAMELY TUBES AND CONNECTORS FOR A BICYCLE FRAME (U.S. CLS. 19, 21, 23, 31, 35 AND 44).

FIRST USE 10-1-1998; IN COMMERCE 10-1-1998.
NANCY CLARKE, EXAMINING ATTORNEY

SN 78-278,404. ADRIAN STEEL COMPANY, ADRIAN, MI. FILED 7-24-2003.

LOAD RUNNER

NO CLAIM IS MADE TO THE EXCLUSIVE RIGHT TO USE "LOAD", APART FROM THE MARK AS SHOWN. FOR STEEL ACCESSORIES FOR VEHICLES, NAMELY, A ROOF RACK (U.S. CLS. 19, 21, 23, 31, 35 AND 44).

FIRST USE 5-3-2000; IN COMMERCE 5-3-2000.
HOWARD SMIGA, EXAMINING ATTORNEY

SN 78-285,606. NEELY, ALAN, TAZEWEEL, TN. FILED 8-11-2003.



NO CLAIM IS MADE TO THE EXCLUSIVE RIGHT TO USE RECREATIONAL VEHICLES, APART FROM THE MARK AS SHOWN.

FOR TRAVEL TRAILERS (U.S. CLS. 19, 21, 23, 31, 35 AND 44).

FIRST USE 7-30-2003; IN COMMERCE 7-30-2003.
KARLA PERKINS, EXAMINING ATTORNEY

SN 78-309,844. FIAT AUTO S.P.A., 10135 TORINO, ITALY, FILED 10-6-2003.

ALFA 157

OWNER OF ITALY REG. NO. 00917823, DATED 11-5-2003, EXPIRES 5-3-2012.

OWNER OF U.S. REG. NOS. 2,704,676, 2,777,931 AND OTHERS.

FOR MOTOR VEHICLES, NAMELY, AUTOMOBILES; SKI-RACKS, SEAT COVERS, AND WHEEL COVERS; WIND-SCREEN WIPERS, SHOCK ABSORBERS, WHEEL RIMS, ORNAMENTAL HUB-CAPS, SAFETY BELTS, TIRES, ROOF RACKS, WHEELS, DOORS, ALL FOR MOTOR VEHICLES (U.S. CLS. 19, 21, 23, 31, 35 AND 44).

AISHA CLARKE, EXAMINING ATTORNEY

CLASS 12—(Continued).

SN 78-309,852. FIAT AUTO S.P.A., 10135 TORINO, ITALY, FILED 10-6-2003.

ALFA 167

OWNER OF ITALY REG. NO. 917822, DATED 11-5-2003, EXPIRES 5-3-2012.

OWNER OF U.S. REG. NOS. 2,704,676, 2,777,931 AND OTHERS.

FOR MOTOR VEHICLES, NAMELY, AUTOMOBILES; SKI-RACKS, SEAT COVERS, AND WHEEL COVERS; WIND-SCREEN WIPERS, SHOCK ABSORBERS, WHEEL RIMS, ORNAMENTAL HUB-CAPS, SAFETY BELTS, TIRES, ROOF RACKS, WHEELS, DOORS, ALL FOR MOTOR VEHICLES (U.S. CLS. 19, 21, 23, 31, 35 AND 44).

AISHA CLARKE, EXAMINING ATTORNEY

SN 78-334,979. JOHNSON OUTDOORS INC., RACINE, WI. FILED 12-2-2003.

ESCAPE

THE MARK CONSISTS OF STANDARD CHARACTERS WITHOUT CLAIM TO ANY PARTICULAR FONT, STYLE, SIZE, OR COLOR.

FOR WATERCRAFT, NAMELY, BOATS, CANOES AND KAYAKS (U.S. CLS. 19, 21, 23, 31, 35 AND 44).

MICHAEL SOUDERS, EXAMINING ATTORNEY

CLASS 12—(Continued).

SN 78-335,791. AM GENERAL LLC, SOUTH BEND, IN. FILED 12-3-2003.

HMMWV

THE MARK CONSISTS OF STANDARD CHARACTERS WITHOUT CLAIM TO ANY PARTICULAR FONT, STYLE, SIZE, OR COLOR.
OWNER OF U.S. REG. NOS. 1,697,530 AND 2,305,256.
FOR VEHICLES, NAMELY, TRUCKS (U.S. CLS. 19, 21, 23, 31, 35 AND 44).
FIRST USE 12-13-1986; IN COMMERCE 12-13-1986.
KIM SAITO, EXAMINING ATTORNEY

CLASS 12—(Continued).

SN 78-358,836. WANG, JOHN, DEL MAR, CA. FILED 1-28-2004.



THE COLOR(S) RED AND GRAY IS/ARE CLAIMED AS A FEATURE OF THE MARK.
THE COLOR GRAY APPEARS IN THE LETTER "Q" IN THE MARK AND THE COLOR RED APPEARS IN THE DOT IN THE MARK.
FOR MOTORIZED SELF PROPELLED WHEELED PERSONAL MOBILITY DEVICE, NAMELY, ELECTRIC CHARIOTS (U.S. CLS. 19, 21, 23, 31, 35 AND 44).
FIRST USE 12-15-2003; IN COMMERCE 1-15-2004.
MATTHEW KLINE, EXAMINING ATTORNEY

SN 78-382,618. LOEGERING MFG. INC., CASSELTON, ND. FILED 3-11-2004.

SN 78-346,153. TOYOTA JIDOSHA KABUSHIKI KAISHA, TA TOYOTA MOTOR CORPORATION, TOYOTA-SHI, AICHI-KEN, JAPAN, FILED 12-29-2003.

RELEASE SERIES

VTS Versatile Track System

THE MARK CONSISTS OF STANDARD CHARACTERS WITHOUT CLAIM TO ANY PARTICULAR FONT, STYLE, SIZE, OR COLOR.
NO CLAIM IS MADE TO THE EXCLUSIVE RIGHT TO USE "SERIES", APART FROM THE MARK AS SHOWN.
FOR MOTOR CARS AND STRUCTURAL PARTS THEREOF (U.S. CLS. 19, 21, 23, 31, 35 AND 44).
JULIE WATSON, EXAMINING ATTORNEY

THE MARK CONSISTS OF STANDARD CHARACTERS WITHOUT CLAIM TO ANY PARTICULAR FONT, STYLE, SIZE, OR COLOR.
NO CLAIM IS MADE TO THE EXCLUSIVE RIGHT TO USE VERSATILE TRACK SYSTEM, APART FROM THE MARK AS SHOWN.
FOR TRACK UNDERCARRIAGE FOR CONVERTING WHEELED VEHICLES TO TRACKED VEHICLES (U.S. CLS. 19, 21, 23, 31, 35 AND 44).
TANYA AMOS, EXAMINING ATTORNEY

CLASS 12—(Continued).

SN 78-391,855. KRINEY, JOHN V., SAN DIEGO, CA. FILED 3-26-2004.

SHOWOFF CARS

THE MARK CONSISTS OF STANDARD CHARACTERS WITHOUT CLAIM TO ANY PARTICULAR FONT, STYLE, SIZE, OR COLOR.

NO CLAIM IS MADE TO THE EXCLUSIVE RIGHT TO USE "CARS", APART FROM THE MARK AS SHOWN.

FOR AFTERMARKET AUTO PARTS, NAMELY, BODY KITS COMPRISING WINGS, HOODS, FENDERS, COWLINGS, AIR DAMS, SIDE SKIRTS, AND ASSOCIATED MOUNTING HARDWARE, AND PERFORMANCE PARTS, NAMELY, WINGS, HOODS, FENDERS, COWLINGS, AIR DAMS, SIDE SKIRTS, AND ASSOCIATED MOUNTING HARDWARE, AND WHEELS, RIMS, AND SUSPENSION PARTS, NAMELY, COIL SPRINGS, LEAF SPRINGS, SHOCK ABSORBERS, STRUTS AND ASSOCIATED MOUNTING HARDWARE (U.S. CLS. 19, 21, 23, 31, 35 AND 44).

WON TEAK OH, EXAMINING ATTORNEY

SN 78-394,348. THULE TRAILERS, INC., WINSLOW, ME. FILED 3-31-2004.

S-PRO

THE MARK CONSISTS OF STANDARD CHARACTERS WITHOUT CLAIM TO ANY PARTICULAR FONT, STYLE, SIZE, OR COLOR.

OWNER OF U.S. REG. NOS. 2,487,721 AND 2,571,520.
FOR VEHICLE TOWING APPARATUS, NAMELY, TRAILERS AND CARRIAGES FOR THE TRANSPORTATION OF TOWING VEHICLES; SNOWMOBILE AND RECREATIONAL VEHICLE TRAILERS, CARGO TRAILERS, MOTORCYCLE TRAILERS, CAR HAULING TRAILERS, AND ATV TRAILERS, TRAILER HITCHES, CARGO OVERHEAD CARRIERS FOR VEHICLES AND TRAILERS, AND TRAILER TOWING ACCESSORIES, NAMELY, AERO-DYNAMIC FAIRINGS FOR VEHICLES AND TRAILERS, ADJUSTMENT CHAINS, HITCHES AND TOW BARS FOR VEHICLES AND TRAILERS, AND STRUCTURAL PARTS THEREFOR (U.S. CLS. 19, 21, 23, 31, 35 AND 44).

RICHARD WHITE, EXAMINING ATTORNEY

CLASS 12—(Continued).

SN 78-401,746. PACIFIC BRANDS HOUSEHOLD PRODUCTS PTY LTD, HAWTHORN, AUSTRALIA, FILED 4-14-2004.

AEROFOAM

THE MARK CONSISTS OF STANDARD CHARACTERS WITHOUT CLAIM TO ANY PARTICULAR FONT, STYLE, SIZE, OR COLOR.

FOR VEHICLE SEATS; COMPONENTS FOR VEHICLE SEATS NOT OF METAL, NAMELY, SEAT, SEAT BACK, ARMREST AND HEADREST CUSHIONING; CELLULAR PLASTIC FOAM OR CELLULAR RUBBER FOAM COMPONENTS FOR VEHICLE SEATS, INCLUDING AIRCRAFT SEATS, NAMELY, SEAT, SEAT BACK, ARMREST AND HEADREST CUSHIONING (U.S. CLS. 19, 21, 23, 31, 35 AND 44).

JILL C. ALT, EXAMINING ATTORNEY

SN 78-407,073. DIAMOND ROLL-UP DOOR, INC., UPPER SANDUSKY, OH. FILED 4-23-2004.



NO CLAIM IS MADE TO THE EXCLUSIVE RIGHT TO USE "ROLLER SHUTTERS", APART FROM THE MARK AS SHOWN.

FOR STRUCTURAL PARTS FOR TRUCKS, TRAILERS AND COMMERCIAL LAND VEHICLES, NAMELY, METAL ROLL-UP DOORS, ROLLER SHUTTERS AND METAL COMPONENT PARTS THEREOF, NAMELY, DOOR CASES, FRAMES, HANDLES AND PANELS (U.S. CLS. 19, 21, 23, 31, 35 AND 44).

FIRST USE 0-0-1946; IN COMMERCE 3-1-2004.

IRA J. GOODSaid, EXAMINING ATTORNEY

CLASS 12—(Continued).

SN 78-411,260. KMC PRODUCTS, INC., RANCHO DOMINGUEZ, CA. FILED 4-30-2004.

KMC

THE MARK CONSISTS OF STANDARD CHARACTERS WITHOUT CLAIM TO ANY PARTICULAR FONT, STYLE, SIZE, OR COLOR.

OWNER OF U.S. REG. NO. 2,298,513.
FOR ACCESSORIES FOR AUTOMOBILES, LIGHT TRUCKS, HEAVY TRUCKS, SPORT UTILITY VEHICLES, VANS, GOLF CARS, AND ALL TERRAIN VEHICLES, NAMELY WHEELS; WHEEL PARTS AND ACCESSORIES FOR AUTOMOBILES, LIGHT TRUCKS, HEAVY TRUCKS, SPORT UTILITY VEHICLES, VANS, GOLF CARS, AND ALL TERRAIN VEHICLES, NAMELY, LUG NUTS, WHEEL COVERS, WHEEL RIMS, WHEEL SPOKES, HUB CAPS AND CENTER CAPS; INTEGRAL COMPONENTS OF WHEELS FOR AUTOMOBILES, LIGHT TRUCKS, HEAVY TRUCKS, SPORT UTILITY VEHICLES, VANS, GOLF CARS, AND ALL TERRAIN VEHICLES, NAMELY, SPINNERS, SPACERS, STUDS AND ADAPTERS (U.S. CLS. 19, 21, 23, 31, 35 AND 44).

FIRST USE 6-1-1982; IN COMMERCE 6-1-1985.
ANDREW RHIM, EXAMINING ATTORNEY

SN 78-411,539. KEWLMETAL, WHITTIER, CA. FILED 4-30-2004.

KEWLMETAL

THE MARK CONSISTS OF STANDARD CHARACTERS WITHOUT CLAIM TO ANY PARTICULAR FONT, STYLE, SIZE, OR COLOR.

FOR MOTORCYCLE ACCESSORIES, NAMELY MOUNTING BRACKETS (U.S. CLS. 19, 21, 23, 31, 35 AND 44).

FIRST USE 7-5-2003; IN COMMERCE 7-5-2003.
TRACY CROSS, EXAMINING ATTORNEY

CLASS 12—(Continued).

SN 78-414,568. AUTOMATED WHEEL FINISHERS, LLC, WHITTIER, CA. FILED 5-6-2004.

VANATIZE

THE MARK CONSISTS OF STANDARD CHARACTERS WITHOUT CLAIM TO ANY PARTICULAR FONT, STYLE, SIZE, OR COLOR.

FOR WHEEL RIMS FOR VEHICLES (U.S. CLS. 19, 21, 23, 31, 35 AND 44).

BILL DAWE, EXAMINING ATTORNEY

SN 78-421,232. SUNRISE MEDICAL HHG INC., LONGMONT, CO. FILED 5-19-2004.

GUARDIAN ACCLAIM

THE MARK CONSISTS OF STANDARD CHARACTERS WITHOUT CLAIM TO ANY PARTICULAR FONT, STYLE, SIZE, OR COLOR.

OWNER OF U.S. REG. NOS. 1,404,794, 1,938,116 AND OTHERS.

FOR ELECTRICALLY POWERED PERSONAL MOBILITY VEHICLES, NAMELY MOTORIZED SCOOTERS FOR USE PRIMARILY BY ELDERLY, DISABLED AND INFIRM PERSONS (U.S. CLS. 19, 21, 23, 31, 35 AND 44).

ANDREW RHIM, EXAMINING ATTORNEY

CLASS 12—(Continued).

SN 78-425,412. KMC PRODUCTS, INC., RIVERSIDE, CA.
FILED 5-26-2004.

SR KMC RACING

THE MARK CONSISTS OF STANDARD CHARACTERS WITHOUT CLAIM TO ANY PARTICULAR FONT, STYLE, SIZE, OR COLOR.

OWNER OF U.S. REG. NO. 2,298,513.

NO CLAIM IS MADE TO THE EXCLUSIVE RIGHT TO USE "RACING", APART FROM THE MARK AS SHOWN.

FOR ACCESSORIES FOR AUTOMOBILES, LIGHT TRUCKS, HEAVY TRUCKS, SPORT UTILITY VEHICLES, VANS, GOLF CARS AND ALL-TERRAIN VEHICLES, NAMELY WHEELS; WHEEL PARTS AND ACCESSORIES FOR AUTOMOBILES, LIGHT TRUCKS, HEAVY TRUCKS, SPORT UTILITY VEHICLES, VANS, GOLF CARS AND ALL-TERRAIN VEHICLES, NAMELY, LUG NUTS, WHEEL COVERS, WHEEL RIMS, WHEEL SPOKES, HUB CAPS AND CENTER CAPS; INTEGRAL COMPONENTS OF WHEELS FOR AUTOMOBILES, LIGHT TRUCKS, HEAVY TRUCKS, SPORT UTILITY VEHICLES, VANS, GOLF CARS AND ALL-TERRAIN VEHICLES, NAMELY, SPINNERS, SPACERS, STUDS AND ADAPTERS (U.S. CLS. 19, 21, 23, 31, 35 AND 44).

FIRST USE 8-1-2003; IN COMMERCE 8-1-2003.

ANDREW RHIM, EXAMINING ATTORNEY

SN 78-432,172. SUNRISE MEDICAL HHG INC., LONGMONT, CO. FILED 6-9-2004.

GUARDIAN TREK

THE MARK CONSISTS OF STANDARD CHARACTERS WITHOUT CLAIM TO ANY PARTICULAR FONT, STYLE, SIZE, OR COLOR.

OWNER OF U.S. REG. NOS. 1,404,794, 1,938,116 AND OTHERS.

FOR ELECTRICALLY POWERED PERSONAL MOBILITY VEHICLES, NAMELY MOTORIZED SCOOTERS FOR USE PRIMARILY BY ELDERLY, DISABLED AND INFIRM PERSONS (U.S. CLS. 19, 21, 23, 31, 35 AND 44).

ANDREW RHIM, EXAMINING ATTORNEY

CLASS 12—(Continued).

SN 78-440,841. FREEMAN, ANDREW CHARLES, NORTHAMPTON, UNITED KINGDOM, FILED 6-24-2004.

CITY PRO

THE MARK CONSISTS OF STANDARD CHARACTERS WITHOUT CLAIM TO ANY PARTICULAR FONT, STYLE, SIZE, OR COLOR.

FOR AUTOMOTIVE PARTS, NAMELY, BRAKES, BRAKE PADS, BRAKE SHOES, BRAKE DISCS, BRAKE DRUMS, BRAKE ACTUATORS (U.S. CLS. 19, 21, 23, 31, 35 AND 44).

CATHERINE FAINT, EXAMINING ATTORNEY

SN 78-450,494. BENCHMARK PARTNERS LLC, SPRINGBORO, OH. FILED 7-14-2004.

TECHNICA

THE MARK CONSISTS OF STANDARD CHARACTERS WITHOUT CLAIM TO ANY PARTICULAR FONT, STYLE, SIZE, OR COLOR.

FOR BICYCLES, AND PARTS AND ACCESSORIES NAMELY PEDALS, KICKSTANDS, MIRRORS, FORKS, TIRES, SPOKE WHEELS (U.S. CLS. 19, 21, 23, 31, 35 AND 44).

FIRST USE 6-15-2004; IN COMMERCE 9-15-2004.
RAMONA ORTIGA, EXAMINING ATTORNEY

CLASS 12—(Continued).

SN 78-458,794. CHICAGO CHASSIS INC., ORLAND PARK, IL. FILED 7-29-2004.



NO CLAIM IS MADE TO THE EXCLUSIVE RIGHT TO USE "CHICAGO CHASSIS", APART FROM THE MARK AS SHOWN.

FOR AUTOMOTIVE CHASSIS COMPONENTS, NAMELY STRUT MOUNTS, STRUT BOOTS, CONTROL ARM ASSEMBLIES, CONTROL ARM BUSHINGS, CONTROL ARM BUSHING KITS, STABILIZER BAR BUSHINGS, STABILIZER END LINKS, AND TRAILING ARM BUSHINGS (U.S. CLS. 19, 21, 23, 31, 35 AND 44).

PRISCILLA MILTON, EXAMINING ATTORNEY

CLASS 12—(Continued).

SN 78-474,490. ADLER, CONSTANCE E, WACO, TX. FILED 8-26-2004.

L'EAU RIDER

THE MARK CONSISTS OF STANDARD CHARACTERS WITHOUT CLAIM TO ANY PARTICULAR FONT, STYLE, SIZE, OR COLOR.

THE FOREIGN WORDING IN THE MARK TRANSLATES INTO ENGLISH AS WATER.

FOR PERSONAL WATER CRAFT, NAMELY RECREATIONAL BOATS (U.S. CLS. 19, 21, 23, 31, 35 AND 44).

SKYE YOUNG, EXAMINING ATTORNEY

SN 78-461,900. QUINONES, ANTHONY J, MURRIETA, CA. FILED 8-4-2004.

FOR MOTORCYCLE PARTS, NAMELY, WHEELS, FOOT CONTROLS, BRAKE PEDALS, SHIFT LINKAGES, SIDE VIEW MIRRORS, AND CABLE CLAMPS (U.S. CLS. 19, 21, 23, 31, 35 AND 44).

FIRST USE 1-1-1997; IN COMMERCE 1-1-1997.
KIMBERLY FRYE, EXAMINING ATTORNEY

SN 78-476,252. ROKON INTERNATIONAL, INC., ROCHESTER, NH. FILED 8-31-2004.

SN 78-472,471. GLAREGONE LTD, LAKEWOOD, OH. FILED 8-24-2004.

LITEOWL

THE MARK CONSISTS OF STANDARD CHARACTERS WITHOUT CLAIM TO ANY PARTICULAR FONT, STYLE, SIZE, OR COLOR.

FOR NIGHT VISION PROTECTOR FOR AUTOMOTIVE USE, NAMELY AUTOMOTIVE VISOR (U.S. CLS. 19, 21, 23, 31, 35 AND 44).

DARRYL SPRUILL, EXAMINING ATTORNEY

TRAIL-BREAKER

THE MARK CONSISTS OF STANDARD CHARACTERS WITHOUT CLAIM TO ANY PARTICULAR FONT, STYLE, SIZE, OR COLOR.

FOR MOTORIZED TWO-WHEEL, CROSS-COUNTRY PASSENGER AND CARGO VEHICLE IN THE NATURE OF A HEAVY DUTY MOTORCYCLE (U.S. CLS. 19, 21, 23, 31, 35 AND 44).

FIRST USE 7-24-1962; IN COMMERCE 7-24-1962.
TANYA AMOS, EXAMINING ATTORNEY

CLASS 12—(Continued).

SN 78-477,565. VAN NIEKERK, WESSEL J., HOVE, AUSTRALIA, FILED 9-2-2004.

CLASS 12—(Continued).

SN 78-495,341. HONDA GIKEN KOGYO KABUSHIKI KAISHA (HONDA MOTOR CO., LTD.), TOKYO, JAPAN, FILED 10-6-2004.

MARSHIN

RELENTLESS

THE MARK CONSISTS OF STANDARD CHARACTERS WITHOUT CLAIM TO ANY PARTICULAR FONT, STYLE, SIZE, OR COLOR.

PRIORITY CLAIMED UNDER SEC. 44(D) ON AUSTRALIA APPLICATION NO. 993179, FILED 3-12-2004, REG. NO. 993179, DATED 11-1-2004, EXPIRES 3-12-2014.

FOR MOTORBIKES, MOTORCYCLES, MOTORIZED SCOOTERS AND MOTOR QUADS; PARTS AND FITTINGS IN THIS CLASS FOR THE AFOREMENTIONED GOODS (U.S. CLS. 19, 21, 23, 31, 35 AND 44).

SCOTT OSICK, EXAMINING ATTORNEY

THE MARK CONSISTS OF STANDARD CHARACTERS WITHOUT CLAIM TO ANY PARTICULAR FONT, STYLE, SIZE, OR COLOR.

FOR LAND MOTOR VEHICLES OF ALL TYPES, NAMELY, AUTOMOBILES, ELECTRIC VEHICLES, FOUR-WHEEL LAND MOTOR VEHICLES, ALL-TERRAIN VEHICLES; SPORT UTILITY VEHICLES, PASSENGER LAND MOTOR VEHICLES, MINIVANS, MOTOR CARS, TRUCKS, VANS AND STRUCTURAL AND MECHANICAL PARTS THEREOF (U.S. CLS. 19, 21, 23, 31, 35 AND 44).

JASON TURNER, EXAMINING ATTORNEY

SN 78-495,237. TITAN INTERNATIONAL, INC, QUINCY, IL. FILED 10-6-2004.

SN 78-495,484. FEDERAL CORPORATION, TAOYUAN, TAIWAN, FILED 10-6-2004.

TITAN GRIZZ LSW

DYNASTORM

THE MARK CONSISTS OF STANDARD CHARACTERS WITHOUT CLAIM TO ANY PARTICULAR FONT, STYLE, SIZE, OR COLOR.

OWNER OF U.S. REG. NOS. 2,510,941, 2,933,421 AND OTHERS.

FOR TIRES (U.S. CLS. 19, 21, 23, 31, 35 AND 44).

FIRST USE 9-30-2002; IN COMMERCE 9-30-2002.
ESTHER A. BORSUK, EXAMINING ATTORNEY

FOR TIRES (U.S. CLS. 19, 21, 23, 31, 35 AND 44).

ANNE MADDEN, EXAMINING ATTORNEY

CLASS 12—(Continued).

SN 78-495,999. PRIDE MOBILITY PRODUCTS CORPORATION, EXETER, PA. FILED 10-7-2004.

GO CHAIR

THE MARK CONSISTS OF STANDARD CHARACTERS WITHOUT CLAIM TO ANY PARTICULAR FONT, STYLE, SIZE, OR COLOR.

NO CLAIM IS MADE TO THE EXCLUSIVE RIGHT TO USE "CHAIR", APART FROM THE MARK AS SHOWN.

FOR ELECTRICALLY POWERED PERSONAL MOBILITY VEHICLES FOR USE BY ELDERLY, INFIRM AND DISABLED PERSONS (U.S. CLS. 19, 21, 23, 31, 35 AND 44).

FIRST USE 12-31-2004; IN COMMERCE 12-31-2004.
JOHN SCHUYLER YARD, EXAMINING ATTORNEY

CLASS 12—(Continued).

SN 78-502,725. E-ONE, INC., OCALA, FL. FILED 10-20-2004.

TRADITION

THE MARK CONSISTS OF STANDARD CHARACTERS WITHOUT CLAIM TO ANY PARTICULAR FONT, STYLE, SIZE, OR COLOR.

FOR TRUCK CHASSIS, NAMELY, CHASSIS USED IN FIREFIGHTING AND RESCUE VEHICLES (U.S. CLS. 19, 21, 23, 31, 35 AND 44).

FIRST USE 11-0-2001; IN COMMERCE 11-0-2001.
CURTIS FRENCH, EXAMINING ATTORNEY

SN 78-503,210. RIDEABLE BICYCLE REPLICAS INC., ALAMEDA, CA. FILED 10-20-2004.

SN 78-499,694. WHEELED COACH CORPORATION, WINTER PARK, FL. FILED 10-14-2004.

THE GENERAL

THE MARK CONSISTS OF STANDARD CHARACTERS WITHOUT CLAIM TO ANY PARTICULAR FONT, STYLE, SIZE, OR COLOR.

FOR AMBULANCES (U.S. CLS. 19, 21, 23, 31, 35 AND 44).

FIRST USE 8-13-2004; IN COMMERCE 8-13-2004.
MICHAEL WEBSTER, EXAMINING ATTORNEY



NO CLAIM IS MADE TO THE EXCLUSIVE RIGHT TO USE "BONESHAKER" AND "BICYCLE REPLICAS INC"., APART FROM THE MARK AS SHOWN.

FOR ANTIQUE STYLE HIGH WHEEL BICYCLE (U.S. CLS. 19, 21, 23, 31, 35 AND 44).

FIRST USE 0-0-1972; IN COMMERCE 0-0-1972.
TANYA AMOS, EXAMINING ATTORNEY

CLASS 12—(Continued).

SN 78-504,636. KWANG YANG MOTOR CO., LTD., KAOHSIUNG, TAIWAN, FILED 10-22-2004.

CLASS 12—(Continued).

SN 78-509,414. NORTH AMERICAN RESOURCES, INC., ANOKA, MN. FILED 11-1-2004.

BOXTON

The Bull

THE MARK CONSISTS OF STANDARD CHARACTERS WITHOUT CLAIM TO ANY PARTICULAR FONT, STYLE, SIZE, OR COLOR.

FOR AUTOMOBILES; ELECTRIC AUTOMOBILES; MOTORCYCLES; ALL TERRAIN VEHICLES; ALL TERRAIN BUGGIES FOR USE ON BEACHES; OFF-ROAD VEHICLES; ELECTRIC ALL TERRAIN VEHICLES; MOTORIZED AND NON-MOTORIZED MOBILITY SCOOTERS; ELECTRIC MOTORIZED MOBILITY SCOOTERS; STRUCTURAL AND REPLACEMENT PARTS THEREFOR (U.S. CLS. 19, 21, 23, 31, 35 AND 44).

JOHN LINCOSKI, EXAMINING ATTORNEY

THE MARK CONSISTS OF STANDARD CHARACTERS WITHOUT CLAIM TO ANY PARTICULAR FONT, STYLE, SIZE, OR COLOR.

FOR 4-IN-1 MATERIAL HANDLING CARTS (U.S. CLS. 19, 21, 23, 31, 35 AND 44).

MARY BOAGNI, EXAMINING ATTORNEY

SN 78-508,955. DETOURS SPORTS, INC., MAMMOTH LAKES, CA. FILED 11-1-2004.

SN 78-511,889. GOODYEAR TIRE & RUBBER COMPANY, THE, AKRON, OH. FILED 11-5-2004.

DETOURS

ENGINEERED FOR HARDWORKING DEPENDABILITY

THE MARK CONSISTS OF STANDARD CHARACTERS WITHOUT CLAIM TO ANY PARTICULAR FONT, STYLE, SIZE, OR COLOR.

FOR BICYCLE ACCESSORIES, NAMELY, HANDLE BAR BAGS, SEAT BAGS, RACK BAGS, PANNIERS (U.S. CLS. 19, 21, 23, 31, 35 AND 44).

FIRST USE 11-1-2003; IN COMMERCE 11-1-2003.

GEOFFREY FOSDICK, EXAMINING ATTORNEY

THE MARK CONSISTS OF STANDARD CHARACTERS WITHOUT CLAIM TO ANY PARTICULAR FONT, STYLE, SIZE, OR COLOR.

FOR TIRES (U.S. CLS. 19, 21, 23, 31, 35 AND 44).

KELLY CHOE, EXAMINING ATTORNEY

CLASS 12—(Continued).

SN 78-513,070. BENNINGTON-MARINE, LLC, ELKHART, IN. FILED 11-8-2004.

CLASS 12—(Continued).

SN 78-514,040. JAGGER AUTOMOTIVE, LLC, WINTER PARK, FL. FILED 11-9-2004.

SEDONA

BLING YOUR RIDE

THE MARK CONSISTS OF STANDARD CHARACTERS WITHOUT CLAIM TO ANY PARTICULAR FONT, STYLE, SIZE, OR COLOR.
FOR RECREATIONAL BOATS (U.S. CLS. 19, 21, 23, 31, 35 AND 44).
JULIE WATSON, EXAMINING ATTORNEY

THE MARK CONSISTS OF STANDARD CHARACTERS WITHOUT CLAIM TO ANY PARTICULAR FONT, STYLE, SIZE, OR COLOR.
FOR LUG NUTS FOR VEHICLE WHEELS, INCLUDING DECORATIVE LUG NUTS (U.S. CLS. 19, 21, 23, 31, 35 AND 44).
FIRST USE 8-15-2004; IN COMMERCE 8-22-2004.
IRA J. GOODSaid, EXAMINING ATTORNEY

SN 78-513,100. DANA CORPORATION, TOLEDO, OH. FILED 11-8-2004.

SN 78-514,548. BROWN, J.C., FORT WAYNE, IN. FILED 11-10-2004.

SMARTRIDE

AMAZE-N-TOW

THE MARK CONSISTS OF STANDARD CHARACTERS WITHOUT CLAIM TO ANY PARTICULAR FONT, STYLE, SIZE, OR COLOR.
FOR SUSPENSION SYSTEMS FOR COMMERCIAL VEHICLES (U.S. CLS. 19, 21, 23, 31, 35 AND 44).
KIMBERLY FRYE, EXAMINING ATTORNEY

THE MARK CONSISTS OF STANDARD CHARACTERS WITHOUT CLAIM TO ANY PARTICULAR FONT, STYLE, SIZE, OR COLOR.
FOR MATERIAL HANDLING TRAILERS, NAMELY LOAD LIFTING AND TRANSPORTING TRAILERS FOR ATTACHMENT TO A VEHICLE (U.S. CLS. 19, 21, 23, 31, 35 AND 44).
FIRST USE 10-14-1994; IN COMMERCE 10-14-1994.
CAROLYN CATALDO, EXAMINING ATTORNEY

CLASS 12—(Continued).

SN 78-515,794. SHIMANO INC., SAKAI, OSAKA, JAPAN,
FILED 11-12-2004.

CYBER NEXUS

THE MARK CONSISTS OF STANDARD CHARACTERS WITHOUT CLAIM TO ANY PARTICULAR FONT, STYLE, SIZE, OR COLOR.

OWNER OF U.S. REG. NOS. 1,964,549, 2,447,088 AND 2,542,372.

FOR BICYCLES, PARTS AND FITTINGS FOR BICYCLES, NAMELY, HUBS, INTERNAL GEAR HUBS, HUB QUICK RELEASE LEVERS, GEAR RELEASE LEVERS, GEAR SHIFT LEVERS, FRONT DERAILLEURS, REAR DERAILLEURS, CHAIN GUIDES, FREEWHEELS, SPROCKETS, PULLEYS, CHAINS, CHAIN DEFLECTORS, SHIFT CABLES, CRANKS, CRANK SETS, CHAIN WHEELS, PEDALS, TOE CLIPS, BRAKE LEVERS, FRONT BRAKES, REAR BRAKES, BRAKE CABLES, BRAKE SHOES, RIMS, WHEELS, SPOKES, SPOKE CLIPS, BOTTOM BRACKETS, SEAT PILLARS, SEAT PILLAR QUICK RELEASE, HEAD PARTS FOR FRAME-FORK ASSEMBLY, FRAMES, SUSPENSIONS, HANDLEBARS, HANDLE STEMS, GRIPS FOR HANDLEBARS, SADDLES, MUD GUARDS, KICK STANDS, CARRIERS, BELLS, HORNS AND REARVIEW MIRRORS FOR BICYCLES, DERAILLEURS CONTROLLED BY COMPUTER (U.S. CLS. 19, 21, 23, 31, 35 AND 44).

KRISTINA KLOIBER, EXAMINING ATTORNEY

SN 78-518,519. MIDWEST MOTORCYCLE SUPPLY DISTRIBUTORS CORP., ARNOLD, MO. FILED 11-17-2004.

DOUBLE DARE

THE MARK CONSISTS OF STANDARD CHARACTERS WITHOUT CLAIM TO ANY PARTICULAR FONT, STYLE, SIZE, OR COLOR.

FOR MOTORCYCLES AND STRUCTURAL PARTS THEREFOR (U.S. CLS. 19, 21, 23, 31, 35 AND 44).

ARETHA SOMERVILLE, EXAMINING ATTORNEY

CLASS 12—(Continued).

SN 78-522,959. REBICK, MICHAEL S., LITTLE ROCK, AR,
FILED 11-24-2004.

Hitchrific

THE MARK CONSISTS OF STANDARD CHARACTERS WITHOUT CLAIM TO ANY PARTICULAR FONT, STYLE, SIZE, OR COLOR.

FOR TRAILER HITCH HEIGHT ADJUSTMENT MECHANISM MOUNTED ON THE HITCH RECEIVER (U.S. CLS. 19, 21, 23, 31, 35 AND 44).

JOHN WILKE, EXAMINING ATTORNEY

SN 78-523,369. DETROIT INNOVATIVE PRODUCTS COMPANY, OXFORD, MI. FILED 11-28-2004.

WINTERCOUPE

THE MARK CONSISTS OF STANDARD CHARACTERS WITHOUT CLAIM TO ANY PARTICULAR FONT, STYLE, SIZE, OR COLOR.

FOR REMOVABLE HARDTOP ROOF FOR TEMPORARY MOUNTING ON A CONVERTIBLE AUTOMOBILE (U.S. CLS. 19, 21, 23, 31, 35 AND 44).

NORA BUCHANAN WILL, EXAMINING ATTORNEY

CLASS 12—(Continued).

SN 78-524,196. ELECTRIC MOBILITY CORPORATION, SEWELL, NJ. FILED 11-30-2004.

CLASS 12—(Continued).

SN 78-526,073. ELECTRIC MOBILITY CORPORATION, SEWELL, NJ. FILED 12-2-2004.

AutoGo Vision

PowerShopper

THE MARK CONSISTS OF STANDARD CHARACTERS WITHOUT CLAIM TO ANY PARTICULAR FONT, STYLE, SIZE, OR COLOR.

OWNER OF U.S. REG. NO. 2,810,755.

FOR ELECTRIC POWERED, FOLDING MOBILITY SCOOTERS AND ELECTRIC POWERED, FOLDING MOBILITY WHEELED CHAIRS (U.S. CLS. 19, 21, 23, 31, 35 AND 44).

FIRST USE 11-8-2004; IN COMMERCE 11-8-2004.
MELISSA VALLILLO, EXAMINING ATTORNEY

THE MARK CONSISTS OF STANDARD CHARACTERS WITHOUT CLAIM TO ANY PARTICULAR FONT, STYLE, SIZE, OR COLOR.

FOR ELECTRIC MOBILITY SCOOTERS, POWER-CHAIRS AND ELECTRIC WHEELED CHAIRS (U.S. CLS. 19, 21, 23, 31, 35 AND 44).

FIRST USE 8-18-2004; IN COMMERCE 8-18-2004.
DOUGLAS LEE, EXAMINING ATTORNEY

SN 78-525,285. DURAKON INDUSTRIES, INC., LAPEER, MI. FILED 12-1-2004.

SN 78-528,633. SMART MEDICAL TECHNOLOGY, INC., DARIEN, IL. FILED 12-7-2004.

DURALID

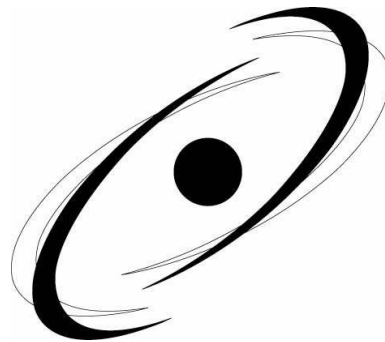

THE MARK CONSISTS OF STANDARD CHARACTERS WITHOUT CLAIM TO ANY PARTICULAR FONT, STYLE, SIZE, OR COLOR.

FOR FITTED AND UNFITTED COVERS FOR THE CARGO AREAS OF TRUCKS, VANS AND AUTOMOBILES (U.S. CLS. 19, 21, 23, 31, 35 AND 44).

LINDA ESTRADA, EXAMINING ATTORNEY

THE MARK CONSISTS OF DOUBLE CONCENTRIC CURVES SURROUNDING A FILLED CIRCLE.

FOR HOSPITAL CARTS, NAMELY, CART WHICH STORES INFLATABLE AIR MATTRESSES, A BLOWER AND A BATTERY POWER SOURCE (U.S. CLS. 19, 21, 23, 31, 35 AND 44).

FIRST USE 11-24-2004; IN COMMERCE 11-24-2004.
LOURDES AYALA, EXAMINING ATTORNEY

CLASS 12—(Continued).

SN 78-529,317. SPECTRUM AERONAUTICAL SERVICES, INC., ENCINITAS, CA. FILED 12-8-2004.

**SPECTRUM
AERONAUTICAL**

THE MARK CONSISTS OF STANDARD CHARACTERS WITHOUT CLAIM TO ANY PARTICULAR FONT, STYLE, SIZE, OR COLOR.

NO CLAIM IS MADE TO THE EXCLUSIVE RIGHT TO USE "AERONAUTICAL", APART FROM THE MARK AS SHOWN.

FOR AIRBORNE VEHICLES AND AIRCRAFT: NAMELY, JET AIRCRAFT FOR GENERAL AVIATION (U.S. CLS. 19, 21, 23, 31, 35 AND 44).

TIMOTHY FINNEGAN, EXAMINING ATTORNEY

CLASS 12—(Continued).

SN 78-534,572. BAKER, SCOTT DAMON, BAYFIELD, CO. FILED 12-17-2004.

RyderEyes

THE MARK CONSISTS OF STANDARD CHARACTERS WITHOUT CLAIM TO ANY PARTICULAR FONT, STYLE, SIZE, OR COLOR.

FOR AUTOMOTIVE TRIM NAMELY, REAR-VIEW MIRRORS (U.S. CLS. 19, 21, 23, 31, 35 AND 44).

MARC LEIPZIG, EXAMINING ATTORNEY

SN 78-534,287. GOODYEAR TIRE & RUBBER COMPANY, THE, AKRON, OH. FILED 12-17-2004.

UMS

THE MARK CONSISTS OF STANDARD CHARACTERS WITHOUT CLAIM TO ANY PARTICULAR FONT, STYLE, SIZE, OR COLOR.

FOR TIRES (U.S. CLS. 19, 21, 23, 31, 35 AND 44).

FIRST USE 2-17-2004; IN COMMERCE 2-17-2004.

JASON TURNER, EXAMINING ATTORNEY

SN 78-535,280. U-HAUL INTERNATIONAL, INC., PHOENIX, AZ. FILED 12-20-2004.

U-HAUL

THE MARK CONSISTS OF STANDARD CHARACTERS WITHOUT CLAIM TO ANY PARTICULAR FONT, STYLE, SIZE, OR COLOR.

OWNER OF U.S. REG. NOS. 746,034, 893,891 AND OTHERS.

FOR TRAILER HITCH BALLS AND SHANKS (U.S. CLS. 19, 21, 23, 31, 35 AND 44).

FIRST USE 12-1-2001; IN COMMERCE 12-1-2001.

THEODORE MCBRIDE, EXAMINING ATTORNEY

CLASS 12—(Continued).

SN 78-537,256. ASC INCORPORATED, SOUTHGATE, MI.
FILED 12-22-2004.

INFINIVU

THE MARK CONSISTS OF STANDARD CHARACTERS WITHOUT CLAIM TO ANY PARTICULAR FONT, STYLE, SIZE, OR COLOR.

FOR SHOW-CAR VEHICLES; CUSTOMIZED AUTOMOTIVE VEHICLES; OPEN AIR SYSTEMS FOR VEHICLES, NAMELY CONVERTIBLE ROOFS, SUNROOFS AND RETRACTABLE ROOFS (U.S. CLS. 19, 21, 23, 31, 35 AND 44).

JANICE L. MCMORROW, EXAMINING ATTORNEY

SN 78-538,162. SINOCEM NINGBO LTD., NINGBO, ZHEJIANG, CHINA, FILED 12-23-2004.

CARSTECH

THE MARK CONSISTS OF THE WORD CARSTECH WHICH IS AN INVENTED WORD AND HAS NO MEANING OR SIGNIFICANCE IN THE RELEVANT TRADE OR IN ANY LANGUAGES.

FOR AIR COMPRESSORS FOR VEHICLES; PUMPS FOR BICYCLES; PUMPS FOR TRICYCLES; AIR PUMPS OF AUTOMOBILES; AIR PUMPS OF TWO-WHEELED MOTOR VEHICLES OR BICYCLES (U.S. CLS. 19, 21, 23, 31, 35 AND 44).

FIRST USE 8-1-2002; IN COMMERCE 11-30-2003.
JEFF DEFORD, EXAMINING ATTORNEY

CLASS 12—(Continued).

SN 79-000,843. UNION CYCLISTE INTERNATIONALE, CH-1860 AIGLE, SWITZERLAND, FILED 1-15-2004.



OWNER OF INTERNATIONAL REGISTRATION 0637279 DATED 1-25-1995, EXPIRES 1-25-2015.

OWNER OF U.S. REG. NO. 2,078,304.

THE COLOR(S) BLUE, RED, BLACK, YELLOW AND GREEN IS/ARE CLAIMED AS A FEATURE OF THE MARK.

THE LETTERS UCI AND THE OVAL APPEAR IN BLACK, AND THE BARS TO THE LEFT OF THE LETTERS APPEAR FROM TOP TO BOTTOM IN BLUE, RED, BLACK, YELLOW AND GREEN.

FOR BICYCLES AND BICYCLE ACCESSORIES, NAMELY, PUMPS, SADDLE COVERS, KICKSTANDS, HANDLEBAR GRIPS, BELLS, HORNS, AND WATER BOTTLE CAGES (U.S. CLS. 19, 21, 23, 31, 35 AND 44).

MARTHA FROMM, EXAMINING ATTORNEY

SN 79-006,941. S.C. AEROSTAR S.A., ROMANIA, FILED 5-26-2004.

iaak-52

OWNER OF INTERNATIONAL REGISTRATION 0837832 DATED 5-26-2004, EXPIRES 5-26-2014.

FOR AIRCRAFT (U.S. CLS. 19, 21, 23, 31, 35 AND 44).
DANIEL BRODY, EXAMINING ATTORNEY

CLASS 13—FIREARMS

SN 76-403,346. SNC TECHNOLOGIES INC., LE GARDEUR, QUEBEC, CANADA, FILED 5-3-2002.

SECURIBLANK

PRIORITY CLAIMED UNDER SEC. 44(D) ON CANADA APPLICATION NO. 1,132,325, FILED 3-1-2002, REG. NO. TMA618207, DATED 8-31-2004, EXPIRES 8-31-2019.

FOR AMMUNITION (U.S. CLS. 2 AND 9).
MATTHEW PAPPAS, EXAMINING ATTORNEY

CLASS 13—(Continued).

SN 76-611,835. COOPER FIREARMS OF MONTANA, INC., STEVENSVILLE, MT. FILED 9-17-2004.

VARMINT EXTREME

THE MARK CONSISTS OF STANDARD CHARACTERS WITHOUT CLAIM TO ANY PARTICULAR FONT, STYLE, SIZE, OR COLOR.

FOR FIREARMS, NAMELY RIFLES AND PARTS THEREOF; AMMUNITION (U.S. CLS. 2 AND 9).
FIRST USE 9-21-1992; IN COMMERCE 9-21-1992.
KENNETH D. BATTLE, EXAMINING ATTORNEY

CLASS 13—(Continued).

SN 78-242,374. ARSENAL AD, KAZANLAK, BULGARIA, FILED 4-25-2003.



SN 76-615,733. JONN JAMES, L.L.C., FARMINGTON, CT. FILED 10-14-2004.

JONN JAMES

THE MARK CONSISTS OF STANDARD CHARACTERS WITHOUT CLAIM TO ANY PARTICULAR FONT, STYLE, SIZE, OR COLOR.

JONN JAMES, IS NOT THE NAME OF A LIVING INDIVIDUAL.

FOR GUN CASES AND GUN CLEANING IMPLEMENTS, NAMELY, BRUSHES (U.S. CLS. 2 AND 9).
JUDITH HELFMAN, EXAMINING ATTORNEY

OWNER OF BULGARIA REG. NO. 39102, DATED 12-11-2000, EXPIRES 2-22-2010.

FOR RIFLES, AUTOMATIC RIFLES, COMPONENT PARTS FOR RIFLES; MILITARY RIFLES; SPORTING RIFLES; RIFLES AND PARTS THEREOF; PISTOLS AND PARTS THEREOF; ARTILLERY GUNS; AUTOMATIC GUNS; AUTOMATIC PISTOLS; GUN BARRELS; RIFLE BARRELS; AMMUNITION; SMALL ARMS AMMUNITION; ANTI-AIRCRAFT GUNS; GUN CARTRIDGES; RIFLE CARTRIDGES; SPORTING CARTRIDGES; CLEANING IMPLEMENTS FOR FIREARMS, NAMELY, BRUSHES, RODS, PULL-THROUGHS, CLOSER CUPS AND SHELL EXTRACTORS; DETONATORS; EXPLOSIVES; FIREARMS; MORTAR BOMBS; FORESIGHTS FOR FIREARMS; SLING STRAPS FOR FIREARMS; SUPPLEMENTAL CHAMBERS FOR FIREARMS; GUN SIGHTS FOR FIREARMS; FIRECRACKERS; GRENADE LAUNCHERS; GRENADES; GRIPS FOR SMALL ARMS; GUN CARRIAGES; GUN CASES; GUN MOUNTS; MOBILE GUN MOUNTS; GUN PARTS; GUN STOCKS; MACHINE GUN TURRETS; BELTS FOR MILITARY EQUIPMENT; AMMUNITION BAGS; MACHINE GUNS; SUBMACHINE GUNS; ROCKET LAUNCHERS; LOADING CLIPS FOR PISTOLS; LOADING CLIPS FOR SMALL ARMS; MACHINE GUN CHARGES; MAGAZINES FOR WEAPONS; NAVAL GUNS; PERCUSSION CAPS; PISTOL CAPS; AUTOMATIC REVOLVERS; HANDLES FOR REVOLVERS; REVOLVERS AND PARTS THEREOF; CLEANING RODS FOR FIREARMS; WIPING RODS FOR GUNS; SHELL BELTS; ARMOR-PIERCING SHELLS; BLANK CARTRIDGE SHELLS; SHOTGUN SHELLS; SHOTGUNS AND PARTS THEREOF; SIGHT PROTECTORS FOR FIREARMS; SMALL ARMS; STANDS FOR FIREARMS; MORTARS; BUTT PLATES FOR PISTOLS; BUTT PLATES FOR RIFLES; PERCUSSION PRIMERS; COLORED SIGNAL FLARES; SHOTGUN POWDER; GUN POWDER; ROCKETS; AND DETONATING PRIMERS (U.S. CLS. 2 AND 9).

FIRST USE 3-11-1994; IN COMMERCE 3-11-1994.
APRIL L. RADEMACHER, EXAMINING ATTORNEY

SN 76-625,919. WOOD, JOHN D, N. CANTON, OH. FILED 12-27-2004.

SELF DEFENDER

THE MARK CONSISTS OF STANDARD CHARACTERS WITHOUT CLAIM TO ANY PARTICULAR FONT, STYLE, SIZE, OR COLOR.

FOR STUN GUN FOR SELF PROTECTION (U.S. CLS. 2 AND 9).

FIRST USE 12-31-2004; IN COMMERCE 12-31-2004.
RENEE MCCRAY, EXAMINING ATTORNEY

CLASS 13—(Continued).

SN 78-369,141. STEVEN SIMS, INC., SHELTON, WA. FILED 2-17-2004.

CLASS 13—(Continued).

SN 78-493,760. FABBRICA D'ARMI P. BERETTA, S.P.A., GARDONE VAL TROMPIA, BRESCIA, ITALY, FILED 10-4-2004.

LimbSaver

GOLD RUSH

THE MARK CONSISTS OF STANDARD CHARACTERS WITHOUT CLAIM TO ANY PARTICULAR FONT, STYLE, SIZE, OR COLOR.

FOR FIREARMS AND REPLACEMENT COMPONENT PARTS THEREFOR- ACCESSORIES FOR FIREARMS, NAMELY RECOIL PADS (U.S. CLS. 2 AND 9).
FIRST USE 6-22-2001; IN COMMERCE 6-22-2001.
ASMAT KHAN, EXAMINING ATTORNEY

THE MARK CONSISTS OF STANDARD CHARACTERS WITHOUT CLAIM TO ANY PARTICULAR FONT, STYLE, SIZE, OR COLOR.

FOR FIREARMS (U.S. CLS. 2 AND 9).
BARBARA A. LOUGHRAN, EXAMINING ATTORNEY

SN 78-455,651. TACTICAL LINK, LLC, BELLEVUE, WA. FILED 7-23-2004.

SN 78-497,365. LDE CORPORATION, GILLETTE, WY. FILED 10-9-2004.

X-180

SOFTLOAD

THE MARK CONSISTS OF STANDARD CHARACTERS WITHOUT CLAIM TO ANY PARTICULAR FONT, STYLE, SIZE, OR COLOR.

FOR TACTICAL SLINGS AND MOUNTS FOR FIREARMS (U.S. CLS. 2 AND 9).
FIRST USE 3-30-2004; IN COMMERCE 7-1-2004.
JOHN GARTNER, EXAMINING ATTORNEY

THE MARK CONSISTS OF STANDARD CHARACTERS WITHOUT CLAIM TO ANY PARTICULAR FONT, STYLE, SIZE, OR COLOR.

FOR EXPLOSIVES (U.S. CLS. 2 AND 9).
FIRST USE 4-0-1999; IN COMMERCE 1-0-2001.
DOMINICK J. SALEMI, EXAMINING ATTORNEY

CLASS 13—(Continued).

SN 78-504,077. TACTICAL LINK, L.L.C., BELLEVUE, WA.
FILED 10-21-2004.

CLASS 13—(Continued).

SN 78-538,551. STEVEN SIMS, INC., SHELTON, WA. FILED
12-27-2004.

Hold Your Own

THE MARK CONSISTS OF STANDARD CHARACTERS
WITHOUT CLAIM TO ANY PARTICULAR FONT, STYLE,
SIZE, OR COLOR.

FOR SLINGS AND SLING MOUNTS FOR FIREARMS
(U.S. CLS. 2 AND 9).

FIRST USE 10-1-2004; IN COMMERCE 10-1-2004.
WON TEAK OH, EXAMINING ATTORNEY

Grind To Fit

THE MARK CONSISTS OF STANDARD CHARACTERS
WITHOUT CLAIM TO ANY PARTICULAR FONT, STYLE,
SIZE, OR COLOR.

FOR ACCESSORIES FOR FIREARMS; NAMELY, RE-
COIL PADS; COMPONENTS OF FIREARMS, NAMELY,
RECOIL PADS (U.S. CLS. 2 AND 9).

FIRST USE 2-11-2003; IN COMMERCE 2-11-2003.
GIANCARLO CASTRO, EXAMINING ATTORNEY

SN 78-511,159. H & R 1871, LLC, NORTH HAVEN, CT. FILED
11-4-2004.

EXCELL AUTO 5

THE MARK CONSISTS OF STANDARD CHARACTERS
WITHOUT CLAIM TO ANY PARTICULAR FONT, STYLE,
SIZE, OR COLOR.

NO CLAIM IS MADE TO THE EXCLUSIVE RIGHT TO
USE "AUTO", APART FROM THE MARK AS SHOWN.

FOR FIREARMS (U.S. CLS. 2 AND 9).
ANDREA SAUNDERS, EXAMINING ATTORNEY

SN 79-005,840. PATRIA VAMMAS OY, FINLAND, FILED 6-
22-2004.

SN 78-536,825. BERETTA USA CORP., ACCOKEEK, MD.
FILED 12-22-2004.

NEMO**AMBASSADOR**

THE MARK CONSISTS OF STANDARD CHARACTERS
WITHOUT CLAIM TO ANY PARTICULAR FONT, STYLE,
SIZE, OR COLOR.

FOR FIREARMS (U.S. CLS. 2 AND 9).
JEAN IM, EXAMINING ATTORNEY

THE MARK CONSISTS OF STANDARD CHARACTERS
WITHOUT CLAIM TO ANY PARTICULAR FONT, STYLE,
SIZE, OR COLOR.

PRIORITY DATE OF 1-30-2004 IS CLAIMED.
OWNER OF INTERNATIONAL REGISTRATION 0834689
DATED 6-22-2004, EXPIRES 6-22-2014.

FOR 120MM MODULAR MORTAR, WHICH CAN
INCLUDE AMONG OTHERS A BREECH LOADING
WEAPON, A TURRET AND/OR VEHICLE (U.S. CLS. 2
AND 9).

ANN LINNEHAN, EXAMINING ATTORNEY

CLASS 14—JEWELRY

SN 76-273,676. D.S. SALES, INC., SAN FRANCISCO, CA. FILED 6-20-2001.

PLIE

THE MARK CONSISTS OF STANDARD CHARACTERS WITHOUT CLAIM TO ANY PARTICULAR FONT, STYLE, SIZE, OR COLOR.

FOR COSTUME JEWELRY, NAMELY BRACELETS, NECKLACES, PINS, EARRINGS, BARRETTES, CHAINS (U.S. CLS. 2, 27, 28 AND 50).

FIRST USE 4-1-2001; IN COMMERCE 4-1-2001.

ANDREW BENZMILLER, EXAMINING ATTORNEY

SN 76-493,289. OTKRITOE AKTSIONERNOE OBSHCHESTVO "PERVY MOSKOVSKY CHASOVOY ZAVOD", RU-109147, MOSCOW, RUSSIAN FED., FILED 2-27-2003.

ИЮJIET

OWNER OF RUSSIAN FED. REG. NO. 60493, DATED 11-10-1976, EXPIRES 11-10-2006.

FOR WATCHES AND CHRONOMETRIC INSTRUMENTS, NAMELY, CHRONOMETERS, CHRONOGRAPHS FOR USE AS WATCHES, CHRONOSCOPES (U.S. CLS. 2, 27, 28 AND 50).

H. M. FISHER, EXAMINING ATTORNEY

SN 76-534,561. BROCKBANK, MARA, DBA MARA FINE SILVER, CHARLESTON, SC. FILED 8-5-2003.

A THING OF BEAUTY IS A JOY FOREVER

THE MARK CONSISTS OF STANDARD CHARACTERS WITHOUT CLAIM TO ANY PARTICULAR FONT, STYLE, SIZE, OR COLOR.

OWNER OF U.S. REG. NO. 2,353,415.

FOR SILVER, SILVER-PLATED GOODS AND PEWTER ITEMS AND BABY GIFTS, NAMELY CUPS, BOWLS, RATTLES AND JEWELRY, ALL OF PRECIOUS METAL; AND GENERAL DECORATIVE ACCESSORIES AND TABLETOP ITEMS, NAMELY, SERVING TRAYS, VASES, PUNCH BOWLS, CANDLESTICKS AND CANDLABRA, MIRRORS, JEWELRY BOXES, DECORATIVE BOXES, VANITY SETS, AND PICTURE FRAMES, ALL MADE OF PRECIOUS METAL (U.S. CLS. 2, 27, 28 AND 50).

FIRST USE 0-0-1993; IN COMMERCE 0-0-1993.

KEVON CHISOLM, EXAMINING ATTORNEY

CLASS 14—(Continued).

SN 76-557,955. CESPA S.R.L., CIVITANOVA MARCHE (MACERATA), ITALY, FILED 10-20-2003.

CESARE PACIOTTI

PRIORITY CLAIMED UNDER SEC. 44(D) ON ITALY APPLICATION NO. AN2003C00130, FILED 5-16-2003, REG. NO. 917795, DATED 11-5-2003, EXPIRES 5-16-2013.

OWNER OF U.S. REG. NOS. 1,640,592, 2,787,369 AND OTHERS.

THE NAME CESARE PACIOTTI IDENTIFIES A LIVING INDIVIDUAL WHOSE CONSENT IS OF RECORD.

FOR HOROLOGICAL AND CHRONOMETRIC INSTRUMENTS, NAMELY CLOCKS, WATCHES, TABLE CLOCKS, STOPWATCHES, ALARM WATCHES, CHRONOMETERS; WATCH CHAINS AND GOODS OF PRECIOUS METAL NAMELY EARRINGS, EAR-PENDANTS, BRACELETS, NECKLACES, CHAINS, RINGS; PRECIOUS STONES, PICTURE FRAMES OF PRECIOUS METAL (U.S. CLS. 2, 27, 28 AND 50).

KELLEY WELLS, EXAMINING ATTORNEY

SN 76-562,842. TXDC, L.P., IRVING, TX. FILED 11-19-2003.

BRILLIANT BUY

THE MARK CONSISTS OF STANDARD CHARACTERS WITHOUT CLAIM TO ANY PARTICULAR FONT, STYLE, SIZE, OR COLOR.

OWNER OF U.S. REG. NO. 2,436,208 AND OTHERS.

FOR JEWELRY (U.S. CLS. 2, 27, 28 AND 50).

FIRST USE 10-1-1995; IN COMMERCE 10-1-1995.

STACY WAHLBERG, EXAMINING ATTORNEY

SN 76-562,843. TXDC, L.P., IRVING, TX. FILED 11-19-2003.

UNA COMPRA BRILLANTE

THE MARK CONSISTS OF STANDARD CHARACTERS WITHOUT CLAIM TO ANY PARTICULAR FONT, STYLE, SIZE, OR COLOR.

THE ENGLISH TRANSLATION OF "UNA COMPRA BRILLANTE" IS "BRILLIANT BUY".

FOR JEWELRY (U.S. CLS. 2, 27, 28 AND 50).

FIRST USE 0-0-1994; IN COMMERCE 0-0-1994.

STACY WAHLBERG, EXAMINING ATTORNEY

CLASS 14—(Continued).

SN 76-581,587. VARELLA, LLC, HAYWARD, CA. FILED 3-17-2004.

VAR

THE MARK CONSISTS OF STANDARD CHARACTERS WITHOUT CLAIM TO ANY PARTICULAR FONT, STYLE, SIZE, OR COLOR.

FOR JEWELRY (U.S. CLS. 2, 27, 28 AND 50).
STEVEN JACKSON, EXAMINING ATTORNEY

SN 76-587,558. ROSATO S.R.L., I-52100 AREZZO, ITALY, FILED 4-20-2004.

ROSATO

THE MARK CONSISTS OF STANDARD CHARACTERS WITHOUT CLAIM TO ANY PARTICULAR FONT, STYLE, SIZE, OR COLOR.

I, SIMONETTA "ROSATO", CONSENT TO USE AND REGISTRATION OF MY NAME AS A TRADEMARK FOR THE GOODS RECITED IN THE ABOVE-IDENTIFIED APPLICATION AND BY THE ABOVE-IDENTIFIED APPLICANT.

"ROSATO" TRANSLATES FROM ITALIAN INTO ENGLISH AS "ROSY."

FOR JEWELRY, NAMELY RINGS, BRACELETS, CHAINS, NECKLACES, PENDANTS, TIEPINS, CUFFLINKS, EARRINGS, KEY-HOLDERS, BROOCHES, ALL MADE OF PRECIOUS METALS (U.S. CLS. 2, 27, 28 AND 50).

FIRST USE 5-28-2001; IN COMMERCE 5-3-2002.
BARBARA BROWN, EXAMINING ATTORNEY

CLASS 14—(Continued).

SN 76-593,693. STATE OF IDAHO, BOISE, ID. FILED 5-21-2004.



NO CLAIM IS MADE TO THE EXCLUSIVE RIGHT TO USE "SUPPORT IDAHO'S HEROES 2004, ONE TROY OUNCE, .999 FINE SILVER AND THE PICTORAL REPRESENTATION OF THE AMERICAN FLAG", APART FROM THE MARK AS SHOWN.

THE STIPPLING IS A FEATURE OF THE MARK.

THE PORTRAIT OF THE INDIVIDUAL DOES NOT IDENTIFY ANY PARTICULAR LIVING INDIVIDUAL

THE MARK CONSISTS OF A NON-LIVING INDIVIDUAL IN MILITARY UNIFORM HOLDING A HORN LOOKING OVER A CEMETARY. THE WORDS A SACRED TRUST SUPPORT IDAHO'S HEROES 2004 ONE TROY OUNCE .999 FINE SILVER ARE WRITTEN IN CIRCUMVOLVING FASHION AROUND THE EDGE OF THE CIRCLE.

FOR COMMEMORATIVE MEDALLIONS (U.S. CLS. 2, 27, 28 AND 50).

STEVEN JACKSON, EXAMINING ATTORNEY

SN 76-597,456. K.L.H. DIAMONDS INC., NEW YORK, NY. FILED 6-14-2004.

HEAVENLY WOMAN

THE MARK CONSISTS OF STANDARD CHARACTERS WITHOUT CLAIM TO ANY PARTICULAR FONT, STYLE, SIZE, OR COLOR.

NO CLAIM IS MADE TO THE EXCLUSIVE RIGHT TO USE "WOMAN", APART FROM THE MARK AS SHOWN.

FOR DIAMONDS; AND JEWELRY THAT IS SET WITH DIAMONDS AND/OR PRECIOUS OR SEMI-PRECIOUS GEMSTONES (U.S. CLS. 2, 27, 28 AND 50).

MICHAEL ENGEL, EXAMINING ATTORNEY

CLASS 14—(Continued).

SN 76-604,749. RCI JEWELRY CORPRATION, AKA RAICO GEM DESIGNS, GREAT NECK, NY. FILED 7-29-2004.

RAYMOND HAK

THE MARK CONSISTS OF STANDARD CHARACTERS WITHOUT CLAIM TO ANY PARTICULAR FONT, STYLE, SIZE, OR COLOR.

THE NAME "RAYMOND HAK" IDENTIFIES A LIVING INDIVIDUAL WHOSE CONSENT IS OF RECORD. FOR JEWELRY; JEWELRY MADE OF PRECIOUS METAL (U.S. CLS. 2, 27, 28 AND 50). FIRST USE 6-1-2004; IN COMMERCE 6-1-2004. BARBARA A. GOLD, EXAMINING ATTORNEY

CLASS 14—(Continued).

SN 76-617,052. HAYDEN, CHERI L., JEANNETTE, PA. AND HAYDEN, DANIEL S., JEANNETTE, PA. FILED 10-18-2004.

BACKLACE

THE MARK CONSISTS OF STANDARD CHARACTERS WITHOUT CLAIM TO ANY PARTICULAR FONT, STYLE, SIZE, OR COLOR.

FOR JEWELRY IN THE NATURE OF NECKLACES (U.S. CLS. 2, 27, 28 AND 50). DAHLIA GEORGE, EXAMINING ATTORNEY

SN 76-613,211. RICH DIAL CORPORATION, MARINA DEL REY, CA. FILED 9-28-2004.

ILLINOIS

THE MARK CONSISTS OF STANDARD CHARACTERS WITHOUT CLAIM TO ANY PARTICULAR FONT, STYLE, SIZE, OR COLOR.

FOR WATCHES (U.S. CLS. 2, 27, 28 AND 50). JOHN GARTNER, EXAMINING ATTORNEY

SN 76-617,775. F.I.OR. - FABBRICA ITALIANA OREFICERIA S.P.A., I-52020 LATERINA (AREZZO), ITALY, FILED 10-26-2004.

fior

SN 76-616,818. CYBEL TRADING CORPORATION, NEW YORK, NY. FILED 10-19-2004.

belpearl

THE MARK CONSISTS OF STANDARD CHARACTERS WITHOUT CLAIM TO ANY PARTICULAR FONT, STYLE, SIZE, OR COLOR.

FOR JEWELRY (U.S. CLS. 2, 27, 28 AND 50). FIRST USE 3-22-2004; IN COMMERCE 3-22-2004. MITCHELL FRONT, EXAMINING ATTORNEY

OWNER OF U.S. REG. NO. 1,298,736. FOR SPRING RINGS AND CLASPS SOLD TO JEWELRY MANUFACTURERS AND JEWELRY MANUFACTURER SUPPLIERS, ALL MADE OF PRECIOUS METALS (U.S. CLS. 2, 27, 28 AND 50).

FIRST USE 10-28-1975; IN COMMERCE 0-0-1977. FRED MANDIR, EXAMINING ATTORNEY

CLASS 14—(Continued).

SN 76-620,392. MSG MANAGEMENT BERATUNGSGESELLSCHAFT M.B.H., A-1190 VIENNA, AUSTRIA, FILED 11-10-2004.

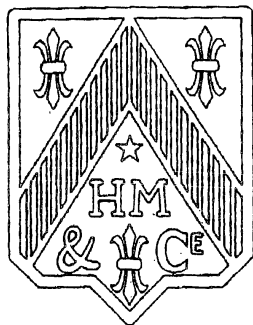

PRIORITY CLAIMED UNDER SEC. 44(D) ON AUSTRIA APPLICATION NO. AM3339/2004, FILED 5-12-2004, REG. NO. 218902, DATED 7-23-2004, EXPIRES 7-31-2014.

FOR WRIST WATCHES, HALL CLOCKS, LONG CASE CLOCKS, POCKET WATCHES (U.S. CLS. 2, 27, 28 AND 50).

DAWN HAN, EXAMINING ATTORNEY

SN 76-622,509. DIARA, INC., BOCA RATON, FL. FILED 11-29-2004.

DIARA

THE MARK CONSISTS OF STANDARD CHARACTERS WITHOUT CLAIM TO ANY PARTICULAR FONT, STYLE, SIZE, OR COLOR.

FOR JEWELRY, NAMELY, RINGS, BRACELETS, EARRINGS, NECKLACES AND PENDANTS MADE OF PRECIOUS METALS (U.S. CLS. 2, 27, 28 AND 50).

DANIEL BRODY, EXAMINING ATTORNEY

SN 76-625,865. BYARD F. BROGAN INCORPORATED, GLENSIDE, PA. FILED 12-27-2004.

PRINCESSE

THE MARK CONSISTS OF STANDARD CHARACTERS WITHOUT CLAIM TO ANY PARTICULAR FONT, STYLE, SIZE, OR COLOR.

FOR PEARLS (U.S. CLS. 2, 27, 28 AND 50).

FIRST USE 12-31-1952; IN COMMERCE 12-31-1952.
DORITT L. CARROLL, EXAMINING ATTORNEY

CLASS 14—(Continued).

SN 78-272,052. AKZAN USA INC, MERCER ISLAND, WA. FILED 7-9-2003.

AKZAN

FOR WATCHES (U.S. CLS. 2, 27, 28 AND 50).
FIRST USE 5-30-2003; IN COMMERCE 5-30-2003.
KIM SAITO, EXAMINING ATTORNEY

SN 78-286,909. HEARTS ON FIRE COMPANY LLC, BOSTON, MA. FILED 8-13-2003.

ILLUSION

FOR GEMSTONES, NAMELY CUT DIAMONDS, AND JEWELRY, EXCLUDING WATCHES, CLOCKS AND PARTS THEREFOR (U.S. CLS. 2, 27, 28 AND 50).

SUSAN HAYASH, EXAMINING ATTORNEY

SN 78-333,189. AURAFIN LLC, TAMARAC, FL. FILED 11-25-2003.

UC URBAN COUTURE

THE MARK CONSISTS OF STANDARD CHARACTERS WITHOUT CLAIM TO ANY PARTICULAR FONT, STYLE, SIZE, OR COLOR.

NO CLAIM IS MADE TO THE EXCLUSIVE RIGHT TO USE "URBAN COUTURE", APART FROM THE MARK AS SHOWN.

FOR JEWELRY, WATCHES AND CHRONOMETERS AND PARTS THEREOF; WATCH CASES; WATCH BANDS; WATCH STRAPS (U.S. CLS. 2, 27, 28 AND 50).

GWEN STOKOLS, EXAMINING ATTORNEY

SN 78-341,574. J. C. PENNEY PRIVATE BRANDS, INC., PLANO, TX. FILED 12-16-2003.

BOLD COLLECTION

THE MARK CONSISTS OF STANDARD CHARACTERS WITHOUT CLAIM TO ANY PARTICULAR FONT, STYLE, SIZE, OR COLOR.

NO CLAIM IS MADE TO THE EXCLUSIVE RIGHT TO USE "COLLECTION", APART FROM THE MARK AS SHOWN.

FOR JEWELRY (U.S. CLS. 2, 27, 28 AND 50).
CURTIS FRENCH, EXAMINING ATTORNEY

CLASS 14—(Continued).

SN 78-348,309. D.M. MERCHANDISING, INC., SCHILLER PARK, IL. FILED 1-6-2004.

CLASS 14—(Continued).

SN 78-384,241. HEARTS ON FIRE COMPANY LLC, BOSTON, MA. FILED 3-15-2004.

RED H'ATTITUDE

THE MARK CONSISTS OF STANDARD CHARACTERS WITHOUT CLAIM TO ANY PARTICULAR FONT, STYLE, SIZE, OR COLOR.
FOR JEWELRY (U.S. CLS. 2, 27, 28 AND 50).
FIRST USE 9-30-2003; IN COMMERCE 10-31-2003.
MELVIN AXILBUND, EXAMINING ATTORNEY

SN 78-380,866. LITTLE ONE ENTERPRISES, INC., ENCINO, CA. FILED 3-9-2004.

**Lizzie Scheck
Jewelry**

THE MARK CONSISTS OF STANDARD CHARACTERS WITHOUT CLAIM TO ANY PARTICULAR FONT, STYLE, SIZE, OR COLOR.
NO CLAIM IS MADE TO THE EXCLUSIVE RIGHT TO USE "JEWELRY", APART FROM THE MARK AS SHOWN.
THE NAME(S), PORTRAIT(S), AND/OR SIGNATURE(S) SHOWN IN THE MARK IDENTIFIES ELIZABETH SCHECK, WHOSE CONSENT(S) TO REGISTER IS SUBMITTED.
FOR JEWELRY, NAMELY, RINGS, EARRINGS, NECKLACES, CHARMS, BRACELETS, PENDANTS, ANKLETS, CUFF LINKS AND JEWELRY MADE WITH PRECIOUS METALS AND PRECIOUS STONES (U.S. CLS. 2, 27, 28 AND 50).
FIRST USE 1-1-2003; IN COMMERCE 1-1-2003.
BRIDGETT SMITH, EXAMINING ATTORNEY

DESIRE

THE MARK CONSISTS OF STANDARD CHARACTERS WITHOUT CLAIM TO ANY PARTICULAR FONT, STYLE, SIZE, OR COLOR.
FOR JEWELRY (U.S. CLS. 2, 27, 28 AND 50).
FIRST USE 1-1-2003; IN COMMERCE 6-1-2003.
WILLIAM BRECKENFELD, EXAMINING ATTORNEY

SN 78-390,023. WOLFF, NATALEE, BRIARCLIFF MANOR, NY. FILED 3-24-2004.

**ICE WILL MAKE YOU
SHINE**

THE MARK CONSISTS OF STANDARD CHARACTERS WITHOUT CLAIM TO ANY PARTICULAR FONT, STYLE, SIZE, OR COLOR.
NO CLAIM IS MADE TO THE EXCLUSIVE RIGHT TO USE "ICE", APART FROM THE MARK AS SHOWN.
FOR JEWELRY (U.S. CLS. 2, 27, 28 AND 50).
DAWN HAN, EXAMINING ATTORNEY

CLASS 14—(Continued).

SN 78-396,842. CLAIBORNE S. MASON AND LORI D. ROWLAND PARTNERSHIP, THE, RICHMOND, VA. FILED 4-6-2004.

Fandangle

THE MARK CONSISTS OF STANDARD CHARACTERS WITHOUT CLAIM TO ANY PARTICULAR FONT, STYLE, SIZE, OR COLOR.

FOR JEWELRY, PRIMARILY NECKLACES, BRACELETS, EARRINGS; MADE PRIMARILY OF BEADS, SEMI-PRECIOUS STONES AND SILVER (U.S. CLS. 2, 27, 28 AND 50).

FIRST USE 10-1-2003; IN COMMERCE 1-15-2004.
KEVON CHISOLM, EXAMINING ATTORNEY

CLASS 14—(Continued).

SN 78-407,554. HEATER, ALYCIA M.G., PLACERVILLE, CA. FILED 4-24-2004.

**Cleavage Clip
Jewelry Co. www.
CleavageClip.Com**

THE MARK CONSISTS OF STANDARD CHARACTERS WITHOUT CLAIM TO ANY PARTICULAR FONT, STYLE, SIZE, OR COLOR.

NO CLAIM IS MADE TO THE EXCLUSIVE RIGHT TO USE "CLEAVAGE CLIP JEWELRY CO.", APART FROM THE MARK AS SHOWN.

FOR JEWELRY CLIP DESIGNED TO ATTACH ONTO BOTH BRA CUPS (U.S. CLS. 2, 27, 28 AND 50).

FIRST USE 3-23-2004; IN COMMERCE 3-23-2004.
NAAKWAMA ANKRAH, EXAMINING ATTORNEY

SN 78-397,892. MICHAEL ANTHONY JEWELERS, INC., MOUNT VERNON, NY. FILED 4-7-2004.

T&C

THE MARK CONSISTS OF STANDARD CHARACTERS WITHOUT CLAIM TO ANY PARTICULAR FONT, STYLE, SIZE, OR COLOR.

FOR JEWELRY (U.S. CLS. 2, 27, 28 AND 50).
FIRST USE 0-0-1985; IN COMMERCE 0-0-1985.
CURTIS FRENCH, EXAMINING ATTORNEY

SN 78-414,232. SANDBERG & SIKORSKI CORPORATION, NEW YORK, NY. FILED 5-6-2004.

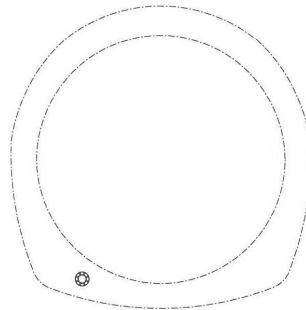

OWNER OF U.S. REG. NO. 2,580,096.

THE MARK CONSISTS OF A DIAMOND APPEARING ON THE BOTTOM LEFT-HAND SIDE OF THE SHANK OF A RING. THE BROKEN LINES SHOW THE MARK'S POSITION ON THE GOODS. THE OUTLINE OF A RING IS NOT PART OF THE MARK.

FOR JEWELRY (U.S. CLS. 2, 27, 28 AND 50).
FIRST USE 10-30-2000; IN COMMERCE 10-30-2000.
MELVIN AXILBUND, EXAMINING ATTORNEY

CLASS 14—(Continued).

SN 78-417,062. SHENZHEN FUQI JEWELRY CO., LTD., TSIM SHA TSUI, KOWLOON, HONG KONG, FILED 5-11-2004.



FOR INGOTS OF PRECIOUS METALS; PRECIOUS METALS, NAMELY, PALLADIUM; PRECIOUS METALS, NAMELY, PLATINUM; HOUSEHOLD UTENSILS OF PRECIOUS METAL, NAMELY, DRINKING VESSELS, EGG CUPS, VASES; GOLD AND SILVER WARE, NAMELY, TOOTHPICK HOLDERS, TEA SERVICES, CANDLE HOLDERS; TABLEWARE OF PRECIOUS METALS, NAMELY, CUPS, DISHES, SERVING PLATTERS; JEWELRY CASES OF PRECIOUS METAL; BRACELETS; CHARMS; BROOCHES; JEWELRY CHAINS; NECKLACES; DIAMONDS; JEWELRY; MEDALLIONS; MEDALS; ORNAMENTS OF PRECIOUS METAL; PRECIOUS GEMSTONES; RINGS BEING JEWELRY; WORKS OF ART OF PRECIOUS METAL, NAMELY, BUSTS, FIGURES; EARRINGS; STATUETTES OF PRECIOUS METAL; PINS BEING JEWELRY; TIE PINS; BADGES OF PRECIOUS METAL; JADE; WORKS OF ART OF SILVER, NAMELY, RINGS, CHAINS, ORNAMENTS; WRISTWATCHES; WATCH CHAINS; FIGURINES OF PRECIOUS METAL (U.S. CLS. 2, 27, 28 AND 50).
MICHAEL SOUDERS, EXAMINING ATTORNEY

SN 78-418,958. JOE RODEO WATCHES LTD., GREAT NECK, NY. FILED 5-14-2004.

Joe Rodeo

THE NAME "JOE RODEO" DOES NOT IDENTIFY A LIVING INDIVIDUAL.
FOR WATCHES AND TIMEPIECES (U.S. CLS. 2, 27, 28 AND 50).
FIRST USE 2-5-2003; IN COMMERCE 2-5-2003.
RUSS HERMAN, EXAMINING ATTORNEY

CLASS 14—(Continued).

SN 78-438,644. J. DAVID HAUSER INC., CAMBRIA, CA. FILED 6-21-2004.

ORO-GAMI

THE MARK CONSISTS OF STANDARD CHARACTERS WITHOUT CLAIM TO ANY PARTICULAR FONT, STYLE, SIZE, OR COLOR.

THE ENGLISH TRANSLATION OF ORO IS "GOLD".
FOR JEWELRY (U.S. CLS. 2, 27, 28 AND 50).
FIRST USE 12-15-2003; IN COMMERCE 6-5-2004.
SCOTT OSLICK, EXAMINING ATTORNEY

SN 78-440,012. MERIT DIAMOND CORPORATION, NEW YORK, NY. FILED 6-23-2004.

IMPECCABLE FIT

THE MARK CONSISTS OF STANDARD CHARACTERS WITHOUT CLAIM TO ANY PARTICULAR FONT, STYLE, SIZE, OR COLOR.

FOR JEWELRY, NAMELY PRECIOUS METALS, PRECIOUS STONES AND/OR SEMI-PRECIOUS STONES (U.S. CLS. 2, 27, 28 AND 50).
INGA ERVIN, EXAMINING ATTORNEY

SN 78-440,849. GIZUZ STYLEZ, ELMONT, NY. FILED 6-24-2004.

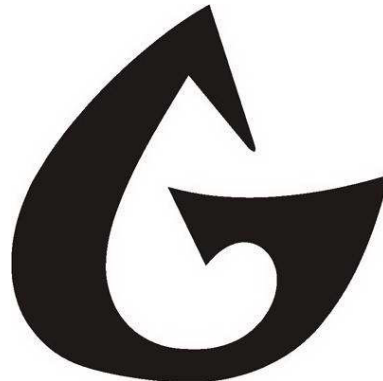

THE MARK CONSISTS OF THE STYLIZED CAPITAL LETTER "G" WHICH HAS A POINT AT BOTH THE TOP AND THE BOTTOM OF THE INITIAL UPWARD STROKE.

FOR JEWELRY, NAMELY, PENDANTS, NECKLACES, BRACELETS, EARRINGS, RINGS, AND CROSSES (U.S. CLS. 2, 27, 28 AND 50).
FIRST USE 3-26-2002; IN COMMERCE 3-26-2002.
REBECCA SMITH, EXAMINING ATTORNEY

CLASS 14—(Continued).

SN 78-442,892. PAULY, SHEREE L., COLORADO SPRINGS, CO. FILED 6-29-2004.

**DEPLOYMENT
BRACELET**

THE MARK CONSISTS OF STANDARD CHARACTERS WITHOUT CLAIM TO ANY PARTICULAR FONT, STYLE, SIZE, OR COLOR.

NO CLAIM IS MADE TO THE EXCLUSIVE RIGHT TO USE "BRACELET", APART FROM THE MARK AS SHOWN.

FOR JEWELRY, NAMELY, BRACELETS, NECKLACES AND EARRINGS MADE OF PRECIOUS METALS (U.S. CLS. 2, 27, 28 AND 50).

FIRST USE 3-10-2003; IN COMMERCE 5-2-2003.
LA TONIA FISHER, EXAMINING ATTORNEY

SN 78-453,078. KRAHENMANN, CHRISTOPH, SANTA BARBARA, CA. FILED 7-19-2004.



KRÄHENMANN

THE NAME(S), PORTRAIT(S), AND/OR SIGNATURE(S) SHOWN IN THE MARK IDENTIFIES CHRISTOPH KRAHENMANN, WHOSE CONSENT(S) TO REGISTER IS SUBMITTED.

THE MARK CONSISTS OF A DESIGN ELEMENT, CONSISTING OF A "RING SETTING" DESIGN BEHIND A STYLIZED ROMAN NUMERAL II, AND THE WORD "KRAHENMANN".

FOR CUSTOM JEWELRY (U.S. CLS. 2, 27, 28 AND 50).
FIRST USE 4-15-2004; IN COMMERCE 4-15-2004.
SHARON MEIER, EXAMINING ATTORNEY

SN 78-459,307. STAR DIAMOND GROUP, ANTWERP, BELGIUM, FILED 7-30-2004.



NO CLAIM IS MADE TO THE EXCLUSIVE RIGHT TO USE "BOTSWANA", "DIAMONDS" AND "BOTSWANA DIAMOND", APART FROM THE MARK AS SHOWN.

THE MARK CONSISTS OF THE WORD BOTSWANA WRITTEN ABOVE THE WORD DIAMONDS WITH A LINE BETWEEN THEM, SAID WORDS BEING TO THE LEFT A DESIGN CONSISTING OF A MARQUIS-SHAPED DIAMOND WITH A STANDING ZEBRA ON EACH SIDE, SAID DESIGN BEING WRITTEN ABOVE A BANNER WITH THE WORDS BOTSWANA DIAMONDS.

FOR DIAMONDS (U.S. CLS. 2, 27, 28 AND 50).
CHARLES JOYNER, EXAMINING ATTORNEY

CLASS 14—(Continued).

SN 78-468,155. TEACHEY, JULIA, SANTA MONICA, CA. FILED 8-16-2004.



NO CLAIM IS MADE TO THE EXCLUSIVE RIGHT TO USE "JEWELRY", APART FROM THE MARK AS SHOWN.

THE MARK CONSISTS OF A SILHOUETTE OF A DRESS IN A FROZEN MOMENT OF A DANCE WITH THE LOGOTYPE REVERSING OUT OF THE BACKGROUND ICON. LOGOTYPE: UPPERCASE TYPE (JULIERI) RUNS VERTICALLY TOP TO BOTTOM ON FRONT OF DRESS. A REVERSED OUT SKEWED OVAL NEAR THE NECKLINE OF THE DRESS IS REPRESENTATIVE OF THE JEWELRY.

FOR JEWELRY (U.S. CLS. 2, 27, 28 AND 50).
FIRST USE 5-20-2002; IN COMMERCE 9-10-2002.
CATHERINE FAINT, EXAMINING ATTORNEY

SN 78-470,527. METCALF, LINDA, SAN DIEGO, CA. FILED 8-19-2004.

**Do you know where
your parents are?**

THE MARK CONSISTS OF STANDARD CHARACTERS WITHOUT CLAIM TO ANY PARTICULAR FONT, STYLE, SIZE, OR COLOR.

NO CLAIM IS MADE TO THE EXCLUSIVE RIGHT TO USE "DO YOU KNOW", APART FROM THE MARK AS SHOWN.

FOR DESKTOP CLOCKS, CLOCKS AND WATCHES (U.S. CLS. 2, 27, 28 AND 50).
FIRST USE 1-1-2004; IN COMMERCE 7-1-2004.
DOMINIC J. FERRAIUOLO, EXAMINING ATTORNEY

CLASS 14—(Continued).

SN 78-472,702. DIAMOND BOUTIQUE INC., SAN DIEGO, CA. FILED 8-24-2004.

Kosher Diamonds

THE MARK CONSISTS OF STANDARD CHARACTERS WITHOUT CLAIM TO ANY PARTICULAR FONT, STYLE, SIZE, OR COLOR.
NO CLAIM IS MADE TO THE EXCLUSIVE RIGHT TO USE "DIAMONDS", APART FROM THE MARK AS SHOWN.
FOR JEWELRY FEATURING DIAMONDS (U.S. CLS. 2, 27, 28 AND 50).
KHANH LE, EXAMINING ATTORNEY

SN 78-478,861. AHUJA, RAMESH HOLARAM, KOWLOON, HONG KONG, AND HK WATCHBANDS CORP., KOWLOON, HONG KONG, FILED 9-3-2004.



THE MARK CONSISTS OF A STYLIZED "A" POSITIONED ABOVE THE WORD ALFA
FOR WATCHES; WATCH BANDS; WATCH STRAPS; WATCH CHAINS; BUCKLES PLATED WITH PRECIOUS METAL; IMITATION JEWELRY; ELECTRIC CLOCKS AND WATCHES; WRISTWATCHES; WATCH CASES; AND WATCH GLASSES (U.S. CLS. 2, 27, 28 AND 50).
FIRST USE 9-12-1997; IN COMMERCE 6-8-2001.
CHARLES L. JENKINS, EXAMINING ATTORNEY

CLASS 14—(Continued).

SN 78-492,163. NATIONAL HOT ROD ASSOCIATION, GLEN-DORA, CA. FILED 9-30-2004.



OWNER OF U.S. REG. NOS. 1,293,428, 2,220,219 AND 2,221,363.
FOR CLOCKS AND WATCHES (U.S. CLS. 2, 27, 28 AND 50).
FIRST USE 7-31-2000; IN COMMERCE 7-31-2000.
STEVEN R. FOSTER, EXAMINING ATTORNEY

SN 78-492,425. CYNTHIA NASH, LTD., WILMETTE, IL. FILED 9-30-2004.

CYNTHIA NASH

THE MARK CONSISTS OF STANDARD CHARACTERS WITHOUT CLAIM TO ANY PARTICULAR FONT, STYLE, SIZE, OR COLOR.
"CYNTHIA NASH" IDENTIFIES A LIVING INDIVIDUAL WHOSE CONSENT IS OF RECORD.
FOR JEWELRY (U.S. CLS. 2, 27, 28 AND 50).
LA TONIA FISHER, EXAMINING ATTORNEY

SN 78-493,866. CYNTHIA NASH, LTD., WILMETTE, IL. FILED 10-4-2004.

**SISTERHOOD
BRACELET**

THE MARK CONSISTS OF STANDARD CHARACTERS WITHOUT CLAIM TO ANY PARTICULAR FONT, STYLE, SIZE, OR COLOR.
NO CLAIM IS MADE TO THE EXCLUSIVE RIGHT TO USE "BRACELET", APART FROM THE MARK AS SHOWN.
FOR JEWELRY (U.S. CLS. 2, 27, 28 AND 50).
ALLISON SCHRODY, EXAMINING ATTORNEY

CLASS 14—(Continued).

SN 78-494,135. LOCKES DIAMANTAIRES HOLDING CORP., NEW YORK, NY. FILED 10-4-2004.

L O C K E S

THE MARK CONSISTS OF THE WORD "LOCKES" IN A STYLIZED FORM.
FOR JEWELRY (U.S. CLS. 2, 27, 28 AND 50).
FIRST USE 9-20-2004; IN COMMERCE 9-20-2004.
HOWARD SMIGA, EXAMINING ATTORNEY

SN 78-495,874. HINES, DARRELL JR., RIVER HILLS, WI. FILED 10-6-2004.



**S H O E
J E W E L Z**

NO CLAIM IS MADE TO THE EXCLUSIVE RIGHT TO USE "SHOE JEWELZ", APART FROM THE MARK AS SHOWN.

THE MARK CONSISTS OF A STYLIZED "S" APPEARING INSIDE A STYLIZED "J," ABOVE WHICH APPEARS A STYLIZED DEPICTION OF A DIAMOND SHAPE, AND BELOW WHICH APPEAR THE WORDS "SHOE JEWELZ".

FOR JEWELRY FOR FOOTWEAR (U.S. CLS. 2, 27, 28 AND 50).

ROBERT LAVACHE, EXAMINING ATTORNEY

SN 78-496,666. CIPRIANO, ANTHONY, BRISTOL, RI. FILED 10-8-2004.

**THANK YOU GOD
ALWAYS**

THE MARK CONSISTS OF STANDARD CHARACTERS WITHOUT CLAIM TO ANY PARTICULAR FONT, STYLE, SIZE, OR COLOR.

FOR PRECIOUS METAL AND COSTUME JEWELRY, NAMELY BRACELETS, NECKLACES, EARRINGS, PENDANTS, AND RINGS; AND HOROLOGICAL INSTRUMENTS, NAMELY WATCHES (U.S. CLS. 2, 27, 28 AND 50).

FIRST USE 1-1-2002; IN COMMERCE 1-1-2002.

JERI J. FICKES, EXAMINING ATTORNEY

CLASS 14—(Continued).

SN 78-498,615. HEADSPACE TECHNOLOGIES, INC., AUSTIN, TX. FILED 10-12-2004.

MISS NOSEY POSEY

THE MARK CONSISTS OF STANDARD CHARACTERS WITHOUT CLAIM TO ANY PARTICULAR FONT, STYLE, SIZE, OR COLOR.

FOR JEWELRY (U.S. CLS. 2, 27, 28 AND 50).
KEVON CHISOLM, EXAMINING ATTORNEY

SN 78-498,992. STYLE ASIA INC, MOONACHIE, NJ. FILED 10-13-2004.



FOR WATCHES (U.S. CLS. 2, 27, 28 AND 50).
FIRST USE 10-1-2004; IN COMMERCE 10-1-2004.
JOHN WILKE, EXAMINING ATTORNEY

SN 78-499,719. FIELDS, ANTONI, LONDON, UNITED KINGDOM, FILED 10-14-2004.

ZEITNER

THE MARK CONSISTS OF STANDARD CHARACTERS WITHOUT CLAIM TO ANY PARTICULAR FONT, STYLE, SIZE, OR COLOR.

OWNER OF U.S. REG. NO. 2,139,840.

SEC. 2(F).

FOR WATCHES AND PARTS AND FITTINGS THEREFOR (U.S. CLS. 2, 27, 28 AND 50).

FIRST USE 3-0-1996; IN COMMERCE 8-15-1997.

LAURIE MAYES, EXAMINING ATTORNEY

CLASS 14—(Continued).

SN 78-499,855. DAVID, ZOLTAN, AUSTIN, TX. FILED 10-14-2004.

CLASS 14—(Continued).

SN 78-501,025. SILVER MOON CONCEPTS, LLC, WINTER PARK, FL. FILED 10-16-2004.

Dangelier

tiggler

THE MARK CONSISTS OF STANDARD CHARACTERS WITHOUT CLAIM TO ANY PARTICULAR FONT, STYLE, SIZE, OR COLOR.
FOR EARRINGS (U.S. CLS. 2, 27, 28 AND 50).
CURTIS FRENCH, EXAMINING ATTORNEY

THE MARK CONSISTS OF STANDARD CHARACTERS WITHOUT CLAIM TO ANY PARTICULAR FONT, STYLE, SIZE, OR COLOR.
FOR BODY JEWELRY (U.S. CLS. 2, 27, 28 AND 50).
FIRST USE 10-14-2004; IN COMMERCE 10-14-2004.
GENE MACIOL, EXAMINING ATTORNEY

SN 78-500,022. DEUTSCHE TELEKOM AG, BONN, FED REP GERMANY, FILED 10-14-2004.

SN 78-504,843. AMANDA RAAB, HOUSTON, TX. FILED 10-23-2004.

T Systems



PRIORITY CLAIMED UNDER SEC. 44(D) ON FED REP GERMANY APPLICATION NO. 30421579.135, FILED 4-15-2004, REG. NO. 30421579, DATED 9-9-2004, EXPIRES 4-30-2014.

OWNER OF U.S. REG. NOS. 2,448,571, 2,880,613 AND OTHERS.

THE COLOR(S) MAGENTA AND GREY IS/ARE CLAIMED AS A FEATURE OF THE MARK.

THE COLOR MAGENTA APPEARS IN THE LETTER "T" IN THE MARK; THE REMAINDER OF THE MARK APPEARS IN THE COLOR GREY.

FOR JEWELRY, NAMELY CHAINS, LAPEL PINS AND PINS BEING JEWELRY, PENDANTS, EARRINGS, BRACELETS, RINGS, ALL MADE EITHER OF PRECIOUS METALS, COATED THEREWITH OR FOR COSTUME JEWELRY; PRECIOUS STONES, NAMELY DIAMONDS, RUBIES, EMERALDS, PEARLS; HOROLOGICAL INSTRUMENTS, NAMELY, CLOCKS AND WATCHES; CHRONOMETERS AND CHRONOGRAPHS (U.S. CLS. 2, 27, 28 AND 50).
SKYE YOUNG, EXAMINING ATTORNEY

NO CLAIM IS MADE TO THE EXCLUSIVE RIGHT TO USE "PEARLS", APART FROM THE MARK AS SHOWN.

THE COLOR(S) BLACK, WHITE, AND PINK IS/ARE CLAIMED AS A FEATURE OF THE MARK.

THE COLOR BLACK APPEARS IN THE BACKGROUND OF THE MARK. THE COLOR PINK APPEARS IN THE MAIN TEXT "PURE PEARLS." THE COLOR WHITE APPEARS IN THE SLOGAN "CLASSIC. TIMELESS. LUXURY."

FOR PEARLS, PEARL NECKLACES, PEARL EARRINGS, PEARL BRACELETS, PEARL RINGS, PEARL PENDANTS, PEARL CUFF LINKS, DIAMOND CLASPS (U.S. CLS. 2, 27, 28 AND 50).

FIRST USE 9-30-2004; IN COMMERCE 9-30-2003.
DORITT L. CARROLL, EXAMINING ATTORNEY

CLASS 14—(Continued).

SN 78-505,741. EMKAY INTERNATIONAL, INC., NEW YORK, NY. FILED 10-26-2004.

CLASS 14—(Continued).

SN 78-510,364. ETNIA ACCESSORIES, INC., HIALEAH, FL. FILED 11-3-2004.

AURALITE

NO CLAIM IS MADE TO THE EXCLUSIVE RIGHT TO USE "ETNIA ACCESSORIES", APART FROM THE MARK AS SHOWN.

THE ENGLISH TRANSLATION OF THE WORD ETNIA IN THE MARK IS "ETHNIC GROUP".

FOR FASHION JEWELRY (U.S. CLS. 2, 27, 28 AND 50).

FIRST USE 5-8-2002; IN COMMERCE 5-15-2002.

MICHAEL HALL, EXAMINING ATTORNEY

THE MARK CONSISTS OF STANDARD CHARACTERS WITHOUT CLAIM TO ANY PARTICULAR FONT, STYLE, SIZE, OR COLOR.

FOR LOOSE SEMI-PRECIOUS GEMSTONES AND SEMI-PRECIOUS GEMSTONE JEWELRY (U.S. CLS. 2, 27, 28 AND 50).

FIRST USE 8-1-2004; IN COMMERCE 8-1-2004.

THEODORE MCBRIDE, EXAMINING ATTORNEY

SN 78-516,525. JB-DM JEWELRY, LLC, LOS ANGELES, CA. FILED 11-13-2004.

CIRCLES OF AFFECTION

THE MARK CONSISTS OF STANDARD CHARACTERS WITHOUT CLAIM TO ANY PARTICULAR FONT, STYLE, SIZE, OR COLOR.

FOR DIAMONDS AND JEWELRY (U.S. CLS. 2, 27, 28 AND 50).

BRENDAN REGAN, EXAMINING ATTORNEY

SN 78-505,948. HAMPDEN CORPORATION, CHICAGO, IL. FILED 10-26-2004.

American Liberty

THE BLUEPRINT

THE MARK CONSISTS OF STANDARD CHARACTERS WITHOUT CLAIM TO ANY PARTICULAR FONT, STYLE, SIZE, OR COLOR.

FOR WATCHES, WATCHBANDS AND JEWELRY (U.S. CLS. 2, 27, 28 AND 50).

FIRST USE 2-1-2004; IN COMMERCE 2-1-2004.

JOHN E. MICHOS, EXAMINING ATTORNEY

THE MARK CONSISTS OF STANDARD CHARACTERS WITHOUT CLAIM TO ANY PARTICULAR FONT, STYLE, SIZE, OR COLOR.

OWNER OF U.S. REG. NO. 2,594,911.

FOR JEWELRY, NAMELY, BRACELETS, BROOCHES, CHAINS, CHARMS, COSTUME JEWELRY, EARRINGS, NECKLACES, PENDANTS, LAPEL PINS, RINGS, AND WRISTWATCHES (U.S. CLS. 2, 27, 28 AND 50).

CARRIE ACHEN, EXAMINING ATTORNEY

CLASS 14—(Continued).

SN 78-517,878. BRAG, INC., NEWPORT BEACH, CA. FILED 11-16-2004.

bragalittle

THE MARK CONSISTS OF STANDARD CHARACTERS WITHOUT CLAIM TO ANY PARTICULAR FONT, STYLE, SIZE, OR COLOR.

FOR JEWELRY, NAMELY, STERLING SILVER OPEN-FACED SHADOW BOX PHOTO LOCKET (U.S. CLS. 2, 27, 28 AND 50).

TANYA AMOS, EXAMINING ATTORNEY

CLASS 14—(Continued).

SN 78-521,206. HOWARD MILLER CLOCK COMPANY, ZEELAND, MI. FILED 11-22-2004.

RIDGEWAY

THE MARK CONSISTS OF STANDARD CHARACTERS WITHOUT CLAIM TO ANY PARTICULAR FONT, STYLE, SIZE, OR COLOR.

SEC. 2(F).

FOR CLOCKS (U.S. CLS. 2, 27, 28 AND 50).

FIRST USE 10-1-1947; IN COMMERCE 10-1-1947.

SCOTT OSLICK, EXAMINING ATTORNEY

SN 78-522,731. VANDENBULCKE, AXELLE C., NEW YORK, NY. FILED 11-24-2004.

SN 78-518,255. RAPAPORT, MARTIN, LAS VEGAS, NV. FILED 11-17-2004.

DIAMONDS THAT MAKE
THE WORLD A BETTER
PLACE

THE MARK CONSISTS OF STANDARD CHARACTERS WITHOUT CLAIM TO ANY PARTICULAR FONT, STYLE, SIZE, OR COLOR.

NO CLAIM IS MADE TO THE EXCLUSIVE RIGHT TO USE DIAMONDS, APART FROM THE MARK AS SHOWN.

FOR JEWELRY, DIAMONDS, PRECIOUS GEMSTONES, SEMI-PRECIOUS GEMSTONES, PRECIOUS GEMS AND WATCHES (U.S. CLS. 2, 27, 28 AND 50).

HEATHER THOMPSON, EXAMINING ATTORNEY



THE COLOR PURPLE IS CLAIMED AS A FEATURE OF THE MARK.

THE LETTER "A" IN THE MARK IS PURPLE.

THE MARK CONSISTS OF THE WORD "AXELLE" IN A STYLIZED DESIGN.

FOR TIMEPIECES, WATCHES, WRISTWATCHES, HOROLOGICAL AND CHRONOMETRIC INSTRUMENTS, JEWELRY WATCHES, JEWELRY, EARRINGS, NECKLACES, BRACELETS, RINGS, PINS, BROOCHES, JEWELRY CHAINS, COSTUME JEWELRY, CUFFLINKS, KEY RINGS OF PRECIOUS METAL, PRECIOUS STONES, PRECIOUS METALS (U.S. CLS. 2, 27, 28 AND 50).

ALICE SUE CARRUTHERS, EXAMINING ATTORNEY

CLASS 14—(Continued).

SN 78-528,120. KLEIN, SHERRYL GOLD, NEW YORK, NY.
AND GOLD, LARA, NEW YORK, NY. FILED 12-7-2004.

g-stringers

THE MARK CONSISTS OF STANDARD CHARACTERS
WITHOUT CLAIM TO ANY PARTICULAR FONT, STYLE,
SIZE, OR COLOR.

FOR JEWELRY (U.S. CLS. 2, 27, 28 AND 50).
FIRST USE 11-15-2004; IN COMMERCE 11-15-2004.
ANDREA K. NADELMAN, EXAMINING ATTORNEY

SN 78-528,556. PRL USA HOLDINGS, INC., WILMINGTON,
DE. FILED 12-7-2004.



OWNER OF U.S. REG. NOS. 1,212,060, 2,823,094 AND
OTHERS.

THE MARK CONSISTS OF A POLO PLAYER RIDING A
HORSE.

FOR HOROLOGICAL AND CHRONOMETRIC IN-
STRUMENTS, NAMELY, MECHANICAL AND AUTO-
MATIC WATCHES, WRIST WATCHES, DIVING
WATCHES, STOP WATCHES, POCKET WATCHES,
WATCH FOBS, JEWELRY WATCHES; HOROLOGICAL
AND CHRONOMETRIC FITTINGS NAMELY, PARTS,
FACES, MOVEMENTS, CASINGS, CROWNS, BANDS,
STRAPS, POUCHES, BOXES, CLASPS, WINDERS, WIND-
ING BUTTONS, DIALS, CHAINS, CASES, STRAPS
MADE OF METAL, LEATHER AND PLASTIC (U.S.
CLS. 2, 27, 28 AND 50).

ALINA MORRIS, EXAMINING ATTORNEY

CLASS 14—(Continued).

SN 78-536,203. M. FABRIKANT & SONS, INC., NEW YORK,
NY. FILED 12-21-2004.

PRISM LITE

THE MARK CONSISTS OF STANDARD CHARACTERS
WITHOUT CLAIM TO ANY PARTICULAR FONT, STYLE,
SIZE, OR COLOR.

NO CLAIM IS MADE TO THE EXCLUSIVE RIGHT TO
USE "PRISM", APART FROM THE MARK AS SHOWN.
FOR JEWELRY (U.S. CLS. 2, 27, 28 AND 50).
RENEE MCCRAY, EXAMINING ATTORNEY

SN 78-537,633. THE BRANDING GROUP, LLC, MIAMI, FL.
FILED 12-23-2004.

KO.KO.MO.

THE MARK CONSISTS OF STANDARD CHARACTERS
WITHOUT CLAIM TO ANY PARTICULAR FONT, STYLE,
SIZE, OR COLOR.

FOR JEWELRY (U.S. CLS. 2, 27, 28 AND 50).
BRIAN PINO, EXAMINING ATTORNEY

CLASS 14—(Continued).

SN 78-538,418. CAUSEKEEPERS, INC., RAMSEUR, NC. FILED 12-27-2004.

4 THE FIGHT

THE MARK CONSISTS OF STANDARD CHARACTERS WITHOUT CLAIM TO ANY PARTICULAR FONT, STYLE, SIZE, OR COLOR.
 FOR JEWELRY (U.S. CLS. 2, 27, 28 AND 50).
 FIRST USE 10-1-2004; IN COMMERCE 10-1-2004.
 CHARLES JOYNER, EXAMINING ATTORNEY

SN 79-002,652. HARRY WINSTON; ULTIMATE TIMEPIECE SA, CH-1202 GENEVE, SWITZERLAND, FILED 5-12-2004.

Project Z 1

THE MARK CONSISTS OF STANDARD CHARACTERS WITHOUT CLAIM TO ANY PARTICULAR FONT, STYLE, SIZE, OR COLOR.
 PRIORITY DATE OF 3-22-2004 IS CLAIMED.
 OWNER OF INTERNATIONAL REGISTRATION 0825183 DATED 5-12-2004, EXPIRES 5-12-2014.
 FOR PRECIOUS METALS AND ALLOYS THEREOF SOLD IN BULK; JEWELLERY, PRECIOUS STONES; TIMEPIECES AND CHRONOMETRIC INSTRUMENTS, NAMELY CLOCKS, WATCHES, TABLE CLOCKS AND CHRONOMETERS (U.S. CLS. 2, 27, 28 AND 50).
 KHANH LE, EXAMINING ATTORNEY

CLASS 14—(Continued).

SN 79-006,787. I.G.I.M. INTERNATIONAL GROUP ITALIAN MANUFACTURES S.P.A., ITALY, FILED 6-18-2004.



Brings Diamonds To Life.

OWNER OF INTERNATIONAL REGISTRATION 0768477 DATED 9-19-2001, EXPIRES 9-19-2011.
 THE NAME DOES NOT IDENTIFY A LIVING INDIVIDUAL.

SHAPE COMPRISING THE FANCY EXPRESSION "LUCA CARATI" AS PART OF THE COMPANY NAME OF THE APPLICANT, IN SPECIFIC UPPERCASE FONT, WITH A LARGER INITIAL LETTER "C", ALL THE CONTENTS WITHIN A RECTANGULAR FRAME WITH LARGER HORIZONTAL SIDES; ABOVE THIS AND CENTERED, THERE IS THE STYLIZED REPRESENTATION OF A SUN, BELOW WHICH THERE IS THE EXPRESSION "BRINGS DIAMONDS TO LIFE" IN SPECIFIC LOWERCASE FONT WITH THE INITIAL LETTERS IN UPPERCASE.

FOR GENUINE AND IMITATION JEWELRY, NECKLACES, BRACELETS, EARRINGS, RINGS, BROOCHES, CUFF LINKS AND TIEPINS; GOODS IN PRECIOUS METALS, THEIR ALLOYS OR COATED THEREWITH AND GOODS MADE OF PRECIOUS OR SEMI-PRECIOUS STONES; NAMELY ASHTRAYS, ORNAMENTAL BOXES, NIBS, TRINKETS, TABLE CENTERPIECES, STATUETTES, VASES, CUPS AND TRINKETS, TABLE CENTERPIECES; STATUETTES, VASES AND CUPS IN THE FORM OF ANIMALS OR PLANTS; CLOCKS, SMALL CLOCKS AND WATCHES (U.S. CLS. 2, 27, 28 AND 50).
 CHARLES JOYNER, EXAMINING ATTORNEY

SN 79-007,087. TOKYO TRADING CO., LTD., JAPAN, FILED 8-4-2004.

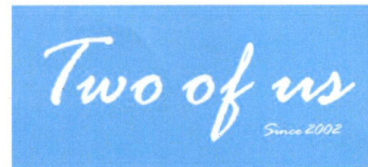

OWNER OF INTERNATIONAL REGISTRATION 0838282 DATED 8-4-2004, EXPIRES 8-4-2014.

NO CLAIM IS MADE TO THE EXCLUSIVE RIGHT TO USE "SINCE 2002", APART FROM THE MARK AS SHOWN. THE COLOR(S) LIGHT (PALE) BLUE, AND WHITE IS/ ARE CLAIMED AS A FEATURE OF THE MARK.

BACKGROUND: LIGHT (PALE) BLUE; LETTERS: WHITE.
 FOR PRECIOUS METALS; CLOCKS AND WATCHES; PERSONAL ORNAMENTS, NAMELY RINGS, NECKLACE, BRACELETS, BANGLES, EARRINGS, PIERCED EARRINGS AND BROOCHES MADE FROM PRECIOUS METALS (U.S. CLS. 2, 27, 28 AND 50).
 KIMBERLY PERRY, EXAMINING ATTORNEY

CLASS 15—MUSICAL INSTRUMENTS

SN 76-551,185. BEE BASSES L.L.C., MCMINNVILLE, OR.
FILED 9-24-2003.

BEE BASSES

NO CLAIM IS MADE TO THE EXCLUSIVE RIGHT TO
USE BASSES, APART FROM THE MARK AS SHOWN.
FOR MUSICAL INSTRUMENTS, NAMELY BASS GUI-
TARS (U.S. CLS. 2, 21 AND 36).
FIRST USE 1-1-1999; IN COMMERCE 8-1-2001.
KEVON CHISOLM, EXAMINING ATTORNEY

SN 76-615,259. ALTO RESEARCH LLC, SAN CARLOS, CA.
FILED 10-12-2004.

VOCOLO

THE MARK CONSISTS OF STANDARD CHARACTERS
WITHOUT CLAIM TO ANY PARTICULAR FONT, STYLE,
SIZE, OR COLOR.
FOR ELECTRONIC MUSICAL INSTRUMENTS (U.S.
CLS. 2, 21 AND 36).
FIRST USE 10-0-2003; IN COMMERCE 10-0-2003.
MARY CRAWFORD, EXAMINING ATTORNEY

SN 76-625,578. ROLAND CORPORATION, OSAKA 530-0002,
JAPAN, FILED 12-21-2004.

SKIP BACK SAMPLING

THE MARK CONSISTS OF STANDARD CHARACTERS
WITHOUT CLAIM TO ANY PARTICULAR FONT, STYLE,
SIZE, OR COLOR.
NO CLAIM IS MADE TO THE EXCLUSIVE RIGHT TO
USE "SAMPLING", APART FROM THE MARK AS SHOWN.
FOR ELECTRONIC MUSICAL KEYBOARDS (U.S. CLS.
2, 21 AND 36).
ESTHER A. BORSUK, EXAMINING ATTORNEY

SN 76-625,692. SUNFLOWER MANUFACTURING, L.L.C.,
SHAWNEE, KS. FILED 12-21-2004.

VAUGHNCRAFT

THE MARK CONSISTS OF STANDARD CHARACTERS
WITHOUT CLAIM TO ANY PARTICULAR FONT, STYLE,
SIZE, OR COLOR.
FOR MUSICAL INSTRUMENTS (U.S. CLS. 2, 21 AND
36).
FIRST USE 8-2-2002; IN COMMERCE 8-2-2002.
RONALD MCMORROW, EXAMINING ATTORNEY

CLASS 15—(Continued).

SN 78-374,560. FRANCIANE, CHARLES, FLUSHING, NY.
FILED 2-26-2004.



FOR GUITARS (U.S. CLS. 2, 21 AND 36).
FIRST USE 2-1-2004; IN COMMERCE 2-1-2004.
GEORGIA CARTY, EXAMINING ATTORNEY

SN 78-380,264. LEE, BEOM SU, LOS ANGELES, CA. FILED 3-
8-2004.

INTERPINO

THE MARK CONSISTS OF STANDARD CHARACTERS
WITHOUT CLAIM TO ANY PARTICULAR FONT, STYLE,
SIZE, OR COLOR.
FOR ELECTRONIC MUSICAL KEYBOARD; ELEC-
TRONIC MUSICAL KEYBOARD USING A USB PORT
(U.S. CLS. 2, 21 AND 36).
FIRST USE 12-31-2003; IN COMMERCE 2-15-2004.
JACQUELINE A. LAVINE, EXAMINING ATTORNEY

CLASS 15—(Continued).

SN 78-383,065. EASTMAN STRINGS, INC., CLARKSBURG, MD. FILED 3-12-2004.

Frederich Wyss

THE MARK CONSISTS OF STANDARD CHARACTERS WITHOUT CLAIM TO ANY PARTICULAR FONT, STYLE, SIZE, OR COLOR.

THE NAME "FREDERICH WYSS" DOES NOT IDENTIFY A LIVING INDIVIDUAL.

FOR MUSICAL INSTRUMENTS, NAMELY, VIOLINS, VIOLAS, CELLOS, AND DOUBLE BASSES (U.S. CLS. 2, 21 AND 36).

FIRST USE 10-1-1996; IN COMMERCE 10-1-1996.
SONYA STEPHENS, EXAMINING ATTORNEY

CLASS 15—(Continued).

SN 78-481,677. MUSIC INDUSTRIES CORPORATION, GARDEN CITY, NY. FILED 9-10-2004.

JJ Heart

THE NAME(S), PORTRAIT(S), AND/OR SIGNATURE(S) SHOWN IN THE MARK DOES NOT IDENTIFY A PARTICULAR LIVING INDIVIDUAL.

FOR GUITARS (U.S. CLS. 2, 21 AND 36).
FIRST USE 1-12-2004; IN COMMERCE 1-12-2004.
ANDREW RHIM, EXAMINING ATTORNEY

SN 78-483,454. HARRISON, STERLING T., CYPRESS, TX. FILED 9-14-2004.

SN 78-444,053. HOLZ LTD, CASTRO VALLEY, CA. FILED 6-30-2004.

HOLZ

THE MARK CONSISTS OF STANDARD CHARACTERS WITHOUT CLAIM TO ANY PARTICULAR FONT, STYLE, SIZE, OR COLOR.

FOR ACCESSORIES FOR PERCUSSION INSTRUMENTS, NAMELY, REINFORCING DRUM RINGS IN THE NATURE OF RINGS THAT STABILIZE HOLES PLACED IN THE MUSICAL DRUM HEADS (U.S. CLS. 2, 21 AND 36).

FIRST USE 12-31-1984; IN COMMERCE 1-1-1987.
TANYA AMOS, EXAMINING ATTORNEY



NO CLAIM IS MADE TO THE EXCLUSIVE RIGHT TO USE "TEXAS COUNTRY BAR", "THE ULTIMATE TONE BAR," THE REPRESENTATION OF THE MAP OF TEXAS, AND THE REPRESENTATION OF A GUITAR TONE BAR SLIDE, APART FROM THE MARK AS SHOWN.

THE COLOR(S) RED, YELLOW, PURPLE, SILVER IS/ARE CLAIMED AS A FEATURE OF THE MARK.

THE MARK CONSISTS OF "TEXAS COUNTRY BAR" (IN RED AND YELLOW LETTERING APPEARING HORIZONTALLY ACROSS THE SHAPE OF THE STATE OF TEXAS WHICH IS PURPLE), A STEEL GUITAR SLIDE IS DIRECTLY UNDERNEATH IN SILVER SHADES, ALSO IN A HORIZONTAL POSITION ACROSS THE SHAPE OF TEXAS, BELOW THE STEEL GUITAR SLIDE ARE THE WORDS, "THE ULTIMATE TONE BAR," (IN YELLOW LETTERING, ALSO HORIZONTALLY POSITIONED ACROSS THE SOUTHERN PART OF THE SHAPE OF TEXAS).

FOR GUITAR SLIDE (U.S. CLS. 2, 21 AND 36).
STEVEN PEREZ, EXAMINING ATTORNEY

CLASS 15—(Continued).

SN 78-495,670. FERNANDES GUITARS INTERNATIONAL, INC., NORTH HOLLYWOOD, CA. FILED 10-6-2004.

NOMAD

THE MARK CONSISTS OF STANDARD CHARACTERS WITHOUT CLAIM TO ANY PARTICULAR FONT, STYLE, SIZE, OR COLOR.

FOR GUITARS (U.S. CLS. 2, 21 AND 36).
FIRST USE 1-1-1998; IN COMMERCE 1-1-1998.
TEJBIR SINGH, EXAMINING ATTORNEY

SN 78-495,673. FERNANDES GUITARS INTERNATIONAL, INC., NORTH HOLLYWOOD, CA. FILED 10-6-2004.

X-PACK

THE MARK CONSISTS OF STANDARD CHARACTERS WITHOUT CLAIM TO ANY PARTICULAR FONT, STYLE, SIZE, OR COLOR.

FOR GUITARS (U.S. CLS. 2, 21 AND 36).
FIRST USE 1-1-2004; IN COMMERCE 1-1-2004.
TEJBIR SINGH, EXAMINING ATTORNEY

CLASS 15—(Continued).

SN 78-497,355. HARRINGTON, TIMOTHY L, LEAGUE CITY, TX. FILED 10-9-2004.

Bassfish

THE MARK CONSISTS OF STANDARD CHARACTERS WITHOUT CLAIM TO ANY PARTICULAR FONT, STYLE, SIZE, OR COLOR.

FOR MUSICAL INSTRUMENTS NAMELY ELECTRIC GUITARS, BASS GUITARS, AND ACOUSTIC GUITARS; GUITAR ACCESSORIES NAMELY GUITAR CASES, GUITAR STRAPS AND GUITAR PICKS (U.S. CLS. 2, 21 AND 36).

FIRST USE 3-15-2002; IN COMMERCE 4-15-2003.
WON TEAK OH, EXAMINING ATTORNEY

SN 78-510,327. MOSER CUSTOM SHOP, LLC, LAKEVIEW TERRACE, CA. FILED 11-3-2004.

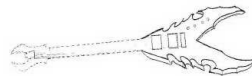

THE MARK CONSISTS OF A UNIQUE FANCIFULLY SHAPED DESIGN OF A GUITAR BODY. THE NECK, HEADSTOCK FRETS, PICKUPS AND OTHER PICTURED GUITAR PARTS ARE SHOWN IN BROKEN LINES AND FORM NO PART OF THE MARK.

SEC. 2(F).
FOR GUITARS, GUITAR BODIES (U.S. CLS. 2, 21 AND 36).

FIRST USE 0-0-1989; IN COMMERCE 0-0-1989.
MARK T. MULLEN, EXAMINING ATTORNEY

CLASS 15—(Continued).

SN 78-535,090. HARRINGTON, TIMOTHY, LEAGUE CITY, TX. FILED 12-18-2004.

Angelfish

THE MARK CONSISTS OF STANDARD CHARACTERS WITHOUT CLAIM TO ANY PARTICULAR FONT, STYLE, SIZE, OR COLOR.

FOR MUSICAL INSTRUMENTS NAMELY ELECTRIC GUITARS, BASS GUITARS AND ACOUSTIC GUITARS; GUITAR ACCESORIES NAMELY GUITAR CASES, GUITAR STRAPS, GUITAR PICKS AND GUITAR STANDS (U.S. CLS. 2, 21 AND 36).

FIRST USE 10-10-2002; IN COMMERCE 5-11-2004.
ROBIN CHOSID, EXAMINING ATTORNEY

CLASS 16—PAPER GOODS AND PRINTED MATTER

SN 76-190,034. TEIKOKU PRINTING INKS MFG. CO., LTD., TOKYO 108-0073, JAPAN, FILED 1-5-2001.

JUSTFIT-VARY

OWNER OF JAPAN REG. NO. 4501219, DATED 8-24-2001, EXPIRES 8-24-2011.

OWNER OF U.S. REG. NO. 2,451,497.
FOR PAPER AND PLASTIC SHEETS WITH A PRINTABLE SURFACE ON ONE SIDE AND AN ADHESIVE SURFACE ON THE OTHER SIDE WHICH CAN BE REPEATEDLY APPLIED AND PEELED OFF (U.S. CLS. 2, 5, 22, 23, 29, 37, 38 AND 50).

MARTHA FROMM, EXAMINING ATTORNEY

SN 76-361,996. GRASSLANDS ENTERTAINMENT GROUP INC., THE, CALGARY, ALBERTA T2G 0Y8, CANADA, FILED 1-22-2002.

THE THIRSTY TRAVELER

FOR PRINTED MATTER, NAMELY, BOOKS, GUIDE BOOKS, TRAVEL BOOKS, AND FOOD BOOKS IN THE FIELD OF TRAVEL, SPIRITS, NAMELY BEER AND WINE, FOOD, AND CULTURE (U.S. CLS. 2, 5, 22, 23, 29, 37, 38 AND 50).

FIRST USE 8-31-2003; IN COMMERCE 8-31-2003.
REBECCA GILBERT, EXAMINING ATTORNEY

CLASS 16—(Continued).

SN 76-463,552. JOHN HENRY COMPANY, THE, LANSING, MI. FILED 11-1-2002.

OPAL SERIES

NO CLAIM IS MADE TO THE EXCLUSIVE RIGHT TO USE "SERIES", APART FROM THE MARK AS SHOWN.
FOR FLORAL AND GIFT ENCLOSURE CARDS (U.S. CLS. 2, 5, 22, 23, 29, 37, 38 AND 50).

FIRST USE 9-1-2002; IN COMMERCE 9-1-2002.
STEVEN R. FOSTER, EXAMINING ATTORNEY

SN 76-476,894. CELESTIAL PICTURES LIMITED, KOW-LOON, HONG KONG, FILED 12-18-2002.

天映

OWNER OF U.S. REG. NO. 2,649,601.
THE NON-LATIN CHARACTERS IN THE MARK TRANSLITERATE TO TIAN YING AND THIS ROUGHLY MEANS SKY, SHINE, AND REFLECT IN ENGLISH.
FOR BOOKMARKS; CALENDARS; GREETING CARDS; PRINTED MAGAZINES ON THE SUBJECTS OF FILM, TELEVISION, MUSIC AND ENTERTAINMENT INDUSTRIES; PHOTOGRAPHS; POSTERS; NOTEBOOKS; WRITING INSTRUMENTS, NAMELY PENS (U.S. CLS. 2, 5, 22, 23, 29, 37, 38 AND 50).
TONI HICKEY, EXAMINING ATTORNEY

SN 76-476,895. CELESTIAL PICTURES LIMITED, KOW-LOON, HONG KONG, FILED 12-18-2002.

天映頻道

OWNER OF U.S. REG. NO. 2,649,601.
THE NON-LATIN CHARACTERS IN THE MARK TRANSLITERATE TO TIAN YING YU LE AND THIS ROUGHLY MEANS SKY, SHINE, REFLECT, AND FREQUENCY IN ENGLISH.

FOR BOOKMARKS; CALENDARS; GREETING CARDS; PRINTED MAGAZINES ON THE SUBJECTS OF FILM, TELEVISION, MUSIC AND ENTERTAINMENT INDUSTRIES; PHOTOGRAPHS; POSTERS; NOTEBOOKS; WRITING INSTRUMENTS, NAMELY PENS (U.S. CLS. 2, 5, 22, 23, 29, 37, 38 AND 50).
TONI HICKEY, EXAMINING ATTORNEY

CLASS 16—(Continued).

SN 76-521,610. PRINCETON MEDIA ASSOCIATES, LLC, MILLSTONE TOWNSHIP, NJ. FILED 6-10-2003.

FIRST REPORT

NO CLAIM IS MADE TO THE EXCLUSIVE RIGHT TO USE REPORT, APART FROM THE MARK AS SHOWN.
FOR NEWSLETTERS PERTAINING TO MEDICAL CONFERENCES (U.S. CLS. 2, 5, 22, 23, 29, 37, 38 AND 50).
FIRST USE 4-0-2003; IN COMMERCE 4-0-2003.
MICHAEL SOUDERS, EXAMINING ATTORNEY

SN 76-543,215. TRENDS PUBLISHING USA, INC., SAN DIEGO, CA. FILED 9-8-2003.

HOME AND ARCHITECTURAL TRENDS

NO CLAIM IS MADE TO THE EXCLUSIVE RIGHT TO USE "HOME AND ARCHITECTURAL", APART FROM THE MARK AS SHOWN.
FOR PUBLICATIONS, NAMELY, BOOKS, MAGAZINES AND PERIODICALS ON THE SUBJECT OF HOME DECORATING AND ARCHITECTURAL DESIGN (U.S. CLS. 2, 5, 22, 23, 29, 37, 38 AND 50).
FIRST USE 6-0-1999; IN COMMERCE 6-0-1999.
ELIZABETH J. WINTER, EXAMINING ATTORNEY

SN 76-548,140. MCC MAGAZINES, LLC, AUGUSTA, GA. FILED 9-11-2003.

AMERICAN ANGLER

OWNER OF U.S. REG. NOS. 1,526,269, 1,909,548 AND 2,527,083.
SEC. 2(F).
FOR MAGAZINES FOR FISHERMEN OR SPORTSMEN (U.S. CLS. 2, 5, 22, 23, 29, 37, 38 AND 50).
FIRST USE 12-1-1990; IN COMMERCE 12-1-1990.
ARETHA SOMERVILLE, EXAMINING ATTORNEY

SN 76-548,535. NAKACH, SALOMON CHAILLO, MEXICO, D.F., C.P. 11000, MEXICO, FILED 10-2-2003.



OWNER OF MEXICO REG. NO. 761680, DATED 8-27-2002, EXPIRES 7-17-2012.
THE COLOR(S) GRAY IS/ARE CLAIMED AS A FEATURE OF THE MARK.
THE COLOR GRAY APPEARS IN THE BARA PORTION OF THE MARK.
FOR TELEPHONE CALLING CARDS NOT MAGNETICALLY ENCODED (U.S. CLS. 2, 5, 22, 23, 29, 37, 38 AND 50).
ELLEN B. AWRICH, EXAMINING ATTORNEY

CLASS 16—(Continued).

SN 76-551,650. VIZVARY, MICHAEL, CALABASAS, CA. FILED 10-16-2003.

RUSTY

FOR CHILDREN'S BOOKS (U.S. CLS. 2, 5, 22, 23, 29, 37, 38 AND 50).
KARLA PERKINS, EXAMINING ATTORNEY

SN 76-559,905. SCHOLASTIC INC., NEW YORK, NY. FILED 10-27-2003.



OWNER OF U.S. REG. NOS. 273,405, 1,264,901 AND OTHERS.
NO CLAIM IS MADE TO THE EXCLUSIVE RIGHT TO USE "AMERICA'S LEADING NEWS SOURCE FOR KIDS" OR "NEWS", APART FROM THE MARK AS SHOWN.
SEC. 2(F) AS TO "SCHOLASTIC".
FOR EDUCATIONALLY ORIENTED NEWS MAGAZINES ON TOPICS OF INTEREST TO SCHOOL AGE CHILDREN (U.S. CLS. 2, 5, 22, 23, 29, 37, 38 AND 50).
FIRST USE 1-31-2003; IN COMMERCE 1-31-2003.
TINA L. SNAPP, EXAMINING ATTORNEY

SN 76-565,712. COVENANT MINISTRIES INTERNATIONAL, MARYLAND HEIGHTS, MO. FILED 12-8-2003.

SEEDTIME PUBLICATIONS

NO CLAIM IS MADE TO THE EXCLUSIVE RIGHT TO USE "PUBLICATIONS", APART FROM THE MARK AS SHOWN.
FOR PRINTED INSTRUCTIONAL, EDUCATIONAL AND TEACHING MATERIALS IN THE FIELD OF BIBLE, RELIGIOUS AND SPIRITUAL STUDIES (U.S. CLS. 2, 5, 22, 23, 29, 37, 38 AND 50).
FIRST USE 2-12-2003; IN COMMERCE 2-12-2003.
BARNEY CHARLON, EXAMINING ATTORNEY

CLASS 16—(Continued).

SN 76-572,023. ACADEMY OF COUNTRY MUSIC, BURBANK, CA. FILED 1-21-2004.

THE TEMPO

THE MARK CONSISTS OF STANDARD CHARACTERS WITHOUT CLAIM TO ANY PARTICULAR FONT, STYLE, SIZE, OR COLOR.

OWNER OF U.S. REG. NOS. 2,855,980, 2,893,004 AND OTHERS.

FOR MAGAZINE SOLELY FOR OFFICIAL MEMBERS OF AN ORGANIZATION IN THE FIELD OF COUNTRY MUSIC (U.S. CLS. 2, 5, 22, 23, 29, 37, 38 AND 50).

FIRST USE 8-1-2003; IN COMMERCE 8-1-2003.

TRACY CROSS, EXAMINING ATTORNEY

CLASS 16—(Continued).

SN 76-573,016. ANDERSON KILL & OLICK, P.C., NEW YORK, NY. FILED 2-2-2004.

AKO POLICYHOLDER ALERT

THE MARK CONSISTS OF STANDARD CHARACTERS WITHOUT CLAIM TO ANY PARTICULAR FONT, STYLE, SIZE, OR COLOR.

NO CLAIM IS MADE TO THE EXCLUSIVE RIGHT TO USE "POLICYHOLDER", APART FROM THE MARK AS SHOWN.

FOR NEWSLETTERS DISCUSSING ISSUES RELATING TO INSURANCE LAW (U.S. CLS. 2, 5, 22, 23, 29, 37, 38 AND 50).

FIRST USE 3-1-2003; IN COMMERCE 3-1-2003.

DOUGLAS LEE, EXAMINING ATTORNEY

SN 76-572,673. NATIONAL ASSOCIATION FOR THE SELF-EMPLOYED, INC., GRAPEVINE, TX. FILED 1-12-2004.

Self-Employed America

SEC. 2(F).

FOR MAGAZINE FOR SMALL BUSINESSES (U.S. CLS. 2, 5, 22, 23, 29, 37, 38 AND 50).

FIRST USE 12-29-1988; IN COMMERCE 12-29-1988.

BERYL GARDNER, EXAMINING ATTORNEY

SN 76-573,017. ANDERSON KILL & OLICK, P.C., NEW YORK, NY. FILED 2-2-2004.

AKO PHARMACEUTICAL & HEALTHCARE INSURANCE ALERT

THE MARK CONSISTS OF STANDARD CHARACTERS WITHOUT CLAIM TO ANY PARTICULAR FONT, STYLE, SIZE, OR COLOR.

NO CLAIM IS MADE TO THE EXCLUSIVE RIGHT TO USE "PHARMACEUTICAL & HEALTHCARE INSURANCE", APART FROM THE MARK AS SHOWN.

FOR NEWSLETTERS DISCUSSING LEGAL ISSUES IN THE FIELD OF PHARMACEUTICAL AND HEALTHCARE INSURANCE (U.S. CLS. 2, 5, 22, 23, 29, 37, 38 AND 50).

FIRST USE 12-1-2001; IN COMMERCE 12-1-2001.

DOUGLAS LEE, EXAMINING ATTORNEY

SN 76-572,701. UNIVERSITY OF HOUSTON SYSTEM, HOUSTON, TX. FILED 1-29-2004.

University of Houston

THE MARK CONSISTS OF STANDARD CHARACTERS WITHOUT CLAIM TO ANY PARTICULAR FONT, STYLE, SIZE, OR COLOR.

OWNER OF U.S. REG. NO. 917,683.

SEC. 2(F).

FOR PRINTED PUBLICATIONS, NAMELY, REPORTS, CATALOGS, BOOKS, BROCHURES, DIRECTORIES, PAMPHLETS, DIPLOMAS, AND MANUALS IN THE FIELD OF UNIVERSITY CURRICULUM FOR THE USE BY THE PUBLIC, STUDENTS, STAFF AND FACULTY (U.S. CLS. 2, 5, 22, 23, 29, 37, 38 AND 50).

FIRST USE 0-0-1934; IN COMMERCE 0-0-1934.

TARAH HARDY, EXAMINING ATTORNEY

SN 76-574,387. ABC TELECOM INC., ROSLYN HEIGHTS, NY. FILED 2-6-2004.

TIME WORKS PHONECARD

THE MARK CONSISTS OF STANDARD CHARACTERS WITHOUT CLAIM TO ANY PARTICULAR FONT, STYLE, SIZE, OR COLOR.

NO CLAIM IS MADE TO THE EXCLUSIVE RIGHT TO USE "PHONECARD", APART FROM THE MARK AS SHOWN.

FOR PREPAID TELEPHONE CALLING CARDS NOT MAGNETICALLY ENCODED (U.S. CLS. 2, 5, 22, 23, 29, 37, 38 AND 50).

FIRST USE 9-26-2003; IN COMMERCE 9-26-2003.

JAMES A. RAUEN, EXAMINING ATTORNEY

CLASS 16—(Continued).

SN 76-580,205. FIRST SBF HOLDINGS, INC., MONSEY, NY.
FILED 3-10-2004.

CALIBRE OF LUXURY

THE MARK CONSISTS OF STANDARD CHARACTERS WITHOUT CLAIM TO ANY PARTICULAR FONT, STYLE, SIZE, OR COLOR.

FOR PUBLICATIONS, NAMELY, MAGAZINES FEATURING ALL ASPECTS OF A LUXURIOUS LIFESTYLE INCLUDING, CARS, BOATS, CLOTHING, JEWELRY, AND WATCHES, AMONG OTHERS (U.S. CLS. 2, 5, 22, 23, 29, 37, 38 AND 50).

DANIEL BRODY, EXAMINING ATTORNEY

SN 76-582,574. OMS INVESTMENTS, INC., LOS ANGELES, CA. FILED 3-19-2004.

PROBLEM SOLVER

FOR HANDBOOKS ON THE SUBJECT OF GROWING AND MAINTAINING HOUSEPLANTS; CATALOGS ON THE SUBJECT OF PLANT CARE PRODUCTS AND ACCESSORIES, BUT NOT INCLUDING MAIL ORDER CATALOGS; PUBLICATIONS, NAMELY ESSAYS AND ARTICLES IN THE FIELD OF GARDENING FOR DISTRIBUTION AND SYNDICATION TO NEWSPAPERS, MAGAZINES AND ELECTRONIC PUBLISHING INTERESTS; BOOKS, PAMPHLETS AND LEAFLETS ON THE SUBJECT OF PLANTS, LAWN, LANDSCAPE AND GARDEN CARE, MANAGEMENT, MAINTENANCE AND DISEASE CONTROL (U.S. CLS. 2, 5, 22, 23, 29, 37, 38 AND 50).

FIRST USE 12-31-1982; IN COMMERCE 12-31-1982.
ZACHARY BELLO, EXAMINING ATTORNEY

SN 76-584,022. EXECUTIVE MACHINES, INC., BROOKLYN, NY. FILED 3-30-2004.

SHREDPRO

THE MARK CONSISTS OF STANDARD CHARACTERS WITHOUT CLAIM TO ANY PARTICULAR FONT, STYLE, SIZE, OR COLOR.

FOR PAPER SHREDDERS FOR OFFICE USE (U.S. CLS. 2, 5, 22, 23, 29, 37, 38 AND 50).

LESLEY LAMOTHE, EXAMINING ATTORNEY

CLASS 16—(Continued).

SN 76-584,303. 2CITYCHICKS, INC., NEW YORK, NY. FILED 4-1-2004.

MINOR LEAGUE SMALL STARS

THE MARK CONSISTS OF STANDARD CHARACTERS WITHOUT CLAIM TO ANY PARTICULAR FONT, STYLE, SIZE, OR COLOR.

FOR TRADING CARDS IN REFERENCE TO FICTIONAL CARTOON CHARACTERS (U.S. CLS. 2, 5, 22, 23, 29, 37, 38 AND 50).

FIRST USE 3-10-2004; IN COMMERCE 3-10-2004.
ESTHER A. BORSUK, EXAMINING ATTORNEY

SN 76-584,919. VISIBLE INK PRESS, CANTON, MI. FILED 4-1-2004.



NO CLAIM IS MADE TO THE EXCLUSIVE RIGHT TO USE "PRESS", APART FROM THE MARK AS SHOWN.

FOR BOOKS IN THE FIELD OF AUTO RACING (U.S. CLS. 2, 5, 22, 23, 29, 37, 38 AND 50).

FIRST USE 3-1-2004; IN COMMERCE 3-1-2004.
ANDREW RHIM, EXAMINING ATTORNEY

CLASS 16—(Continued).

SN 76-587,322. DISNEY ENTERPRISES, INC., BURBANK, CA. FILED 4-19-2004.



OWNER OF U.S. REG. NO. 2,700,620.
FOR GIFT WRAPPING PAPER; DECORATIVE PAPER CENTERPIECES; PAPER PARTY BAGS; PAPER GIFT WRAP BOWS; PAPER CAKE DECORATIONS; PAPER PARTY DECORATIONS; PAPER PARTY HATS; PAPER NAPKINS; PAPER TABLE CLOTHS; PAPER COASTERS; PAPER MATS; TRADING CARDS; STICKERS; APPLIQUES IN THE FORM OF DECALS; GIFT CARDS; GREETING CARDS; POSTCARDS; POSTERS; PHOTOGRAPHS; CALENDARS; CARTOONS, NAMELY, CARTOON PRINTS AND CARTOON STRIPS; MAGAZINES AND PERIODICALS FEATURING COMICS, STORIES, GAMES AND ACTIVITIES; NEWSPAPERS; COMIC STRIPS; ADDRESS BOOKS; PHOTOGRAPH ALBUMS; APPOINTMENT BOOKS; AUTOGRAPH BOOKS; BABY BOOKS; CHILDREN'S ACTIVITY BOOKS; COLORING BOOKS; COMIC BOOKS; NOTEBOOKS; DIARIES; ARTS AND CRAFT PAINT KITS; BALL-POINT PENS; BINDERS; BOOKENDS; BOOKMARKS; PEN AND PENCIL CASES; CHALK; MODELING CLAY; PENS; PENCILS; STATIONERY; ERASERS; PENCIL SHARPENERS; STAPLERS; WRITING PAPER; ENVELOPES; PAPER WEIGHTS; MEMO PADS; UNGRADUATED RULERS AND RUBBER STAMPS (U.S. CLS. 2, 5, 22, 23, 29, 37, 38 AND 50).

MARLENE BELL, EXAMINING ATTORNEY

SN 76-587,338. SCHULER, KAREN, WALTON, KY. FILED 4-19-2004.

BACKYARD BEARS

THE MARK CONSISTS OF STANDARD CHARACTERS WITHOUT CLAIM TO ANY PARTICULAR FONT, STYLE, SIZE, OR COLOR.

NO CLAIM IS MADE TO THE EXCLUSIVE RIGHT TO USE "BEARS", APART FROM THE MARK AS SHOWN.

FOR PRINTED MATTER, NAMELY, BOOKS FOR CHILDREN (U.S. CLS. 2, 5, 22, 23, 29, 37, 38 AND 50).

MARLENE BELL, EXAMINING ATTORNEY

CLASS 16—(Continued).

SN 76-587,879. MAZZY STAR, ENCINO, CA. FILED 4-21-2004.

MAZZY STAR

THE MARK CONSISTS OF STANDARD CHARACTERS WITHOUT CLAIM TO ANY PARTICULAR FONT, STYLE, SIZE, OR COLOR.

"MAZZY STAR" DOES NOT IDENTIFY A LIVING INDIVIDUAL.

FOR PRINTS AND PUBLICATIONS, NAMELY, POSTERS, PRINTED PAPER SIGNAGE, PRINTED PAPER LINER NOTES FOR SOUND RECORDINGS (U.S. CLS. 2, 5, 22, 23, 29, 37, 38 AND 50).

FIRST USE 12-31-1990; IN COMMERCE 12-31-1990.
KATHERINE STOIDES, EXAMINING ATTORNEY

SN 76-588,554. SCOTT PAPER LIMITED, MISSISSAUGA, ONTARIO, CANADA, FILED 4-26-2004.

SPONGEUPS

THE MARK CONSISTS OF STANDARD CHARACTERS WITHOUT CLAIM TO ANY PARTICULAR FONT, STYLE, SIZE, OR COLOR.

PRIORITY CLAIMED UNDER SEC. 44(D) ON CANADA APPLICATION NO. 1,208,330, FILED 3-3-2004, REG. NO. TMA630483, DATED 1-18-2005, EXPIRES 1-18-2020.

FOR PAPER PRODUCTS, NAMELY, BATHROOM AND FACIAL TISSUES, PAPER TOWELS, PAPER NAPKINS, PAPER WIPES NOT IMPREGNATED WITH CHEMICALS OR COMPOUNDS; REUSABLE PAPER WIPES NOT IMPREGNATED WITH CHEMICALS OR COMPOUNDS (U.S. CLS. 2, 5, 22, 23, 29, 37, 38 AND 50).

AMY HELLA, EXAMINING ATTORNEY

SN 76-588,663. TAYLOR, JANICE, NEW YORK, NY. FILED 4-26-2004.

DEADWEIGHT

THE MARK CONSISTS OF STANDARD CHARACTERS WITHOUT CLAIM TO ANY PARTICULAR FONT, STYLE, SIZE, OR COLOR.

FOR PAPERWEIGHTS; FOR PRINTED MATTER NAMELY GREETING CARDS, CALENDARS, POSTERS, POST CARDS, BOOK COVERS, STICKERS, PAPER NAPKINS, NOTEBOOKS, COMIC BOOKS AND TRADING CARDS (U.S. CLS. 2, 5, 22, 23, 29, 37, 38 AND 50).

CURTIS FRENCH, EXAMINING ATTORNEY

CLASS 16—(Continued).

SN 76-591,697. HOUGHTON MIFFLIN COMPANY, BOSTON, MA. FILED 5-12-2004.

FIVE LITTLE MONKEYS

THE MARK CONSISTS OF STANDARD CHARACTERS WITHOUT CLAIM TO ANY PARTICULAR FONT, STYLE, SIZE, OR COLOR.

FOR CHILDREN'S BOOKS (U.S. CLS. 2, 5, 22, 23, 29, 37, 38 AND 50).

FIRST USE 3-20-1989; IN COMMERCE 3-20-1989.
DORITT L. CARROLL, EXAMINING ATTORNEY

CLASS 16—(Continued).

SN 76-593,040. BACON, CHERILYN, PROVO, UT. FILED 5-17-2004.

A MISTRESS NAMED PORNOGRAPHY

THE MARK CONSISTS OF STANDARD CHARACTERS WITHOUT CLAIM TO ANY PARTICULAR FONT, STYLE, SIZE, OR COLOR.

FOR PUBLICATIONS, NAMELY, A SERIES OF NON-FICTION BOOKS, WORKBOOKS, MANUALS, NEWSLETTERS, PRINTED CHARTS AND PRINTED TABLES, ALL IN THE CLASS OF THE CAUSES, EFFECTS AND TREATMENTS OF PORNOGRAPHY OBSESSION AND ADDICTION (U.S. CLS. 2, 5, 22, 23, 29, 37, 38 AND 50).

MATTHEW KLINE, EXAMINING ATTORNEY

SN 76-592,471. WHITE STAR S.R.L., VERCELLI (VC), ITALY, FILED 5-17-2004.



NO CLAIM IS MADE TO THE EXCLUSIVE RIGHT TO USE PUBLISHERS, APART FROM THE MARK AS SHOWN.

FOR BOOKS, NAMELY PHOTOGRAPHIC ILLUSTRATION BOOKS, HISTORICAL BOOKS, GEOGRAPHIC BOOKS, AND SCIENTIFIC BOOKS (U.S. CLS. 2, 5, 22, 23, 29, 37, 38 AND 50).

FIRST USE 2-0-1996; IN COMMERCE 10-0-1996.
MICHAEL ENGEL, EXAMINING ATTORNEY

SN 76-594,999. BLI, INC., GRAND RAPIDS, MI. FILED 6-1-2004.

BETTERLIFE, A 30 DAY PLAN

THE MARK CONSISTS OF STANDARD CHARACTERS WITHOUT CLAIM TO ANY PARTICULAR FONT, STYLE, SIZE, OR COLOR.

OWNER OF U.S. REG. NOS. 1,362,323, 1,758,818 AND 1,794,930.

NO CLAIM IS MADE TO THE EXCLUSIVE RIGHT TO USE "A 30 DAY PLAN", APART FROM THE MARK AS SHOWN.

FOR WEIGHT LOSS AND EXERCISE KIT PRIMARILY CONSISTING OF COLOR CODED CARDS WITH INFORMATION ON PROPER NUTRITION, MEAL PLANNING, DIET AND EXERCISE, RECIPE BOOKS, AND MOTIVATIONAL CD FEATURING TESTIMONIALS OF SUCCESSFUL USERS OF THE KIT; BOOKS FEATURING INFORMATION ON PROPER NUTRITION, MEAL PLANNING, DIET AND EXERCISE (U.S. CLS. 2, 5, 22, 23, 29, 37, 38 AND 50).

FIRST USE 1-2-2004; IN COMMERCE 1-2-2004.
DARRYL SPRUILL, EXAMINING ATTORNEY

SN 76-592,692. SILVER CINEMAS ACQUISITION CO., DBA LANDMARK THEATRES, LOS ANGELES, CA. FILED 5-17-2004.

FILMCALENDAR

THE MARK CONSISTS OF STANDARD CHARACTERS WITHOUT CLAIM TO ANY PARTICULAR FONT, STYLE, SIZE, OR COLOR.

FOR PUBLICATIONS, NAMELY, NEWSPAPERS FEATURING THE MOTION PICTURE INDUSTRY AND MOTION PICTURES (U.S. CLS. 2, 5, 22, 23, 29, 37, 38 AND 50).

FIRST USE 0-0-1986; IN COMMERCE 0-0-1986.
TIMOTHY FINNEGAN, EXAMINING ATTORNEY

SN 76-596,221. SOURCE MEDIA, INC., AKA AB HOLDING INC., NEW YORK, NY. FILED 6-9-2004.

REGULATORY REGISTER

THE MARK CONSISTS OF STANDARD CHARACTERS WITHOUT CLAIM TO ANY PARTICULAR FONT, STYLE, SIZE, OR COLOR.

NO CLAIM IS MADE TO THE EXCLUSIVE RIGHT TO USE "REGULATORY", APART FROM THE MARK AS SHOWN.

SEC. 2(F).

FOR PRINTED PUBLICATIONS, NAMELY, A MONTHLY NEWSLETTER ON THE TOPIC OF CORPORATE COMPLIANCE (U.S. CLS. 2, 5, 22, 23, 29, 37, 38 AND 50).

FIRST USE 9-30-1985; IN COMMERCE 9-30-1985.
RONALD AIKENS, EXAMINING ATTORNEY

CLASS 16—(Continued).

SN 76-596,559. NOVATIONS GROUP, INC., BOSTON, MA.
FILED 6-10-2004.

JUST ENOUGH PROJECT MANAGEMENT

THE MARK CONSISTS OF STANDARD CHARACTERS WITHOUT CLAIM TO ANY PARTICULAR FONT, STYLE, SIZE, OR COLOR.

NO CLAIM IS MADE TO THE EXCLUSIVE RIGHT TO USE "PROJECT MANAGEMENT", APART FROM THE MARK AS SHOWN.

FOR BOOKS, PAMPHLETS, PRINTED FORMS, BOUND INSTRUCTIONS, AND NOTES ON PLANNING, LAUNCHING, EXECUTING, CONTROLLING AND CLOSING PROJECTS (U.S. CLS. 2, 5, 22, 23, 29, 37, 38 AND 50).

FIRST USE 4-0-2004; IN COMMERCE 4-0-2004.
STEPHANIE DAVIS, EXAMINING ATTORNEY

CLASS 16—(Continued).

SN 76-598,187. SCHOLASTIC INC., NEW YORK, NY. FILED
6-18-2004.

SCHOLASTIC TESTING

THE MARK CONSISTS OF STANDARD CHARACTERS WITHOUT CLAIM TO ANY PARTICULAR FONT, STYLE, SIZE, OR COLOR.

NO CLAIM IS MADE TO THE EXCLUSIVE RIGHT TO USE "TESTING", APART FROM THE MARK AS SHOWN.

SEC. 2(F).
FOR PRINTED MATERIAL, NAMELY, BOOKS, MAGAZINE AND PAMPHLETS IN THE FIELD OF TESTING OF READING, MATH, SOCIAL STUDIES, SCIENCE, AND LANGUAGE ARTS (U.S. CLS. 2, 5, 22, 23, 29, 37, 38 AND 50).

ANN E. SAPPENFIELD, EXAMINING ATTORNEY

SN 76-596,840. THOMSON LEARNING INC., STAMFORD,
CT. FILED 6-10-2004.

THE 80/20 SERIES

THE MARK CONSISTS OF STANDARD CHARACTERS WITHOUT CLAIM TO ANY PARTICULAR FONT, STYLE, SIZE, OR COLOR.

NO CLAIM IS MADE TO THE EXCLUSIVE RIGHT TO USE "SERIES", APART FROM THE MARK AS SHOWN.

FOR PRINTED MATTER, NAMELY, A SERIES OF BOOKS ON THE TOPIC OF PERSONAL COMPUTER SERVICE SPECIALIST CERTIFICATION (U.S. CLS. 2, 5, 22, 23, 29, 37, 38 AND 50).

SCOTT OSLUCK, EXAMINING ATTORNEY

SN 76-599,144. COASTAL PET PRODUCTS, INC., ALLIANCE,
OH. FILED 6-24-2004.

ADVANCE

THE MARK CONSISTS OF STANDARD CHARACTERS WITHOUT CLAIM TO ANY PARTICULAR FONT, STYLE, SIZE, OR COLOR.

OWNER OF U.S. REG. NO. 1,818,962.
FOR PET HOUSEBREAKING PAD HOLDERS AND DISPOSABLE PET HOUSEBREAKING PADS (U.S. CLS. 2, 5, 22, 23, 29, 37, 38 AND 50).

FIRST USE 1-0-2001; IN COMMERCE 1-0-2001.
PRISCILLA MILTON, EXAMINING ATTORNEY

SN 76-597,467. HEALTH COMMUNICATIONS, INC., DEER-
FIELD BEACH, FL. FILED 6-14-2004.



NO CLAIM IS MADE TO THE EXCLUSIVE RIGHT TO USE "AMERICAN", APART FROM THE MARK AS SHOWN.

FOR NON-FICTION BOOKS IN THE FIELDS OF LIFE ISSUES, HEALTH AND WELLNESS, INSPIRATION, PARENTING, RELATIONSHIPS, SELF-HELP, RECOVERY AND SPIRITUALITY (U.S. CLS. 2, 5, 22, 23, 29, 37, 38 AND 50).

FIRST USE 5-1-2004; IN COMMERCE 5-1-2004.
DAWN FELDMAN, EXAMINING ATTORNEY

SN 76-600,525. THOMAS NELSON, INC., NASHVILLE, TN.
FILED 7-2-2004.

BIBLEZINE

THE MARK CONSISTS OF STANDARD CHARACTERS WITHOUT CLAIM TO ANY PARTICULAR FONT, STYLE, SIZE, OR COLOR.

FOR PRINTED MATTER, NAMELY, BIBLES, RELIGIOUS AND INSPIRATIONAL DEVOTIONALS AND STUDY GUIDES (U.S. CLS. 2, 5, 22, 23, 29, 37, 38 AND 50).

LEIGH LOWRY, EXAMINING ATTORNEY

CLASS 16—(Continued).

SN 76-600,777. BLAINE BROOKE PHOTOGRAPHY, INC., LOUISVILLE, KY. FILED 7-6-2004.

**THE LIGHT OF JUSTICE WILL NOT
FADE WITH THE PASSAGE OF TIME**

THE MARK CONSISTS OF STANDARD CHARACTERS WITHOUT CLAIM TO ANY PARTICULAR FONT, STYLE, SIZE, OR COLOR.

FOR PAPER GOODS AND PRINTED MATTER, NAMELY, ORIGINAL ART PRINTS, POSTERS, ART PRINTS, LIMITED EDITION ART PRINTS, AND POSTCARDS (U.S. CLS. 2, 5, 22, 23, 29, 37, 38 AND 50).

FIRST USE 3-5-2004; IN COMMERCE 3-5-2004.

RUSS HERMAN, EXAMINING ATTORNEY

SN 76-601,735. ENTHUSIAST PUBLISHING SERVICES LLC, CORONA, CA. FILED 7-12-2004.

TEN MAGAZINES

THE MARK CONSISTS OF STANDARD CHARACTERS WITHOUT CLAIM TO ANY PARTICULAR FONT, STYLE, SIZE, OR COLOR.

NO CLAIM IS MADE TO THE EXCLUSIVE RIGHT TO USE MAGAZINES, APART FROM THE MARK AS SHOWN.

FOR MAGAZINES RELATING TO AUTOMOTIVE MATTERS INCLUDING TRUCKS, SUVs, OFF ROAD VEHICLES AND THE LIKE (U.S. CLS. 2, 5, 22, 23, 29, 37, 38 AND 50).

FIRST USE 6-30-2002; IN COMMERCE 6-30-2002.

AMY GEARIN, EXAMINING ATTORNEY

SN 76-602,840. RODMAN PUBLICATIONS, INC., RAMSEY, NJ. FILED 7-19-2004.

L&NW LABEL & NARROW WEB

THE MARK CONSISTS OF STANDARD CHARACTERS WITHOUT CLAIM TO ANY PARTICULAR FONT, STYLE, SIZE, OR COLOR.

NO CLAIM IS MADE TO THE EXCLUSIVE RIGHT TO USE "LABEL" AND "NARROW WEB", APART FROM THE MARK AS SHOWN.

FOR PRINTED PUBLICATIONS, NAMELY, PERIODICALS IN THE FIELD OF PRODUCT LABELING AND THE NARROW WEB PRINTING INDUSTRY (U.S. CLS. 2, 5, 22, 23, 29, 37, 38 AND 50).

FIRST USE 9-1-1995; IN COMMERCE 3-1-1996.

CHRISTOPHER BUONGIORNO, EXAMINING ATTORNEY

CLASS 16—(Continued).

SN 76-602,888. KLUTZ, PALO ALTO, CA. FILED 7-16-2004.



OWNER OF U.S. REG. NOS. 1,347,667, 2,005,288 AND OTHERS.

NO CLAIM IS MADE TO THE EXCLUSIVE RIGHT TO USE "TO GO", APART FROM THE MARK AS SHOWN.

FOR ENTERTAINMENT TRAVEL KITS FOR CHILDREN COMPRISED OF ACTIVITY BOOKS, STICKERS, PENCILS AND ERASERS IN A CUSTOM CASE WHICH FITS IN A STANDARD CAR CUP HOLDER (U.S. CLS. 2, 5, 22, 23, 29, 37, 38 AND 50).

FIRST USE 3-1-2005; IN COMMERCE 3-1-2005.

APRIL L. RADEMACHER, EXAMINING ATTORNEY

SN 76-604,676. ALL ABOUT PACKAGING, INC., APPLETON, WI. FILED 7-29-2004.



FOR PACKAGING, NAMELY BLISTER PACKAGING FEATURING A LOCKING SLIDE (U.S. CLS. 2, 5, 22, 23, 29, 37, 38 AND 50).

FIRST USE 7-23-2004; IN COMMERCE 7-23-2004.

SUSAN HAYASH, EXAMINING ATTORNEY

CLASS 16—(Continued).

SN 76-606,808. LITTLE DIVERSIFIED ARCHITECTURAL CONSULTING, INC., CHARLOTTE, NC. FILED 8-13-2004.



OWNER OF U.S. REG. NOS. 2,900,289, 2,909,068 AND OTHERS.

NO CLAIM IS MADE TO THE EXCLUSIVE RIGHT TO USE "DIVERSIFIED ARCHITECTURAL CONSULTING", APART FROM THE MARK AS SHOWN.

THE MARK CONSISTS OF THE WORD LITTLE IN A LARGE SPECIAL TYPE STYLE IN ALL CAPITAL LETTERS EXCEPT FOR THE LETTER "I" WHICH IS IN LOWER CASE BUT STILL THE SAME SIZE AS THE CAPITAL LETTERS ABOVE THE WORDS DIVERSIFIED ARCHITECTURAL CONSULTING IN SMALL CAPITAL LETTERS. THE LETTERFORMS ARE IN WHITE AGAINST A BLACK BACKGROUND. COLOR IS NOT A FEATURE OF THE MARK.

FOR ARCHITECTURAL MODELS; ARCHITECTURAL PLANS AND SPECIFICATIONS (U.S. CLS. 2, 5, 22, 23, 29, 37, 38 AND 50).

FIRST USE 9-1-2002; IN COMMERCE 9-1-2002.

CHERYL CLAYTON, EXAMINING ATTORNEY

SN 76-607,393. ST. LOUIS MAGAZINE, L.L.C., ST. LOUIS, MO. FILED 8-17-2004.

ST. LOUIS AT HOME

THE MARK CONSISTS OF STANDARD CHARACTERS WITHOUT CLAIM TO ANY PARTICULAR FONT, STYLE, SIZE, OR COLOR.

NO CLAIM IS MADE TO THE EXCLUSIVE RIGHT TO USE ST. LOUIS, APART FROM THE MARK AS SHOWN.

FOR GENERAL FEATURE MAGAZINES AND PERIODICALS IN THE FIELD OF HOMES AND GARDENS (U.S. CLS. 2, 5, 22, 23, 29, 37, 38 AND 50).

FIRST USE 6-1-2005; IN COMMERCE 6-1-2005.

CAROLYN GRAY, EXAMINING ATTORNEY

SN 76-607,609. SOURCE MEDIA, INC., AKA AB HOLDING INC., NEW YORK, NY. FILED 8-19-2004.

HIGH YIELD REPORT

THE MARK CONSISTS OF STANDARD CHARACTERS WITHOUT CLAIM TO ANY PARTICULAR FONT, STYLE, SIZE, OR COLOR.

NO CLAIM IS MADE TO THE EXCLUSIVE RIGHT TO USE "REPORT", APART FROM THE MARK AS SHOWN.

SEC. 2(F).

FOR PRINTED PUBLICATION, NAMELY, NEWSLETTER FEATURING INFORMATION ON THE \$250 BILLION BELOW-INVESTMENT GRADE MARKET (U.S. CLS. 2, 5, 22, 23, 29, 37, 38 AND 50).

FIRST USE 12-31-1992; IN COMMERCE 12-31-1992.

ANDREW BENZMILLER, EXAMINING ATTORNEY

CLASS 16—(Continued).

SN 76-607,610. SOURCE MEDIA, INC., AKA AB HOLDING INC., NEW YORK, NY. FILED 8-19-2004.

ASSET SECURITIZATION DIRECTORY

THE MARK CONSISTS OF STANDARD CHARACTERS WITHOUT CLAIM TO ANY PARTICULAR FONT, STYLE, SIZE, OR COLOR.

NO CLAIM IS MADE TO THE EXCLUSIVE RIGHT TO USE "DIRECTORY", APART FROM THE MARK AS SHOWN.

SEC. 2(F).

FOR PRINTED PUBLICATION, NAMELY, ANNUAL DIRECTORY FEATURING CONTACT INFORMATION ABOUT FIRMS AND PROFESSIONALS IN THE ASSET-BASED SECURITIES MARKET (U.S. CLS. 2, 5, 22, 23, 29, 37, 38 AND 50).

FIRST USE 12-31-1999; IN COMMERCE 12-31-1999.

ANDREW BENZMILLER, EXAMINING ATTORNEY

SN 76-608,333. READING ETC., INC., DEERFIELD BEACH, FL. FILED 8-23-2004.

OCEAN TREASURES COLLECTION

THE MARK CONSISTS OF STANDARD CHARACTERS WITHOUT CLAIM TO ANY PARTICULAR FONT, STYLE, SIZE, OR COLOR.

NO CLAIM IS MADE TO THE EXCLUSIVE RIGHT TO USE "COLLECTION", APART FROM THE MARK AS SHOWN.

FOR AQUARIUMS (U.S. CLS. 2, 5, 22, 23, 29, 37, 38 AND 50).

FIRST USE 8-5-2004; IN COMMERCE 8-5-2004.

ROBERT C. CLARK JR., EXAMINING ATTORNEY

SN 76-609,431. ABC TELECOM INC., ROSLYN HEIGHTS, NY. FILED 8-31-2004.

PLATANO

THE MARK CONSISTS OF STANDARD CHARACTERS WITHOUT CLAIM TO ANY PARTICULAR FONT, STYLE, SIZE, OR COLOR.

THE ENGLISH TRANSLATION OF THE MARK IS "PLANTAIN".

FOR PREPAID TELEPHONE CALLING CARDS NOT MAGNETICALLY ENCODED (U.S. CLS. 2, 5, 22, 23, 29, 37, 38 AND 50).

FIRST USE 6-1-2004; IN COMMERCE 6-1-2004.

GEORGIA CARTY, EXAMINING ATTORNEY

CLASS 16—(Continued).

SN 76-609,587. LUKEBABY PRODUCTIONS, INC., CHICAGO, IL. FILED 8-30-2004.

FLAVA MEN

THE MARK CONSISTS OF STANDARD CHARACTERS WITHOUT CLAIM TO ANY PARTICULAR FONT, STYLE, SIZE, OR COLOR.

NO CLAIM IS MADE TO THE EXCLUSIVE RIGHT TO USE "MEN", APART FROM THE MARK AS SHOWN.

FOR MONTHLY MEN'S ENTERTAINMENT MAGAZINE FEATURING PICTURES AND TEXT (U.S. CLS. 2, 5, 22, 23, 29, 37, 38 AND 50).

FIRST USE 6-1-2004; IN COMMERCE 8-1-2004.
TARAH HARDY, EXAMINING ATTORNEY

SN 76-610,161. TRACTOR SUPPLY CO. OF TEXAS, LP, BRENTWOOD, TN. FILED 9-3-2004.

LIVING & LOVING THE GOOD LIFE

THE MARK CONSISTS OF STANDARD CHARACTERS WITHOUT CLAIM TO ANY PARTICULAR FONT, STYLE, SIZE, OR COLOR.

FOR MAGAZINE IN THE FIELD OF FARMING AND RURAL LIVING (U.S. CLS. 2, 5, 22, 23, 29, 37, 38 AND 50).

FIRST USE 11-5-2003; IN COMMERCE 11-5-2003.
ANDREA K. NADELMAN, EXAMINING ATTORNEY

SN 76-611,847. ROGERS, STEPHEN M., WINONA LAKE, IN. AND ARNOLT, STANLEY H., WINONA LAKE, IN. FILED 9-17-2004.



THE MARK CONSISTS OF THE DESIGN OF A WINGED HORSE FLYING THROUGH A CAPITAL LETTER "A" AND ABOVE THE WORD ARNOLT.

FOR DECALS (U.S. CLS. 2, 5, 22, 23, 29, 37, 38 AND 50).
FIRST USE 1-0-1938; IN COMMERCE 2-0-1977.
TRACY CROSS, EXAMINING ATTORNEY

CLASS 16—(Continued).

SN 76-612,934. ACCLIVUS CORPORATION, DALLAS, TX. FILED 9-27-2004.

CO-CREATING A MORE COLLABORATIVE WORLD

THE MARK CONSISTS OF STANDARD CHARACTERS WITHOUT CLAIM TO ANY PARTICULAR FONT, STYLE, SIZE, OR COLOR.

FOR PRINTED MATERIALS, NAMELY, WORKBOOKS, WALL CHARTS AND SKILL GUIDES FOR USE IN WORKSHOPS, LECTURES, COURSE SYMPOSIA AND CONFERENCES IN THE FIELD OF BUSINESS MANAGEMENT, SALES COMMUNICATION AND BUILDING RELATIONSHIPS WITH CUSTOMERS (U.S. CLS. 2, 5, 22, 23, 29, 37, 38 AND 50).

ODESSA BIBBINS, EXAMINING ATTORNEY

SN 76-613,321. BIG MOUNTAIN PUBLISHING, WHITEFISH, MT. FILED 9-20-2004.

BIGFORK

THE MARK CONSISTS OF STANDARD CHARACTERS WITHOUT CLAIM TO ANY PARTICULAR FONT, STYLE, SIZE, OR COLOR.

SEC. 2(F).

FOR MAGAZINES DEALING WITH RURAL AND RESORT LIFESTYLES (U.S. CLS. 2, 5, 22, 23, 29, 37, 38 AND 50).

FIRST USE 0-0-2000; IN COMMERCE 0-0-2000.
KAREN K. BUSH, EXAMINING ATTORNEY

SN 76-614,389. CASTLEBERRY'S FOOD COMPANY, AUGUSTA, GA. FILED 10-1-2004.

CASTLEBERRY'S MEAT TALK

THE MARK CONSISTS OF STANDARD CHARACTERS WITHOUT CLAIM TO ANY PARTICULAR FONT, STYLE, SIZE, OR COLOR.

OWNER OF U.S. REG. NOS. 825,879 AND 2,041,739.

NO CLAIM IS MADE TO THE EXCLUSIVE RIGHT TO USE "MEAT", APART FROM THE MARK AS SHOWN.

FOR NEWSLETTERS IN THE FIELD OF FOOD (U.S. CLS. 2, 5, 22, 23, 29, 37, 38 AND 50).

FIRST USE 8-0-2003; IN COMMERCE 8-0-2003.

DORITT L. CARROLL, EXAMINING ATTORNEY

CLASS 16—(Continued).

SN 76-615,032. SEIDEL, SCOTT M., DALLAS, TX. FILED 10-6-2004.

X DAY

THE MARK CONSISTS OF STANDARD CHARACTERS WITHOUT CLAIM TO ANY PARTICULAR FONT, STYLE, SIZE, OR COLOR.
FOR GREETING CARDS (U.S. CLS. 2, 5, 22, 23, 29, 37, 38 AND 50).
KIMBERLY PERRY, EXAMINING ATTORNEY

SN 76-615,182. LIFEWAY CHRISTIAN RESOURCES OF THE SOUTHERN BAPTIST CONVENTION, NASHVILLE, TN. FILED 10-12-2004.

READ TO ME

FOR BIBLES; AND PRINTED TEACHING MATERIALS IN THE FIELD OF BIBLE STUDIES (U.S. CLS. 2, 5, 22, 23, 29, 37, 38 AND 50).
ALEXANDER L. POWERS, EXAMINING ATTORNEY

SN 76-615,354. RO ENTERPRISES, INCORPORATED, CHICAGO, IL. FILED 10-6-2004.



POLONIA

NO CLAIM IS MADE TO THE EXCLUSIVE RIGHT TO USE "POLONIA", APART FROM THE MARK AS SHOWN.
THE ENGLISH TRANSLATION OF THE WORD "POLONIA" IN THE MARK IS POLISH EMIGRANT.
FOR MAGAZINES CONTAINING ARTICLES OF INTEREST TO PERSONS OF POLISH OR POLISH-AMERICAN HERITAGE (U.S. CLS. 2, 5, 22, 23, 29, 37, 38 AND 50).
FIRST USE 12-1-2003; IN COMMERCE 12-1-2003.
LOURDES AYALA, EXAMINING ATTORNEY

CLASS 16—(Continued).

SN 76-615,504. MARQUEZ BROTHERS INTERNATIONAL, INC., SAN JOSE, CA. FILED 10-12-2004.

LILY'S

THE MARK CONSISTS OF STANDARD CHARACTERS WITHOUT CLAIM TO ANY PARTICULAR FONT, STYLE, SIZE, OR COLOR.
FOR TOILET PAPER, TISSUE PAPER, PAPER TOWELS (U.S. CLS. 2, 5, 22, 23, 29, 37, 38 AND 50).
REGINA DRUMMOND, EXAMINING ATTORNEY

SN 76-615,647. DIAMOND PHONE CARD, INC., ELMHURST, NY. FILED 10-13-2004.

HASTA LA VISTA NEW YORK PHONE CARD

THE MARK CONSISTS OF STANDARD CHARACTERS WITHOUT CLAIM TO ANY PARTICULAR FONT, STYLE, SIZE, OR COLOR.
NO CLAIM IS MADE TO THE EXCLUSIVE RIGHT TO USE "NEW YORK PHONE CARD", APART FROM THE MARK AS SHOWN.
THE ENGLISH TRANSLATION OF THE SPANISH WORDING, "HASTA LA VISTA," IS "SEE YOU LATER".
FOR PREPAID TELEPHONE CALLING CARDS, NOT MAGNETICALLY ENCODED (U.S. CLS. 2, 5, 22, 23, 29, 37, 38 AND 50).
FIRST USE 6-1-2004; IN COMMERCE 6-1-2004.
BARBARA A. GOLD, EXAMINING ATTORNEY

SN 76-615,648. DIAMOND PHONE CARD, INC., ELMHURST, NY. FILED 10-13-2004.

BOOM! AFRICA PHONE CARD

THE MARK CONSISTS OF STANDARD CHARACTERS WITHOUT CLAIM TO ANY PARTICULAR FONT, STYLE, SIZE, OR COLOR.
NO CLAIM IS MADE TO THE EXCLUSIVE RIGHT TO USE "AFRICA PHONE CARD", APART FROM THE MARK AS SHOWN.
FOR PREPAID TELEPHONE CALLING CARDS, NOT MAGNETICALLY ENCODED (U.S. CLS. 2, 5, 22, 23, 29, 37, 38 AND 50).
FIRST USE 6-1-2004; IN COMMERCE 6-1-2004.
BARBARA A. GOLD, EXAMINING ATTORNEY

CLASS 16—(Continued).

SN 76-615,897. STANTON, BRIAN, EDMOND, OK. FILED 10-12-2004.

LANGUAGEMED

THE MARK CONSISTS OF STANDARD CHARACTERS WITHOUT CLAIM TO ANY PARTICULAR FONT, STYLE, SIZE, OR COLOR.

FOR PRINTED MATERIALS, NAMELY MEDICAL FORMS (U.S. CLS. 2, 5, 22, 23, 29, 37, 38 AND 50).
FIRST USE 8-5-2004; IN COMMERCE 8-5-2004.
KEVIN DINALLO, EXAMINING ATTORNEY

SN 76-616,066. THE WOOSTER BRUSH COMPANY, WOOSTER, OH. FILED 10-14-2004.

CANDY STRIPE

THE MARK CONSISTS OF STANDARD CHARACTERS WITHOUT CLAIM TO ANY PARTICULAR FONT, STYLE, SIZE, OR COLOR.

OWNER OF U.S. REG. NO. 780,303.
FOR PAINT ROLLER COVERS (U.S. CLS. 2, 5, 22, 23, 29, 37, 38 AND 50).
FIRST USE 9-0-1957; IN COMMERCE 9-0-1957.
NAAKWAMA ANKRAH, EXAMINING ATTORNEY

SN 76-616,351. CASTLEBERRY'S FOOD COMPANY, AUGUSTA, GA. FILED 10-18-2004.

CLAMEMO

THE MARK CONSISTS OF STANDARD CHARACTERS WITHOUT CLAIM TO ANY PARTICULAR FONT, STYLE, SIZE, OR COLOR.

FOR NEWSLETTERS IN THE FIELD OF FOOD (U.S. CLS. 2, 5, 22, 23, 29, 37, 38 AND 50).
FIRST USE 8-0-2003; IN COMMERCE 8-0-2003.
KHANH LE, EXAMINING ATTORNEY

CLASS 16—(Continued).

SN 76-617,101. NATIONAL OCEANIC AND ATMOSPHERIC ADMINISTRATION, WASHINGTON, DC. FILED 10-18-2004.

BREAK THE GRIP OF THE RIP

THE MARK CONSISTS OF STANDARD CHARACTERS WITHOUT CLAIM TO ANY PARTICULAR FONT, STYLE, SIZE, OR COLOR.

FOR PRINTED MATTER, NAMELY, POSTERS, STICKERS, PAMPHLETS AND BROCHURES CONCERNING A PUBLIC AWARENESS CAMPAIGN DESIGNED TO PREVENT RIP CURRENT DEATHS AND EDUCATE PEOPLE ABOUT SWIMMING SAFETY (U.S. CLS. 2, 5, 22, 23, 29, 37, 38 AND 50).

FIRST USE 5-13-2004; IN COMMERCE 5-13-2004.
DAVID MURRAY, EXAMINING ATTORNEY

SN 76-617,452. TOUCHSTONE APPLIED SCIENCE ASSOCIATES, INC., BREWSTER, NY. FILED 10-25-2004.

DWMM

THE MARK CONSISTS OF STANDARD CHARACTERS WITHOUT CLAIM TO ANY PARTICULAR FONT, STYLE, SIZE, OR COLOR.

FOR PRINTED EDUCATIONAL MATERIALS; NAMELY, VOCABULARY TESTS FOR PRIMARY, ELEMENTARY AND SECONDARY GRADES AND COLLEGE (U.S. CLS. 2, 5, 22, 23, 29, 37, 38 AND 50).
FIRST USE 1-0-1993; IN COMMERCE 1-0-1993.
TARAH HARDY, EXAMINING ATTORNEY

SN 76-617,604. THE HADRON GROUP, INC., ALTON, IL. FILED 10-22-2004.

BRAIN MODE_{power}

FOR PRINTED PERSONAL ASSESSMENT AND INSTRUCTIONAL MATERIALS IN THE FIELD OF INDIVIDUAL THINKING STYLE AND PERFORMANCE ANALYSES (U.S. CLS. 2, 5, 22, 23, 29, 37, 38 AND 50).

FIRST USE 2-27-2004; IN COMMERCE 2-27-2004.
ARETHA SOMERVILLE, EXAMINING ATTORNEY

CLASS 16—(Continued).

SN 76-617,721. THE TRIBUNE COMPANY HOLDINGS, INC., RICHMOND, VA. FILED 10-25-2004.

THE TAMPA TIMES

THE MARK CONSISTS OF STANDARD CHARACTERS WITHOUT CLAIM TO ANY PARTICULAR FONT, STYLE, SIZE, OR COLOR.

OWNER OF U.S. REG. NO. 898,333.
FOR NEWSPAPER FOR GENERAL CIRCULATION (U.S. CLS. 2, 5, 22, 23, 29, 37, 38 AND 50).
FIRST USE 12-31-1958; IN COMMERCE 12-31-1958.
MICHAEL TANNER, EXAMINING ATTORNEY

SN 76-617,993. JACKSON, CLARENCE H., NEW YORK, NY. FILED 10-27-2004.

CJACK

THE MARK CONSISTS OF STANDARD CHARACTERS WITHOUT CLAIM TO ANY PARTICULAR FONT, STYLE, SIZE, OR COLOR.

FOR PAPER; STATIONERY, BUSINESS CARDS (U.S. CLS. 2, 5, 22, 23, 29, 37, 38 AND 50).
FIRST USE 1-19-2005; IN COMMERCE 1-19-2005.
MARK T. MULLEN, EXAMINING ATTORNEY

SN 76-618,039. COUNCE, PAULA, VENICE, FL. FILED 10-27-2004.

A JOURNEY REMEMBERED

THE MARK CONSISTS OF STANDARD CHARACTERS WITHOUT CLAIM TO ANY PARTICULAR FONT, STYLE, SIZE, OR COLOR.

FOR CHILDREN'S FICTION BOOKS; ART PRINTS; GREETING CARDS; NOTE CARDS; AND STATIONERY (U.S. CLS. 2, 5, 22, 23, 29, 37, 38 AND 50).
FIRST USE 10-19-2004; IN COMMERCE 10-19-2004.
VERNA BETH RIRIE, EXAMINING ATTORNEY

CLASS 16—(Continued).

SN 76-618,299. DIAMOND PHONE CARD CORP., ELMHURST, NY. FILED 10-28-2004.

DIAMOND EXPRESS PHONE CARD

THE MARK CONSISTS OF STANDARD CHARACTERS WITHOUT CLAIM TO ANY PARTICULAR FONT, STYLE, SIZE, OR COLOR.

NO CLAIM IS MADE TO THE EXCLUSIVE RIGHT TO USE "PHONE CARD", APART FROM THE MARK AS SHOWN.

FOR PREPAID TELEPHONE CALLING CARDS, NOT MAGNETICALLY ENCODED (U.S. CLS. 2, 5, 22, 23, 29, 37, 38 AND 50).

FIRST USE 6-1-2004; IN COMMERCE 6-1-2004.
BARBARA A. GOLD, EXAMINING ATTORNEY

SN 76-622,284. MEDIA EXPRESS CO. LTD., WARSAW, POLAND, FILED 11-22-2004.

SUPER

THE MARK CONSISTS OF STANDARD CHARACTERS WITHOUT CLAIM TO ANY PARTICULAR FONT, STYLE, SIZE, OR COLOR.

OWNER OF U.S. REG. NOS. 2,030,950 AND 2,158,241.
FOR PRINTED PUBLICATIONS, NAMELY NEWSPAPERS, JOURNALS, MAGAZINES, NEWSLETTERS AND BOOKLETS FEATURING INFORMATION ABOUT POLITICAL, CULTURAL, SPORT, FINANCIAL AND SOCIOLOGICAL EVENTS (U.S. CLS. 2, 5, 22, 23, 29, 37, 38 AND 50).

DEZMONA MIZELLE, EXAMINING ATTORNEY

CLASS 16—(Continued).

SN 76-623,279. MERCUR S.A., CEP 96825-010 - SANTA CRUZ DO SUL - RS, BRAZIL, FILED 12-6-2004.

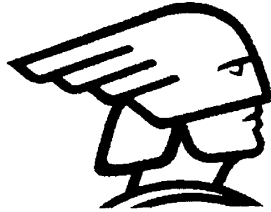

FOR ERASERS, CORRECTION FLUID FOR DOCUMENTS, PENS FILLED WITH CORRECTIVE FLUID FOR USE WITH DOCUMENTS, PEN ERASERS, MECHANICAL PENCILS, PENCILS, PENS, MARKING PENS, WATER COLOR PENS, COLORED PENCILS, DRAFTING RULERS, GLUE FOR OFFICE USE, GLUE FOR STATIONERY USE, NAMELY, GLITTER GLUE, COLORED GLUE, INKS FOR WRITING INSTRUMENTS FOR USE IN SCHOOLS, PLASTIC BAGS FOR PACKAGING, PLASTIC STATIONERY FOLDERS, PLASTIC PROTECTIVE COVERS, STATIONERY TYPE PORTFOLIOS, PENCIL SHARPENERS, MULTI-RING BINDERS, STAPLERS, PAPER HOLE PUNCHES, RUBBER BANDS, STATIONERY, WAX CRAYONS, MODELING CLAY, PAINT BRUSHES, BLACKBOARD ERASER (U.S. CLS. 2, 5, 22, 23, 29, 37, 38 AND 50).

FIRST USE 3-0-2002; IN COMMERCE 4-0-2003.
DAVID MURRAY, EXAMINING ATTORNEY

SN 76-623,315. LOGIC DREAM PRODUCTIONS, INC., EL PRADO, NM. FILED 12-6-2004.

SUBE

THE MARK CONSISTS OF STANDARD CHARACTERS WITHOUT CLAIM TO ANY PARTICULAR FONT, STYLE, SIZE, OR COLOR.

THE ENGLISH TRANSLATION OF SUBE IS "HE/SHE GOES UP".

FOR PRINTED INSTRUCTIONAL, EDUCATIONAL AND TEACHING MATERIALS RELATED TO SPANISH LANGUAGE INSTRUCTION FOR CHILDREN (U.S. CLS. 2, 5, 22, 23, 29, 37, 38 AND 50).

FIRST USE 10-15-1996; IN COMMERCE 10-15-1996.
RONALD MCMORROW, EXAMINING ATTORNEY

CLASS 16—(Continued).

SN 76-624,709. TRADER PUBLISHING COMPANY, NORFOLK, VA. FILED 12-14-2004.

THE EMPLOYMENT GUIDE

THE MARK CONSISTS OF STANDARD CHARACTERS WITHOUT CLAIM TO ANY PARTICULAR FONT, STYLE, SIZE, OR COLOR.

OWNER OF U.S. REG. NO. 1,687,101.

NO CLAIM IS MADE TO THE EXCLUSIVE RIGHT TO USE GUIDE, APART FROM THE MARK AS SHOWN.

SEC. 2(F).

FOR NEWSPAPERS FEATURING ADVERTISEMENTS AND INFORMATION IN THE FIELDS OF HUMAN RESOURCES AND CAREER DEVELOPMENT (U.S. CLS. 2, 5, 22, 23, 29, 37, 38 AND 50).

FIRST USE 1-20-1990; IN COMMERCE 1-20-1990.

JOHN E. MICHOS, EXAMINING ATTORNEY

SN 76-624,955. CREATIVE AGE COMMUNICATIONS, INC., VAN NUYS, CA. FILED 12-17-2004.

INSPIRE

THE MARK CONSISTS OF STANDARD CHARACTERS WITHOUT CLAIM TO ANY PARTICULAR FONT, STYLE, SIZE, OR COLOR.

FOR MAGAZINES, PUBLISHED PERIODICALLY, RELATING TO HAIR STYLING (U.S. CLS. 2, 5, 22, 23, 29, 37, 38 AND 50).

FIRST USE 6-0-1992; IN COMMERCE 6-0-1992.

ROBIN CHOSID, EXAMINING ATTORNEY

CLASS 16—(Continued).

SN 76-625,172. MASTERYWORKS, INC., MCLEAN, VA. FILED 12-20-2004.



OWNER OF U.S. REG. NOS. 2,265,357 AND 2,265,358.
 THE MARK CONSISTS OF A STYLIZED HUMAN STICK-FIGURE WITH TWO ARMS, TWO LEGS AND A ROUND HEAD ABOVE THE WORDS "MASTERY WORKS" IN UPPERCASE STYLIZED TEXT. THE FIGURE'S ARMS ARE RAISED IN AN UPWARD POSITION ON EITHER SIDE OF THE FIGURE'S HEAD.
 FOR BOOKS AND PRINTED EDUCATIONAL MATERIALS IN THE AREA OF CAREER AND PERSONAL DEVELOPMENT FOR INDIVIDUALS AND ORGANIZATIONS (U.S. CLS. 2, 5, 22, 23, 29, 37, 38 AND 50).
 FIRST USE 1-1-2001; IN COMMERCE 1-1-2001.
 MARGERY A. TIERNEY, EXAMINING ATTORNEY

SN 76-626,060. NASHUA CORPORATION, NASHUA, NH. FILED 12-27-2004.

SCRATCH & SECURE

THE MARK CONSISTS OF STANDARD CHARACTERS WITHOUT CLAIM TO ANY PARTICULAR FONT, STYLE, SIZE, OR COLOR.
 FOR RETAIL RECEIPT PAPER ROLLS (U.S. CLS. 2, 5, 22, 23, 29, 37, 38 AND 50).
 FIRST USE 0-0-1999; IN COMMERCE 0-0-1999.
 ROBERT COGGINS, EXAMINING ATTORNEY

CLASS 16—(Continued).

SN 76-626,225. JOY, RICK, CARPINTERIA, CA. FILED 12-27-2004.



NO CLAIM IS MADE TO THE EXCLUSIVE RIGHT TO USE "CARPINTERIA CALENDAR", APART FROM THE MARK AS SHOWN.
 THE COLOR(S) BLUE IS/ARE CLAIMED AS A FEATURE OF THE MARK.
 THE MARK CONSISTS OF TWO BLUE WAVES APPEAR PRIOR TO THE STANDARD CHARACTERS "THE CARPINTERIA CALENDAR".
 FOR YEARLY CALENDAR WITH TIDAL PREDICTIONS (U.S. CLS. 2, 5, 22, 23, 29, 37, 38 AND 50).
 RENEE MCCRAY, EXAMINING ATTORNEY

SN 76-626,673. GENERAL PENCIL COMPANY, INC., JERSEY CITY, NJ. FILED 1-3-2005.

PRIMO

THE MARK CONSISTS OF STANDARD CHARACTERS WITHOUT CLAIM TO ANY PARTICULAR FONT, STYLE, SIZE, OR COLOR.
 THE ENGLISH TRANSLATION OF "PRIMO" IS "FIRST".
 FOR ARTISTS' PENCILS (U.S. CLS. 2, 5, 22, 23, 29, 37, 38 AND 50).
 FIRST USE 6-3-2004; IN COMMERCE 6-3-2004.
 DAVID H. STINE, EXAMINING ATTORNEY

SN 76-633,275. DIAMOND PHONE CARD INC., ELMHURST, NY. FILED 3-15-2005.

ARENQUE PHONE CARD

THE MARK CONSISTS OF STANDARD CHARACTERS WITHOUT CLAIM TO ANY PARTICULAR FONT, STYLE, SIZE, OR COLOR.
 NO CLAIM IS MADE TO THE EXCLUSIVE RIGHT TO USE "PHONE CARD", APART FROM THE MARK AS SHOWN.
 THE ENGLISH TRANSLATION OF THE SPANISH WORDING "ARENQUE" IS "HERRING".
 FOR PREPAID TELEPHONE CALLING CARDS, NOT MAGNETICALLY ENCODED (U.S. CLS. 2, 5, 22, 23, 29, 37, 38 AND 50).
 FIRST USE 1-20-2005; IN COMMERCE 1-20-2005.
 BARBARA A. GOLD, EXAMINING ATTORNEY

CLASS 16—(Continued).

SN 76-977,298. HARRIS PUBLICATIONS, INC., NEW YORK, NY. FILED 6-2-2003.

RIDES

FOR MAGAZINE IN THE FIELD OF AUTOMOBILES (U.S. CLS. 2, 5, 22, 23, 29, 37, 38 AND 50).
FIRST USE 5-27-2003; IN COMMERCE 5-27-2003.
LAURA KOVAISKY, EXAMINING ATTORNEY

SN 78-060,791. YOGAVIDYA.COM LLC, WOODSTOCK, NY. FILED 4-27-2001.

YOGAVIDYA.COM

FOR FICTION AND NONFICTION BOOKS ON A VARIETY OF TOPICS. (U.S. CLS. 2, 5, 22, 23, 29, 37, 38 AND 50).
BARBARA BROWN, EXAMINING ATTORNEY

SN 78-204,802. NO STARCH PRESS, INC., SAN FRANCISCO, CA. FILED 1-17-2003.

STEAL THIS

THE MARK CONSISTS OF STANDARD CHARACTERS WITHOUT CLAIM TO ANY PARTICULAR FONT, STYLE, SIZE, OR COLOR.

FOR BOOKS, MAGAZINES, CATALOGS, MANUALS, BROCHURES, PAMPHLETS, WRITTEN GUIDES, AND NEWSLETTERS IN THE FIELDS OF COMPUTING, TECHNOLOGY, BUSINESS, TRAVEL, FINANCE, MARKETING, AND SALES (U.S. CLS. 2, 5, 22, 23, 29, 37, 38 AND 50).

FIRST USE 0-0-1998; IN COMMERCE 0-0-1998.
SHAUNIA WALLACE, EXAMINING ATTORNEY

SN 78-240,525. THIS OLD HOUSE VENTURES, INC., NEW YORK, NY. FILED 4-22-2003.

FIND

FOR GENERAL INTEREST MAGAZINES, A SERIES OF FICTION AND NON FICTION BOOKS IN THE FIELD OF ANTIQUES, ANTIQUE COLLECTING, HOME FURNISHINGS, HOME DECORATING AND RELATED TOPICS IN CONNECTION WITH A TELEVISION PROGRAM OF THE SAME NAME (U.S. CLS. 2, 5, 22, 23, 29, 37, 38 AND 50).

REBECCA GILBERT, EXAMINING ATTORNEY

CLASS 16—(Continued).

SN 78-272,091. BLACK WORLD FOUNDATION, OAKLAND, CA. FILED 7-9-2003.

THE BLACK SCHOLAR

SEC. 2(F).
FOR SERIES OF JOURNALS IN THE FIELDS OF CULTURE, POLITICS AND ACADEMIC RESEARCH AND STUDIES (U.S. CLS. 2, 5, 22, 23, 29, 37, 38 AND 50).
FIRST USE 0-0-1973; IN COMMERCE 0-0-1973.
WENDY GOODMAN, EXAMINING ATTORNEY

SN 78-295,726. JIN SHIN JYUTSU, INC., SCOTTSDALE, AZ. FILED 9-3-2003.

JIN SHIN JYUTSU

OWNER OF U.S. REG. NO. 2,425,297.
THE FOREIGN WORDING IN THE MARK TRANSLATES INTO ENGLISH AS "ART OF THE CREATOR THROUGH MAN OF KNOWING AND COMPASSION".

SEC. 2(F).
FOR NEWSLETTERS, PAMPHLETS AND PRINTED INSTRUCTIONAL, EDUCATIONAL AND TEACHING MATERIALS REGARDING ORIENTAL PHYSIO-PHILOSOPHY; PRINTED CHARTS (U.S. CLS. 2, 5, 22, 23, 29, 37, 38 AND 50).

FIRST USE 0-0-1965; IN COMMERCE 0-0-1965.
MARC LEIPZIG, EXAMINING ATTORNEY

SN 78-320,320. PECK, DEREK, SAN FRANCISCO, CA. FILED 10-29-2003.

PLANET

FOR CONSUMER LIFESTYLE MAGAZINE FOCUSING ON GLOBAL CULTURE, NAMELY THE ARTS, MUSIC, FILM, LITERATURE, ARCHITECTURE, PERSONALITIES, TRAVEL AND PERSONAL ESSAY, PUBLISHED MONTHLY AND SOLD ON NEWSSTANDS AND THROUGH SUBSCRIPTION (U.S. CLS. 2, 5, 22, 23, 29, 37, 38 AND 50).

FIRST USE 9-28-1999; IN COMMERCE 9-1-2001.
JEFF DEFORD, EXAMINING ATTORNEY

SN 78-321,453. DEB MAUPIN & ASSOCIATES, INC., DBA EMERGENCY LINKS MATTER, MARYVILLE, TN. FILED 10-31-2003.

E.L.M. EMERGENCY LINKS MATTER

NO CLAIM IS MADE TO THE EXCLUSIVE RIGHT TO USE "EMERGENCY", APART FROM THE MARK AS SHOWN.

FOR KITS FOR ORGANIZING PERSONAL INFORMATION SO THAT IT CAN BE QUICKLY ACCESSED DURING EMERGENCY SITUATIONS, THE KITS CONTAINING CARDS, DECALS AND INSTRUCTIONS FOR USING THE KIT (U.S. CLS. 2, 5, 22, 23, 29, 37, 38 AND 50).

FIRST USE 2-21-2003; IN COMMERCE 2-21-2003.
MARY I. SPARROW, EXAMINING ATTORNEY

CLASS 16—(Continued).

SN 78-323,525. LEHMAN TRIKES, INC., WESTLOCK, ALBERTA, CANADA, FILED 11-5-2003.

CLASS 16—(Continued).

SN 78-355,621. SNC EDITIONS PLAY-BAC, PARIS, FRANCE, FILED 1-22-2004.

PRIDE MATTERS

THE MARK CONSISTS OF STANDARD CHARACTERS WITHOUT CLAIM TO ANY PARTICULAR FONT, STYLE, SIZE, OR COLOR.
PRIORITY CLAIMED UNDER SEC. 44(D) ON CANADA APPLICATION NO. 1175605, FILED 5-5-2003, REG. NO. TMA637621, DATED 4-18-2005, EXPIRES 4-18-2020.
FOR MAGAZINE IN THE FIELD OF MOTORIZED TRICYCLES (U.S. CLS. 2, 5, 22, 23, 29, 37, 38 AND 50).
FIRST USE 1-1-2000; IN COMMERCE 1-1-2000.
MITCHELL FRONT, EXAMINING ATTORNEY

SN 78-353,525. MULLINS, ELIZABETH RENEE, YORK, SC. FILED 1-19-2004.

Plum Purdy

THE MARK CONSISTS OF STANDARD CHARACTERS WITHOUT CLAIM TO ANY PARTICULAR FONT, STYLE, SIZE, OR COLOR.
FOR DECORATIVE PAINTING PATTERNS, ALSO KNOWN AS STENCILS; STATIONERY (U.S. CLS. 2, 5, 22, 23, 29, 37, 38 AND 50).
FIRST USE 1-1-2000; IN COMMERCE 1-1-2000.
RONALD AIKENS, EXAMINING ATTORNEY

LILI CHANTILLY

THE MARK CONSISTS OF STANDARD CHARACTERS WITHOUT CLAIM TO ANY PARTICULAR FONT, STYLE, SIZE, OR COLOR.

OWNER OF FRANCE REG. NO. 003047582, DATED 8-21-2000, EXPIRES 8-20-2010.

THE NAME LILI CHANTILLY DOES NOT IDENTIFIES A LIVING INDIVIDUAL.

FOR PRINTED MATTER, NAMELY NEWSPAPERS, BOOKS, MAGAZINES FOR CHILDREN, PHOTOGRAPHS, STATIONERY, ADHESIVES FOR STATIONERY PURPOSES, ARTIST'S MATERIALS, NAMELY, PAINT BRUSHES, PENS, FOUNTAINS PENS, WRITING OR DRAWING BOOKS, WRITING PADS, WRITING PAPER, WRITING MATERIALS, NAMELY PENS, FOUNTAIN PENS, WRITING TABLETS, ALBUMS, NAMELY, COINS ALBUMS, PHOTOGRAPHS ALBUMS, STAMPS ALBUMS, PICTURES ALBUMS, AND STICKERS ALBUMS, BOXES OF CARDBOARD OR PAPER, DATE BOOKS, NOTE BOOKS, NAMELY DIARIES, PERSONAL ORGANIZERS, JOURNALS FOR CHILDREN, CHILDREN BOOKS, PRINTED PUBLICATIONS, NAMELY, MAGAZINES CONTAINING TOPICS OF GENERAL INTEREST FOR CHILDREN, PRINTER'S TYPE, PRINTING BLOCKS; PAPER, CARDBOARD AND GOODS MADE FROM THESE MATERIALS, NAMELY BOXES OF CARDBOARD OR PAPER, WRITING PAPER, TRACING PAPER, CARBON PAPER, GREETING CARDS, INVITATION CARDS, POSTCARDS AND ENVELOPES (U.S. CLS. 2, 5, 22, 23, 29, 37, 38 AND 50).

ALICE BENMAMAN, EXAMINING ATTORNEY

SN 78-355,907. NATIONAL BUSINESS FORMS INC., GREENVILLE, TN. FILED 1-22-2004.



THE MARK CONSISTS OF A FANCILY DEPICTED GENERIC BUSINESS FORM MICRO PERFORATED, EIGHT ROUND HOLES PUNCHED, WITH A HARD EDGED SHADOW POSITIONED ON ITS LEFT TOP SIDE AND THE STYLIZED LETTERS "NBF" DESIGNED ON THE LOWER PART OF THE BUSINESS FORM.

FOR PAPER GOODS AND PRINTED MATTER, NAMELY, SNAP-OUT AND CONTINUOUS BUSINESS FORMS (U.S. CLS. 2, 5, 22, 23, 29, 37, 38 AND 50).
FIRST USE 1-0-1980; IN COMMERCE 2-0-1980.
DAVID ELTON, EXAMINING ATTORNEY

CLASS 16—(Continued).

SN 78-372,997. CMP MEDIA LLC, MANHASSET, NY. FILED 2-24-2004.

TECHBUILDER

THE MARK CONSISTS OF STANDARD CHARACTERS WITHOUT CLAIM TO ANY PARTICULAR FONT, STYLE, SIZE, OR COLOR.

FOR PRINT PUBLICATIONS, NAMELY, MAGAZINES AND NEWSLETTERS IN THE FIELDS OF IT AND DESIGNING AND MAINTAINING IT SYSTEMS (U.S. CLS. 2, 5, 22, 23, 29, 37, 38 AND 50).

KHANH LE, EXAMINING ATTORNEY

SN 78-385,095. LASH'S LESSONS, LLC, SCIENCE HILL, KY. FILED 3-16-2004.

HEAVENLY DANCER

THE MARK CONSISTS OF STANDARD CHARACTERS WITHOUT CLAIM TO ANY PARTICULAR FONT, STYLE, SIZE, OR COLOR.

FOR BOOKS FEATURING HORSES; CHILDREN'S ACTIVITY BOOKS AND COLORING BOOKS; STICKERS; AND NOTEPADS (U.S. CLS. 2, 5, 22, 23, 29, 37, 38 AND 50).

DAWN HAN, EXAMINING ATTORNEY

SN 78-385,748. CHAMBER MANAGEMENT SERVICES, LLC, KANSAS CITY, MO. FILED 3-17-2004.

**GREATER KANSAS
CITY BUSINESS**

THE MARK CONSISTS OF STANDARD CHARACTERS WITHOUT CLAIM TO ANY PARTICULAR FONT, STYLE, SIZE, OR COLOR.

SEC. 2(F).

FOR MAGAZINES AND NEWSLETTERS FEATURING NEWS AND INFORMATION RELATING TO BUSINESS, COMMUNITY EVENTS AND TOURISM IN THE KANSAS CITY METROPOLITAN AREA (U.S. CLS. 2, 5, 22, 23, 29, 37, 38 AND 50).

FIRST USE 3-0-2000; IN COMMERCE 3-0-2000.

MARTHA SANTOMARTINO, EXAMINING ATTORNEY

CLASS 16—(Continued).

SN 78-386,649. OAKES, JIM, SIMPSONVILLE, KY. FILED 3-18-2004.

SMART

THE MARK CONSISTS OF STANDARD CHARACTERS WITHOUT CLAIM TO ANY PARTICULAR FONT, STYLE, SIZE, OR COLOR.

FOR OFFICE SUPPLY PRODUCTS, NAMELY PAPER BINDING CLIP DRIVERS, CLIPS FOR SAID CLIP DRIVERS AND CLIP CASSETTES (U.S. CLS. 2, 5, 22, 23, 29, 37, 38 AND 50).

KARLA PERKINS, EXAMINING ATTORNEY

SN 78-388,148. THE JOAN NOVELLI AND HOLLY GRUNDON JOINT VENTURE, BRANDON, MS. FILED 3-21-2004.

SmartPads!

THE MARK CONSISTS OF STANDARD CHARACTERS WITHOUT CLAIM TO ANY PARTICULAR FONT, STYLE, SIZE, OR COLOR.

FOR PRINTED INSTRUCTIONAL AND TEACHING MATERIAL IN THE FIELD OF PREK-8 CURRICULA (U.S. CLS. 2, 5, 22, 23, 29, 37, 38 AND 50).

JASON TURNER, EXAMINING ATTORNEY

CLASS 16—(Continued).

SN 78-390,215. WORK FROM HOME, INC., STEAMBOAT SPRINGS, CO. FILED 3-24-2004.

CLASS 16—(Continued).

SN 78-393,706. LEE PROCUREMENT SOLUTIONS CO., DAVENPORT, IA. FILED 3-31-2004.



The Post-Star

THE MARK CONSISTS OF CIRCULAR DRAWING WITH THE OUTLINE OF 3 HOUSES WITHIN THE CIRCLE. FOR PRINTED EDUCATIONAL, INSTRUCTIONAL AND TRAINING MATERIALS IN THE FIELD OF BUSINESS DEVELOPMENT, MARKETING AND MANAGEMENT (U.S. CLS. 2, 5, 22, 23, 29, 37, 38 AND 50). FIRST USE 1-31-2001; IN COMMERCE 1-31-2001. KATHRYN COWARD, EXAMINING ATTORNEY

THE MARK CONSISTS OF STANDARD CHARACTERS WITHOUT CLAIM TO ANY PARTICULAR FONT, STYLE, SIZE, OR COLOR. FOR DAILY NEWSPAPER (U.S. CLS. 2, 5, 22, 23, 29, 37, 38 AND 50). FIRST USE 12-31-1909; IN COMMERCE 12-31-1909. KELLY CHOE, EXAMINING ATTORNEY

SN 78-391,339. KING, LLEWELLYN, DBA KING PUBLISHING GROUP, WASHINGTON, DC. FILED 3-26-2004.

SN 78-394,861. SCHWASS, MICHAEL, DES PLAINES, IL. FILED 4-1-2004.



Don't Blame the Game

NO CLAIM IS MADE TO THE EXCLUSIVE RIGHT TO USE "DEFENSE", APART FROM THE MARK AS SHOWN. FOR DAILY NEWSLETTER COVERING BUSINESS RELATIONS BETWEEN MILITARY POLICYMAKERS AND THE DEFENSE INDUSTRY, INCLUDING CONTRACTS, RESEARCH AND OTHER ISSUES, PROVIDING CLEAR AND COMPREHENSIVE NEWS ON AVIATION, NAVAL AND LAND SYSTEMS (U.S. CLS. 2, 5, 22, 23, 29, 37, 38 AND 50). FIRST USE 2-26-2004; IN COMMERCE 2-26-2004. FRED MANDIR, EXAMINING ATTORNEY

THE MARK CONSISTS OF STANDARD CHARACTERS WITHOUT CLAIM TO ANY PARTICULAR FONT, STYLE, SIZE, OR COLOR. FOR SERIES OF BOOKS IN THE FIELD OF MOTIVATION (U.S. CLS. 2, 5, 22, 23, 29, 37, 38 AND 50). ANDREA SAUNDERS, EXAMINING ATTORNEY

CLASS 16—(Continued).

SN 78-395,678. BERGER, BRADLEY IAN, RANCHO SANTA FE, CA. FILED 4-2-2004.

CLASS 16—(Continued).

SN 78-396,398. DC COMICS, NEW YORK, NY. FILED 4-5-2004.

AIM HIGH! 101 TIPS

THE MARK CONSISTS OF STANDARD CHARACTERS WITHOUT CLAIM TO ANY PARTICULAR FONT, STYLE, SIZE, OR COLOR.

NO CLAIM IS MADE TO THE EXCLUSIVE RIGHT TO USE 101 TIPS, APART FROM THE MARK AS SHOWN.

FOR PRINTED MATERIALS, NAMELY BOOKS, PAMPHLETS AND BROCHURES IN THE FIELD OF PERSONAL MOTIVATION (U.S. CLS. 2, 5, 22, 23, 29, 37, 38 AND 50).

JOHN WILKE, EXAMINING ATTORNEY

KRYPTO THE SUPERDOG

SN 78-396,209. NEW ORLEANS ZEPHYRS BASEBALL CLUB, LLC, METAIRIE, LA. FILED 4-5-2004.



OWNER OF U.S. REG. NOS. 1,319,964 AND 1,320,905.

THE MARK CONSISTS OF A RODENT WEARING A BASEBALL CAP WEARING THE LETTER "Z" BITING THE WORD "ZEPHYRS".

FOR PAPER GOODS AND PRINTED MATTER, NAMELY AUTOGRAPH BOOKS, BINDERS, BOOKMARKS, BUMPER STICKERS, CALENDARS, CATALOGS OF INTEREST TO BASEBALL FANS, DECALS, MERCHANDISE BAGS, NEWSLETTERS OF INTEREST TO BASEBALL FANS, NOTE PADS, PAPER CONTAINERS, PAPER PENNANTS, PAPER SCHEDULES, POSTCARDS, POSTERS, PRINTED AWARDS, PRINTED GAME TICKETS, PRINTED GUIDES OF INTEREST TO BASEBALL FANS, REFERENCE BOOKS OF INTEREST TO BASEBALL FANS, SCORE BOOKS, SCORE CARDS, SCORE SHEETS, SOUVENIR PENCILS, SOUVENIR PENS, STATIONERY, STICKERS, STICKER ALBUMS AND TRADING CARDS (U.S. CLS. 2, 5, 22, 23, 29, 37, 38 AND 50).

FIRST USE 1-0-2004; IN COMMERCE 2-10-2004.

G. MAYERSCHOFF, EXAMINING ATTORNEY

THE MARK CONSISTS OF STANDARD CHARACTERS WITHOUT CLAIM TO ANY PARTICULAR FONT, STYLE, SIZE, OR COLOR.

FOR PRINTED MATTER AND PAPER GOODS—NAMELY, A SERIES OF FICTION AND NON-FICTION BOOKS FEATURING CHARACTERS FROM ANIMATED, ACTION ADVENTURE, COMEDY AND/OR DRAMA FEATURES, COMIC BOOKS, CHILDREN'S BOOKS, MAGAZINES FEATURING CHARACTERS FROM ANIMATED, ACTION ADVENTURE, COMEDY AND/OR DRAMA FEATURES, COLORING BOOKS, CHILDREN'S ACTIVITY BOOKS; STATIONERY, WRITING PAPER, ENVELOPES, NOTEBOOKS, DIARIES, NOTE CARDS, GREETING CARDS, TRADING CARDS; LITHOGRAPHS; PENS, PENCILS, CASES THEREFOR, ERASERS, CRAYONS, MARKERS, COLORED PENCILS, PAINTING SETS, CHALK AND CHALKBOARDS; DECALS, HEAT TRANSFERS; POSTERS; MOUNTED AND/OR UNMOUNTED PHOTOGRAPHS; BOOK COVERS, BOOK MARKS, CALENDARS, GIFT WRAPPING PAPER; PAPER PARTY FAVORS AND PAPER PARTY DECORATIONS—NAMELY, PAPER NAPKINS, PAPER DOILIES, PAPER PLACE MATS, CREPE PAPER, PAPER HATS, INVITATIONS, PAPER TABLE CLOTHS, PAPER CAKE DECORATIONS; PRINTED TRANSFERS FOR EMBROIDERY OR FABRIC APPLIQUES; PRINTED PATTERNS FOR COSTUMES, PAJAMAS, SWEATSHIRTS AND T-SHIRTS (U.S. CLS. 2, 5, 22, 23, 29, 37, 38 AND 50).

CHERYL STEPLIGHT, EXAMINING ATTORNEY

CLASS 16—(Continued).

SN 78-397,220. ROUND ROCK BASEBALL, INC, ROUND ROCK, TX. FILED 4-6-2004.



NO CLAIM IS MADE TO THE EXCLUSIVE RIGHT TO USE "CORPUS CHRISTI", APART FROM THE MARK AS SHOWN.

THE MARK CONSISTS OF "CORPUS CHRISTI HOOKS" STYLIZED WITH TWO HOOKS.

FOR PAPER GOODS AND PRINTED MATTER, NAMELY AUTOGRAPH BOOKS, BINDERS, BOOK-MARKS, BUMPER STICKERS, CALENDARS, CATALOGS OF INTEREST TO BASEBALL FANS, DECALS, MERCHANDISE BAGS, NEWSLETTERS OF INTEREST TO BASEBALL FANS, NOTE PADS, PAPER CONTAINERS, PAPER PENNANTS, PENS, PENCILS, POSTCARDS, POSTERS, PRINTED AWARDS, PRINTED BASEBALL GAME SCHEDULES PRINTED GAME TICKETS, PRINTED GUIDES OF INTEREST TO BASEBALL FANS, REFERENCE BOOKS OF INTEREST TO BASEBALL FANS, SCORE BOOKS, SCORE CARDS, SCORE SHEETS, STATIONERY, STICKERS, STICKER ALBUMS AND TRADING CARDS (U.S. CLS. 2, 5, 22, 23, 29, 37, 38 AND 50).

FIRST USE 2-0-2004; IN COMMERCE 3-11-2004.
LANA PHAM, EXAMINING ATTORNEY

CLASS 16—(Continued).

SN 78-399,628. CELINE COUNTRYMAN, LLC, MINNEAPOLIS, MN. FILED 4-9-2004.

CELINE COUNTRYMAN IMAGE ARCHIVES

THE MARK CONSISTS OF STANDARD CHARACTERS WITHOUT CLAIM TO ANY PARTICULAR FONT, STYLE, SIZE, OR COLOR.

NO CLAIM IS MADE TO THE EXCLUSIVE RIGHT TO USE IMAGE ARCHIVES, APART FROM THE MARK AS SHOWN.

FOR PHOTO ALBUMS FOR STORING TRADITIONAL AND DIGITAL PHOTOS; STATIONERY; SCRAPBOOKS; SKETCH BOOKS; BLANK JOURNALS; ARCHIVAL STORAGE PAGES, STORAGE BOXES MADE OF CARDBOARD, PHOTO MOUNTING MATERIALS, NAMELY, CORNER MOUNTS, AND SELF ADHESIVE PHOTO POUCHES; HOME PHOTOGRAPHY STORAGE TOOLS, NAMELY, CATALOGING PHOTO BOX AND ARCHIVAL ENVELOPES TO STORE NEGATIVES, PRINTS, AND CD'S; PRINTED EDUCATIONAL MATERIALS IN THE FIELD OF SCRAPBOOKING, PHOTOGRAPHY AND PRESERVING MEMORIES (U.S. CLS. 2, 5, 22, 23, 29, 37, 38 AND 50).

FIRST USE 9-30-2002; IN COMMERCE 9-30-2002.
JOHN DALIER, EXAMINING ATTORNEY

SN 78-400,093. FLIPP SPORTS, INC., CANTON, MA. FILED 4-12-2004.

FLIPSPORTS

BULLETIN FRAME

THE MARK CONSISTS OF STANDARD CHARACTERS WITHOUT CLAIM TO ANY PARTICULAR FONT, STYLE, SIZE, OR COLOR.

FOR DRY ERASE BOARDS AND DRY ERASE MARKERS (U.S. CLS. 2, 5, 22, 23, 29, 37, 38 AND 50).

ERNEST SHOSHO, EXAMINING ATTORNEY

THE MARK CONSISTS OF STANDARD CHARACTERS WITHOUT CLAIM TO ANY PARTICULAR FONT, STYLE, SIZE, OR COLOR.

FOR SERIES OF PRINTED FLIPBOOKS THAT CONTAIN MULTIPLE PICTURES OF SPORTS FIGURES AND INFORMATION ABOUT SPORTS FIGURES; SERIES OF PRINTED FLIPBOOKS THAT CONTAIN MULTIPLE PICTURES OF SPORTS FIGURES AND INFORMATION ABOUT SPORTS FIGURES, AND AN ENCODED ELECTRONIC CHIP THAT PLAYS SOUND (U.S. CLS. 2, 5, 22, 23, 29, 37, 38 AND 50).

TARAH HARDY, EXAMINING ATTORNEY

CLASS 16—(Continued).

SN 78-401,195. MY GRANDMA AND ME PUBLISHERS LLC, ST. JOHNS, MI. FILED 4-13-2004.

Grandma Janet Mary

THE MARK CONSISTS OF STANDARD CHARACTERS WITHOUT CLAIM TO ANY PARTICULAR FONT, STYLE, SIZE, OR COLOR.

THE NAME(S), PORTRAIT(S), AND/OR SIGNATURE(S) SHOWN IN THE MARK IDENTIFIES JANET MARY SINKE, WHOSE CONSENT(S) TO REGISTER IS SUBMITTED.

FOR BOOKS AND A SERIES OF BOOKS FEATURING CHILDREN'S STORIES (U.S. CLS. 2, 5, 22, 23, 29, 37, 38 AND 50).

FIRST USE 2-9-2004; IN COMMERCE 2-18-2004.
CHRISTOPHER ADKINS, EXAMINING ATTORNEY

CLASS 16—(Continued).

SN 78-401,543. MOM INVENTORS, INC., WALNUT CREEK, CA. FILED 4-14-2004.



NO CLAIM IS MADE TO THE EXCLUSIVE RIGHT TO USE SHOE, APART FROM THE MARK AS SHOWN.

THE MARK CONSISTS OF STYLIZED PHRASE SHOE CLUES ADJACENT TO A CIRCLE CONTAINING THE WORDS MOM INVENTED AND ADJACENT TO A PAIR OF SHOES.

FOR NONMETALLIC ADHESIVE LABELS THAT ATTACH TO SHOES (U.S. CLS. 2, 5, 22, 23, 29, 37, 38 AND 50).

ASMAT KHAN, EXAMINING ATTORNEY

SN 78-401,208. CHECKS IN THE MAIL, INC., NEW BRAUNFELS, TX. FILED 4-13-2004.

PICTURE THIS!

THE MARK CONSISTS OF STANDARD CHARACTERS WITHOUT CLAIM TO ANY PARTICULAR FONT, STYLE, SIZE, OR COLOR.

FOR BANK CHECKS AND CHECKBOOK COVERS (U.S. CLS. 2, 5, 22, 23, 29, 37, 38 AND 50).

FIRST USE 8-0-2004; IN COMMERCE 8-0-2004.
CHERYL STEPLIGHT, EXAMINING ATTORNEY

SN 78-403,816. T.F.H. PUBLICATIONS, INC., NEPTUNE CITY, NJ. FILED 4-19-2004.

THE SIMPLE GUIDE TO

THE MARK CONSISTS OF STANDARD CHARACTERS WITHOUT CLAIM TO ANY PARTICULAR FONT, STYLE, SIZE, OR COLOR.

NO CLAIM IS MADE TO THE EXCLUSIVE RIGHT TO USE GUIDE, APART FROM THE MARK AS SHOWN.

FOR PRINTED PUBLICATIONS, NAMELY, BOOKS ON THE SUBJECT OF PETS AND PET CARE (U.S. CLS. 2, 5, 22, 23, 29, 37, 38 AND 50).

FIRST USE 3-22-2001; IN COMMERCE 3-22-2001.
SOPHIA S. KIM, EXAMINING ATTORNEY

CLASS 16—(Continued).

SN 78-404,383. WORLD WRESTLING ENTERTAINMENT, INC., STAMFORD, CT. FILED 4-19-2004.

CLASS 16—(Continued).

SN 78-404,731. WORLD WRESTLING ENTERTAINMENT, INC., STAMFORD, CT. FILED 4-20-2004.

DAWN MARIE**MR. THURSDAY NIGHT**

THE MARK CONSISTS OF STANDARD CHARACTERS WITHOUT CLAIM TO ANY PARTICULAR FONT, STYLE, SIZE, OR COLOR.

THE NAME(S), PORTRAIT(S), AND/OR SIGNATURE(S) SHOWN IN THE MARK IDENTIFIES DAWN MARIE PSALTIS, WHOSE CONSENT(S) TO REGISTER IS SUBMITTED.

FOR PAPER HANGTAGS; PACKAGING, NAMELY BLISTER CARDS, PAPER FOR WRAPPING AND PACKAGING, PAPER POUCHES FOR PACKAGING, PLASTIC BAGS FOR PACKAGING, PLASTIC BUBBLE PACKS FOR WRAPPING OR PACKAGING; LABELS, NAMELY, PRINTED PAPER LABELS, PRINTED SHIPPING LABELS; FOLDERS; PLASTIC BAGS FOR GENERAL USE; PAPER TABLEWARE, NAMELY, PAPER PLACE MATS, PAPER TABLE MATS, PAPER TABLE LINENS; FRAMED PICTURES; PENS; PENCILS; NOTEBOOKS; CALENDARS; PAPER TABLECLOTHS; PHOTOGRAPHS; CHALK; BROCHURES, MAGAZINES, AND NEWSPAPERS CONCERNING SPORTS ENTERTAINMENT; PHOTOGRAPHIC PRINTS; POSTCARDS; GREETING CARDS; DECALS; TEMPORARY TATTOO TRANSFERS; COLORING BOOKS; CHILDREN'S ACTIVITY BOOKS; SOUVENIR PROGRAMS CONCERNING SPORTS ENTERTAINMENT; BOOKS FEATURING PICTORIAL BIOGRAPHIES; BOOK COVERS; PAPER BOOK MARKERS; BOOKPLATES; PAPER LUNCH BAGS; PAPER NAPKINS; STICKER ALBUMS; MEMO PADS; DATE BOOKS; ADDRESS BOOKS; AGENDA BOOKS; PENCIL SHARPENERS; RUBBER STAMPS; STAMP PADS; COLLECTIBLE PREPAID TELEPHONE CARDS NOT MAGNETICALLY ENCODED; COLLECTOR STAMPS, NAMELY, COMMEMORATIVE STAMP SHEETS; CUSTOMIZED PERSONAL CHECKS; CHECKBOOK COVERS AND RETURN ADDRESS LABELS NOT OF TEXTILE; PAPER BANNERS; PRINTED PAPER SIGNS FOR DOORS; PENCIL CASES; DRAWING RULERS; ERASERS, NAMELY, RUBBER ERASERS, CHALK ERASERS, BLACKBOARD ERASERS; SCRIBBLE PAD; PHOTO ALBUMS; BUMPER STICKERS; WINDOW DECALS; COLLECTOR STAMPS; LITHOGRAPHS; PAPER PARTY BAGS; PAPER PARTY FAVORS, NAMELY, PAPER HATS; STENCILS FOR TRACING DESIGNS ONTO PAPER; PAPER GIFT WRAP; PAPER CAKE DECORATIONS (U.S. CLS. 2, 5, 22, 23, 29, 37, 38 AND 50).

ANDREW RHIM, EXAMINING ATTORNEY

THE MARK CONSISTS OF STANDARD CHARACTERS WITHOUT CLAIM TO ANY PARTICULAR FONT, STYLE, SIZE, OR COLOR.

FOR PAPER HANGTAGS; PACKAGING, NAMELY BLISTER CARDS, PAPER FOR WRAPPING AND PACKAGING, PAPER POUCHES FOR PACKAGING, PLASTIC BAGS FOR PACKAGING, PLASTIC BUBBLE PACKS FOR WRAPPING OR PACKAGING; COLLECTOR ALBUMS, NAMELY, FOR STICKER COLLECTIBLE CARDS, PHOTO COLLECTIBLES; LABELS, NAMELY, PRINTED PAPER LABELS, PRINTED SHIPPING LABELS; FOLDERS; PLASTIC BAGS FOR GENERAL USE; PAPER TABLEWARE, NAMELY, PAPER PLACE MATS, PAPER TABLE MATS, PAPER TABLE LINENS; STICKERS; FRAMED PICTURES; PENS; PENCILS; POSTERS; NOTEBOOKS; TRADING CARDS; CALENDARS; PAPER TABLECLOTHS; PHOTOGRAPHS; CHALK; BROCHURES, MAGAZINES, AND NEWSPAPERS CONCERNING SPORTS ENTERTAINMENT; PHOTOGRAPHIC PRINTS; POSTCARDS; GREETING CARDS; PICTURES; DECALS; TEMPORARY TATTOO TRANSFERS; COLORING BOOKS; CHILDREN'S ACTIVITY BOOKS; SOUVENIR PROGRAMS CONCERNING SPORTS ENTERTAINMENT; BOOKS FEATURING PICTORIAL BIOGRAPHIES; COMIC BOOKS; BOOK COVERS; PAPER BOOK MARKERS; BOOKPLATES; PAPER LUNCH BAGS; PAPER NAPKINS; PICTURE BOOKS; STICKER ALBUMS; MEMO PADS; DATE BOOKS; ADDRESS BOOKS; AGENDA BOOKS; PENCIL SHARPENERS; RUBBER STAMPS; STAMP PADS; COLLECTIBLE PREPAID TELEPHONE CARDS NOT MAGNETICALLY ENCODED; COLLECTOR STAMPS, NAMELY, COMMEMORATIVE STAMP SHEETS; CUSTOMIZED PERSONAL CHECKS; CHECKBOOK COVERS AND RETURN ADDRESS LABELS NOT OF TEXTILE; PAPER BANNERS; PRINTED PAPER SIGNS FOR DOORS; PENCIL CASES; DRAWING RULERS; ERASERS, NAMELY, RUBBER ERASERS, CHALK ERASERS, BLACKBOARD ERASERS; SCRIBBLE PAD; PHOTO ALBUMS; BUMPER STICKERS; WINDOW DECALS; COLLECTOR STAMPS; LITHOGRAPHS; PAPER PARTY BAGS; PAPER PARTY FAVORS, NAMELY, PAPER HATS; STENCILS FOR TRACING DESIGNS ONTO PAPER; PAPER GIFT WRAP; PAPER CAKE DECORATIONS (U.S. CLS. 2, 5, 22, 23, 29, 37, 38 AND 50).

JAMES GRIFFIN, EXAMINING ATTORNEY

CLASS 16—(Continued).

SN 78-405,525. CTA, INC., FENTON, MO. FILED 4-21-2004.

CLASS 16—(Continued).

SN 78-409,336. FLYING COLORS TOYS, INC., MALIBU, CA. FILED 4-28-2004.

STRONG IN THE LORD

THE MARK CONSISTS OF STANDARD CHARACTERS WITHOUT CLAIM TO ANY PARTICULAR FONT, STYLE, SIZE, OR COLOR.

FOR PRINTED MATERIALS, NAMELY, NOTE CARDS, GREETING CARDS, SCRIPTURE CARDS, INSPIRATIONAL CARDS, PRAYER CARDS, GIFT CARDS, PICTURES, INSPIRATIONAL GIFT BOOKS, RELIGIOUS DEVOTIONALS, BOOK MARKS, NOTE PADS, AND STATIONERY (U.S. CLS. 2, 5, 22, 23, 29, 37, 38 AND 50).

FIRST USE 12-29-2003; IN COMMERCE 12-29-2003.
MICHAEL KEATING, EXAMINING ATTORNEY

SN 78-406,669. UNIVERSITY OF GEORGIA ATHLETIC ASSOCIATION, INC., ATHENS, GA. FILED 4-22-2004.

VANITY KEEPSAKE**HOW 'BOUT THEM
DOGS**

THE MARK CONSISTS OF STANDARD CHARACTERS WITHOUT CLAIM TO ANY PARTICULAR FONT, STYLE, SIZE, OR COLOR.

OWNER OF U.S. REG. NO. 1,249,346.

FOR DECALS, NOTEPAPER, NOTEBOOKS, PAPER FOLDERS; PRINTED BOOKLETS, CATALOGS, NEWSLETTERS, AND BROCHURES ALL FEATURING COLLEGE FOOTBALL (U.S. CLS. 2, 5, 22, 23, 29, 37, 38 AND 50).

FIRST USE 9-30-1978; IN COMMERCE 9-30-1978.
ERNEST SHOSHO, EXAMINING ATTORNEY

SN 78-408,140. PENCILPAPER, NEW YORK, NY. FILED 4-26-2004.

PENC▼LPAPER

THE MARK CONSISTS OF A STYLIZED LETTER I. FOR REWRITABLE PRODUCTS, NAMELY, NOTE PAD WITH INTEGRATED PENCIL CLIP (U.S. CLS. 2, 5, 22, 23, 29, 37, 38 AND 50).

FIRST USE 1-1-2004; IN COMMERCE 4-1-2004.
SCOTT OSLICK, EXAMINING ATTORNEY

THE MARK CONSISTS OF STANDARD CHARACTERS WITHOUT CLAIM TO ANY PARTICULAR FONT, STYLE, SIZE, OR COLOR.

FOR SCRAPBOOKS; SCRAPBOOK KITS CONSISTING PRIMARILY OF A SCRAPBOOK ALBUM, SCRAPBOOK PAPERS AND PHOTOGRAPHIC MOUNTS FOR PRESERVING DOCUMENTS AND PHOTOGRAPHS; WRITING INSTRUMENTS NAMELY PENS, PENCILS, MARKERS AND CRAYONS; PAPER PRODUCTS NAMELY NOTEBOOK PAPER, NOTE PADS, DIE CUT NOTE PADS, COLORED CRAFT PAPER, CONSTRUCTION PAPER; STICKERS; STENCILS; ENVELOPES; PHOTO MOUNTING CORNERS; RUBBER STAMPS (U.S. CLS. 2, 5, 22, 23, 29, 37, 38 AND 50).

H. M. FISHER, EXAMINING ATTORNEY

CLASS 16—(Continued).

SN 78-412,363. DEUTSCHE TELEKOM AG, BONN, FED REP GERMANY, FILED 5-3-2004.

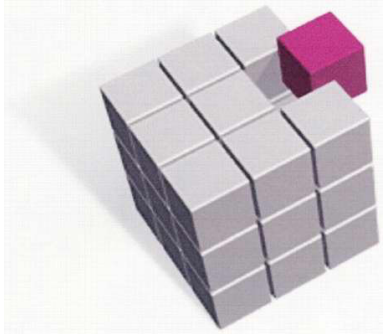

OWNER OF FED REP GERMANY REG. NO. 30356147, DATED 11-30-2003, EXPIRES 11-30-2013.

THE COLOR(S) MAGENTA AND GRAY IS/ARE CLAIMED AS A FEATURE OF THE MARK.

THE COLOR GRAY APPEARS IN THE THREE DIMENSIONAL DRAWING OF A CUBE COMPOSED OF A SERIES OF SMALLER CUBES, AND THE COLOR MAGENTA APPEARS IN THE SMALLER CUBE PULLED OUT OF PLACE IN THE TOP RIGHT ROW.

THE MARK CONSISTS OF A THREE DIMENSIONAL CUBE COMPOSED OF A SERIES OF SMALLER CUBES WITH ONE OF THE SMALLER CUBES PARTIALLY SEPARATED FROM THE TOP RIGHT ROW.

FOR PRINTED MATTER, NAMELY, TELEPHONE DIRECTORIES, SERIES OF BOOKS, NEWSLETTERS, PAMPHLETS, BROCHURES, MAGAZINES AND PAPERBACKS, ALL IN THE FIELD OF TELECOMMUNICATIONS; PRINTED AND STAMPED PLASTIC AND CARDBOARD GREETING, BLANK, NOTE, AND INDEX CARDS; NOTE PAPER AND ENVELOPES; NAMETAGS AND LABELS MADE FROM PAPER OR CARDBOARD; NOTEBOOKS; NOTE PADS; STATIONERY; PAPER, NAMELY, BOND PAPER AND ART PAPER; GIFT-WRAP PAPER; DIARIES; ADDRESS BOOKS; STUDENT CALENDARS; STAMP ALBUMS AND PHOTO-ALBUMS; FOLDERS FOR LETTERS AND LOOSE PAPERS; CLEAR HOLE REINFORCEMENTS FOR PAPER; RUBBER STAMPS AND IMPRESSION STAMPS; PAPER WEIGHTS; LETTER OPENERS; DRAWING AND UNGRADUATED RULERS; ERASERS; STAPLERS; PAPER CLIPS; BLOTTING PADS; DESK FILE TRAYS; DESK STANDS AND HOLDERS FOR HOLDING STATIONERY AND OFFICE IMPLEMENTS; PRINTED INSTRUCTIONAL AND TEACHING MATERIALS, ALL IN THE FIELDS OF TELECOMMUNICATIONS, INFORMATION TECHNOLOGY, SAFETY, NEWS, SPORTS, ENTERTAINMENT, CULTURE, BUSINESS AND FINANCE, WEATHER AND TRAVEL; BOOKMARKERS; STENCILS; SCRATCH PICTURES; PVC STICKERS; BLACKBOARDS; CHALK STICKS; ADHESIVES FOR STATIONERY OR HOUSEHOLD PURPOSES; DRAWING AND PAINTING MATERIALS, NAMELY, PENCILS, DRAWING PENCILS, PENS, DRAWING PENS. (U.S. CLS. 2, 5, 22, 23, 29, 37, 38 AND 50).

MICHAEL HALL, EXAMINING ATTORNEY

CLASS 16—(Continued).

SN 78-414,042. DC COMICS, NEW YORK, NY. FILED 5-6-2004.



FOR PRINTED MATTER AND PAPER GOODS NAMELY, A SERIES OF FICTION AND NON-FICTION BOOKS FEATURING CHARACTERS FROM ANIMATED, ACTION ADVENTURE, COMEDY AND/OR DRAMA FEATURES, COMIC BOOKS, CHILDREN'S BOOKS, MAGAZINES FEATURING CHARACTERS FROM ANIMATED, ACTION ADVENTURE, COMEDY AND/OR DRAMA FEATURES, COLORING BOOKS, CHILDREN'S ACTIVITY BOOKS; STATIONERY, WRITING PAPER, ENVELOPES, NOTEBOOKS, DIARIES, NOTE CARDS, GREETING CARDS, TRADING CARDS; LITHOGRAPHS; PENS, PENCILS, CASES THEREFOR, ERASERS, CRAYONS, MARKERS, COLORED PENCILS, PAINTING SETS, CHALK AND CHALKBOARDS; DECALS, HEAT TRANSFERS; POSTERS; MOUNTED AND/OR UNMOUNTED PHOTOGRAPHS; BOOK COVERS, BOOK MARKS, CALENDARS, GIFT WRAPPING PAPER; PAPER PARTY FAVORS AND PAPER PARTY DECORATIONS—NAMELY, PAPER NAPKINS, PAPER DOILIES, PAPER PLACE MATS, CREPE PAPER, PAPER HATS, INVITATIONS, PAPER TABLE CLOTHS, PAPER CAKE DECORATIONS; PRINTED TRANSFERS FOR EMBROIDERY OR FABRIC APPLIQUES; PRINTED PATTERNS FOR COSTUMES, PAJAMAS, SWEATSHIRTS AND T-SHIRTS (U.S. CLS. 2, 5, 22, 23, 29, 37, 38 AND 50).

CHERYL STEPLIGHT, EXAMINING ATTORNEY

SN 78-414,298. JOOMA, ASEYA M., SANTA MONICA, CA. FILED 5-6-2004.

Simply Invitations

THE MARK CONSISTS OF STANDARD CHARACTERS WITHOUT CLAIM TO ANY PARTICULAR FONT, STYLE, SIZE, OR COLOR.

NO CLAIM IS MADE TO THE EXCLUSIVE RIGHT TO USE "INVITATIONS", APART FROM THE MARK AS SHOWN.

FOR PRINTED INVITATIONS, STATIONERY, ANNOUNCEMENTS (U.S. CLS. 2, 5, 22, 23, 29, 37, 38 AND 50).

FIRST USE 7-1-2002; IN COMMERCE 9-1-2002.
RON FAIRBANKS, EXAMINING ATTORNEY

CLASS 16—(Continued).

SN 78-415,563. WALLRAFF, BARBARA, BROOKLINE, MA.
FILED 5-9-2004.

CLASS 16—(Continued).

SN 78-418,375. RMC OF ILLINOIS, INC., PHILADELPHIA,
PA. FILED 5-13-2004.

Word Court

THE MARK CONSISTS OF STANDARD CHARACTERS WITHOUT CLAIM TO ANY PARTICULAR FONT, STYLE, SIZE, OR COLOR.

NO CLAIM IS MADE TO THE EXCLUSIVE RIGHT TO USE "WORD", APART FROM THE MARK AS SHOWN.

FOR MAGAZINE AND NEWSPAPER COLUMNS IN THE FIELD OF GRAMMAR, LANGUAGE AND COPY-EDITING (U.S. CLS. 2, 5, 22, 23, 29, 37, 38 AND 50).

FIRST USE 1-1-1995; IN COMMERCE 1-1-1995.
PRISCILLA MILTON, EXAMINING ATTORNEY

THE RIGHT TIMES

THE MARK CONSISTS OF STANDARD CHARACTERS WITHOUT CLAIM TO ANY PARTICULAR FONT, STYLE, SIZE, OR COLOR.

FOR LIMITED CIRCULATION NEWSLETTER IN THE FIELD OF CAREER TRANSITION DIRECTED EXCLUSIVELY TO THE ALUMNI OF THE APPLICANT'S PROGRAMS FOR ASSISTING EMPLOYEES AND FORMER EMPLOYEES IN IDENTIFYING AND PURSUING NEW CAREERS, EXCLUDING CAREERS IN THE FINANCIAL INDUSTRY (U.S. CLS. 2, 5, 22, 23, 29, 37, 38 AND 50).

CAROL SPILS, EXAMINING ATTORNEY

SN 78-415,793. POSITIVE ATTITUDE, INC., NEW YORK, NY.
FILED 5-10-2004.

SN 78-419,501. INTERNATIONAL PAPER COMPANY,
STAMFORD, CT. FILED 5-16-2004.

POSITIVE ATTITUDE

THE MARK CONSISTS OF STANDARD CHARACTERS WITHOUT CLAIM TO ANY PARTICULAR FONT, STYLE, SIZE, OR COLOR.

OWNER OF U.S. REG. NO. 1,530,965.

FOR ADDRESS BOOKS, TELEPHONE NUMBER BOOKS, APPOINTMENT BOOKS, AGENDAS, CALENDARS, CHECKBOOK HOLDERS, CHECKBOOK AND PASSBOOK WALLETS, DAILY PLANNERS, PERSONAL PLANNERS, DESK TOP ORGANIZERS, DESK TOP PLANNERS, PERSONAL ORGANIZERS, DIARIES, PENS, PENCILS, PEN OR PENCIL HOLDERS, PENCIL OR PEN CASES, INDEX CARDS, POST CARDS, WRITING PADS, NOTE BOOKS, NOTE PADS, NOTE CARDS, NOTE PAPER, ORGANIZERS FOR STATIONERY USE, BLANK DAILY JOURNALS, NEWSPAPERS, NEWSLETTERS IN THE FIELD OF CLOTHES, NEWSLETTERS IN THE FIELD OF SPORTS, STATIONERY, STATIONARY FOLDERS, DOCUMENT PORTFOLIOS, STATIONERY-TYPE PORTFOLIOS, STATIONERY WRITING PAPER AND ENVELOPES, PAPERWEIGHTS (U.S. CLS. 2, 5, 22, 23, 29, 37, 38 AND 50).

SHAUNIA WALLACE, EXAMINING ATTORNEY

SheetGuard

THE MARK CONSISTS OF STANDARD CHARACTERS WITHOUT CLAIM TO ANY PARTICULAR FONT, STYLE, SIZE, OR COLOR.

FOR PAPER BASED EDGE PROTECTOR OR CORNER BOARDS FOR PROTECTING THE EDGES OF PACKAGES (U.S. CLS. 2, 5, 22, 23, 29, 37, 38 AND 50).

NAKWAMA ANKRAH, EXAMINING ATTORNEY

CLASS 16—(Continued).

SN 78-420,596. WORLD PUBLICATIONS LLC, WINTER PARK, FL. FILED 5-18-2004.

CLASS 16—(Continued).

SN 78-423,568. DAMON INDUSTRIES, INC., CHICAGO, IL. FILED 5-24-2004.

**SPORT FISHING THE
MAGAZINE OF
SALTWATER
FISHING**

JAZZ-IZMS

THE MARK CONSISTS OF STANDARD CHARACTERS WITHOUT CLAIM TO ANY PARTICULAR FONT, STYLE, SIZE, OR COLOR.

OWNER OF U.S. REG. NOS. 1,854,625 AND 2,350,988.

NO CLAIM IS MADE TO THE EXCLUSIVE RIGHT TO USE "MAGAZINE", APART FROM THE MARK AS SHOWN. SEC. 2(F).

FOR PUBLICATION, NAMELY MAGAZINES IN THE FIELDS OF OFFSHORE AND NEARSHORE FISHING, INSTRUCTIONAL TECHNIQUE, BOATING, SAFETY AND CONSERVATION (U.S. CLS. 2, 5, 22, 23, 29, 37, 38 AND 50).

FIRST USE 11-1-1994; IN COMMERCE 11-1-1994.
JOHN DWYER, EXAMINING ATTORNEY

THE MARK CONSISTS OF STANDARD CHARACTERS WITHOUT CLAIM TO ANY PARTICULAR FONT, STYLE, SIZE, OR COLOR.

FOR DICTIONARY OF JAZZ WORDS, PHRASES AND TERMS (U.S. CLS. 2, 5, 22, 23, 29, 37, 38 AND 50).

FIRST USE 5-1-1961; IN COMMERCE 5-1-1961.
LINDA POWELL, EXAMINING ATTORNEY

SN 78-422,855. HOFFMAN MEDIA, LLC, BIRMINGHAM, AL. FILED 5-21-2004.

SN 78-424,785. LEE PROCUREMENT SOLUTIONS CO., DAVENPORT, IA. FILED 5-25-2004.

**SOUTHERN LADY'S
SOUTHERN COOKIN'**

INDEPENDENT RECORD

THE MARK CONSISTS OF STANDARD CHARACTERS WITHOUT CLAIM TO ANY PARTICULAR FONT, STYLE, SIZE, OR COLOR.

OWNER OF U.S. REG. NO. 2,588,905.

NO CLAIM IS MADE TO THE EXCLUSIVE RIGHT TO USE SOUTHERN OR SOUTHERN COOKING, APART FROM THE MARK AS SHOWN.

FOR MAGAZINE IN THE FIELD OF FOOD PREPARATION (U.S. CLS. 2, 5, 22, 23, 29, 37, 38 AND 50).

FRED MANDIR, EXAMINING ATTORNEY

THE MARK CONSISTS OF STANDARD CHARACTERS WITHOUT CLAIM TO ANY PARTICULAR FONT, STYLE, SIZE, OR COLOR.

NO CLAIM IS MADE TO THE EXCLUSIVE RIGHT TO USE "RECORD", APART FROM THE MARK AS SHOWN. FOR DAILY NEWSPAPER (U.S. CLS. 2, 5, 22, 23, 29, 37, 38 AND 50).

FIRST USE 11-22-1943; IN COMMERCE 11-22-1943.
JASON LOTT, EXAMINING ATTORNEY

CLASS 16—(Continued).

SN 78-428,350. MEADWESTVACO CORPORATION, STAMFORD, CT. FILED 6-2-2004.

WINDOW GRIP-SEAL

THE MARK CONSISTS OF STANDARD CHARACTERS WITHOUT CLAIM TO ANY PARTICULAR FONT, STYLE, SIZE, OR COLOR.

OWNER OF U.S. REG. NOS. 616,567, 1,567,128 AND OTHERS.

NO CLAIM IS MADE TO THE EXCLUSIVE RIGHT TO USE "WINDOW", APART FROM THE MARK AS SHOWN.

FOR ENVELOPES (U.S. CLS. 2, 5, 22, 23, 29, 37, 38 AND 50).

DAVID H. STINE, EXAMINING ATTORNEY

SN 78-430,645. DBC ALLIANCE, LLC., NORTHRIDGE, CA. FILED 6-6-2004.



NO CLAIM IS MADE TO THE EXCLUSIVE RIGHT TO USE "DEPORTES" AND "SPORTS", APART FROM THE MARK AS SHOWN.

THE COLOR(S) ORANGE, GREY, BLACK IS/ARE CLAIMED AS A FEATURE OF THE MARK.

THE MARK CONSISTS OF THE WORDS "DEPORTES REPLAY", COLORED IN ORANGE, WITH THE WORDS "SPORTS REPLAY", COLORED IN GREY, SLIGHTLY BELOW. THERE IS A BLACK ARROW POINTING TO THE LEFT ABOVE THE WORDS DEPORTES REPLAY AND A BLACK ARROW POINTING TO THE RIGHT BELOW THE WORDS SPORTS REPLAY.

THE FOREIGN WORDING IN THE MARK TRANSLATES INTO ENGLISH AS SPORTS.

FOR NEWSPAPERS IN THE FIELD OF SPORTS (U.S. CLS. 2, 5, 22, 23, 29, 37, 38 AND 50).

FIRST USE 11-1-2003; IN COMMERCE 1-13-2004.

APRIL L. RADEMACHER, EXAMINING ATTORNEY

SN 78-430,969. THE BABY EINSTEIN COMPANY, LLC, BURBANK, CA. FILED 6-7-2004.

**GREAT MINDS START
LITTLE**

THE MARK CONSISTS OF STANDARD CHARACTERS WITHOUT CLAIM TO ANY PARTICULAR FONT, STYLE, SIZE, OR COLOR.

OWNER OF U.S. REG. NOS. 2,444,197, 2,524,144 AND 2,853,152.

FOR BOOKS FOR CHILDREN; FLASHCARDS (U.S. CLS. 2, 5, 22, 23, 29, 37, 38 AND 50).

FIRST USE 9-30-2003; IN COMMERCE 9-30-2003.

YONG KIM, EXAMINING ATTORNEY

CLASS 16—(Continued).

SN 78-432,865. DAVIS, ROBERT KENT, ANNA MARIA, FL. FILED 6-10-2004.

MAN VS. MACHINE

THE MARK CONSISTS OF STANDARD CHARACTERS WITHOUT CLAIM TO ANY PARTICULAR FONT, STYLE, SIZE, OR COLOR.

FOR POSTERS; PHOTOGRAPHS; COLLECTOR ALBUMS FOR PHOTOGRAPHS; COLORING BOOKS; CHILDREN'S ACTIVITY BOOKS; COMIC BOOKS; PICTURE BOOKS; SOUVENIR PROGRAMS CONCERNING DEMONSTRATIONS AND SHOWS FEATURING FIGHTS BETWEEN HUMAN AND ROBOT PERFORMERS; TRADING CARDS; CALENDARS; LABELS, NAMELY, PRINTED LABELS NOT OF TEXTILE, BUMPER STICKERS, STICKERS, STICKER ALBUMS; FOLDERS, BROCHURES CONCERNING DEMONSTRATIONS AND SHOWS FEATURING FIGHTS BETWEEN HUMAN AND ROBOT PERFORMERS; PAPER TABLEWARE, NAMELY, PLACE MATS, NAPKINS, TABLECLOTHS, PARTY FAVORS AND HATS; GIFT WRAP MADE FROM PAPER, PLASTIC OR METALLIC MATERIAL; MEMO PADS; RUBBER STAMPS; PENS; PENCILS; PENCIL CASES; RULERS; BOOK COVERS; MAGAZINES CONCERNING DEMONSTRATIONS AND SHOWS FEATURING FIGHTS BETWEEN HUMAN AND ROBOT PERFORMERS; POSTCARDS; GREETING CARDS; TEMPORARY TATTOO TRANSFERS; WINDOW DECALS AND LITHOGRAPHS (U.S. CLS. 2, 5, 22, 23, 29, 37, 38 AND 50).

CHRIS WELLS, EXAMINING ATTORNEY

SN 78-433,197. THERMOPATCH CORPORATION, SYRACUSE, NY. FILED 6-10-2004.



OWNER OF U.S. REG. NOS. 746,743 AND 2,879,449.
THE COLOR(S) RED AND BLACK IS/ARE CLAIMED AS A FEATURE OF THE MARK.

THE MARK CONSISTS OF THE COLOR RED WHICH APPEARS IN THE CIRCLE BEHIND THE TERM DECO AND IN THE CIRCLE OVER THE TERM PRINT. THE COLOR BLACK APPEARS IN THE TERM PRINT BY THERMOPATCH AND THE CIRCLE BEHIND THE TERMS.

FOR PAPER AND PRINTED GOODS NAMELY, PRINTED LABELS, IRON-ON AND PLASTIC TRANSFERS, EMBLEMS, PATCHES, RIBBONS AND PAPER AND PLASTIC TAPES FOR MENDING, MARKING AND CODING TEXTILES (U.S. CLS. 2, 5, 22, 23, 29, 37, 38 AND 50).

FIRST USE 5-18-2004; IN COMMERCE 5-18-2004.

CAROLINE WOOD, EXAMINING ATTORNEY

CLASS 16—(Continued).

SN 78-435,973. COLEMAN, DARREN L, FORT LAUDEDALE, FL. FILED 6-16-2004.

CLASS 16—(Continued).

SN 78-437,441. MILLERQUILTS, INC., BREMERTON, WA. FILED 6-18-2004.

Ponderstick



MillerQuilts, Inc.
AnglePlay Templates

THE MARK CONSISTS OF STANDARD CHARACTERS WITHOUT CLAIM TO ANY PARTICULAR FONT, STYLE, SIZE, OR COLOR.

FOR PENCILS, INKPENS, HIGHLIGHTER (U.S. CLS. 2, 5, 22, 23, 29, 37, 38 AND 50).
ZACHARY BELLO, EXAMINING ATTORNEY

NO CLAIM IS MADE TO THE EXCLUSIVE RIGHT TO USE "INC", OR "TEMPLATES", APART FROM THE MARK AS SHOWN.

THE MARK CONSISTS OF A BLACK SPIRAL.
FOR ACRYLIC DRAFTING TRIANGLES (U.S. CLS. 2, 5, 22, 23, 29, 37, 38 AND 50).
FIRST USE 1-2-2002; IN COMMERCE 4-1-2002.
ARETHA SOMERVILLE, EXAMINING ATTORNEY

SN 78-437,251. BAMBOO NEST LLC, LOS ANGELES, CA. FILED 6-17-2004.

SN 78-437,456. GOVE, NANCY, KAUNAKAKAI, HI. FILED 6-18-2004.

DailyOM

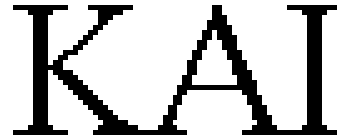

THE MARK CONSISTS OF STANDARD CHARACTERS WITHOUT CLAIM TO ANY PARTICULAR FONT, STYLE, SIZE, OR COLOR.

FOR PRINTED PUBLICATIONS, NAMELY MAGAZINES, NEWSPAPER COLUMNS AND BOOKS FEATURING ARTICLES OR INFORMATION ON MEDITATION AND SPIRITUALITY (U.S. CLS. 2, 5, 22, 23, 29, 37, 38 AND 50).
ARETHA SOMERVILLE, EXAMINING ATTORNEY

THE MARK CONSISTS OF STANDARD CHARACTERS WITHOUT CLAIM TO ANY PARTICULAR FONT, STYLE, SIZE, OR COLOR.

THE FOREIGN WORDING IN THE MARK TRANSLATES INTO ENGLISH AS HAWAIIAN FOR OCEAN.
FOR SERIES OF FICTION AND NON-FICTION BOOKS ON A VARIETY OF TOPICS (U.S. CLS. 2, 5, 22, 23, 29, 37, 38 AND 50).
FIRST USE 12-1-2000; IN COMMERCE 3-28-2001.
JANICE L. MCMORROW, EXAMINING ATTORNEY

CLASS 16—(Continued).

SN 78-437,617. PRL USA HOLDINGS, INC., WILMINGTON, DE. FILED 6-18-2004.

**RALPH LAUREN
AMERICAN LIVING**

THE MARK CONSISTS OF STANDARD CHARACTERS WITHOUT CLAIM TO ANY PARTICULAR FONT, STYLE, SIZE, OR COLOR.

OWNER OF U.S. REG. NOS. 2,042,967 AND 2,077,090.
NO CLAIM IS MADE TO THE EXCLUSIVE RIGHT TO USE "AMERICAN", APART FROM THE MARK AS SHOWN. THE NAME(S), PORTRAIT(S), AND/OR SIGNATURE(S) SHOWN IN THE MARK IDENTIFIES RALPH LAUREN, WHOSE CONSENT(S) TO REGISTER IS SUBMITTED.
FOR A SERIES OF BOOKS REGARDING INFORMATION ABOUT BUILDING, REMODELING, ARCHITECTS, ARCHITECTURE, DECORATING, INTERIOR DESIGN, INTERIOR DESIGNERS, FURNITURE, TECHNOLOGY, ART, ANTIQUES AND COLLECTIBLES, GARDENING, LANDSCAPING, ENTERTAINING, HOMEMAKING, HOME CARE, COOKING, ENTERTAINING; AND PERIODICALLY PUBLISHED MAGAZINE FEATURING ARTICLES AND INFORMATION OF GENERAL INTEREST SUBJECT MATTER (U.S. CLS. 2, 5, 22, 23, 29, 37, 38 AND 50).
JASON TURNER, EXAMINING ATTORNEY

SN 78-438,950. DOLAN MEDIA COMPANY, MINNEAPOLIS, MN. FILED 6-21-2004.

**ST. LOUIS DAILY
RECORD**

THE MARK CONSISTS OF STANDARD CHARACTERS WITHOUT CLAIM TO ANY PARTICULAR FONT, STYLE, SIZE, OR COLOR.

NO CLAIM IS MADE TO THE EXCLUSIVE RIGHT TO USE "DAILY", APART FROM THE MARK AS SHOWN. SEC. 2(F).
FOR PRINTED PUBLICATIONS, NAMELY, DAILY NEWSPAPERS (U.S. CLS. 2, 5, 22, 23, 29, 37, 38 AND 50).
FIRST USE 10-16-1890; IN COMMERCE 10-16-1890.
MICHELE SWAIN, EXAMINING ATTORNEY

CLASS 16—(Continued).

SN 78-440,498. DOLAN MEDIA COMPANY, MINNEAPOLIS, MN. FILED 6-24-2004.

THE COUNTIAN

THE MARK CONSISTS OF STANDARD CHARACTERS WITHOUT CLAIM TO ANY PARTICULAR FONT, STYLE, SIZE, OR COLOR.

FOR PRINTED PUBLICATION, NAMELY, NEWSPAPERS FEATURING BUSINESS AND LEGAL NEWS (U.S. CLS. 2, 5, 22, 23, 29, 37, 38 AND 50).
FIRST USE 0-0-1999, THE MARK WAS FIRST USED ANYWHERE IN A DIFFERENT FORM OTHER THAN THAT SOUGHT TO BE REGISTERED ON 00/00/1902.; IN COMMERCE 0-0-1999, THE MARK WAS FIRST USED IN COMMERCE IN A DIFFERENT FORM OTHER THAN THAT SOUGHT TO BE REGISTERED ON 00/00/1902..
GEOFFREY FOSDICK, EXAMINING ATTORNEY

SN 78-440,987. COOL GAL, LLC, LAKE MILLS, WI. FILED 6-24-2004.

**I'M THE BOSS OF MY
HEARING LOSS**

THE MARK CONSISTS OF STANDARD CHARACTERS WITHOUT CLAIM TO ANY PARTICULAR FONT, STYLE, SIZE, OR COLOR.

FOR CHILDREN'S BOOKS FOR CHILDREN WITH HEARING LOSS AND THEIR FAMILIES (U.S. CLS. 2, 5, 22, 23, 29, 37, 38 AND 50).
KATHLEEN M. VANSTON, EXAMINING ATTORNEY

CLASS 16—(Continued).

SN 78-441,931. TRESS, MARCIA F., DBA THE PETASAURUS GROUP, CHICAGO, IL. AND CARY, ARLENE D., DBA THE PETASAURUS GROUP, CHICAGO, IL. FILED 6-26-2004.

Petasaurus

THE MARK CONSISTS OF STANDARD CHARACTERS WITHOUT CLAIM TO ANY PARTICULAR FONT, STYLE, SIZE, OR COLOR.

FOR SERIES OF FICTION BOOKS (U.S. CLS. 2, 5, 22, 23, 29, 37, 38 AND 50).

DAVID MURRAY, EXAMINING ATTORNEY

CLASS 16—(Continued).

SN 78-445,705. CHINESE INFORMATION & NETWORKING ASSOCIATION, SANTA CLARA, CA. FILED 7-2-2004.

CINA

THE MARK CONSISTS OF STANDARD CHARACTERS WITHOUT CLAIM TO ANY PARTICULAR FONT, STYLE, SIZE, OR COLOR.

FOR BROCHURES, LEAFLETS, AND NEWSLETTERS IN THE FIELD OF HIGH TECHNOLOGY AND BUSINESS MARKETING; PRINTED EDUCATIONAL MANUALS IN THE FIELD OF HIGH TECHNOLOGY AND BUSINESS MARKETING (U.S. CLS. 2, 5, 22, 23, 29, 37, 38 AND 50).

CURTIS FRENCH, EXAMINING ATTORNEY

SN 78-443,161. THE SMEAD MANUFACTURING COMPANY, HASTINGS, MN. FILED 6-29-2004.



NO CLAIM IS MADE TO THE EXCLUSIVE RIGHT TO USE "INC", APART FROM THE MARK AS SHOWN.

THE MARK CONSISTS OF A CIRCLE CONTAINING THE LETTERS M AND O SEPARATED BY A VERTICLE LINE OF DOTS; THE LETTERS INC ARE OUTSIDE THE CIRCLE.

FOR OFFICE AND ORGANIZATIONAL SUPPLIES, NAMELY, THREE RING BINDERS, DOCUMENT PORTFOLIOS, EXPANDING FILE FOLDERS, HANGING FILE FOLDERS, EXPANDABLE HANGING FILE FOLDERS, INDEX TABS, FOLDER DIVIDERS, WRITING TABLETS, NOTE PADS, NOTE PAPER, MEMO PADS, ADHESIVE BACK FILING PRONGS, LABELS, NAMELY, PAPER LABELS AND ADHESIVE LABELS, VINYL ADHESIVE FILE POCKETS, HANGING FILE FRAMES, ADHESIVE BACK NOTE PADS, MEMO CUBE PADS, MEMO CUBE HOLDERS, PAPER PUNCHERS, FILE FOLDERS, ADHESIVE FILE POCKETS, STAPLERS, TAPE DISPENSERS (U.S. CLS. 2, 5, 22, 23, 29, 37, 38 AND 50).

RICHARD WHITE, EXAMINING ATTORNEY

SN 78-446,959. RIGHT THOUGHT PENS, INC., NASHVILLE, TN. FILED 7-7-2004.

BABY PEN

THE MARK CONSISTS OF STANDARD CHARACTERS WITHOUT CLAIM TO ANY PARTICULAR FONT, STYLE, SIZE, OR COLOR.

NO CLAIM IS MADE TO THE EXCLUSIVE RIGHT TO USE "PEN", APART FROM THE MARK AS SHOWN.

FOR PENS (U.S. CLS. 2, 5, 22, 23, 29, 37, 38 AND 50).

BRENDAN MCCAULEY, EXAMINING ATTORNEY

CLASS 16—(Continued).

SN 78-446,990. INTERNATIONAL FRESH-CUT PRODUCE ASSOCIATION, ALEXANDRIA, VA. FILED 7-7-2004.

Inside Fresh-Cuts

THE MARK CONSISTS OF STANDARD CHARACTERS WITHOUT CLAIM TO ANY PARTICULAR FONT, STYLE, SIZE, OR COLOR.

NO CLAIM IS MADE TO THE EXCLUSIVE RIGHT TO USE "FRESH-CUTS", APART FROM THE MARK AS SHOWN.

FOR MAGAZINES ON THE SUBJECT OF FRESH PRODUCE (U.S. CLS. 2, 5, 22, 23, 29, 37, 38 AND 50).

RONALD MCMORROW, EXAMINING ATTORNEY

CLASS 16—(Continued).

SN 78-447,839. KAREN S. O'LEARY, ANTHEM, AZ. AND O'LEARY, KAREN S., ANTHEM, AZ. FILED 7-8-2004.



NO CLAIM IS MADE TO THE EXCLUSIVE RIGHT TO USE "CASTLE", APART FROM THE MARK AS SHOWN.

FOR TRI-FOLD CASTLE-SHAPED PAPER BOARD THAT STANDS ON DESKS FOR PURPOSES OF STUDENT PRIVACY (U.S. CLS. 2, 5, 22, 23, 29, 37, 38 AND 50).

FIRST USE 6-1-2004; IN COMMERCE 6-12-2004.
JOHN GARTNER, EXAMINING ATTORNEY

SN 78-447,241. SB PHARMCO PUERTO RICO INC., CIDRA 00639, PUERTO RICO, FILED 7-7-2004.

YOU CAN BE STRONGER THAN DIABETES

THE MARK CONSISTS OF STANDARD CHARACTERS WITHOUT CLAIM TO ANY PARTICULAR FONT, STYLE, SIZE, OR COLOR.

FOR PRINTED MATERIALS, NAMELY BROCHURES, PAMPHLETS, LEAFLETS AND BOOKLETS FEATURING HEALTH INFORMATION RELATING TO THE TREATMENT AND PREVENTION OF DIABETES (U.S. CLS. 2, 5, 22, 23, 29, 37, 38 AND 50).

FIRST USE 5-30-2003; IN COMMERCE 5-30-2003.
MARK T. MULLEN, EXAMINING ATTORNEY

SN 78-450,334. BIOCORP, INC., ROGERS, MN. FILED 7-14-2004.

BIOCORP KITCHEN ORGANICS

THE MARK CONSISTS OF STANDARD CHARACTERS WITHOUT CLAIM TO ANY PARTICULAR FONT, STYLE, SIZE, OR COLOR.

OWNER OF U.S. REG. NOS. 2,145,310, 2,371,932 AND OTHERS.

NO CLAIM IS MADE TO THE EXCLUSIVE RIGHT TO USE "KITCHEN ORGANICS", APART FROM THE MARK AS SHOWN.

FOR PRINTED GUIDES FOR COMPOSTING AND RECYCLING; AND PRINTED INSTRUCTIONAL, EDUCATIONAL, AND TEACHING MATERIALS IN THE AREA OF COMPOSTING, RECYCLING, WASTE REDUCTION, AND WASTE MANAGEMENT, AND THE USE OF BIODEGRADABLE MATERIALS (U.S. CLS. 2, 5, 22, 23, 29, 37, 38 AND 50).

FIRST USE 10-0-1998; IN COMMERCE 10-0-1998.
HEATHER THOMPSON, EXAMINING ATTORNEY

CLASS 16—(Continued).

SN 78-450,400. BEASLEY, MICHAEL JOHN, PFAFFTOWN, NC. FILED 7-14-2004.

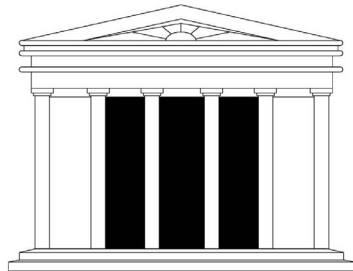

THE FIRST INSTITUTION

NO CLAIM IS MADE TO THE EXCLUSIVE RIGHT TO USE "INSTITUTION", APART FROM THE MARK AS SHOWN.

FOR NON-FICTION BOOKS ABOUT MARRIAGE, FAMILY AND CHILD TRAINING (U.S. CLS. 2, 5, 22, 23, 29, 37, 38 AND 50).

MARY BOAGNI, EXAMINING ATTORNEY

CLASS 16—(Continued).

SN 78-454,649. TIM-BAR CORPORATION, HANOVER, PA. FILED 7-22-2004.

**PACKAGING
SOLUTIONS THAT
BUILD RELATIONSHIPS**

THE MARK CONSISTS OF STANDARD CHARACTERS WITHOUT CLAIM TO ANY PARTICULAR FONT, STYLE, SIZE, OR COLOR.

FOR PACKAGING PRODUCTS AND MATERIALS MADE OF CORRUGATED BOARD, NAMELY, BOXES, CORRUGATED CONTAINERS AND SHEETS, LAMINATED SHEETS, INTERIOR FORMS AND PIECES, AND DISPLAY UNITS FOR MERCHANDISING PRODUCTS (U.S. CLS. 2, 5, 22, 23, 29, 37, 38 AND 50).

SUSAN HAYASH, EXAMINING ATTORNEY

SN 78-454,650. TIM-BAR CORPORATION, HANOVER, PA. FILED 7-22-2004.

SN 78-453,733. STANDARD PACKAGING CORP., GARDENA, CA. FILED 7-20-2004.

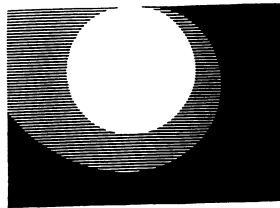

THE COLORS BLACK, WHITE AND GRAY ARE CLAIMED AS FEATURES OF THE MARK.

THE MARK CONSISTS OF A WHITE CIRCLE SURROUNDED (EXCEPT AT THE EXTREME TOP) BY THE HEAD OF A COMET THAT IS FORMED BY HORIZONTAL LINES ON A WHITE BACKGROUND THAT APPEAR AS GRAY TONES, AND ALL LYING IN A BOX WITH BLACK SURROUNDING THE COMET HEAD.

FOR PACKAGING AND SHIPPING MATERIALS, NAMELY CARDBOARD PACKAGING AND PLASTIC SHEET PACKAGING MATERIAL (U.S. CLS. 2, 5, 22, 23, 29, 37, 38 AND 50).

FIRST USE 9-23-2002; IN COMMERCE 9-23-2002.
G. MAYERSCHOFF, EXAMINING ATTORNEY

TIMBAR
PACKAGING & DISPLAY

NO CLAIM IS MADE TO THE EXCLUSIVE RIGHT TO USE "PACKAGING & DISPLAY", APART FROM THE MARK AS SHOWN.

FOR PACKAGING PRODUCTS AND MATERIALS MADE OF CORRUGATED BOARD, NAMELY, BOXES, CORRUGATED CONTAINERS AND SHEETS, LAMINATED SHEETS, INTERIOR FORMS AND PIECES, AND DISPLAY UNITS FOR MERCHANDISING PRODUCTS (U.S. CLS. 2, 5, 22, 23, 29, 37, 38 AND 50).

SUSAN HAYASH, EXAMINING ATTORNEY

SN 78-455,385. UNDER THE PURPLE SUN, LLC, MINNEAPOLIS, MN. FILED 7-23-2004.

GLASSWEARABLES

THE MARK CONSISTS OF STANDARD CHARACTERS WITHOUT CLAIM TO ANY PARTICULAR FONT, STYLE, SIZE, OR COLOR.

FOR REMOVABLE AND REUSABLE SELF-ADHERING VINYL DECALS (U.S. CLS. 2, 5, 22, 23, 29, 37, 38 AND 50).

FIRST USE 6-21-2004; IN COMMERCE 7-1-2004.
SUSAN STIGLITZ, EXAMINING ATTORNEY

CLASS 16—(Continued).

SN 78-455,857. 200 KELSEY ASSOCIATES, LLC, NEW ROCHELLE, NJ. FILED 7-23-2004.

SCREEN GUIDE

THE MARK CONSISTS OF STANDARD CHARACTERS WITHOUT CLAIM TO ANY PARTICULAR FONT, STYLE, SIZE, OR COLOR.

NO CLAIM IS MADE TO THE EXCLUSIVE RIGHT TO USE "GUIDE", APART FROM THE MARK AS SHOWN.

FOR GENERAL INTEREST MAGAZINE PUBLISHED PERIODICALLY IN THE FIELD OF VIDEOS, MOVIES, TELEVISION SHOWS AND CELEBRITIES (U.S. CLS. 2, 5, 22, 23, 29, 37, 38 AND 50).

ANDRÉA SAUNDERS, EXAMINING ATTORNEY

SN 78-456,535. DEEP INTERNATIONAL, LLC, DBA SAVITRI'S, DENVER, CO. FILED 7-26-2004.



THE COLOR(S) BLUE AND GREEN ARE CLAIMED AS FEATURES OF THE MARK.

THE MARK CONSISTS OF A T STYLIZED AS A TREE AND IN BLUE AND GREEN THE COLOR GREEN APPEARS IN THE LETTERING AND THE COLOR GREEN APPEARS IN THE TREE PORTION OF THE MARK.

FOR STATIONERY, GIFT WRAP PAPER, DECORATIVE AND OFFICE PAPER, OFFICE SUPPLIES NAMELY, FOLDERS, FILES, PEN-STANDS AND NOTE-PADS, ENVELOPES, GREETING CARDS, NOTE-CARDS (U.S. CLS. 2, 5, 22, 23, 29, 37, 38 AND 50).

FIRST USE 5-1-2002; IN COMMERCE 5-1-2002.

MIDGE BUTLER, EXAMINING ATTORNEY

CLASS 16—(Continued).

SN 78-457,039. GENIX INTERNATIONAL CORPORATION, OAKVILLE ONTARIO, CANADA, FILED 7-26-2004.

TIDY TRAVEL

THE MARK CONSISTS OF STANDARD CHARACTERS WITHOUT CLAIM TO ANY PARTICULAR FONT, STYLE, SIZE, OR COLOR.

FOR DISPOSABLE PLASTIC LITTER BAGS FOR TRASH (U.S. CLS. 2, 5, 22, 23, 29, 37, 38 AND 50).

FIRST USE 7-1-2004; IN COMMERCE 7-1-2004.

BARBARA GAYNOR, EXAMINING ATTORNEY

SN 78-459,605. BOWATER INCORPORATED, GREENVILLE, SC. FILED 7-30-2004.

BOWOFFSET

THE MARK CONSISTS OF STANDARD CHARACTERS WITHOUT CLAIM TO ANY PARTICULAR FONT, STYLE, SIZE, OR COLOR.

OWNER OF U.S. REG. NO. 2,104,916.

FOR PAPER, NAMELY, NEWSPRINT, DIRECTORY, COATED AND NON-COATED PUBLICATION, BOND AND COPY PAPER (U.S. CLS. 2, 5, 22, 23, 29, 37, 38 AND 50).

FIRST USE 1-31-2003; IN COMMERCE 1-31-2003.

CURTIS FRENCH, EXAMINING ATTORNEY

CLASS 16—(Continued).

SN 78-461,226. BUTTONED UP, INC., BEVERLY HILLS, CA. FILED 8-3-2004.

**YOUR DATES
BUTTONED UP**

THE MARK CONSISTS OF STANDARD CHARACTERS WITHOUT CLAIM TO ANY PARTICULAR FONT, STYLE, SIZE, OR COLOR.

FOR PAPER GOODS AND PRINTED MATTER, NAMELY STATIONERY, DOCUMENT PORTFOLIOS, NOTEBOOK BINDERS, NOTEBOOK PAPER, NOTE CARDS, NOTE PADS, PAPER NOTE TABLETS, PRINTED PAPER LABELS, PRINTED PAPER SIGNS, WRITING PADS, WRITING PAPER, ORGANIZERS FOR STATIONERY USE, PRINTED CALENDARS, PRINTED APPOINTMENT BOOKS, AND PRINTED ADDRESS BOOKS (U.S. CLS. 2, 5, 22, 23, 29, 37, 38 AND 50).
STANLEY I. OSBORNE, EXAMINING ATTORNEY

CLASS 16—(Continued).

SN 78-463,860. DORCHESTER MEDIA, LLC, NEW YORK, NY. FILED 8-7-2004.

BLACK CONFESSIONS

THE MARK CONSISTS OF STANDARD CHARACTERS WITHOUT CLAIM TO ANY PARTICULAR FONT, STYLE, SIZE, OR COLOR.

NO CLAIM IS MADE TO THE EXCLUSIVE RIGHT TO USE BLACK, APART FROM THE MARK AS SHOWN.

FOR MAGAZINES FOR ENTERTAINMENT PURPOSES CONTAINING SHORT STORIES AND ARTICLES (U.S. CLS. 2, 5, 22, 23, 29, 37, 38 AND 50).

FIRST USE 0-0-1952; IN COMMERCE 0-0-1952.
BARBARA BROWN, EXAMINING ATTORNEY

SN 78-463,865. DORCHESTER MEDIA, LLC, NEW YORK, NY. FILED 8-7-2004.

BRONZE THRILLS

THE MARK CONSISTS OF STANDARD CHARACTERS WITHOUT CLAIM TO ANY PARTICULAR FONT, STYLE, SIZE, OR COLOR.

FOR MAGAZINES IN THE FIELD OF ROMANCE AND LIFESTYLES (U.S. CLS. 2, 5, 22, 23, 29, 37, 38 AND 50).

FIRST USE 0-0-1948; IN COMMERCE 0-0-1948.
BARBARA BROWN, EXAMINING ATTORNEY

SN 78-461,709. PERK-UP INC., WHITE PLAINS, NY. FILED 8-4-2004.



THE COLOR(S) RED AND YELLOW IS/ARE CLAIMED AS A FEATURE OF THE MARK.

THE MARK CONSISTS OF YELLOW CHINESE CHARACTERS SURROUNDED BY A YELLOW CIRCULAR DESIGN AND FLANKED ON THE LEFT BY A YELLOW PHOENIX AND ON THE RIGHT BY A YELLOW DRAGON ALL AGAINST A RED BACKGROUND.

THE NON-LATIN CHARACTER(S) IN THE MARK TRANSLITERATES INTO XI IN CHINESE PIN YING , AND THIS MEANS DOUBLE HAPPINESS IN ENGLISH.
SEC. 2(F).

FOR PAPER CONTAINERS FOR FOOD (U.S. CLS. 2, 5, 22, 23, 29, 37, 38 AND 50).

FIRST USE 12-31-1998; IN COMMERCE 12-31-1998.
AMY HELLA, EXAMINING ATTORNEY

SN 78-464,359. RUBEL, BARBARA, KENDALL PARK, NJ. FILED 8-9-2004.

Palette of Grief

THE MARK CONSISTS OF STANDARD CHARACTERS WITHOUT CLAIM TO ANY PARTICULAR FONT, STYLE, SIZE, OR COLOR.

NO CLAIM IS MADE TO THE EXCLUSIVE RIGHT TO USE PALETTE, APART FROM THE MARK AS SHOWN.

FOR PRINTED EDUCATIONAL MATERIALS FOR GRIEF AND LOSS PROFESSIONALS FEATURING TOPICS RELATING TO GRIEF, BEREAVEMENT AND MOURNING (U.S. CLS. 2, 5, 22, 23, 29, 37, 38 AND 50).

FIRST USE 12-1-1994; IN COMMERCE 12-1-1994.
HOWARD SMIGA, EXAMINING ATTORNEY

CLASS 16—(Continued).

SN 78-471,792. HOFFMAN MEDIA, LLC, BIRMINGHAM, AL. FILED 8-23-2004.

**SOUTHERN LADY
PRESENTS TASTE OF
THE SOUTH**

THE MARK CONSISTS OF STANDARD CHARACTERS WITHOUT CLAIM TO ANY PARTICULAR FONT, STYLE, SIZE, OR COLOR.

OWNER OF U.S. REG. NO. 2,588,905.
FOR CULINARY MAGAZINE (U.S. CLS. 2, 5, 22, 23, 29, 37, 38 AND 50).
SCOTT BALDWIN, EXAMINING ATTORNEY

SN 78-471,815. HOFFMAN MEDIA, LLC, BIRMINGHAM, AL. FILED 8-23-2004.

TASTE OF THE SOUTH

THE MARK CONSISTS OF STANDARD CHARACTERS WITHOUT CLAIM TO ANY PARTICULAR FONT, STYLE, SIZE, OR COLOR.

FOR CULINARY MAGAZINE (U.S. CLS. 2, 5, 22, 23, 29, 37, 38 AND 50).
SCOTT BALDWIN, EXAMINING ATTORNEY

SN 78-472,488. KOCHALKA, JAMES, BURLINGTON, VT. FILED 8-24-2004.

MONKEY VS. ROBOT

THE MARK CONSISTS OF STANDARD CHARACTERS WITHOUT CLAIM TO ANY PARTICULAR FONT, STYLE, SIZE, OR COLOR.

SEC. 2(F).
FOR PRINTED PUBLICATIONS FEATURING PARTICULAR FICTIONAL CHARACTERS AND STORYLINES, NAMELY A SERIES OF BOOKS, STORY BOOKS, PICTURE BOOKS, COMIC BOOKS AND NOVELS (U.S. CLS. 2, 5, 22, 23, 29, 37, 38 AND 50).
FIRST USE 9-3-1997; IN COMMERCE 9-3-1997.
STEVEN R. FOSTER, EXAMINING ATTORNEY

CLASS 16—(Continued).

SN 78-472,874. ASPIRE PUBLICATIONS LLC, BAYSIDE, NY. FILED 8-24-2004.

ADMISSIONS

THE MARK CONSISTS OF STANDARD CHARACTERS WITHOUT CLAIM TO ANY PARTICULAR FONT, STYLE, SIZE, OR COLOR.

FOR PUBLICATIONS, NAMELY, MAGAZINES IN THE FIELD OF COLLEGE LIFE (U.S. CLS. 2, 5, 22, 23, 29, 37, 38 AND 50).
DAVID MURRAY, EXAMINING ATTORNEY

SN 78-474,340. VICTORIOUS CHRISTIAN LIVING INTERNATIONAL, PHOENIX, AZ. FILED 8-26-2004.

**Seven Areas of
Life Training**

THE MARK CONSISTS OF STANDARD CHARACTERS WITHOUT CLAIM TO ANY PARTICULAR FONT, STYLE, SIZE, OR COLOR.

FOR PRINTED INSTRUCTIONAL, EDUCATIONAL, AND TEACHING MATERIALS FOR RELIGIOUS EDUCATION (U.S. CLS. 2, 5, 22, 23, 29, 37, 38 AND 50).
FIRST USE 6-0-1999; IN COMMERCE 6-0-1999.
JOHN DALIER, EXAMINING ATTORNEY

SN 78-474,855. QUAD INT'L INCORPORATED, MIAMI, FL. FILED 8-27-2004.

LOOKER BABES - SEX - STUFF

THE MARK CONSISTS OF STANDARD CHARACTERS WITHOUT CLAIM TO ANY PARTICULAR FONT, STYLE, SIZE, OR COLOR.

FOR MAGAZINES FEATURING NUDE MODELS, EDITORIALS AND ART FOR ADULT ENTERTAINMENT PURPOSES (U.S. CLS. 2, 5, 22, 23, 29, 37, 38 AND 50).
FIRST USE 11-1-2002; IN COMMERCE 1-21-2003.
ALLISON SCHRODY, EXAMINING ATTORNEY

CLASS 16—(Continued).

SN 78-476,105. THE BUFFALO EXAMINER, INC., BUFFALO, NY. FILED 8-31-2004.

Buffalo Examiner

THE MARK CONSISTS OF STANDARD CHARACTERS WITHOUT CLAIM TO ANY PARTICULAR FONT, STYLE, SIZE, OR COLOR.

NO CLAIM IS MADE TO THE EXCLUSIVE RIGHT TO USE "BUFFALO", APART FROM THE MARK AS SHOWN, FOR NEWSPAPER (U.S. CLS. 2, 5, 22, 23, 29, 37, 38 AND 50).

SAMUEL E. SHARPER JR., EXAMINING ATTORNEY

SN 78-477,727. NEWS AMERICA MARKETING PROPERTIES L.L.C., CHICAGO, IL. FILED 9-2-2004.

**SMARTSOURCE
SHELFTALK BANNER**

THE MARK CONSISTS OF STANDARD CHARACTERS WITHOUT CLAIM TO ANY PARTICULAR FONT, STYLE, SIZE, OR COLOR.

OWNER OF U.S. REG. NOS. 2,186,735, 2,318,250 AND 2,554,497.

NO CLAIM IS MADE TO THE EXCLUSIVE RIGHT TO USE "BANNER", APART FROM THE MARK AS SHOWN.

FOR PRINTED CARDBOARD SIGNS FOR IN-STORE USE ON GROCERY SHELVES CONTAINING THE ADVERTISEMENTS AND PROMOTIONS OF OTHERS (U.S. CLS. 2, 5, 22, 23, 29, 37, 38 AND 50).

FIRST USE 1-0-2003; IN COMMERCE 1-0-2003.

MARK RADEMACHER, EXAMINING ATTORNEY

CLASS 16—(Continued).

SN 78-481,031. DEWBERRY, JOEL T., CLERMONT, FL. FILED 9-9-2004.

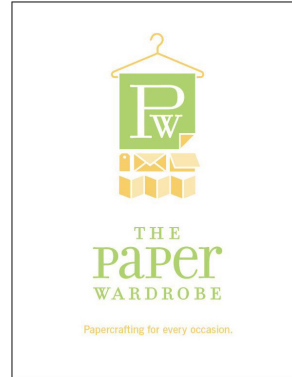

THE COLORS GREEN, ORANGE, AND LIGHT ORANGE ARE CLAIMED AS A FEATURE OF THE MARK.

THE MARK CONSISTS OF A STYLIZED HANGER (ORANGE) WITH A SHEET OF PAPER (GREEN), ALSO DIFFERENT PAPER-CRAFTED ELEMENTS ARE HANGING UNDERNEATH THE PAPER (IN ORANGE AND LIGHT ORANGE), THE WORDS "THE PAPER WARDROBE" (GREEN), AND FINALLY "PAPERCRAFTING FOR EVERY OCCASION" IN (ORANGE).

FOR PAPER FOR SCRAPBOOKING AND PAPER-CRAFTING (U.S. CLS. 2, 5, 22, 23, 29, 37, 38 AND 50).

FIRST USE 7-23-2004; IN COMMERCE 7-29-2004.
MELISSA VALLILLO, EXAMINING ATTORNEY

SN 78-481,274. C&T PUBLISHING, INC., CONCORD, CA. FILED 9-9-2004.

fast, fun & easy

THE MARK CONSISTS OF STANDARD CHARACTERS WITHOUT CLAIM TO ANY PARTICULAR FONT, STYLE, SIZE, OR COLOR.

FOR SERIES OF BOOKS FEATURING INFORMATION ON HOBBY AND CRAFTS (U.S. CLS. 2, 5, 22, 23, 29, 37, 38 AND 50).

FIRST USE 2-1-2003; IN COMMERCE 7-1-2003.

LAURIE MAYES, EXAMINING ATTORNEY

CLASS 16—(Continued).

SN 78-482,143. ME PUBLICATIONS, INC., WHITE PLAINS, NY. FILED 9-12-2004.

Me Magazine

THE MARK CONSISTS OF STANDARD CHARACTERS WITHOUT CLAIM TO ANY PARTICULAR FONT, STYLE, SIZE, OR COLOR.

NO CLAIM IS MADE TO THE EXCLUSIVE RIGHT TO USE MAGAZINE, APART FROM THE MARK AS SHOWN.

FOR MAGAZINE IN THE FIELDS OF FASHION, THE ARTS, MUSIC, DESIGN, AND CULTURE (U.S. CLS. 2, 5, 22, 23, 29, 37, 38 AND 50).

FIRST USE 3-1-2004; IN COMMERCE 8-26-2004.
CAROLYN CATALDO, EXAMINING ATTORNEY

CLASS 16—(Continued).

SN 78-483,776. TRUCK ADS, LLC, MCLEAN, VA. FILED 9-15-2004.

TRUCK ADS

THE MARK CONSISTS OF STANDARD CHARACTERS WITHOUT CLAIM TO ANY PARTICULAR FONT, STYLE, SIZE, OR COLOR.

OWNER OF U.S. REG. NOS. 2,804,676 AND 2,838,348.
SEC. 2(F).

FOR VINYL ADHESIVE DECALS AND FITTED STRETCH VINYL DECALS APPLIED TO THE EXTERIOR SIDES OF CARS, TRUCKS AND MOTORIZED VEHICLES (U.S. CLS. 2, 5, 22, 23, 29, 37, 38 AND 50).

FIRST USE 2-7-1996; IN COMMERCE 6-13-1996.
KEVIN DINALLO, EXAMINING ATTORNEY

SN 78-484,641. EDUCATIONAL CONCEPTS, TULSA, OK. FILED 9-16-2004.

SN 78-482,767. CLERMONT PUBLISHING, GROUP, LLC, MIAMI, FL. FILED 9-13-2004.

Fashion's new face

THE MARK CONSISTS OF STANDARD CHARACTERS WITHOUT CLAIM TO ANY PARTICULAR FONT, STYLE, SIZE, OR COLOR.

FOR MAGAZINE FEATURING BEAUTY AND FASHION INFORMATION (U.S. CLS. 2, 5, 22, 23, 29, 37, 38 AND 50).

FIRST USE 1-1-2004; IN COMMERCE 1-1-2004.
KEVON CHISOLM, EXAMINING ATTORNEY

VeTeam Advisor

THE MARK CONSISTS OF STANDARD CHARACTERS WITHOUT CLAIM TO ANY PARTICULAR FONT, STYLE, SIZE, OR COLOR.

FOR PRINTED PUBLICATIONS, NAMELY, SUPPLEMENTAL VETERINARY PUBLICATIONS FOR VETERINARY JOURNALS (U.S. CLS. 2, 5, 22, 23, 29, 37, 38 AND 50).

PAULA MAHONEY, EXAMINING ATTORNEY

CLASS 16—(Continued).

SN 78-484,760. TONY MAGAZINE LLC, RED BANK, NJ.
FILED 9-16-2004.

M.A.R.

THE MARK CONSISTS OF STANDARD CHARACTERS WITHOUT CLAIM TO ANY PARTICULAR FONT, STYLE, SIZE, OR COLOR.

FOR PUBLICATIONS, NAMELY, MAGAZINES IN THE FIELDS OF FASHION AND BEAUTY (U.S. CLS. 2, 5, 22, 23, 29, 37, 38 AND 50).

FIRST USE 10-15-2004; IN COMMERCE 10-15-2004.
JOHN E. MICHOŠ, EXAMINING ATTORNEY

SN 78-487,760. VOLUME DISTRIBUTORS, VERNON, CA.
FILED 9-22-2004.

DURA-FLEX

THE MARK CONSISTS OF STANDARD CHARACTERS WITHOUT CLAIM TO ANY PARTICULAR FONT, STYLE, SIZE, OR COLOR.

FOR PLASTIC BAGS, NAMELY, FOOD STORAGE BAGS FOR HOUSEHOLD USE, FREEZER BAGS, GARBAGE BAGS, GENERAL PURPOSE BAGS, SANDWICH BAGS, AND TRASH BAGS; AND PLASTIC WRAP (U.S. CLS. 2, 5, 22, 23, 29, 37, 38 AND 50).

FIRST USE 8-1-2002; IN COMMERCE 8-1-2002.
C. DIONNE CLYBURN, EXAMINING ATTORNEY

CLASS 16—(Continued).

SN 78-488,265. TRAILS AND PATH PREMIER PROPERTIES, INC., MESA, AZ. FILED 9-23-2004.

Trails and Paths
PREMIER PROPERTIES

NO CLAIM IS MADE TO THE EXCLUSIVE RIGHT TO USE "PREMIER PROPERTIES", APART FROM THE MARK AS SHOWN.

THE MARK CONSISTS OF STYLIZED CHARACTERS FOR "TRAILS AND PATHS" IN THE FONT, SHEER ELEGANCE, AND IN THE FONT, TIMES NEW ROMAN, FOR "PREMIER PROPERTIES"; AN IMAGE OF A CACTUS SEPARATES THE WORDS "PREMIER" AND "PROPERTIES".

FOR PRINTED MATERIALS, NAMELY, GUIDEBOOKS, NEWSLETTERS, BROCHURES, PAMPHLETS, AND INFORMATIONAL FLYERS IN THE FIELD OF REAL ESTATE (U.S. CLS. 2, 5, 22, 23, 29, 37, 38 AND 50).

FIRST USE 10-31-2003; IN COMMERCE 10-31-2003.
TIMOTHY FINNEGAN, EXAMINING ATTORNEY

SN 78-488,907. LORRAINE COMMUNICATIONS, INC., ATHENS, GA. FILED 9-23-2004.

MEALTIME MESSAGES

THE MARK CONSISTS OF STANDARD CHARACTERS WITHOUT CLAIM TO ANY PARTICULAR FONT, STYLE, SIZE, OR COLOR.

NO CLAIM IS MADE TO THE EXCLUSIVE RIGHT TO USE MESSAGES, APART FROM THE MARK AS SHOWN.

FOR PLACE MATS OF PAPER WITH INSPIRATIONAL OR DEVOTIONAL MESSAGES (U.S. CLS. 2, 5, 22, 23, 29, 37, 38 AND 50).

FIRST USE 7-3-2002; IN COMMERCE 3-11-2003.
PAULA MAHONEY, EXAMINING ATTORNEY

SN 78-490,605. SUCHMA, GENE A., CAMP HILL, PA. FILED 9-28-2004.

Peaceable Pals

THE MARK CONSISTS OF STANDARD CHARACTERS WITHOUT CLAIM TO ANY PARTICULAR FONT, STYLE, SIZE, OR COLOR.

FOR ARTWORK, NAMELY, PRINTS AND PRINTABLE ART REPRODUCTIONS. (U.S. CLS. 2, 5, 22, 23, 29, 37, 38 AND 50).

DEZMONA MIZELLE, EXAMINING ATTORNEY

CLASS 16—(Continued).

SN 78-490,984. TAYLOR CORPORATION, NORTH MANKATO, MN. FILED 9-28-2004.

FINE IMPRESSIONS

THE MARK CONSISTS OF STANDARD CHARACTERS WITHOUT CLAIM TO ANY PARTICULAR FONT, STYLE, SIZE, OR COLOR.

FOR GREETING CARDS, WEDDING AND SOCIAL STATIONERY AND INVITATIONS, ENVELOPES AND PAPER NAPKINS (U.S. CLS. 2, 5, 22, 23, 29, 37, 38 AND 50).

FIRST USE 12-31-1983; IN COMMERCE 12-31-1983.
WENDY GOODMAN, EXAMINING ATTORNEY

SN 78-491,391. PARKER PEN PRODUCTS, FREEPORT, IL. FILED 9-29-2004.

PARKER FACET

THE MARK CONSISTS OF STANDARD CHARACTERS WITHOUT CLAIM TO ANY PARTICULAR FONT, STYLE, SIZE, OR COLOR.

OWNER OF U.S. REG. NOS. 165,783, 510,520 AND OTHERS.

FOR WRITING INSTRUMENTS, NAMELY, FOUNTAIN PENS, BALL POINT PENS, ROLLER BALL PENS, MARKERS, INK, INK REFILLS AND CARTRIDGES, MECHANICAL PENCILS, LEADS AND ERASERS FOR MECHANICAL PENCILS, ALL SOLD INDIVIDUALLY OR AS SETS (U.S. CLS. 2, 5, 22, 23, 29, 37, 38 AND 50).

SHARI SHEFFIELD, EXAMINING ATTORNEY

CLASS 16—(Continued).

SN 78-491,862. TOBUTSU AMERICA CORPORATION, SANTA FE SPRINGS, CA. FILED 9-29-2004.

MEMORALABEL

THE MARK CONSISTS OF STANDARD CHARACTERS WITHOUT CLAIM TO ANY PARTICULAR FONT, STYLE, SIZE, OR COLOR.

FOR WINE LABEL REMOVER COMPRISED OF AN ADHESIVE AND PLASTIC FILM FOR REMOVING THE PRINTED SURFACE OF A PRINTED LABEL FROM A WINE BOTTLE (U.S. CLS. 2, 5, 22, 23, 29, 37, 38 AND 50).

FIRST USE 12-22-2003; IN COMMERCE 7-8-2004.
LAURIE MAYES, EXAMINING ATTORNEY

SN 78-491,871. CLEVELAND, DANYAL L., LUBBOCK, TX. FILED 9-29-2004.



NO CLAIM IS MADE TO THE EXCLUSIVE RIGHT TO USE "THE MAGAZINE", APART FROM THE MARK AS SHOWN.

THE COLOR(S) BLACK, WHITE, GRAY, SILVER, CHROME AND RED IS/ARE CLAIMED AS A FEATURE OF THE MARK.

THE MARK CONSISTS OF THE WORDS SO AND GIFTED COLORED RED AND OUTLINED IN WHITE. A CROWN COLORED RED AND BLACK OUTLINED IN SILVER. A CROSS ATTACHED TO THE CROWN COLORED IN SILVER AND CHROME. THE WORDS SO GIFTED THE MAGAZINE COLORED IN RED, SILVER AND GREY.

FOR PRINTED PUBLICATIONS, NAMELY, GENERAL FEATURE MAGAZINES (U.S. CLS. 2, 5, 22, 23, 29, 37, 38 AND 50).

MARIAM MAHMOUDI, EXAMINING ATTORNEY

SN 78-491,968. SIMON & SCHUSTER, INC., NEW YORK, NY. FILED 9-30-2004.

THE BOBBSEY TWINS

THE MARK CONSISTS OF STANDARD CHARACTERS WITHOUT CLAIM TO ANY PARTICULAR FONT, STYLE, SIZE, OR COLOR.

FOR SERIES OF FICTION BOOKS (U.S. CLS. 2, 5, 22, 23, 29, 37, 38 AND 50).

FIRST USE 12-31-1904; IN COMMERCE 12-31-1904.
JULIE GUTTADAURO, EXAMINING ATTORNEY

CLASS 16—(Continued).

SN 78-492,237. DEUTSCHE TELEKOM AG, BONN, FED REP GERMANY, FILED 9-30-2004.

T-Mobile news
express

THE MARK CONSISTS OF STANDARD CHARACTERS WITHOUT CLAIM TO ANY PARTICULAR FONT, STYLE, SIZE, OR COLOR.

PRIORITY CLAIMED UNDER SEC. 44(D) ON FED REP GERMANY APPLICATION NO. 30418518338, FILED 4-2-2004, REG. NO. 30418518, DATED 4-22-2004, EXPIRES 4-30-2014.

OWNER OF U.S. REG. NO. 2,282,432.

NO CLAIM IS MADE TO THE EXCLUSIVE RIGHT TO USE NEWS EXPRESS, APART FROM THE MARK AS SHOWN.

FOR PRINTED MATTER, NAMELY, TELEPHONE DIRECTORIES, SERIES OF BOOKS, NEWSLETTERS, PAMPHLETS, BROCHURES, MAGAZINES AND PAPERBACKS, ALL IN THE FIELD OF TELECOMMUNICATIONS; PRINTED AND STAMPED PLASTIC AND CARDBOARD GREETING, BLANK, NOTE, AND INDEX CARDS; NOTE PAPER AND ENVELOPES; NAMETAGS AND LABELS MADE FROM PAPER OR CARDBOARD; NOTEBOOKS; NOTE PADS; STATIONERY; PAPER, NAMELY, BOND PAPER AND ART PAPER; GIFT-WRAP PAPER; DIARIES; ADDRESS BOOKS; STUDENT CALENDARS; STAMP ALBUMS AND PHOTO-ALBUMS; FOLDERS FOR LETTERS AND LOOSE PAPERS; STATIONERY CLEAR HOLE TAB REINFORCEMENTS; RUBBER STAMPS AND IMPRESSION STAMPS; PAPER WEIGHTS; LETTER OPENERS; DRAWING AND UNGRADUATED RULERS; ERASERS; STAPLERS; PAPER CLIPS; BLOTTER PADS; DESK FILE TRAYS; DESK STANDS AND HOLDERS FOR HOLDING STATIONERY AND OFFICE IMPLEMENTS; PRINTED INSTRUCTIONAL AND TEACHING MATERIALS, ALL IN THE FIELDS OF TELECOMMUNICATIONS, INFORMATION TECHNOLOGY, SAFETY, NEWS, SPORTS, ENTERTAINMENT, CULTURE, BUSINESS AND FINANCE, WEATHER AND TRAVEL; BOOKMARKERS; STENCILS; SCRATCH PICTURES; PVC STICKERS; BLACKBOARDS; CHALK STICKS; ADHESIVES FOR STATIONERY OR HOUSEHOLD PURPOSES; DRAWING AND PAINTING MATERIALS, NAMELY, PENCILS, DRAWING PENCILS, PENS, DRAWING PENS, PAINT TRAYS, PAINTING SETS FOR ARTISTS, PAINTING SETS FOR CHILDREN, ARTS AND CRAFT PAINT (U.S. CLS. 2, 5, 22, 23, 29, 38 AND 50).

ROBERT C. CLARK JR., EXAMINING ATTORNEY

CLASS 16—(Continued).

SN 78-493,322. DEUTSCHE TELEKOM AG, BONN, FED REP GERMANY, FILED 10-1-2004.

T-Mobile
multimedia
experience

THE MARK CONSISTS OF STANDARD CHARACTERS WITHOUT CLAIM TO ANY PARTICULAR FONT, STYLE, SIZE, OR COLOR.

PRIORITY CLAIMED UNDER SEC. 44(D) ON FED REP GERMANY APPLICATION NO. 30418510838, FILED 4-2-2004, REG. NO. 30418510, DATED 4-22-2004, EXPIRES 4-30-2014.

OWNER OF U.S. REG. NO. 2,282,432.

NO CLAIM IS MADE TO THE EXCLUSIVE RIGHT TO USE "MULTIMEDIA", APART FROM THE MARK AS SHOWN.

FOR PRINTED MATTER, NAMELY, TELEPHONE DIRECTORIES, SERIES OF BOOKS, NEWSLETTERS, PAMPHLETS, BROCHURES, MAGAZINES AND PAPERBACKS, ALL IN THE FIELD OF TELECOMMUNICATIONS; PRINTED AND STAMPED PLASTIC AND CARDBOARD GREETING, BLANK, NOTE, AND INDEX CARDS; NOTE PAPER AND ENVELOPES; NAMETAGS AND LABELS MADE FROM PAPER OR CARDBOARD; NOTEBOOKS; NOTE PADS; STATIONERY; PAPER, NAMELY, BOND PAPER AND ART PAPER; GIFT-WRAP PAPER; DIARIES; ADDRESS BOOKS; STUDENT CALENDARS; STAMP ALBUMS AND PHOTO-ALBUMS; FOLDERS FOR LETTERS AND LOOSE PAPERS; STATIONERY CLEAR HOLE TAB REINFORCEMENTS; RUBBER STAMPS AND IMPRESSION STAMPS; PAPER WEIGHTS; LETTER OPENERS; DRAWING AND UNGRADUATED RULERS; ERASERS; STAPLERS; PAPER CLIPS; BLOTTER PADS; DESK FILE TRAYS; DESK STANDS AND HOLDERS FOR HOLDING STATIONERY AND OFFICE IMPLEMENTS; PRINTED INSTRUCTIONAL AND TEACHING MATERIALS, ALL IN THE FIELDS OF TELECOMMUNICATIONS, INFORMATION TECHNOLOGY, SAFETY, NEWS, SPORTS, ENTERTAINMENT, CULTURE, BUSINESS AND FINANCE, WEATHER AND TRAVEL; BOOKMARKERS; STENCILS; SCRATCH PICTURES; PVC STICKERS; BLACKBOARDS; CHALK STICKS; ADHESIVES FOR STATIONERY OR HOUSEHOLD PURPOSES; DRAWING AND PAINTING MATERIALS, NAMELY, PENCILS, DRAWING PENCILS, PENS, DRAWING PENS, PAINT TRAYS, PAINTING SETS FOR ARTISTS, PAINTING SETS FOR CHILDREN, ARTS AND CRAFT PAINT KITS, AND PENCIL CASES; NON-MAGNETICALLY ENCODED PREPAID TELEPHONE CALLING CARDS (U.S. CLS. 2, 5, 22, 23, 29, 37, 38 AND 50).

FLORENTINA BLANDU, EXAMINING ATTORNEY

CLASS 16—(Continued).

SN 78-493,999. DEUTSCHE TELEKOM AG, BONN, FED REP GERMANY, FILED 10-4-2004.

CLASS 16—(Continued).

SN 78-494,001. D'ADDONO, BETH C., BELMONT HILLS, PA. FILED 10-4-2004.

T-Mobile mms&messaging

THE MARK CONSISTS OF STANDARD CHARACTERS WITHOUT CLAIM TO ANY PARTICULAR FONT, STYLE, SIZE, OR COLOR.

PRIORITY CLAIMED UNDER SEC. 44(D) ON FED REP GERMANY APPLICATION NO. 30418512438, FILED 4-2-2004, REG. NO. 30418512, DATED 4-22-2004, EXPIRES 4-22-2014.

OWNER OF U.S. REG. NO. 2,282,432.

NO CLAIM IS MADE TO THE EXCLUSIVE RIGHT TO USE "MMS&MESSAGING", APART FROM THE MARK AS SHOWN.

FOR PRINTED MATTER, NAMELY, TELEPHONE DIRECTORIES, SERIES OF BOOKS, NEWSLETTERS, PAMPHLETS, BROCHURES, MAGAZINES AND PAPERBACKS, ALL IN THE FIELD OF TELECOMMUNICATIONS; PRINTED AND STAMPED PLASTIC AND CARDBOARD GREETING, BLANK, NOTE, AND INDEX CARDS; NOTE PAPER AND ENVELOPES; NAMETAGS AND LABELS MADE FROM PAPER OR CARDBOARD; NOTEBOOKS; NOTE PADS; STATIONERY; PAPER, NAMELY, BOND PAPER AND ART PAPER; GIFT-WRAP PAPER; DIARIES; ADDRESS BOOKS; STUDENT CALENDARS; STAMP ALBUMS AND PHOTO-ALBUMS; FOLDERS FOR LETTERS AND LOOSE PAPERS; STATIONERY CLEAR HOLE TAB REINFORCEMENTS; RUBBER STAMPS AND IMPRESSION STAMPS; PAPER WEIGHTS; LETTER OPENERS; DRAWING AND UNGRADUATED RULERS; ERASERS; STAPLERS; PAPER CLIPS; BLOTTING PADS; DESK FILE TRAYS; DESK STANDS AND HOLDERS FOR HOLDING STATIONERY AND OFFICE IMPLEMENTS; PRINTED INSTRUCTIONAL AND TEACHING MATERIALS, ALL IN THE FIELDS OF TELECOMMUNICATIONS, INFORMATION TECHNOLOGY, SAFETY, NEWS, SPORTS, ENTERTAINMENT, CULTURE, BUSINESS AND FINANCE, WEATHER AND TRAVEL; BOOKMARKERS; STENCILS; SCRATCH PICTURES; PVC STICKERS; BLACKBOARDS; CHALK STICKS; ADHESIVES FOR STATIONERY OR HOUSEHOLD PURPOSES; DRAWING AND PAINTING MATERIALS, NAMELY, PENCILS, DRAWING PENCILS, PENS, DRAWING PENS, PAINT TRAYS, PAINTING SETS FOR ARTISTS, PAINTING SETS FOR CHILDREN, ARTS AND CRAFT PAINT KITS, AND PENCIL CASES; NON-MAGNETICALLY ENCODED PREPAID TELEPHONE CALLING CARDS (U.S. CLS. 2, 5, 22, 23, 29, 37, 38 AND 50).

FLORENTINA BLANDU, EXAMINING ATTORNEY

UnchainedTravel

THE MARK CONSISTS OF STANDARD CHARACTERS WITHOUT CLAIM TO ANY PARTICULAR FONT, STYLE, SIZE, OR COLOR.

FOR SERIES OF POCKET TRAVEL GUIDES (U.S. CLS. 2, 5, 22, 23, 29, 37, 38 AND 50).

KARLA PERKINS, EXAMINING ATTORNEY

CLASS 16—(Continued).

SN 78-494,040. DEUTSCHE TELEKOM AG, BONN, FED REP GERMANY, FILED 10-4-2004.

**T-Mobile
email&chat**

THE MARK CONSISTS OF STANDARD CHARACTERS WITHOUT CLAIM TO ANY PARTICULAR FONT, STYLE, SIZE, OR COLOR.

PRIORITY CLAIMED UNDER SEC. 44(D) ON FED REP GERMANY APPLICATION NO. 30418465938, FILED 4-2-2004, REG. NO. 30418465, DATED 5-7-2004, EXPIRES 4-30-2014.

OWNER OF U.S. REG. NO. 2,282,432.

NO CLAIM IS MADE TO THE EXCLUSIVE RIGHT TO USE "EMAIL&CHAT", APART FROM THE MARK AS SHOWN.

FOR PRINTED MATTER, NAMELY, TELEPHONE DIRECTORIES, SERIES OF BOOKS, NEWSLETTERS, PAMPHLETS, BROCHURES, MAGAZINES AND PAPERBACKS, ALL IN THE FIELD OF TELECOMMUNICATIONS; PRINTED AND STAMPED PLASTIC AND CARDBOARD GREETING, BLANK, NOTE, AND INDEX CARDS; NOTE PAPER AND ENVELOPES; NAMETAGS AND LABELS MADE FROM PAPER OR CARDBOARD; NOTEBOOKS; NOTE PADS; STATIONERY; PAPER, NAMELY, BOND PAPER AND ART PAPER; GIFT-WRAP PAPER; DIARIES; ADDRESS BOOKS; STUDENT CALENDARS; STAMP ALBUMS AND PHOTO-ALBUMS; FOLDERS FOR LETTERS AND LOOSE PAPERS; STATIONERY CLEAR HOLE TAB REINFORCEMENTS; RUBBER STAMPS AND IMPRESSION STAMPS; PAPER WEIGHTS; LETTER OPENERS; DRAWING AND UNGRADUATED RULERS; ERASERS; STAPLERS; PAPER CLIPS; BLOTting PADS; DESK FILE TRAYS; DESK STANDS AND HOLDERS FOR HOLDING STATIONERY AND OFFICE IMPLEMENTS; PRINTED INSTRUCTIONAL AND TEACHING MATERIALS, ALL IN THE FIELDS OF TELECOMMUNICATIONS, INFORMATION TECHNOLOGY, SAFETY, NEWS, SPORTS, ENTERTAINMENT, CULTURE, BUSINESS AND FINANCE, WEATHER AND TRAVEL; BOOKMARKERS; STENCILS; SCRATCH PICTURES; PVC STICKERS; BLACKBOARDS; CHALK STICKS; ADHESIVES FOR STATIONERY OR HOUSEHOLD PURPOSES; DRAWING AND PAINTING MATERIALS, NAMELY, PENCILS, DRAWING PENCILS, PENS, DRAWING PENS, PAINT TRAYS, PAINTING SETS FOR ARTISTS, PAINTING SETS FOR CHILDREN, ARTS AND CRAFT PAINT KITS, AND PENCIL CASES; NON-MAGNETICALLY ENCODED PREPAID TELEPHONE CALLING CARDS (U.S. CLS. 2, 5, 22, 23, 29, 37, 38 AND 50).

FLORENTINA BLANDU, EXAMINING ATTORNEY

CLASS 16—(Continued).

SN 78-494,113. DEUTSCHE TELEKOM AG, BONN, FED REP GERMANY, FILED 10-4-2004.

**T-Mobile
multimedia netcard**

THE MARK CONSISTS OF STANDARD CHARACTERS WITHOUT CLAIM TO ANY PARTICULAR FONT, STYLE, SIZE, OR COLOR.

PRIORITY CLAIMED UNDER SEC. 44(D) ON FED REP GERMANY APPLICATION NO. 30418509438, FILED 4-2-2004, REG. NO. 30418509, DATED 4-22-2004, EXPIRES 4-30-2014.

OWNER OF U.S. REG. NO. 2,282,432.

NO CLAIM IS MADE TO THE EXCLUSIVE RIGHT TO USE "MULTIMEDIA NETCARD", APART FROM THE MARK AS SHOWN.

FOR PRINTED MATTER, NAMELY, TELEPHONE DIRECTORIES, SERIES OF BOOKS, NEWSLETTERS, PAMPHLETS, BROCHURES, MAGAZINES AND PAPERBACKS, ALL IN THE FIELD OF TELECOMMUNICATIONS; PRINTED AND STAMPED PLASTIC AND CARDBOARD GREETING, BLANK, NOTE, AND INDEX CARDS; NOTE PAPER AND ENVELOPES; NAMETAGS AND LABELS MADE FROM PAPER OR CARDBOARD; NOTEBOOKS; NOTE PADS; STATIONERY; PAPER, NAMELY, BOND PAPER AND ART PAPER; GIFT-WRAP PAPER; DIARIES; ADDRESS BOOKS; STUDENT CALENDARS; STAMP ALBUMS AND PHOTO-ALBUMS; FOLDERS FOR LETTERS AND LOOSE PAPERS; STATIONERY CLEAR HOLE TAB REINFORCEMENTS; RUBBER STAMPS AND IMPRESSION STAMPS; PAPER WEIGHTS; LETTER OPENERS; DRAWING AND UNGRADUATED RULERS; ERASERS; STAPLERS; PAPER CLIPS; BLOTting PADS; DESK FILE TRAYS; DESK STANDS AND HOLDERS FOR HOLDING STATIONERY AND OFFICE IMPLEMENTS; PRINTED INSTRUCTIONAL AND TEACHING MATERIALS, ALL IN THE FIELDS OF TELECOMMUNICATIONS, INFORMATION TECHNOLOGY, SAFETY, NEWS, SPORTS, ENTERTAINMENT, CULTURE, BUSINESS AND FINANCE, WEATHER AND TRAVEL; BOOKMARKERS; STENCILS; SCRATCH PICTURES; PVC STICKERS; BLACKBOARDS; CHALK STICKS; ADHESIVES FOR STATIONERY OR HOUSEHOLD PURPOSES; DRAWING AND PAINTING MATERIALS, NAMELY, PENCILS, DRAWING PENCILS, PENS, DRAWING PENS, PAINT TRAYS, PAINTING SETS FOR ARTISTS, PAINTING SETS FOR CHILDREN, ARTS AND CRAFT PAINT KITS, AND PENCIL CASES; NON-MAGNETICALLY ENCODED PREPAID TELEPHONE CALLING CARDS (U.S. CLS. 2, 5, 22, 23, 29, 37, 38 AND 50).

FLORENTINA BLANDU, EXAMINING ATTORNEY

CLASS 16—(Continued).

SN 78-494,151. DEUTSCHE TELEKOM AG, BONN, FED REP GERMANY, FILED 10-4-2004.

T-Mobile instant email

THE MARK CONSISTS OF STANDARD CHARACTERS WITHOUT CLAIM TO ANY PARTICULAR FONT, STYLE, SIZE, OR COLOR.

PRIORITY CLAIMED UNDER SEC. 44(D) ON FED REP GERMANY APPLICATION NO. 30418511638, FILED 4-2-2004, REG. NO. 30418511, DATED 4-22-2004, EXPIRES 4-30-2014.

OWNER OF U.S. REG. NO. 2,282,432.

NO CLAIM IS MADE TO THE EXCLUSIVE RIGHT TO USE "INSTANT EMAIL", APART FROM THE MARK AS SHOWN.

FOR PRINTED MATTER, NAMELY, TELEPHONE DIRECTORIES, SERIES OF BOOKS, NEWSLETTERS, PAMPHLETS, BROCHURES, MAGAZINES AND PAPERBACKS, ALL IN THE FIELD OF TELECOMMUNICATIONS; PRINTED AND STAMPED PLASTIC AND CARDBOARD GREETING, BLANK, NOTE, AND INDEX CARDS; NOTE PAPER AND ENVELOPES; NAMETAGS AND LABELS MADE FROM PAPER OR CARDBOARD; NOTEBOOKS; NOTE PADS; STATIONERY; PAPER, NAMELY, BOND PAPER AND ART PAPER; GIFT-WRAP PAPER; DIARIES; ADDRESS BOOKS; STUDENT CALENDARS; STAMP ALBUMS AND PHOTO-ALBUMS; FOLDERS FOR LETTERS AND LOOSE PAPERS; STATIONERY CLEAR HOLE TAB REINFORCEMENTS; RUBBER STAMPS AND IMPRESSION STAMPS; PAPER WEIGHTS; LETTER OPENERS; DRAWING AND UNGRADUATED RULERS; ERASERS; STAPLERS; PAPER CLIPS; BLOTTER PADS; DESK FILE TRAYS; DESK STANDS AND HOLDERS FOR HOLDING STATIONERY AND OFFICE IMPLEMENTS; PRINTED INSTRUCTIONAL AND TEACHING MATERIALS, ALL IN THE FIELDS OF TELECOMMUNICATIONS, INFORMATION TECHNOLOGY, SAFETY, NEWS, SPORTS, ENTERTAINMENT, CULTURE, BUSINESS AND FINANCE, WEATHER AND TRAVEL; BOOKMARKERS; STENCILS; SCRATCH PICTURES; PVC STICKERS; BLACKBOARDS; CHALK STICKS; ADHESIVES FOR STATIONERY OR HOUSEHOLD PURPOSES; DRAWING AND PAINTING MATERIALS, NAMELY, PENCILS, DRAWING PENCILS, PENS, DRAWING PENS, PAINT TRAYS, PAINTING SETS FOR ARTISTS, PAINTING SETS FOR CHILDREN, ARTS AND CRAFT PAINT KITS, AND PENCIL CASES; NON-MAGNETICALLY ENCODED PREPAID TELEPHONE CALLING CARDS (U.S. CLS. 2, 5, 22, 23, 29, 37, 38 AND 50).

FLORENTINA BLANDU, EXAMINING ATTORNEY

CLASS 16—(Continued).

SN 78-494,168. DEUTSCHE TELEKOM AG, BONN, FED REP GERMANY, FILED 10-4-2004.

T-Mobile screen styles

THE MARK CONSISTS OF STANDARD CHARACTERS WITHOUT CLAIM TO ANY PARTICULAR FONT, STYLE, SIZE, OR COLOR.

PRIORITY CLAIMED UNDER SEC. 44(D) ON FED REP GERMANY APPLICATION NO. 304185159/38, FILED 4-2-2004, REG. NO. 30418515, DATED 4-22-2004, EXPIRES 4-30-2014.

OWNER OF U.S. REG. NO. 2,282,432.

NO CLAIM IS MADE TO THE EXCLUSIVE RIGHT TO USE "SCREEN STYLES", APART FROM THE MARK AS SHOWN.

FOR PRINTED MATTER, NAMELY, TELEPHONE DIRECTORIES, SERIES OF BOOKS, NEWSLETTERS, PAMPHLETS, BROCHURES, MAGAZINES AND PAPERBACKS, ALL IN THE FIELD OF TELECOMMUNICATIONS; PRINTED AND STAMPED PLASTIC AND CARDBOARD GREETING, BLANK, NOTE, AND INDEX CARDS; NOTE PAPER AND ENVELOPES; NAMETAGS AND LABELS MADE FROM PAPER OR CARDBOARD; NOTEBOOKS; NOTE PADS; STATIONERY; PAPER, NAMELY, BOND PAPER AND ART PAPER; GIFT-WRAP PAPER; DIARIES; ADDRESS BOOKS; STUDENT CALENDARS; STAMP ALBUMS AND PHOTO-ALBUMS; FOLDERS FOR LETTERS AND LOOSE PAPERS; STATIONERY CLEAR HOLE TAB REINFORCEMENTS; RUBBER STAMPS AND IMPRESSION STAMPS; PAPER WEIGHTS; LETTER OPENERS; DRAWING AND UNGRADUATED RULERS; ERASERS; STAPLERS; PAPER CLIPS; BLOTTER PADS; DESK FILE TRAYS; DESK STANDS AND HOLDERS FOR HOLDING STATIONERY AND OFFICE IMPLEMENTS; PRINTED INSTRUCTIONAL AND TEACHING MATERIALS, ALL IN THE FIELDS OF TELECOMMUNICATIONS, INFORMATION TECHNOLOGY, SAFETY, NEWS, SPORTS, ENTERTAINMENT, CULTURE, BUSINESS AND FINANCE, WEATHER AND TRAVEL; BOOKMARKERS; STENCILS; SCRATCH PICTURES; PVC STICKERS; BLACKBOARDS; CHALK STICKS; ADHESIVES FOR STATIONERY OR HOUSEHOLD PURPOSES; DRAWING AND PAINTING MATERIALS, NAMELY, PENCILS, DRAWING PENCILS, PENS, DRAWING PENS, PAINT TRAYS, PAINTING SETS FOR ARTISTS, PAINTING SETS FOR CHILDREN, ARTS AND CRAFT PAINT KITS, AND PENCIL CASES; NON-MAGNETICALLY ENCODED PREPAID TELEPHONE CALLING CARDS (U.S. CLS. 2, 5, 22, 23, 29, 37, 38 AND 50).

FLORENTINA BLANDU, EXAMINING ATTORNEY

CLASS 16—(Continued).

SN 78-494,437. MEADWESTVACO CORPORATION, STAMFORD, CT. FILED 10-5-2004.

CLASS 16—(Continued).

SN 78-494,735. THE GLIDDEN COMPANY, STRONGSVILLE, OH. FILED 10-5-2004.

TRULOCK

Glidden Xpressions

THE MARK CONSISTS OF STANDARD CHARACTERS WITHOUT CLAIM TO ANY PARTICULAR FONT, STYLE, SIZE, OR COLOR.

OWNER OF U.S. REG. NOS. 1,642,055 AND 1,927,684. FOR BINDERS (U.S. CLS. 2, 5, 22, 23, 29, 37, 38 AND 50).

STACY WAHLBERG, EXAMINING ATTORNEY

THE MARK CONSISTS OF STANDARD CHARACTERS WITHOUT CLAIM TO ANY PARTICULAR FONT, STYLE, SIZE, OR COLOR.

FOR PRINTED MATTER, NAMELY, PAINT COLOR CARDS CONTAINING ADHESIVE ON ONE SIDE FOR ATTACHMENT TO SURFACES (U.S. CLS. 2, 5, 22, 23, 29, 37, 38 AND 50).

BARBARA A. LOUGHRAN, EXAMINING ATTORNEY

SN 78-494,609. PUBLISHING GROUP OF AMERICA, INC., FRANKLIN, TN. FILED 10-5-2004.

SN 78-495,311. PETSMART STORE SUPPORT GROUP, INC., PHOENIX, AZ. FILED 10-6-2004.

**AMERICAN PROFILE
HOMETOWN RECIPES**

SURE-FIT ELASTIC

THE MARK CONSISTS OF STANDARD CHARACTERS WITHOUT CLAIM TO ANY PARTICULAR FONT, STYLE, SIZE, OR COLOR.

NO CLAIM IS MADE TO THE EXCLUSIVE RIGHT TO USE "AMERICAN" AND "RECIPES", APART FROM THE MARK AS SHOWN.

FOR PRINTED MATERIALS, NAMELY, A SERIES OF RECIPE BOOKS, RECIPE BOOKLETS AND COOK BOOKS (U.S. CLS. 2, 5, 22, 23, 29, 37, 38 AND 50).

FIRST USE 5-0-2004; IN COMMERCE 5-0-2004.
MELISSA VALLILLO, EXAMINING ATTORNEY

THE MARK CONSISTS OF STANDARD CHARACTERS WITHOUT CLAIM TO ANY PARTICULAR FONT, STYLE, SIZE, OR COLOR.

NO CLAIM IS MADE TO THE EXCLUSIVE RIGHT TO USE "ELASTIC", APART FROM THE MARK AS SHOWN.

FOR CAT LITTER PAN LINERS COMPRISED OF PLASTIC AND ELASTIC (U.S. CLS. 2, 5, 22, 23, 29, 37, 38 AND 50).

JOHN DWYER, EXAMINING ATTORNEY

CLASS 16—(Continued).

SN 78-495,453. RLJ BASKETBALL, LLC, CHARLOTTE, NC. FILED 10-6-2004.



THE MARK CONSISTS OF THE HEAD OF A BOBCAT OVER A BASKETBALL.

FOR PUBLICATIONS AND PRINTED MATTER, NAMELY BASKETBALL TRADING CARDS, TRADING CARDS, STICKERS, DECALS, COMMEMORATIVE BASKETBALL STAMPS, COLLECTIBLE CARDBOARD TRADING DISCS, MEMO BOARDS, CLIPBOARDS, PAPER COASTERS, POST CARDS, PLACE MATS OF PAPER, NOTE CARDS, PLAYING CARDS, MEMO PADS, NOTE PADS, BALL POINT PENS, RUBBER BANDS, PENCILS, PEN AND PAPER HOLDERS, DESKTOP DOCUMENT STANDS, SCRAP BOOKS, RUBBER STAMPS, PAPER BANNERS AND FLAGS, BOOK-MARKS, 3-RING BINDERS, STATIONERY FOLDERS, WIREBOUND NOTEBOOKS, PORTFOLIO NOTEBOOKS, UNMOUNTED AND MOUNTED PHOTOGRAPHS, POSTERS, CALENDARS, BUMPER STICKERS, BOOK COVERS, WRAPPING PAPER, CHILDREN'S ACTIVITY BOOKS, CHILDREN'S COLORING BOOKS, STATISTICAL BOOKS, GUIDE BOOKS, AND REFERENCE BOOKS IN THE FIELD OF BASKETBALL, MAGAZINES IN THE FIELD OF BASKETBALL, CATALOGS FEATURING BASKETBALL, COMMEMORATIVE GAME AND SOUVENIR PROGRAMS, PAPER PENNANTS, STATIONERY, STATIONERY-TYPE PORTFOLIOS, POST CARDS, INVITATION CARDS, CERTIFICATES, GREETING CARDS, CHRISTMAS CARDS, HOLIDAY CARDS, STATISTICAL SHEETS FOR BASKETBALL TOPICS, NEWSLETTERS, BROCHURES, PAMPHLETS, AND GAME SCHEDULES IN THE FIELD OF BASKETBALL, BANK CHECKS, CHECK BOOK COVERS, CHECK BOOK HOLDERS, CREDIT CARDS AND TELEPHONE CALLING CARDS NOT MAGNETICALLY ENCODED; LUNCH BAGS (U.S. CLS. 2, 5, 22, 23, 29, 37, 38 AND 50).

RONALD AIKENS, EXAMINING ATTORNEY

CLASS 16—(Continued).

SN 78-495,482. ABC DEVELOPMENT, INC. OF CENTRAL FLORIDA, WINTER PARK, FL. FILED 10-6-2004.

TINY PRINCESS

THE MARK CONSISTS OF STANDARD CHARACTERS WITHOUT CLAIM TO ANY PARTICULAR FONT, STYLE, SIZE, OR COLOR.

FOR BOOKS, NAMELY, BABY BOOKS, TODDLER BOOKS, CHILDREN'S BOOKS (U.S. CLS. 2, 5, 22, 23, 29, 37, 38 AND 50).

ANNE MADDEN, EXAMINING ATTORNEY

SN 78-495,552. HERITAGE FINANCIAL LIMITED OF JACKSONVILLE, LLLP, JACKSONVILLE, FL. FILED 10-6-2004.

THE LESS I DO THE MORE I MAKE

THE MARK CONSISTS OF STANDARD CHARACTERS WITHOUT CLAIM TO ANY PARTICULAR FONT, STYLE, SIZE, OR COLOR.

FOR PUBLICATIONS, NAMELY, GUIDEBOOKS, DIRECTORIES, NEWSLETTERS, MANUALS, PRINTED INSTRUCTIONAL AND TEACHING MATERIALS, IN THE FIELD OF REAL ESTATE INVESTMENTS, NAMELY, HOME STUDY INSTRUCTION AND TRAINING IN BUYING AND SELLING REAL ESTATE FOR ACHIEVING PERSONAL WEALTH, INFORMATION AND INTERNET MARKETING ON NEW PRODUCTS AND PRODUCT LICENSING (U.S. CLS. 2, 5, 22, 23, 29, 37, 38 AND 50).

FIRST USE 12-0-1995; IN COMMERCE 12-0-1995.

REBECCA GAN, EXAMINING ATTORNEY

CLASS 16—(Continued).

SN 78-495,571. ABC DEVELOPMENT, INC. OF CENTRAL FLORIDA, WINTER PARK, FL. FILED 10-6-2004.

CLASS 16—(Continued).

SN 78-496,215. LITTLE BIG MOUTH LLC, WHITE PLAINS, NY. FILED 10-7-2004.

TAG-IT

DOCTOR QUACK

THE MARK CONSISTS OF STANDARD CHARACTERS WITHOUT CLAIM TO ANY PARTICULAR FONT, STYLE, SIZE, OR COLOR.

FOR BOOKS, NAMELY, BABY BOOKS, TODDLER BOOKS, CHILDREN'S BOOKS (U.S. CLS. 2, 5, 22, 23, 29, 37, 38 AND 50).

DAWN FELDMAN, EXAMINING ATTORNEY

THE MARK CONSISTS OF STANDARD CHARACTERS WITHOUT CLAIM TO ANY PARTICULAR FONT, STYLE, SIZE, OR COLOR.

FOR SERIES OF CHILDREN'S BOOKS (U.S. CLS. 2, 5, 22, 23, 29, 37, 38 AND 50).

GENE MACIOL, EXAMINING ATTORNEY

SN 78-496,375. SUNTRUST OF TRI-STATE, INC, BRIDGEPORT, CT. FILED 10-7-2004.

SN 78-495,573. JOHNSON, JEFFREY O, DES MOINES, WA. FILED 10-6-2004.

TILT

**golden minutes
phonecard**

THE MARK CONSISTS OF STANDARD CHARACTERS WITHOUT CLAIM TO ANY PARTICULAR FONT, STYLE, SIZE, OR COLOR.

FOR TRADING CARDS WITH A POKER THEME (U.S. CLS. 2, 5, 22, 23, 29, 37, 38 AND 50).

DAWN FELDMAN, EXAMINING ATTORNEY

THE MARK CONSISTS OF STANDARD CHARACTERS WITHOUT CLAIM TO ANY PARTICULAR FONT, STYLE, SIZE, OR COLOR.

NO CLAIM IS MADE TO THE EXCLUSIVE RIGHT TO USE "MINUTES PHONECARD", APART FROM THE MARK AS SHOWN.

FOR PREPAID TELEPHONE CALLING CARDS, NOT MAGNETICALLY ENCODED (U.S. CLS. 2, 5, 22, 23, 29, 37, 38 AND 50).

MITCHELL FRONT, EXAMINING ATTORNEY

CLASS 16—(Continued).

SN 78-496,937. HUMANA INC., LOUISVILLE, KY. FILED 10-8-2004.

PLANPALS

THE MARK CONSISTS OF STANDARD CHARACTERS WITHOUT CLAIM TO ANY PARTICULAR FONT, STYLE, SIZE, OR COLOR.

FOR MAGAZINE, NEWSLETTER, AND POSTERS IN THE FIELDS OF HEALTH CARE, DENTAL, AND VISION SERVICES AND PLANS; EDUCATIONAL PUBLICATIONS, NAMELY, TRAINING MANUALS IN THE FIELDS OF HEALTH CARE, DENTAL, AND VISION SERVICES AND PLANS (U.S. CLS. 2, 5, 22, 23, 29, 37, 38 AND 50).

FIRST USE 6-30-2003; IN COMMERCE 6-30-2003.
ADA HAN, EXAMINING ATTORNEY

SN 78-496,968. HUMANA INC., LOUISVILLE, KY. FILED 10-8-2004.



PlanPALS

Peers Assisting and Lending Support

THE MARK CONSISTS OF A HIGHLY STYLIZED COMPASS SUPERIMPOSED OVER A CIRCLE WITH THE LITERAL ELEMENT "PLANPROFESSOR" APPEARING OUTSIDE THE BOTTOM RIGHT QUADRANT OF THE CIRCLE. THE WORDS PLANPALS APPEAR TO THE RIGHT OF THE COMPASS DESIGN ELEMENT IN A LARGE STYLIZED FONT, UNDER WHICH ARE THE WORDS "PEERS ASSISTING AND LENDING SUPPORT".

FOR MAGAZINE, NEWSLETTER, AND POSTERS IN THE FIELDS OF HEALTH CARE, DENTAL, AND VISION SERVICES AND PLANS; EDUCATIONAL PUBLICATIONS, NAMELY, TRAINING MANUALS IN THE FIELDS OF HEALTH CARE, DENTAL, AND VISION SERVICES AND PLANS (U.S. CLS. 2, 5, 22, 23, 29, 37, 38 AND 50).

FIRST USE 6-30-2003; IN COMMERCE 6-30-2003.
ELLEN BURNS, EXAMINING ATTORNEY

CLASS 16—(Continued).

SN 78-497,186. EUREKA HOUSE, INC., WINDSOR, CA. FILED 10-8-2004.

PRESIDIO SOCIAL CLUB

THE MARK CONSISTS OF STANDARD CHARACTERS WITHOUT CLAIM TO ANY PARTICULAR FONT, STYLE, SIZE, OR COLOR.

FOR PRINTED MATTER, NAMELY BOOKS, BOOKLETS, NEWSLETTERS AND MAGAZINES IN THE FIELDS OF FOOD, RESTAURANTS AND THE FOOD SERVICE INDUSTRY; CALENDARS, NOTEPADS, RECIPE CARDS AND DATE BOOKS (U.S. CLS. 2, 5, 22, 23, 29, 37, 38 AND 50).

KEVIN D'INALLO, EXAMINING ATTORNEY

SN 78-497,196. DALTON, PATRICIA, WASHINGTON, DC. FILED 10-8-2004.

FROM HELL

THE MARK CONSISTS OF STANDARD CHARACTERS WITHOUT CLAIM TO ANY PARTICULAR FONT, STYLE, SIZE, OR COLOR.

FOR SERIES OF NON-FICTION BOOKS CONTAINING HUMAN INTEREST STORIES AND STORIES CONCERNING VARIOUS CATEGORIES OF PEOPLE, PLACES, ANIMALS AND THINGS (U.S. CLS. 2, 5, 22, 23, 29, 37, 38 AND 50).

MICHAEL SOUDERS, EXAMINING ATTORNEY

CLASS 16—(Continued).

SN 78-497,216. SHARKS MINOR HOLDINGS, LLC, SAN JOSE, CA. FILED 10-8-2004.



FOR PAPER GOODS, NAMELY, TRADING CARDS, COLORING BOOKS, PICTURES, PENS, NOTEBOOKS, FOLDERS, STICKERS AND PENS AND PENCILS (U.S. CLS. 2, 5, 22, 23, 29, 37, 38 AND 50).
TRACY FLETCHER, EXAMINING ATTORNEY

SN 78-497,228. THE ASSOCIATION OF BONE AND JOINT SURGEONS, ROSEMONT, IL. FILED 10-8-2004.



OWNER OF U.S. REG. NOS. 2,575,216 AND 2,729,220.
NO CLAIM IS MADE TO THE EXCLUSIVE RIGHT TO USE "ORTHOPAEDIC DEVICE REFERENCE", APART FROM THE MARK AS SHOWN.
THE MARK CONSISTS OF, IN PART, A BENT TREE TO WHICH A SPLINT IS ATTACHED.
SEC. 2(F) AS TO ASSOCIATION OF BONE AND JOINT SURGEONS.
FOR ORTHOPAEDIC DEVICE REFERENCE BOOKS (U.S. CLS. 2, 5, 22, 23, 29, 37, 38 AND 50).
IRA J. GOODSAD, EXAMINING ATTORNEY

CLASS 16—(Continued).

SN 78-497,424. HACKETT, EARNESTINE, JACKSON, MS. FILED 10-9-2004.

Letter to a Friend Publishing

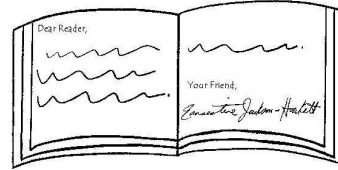

Where each book is written like writing a letter to a friend.

NO CLAIM IS MADE TO THE EXCLUSIVE RIGHT TO USE "PUBLISHING", APART FROM THE MARK AS SHOWN.

THE MARK CONSISTS OF THE BUSINESS NAME "LETTER TO A FRIEND PUBLISHING"; AN ILLUSTRATION OF AN OPEN BOOK UNDER THE BUSINESS NAME WITH THE WORDS AND PUNCTUATION "DEAR READER," AND SCRIBBLE LINES ON THE LEFT PAGE; SCRIBBLE LINES, THE WORDS AND PUNCTUATION "YOUR FRIEND," AND THE BUSINESS OWNER, EARNESTINE JACKSON-HACKETT'S SIGNATURE ON THE RIGHT PAGE OF THE OPEN BOOK; AND THE BUSINESS SLOGAN, "WHERE EACH BOOK IS WRITTEN LIKE WRITING A LETTER TO A FRIEND." UNDER THE ILLUSTRATION OF THE OPEN BOOK.

FOR SELF-HELP BOOKS THAT TEACH READERS HOW TO IMPROVE THEIR MENTAL, EMOTIONAL, PHYSICAL, SPIRITUAL, INTELLECTUAL, PROFESSIONAL, FINANCIAL, AND SOCIAL STATES (U.S. CLS. 2, 5, 22, 23, 29, 37, 38 AND 50).
RONALD AIKENS, EXAMINING ATTORNEY

SN 78-497,553. DULIN, STEVE, PLANO, TX. FILED 10-11-2004.

God's Ways Work

THE MARK CONSISTS OF STANDARD CHARACTERS WITHOUT CLAIM TO ANY PARTICULAR FONT, STYLE, SIZE, OR COLOR.
NO CLAIM IS MADE TO THE EXCLUSIVE RIGHT TO USE "GOD'S", APART FROM THE MARK AS SHOWN.
FOR RELIGIOUS PRINTED PUBLICATIONS, NAMELY, MAGAZINES, NEWSLETTERS, BOOKS, NEWSPAPERS, BROCHURES, AND PAMPHLETS (U.S. CLS. 2, 5, 22, 23, 29, 37, 38 AND 50).
ALEX KEAM, EXAMINING ATTORNEY

CLASS 16—(Continued).

SN 78-497,690. TECHKO, INC., LAGUNA HILLS, CA. FILED 10-11-2004.

RANTECH

THE MARK CONSISTS OF STANDARD CHARACTERS WITHOUT CLAIM TO ANY PARTICULAR FONT, STYLE, SIZE, OR COLOR.

FOR PAPER SHREDDERS (U.S. CLS. 2, 5, 22, 23, 29, 37, 38 AND 50).

BRIAN PINO, EXAMINING ATTORNEY

SN 78-498,018. MIDWEST SUBURBAN PUBLISHING, INC., TINLEY PARK, IL. FILED 10-11-2004.

Daily Southtown

NO CLAIM IS MADE TO THE EXCLUSIVE RIGHT TO USE DAILY, APART FROM THE MARK AS SHOWN.

FOR NEWSPAPERS FOR GENERAL CIRCULATION (U.S. CLS. 2, 5, 22, 23, 29, 37, 38 AND 50).

FIRST USE 5-1-2001. THE MARK WAS FIRST USED ANYWHERE IN A DIFFERENT FORM OTHER THAN THAT SOUGHT TO BE REGISTERED ON 06/01/1993.; IN COMMERCE 5-1-2001, THE MARK WAS FIRST USED IN COMMERCE IN A DIFFERENT FORM OTHER THAN THAT SOUGHT TO BE REGISTERED ON 06/01/1993..

PAULA MAHONEY, EXAMINING ATTORNEY

SN 78-498,068. MEADWESTVACO CORPORATION, STAMFORD, CT. FILED 10-12-2004.

expandables

OWNER OF U.S. REG. NOS. 1,498,600 AND 2,694,615. FOR FILE FOLDERS, POCKET FILES, FILE JACKETS, FILE ENVELOPES, PADFOLIOS, STATIONERY-TYPE PORTFOLIOS (U.S. CLS. 2, 5, 22, 23, 29, 37, 38 AND 50).

FIRST USE 11-10-2003; IN COMMERCE 11-10-2003.

JOSETTE BEVERLY, EXAMINING ATTORNEY

CLASS 16—(Continued).

SN 78-498,243. BROWN, KATHRYN J., PASADENA, CA. FILED 10-12-2004.

Cook Up A Book

THE MARK CONSISTS OF STANDARD CHARACTERS WITHOUT CLAIM TO ANY PARTICULAR FONT, STYLE, SIZE, OR COLOR.

FOR PRINTED MATERIALS FOR INSTRUCTIONAL AND EDUCATIONAL PURPOSES FOR USE IN THE FIELD OF CHILD DEVELOPMENT (U.S. CLS. 2, 5, 22, 23, 29, 37, 38 AND 50).

FIRST USE 3-0-1993; IN COMMERCE 6-0-1993.

EVELYN BRADLEY, EXAMINING ATTORNEY

SN 78-498,348. PENTECH INTERNATIONAL, INC., MALIBU, CA. FILED 10-12-2004.

FOCUS

THE MARK CONSISTS OF STANDARD CHARACTERS WITHOUT CLAIM TO ANY PARTICULAR FONT, STYLE, SIZE, OR COLOR.

FOR WRITING INSTRUMENTS, NAMELY, PENS, PENCILS, MECHANICAL PENCILS AND MARKING PENS (U.S. CLS. 2, 5, 22, 23, 29, 37, 38 AND 50).

FIRST USE 4-30-1997; IN COMMERCE 4-30-1997.

CIMMERIAN COLEMAN, EXAMINING ATTORNEY

CLASS 16—(Continued).

SN 78-498,435. FRANCIS, MARILLYN S, EL PASO, TX. FILED 10-12-2004.

CLASS 16—(Continued).

SN 78-498,768. MIDWEST SUBURBAN PUBLISHING, INC., TINLEY PARK, IL. FILED 10-13-2004.

Flip Over Phonics

DAILY SOUTHTOWN

THE MARK CONSISTS OF STANDARD CHARACTERS WITHOUT CLAIM TO ANY PARTICULAR FONT, STYLE, SIZE, OR COLOR.

NO CLAIM IS MADE TO THE EXCLUSIVE RIGHT TO USE "PHONICS", APART FROM THE MARK AS SHOWN.

FOR EDUCATIONAL BOOKS FEATURING INSTRUCTION IN PHONICS AND READING FOR YOUNG CHILDREN (U.S. CLS. 2, 5, 22, 23, 29, 37, 38 AND 50).

FIRST USE 1-1-2003; IN COMMERCE 10-1-2004.

HEATHER THOMPSON, EXAMINING ATTORNEY

THE MARK CONSISTS OF STANDARD CHARACTERS WITHOUT CLAIM TO ANY PARTICULAR FONT, STYLE, SIZE, OR COLOR.

NO CLAIM IS MADE TO THE EXCLUSIVE RIGHT TO USE DAILY, APART FROM THE MARK AS SHOWN.

FOR NEWSPAPERS FOR GENERAL CIRCULATION (U.S. CLS. 2, 5, 22, 23, 29, 37, 38 AND 50).

FIRST USE 6-1-1993; IN COMMERCE 6-1-1993.

PAULA MAHONEY, EXAMINING ATTORNEY

SN 78-498,709. LITTLE, MARIE, LAS VEGAS, NV. FILED 10-12-2004.

SN 78-498,770. PURPLINK, LLC, LEESBURG, VA. FILED 10-13-2004.

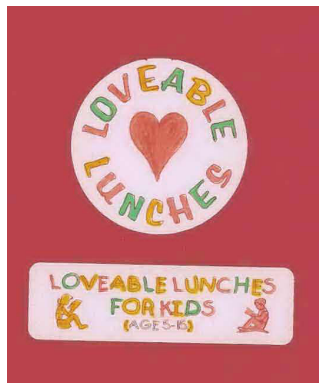

NO CLAIM IS MADE TO THE EXCLUSIVE RIGHT TO USE "LUNCHES" AND "FOR KIDS (AGE 5- 15)", APART FROM THE MARK AS SHOWN.

THE COLOR(S) RED, GREEN, YELLOW AND WHITE IS/ ARE CLAIMED AS A FEATURE OF THE MARK.

THE BACKGROUND OF THE MARK IS IN THE COLOR RED. SUPERIMPOSED ON THE RED BACKGROUND ARE A WHITE CIRCLE AND A WHITE RECTANGLE. THE TERM LOVEABLE LUNCHES, IN THE COLORS RED, YELLOW AND GREEN, IS SET ON TOP OF THE WHITE CIRCLE. THE TERM LOVEABLE LUNCHES FOR KIDS (AGES 5-15), IN THE COLORS RED, YELLOW AND GREEN, IS SET ON TOP OF THE WHITE RECTANGLE. THE LITTLE GIRL AND BOY ON THE WHITE RECTANGLE ARE IN YELLOW AND RED, RESPECTIVELY

FOR STATIONERY DESIGNED FOR PARENTS TO GIVE TO CHILDREN (U.S. CLS. 2, 5, 22, 23, 29, 37, 38 AND 50).

GWEN STOKOLS, EXAMINING ATTORNEY

THE COLORS PURPLE, RED, AND BLACK ARE CLAIMED AS A FEATURE OF THE MARK.

THE COLOR PURPLE IS USED ON THE LETTERS AND ON THE CAP PORTION OF THE PEN DESIGN. THE COLOR RED IS USED ON BODY OF THE PEN DESIGN AND THE COLOR BLACK IS USED TO OUTLINE THE DRAWING DESIGN.

THE MARK CONSISTS OF STYLIZED WORD "PURPLINK" WITH A HAND-DRAWN INK PEN DRAWING IN THE LETTER "I".

FOR CARDS WITH UNIVERSAL GREETINGS, NOTE-CARDS, OCCASION CARDS (U.S. CLS. 2, 5, 22, 23, 29, 37, 38 AND 50).

FIRST USE 4-1-2004; IN COMMERCE 4-1-2004.

CURTIS FRENCH, EXAMINING ATTORNEY

CLASS 16—(Continued).

SN 78-499,096. ELEVATION ENTERTAINMENT, LLC, LOS ANGELES, CA. FILED 10-13-2004.

CLASS 16—(Continued).

SN 78-499,618. TYWIN COMMUNICATIONS, L.L.C., HIGHLAND PARK, NJ. FILED 10-14-2004.

Orchestrated

THE MARK CONSISTS OF STANDARD CHARACTERS WITHOUT CLAIM TO ANY PARTICULAR FONT, STYLE, SIZE, OR COLOR.

FOR POSTERS AND PHOTOGRAPHS (U.S. CLS. 2, 5, 22, 23, 29, 37, 38 AND 50).

ESTHER BELENKER, EXAMINING ATTORNEY

Contagion

THE MARK CONSISTS OF STANDARD CHARACTERS WITHOUT CLAIM TO ANY PARTICULAR FONT, STYLE, SIZE, OR COLOR.

FOR PRINTED PUBLICATIONS, NAMELY, PEER-REVIEWED MEDICAL MAGAZINES, JOURNALS, NEWSLETTERS, FEATURE REPORTS, MONOGRAPHS AND SUPPLEMENTS IN THE FIELDS OF HIV AND INFECTIOUS DISEASE RESEARCH (U.S. CLS. 2, 5, 22, 23, 29, 37, 38 AND 50).

FIRST USE 9-1-2004; IN COMMERCE 9-1-2004.

ADA HAN, EXAMINING ATTORNEY

SN 78-499,792. SENSIBLE FOODS LLC, PETALUMA, CA. FILED 10-14-2004.

SN 78-499,194. REVIEW PUBLISHING LIMITED PARTNERSHIP, PHILADELPHIA, PA. FILED 10-13-2004.

Sensible Foods

CONNECTIONS WEEKLY

THE MARK CONSISTS OF STANDARD CHARACTERS WITHOUT CLAIM TO ANY PARTICULAR FONT, STYLE, SIZE, OR COLOR.

NO CLAIM IS MADE TO THE EXCLUSIVE RIGHT TO USE "WEEKLY", APART FROM THE MARK AS SHOWN, FOR NEWSPAPERS FOR GENERAL CIRCULATION (U.S. CLS. 2, 5, 22, 23, 29, 37, 38 AND 50).

FIRST USE 9-29-2004; IN COMMERCE 9-29-2004.

ASMAT KHAN, EXAMINING ATTORNEY

THE MARK CONSISTS OF STANDARD CHARACTERS WITHOUT CLAIM TO ANY PARTICULAR FONT, STYLE, SIZE, OR COLOR.

OWNER OF U.S. REG. NO. 2,861,273.

NO CLAIM IS MADE TO THE EXCLUSIVE RIGHT TO USE "FOOD", APART FROM THE MARK AS SHOWN.

FOR MAGAZINES, LEAFLETS, BROCHURES, AND NEWSLETTERS FEATURING FOOD, HEALTH AND NUTRITION; CATALOGS FEATURING FOOD, SNACKS, NUTRITIONAL SUPPLEMENTS, AND GENERAL NUTRITIONAL PRODUCTS (U.S. CLS. 2, 5, 22, 23, 29, 37, 38 AND 50).

JASON LOTT, EXAMINING ATTORNEY

CLASS 16—(Continued).

SN 78-500,038. U-HAUL INTERNATIONAL, INC., PHOENIX, AZ. FILED 10-14-2004.

ENVIRO-BUBBLE

THE MARK CONSISTS OF STANDARD CHARACTERS WITHOUT CLAIM TO ANY PARTICULAR FONT, STYLE, SIZE, OR COLOR.

FOR BUBBLE SACKS AND WRAP FOR WRAPPING AND PACKAGING (U.S. CLS. 2, 5, 22, 23, 29, 37, 38 AND 50).

FIRST USE 2-1-1991; IN COMMERCE 2-1-1991.
LINDA POWELL, EXAMINING ATTORNEY

CLASS 16—(Continued).

SN 78-501,153. INTERNATIONAL DATA GROUP, INC., FRAMINGHAM, MA. FILED 10-18-2004.

BUYORGANIC!

THE MARK CONSISTS OF STANDARD CHARACTERS WITHOUT CLAIM TO ANY PARTICULAR FONT, STYLE, SIZE, OR COLOR.

FOR PRINT PUBLICATIONS, NAMELY NEWSLETTERS, MAGAZINES AND SUPPLEMENTS SOLD THEREWITH, JOURNALS, AND POSTERS ALL FEATURING INFORMATION RELATING TO THE HEALTHY LIVING INDUSTRY (U.S. CLS. 2, 5, 22, 23, 29, 37, 38 AND 50).

FIRST USE 9-30-2002; IN COMMERCE 9-30-2002.
ALINA MORRIS, EXAMINING ATTORNEY

SN 78-501,824. THE ANTIOCH COMPANY, YELLOW SPRINGS, OH. FILED 10-19-2004.

SN 78-500,213. PROVIDENT LIVING CENTER, OREM, UT. FILED 10-14-2004.

Provident Living

THE MARK CONSISTS OF STANDARD CHARACTERS WITHOUT CLAIM TO ANY PARTICULAR FONT, STYLE, SIZE, OR COLOR.

FOR EDUCATIONAL PUBLICATIONS, NAMELY, TRAINING MANUALS IN THE FIELD OF SELF-RELIANT LIVING (U.S. CLS. 2, 5, 22, 23, 29, 37, 38 AND 50).

FIRST USE 1-15-1993; IN COMMERCE 2-1-1993.
JOHN DWYER, EXAMINING ATTORNEY

POWER

THE MARK CONSISTS OF STANDARD CHARACTERS WITHOUT CLAIM TO ANY PARTICULAR FONT, STYLE, SIZE, OR COLOR.

OWNER OF U.S. REG. NO. 2,490,927.
FOR ORGANIZATION SYSTEM, COMPRISED OF DIVIDERS AND INDIVIDUAL COMPARTMENTS FOR STORAGE AND ORGANIZING PHOTOGRAPHS AND NEGATIVES, ALL MADE OF POLYPROPYLENE MATERIAL (U.S. CLS. 2, 5, 22, 23, 29, 37, 38 AND 50).

FIRST USE 8-8-2004; IN COMMERCE 8-8-2004.
TARAH HARDY, EXAMINING ATTORNEY

CLASS 16—(Continued).

SN 78-501,972. INFO PROJECT, INC., THE, DBA THEINFO-PRO, NEW YORK, NY. FILED 10-19-2004.

CLASS 16—(Continued).

SN 78-504,321. CENTRAL VALLEY LABELS, INC., FRESNO, CA. FILED 10-22-2004.

TECHNOLOGY HEAT INDEX

THE MARK CONSISTS OF STANDARD CHARACTERS WITHOUT CLAIM TO ANY PARTICULAR FONT, STYLE, SIZE, OR COLOR.

NO CLAIM IS MADE TO THE EXCLUSIVE RIGHT TO USE "TECHNOLOGY" AND "INDEX", APART FROM THE MARK AS SHOWN.

FOR PRINTED MATERIALS, NAMELY, MARKET INTELLIGENCE REPORTS FOR THE INFORMATION TECHNOLOGY INDUSTRY (U.S. CLS. 2, 5, 22, 23, 29, 37, 38 AND 50).

FIRST USE 7-18-2003; IN COMMERCE 7-18-2003.
TIMOTHY FINNEGAN, EXAMINING ATTORNEY

RIPPIN' FREAKS

THE MARK CONSISTS OF STANDARD CHARACTERS WITHOUT CLAIM TO ANY PARTICULAR FONT, STYLE, SIZE, OR COLOR.

FOR DECALS FOR USE ON AUTOMOBILES, TRUCKS, BOATS, MOTORCYCLES, RECREATIONAL VEHICLES, AND SPORTING EQUIPMENT SUCH AS BOOGIE BOARDS AND SKATEBOARDS (U.S. CLS. 2, 5, 22, 23, 29, 37, 38 AND 50).

FIRST USE 10-21-2004; IN COMMERCE 10-21-2004.
FRED MANDIR, EXAMINING ATTORNEY

SN 78-503,366. WAGNER, L. KATHRYN, AVENTURA, FL. AND DAVIDSON, MELODY B., PRAIRIE VILLAGE, KS. FILED 10-21-2004.

SN 78-504,334. THE NORTH BEACH DIET, INC., TAMPA, FL. FILED 10-22-2004.

THE NORTH BEACH DIET

DYI

THE MARK CONSISTS OF STANDARD CHARACTERS WITHOUT CLAIM TO ANY PARTICULAR FONT, STYLE, SIZE, OR COLOR.

FOR PAPER FURNITURE TEMPLATES FOR POSITIONING FURNITURE ITEMS WITHIN A ROOM (U.S. CLS. 2, 5, 22, 23, 29, 37, 38 AND 50).

FIRST USE 10-21-2004; IN COMMERCE 10-21-2004.
CHRISIE B. KING, EXAMINING ATTORNEY

THE MARK CONSISTS OF STANDARD CHARACTERS WITHOUT CLAIM TO ANY PARTICULAR FONT, STYLE, SIZE, OR COLOR.

NO CLAIM IS MADE TO THE EXCLUSIVE RIGHT TO USE "DIET", APART FROM THE MARK AS SHOWN.

FOR PAPER GOODS AND PRINTED MATTER, NAMELY, PAMPHLETS, BROCHURES, POSTERS AND POSTCARDS, CARTOON STRIPS AND PRINTS, ALL IN THE FIELD OF HUMOR, PARODY AND SATIRE PERTAINING TO COOKING, RECIPES, WEIGHT LOSS, DIETING, AND MENU PLANNING; CALENDARS; GREETING CARDS; RECIPE CARDS, RECIPE BOOKS, PERIODICALS AND BOOKS, ALL IN THE FIELD OF HUMOR, PARODY AND SATIRE PERTAINING TO COOKING, RECIPES, WEIGHT LOSS, DIETING, AND MENU PLANNING. (U.S. CLS. 2, 5, 22, 23, 29, 37, 38 AND 50).

YONG KIM, EXAMINING ATTORNEY

CLASS 16—(Continued).

SN 78-504,975. SEAN CONWAY, INC., TIVERTON, RI. FILED 10-25-2004.

CULTIVATING LIFE

THE MARK CONSISTS OF STANDARD CHARACTERS WITHOUT CLAIM TO ANY PARTICULAR FONT, STYLE, SIZE, OR COLOR.

FOR ALMANACS; BOOKLETS; BOOKS; BULLETINS; CALENDARS; CIRCULARS; COLUMNS; EDUCATIONAL BOOKS; EDUCATIONAL PUBLICATIONS, NAMELY, CIRCULARS, TEXT BOOKS, WORKBOOKS, COLORING BOOKS; MAGAZINES; SYNDICATED ARTICLES, INFORMATIONAL FLYERS, SYNDICATED MAGAZINE ARTICLES, COLUMNS, SYNDICATED MAGAZINE SECTIONS AND FEATURES; NEWSLETTERS AND PAMPHLETS, ALL IN THE FIELDS OF HORTICULTURE AND GARDENING (U.S. CLS. 2, 5, 22, 23, 29, 37, 38 AND 50).

JULIE WATSON, EXAMINING ATTORNEY

CLASS 16—(Continued).

SN 78-507,691. JAKKS PACIFIC, INC., MALIBU, CA. FILED 10-28-2004.

SYNTECH

THE MARK CONSISTS OF STANDARD CHARACTERS WITHOUT CLAIM TO ANY PARTICULAR FONT, STYLE, SIZE, OR COLOR.

FOR WRITING INSTRUMENTS, NAMELY, PENS, PENCILS, MECHANICAL PENCILS AND MARKING PENS (U.S. CLS. 2, 5, 22, 23, 29, 37, 38 AND 50).

FIRST USE 4-30-2004; IN COMMERCE 4-30-2004.
HOWARD B. LEVINE, EXAMINING ATTORNEY

SN 78-508,371. HOWARD, GAIL, JESI, ITALY, FILED 10-29-2004.

SN 78-507,086. CENTER FOR BAPTIST HERITAGE & STUDIES, UNIVERSITY OF RICHMOND, VA. FILED 10-27-2004.



FOR CHILDREN'S MAGAZINE THAT TEACHES BAPTIST HERITAGE (U.S. CLS. 2, 5, 22, 23, 29, 37, 38 AND 50).

FIRST USE 9-14-2004; IN COMMERCE 10-15-2004.
KAREN BRACEY, EXAMINING ATTORNEY

JACKPOT BUSTER

THE MARK CONSISTS OF STANDARD CHARACTERS WITHOUT CLAIM TO ANY PARTICULAR FONT, STYLE, SIZE, OR COLOR.

NO CLAIM IS MADE TO THE EXCLUSIVE RIGHT TO USE "JACKPOT", APART FROM THE MARK AS SHOWN.

FOR PRINTED MATERIAL, NAMELY, BOOKS, BOOKLETS, PAMPHLETS, INFORMATIONAL CHARTS, NUMBER SELECTION CHARTS, AND WHEELING SYSTEM CHARTS RELATING TO INFORMATION, SYSTEMS AND ADVICE FOR PLAYING LOTTERIES (U.S. CLS. 2, 5, 22, 23, 29, 37, 38 AND 50).

LA TONIA FISHER, EXAMINING ATTORNEY

CLASS 16—(Continued).

SN 78-509,285. GOES LITHOGRAPHING COMPANY, CHICAGO, IL. FILED 11-1-2004.

CLASS 16—(Continued).

SN 78-509,985. DEUTSCHE TELEKOM AG, BONN, FED REP GERMANY, FILED 11-2-2004.

TeleWay

ROCKETLINE

THE MARK CONSISTS OF STANDARD CHARACTERS WITHOUT CLAIM TO ANY PARTICULAR FONT, STYLE, SIZE, OR COLOR.

PRIORITY CLAIMED UNDER SEC. 44(D) ON FED REP GERMANY APPLICATION NO. 30424197038, FILED 5-3-2004, REG. NO. 30424197, DATED 10-4-2004, EXPIRES 5-31-2014.

FOR PRINTED MATTER, NAMELY, TELEPHONE DIRECTORIES, SERIES OF BOOKS, NEWSLETTERS, PAMPHLETS, BROCHURES, MAGAZINES AND PAPERBACKS, ALL IN THE FIELD OF TELECOMMUNICATIONS; PRINTED AND STAMPED PLASTIC AND CARDBOARD GREETING, BLANK, NOTE, AND INDEX CARDS; NOTE PAPER AND ENVELOPES; NAMETAGS AND LABELS MADE FROM PAPER OR CARDBOARD; NOTEBOOKS; NOTE PADS; STATIONERY; PAPER, NAMELY, BOND PAPER AND ART PAPER; GIFT-WRAP PAPER; DIARIES; ADDRESS BOOKS; STUDENT CALENDARS; STAMP ALBUMS AND PHOTO-ALBUMS; FOLDERS FOR LETTERS AND LOOSE PAPERS; STATIONERY CLEAR HOLE TAB REINFORCEMENTS; RUBBER STAMPS AND IMPRESSION STAMPS; PAPER WEIGHTS; LETTER OPENERS; DRAWING AND UNGRADUATED RULERS; ERASERS; STAPLERS; PAPER CLIPS; BLOTTER PADS; DESK FILE TRAYS; DESK STANDS AND HOLDERS FOR HOLDING STATIONERY AND OFFICE IMPLEMENTS; PRINTED INSTRUCTIONAL AND TEACHING MATERIALS, ALL IN THE FIELDS OF TELECOMMUNICATIONS, INFORMATION TECHNOLOGY, SAFETY, NEWS, SPORTS, ENTERTAINMENT, CULTURE, BUSINESS AND FINANCE, WEATHER AND TRAVEL; BOOKMARKERS; STENCILS; SCRATCH PICTURES; PVC STICKERS; BLACKBOARDS; CHALK STICKS; ADHESIVES FOR STATIONERY OR HOUSEHOLD PURPOSES; DRAWING AND PAINTING MATERIALS, NAMELY, PENCILS, DRAWING PENCILS, PENS, DRAWING PENS, PAINT TRAYS, PAINTING SETS FOR ARTISTS, PAINTING SETS FOR CHILDREN, ARTS AND CRAFT PAINT KITS, AND PENCIL CASES; NON-MAGNETICALLY ENCODED PREPAID TELEPHONE CALLING CARDS (U.S. CLS. 2, 5, 22, 23, 29, 37, 38 AND 50).

THE MARK CONSISTS OF STANDARD CHARACTERS WITHOUT CLAIM TO ANY PARTICULAR FONT, STYLE, SIZE, OR COLOR.

FOR CALENDARS (U.S. CLS. 2, 5, 22, 23, 29, 37, 38 AND 50).

FIRST USE 1-1-1951; IN COMMERCE 1-1-1951.

TRACY FLETCHER, EXAMINING ATTORNEY

ALINA MORRIS, EXAMINING ATTORNEY

CLASS 16—(Continued).

SN 78-510,287. PHENOMENEWS CORPORATION, SOUTH-FIELD, MI. FILED 11-2-2004.



FOR NEWSPAPERS AND MAGAZINES IN THE FIELD OF NEW AGE SUBJECTS (U.S. CLS. 2, 5, 22, 23, 29, 37, 38 AND 50).

FIRST USE 5-12-1978; IN COMMERCE 5-12-1978.
JOHN LINCOSKI, EXAMINING ATTORNEY

CLASS 16—(Continued).

SN 78-513,472. FREEDOM COMMUNICATIONS, INC., DBA THE ORANGE COUNTY REGISTER, SANTA ANA, CA. FILED 11-8-2004.

**TAKE BACK THE
MORNING. EVERY
MORNING.**

SN 78-511,607. STEELMAN, MICHAEL JAMES, JR., SALINAS, CA. FILED 11-4-2004.

ScriPics

THE MARK CONSISTS OF STANDARD CHARACTERS WITHOUT CLAIM TO ANY PARTICULAR FONT, STYLE, SIZE, OR COLOR.

OWNER OF U.S. REG. NO. 2,891,992.
FOR NEWSPAPERS FOR GENERAL CIRCULATION (U.S. CLS. 2, 5, 22, 23, 29, 37, 38 AND 50).
FIRST USE 12-0-2004; IN COMMERCE 12-0-2004.
GINA FINK, EXAMINING ATTORNEY

THE MARK CONSISTS OF STANDARD CHARACTERS WITHOUT CLAIM TO ANY PARTICULAR FONT, STYLE, SIZE, OR COLOR.

FOR MOUNTED AND UNMOUNTED, MATTED AND UNMATTED, FRAMED AND UNFRAMED PHOTOGRAPHS (U.S. CLS. 2, 5, 22, 23, 29, 37, 38 AND 50).
FIRST USE 10-1-2003; IN COMMERCE 10-1-2003.
ALICIA COLLINS, EXAMINING ATTORNEY

SN 78-513,718. APPEL CREATIONS, LLC, CHESTERFIELD, MO. FILED 11-9-2004.

SN 78-511,961. REHABWORKS, LLC, HUNT VALLEY, MD. FILED 11-5-2004.

REHABWORKINGS

ANOTHER BRANCH

THE MARK CONSISTS OF STANDARD CHARACTERS WITHOUT CLAIM TO ANY PARTICULAR FONT, STYLE, SIZE, OR COLOR.

FOR NEWSLETTERS REGARDING PHYSICAL THERAPY, OCCUPATIONAL THERAPY AND REHABILITATION SERVICES (U.S. CLS. 2, 5, 22, 23, 29, 37, 38 AND 50).
FIRST USE 5-1-2003; IN COMMERCE 5-1-2003.
MARIA-VICTORIA SUAREZ, EXAMINING ATTORNEY

THE MARK CONSISTS OF STANDARD CHARACTERS WITHOUT CLAIM TO ANY PARTICULAR FONT, STYLE, SIZE, OR COLOR.

FOR PRINTED MATTER, NAMELY, MEMORY BOOKS (U.S. CLS. 2, 5, 22, 23, 29, 37, 38 AND 50).
ELISSA GARBER KON, EXAMINING ATTORNEY

CLASS 16—(Continued).

SN 78-515,358. HEALY, DAN, BLOOMINGDALE, NJ. FILED 11-11-2004.

CLASS 16—(Continued).

SN 78-516,609. INDEPENDENCE PUBLISHING LLC, BALTIMORE, MD. FILED 11-14-2004.

NOID

THE MARK CONSISTS OF STANDARD CHARACTERS WITHOUT CLAIM TO ANY PARTICULAR FONT, STYLE, SIZE, OR COLOR.

FOR GREETING CARDS, POSTCARDS, STICKERS, AND HEAT TRANSFER PAPER (U.S. CLS. 2, 5, 22, 23, 29, 37, 38 AND 50).

ADA HAN, EXAMINING ATTORNEY

Paper Doll

THE MARK CONSISTS OF STANDARD CHARACTERS WITHOUT CLAIM TO ANY PARTICULAR FONT, STYLE, SIZE, OR COLOR.

FOR MAGAZINE ABOUT SHOPPING (U.S. CLS. 2, 5, 22, 23, 29, 37, 38 AND 50).

ROBERT LAVACHE, EXAMINING ATTORNEY

SN 78-517,479. COMMERCIAL LAW LEAGUE OF AMERICA, CHICAGO, IL. FILED 11-16-2004.

SN 78-515,754. ENDLESS POSSIBILITIES PRODUCTIONS, INC., SANTA MONICA, CA. FILED 11-12-2004.

COUNSELOR IN A BOX

THE MARK CONSISTS OF STANDARD CHARACTERS WITHOUT CLAIM TO ANY PARTICULAR FONT, STYLE, SIZE, OR COLOR.

FOR PRINTED INSTRUCTIONAL AND TEACHING MATERIALS FEATURING SELF-HELP AND SELF ANALYSIS IN THE AREAS OF RELATIONSHIPS, MARRIAGE AND FAMILY; PRINTED INSTRUCTIONAL AND TEACHING MATERIALS, NAMELY, PRINTED EXERCISES AND GAMES FEATURING SELF-HELP AND SELF ANALYSIS IN THE AREAS OF RELATIONSHIPS, MARRIAGE AND FAMILY (U.S. CLS. 2, 5, 22, 23, 29, 37, 38 AND 50).

CHRISTOPHER ADKINS, EXAMINING ATTORNEY

DEBT3

THE MARK CONSISTS OF STANDARD CHARACTERS WITHOUT CLAIM TO ANY PARTICULAR FONT, STYLE, SIZE, OR COLOR.

FOR PRINTED PUBLICATIONS, NAMELY A MAGAZINE IN THE FIELD OF COMMERCIAL LAW, COMMERCIAL COLLECTIONS, BANKRUPTCY AND REORGANIZATION (U.S. CLS. 2, 5, 22, 23, 29, 37, 38 AND 50).

CATHERINE CAIN, EXAMINING ATTORNEY

CLASS 16—(Continued).

SN 78-517,921. HANLEY-WOOD, LLC, WASHINGTON, DC. FILED 11-16-2004.

CLASS 16—(Continued).

SN 78-519,233. THE TOPPS COMPANY, INC., NEW YORK, NY. FILED 11-18-2004.

RESIDENTIAL CONCRETE

THE MARK CONSISTS OF STANDARD CHARACTERS WITHOUT CLAIM TO ANY PARTICULAR FONT, STYLE, SIZE, OR COLOR.

FOR PERIODIC MAGAZINE FOR RESIDENTIAL ARCHITECTS, BUILDING DESIGNERS, CONCRETE CONTRACTORS AND CUSTOM HOME BUILDERS (U.S. CLS. 2, 5, 22, 23, 29, 37, 38 AND 50).

FIRST USE 7-1-2004; IN COMMERCE 7-1-2004.
INGRID C. EULIN, EXAMINING ATTORNEY

WACKYPAKS

THE MARK CONSISTS OF STANDARD CHARACTERS WITHOUT CLAIM TO ANY PARTICULAR FONT, STYLE, SIZE, OR COLOR.

OWNER OF U.S. REG. NOS. 852,416 AND 1,276,119.
FOR STICKERS HAVING HUMOROUS CONTENT AND ALBUMS THEREFOR (U.S. CLS. 2, 5, 22, 23, 29, 37, 38 AND 50).

KATHY DE JONGE, EXAMINING ATTORNEY

SN 78-518,353. MEADWESTVACO CORPORATION, STAMFORD, CT. FILED 11-17-2004.

MAIL 'N FILE

THE MARK CONSISTS OF STANDARD CHARACTERS WITHOUT CLAIM TO ANY PARTICULAR FONT, STYLE, SIZE, OR COLOR.

FOR ENVELOPE THAT CONVERTS INTO A FILE (U.S. CLS. 2, 5, 22, 23, 29, 37, 38 AND 50).

MICHELE SWAIN, EXAMINING ATTORNEY

SN 78-519,241. THE TOPPS COMPANY, INC., NEW YORK, NY. FILED 11-18-2004.

WACKYPAKS.COM

SN 78-519,057. FORTE COMMUNICATIONS, INC., TUCSON, AZ. FILED 11-18-2004.

SERVICE WITH A SMILE

THE MARK CONSISTS OF STANDARD CHARACTERS WITHOUT CLAIM TO ANY PARTICULAR FONT, STYLE, SIZE, OR COLOR.

FOR NEWSLETTERS IN THE FIELD OF REAL ESTATE AND GENERAL INTEREST (U.S. CLS. 2, 5, 22, 23, 29, 37, 38 AND 50).

ROBERT LAVACHE, EXAMINING ATTORNEY

THE MARK CONSISTS OF STANDARD CHARACTERS WITHOUT CLAIM TO ANY PARTICULAR FONT, STYLE, SIZE, OR COLOR.

OWNER OF U.S. REG. NOS. 852,416 AND 1,276,119.
FOR STICKERS HAVING HUMOROUS CONTENT AND ALBUMS THEREFOR (U.S. CLS. 2, 5, 22, 23, 29, 37, 38 AND 50).

KATHY DE JONGE, EXAMINING ATTORNEY

CLASS 16—(Continued).

SN 78-520,006. CANNON & ASSOCIATES, LLC, HUNT VALLEY, MD. FILED 11-19-2004.

POLARIS PULSE

THE MARK CONSISTS OF STANDARD CHARACTERS WITHOUT CLAIM TO ANY PARTICULAR FONT, STYLE, SIZE, OR COLOR.

FOR NEWSLETTERS REGARDING HOSPITAL AND HEALTH CARE FACILITIES MANAGEMENT AND CONSULTATION IN THE FIELDS OF MANAGING HOSPITALS AND HEALTH CARE FACILITIES (U.S. CLS. 2, 5, 22, 23, 29, 37, 38 AND 50).

FIRST USE 1-1-1996; IN COMMERCE 1-1-1996.
PAM WILLIS, EXAMINING ATTORNEY

CLASS 16—(Continued).

SN 78-521,064. INSIDE PUBLICATIONS, LLC, ATLANTA, GA. FILED 11-22-2004.

**inside
Cheerleading**

NO CLAIM IS MADE TO THE EXCLUSIVE RIGHT TO USE "CHEERLEADING", APART FROM THE MARK AS SHOWN.

FOR PUBLICATIONS RELATING TO CHEERLEADING, NAMELY MAGAZINES, BOOKS, AND PERIODICAL REPORTS (U.S. CLS. 2, 5, 22, 23, 29, 37, 38 AND 50).

FIRST USE 12-31-2003; IN COMMERCE 12-31-2003.
TARAH HARDY, EXAMINING ATTORNEY

SN 78-520,282. MEADWESTVACO CORPORATION, STAMFORD, CT. FILED 11-19-2004.

DAY RUNNER

THE MARK CONSISTS OF STANDARD CHARACTERS WITHOUT CLAIM TO ANY PARTICULAR FONT, STYLE, SIZE, OR COLOR.

OWNER OF U.S. REG. NOS. 1,381,281, 2,113,058 AND OTHERS.

FOR CORKBOARDS, BULLETIN BOARDS, MAGNETIC BOARDS, DRY-ERASE WRITING BOARDS AND WRITING SURFACES, TELEPHONE-ADDRESS BOOKS, ASSIGNMENT BOOKS, DESKTOP BUSINESS CARD HOLDERS, WRITING PAPER PADS AND PAPER PAD HOLDERS, TRAVEL DOCUMENT HOLDERS; PERSONAL AND DESKTOP MULTIPURPOSE ORGANIZING AND INFORMATION CENTER CONSISTING OF ONE OR MORE OF THE FOLLOWING: DRY ERASE WRITING BOARD, BULLETIN BOARD, MAGNETIC BOARD, CALENDAR HOLDER, CALENDAR, HOLDER FOR NOTE PADS, AND HOLDER FOR WRITING INSTRUMENTS SOLD TOGETHER AS A SINGLE UNIT, AND ACCESSORIES THEREFORE, NAMELY, REFILL CALENDARS, NOTE PADS AND MARKERS, HIGHLIGHTING MARKERS, FELT-TIP MARKERS, AND DRY-ERASE MARKERS, ALL SOLD SEPARATELY (U.S. CLS. 2, 5, 22, 23, 29, 37, 38 AND 50).

FIRST USE 11-12-1996; IN COMMERCE 11-12-1996.
INGA ERVIN, EXAMINING ATTORNEY

SN 78-521,701. SIMPSON TACOMA KRAFT COMPANY, LLC, TACOMA, WA. FILED 11-23-2004.

SIMPSON

THE MARK CONSISTS OF STANDARD CHARACTERS WITHOUT CLAIM TO ANY PARTICULAR FONT, STYLE, SIZE, OR COLOR.

OWNER OF U.S. REG. NOS. 656,840, 1,002,147 AND 2,217,163.

SEC. 2(F).
FOR PAPER LINER BOARD USED IN CORRUGATED BOXES (U.S. CLS. 2, 5, 22, 23, 29, 37, 38 AND 50).

FIRST USE 9-0-1985; IN COMMERCE 9-0-1985.
MELISSA VALLILLO, EXAMINING ATTORNEY

CLASS 16—(Continued).

SN 78-523,005. MCGORTY, RORY THOMAS, HONOLULU, HI. FILED 11-25-2004.

CLASS 16—(Continued).

SN 78-524,621. RETAIL CONSTRUCTION MAGAZINE, LLC, CUMMING, GA. FILED 11-30-2004.

MemRead

THE MARK CONSISTS OF STANDARD CHARACTERS WITHOUT CLAIM TO ANY PARTICULAR FONT, STYLE, SIZE, OR COLOR.
FOR BOOKS FEATURING A SYSTEM OF MEMORIZATION TECHNIQUES (U.S. CLS. 2, 5, 22, 23, 29, 37, 38 AND 50).
BRIAN PINO, EXAMINING ATTORNEY

TRP-zine

THE MARK CONSISTS OF STANDARD CHARACTERS WITHOUT CLAIM TO ANY PARTICULAR FONT, STYLE, SIZE, OR COLOR.
FOR PUBLICATIONS, NAMELY, NEWSLETTERS REGARDING NEWS, EVENTS AND ACTIVITIES AMONG PEOPLE IN THE RETAIL CONSTRUCTION INDUSTRY (U.S. CLS. 2, 5, 22, 23, 29, 37, 38 AND 50).
FIRST USE 10-22-2003; IN COMMERCE 10-22-2003.
PAUL E. FAHRENKOPF, EXAMINING ATTORNEY

SN 78-524,965. ADVANSTAR COMMUNICATIONS INC., DULUTH, MN. FILED 12-1-2004.

SN 78-523,788. JANLYNN CORPORATION, CHICOPEE, MA. FILED 11-29-2004.

GOT LAYOUTS?

THE MARK CONSISTS OF STANDARD CHARACTERS WITHOUT CLAIM TO ANY PARTICULAR FONT, STYLE, SIZE, OR COLOR.
FOR PAPER SHEETS, NAMELY FOR SCRAPBOOKS, AND PAPER DIE CUT SHAPES (U.S. CLS. 2, 5, 22, 23, 29, 37, 38 AND 50).
WILLIAM P. SHANAHAN, EXAMINING ATTORNEY

HEALTHCARE STAFFING & MANAGEMENT SOLUTIONS

THE MARK CONSISTS OF STANDARD CHARACTERS WITHOUT CLAIM TO ANY PARTICULAR FONT, STYLE, SIZE, OR COLOR.
NO CLAIM IS MADE TO THE EXCLUSIVE RIGHT TO USE HEALTHCARE STAFFING & MANAGEMENT, APART FROM THE MARK AS SHOWN.
FOR MAGAZINE IN THE FIELD OF HEALTHCARE ADMINISTRATION, NAMELY EMPLOYEE RECRUITMENT, RETENTION, MANAGEMENT AND QUALITY ASSURANCE (U.S. CLS. 2, 5, 22, 23, 29, 37, 38 AND 50).
JOHN HWANG, EXAMINING ATTORNEY

CLASS 16—(Continued).

SN 78-526,358. OFFSIDE PUBLICATIONS, INC, AURORA, IL. FILED 12-2-2004.

CLASS 16—(Continued).

SN 78-526,920. DEUTSCHE TELEKOM AG, BONN, FED REP GERMANY, FILED 12-3-2004.

Ultimas Noticias

THE MARK CONSISTS OF STANDARD CHARACTERS WITHOUT CLAIM TO ANY PARTICULAR FONT, STYLE, SIZE, OR COLOR.

NO CLAIM IS MADE TO THE EXCLUSIVE RIGHT TO USE "NOTICIAS", APART FROM THE MARK AS SHOWN. THE FOREIGN WORDING IN THE MARK TRANSLATES INTO ENGLISH AS LATEST NEWS.

FOR PRINTED NEWSPAPERS AND NEWSPAPER SUPPLEMENTS RELATING TO ISSUES OF GENERAL INTEREST WITH A CONCENTRATION ON ISSUES OF INTEREST DIRECTED TOWARDS THE HISPANIC COMMUNITY (U.S. CLS. 2, 5, 22, 23, 29, 37, 38 AND 50).
KIMBERLY FRYE, EXAMINING ATTORNEY

SN 78-526,876. THE HARTZ MOUNTAIN CORPORATION, SECAUCUS, NJ. FILED 12-3-2004.

VMX PETVANTAGE NO SLIP PUPPY TRAINING PADS FOR DOGS & PUPPIES

THE MARK CONSISTS OF STANDARD CHARACTERS WITHOUT CLAIM TO ANY PARTICULAR FONT, STYLE, SIZE, OR COLOR.

NO CLAIM IS MADE TO THE EXCLUSIVE RIGHT TO USE "NO SLIP PUPPY TRAINING PADS FOR DOGS & PUPPIES", APART FROM THE MARK AS SHOWN.

FOR DISPOSABLE HOUSEBREAKING PADS FOR USE IN TRAINING PUPPIES AND DOGS (U.S. CLS. 2, 5, 22, 23, 29, 37, 38 AND 50).
PRISCILLA MILTON, EXAMINING ATTORNEY

T-Mobile M2M Connect

THE MARK CONSISTS OF STANDARD CHARACTERS WITHOUT CLAIM TO ANY PARTICULAR FONT, STYLE, SIZE, OR COLOR.

PRIORITY CLAIMED UNDER SEC. 44(D) ON FED REP GERMANY APPLICATION NO. 30433156238, FILED 6-7-2004, REG. NO. 30433156, DATED 7-20-2004, EXPIRES 6-30-2014.

OWNER OF U.S. REG. NOS. 2,282,432 AND 2,889,632.
FOR PRINTED MATTER, NAMELY, TELEPHONE DIRECTORIES, SERIES OF BOOKS, NEWSLETTERS, PAMPHLETS, BROCHURES, MAGAZINES AND PAPERBACKS, ALL IN THE FIELD OF TELECOMMUNICATIONS; PRINTED AND STAMPED PLASTIC AND CARDBOARD GREETING, BLANK, NOTE, AND INDEX CARDS; NOTE PAPER AND ENVELOPES; NAMETAGS AND LABELS MADE FROM PAPER OR CARDBOARD; NOTEBOOKS; NOTE PADS; STATIONERY; PAPER, NAMELY, BOND PAPER AND ART PAPER; GIFT-WRAP PAPER; DIARIES; ADDRESS BOOKS; STUDENT CALENDARS; STAMP ALBUMS AND PHOTO-ALBUMS; FOLDERS FOR LETTERS AND LOOSE PAPERS; STATIONERY CLEAR HOLE TAB REINFORCEMENTS; RUBBER STAMPS AND IMPRESSION STAMPS; PAPER WEIGHTS; LETTER OPENERS; DRAWING AND UNGRADUATED RULERS; ERASERS; STAPLERS; PAPER CLIPS; BLOTTER PADS; DESK FILE TRAYS; DESK STANDS AND HOLDERS FOR HOLDING STATIONERY AND OFFICE IMPLEMENTS; PRINTED INSTRUCTIONAL AND TEACHING MATERIALS, ALL IN THE FIELDS OF TELECOMMUNICATIONS, INFORMATION TECHNOLOGY, SAFETY, NEWS, SPORTS, ENTERTAINMENT, CULTURE, BUSINESS AND FINANCE, WEATHER AND TRAVEL; BOOKMARKERS; STENCILS; SCRATCH PICTURES; PVC STICKERS; BLACKBOARDS; CHALK STICKS; ADHESIVES FOR STATIONERY OR HOUSEHOLD PURPOSES; DRAWING AND PAINTING MATERIALS, NAMELY, PENCILS, DRAWING PENCILS, PENS, DRAWING PENS, PAINT TRAYS, PAINTING SETS FOR ARTISTS, PAINTING SETS FOR CHILDREN, ARTS AND CRAFT PAINT KITS, AND PENCIL CASES; NON-MAGNETICALLY ENCODED PREPAID TELEPHONE CALLING CARDS (U.S. CLS. 2, 5, 22, 23, 29, 37, 38 AND 50).
LAURIE MAYES, EXAMINING ATTORNEY

CLASS 16—(Continued).

SN 78-527,558. SZENTANAI, IOANA AMALIA, SACRAMENTO, CA. FILED 12-6-2004.



NO CLAIM IS MADE TO THE EXCLUSIVE RIGHT TO USE "MAGAZINE", APART FROM THE MARK AS SHOWN. THE COLOR GRAY IN THE DRAWING IS INTENDED TO INDICATE SHADING OR CONTRAST ONLY.

FOR NATIONALLY DISTRIBUTED PUBLICATION, NAMELY BRIDAL MAGAZINES DISTRIBUTED IN NEWSSTANDS AND BOOKSTORES THAT FEATURE WEDDING GOWNS, SHOES, BRIDAL ACCESSORIES, KITCHEN PRODUCTS, HOME DESIGN PRODUCTS, CASUAL CLOTHING ATTIRE, TRAVEL LOCATION FOR HONEYMOONS, VENUES, FLOWERS, PHOTOGRAPHERS, VIDEOGRAPHERS, CHAIR COVERS, WEDDING AND RECEPTION PLANNERS, BEAUTY PRODUCTS, DJs AND OTHER TYPES OF MUSIC FOR WEDDINGS AND RECEPTIONS, LIGHTING AND SOUND, INVITATIONS, THANK YOU NOTES, GAMES AND JEWELRY (U.S. CLS. 2, 5, 22, 23, 29, 37, 38 AND 50).
KATRINA EDGE, EXAMINING ATTORNEY

SN 78-528,066. MEADWESTVACO CORPORATION, STAMFORD, CT. FILED 12-7-2004.

MAIL 'N FILE

THE MARK CONSISTS OF STANDARD CHARACTERS WITHOUT CLAIM TO ANY PARTICULAR FONT, STYLE, SIZE, OR COLOR.

NO CLAIM IS MADE TO THE EXCLUSIVE RIGHT TO USE "MAIL", APART FROM THE MARK AS SHOWN.

FOR ENVELOPES (U.S. CLS. 2, 5, 22, 23, 29, 37, 38 AND 50).
WARREN L. OLANDRIA, EXAMINING ATTORNEY

CLASS 16—(Continued).

SN 78-528,210. TRI-VILLAGE PENNYSAYER, INC., INTERLAKEN, NY. FILED 12-7-2004.

ITHACA PENNYSAYER

THE MARK CONSISTS OF STANDARD CHARACTERS WITHOUT CLAIM TO ANY PARTICULAR FONT, STYLE, SIZE, OR COLOR.

NO CLAIM IS MADE TO THE EXCLUSIVE RIGHT TO USE "PENNYSAYER", APART FROM THE MARK AS SHOWN.

SEC. 2(F).
FOR GENERAL FEATURE AND ADVERTISING NEWSPAPER (U.S. CLS. 2, 5, 22, 23, 29, 37, 38 AND 50).

FIRST USE 0-0-1978; IN COMMERCE 0-0-1978.
MARK SPARACINO, EXAMINING ATTORNEY

SN 78-529,042. ANN ARBOR MEDIA GROUP, ANN ARBOR, MI. FILED 12-8-2004.



NO CLAIM IS MADE TO THE EXCLUSIVE RIGHT TO USE SPORTS MEDIA GROUP, APART FROM THE MARK AS SHOWN.

THE MARK CONSISTS OF THE LITERAL ELEMENT OF THE MARK BELOW A DESIGN COMPRISING A SERIES OF NARROW TRIANGLES CONFIGURED IN A SWIRL, WITH EACH TRIANGLE POINTING OUTWARD AND BECOMING LARGER MOVING IN THE CLOCKWISE DIRECTION.

FOR SERIES OF FICTION AND NON-FICTION BOOKS ON A VARIETY OF TOPICS (U.S. CLS. 2, 5, 22, 23, 29, 37, 38 AND 50).

FIRST USE 2-0-2004; IN COMMERCE 2-0-2004.
PAUL E. FAHRENKOPF, EXAMINING ATTORNEY

CLASS 16—(Continued).

SN 78-529,407. BHAKTIVEDANTA BOOK TRUST, ALACHUA, FL. FILED 12-8-2004.

Back to Godhead

THE MARK CONSISTS OF STANDARD CHARACTERS WITHOUT CLAIM TO ANY PARTICULAR FONT, STYLE, SIZE, OR COLOR.

NO CLAIM IS MADE TO THE EXCLUSIVE RIGHT TO USE "GODHEAD", APART FROM THE MARK AS SHOWN. FOR PERIODIC MAGAZINES IN THE FIELD OF GOD AND SPIRITUALITY (U.S. CLS. 2, 5, 22, 23, 29, 37, 38 AND 50).

FIRST USE 1-1-1968; IN COMMERCE 1-1-1968.
DANIEL CAPSHAW, EXAMINING ATTORNEY

SN 78-531,314. COSTANTINO, LISA, NORTH PROVIDENCE, RI. FILED 12-13-2004.

BODY GLAM

THE MARK CONSISTS OF STANDARD CHARACTERS WITHOUT CLAIM TO ANY PARTICULAR FONT, STYLE, SIZE, OR COLOR.

NO CLAIM IS MADE TO THE EXCLUSIVE RIGHT TO USE "BODY", APART FROM THE MARK AS SHOWN.

FOR DECORATIVE STICKERS APPLIED TO THE BODY MADE WITH JEWEL-LIKE SEQUINS (U.S. CLS. 2, 5, 22, 23, 29, 37, 38 AND 50).

KIM SAITO, EXAMINING ATTORNEY

CLASS 16—(Continued).

SN 78-533,053. BRIAN C. HEILWECK, RIVERSIDE, CA. FILED 12-15-2004.

MoonBeagle

THE MARK CONSISTS OF STANDARD CHARACTERS WITHOUT CLAIM TO ANY PARTICULAR FONT, STYLE, SIZE, OR COLOR.

FOR PRINTED EDUCATIONAL MATERIALS FOR HEALTHCARE PROFESSIONALS TO MAINTAIN LICENSURE AS PART OF CONTINUING EDUCATION (U.S. CLS. 2, 5, 22, 23, 29, 37, 38 AND 50).

FIRST USE 12-1-2004; IN COMMERCE 12-1-2004.
TARAH HARDY, EXAMINING ATTORNEY

SN 78-533,574. HOWARD, GAIL, LAS VEGAS, NV. FILED 12-16-2004.

POWER NUMBER

THE MARK CONSISTS OF STANDARD CHARACTERS WITHOUT CLAIM TO ANY PARTICULAR FONT, STYLE, SIZE, OR COLOR.

NO CLAIM IS MADE TO THE EXCLUSIVE RIGHT TO USE "NUMBER", APART FROM THE MARK AS SHOWN.

FOR PRINTED MATERIAL, NAMELY, INFORMATION CHARTS, NUMBER SELECTION CHARTS, AND WHEELING SYSTEM CHARTS RELATING TO INFORMATION, SYSTEMS AND ADVICE FOR PLAYING LOTTERIES (U.S. CLS. 2, 5, 22, 23, 29, 37, 38 AND 50).

FIRST USE 12-31-1988; IN COMMERCE 12-31-1988.
CIMMERIAN COLEMAN, EXAMINING ATTORNEY

CLASS 16—(Continued).

SN 78-534,791. CO-FAMILY EXPRESSIONS, INC., CARY, IL.
FILED 12-17-2004.

CO-FAMILY

THE MARK CONSISTS OF STANDARD CHARACTERS WITHOUT CLAIM TO ANY PARTICULAR FONT, STYLE, SIZE, OR COLOR.

OWNER OF U.S. REG. NO. 2,254,110.
FOR GREETING CARDS (U.S. CLS. 2, 5, 22, 23, 29, 37, 38 AND 50).

FIRST USE 3-1-1993; IN COMMERCE 1-20-1999.
EVELYN BRADLEY, EXAMINING ATTORNEY

SN 78-534,813. CO-FAMILY EXPRESSIONS, INC., CARY, IL.
FILED 12-17-2004.

**CO-FAMILY
EXPRESSIONS**

THE MARK CONSISTS OF STANDARD CHARACTERS WITHOUT CLAIM TO ANY PARTICULAR FONT, STYLE, SIZE, OR COLOR.

FOR GREETING CARDS (U.S. CLS. 2, 5, 22, 23, 29, 37, 38 AND 50).

FIRST USE 3-1-1993; IN COMMERCE 1-20-1999.
JACQUELINE A. LAVINE, EXAMINING ATTORNEY

SN 78-535,054. CAPSTONE PRESS, INC., MANKATO, MN.
FILED 12-18-2004.

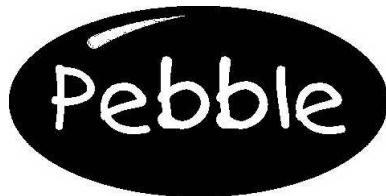

OWNER OF U.S. REG. NO. 2,763,151.
THE MARK CONSISTS OF THE WORD PEBBLE IN AN OVAL DESIGN WITH A SWOOSH ABOVE THE "P".
FOR BOOKS FOR SCHOOL AGE CHILDREN (U.S. CLS. 2, 5, 22, 23, 29, 37, 38 AND 50).
FIRST USE 8-15-2003; IN COMMERCE 8-15-2003.
CHARLES JOYNER, EXAMINING ATTORNEY

CLASS 16—(Continued).

SN 78-535,540. JUST BECAUSE INVITATIONS, LLC, NEW YORK, NY. FILED 12-20-2004.

**JUST BECAUSE
INVITATIONS**

THE MARK CONSISTS OF STANDARD CHARACTERS WITHOUT CLAIM TO ANY PARTICULAR FONT, STYLE, SIZE, OR COLOR.

NO CLAIM IS MADE TO THE EXCLUSIVE RIGHT TO USE INVITATIONS, APART FROM THE MARK AS SHOWN.

FOR PERSONALIZED STATIONARY, ENVELOPES, NOTECARDS, GREETING CARDS, PRINTED INVITATIONS, PLACE CARDS, BUSINESS CARDS, AND PICTURE CARDS (U.S. CLS. 2, 5, 22, 23, 29, 37, 38 AND 50).

FIRST USE 3-0-2004; IN COMMERCE 10-0-2004.
JEFF DEFORD, EXAMINING ATTORNEY

SN 78-536,275. STRING LETTER PUBLISHING, INC., SAN ANSELMO, CA. FILED 12-21-2004.

GUITARTEACHER

NO CLAIM IS MADE TO THE EXCLUSIVE RIGHT TO USE GUITAR TEACHER, APART FROM THE MARK AS SHOWN.

THE MARK CONSISTS OF GUITARTEACHER IN A STYLIZED FORMAT WITH THE "H" HAVING THE OUTLINE OF A PEGHEAD OF A GUITAR.

FOR PRINTED MATERIALS; NAMELY, MAGAZINE SUPPLEMENTS ON MUSIC AND MUSIC INSTRUCTION, AND INSTRUCTIONAL MATERIALS ON MUSIC (U.S. CLS. 2, 5, 22, 23, 29, 37, 38 AND 50).

FIRST USE 9-30-2004; IN COMMERCE 9-30-2004.
JOHN E. MICHOS, EXAMINING ATTORNEY

SN 78-536,903. BINNEY & SMITH INC., EASTON, PA. FILED 12-22-2004.

TWISTABLES

THE MARK CONSISTS OF STANDARD CHARACTERS WITHOUT CLAIM TO ANY PARTICULAR FONT, STYLE, SIZE, OR COLOR.

OWNER OF U.S. REG. NO. 2,762,437.
FOR PENCILS (U.S. CLS. 2, 5, 22, 23, 29, 37, 38 AND 50).
FIRST USE 12-15-2004; IN COMMERCE 12-15-2004.
GIANCARLO CASTRO, EXAMINING ATTORNEY

CLASS 16—(Continued).

SN 78-536,941. MEADWESTVACO CORPORATION, STAMFORD, CT. FILED 12-22-2004.



OWNER OF U.S. REG. NOS. 1,204,022 AND 1,213,923.
NO CLAIM IS MADE TO THE EXCLUSIVE RIGHT TO USE "COOPERATIVE FOREST MANAGEMENT", APART FROM THE MARK AS SHOWN.
FOR NEWSLETTERS ON THE SUBJECT OF FOREST MANAGEMENT (U.S. CLS. 2, 5, 22, 23, 29, 37, 38 AND 50).
FIRST USE 4-26-2004; IN COMMERCE 4-26-2004.
JUDITH HELFMAN, EXAMINING ATTORNEY

SN 78-537,112. CHICKSPORTS, INC., AUSTIN, TX. FILED 12-22-2004.

CHICKSPORTS

THE MARK CONSISTS OF STANDARD CHARACTERS WITHOUT CLAIM TO ANY PARTICULAR FONT, STYLE, SIZE, OR COLOR.
FOR BOOKS, NAMELY, A SERIES OF NON-FICTION BOOKS COVERING THE RULES, CULTURAL MORES AND SOCIAL ACTIVITIES SURROUNDING SPORTS (U.S. CLS. 2, 5, 22, 23, 29, 37, 38 AND 50).
CARRIE ACHEN, EXAMINING ATTORNEY

SN 78-537,254. PACIFICBASIN COMMUNICATIONS, LLC, HONOLULU, HI. FILED 12-22-2004.

HAWAII BUSINESS

THE MARK CONSISTS OF STANDARD CHARACTERS WITHOUT CLAIM TO ANY PARTICULAR FONT, STYLE, SIZE, OR COLOR.
SEC. 2(F).
FOR PERIODICAL MAGAZINE CONCERNING NEWS, EVENTS, AND PERSONALITIES IN THE STATE-WIDE HAWAII BUSINESS COMMUNITY (U.S. CLS. 2, 5, 22, 23, 29, 37, 38 AND 50).
FIRST USE 11-1-1968; IN COMMERCE 11-1-1968.
JANICE L. MCMORROW, EXAMINING ATTORNEY

CLASS 16—(Continued).

SN 78-537,904. INTEGRATED LABEL CORPORATION, ROCKFORD, IL. FILED 12-23-2004.

INTEGRATED LABELS

THE MARK CONSISTS OF STANDARD CHARACTERS WITHOUT CLAIM TO ANY PARTICULAR FONT, STYLE, SIZE, OR COLOR.
NO CLAIM IS MADE TO THE EXCLUSIVE RIGHT TO USE "LABELS", APART FROM THE MARK AS SHOWN.
SEC. 2(F).
FOR BUSINESS FORMS (U.S. CLS. 2, 5, 22, 23, 29, 37, 38 AND 50).
FIRST USE 7-9-1999; IN COMMERCE 7-9-1999.
SANI KHOURI, EXAMINING ATTORNEY

SN 78-539,034. SARGENT ART, INC., HAZLETON, PA. FILED 12-28-2004.

WHITE BOARD

THE MARK CONSISTS OF STANDARD CHARACTERS WITHOUT CLAIM TO ANY PARTICULAR FONT, STYLE, SIZE, OR COLOR.
OWNER OF U.S. REG. NO. 2,299,111.
SEC. 2(F).
FOR CRAYONS (U.S. CLS. 2, 5, 22, 23, 29, 37, 38 AND 50).
FIRST USE 2-4-1999; IN COMMERCE 2-4-1999.
ALICE BENMAMAN, EXAMINING ATTORNEY

SN 78-539,106. CREATIVE AGE PUBLICATIONS, INC., VAN NUYS, CA. FILED 12-28-2004.

**DIALYSIS &
TRANSPLANTATION**

THE MARK CONSISTS OF STANDARD CHARACTERS WITHOUT CLAIM TO ANY PARTICULAR FONT, STYLE, SIZE, OR COLOR.
SEC. 2(F).
FOR MAGAZINE RELATING TO NEPHROLOGY (U.S. CLS. 2, 5, 22, 23, 29, 37, 38 AND 50).
FIRST USE 11-30-1971; IN COMMERCE 11-30-1971.
ELIZABETH PIGNATELLO, EXAMINING ATTORNEY

CLASS 16—(Continued).

SN 78-540,218. MDG DEVELOPMENT GROUP, INC., DBA MARKET DEVELOPMENT GROUP, CHESTER, NJ. FILED 12-30-2004.

CLASS 16—(Continued).

SN 78-579,379. PURCELL ENTERPRISES, INC., HILTON HEAD ISLAND, SC. FILED 3-3-2005.



LINKS

OWNER OF U.S. REG. NO. 2,235,923.
 NO CLAIM IS MADE TO THE EXCLUSIVE RIGHT TO USE "HEPATOLOGY", APART FROM THE MARK AS SHOWN.
 FOR NEWSLETTERS IN THE FIELD OF HEPATOLOGY (U.S. CLS. 2, 5, 22, 23, 29, 37, 38 AND 50).
 FIRST USE 1-1-2000, THE MARK WAS FIRST USED ANYWHERE IN A DIFFERENT FORM OTHER THAN THAT SOUGHT TO BE REGISTERED ON 04/03/1998.; IN COMMERCE 1-1-2000, THE MARK WAS FIRST USED IN COMMERCE IN A DIFFERENT FORM OTHER THAN THAT SOUGHT TO BE REGISTERED ON 04/03/1998..
 KELLEY WELLS, EXAMINING ATTORNEY

THE MARK CONSISTS OF STANDARD CHARACTERS WITHOUT CLAIM TO ANY PARTICULAR FONT, STYLE, SIZE, OR COLOR.
 OWNER OF U.S. REG. NOS. 1,656,785 AND 1,993,681.
 SEC. 2(F).
 FOR PUBLICATIONS, NAMELY, MAGAZINES PERTAINING TO GOLF AND LIFESTYLES (U.S. CLS. 2, 5, 22, 23, 29, 37, 38 AND 50).
 FIRST USE 4-30-1993; IN COMMERCE 4-30-1993.
 ANGELA M. MICHELI, EXAMINING ATTORNEY

SN 78-543,477. TRS QUALITY, INC., FORT WORTH, TX. FILED 1-6-2005.

SN 78-650,182. SUNSHINE PUBLICATIONS, INC., BONITA SPRINGS, FL. FILED 6-14-2005.

VEX

LET'S DO LUNCH

THE MARK CONSISTS OF STANDARD CHARACTERS WITHOUT CLAIM TO ANY PARTICULAR FONT, STYLE, SIZE, OR COLOR.
 FOR EDUCATIONAL INSTRUCTIONAL MANUALS FOR USE IN TEACHING ENGINEERING, MATH, SCIENCE, TECHNOLOGY, AND MEANS FOR BUILDING ROBOTS (U.S. CLS. 2, 5, 22, 23, 29, 37, 38 AND 50).
 GLENN CLARK, EXAMINING ATTORNEY

THE MARK CONSISTS OF STANDARD CHARACTERS WITHOUT CLAIM TO ANY PARTICULAR FONT, STYLE, SIZE, OR COLOR.
 OWNER OF U.S. REG. NO. 2,820,513.
 FOR SYNDICATED NEWSPAPER COLUMN DEALING WITH DIET, NUTRITION, HEALTH, FOODS, FITNESS, AND WELL-BEING (U.S. CLS. 2, 5, 22, 23, 29, 37, 38 AND 50).
 RONALD MCMORROW, EXAMINING ATTORNEY

CLASS 16—(Continued).

SN 78-975,727. ANDERSON, KENNETH, EL DORADO, AR.
FILED 11-3-2003.

BEAM ME UP, LORD!

THE MARK CONSISTS OF STANDARD CHARACTERS WITHOUT CLAIM TO ANY PARTICULAR FONT, STYLE, SIZE, OR COLOR.

FOR SERIES OF BOOKS IN THE FIELD OF PROPHECIC SCIENCE FICTION (U.S. CLS. 2, 5, 22, 23, 29, 37, 38 AND 50).

FIRST USE 6-16-2003; IN COMMERCE 10-7-2003.
MARTHA FROMM, EXAMINING ATTORNEY

SN 79-002,598. FACTIS, S.A., E-17200 PALAFRUGUELL (GIRONA), SPAIN, FILED 1-14-2004.

FACTIS

OWNER OF INTERNATIONAL REGISTRATION 0425558 DATED 10-19-1976, EXPIRES 10-19-2006.

FOR RUBBER ERASERS, PENCILS, MARKERS AND INSTRUMENTS FOR WRITING; ADHESIVE PAPER, ADHESIVE BOOKMARKS, GLUES FOR STATIONERY OR HOUSEHOLD PURPOSES, SEALING WAX FOR ARTS AND CRAFTS PAINTING, PAPER PAINT BOXES, ARTS AND CRAFTS PAINT KITS, NOTEBOOKS, YEARBOOKS, PAPER FOR ARTS AND CRAFTS, PASTES FOR MODELING FOR ARTS AND CRAFTS, COMPASSES FOR DRAWING, PEN AND PENCIL CASES FOR SCHOOL AND OFFICE, PLAN HOLDER CARDBOARD TUBES, CHALK ADHESIVE TAPES FOR ARTS AND CRAFTS, PENCIL SHARPENERS, DRAWING PINS FOR ARTS AND CRAFTS, PAPER CLIPS, STAPLES FOR STATIONERY PURPOSES, DRAWING RULERS, DRAWING SQUARES, DRAWING T-SQUARES, STENCILS FOR STATIONERY AND DRAWING USE, FOLDERS, STATIONERY ARTICLES, NAMELY WRITING PAPER, ENVELOPES, WRITING TABLETS, WRITING PADS (U.S. CLS. 2, 5, 22, 23, 29, 37, 38 AND 50).

DAWN HAN, EXAMINING ATTORNEY

SN 79-002,819. OMYACOLOR S.A., FRANCE, FILED 4-23-2004.

ROBERCOLOR

OWNER OF INTERNATIONAL REGISTRATION 0435294 DATED 1-25-1978, EXPIRES 1-25-2008.

FOR INSTRUMENTS FOR WRITING, DRAWING AND MARKING, NAMELY, WHITE AND COLORED CHALKS, MARKERS, PENS AND PENCILS (U.S. CLS. 2, 5, 22, 23, 29, 37, 38 AND 50).

DAWN FELDMAN, EXAMINING ATTORNEY

CLASS 16—(Continued).

SN 79-003,446. CARTIERE DEL GARDA SPA, ITALY, FILED 4-6-2004.

GARDAPAT

THE MARK CONSISTS OF STANDARD CHARACTERS WITHOUT CLAIM TO ANY PARTICULAR FONT, STYLE, SIZE, OR COLOR.

OWNER OF INTERNATIONAL REGISTRATION 0679953 DATED 9-9-1997, EXPIRES 9-9-2007.

FOR PAPER, NAMELY, PRINTING PAPER IN REELS AND SHEETS, PAPERBOARD, CARDBOARD (U.S. CLS. 2, 5, 22, 23, 29, 37, 38 AND 50).

JEAN IM, EXAMINING ATTORNEY

SN 79-005,693. IPL - SCHMIDT PLASTIC GMBH, FED REP GERMANY, FILED 3-18-2004.

IPL

PRIORITY DATE OF 9-23-2003 IS CLAIMED.

OWNER OF INTERNATIONAL REGISTRATION 0834467 DATED 3-18-2004, EXPIRES 3-18-2014.

THE MARK CONSISTS OF THE LETTERS IPL, WITH THE LETTERS IPL ALSO APPEARING WITHIN THE DOT OVER THE LETTER "I".

FOR OFFICE REQUISITES, NAMELY ENVELOPES, STATIONERY, FOLDERS AND FOLDER COVERS, HOLDERS FOR PASSPORTS AND CARDS; COVERS FOR CREDIT CARDS; HOLDERS FOR NAME CARDS; PAGES FOR HOLDING PHOTOGRAPHS; PHOTOGRAPH ALBUM PAGES; STAPLING PRESSES FOR NON-ELECTRIC STAPLERS; CLIPBOARDS; INDEX DIVIDERS AND CARDS; SEPARATION SHEETS, NAMELY FOLDER DIVIDERS; FILING CARDS; PAPER NAME BADGES; BINDERS; BOOKBINDING MATERIALS, NAMELY BOOKBINDING TAPE AND WIRE; DOCUMENT FILES; FOLDERS FOR PAPER; PAPER-CLIPS; LOOSE-LEAF BINDERS; HOLDERS FOR CHECKBOOKS (U.S. CLS. 2, 5, 22, 23, 29, 37, 38 AND 50).

REBECCA SMITH, EXAMINING ATTORNEY

CLASS 17—RUBBER GOODS

SN 76-492,928. MITSUI CHEMICALS, INC., AKA MITSUI KAGAKU KABUSHIKI KAISHA, CHIYODA-KU, TOKYO, JAPAN, FILED 2-25-2003.

WHITE REFLECTOR

FOR PLASTIC FILMS FOR USE IN FURTHER MANUFACTURE OF ELECTRICAL AND ELECTRONIC PRODUCTS; PLASTIC IN SHEET FORM FOR GENERAL MANUFACTURING USE (U.S. CLS. 1, 5, 12, 13, 35 AND 50).

IRENE D. WILLIAMS, EXAMINING ATTORNEY

SN 76-579,153. HINGE MASK, INC., ST. LOUIS, MO. FILED 3-4-2004.

HINGE MASK

THE MARK CONSISTS OF STANDARD CHARACTERS WITHOUT CLAIM TO ANY PARTICULAR FONT, STYLE, SIZE, OR COLOR.

NO CLAIM IS MADE TO THE EXCLUSIVE RIGHT TO USE "HINGE", APART FROM THE MARK AS SHOWN.

FOR REMOVABLE PLASTIC COVERINGS FOR PREVENTING HINGES FROM BEING COATED WITH PAINT, STAINS, OR OILS WHEN ADJACENT DOOR STRUCTURES ARE BEING FINISHED WITH A COATING (U.S. CLS. 1, 5, 12, 13, 35 AND 50).

FIRST USE 5-15-2002; IN COMMERCE 8-11-2002.

DOUGLAS LEE, EXAMINING ATTORNEY

SN 76-591,461. LIG INTERNATIONAL, INC., JACKSONVILLE, FL. FILED 5-10-2004.

COMMAND FORM TECHNOLOGY

THE MARK CONSISTS OF STANDARD CHARACTERS WITHOUT CLAIM TO ANY PARTICULAR FONT, STYLE, SIZE, OR COLOR.

NO CLAIM IS MADE TO THE EXCLUSIVE RIGHT TO USE TECHNOLOGY, APART FROM THE MARK AS SHOWN.

FOR ADHESIVE-BACKED CAST PVC FILM FOR WRAPPING COMMERCIAL VEHICLES FOR ADVERTISING OR OTHER PROMOTIONAL PURPOSES (U.S. CLS. 1, 5, 12, 13, 35 AND 50).

FIRST USE 4-1-2004; IN COMMERCE 4-1-2004.

RON FAIRBANKS, EXAMINING ATTORNEY

CLASS 17—(Continued).

SN 76-604,620. NITTO DENKO CORPORATION, IBARAKI-SHI, OSAKA, JAPAN, FILED 7-29-2004.

E-MASK

THE MARK CONSISTS OF STANDARD CHARACTERS WITHOUT CLAIM TO ANY PARTICULAR FONT, STYLE, SIZE, OR COLOR.

FOR SURFACE PROTECTION PLASTIC FILMS FOR OPTICAL AND ELECTRONICS RELATED APPLICATIONS; PLASTIC MASKING FILM FOR OPTICAL AND ELECTRONICS RELATED APPLICATIONS; TRANSPARENT PLASTIC FILM FOR USE IN MANUFACTURING ELECTRONIC CIRCUITS (U.S. CLS. 1, 5, 12, 13, 35 AND 50).

FIRST USE 10-0-1996; IN COMMERCE 10-0-2001.

MONTIA G. PRESSEY, EXAMINING ATTORNEY

SN 78-280,316. POLYMER SEALING SOLUTIONS, INC., FORT WAYNE, IN. FILED 7-29-2003.

A Q SEAL

OWNER OF U.S. REG. NO. 1,210,482.

NO CLAIM IS MADE TO THE EXCLUSIVE RIGHT TO USE "SEAL", APART FROM THE MARK AS SHOWN.

FOR NON-METAL SEALS, NAMELY, THREE PIECE PISTON SEAL ASSEMBLY OF ELASTOMERS AND PLASTIC FOR HYDRAULIC AND PRESSURE APPLICATIONS (U.S. CLS. 1, 5, 12, 13, 35 AND 50).

FIRST USE 6-11-1979; IN COMMERCE 6-11-1979.

ALICIA COLLINS, EXAMINING ATTORNEY

SN 78-308,993. JANCA, TIMOTHY J., SILVERADO, CA. FILED 10-3-2003.



NO CLAIM IS MADE TO THE EXCLUSIVE RIGHT TO USE "PROTECT TURF" AND "RESILIENT PLAYGROUND SURFACING", APART FROM THE MARK AS SHOWN.

THE STIPPLING IS A FEATURE OF THE MARK.

FOR RUBBER CHIPS OR GRANULES FOR USE AS A PLAYGROUND GROUND COVER (U.S. CLS. 1, 5, 12, 13, 35 AND 50).

FIRST USE 8-1-2000; IN COMMERCE 8-1-2000.

STACY WAHLBERG, EXAMINING ATTORNEY

CLASS 17—(Continued).

SN 78-395,579. ROSSI, DENNIS T., BALTIMORE, MD. FILED 4-2-2004.

PREMIER

THE MARK CONSISTS OF STANDARD CHARACTERS WITHOUT CLAIM TO ANY PARTICULAR FONT, STYLE, SIZE, OR COLOR.

FOR ACRYLIC COATING, FOR THE COATING OF ALL-WEATHER TENNIS COURTS (U.S. CLS. 1, 5, 12, 13, 35 AND 50).

RONALD AIKENS, EXAMINING ATTORNEY

SN 78-395,589. PAWLING CORPORATION, PAWLING, NY. FILED 4-2-2004.

PNEUMA-CEL

THE MARK CONSISTS OF STANDARD CHARACTERS WITHOUT CLAIM TO ANY PARTICULAR FONT, STYLE, SIZE, OR COLOR.

FOR INFLATABLE ELASTOMERIC BLADDERS FOR APPLYING ACTUATING AND CLAMPING FORCES (U.S. CLS. 1, 5, 12, 13, 35 AND 50).

MATTHEW PAPPAS, EXAMINING ATTORNEY

CLASS 17—(Continued).

SN 78-407,160. NEXT GENERATION HOLDINGS, LLC, ROGERS, AR. FILED 4-23-2004.

**BUILD HEALTHY.
BUILD SMART.**

THE MARK CONSISTS OF STANDARD CHARACTERS WITHOUT CLAIM TO ANY PARTICULAR FONT, STYLE, SIZE, OR COLOR.

FOR BUILDING INSULATION (U.S. CLS. 1, 5, 12, 13, 35 AND 50).

EVELYN BRADLEY, EXAMINING ATTORNEY

SN 78-424,103. BEMIS CLYSAR, INC., OSHKOSH, WI. FILED 5-24-2004.

SHRINKBOX

THE MARK CONSISTS OF STANDARD CHARACTERS WITHOUT CLAIM TO ANY PARTICULAR FONT, STYLE, SIZE, OR COLOR.

FOR FILM USED FOR A COMMERCIAL PACKING (U.S. CLS. 1, 5, 12, 13, 35 AND 50).

FIRST USE 6-11-2003; IN COMMERCE 6-11-2003.

CAROL SPILS, EXAMINING ATTORNEY

SN 78-429,310. RADIANT FLOOR COMPANY, BARTON, VT. FILED 6-3-2004.

7/8" DURA POLY XL

THE MARK CONSISTS OF STANDARD CHARACTERS WITHOUT CLAIM TO ANY PARTICULAR FONT, STYLE, SIZE, OR COLOR.

NO CLAIM IS MADE TO THE EXCLUSIVE RIGHT TO USE "7/8" AND "POLY", APART FROM THE MARK AS SHOWN.

FOR PLASTIC PIPE FOR PLUMBING PURPOSES (U.S. CLS. 1, 5, 12, 13, 35 AND 50).

FIRST USE 9-1-2001; IN COMMERCE 9-1-2001.

KIMBERLY PERRY, EXAMINING ATTORNEY

CLASS 17—(Continued).

SN 78-431,139. CABOT CORPORATION, BOSTON, MA.
FILED 6-7-2004.

CLASS 17—(Continued).

SN 78-453,632. POLYCHEM ALLOY, INC., LENOIR, NC.
FILED 7-20-2004.

XANFLEX

RHEADYN

THE MARK CONSISTS OF STANDARD CHARACTERS WITHOUT CLAIM TO ANY PARTICULAR FONT, STYLE, SIZE, OR COLOR.

FOR RUBBER OR ELASTOMERIC COMPOSITES AND BLENDS THEREOF, SOLD IN THE FORM OF PELLETS, SHEETS, STRIPS AND BALES, FOR USE IN MANUFACTURING AND/OR GENERAL INDUSTRIAL USE (U.S. CLS. 1, 5, 12, 13, 35 AND 50).

ALICE SUE CARRUTHERS, EXAMINING ATTORNEY

THE MARK CONSISTS OF STANDARD CHARACTERS WITHOUT CLAIM TO ANY PARTICULAR FONT, STYLE, SIZE, OR COLOR.

FOR THERMOPLASTIC COMPOUNDS IN PELLET FORM FOR USE IN THE MANUFACTURE OF MEDICAL, ELECTRONIC, PACKAGING, WIRE AND CABLE, AUTOMOTIVE AND TEXTILE GOODS (U.S. CLS. 1, 5, 12, 13, 35 AND 50).

FIRST USE 8-5-2000; IN COMMERCE 8-5-2000.
AMY GEARIN, EXAMINING ATTORNEY

SN 78-438,960. STANDARD PACKAGING CORP., GARDENA, CA. FILED 6-21-2004.

SN 78-458,213. PLASTICOS ESPANOLES, S.A. ASPLA, CANTABRIA, SPAIN, FILED 7-28-2004.

RollingWonder

POWERSTRETCH

THE MARK CONSISTS OF STANDARD CHARACTERS WITHOUT CLAIM TO ANY PARTICULAR FONT, STYLE, SIZE, OR COLOR.

FOR PLASTIC FLEXIBLE PACKAGING FILM SOLD IN BULK TO INDUSTRIAL AND COMMERCIAL MANUFACTURERS (U.S. CLS. 1, 5, 12, 13, 35 AND 50).

FIRST USE 8-1-2002; IN COMMERCE 8-1-2002.
JENNIFER KRISP, EXAMINING ATTORNEY

THE MARK CONSISTS OF STANDARD CHARACTERS WITHOUT CLAIM TO ANY PARTICULAR FONT, STYLE, SIZE, OR COLOR.

FOR PLASTIC FILM FOR INDUSTRIAL OR COMMERCIAL AGRICULTURAL PACKAGING USE, MAINLY FOR THE PACKAGING OF SILAGE GRASS AND FODDER (U.S. CLS. 1, 5, 12, 13, 35 AND 50).

SCOTT OSLICK, EXAMINING ATTORNEY

CLASS 17—(Continued).

SN 78-469,945. POLYMER GROUP, INC., NORTH CHARLESTON, SC. FILED 8-19-2004.

COMFORTLACE

THE MARK CONSISTS OF STANDARD CHARACTERS WITHOUT CLAIM TO ANY PARTICULAR FONT, STYLE, SIZE, OR COLOR.

FOR APERTURED PLASTIC FILM FOR USE IN MEDICAL AND HYGIENIC PRODUCTS (U.S. CLS. 1, 5, 12, 13, 35 AND 50).

FIRST USE 2-24-2004; IN COMMERCE 2-24-2004.
ANN E. SAPPENFIELD, EXAMINING ATTORNEY

CLASS 17—(Continued).

SN 78-487,302. MADICO, INC., WOBURN, MA. FILED 9-21-2004.

SIGN SHIELD

THE MARK CONSISTS OF STANDARD CHARACTERS WITHOUT CLAIM TO ANY PARTICULAR FONT, STYLE, SIZE, OR COLOR.

NO CLAIM IS MADE TO THE EXCLUSIVE RIGHT TO USE "SHIELD", APART FROM THE MARK AS SHOWN.

FOR PROTECTIVE PLASTIC FILM TO BE APPLIED TO GLASS SOLD IN SHEET OR ROLL FORM (U.S. CLS. 1, 5, 12, 13, 35 AND 50).

DAVID MURRAY, EXAMINING ATTORNEY

SN 78-501,889. RISERCLAD INTERNATIONAL, INC., HOUSTON, TX. FILED 10-19-2004.

SN 78-474,097. ELK PREMIUM BUILDING PRODUCTS, INC., DALLAS, TX. FILED 8-26-2004.

ELK

THE MARK CONSISTS OF STANDARD CHARACTERS WITHOUT CLAIM TO ANY PARTICULAR FONT, STYLE, SIZE, OR COLOR.

OWNER OF U.S. REG. NOS. 1,533,120 AND 2,931,649.

FOR SELF-SEALING ADHESIVE STRIPS; FIBERGLASS ROOFING PANELS; FIRE BARRIER SLIP SHEETS USED AS PROTECTION AGAINST FLAME SPREAD AND PENETRATION; COATED SUBSTRATES, NAMELY, SYNTHETIC FIBER SUITABLE FOR USE AS A BARRIER AGAINST FIRE, MOISTURE, CORROSIVE CHEMICALS AND ACOUSTICAL NOISE (U.S. CLS. 1, 5, 12, 13, 35 AND 50).

FIRST USE 6-0-2001; IN COMMERCE 7-0-2001.
KELLY CHOE, EXAMINING ATTORNEY

SleeperGard

THE MARK CONSISTS OF STANDARD CHARACTERS WITHOUT CLAIM TO ANY PARTICULAR FONT, STYLE, SIZE, OR COLOR.

FOR ADHESIVE COATED FIBERGLASS SHEETS USED AS PIPE SUPPORT CORROSION BARRIERS FOR USE ON PIPES ASSOCIATED WITH TRANSPORTING OIL, GAS, AND OTHER CHEMICALS (U.S. CLS. 1, 5, 12, 13, 35 AND 50).

FIRST USE 8-1-2003; IN COMMERCE 8-1-2003.
PAUL F. GAST, EXAMINING ATTORNEY

CLASS 17—(Continued).

SN 78-502,078. SAINT-GOBAIN PERFORMANCE PLASTICS CORPORATION, WAYNE, NJ. FILED 10-19-2004.

CLASS 17—(Continued).

SN 78-503,834. WINCKLER, STEVEN J., TROY, NY. FILED 10-21-2004.

TRANSFLOW

BottleCore

THE MARK CONSISTS OF STANDARD CHARACTERS WITHOUT CLAIM TO ANY PARTICULAR FONT, STYLE, SIZE, OR COLOR.

FOR CLEAR FLEXIBLE PLASTIC TUBING TO HANDLE RAW MILK IN BULK (U.S. CLS. 1, 5, 12, 13, 35 AND 50).

FIRST USE 11-0-1954; IN COMMERCE 11-0-1954.
PATRICIA EVANKO, EXAMINING ATTORNEY

THE MARK CONSISTS OF STANDARD CHARACTERS WITHOUT CLAIM TO ANY PARTICULAR FONT, STYLE, SIZE, OR COLOR.

FOR HOLLOW PLASTIC BLOCK MATERIAL USED IN THE MANUFACTURE OF SANDWICH STRUCTURES (U.S. CLS. 1, 5, 12, 13, 35 AND 50).

SUSAN HAYASH, EXAMINING ATTORNEY

SN 78-502,217. FOAMEX L.P., LINWOOD, PA. FILED 10-19-2004.

SN 78-503,860. ILLINOIS TOOL WORKS INC., GLENVIEW, IL. FILED 10-21-2004.

ELECTRELL

UB¹

THE MARK CONSISTS OF STANDARD CHARACTERS WITHOUT CLAIM TO ANY PARTICULAR FONT, STYLE, SIZE, OR COLOR.

FOR ELECTRICALLY CONDUCTIVE POLYURETHANE FOAMS SOLD IN BLOCK, BUN OR SLAB FORM FOR FURTHER FABRICATION INTO CUSHIONS, GAS OR FLUID FILTERS, OR PACKAGING FOR ELECTRONIC COMPONENTS FOR SHIPPING (U.S. CLS. 1, 5, 12, 13, 35 AND 50).

FIRST USE 1-0-1994; IN COMMERCE 4-0-1997.
GINNY ISAACSON, EXAMINING ATTORNEY

FOR INSULATED PANELS FOR USE IN REFRIGERATED TRUCK TRAILERS WHICH ADJUST TO CONFORM TO DIFFERENT TRAILER DIMENSIONS (U.S. CLS. 1, 5, 12, 13, 35 AND 50).

FIRST USE 9-1-2004; IN COMMERCE 9-1-2004.
MICHAEL KEATING, EXAMINING ATTORNEY

CLASS 17—(Continued).

SN 78-506,639. MUDANJIANG TIPTOP ELECETRIC COMPANY LTD., MUDANJIANG CITY, HEILONGJIANG PROVINCE, CHINA, FILED 10-27-2004.



THE COLOR(S) BLUE AND ORANGE IS/ARE CLAIMED AS A FEATURE OF THE MARK.

THE COLOR(S) BLUE APPEARS IN THE DESIGN PORTION AND ORANGE IN THE WORDING.

FOR VULCANIZED FIBER FOR USE IN THE MANUFACTURE OF ELECTRIC INSULATION, WASHERS OF VULCANIZED FIBER, VULCANIZED FIBER IN FORM OF SHEETS, RODS AND TUBES (U.S. CLS. 1, 5, 12, 13, 35 AND 50).

SUSAN HAYASH, EXAMINING ATTORNEY

SN 78-516,041. COBALT HOLDINGS, LLC, EVANSTON, IL. FILED 11-12-2004.

ENDURA PREMIUM

THE MARK CONSISTS OF STANDARD CHARACTERS WITHOUT CLAIM TO ANY PARTICULAR FONT, STYLE, SIZE, OR COLOR.

NO CLAIM IS MADE TO THE EXCLUSIVE RIGHT TO USE "PREMIUM", APART FROM THE MARK AS SHOWN.

FOR RUBBER PRODUCTS, NAMELY, MULCH MADE OF RECYCLED RUBBER FOR USE IN LANDSCAPING AND HORTICULTURE APPLICATIONS; RUBBER PRODUCTS, NAMELY, MULCH MADE OF RECYCLED RUBBER FOR USE WITH RESIDENTIAL, COMMERCIAL AND MUNICIPAL PLAY APPARATUS; RUBBER CHIPS, GRANULES, OR BUFFINGS FOR USE AS A GROUND COVER FOR RESIDENTIAL, COMMERCIAL AND MUNICIPAL PLAY APPARATUS; RUBBER CHIPS, GRANULES, OR BUFFINGS FOR USE AS A GROUND COVER FOR RESIDENTIAL AND COMMERCIAL DECORATIVE APPLICATIONS (U.S. CLS. 1, 5, 12, 13, 35 AND 50).

DANIEL BRODY, EXAMINING ATTORNEY

CLASS 17—(Continued).

SN 78-517,337. JR PRODUCTS, INC, JOHNSON CITY, TN. FILED 11-16-2004.

NO-TRIM

THE MARK CONSISTS OF STANDARD CHARACTERS WITHOUT CLAIM TO ANY PARTICULAR FONT, STYLE, SIZE, OR COLOR.

FOR PLIABLE PLASTIC SHEETING MADE OF HIGH DENSITY POLYETHYLENE THAT IS ANCHORED TO THE GROUND WITH SPIKES TO PREVENT WEEDS AND GRASSES FROM GROWING UNDER FENCE LINES, AND AROUND HOUSES, BUILDINGS, SHRUBS AND TREES (U.S. CLS. 1, 5, 12, 13, 35 AND 50).

ALLISON SCHRODY, EXAMINING ATTORNEY

SN 78-522,506. CERTAINTED CORPORATION, VALLEY FORGE, PA. FILED 11-24-2004.

SMARTROLL

THE MARK CONSISTS OF STANDARD CHARACTERS WITHOUT CLAIM TO ANY PARTICULAR FONT, STYLE, SIZE, OR COLOR.

FOR FIBER GLASS INSULATION FOR BUILDINGS WITH VAPOR BARRIER (U.S. CLS. 1, 5, 12, 13, 35 AND 50).

BRIAN PINO, EXAMINING ATTORNEY

CLASS 17—(Continued).

SN 78-533,887. GOODYEAR TIRE & RUBBER COMPANY, THE, AKRON, OH. FILED 12-16-2004.

CLASS 17—(Continued).

SN 78-538,770. FLEX-O-GLASS, INC., CHICAGO, IL. FILED 12-27-2004.

GREEN HORNET

LEMON DROP

THE MARK CONSISTS OF STANDARD CHARACTERS WITHOUT CLAIM TO ANY PARTICULAR FONT, STYLE, SIZE, OR COLOR.

NO CLAIM IS MADE TO THE EXCLUSIVE RIGHT TO USE "GREEN", APART FROM THE MARK AS SHOWN.

FOR NONMETALLIC HOSE FOR USE IN THE AGRICULTURAL, CONSTRUCTION, INDUSTRIAL MANUFACTURING, MARINE AND WASTE MANAGEMENT INDUSTRIES (U.S. CLS. 1, 5, 12, 13, 35 AND 50).

FIRST USE 5-22-2002; IN COMMERCE 5-22-2002.
ROBERT LAVACHE, EXAMINING ATTORNEY

THE MARK CONSISTS OF STANDARD CHARACTERS WITHOUT CLAIM TO ANY PARTICULAR FONT, STYLE, SIZE, OR COLOR.

FOR PLASTIC DROP CLOTHS (U.S. CLS. 1, 5, 12, 13, 35 AND 50).

FIRST USE 11-5-2004; IN COMMERCE 12-15-2004.
KEVIN DINALLO, EXAMINING ATTORNEY

SN 78-576,889. VALUE VINYL, INC., ARLINGTON, TX. FILED 2-28-2005.

SN 78-538,010. PREMARK RWP HOLDINGS, INC., WILMINGTON, DE. FILED 12-23-2004.

LOOK DEEPER

Freedom

THE MARK CONSISTS OF STANDARD CHARACTERS WITHOUT CLAIM TO ANY PARTICULAR FONT, STYLE, SIZE, OR COLOR.

FOR SOLID SURFACING IN THE FORM OF SLAB RESIN FOR USE IN THE MANUFACTURE OF COUNTERTOPS, VANITY TOPS, DECORATIVE EDGE MOLDING, WALL PANELS, AND INTERIOR HOME AND COMMERCIAL FURNISHINGS AND FIXTURES (U.S. CLS. 1, 5, 12, 13, 35 AND 50).

JENNIFER CHICOSKI, EXAMINING ATTORNEY

THE MARK CONSISTS OF STANDARD CHARACTERS WITHOUT CLAIM TO ANY PARTICULAR FONT, STYLE, SIZE, OR COLOR.

FOR VINYL SUBSTRATES USED BY OUTDOOR ADVERTISING INDUSTRY AND THE LIKE (U.S. CLS. 1, 5, 12, 13, 35 AND 50).

FIRST USE 10-0-2002; IN COMMERCE 10-0-2002.
DEZMONA MIZELLE, EXAMINING ATTORNEY

CLASS 17—(Continued).

SN 79-005,016. HENCO INDUSTRIES.; NAAMLOZE VEN-
NOOTSCHAP, BELGIUM, FILED 6-21-2004.



OWNER OF INTERNATIONAL REGISTRATION 0690614
DATED 3-24-1998, EXPIRES 3-24-2008.

THE COLOR(S) BLUE, RED, YELLOW AND WHITE IS/
ARE CLAIMED AS A FEATURE OF THE MARK.

THE COLOR WHITE APPEARS IN THE WORD HENCO,
THE CIRCLE TO THE LEFT OF HENCO AND THE
RECTANGULAR BACKGROUND; THE COLOR BLUE AP-
PEARS IN THE OUTERMOST OBLONG BAND, THE BACK-
GROUND FOR THE WORD HENCO AND THE BAND
INSIDE THE CIRCLE; THE COLOR YELLOW APPEARS IN
THE MIDDLE OBLONG BAND AND RED APPEARS IN
THE INNERMOST OBLONG BAND.

FOR SINGLE-WALL OR MULTIPLE-WALL NON-ME-
TALLIC FLEXIBLE PLASTIC PIPES WITH OR WITHOUT
INSULATING PROPERTIES FOR PLUMBING PUR-
POSES AND FOR USE IN SANITARY INSTALLATIONS
(U.S. CLS. 1, 5, 12, 13, 35 AND 50).

CHRISIE B. KING, EXAMINING ATTORNEY

SN 79-009,162. TOYO BOSEKI KABUSHIKI KAISHA, JAPAN,
FILED 12-17-2004.

XENO

PRIORITY DATE OF 11-17-2004 IS CLAIMED.

OWNER OF INTERNATIONAL REGISTRATION 0844053
DATED 12-17-2004, EXPIRES 12-17-2014.

FOR PLASTIC FILM FOR INDUSTRIAL AND COM-
MERCIAL PACKING USE (U.S. CLS. 1, 5, 12, 13, 35 AND
50).

NORA BUCHANAN WILL, EXAMINING ATTORNEY

SN 79-009,163. TOYO BOSEKI KABUSHIKI KAISHA, JAPAN,
FILED 12-17-2004.

PIBO

THE MARK CONSISTS OF STANDARD CHARACTERS
WITHOUT CLAIM TO ANY PARTICULAR FONT, STYLE,
SIZE, OR COLOR.

PRIORITY DATE OF 11-16-2004 IS CLAIMED.

OWNER OF INTERNATIONAL REGISTRATION 0844054
DATED 12-17-2004, EXPIRES 12-17-2014.

FOR PLASTIC FILM FOR INDUSTRIAL AND COM-
MERCIAL PACKING USE (U.S. CLS. 1, 5, 12, 13, 35 AND
50).

PRISCILLA MILTON, EXAMINING ATTORNEY

CLASS 18—LEATHER GOODS

SN 76-584,505. GIRLS CUBED, INC., NORTH MIAMI
BEACH, FL. FILED 3-31-2004.

GIRLS CUBED

THE MARK CONSISTS OF STANDARD CHARACTERS
WITHOUT CLAIM TO ANY PARTICULAR FONT, STYLE,
SIZE, OR COLOR.

NO CLAIM IS MADE TO THE EXCLUSIVE RIGHT TO
USE "GIRLS", APART FROM THE MARK AS SHOWN.

FOR HANDBAGS (U.S. CLS. 1, 2, 3, 22 AND 41).

RAUL CORDOVA, EXAMINING ATTORNEY

SN 76-584,775. LIBERTYVILLE SADDLE SHOP, INC., LIB-
ERTYVILLE, IL. FILED 4-5-2004.

EXCELER

THE MARK CONSISTS OF STANDARD CHARACTERS
WITHOUT CLAIM TO ANY PARTICULAR FONT, STYLE,
SIZE, OR COLOR.

FOR HORSE BLANKET CLOSURES, NAMELY A
DUAL FRONT CLOSURE SYSTEM FOR THE FRONT
FLAPS OF A HORSE BLANKET HAVING AN INNER
FABRIC FASTENER AND AN OUTER ADJUSTABLE
STRAP FASTENER (U.S. CLS. 1, 2, 3, 22 AND 41).

WARREN L. OLANDRIA, EXAMINING ATTORNEY

SN 76-584,973. J CHOO (JERSEY) LIMITED, ST. HELIER,
JERSEY, GREAT BRITAIN, FILED 4-2-2004.

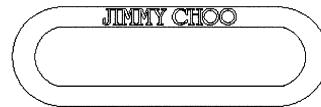

OWNER OF U.S. REG. NO. 2,641,408.

THE NAME "JIMMY CHOO" IDENTIFIES A LIVING
INDIVIDUAL WHOSE CONSENT IS OF RECORD.

THE MARK CONSISTS OF THE WORDING JIMMY
CHOO ENGRAVED IN THE TOP CENTER OF A SINGLE
OVAL-SHAPED LINK.

FOR LEATHER AND IMITATIONS OF LEATHER
SOLD IN BULK, TRAVEL TRUNKS, TRAVELING BAGS,
HANDBAGS, PURSES, WALLETS, HAT BOXES FOR
TRAVEL, UMBRELLAS, PARASOLS, AND WALKING
STICKS (U.S. CLS. 1, 2, 3, 22 AND 41).

FIRST USE 10-14-2002; IN COMMERCE 6-7-2003.

BARBARA GAYNOR, EXAMINING ATTORNEY

CLASS 18—(Continued).

SN 76-586,258. FIELD, PATRICIA, NEW YORK, NY. FILED 4-9-2004.

PATRICIA FIELD

THE MARK CONSISTS OF STANDARD CHARACTERS WITHOUT CLAIM TO ANY PARTICULAR FONT, STYLE, SIZE, OR COLOR.

THE NAME PATRICIA FIELD SHOWN IN THE MARK IDENTIFIES, A LIVING INDIVIDUAL WHOSE CONSENT IS OF RECORD.

FOR BAGS, NAMELY, HANDBAGS, POCKETBOOKS, PURSES, BOOK BAGS, BACKPACKS, TRAVELING BAGS, TOTE BAGS, ALL PURPOSE SPORT BAGS, BEACH BAGS, CARRY ON BAGS, CHANGE PURSES, COSMETIC BAGS SOLD EMPTY, FANNY PACKS, DIAPER BAGS, SUITCASES, BRIEFCASES, OVERNIGHT BAGS, GYM BAGS; UMBRELLAS, PARISOLS, WALLET, LUGGAGE, LEATHER BAGS, LEATHER KEY CHAINS (U.S. CLS. 1, 2, 3, 22 AND 41).

FIRST USE 1-1-1995; IN COMMERCE 1-1-1995.
LESLEY LAMOTHE, EXAMINING ATTORNEY

CLASS 18—(Continued).

SN 76-588,848. ANNA STREET, LLC, PORTSMOUTH, NH. FILED 4-23-2004.

ANNA STREET

THE MARK CONSISTS OF STANDARD CHARACTERS WITHOUT CLAIM TO ANY PARTICULAR FONT, STYLE, SIZE, OR COLOR.

THE NAME(S), PORTRAIT(S), AND/OR SIGNATURE(S) SHOWN IN THE MARK DOES NOT IDENTIFY A PARTICULAR LIVING INDIVIDUAL.

FOR PURSES AND HANDBAGS (U.S. CLS. 1, 2, 3, 22 AND 41).

FIRST USE 5-30-2002; IN COMMERCE 5-30-2002.
SALLY SHIH, EXAMINING ATTORNEY

SN 76-613,246. STONE MANUFACTURING & SUPPLY CO., INC., KANSAS CITY, MO. FILED 9-22-2004.

MOUNTAIN MAN

THE MARK CONSISTS OF STANDARD CHARACTERS WITHOUT CLAIM TO ANY PARTICULAR FONT, STYLE, SIZE, OR COLOR.

FOR HITCH-MOUNTED ANIMAL RESTRAINING DEVICE IN THE NATURE OF A METAL HARNESS USED TO IMMOBILIZE LARGE ANIMALS (U.S. CLS. 1, 2, 3, 22 AND 41).

FIRST USE 9-7-2004; IN COMMERCE 9-7-2004.
KELLY BOULTON, EXAMINING ATTORNEY

SN 76-587,321. DISNEY ENTERPRISES, INC., BURBANK, CA. FILED 4-19-2004.



OWNER OF U.S. REG. NO. 2,700,620.
FOR ATHLETIC BAGS; BEACH BAGS; BOOK BAGS; DIAPER BAGS; DUFFEL BAGS; GYM BAGS; TOTE BAGS; SHOPPING BAGS, NAMELY, MESH SHOPPING BAGS, LEATHER SHOPPING BAGS AND TEXTILE SHOPPING BAGS; HANDBAGS; BACKPACKS; FANNY PACKS; KNAPSACKS; WAIST PACKS; PURSES; WALLET; COIN PURSES; UMBRELLAS AND LUGGAGE (U.S. CLS. 1, 2, 3, 22 AND 41).

MARLENE BELL, EXAMINING ATTORNEY

SN 76-615,089. CHANEL, INC., NEW YORK, NY. FILED 10-8-2004.

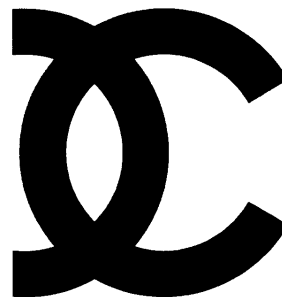

OWNER OF U.S. REG. NOS. 195,359, 1,734,822 AND OTHERS.

THIS MARK IS A THREE-QUARTER VIEW OF THE CHANEL CC MONOGRAM WHICH IS COMPRISED OF INTERLOCKING C'S.

FOR HANDBAGS (U.S. CLS. 1, 2, 3, 22 AND 41).
FIRST USE 6-1-2004; IN COMMERCE 6-1-2004.
KIMBERLY PERRY, EXAMINING ATTORNEY

CLASS 18—(Continued).

SN 76-625,145. PERDIKAKIS, MANDIE N., DBA HANDLE, BROOKLYN, NY. FILED 12-20-2004.

HANDLE

THE MARK COMPRISES THE WORD ELEMENT HANDLE, IN STYLIZED LETTERS IN WHICH A DESIGN OF A BAG IS INCORPORATED INTO THE LETTER A. COLOR IS NOT CLAIMED AS PART OF THE MARK.

FOR HANDBAGS, WALLETS (U.S. CLS. 1, 2, 3, 22 AND 41).

FIRST USE 11-16-2004; IN COMMERCE 11-16-2004.
KELLY BOULTON, EXAMINING ATTORNEY

SN 76-626,209. F. C. CASTLES, LLC, RAMSEY, NJ. FILED 12-23-2004.

RUFFLIFE

THE MARK CONSISTS OF STANDARD CHARACTERS WITHOUT CLAIM TO ANY PARTICULAR FONT, STYLE, SIZE, OR COLOR.

FOR DOG COLLAR, DOG APPAREL (U.S. CLS. 1, 2, 3, 22 AND 41).

TARAH HARDY, EXAMINING ATTORNEY

SN 78-168,869. CANNON RUBBER LIMITED, LONDON, UNITED KINGDOM N17 9LH, ENGLAND, FILED 9-27-2002.

AVENT KITBAG

OWNER OF UNITED KINGDOM REG. NO. 2249695, DATED 10-24-2000, EXPIRES 10-24-2010.

NO CLAIM IS MADE TO THE EXCLUSIVE RIGHT TO USE KITBAG, APART FROM THE MARK AS SHOWN.

FOR BABY CARRIERS WORN ON THE BODY; BABY HARNESSSES FOR BABY CARRIERS WORN ON THE BODY; DIAPER BAGS; BABY BACKPACKS IN THE NATURE OF BABY CHANGING BAGS; TRAVEL BAGS FOR CARRYING BABY BOTTLES AND ACCESSORIES; TRAVEL BAGS FOR CARRYING BABY BOTTLES AND BREAST FEEDING ACCESSORIES; CARRY-ALL BAGS; BABY BACKPACKS (U.S. CLS. 1, 2, 3, 22 AND 41).

NORA BUCHANAN WILL, EXAMINING ATTORNEY

CLASS 18—(Continued).

SN 78-187,192. REMO IMPORTS, LTD., ST. LAURENT, QUEBEC, CANADA, FILED 11-20-2002.

EAGLE TRAIL

OWNER OF CANADA REG. NO. TMA587092, DATED 8-13-2003, EXPIRES 8-13-2018.

FOR LUGGAGE, ALL-PURPOSE SPORTS BAGS, ATHLETIC BAGS, BEACH BAGS, CARRY-ON BAGS, DUFFEL BAGS, GARMENT BAGS FOR TRAVEL, GYM BAGS, OVERNIGHT BAGS, SCHOOL BAGS, SHOE BAGS FOR TRAVEL, SHOULDER BAGS, SUIT BAGS, TOTE BAGS, TRAVEL BAGS, ATTACHE CASES, BACKPACKS, BRIEFCASES, BUSINESS CASES, FANNY PACKS, KNAPSACKS, BRIEFCASE-STYLE PORTFOLIOS, AND RUCKSACKS (U.S. CLS. 1, 2, 3, 22 AND 41).

LINDA M. KING, EXAMINING ATTORNEY

SN 78-231,198. ALBION SADDLEMAKERS COMPANY LIMITED, WALSALL, WEST MIDLANDS, UNITED KINGDOM, FILED 3-28-2003.

ALBION

PRIORITY CLAIMED UNDER SEC. 44(D) ON ERPNCMNTY TM OFC APPLICATION NO. 2899086, FILED 10-21-2002, REG. NO. 2899086, DATED 10-21-2002, EXPIRES 10-21-2012.

FOR SADDLES, SADDLERY, HARNESS AND PARTS AND FITTINGS FOR ALL THE AFORESAID GOODS; RIDING CROPS AND WHIPS; HORSE SADDLE BAGS AND LUGGAGE; HORSE BLANKETS AND CLOTHING FOR HORSES, NAMELY, HOODS, EAR NETS, FLY VEILS, RAIN SHEETS, STABLE SHEETS, TURNOUT SHEETS, COOLERS, TAIL GUARDS, TAIL WRAPS, TAIL BAGS, RUGS, SADDLE PADS, NUMNAHS, SADDLE CLOTH, SWEATS, MANETRANERS AND VESTS (U.S. CLS. 1, 2, 3, 22 AND 41).

SAMUEL E. SHARPER JR., EXAMINING ATTORNEY

SN 78-276,773. AMERIBAG, INC., KINGSTON, NY. FILED 7-21-2003.



FOR SHOULDER BAGS AND TOTE BAGS (U.S. CLS. 1, 2, 3, 22 AND 41).

FIRST USE 9-30-1993; IN COMMERCE 9-30-1993.
CHERYL CLAYTON, EXAMINING ATTORNEY

CLASS 18—(Continued).

SN 78-324,417. MICAL, KAREN J., GRAHAM, NC. FILED 11-6-2003.

Charm for the Barn

THE MARK CONSISTS OF STANDARD CHARACTERS WITHOUT CLAIM TO ANY PARTICULAR FONT, STYLE, SIZE, OR COLOR.
FOR PURSES (U.S. CLS. 1, 2, 3, 22 AND 41).
LESLEY LAMOTHE, EXAMINING ATTORNEY

CLASS 18—(Continued).

SN 78-360,544. DIANA LYNN DOVER, GRANADA HILLS, CA. FILED 1-30-2004.



NO CLAIM IS MADE TO THE EXCLUSIVE RIGHT TO USE "BLANKET OF CALIFORNIA", APART FROM THE MARK AS SHOWN.

THE MARK CONSISTS OF A BLACK SILHOUETTE OF A HORSE WEARING A BLANKET WITH THE WORDS "DIANA D'S BLANKET OF CALIFORNIA" STYLIZED IN WHITE LETTERING IMPRINTED ON THE BLANKET.
FOR HORSE BLANKETS (U.S. CLS. 1, 2, 3, 22 AND 41).
FIRST USE 10-17-2003; IN COMMERCE 10-17-2003.
ADA HAN, EXAMINING ATTORNEY

SN 78-327,316. BUILT NY, INC., TUXEDO, NY. FILED 11-13-2003.

BUILTNY

THE MARK CONSISTS OF STANDARD CHARACTERS WITHOUT CLAIM TO ANY PARTICULAR FONT, STYLE, SIZE, OR COLOR.
NO CLAIM IS MADE TO THE EXCLUSIVE RIGHT TO USE "NY", APART FROM THE MARK AS SHOWN.
FOR LEATHER TOTE BAGS FOR CARRYING BOTTLES (U.S. CLS. 1, 2, 3, 22 AND 41).
FIRST USE 4-0-2002; IN COMMERCE 4-0-2002.
CHRISIE B. KING, EXAMINING ATTORNEY

SN 78-363,872. NORDSTROM, INC., SEATTLE, WA. FILED 2-6-2004.

**NORDSTROM TRAVEL
CONNECTION. QUALITY.
STYLE. PERFORMANCE.**

THE MARK CONSISTS OF STANDARD CHARACTERS WITHOUT CLAIM TO ANY PARTICULAR FONT, STYLE, SIZE, OR COLOR.

OWNER OF U.S. REG. NO. 2,318,259.
NO CLAIM IS MADE TO THE EXCLUSIVE RIGHT TO USE "QUALITY. STYLE.", APART FROM THE MARK AS SHOWN.

FOR SMALL LEATHER GOODS, NAMELY, SUITCASES, EXPANDABLE ROLLING LUGGAGE, CARRY-ON LUGGAGE, WHEELED WARDROBES, BRIEFCASES, TOTE BAGS, GARMENT BAGS FOR TRAVEL AND TOILETRY KITS SOLD EMPTY (U.S. CLS. 1, 2, 3, 22 AND 41).

KHANH LE, EXAMINING ATTORNEY

CLASS 18—(Continued).

SN 78-407,751. BAG BORROW OR STEAL, INC., HOLLYWOOD, FL. FILED 4-26-2004.

BAG BORROW OR STEAL

THE MARK CONSISTS OF STANDARD CHARACTERS WITHOUT CLAIM TO ANY PARTICULAR FONT, STYLE, SIZE, OR COLOR.

NO CLAIM IS MADE TO THE EXCLUSIVE RIGHT TO USE "BAG", APART FROM THE MARK AS SHOWN. FOR HANDBAGS (U.S. CLS. 1, 2, 3, 22 AND 41).
LANA PHAM, EXAMINING ATTORNEY

CLASS 18—(Continued).

SN 78-424,331. HENRY.BROWN, LLC, LEXINGTON, KY. FILED 5-25-2004.

HENRY BROWN

THE MARK CONSISTS OF STANDARD CHARACTERS WITHOUT CLAIM TO ANY PARTICULAR FONT, STYLE, SIZE, OR COLOR.

THE NAME(S), PORTRAIT(S), AND/OR SIGNATURE(S) SHOWN IN THE MARK DOES NOT IDENTIFY A PARTICULAR LIVING INDIVIDUAL.

FOR TOTE BAGS, DIAPER BAGS, TOTE BAGS FOR DIAPER CHANGING PADS AND DIAPERS, BUCKET STYLE TOTE BAGS FOR BEACH AND SWIM WEAR, BEACH TOWELS, KIDS' TOYS AND TRAVEL WEAR. (U.S. CLS. 1, 2, 3, 22 AND 41).
FIRST USE 11-1-2001; IN COMMERCE 11-1-2001.
JASON TURNER, EXAMINING ATTORNEY

SN 78-416,452. WORLD GOLF FOUNDATION, INC., ST. AUGUSTINE, FL. FILED 5-11-2004.



OWNER OF U.S. REG. NO. 2,190,342.
NO CLAIM IS MADE TO THE EXCLUSIVE RIGHT TO USE "GOLF", APART FROM THE MARK AS SHOWN.
FOR TOTE BAGS, UMBRELLAS, BRIEF CASES, ATHLETIC BAGS AND LUGGAGE (U.S. CLS. 1, 2, 3, 22 AND 41).
FIRST USE 5-19-1998; IN COMMERCE 5-19-1998.
CAROL SPILS, EXAMINING ATTORNEY

SN 78-430,655. EDWARDS, DEVAUGHN, RALEIGH, NC. FILED 6-6-2004.

Laurese NY

THE MARK CONSISTS OF STANDARD CHARACTERS WITHOUT CLAIM TO ANY PARTICULAR FONT, STYLE, SIZE, OR COLOR.

NO CLAIM IS MADE TO THE EXCLUSIVE RIGHT TO USE NY, APART FROM THE MARK AS SHOWN.

THE NY IN THE MARK REPRESENTS "NEW YOU"
FOR HANDBAGS AND FASHION ACCESSORIES, NAMELY, LEATHER WALLETS (U.S. CLS. 1, 2, 3, 22 AND 41).
FIRST USE 3-1-2004; IN COMMERCE 3-1-2004.
ANDREA SAUNDERS, EXAMINING ATTORNEY

CLASS 18—(Continued).

SN 78-432,963. YAKIRA, LLC, SOUTH RIVER, NJ. FILED 6-10-2004.

CLASS 18—(Continued).

SN 78-441,744. AUSLAND, KELLY, BEND, OR. FILED 6-25-2004.



OWNER OF U.S. REG. NOS. 2,262,749, 2,729,329 AND 2,890,165.

NO CLAIM IS MADE TO THE EXCLUSIVE RIGHT TO USE UNLTD., APART FROM THE MARK AS SHOWN.

THE MARK CONSISTS OF A RHINO WITH A BORDER DESIGN FOLLOWED BY THE WORD UNLTD.

FOR ALL PURPOSE ATHLETIC BAGS, BACKPACKS, BOOK BAGS, SCHOOL BAGS, DUFFEL BAGS, GYM BAGS, OVERNIGHT BAGS, SHOULDER BAGS, PURSES, TOTE BAGS, TRAVEL BAGS, AND GARMENT BAGS FOR TRAVEL, MAINLY MADE OF LEATHER OR NON-LEATHER MATERIALS; SMALL LEATHER GOODS, NAMELY WALLETS (U.S. CLS. 1, 2, 3, 22 AND 41).

SCOTT OSLICK, EXAMINING ATTORNEY

GIDDYUP GIRLS

SN 78-439,237. BOVANO U.S.A. CO., VERNON, CA. FILED 6-22-2004.



NO CLAIM IS MADE TO THE EXCLUSIVE RIGHT TO USE "AMERICAN" AND "SPORT", APART FROM THE MARK AS SHOWN.

FOR BRIEFCASES, BACKPACKS, LUGGAGE, AND RELATED ACCESSORIES, NAMELY, PURSES, HANDBAGS, TRAVEL BAGS, CARRY-ON BAGS, AND PASSPORT CASES, EXPANDABLE PULLMAN, ROLLING LUGGAGE, ROLLING GARMENT BAGS, ROLLING DUFFLES, BUSINESS BRIEFCASES, AND DELUXE BOARDING TOTES (U.S. CLS. 1, 2, 3, 22 AND 41).

DAWN FELDMAN, EXAMINING ATTORNEY

THE MARK CONSISTS OF STANDARD CHARACTERS WITHOUT CLAIM TO ANY PARTICULAR FONT, STYLE, SIZE, OR COLOR.

NO CLAIM IS MADE TO THE EXCLUSIVE RIGHT TO USE GIRLS, APART FROM THE MARK AS SHOWN.

FOR PURSES, COIN PURSES, CLUTCH PURSES, BACKPACKS, LUGGAGE, AND SUITCASES (U.S. CLS. 1, 2, 3, 22 AND 41).

JOHN E. MICHOS, EXAMINING ATTORNEY

CLASS 18—(Continued).

SN 78-454,102. LOUIS, KENETTE, NEW YORK, NY. FILED 7-21-2004.



OWNER OF U.S. REG. NO. 2,872,378.
 THE NAME KENETTE LOUIS IDENTIFIES A LIVING INDIVIDUAL WHOSE CONSENT IS OF RECORD.
 FOR ALL PURPOSE SPORT BAGS, ALL-PURPOSE ATHLETIC BAGS, ATHLETIC BAGS, BABY BACKPACKS, BABY CARRIERS WORN ON THE BODY, BACKPACKS, BOOK BAGS, BOSTON BAGS, BRIEFBAGS, BRIEFCASES, BRIEFCASE-TYPE PORTFOLIOS, BUSINESS CARD CASES, BUSINESS CASES, CALLING CARD CASES, CARRY-ON BAGS, CHANGE PURSES, CLOTHING FOR ANIMALS, CLUTCH BAGS, CLUTCH PURSES, CLUTCHES IN THE NATURE OF PURSES, COIN PURSES, COLLARS FOR PETS BEARING MEDICAL INFORMATION, COSMETIC BAGS SOLD EMPTY, COSMETIC CASES SOLD EMPTY, CREDIT CARD CASES, DAYPACKS, DIAPER BAGS, DOG APPAREL, DOG CLOTHING, DOG COLLARS, DOG LEASHES, DRAWSTRING POUCHES, DUFFEL BAGS, GARMENT BAGS FOR TRAVEL, GYM BAGS, HANDBAGS, LEATHER BAGS FOR MERCHANDISE PACKAGING IN THE NATURE OF LEATHER ENVELOPES AND POUCHES FOR MERCHANDISE PACKAGING, LEATHER KEY CHAINS, LEATHER SHOPPING BAGS, LIPSTICK CASES, LIPSTICK HOLDERS, LUGGAGE, LUGGAGE TAGS, MESH SHOPPING BAGS, MUZZLES, NAME CARD CASES, NON-MOTORIZED, COLLAPSIBLE LUGGAGE CARTS, OVERNIGHT BAGS, OVERNIGHT CASES, PET CLOTHING, POCKETBOOKS, PURSES, ROLL BAGS, RUCKSACKS, SADDLEBAGS, SADDLERY, SADDLES, SATCHELS, SCHOOL BAGS, SCHOOL BOOK BAGS, SHAVING BAGS SOLD EMPTY, SHOE BAGS FOR TRAVEL, SHOPPING BAGS WITH WHEELS ATTACHED, SHOULDER BAGS, SOUVENIR BAGS, SUIT BAGS, SUITCASES, TEXTILE SHOPPING BAGS, TOTE BAGS, TRAIN CASES, TRAVEL BAGS, TRAVELING BAGS, TRUNKS IN THE NATURE OF LUGGAGE, WALLETS (U.S. CLS. 1, 2, 3, 22 AND 41).
 FIRST USE 2-1-2004; IN COMMERCE 2-1-2004.
 SCOTT OSLICK, EXAMINING ATTORNEY

CLASS 18—(Continued).

SN 78-454,500. CHENSON INDUSTRIAL CO., LTD., INC., LOS ANGELES, CA. FILED 7-21-2004.



NO CLAIM IS MADE TO THE EXCLUSIVE RIGHT TO USE LOS ANGELES, APART FROM THE MARK AS SHOWN.
 FOR HANDBAGS, WALLETS, AND BACKPACKS (U.S. CLS. 1, 2, 3, 22 AND 41).
 FIRST USE 1-1-2004; IN COMMERCE 1-1-2004.
 TARAH HARDY, EXAMINING ATTORNEY

SN 78-455,247. STUART, JACQUELYN A., CARLSBAD, CA. AND STUART, JAMES D., CARLSBAD, CA. FILED 7-22-2004.

CABO GEAR

THE MARK CONSISTS OF STANDARD CHARACTERS WITHOUT CLAIM TO ANY PARTICULAR FONT, STYLE, SIZE, OR COLOR.
 OWNER OF U.S. REG. NOS. 1,435,637, 1,696,095 AND 1,811,576.
 NO CLAIM IS MADE TO THE EXCLUSIVE RIGHT TO USE "GEAR", APART FROM THE MARK AS SHOWN.
 THE FOREIGN WORDING IN THE MARK TRANSLATES INTO ENGLISH AS CAPE.
 FOR BAGS, NAMELY, BACKPACKS, TRAVEL BAGS, ALL-PURPOSE SPORT BAGS, GARMENT BAGS FOR TRAVEL, COSMETIC BAGS SOLD EMPTY, AND DUFFLE BAGS (U.S. CLS. 1, 2, 3, 22 AND 41).
 FIRST USE 9-1-1994; IN COMMERCE 2-28-1995.
 NELSON SNYDER, EXAMINING ATTORNEY

CLASS 18—(Continued).

SN 78-455,695. EQUESPORT, LLC, ROCHESTER, WA. FILED 7-23-2004.

CLASS 18—(Continued).

SN 78-471,223. UNITED PET GROUP, INC., HAUPAGUE, NY. FILED 8-20-2004.

EQUESPORT

MEATY MIDDLES

THE MARK CONSISTS OF STANDARD CHARACTERS WITHOUT CLAIM TO ANY PARTICULAR FONT, STYLE, SIZE, OR COLOR.

FOR HAND STITCHED PRODUCTS AND ACCESSORIES FOR HORSES, HOUNDS AND PETS CONTAINING SEMI-PRECIOUS STONES, NAMELY, COLLARS, BROWBANDS, HALTERS AND PINS (U.S. CLS. 1, 2, 3, 22 AND 41).

FIRST USE 7-0-2003; IN COMMERCE 7-0-2003.
TRACY CROSS, EXAMINING ATTORNEY

THE MARK CONSISTS OF STANDARD CHARACTERS WITHOUT CLAIM TO ANY PARTICULAR FONT, STYLE, SIZE, OR COLOR.

NO CLAIM IS MADE TO THE EXCLUSIVE RIGHT TO USE "MEATY", APART FROM THE MARK AS SHOWN.
FOR RAWHIDE BONES AND RAWHIDE CHEWS FOR DOGS (U.S. CLS. 1, 2, 3, 22 AND 41).

MONIQUE MILLER, EXAMINING ATTORNEY

SN 78-469,065. DOLLAR EMPIRE, LLC, VERNON, CA. FILED 8-17-2004.

SN 78-484,902. J. MITTON & ASSOCIATES, INC., NEW HOLLAND, PA. FILED 9-16-2004.

EST≅LLA

ADJUSTA BIT

THE MARK CONSISTS OF ESTELLA IN STYLIZED CHARACTERS.

FOR HANDBAGS (U.S. CLS. 1, 2, 3, 22 AND 41).
FIRST USE 4-15-2003; IN COMMERCE 4-15-2003.
KIMBERLY FRYE, EXAMINING ATTORNEY

THE MARK CONSISTS OF STANDARD CHARACTERS WITHOUT CLAIM TO ANY PARTICULAR FONT, STYLE, SIZE, OR COLOR.

NO CLAIM IS MADE TO THE EXCLUSIVE RIGHT TO USE "BIT", APART FROM THE MARK AS SHOWN.
FOR HORSE BITS (U.S. CLS. 1, 2, 3, 22 AND 41).

RENEE MCCRAY, EXAMINING ATTORNEY

CLASS 18—(Continued).

SN 78-495,464. RLJ BASKETBALL, LLC, CHARLOTTE, NC.
FILED 10-6-2004.



THE MARK CONSISTS OF THE HEAD OF A BOBCAT OVER A BASKETBALL.

FOR ATHLETIC BAGS, SHOE BAGS FOR TRAVEL, OVERNIGHT BAGS, UMBRELLAS, BACKPACKS, BABY BACKPACKS, DUFFEL BAGS, TOTE BAGS, LUGGAGE, LUGGAGE TAGS, PATIO UMBRELLAS, VALISES, AT-TACHE CASES, BILLFOLDS, WALLETS, BRIEFCASES, CANES, BUSINESS CARD CASES, BOOK BAGS, ALL PURPOSE SPORTS BAGS, GOLF UMBRELLAS, GYM BAGS, PURSES, COIN PURSES, FANNY PACKS, WAIST PACKS, COSMETIC CASES SOLD EMPTY, GARMENT BAGS FOR TRAVEL, HANDBAGS, KEY CASES, KNAP-SACKS, SUITCASES, TOILETRY CASES SOLD EMPTY, TRUNKS FOR TRAVELING AND RUCKSACKS (U.S. CLS. 1, 2, 3, 22 AND 41).

AMOS T. MATTHEWS, JR., EXAMINING ATTORNEY

SN 78-495,901. SIMMS FISHING PRODUCTS CORPORA-TION, BOZEMAN, MT. FILED 10-6-2004.

DRY CREEK

THE MARK CONSISTS OF STANDARD CHARACTERS WITHOUT CLAIM TO ANY PARTICULAR FONT, STYLE, SIZE, OR COLOR.

FOR CHEST PACKS; BACKPACKS; FANNY PACKS; ALL-PURPOSE SPORT BAGS; ALL-PURPOSE ATHLETIC BAGS; ALL-PURPOSE CARRYING BAGS; TRAVEL BAGS; DUFFEL BAGS; ROLL BAGS (U.S. CLS. 1, 2, 3, 22 AND 41).

JENNIFER KRISP, EXAMINING ATTORNEY

CLASS 18—(Continued).

SN 78-496,794. MULTI-VET LTD., SAINT-HYACINTHE, QUEBEC, CANADA, FILED 10-8-2004.

BARKENDER

THE MARK CONSISTS OF STANDARD CHARACTERS WITHOUT CLAIM TO ANY PARTICULAR FONT, STYLE, SIZE, OR COLOR.

FOR TRAINING COLLAR FOR DOGS (U.S. CLS. 1, 2, 3, 22 AND 41).

JOHN LINCOSKI, EXAMINING ATTORNEY

SN 78-498,200. TRG ACCESSORIES, L.L.C., ST. LOUIS, MO.
FILED 10-12-2004.

LINGO

THE MARK CONSISTS OF STANDARD CHARACTERS WITHOUT CLAIM TO ANY PARTICULAR FONT, STYLE, SIZE, OR COLOR.

FOR LUGGAGE (U.S. CLS. 1, 2, 3, 22 AND 41).

KEVON CHISOLM, EXAMINING ATTORNEY

CLASS 18—(Continued).

SN 78-499,063. PRO-LITE INTERNATIONAL, SAN CLEM-
ENTE, CA. FILED 10-13-2004.

CLASS 18—(Continued).

SN 78-499,987. DEUTSCHE TELEKOM AG, BONN, FED REP
GERMANY, FILED 10-14-2004.

STORMPROOF

T-Systems

THE MARK CONSISTS OF STANDARD CHARACTERS
WITHOUT CLAIM TO ANY PARTICULAR FONT, STYLE,
SIZE, OR COLOR.

FOR ATHLETIC BAGS, DUFFLE BAGS, BACKPACKS,
BEACH BAGS, ATTACHE CASES, TRAVEL BAGS,
NAMELY LUGGAGE, TRAVEL KIT BAGS, TRAVEL
BAGS FOR SNOWBOARDS AND SURFBOARDS; MES-
SENGER BAGS, DUFFEL BAGS AND ALL PURPOSE
SPORTS BAGS (U.S. CLS. 1, 2, 3, 22 AND 41).
FIRST USE 12-0-1989; IN COMMERCE 12-0-1989.
CHRIS WELLS, EXAMINING ATTORNEY

THE MARK CONSISTS OF STANDARD CHARACTERS
WITHOUT CLAIM TO ANY PARTICULAR FONT, STYLE,
SIZE, OR COLOR.

PRIORITY CLAIMED UNDER SEC. 44(D) ON FED REP
GERMANY APPLICATION NO. 30421580.535, FILED 4-15-
2004, REG. NO. 30421580, DATED 9-9-2004, EXPIRES 4-30-
2014.

OWNER OF U.S. REG. NOS. 2,448,571, 2,880,613 AND
OTHERS.

FOR UMBRELLAS, PARASOLS; GOODS MADE OF
LEATHER AND IMITATIONS OF LEATHERS, NAMELY,
WALLETS, VALISES, CARRYING CASES FOR CREDIT
CARDS, TICKETS IN PARTICULAR, AIR TRAVEL
TICKETS, PURSES, WRITING CASES, NAMELY, BRIEF-
CASE-TYPE PORTFOLIOS, SUITCASES, TRAVELING
BAGS, AND BRIEFCASES; TRUNKS FOR TRAVEL
AND TRAVEL BAGS (U.S. CLS. 1, 2, 3, 22 AND 41).
SKYE YOUNG, EXAMINING ATTORNEY

SN 78-499,671. SIZEMORE, EDRIC D., CALUMET PARK, IL.
FILED 10-14-2004.

SN 78-500,024. DEUTSCHE TELEKOM AG, BONN, FED REP
GERMANY, FILED 10-14-2004.

CARLIE Security Backpacks



PRIORITY CLAIMED UNDER SEC. 44(D) ON FED REP
GERMANY APPLICATION NO. 30421579135, FILED 4-15-
2004, REG. NO. 30421579, DATED 9-9-2004, EXPIRES 4-30-
2014.

OWNER OF U.S. REG. NOS. 2,448,571, 2,880,613 AND
OTHERS.

THE COLOR(S) MAGENTA AND GREY IS/ARE
CLAIMED AS A FEATURE OF THE MARK.

THE COLOR MAGENTA APPEARS IN THE LETTER "T"
IN THE MARK; THE REMAINDER OF THE MARK
APPEARS IN THE COLOR GREY.

FOR UMBRELLAS, PARASOLS; GOODS MADE OF
LEATHER AND IMITATIONS OF LEATHERS, NAMELY,
WALLETS, VALISES, CARRYING CASES FOR CREDIT
CARDS, TICKETS IN PARTICULAR, AIR TRAVEL
TICKETS, PURSES, WRITING CASES, NAMELY, BRIEF-
CASE-TYPE PORTFOLIOS, SUITCASES, TRAVELING
BAGS, AND BRIEFCASES; TRUNKS FOR TRAVEL
AND TRAVEL BAGS (U.S. CLS. 1, 2, 3, 22 AND 41).
SKYE YOUNG, EXAMINING ATTORNEY

THE MARK CONSISTS OF STANDARD CHARACTERS
WITHOUT CLAIM TO ANY PARTICULAR FONT, STYLE,
SIZE, OR COLOR.

NO CLAIM IS MADE TO THE EXCLUSIVE RIGHT TO
USE "SECURITY BACKPACKS", APART FROM THE
MARK AS SHOWN.

FOR BACKPACKS THAT ARE EQUIPPED WITH A
CONCEALED PERSONAL ALARM SYSTEM (U.S. CLS. 1,
2, 3, 22 AND 41).

MONTIA G. PRESSEY, EXAMINING ATTORNEY

CLASS 18—(Continued).

SN 78-500,958. STERRACLIMB LLC, PRINCETON, NJ.
FILED 10-16-2004.

STERRACLIMB

THE MARK CONSISTS OF STANDARD CHARACTERS WITHOUT CLAIM TO ANY PARTICULAR FONT, STYLE, SIZE, OR COLOR.

FOR POWERED STAIR CLIMBING LUGGAGE (U.S. CLS. 1, 2, 3, 22 AND 41).

FIRST USE 9-1-2004; IN COMMERCE 10-16-2004.
DANIEL CAPSHAW, EXAMINING ATTORNEY

SN 78-501,404. TRAILMASTER SADDLES, ELIZABETH, CO.
FILED 10-18-2004.

TRAILMASTER SADDLES

THE MARK CONSISTS OF STANDARD CHARACTERS WITHOUT CLAIM TO ANY PARTICULAR FONT, STYLE, SIZE, OR COLOR.

NO CLAIM IS MADE TO THE EXCLUSIVE RIGHT TO USE "SADDLES", APART FROM THE MARK AS SHOWN, FOR EQUINE SADDLES (U.S. CLS. 1, 2, 3, 22 AND 41).

FIRST USE 7-16-2004; IN COMMERCE 7-16-2004.
CYNTHIA SLOAN, EXAMINING ATTORNEY

SN 78-502,491. GOSSMAN, JIMMY L, SACRAMENTO, CA.
FILED 10-19-2004.



THE MARK CONSISTS OF STYLIZED SILHOUETTE OF FLYING GOOSE PROFILE WITH STYLIZED WORD "GOOSE" HAVING SECOND "O" RAISED SLIGHTLY FROM FIRST "O".

FOR DOG LEASHES AND COLLARS FOR PETS (U.S. CLS. 1, 2, 3, 22 AND 41).

FIRST USE 6-1-1993; IN COMMERCE 10-10-2004.
LOURDES AYALA, EXAMINING ATTORNEY

CLASS 18—(Continued).

SN 78-516,959. MR. SMITH RECOMMENDS, INC., STOCK-BRIDGE, MA. FILED 11-15-2004.



THE MARK CONSISTS OF THE WORD "JIMI" OVER THE PHRASE "BY MR. SMITH" ALL OVER THE PHRASE "THE WALLET FOR PEOPLE WHO HATE WALLETS".

FOR CARRYING CASES FOR PERSONAL ARTICLES (U.S. CLS. 1, 2, 3, 22 AND 41).

CURTIS FRENCH, EXAMINING ATTORNEY

SN 78-530,784. HOMER TLC, INC., CLAYMONT, DE. FILED
12-10-2004.

TrafficMaster

THE MARK CONSISTS OF STANDARD CHARACTERS WITHOUT CLAIM TO ANY PARTICULAR FONT, STYLE, SIZE, OR COLOR.

OWNER OF U.S. REG. NOS. 2,321,766 AND 2,730,350.
FOR PATIO UMBRELLAS (U.S. CLS. 1, 2, 3, 22 AND 41).

WON TEAK OH, EXAMINING ATTORNEY

CLASS 18—(Continued).

SN 78-531,136. DIOPHY INT'L TRADING USA, INC., AL-HAMBRA, CA. FILED 12-12-2004.

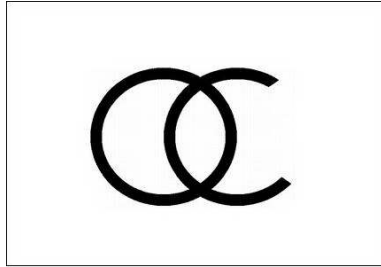

THE MARK CONSISTS OF A COMPLETED CIRCLE AND A NON-COMPLETED CIRCLE OVERLAPPED IN THE MIDDLE.
 FOR HANDBAGS (U.S. CLS. 1, 2, 3, 22 AND 41).
 FIRST USE 12-1-2004; IN COMMERCE 12-1-2004.
 SOPHIA S. KIM, EXAMINING ATTORNEY

CLASS 18—(Continued).

SN 78-537,476. EXPERIENCE LEARNING COMMUNITY, SEATTLE, WA. FILED 12-22-2004.

SCIENCE FICTION
 MUSEUM AND HALL
 OF FAME

THE MARK CONSISTS OF STANDARD CHARACTERS WITHOUT CLAIM TO ANY PARTICULAR FONT, STYLE, SIZE, OR COLOR.
 FOR TOTE BAGS AND UMBRELLAS (U.S. CLS. 1, 2, 3, 22 AND 41).
 FIRST USE 6-18-2004; IN COMMERCE 6-18-2004.
 ROBERT LORENZO, EXAMINING ATTORNEY

SN 78-535,961. HOMER TLC, INC., CLAYMONT, DE. FILED 12-21-2004.

DESIGN VIEW

THE MARK CONSISTS OF STANDARD CHARACTERS WITHOUT CLAIM TO ANY PARTICULAR FONT, STYLE, SIZE, OR COLOR.
 OWNER OF U.S. REG. NO. 2,432,129.
 FOR PATIO UMBRELLAS (U.S. CLS. 1, 2, 3, 22 AND 41).
 REBECCA GILBERT, EXAMINING ATTORNEY

CLASS 19—NON-METALLIC BUILDING MATERIALS

SN 75-722,071. BASF AKTIENGESELLSCHAFT, LUDWIG-SHAFEN, FED REP GERMANY, FILED 6-4-1999.

SN 78-537,474. EXPERIENCE LEARNING COMMUNITY, SEATTLE, WA. FILED 12-22-2004.



THE MARK CONSISTS OF A THREE LEGGED WINGED CREATURE CENTERED OVER THE STYLIZED LETTERS SFM.
 FOR TOTE BAGS AND UMBRELLAS (U.S. CLS. 1, 2, 3, 22 AND 41).
 FIRST USE 6-18-2004; IN COMMERCE 6-18-2004.
 ROBERT LORENZO, EXAMINING ATTORNEY

Peripor

PRIORITY CLAIMED UNDER SEC. 44(D) ON ERP N CMNTY TM OFC APPLICATION NO. 1118280, FILED 3-25-1999, REG. NO. 001118280, DATED 12-5-2002, EXPIRES 3-25-2009.
 FOR NON-METAL CASTING FORMS MADE OF POROUS MATERIAL FOR CONCRETE; AND NON-METAL WALL BOARDS WITH THERMAL INSULATION (U.S. CLS. 1, 12, 33 AND 50).
 KARLA PERKINS, EXAMINING ATTORNEY

CLASS 19—(Continued).

SN 76-304,412. PYROLAVE SOCIETE ANONYME, 82100 CASTELSARRASIN, FRANCE, FILED 8-27-2001.

PYRO LAVE

PRIORITY CLAIMED UNDER SEC. 44(D) ON ERPNCMNTY TM OFC APPLICATION NO. 2311827, FILED 7-23-2001.

NO CLAIM IS MADE TO THE EXCLUSIVE RIGHT TO USE "LAVE", APART FROM THE MARK AS SHOWN.

FOR NON-METALLIC BUILDING MATERIALS, NAMELY, TILES, BLOCKS, AND SLABS FORMED OF LAVASTONE, NATURAL STONE, AND ARTIFICIAL STONE, FOR BUILDING FLOORS, WALKWAYS, SIDEWALKS, WALLS, STAIRS, BENCHES, COUNTER TOPS, AND VANITY TOPS (U.S. CLS. 1, 12, 33 AND 50).

FIRST USE 0-0-1997; IN COMMERCE 0-0-1997.

WON TEAK OH, EXAMINING ATTORNEY

CLASS 19—(Continued).

SN 76-581,674. TITAN VIRGINIA READY-MIX LLC, NORFOLK, VA. FILED 3-15-2004.



NO CLAIM IS MADE TO THE EXCLUSIVE RIGHT TO USE "INTEGRAL COLOR CONCRETE", APART FROM THE MARK AS SHOWN.

THE COLORS GREEN, YELLOW, ORANGE, RED, VIOLET, INDIGO AND BLUE ARE CLAIMED AS A FEATURE OF THE MARK.

SUCH COLORS APPEAR IN THE TEARDROP DESIGN COVERING THE "O" IN CHROMA, AND IN TWO BANDS PARTIALLY SURROUNDING THE WORD CHROMA IN AN INCOMPLETE OVAL.

FOR COLORED CONCRETE IN WET-MIX FORM (U.S. CLS. 1, 12, 33 AND 50).

MONIQUE MILLER, EXAMINING ATTORNEY

SN 76-584,331. TREX COMPANY, INC., WINCHESTER, VA. FILED 4-1-2004.

CREATE YOUR SPACE

THE MARK CONSISTS OF STANDARD CHARACTERS WITHOUT CLAIM TO ANY PARTICULAR FONT, STYLE, SIZE, OR COLOR.

FOR COMPOSITE BUILDING MATERIALS COMPRISING WOOD FIBER AND POLYMER FOR DECKING, RAILING, FENCING, AND OTHER OUTDOOR PRODUCTS (U.S. CLS. 1, 12, 33 AND 50).

FIRST USE 1-13-2005; IN COMMERCE 1-13-2005.

RUSS HERMAN, EXAMINING ATTORNEY

SN 76-591,200. ACCO BOARD, LLC, APOPKA, FL. FILED 5-10-2004.



AS SHOWN IN THE ACCOMPANYING DRAWING, THE MARK SOUGHT TO BE REGISTERED IS COMPRISED OF THE COINED WORD MARK "ACCO-BACKER" IN COMBINATION WITH AN INVERTED "V" DESIGN WITHIN A RECTANGLE SET FORTH ABOVE THE WORD "ACCO".

FOR CONCRETE DRYWALL WALLBOARDS FOR INTERIOR AND EXTERIOR USE (U.S. CLS. 1, 12, 33 AND 50).

MICHAEL KAZAZIAN, EXAMINING ATTORNEY

SN 76-574,229. CLAM CORPORATION, PLYMOUTH, MN. FILED 2-5-2004.

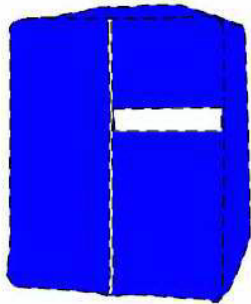

OWNER OF U.S. REG. NOS. 1,829,427, 2,233,474 AND OTHERS.

THE COLOR(S) BLUE IS/ARE CLAIMED AS A FEATURE OF THE MARK.

THE MARK CONSISTS OF THE CLAIMED COLOR BLUE AS APPLIED TO THE GOODS. THE CONFIGURATION OF THE GOODS AND THE DOTTED OUTLINE OF THE GOODS, ZIPPER, DOOR FLAP EDGES AND WINDOW IS INTENDED TO SHOW THE POSITION OF THE MARK AND IS NOT PART OF THE MARK AS SHOWN.

SEC. 2(F).

FOR FABRIC-COVERED PORTABLE ICE FISHING SHELTERS (U.S. CLS. 1, 12, 33 AND 50).

FIRST USE 11-0-1988; IN COMMERCE 11-0-1988.

SEAN DWYER, EXAMINING ATTORNEY

CLASS 19—(Continued).

SN 76-605,692. ARTISTIC ENCLOSURES, INC., BARTO, PA. FILED 8-5-2004.

SCREEN + PLUS

THE MARK CONSISTS OF STANDARD CHARACTERS WITHOUT CLAIM TO ANY PARTICULAR FONT, STYLE, SIZE, OR COLOR.

NO CLAIM IS MADE TO THE EXCLUSIVE RIGHT TO USE SCREEN, APART FROM THE MARK AS SHOWN.

FOR WOODEN FRAMES ADAPTED TO RECEIVE SCREENS OR GLASS (U.S. CLS. 1, 12, 33 AND 50).

FIRST USE 11-26-1996; IN COMMERCE 11-26-1996.
YSA DEJESUS, EXAMINING ATTORNEY

CLASS 19—(Continued).

SN 76-607,513. MADMAN, INC., DBA RAYDOOR, NEW YORK, NY. FILED 8-18-2004.

RAYDOOR

THE MARK CONSISTS OF STANDARD CHARACTERS WITHOUT CLAIM TO ANY PARTICULAR FONT, STYLE, SIZE, OR COLOR.

FOR SLIDING NON-METAL WALLS AND DOORS; SLIDING, SWINGING, FIXED AND FREESTANDING DIVIDING SYSTEMS FOR DIVIDING ROOMS, COMPRISED OF NON-METAL WALLS AND DOORS (U.S. CLS. 1, 12, 33 AND 50).

FIRST USE 10-0-2000; IN COMMERCE 5-0-2002.
JOHN LINCOSKI, EXAMINING ATTORNEY

SN 76-610,458. HANCOR, INC., FINDLAY, OH. FILED 9-2-2004.



THE COLOR(S) BLUE IS/ARE CLAIMED AS A FEATURE OF THE MARK.

THE COLOR BLUE APPEARS IN THE ARCH ABOVE THE LETTERS STOR.

FOR POLYPROPYLENE UNDERGROUND RETENTION/DETENTION CHAMBERS TO MANAGE WATER RUN-OFF (U.S. CLS. 1, 12, 33 AND 50).

FIRST USE 8-24-2004; IN COMMERCE 8-24-2004.
AMOS T. MATTHEWS, JR., EXAMINING ATTORNEY

SN 76-606,618. FRANK PAXTON LUMBER COMPANY, BEECHWOOD, OH. FILED 8-9-2004.



NO CLAIM IS MADE TO THE EXCLUSIVE RIGHT TO USE "LUMBER COMPANY", APART FROM THE MARK AS SHOWN.

THE NAME IN THE MARK DOES NOT IDENTIFY A PARTICULAR LIVING INDIVIDUAL. "FRANK PAXTON" DOES NOT IDENTIFY A LIVING INDIVIDUAL.

THE COLORS RED, YELLOW, BLACK AND WHITE ARE CLAIMED AS A FEATURE OF THE MARK.

THE COLOR BLACK APPEARS IN THE PICTURE OF THE TREES. THE COLOR RED APPEARS IN THE CIRCLE SURROUNDING THE TREES. THE COLOR WHITE APPEARS IN A THIN CIRCULAR BAND AND ALSO THE WORDS "FRANK PAXTON LUMBER COMPANY". THE COLOR YELLOW APPEARS INSIDE THE RED CIRCLE AND CREATES THE TREES.

FOR PLYWOOD, PARTLY PROCESSED TIMBER, WOOD BEAMS, WOOD BOARDS, WOOD DOOR FRAMES, WOOD MOLDINGS, WOOD PANNELLING, WOOD POSTS, WOODEN FLOORING, PARQUET WOOD FLOORING (U.S. CLS. 1, 12, 33 AND 50).

FIRST USE 8-2-2004; IN COMMERCE 8-2-2004.
JOANNA DUKOVIC, EXAMINING ATTORNEY

SN 76-613,580. BROWN WOOD PRODUCTS CO., LINCOLN-WOOD, IL. FILED 9-30-2004.

DESIGNS OF DISTINCTION

THE MARK CONSISTS OF STANDARD CHARACTERS WITHOUT CLAIM TO ANY PARTICULAR FONT, STYLE, SIZE, OR COLOR.

FOR WOOD CABINERY ACCENT PRODUCTS, NAMELY WOOD COLUMNS, WOOD MOLDINGS, WOOD SPINDLES, WOOD BUNN FEET, WOOD POSTS, WOOD LEGS AND WOODEN CARVED APPLIQUES (U.S. CLS. 1, 12, 33 AND 50).

FIRST USE 1-1-2001; IN COMMERCE 1-1-2001.
NORA BUCHANAN WILL, EXAMINING ATTORNEY

CLASS 19—(Continued).

SN 76-614,481. AMERICAN FLOOR DISCOUNT, INC., LAWRENCEVILLE, GA. FILED 10-1-2004.



NO CLAIM IS MADE TO THE EXCLUSIVE RIGHT TO USE AMERICAN FLOOR, APART FROM THE MARK AS SHOWN.

FOR FLOORING, NAMELY, ATHLETIC, CERAMIC TILES, LAMINATE, PARQUET OF WOOD, RUBBER, SYNTHETIC, WOOD TILES, WOODEN, MARBLE AND GRANITE; ROCK MATERIALS FOR FLOORING; FLOORING UNDERLAYMENTS AND FLOOR PANELS (U.S. CLS. 1, 12, 33 AND 50).

FIRST USE 4-4-1999; IN COMMERCE 4-15-2002.
WILLIAM VERHOSEK, EXAMINING ATTORNEY

SN 76-614,533. OLD MASTER PRODUCTS, INC., VAN NUYS, CA. FILED 9-29-2004.

THE GARRISON COLLECTION

THE MARK CONSISTS OF STANDARD CHARACTERS WITHOUT CLAIM TO ANY PARTICULAR FONT, STYLE, SIZE, OR COLOR.

NO CLAIM IS MADE TO THE EXCLUSIVE RIGHT TO USE "COLLECTION", APART FROM THE MARK AS SHOWN.

THE NAME IN THE MARK DOES NOT IDENTIFY A PARTICULAR LIVING INDIVIDUAL.

FOR WOODEN FLOORING (U.S. CLS. 1, 12, 33 AND 50).

FIRST USE 7-0-2000; IN COMMERCE 7-0-2000.
MICHELLE S. WISEMAN, EXAMINING ATTORNEY

SN 76-614,883. K.T. MANUFACTURING, INC., PROSPERITY, SC. FILED 10-1-2004.

PURR PALACE

THE MARK CONSISTS OF STANDARD CHARACTERS WITHOUT CLAIM TO ANY PARTICULAR FONT, STYLE, SIZE, OR COLOR.

FOR PET PRODUCTS, NAMELY, PREFABRICATED CAT HOUSES (U.S. CLS. 1, 12, 33 AND 50).

FIRST USE 2-13-2003; IN COMMERCE 2-13-2003.
EDWARD NELSON, EXAMINING ATTORNEY

CLASS 19—(Continued).

SN 76-617,106. SPRINGS WINDOW FASHIONS LP, MIDDLETON, WI. FILED 10-20-2004.

CAPITAL

THE MARK CONSISTS OF STANDARD CHARACTERS WITHOUT CLAIM TO ANY PARTICULAR FONT, STYLE, SIZE, OR COLOR.

FOR NON-METAL NON-FABRIC VALANCES FOR VERTICAL BLINDS (U.S. CLS. 1, 12, 33 AND 50).

FIRST USE 4-0-2004; IN COMMERCE 4-0-2004.
ALEX KEAM, EXAMINING ATTORNEY

SN 76-617,430. OLDCASTLE, INC., ATLANTA, GA. FILED 10-25-2004.

BELGARD

THE MARK CONSISTS OF STANDARD CHARACTERS WITHOUT CLAIM TO ANY PARTICULAR FONT, STYLE, SIZE, OR COLOR.

OWNER OF U.S. REG. NOS. 2,186,972 AND 2,923,735.
SEC. 2(F).

FOR PAVING STONES AND RETAINING WALLS MADE OF STONE (U.S. CLS. 1, 12, 33 AND 50).

FIRST USE 3-4-1998; IN COMMERCE 3-4-1998.
ELISSA GARBER KON, EXAMINING ATTORNEY

SN 76-619,769. AWI LICENSING COMPANY, WILMINGTON, DE. FILED 11-8-2004.

HOMESTYLE

THE MARK CONSISTS OF STANDARD CHARACTERS WITHOUT CLAIM TO ANY PARTICULAR FONT, STYLE, SIZE, OR COLOR.

FOR NON-METAL CEILING TILES, PANELS AND PLANKS (U.S. CLS. 1, 12, 33 AND 50).

FIRST USE 9-0-2000; IN COMMERCE 9-0-2000.
JOHN SCHUYLER YARD, EXAMINING ATTORNEY

CLASS 19—(Continued).

SN 76-622,336. THE INNOVATIVE COMPANIES, LLC,
HAUPPAUGE, NY. FILED 11-26-2004.

SILHOUETTE

THE MARK CONSISTS OF STANDARD CHARACTERS
WITHOUT CLAIM TO ANY PARTICULAR FONT, STYLE,
SIZE, OR COLOR.

FOR QUARRY STONES FOR CONSTRUCTION AND
DECORATION FOR VANITIES (U.S. CLS. 1, 12, 33 AND
50).

CHERYL CLAYTON, EXAMINING ATTORNEY

SN 76-626,232. SCHMEICHEL, JAY, MENOKEN, ND. FILED
12-27-2004.

ICE CAP

FOR COLLAPSIBLE AND PORTABLE ICE FISHING
HOUSES NOT OF METAL (U.S. CLS. 1, 12, 33 AND 50).
JOHN WILKE, EXAMINING ATTORNEY

SN 78-113,481. ALPA LUMBER INC., MISSISSAUGA, ON-
TARIO, CANADA, FILED 3-8-2002.

UNIWOOD

PRIORITY CLAIMED UNDER SEC. 44(D) ON CANADA
APPLICATION NO. 1117413, FILED 10-3-2001, REG. NO.
TMA610612, DATED 5-18-2004, EXPIRES 5-18-2019.

FOR NON-METAL WINDOWS, WINDOW CASE-
MENTS, WINDOW FRAMES, AND PARTS THEREFOR
(U.S. CLS. 1, 12, 33 AND 50).

JILL C. ALT, EXAMINING ATTORNEY

CLASS 19—(Continued).

SN 78-184,347. EXEL OYJ, MÄNTYHARJU, FINLAND,
FILED 11-12-2002.

EXTENS

OWNER OF ERPN CMNTY TM OFC REG. NO. 002829075,
DATED 8-25-2004, EXPIRES 8-25-2012.

FOR NON-METALLIC BUILDING STRUCTURES AND
ELEMENTS, NAMELY CARBON FIBER PLATES AND
STRIPS FOR REINFORCEMENT OF BRIDGES, FLOOR
SLABS, BEAMS, WALLS AND MACHINE INSTALLA-
TION SLABS; REINFORCING MATERIALS, NOT OF
METAL, FOR BUILDING, NAMELY SHORES, SUP-
PORTS, BRACES, FIBER PLATES AND STRIPS FOR
REINFORCEMENT OF CONCRETE; REINFORCED
PLASTIC PROFILES AND PLATES FOR REINFORCE-
MENT OF STRUCTURES IN BUILDINGS, NAMELY
SHORES, SUPPORTS, BRACES, FLOOR SLABS REIN-
FORCED WITH COMPOSITE MATERIALS, WALLS RE-
INFORCED WITH COMPOSITE MATERIALS, AND
ROOFS, SUPPORTING BEAMS AND FLOOR STRUC-
TURES AND ELEMENTS REINFORCED WITH COMPO-
SITE MATERIALS. (U.S. CLS. 1, 12, 33 AND 50).

MARY CRAWFORD, EXAMINING ATTORNEY

SN 78-275,320. CERACASA, S.A., L'ALCORCA (CASTELLON),
SPAIN, FILED 7-17-2003.

CERAMICA CABRERA

PRIORITY CLAIMED UNDER SEC. 44(D) ON SPAIN
APPLICATION NO. 2,549,177, FILED 7-4-2003, REG. NO.
2549177, DATED 12-9-2003, EXPIRES 12-9-2013.

OWNER OF U.S. REG. NO. 1,775,222.

NO CLAIM IS MADE TO THE EXCLUSIVE RIGHT TO
USE "CERAMICA", APART FROM THE MARK AS SHOWN.
THE ENGLISH TRANSLATION OF CABRERA IS
"GOATHERDESS".

FOR NON METAL WALL TILES, NON METAL FLOOR
TILES, FLOOR PAVINGS OF CERAMIC, STONEWARE
AND PORCELAIN MATERIALS (U.S. CLS. 1, 12, 33 AND
50).

AISHA CLARKE, EXAMINING ATTORNEY

SN 78-287,482. DECEUNINCK NORTH AMERICA, LLC,
MONROE, OH. FILED 8-14-2003.



OWNER OF U.S. REG. NO. 2,007,802.

NO CLAIM IS MADE TO THE EXCLUSIVE RIGHT TO
USE "VINYL WINDOW SYSTEMS", APART FROM THE
MARK AS SHOWN.

FOR VINYL WINDOWS AND REPLACEMENT PARTS
THEREFOR (U.S. CLS. 1, 12, 33 AND 50).

FIRST USE 3-1-1995; IN COMMERCE 3-1-1995.

EDWARD NELSON, EXAMINING ATTORNEY

CLASS 19—(Continued).

SN 78-350,536. ARAUPEL S.A., PORTO ALEGRE, BRAZIL,
FILED 1-12-2004.

ARAUPEL

THE MARK CONSISTS OF STANDARD CHARACTERS WITHOUT CLAIM TO ANY PARTICULAR FONT, STYLE, SIZE, OR COLOR.

FOR WOOD DOOR JAMBS BOTH SPLIT AND FLAT, EXTERIOR WOODEN DOOR FRAMES, WOOD PANELS, WOOD BLOCKS AND WOOD BLANKS, WOOD CUT-STOCKS, SAWN WOOD, WOOD MOLDINGS, CUT WOOD NAMELY BOARDS, WOOD LAMINATED BEAMS, WOOD FLOORING, WOOD DOOR AND WINDOW COMPONENTS, WOOD WAINSCOT, WOOD SHELVES (U.S. CLS. 1, 12, 33 AND 50).

FIRST USE 1-10-1993; IN COMMERCE 1-10-1993.
DAVID C. REIHNER, EXAMINING ATTORNEY

SN 78-356,606. SURFACE AMERICA, INC., BUFFALO, NY.
FILED 1-23-2004.

ElastoFloor

THE MARK CONSISTS OF STANDARD CHARACTERS WITHOUT CLAIM TO ANY PARTICULAR FONT, STYLE, SIZE, OR COLOR.

FOR MULTI-PURPOSE GYMNASIUM AND ATHLETIC FLOORING COMPOSED OF RUBBER AND URETHANE (U.S. CLS. 1, 12, 33 AND 50).

FIRST USE 6-1-2003; IN COMMERCE 6-1-2003.
KELLY CHOE, EXAMINING ATTORNEY

CLASS 19—(Continued).

SN 78-384,730. JOHNSON, DAVID, WHITE SALMON, WA.
FILED 3-15-2004.

AVENTE

THE MARK CONSISTS OF STANDARD CHARACTERS WITHOUT CLAIM TO ANY PARTICULAR FONT, STYLE, SIZE, OR COLOR.

THE ENGLISH TRANSLATION OF THE WORDING "AVENTE" IS "HAVING".

FOR NON-METALLIC FLOATING PLATFORMS AND DOCKS (U.S. CLS. 1, 12, 33 AND 50).

JULIE WATSON, EXAMINING ATTORNEY

SN 78-391,786. WHITE CAP CONSTRUCTION SUPPLY, INC.,
COSTA MESA, CA. FILED 3-26-2004.



OWNER OF U.S. REG. NOS. 1,478,065 AND 2,619,417.
FOR NON-METAL BUILDING MATERIALS, NAMELY, SOFFITS, SEWER AND DRAIN PIPE OF CERAMIC OR EARTHENWARE OR CONCRETE OR SANDSTONE; DECK DRAINS OF CONCRETE OR CERAMIC; BITUMINOUS WATERPROOFING SHEETS; NON-METAL STORM WATER POLLUTION PREVENTION PRODUCTS USED AS CONSTRUCTION MATERIALS, NAMELY STORM WATER CHANNELS, EROSION CONTROL JUTE MESH MATS, SILT FENCING, DRAIN FILTERS, DRAINAGE ABSORTION PRODUCTS, SAND BAGS; NON-METAL CONCRETE FORMING PRODUCTS, NAMELY, PANELS, GROUT BAGS, ROCK TEXTURE MATS, NON-CHEMICAL CONCRETE BOND BRAKERS, EXPANSION BOARD, CURB AND GUTTER FELT, REBAR CAPS, COLUMN FORMS, AND FORM BOARD (U.S. CLS. 1, 12, 33 AND 50).

FIRST USE 2-1-2004; IN COMMERCE 2-1-2004.

CIMMERIAN COLEMAN, EXAMINING ATTORNEY

CLASS 19—(Continued).

SN 78-391,822. ALLAN BLOCK CORPORATION, EDINA, MN. FILED 3-26-2004.

GREEN SLOPE

THE MARK CONSISTS OF STANDARD CHARACTERS WITHOUT CLAIM TO ANY PARTICULAR FONT, STYLE, SIZE, OR COLOR.
 FOR CONCRETE LANDSCAPING BLOCKS (U.S. CLS. 1, 12, 33 AND 50).
 WON TEAK OH, EXAMINING ATTORNEY

SN 78-396,578. CENTRAL PRECAST INC., ONTARIO, CANADA, FILED 4-5-2004.

ANTIQUE STACK

THE MARK CONSISTS OF STANDARD CHARACTERS WITHOUT CLAIM TO ANY PARTICULAR FONT, STYLE, SIZE, OR COLOR.
 PRIORITY CLAIMED UNDER SEC. 44(D) ON CANADA APPLICATION NO. 1,210,389, FILED 3-19-2004, REG. NO. TMA629,758, DATED 1-10-2005, EXPIRES 1-10-2020.
 FOR CONCRETE RETAINING WALL BLOCKS (U.S. CLS. 1, 12, 33 AND 50).
 FIRST USE 3-5-2004; IN COMMERCE 3-5-2004.
 JEFF DEFORD, EXAMINING ATTORNEY

SN 78-402,892. W.R. GRACE & CO.-CONN., COLUMBIA, MD. FILED 4-16-2004.

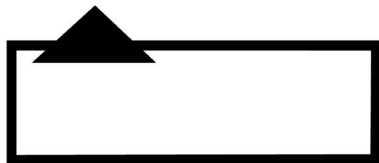

THE MARK CONSISTS OF A RECTANGLE AND A TRIANGLE COMBINED TO SUGGEST COHERENT BUILDING STRUCTURE; THE RECTANGLE HAVING SPACE WITHIN WHICH TO DISPLAY EMPHATIC STATEMENTS.
 FOR NON-METALLIC BUILDING MATERIALS FOR WEATHERPROOFING, NAMELY, FLASHING AND WATERPROOFING MEMBRANES AND BARRIERS FOR USE IN THE CONSTRUCTION OF BUILDING AND CIVIL ENGINEERING STRUCTURES (U.S. CLS. 1, 12, 33 AND 50).
 FIRST USE 2-26-2002; IN COMMERCE 2-26-2002.
 JOHN DWYER, EXAMINING ATTORNEY

CLASS 19—(Continued).

SN 78-423,534. FABSOURCE, INC., MCPHERSON, KS. FILED 5-23-2004.



NO CLAIM IS MADE TO THE EXCLUSIVE RIGHT TO USE "DOCK", APART FROM THE MARK AS SHOWN.
 THE COLOR(S) RED, YELLOW, WHITE AND BLACK IS/ARE CLAIMED AS A FEATURE OF THE MARK.
 THE WORDING DOCK GUARDIAN APPEARS IN YELLOW OUTLINED IN RED ON A BLACK BACKGROUND; THE "STOP SIGN" APPEARS IN RED OUTLINED IN WHITE WITH THE SILHOUETTE OF A MAN APPEARING IN BLACK.
 FOR LOADING DOCK ACCESS PREVENTION SAFETY DEVICES IN THE NATURE OF RETRACTABLE NON-METAL GUARD BARRIERS (U.S. CLS. 1, 12, 33 AND 50).
 FIRST USE 11-1-2003; IN COMMERCE 11-1-2003.
 SUE LAWRENCE, EXAMINING ATTORNEY

SN 78-424,635. MONZI, INC., BELMER, NJ. FILED 5-25-2004.

Leaf Defier

THE MARK CONSISTS OF STANDARD CHARACTERS WITHOUT CLAIM TO ANY PARTICULAR FONT, STYLE, SIZE, OR COLOR.
 NO CLAIM IS MADE TO THE EXCLUSIVE RIGHT TO USE "LEAF", APART FROM THE MARK AS SHOWN.
 FOR NON-METAL GUTTER PROTECTION PRODUCTS, NAMELY, GUTTERS, GUTTER PIPES, DOWN SPOUT COVERS, GUTTER COVERS, END CAPS AND EAVES (U.S. CLS. 1, 12, 33 AND 50).
 FIRST USE 12-17-2003; IN COMMERCE 3-22-2004.
 ELIZABETH J. WINTER, EXAMINING ATTORNEY

CLASS 19—(Continued).

SN 78-425,681. WESTPOINT CONSTRUCTION INC., WOODBRIDGE, ONTARIO, CANADA, FILED 5-26-2004.

SPORTVENT

THE MARK CONSISTS OF STANDARD CHARACTERS WITHOUT CLAIM TO ANY PARTICULAR FONT, STYLE, SIZE, OR COLOR.

PRIORITY CLAIMED UNDER SEC. 44(D) ON CANADA APPLICATION NO. 1214575, FILED 4-26-2004, REG. NO. TMA635796, DATED 3-21-2005, EXPIRES 3-21-2020.

FOR NON-METALLIC STRUCTURAL MATERIALS, NAMELY, WALL BASES TO ALLOW VENTILATION AND CIRCULATION OF AIR IN HARDWOOD FLOATING/SUSPENDED FLOORING SYSTEMS (U.S. CLS. 1, 12, 33 AND 50).

FIRST USE 1-18-2004; IN COMMERCE 1-18-2004.
JAMES A. RAUEN, EXAMINING ATTORNEY

CLASS 19—(Continued).

SN 78-437,165. INTERWRAP INC., MISSION, BRITISH COLUMBIA, CANADA, FILED 6-17-2004.

**USE YOUR GRAY
MATTER**

THE MARK CONSISTS OF STANDARD CHARACTERS WITHOUT CLAIM TO ANY PARTICULAR FONT, STYLE, SIZE, OR COLOR.

FOR ROOFING UNDERLAYMENTS (U.S. CLS. 1, 12, 33 AND 50).

HEATHER THOMPSON, EXAMINING ATTORNEY

SN 78-439,447. SILVER LINE BUILDING PRODUCTS CORPORATION, NORTH BRUNSWICK, NJ. FILED 6-22-2004.

SN 78-436,743. PERMAR SYSTEMS, INC., WOLCOTT, NY. FILED 6-17-2004.



Shock-In-The-Box

THE MARK CONSISTS OF STANDARD CHARACTERS WITHOUT CLAIM TO ANY PARTICULAR FONT, STYLE, SIZE, OR COLOR.

FOR NON-LUMINOUS, NON-MECHANICAL PLASTIC SIGNS (U.S. CLS. 1, 12, 33 AND 50).

FIRST USE 6-0-1994; IN COMMERCE 6-0-1994.
JASON TURNER, EXAMINING ATTORNEY

OWNER OF U.S. REG. NO. 1,741,319.
NO CLAIM IS MADE TO THE EXCLUSIVE RIGHT TO USE "WINDOWS". APART FROM THE MARK AS SHOWN. THE COLORS RED AND BLUE ARE CLAIMED AS A FEATURE OF THE MARK.

THE COLOR RED APPEARS AS THE STRIPES IN THE LOGO AND IN THE WORD "WINDOWS". AND THE COLOR BLUE APPEARS AS A BACKGROUND FOR STARS AND AS THE STRUCTURE IN THE LOGO AND IN THE WORDS "AMERICAN" AND "CRAFTSMAN".

FOR NON-METAL WINDOWS (U.S. CLS. 1, 12, 33 AND 50).

FIRST USE 1-28-2003; IN COMMERCE 1-28-2003.
RICHARD WHITE, EXAMINING ATTORNEY

CLASS 19—(Continued).

SN 78-445,901. NAPOLI, ANN MARIE, BROOKLYN, NY. FILED 7-5-2004.

THE COLOR(S) RED, ORANGE, YELLOW, GREEN, BLUE, PURPLE, AND VIOLET IS/ARE CLAIMED AS A FEATURE OF THE MARK.

THE COLOR RED AND ORANGE APPEAR IN THE LETTER K. THE COLOR YELLOW APPEARS IN THE LETTER N. THE COLOR GREEN APPEARS IN THE LETTER O, W AND B. THE COLOR BLUE APPEARS IN THE LETTER B, O AND D. THE COLOR PURPLE APPEARS IN THE LETTER Y AND S. THE COLOR VIOLET APPEARS IN THE LETTER S.

FOR CLAY SCULPTURES (U.S. CLS. 1, 12, 33 AND 50). BRENDAN MCCAULEY, EXAMINING ATTORNEY

CLASS 19—(Continued).

SN 78-457,590. R E P TECHNOLOGY LTD., CENTRAL, HONG KONG, FILED 7-27-2004.

EVERBOARD

THE MARK CONSISTS OF STANDARD CHARACTERS WITHOUT CLAIM TO ANY PARTICULAR FONT, STYLE, SIZE, OR COLOR.

FOR WATER-RESISTANT BOARDS AND PANELS NOT OF METAL FOR CONSTRUCTION (U.S. CLS. 1, 12, 33 AND 50).

FIRST USE 1-3-2004; IN COMMERCE 1-3-2004. DARRYL SPRUILL, EXAMINING ATTORNEY

SN 78-466,107. YEKALON INDUSTRY, INC., SHENZHEN CITY, CHINA, FILED 8-11-2004.

SN 78-450,248. MINNESOTA QUARRIES, INC., MANKATO, MN. FILED 7-13-2004.

**MANKATO KASOTA
STONE**

PETRUS

THE MARK CONSISTS OF STANDARD CHARACTERS WITHOUT CLAIM TO ANY PARTICULAR FONT, STYLE, SIZE, OR COLOR.

NO CLAIM IS MADE TO THE EXCLUSIVE RIGHT TO USE "STONE", APART FROM THE MARK AS SHOWN. SEC. 2(F).

FOR STONE FOR BUILDING, CONSTRUCTION AND LANDSCAPING; DOLOMITIC LIMESTONE FOR BUILDING, CONSTRUCTION AND LANDSCAPING (U.S. CLS. 1, 12, 33 AND 50).

FIRST USE 8-6-1984; IN COMMERCE 8-6-1984. ALLISON HOLTZ, EXAMINING ATTORNEY

THE MARK CONSISTS OF STANDARD CHARACTERS WITHOUT CLAIM TO ANY PARTICULAR FONT, STYLE, SIZE, OR COLOR.

FOR WOODEN FLOORING; FLOOR BOARDS OF WOOD; NON-METALLIC RESIN COMPOSITE BOARDS FOR BUILDING AND CONSTRUCTION; PLYWOOD; NON-METAL BUILDING MATERIALS, NAMELY, WOOD CHIP BOARDS; NON-METAL FLOORS; PARQUET FLOORING AND PARQUET SLABS; VENEERS FOR FLOORS; WOOD VENEERS; WOOD PANNELLING; WOOD FLOOR PANELS; WOOD WALL PANELS; PLANKS; SEMI-WORKED WOOD (U.S. CLS. 1, 12, 33 AND 50).

MICHELLE DUBOIS, EXAMINING ATTORNEY

CLASS 19—(Continued).

SN 78-472,272. SPA LOGIC INC., THORSBY, ALBERTA, CANADA, FILED 8-24-2004.

CLASS 19—(Continued).

SN 78-476,910. TEMPCO PRODUCTS CO., ROBINSON, IL. FILED 9-1-2004.

FOREVER FLOOR

THE MARK CONSISTS OF STANDARD CHARACTERS WITHOUT CLAIM TO ANY PARTICULAR FONT, STYLE, SIZE, OR COLOR.

NO CLAIM IS MADE TO THE EXCLUSIVE RIGHT TO USE "FLOOR", APART FROM THE MARK AS SHOWN.

FOR FIBERGLASS FLOORS FOR HOT TUBS (U.S. CLS. 1, 12, 33 AND 50).

FIRST USE 1-1-2002; IN COMMERCE 1-1-2002.
TRACY CROSS, EXAMINING ATTORNEY

GREATTRIM

THE MARK CONSISTS OF STANDARD CHARACTERS WITHOUT CLAIM TO ANY PARTICULAR FONT, STYLE, SIZE, OR COLOR.

OWNER OF U.S. REG. NO. 2,269,958.

SEC. 2(F).

FOR NON-METAL PREFABRICATED WINDOW AND DOOR CASING AND TRIM ASSEMBLIES (U.S. CLS. 1, 12, 33 AND 50).

FIRST USE 7-1-1997; IN COMMERCE 7-17-1997.

EDWARD NELSON, EXAMINING ATTORNEY

SN 78-473,974. DUALITE, INC., WILLIAMSBURG, OH. FILED 8-26-2004.

SN 78-486,343. PRECISION PET PRODUCTS, COSTA MESA, CA. FILED 9-20-2004.

**PRO CONCEPTS**

OWNER OF U.S. REG. NOS. 647,381, 1,821,122 AND OTHERS.

FOR NON-METAL, NON-LUMINOUS SIGNS AND DISPLAYS (U.S. CLS. 1, 12, 33 AND 50).

FIRST USE 3-13-1973; IN COMMERCE 3-13-1973.
PRISCILLA MILTON, EXAMINING ATTORNEY

THE MARK CONSISTS OF STANDARD CHARACTERS WITHOUT CLAIM TO ANY PARTICULAR FONT, STYLE, SIZE, OR COLOR.

FOR DOG HOUSES- PRE-FABRICATED (U.S. CLS. 1, 12, 33 AND 50).

FIRST USE 1-1-2003; IN COMMERCE 1-1-2003.

ESTHER A. BORSUK, EXAMINING ATTORNEY

CLASS 19—(Continued).

SN 78-495,556. BEST, CAROLIN R., DENVER, CO. FILED 10-6-2004.

CLASS 19—(Continued).

SN 78-496,140. CONTINUOUS COATING CORP., ORANGE, CA. FILED 10-7-2004.

PET PEEK



THE MARK CONSISTS OF STANDARD CHARACTERS WITHOUT CLAIM TO ANY PARTICULAR FONT, STYLE, SIZE, OR COLOR.
FOR NON-METALLIC WINDOWS (U.S. CLS. 1, 12, 33 AND 50).
REBECCA GAN, EXAMINING ATTORNEY

OWNER OF U.S. REG. NOS. 2,555,875 AND 2,563,657.
FOR BUILDING MATERIAL, NAMELY DRYWALL TRIM AND CORNER BEADS FOR USE WITH DRYWALL, MADE PRIMARILY OF PAPER (U.S. CLS. 1, 12, 33 AND 50).
FIRST USE 0-0-2001; IN COMMERCE 0-0-2001.
AMOS T. MATTHEWS, JR., EXAMINING ATTORNEY

SN 78-496,032. ALIEN OUTFITTERS LLC, AUSTIN, TX. FILED 10-7-2004.

SN 78-496,386. O'BRIEN ASSET MANAGEMENT, LLC, ST. LOUIS, MO. FILED 10-7-2004.

Alien Outfitters

HAWTHORN BOND

THE MARK CONSISTS OF STANDARD CHARACTERS WITHOUT CLAIM TO ANY PARTICULAR FONT, STYLE, SIZE, OR COLOR.
NO CLAIM IS MADE TO THE EXCLUSIVE RIGHT TO USE "OUTFITTERS", APART FROM THE MARK AS SHOWN.
FOR AFTERMARKET MARINE PRODUCTS, NAMELY, BUMPERS OR PADS FOR PILINGS OR DOCK POSTS (U.S. CLS. 1, 12, 33 AND 50).
MARIAM MAHMOUDI, EXAMINING ATTORNEY

THE MARK CONSISTS OF STANDARD CHARACTERS WITHOUT CLAIM TO ANY PARTICULAR FONT, STYLE, SIZE, OR COLOR.
OWNER OF U.S. REG. NO. 2,135,180.
NO CLAIM IS MADE TO THE EXCLUSIVE RIGHT TO USE "BOND", APART FROM THE MARK AS SHOWN.
FOR PLASTIC FIRE CLAY AND BOND CLAY USED IN THE MANUFACTURE OF CERAMICS AND REFRACTORIES (U.S. CLS. 1, 12, 33 AND 50).
FIRST USE 4-15-1974; IN COMMERCE 4-15-1974.
INGA ERVIN, EXAMINING ATTORNEY

CLASS 19—(Continued).

SN 78-500,469. O'NEIL RUPPEL, LLC, ATLANTA, GA. FILED 10-15-2004.

CLASS 19—(Continued).

SN 78-511,247. JELD-WEN, INC., KLAMATH FALLS, OR. FILED 11-4-2004.

NEST

PÜR-FIBER

THE MARK CONSISTS OF STANDARD CHARACTERS WITHOUT CLAIM TO ANY PARTICULAR FONT, STYLE, SIZE, OR COLOR.

FOR NON-METAL DECORATIVE TILE FOR WALLS, CEILINGS, FLOORS AND OTHER SURFACES (U.S. CLS. 1, 12, 33 AND 50).

FIRST USE 9-15-2004; IN COMMERCE 9-15-2004.
CHRISTOPHER ADKINS, EXAMINING ATTORNEY

THE MARK CONSISTS OF STANDARD CHARACTERS WITHOUT CLAIM TO ANY PARTICULAR FONT, STYLE, SIZE, OR COLOR.

FOR NON-METAL DOORS; NON-METAL DOOR SKINS (U.S. CLS. 1, 12, 33 AND 50).

SUE LAWRENCE, EXAMINING ATTORNEY

SN 78-514,385. RAILING DYNAMICS, INC., EGG HARBOR TOWNSHIP, NJ. FILED 11-10-2004.

SN 78-507,219. TARKETT INC., FARNHAM, QUEBEC, CANADA, FILED 10-28-2004.

OCCASIONS

NOVALINE

THE MARK CONSISTS OF STANDARD CHARACTERS WITHOUT CLAIM TO ANY PARTICULAR FONT, STYLE, SIZE, OR COLOR.

FOR LAMINATE FLOORING (U.S. CLS. 1, 12, 33 AND 50).

FIRST USE 6-30-2004; IN COMMERCE 6-30-2004.
DAVID TAYLOR, EXAMINING ATTORNEY

THE MARK CONSISTS OF STANDARD CHARACTERS WITHOUT CLAIM TO ANY PARTICULAR FONT, STYLE, SIZE, OR COLOR.

FOR NON-METALLIC RAILINGS, GUARD RAILS, HANDRAILS AND BANISTERS (U.S. CLS. 1, 12, 33 AND 50).

MARY ROSSMAN, EXAMINING ATTORNEY

CLASS 19—(Continued).

SN 78-515,104. CORRECT BUILDING PRODUCTS, LLC, BIDDEFORD, ME. FILED 11-11-2004.

CHROMAGARD

THE MARK CONSISTS OF STANDARD CHARACTERS WITHOUT CLAIM TO ANY PARTICULAR FONT, STYLE, SIZE, OR COLOR.

FOR BUILDING MATERIALS FOR DECKS, PLAY-GROUNDS, AND BOARDWALKS, NAMELY, NON-METAL PLANKS, COLUMNS, RAILS, POSTS, STAIRS, STAIR TREADS, BEAMS AND JOISTS; NON-METAL DOOR JAMS; NON-METAL WINDOW AND DOOR SILLS; VINYL AND WOOD SIDINGS; AND NON-METAL ROOFING PANELS (U.S. CLS. 1, 12, 33 AND 50).
ALICE SUE CARRUTHERS, EXAMINING ATTORNEY

CLASS 19—(Continued).

SN 78-518,660. QUIKRETE INTERNATIONAL, INC., ATLANTA, GA. FILED 11-17-2004.

QUIKRETE SHOTCRETE

THE MARK CONSISTS OF STANDARD CHARACTERS WITHOUT CLAIM TO ANY PARTICULAR FONT, STYLE, SIZE, OR COLOR.

NO CLAIM IS MADE TO THE EXCLUSIVE RIGHT TO USE "SHOTCRETE", APART FROM THE MARK AS SHOWN.

FOR CEMENT MIXES (U.S. CLS. 1, 12, 33 AND 50).
MIDGE BUTLER, EXAMINING ATTORNEY

SN 78-527,021. NATIONAL DIVERSIFIED SALES, INC., FRESNO, CA. FILED 12-3-2004.

SN 78-518,410. RAMSDEN, PAUL A, DENVER, CO. FILED 11-17-2004.

Mural Maker

EZ ROLL

THE MARK CONSISTS OF STANDARD CHARACTERS WITHOUT CLAIM TO ANY PARTICULAR FONT, STYLE, SIZE, OR COLOR.

NO CLAIM IS MADE TO THE EXCLUSIVE RIGHT TO USE MURAL, APART FROM THE MARK AS SHOWN.
FOR CERAMIC TILES (U.S. CLS. 1, 12, 33 AND 50).
ANDREW BENZMILLER, EXAMINING ATTORNEY

THE MARK CONSISTS OF STANDARD CHARACTERS WITHOUT CLAIM TO ANY PARTICULAR FONT, STYLE, SIZE, OR COLOR.

NO CLAIM IS MADE TO THE EXCLUSIVE RIGHT TO USE "ROLL", APART FROM THE MARK AS SHOWN.

FOR NONMETALLIC WEIGHT-SUPPORTING GRID PAVERS FOR PLANT GROWTH BETWEEN THE WEIGHT SUPPORTING MEMBERS (U.S. CLS. 1, 12, 33 AND 50).
JASON ROTH, EXAMINING ATTORNEY

CLASS 19—(Continued).

SN 78-530,382. LAMINATED WOOD SYSTEMS, INC., SEWARD, NE. FILED 12-10-2004.

NEVER-TWIST

THE MARK CONSISTS OF STANDARD CHARACTERS WITHOUT CLAIM TO ANY PARTICULAR FONT, STYLE, SIZE, OR COLOR.

FOR UTILITY STRUCTURES, NAMELY, POLES MADE OF ENGINEERED LAMINATED WOOD UPON WHICH ELECTRIC SWITCHES ARE MOUNTED (U.S. CLS. 1, 12, 33 AND 50).

FIRST USE 11-9-2004; IN COMMERCE 12-3-2004.
KARANENDRA S. CHHINA, EXAMINING ATTORNEY

CLASS 19—(Continued).

SN 78-535,292. VITRO AMERICA, INC., MEMPHIS, TN. FILED 12-20-2004.

M PactSafe

THE MARK CONSISTS OF STANDARD CHARACTERS WITHOUT CLAIM TO ANY PARTICULAR FONT, STYLE, SIZE, OR COLOR.

FOR HURRICANE AND WEATHER RESISTANT WINDOW GLASS (U.S. CLS. 1, 12, 33 AND 50).

ANNE E. GUSTASON, EXAMINING ATTORNEY

SN 78-537,758. GOSSEN CORPORATION, MILWAUKEE, WI. FILED 12-23-2004.

SN 78-532,932. MLR INTERNATIONAL LLC, FAIRFIELD, NJ. FILED 12-15-2004.

NO DRAFT

MINIT

THE MARK CONSISTS OF STANDARD CHARACTERS WITHOUT CLAIM TO ANY PARTICULAR FONT, STYLE, SIZE, OR COLOR.

FOR EXTRUDED CELLULAR PVC PROFILES FOR THE FENESTRATION INDUSTRY (U.S. CLS. 1, 12, 33 AND 50).

FIRST USE 10-1-2004; IN COMMERCE 10-1-2004.
FRED MANDIR, EXAMINING ATTORNEY

SN 78-975,163. TED LANSING CORPORATION, RICHMOND, VA. FILED 8-30-2002.

WINDJAMMER

THE MARK CONSISTS OF STANDARD CHARACTERS WITHOUT CLAIM TO ANY PARTICULAR FONT, STYLE, SIZE, OR COLOR.

FOR NON-METAL CONSTRUCTION SITE WALL BARRICADES, CONSTRUCTION BARRIERS, AND FENCES; PLASTIC CRASH BARRIERS FOR ROADS (U.S. CLS. 1, 12, 33 AND 50).

FIRST USE 5-28-2004; IN COMMERCE 5-28-2004.
MICHELLE DUBOIS, EXAMINING ATTORNEY

FOR BUILDING MATERIALS, NAMELY, NON-METAL WINDOWS, NON-METAL PATIO DOORS; AND NON-METAL RAILS (U.S. CLS. 1, 12, 33 AND 50).

FIRST USE 10-31-1971; IN COMMERCE 10-31-1971.
EDWARD NELSON, EXAMINING ATTORNEY

CLASS 20—FURNITURE AND ARTICLES NOT OTHERWISE CLASSIFIED

SN 76-423,721. CREATIVE CONNECTORS CORP., VERNON, BRITISH COLUMBIA, V1T 7G8, CANADA, FILED 6-20-2002.

ORNA-MANTEL

PRIORITY CLAIMED UNDER SEC. 44(D) ON CANADA APPLICATION NO. 1141722, FILED 5-24-2002, REG. NO. TMA643575, DATED 7-5-2005, EXPIRES 7-5-2020.

FOR WALL SHELVING (U.S. CLS. 2, 13, 22, 25, 32 AND 50).

SUSAN STIGLITZ, EXAMINING ATTORNEY

SN 76-447,538. EURO DESIGN INTERNATIONAL INC., ST-LEONARD, QUEBEC, CANADA, FILED 9-5-2002.

IQON

PRIORITY CLAIMED UNDER SEC. 44(D) ON CANADA APPLICATION NO. 1150363, FILED 8-26-2002, REG. NO. TMA640172, DATED 5-19-2005, EXPIRES 5-19-2020.

FOR OFFICE FURNITURE (U.S. CLS. 2, 13, 22, 25, 32 AND 50).

TRACY CROSS, EXAMINING ATTORNEY

SN 76-480,577. MOBILIER RUSTIQUE (BEAUCE) INC., PROVINCE OF QUEBEC, CANADA, FILED 1-2-2003.



NO CLAIM IS MADE TO THE EXCLUSIVE RIGHT TO USE "CEDAR AND THE REPRESENTATION OF A CHAIR", APART FROM THE MARK AS SHOWN.

FOR WHITE CEDAR RUSTIC FURNITURE FOR INDOOR AND OUTDOOR USE (U.S. CLS. 2, 13, 22, 25, 32 AND 50).

STEPHANIE DAVIS, EXAMINING ATTORNEY

CLASS 20—(Continued).

SN 76-494,426. THE HAMILTON COLLECTION, INC., JACKSONVILLE, FL. FILED 3-4-2003.



THE STIPPLING IS FOR SHADING PURPOSES. SEC. 2(F). FOR ACRYLIC FRAMES, BASES AND HOLDERS FOR A SERIES OF FIGURINES (U.S. CLS. 2, 13, 22, 25, 32 AND 50).

FIRST USE 1-20-2002; IN COMMERCE 8-9-2002. STACY WAHLBERG, EXAMINING ATTORNEY

SN 76-523,768. FELLFAB LIMITED, HAMILTON, ONTARIO, CANADA, FILED 6-16-2003.

BEAVERBAG

PRIORITY CLAIMED UNDER SEC. 44(D) ON CANADA APPLICATION NO. 1,177,166, FILED 5-6-2003, REG. NO. TMA636396, DATED 3-30-2005, EXPIRES 3-30-2020.

FOR CONTAINERS BEING FLEXIBLE LINER SYSTEMS COMPRISED OF TOUGH, TEAR-RESISTANT, LIGHTWEIGHT, WOVEN, NON-METAL MATERIALS, AND OPTIONAL FORMS FOR MAINTAINING THEIR SHAPE, USED FOR THE TRANSPORTATION OF BULK MATERIAL (U.S. CLS. 2, 13, 22, 25, 32 AND 50).

BRIAN NEVILLE, EXAMINING ATTORNEY

SN 76-538,748. TRIMQUICK, CHINO, CA. FILED 8-21-2003.

TRIMQUICK

FOR VINYL TRIM FOR WINDOWS (U.S. CLS. 2, 13, 22, 25, 32 AND 50).

FIRST USE 3-0-2001; IN COMMERCE 3-0-2001. MICHAEL KEATING, EXAMINING ATTORNEY

CLASS 20—(Continued).

SN 76-580,428. TATTA, ANDREW R., WAYNE, PA. FILED 3-11-2004.

DISC PIC

THE MARK CONSISTS OF STANDARD CHARACTERS WITHOUT CLAIM TO ANY PARTICULAR FONT, STYLE, SIZE, OR COLOR.

NO CLAIM IS MADE TO THE EXCLUSIVE RIGHT TO USE DISC, APART FROM THE MARK AS SHOWN.

FOR DEVICES IN THE NATURE OF A PLASTIC CLIP FOR USE IN PICKING UP AND MOVING OPTICAL DATA STORAGE DISCS TO PREVENT THEM FROM BEING DAMAGED BY DUST, FINGERPRINT OIL AND OTHER FILMS (U.S. CLS. 2, 13, 22, 25, 32 AND 50).

FIRST USE 6-15-2003; IN COMMERCE 6-15-2003.
JENNIFER MARTIN, EXAMINING ATTORNEY

SN 76-584,902. NWN, INC., WHITE BEAR LAKE, MN. FILED 4-2-2004.

MARDI

THE MARK CONSISTS OF STANDARD CHARACTERS WITHOUT CLAIM TO ANY PARTICULAR FONT, STYLE, SIZE, OR COLOR.

THE ENGLISH TRANSLATION OF THE WORD "MARDI" IN THE MARK IS "TUESDAY".

FOR FURNITURE, NAMELY, CHAIRS AND TABLES (U.S. CLS. 2, 13, 22, 25, 32 AND 50).

FIRST USE 4-5-2004; IN COMMERCE 4-5-2004.
DOUGLAS LEE, EXAMINING ATTORNEY

SN 76-585,385. AMERICAN WOODMARK CORPORATION, WINCHESTER, VA. FILED 4-2-2004.

DESIGNER SERIES

THE MARK CONSISTS OF STANDARD CHARACTERS WITHOUT CLAIM TO ANY PARTICULAR FONT, STYLE, SIZE, OR COLOR.

OWNER OF U.S. REG. NOS. 1,284,329 AND 1,782,707.
NO CLAIM IS MADE TO THE EXCLUSIVE RIGHT TO USE "SERIES", APART FROM THE MARK AS SHOWN.
SEC. 2(F).

FOR KITCHEN CABINETS AND BATHROOM CABINETS (U.S. CLS. 2, 13, 22, 25, 32 AND 50).

FIRST USE 1-0-1996; IN COMMERCE 5-0-1996.
KIMBERLY PERRY, EXAMINING ATTORNEY

CLASS 20—(Continued).

SN 76-585,387. AMERICAN WOODMARK CORPORATION, WINCHESTER, VA. FILED 4-2-2004.

AMERICAN WOODMARK

THE MARK CONSISTS OF STANDARD CHARACTERS WITHOUT CLAIM TO ANY PARTICULAR FONT, STYLE, SIZE, OR COLOR.

OWNER OF U.S. REG. NOS. 1,284,329 AND 1,782,707.
SEC. 2(F) AS TO "AMERICAN".
FOR KITCHEN CABINETS AND BATHROOM CABINETS (U.S. CLS. 2, 13, 22, 25, 32 AND 50).
FIRST USE 3-23-1991; IN COMMERCE 3-23-1991.
KIMBERLY PERRY, EXAMINING ATTORNEY

SN 76-585,388. AMERICAN WOODMARK CORPORATION, WINCHESTER, VA. FILED 4-2-2004.

AMERICAN WOODMARK CORPORATION

THE MARK CONSISTS OF STANDARD CHARACTERS WITHOUT CLAIM TO ANY PARTICULAR FONT, STYLE, SIZE, OR COLOR.

OWNER OF U.S. REG. NOS. 1,284,329 AND 1,782,707.
SEC. 2(F) AS TO AMERICAN AND CORPORATION.
FOR KITCHEN CABINETS AND BATHROOM CABINETS (U.S. CLS. 2, 13, 22, 25, 32 AND 50).
FIRST USE 3-23-1991; IN COMMERCE 3-23-1991.
KIMBERLY PERRY, EXAMINING ATTORNEY

SN 76-588,117. DISNEY ENTERPRISES, INC., BURBANK, CA. FILED 4-19-2004.



OWNER OF U.S. REG. NO. 2,700,619.
FOR FURNITURE; JEWELRY BOXES NOT OF METAL; PICTURE FRAMES; SLEEPING BAGS; DECORATIVE WALL PLAQUES; DECORATIVE MOBILES; FIGURINES MADE OF WOOD, WAX, PLASTER, OR PLASTIC; PLASTIC NAME BADGES AND PILLOWS (U.S. CLS. 2, 13, 22, 25, 32 AND 50).
WILLIAM BRECKENFELD, EXAMINING ATTORNEY

CLASS 20—(Continued).

SN 76-588,134. DISNEY ENTERPRISES, INC., BURBANK, CA. FILED 4-19-2004.



FOR FURNITURE; JEWELRY BOXES NOT OF METAL; PICTURE FRAMES; SLEEPING BAGS; DECORATIVE WALL PLAQUES; DECORATIVE MOBILES; FIGURINES MADE OF WOOD, WAX, PLASTER, OR PLASTIC; PLASTIC NAME BADGES AND PILLOWS (U.S. CLS. 2, 13, 22, 25, 32 AND 50).
WILLIAM BRECKENFELD, EXAMINING ATTORNEY

SN 76-588,163. DISNEY ENTERPRISES, INC., BURBANK, CA. FILED 4-19-2004.



FOR FURNITURE; JEWELRY BOXES NOT OF METAL; PICTURE FRAMES; SLEEPING BAGS; DECORATIVE WALL PLAQUES; DECORATIVE MOBILES; FIGURINES MADE OF WOOD, WAX, PLASTER, OR PLASTIC; PLASTIC NAME BADGES AND PILLOWS (U.S. CLS. 2, 13, 22, 25, 32 AND 50).
GEOFFREY FOSDICK, EXAMINING ATTORNEY

CLASS 20—(Continued).

SN 76-594,086. FINGER LAKES INTELLECTUAL PROPERTY, LLC, TEANECK, NJ. FILED 5-26-2004.

EVENTIDE

THE MARK CONSISTS OF STANDARD CHARACTERS WITHOUT CLAIM TO ANY PARTICULAR FONT, STYLE, SIZE, OR COLOR.
FOR BEDFRAMES AND PARTS SOLD AS A UNIT (U.S. CLS. 2, 13, 22, 25, 32 AND 50).
FIRST USE 6-0-2002; IN COMMERCE 6-0-2002.
RON FAIRBANKS, EXAMINING ATTORNEY

SN 76-601,053. PRIMEPAL L.P., HOUSTON, TX. FILED 7-6-2004.



FOR REUSABLE, RECYCLABLE AND REPAIRABLE STORAGE AND SHIPPING PLATFORM; NAMELY, A PALLET, CONSTRUCTED OF PLASTIC MATERIALS AND SUITABLE FOR GENERAL INDUSTRIAL USE, WHICH IS STRONG; DURABLE AND LIGHTWEIGHT (U.S. CLS. 2, 13, 22, 25, 32 AND 50).
STEPHANIE DAVIS, EXAMINING ATTORNEY

SN 76-601,983. HONG KONG SUI LONG INTERNATIONAL ENTERPRISES GROUP LIMITED, HONG KONG, HONG KONG, FILED 7-2-2004.



THE NON-LATIN CHARACTERS IN THE MARK TRANSLITERATE TO "SUI LONG", AND THIS MEANS "SOUTHERN DRAGON" IN ENGLISH.
FOR MATTRESSES (U.S. CLS. 2, 13, 22, 25, 32 AND 50).
GINA FINK, EXAMINING ATTORNEY

CLASS 20—(Continued).

SN 76-614,122. E. S. KLUFT & COMPANY, LLC, ONTARIO, CA. FILED 9-30-2004.

ROYAL AIRELOOM

THE MARK CONSISTS OF STANDARD CHARACTERS WITHOUT CLAIM TO ANY PARTICULAR FONT, STYLE, SIZE, OR COLOR.

OWNER OF U.S. REG. NO. 1,895,115.
FOR MATTRESSES AND MATTRESS FOUNDATIONS (U.S. CLS. 2, 13, 22, 25, 32 AND 50).
JASON LOTT, EXAMINING ATTORNEY

SN 76-615,090. CHANEL, INC., NEW YORK, NY. FILED 10-8-2004.

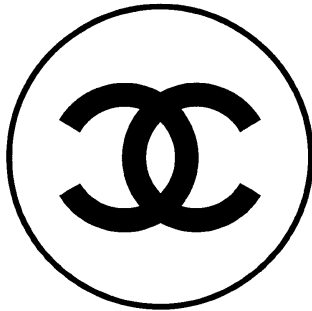

OWNER OF U.S. REG. NOS. 195,359, 1,734,822 AND OTHERS.

THE MARK IS COMPROMISED OF INTERLOCKING C'S SURROUNDED BY A CIRCLE.

FOR MIRRORS, NAMELY PERSONAL COMPACTS AND HAND-HELD MIRRORS (U.S. CLS. 2, 13, 22, 25, 32 AND 50).

FIRST USE 9-1-2004; IN COMMERCE 9-1-2004.
KIMBERLY PERRY, EXAMINING ATTORNEY

SN 76-615,159. STYLE FORUM, INC., DBA HARRISON & GIL, FORT MYERS, FL. FILED 10-8-2004.

**A CONTEMPORARY MOOD
WITH CLASSIC VALUES**

THE MARK CONSISTS OF STANDARD CHARACTERS WITHOUT CLAIM TO ANY PARTICULAR FONT, STYLE, SIZE, OR COLOR.

FOR FURNITURE, NAMELY, CHAIRS, TABLES, SOFAS, CABINETS, CONSOLES, BEDROOM FURNITURE, PICTURE AND MIRROR FRAMES (U.S. CLS. 2, 13, 22, 25, 32 AND 50).
JOHN DWYER, EXAMINING ATTORNEY

CLASS 20—(Continued).

SN 76-615,544. TRUCO ENTERPRISES, INC., DALLAS, TX. FILED 10-5-2004.

FIRE MOUNTAIN

THE MARK CONSISTS OF STANDARD CHARACTERS WITHOUT CLAIM TO ANY PARTICULAR FONT, STYLE, SIZE, OR COLOR.

OWNER OF U.S. REG. NO. 2,728,072.
FOR FIREPLACE ACCESSORIES, NAMELY, NON-METAL FIREWOOD CONTAINERS (U.S. CLS. 2, 13, 22, 25, 32 AND 50).
DAWN FELDMAN, EXAMINING ATTORNEY

SN 76-615,842. COMONSENTS, INC., TAMPA, FL. FILED 10-7-2004.

CREATURE CADDY

THE MARK CONSISTS OF STANDARD CHARACTERS WITHOUT CLAIM TO ANY PARTICULAR FONT, STYLE, SIZE, OR COLOR.

NO CLAIM IS MADE TO THE EXCLUSIVE RIGHT TO USE "CADDY", APART FROM THE MARK AS SHOWN.

FOR PLASTIC STORAGE CONTAINER, NAMELY, AN ORGANIZER WITH AN ELECTRIC POWER STRIP FOR PET GROOMING EQUIPMENT AND SUPPLIES, SOLD AS A UNIT (U.S. CLS. 2, 13, 22, 25, 32 AND 50).

ELLEN B. AWRICH, EXAMINING ATTORNEY

SN 76-616,716. ENCOMPASS GROUP, LLC, MCDONOUGH, GA. FILED 10-20-2004.

CAREGUARD

THE MARK CONSISTS OF STANDARD CHARACTERS WITHOUT CLAIM TO ANY PARTICULAR FONT, STYLE, SIZE, OR COLOR.

FOR PILLOWS (U.S. CLS. 2, 13, 22, 25, 32 AND 50).
FIRST USE 4-0-2004; IN COMMERCE 4-0-2004.

KATHLEEN M. VANSTON, EXAMINING ATTORNEY

CLASS 20—(Continued).

SN 76-617,105. SPRINGS WINDOW FASHIONS LP, MIDDLETON, WI. FILED 10-20-2004.

LAKE FOREST

THE MARK CONSISTS OF STANDARD CHARACTERS WITHOUT CLAIM TO ANY PARTICULAR FONT, STYLE, SIZE, OR COLOR.

FOR WINDOW BLINDS (U.S. CLS. 2, 13, 22, 25, 32 AND 50).

FIRST USE 4-0-2004; IN COMMERCE 4-0-2004.
ALEX KEAM, EXAMINING ATTORNEY

SN 76-619,612. FREEBURY, RUSSELL E., RANCHO DOMINGUEZ, CA. FILED 11-8-2004.

ZINKA

THE MARK CONSISTS OF STANDARD CHARACTERS WITHOUT CLAIM TO ANY PARTICULAR FONT, STYLE, SIZE, OR COLOR.

OWNER OF U.S. REG. NO. 2,814,691.
FOR WRISTBAND PLASTIC STORAGE CONTAINERS (U.S. CLS. 2, 13, 22, 25, 32 AND 50).

FIRST USE 4-30-1991; IN COMMERCE 4-30-1991.
KIM SAITO, EXAMINING ATTORNEY

SN 76-622,091. JOSEPH STRUHL COMPANY, INC., GARDEN CITY PARK, NY. FILED 11-24-2004.

SUPER SUCKER

THE MARK CONSISTS OF STANDARD CHARACTERS WITHOUT CLAIM TO ANY PARTICULAR FONT, STYLE, SIZE, OR COLOR.

FOR SIGN AND BANNER HANGING HARDWARE, NAMELY, NON-METAL WINDOW OR VEHICLE MOUNTED RODS AND ATTACHMENT RINGS WITH ROPES AND BUNGIES USED FOR HANGING SIGNS AND BANNERS (U.S. CLS. 2, 13, 22, 25, 32 AND 50).

FIRST USE 10-28-2004; IN COMMERCE 10-28-2004.
MARIAM MAHMOUDI, EXAMINING ATTORNEY

CLASS 20—(Continued).

SN 76-625,540. LIFESTYLE SOLUTIONS, INC., MILPITAS, CA. FILED 12-27-2004.

VICE PROTECTION SYSTEM

THE MARK CONSISTS OF STANDARD CHARACTERS WITHOUT CLAIM TO ANY PARTICULAR FONT, STYLE, SIZE, OR COLOR.

FOR FURNITURE, NAMELY COUCHES, CHAIRS, FUTONS AND MATTRESSES (U.S. CLS. 2, 13, 22, 25, 32 AND 50).

MELVIN AXILBUND, EXAMINING ATTORNEY

SN 76-977,335. GENERAL CAGE LLC, ELWOOD, IN. FILED 6-30-2003.

IT'Z A BREEZE TOO

FOR PET PRODUCTS, NAMELY, CAGES/CRATES (U.S. CLS. 2, 13, 22, 25, 32 AND 50).

FIRST USE 3-0-2002; IN COMMERCE 3-0-2002.
SAMUEL E. SHARPER JR., EXAMINING ATTORNEY

SN 78-045,924. ROPAK CORPORATION, FULLERTON, CA. FILED 1-31-2001.

EZ GRIP

NO CLAIM IS MADE TO THE EXCLUSIVE RIGHT TO USE "GRIP", APART FROM THE MARK AS SHOWN.

FOR PLASTIC HANDLE FOR BUCKETS AND PAILS (U.S. CLS. 2, 13, 22, 25, 32 AND 50).

ANDREA K. NADELMAN, EXAMINING ATTORNEY

SN 78-157,896. PORRARO, RICHARD, A., TAMPA, FL. FILED 8-26-2002.

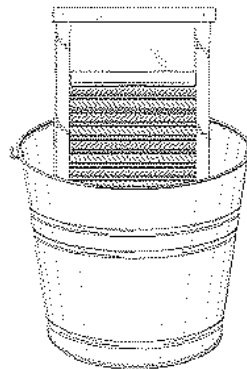

SEC. 2(F).
FOR POINT OF SALE DISPLAY FOR DETERGENT, NAMELY, SPOT AND STAIN REMOVER FOR USE ON TEXTILES, FABRICS, AND CLOTHING (U.S. CLS. 2, 13, 22, 25, 32 AND 50).

FIRST USE 3-3-1999; IN COMMERCE 3-3-1999.
DAVID TAYLOR, EXAMINING ATTORNEY

CLASS 20—(Continued).

SN 78-181,682. UNIWEB INCORPORATED, CORONA, CA.
FILED 11-5-2002.

SYSTEMIZER

FOR ORGANIZATIONAL STORAGE SHELVING COMPRISING OF AN ALL STEEL BACK PANEL WITH HORIZONTAL GROOVES VERTICALLY SPACED EVERY INCH THAT ACCEPTS A STEEL STORAGE SHELF AND FIVE STEELS HOOKS (U.S. CLS. 2, 13, 22, 25, 32 AND 50).

DOMINIC J. FERRAIUOLO, EXAMINING ATTORNEY

SN 78-212,704. SAMI S.R.L., GIUSSANO, ITALY, FILED 2-10-2003.

SLALOM

PRIORITY CLAIMED UNDER SEC. 44(D) ON ITALY APPLICATION NO. MI2002C-0081, FILED 8-9-2002.

FOR BOOKCASES; FREE STANDING OFFICE PARTITIONS, FURNITURE PARTITIONS, MOVABLE PARTITIONS AND WORK STATION PARTITIONS HAVING MULTI-USE WORK SURFACES FOR USE IN A WIDE VARIETY OF FIELDS (U.S. CLS. 2, 13, 22, 25, 32 AND 50).
STEPHANIE DAVIS, EXAMINING ATTORNEY

SN 78-276,506. XSTAND PTY LTD, MENTONE, VICTORIA, AUSTRALIA, FILED 7-21-2003.

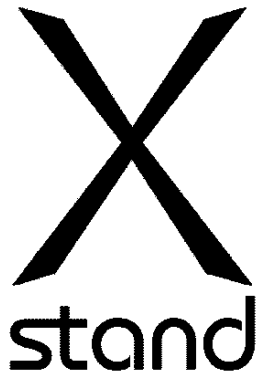

OWNER OF AUSTRALIA REG. NO. 925489, DATED 9-1-2002, EXPIRES 9-1-2012.

FOR BANNER DISPLAYS MADE OF POLYCARBONATE FOR USE IN EXHIBITIONS. AT POINT OF PURCHASE, OR TO DISPLAY PROMOTIONAL BANNERS, ADVERTISEMENTS, NOTICES, PROMOTIONAL MATERIAL (U.S. CLS. 2, 13, 22, 25, 32 AND 50).

AISHA CLARKE, EXAMINING ATTORNEY

CLASS 20—(Continued).

SN 78-291,510. OWEN, MARY CLAIRE, ARLINGTON, VA.
FILED 8-24-2003.

MUSTARD SEEDS

FOR COLLECTION OF PLASTIC CARDS CONTAINING BIBLE VERSES FOR ATTACHMENT TO KEYRINGS (U.S. CLS. 2, 13, 22, 25, 32 AND 50).

H. M. FISHER, EXAMINING ATTORNEY

SN 78-300,838. BROOKSTONE PURCHASING, INC., MERRIMACK, NH. FILED 9-16-2003.

FÖM

NO CLAIM IS MADE TO THE EXCLUSIVE RIGHT TO USE "FOAM", APART FROM THE MARK AS SHOWN.
SEC. 2(F).

FOR STRESS RELIEVING BEDDING, NAMELY, PILLOWS AND CUSHIONS (U.S. CLS. 2, 13, 22, 25, 32 AND 50).

FIRST USE 11-14-2003; IN COMMERCE 11-14-2003.
TRACY CROSS, EXAMINING ATTORNEY

SN 78-307,968. SIGNATURES NETWORK, INC., SAN FRANCISCO, CA. FILED 10-1-2003.

GOOD VIBRATIONS

FOR FURNITURE AND HOME DÉCOR, NAMELY, STOOLS, CHAIRS, BENCHES, BOOKENDS, CABINETS, DINING FURNITURE, FURNITURE CHESTS WHICH RESEMBLE FOOT LOCKERS BUT NOT BEING LUGGAGE, FRAMES, NAMELY, BED FRAMES AND NON-METAL PICTURE FRAMES, LIVING ROOM FURNITURE, OCCASIONAL FURNITURE, OUTDOOR FURNITURE, SHELVES, TABLES; UMBRELLA STANDS, BEAN BAG CHAIRS, BODY PILLOWS, CHAIR PADS, MATTRESSES, MIRRORS, PILLOWS, PLASTIC DOORSTOPS, DRESSERS, WARDROBES, BEDS, HEADBOARDS, AND FOOTBOARDS, AND CHESTS, NAMELY, NON-METAL STORAGE CONTAINERS (U.S. CLS. 2, 13, 22, 25, 32 AND 50).

NORA BUCHANAN WILL, EXAMINING ATTORNEY

SN 78-315,469. KABUSHIKI KAISHA MONTBELL, OSAKA, JAPAN, FILED 10-17-2003.

BURROW BAG

NO CLAIM IS MADE TO THE EXCLUSIVE RIGHT TO USE "BAG", APART FROM THE MARK AS SHOWN.

FOR SLEEPING BAGS, SLEEPING BAG COVERS; PILLOWS FOR USE WITH CAMPING; CUSHIONS (U.S. CLS. 2, 13, 22, 25, 32 AND 50).

GENE MACIOL, EXAMINING ATTORNEY

CLASS 20—(Continued).

SN 78-326,987. MULHOLLAND BROTHERS, SAN FRANCISCO, CA. FILED 11-12-2003.

CLASS 20—(Continued).

SN 78-360,453. MONSTER, LLC, LAS VEGAS, NV. FILED 1-30-2004.

MULHOLLAND

CENTRA

THE MARK CONSISTS OF STANDARD CHARACTERS WITHOUT CLAIM TO ANY PARTICULAR FONT, STYLE, SIZE, OR COLOR.
OWNER OF U.S. REG. NOS. 2,242,225, 2,269,964 AND OTHERS.
SEC. 2(F).
FOR FURNITURE (U.S. CLS. 2, 13, 22, 25, 32 AND 50).
FIRST USE 5-15-1998; IN COMMERCE 5-15-1998.
SCOTT BALDWIN, EXAMINING ATTORNEY

THE MARK CONSISTS OF STANDARD CHARACTERS WITHOUT CLAIM TO ANY PARTICULAR FONT, STYLE, SIZE, OR COLOR.
FOR FURNITURE (U.S. CLS. 2, 13, 22, 25, 32 AND 50).
FIRST USE 9-5-2003; IN COMMERCE 9-5-2003.
SOPHIA S. KIM, EXAMINING ATTORNEY

SN 78-368,792. KENSINGTON ART CENTRE, INC., CAMPBELL, CA. FILED 2-16-2004.

SN 78-357,720. PAMELA SMITH, DBA TOWANDA, INC., ATLANTA, GA. FILED 1-26-2004.



THE BOX

THE COLOR(S) GREEN IS/ARE CLAIMED AS A FEATURE OF THE MARK.
THE COLOR GREEN APPEARS IN THE WORDING SLEEP 'N SWING AND PALM TREE DESIGN.
FOR HAMMOCK BED (U.S. CLS. 2, 13, 22, 25, 32 AND 50).
FIRST USE 8-11-2003; IN COMMERCE 8-11-2003.
MARY ROSSMAN, EXAMINING ATTORNEY

THE MARK CONSISTS OF STANDARD CHARACTERS WITHOUT CLAIM TO ANY PARTICULAR FONT, STYLE, SIZE, OR COLOR.
FOR PORTABLE ARTWORK FRAMING KIT COMPOSED OF IMAGES OF FRAMES, STANDARD-SIZE FRAME CORNERS, REDUCED IMAGES OF FLAT WORKS OF ART WORK, MATTS, GLASS, AND A CONTAINER FOR THEM (U.S. CLS. 2, 13, 22, 25, 32 AND 50).
FIRST USE 6-30-2003; IN COMMERCE 11-30-2003.
DAVID ELTON, EXAMINING ATTORNEY

CLASS 20—(Continued).

SN 78-370,232. VERSTRAETEN, GAETAN, BEVERLY HILLS, CA. FILED 2-18-2004.

CLAMP-AID

THE MARK CONSISTS OF STANDARD CHARACTERS WITHOUT CLAIM TO ANY PARTICULAR FONT, STYLE, SIZE, OR COLOR.

FOR PLASTIC COVERS AND SLEEVES FOR METAL HOSE CLAMPS (U.S. CLS. 2, 13, 22, 25, 32 AND 50).
BRIDGETT SMITH, EXAMINING ATTORNEY

SN 78-376,446. INSTACOTE, INC., ERIE, MI. FILED 3-1-2004.

CACCOON

THE MARK CONSISTS OF STANDARD CHARACTERS WITHOUT CLAIM TO ANY PARTICULAR FONT, STYLE, SIZE, OR COLOR.

FOR CUSTOM PACKAGES FOR SHIPPING AND STORAGE OF GOODS COMPOSED PRIMARILY OF A FILM OR SUBSTRATE BASE COATED WITH A SPRAYABLE POLYMER (U.S. CLS. 2, 13, 22, 25, 32 AND 50).
FIRST USE 2-1-2003; IN COMMERCE 2-1-2003.

PATRICIA EVANKO, EXAMINING ATTORNEY

SN 78-395,224. DECKER, DEBORAH JILL, MATTAWAN, MI. FILED 4-2-2004.

JUST JILLS

THE MARK CONSISTS OF STANDARD CHARACTERS WITHOUT CLAIM TO ANY PARTICULAR FONT, STYLE, SIZE, OR COLOR.

FOR MARKERS FOR INTERIOR OR EXTERIOR USE IN DECORATIVE AND/OR INFORMATIONAL DISPLAYS, MADE PRIMARILY OF PLASTIC (U.S. CLS. 2, 13, 22, 25, 32 AND 50).
FIRST USE 6-15-2003; IN COMMERCE 8-9-2003.

NAKWAMA ANKRAH, EXAMINING ATTORNEY

CLASS 20—(Continued).

SN 78-397,866. DAVEY, MARK, MESA, AZ. FILED 4-7-2004.

STAGEMAGIX

THE MARK CONSISTS OF STANDARD CHARACTERS WITHOUT CLAIM TO ANY PARTICULAR FONT, STYLE, SIZE, OR COLOR.

FOR UNIVERSAL HOME ENTERTAINMENT SYSTEMS AND HOME THEATER SYSTEMS, COMPRISED OF ONE OR MORE MODULAR COMPONENTS, SUCH AS PROSCENIUMS, LINKABLE WALLS, TRAP DOORS, COLUMNS, SLOTS, ROOFING, SETS, STAGES, GREEN ROOMS, MAKEUP ROOMS, STORAGE ROOMS, AND OTHER ROOMS AND/OR ENTERTAINMENT SPACES; HOME THEATER SYSTEMS COMPRISED OF CURTAINS, DESKS, CHAIRS, BACKGROUND DECORATIONS, POSTER BOARDS, AND OTHER FIXTURES AND FURNISHINGS RELATED TO CREATING AN ALTERNATIVE HOME ENTERTAINMENT EXPERIENCE; INTERCHANGEABLE STRUCTURAL PORTIONS OF A HOME THEATER SYSTEM CAPABLE OF BEING ASSEMBLED IN AN VARIETY OF CONFIGURATIONS; AND REPLACEMENT PARTS THEREFORE (U.S. CLS. 2, 13, 22, 25, 32 AND 50).

TRACY CROSS, EXAMINING ATTORNEY

SN 78-398,142. ROBINSON & ROBINSON INC., SAN DIEGO, CA. FILED 4-7-2004.

COMFY KIDS

THE MARK CONSISTS OF STANDARD CHARACTERS WITHOUT CLAIM TO ANY PARTICULAR FONT, STYLE, SIZE, OR COLOR.

NO CLAIM IS MADE TO THE EXCLUSIVE RIGHT TO USE "KIDS", APART FROM THE MARK AS SHOWN.

FOR UPHOLSTERED FURNITURE (U.S. CLS. 2, 13, 22, 25, 32 AND 50).

VIVIAN MICZNIK FIRST, EXAMINING ATTORNEY

CLASS 20—(Continued).

SN 78-425,100. SANDBERG FURNITURE, LOS ANGELES, CA. FILED 5-26-2004.

CLASS 20—(Continued).

SN 78-428,490. SHADES UNLIMITED, INC., COTATI, CA. FILED 6-2-2004.

MONSTER BOYS CLUB

THE MARK CONSISTS OF STANDARD CHARACTERS WITHOUT CLAIM TO ANY PARTICULAR FONT, STYLE, SIZE, OR COLOR.
FOR FURNITURE (U.S. CLS. 2, 13, 22, 25, 32 AND 50).
FIRST USE 7-21-2004; IN COMMERCE 7-21-2004.
ROBIN CHOSID, EXAMINING ATTORNEY

STYLE FOR AWHILE

SN 78-425,789. CARR, RORY, VANCOUVER, BRITISH COLUMBIA, CANADA, FILED 5-26-2004.

THE MARK CONSISTS OF STANDARD CHARACTERS WITHOUT CLAIM TO ANY PARTICULAR FONT, STYLE, SIZE, OR COLOR.
FOR WINDOW COVERINGS, NAMELY, WINDOW BLINDS AND WINDOW SHADES (U.S. CLS. 2, 13, 22, 25, 32 AND 50).
ANNE FARRELL, EXAMINING ATTORNEY

ECOBED

SN 78-434,122. COUNTERFIT SYSTEMS, INC., NIXA, MO. FILED 6-11-2004.

THE MARK CONSISTS OF STANDARD CHARACTERS WITHOUT CLAIM TO ANY PARTICULAR FONT, STYLE, SIZE, OR COLOR.
PRIORITY CLAIMED UNDER SEC. 44(D) ON CANADA APPLICATION NO. 1,201,533, FILED 2-6-2004, REG. NO. TMA629608, DATED 1-6-2005, EXPIRES 1-6-2020.
FOR PET BEDS (U.S. CLS. 2, 13, 22, 25, 32 AND 50).
JEFFERY COWARD, EXAMINING ATTORNEY

FOSSILITE

SN 78-428,483. SHADES UNLIMITED, INC., COTATI, CA. FILED 6-2-2004.

INSTANT STYLE FOR AWHILE

THE MARK CONSISTS OF STANDARD CHARACTERS WITHOUT CLAIM TO ANY PARTICULAR FONT, STYLE, SIZE, OR COLOR.
FOR INTERIOR WINDOW COVERINGS, NAMELY, WINDOW SHADES AND BLINDS (U.S. CLS. 2, 13, 22, 25, 32 AND 50).
THEODORE MCBRIDE, EXAMINING ATTORNEY

THE MARK CONSISTS OF STANDARD CHARACTERS WITHOUT CLAIM TO ANY PARTICULAR FONT, STYLE, SIZE, OR COLOR.
FOR KITCHEN AND BATHROOM COUNTERTOPS AND BAR COUNTERTOPS MADE OF CEMENTITIOUS MATERIALS DESIGNED TO SIMULATE STONE OR MARBLE (U.S. CLS. 2, 13, 22, 25, 32 AND 50).
MICHAEL TANNER, EXAMINING ATTORNEY

CLASS 20—(Continued).

SN 78-434,839. COLEFAX GROUP PLC, LONDON, UNITED KINGDOM, FILED 6-14-2004.

KINGCOME

THE MARK CONSISTS OF STANDARD CHARACTERS WITHOUT CLAIM TO ANY PARTICULAR FONT, STYLE, SIZE, OR COLOR.

OWNER OF UNITED KINGDOM REG. NO. 1532659, DATED 3-3-1995, EXPIRES 4-15-2010.

FOR FURNITURE AND REPLACEMENT PARTS AND FITTINGS THEREFOR (U.S. CLS. 2, 13, 22, 25, 32 AND 50).

STEVEN R. FINE, EXAMINING ATTORNEY

CLASS 20—(Continued).

SN 78-442,531. ATRONIC INTERNATIONAL GMBH, LÜB-BECKE, FED REP GERMANY, FILED 6-28-2004.



THE MARK CONSISTS OF A STYLIZED SMALL LETTER "E" IN AN ESSENTIALLY RHOMBOID SHAPE ROTATED CLOCKWISE AT AN ANGLE OF APPROXIMATELY 45 DEGREES.

FOR CABINETS AND CABINET TOPPERS FOR USE WITH GAMING AND SLOT MACHINES, MADE OF METAL, PLASTIC, OR WOOD, ALL SOLD AS A UNIT (U.S. CLS. 2, 13, 22, 25, 32 AND 50).

FIRST USE 2-2-2004; IN COMMERCE 7-23-2004.

RUSS HERMAN, EXAMINING ATTORNEY

SN 78-446,842. THE LEATHER CONSULTANT, DBA CONTINENTAL SEATING, MCKINNEY, TX. FILED 7-7-2004.

SN 78-436,158. WILBERT FUNERAL SERVICES, INC., FOR-EST PARK, IL. FILED 6-16-2004.

ARGUS



NO CLAIM IS MADE TO THE EXCLUSIVE RIGHT TO USE SEATING THEATER-ENTERTAINMENT-MULTIMEDIA, APART FROM THE MARK AS SHOWN.

THE COLOR(S) YELLOW/GOLD AND BLACK IS/ARE CLAIMED AS A FEATURE OF THE MARK.

THE MARK CONSISTS OF BLACK THEATER SEAT IN YELLOW/GOLD CIRCLE WITH YELLOW/GOLD CONTINENTAL SEATING COPY WITH BLACK DROP SHADOW.

FOR HOME THEATER SEATING AND FURNITURE (U.S. CLS. 2, 13, 22, 25, 32 AND 50).

FIRST USE 1-6-2003; IN COMMERCE 1-6-2003.

PATRICIA EVANKO, EXAMINING ATTORNEY

THE MARK CONSISTS OF STANDARD CHARACTERS WITHOUT CLAIM TO ANY PARTICULAR FONT, STYLE, SIZE, OR COLOR.

FOR CREMATION FUNERARY URNS (U.S. CLS. 2, 13, 22, 25, 32 AND 50).

MICHAEL HALL, EXAMINING ATTORNEY

CLASS 20—(Continued).

SN 78-448,092. ALEXANDRE INTERNATIONAL CORP., SHENZHEN CITY, CHINA, FILED 7-8-2004.

CLASS 20—(Continued).

SN 78-452,054. BAKER HUGHES INCORPORATED, HOUSTON, TX. FILED 7-16-2004.



EXXDRILL

THE LINING IS A FEATURE OF THE MARK.
FOR FURNITURE; OFFICE FURNITURE; SCHOOL FURNITURE; SOFAS; MATTRESSES; DECORATIVE WALL PLAQUES; FURNITURE OF METAL; WOOD CRATES; FLOWER-STANDS; INFANT WALKERS (U.S. CLS. 2, 13, 22, 25, 32 AND 50).
RICHARD A. STRASER, EXAMINING ATTORNEY

THE MARK CONSISTS OF STANDARD CHARACTERS WITHOUT CLAIM TO ANY PARTICULAR FONT, STYLE, SIZE, OR COLOR.
THE MARK IS PRESENTED IN STANDARD CHARACTERS, WITHOUT CLAIM TO ANY PARTICULAR FONT, STYLE, SIZE OR COLOR
FOR DOWNHOLE OILFIELD EQUIPMENT, NAMELY NON-METAL PATCHES AND NON-METAL TUBULAR SLEEVES, USED IN OIL, GAS, AND WATER WELLS TO ISOLATE THE FLOW OF FLUIDS OR PORTIONS OF A GEOLOGIC FORMATION IN A WELLBORE (U.S. CLS. 2, 13, 22, 25, 32 AND 50).
FRED MANDIR, EXAMINING ATTORNEY

SN 78-450,789. EKINS, DAVID, O., MIDVALE, UT. FILED 7-14-2004.

SN 78-454,166. ENVIRO TECH CHEMICAL SERVICES, INC., MODESTO, CA. FILED 7-21-2004.

SlumberSleeve

SAFE-T-FEED

THE MARK CONSISTS OF STANDARD CHARACTERS WITHOUT CLAIM TO ANY PARTICULAR FONT, STYLE, SIZE, OR COLOR.
FOR COMFORT PILLOW-LIKE DEVICE COMPRISING PLASTIC CORE, FABRIC AND CUSHION MATERIAL TO BE WORN ON ARM OR LEG WHILE SLEEPING OR AT REST. (U.S. CLS. 2, 13, 22, 25, 32 AND 50).
GRETTA YAO, EXAMINING ATTORNEY

THE MARK CONSISTS OF STANDARD CHARACTERS WITHOUT CLAIM TO ANY PARTICULAR FONT, STYLE, SIZE, OR COLOR.
FOR SAFETY VALVES OF PLASTIC BEING OTHER THAN MACHINE PARTS FOR USE IN INDUSTRIAL PACKAGING (U.S. CLS. 2, 13, 22, 25, 32 AND 50).
FIRST USE 6-1-2004; IN COMMERCE 6-15-2004.
MICHAEL KEATING, EXAMINING ATTORNEY

CLASS 20—(Continued).

SN 78-456,467. DYNASTY CONSOLIDATED INDUSTRIES, INC., DALLAS, TX. FILED 7-26-2004.

SEVEN CONTINENTS COLLECTION

THE MARK CONSISTS OF STANDARD CHARACTERS WITHOUT CLAIM TO ANY PARTICULAR FONT, STYLE, SIZE, OR COLOR.

NO CLAIM IS MADE TO THE EXCLUSIVE RIGHT TO USE COLLECTION, APART FROM THE MARK AS SHOWN, FOR SLEEP PRODUCTS, NAMELY MATTRESSES, SPRING MATTRESSES, BOX SPRINGS, AND MATTRESS FOUNDATIONS (U.S. CLS. 2, 13, 22, 25, 32 AND 50).

FIRST USE 6-7-2004; IN COMMERCE 6-7-2004.
BRIDGETT SMITH, EXAMINING ATTORNEY

SN 78-469,646. LUCKY BREAK WISHBONE CORP., SEATTLE, WA. FILED 8-18-2004.

LUCKY BREAK

THE MARK CONSISTS OF STANDARD CHARACTERS WITHOUT CLAIM TO ANY PARTICULAR FONT, STYLE, SIZE, OR COLOR.

FOR NOVELTY ITEMS, NAMELY, ARTIFICIAL WISHBONES (U.S. CLS. 2, 13, 22, 25, 32 AND 50).
CHARLES L. JENKINS, EXAMINING ATTORNEY

SN 78-471,667. TRION INDUSTRIES, INC., WILKES-BARRE, PA. FILED 8-23-2004.

SCANLOCK

THE MARK CONSISTS OF STANDARD CHARACTERS WITHOUT CLAIM TO ANY PARTICULAR FONT, STYLE, SIZE, OR COLOR.

FOR LOCKING DEVICES, NAMELY, NON-METAL LOCKS FOR USE WITH MERCHANDISE DISPLAY HOOKS (U.S. CLS. 2, 13, 22, 25, 32 AND 50).

DAVID MURRAY, EXAMINING ATTORNEY

CLASS 20—(Continued).

SN 78-475,126. THERMODYNE INTERNATIONAL LTD., ONTARIO, CA. FILED 8-27-2004.

Slimline

FOR INDUSTRIAL SHIPPING CASES, WHICH ARE PRIMARILY FORMED OUT OF PLASTIC WITH SOME METAL-PARTS, FOR HIGH TECHNOLOGY ELECTRONIC DEVICES SUCH AS MICROCOMPUTERS SO THAT THESE DEVICES MAY BE TRANSPORTED WITHOUT BEING DAMAGED (U.S. CLS. 2, 13, 22, 25, 32 AND 50).

FIRST USE 2-2-1987; IN COMMERCE 2-2-1987.
DANIEL BRODY, EXAMINING ATTORNEY

SN 78-481,564. GUANG ZHOU EUROPEAN KITCHEN ENTERPRISE CO., LTD, GUANGZHOU, GUANGDONG, CHINA, FILED 9-10-2004.



FOR KITCHEN CABINETS (U.S. CLS. 2, 13, 22, 25, 32 AND 50).
RONALD MCMORROW, EXAMINING ATTORNEY

SN 78-488,996. GROUPE LACASSE LLC, HOLLAND, MI. FILED 9-24-2004.

AVENUE

THE MARK CONSISTS OF STANDARD CHARACTERS WITHOUT CLAIM TO ANY PARTICULAR FONT, STYLE, SIZE, OR COLOR.

OWNER OF U.S. REG. NO. 1,850,711.

FOR FURNITURE (U.S. CLS. 2, 13, 22, 25, 32 AND 50).
FIRST USE 9-25-1992; IN COMMERCE 9-25-1992.

LEIGH CAROLINE CASE, EXAMINING ATTORNEY

CLASS 20—(Continued).

SN 78-489,374. DUCK SOUP, LLC, LOS ANGELES, CA. FILED 9-24-2004.

CLASS 20—(Continued).

SN 78-491,844. THE LOVESAC CORPORATION, WILMINGTON, NEW CASTLE COUNTY, DE. FILED 9-29-2004.

Duck Soup

THE MARK CONSISTS OF STANDARD CHARACTERS WITHOUT CLAIM TO ANY PARTICULAR FONT, STYLE, SIZE, OR COLOR.
FOR FURNITURE, NAMELY, CHAIRS, TABLES, SIDEBOARDS, MIRRORS AND PICTURE FRAMES (U.S. CLS. 2, 13, 22, 25, 32 AND 50).
FIRST USE 5-0-2004; IN COMMERCE 7-0-2004.
STEVEN PEREZ, EXAMINING ATTORNEY

SN 78-491,167. MERILLAT INDUSTRIES, LLC, ADRIAN, MI. FILED 9-29-2004.

MONTEBELLO

THE MARK CONSISTS OF STANDARD CHARACTERS WITHOUT CLAIM TO ANY PARTICULAR FONT, STYLE, SIZE, OR COLOR.
FOR CABINETS, NAMELY KITCHEN AND BATH CABINETS AND CABINET DOORS (U.S. CLS. 2, 13, 22, 25, 32 AND 50).
ERNEST SHOSHO, EXAMINING ATTORNEY

SAC

THE MARK CONSISTS OF STANDARD CHARACTERS WITHOUT CLAIM TO ANY PARTICULAR FONT, STYLE, SIZE, OR COLOR.
FOR FURNITURE; FOAM-FILLED CHAIRS; FRAMELESS FOAM-FILLED FURNITURE (U.S. CLS. 2, 13, 22, 25, 32 AND 50).
FIRST USE 4-27-1999; IN COMMERCE 4-27-1999.
ALINA MORRIS, EXAMINING ATTORNEY

SN 78-492,213. INDUSTRIA AMERICANA DE COLCHONES INDUAMERCOL S.A., BOGOTA D.C., COLOMBIA, FILED 9-30-2004.

AMERICAN HOUSE

THE MARK CONSISTS OF STANDARD CHARACTERS WITHOUT CLAIM TO ANY PARTICULAR FONT, STYLE, SIZE, OR COLOR.
FOR PILLOWS AND MATTRESSES (U.S. CLS. 2, 13, 22, 25, 32 AND 50).
TINA L. SNAPP, EXAMINING ATTORNEY

SN 78-492,707. HUNTER DOUGLAS INC., UPPER SADDLE RIVER, NJ. FILED 9-30-2004.

**WHERE BEAUTY TAKES
SHAPE**

THE MARK CONSISTS OF STANDARD CHARACTERS WITHOUT CLAIM TO ANY PARTICULAR FONT, STYLE, SIZE, OR COLOR.
FOR WINDOW BLINDS AND WINDOW SHADES (U.S. CLS. 2, 13, 22, 25, 32 AND 50).
CARRIE ACHEN, EXAMINING ATTORNEY

CLASS 20—(Continued).

SN 78-494,493. WHITE DOVE MATTRESS, LTD., CLEVELAND, OH. FILED 10-5-2004.

CLASS 20—(Continued).

SN 78-495,186. MERILLAT INDUSTRIES, LLC, ADRIAN, MI. FILED 10-6-2004.

CHIROSENSE

THE MARK CONSISTS OF STANDARD CHARACTERS WITHOUT CLAIM TO ANY PARTICULAR FONT, STYLE, SIZE, OR COLOR.

FOR MATTRESSES, BOX SPRINGS AND PILLOWS (U.S. CLS. 2, 13, 22, 25, 32 AND 50).
APRIL L. RADEMACHER, EXAMINING ATTORNEY

GRAMBLING

THE MARK CONSISTS OF STANDARD CHARACTERS WITHOUT CLAIM TO ANY PARTICULAR FONT, STYLE, SIZE, OR COLOR.

FOR CABINETRY (U.S. CLS. 2, 13, 22, 25, 32 AND 50).
MICHAEL KAZAZIAN, EXAMINING ATTORNEY

SN 78-494,713. MENARD, INC., EAU CLAIRE, WI. FILED 10-5-2004.

BACKYARD CREATIONS

THE MARK CONSISTS OF STANDARD CHARACTERS WITHOUT CLAIM TO ANY PARTICULAR FONT, STYLE, SIZE, OR COLOR.

NO CLAIM IS MADE TO THE EXCLUSIVE RIGHT TO USE "BACKYARD", APART FROM THE MARK AS SHOWN.

FOR PATIO FURNITURE (U.S. CLS. 2, 13, 22, 25, 32 AND 50).
BARBARA A. LOUGHRAN, EXAMINING ATTORNEY

SN 78-495,193. MERILLAT INDUSTRIES, LLC, ADRIAN, MI. FILED 10-6-2004.

SN 78-494,920. ENDICK, MITCHELL, ATHENS, OH. FILED 10-5-2004.

ABE FELLER

THE MARK CONSISTS OF STANDARD CHARACTERS WITHOUT CLAIM TO ANY PARTICULAR FONT, STYLE, SIZE, OR COLOR.

THE NAME(S), PORTRAIT(S), AND/OR SIGNATURE(S) SHOWN IN THE MARK DOES NOT IDENTIFY A PARTICULAR LIVING INDIVIDUAL.

FOR MATTRESSES AND FUTONS (U.S. CLS. 2, 13, 22, 25, 32 AND 50).
FIRST USE 8-30-2004; IN COMMERCE 8-30-2004.
TEJBIR SINGH, EXAMINING ATTORNEY

DARTMOOR

THE MARK CONSISTS OF STANDARD CHARACTERS WITHOUT CLAIM TO ANY PARTICULAR FONT, STYLE, SIZE, OR COLOR.

FOR CABINETRY (U.S. CLS. 2, 13, 22, 25, 32 AND 50).
MICHAEL KAZAZIAN, EXAMINING ATTORNEY

CLASS 20—(Continued).

SN 78-495,456. INNERSPACE CORPORATION, GRAND RAPIDS, MI. FILED 10-6-2004.

CLASS 20—(Continued).

SN 78-497,915. JRA FURNITURE INDUSTRIES, LLC, CERRITOS, CA. FILED 10-11-2004.

QUICKWALL

Verrado Collection

THE MARK CONSISTS OF STANDARD CHARACTERS WITHOUT CLAIM TO ANY PARTICULAR FONT, STYLE, SIZE, OR COLOR.
FOR MEDICAL STORAGE AND SHELVING SYSTEMS MADE FROM WIRE AND DESIGNED TO STORE MEDICAL AND SURGICAL INSTRUMENTS AND SUPPLIES (U.S. CLS. 2, 13, 22, 25, 32 AND 50).
RONALD AIKENS, EXAMINING ATTORNEY

THE MARK CONSISTS OF STANDARD CHARACTERS WITHOUT CLAIM TO ANY PARTICULAR FONT, STYLE, SIZE, OR COLOR.
NO CLAIM IS MADE TO THE EXCLUSIVE RIGHT TO USE "COLLECTION", APART FROM THE MARK AS SHOWN.
FOR OUTDOOR FURNITURE (U.S. CLS. 2, 13, 22, 25, 32 AND 50).
SUSAN HAYASH, EXAMINING ATTORNEY

SN 78-496,395. ALL ABOUT BLINDS, LLC, OMAHA, NE. FILED 10-7-2004.

SN 78-497,930. JRA FURNITURE INDUSTRIES, LLC, CERRITOS, CA. FILED 10-11-2004.



Calista Collection

NO CLAIM IS MADE TO THE EXCLUSIVE RIGHT TO USE BLINDS LLC, APART FROM THE MARK AS SHOWN.
THE COLOR(S) RED, BLACK, AND WHITE IS/ARE CLAIMED AS A FEATURE OF THE MARK.
THE MARK CONSISTS OF THE WORDS "ALL ABOUT" IN BLACK, THE WORD "BLINDS" IN RED, AND A DRAWING OF A WINDOW BLIND IN RED, WHITE, AND BLACK.
THE MARK CONSISTS OF THE WORDS "ALL ABOUT" IN BLACK, THE WORD "BLINDS" IN RED, AND A DRAWING OF A WINDOW BLIND IN RED, WHITE, AND BLACK.
FOR WINDOW COVERINGS, NAMELY, WINDOW BLINDS, WINDOW SHADES, AND INTERIOR WINDOW SHUTTERS (U.S. CLS. 2, 13, 22, 25, 32 AND 50).
JOHN E. MICHOS, EXAMINING ATTORNEY

THE MARK CONSISTS OF STANDARD CHARACTERS WITHOUT CLAIM TO ANY PARTICULAR FONT, STYLE, SIZE, OR COLOR.
NO CLAIM IS MADE TO THE EXCLUSIVE RIGHT TO USE "COLLECTION", APART FROM THE MARK AS SHOWN.
FOR OUTDOOR FURNITURE (U.S. CLS. 2, 13, 22, 25, 32 AND 50).
SUSAN HAYASH, EXAMINING ATTORNEY

CLASS 20—(Continued).

SN 78-499,513. LCO DESTINY, LLC, WATERTOWN, NY. FILED 10-14-2004.

Timeless Frames

THE MARK CONSISTS OF STANDARD CHARACTERS WITHOUT CLAIM TO ANY PARTICULAR FONT, STYLE, SIZE, OR COLOR.

NO CLAIM IS MADE TO THE EXCLUSIVE RIGHT TO USE "FRAMES", APART FROM THE MARK AS SHOWN.

FOR PICTURE FRAMES (U.S. CLS. 2, 13, 22, 25, 32 AND 50).

FIRST USE 1-6-1998; IN COMMERCE 1-6-1998.
CAROLYN GRAY, EXAMINING ATTORNEY

CLASS 20—(Continued).

SN 78-500,880. ZINUS, INC., PLEASANTON, CA. FILED 10-15-2004.

So-Cozi

THE MARK CONSISTS OF STANDARD CHARACTERS WITHOUT CLAIM TO ANY PARTICULAR FONT, STYLE, SIZE, OR COLOR.

FOR PILLOW (U.S. CLS. 2, 13, 22, 25, 32 AND 50).
JIM RINGLE, EXAMINING ATTORNEY

SN 78-502,783. LEGARE, L.P., FORT WORTH, TX. FILED 10-20-2004.



THE MARK CONSISTS OF TWO INTERLOCKING, STYLIZED FACES AND TWO STYLIZED HANDS.
FOR MODULAR FURNITURE (U.S. CLS. 2, 13, 22, 25, 32 AND 50).

FIRST USE 11-1-2003; IN COMMERCE 11-1-2003.
MARGERY A. TIERNEY, EXAMINING ATTORNEY

SN 78-500,383. CHANG, LILY, CORONA, CA. FILED 10-15-2004.

DURO-TEK

THE MARK CONSISTS OF STANDARD CHARACTERS WITHOUT CLAIM TO ANY PARTICULAR FONT, STYLE, SIZE, OR COLOR.

FOR METAL STORAGE CABINETS, STORAGE RACKS, FREESTANDING METAL TOOL CHESTS, MULTI-DRAWER TOOL CABINETS, TOOL CABINETS MOVABLE BY WHEELS (U.S. CLS. 2, 13, 22, 25, 32 AND 50).

FIRST USE 9-28-2004; IN COMMERCE 9-28-2004.
MARTHA SANTOMARTINO, EXAMINING ATTORNEY

SN 78-512,179. O2DIESEL CORPORATION, NEWARK, DE. FILED 11-5-2004.



FOR PLASTIC BANNERS (U.S. CLS. 2, 13, 22, 25, 32 AND 50).

CATHERINE CAIN, EXAMINING ATTORNEY

CLASS 20—(Continued).

SN 78-512,509. CROWN AWARDS, INC., HAWTHORNE, NY. FILED 11-5-2004.



NO CLAIM IS MADE TO THE EXCLUSIVE RIGHT TO USE "SPORT", APART FROM THE MARK AS SHOWN.

THE COLORS BLUE, BLACK, GREEN, & WHITE ARE CLAIMED AS A FEATURE OF THE MARK.

THE GEOMETRIC SHAPE IS OUTLINED IN BLUE AND BLACK, YELLOW AND GREEN ARE THE COLORS OF THE SPORT LIGHT, WITH BLACK BASE, AND BLUE ON THE OUTSIDE OF THE LIGHT.

THE MARK CONSISTS OF A GEOMETRIC SHAPE OUTLINED BY A BLUE & BLACK BORDER. THE WORDS SPORT LIGHT ARE IN AN ARC, SET WITHIN THE SHAPE IN WHITE AND OUTLINED IN BLACK WITH A GREEN BORDER. BELOW THE WORDS "SPORT LIGHT" IS A CIRCULAR LIGHT FIXTURE WITH A BLACK BASE WITH LIGHT BEAMS BURSTING OUT ABOVE IT TOWARDS THE WORDS "SPORT LIGHT." THERE ARE WHITE STARS HIGHLIGHTING THE GLOW OF THE LIGHT BEAMS.

FOR NON-METAL TROPHIES AND AWARDS, NAMELY, PLAQUES (U.S. CLS. 2, 13, 22, 25, 32 AND 50). JUDITH HELFMAN, EXAMINING ATTORNEY

CLASS 20—(Continued).

SN 78-523,111. BOJUY PARTICIPACAO ADMINISTRACAO E MARCAS LTDA, SAO PAULO, BRAZIL, FILED 11-26-2004.

Orthobom

THE MARK CONSISTS OF STANDARD CHARACTERS WITHOUT CLAIM TO ANY PARTICULAR FONT, STYLE, SIZE, OR COLOR.

FOR MATTRESSES, PILLOWS, CUSHIONS (U.S. CLS. 2, 13, 22, 25, 32 AND 50). BRIAN PINO, EXAMINING ATTORNEY

SN 78-517,404. UNITED STATES POSTAL SERVICE, WASHINGTON, DC. FILED 11-16-2004.



OWNER OF U.S. REG. NOS. 2,213,699 AND 2,900,954. THE MARK CONSISTS OF AN OVAL CONTAINING THE WORDS "PONY EXPRESS UNITED STATES MAIL" AND A HORSE AND RIDER DESIGN.

FOR MIRRORS, NAMELY, HAND HELD MIRRORS, AND FURNITURE MIRRORS, PILLOWS, PICTURE FRAMES, NON METAL KEY HOLDERS, NON-METAL MONEY CLIPS, COLLECTIVE FIGURINES, NAMELY, FIGURINES OF BONE, IVORY, PLASTER, PLASTIC, WAX, AND WOOD, WINDOW SHADES, INTERIOR WINDOW BLINDS, SLEEPING BAGS, DECORATIVE MOBILES (U.S. CLS. 2, 13, 22, 25, 32 AND 50). JEFFERY COWARD, EXAMINING ATTORNEY

SN 78-523,662. ZINUS INC., PLEASANTON, CA. FILED 11-29-2004.

Z-Sac

THE MARK CONSISTS OF STANDARD CHARACTERS WITHOUT CLAIM TO ANY PARTICULAR FONT, STYLE, SIZE, OR COLOR.

FOR MEMORY FOAM COMFORT CHAIR/PORTABLE MATTRESS (U.S. CLS. 2, 13, 22, 25, 32 AND 50). LINDA M. KING, EXAMINING ATTORNEY

CLASS 20—(Continued).

SN 78-524,310. KUSCH & CO. SITZMOBEL WERKE GMBH & CO., HALLENBERG, FED REP GERMANY, FILED 11-30-2004.



OWNER OF U.S. REG. NOS. 1,452,678 AND 1,852,416.
NO CLAIM IS MADE TO THE EXCLUSIVE RIGHT TO USE "CO", APART FROM THE MARK AS SHOWN.
THE COLOR(S) RED IS/ARE CLAIMED AS A FEATURE OF THE MARK.
THE COLOR RED APPEARS IN THE ENTIRETY OF THE MARK.
THE MARK CONSISTS OF THE WORD "KUSCH" FOLLOWED BY A STYLIZED PLUS ("+") SYMBOL AND "CO".
FOR FURNITURE, NAMELY, TABLES AND CHAIRS (U.S. CLS. 2, 13, 22, 25, 32 AND 50).
FIRST USE 10-1-1998; IN COMMERCE 10-1-1998.
DAWN HAN, EXAMINING ATTORNEY

SN 78-526,504. KRAFTMAID CABINETRY, INC., MIDDLEFIELD, OH. FILED 12-3-2004.

VENICIA

THE MARK CONSISTS OF STANDARD CHARACTERS WITHOUT CLAIM TO ANY PARTICULAR FONT, STYLE, SIZE, OR COLOR.
FOR KITCHEN AND BATH CABINETS (U.S. CLS. 2, 13, 22, 25, 32 AND 50).
KIMBERLY FRYE, EXAMINING ATTORNEY

CLASS 20—(Continued).

SN 78-528,338. PENLEY CORPORATION, WEST PARIS, ME. FILED 12-7-2004.

PENLEY

THE MARK CONSISTS OF STANDARD CHARACTERS WITHOUT CLAIM TO ANY PARTICULAR FONT, STYLE, SIZE, OR COLOR.
SEC. 2(F).
FOR DRINKING STRAWS (U.S. CLS. 2, 13, 22, 25, 32 AND 50).
FIRST USE 6-30-1999; IN COMMERCE 6-30-1999.
KAREN K. BUSH, EXAMINING ATTORNEY

SN 78-533,191. BROYHILL FURNITURE INDUSTRIES, INC., LENOIR, NC. FILED 12-15-2004.

PAINTER'S SHED

THE MARK CONSISTS OF STANDARD CHARACTERS WITHOUT CLAIM TO ANY PARTICULAR FONT, STYLE, SIZE, OR COLOR.
FOR FURNITURE (U.S. CLS. 2, 13, 22, 25, 32 AND 50).
FIRST USE 12-16-2004; IN COMMERCE 12-16-2004.
KATRINA EDGE, EXAMINING ATTORNEY

CLASS 20—(Continued).

SN 78-534,610. BASIC COMFORT, INC., DENVER, CO. FILED 12-17-2004.

Amuse-n-Me

THE MARK CONSISTS OF STANDARD CHARACTERS WITHOUT CLAIM TO ANY PARTICULAR FONT, STYLE, SIZE, OR COLOR.

FOR VEHICLE SEAT BACK COVER INCORPORATING A STORAGE COMPARTMENT AND FOLD OUT ACTIVITY LAP PAD (U.S. CLS. 2, 13, 22, 25, 32 AND 50). FIRST USE 12-10-2004; IN COMMERCE 12-10-2004. APRIL L. RADEMACHER, EXAMINING ATTORNEY

CLASS 20—(Continued).

SN 78-598,877. TEMPUR WORLD, LLC, LEXINGTON, KY. FILED 3-31-2005.

**THE RHAPSODYBED BY
TEMPUR-PEDIC**

THE MARK CONSISTS OF STANDARD CHARACTERS WITHOUT CLAIM TO ANY PARTICULAR FONT, STYLE, SIZE, OR COLOR.

OWNER OF U.S. REG. NOS. 2,823,185, 2,840,686 AND 2,840,687.

FOR SEATING AND COUCHING MATS IN THE NATURE OF A PILLOW OR SEAT LINER, PILLOWS, CUSHIONS, MATTRESSES, TOP MATTRESSES, BOLSTERS AND CHAIR PADS (U.S. CLS. 2, 13, 22, 25, 32 AND 50). KIMBERLY FRYE, EXAMINING ATTORNEY

SN 78-537,437. SHAW, SARAH, LOS ANGELES, CA. AND APOTHAKER, HELENA, LOS ANGELES, CA. FILED 12-22-2004.

NEAT'N IT!

THE MARK CONSISTS OF STANDARD CHARACTERS WITHOUT CLAIM TO ANY PARTICULAR FONT, STYLE, SIZE, OR COLOR.

FOR PERSONAL ORGANIZER CONSISTING OF A WALL MOUNTED UNIT THAT HOLDS CLOTHING, PURSES, KEY CHAINS, HATS AND OTHER ITEMS (U.S. CLS. 2, 13, 22, 25, 32 AND 50). TRICIA SONNEBORN, EXAMINING ATTORNEY

CLASS 21—HOUSEWARES AND GLASS

SN 76-574,389. POTTERY PALACE STONWARE LTD., COLUMBUS, OH. FILED 2-5-2004.

STONEWARE PALACE

THE MARK CONSISTS OF STANDARD CHARACTERS WITHOUT CLAIM TO ANY PARTICULAR FONT, STYLE, SIZE, OR COLOR.

NO CLAIM IS MADE TO THE EXCLUSIVE RIGHT TO USE "STONEWARE", APART FROM THE MARK AS SHOWN.

FOR APPARATUS FOR HEATING AND COOKING, NAMELY, CERAMIC COOKING BLOCKS, CERAMIC BAKING BLOCKS, AND CERAMIC COOKIE SHEETS (U.S. CLS. 2, 13, 23, 29, 30, 33, 40 AND 50).

FIRST USE 2-10-2003; IN COMMERCE 2-10-2003. LINDA MICKLEBURGH, EXAMINING ATTORNEY

CLASS 21—(Continued).

SN 76-587,319. DISNEY ENTERPRISES, INC., BURBANK, CA. FILED 4-19-2004.



OWNER OF U.S. REG. NO. 2,700,620.
 FOR DINNERWARE; BEVERAGeware; COASTERS NOT OF PAPER AND NOT BEING TABLE LINEN; PLASTIC COASTERS; REMOVABLE INSULATOR SLEEVES FOR DRINK CANS AND BOTTLES; LUNCH KITS CONSISTING OF LUNCH BOXES AND THERMAL INSULATED CONTAINERS; SERVING TRAYS NOT OF PRECIOUS METAL; HAIR BRUSHES AND HAIR COMBS; ELECTRIC AND NON-ELECTRIC TOOTHBRUSHES; TOOTHBRUSH HOLDERS; CERAMIC FIGURINES; FIGURINES MADE OF CHINA, CRYSTAL, EARTHENWARE, GLASS, PORCELAIN AND TERRA COTTA; PLASTIC CUPS; COOKIE JARS; PAPER CUPS AND PAPER PLATES (U.S. CLS. 2, 13, 23, 29, 30, 33, 40 AND 50).

MARLENE BELL, EXAMINING ATTORNEY

SN 76-588,116. DISNEY ENTERPRISES, INC., BURBANK, CA. FILED 4-19-2004.



OWNER OF U.S. REG. NO. 2,700,619.
 FOR DINNERWARE; BEVERAGeware; COASTERS NOT OF PAPER AND NOT BEING TABLE LINEN; PLASTIC COASTERS; REMOVABLE INSULATOR SLEEVES FOR DRINK CANS AND BOTTLES; LUNCH KITS CONSISTING OF LUNCH BOXES AND THERMAL INSULATED CONTAINERS; SERVING TRAYS NOT OF PRECIOUS METAL; HAIR BRUSHES AND HAIR COMBS; ELECTRIC AND NON-ELECTRIC TOOTHBRUSHES; TOOTHBRUSH HOLDERS; CERAMIC FIGURINES; FIGURINES MADE OF CHINA, CRYSTAL, EARTHENWARE, GLASS, PORCELAIN AND TERRA COTTA; PLASTIC CUPS; COOKIE JARS; PAPER CUPS AND PAPER PLATES (U.S. CLS. 2, 13, 23, 29, 30, 33, 40 AND 50).

WILLIAM BRECKENFELD, EXAMINING ATTORNEY

CLASS 21—(Continued).

SN 76-588,133. DISNEY ENTERPRISES, INC., BURBANK, CA. FILED 4-19-2004.



FOR DINNERWARE; BEVERAGeware; COASTERS NOT OF PAPER AND NOT BEING TABLE LINEN; PLASTIC COASTERS; REMOVABLE INSULATOR SLEEVES FOR DRINK CANS AND BOTTLES; LUNCH KITS CONSISTING OF LUNCH BOXES AND THERMAL INSULATED CONTAINERS; SERVING TRAYS NOT OF PRECIOUS METAL; HAIRBRUSHES AND HAIR COMBS; ELECTRIC AND NON-ELECTRIC TOOTHBRUSHES; TOOTHBRUSH HOLDERS; CERAMIC FIGURINES; FIGURINES MADE OF CHINA, CRYSTAL, EARTHENWARE, GLASS, PORCELAIN AND TERRA COTTA; PLASTIC CUPS; COOKIE JARS; PAPER CUPS AND PAPER PLATES (U.S. CLS. 2, 13, 23, 29, 30, 33, 40 AND 50).

WILLIAM BRECKENFELD, EXAMINING ATTORNEY

SN 76-592,252. DR. ING. H.C. F. PORSCHE AKTIENGESELLSCHAFT, 70435 STUTTGART-ZUFFENHAUSEN, FED REP GERMANY, FILED 5-14-2004.

PORSCHE

OWNER OF FED REP GERMANY REG. NO. 1035701, DATED 7-16-1982, EXPIRES 4-30-2012.

OWNER OF U.S. REG. NOS. 618,932, 1,279,014 AND OTHERS.

FOR PILL BOXES, VASES, FLASKS FOR PERFUME, SMALL DOMESTIC UTENSILS, NAMELY SPATULAS, STRAINERS, MINCERS, CITRUS PRESSES, COOKIE AND PANCAKE MOLDS, HERB MILLS AND WIRE BASKETS, GENERAL DINNERWARE, HAIRBRUSHES AND COMBS AND LEATHER COASTERS (U.S. CLS. 2, 13, 23, 29, 30, 33, 40 AND 50).

RONALD AIKENS, EXAMINING ATTORNEY

CLASS 21—(Continued).

SN 76-592,466. DOMKE, TODD P., ROCKVILLE, MD. FILED 5-17-2004.



NO CLAIM IS MADE TO THE EXCLUSIVE RIGHT TO USE "TOOTHBRUSH" OR "WALLET SIZE DISPOSABLE TOOTHBRUSH", APART FROM THE MARK AS SHOWN. FOR MANUAL TOOTHBRUSHES (U.S. CLS. 2, 13, 23, 29, 30, 33, 40 AND 50). THEODORE MCBRIDE, EXAMINING ATTORNEY

CLASS 21—(Continued).

SN 76-602,375. MY SPIRIT, INC., CHARLESTON, SC. FILED 7-15-2004.



THE MARK CONSISTS OF STANDARD CHARACTERS WITHOUT CLAIM TO ANY PARTICULAR FONT, STYLE, SIZE, OR COLOR. OWNER OF U.S. REG. NO. 2,801,137. FOR DINNER PLATES, SALAD PLATES, DESERT PLATES, BOWLS, PLATTERS, CHEESE BOARDS, COFFEE CUPS, VASES, AND CANDLE HOLDERS NOT MADE OF PRECIOUS METALS (U.S. CLS. 2, 13, 23, 29, 30, 33, 40 AND 50). FIRST USE 2-0-2003; IN COMMERCE 2-0-2003. DANIEL BRODY, EXAMINING ATTORNEY

SN 76-596,464. HOLLYWOOD CHAIRS, DBA TOTALLY BAMBOO, NORTH HOLLYWOOD, CA. FILED 6-9-2004.



THE MARK CONSISTS OF STANDARD CHARACTERS WITHOUT CLAIM TO ANY PARTICULAR FONT, STYLE, SIZE, OR COLOR. NO CLAIM IS MADE TO THE EXCLUSIVE RIGHT TO USE BAMBOO, APART FROM THE MARK AS SHOWN. FOR HOUSEWARES MADE IN WHOLE OR PART FROM BAMBOO, NAMELY CUTTING BOARDS, CHOPPING BLOCKS, CUTTING BOARD HOLDERS, BOWLS, SUSHI SERVING STANDS, PLATES, CHOP STICKS, FOOD SPREADERS, AND SALAD SERVERS (U.S. CLS. 2, 13, 23, 29, 30, 33, 40 AND 50). FIRST USE 11-0-2000; IN COMMERCE 11-0-2000. MARY ROSSMAN, EXAMINING ATTORNEY

SN 76-603,613. BUTLER HOME PRODUCTS, LLC., HOLLISTON, MA. FILED 7-23-2004.

SN 76-600,058. ANNE TAINTOR, INC., YOUNGSVILLE, NM. FILED 7-1-2004.



THE MARK CONSISTS OF STANDARD CHARACTERS WITHOUT CLAIM TO ANY PARTICULAR FONT, STYLE, SIZE, OR COLOR. THE NAME ANNE TAINTOR IDENTIFIES A LIVING INDIVIDUAL WHOSE CONSENT IS OF RECORD. FOR MUGS, MELAMINE TRAYS AND PLATES, BEVERAGE GLASSWARE, COCKTAIL SHAKERS, AND PAPER PLATES (U.S. CLS. 2, 13, 23, 29, 30, 33, 40 AND 50). FIRST USE 4-30-2003; IN COMMERCE 4-30-2003. SONYA STEPHENS, EXAMINING ATTORNEY



NO CLAIM IS MADE TO THE EXCLUSIVE RIGHT TO USE "SQUIRT", APART FROM THE MARK AS SHOWN. FOR WET MOPS AND REFILL CLEANING PADS FOR USE IN SAID WET MOPS (U.S. CLS. 2, 13, 23, 29, 30, 33, 40 AND 50). FIRST USE 12-31-2003; IN COMMERCE 12-31-2003. CHERYL CLAYTON, EXAMINING ATTORNEY

CLASS 21—(Continued).

SN 76-605,856. TRAYBRELLA DESIGNS, INC., ZIONSVILLE, IN. FILED 8-6-2004.

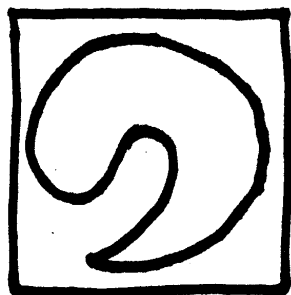

FOR HOUSEHOLD CONTAINERS, NAMELY, TRAYS FOR HOLDING OR STORING ITEMS THAT MAY BE POSITIONED ABOUT AN UMBRELLA POLE (U.S. CLS. 2, 13, 23, 29, 30, 33, 40 AND 50).
FIRST USE 6-0-2004; IN COMMERCE 6-0-2004.
ANDREA SAUNDERS, EXAMINING ATTORNEY

CLASS 21—(Continued).

SN 76-615,824. INTELLIGENT PRODUCTS INCORPORATED, BURLINGTON, KY. FILED 10-12-2004.

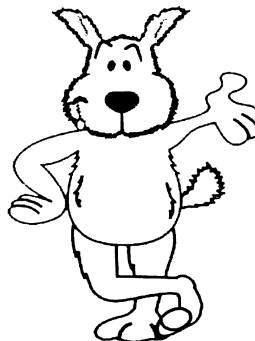

OWNER OF U.S. REG. NO. 1,683,820.
FOR PLASTIC DISPOSABLE MITTENS FOR RETRIEVAL AND COLLECTION OF ANIMAL WASTE (U.S. CLS. 2, 13, 23, 29, 30, 33, 40 AND 50).
FIRST USE 7-23-2000; IN COMMERCE 9-9-2000.
EDWARD NELSON, EXAMINING ATTORNEY

SN 76-616,889. WIRTHCO ENGINEERING, INC., BLOOMINGTON, MN. FILED 10-19-2004.

Funnel King

THE MARK CONSISTS OF STANDARD CHARACTERS WITHOUT CLAIM TO ANY PARTICULAR FONT, STYLE, SIZE, OR COLOR.
NO CLAIM IS MADE TO THE EXCLUSIVE RIGHT TO USE "FUNNEL", APART FROM THE MARK AS SHOWN.
FOR FUNNEL FOR TRANSFERRING MATERIAL FROM ONE CONTAINER TO ANOTHER FOR AUTOMOTIVE, BOAT AND HOME USAGE (U.S. CLS. 2, 13, 23, 29, 30, 33, 40 AND 50).
FIRST USE 5-4-2004; IN COMMERCE 5-4-2004.
MITCHELL FRONT, EXAMINING ATTORNEY

SN 76-626,299. BUY MY BIKES INC., SAN JUAN CAPISTRANO, CA. FILED 12-30-2004.

BUY MY BIKES

THE MARK CONSISTS OF STANDARD CHARACTERS WITHOUT CLAIM TO ANY PARTICULAR FONT, STYLE, SIZE, OR COLOR.
FOR WATER BOTTLES SOLD EMPTY (U.S. CLS. 2, 13, 23, 29, 30, 33, 40 AND 50).
FIRST USE 6-0-1992; IN COMMERCE 6-0-1992.
DANIEL CAPSHAW, EXAMINING ATTORNEY

SN 76-615,387. BRIDWELL, NORMAN, EDGARTOWN, MA. FILED 10-6-2004.



OWNER OF U.S. REG. NOS. 1,972,490, 2,906,083 AND OTHERS.
FOR ELECTRIC AND NON-ELECTRIC TOOTHBRUSHES, TOOTHBRUSH HOLDERS, LOTION DISPENSERS, SOAP DISPENSERS, SOAP DISHES, BATH SPONGES, TISSUE BOX COVERS NOT MADE OF FABRIC, PLATES, BOWLS, CUPS, MUGS; PAPER PLATES, BOWLS AND CUPS; THERMOPLASTIC AND MELAMINE PLATES, BOWLS AND CUPS; CAKE MOLDS, CUPCAKE PICKS AND RINGS, TRASH CANS, DECORATIVE BOXES MADE OF PORCELAIN, PORCELAIN FIGURINES, CANTEENS, SPORTS BOTTLES SOLD EMPTY, LUNCH BOXES (U.S. CLS. 2, 13, 23, 29, 30, 33, 40 AND 50).
FIRST USE 7-1-2003; IN COMMERCE 7-1-2003.
DAYNA BROWNE, EXAMINING ATTORNEY

CLASS 21—(Continued).

SN 78-189,578. BARMAN, ROLF, NATTLAND, NORWAY, FILED 11-27-2002.



SUPER BRUSH

OWNER OF NORWAY REG. NO. 144694, DATED 4-11-1991, EXPIRES 4-11-2011.

NO CLAIM IS MADE TO THE EXCLUSIVE RIGHT TO USE "SUPER BRUSH", APART FROM THE MARK AS SHOWN.

FOR NON-ELECTRIC TOOTHBRUSHES; ELECTRIC TOOTHBRUSHES; TOOTHPICKS (U.S. CLS. 2, 13, 23, 29, 30, 33, 40 AND 50).

KARLA PERKINS, EXAMINING ATTORNEY

SN 78-216,457. BRANDON FEMME, INC., CHATSWORTH, CA. FILED 2-19-2003.

BRANDON

FOR COSMETIC ACCESSORIES, NAMELY, COSMETIC BRUSHES, COTTON BALLS, COMBS, AND PERFUME SPRAYERS SOLD EMPTY (U.S. CLS. 2, 13, 23, 29, 30, 33, 40 AND 50).

FIRST USE 1-1-1982; IN COMMERCE 1-1-1982.
TONI HICKEY, EXAMINING ATTORNEY

SN 78-233,524. THE HOWARD AND VERONICA ALLEN-BAUGH FAMILY TRUST, HUNTINGTON BEACH, CA. FILED 4-3-2003.

KLEER DRAIN

SEC. 2(F).

FOR FLUID POWERED DRAIN OPENER IN THE NATURE OF A PLUNGER AND REPLACEMENT PARTS THEREFOR (U.S. CLS. 2, 13, 23, 29, 30, 33, 40 AND 50).

FIRST USE 9-23-2002; IN COMMERCE 9-23-2002.
SCOTT BALDWIN, EXAMINING ATTORNEY

CLASS 21—(Continued).

SN 78-314,215. LONG, BILLY C., LEE'S SUMMIT, MO. FILED 10-15-2003.

GOTTA GO TO WORK

FOR DOMESTIC UTENSILS, NAMELY PLATES, DISHES; CONTAINERS FOR HOUSEHOLD OR KITCHEN USE; CHINAWARE, IN THE NATURE OF DINNERWARE; BEVERAGE GLASSWARE; DINNERWARE OF PORCELAIN, POTTERY AND EARTHENWARE; DRINKING GLASSES; TUMBLERS; MUGS; WHISKEY GLASSES; WINE GLASSES; CHAMPAGNE FLUTES; GLASS TUMBLERS; BEER MUGS; THERMAL INSULATED CONTAINERS FOR BEVERAGES; BOTTLE OPENERS; PLASTIC SPORTS BOTTLES, SOLD EMPTY; STATUETTES AND FIGURINES OF PORCELAIN, TERRACOTTA, GLASS, CHINA OR EARTHENWARE; DISHES; FITTED PICNIC BASKETS; DRINKING VESSELS AND FLASKS; COCKTAIL SHAKERS; NAPKIN HOLDERS AND NAPKIN RINGS NOT OF PRECIOUS METAL; COASTERS MADE OF PLASTIC AND COASTERS NOT OF PAPER AND NOT BEING TABLE LINENS; CORK SCREWS AND PORTABLE COOLERS FOR HOLDING FOODS AND BEVERAGES. (U.S. CLS. 2, 13, 23, 29, 30, 33, 40 AND 50).

HEATHER THOMPSON, EXAMINING ATTORNEY

SN 78-331,394. LIPTON, ARTHUR JOSEPH, NEW YORK, NY. AND WEISS, JOHN, NEW YORK, NY. FILED 11-21-2003.

CANDLE DELIGHTS

THE MARK CONSISTS OF STANDARD CHARACTERS WITHOUT CLAIM TO ANY PARTICULAR FONT, STYLE, SIZE, OR COLOR.

NO CLAIM IS MADE TO THE EXCLUSIVE RIGHT TO USE "CANDLE", APART FROM THE MARK AS SHOWN.

FOR DECORATIVE APPARATUS OF ANY NON-FLAMMABLE MATERIAL, INCLUDING STEEL, PEWTER, GLASS, COPPER AND CERAMICS, DESIGNED TO PERMANENTLY FIT OVER A CANDLE AND USED TO EXTINGUISH ITS FLAME WHILE PROTECTING THE WICK AND ELIMINATING ODORS (U.S. CLS. 2, 13, 23, 29, 30, 33, 40 AND 50).

RUSS HERMAN, EXAMINING ATTORNEY

CLASS 21—(Continued).

SN 78-338,443. CLEMENS, BIRGIT, HAMBURG, FED REP GERMANY, FILED 12-9-2003.

SCUP

THE MARK CONSISTS OF STANDARD CHARACTERS WITHOUT CLAIM TO ANY PARTICULAR FONT, STYLE, SIZE, OR COLOR.

OWNER OF FED REP GERMANY REG. NO. 39932276, DATED 9-3-1999, EXPIRES 6-30-2009.

FOR DRINKING VESSELS OF PLASTIC, GLASS, EARTHENWARE, PORCELAIN OR METALS OF RAW MATERIALS (U.S. CLS. 2, 13, 23, 29, 30, 33, 40 AND 50). RONALD MCMORROW, EXAMINING ATTORNEY

CLASS 21—(Continued).

SN 78-346,757. SIMONS, GILBERT, SEAL BEACH, CA. FILED 12-30-2003.

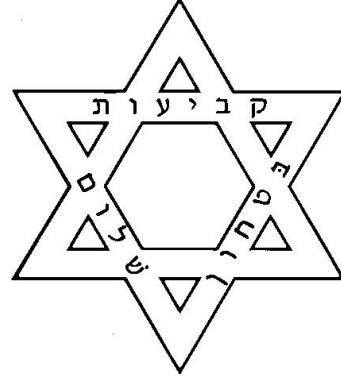

THE NON-LATIN CHARACTERS IN THE MARK TRANSLITERATE TO "KVIUT, BETAHON, SHALOM" AND THIS MEANS "PERMANENCE, SECURITY, PEACE" IN ENGLISH.

FOR MUGS (U.S. CLS. 2, 13, 23, 29, 30, 33, 40 AND 50). FIRST USE 8-7-1996; IN COMMERCE 8-7-1996. STEVEN R. FOSTER, EXAMINING ATTORNEY

SN 78-366,207. BATESVILLE SERVICES, INC., BATESVILLE, IN. FILED 2-11-2004.

TENDER EXPRESSIONS

SN 78-346,749. SIMONS, GILBERT, SEAL BEACH, CA. FILED 12-30-2003.

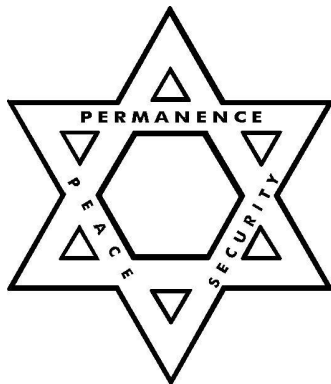

THE MARK CONSISTS OF STANDARD CHARACTERS WITHOUT CLAIM TO ANY PARTICULAR FONT, STYLE, SIZE, OR COLOR.

FOR URNS, NAMELY, FUNERY URNS (U.S. CLS. 2, 13, 23, 29, 30, 33, 40 AND 50).

FIRST USE 4-8-2003; IN COMMERCE 4-8-2003. SEAN DWYER, EXAMINING ATTORNEY

SN 78-386,927. MUSCLETECH RESEARCH AND DEVELOPMENT, INC., MISSISSAUGA, ONTARIO, CANADA, FILED 3-18-2004.

Supplements That Work!

FOR MUGS (U.S. CLS. 2, 13, 23, 29, 30, 33, 40 AND 50). FIRST USE 8-7-1996; IN COMMERCE 8-7-1996. STEVEN R. FOSTER, EXAMINING ATTORNEY

FOR CUPS (U.S. CLS. 2, 13, 23, 29, 30, 33, 40 AND 50). FIRST USE 1-0-2004; IN COMMERCE 1-0-2004. NELSON SNYDER, EXAMINING ATTORNEY

CLASS 21—(Continued).

SN 78-389,579. TWENTIETH CENTURY FOX FILM CORPORATION, LOS ANGELES, CA. FILED 3-23-2004.



FOR COFFEE MUGS (U.S. CLS. 2, 13, 23, 29, 30, 33, 40 AND 50).
MARY ROSSMAN, EXAMINING ATTORNEY

CLASS 21—(Continued).

SN 78-405,721. FORT JAMES OPERATING COMPANY, ATLANTA, GA. FILED 4-21-2004.

ULTRASTRONG

THE MARK CONSISTS OF STANDARD CHARACTERS WITHOUT CLAIM TO ANY PARTICULAR FONT, STYLE, SIZE, OR COLOR.

OWNER OF U.S. REG. NOS. 2,743,149 AND 2,743,150.
SEC. 2(F).
FOR DISPOSABLE PLATES AND BOWLS (U.S. CLS. 2, 13, 23, 29, 30, 33, 40 AND 50).
FIRST USE 3-31-1998; IN COMMERCE 3-31-1998.
DANIEL BRODY, EXAMINING ATTORNEY

SN 78-395,271. BUILT NY, INC., TUXEDO, NY. FILED 4-2-2004.

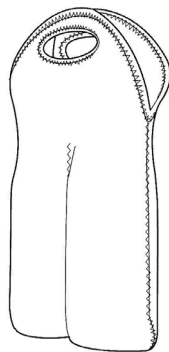

THE MARK CONSISTS OF THE CONFIGURATION OF A BEVERAGE TOTE HAVING TWO DISTINCT CHAMBERS WHEN FILLED. THE PORTION OF THE MARK SHOWN IN DOTTED LINES REPRESENTS STITCHING ON THE TOTE AND IS CLAIMED AS A FEATURE OF THE MARK.

SEC. 2(F).
FOR THERMAL INSULATED BOTTLE TOTES FOR BEVERAGES (U.S. CLS. 2, 13, 23, 29, 30, 33, 40 AND 50).
FIRST USE 4-28-2003; IN COMMERCE 4-28-2003.
JULIE WATSON, EXAMINING ATTORNEY

SN 78-405,752. DUDSON (HOLDINGS) LIMITED, STAFFORDSHIRE, UNITED KINGDOM, FILED 4-21-2004.



PRIORITY CLAIMED UNDER SEC. 44(D) ON ERPN CMNTY TM OFC APPLICATION NO. 3446945, FILED 10-23-2003.

OWNER OF U.S. REG. NO. 1,327,041.
FOR BEVERAGE GLASSWARE; BAKEWARE, CONTAINERS FOR HOUSEHOLD USE, PLANT POTS AND VASES ALL MADE OF CERAMIC AND GLASS; MUGS, PLATES, CUPS, BOWLS, DISHES, SAUCERS, TEA POTS, COFFEE POTS, JUGS, EGG CUPS, SALT AND PEPPER POTS, COASTERS, SAUCER BOATS, RAMEKINS, AND FIGURINES ALL MADE OF CHINA, PORCELAIN, CERAMIC POTTERY AND EARTHENWARE (U.S. CLS. 2, 13, 23, 29, 30, 33, 40 AND 50).
FIRST USE 0-0-1983; IN COMMERCE 3-21-1985.
ELIZABETH J. WINTER, EXAMINING ATTORNEY

CLASS 21—(Continued).

SN 78-406,689. AMERICAN AGRITECH LLC, TEMPE, AZ.
FILED 4-22-2004.

CLASS 21—(Continued).

SN 78-421,720. STONEAGE CERAMICS INTERNATIONAL
HONG KONG LTD., HONG KONG, CHINA, FILED 5-19-
2004.

MICRO GARDEN

THE MARK CONSISTS OF STANDARD CHARACTERS
WITHOUT CLAIM TO ANY PARTICULAR FONT, STYLE,
SIZE, OR COLOR.

FOR PLASTIC HYDROPONICS UNIT, NAMELY RE-
SERVOIRS, TRAYS, PORTHOLE COVERS AND TUBING
(U.S. CLS. 2, 13, 23, 29, 30, 33, 40 AND 50).

FIRST USE 4-15-2002; IN COMMERCE 4-15-2002.
SALLY SHIH, EXAMINING ATTORNEY

LUMINITE

THE MARK CONSISTS OF STANDARD CHARACTERS
WITHOUT CLAIM TO ANY PARTICULAR FONT, STYLE,
SIZE, OR COLOR.

FOR TABLEWARE AND TABLE ACCESSORIES MADE
OF PORCELAIN, STONEWARE, EARTHENWARE AND
GLASS, NAMELY, PLATES, CUPS, MUGS, SAUCERS,
BOWLS, CANDLESTICK HOLDERS, VASES AND SER-
VING PIECES, NAMELY DISHES, PLATTERS AND
BOWLS. (U.S. CLS. 2, 13, 23, 29, 30, 33, 40 AND 50).

GENE MACIOL, EXAMINING ATTORNEY

SN 78-410,197. OMEGA PRODUCTS COMPANY, LLC, HEN-
DERSONVILLE, TN. FILED 4-29-2004.

SN 78-421,867. ZOE'S GIFTS AND COLLECTIBLES LLC,
WICHITA, KS. FILED 5-19-2004.

CAST HOME**ZOE'S GIFTS AND COLLECTIBLES**

THE MARK CONSISTS OF STANDARD CHARACTERS
WITHOUT CLAIM TO ANY PARTICULAR FONT, STYLE,
SIZE, OR COLOR.

NO CLAIM IS MADE TO THE EXCLUSIVE RIGHT TO
USE CAST, APART FROM THE MARK AS SHOWN.

FOR COOKWARE, NAMELY, POTS, PANS, ROAST-
ING PANS, BAKING PANS, BROILERS, STEAMERS,
AND SKILLETS (U.S. CLS. 2, 13, 23, 29, 30, 33, 40 AND
50).

JOHN WILKE, EXAMINING ATTORNEY

THE MARK CONSISTS OF STANDARD CHARACTERS
WITHOUT CLAIM TO ANY PARTICULAR FONT, STYLE,
SIZE, OR COLOR.

NO CLAIM IS MADE TO THE EXCLUSIVE RIGHT TO
USE "GIFTS AND COLLECTIBLES", APART FROM THE
MARK AS SHOWN.

FOR CERAMIC FIGURINES (U.S. CLS. 2, 13, 23, 29, 30,
33, 40 AND 50).

FIRST USE 4-15-2004; IN COMMERCE 4-15-2004.
JOHN WILKE, EXAMINING ATTORNEY

CLASS 21—(Continued).

SN 78-425,514. CARLSON, SHERRY ANITA, OJAI, CA. FILED 5-26-2004.

PLAY ON!

THE MARK CONSISTS OF STANDARD CHARACTERS WITHOUT CLAIM TO ANY PARTICULAR FONT, STYLE, SIZE, OR COLOR.

FOR BEER MUGS; BEVERAGE GLASSWARE; BOTTLE OPENERS; BOTTLES, SOLD EMPTY; COFFEE CUPS; CUPS; EMPTY SPRAY BOTTLES; DRINKING GLASSES; DRINKING VESSELS; FOAM DRINK HOLDERS; GLASS BEVERAGE WARE; LUNCH BOXES; LUNCH PAILS; MUGS; NON-METAL PIGGY BANKS; PLASTIC CUPS; PLASTIC WATER BOTTLES SOLD EMPTY; PORTABLE BEVERAGE COOLERS; PORTABLE BEVERAGE DISPENSERS; PORTABLE COOLERS; PORTABLE ICE CHESTS FOR FOOD AND BEVERAGES; SHOT GLASSES; SPORTS BOTTLES SOLD EMPTY; THERMAL INSULATED CONTAINERS FOR FOOD AND BEVERAGE; THERMAL INSULATED TOTE BAGS FOR FOOD AND BEVERAGE; THERMAL INSULATED WRAP FOR CANS; TOOTHBRUSHES; VACUUM BOTTLES; WASHING CLOTHS (U.S. CLS. 2, 13, 23, 29, 30, 33, 40 AND 50).
CATHERINE FAINT, EXAMINING ATTORNEY

SN 78-432,549. PREVUE PET PRODUCTS, INC., CHICAGO, IL. FILED 6-9-2004.

FEATHERSTONE HEIGHTS

THE MARK CONSISTS OF STANDARD CHARACTERS WITHOUT CLAIM TO ANY PARTICULAR FONT, STYLE, SIZE, OR COLOR.

FOR BIRDCAGES (U.S. CLS. 2, 13, 23, 29, 30, 33, 40 AND 50).
FIRST USE 2-1-2003; IN COMMERCE 2-1-2003.
MICHAEL SOUDERS, EXAMINING ATTORNEY

CLASS 21—(Continued).

SN 78-438,982. MEROLLE, PAUL M., SHREWSBURY, MA. FILED 6-21-2004.

Toon Tumblers

THE MARK CONSISTS OF STANDARD CHARACTERS WITHOUT CLAIM TO ANY PARTICULAR FONT, STYLE, SIZE, OR COLOR.

NO CLAIM IS MADE TO THE EXCLUSIVE RIGHT TO USE "TUMBLERS", APART FROM THE MARK AS SHOWN. FOR DRINKING GLASSES AND BEVERAGE GLASSWARE FEATURING LICENSED CARTOON AND COMIC BOOK CHARACTERS (U.S. CLS. 2, 13, 23, 29, 30, 33, 40 AND 50).

FIRST USE 6-1-2004; IN COMMERCE 6-4-2004.
KIMBERLY PERRY, EXAMINING ATTORNEY

SN 78-441,714. AUSLAND, KELLY, BEND, OR. FILED 6-25-2004.

GIDDYUP GIRLS

THE MARK CONSISTS OF STANDARD CHARACTERS WITHOUT CLAIM TO ANY PARTICULAR FONT, STYLE, SIZE, OR COLOR.

NO CLAIM IS MADE TO THE EXCLUSIVE RIGHT TO USE GIRLS, APART FROM THE MARK AS SHOWN. FOR HOUSEHOLD ITEMS, NAMELY, BOWLS, CUPS, PLATES, PAPER PLATES, LUNCH BOXES, AND BATH PRODUCTS NAMELY, BODY SPONGES (U.S. CLS. 2, 13, 23, 29, 30, 33, 40 AND 50).

JOHN E. MICHOS, EXAMINING ATTORNEY

CLASS 21—(Continued).

SN 78-441,942. BAGOS, RUBINA S., DOUGLASVILLE, GA. FILED 6-26-2004.



NO CLAIM IS MADE TO THE EXCLUSIVE RIGHT TO USE "LINT", APART FROM THE MARK AS SHOWN. THE COLORS BLUE AND YELLOW ARE CLAIMED AS A FEATURE OF THE MARK. THE COLOR(S) "WAY BEYOND" WRITTEN IN A PARTICULAR FONT IN YELLOW ON A BLUE BACKGROUND. "LINT" WRITTEN IN ANOTHER PARTICULAR FONT AGAINST THE BLUE BACKGROUND. SEC. 2(F). FOR ADHESIVE LINT ROLLERS AND REFILLS (U.S. CLS. 2, 13, 23, 29, 30, 33, 40 AND 50). FIRST USE 1-4-2004; IN COMMERCE 6-20-2004. RICHARD WHITE, EXAMINING ATTORNEY

SN 78-446,365. IRON-TONGUE, LLC, INCLINE VILLAGE, NV. FILED 7-6-2004.

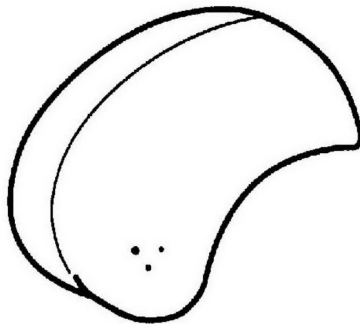

THE MARK CONSISTS OF A WHIMSICAL DEPICTION OF A HUMAN TONGUE. FOR CLEANING PADS AND CLEANING CLOTHS FOR CLEANING PRIMARILY GOLF EQUIPMENT AND ATHLETIC SHOES (U.S. CLS. 2, 13, 23, 29, 30, 33, 40 AND 50). DANIEL BRODY, EXAMINING ATTORNEY

CLASS 21—(Continued).

SN 78-448,517. MAPA SPONTEX, INC., COLUMBIA, TN. FILED 7-9-2004.

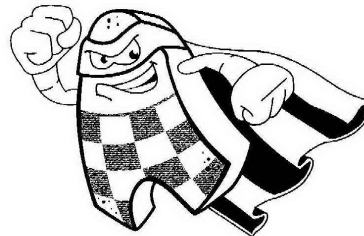

THE LINING AND STIPPLING ON THE CHEST AND LEGS OF THE FIGURE IS FOR SHADING THE CHECKER DESIGN FEATURE OF THE MARK. FOR SCRUB SPONGES (U.S. CLS. 2, 13, 23, 29, 30, 33, 40 AND 50). FIRST USE 3-20-2004; IN COMMERCE 3-20-2004. JOHN DWYER, EXAMINING ATTORNEY

SN 78-448,709. POWELL PRODUCTS INC., COLORADO SPRINGS, CO. FILED 7-9-2004.



NO CLAIM IS MADE TO THE EXCLUSIVE RIGHT TO USE "PRODUCTS INC", APART FROM THE MARK AS SHOWN. THE MARK CONSISTS OF POWELL PRODUCTS INC TO THE RIGHT OF THREE CRESCENT SHAPES. FOR FOAM APPLICATORS IN STICK FORM FOR APPLYING COSMETICS, PHARMACEUTICALS AND MEDICINES, AND FOR USE IN CLEANING MACHINERY AND COMPUTER HARDWARE (U.S. CLS. 2, 13, 23, 29, 30, 33, 40 AND 50). FIRST USE 2-28-1980; IN COMMERCE 2-28-1980. ZHALEH DELANEY, EXAMINING ATTORNEY

CLASS 21—(Continued).

SN 78-458,798. PHARMELLE L.L.C., FLORISSANT, MO.
FILED 7-29-2004.

CLASS 21—(Continued).

SN 78-466,332. KUBALA, GARY J, MANORVILLE, NY.
FILED 8-12-2004.

Dado500

Catfeteria

THE MARK CONSISTS OF STANDARD CHARACTERS WITHOUT CLAIM TO ANY PARTICULAR FONT, STYLE, SIZE, OR COLOR.

FOR SOAP DISPENSERS, AND DISPENSERS FOR LIQUID PERSONAL LUBRICANTS (U.S. CLS. 2, 13, 23, 29, 30, 33, 40 AND 50).

PRISCILLA MILTON, EXAMINING ATTORNEY

THE MARK CONSISTS OF STANDARD CHARACTERS WITHOUT CLAIM TO ANY PARTICULAR FONT, STYLE, SIZE, OR COLOR.

FOR SMALL ANIMAL FEEDERS; ANIMAL ACTIVATED ANIMAL FEEDERS (U.S. CLS. 2, 13, 23, 29, 30, 33, 40 AND 50).

ELLEN PERKINS, EXAMINING ATTORNEY

SN 78-464,548. GO WITH PROPANE, INC., ELMWOOD PARK, NJ. FILED 8-9-2004.

SN 78-476,133. MAITLAND-KRAFT, PHILIP, NEW YORK, NY. FILED 8-31-2004.



PRESS 'N WRAP

THE MARK CONSISTS OF A MAN'S FACE WEARING A CHEF'S HAT FLANKED BY RIGHT AND LEFT HAND IMAGES WITH A PAIR OF TONGS IN THE RIGHT HAND. THE ABOVE IMAGES AND THE LITERAL ELEMENT ARE ENCLOSED IN AN OVAL.

FOR GRILLING UTENSILS FOR BARBECUES, NAMELY FORKS, TONGS, TURNERS, BRUSHES AND SPATULAS (U.S. CLS. 2, 13, 23, 29, 30, 33, 40 AND 50).

LA TONIA FISHER, EXAMINING ATTORNEY

THE MARK CONSISTS OF STANDARD CHARACTERS WITHOUT CLAIM TO ANY PARTICULAR FONT, STYLE, SIZE, OR COLOR.

NO CLAIM IS MADE TO THE EXCLUSIVE RIGHT TO USE "PRESS", APART FROM THE MARK AS SHOWN.

FOR KITCHEN FOOD PRESS (U.S. CLS. 2, 13, 23, 29, 30, 33, 40 AND 50).

ANDREA SAUNDERS, EXAMINING ATTORNEY

CLASS 21—(Continued).

SN 78-476,329. FAMOUS HOME FASHIONS INC., PLATTSBURGH, NY. FILED 8-31-2004.

FAMOUS HOME FASHIONS

THE MARK CONSISTS OF STANDARD CHARACTERS WITHOUT CLAIM TO ANY PARTICULAR FONT, STYLE, SIZE, OR COLOR.

NO CLAIM IS MADE TO THE EXCLUSIVE RIGHT TO USE "HOME FASHIONS", APART FROM THE MARK AS SHOWN.

FOR TOOTHBRUSH HOLDERS, TOILET PAPER HOLDERS, TOWEL RODS, SHOWER CURTAIN HOOKS, SOAP DISHES, DRINKING CUPS, LOTION DISPENSERS, FACIAL TISSUE DISPENSERS, WASTE BASKETS, COTTON JARS, TOILET BRUSHES, AND CANDLE HOLDERS (U.S. CLS. 2, 13, 23, 29, 30, 33, 40 AND 50).

FIRST USE 9-1-1999; IN COMMERCE 9-1-1999.

SHARON MEIER, EXAMINING ATTORNEY

CLASS 21—(Continued).

SN 78-480,045. MILLER, DAVID W., REEDLEY, CA. FILED 9-8-2004.

PIT POPPER

THE MARK CONSISTS OF STANDARD CHARACTERS WITHOUT CLAIM TO ANY PARTICULAR FONT, STYLE, SIZE, OR COLOR.

NO CLAIM IS MADE TO THE EXCLUSIVE RIGHT TO USE PIT, APART FROM THE MARK AS SHOWN.

FOR HAND-HELD DEVICES FOR REMOVING PITS FROM FRUIT (U.S. CLS. 2, 13, 23, 29, 30, 33, 40 AND 50).

NANCY CLARKE, EXAMINING ATTORNEY

SN 78-477,348. CONVENIENCE PACKAGING COMPANY, ST. LOUIS, MO. FILED 9-1-2004.

FINGER-BRUSH

THE MARK CONSISTS OF STANDARD CHARACTERS WITHOUT CLAIM TO ANY PARTICULAR FONT, STYLE, SIZE, OR COLOR.

OWNER OF U.S. REG. NOS. 1,855,420 AND 1,868,338.

SEC. 2(F).

FOR DENTAL CLEANERS; NAMELY, A DISPOSABLE NON-WOVEN FABRIC APPLICATOR IMPREGNATED WITH DENTRIFICE FOR PLACEMENT OVER A FINGER FOR USE IN CLEANING TEETH (U.S. CLS. 2, 13, 23, 29, 30, 33, 40 AND 50).

FIRST USE 0-0-1978; IN COMMERCE 0-0-1978.

AISHA CLARKE, EXAMINING ATTORNEY

SN 78-482,806. ORAMEDIX, INC., LANCASTER, CA. FILED 9-13-2004.

OFresh

THE MARK CONSISTS OF STANDARD CHARACTERS WITHOUT CLAIM TO ANY PARTICULAR FONT, STYLE, SIZE, OR COLOR.

FOR TOOTHBRUSHES (U.S. CLS. 2, 13, 23, 29, 30, 33, 40 AND 50).

FIRST USE 3-17-1998; IN COMMERCE 3-17-1998.

JENNIFER WILLISTON, EXAMINING ATTORNEY

CLASS 21—(Continued).

SN 78-488,988. HANDI-FOIL CORPORATION, WHEELING, IL. FILED 9-24-2004.

CLASS 21—(Continued).

SN 78-492,201. DIRECT CAMPAIGNS, INC., WOODLAND HILLS, CA. FILED 9-30-2004.

PERFECT PLACEMENT

THE MARK CONSISTS OF STANDARD CHARACTERS WITHOUT CLAIM TO ANY PARTICULAR FONT, STYLE, SIZE, OR COLOR.

FOR CONTAINERS FORMED OF ALUMINUM FOIL FOR HOUSEHOLD USE (U.S. CLS. 2, 13, 23, 29, 30, 33, 40 AND 50).

CARRIE ACHEN, EXAMINING ATTORNEY

HYDRATOR

THE MARK CONSISTS OF STANDARD CHARACTERS WITHOUT CLAIM TO ANY PARTICULAR FONT, STYLE, SIZE, OR COLOR.

FOR PLASTIC BOTTLES SOLD EMPTY (U.S. CLS. 2, 13, 23, 29, 30, 33, 40 AND 50).

FIRST USE 1-28-1996; IN COMMERCE 1-28-1996.
NELSON SNYDER, EXAMINING ATTORNEY

SN 78-489,901. BRAMLAGE, MELISSA E., FORT ANN, NY. FILED 9-27-2004.

SaraBear

SN 78-492,836. CHURCH & DWIGHT COMPANY, GREEN RIVER, WY. FILED 10-1-2004.

THE MARK CONSISTS OF STANDARD CHARACTERS WITHOUT CLAIM TO ANY PARTICULAR FONT, STYLE, SIZE, OR COLOR.

FOR CADDY FOR PURPOSES OF HOLDING A BABY WIPES CONTAINER AND BABY DIAPERS (U.S. CLS. 2, 13, 23, 29, 30, 33, 40 AND 50).

LINDA ESTRADA, EXAMINING ATTORNEY

PROCARE

SN 78-491,539. TURBO TEK INTERNATIONAL, INC., LOS ANGELES, CA. FILED 9-29-2004.

TURBO POWER WASHER

THE MARK CONSISTS OF STANDARD CHARACTERS WITHOUT CLAIM TO ANY PARTICULAR FONT, STYLE, SIZE, OR COLOR.

OWNER OF U.S. REG. NO. 1,908,506.
NO CLAIM IS MADE TO THE EXCLUSIVE RIGHT TO USE "POWER WASHER", APART FROM THE MARK AS SHOWN.

FOR PRESSURE SPRAY WASHING ATTACHMENT FOR HOSES (U.S. CLS. 2, 13, 23, 29, 30, 33, 40 AND 50).
CHARLES L. JENKINS, EXAMINING ATTORNEY

THE MARK CONSISTS OF STANDARD CHARACTERS WITHOUT CLAIM TO ANY PARTICULAR FONT, STYLE, SIZE, OR COLOR.

OWNER OF U.S. REG. NO. 2,254,338.
FOR TOOTHBRUSHES (U.S. CLS. 2, 13, 23, 29, 30, 33, 40 AND 50).

FIRST USE 11-4-1997; IN COMMERCE 11-4-1997.
RUSS HERMAN, EXAMINING ATTORNEY

CLASS 21—(Continued).

SN 78-493,693. KUBALA, GARY J, MANORVILLE, NY.
FILED 10-4-2004.

CLASS 21—(Continued).

SN 78-496,965. DART CONTAINER CORPORATION, MA-
SON, MI. FILED 10-8-2004.

Cat Utopia

RPM

THE MARK CONSISTS OF STANDARD CHARACTERS
WITHOUT CLAIM TO ANY PARTICULAR FONT, STYLE,
SIZE, OR COLOR.

NO CLAIM IS MADE TO THE EXCLUSIVE RIGHT TO
USE "CAT", APART FROM THE MARK AS SHOWN.

FOR SMALL ANIMAL FEEDERS; ANIMAL ACTI-
VATED ANIMAL FEEDERS (U.S. CLS. 2, 13, 23, 29, 30,
33, 40 AND 50).

ELLEN PERKINS, EXAMINING ATTORNEY

THE MARK CONSISTS OF STANDARD CHARACTERS
WITHOUT CLAIM TO ANY PARTICULAR FONT, STYLE,
SIZE, OR COLOR.

FOR CUPS (U.S. CLS. 2, 13, 23, 29, 30, 33, 40 AND 50).
DANIEL CAPSHAW, EXAMINING ATTORNEY

SN 78-495,917. KUBALA, GARY J, MANORVILLE, NY.
FILED 10-7-2004.

SN 78-497,454. MOTHERS POLISHES WAXES CLEANERS,
HUNTINGTON BEACH, CA. FILED 10-10-2004.

CAT CATFE

POWERBALL

THE MARK CONSISTS OF STANDARD CHARACTERS
WITHOUT CLAIM TO ANY PARTICULAR FONT, STYLE,
SIZE, OR COLOR.

NO CLAIM IS MADE TO THE EXCLUSIVE RIGHT TO
USE "CAT", APART FROM THE MARK AS SHOWN.

FOR SMALL ANIMAL FEEDERS; ANIMAL ACTI-
VATED ANIMAL FEEDERS (U.S. CLS. 2, 13, 23, 29, 30,
33, 40 AND 50).

ELLEN PERKINS, EXAMINING ATTORNEY

THE MARK CONSISTS OF STANDARD CHARACTERS
WITHOUT CLAIM TO ANY PARTICULAR FONT, STYLE,
SIZE, OR COLOR.

FOR POLISHING AND SCRUBBING BRUSH ATTACH-
MENT FOR USE WITH POWER OPERATED VEHICLE
BUFFERS; AND VEHICLE SPONGE ATTACHMENT
FOR USE WITH POWER OPERATED VEHICLE BUF-
FERS (U.S. CLS. 2, 13, 23, 29, 30, 33, 40 AND 50).

FIRST USE 1-7-2005; IN COMMERCE 1-7-2005.
IRA J. GOODSaid, EXAMINING ATTORNEY

CLASS 21—(Continued).

SN 78-497,795. PATTERSON, RONALD G., SEATTLE, WA. FILED 10-11-2004.

LOC-A-PLATE

THE MARK CONSISTS OF STANDARD CHARACTERS WITHOUT CLAIM TO ANY PARTICULAR FONT, STYLE, SIZE, OR COLOR.

FOR TABLEWARE COMPRISING PLATES, DISHES, AND BEVERAGE CONTAINERS; NAMELY, GLASSES, CUPS AND RECEPTACLES WITH SCREW-ON TOPS (U.S. CLS. 2, 13, 23, 29, 30, 33, 40 AND 50).

FIRST USE 6-2-1993; IN COMMERCE 6-25-1993.
GRETTA YAO, EXAMINING ATTORNEY

SN 78-497,897. KOHN, SARAH C., ABERDEEN, NC. FILED 10-11-2004.

Liquid Luggage

THE MARK CONSISTS OF STANDARD CHARACTERS WITHOUT CLAIM TO ANY PARTICULAR FONT, STYLE, SIZE, OR COLOR.

FOR FABRIC CARRIER FOR WATER AND OTHER BEVERAGE CONTAINERS THAT ATTACHES TO LUGGAGE, STROLLERS, STATIONERY EXERCISE EQUIPMENT (U.S. CLS. 2, 13, 23, 29, 30, 33, 40 AND 50).

FIRST USE 6-0-2004; IN COMMERCE 9-0-2004.
MARK RADEMACHER, EXAMINING ATTORNEY

CLASS 21—(Continued).

SN 78-499,033. HOME CONCEPTS PRODUCTS, INC., VERNON, CA. FILED 10-13-2004.

SMARTNSERVE

THE MARK CONSISTS OF STANDARD CHARACTERS WITHOUT CLAIM TO ANY PARTICULAR FONT, STYLE, SIZE, OR COLOR.

FOR PLASTIC FOOD CONTAINERS (U.S. CLS. 2, 13, 23, 29, 30, 33, 40 AND 50).

FIRST USE 3-1-2004; IN COMMERCE 3-1-2004.
PATRICIA EVANKO, EXAMINING ATTORNEY

SN 78-499,313. FIESTA PRODUCTS LLC, CLARK, NJ. FILED 10-13-2004.



FOR ROLLING PIN (U.S. CLS. 2, 13, 23, 29, 30, 33, 40 AND 50).

FIRST USE 7-20-2004; IN COMMERCE 7-20-2004.
SALLY SHIH, EXAMINING ATTORNEY

SN 78-502,163. RUBBERMAID COMMERCIAL PRODUCTS LLC, FREEPORT, IL. FILED 10-19-2004.

RANGER

THE MARK CONSISTS OF STANDARD CHARACTERS WITHOUT CLAIM TO ANY PARTICULAR FONT, STYLE, SIZE, OR COLOR.

FOR MOLDED PLASTIC WASTE CONTAINER HAVING COVERS WITH ACCESS DOORS (U.S. CLS. 2, 13, 23, 29, 30, 33, 40 AND 50).

FIRST USE 1-3-1978; IN COMMERCE 1-3-1978.
DANIEL CAPSHAW, EXAMINING ATTORNEY

CLASS 21—(Continued).

SN 78-503,463. THE EVERCARE COMPANY, ALPHARETTA, GA. FILED 10-21-2004.

SWEEP 'N STORE

THE MARK CONSISTS OF STANDARD CHARACTERS WITHOUT CLAIM TO ANY PARTICULAR FONT, STYLE, SIZE, OR COLOR.

FOR BROOMS (U.S. CLS. 2, 13, 23, 29, 30, 33, 40 AND 50).

FIRST USE 12-30-2004; IN COMMERCE 12-30-2004.
YONG KIM, EXAMINING ATTORNEY

SN 78-507,094. QUICKIE MANUFACTURING CORPORATION, CINNAMINSON, NJ. FILED 10-27-2004.

SUPER POWER PUSH

THE MARK CONSISTS OF STANDARD CHARACTERS WITHOUT CLAIM TO ANY PARTICULAR FONT, STYLE, SIZE, OR COLOR.

FOR PUSHBROOMS (U.S. CLS. 2, 13, 23, 29, 30, 33, 40 AND 50).

FIRST USE 3-0-2003; IN COMMERCE 3-0-2003.
MARTHA FROMM, EXAMINING ATTORNEY

SN 78-509,232. MEDITERRANEAN TRADE LLC, BALTIMORE, MD. FILED 11-1-2004.



THE COLORS RED AND GREEN ARE CLAIMED AS A FEATURE OF THE MARK.

THE MARK CONSISTS OF THE WORD DUO IN RED AND THE LETTER D IN THE COLOR GREEN TRANSPARENT OVER THE LETTER D IN THE MARK.

FOR PLASTIC CONTAINER FOR DISPENSING OIL AND VINEGAR (U.S. CLS. 2, 13, 23, 29, 30, 33, 40 AND 50).

DAHLIA GEORGE, EXAMINING ATTORNEY

CLASS 21—(Continued).

SN 78-515,351. KLOTZ, DONALD, LARGO, FL. FILED 11-11-2004.

GLASCAR

THE MARK CONSISTS OF STANDARD CHARACTERS WITHOUT CLAIM TO ANY PARTICULAR FONT, STYLE, SIZE, OR COLOR.

FOR PLASTIC AND METAL BEVERAGE COASTER WITH WHEELS (U.S. CLS. 2, 13, 23, 29, 30, 33, 40 AND 50).

FIRST USE 1-1-2003; IN COMMERCE 1-1-2003.
AMY GEARIN, EXAMINING ATTORNEY

SN 78-515,836. THE GILLETTE COMPANY, BOSTON, MA. FILED 11-12-2004.

**SMART
TECHNOLOGY...
BRILLIANT RESULTS**

THE MARK CONSISTS OF STANDARD CHARACTERS WITHOUT CLAIM TO ANY PARTICULAR FONT, STYLE, SIZE, OR COLOR.

NO CLAIM IS MADE TO THE EXCLUSIVE RIGHT TO USE "SMART TECHNOLOGY", APART FROM THE MARK AS SHOWN.

FOR TOOTHBRUSHES AND REPLACEMENT BRUSH-HEADS FOR TOOTHBRUSHES (U.S. CLS. 2, 13, 23, 29, 30, 33, 40 AND 50).

JAMES A. RAUEN, EXAMINING ATTORNEY

CLASS 21—(Continued).

SN 78-516,154. KIERAN, JANET, MARLBOROUGH, MA. FILED 11-12-2004.

CLASS 21—(Continued).

SN 78-518,495. KRAFT FOODS HOLDINGS, INC., NORTH-FIELD, IL. FILED 11-17-2004.

Diaper Dress

MILK-BONE

THE MARK CONSISTS OF STANDARD CHARACTERS WITHOUT CLAIM TO ANY PARTICULAR FONT, STYLE, SIZE, OR COLOR.

NO CLAIM IS MADE TO THE EXCLUSIVE RIGHT TO USE "DIAPER", APART FROM THE MARK AS SHOWN.

FOR FITTED FABRIC COVERS FOR DIAPER PAILS (U.S. CLS. 2, 13, 23, 29, 30, 33, 40 AND 50).

FIRST USE 8-1-2004; IN COMMERCE 8-1-2004.
YSA DEJESUS, EXAMINING ATTORNEY

THE MARK CONSISTS OF STANDARD CHARACTERS WITHOUT CLAIM TO ANY PARTICULAR FONT, STYLE, SIZE, OR COLOR.

OWNER OF U.S. REG. NOS. 72,501 AND 2,534,344. FOR PET BOWLS, BRUSHES AND COMBS (U.S. CLS. 2, 13, 23, 29, 30, 33, 40 AND 50).

DAVID MURRAY, EXAMINING ATTORNEY

SN 78-521,490. WINN, BRIAN J., MILL CREEK, WA. FILED 11-23-2004.

SN 78-517,874. UNIVERSAL STUDIOS WATER PARKS FLORIDA LLC, ORLANDO, FL. FILED 11-16-2004.



EraseAll

THE MARK CONSISTS OF THE WORDING DISCO H2O SET AGAINST A BACKGROUND THAT CONSISTS OF A GROOVED PHONOGRAPH RECORD SURROUNDED BY BUBBLES.

FOR GLASSWARE AND EARTHENWARE, NAMELY, DRINKING GLASSES AND COFFEE MUGS (U.S. CLS. 2, 13, 23, 29, 30, 33, 40 AND 50).

TANYA AMOS, EXAMINING ATTORNEY

THE MARK CONSISTS OF STANDARD CHARACTERS WITHOUT CLAIM TO ANY PARTICULAR FONT, STYLE, SIZE, OR COLOR.

FOR HOUSEHOLD CLEANING PADS (U.S. CLS. 2, 13, 23, 29, 30, 33, 40 AND 50).

JENNIFER CHICOSKI, EXAMINING ATTORNEY

CLASS 21—(Continued).

SN 78-525,972. PROVEEDORA MEXICANA DE MONOFILAMENTOS, S.A. DE C.V., DELEG. IZTACALCO ME 08500 D.F., MEXICO, FILED 12-2-2004.

CLASS 21—(Continued).

SN 78-534,673. THE WINE ENTHUSIAST, INC., ELMSFORD, NY. FILED 12-17-2004.

THE BRIGHT CHOICE

Legacy Opener

THE MARK CONSISTS OF STANDARD CHARACTERS WITHOUT CLAIM TO ANY PARTICULAR FONT, STYLE, SIZE, OR COLOR.
FOR MONOFILAMENTS FOR USE IN MAKING BRUSHES (U.S. CLS. 2, 13, 23, 29, 30, 33, 40 AND 50).
DORITT L. CARROLL, EXAMINING ATTORNEY

THE MARK CONSISTS OF STANDARD CHARACTERS WITHOUT CLAIM TO ANY PARTICULAR FONT, STYLE, SIZE, OR COLOR.
NO CLAIM IS MADE TO THE EXCLUSIVE RIGHT TO USE "OPENER", APART FROM THE MARK AS SHOWN.
FOR COMBINATION WINE BOTTLE OPENER AND RECORKING APPARATUS (U.S. CLS. 2, 13, 23, 29, 30, 33, 40 AND 50).
FIRST USE 8-30-2004; IN COMMERCE 8-30-2004.
EUGENIA MARTIN, EXAMINING ATTORNEY

SN 78-530,792. HOMER TLC, INC., CLAYMONT, DE. FILED 12-10-2004.

SN 78-537,479. EXPERIENCE LEARNING COMMUNITY, SEATTLE, WA. FILED 12-22-2004.

TrafficMaster



THE MARK CONSISTS OF STANDARD CHARACTERS WITHOUT CLAIM TO ANY PARTICULAR FONT, STYLE, SIZE, OR COLOR.
OWNER OF U.S. REG. NOS. 2,321,766 AND 2,730,350.
FOR PLASTIC BUCKETS (U.S. CLS. 2, 13, 23, 29, 30, 33, 40 AND 50).
WON TEAK OH, EXAMINING ATTORNEY

THE MARK CONSISTS OF A THREE-LEGGED, WINGED CREATURE CENTERED OVER THE STYLIZED LETTERS SFM.
FOR DRINKING GLASSES, DISHES, COFFEE CUPS, MUGS, THERMAL INSULATED DRINKING GLASSES, AND EMPTY PLASTIC WATER BOTTLES (U.S. CLS. 2, 13, 23, 29, 30, 33, 40 AND 50).
FIRST USE 6-18-2004; IN COMMERCE 6-18-2004.
ROBERT LORENZO, EXAMINING ATTORNEY

CLASS 21—(Continued).

SN 78-537,482. EXPERIENCE LEARNING COMMUNITY, SEATTLE, WA. FILED 12-22-2004.

CLASS 21—(Continued).

SN 78-539,689. GUDEBROD, INC., POTTSTOWN, PA. FILED 12-29-2004.

SCIENCE FICTION
MUSEUM AND HALL
OF FAME

CHAMPION

THE MARK CONSISTS OF STANDARD CHARACTERS WITHOUT CLAIM TO ANY PARTICULAR FONT, STYLE, SIZE, OR COLOR.

FOR DRINKING GLASSES, DISHES, COFFEE CUPS, MUGS, THERMAL INSULATED DRINKING GLASSES, AND EMPTY PLASTIC WATER BOTTLES (U.S. CLS. 2, 13, 23, 29, 30, 33, 40 AND 50).

FIRST USE 6-18-2004; IN COMMERCE 6-18-2004.
ROBERT LORENZO, EXAMINING ATTORNEY

THE MARK CONSISTS OF STANDARD CHARACTERS WITHOUT CLAIM TO ANY PARTICULAR FONT, STYLE, SIZE, OR COLOR.

FOR DENTAL FLOSS (U.S. CLS. 2, 13, 23, 29, 30, 33, 40 AND 50).

FIRST USE 1-1-1939; IN COMMERCE 1-1-1939.
WON TEAK OH, EXAMINING ATTORNEY

SN 78-538,730. ADAGIO TEAS, CLIFTON, NJ. FILED 12-27-2004.

SN 78-539,705. WINPAK PORTION PACKAGING LTD., TORONTO, ONTARIO, CANADA, FILED 12-29-2004.

ingenuiTEA

CHEERS

THE MARK CONSISTS OF STANDARD CHARACTERS WITHOUT CLAIM TO ANY PARTICULAR FONT, STYLE, SIZE, OR COLOR.

FOR TEA POTS NOT OF PRECIOUS METAL (U.S. CLS. 2, 13, 23, 29, 30, 33, 40 AND 50).

FIRST USE 3-1-2004; IN COMMERCE 3-1-2004.
ALLISON SCHRODY, EXAMINING ATTORNEY

THE MARK CONSISTS OF STANDARD CHARACTERS WITHOUT CLAIM TO ANY PARTICULAR FONT, STYLE, SIZE, OR COLOR.

FOR DISPOSABLE CUPS; PLASTIC AND PAPER DISPOSABLE TABLEWARE, NAMELY, PLATES, CUPS, TUMBLERS, AND BOWLS (U.S. CLS. 2, 13, 23, 29, 30, 33, 40 AND 50).

FIRST USE 3-0-1993; IN COMMERCE 3-0-1993.
AMY GEARIN, EXAMINING ATTORNEY

CLASS 21—(Continued).

SN 79-001,439. HAGER & WERKEN GMBH & CO. KG, FED REP GERMANY, FILED 1-23-2004.

Infant-O-Brush

THE MARK CONSISTS OF STANDARD CHARACTERS WITHOUT CLAIM TO ANY PARTICULAR FONT, STYLE, SIZE, OR COLOR.

PRIORITY DATE OF 10-30-2003 IS CLAIMED.

OWNER OF INTERNATIONAL REGISTRATION 0820782 DATED 1-23-2004, EXPIRES 1-23-2014.

FOR TOOTHBRUSHES (U.S. CLS. 2, 13, 23, 29, 30, 33, 40 AND 50).

RICHARD WHITE, EXAMINING ATTORNEY

CLASS 22—CORDAGE AND FIBERS

SN 76-455,447. SWANKY PET, INC., CHICAGO, IL. FILED 10-3-2002.

SWANKY PET

NO CLAIM IS MADE TO THE EXCLUSIVE RIGHT TO USE "PET", APART FROM THE MARK AS SHOWN.

FOR PLAYHOUSES FOR PETS, NAMELY, DECORATIVE TENT PET SHELTERS FOR USE BY DOMESTIC PETS (U.S. CLS. 1, 2, 7, 19, 22, 42 AND 50).

FIRST USE 10-4-2002; IN COMMERCE 10-4-2002.

ROBERT C. CLARK JR., EXAMINING ATTORNEY

SN 76-573,222. DALTON MOUNTAIN GEAR, LLC, TELLURIDE, CO. FILED 1-30-2004.



THE MARK CONSISTS OF THE CHINESE CHARACTER KNOWN AS "TAO" OR "DAO". THIS CHARACTER IS MADE UP OF THE CHARACTER FOR "GO FORWARD" AND THE CHARACTER FOR "HEAD", TO CONVEY THE IDEA THAT YOUR HEAD CHOOSES A PATH ON WHICH TO GO FORWARD.

THE TRANSLATION OF THE CHINESE CHARACTER "TAO" OR "DAO" IS GENERALLY "PATH" OR "WAY".

FOR TENTS FOR MOUNTAINEERING OR CAMPING; CANVAS TARPULINS; TENT CORDS; TENT FLIES; CAMPING EQUIPMENT, NAMELY, GROUND CLOTHS, TENT STORAGE BAGS, TENT POLE STORAGE SACKS (U.S. CLS. 1, 2, 7, 19, 22, 42 AND 50).

PAULA MAYS, EXAMINING ATTORNEY

CLASS 22—(Continued).

SN 76-589,525. GLOBAL STRATEGIES, INC., SOUTH BOSTON, MA. FILED 4-30-2004.

DEMO BAGS

THE MARK CONSISTS OF STANDARD CHARACTERS WITHOUT CLAIM TO ANY PARTICULAR FONT, STYLE, SIZE, OR COLOR.

NO CLAIM IS MADE TO THE EXCLUSIVE RIGHT TO USE "BAGS", APART FROM THE MARK AS SHOWN.

FOR HEAVY-DUTY BAGS FOR DISPOSAL OF BUILDING MATERIALS AND REFUSE (U.S. CLS. 1, 2, 7, 19, 22, 42 AND 50).

FIRST USE 11-11-1996; IN COMMERCE 11-11-1996.

DARRYL SPRUILL, EXAMINING ATTORNEY

SN 76-597,149. L&P PROPERTY MANAGEMENT COMPANY, SOUTH GATE, CA. FILED 6-14-2004.

FIBERLOFT

THE MARK CONSISTS OF STANDARD CHARACTERS WITHOUT CLAIM TO ANY PARTICULAR FONT, STYLE, SIZE, OR COLOR.

SEC. 2(F).

FOR POLYESTER STUFFING (U.S. CLS. 1, 2, 7, 19, 22, 42 AND 50).

FIRST USE 3-7-1955; IN COMMERCE 3-11-1955.

JOHN DWYER, EXAMINING ATTORNEY

SN 76-614,331. STANLEY, DAVID J., COLORADO SPRINGS, CO. FILED 10-1-2004.

VATTS

THE MARK CONSISTS OF STANDARD CHARACTERS WITHOUT CLAIM TO ANY PARTICULAR FONT, STYLE, SIZE, OR COLOR.

FOR TIE DOWN STRAPS (U.S. CLS. 1, 2, 7, 19, 22, 42 AND 50).

FIRST USE 11-1-2002; IN COMMERCE 2-1-2003.

ZACHARY BELLO, EXAMINING ATTORNEY

CLASS 22—(Continued).

SN 76-621,871. ANCHOR INDUSTRIES INC., EVANSVILLE, IN. FILED 11-23-2004.

MILTRAC

THE MARK CONSISTS OF STANDARD CHARACTERS WITHOUT CLAIM TO ANY PARTICULAR FONT, STYLE, SIZE, OR COLOR.

OWNER OF U.S. REG. NO. 2,677,823.
FOR MODULAR, CHANNELED FRAME CANOPIES, NAMELY, CANOPIES FOR OUTDOOR USE, AND TENTS, PRIMARILY FOR MILITARY PURPOSES (U.S. CLS. 1, 2, 7, 19, 22, 42 AND 50).
FIRST USE 2-1-2003; IN COMMERCE 2-1-2003.
ALLISON SCHRODY, EXAMINING ATTORNEY

SN 78-297,394. TUNTEX (THAILAND) PUBLIC COMPANY LIMITED, BANGKOK, THAILAND, FILED 9-8-2003.



PRIORITY CLAIMED UNDER SEC. 44(D) ON THAILAND APPLICATION NO. 513827, FILED 3-19-2003, REG. NO. KOR190983, DATED 3-19-2003, EXPIRES 3-18-2013.
FOR POLYESTER SYNTHETIC FIBERS FOR TEXTILE USE (U.S. CLS. 1, 2, 7, 19, 22, 42 AND 50).
CATHERINE CAIN, EXAMINING ATTORNEY

SN 78-297,397. TUNTEX (THAILAND) PUBLIC COMPANY LIMITED, BANGKOK, THAILAND, FILED 9-8-2003.

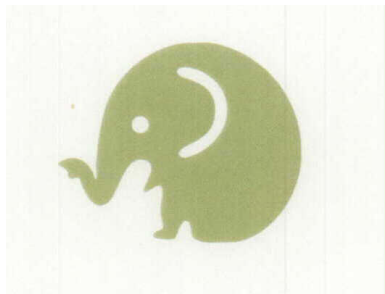

PRIORITY CLAIMED UNDER SEC. 44(D) ON THAILAND APPLICATION NO. 513828, FILED 3-19-2003, REG. NO. KOR190984, DATED 3-19-2003, EXPIRES 3-18-2013.
THE COLOR GREEN IS CLAIMED AS A FEATURE OF THE MARK.
THE COLOR GREEN APPEARS IN ALL PORTIONS OF THE MARK.
FOR POLYESTER SYNTHETIC FIBERS FOR TEXTILE USE (U.S. CLS. 1, 2, 7, 19, 22, 42 AND 50).
CATHERINE CAIN, EXAMINING ATTORNEY

CLASS 22—(Continued).

SN 78-376,249. KEEPER CORPORATION, NORTH WINDHAM, CT. FILED 3-1-2004.

KEEPER

THE MARK CONSISTS OF STANDARD CHARACTERS WITHOUT CLAIM TO ANY PARTICULAR FONT, STYLE, SIZE, OR COLOR.

OWNER OF U.S. REG. NOS. 2,090,413, 2,106,212 AND 2,332,560.
FOR STRAPS FOR TOWING AND DEVICES FOR HANDLING, SECURING AND STOWING CARGO, NAMELY, CARGO-SECURING NETS AND TIE-DOWN, LOAD-HANDLING, BUNDLE-SECURING, STRETCH AND ALL-PURPOSE STRAPS (U.S. CLS. 1, 2, 7, 19, 22, 42 AND 50).

FIRST USE 10-0-1979; IN COMMERCE 10-0-1979.
CHERYL STEPLIGHT, EXAMINING ATTORNEY

SN 78-402,539. TRIOSYN HOLDING INC., MIRABEL, QUEBEC, CANADA, FILED 4-15-2004.

LIFEPOD

THE MARK CONSISTS OF STANDARD CHARACTERS WITHOUT CLAIM TO ANY PARTICULAR FONT, STYLE, SIZE, OR COLOR.

PRIORITY CLAIMED UNDER SEC. 44(D) ON CANADA APPLICATION NO. 1201075, FILED 12-31-2003.
FOR TENTS AND OTHER COLLAPSIBLE SELF-CONTAINED SHELTERS MADE OF FABRIC AND OFFERING PROTECTION AGAINST CERTAIN MICROORGANISMS AND CHEMICAL AGENTS (U.S. CLS. 1, 2, 7, 19, 22, 42 AND 50).
SEAN DWYER, EXAMINING ATTORNEY

CLASS 22—(Continued).

SN 78-447,479. PATTEE, DANIEL P., FLUSHING, MI. FILED 7-8-2004.

CLASS 22—(Continued).

SN 78-499,891. ALLIANCE TRADING, INC., COVINGTON, LA. FILED 10-14-2004.

TAKE 'EM BACK

THE MARK CONSISTS OF STANDARD CHARACTERS WITHOUT CLAIM TO ANY PARTICULAR FONT, STYLE, SIZE, OR COLOR.

FOR WEBBED MESH BAGS FOR STORAGE, NAMELY, CARRYING PLURALITIES OF BOTTLES AND CANS (U.S. CLS. 1, 2, 7, 19, 22, 42 AND 50).

FIRST USE 10-17-2002; IN COMMERCE 10-17-2002.
YSA DEJESUS, EXAMINING ATTORNEY

da Vinci

THE MARK CONSISTS OF STANDARD CHARACTERS WITHOUT CLAIM TO ANY PARTICULAR FONT, STYLE, SIZE, OR COLOR.

FOR STANDARD AND CUSTOM FIT VINYL LINERS FOR IN-GROUND POOLS (U.S. CLS. 1, 2, 7, 19, 22, 42 AND 50).

FIRST USE 3-31-1998; IN COMMERCE 3-31-1998.
LINDA POWELL, EXAMINING ATTORNEY

SN 78-499,889. ALLIANCE TRADING, INC., COVINGTON, LA. FILED 10-14-2004.

SN 78-503,135. FACTORY DIRECT LINERS, INC., ATLANTA, GA. FILED 10-20-2004.

Cavalry

Spartan

THE MARK CONSISTS OF STANDARD CHARACTERS WITHOUT CLAIM TO ANY PARTICULAR FONT, STYLE, SIZE, OR COLOR.

FOR STANDARD AND CUSTOM FIT VINYL LINERS FOR IN-GROUND POOLS (U.S. CLS. 1, 2, 7, 19, 22, 42 AND 50).

FIRST USE 4-30-2001; IN COMMERCE 4-30-2001.
LINDA POWELL, EXAMINING ATTORNEY

THE MARK CONSISTS OF STANDARD CHARACTERS WITHOUT CLAIM TO ANY PARTICULAR FONT, STYLE, SIZE, OR COLOR.

FOR VINYL POOL LINERS (U.S. CLS. 1, 2, 7, 19, 22, 42 AND 50).

FIRST USE 10-21-2004; IN COMMERCE 10-21-2004.
WENDY GOODMAN, EXAMINING ATTORNEY

CLASS 22—(Continued).

SN 78-530,796. HOMER TLC, INC., CLAYMONT, DE. FILED 12-10-2004.

CLASS 22—(Continued).

SN 78-540,188. SHAPPELL CORPORATION, GRAND LEDGE, MI. FILED 12-30-2004.

TrafficMaster

ROVER

THE MARK CONSISTS OF STANDARD CHARACTERS WITHOUT CLAIM TO ANY PARTICULAR FONT, STYLE, SIZE, OR COLOR.
OWNER OF U.S. REG. NOS. 2,321,766 AND 2,730,350.
FOR TARPAULINS (U.S. CLS. 1, 2, 7, 19, 22, 42 AND 50).
WON TEAK OH, EXAMINING ATTORNEY

THE MARK CONSISTS OF STANDARD CHARACTERS WITHOUT CLAIM TO ANY PARTICULAR FONT, STYLE, SIZE, OR COLOR.
FOR ICE FISHING TENTS (U.S. CLS. 1, 2, 7, 19, 22, 42 AND 50).
FIRST USE 5-20-1999; IN COMMERCE 10-7-1999.
NICHOLAS ALTREE, EXAMINING ATTORNEY

CLASS 23—YARNS AND THREADS

SN 78-535,988. HOMER TLC, INC., CLAYMONT, DE. FILED 12-21-2004.

SN 78-442,375. SPECTRUM YARNS LTD, WEST YORKSHIRE, UNITED KINGDOM, FILED 6-28-2004.

DESIGN VIEW

SPIROL

THE MARK CONSISTS OF STANDARD CHARACTERS WITHOUT CLAIM TO ANY PARTICULAR FONT, STYLE, SIZE, OR COLOR.
OWNER OF U.S. REG. NO. 2,432,129.
FOR DROP CLOTHS AND TARPS (U.S. CLS. 1, 2, 7, 19, 22, 42 AND 50).
REBECCA GILBERT, EXAMINING ATTORNEY

THE MARK CONSISTS OF STANDARD CHARACTERS WITHOUT CLAIM TO ANY PARTICULAR FONT, STYLE, SIZE, OR COLOR.
OWNER OF UNITED KINGDOM REG. NO. 2195021,
DATED 4-20-1999, EXPIRES 4-20-2009.
FOR YARNS AND THREADS (U.S. CL. 43).
CYNTHIA SLOAN, EXAMINING ATTORNEY

CLASS 23—(Continued).

SN 78-444,099. TWISTED SISTERS, ESCONDIDO, CA. FILED 6-30-2004.



FOR YARNS AND THREAD FOR TEXTILE USE, NAMELY, KNITTING YARN (U.S. CL. 43). FIRST USE 6-20-2001; IN COMMERCE 6-20-2001. MARY BOAGNI, EXAMINING ATTORNEY

SN 78-512,232. J. & P. COATS, LIMITED, GLASGOW, SCOTLAND, UNITED KINGDOM, FILED 11-5-2004.

TECNO HAIR ORO

THE MARK CONSISTS OF STANDARD CHARACTERS WITHOUT CLAIM TO ANY PARTICULAR FONT, STYLE, SIZE, OR COLOR.

NO CLAIM IS MADE TO THE EXCLUSIVE RIGHT TO USE "HAIR ORO", APART FROM THE MARK AS SHOWN. THE ENGLISH TRANSLATION OF "ORO" IS "GOLD." FOR HANDKNITTING YARNS (U.S. CL. 43). ALICE SUE CARRUTHERS, EXAMINING ATTORNEY

SN 78-512,992. J. & P. COATS, LIMITED, GLASGOW, SCOTLAND, FILED 11-8-2004.

TECNO HAIR

THE MARK CONSISTS OF STANDARD CHARACTERS WITHOUT CLAIM TO ANY PARTICULAR FONT, STYLE, SIZE, OR COLOR.

NO CLAIM IS MADE TO THE EXCLUSIVE RIGHT TO USE "HAIR", APART FROM THE MARK AS SHOWN. FOR HANDKNITTING YARNS (U.S. CL. 43). FIRST USE 7-31-2000; IN COMMERCE 7-31-2000. ALICE SUE CARRUTHERS, EXAMINING ATTORNEY

CLASS 23—(Continued).

SN 78-528,346. J. & P. COATS, LIMITED, GLASGOW, SCOTLAND, FILED 12-7-2004.

CHERI

THE MARK CONSISTS OF STANDARD CHARACTERS WITHOUT CLAIM TO ANY PARTICULAR FONT, STYLE, SIZE, OR COLOR.

FOR HANDKNITTING YARNS (U.S. CL. 43). MATTHEW PAPPAS, EXAMINING ATTORNEY

CLASS 24—FABRICS

SN 76-106,335. ISLAND INTERIORS, FOX ISLAND, WA. FILED 8-10-2000.

BEDBUGS

FOR CHILDREN'S PILLOW CASES (U.S. CLS. 42 AND 50).

FIRST USE 12-6-1999; IN COMMERCE 12-6-1999. MICHAEL KAZAZIAN, EXAMINING ATTORNEY

SN 76-407,346. J.L.M. ACCESSORIES LTD., BURLINGTON, ONTARIO, CANADA, FILED 5-13-2002.

GRAVITAC

PRIORITY CLAIMED UNDER SEC. 44(D) ON CANADA APPLICATION NO. 1122764, FILED 11-20-2001, REG. NO. TMA625,146, DATED 11-9-2004, EXPIRES 11-9-2019.

FOR NON-SLIP MATERIAL, NAMELY PVC COATED SCRIM FABRIC MADE OF POLYESTER (U.S. CLS. 42 AND 50).

SAMUEL E. SHARPER JR., EXAMINING ATTORNEY

CLASS 24—(Continued).

SN 76-547,683. GATTEN, MICHAEL D., MEDFORD, OR. FILED 9-22-2003.

MIRACLE BLANKET

NO CLAIM IS MADE TO THE EXCLUSIVE RIGHT TO USE "BLANKET", APART FROM THE MARK AS SHOWN. FOR FABRIC BLANKET SPECIFICALLY DESIGNED TO WRAP OR SWADDLE BABIES 0-4 MONTHS OF AGE (U.S. CLS. 42 AND 50). FIRST USE 5-1-2002; IN COMMERCE 5-1-2002. SCOTT OSLUCK, EXAMINING ATTORNEY

SN 76-581,430. LINQ INDUSTRIAL FABRICS, INC., SUMMERVILLE, SC. FILED 3-17-2004.

CROHMIQ BLUE

THE MARK CONSISTS OF STANDARD CHARACTERS WITHOUT CLAIM TO ANY PARTICULAR FONT, STYLE, SIZE, OR COLOR. OWNER OF U.S. REG. NO. 2,027,642. SEC. 2(F) AS TO "BLUE". FOR POLYPROPYLENE FABRICS FOR INDUSTRIAL USE (U.S. CLS. 42 AND 50). FIRST USE 0-0-1995; IN COMMERCE 0-0-1995. DOUGLAS LEE, EXAMINING ATTORNEY

SN 76-588,115. DISNEY ENTERPRISES, INC., BURBANK, CA. FILED 4-19-2004.



OWNER OF U.S. REG. NO. 2,700,619. FOR TEXTILE ARTICLES, NAMELY, CURTAINS, NAPKINS, TABLE CLOTHS, HANDKERCHIEFS; BATH LINEN; TABLE LINEN; BED LINEN; HOUSEHOLD LINEN; KITCHEN LINEN; TOWELS; KITCHEN TOWELS; WASHCLOTHS; BEDDING, NAMELY, BED BLANKETS, BED SHEETS, BED SKIRTS, BED SPREADS, CRIB BUMPERS, COMFORTERS, QUILTS, PILLOW CASES AND UNFITTED FURNITURE COVERS (U.S. CLS. 42 AND 50). WILLIAM BRECKENFELD, EXAMINING ATTORNEY

CLASS 24—(Continued).

SN 76-588,132. DISNEY ENTERPRISES, INC., BURBANK, CA. FILED 4-19-2004.



FOR TEXTILE ARTICLES, NAMELY, CURTAINS, NAPKINS, TABLE CLOTHS, HANDKERCHIEFS; BATH LINEN; TABLE LINEN; BED LINEN; HOUSEHOLD LINEN; KITCHEN LINEN; TOWELS; KITCHEN TOWELS; WASHCLOTHS; BEDDING, NAMELY, BED BLANKETS, BED SHEETS, BED SKIRTS, BED SPREADS, CRIB BUMPERS, COMFORTERS, QUILTS, PILLOW CASES AND UNFITTED FURNITURE COVERS (U.S. CLS. 42 AND 50). WILLIAM BRECKENFELD, EXAMINING ATTORNEY

SN 76-608,439. D-GENERATION, INC., ORMOND BEACH, FL. FILED 8-24-2004.



THE MARK CONSISTS OF STANDARD CHARACTERS WITHOUT CLAIM TO ANY PARTICULAR FONT, STYLE, SIZE, OR COLOR. OWNER OF U.S. REG. NOS. 2,623,997, 2,753,876 AND OTHERS. FOR TEXTILES AND TEXTILE GOODS, NAMELY—QUILTS; BED BLANKETS; TABLE LINENS; COUCH COVERS; PILLOW CASE COVERS; BATH LINENS OTHER THAN CLOTHING; TOWELS; BED COVERS; BED SHEETS; SHOWER CURTAINS (U.S. CLS. 42 AND 50). FIRST USE 8-23-2004; IN COMMERCE 8-23-2004. DANIEL BRODY, EXAMINING ATTORNEY

CLASS 24—(Continued).

SN 78-161,616. CABELA'S, INC, SIDNEY, NE. FILED 9-6-2002.

SECLUSION 3D

FOR TEXTILE CAMOUFLAGE FABRIC FOR THE MANUFACTURE OF CLOTHING (U.S. CLS. 42 AND 50). FIRST USE 6-17-2002; IN COMMERCE 6-17-2002. WON TEAK OH, EXAMINING ATTORNEY

SN 78-312,469. JONES STUDIO LTD., STATEN ISLAND, NY. FILED 10-11-2003.

NO CLAIM IS MADE TO THE EXCLUSIVE RIGHT TO USE CALIFORNIA, APART FROM THE MARK AS SHOWN. FOR FABRICS FOR UPHOLSTERY AND DRAPERIES (U.S. CLS. 42 AND 50).

FIRST USE 4-1-2002; IN COMMERCE 4-1-2002. JANICE L. MCMORROW, EXAMINING ATTORNEY

SN 78-318,927. SAMUELSON LIMITED/SAMUELSON LIMITEE, QUEBEC, CANADA, FILED 10-27-2003.

THE TWEEDSDALE COLLECTION

THE MARK CONSISTS OF STANDARD CHARACTERS WITHOUT CLAIM TO ANY PARTICULAR FONT, STYLE, SIZE, OR COLOR.

PRIORITY CLAIMED UNDER SEC. 44(D) ON CANADA APPLICATION NO. 1194427, FILED 10-22-2003, REG. NO. TMA628097, DATED 12-9-2004, EXPIRES 12-9-2019.

NO CLAIM IS MADE TO THE EXCLUSIVE RIGHT TO USE "COLLECTION", APART FROM THE MARK AS SHOWN.

FOR FABRICS TO BE USED IN THE MANUFACTURE OF WEARING APPAREL (U.S. CLS. 42 AND 50). DORITT L. CARROLL, EXAMINING ATTORNEY

CLASS 24—(Continued).

SN 78-367,790. WARREN WIMBROW, LLC, COTO DE CAZA, CA. FILED 2-13-2004.

SPECTATORSWRAP

THE MARK CONSISTS OF STANDARD CHARACTERS WITHOUT CLAIM TO ANY PARTICULAR FONT, STYLE, SIZE, OR COLOR.

FOR BLANKET THROWS, NAMELY A WEATHER-PROOF BLANKET THAT FASTENS AROUND THE WAIST; RELATED ACCESSORIES, NAMELY A CARRY STRAP (U.S. CLS. 42 AND 50).

RONALD AIKENS, EXAMINING ATTORNEY

SN 78-378,748. NICHOLS, SUSAN, SANTA MONICA, CA. FILED 3-4-2004.



SKIDLESS
by yogitoes

NO CLAIM IS MADE TO THE EXCLUSIVE RIGHT TO USE "A TOWEL DESIGNED ESPECIALLY FOR YOUR YOGA MAT. THE FIRST HIGHLY ABSORBENT MICROFIBER TOWEL WITH NUBS THAT PROVIDE TRACTION USED IN REVERSE. THE NUBS STIMULATE PRESSURE POINTS ON YOUR HANDS AND FEET. EASY TO CARE FOR. JUST MACHINE WASH WITH LIKE COLORS AND TUMBLE DRY. PATENT PENDING. SKIDLESS BY YOGITOES. MAT SIZE 24" X 68".", APART FROM THE MARK AS SHOWN.

THE COLOR ORANGE IS CLAIMED AS A FEATURE OF THE MARK.

THE MARK CONSISTS OF AN ORANGE CIRCLE WITH WORDS "WELCOME TO THE SKIDLESS TOWEL BY YOGITOES. A TOWEL DESIGNED ESPECIALLY FOR YOUR YOGA MAT. THE FIRST HIGHLY ABSORBENT MICROFIBER TOWEL WITH NUBS THAT PROVIDE TRACTION USED IN REVERSE. THE NUBS STIMULATE PRESSURE POINTS ON YOUR HANDS AND FEET. EASY TO CARE FOR. JUST MACHINE WASH WITH LIKE COLORS AND TUMBLE DRY. PATENT PENDING SKIDLESS BY YOGITOES. MAT SIZE 24" X 68". WWW.YOGITOES.COM", FOLLOWED BY "SKIDLESS BY YOGITOES" BENEATH THE ORANGE CIRCLE.

FOR TOWELS, CLOTHING AND TEXTILE FABRICS USED IN THE MANUFACTURE OF TOWELS AND CLOTHING (U.S. CLS. 42 AND 50).

FIRST USE 8-1-2003; IN COMMERCE 12-1-2003. TRACY CROSS, EXAMINING ATTORNEY

CLASS 24—(Continued).

SN 78-393,772. MILLIKEN & COMPANY, SPARTANBURG, SC. FILED 3-31-2004.

ANOTHER SMART
FABRIC BY MILLIKEN

THE MARK CONSISTS OF STANDARD CHARACTERS WITHOUT CLAIM TO ANY PARTICULAR FONT, STYLE, SIZE, OR COLOR.

OWNER OF U.S. REG. NOS. 908,674, 1,710,105 AND OTHERS.

NO CLAIM IS MADE TO THE EXCLUSIVE RIGHT TO USE SMART FABRIC, APART FROM THE MARK AS SHOWN.

FOR TEXTILE FABRICS MADE OF COTTON AND SYNTHETIC FIBERS AND COMBINATIONS THEREOF (U.S. CLS. 42 AND 50).

RAUL CORDOVA, EXAMINING ATTORNEY

CLASS 24—(Continued).

SN 78-401,350. SCSAVNICKI, GARY J, ST PETERSBURG, FL. FILED 4-13-2004.

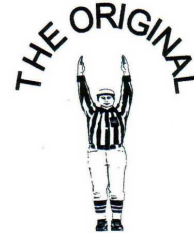

TOUCHDOWN-TOWEL

NO CLAIM IS MADE TO THE EXCLUSIVE RIGHT TO USE "THE ORIGINAL TOUCHDOWN TOWEL", APART FROM THE MARK AS SHOWN.

FOR MULTI - PURPOSE TOWEL FOR CELEBRATING A TOUCHDOWN, OR OUTSTANDING PLAY ON OFFENSE AND OR DEFENSE AND RALLYING YOUR TEAM IN ANYWAY POSSILBE (U.S. CLS. 42 AND 50).

FIRST USE 12-4-1994; IN COMMERCE 12-4-1994.

JIM RINGLE, EXAMINING ATTORNEY

SN 78-400,984. GOOD'S STORE, INC., NEW HOLLAND, PA. FILED 4-13-2004.



NO CLAIM IS MADE TO THE EXCLUSIVE RIGHT TO USE "FABRICS", APART FROM THE MARK AS SHOWN.

THE MARK CONSISTS OF PALM TREE WITH THE WORDS "TROPICAL BREEZE FABRICS" IN STYLIZED LETTERING.

FOR FABRIC, NAMELY, COTTON, LINEN, NYLON, POLYESTER, RAMIE, RAYON, AND WOOLEN FABRICS (U.S. CLS. 42 AND 50).

FIRST USE 1-1-1997; IN COMMERCE 1-1-1997.

ALICE BENMAMAN, EXAMINING ATTORNEY

SN 78-435,248. LONDON LUXURY LLC, NEW ROCHELLE, NY. FILED 6-15-2004.

LUXÉ SPA

THE MARK CONSISTS OF STANDARD CHARACTERS WITHOUT CLAIM TO ANY PARTICULAR FONT, STYLE, SIZE, OR COLOR.

FOR TOWELS (U.S. CLS. 42 AND 50).

FIRST USE 5-0-2004; IN COMMERCE 5-0-2004.

KELLEY WELLS, EXAMINING ATTORNEY

CLASS 24—(Continued).

SN 78-452,536. BABE EASE, LLC, PELHAM, NH. FILED 7-19-2004.

CLASS 24—(Continued).

SN 78-474,451. DASHAMERICA, INC., BROOMFIELD, CO. FILED 8-26-2004.

CLEAN CHANGER

THE MARK CONSISTS OF STANDARD CHARACTERS WITHOUT CLAIM TO ANY PARTICULAR FONT, STYLE, SIZE, OR COLOR.

NO CLAIM IS MADE TO THE EXCLUSIVE RIGHT TO USE CHANGER, APART FROM THE MARK AS SHOWN.

FOR PADS FOR BABIES, NAMELY, PADS WITH A COTTON SURFACE ON ONE SIDE AND A PLASTIC SURFACE ON THE OTHER SIDE FOR CHANGING DIAPERS (U.S. CLS. 42 AND 50).

STEVEN JACKSON, EXAMINING ATTORNEY

AEROSENSOR

THE MARK CONSISTS OF STANDARD CHARACTERS WITHOUT CLAIM TO ANY PARTICULAR FONT, STYLE, SIZE, OR COLOR.

OWNER OF U.S. REG. NOS. 1,932,384 AND 2,585,240. FOR FABRICS FOR USE IN THE MANUFACTURE OF ACTIVE WEAR CLOTHING (U.S. CLS. 42 AND 50). AMY HELLA, EXAMINING ATTORNEY

SN 78-466,884. DISTINCTIVE DESIGNS, INC., NEWPORT NEWS, VA. FILED 8-13-2004.

SN 78-485,189. PRECISION MATERIAL, INC., MINNEAPOLIS, MN. FILED 9-17-2004.

ICEFAB

THE MARK CONSISTS OF STANDARD CHARACTERS WITHOUT CLAIM TO ANY PARTICULAR FONT, STYLE, SIZE, OR COLOR.

FOR PRINTED FABRIC SIGNS; TEXTILE SIGNS; PRINTED FABRIC SIGNS WITH LOGOS AND GRAPHICS THEREON; TEXTILE SIGNS WITH LOGOS AND GRAPHICS THEREON; TEXTILE ICE GRAPHIC SIGNS (U.S. CLS. 42 AND 50).

FIRST USE 3-0-2004; IN COMMERCE 3-0-2004. CYNTHIA SLOAN, EXAMINING ATTORNEY

FluoroMesh

THE MARK CONSISTS OF STANDARD CHARACTERS WITHOUT CLAIM TO ANY PARTICULAR FONT, STYLE, SIZE, OR COLOR.

FOR SYNTHETIC FLUOROPOLYMER BASED MESH FABRICS (U.S. CLS. 42 AND 50).

CURTIS FRENCH, EXAMINING ATTORNEY

CLASS 24—(Continued).

SN 78-489,595. MARIETTA DRAPERY & WINDOW COVERINGS CO., INC., MARIETTA, GA. FILED 9-25-2004.



THE COLORS RED AND BLACK ARE CLAIMED AS A FEATURE OF THE MARK.

THE LETTERS "FAUX" ARE PRESENTED IN THE COLOR RED AND THE LETTERS "VET" ARE PRESENTED IN THE COLOR BLACK.

FOR DUVET AND COVERLET COMBINED (U.S. CLS. 42 AND 50).

FIRST USE 9-13-2004; IN COMMERCE 9-13-2004.
TRICIA SONNEBORN, EXAMINING ATTORNEY

CLASS 24—(Continued).

SN 78-517,688. TORAY ULTRASUEDE (AMERICA), INC., NEW YORK, NY. FILED 11-16-2004.



THE MARK CONSISTS OF STANDARD CHARACTERS WITHOUT CLAIM TO ANY PARTICULAR FONT, STYLE, SIZE, OR COLOR.

FOR TEXTILE SUBSTITUTE MATERIALS MADE FROM SYNTHETIC MATERIALS (U.S. CLS. 42 AND 50).
AMY HELLA, EXAMINING ATTORNEY

SN 78-505,887. SURE FIT INC., NEW YORK, NY. FILED 10-26-2004.



THE MARK CONSISTS OF STANDARD CHARACTERS WITHOUT CLAIM TO ANY PARTICULAR FONT, STYLE, SIZE, OR COLOR.

FOR UNFITTED FABRIC FURNITURE COVERS (U.S. CLS. 42 AND 50).

FIRST USE 10-7-2004; IN COMMERCE 10-7-2004.
MARK T. MULLEN, EXAMINING ATTORNEY

SN 78-538,153. E. E. SCHENCK COMPANY, PORTLAND, OR. FILED 12-23-2004.



SN 78-513,212. TEXCAR S.P.A., 59100 PRATO, ITALY, FILED 11-8-2004.



NO CLAIM IS MADE TO THE EXCLUSIVE RIGHT TO USE FABRIC, APART FROM THE MARK AS SHOWN.

THE PORTION OF THE MARK COMPRISED OF A CROSS DESIGN IS NOT DISPLAYED IN THE COLOR RED OR A COLORABLE IMITATION THEREOF. APPLICANT DOES NOT USE AND WILL NOT USE THE CROSS DESIGN THAT APPEARS IN ITS MARK IN THE COLOR RED OR A COLORABLE IMITATION THEREOF.

FOR FABRICS FOR BEDDING; FABRICS FOR BEDDING TREATED WITH NATURAL PRODUCTS AND METHODS (U.S. CLS. 42 AND 50).

LINDA POWELL, EXAMINING ATTORNEY

THE MARK CONSISTS OF STANDARD CHARACTERS WITHOUT CLAIM TO ANY PARTICULAR FONT, STYLE, SIZE, OR COLOR.

FOR FABRICS FOR QUILTING AND CRAFTS (U.S. CLS. 42 AND 50).

FIRST USE 12-30-1997; IN COMMERCE 12-30-1997.
JEFF DEFORD, EXAMINING ATTORNEY

CLASS 24—(Continued).

SN 79-004,168. SEFAR HOLDING AG, CH-8803 RÜSCHLIKON, SWITZERLAND, FILED 6-10-2004.

PETEX

THE MARK CONSISTS OF STANDARD CHARACTERS WITHOUT CLAIM TO ANY PARTICULAR FONT, STYLE, SIZE, OR COLOR.

PRIORITY DATE OF 4-20-2004 IS CLAIMED.

OWNER OF INTERNATIONAL REGISTRATION 0829933 DATED 6-10-2004, EXPIRES 6-10-2014.

FOR TEXTILE FABRICS FOR FILTRATION AND SCREEN PRINTING, TEXTILE FABRICS FOR USE WITH STENCILS MADE OF TEXTILE FIBERS (U.S. CLS. 42 AND 50).

CATHERINE CAIN, EXAMINING ATTORNEY

SN 79-007,331. TESSITURA MONTI S.P.A., ITALY, FILED 8-23-2004.



Tessitura Monti Spa

OWNER OF INTERNATIONAL REGISTRATION 0493803 DATED 5-20-1985, EXPIRES 5-20-2015.

NO CLAIM IS MADE TO THE EXCLUSIVE RIGHT TO USE TESSITURA, APART FROM THE MARK AS SHOWN.

THE ENGLISH TRANSLATION OF TESSITURA IS WEAVING OR FABRIC MILL AND THE TRANSLATION OF MONTI IS MOUNTAIN.

FOR TEXTILE FABRICS FOR USE IN THE MANUFACTURE OF CLOTHING; BED COVERS AND TABLE CLOTHS NOT OF PAPER; TEXTILE GOODS, NAMELY, COTTON FABRIC, FLANNEL, HOUSEHOLD LINEN, LINEN, TEXTILE LININGS FOR GARMENTS, VELVET AND WOOLEN FABRIC (U.S. CLS. 42 AND 50).

MICHAEL WEBSTER, EXAMINING ATTORNEY

CLASS 25—CLOTHING

SN 74-590,558. CALZADO COQUETA, S.A.DE C.V., 37000 LEON, GUANAJUATO, MEXICO, FILED 10-25-1994.



PRIORITY CLAIMED UNDER SEC. 44(D) ON MEXICO APPLICATION NO. 207399, FILED 8-4-1994, REG. NO. 477399, DATED 10-20-1994, EXPIRES 8-4-1999.

FOR FOOTWEAR (U.S. CLS. 22 AND 39).
HENRY S. ZAK, EXAMINING ATTORNEY

SN 76-113,702. PEACOCK APPAREL GROUP, INC., NEW YORK, NY. FILED 8-22-2000.

BERGAMO NEWYORK

NO CLAIM IS MADE TO THE EXCLUSIVE RIGHT TO USE NEW YORK, APART FROM THE MARK AS SHOWN.
FOR NECKTIES, TUXEDO SHIRTS, DRESS SHIRTS (U.S. CLS. 22 AND 39).

FIRST USE 10-1-1997; IN COMMERCE 10-1-1997.

KATHERINE STOIDES, EXAMINING ATTORNEY

SN 76-342,665. ASCARI CARS LIMITED, ABERDEEN, SCOTLAND, FILED 11-29-2001.

ASCARI

OWNER OF UNITED KINGDOM REG. NO. 2116318, DATED 11-21-1996, EXPIRES 11-21-2006.

OWNER OF U.S. REG. NO. 2,208,165.

FOR CLOTHING, NAMELY, SHIRTS, T-SHIRTS, TIES, BOOTS, SHOES, SLIPPERS AND HEADWEAR (U.S. CLS. 22 AND 39).

CHRISTOPHER BUONGIORNO, EXAMINING ATTORNEY

CLASS 25—(Continued).

SN 76-395,961. WALKER, JANA NEY, SOUTH LAKE TAHOE, CA. FILED 3-18-2002.

SEALED WITH A KISS

FOR CLOTHING AND WEARING APPAREL, NAMELY BRAS, PANTIES, SLEEPWEAR, UNDERWEAR, SHIRTS, PANTS, SWEATSHIRTS, DRESSES, SUITS, HOSIERY, SWIMWEAR, JACKETS (U.S. CLS. 22 AND 39).

FIRST USE 9-8-1998; IN COMMERCE 11-25-1998.
HENRY S. ZAK, EXAMINING ATTORNEY

SN 76-422,537. TOM TAILOR AG, D-22453 HAMBURG-NIENDORF, FED REP GERMANY, FILED 6-17-2002.

BY TOM TAILOR**tom.**

PRIORITY CLAIMED UNDER SEC. 44(D) ON FED REP GERMANY APPLICATION NO. 30217044.8, FILED 4-4-2002, REG. NO. 30217044, DATED 6-20-2002, EXPIRES 4-30-2012.

OWNER OF U.S. REG. NOS. 2,367,526, 2,400,182 AND 2,479,295.

THE NAME TOM TAILOR DOES NOT IDENTIFY A LIVING INDIVIDUAL.

FOR CLOTHING; NAMELY, SHIRTS, TEE SHIRTS, SHORTS, JEANS, PANTS, JACKETS, COATS, SWEATSHIRTS, SWEATPANTS, UNDERGARMENTS, HATS AND FOOTWEAR (U.S. CLS. 22 AND 39).

NICHOLAS ALTREE, EXAMINING ATTORNEY

SN 76-448,726. AMERICAN GIRL, LLC, EL SEGUNDO, CA. FILED 9-12-2002.

AMERICAN GIRL

OWNER OF U.S. REG. NOS. 1,506,148, 2,614,557 AND OTHERS.

FOR HOSIERY, NAMELY TIGHTS (U.S. CLS. 22 AND 39).

FIRST USE 8-4-1997; IN COMMERCE 8-4-1997.
CHRISTOPHER BUONGIORNO, EXAMINING ATTORNEY

CLASS 25—(Continued).

SN 76-467,979. ALYCIUM, LLC, PARKER, CO. FILED 11-19-2002.



THE MARK CONSISTS OF STYLIZED LETTERING OF THE WORD ALYCIUM, TWO PLUS SIGNS TO THE LEFT OF THE 'A'; THREE STYLIZED ARROW-LIKE FIGURES BELOW THE 'A'.

FOR T-SHIRTS, SHIRTS, PANTS, JEANS, HATS, BEANIES, BELTS, SOCKS, CAPS, KNIT HATS, SWEATSHIRTS, BOARD SHORTS, SNOWBOARD JACKETS, SNOWBOARD PANTS, SURFER RASH GUARD SHIRTS, GLOVES (U.S. CLS. 22 AND 39).

FIRST USE 1-1-2001; IN COMMERCE 6-1-2002.
SHAUNIA WALLACE, EXAMINING ATTORNEY

SN 76-476,099. YI, JIMMY, SACRAMENTO, CA. FILED 12-11-2002.



THE MARK CONSISTS OF STYLIZED LETTERING; TWO MEN DRESSED IN PINSTRIPED SUITS WITH TOP HATS AND THE F IN MAFIA IS A STYLIZED CROSS.

FOR CLOTHING, NAMELY, HATS, BEANIES, CAPS, JACKETS, T-SHIRTS, LONG-SLEEVE SHIRTS, SWEATERS, SWEATSHIRTS, SOCKS, SWEATBANDS, UNDERWEAR, BOXERS, PANTIES, PANTS, JEANS, SHORTS AND BELTS (U.S. CLS. 22 AND 39).

FIRST USE 6-1-1997; IN COMMERCE 12-8-1997.
TRACY CROSS, EXAMINING ATTORNEY

CLASS 25—(Continued).

SN 76-483,736. JOYCE LESLIE, INC., MOONACHIE, NJ.
FILED 1-21-2003.

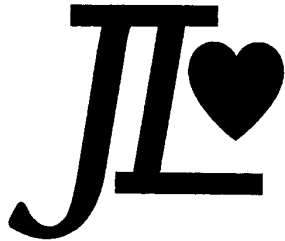

FOR WEARING APPAREL, NAMELY, SWEATERS,
BLOUSES, DRESSES, T-SHIRTS, KNIT TOPS, PANTS,
SKIRTS, JACKETS (U.S. CLS. 22 AND 39).
FIRST USE 3-0-2003; IN COMMERCE 3-0-2003.
SONYA STEPHENS, EXAMINING ATTORNEY

SN 76-487,802. OLIVACCE, BEVERLEY, GUTTENBERG, NJ.
FILED 1-28-2003.

BONY

FOR COATS, JACKETS, JEANS, SHIRTS, BLOUSES,
TOPS, SWEATER, TROUSERS, SKIRTS, SHORTS, HATS,
SCARVES, BELTS, GLOVES, SOCKS (U.S. CLS. 22 AND
39).
FIRST USE 1-23-2003; IN COMMERCE 1-23-2003.
EUGENIA MARTIN, EXAMINING ATTORNEY

SN 76-494,581. FRISKY-NINETEEN, L.L.C., PEMBROKE
PARK, FL. FILED 3-3-2003.

FRISKY

FOR FOOTWEAR (U.S. CLS. 22 AND 39).
FIRST USE 1-0-2002; IN COMMERCE 1-0-2002.
YSA DEJESUS, EXAMINING ATTORNEY

SN 76-504,568. GILLETT, ELIZABETH, NEW YORK, NY.
FILED 4-7-2003.



NO CLAIM IS MADE TO THE EXCLUSIVE RIGHT TO
USE "NYC", APART FROM THE MARK AS SHOWN.
FOR SCARVES, WRAPS, HATS, AND PONCHOS (U.S.
CLS. 22 AND 39).
JASON TURNER, EXAMINING ATTORNEY

CLASS 25—(Continued).

SN 76-507,434. DOMINION HOSIERY INC., TORONTO,
ONTARIO, CANADA, FILED 3-31-2003.

**DEEP RIVER OUTDOOR
COLLECTION**

PRIORITY CLAIMED UNDER SEC. 44(D) ON CANADA
APPLICATION NO. 1167559, FILED 2-10-2003, REG. NO.
TMA630055, DATED 1-12-2005, EXPIRES 1-12-2020.
NO CLAIM IS MADE TO THE EXCLUSIVE RIGHT TO
USE "OUTDOOR COLLECTION", APART FROM THE
MARK AS SHOWN.
FOR SOCKS (U.S. CLS. 22 AND 39).
LINDA MICKLEBURGH, EXAMINING ATTORNEY

SN 76-522,177. THE SARCASTIC COMPANY, GLENDALE,
CA. FILED 6-12-2003.

SARCASTIC

THE MARK CONSISTS OF STANDARD CHARACTERS
WITHOUT CLAIM TO ANY PARTICULAR FONT, STYLE,
SIZE, OR COLOR.
FOR COATS, SHIRTS, T-SHIRTS, SWEATSHIRTS,
SWEATPANTS, SHORT PANTS, PANTS, JACKETS,
VESTS, BELTS, SOCKS, SHOES, SANDALS, SCARVES,
HATS, CAPS, KNITTED CAPS, NECK TIES (U.S. CLS. 22
AND 39).
FIRST USE 1-1-1996; IN COMMERCE 1-1-1996.
JANICE L. MCMORROW, EXAMINING ATTORNEY

SN 76-525,504. SPECCHIO CO., LTD., TOKYO 153-0041,
JAPAN, FILED 6-24-2003.

SPECCHIO

OWNER OF JAPAN REG. NO. 4574115, DATED 5-31-2002,
EXPIRES 5-31-2012.
THE ENGLISH TRANSLATION OF "SPECCHIO" IS "MIR-
ROR".
FOR CLOTHING, NAMELY, T-SHIRT, SHIRTS,
BLOUSES, TANK TOPS, VESTS, SWEAT SHIRTS, JER-
SEYS, PULLOVERS, PANTS, SHORTS, SWEAT PANTS,
SKIRTS, DRESSES, SUITS, JACKETS, COATS, SWEA-
TERS, RAINWEAR, SWEAT SUITS, WARM UP SUITS,
SKI SUITS, JUMP SUITS, SUSPENDERS AND BELTS,
CAPS AND HATS, GLOVES, UNDERWEAR, BOXER
SHORTS, BRASSIERES, UNDERSHIRTS, PANTY HOSE,
PANTIES, HOSIERY, STOCKINGS, SOCKS, TIGHTS,
LEOTARDS, LEG WARMERS, PAJAMAS, ROBES,
NIGHT SHIRTS, NIGHT GOWNS, SWIM SUITS, NECK-
TIES, BELTS, SCARVES, GLOVES, AND WRIST BANDS;
GARTERS, NAMELY, ANKLE GARTERS AND GARTER
BELTS; ATHLETIC FOOTWEAR; COSTUMES FOR HAL-
LOWEEN, MASQUERADES AND PARADES (U.S. CLS.
22 AND 39).
DORITT L. CARROLL, EXAMINING ATTORNEY

CLASS 25—(Continued).

SN 76-531,386. LINKIN PARK, LLC, SHERMAN OAKS, CA. FILED 7-22-2003.

LINKIN PARK

OWNER OF U.S. REG. NOS. 2,573,289 AND 2,606,999. FOR CLOTHING, NAMELY T-SHIRTS, BABY DOLL T-SHIRTS, AND JACKETS (U.S. CLS. 22 AND 39). FIRST USE 6-1-2000; IN COMMERCE 7-20-2000. GEORGIA CARTY, EXAMINING ATTORNEY

CLASS 25—(Continued).

SN 76-572,867. KIM, MYUNG BO, LA HABRA, CA. FILED 1-30-2004.

ZIZIBEH

SN 76-565,747. 3-D BELT COMPANY, INC., SCHULENBURG, TX. FILED 12-17-2003.

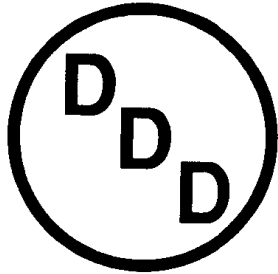

THE MARK CONSISTS OF STANDARD CHARACTERS WITHOUT CLAIM TO ANY PARTICULAR FONT, STYLE, SIZE, OR COLOR.

FOR APPAREL NAMELY WOMEN'S JACKETS, KNIT TOPS, JEANS, T-SHIRTS, VEST, DRESSES, SHORTS, PANTS, BLOUSES AND SKIRTS (U.S. CLS. 22 AND 39). FIRST USE 1-10-2004; IN COMMERCE 1-18-2004. ROBERT COGGINS, EXAMINING ATTORNEY

FOR CLOTHING, NAMELY BELTS (U.S. CLS. 22 AND 39). FIRST USE 1-1-1998; IN COMMERCE 1-1-1998. JIM RINGLE, EXAMINING ATTORNEY

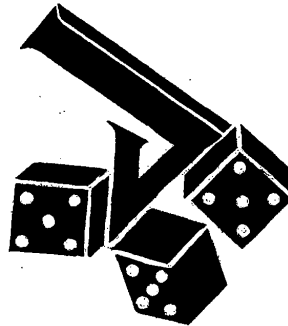

SN 76-579,888. ECHAVARRIA, JESSIE, HIALEAH, FL. FILED 3-8-2004.

SN 76-569,437. BURDETT, ELOY, SAN LEANDRO, CA. FILED 1-2-2004.



FOR CLOTHING, NAMELY, PANTS, SHIRTS, JACKETS, AND SHOES (U.S. CLS. 22 AND 39). FIRST USE 6-19-1998; IN COMMERCE 6-19-1998. KATHRYN COWARD, EXAMINING ATTORNEY

FOR CLOTHING, NAMELY SHIRTS, T-SHIRTS, UNDERSHIRTS, TOPS, HALTER TOPS, TURTLE NECKS, TANK TOPS, SWEATSHIRTS, SHORTS, PANTS, SWEAT-PANTS, JEANS, SKIRTS, DRESSES, BLOUSES, SWEATERS, JACKETS, JERSEYS, VESTS, SUITS, BLAZERS, BODY SUITS, JUMPSUITS, COATS, RAIN COATS, OVERALLS, OVERCOATS, ROBES, BATHROBES, SWIMWEAR, BIKINIS, SWIM TRUNKS, BATHING SUITS, COVER-UPS, WRAP-AROUNDS, SARONGS, PAJAMAS, NIGHT GOWNS, LINGERIE, HOSIERY, SOCKS, GLOVES, SCARVES, BELTS, SUSPENDERS, TIES, UNDERWEAR, BRAS, PANTIES, BOXER SHORTS, HATS, KNITTED HATS, HEAD BANDS, CAPS, VISORS, BANDANNAS, AND FOOTWEAR, SHOES, BOOTS, SANDALS, SNEAKERS, BEACH SHOES, SLIPPERS (U.S. CLS. 22 AND 39). JERI J. FICKES, EXAMINING ATTORNEY

CLASS 25—(Continued).

SN 76-580,373. BCNY INTERNATIONAL, INC., NEW YORK, NY. FILED 3-10-2004.

SLIPPER BUDDIES

THE MARK CONSISTS OF STANDARD CHARACTERS WITHOUT CLAIM TO ANY PARTICULAR FONT, STYLE, SIZE, OR COLOR.

NO CLAIM IS MADE TO THE EXCLUSIVE RIGHT TO USE "SLIPPER", APART FROM THE MARK AS SHOWN.

FOR FOOTWEAR AND PARTS THEREOF, NAMELY, SOLES, HEELS AND UPPERS (U.S. CLS. 22 AND 39).

KATHRYN COWARD, EXAMINING ATTORNEY

SN 76-580,655. CLEGGETT, STACY, MAYBEE, MI. FILED 3-8-2004.

SCHOOL ME

THE MARK CONSISTS OF STANDARD CHARACTERS WITHOUT CLAIM TO ANY PARTICULAR FONT, STYLE, SIZE, OR COLOR.

FOR CLOTHING, NAMELY, HEADWEAR, FOOTWEAR, PANTS, SHORTS, AND SHIRTS (U.S. CLS. 22 AND 39).

RAUL CORDOVA, EXAMINING ATTORNEY

SN 76-581,298. YOUNG, MARK A., ANTIOCH, TN. FILED 3-15-2004.

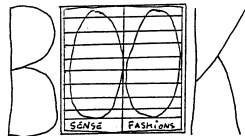

NO CLAIM IS MADE TO THE EXCLUSIVE RIGHT TO USE FASHIONS, APART FROM THE MARK AS SHOWN.

THE LINING IS A FEATURE OF THE MARK.

THE BOOK SENSE FASHIONS MARK CONSISTS OF AN OPEN BOOK WITH RULED LINES ACROSS THE PAGES. THE ONLY WRITING ON THESE PAGES ARE AS FOLLOWS: ON THE OUTSIDE OF THE LEFT PAGE IS AN UPPER CASE 'B'; ON THE FIRST PAGE OF THE BOOK IS

CLASS 25—(Continued).

AN UPPER CASE 'O'; ON THE SECOND PAGE OF THE BOOK IS ANOTHER UPPER CASE 'O'; AND FINALLY, OUTSIDE OF THE SECOND PAGE OF THE BOOK ON THE RIGHT IS AN UPPER CASE 'K'. AT THE BOTTOM OF THE LEFT PAGE OF THE BOOK IS THE WORD 'SENSE' IN UPPER CASE LETTERS BUT A MUCH SMALLER FONT THEN THE WORD 'BOOK', AND AT THE BOTTOM OF THE SECOND PAGE IS THE WORD 'FASHIONS', ALSO IN UPPER CASE LETTERS, THE SAME SIZE AS THE WORD 'SENSE', BUT SMALLER THAN THE WORD 'BOOK'.

FOR MEN AND WOMEN ADULT, BOY TEENS, JUNIOR MISSES, GIRLS, BOYS, TODDLERS, INFANTS AND BABY CLOTHES, NAMELY, JERSEYS, LONG SLEEVE JERSEYS, SHORT SLEEVE JERSEYS, BUTTON-UP JERSEYS, ZIP-UP JERSEYS, PULLOVER JERSEYS, VESTS, BUTTON-UP VESTS, ZIP-UP VESTS, PULLOVER VESTS, SKIRTS, SKIRT SETS COMPOSED OF SKIRTS AND COORDINATING SHIRTS, BLOUSES, AND TOPS, BUTTON-UP SHIRTS, ZIP-UP SHIRTS, SWEATSHIRTS, HOODED SWEATSHIRTS, SWEATPANTS, SLEEPWEAR, SHORT SLEEVE PAJAMAS, LONG SLEEVE PAJAMAS, GOWNS, DENIM SHIRTS, JACKETS, PANTS, SHORTS, AND CAPS, JEANS, JEAN JACKETS, COTTON JACKETS, VINYL JACKETS, HOODED JACKETS, ZIP-UP JACKETS, BUTTON-UP JACKETS, CAPS, HATS, COATS, GLOVES, FOOTWEAR, ATHLETIC FOOTWEAR, ATHLETIC UNIFORMS, TEE-SHIRTS, TANK TOPS, UNIFORMS, SLEEVELESS TEE-SHIRTS, SHORT PANTS, LONG PANTS, UNDER GARMENTS, UNDERWEAR, PANTIES, AND BRIEFS (U.S. CLS. 22 AND 39).

TONI HICKEY, EXAMINING ATTORNEY

SN 76-585,315. SCRIBNER, NINA, OAKLAND, CA. FILED 4-6-2004.



NO CLAIM IS MADE TO THE EXCLUSIVE RIGHT TO USE WEAR, APART FROM THE MARK AS SHOWN.

FOR CLOTHING, NAMELY, T-SHIRTS, SWEAT SHIRTS, PANTS, JACKETS (U.S. CLS. 22 AND 39).

FIRST USE 10-31-2003; IN COMMERCE 10-31-2003.

HOWARD SMIGA, EXAMINING ATTORNEY

SN 76-586,015. BIG ROCK JEANS LTD., LONG ISLAND CITY, NY. FILED 4-9-2004.

HX**HARLEM XPRESS**

NO CLAIM IS MADE TO THE EXCLUSIVE RIGHT TO USE "HARLEM", APART FROM THE MARK AS SHOWN.

FOR DENIM SPORTSWEAR FOR MEN, WOMEN AND CHILDREN, NAMELY JEANS, SHORTS, PANTS, SHIRTS, JACKETS, SKIRTS, AND DRESSES (U.S. CLS. 22 AND 39).

PAULA MAYS, EXAMINING ATTORNEY

CLASS 25—(Continued).

SN 76-586,263. MALCOLM & CO. LLC, NEW YORK, NY.
FILED 4-9-2004.

SIGNATURES BY RICHARD MALCOLM

THE MARK CONSISTS OF STANDARD CHARACTERS WITHOUT CLAIM TO ANY PARTICULAR FONT, STYLE, SIZE, OR COLOR.

RICHARD MALCOLM DOES NOT IDENTIFY A LIVING INDIVIDUAL.

FOR CLOTHING; NAMELY, WOMENS SHIRTS, BLOUSES, SWEATERS, SKIRTS, JACKETS, SCARVES, PANTS AND DRESSES (U.S. CLS. 22 AND 39).

FIRST USE 2-25-2004; IN COMMERCE 2-25-2004.
LESLEY LAMOTHE, EXAMINING ATTORNEY

SN 76-586,817. WAL-MART STORES, INC., BENTONVILLE, AR. FILED 4-15-2004.

YOU'RE NOT JUST A FAN, YOU'RE PART OF THE TEAM.

THE MARK CONSISTS OF STANDARD CHARACTERS WITHOUT CLAIM TO ANY PARTICULAR FONT, STYLE, SIZE, OR COLOR.

FOR CLOTHING, NAMELY, SHIRTS, SWEATSHIRTS, WIND SHIRTS, PANTS, WIND PANTS, OUTERWEAR, NAMELY, COATS, JACKETS, PONCHOS, HATS, SCARVES, AND GLOVES (U.S. CLS. 22 AND 39).

FIRST USE 8-6-2004; IN COMMERCE 8-6-2004.
INGRID C. EULIN, EXAMINING ATTORNEY

SN 76-587,115. AT LAST SPORTSWEAR INC., SECAUCUS, NJ. FILED 4-13-2004.

A . L . N . Y .

FOR MEN'S, WOMEN'S AND CHILDREN'S WEARING APPAREL NAMELY TOPS, SKIRTS, PANTS, BLOUSES, SHORTS, SHIRTS, SWEATERS, DRESSES, PLAY SUITS, JACKETS, VEST, COAT AND SLEEP WEAR (U.S. CLS. 22 AND 39).

FIRST USE 7-1-1991; IN COMMERCE 7-1-1991.
DOUGLAS LEE, EXAMINING ATTORNEY

SN 76-590,661. CSOLKOVITS, ERNEST ADAM, NORTHVILLE, MI. FILED 4-30-2004.

SYMBIOTIC GIVERS GAIN

THE MARK CONSISTS OF STANDARD CHARACTERS WITHOUT CLAIM TO ANY PARTICULAR FONT, STYLE, SIZE, OR COLOR.

FOR WRIST BANDS, T-SHIRTS, HATS (U.S. CLS. 22 AND 39).

FIRST USE 1-1-1991; IN COMMERCE 4-15-2004.
CURTIS FRENCH, EXAMINING ATTORNEY

CLASS 25—(Continued).

SN 76-593,450. BENNARDO, CHARLES E., LONG BEACH, NY. FILED 5-21-2004.

DR. NASTY

THE MARK CONSISTS OF STANDARD CHARACTERS WITHOUT CLAIM TO ANY PARTICULAR FONT, STYLE, SIZE, OR COLOR.

FOR CLOTHING, NAMELY SHIRTS, T-SHIRTS, SHORTS, SWEATSHIRTS AND SWEATPANTS (U.S. CLS. 22 AND 39).

ESTHER BELENKER, EXAMINING ATTORNEY

SN 76-594,144. ALBERTO ASPESI & C. S.P.A., 55 - LEGNANO (MILANO), ITALY, FILED 5-25-2004.

ASPESI

THE MARK CONSISTS OF STANDARD CHARACTERS WITHOUT CLAIM TO ANY PARTICULAR FONT, STYLE, SIZE, OR COLOR.

OWNER OF ERP N CMNTY TM OFC REG. NO. 000366773, DATED 11-24-1998, EXPIRES 5-8-2006.

OWNER OF U.S. REG. NO. 2,175,532.
FOR SHIRTS, BLOUSES, SUITS, DRESSES, FULL DRESSES, EVENING DRESSES, T-SHIRTS, SKIRTS, COATS, RAINCOATS, JACKETS AND BODICES, TROUSERS FOR MEN AND WOMEN, JACKETS FOR MEN AND WOMEN AND TAILLEURS (U.S. CLS. 22 AND 39).
FRED MANDIR, EXAMINING ATTORNEY

SN 76-594,145. ALBERTO ASPESI & C. S.P.A., 55 - LEGNANO (MILANO), ITALY, FILED 5-25-2004.

THIS IS A DOOR; HERE IS A SEA

THE MARK CONSISTS OF STANDARD CHARACTERS WITHOUT CLAIM TO ANY PARTICULAR FONT, STYLE, SIZE, OR COLOR.

OWNER OF ITALY REG. NO. 706873, DATED 3-26-1997, EXPIRES 3-7-2007.

OWNER OF U.S. REG. NOS. 2,196,589 AND 2,235,700.
FOR SHIRTS, BLOUSES, SUITS, DRESSES, FULL DRESSES, EVENING DRESSES, T-SHIRTS, SKIRTS, COATS, RAINCOATS, JACKETS AND BODICES, TROUSERS FOR MEN AND WOMEN, JACKETS FOR MEN AND WOMEN, TAILLEURS, SHOES AND HATS (U.S. CLS. 22 AND 39).

FRED MANDIR, EXAMINING ATTORNEY

CLASS 25—(Continued).

SN 76-594,160. WONG, TOM, BURLINGAME, CA. FILED 5-24-2004.

MERTILLO

THE MARK CONSISTS OF STANDARD CHARACTERS WITHOUT CLAIM TO ANY PARTICULAR FONT, STYLE, SIZE, OR COLOR.

FOR COATS, JACKETS, BLOUSES, SHIRTS, PANTS, SKIRTS IN SILK, LEATHER, SUEDE, COTTON, LINEN, POLYESTER (U.S. CLS. 22 AND 39).

FIRST USE 1-0-2002; IN COMMERCE 1-0-2002.
MIDGE BUTLER, EXAMINING ATTORNEY

SN 76-597,586. SPORIDIS, HOLLY, NEWARK, DE. FILED 6-14-2004.



OWNER OF U.S. REG. NO. 1,701,134.
NO CLAIM IS MADE TO THE EXCLUSIVE RIGHT TO USE "OUTFITTERS", APART FROM THE MARK AS SHOWN.

FOR MEN'S, WOMEN'S AND CHILDREN'S CLOTHING, NAMELY, HATS, SHIRTS, SWEATSHIRTS, SWEATERS, SHORTS, PANTS AND JACKETS (U.S. CLS. 22 AND 39).

FIRST USE 1-10-1991; IN COMMERCE 6-4-1991.
DAWN FELDMAN, EXAMINING ATTORNEY

SN 76-598,833. PREMIUMWEAR, INC., MINNETONKA, MN. FILED 6-23-2004.

COOL SWING

THE MARK CONSISTS OF STANDARD CHARACTERS WITHOUT CLAIM TO ANY PARTICULAR FONT, STYLE, SIZE, OR COLOR.

FOR APPAREL, NAMELY MEN'S AND WOMEN'S TOPS, SHIRTS, PULLOVER WINDSHIRTS, PANTS, SHORTS, SWEAT SHIRTS, JACKETS, HATS; ACTIVEWEAR, NAMELY, JACKETS, PULLOVER WINDSHIRTS, SWEATERS, SHIRTS, SHORTS, PANTS, WARM-UP SUITS, SWEATSUITS, SWEAT SHIRTS; AND SPORTSWEAR, NAMELY SHORTS, JACKETS, PULLOVER WINDSHIRTS, SHIRTS, PANTS, SWEAT SHIRTS (U.S. CLS. 22 AND 39).

FIRST USE 8-1-2004; IN COMMERCE 8-1-2004.
AISHA CLARKE, EXAMINING ATTORNEY

CLASS 25—(Continued).

SN 76-600,059. ANNE TAINTOR, INC., YOUNGSVILLE, NM. FILED 7-1-2004.

ANNE TAINTOR

THE MARK CONSISTS OF STANDARD CHARACTERS WITHOUT CLAIM TO ANY PARTICULAR FONT, STYLE, SIZE, OR COLOR.

THE NAME ANNE TAINTOR IDENTIFIES A LIVING INDIVIDUAL WHOSE CONSENT IS OF RECORD.

FOR T-SHIRTS AND PAJAMAS (U.S. CLS. 22 AND 39).
FIRST USE 10-15-2003; IN COMMERCE 10-15-2003.
SONYA STEPHENS, EXAMINING ATTORNEY

SN 76-601,251. MONTELLE INTIMATES INC., MONTREAL, QUEBEC, H2N 1Z2, CANADA, FILED 7-7-2004.

MONTELLE

FOR LADIES' WEARING APPAREL, NAMELY, PANTIES, SLIPS, CAMISOLES, BODYSUITS, ROBES, SWIM SUITS, JOGGING SUITS, PAJAMAS, BRASSIERES, SLEEPWEAR, T-SHIRTS, SHORTS, SILK LINGERIE, FOUNDATION GARMENTS, NIGHTGOWNS, BUSTIERS, CORSETS (U.S. CLS. 22 AND 39).

FIRST USE 6-30-2004; IN COMMERCE 6-30-2004.
DAVID C. REIHNER, EXAMINING ATTORNEY

SN 76-601,792. CONTINENTAL MERIT (XIAMEN) FOOTWEAR CO., LTD, XIAMEN, CHINA, FILED 7-12-2004.

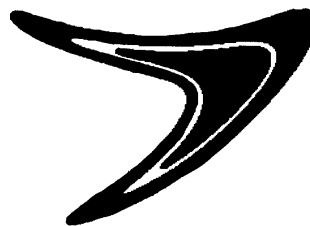

FOR ATHLETIC SHOES AND DRESS SHOES (U.S. CLS. 22 AND 39).

FIRST USE 12-31-2000; IN COMMERCE 4-2-2004.
GEORGE LORENZO, EXAMINING ATTORNEY

CLASS 25—(Continued).

SN 76-602,860. IWEZE-PLATT, MARGARET, HOLLYWOOD, CA. FILED 7-19-2004.

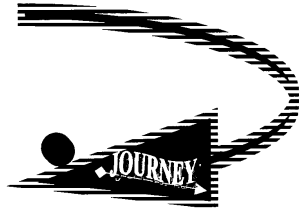

FOR HATS, BANDANAS, SCARVES, CAPS, WAIST BAND AND WRIST BAND (U.S. CLS. 22 AND 39).
FIRST USE 2-6-2004; IN COMMERCE 2-6-2004.
ARETHA SOMERVILLE, EXAMINING ATTORNEY

CLASS 25—(Continued).

SN 76-607,708. COPASETIC CLOTHING LTD., VANCOUVER, BRITISH COLUMBIA, CANADA, FILED 8-19-2004.



PRIORITY CLAIMED UNDER SEC. 44(D) ON CANADA APPLICATION NO. 1,209,487, FILED 3-12-2004, REG. NO. TMA630265, DATED 1-17-2005, EXPIRES 1-17-2020.
FOR WEARING APPAREL NAMELY T-SHIRTS, SHIRTS, SWEATERS, JACKETS, VESTS, CAPS, HATS, TOQUES, VISORS, HEADBANDS, PANTS, SHORTS, NIGHTSHIRTS, SCARVES, TRACK SUITS, SOCKS, SHOES, SLIPPERS AND WRIST BANDS (U.S. CLS. 22 AND 39).
ELLEN PERKINS, EXAMINING ATTORNEY

SN 76-603,459. TAYLOR/GOODWINE PARTNERSHIP, BLACKWOOD, NJ. FILED 7-22-2004.

THE PLAYHERS MANUAL

THE MARK CONSISTS OF STANDARD CHARACTERS WITHOUT CLAIM TO ANY PARTICULAR FONT, STYLE, SIZE, OR COLOR.
FOR CLOTHING; NAMELY, T-SHIRTS AND HATS (U.S. CLS. 22 AND 39).
GLENN CLARK, EXAMINING ATTORNEY

SN 76-609,043. BLUE HAWAII SURF, LLC, HONOLULU, HI. FILED 8-27-2004.

SN 76-606,641. LAFAYETTE 148, INC., NEW YORK, NY. FILED 8-12-2004.

STUDIO 148



THE MARK CONSISTS OF STANDARD CHARACTERS WITHOUT CLAIM TO ANY PARTICULAR FONT, STYLE, SIZE, OR COLOR.
NO CLAIM IS MADE TO THE EXCLUSIVE RIGHT TO USE STUDIO, APART FROM THE MARK AS SHOWN.
FOR CLOTHING, NAMELY- BLAZERS, BLOUSES, COATS, DRESSES, JACKETS, JUMPERS, KNIT SWEATERS, SHIRTS, SWEAT SHIRTS, SWEATERS, TEE SHIRTS, VESTS, PANTS, SHORTS, SKIRTS, BELTS, GLOVES, HATS, SCARVES, SOCKS, TIES, BOOTS, PUMPSTYLE SHOES, SANDALS, SLIPPERS, LINGERIE, PAJAMAS, KNEE HIGHS, PANTYHOSE AND STOCKINGS (U.S. CLS. 22 AND 39).
FIRST USE 1-1-2000; IN COMMERCE 1-1-2000.
SALLY SHIH, EXAMINING ATTORNEY

NO CLAIM IS MADE TO THE EXCLUSIVE RIGHT TO USE "SKATE CO"., APART FROM THE MARK AS SHOWN.
FOR CLOTHING, NAMELY, SHIRTS, TEE SHIRTS, SOCKS, SHORTS, PANTS, SWEATERS, SWEAT SHIRTS, BASEBALL STYLE CAPS, JACKETS, HEADBANDS, BANDANAS, SHOES, AND SANDALS (U.S. CLS. 22 AND 39).
FIRST USE 1-1-1998; IN COMMERCE 1-1-1998.
MICHAEL TANNER, EXAMINING ATTORNEY

CLASS 25—(Continued).

SN 76-609,358. TAFFY PRODUCTIONS, LLC, WOODLAND HILLS, CA. FILED 8-30-2004.

TODD WORLD

THE MARK CONSISTS OF STANDARD CHARACTERS WITHOUT CLAIM TO ANY PARTICULAR FONT, STYLE, SIZE, OR COLOR.

FOR CLOTHING, NAMELY, BANDANNAS, BATHING SUITS, BATHROBES, BEACHWEAR, BELTS, BLOUSES, CLOTH BIBS, COATS, COVER-UPS, DRESSES, EAR MUFFS, GLOVES, GYM SHORTS, MASQUERADE AND HALLOWEEN COSTUMES AND MASKS SOLD IN CONNECTION THEREWITH, HEADBANDS, JACKETS, JEANS, JUMPERS, LEGGINGS, MITTENS, NECKWEAR, NIGHTGOWNS, NIGHTSHIRTS, OVERALLS, PAJAMAS, PANTS, POLO SHIRTS, RAIN SLICKERS, RAINWEAR, ROBES, SCARVES, SHIRTS, SHORTS, SLACKS, SLEEPWEAR, SKI WEAR, SKIRTS, SMOCKS, SNOW SUITS, SOCKS, SUSPENDERS, SWEATERS, SWEATPANTS, SWEATSHIRTS, T-SHIRTS, TIGHTS, TURTLENECKS, UNDERCLOTHES, UNDERWEAR, VESTS, WARM-UP SUITS; FOOTWEAR, NAMELY, BOOTS, SHOES, SANDALS, SNEAKERS, SLIPPERS; HEADWEAR, NAMELY, HATS, SUN VISORS, CAPS, SPORT CAPS (U.S. CLS. 22 AND 39).

APRIL L. RADEMACHER, EXAMINING ATTORNEY

SN 76-609,573. WOLFF FORDING & COMPANY, RICHMOND, VA. FILED 8-23-2004.



THE ENGLISH TRANSLATION OF THE WORD "QUE" IN THE MARK IS "WHAT".
FOR DANCE SNEAKER USED FOR DANCING (U.S. CLS. 22 AND 39).

FIRST USE 2-1-2004; IN COMMERCE 2-1-2004.
ROBERT LORENZO, EXAMINING ATTORNEY

CLASS 25—(Continued).

SN 76-610,255. SEMORE INC., LOS ANGELES, CA. FILED 8-27-2004.

SEMORE

THE MARK CONSISTS OF STANDARD CHARACTERS WITHOUT CLAIM TO ANY PARTICULAR FONT, STYLE, SIZE, OR COLOR.

OWNER OF U.S. REG. NO. 2,229,414.
SEC. 2(F).

FOR CLOTHING AND SPORTSWEAR, NAMELY, JEANS, PANTS, T-SHIRTS, POLO SHIRTS, SHIRTS, SHORTS, JACKETS, SWEATERS, SOCKS, UNDERWEAR AND HATS (U.S. CLS. 22 AND 39).

FIRST USE 1-0-2002; IN COMMERCE 1-0-2002.

VIVIAN MICZNIK FIRST, EXAMINING ATTORNEY

SN 76-610,988. BENCHMARK BRANDS, INC., MEMPHIS, TN. FILED 9-7-2004.

SOFTFIT

THE MARK CONSISTS OF STANDARD CHARACTERS WITHOUT CLAIM TO ANY PARTICULAR FONT, STYLE, SIZE, OR COLOR.

FOR SOCKS AND HOSIERY (U.S. CLS. 22 AND 39).
RENEE MCCRAY, EXAMINING ATTORNEY

SN 76-611,353. VOLUPTE, INC., MALIBU, CA. FILED 9-7-2004.

GVITA

THE MARK CONSISTS OF STANDARD CHARACTERS WITHOUT CLAIM TO ANY PARTICULAR FONT, STYLE, SIZE, OR COLOR.

FOR CLOTHING, NAMELY, SHORTS, SWIM WEAR, SHIRTS, PANTS, ATHLETIC SHOES, HATS, JACKETS, TANK TOPS, T-SHIRTS, BLOUSES, UNDERWEAR, DRESSES, GLOVES, THONG UNDERWEAR, SOCKS, HEADBANDS, WRISTBANDS, SKIRTS, TUBE TOPS, HALTER TOPS AND SCARVES (U.S. CLS. 22 AND 39).

FIRST USE 7-3-2004; IN COMMERCE 7-3-2004.

WARREN L. OLANDRIA, EXAMINING ATTORNEY

CLASS 25—(Continued).

SN 76-612,558. LEE, PETER JAMES, LOS ANGELES, CA. FILED 9-23-2004.



THE MARK CONSISTS OF THE WORD "CASSETTE" IN STYLIZED LETTERS FOLLOWED BY A DESIGN. THE DESIGN CONSISTS OF SIX DASHES ARRANGED IN A CIRCLE THAT SUGGESTS THE SHAPE OF THE SPINDLE GEAR OF AN AUDIO CASSETTE.

FOR CLOTHING; NAMELY, PANTS, JACKETS, KNIT TOPS, WOVEN TOPS, T-SHIRTS, HATS AND SHORTS (U.S. CLS. 22 AND 39).

FIRST USE 9-0-2004; IN COMMERCE 9-0-2004.
MICHAEL ENGEL, EXAMINING ATTORNEY

SN 76-613,975. JEANWEAR, INC., CHINO, CA. FILED 9-27-2004.



NO CLAIM IS MADE TO THE EXCLUSIVE RIGHT TO USE "COUTURE", APART FROM THE MARK AS SHOWN. JOLI COUTURE AND DESIGN, WHEREIN THE WORDS "JOLI COUTURE" ARE PLACED UNDERNEATH THE MISCELLANEOUS DESIGN, WHEREIN THE MISCELLANEOUS DESIGN COMPRISES A STYLIZED "L" AND A "LIGHTNING AND STAR" DESIGN, WHEREIN A LIGHTNING APPEARS TO BE STRIKING TOWARDS THE INNER ANGLE OF THE STYLIZED "L", WHERE A STAR IS LOCATED.

THE ENGLISH TRANSLATION OF THE WORD JOLI IN THE MARK IS PRETTY.

FOR CLOTHING, NAMELY, PANTS, SLACKS, SHORTS, SHIRTS, T-SHIRTS, DRESS SHIRTS, SWEATERS, JACKETS, SPORTS COATS, TRENCH COATS, SCARVES, GLOVES, SUITS, UNIFORMS, JERSEYS, PAJAMAS, SOCKS, UNDER GARMENTS, VESTS AND TIES; HEADWEAR AND FOOTWEAR (U.S. CLS. 22 AND 39).

MARY ROSSMAN, EXAMINING ATTORNEY

CLASS 25—(Continued).

SN 76-615,233. ROY, RACHEL, NEW YORK, NY. FILED 10-12-2004.

RACHEL ROY

RACHEL ROY DECLARES: THAT CONSENT IS HEREBY GRANTED TO REGISTER THE MARK RACHEL ROY.

FOR CLOTHING, NAMELY, DRESSES, SKIRTS, SHIRTS, T-SHIRTS, BLOUSES, JACKETS, COATS, SWEAT SHIRTS, SWEAT PANTS, PANTS, JEANS, SCARVES, UNDERGARMENTS, SOCKS AND FOOTWEAR (U.S. CLS. 22 AND 39).

DAYNA BROWNE, EXAMINING ATTORNEY

SN 76-615,368. SHALOM INTERNATIONAL INC., CARTERET, NJ. FILED 10-6-2004.

SOX & CO.

THE MARK CONSISTS OF STANDARD CHARACTERS WITHOUT CLAIM TO ANY PARTICULAR FONT, STYLE, SIZE, OR COLOR.

OWNER OF U.S. REG. NO. 2,070,918.

NO CLAIM IS MADE TO THE EXCLUSIVE RIGHT TO USE SOX, APART FROM THE MARK AS SHOWN.

SEC. 2(F).

FOR MEN'S, LADIES', AND CHILDREN'S SOCKS, TIGHTS, BELTS, UNDERWEAR, STOCKINGS, PANTIES, SHEER HOSIERY, HEADWEAR, FOOTWEAR, BATHROBES, KNEE-HIGH SOCKS, AND SLIPPERS (U.S. CLS. 22 AND 39).

FIRST USE 2-19-1996; IN COMMERCE 2-19-1996.

LOURDES AYALA, EXAMINING ATTORNEY

SN 76-615,767. ART STONE THEATRICAL CORP., SMITH-TOWN, NY. FILED 10-14-2004.

REVELATIONS - THE SPIRIT OF DANCE

THE MARK CONSISTS OF STANDARD CHARACTERS WITHOUT CLAIM TO ANY PARTICULAR FONT, STYLE, SIZE, OR COLOR.

FOR DANCE APPAREL, NAMELY LITURGICAL DRESSES (U.S. CLS. 22 AND 39).

FIRST USE 9-1-2004; IN COMMERCE 9-1-2004.

DAWN FELDMAN, EXAMINING ATTORNEY

CLASS 25—(Continued).

SN 76-617,027. RFB ENTERPRISES, INC., INDIANAPOLIS, IN. FILED 10-18-2004.

RUPERT

THE MARK CONSISTS OF STANDARD CHARACTERS WITHOUT CLAIM TO ANY PARTICULAR FONT, STYLE, SIZE, OR COLOR.

FOR CLOTHING, NAMELY, SHIRTS, TEE SHIRTS, AND TANK TOPS (U.S. CLS. 22 AND 39).

FIRST USE 4-1-2004; IN COMMERCE 4-1-2004.
SUSAN STIGLITZ, EXAMINING ATTORNEY

SN 76-617,447. B+H PARTNERSHIP, SAN DIEGO, CA. FILED 10-25-2004.

MILITREE

THE MARK CONSISTS OF STANDARD CHARACTERS WITHOUT CLAIM TO ANY PARTICULAR FONT, STYLE, SIZE, OR COLOR.

FOR CLOTHING, NAMELY SHIRTS, SPORT SHIRTS, T-SHIRTS, TANK TOPS, SWEAT SHIRTS, SWEATERS, BLOUSES, DRESSES, JACKETS, COATS, WIND RESISTANT JACKETS, HATS, CAPS, JEANS, PANTS, SHORTS, SURF TRUNKS, SWIMSUITS, GLOVES, UNDERWEAR AND FOOTWEAR (U.S. CLS. 22 AND 39).

FIRST USE 3-10-2003; IN COMMERCE 3-10-2003.
TARAH HARDY, EXAMINING ATTORNEY

SN 76-617,946. WINDRIDGE DESIGN, INC., WEST CHESTER, PA. FILED 10-21-2004.

CHERYL NASH

THE MARK CONSISTS OF STANDARD CHARACTERS WITHOUT CLAIM TO ANY PARTICULAR FONT, STYLE, SIZE, OR COLOR.

CHERYL NASH IS THE NAME OF A LIVING INDIVIDUAL WHOSE CONSENT IS OF RECORD.

FOR WOMEN'S CLOTHING, NAMELY, JACKETS, COATS, WRAPS, SWEATERS, VESTS, BLOUSES, SHIRTS, TURTLENECKS, TANK TOPS, KNIT TOPS, TEE SHIRTS, SKIRTS, PANTS, SHORTS, SKORTS, DRESSES, JUMPERS, SCARVES, HATS, VISORS, BELTS, SWEATSHIRTS, SWEAT PANTS, AND GIRL'S CLOTHING, NAMELY, TEE SHIRTS, SHORTS, SCARVES, HATS, VISORS, SWEAT SHIRTS AND SWEAT PANTS (U.S. CLS. 22 AND 39).

FIRST USE 1-0-1996; IN COMMERCE 6-0-1996.
KATHLEEN M. VANSTON, EXAMINING ATTORNEY

CLASS 25—(Continued).

SN 76-618,144. REBEL WEAR, INC., TIMONIUM, MD. FILED 10-21-2004.

REBEL LACROSSE WEAR

THE MARK CONSISTS OF STANDARD CHARACTERS WITHOUT CLAIM TO ANY PARTICULAR FONT, STYLE, SIZE, OR COLOR.

NO CLAIM IS MADE TO THE EXCLUSIVE RIGHT TO USE "LACROSSE WEAR", APART FROM THE MARK AS SHOWN.

FOR ATHLETIC AND CASUAL APPAREL, NAMELY JERSEYS, SHORTS, SHIRTS, SWEAT SUITS, JACKETS, PANTS, HEADWEAR, AND KILTS (U.S. CLS. 22 AND 39).

FIRST USE 8-21-1996; IN COMMERCE 8-21-1996.
KATRINA EDGE, EXAMINING ATTORNEY

SN 76-619,597. MASON, CLEVELAND, ANNAPOLIS, MD. FILED 11-8-2004.



FOR BASEBALL CAPS/SHIRTS/JACKET (U.S. CLS. 22 AND 39).

FIRST USE 11-6-2004; IN COMMERCE 11-6-2004.
JACQUELINE A. LAVINE, EXAMINING ATTORNEY

SN 76-619,609. I'M ALL IN WEAR, INC., NORTH LAS VEGAS, NV. FILED 11-8-2004.

iai
original poker apparel

NO CLAIM IS MADE TO THE EXCLUSIVE RIGHT TO USE "ORIGINAL POKER APPAREL", APART FROM THE MARK AS SHOWN.

FOR MEN'S AND WOMEN'S CLOTHING, NAMELY, SHIRTS, SHORT-SLEEVED AND LONG-SLEEVED T-SHIRTS, TANK TOPS, SWEATSHIRTS, SWEATERS, FLEECE PULLOVERS, HOODED SWEATSHIRTS AND HOODED SHIRTS (U.S. CLS. 22 AND 39).

FIRST USE 10-5-2004; IN COMMERCE 10-13-2004.
PAUL F. GAST, EXAMINING ATTORNEY

CLASS 25—(Continued).

SN 76-620,072. ECOLAND, INC., BUENA PARK, CA. FILED 11-10-2004.



THE COLOR GREEN IS CLAIMED AS A FEATURE OF THE MARK.

THE COLOR OF GREEN IS USED ON THE ENTIRE MARK "ECOLAND".

FOR INFANT AND BABY CLOTHING, NAMELY CERTIFIED ORGANIC COTTON LAYETTES, KIMONOS, OVERALLS, UNDERGARMENTS, PAJAMAS, T-SHIRTS, TANK TOPS, SHORTS, PANTS, CLOTH BIBS, SOCKS, CLOTH DIAPERS FOR BABY; CERTIFIED ORGANIC COTTON UNDERWEAR, PAJAMAS, T-SHIRTS, TANK TOPS, CAMISOLES, SHORTS, PANTS, ROBES, SOCKS, SLIPPERS, ALL FOR CHILDREN, LADIES AND MEN; HEAD WEAR AND FOOTWEAR (U.S. CLS. 22 AND 39).

FIRST USE 6-9-2004; IN COMMERCE 6-9-2004.
JOHN LINCOSKI, EXAMINING ATTORNEY

CLASS 25—(Continued).

SN 76-622,642. MICHAEL, CHRISTIAN & POWER, INC., LODI, NJ. FILED 11-26-2004.

MC & POWER

OWNER OF U.S. REG. NO. 2,013,958.
FOR APPAREL, NAMELY FOOTWEAR (U.S. CLS. 22 AND 39).

FIRST USE 6-1-1994; IN COMMERCE 6-1-1994.
JOHN WILKE, EXAMINING ATTORNEY

SN 76-622,812. UNI HOSIERY CO., INC., LOS ANGELES, CA. FILED 12-1-2004.

JOYSOX

THE MARK CONSISTS OF STANDARD CHARACTERS WITHOUT CLAIM TO ANY PARTICULAR FONT, STYLE, SIZE, OR COLOR.

FOR MEN'S, WOMEN'S AND CHILDREN'S CLOTHING, NAMELY, SOCKS, HOSIERY, UNDERWEAR, LINGERIE AND T-SHIRTS (U.S. CLS. 22 AND 39).

TANYA AMOS, EXAMINING ATTORNEY

SN 76-622,104. KAY, ALISON, NEW YORK, NY. FILED 11-26-2004.

KeepMe

THE MARK CONSISTS OF STANDARD CHARACTERS WITHOUT CLAIM TO ANY PARTICULAR FONT, STYLE, SIZE, OR COLOR.

FOR CLOTHING AND SLEEPWEAR, NAMELY, SHIRTS, PANTS, SKIRTS, SWEATSHIRTS, JACKETS, SWEATERS, NIGHTGOWNS, ROBES, HATS, SHOES AND SLIPPERS (U.S. CLS. 22 AND 39).

FIRST USE 11-15-2004; IN COMMERCE 11-15-2004.
MARY ROSSMAN, EXAMINING ATTORNEY

SN 76-625,577. GATES, RYAN C., FRESNO, CA. FILED 12-21-2004.

BILLABLUNT

SN 76-622,121. BROOKE & LINDEN, L.L.C., HOUSTON, TX. FILED 11-24-2004.

TEXAS, IT'S JUST BETTER HERE

THE MARK CONSISTS OF STANDARD CHARACTERS WITHOUT CLAIM TO ANY PARTICULAR FONT, STYLE, SIZE, OR COLOR.

FOR CLOTHING, NAMELY, HATS, CAPS, APRONS, SHIRTS, PANTS, SHORTS, DRESSES, SKIRTS, JACKETS, COATS, UNDERWEAR, GLOVES AND BELTS (U.S. CLS. 22 AND 39).

TRICIA SONNEBORN, EXAMINING ATTORNEY

THE MARK CONSISTS OF STANDARD CHARACTERS WITHOUT CLAIM TO ANY PARTICULAR FONT, STYLE, SIZE, OR COLOR.

FOR CLOTHING, NAMELY, MEN'S AND WOMEN'S SWEATSHIRTS, T-SHIRTS, HOODED SWEATSHIRTS, BEANIES, PANTS, SHORTS, UNDERWEAR AND G-STRINGS (U.S. CLS. 22 AND 39).

FIRST USE 10-14-2004; IN COMMERCE 10-14-2004.
ESTHER A. BORSUK, EXAMINING ATTORNEY

CLASS 25—(Continued).

SN 76-625,633. JEWELL, MICHAEL, 8001 ZURICH, SWITZERLAND, FILED 12-27-2004.



FOR CLOTHING, NAMELY T-SHIRTS, HATS, JACKETS, PANTS, SWEATSHIRTS AND SHORTS (U.S. CLS. 22 AND 39).
RONALD MCMORROW, EXAMINING ATTORNEY

CLASS 25—(Continued).

SN 76-626,262. AMERICAN APPAREL, INC., LOS ANGELES, CA. FILED 12-30-2004.

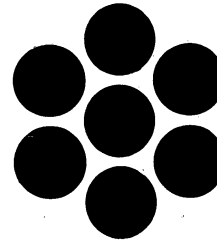

ClassicGirl

SN 76-625,815. PINO, AUDREY, BEVERLY HILLS, CA. FILED 12-27-2004.

1000 PETALED STROKES

THE MARK CONSISTS OF STANDARD CHARACTERS WITHOUT CLAIM TO ANY PARTICULAR FONT, STYLE, SIZE, OR COLOR.

FOR WOMEN'S UNDERGARMENTS AND PANTIES (U.S. CLS. 22 AND 39).

FIRST USE 10-1-2004; IN COMMERCE 10-1-2004.
JENNIFER WILLISTON, EXAMINING ATTORNEY

OWNER OF U.S. REG. NOS. 2,534,188 AND 2,534,189. FOR CLOTHING, NAMELY, T-SHIRTS, SHIRTS, SWEATERS, TOPS, BELTS, JACKETS, VESTS, PANTS, SHORTS, SKIRTS, SKORTS, SLEEPWEAR, UNDERWEAR, SWIM WEAR, HEADWEAR, AND NECKWEAR; FOOTWEAR (U.S. CLS. 22 AND 39).

FIRST USE 0-0-1994; IN COMMERCE 0-0-1994.
CIMMERIAN COLEMAN, EXAMINING ATTORNEY

SN 76-626,298. BUY MY BIKES INC., SAN JUAN CAPISTRANO, CA. FILED 12-30-2004.

BUY MY BIKES

SN 76-626,083. Z-TECH, INC., DBA Z-COIL FOOTWEAR, ALBUQUERQUE, NM. FILED 12-27-2004.

Z-COIL

THE MARK CONSISTS OF STANDARD CHARACTERS WITHOUT CLAIM TO ANY PARTICULAR FONT, STYLE, SIZE, OR COLOR.

OWNER OF U.S. REG. NOS. 2,504,010 AND 2,504,011. FOR FOOTWEAR, NAMELY INSOLES FOR FOOTWEAR AND SHOES (U.S. CLS. 22 AND 39).

FIRST USE 1-2-1998; IN COMMERCE 1-2-1998.
KIMBERLY PERRY, EXAMINING ATTORNEY

THE MARK CONSISTS OF STANDARD CHARACTERS WITHOUT CLAIM TO ANY PARTICULAR FONT, STYLE, SIZE, OR COLOR.

FOR SHIRTS, HATS, T-SHIRTS (U.S. CLS. 22 AND 39). FIRST USE 6-0-1992; IN COMMERCE 6-0-1992.
DANIEL CAPSHAW, EXAMINING ATTORNEY

CLASS 25—(Continued).

SN 76-630,157. COOGI PARTNERS, LLC, LAKE SUCCESS, NY. FILED 2-1-2005.

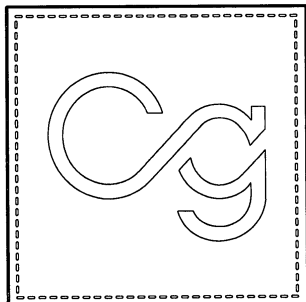

FOR CLOTHING, NAMELY SHIRTS, VESTS, SWEATERS, SHOES, CAPS, BANDANNAS, SHORTS, SWEAT SHIRTS, PANTS, BELTS FOR CLOTHING, SOCKS, SWIMWEAR, JACKETS, RAINWEAR, BLOUSES, DRESSES, FOOTWEAR, HOSIERY, SCARVES, HATS, HEAD BANDS, PAJAMAS AND SLEEPWEAR (U.S. CLS. 22 AND 39).

VERNA BETH RIRIE, EXAMINING ATTORNEY

SN 76-630,158. COOGI PARTNERS, LLC, LAKE SUCCESS, NY. FILED 2-1-2005.

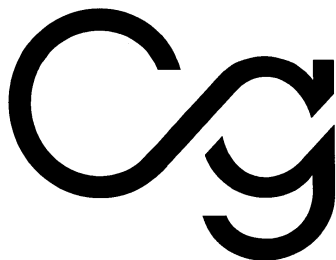

FOR CLOTHING, NAMELY SHIRTS, VESTS, SWEATERS, SHOES, CAPS, BANDANNAS, SHORTS, SWEAT SHIRTS, PANTS, BELTS FOR CLOTHING, SOCKS, SWIMWEAR, JACKETS, RAINWEAR, BLOUSES, DRESSES, FOOTWEAR, HOSIERY, SCARVES, HATS, HEAD BANDS, PAJAMAS AND SLEEPWEAR (U.S. CLS. 22 AND 39).

VERNA BETH RIRIE, EXAMINING ATTORNEY

SN 76-977,119. BOOST WORLDWIDE, INC., RESTON, VA. FILED 7-3-2002.

BOOST

OWNER OF U.S. REG. NO. 2,800,924.
FOR CLOTHING, NAMELY, SHIRTS, SHORTS, HATS AND PANTS; HEADWEAR; FOOTWEAR; LEATHER CLOTHING FOR MOTORCYCLE WEAR, NAMELY, PANTS, JACKETS, VESTS, BOOTS, GLOVES, CHAPS, TOPS, SHORTS, BELTS, WRISTBANDS (U.S. CLS. 22 AND 39).

BILL DAWE, EXAMINING ATTORNEY

CLASS 25—(Continued).

SN 78-074,844. ROSENUIST GESTAO E. SERVICOS SOCIEDADE UNIPESSOAL LDA., FUNCHAL, MADEIRA, PORTUGAL, FILED 7-20-2001.



THE MARK CONSISTS OF THE WORD "RINASCIMENTO" AND A SPECIAL FORM DESIGN OF A BUST OF A WOMAN WITH FLOWING HAIR.

THE WORD "RINASCIMENTO" IS TRANSLATED INTO ENGLISH AS RENAISSANCE.

FOR CLOTHING, NAMELY, SHIRTS, SOCKS, DRESSES, SKIRTS AND TROUSERS; FOOTWEAR, HEADWEAR, JACKETS, OVERCOATS, RAINCOATS, COATS, PULLOVERS, JERKINS, HATS, SCARVES, FOU-LARDS (U.S. CLS. 22 AND 39).

DEZMONA MIZELLE, EXAMINING ATTORNEY

SN 78-132,797. PARAMOUNT APPAREL INTERNATIONAL, INC., BOURBON, MO. FILED 6-3-2002.

PARAMOUNT APPAREL INTERNATIONAL INC.

OWNER OF U.S. REG. NOS. 1,843,706 AND 2,786,282.
NO CLAIM IS MADE TO THE EXCLUSIVE RIGHT TO USE "APPAREL INTERNATIONAL INC", APART FROM THE MARK AS SHOWN.

FOR CAPS, HATS, VISORS, KNIT HATS, STRAW HATS, SCARVES, T-SHIRTS, SWEATSHIRTS AND GLOVES (U.S. CLS. 22 AND 39).

FIRST USE 11-1-2001; IN COMMERCE 11-1-2001.

DOMINIC J. FERRAIUOLO, EXAMINING ATTORNEY

SN 78-203,345. WOOD MANUFACTURING COMPANY, INC., FLIPPIN, AR. FILED 1-15-2003.



FOR CLOTHING, NAMELY, RAIN WEAR IN THE NATURE OF RAIN JACKETS, BIB OVERALLS, AND PANTS; HATS; VISORS; JACKETS; T-SHIRTS; SWEAT-SHIRTS, AND SHORTS (U.S. CLS. 22 AND 39).

TONI HICKEY, EXAMINING ATTORNEY

CLASS 25—(Continued).

SN 78-253,579. WEAR ME APPAREL CORP, NEW YORK, NY. FILED 5-23-2003.

**KIDS HEADQUARTERS
OUTERWEAR**

OWNER OF U.S. REG. NO. 2,079,312.
NO CLAIM IS MADE TO THE EXCLUSIVE RIGHT TO USE "KIDS" AND "OUTERWEAR", APART FROM THE MARK AS SHOWN.

SEC. 2(F) AS TO "KIDS HEADQUARTERS".
FOR CLOTHING, NAMELY, COATS, HATS, CAPS, SHIRTS, KNITTED AND WOVEN TOPS, PANTS, SHORTS, DRESSES, SHOES, TIES, HATS, SCARVES, GLOVES, BELTS, OVERALLS, JEANS, SWEATERS, JACKETS, VESTS, SWEATSHIRTS, SWEATPANTS, SUSPENDERS, UNDERWEAR, SLEEPWEAR; WORKOUT GEAR, NAMELY SWEAT SUITS, SWEATPANTS, SWEATSHIRTS, GYM SHORTS, SNEAKERS, LEG WARMERS, TIGHTS, TRACK SUITS, WRIST BANDS; OUTER WEAR, NAMELY SKI PANTS, COATS, EAR FLAPS, JACKETS, MASKS, VESTS, RAINWEAR, JACKETS, SNOWSUITS, ONE PIECE CHILDREN'S AND BABY'S SUITS, GLOVES, SCARVES, JACKETS, SNOW PANTS, RAINCOATS, RAIN PANTS, VESTS, OVERCOATS (U.S. CLS. 22 AND 39).

JERI J. FICKES, EXAMINING ATTORNEY

CLASS 25—(Continued).

SN 78-277,357. SOJRN LIMITED, INC., KENNESAW, GA. FILED 7-22-2003.



FOR CASHMERE AND CASHMERE BLEND PRODUCTS, NAMELY, SWEATERS, MOCK TURTLE-NECK SWEATERS, TURTLENECK SWEATERS, V-NECK SWEATERS, CAMP SHIRTS, GOLF SHIRTS, KNIT SHIRTS, NIGHT SHIRTS, POLO SHIRTS, SHIRTS, SLEEP SHIRTS, SPORTS SHIRTS, SWEAT SHIRTS, T-SHIRTS, WIND SHIRTS, ROBES, BRIEFS, UNDERWEAR, JACKETS, BED JACKETS, STRAIGHT JACKETS BEING CLOTHING, WIND RESISTANT JACKETS, PANTS, SKI PANTS, SNOW PANTS, SWEAT PANTS, SCARVES, HATS, SOCKS, BLOUSES, DRESSES, SKIRTS, GLOVES, BICYCLE GLOVES (U.S. CLS. 22 AND 39).

FIRST USE 7-18-2003; IN COMMERCE 7-18-2003.
KATHY DE JONGE, EXAMINING ATTORNEY

SN 78-289,073. ROCK JEAN, INC., DBA DENIM ROCK, LOS ANGELES, CA. FILED 8-19-2003.

DENIM ROCK

NO CLAIM IS MADE TO THE EXCLUSIVE RIGHT TO USE "DENIM", APART FROM THE MARK AS SHOWN.

FOR DENIM CLOTHING, NAMELY, LONG PANTS, CAPRI PANTS, SHORTS, SKIRTS, JACKETS, TOPS, SHIRTS AND DRESSES (U.S. CLS. 22 AND 39).

FIRST USE 3-0-2003; IN COMMERCE 3-0-2003.
GEORGE LORENZO, EXAMINING ATTORNEY

SN 78-259,719. KOOL KAT, INC., WINTHROP, MA. FILED 6-8-2003.

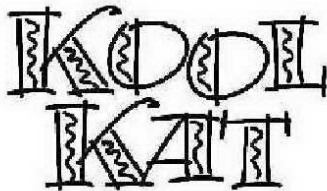

SN 78-296,505. THE KNOT, INC., NEW YORK, NY. FILED 9-5-2003.

TAKEN.

FOR HAWAIIAN SHIRTS, SHIRTS, SKIRTS, DRESSES SARONGS, NECK TIES, HATS, CAPS, KIMONOS, SHORTS ALL MADE IN HAWAIIAN AND/OR TROPICAL PRINT FABRICS (U.S. CLS. 22 AND 39).

FIRST USE 6-0-1996; IN COMMERCE 7-0-1996.
JAMES GRIFFIN, EXAMINING ATTORNEY

FOR CLOTHING, NAMELY, THONG UNDERWEAR (U.S. CLS. 22 AND 39).

FIRST USE 6-0-2003; IN COMMERCE 6-0-2004.
PAULA MAHONEY, EXAMINING ATTORNEY

CLASS 25—(Continued).

SN 78-296,517. KNOT, INC., THE, NEW YORK, NY. FILED 9-5-2003.



FOR CLOTHING, NAMELY, T-SHIRTS (U.S. CLS. 22 AND 39).
FIRST USE 4-0-2003; IN COMMERCE 11-0-2004.
PAULA MAHONEY, EXAMINING ATTORNEY

SN 78-296,559. KNOT, INC., THE, NEW YORK, NY. FILED 9-5-2003.

I DO

FOR CLOTHING, NAMELY, THONG UNDERWEAR (U.S. CLS. 22 AND 39).
FIRST USE 10-0-2002; IN COMMERCE 6-0-2004.
PAULA MAHONEY, EXAMINING ATTORNEY

SN 78-296,595. KNOT, INC., THE, NEW YORK, NY. FILED 9-5-2003.



FOR CLOTHING, NAMELY, T-SHIRTS (U.S. CLS. 22 AND 39).
FIRST USE 4-0-2003; IN COMMERCE 4-0-2004.
PAULA MAHONEY, EXAMINING ATTORNEY

CLASS 25—(Continued).

SN 78-301,343. SIERRA PACIFIC APPAREL, L.T.D., HOUSTON, TX. FILED 9-17-2003.

FEATHERLITE

FOR CLOTHING, NAMELY MEN'S AND WOMEN'S BUTTON-DOWN DRESS AND SPORT SHIRTS (U.S. CLS. 22 AND 39).
TINA L. SNAPP, EXAMINING ATTORNEY

SN 78-307,851. SARA LEE CORPORATION, WINSTON-SALEM, NC. FILED 10-1-2003.

**BODY CREATIONS
ENHANCERS**

OWNER OF U.S. REG. NO. 2,730,617.
FOR GARMENTS THAT SHAPE THE BODY, NAMELY GIRDLES, BODY SUITS, THIGH SHAPERS, LEG SHAPERS AND BRIEFS (U.S. CLS. 22 AND 39).
FIRST USE 1-31-2004; IN COMMERCE 1-31-2004.
NORA BUCHANAN WILL, EXAMINING ATTORNEY

SN 78-310,484. TRETORN AKTIEBOLAG, SE-251 09 HELSINGBORG, SWEDEN, FILED 10-7-2003.

DUNKER

PRIORITY CLAIMED UNDER SEC. 44(D) ON SWEDEN APPLICATION NO. 2003/02313, FILED 4-9-2003, REG. NO. 364747, DATED 12-19-2003, EXPIRES 12-19-2013.
FOR RUBBER HUNTING BOOTS AND RUBBER HIKING BOOTS, ALL FOR EXTREME COLD AND ALL FEATURING UPPERS OF A SPECIALIZED RUBBER COMPOUND (U.S. CLS. 22 AND 39).
CATHERINE CAIN, EXAMINING ATTORNEY

SN 78-314,887. ST. SARA FASHION COMPANY LIMITED, KOWLOON, OTHER, HONG KONG, FILED 10-17-2003.



THE MARK CONSISTS OF WI WI.
THE FOREIGN WORDING IN THE MARK TRANSLATES INTO ENGLISH AS SUPERIOR AND SPIRITED.
FOR CLOTHING, FOOTWEAR AND HEADWEAR, NAMELY, SUITS, TROUSERS, SHIRTS, SKIRTS, DRESSES; SPORTSWEAR AND CHILDREN'S GARMENTS, NAMELY, BLOUSES, OVERCOATS, JACKETS, SHORTS, VESTS AND BELTS (U.S. CLS. 22 AND 39).
FIRST USE 1-9-1997; IN COMMERCE 1-9-1997.
MARY ROSSMAN, EXAMINING ATTORNEY

CLASS 25—(Continued).

SN 78-318,943. CUTTER & BUCK INC., SEATTLE, WA. FILED 10-27-2003.



OWNER OF U.S. REG. NOS. 1,660,896, 2,552,315 AND OTHERS.

FOR APPAREL, NAMELY, SHIRTS, SWEATERS, JACKETS, RAINWEAR, VESTS, PULLOVERS, PANTS, SHORTS, SKIRTS AND SKORTS (U.S. CLS. 22 AND 39).
BARNEY CHARLON, EXAMINING ATTORNEY

SN 78-318,950. CUTTER & BUCK INC., SEATTLE, WA. FILED 10-27-2003.



OWNER OF U.S. REG. NOS. 1,660,896, 2,460,208 AND OTHERS.

FOR APPAREL, NAMELY, SHIRTS, SWEATERS, JACKETS, RAINWEAR, VESTS, PULLOVERS, PANTS, SHORTS, SKIRTS AND SKORTS (U.S. CLS. 22 AND 39).
BARNEY CHARLON, EXAMINING ATTORNEY

CLASS 25—(Continued).

SN 78-322,900. PHILLIPS-VAN HEUSEN CORPORATION, NEW YORK, NY. FILED 11-4-2003.

IZOD X.F.G.

THE MARK CONSISTS OF STANDARD CHARACTERS WITHOUT CLAIM TO ANY PARTICULAR FONT, STYLE, SIZE, OR COLOR.

FOR CLOTHING, NAMELY, SWEATERS, SHIRTS, SHORTS, PANTS, HATS, VESTS, OUTERWEAR, NAMELY, FLEECE PULLOVERS, COATS AND JACKETS (U.S. CLS. 22 AND 39).

FIRST USE 12-31-2001; IN COMMERCE 12-31-2001.
ALICIA COLLINS, EXAMINING ATTORNEY

SN 78-329,196. HANIMIAN, AUGUSTO, MIAMI, FL. FILED 11-17-2003.

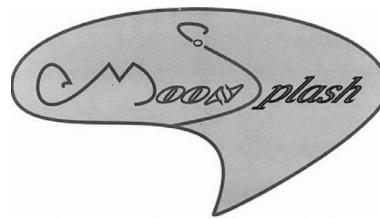

THE COLOR(S) BLACK AND GRAY IS/ARE CLAIMED AS A FEATURE OF THE MARK.

THE COLOR BLACK IS FOUND ON THE OUTLINE OF THE PALETTE, ON THE GRAPHICS INSIDE OF THE PALETTE, AND IN THE LETTERS OF THE WORD "MOON-SPLASH". THE COLOR GRAY IS FOUND INSIDE OF THE PALLETE AS A BACKGROUND COLOR, AND INSIDE OF THE "N" AND THE TWO "O'S" OF THE WORD "MOON".

THE MARK CONSISTS OF A SHADED BACKGROUND AREA SHAPED LIKE AN ARTIST'S PALETTE, WITH THE STYLIZED WORDS INSIDE THE PALETTE "MOON-SPLASH", WHERE THE "M" HAS A BARBED END SIMILAR IN APPEARANCE TO A DEVIL'S TAIL, AND THE "S" HAS A SMALL CIRCLE EMBEDDED IN THE UPPER NECK OF THE LETTER.

FOR BEACHWEAR - BATHING SUITS AND BEACH OUTFITS, NAMELY, SKIRTS, SHIRTS, DRESSES, AND SHORTS, FOR USE AT THE OCEAN, RIVERS, LAKES, POOLS AND OTHER WARM RECREATIONAL LOCATIONS (U.S. CLS. 22 AND 39).

FIRST USE 1-1-1996; IN COMMERCE 1-1-1996.
AMY HELLA, EXAMINING ATTORNEY

CLASS 25—(Continued).

SN 78-329,237. WORLD-ONE INTERNATIONAL, INC., BEVERLY HILLS, CA. FILED 11-17-2003.

Duke of Hollywood Originals

THE MARK CONSISTS OF STANDARD CHARACTERS WITHOUT CLAIM TO ANY PARTICULAR FONT, STYLE, SIZE, OR COLOR.

NO CLAIM IS MADE TO THE EXCLUSIVE RIGHT TO USE "HOLLYWOOD ORIGINALS", APART FROM THE MARK AS SHOWN.

FOR APPAREL FOR MEN, WOMEN AND CHILDREN NAMELY JEANS, PANTS, SLACKS, JUMPSUITS, SHORTS, SKIRTS, TIES, SWEATERS, KNIT TOPS, WOVEN SHIRTS AND SHELLS, SOCKS, SHOES, SNEAKERS, BLOUSES, T-SHIRTS, DRESSES, NECKERCHIEFS, CARDIGANS, TUNICS, HATS, GLOVES, SWEATERS, BELTS, OVERALLS, BLAZERS (U.S. CLS. 22 AND 39).

FIRST USE 9-10-2003; IN COMMERCE 9-10-2003.
SAMUEL E. SHARPER JR., EXAMINING ATTORNEY

SN 78-331,816. FEURTADO, KENDALL C., PLANTATION, FL. FILED 11-22-2003.



THE MARK CONSISTS OF A STYLIZED LETTER G WITHIN TWO CRESCENTS. UNDERNEATH THE STYLIZED G ARE THE WORDS GLAMMA GYAL.

FOR SHIRTS, PANTS AND SHOES (U.S. CLS. 22 AND 39).

FIRST USE 0-0-2003; IN COMMERCE 0-0-2003.
SUSAN STIGLITZ, EXAMINING ATTORNEY

CLASS 25—(Continued).

SN 78-333,995. JACOBSON, EVAN MOSS, GOLDEN VALLEY, MN. FILED 11-27-2003.

Midwest Movement

THE MARK CONSISTS OF STANDARD CHARACTERS WITHOUT CLAIM TO ANY PARTICULAR FONT, STYLE, SIZE, OR COLOR.

FOR CLOTHING AND APPAREL, NAMELY, T-SHIRTS, LONG-SLEEVE SHIRTS, HATS, VISORS, SHORTS, SWEATSUITS, JERSEYS, ARMBANDS, WRISTBANDS, HEADBANDS, SWIMSUITS, SOCKS, SWEATPANTS, BOXER SHORTS, PAJAMAS, POLO SHIRTS, JEANS, SPORTS BRAS, TANK TOPS, TUBE TOPS, SLEEVELESS SHIRTS (U.S. CLS. 22 AND 39).

MARC LEIPZIG, EXAMINING ATTORNEY

SN 78-337,199. MARINOVICH-ZIVNUSKA, DANIELLE SIOBHAN, BERKELEY, CA. FILED 12-5-2003.



THE MARK CONSISTS OF A LITTLE GIRL DOLL NAMED BETTY.

FOR CLOTHING, NAMELY, T-SHIRTS (U.S. CLS. 22 AND 39).

FIRST USE 5-1-2003; IN COMMERCE 5-29-2003.
SUELLEN HICKEY, EXAMINING ATTORNEY

SN 78-340,225. SARA LEE CORPORATION, WINSTON-SALEM, NC. FILED 12-12-2003.

LACE CRAZE

THE MARK CONSISTS OF STANDARD CHARACTERS WITHOUT CLAIM TO ANY PARTICULAR FONT, STYLE, SIZE, OR COLOR.

OWNER OF U.S. REG. NO. 2,626,619.
NO CLAIM IS MADE TO THE EXCLUSIVE RIGHT TO USE "LACE", APART FROM THE MARK AS SHOWN.

FOR PANTIES (U.S. CLS. 22 AND 39).
FIRST USE 9-15-2004; IN COMMERCE 9-15-2004.
NORA BUCHANAN WILL, EXAMINING ATTORNEY

CLASS 25—(Continued).

SN 78-342,530. PARK, KENNY J., LOS ANGELES, CA. FILED 12-18-2003.

SAMPLE JEANS

THE MARK CONSISTS OF STANDARD CHARACTERS WITHOUT CLAIM TO ANY PARTICULAR FONT, STYLE, SIZE, OR COLOR.

NO CLAIM IS MADE TO THE EXCLUSIVE RIGHT TO USE "JEANS", APART FROM THE MARK AS SHOWN.

FOR APPAREL, NAMELY, JEANS, PANTS, SHORTS, BOTTOMS, SHIRTS, TANK TOPS, TOPS (U.S. CLS. 22 AND 39).

JANICE L. MCMORROW, EXAMINING ATTORNEY

SN 78-352,093. OLSON, BRIAN, PLEASANTON, CA. FILED 1-14-2004.

BAYCAL

THE MARK CONSISTS OF STANDARD CHARACTERS WITHOUT CLAIM TO ANY PARTICULAR FONT, STYLE, SIZE, OR COLOR.

FOR CLOTHING, NAMELY, HATS, VISORS, T-SHIRTS, AND SWEATSHIRTS (U.S. CLS. 22 AND 39).

FIRST USE 1-10-2004; IN COMMERCE 1-10-2004.

ELIZABETH PIGNATELLO, EXAMINING ATTORNEY

SN 78-354,726. LYNN BUTLER DESIGN INC., NEW YORK, NY. FILED 1-21-2004.

**Lynn Butler new
york**

THE MARK CONSISTS OF STANDARD CHARACTERS WITHOUT CLAIM TO ANY PARTICULAR FONT, STYLE, SIZE, OR COLOR.

NO CLAIM IS MADE TO THE EXCLUSIVE RIGHT TO USE "NEW YORK", APART FROM THE MARK AS SHOWN.

THE NAME LYNN BUTLER IDENTIFIES A LIVING INDIVIDUAL WHOSE CONSENT IS OF RECORD.

FOR CLOTHING AND APPAREL, NAMELY SHIRTS, TIES, PANTS, UNDERGARMETS, COATS (U.S. CLS. 22 AND 39).

FIRST USE 1-9-2003; IN COMMERCE 1-9-2003.

TERESA M. RUPP, EXAMINING ATTORNEY

CLASS 25—(Continued).

SN 78-359,337. PACIFIC DR LLC, IRVINGTON, NY. FILED 1-29-2004.

1844

THE MARK CONSISTS OF STANDARD CHARACTERS WITHOUT CLAIM TO ANY PARTICULAR FONT, STYLE, SIZE, OR COLOR.

FOR CASUAL APPAREL FOR MEN, WOMEN AND CHILDREN, NAMELY, PANTS, SHIRTS, SOCKS, JACKETS, JEANS, HATS, SCARVES, SKIRTS, SWEATERS, VESTS, COATS AND UNDERGARMENTS (U.S. CLS. 22 AND 39).

ALICE BENMAMAN, EXAMINING ATTORNEY

SN 78-364,792. SARA LEE CORPORATION, WINSTON-SALEM, NC. FILED 2-9-2004.

LIFT APPEAL

THE MARK CONSISTS OF STANDARD CHARACTERS WITHOUT CLAIM TO ANY PARTICULAR FONT, STYLE, SIZE, OR COLOR.

OWNER OF U.S. REG. NO. 2,243,821.

NO CLAIM IS MADE TO THE EXCLUSIVE RIGHT TO USE "LIFT", APART FROM THE MARK AS SHOWN.

FOR BRASSIERES (U.S. CLS. 22 AND 39).

FIRST USE 12-19-2003; IN COMMERCE 12-19-2003.

CHRISTOPHER BUONGIORNO, EXAMINING ATTORNEY

CLASS 25—(Continued).

SN 78-370,076. CELEBRITIES CHOICE, INC., WINTER PARK, FL. FILED 2-18-2004.

TOMASO D'ORO

THE MARK CONSISTS OF STANDARD CHARACTERS WITHOUT CLAIM TO ANY PARTICULAR FONT, STYLE, SIZE, OR COLOR.

THE NAME TOMASO D'ORO DOES NOT IDENTIFY A LIVING INDIVIDUAL.

THE FOREIGN WORDING IN THE MARK TRANSLATES INTO ENGLISH AS "THOMAS OF GOLD".

FOR CLOTHING, NAMELY, FOOTWEAR, SHOES, ATHLETIC SHOES, SANDALS, AQUA SHOES, SPORT SANDALS, CANVAS SHOES, SOCCER SHOES, DRESS SANDALS, BOAT SHOES, SLIPPERS, T-SHIRTS, JERSEYS, SHIRTS, SWEAT SHIRTS, SWEAT PANTS, SWIM WEAR, DRESSES, JACKETS, PANTS, NIGHT SHIRTS, SKIRTS, ROBES, CAPS, HATS, VISORS, BELTS, PAJAMAS, SHORTS, SOCKS, LINGERIE, UNDERWEAR, BANDANNAS, JOGGING OUTFITS, NECKTIES, AND YOGA/EXERCISE PANTS (U.S. CLS. 22 AND 39).

SHARON MEIER, EXAMINING ATTORNEY

CLASS 25—(Continued).

SN 78-375,246. MARVEL CHARACTERS, INC., LOS ANGELES, CA. FILED 2-27-2004.

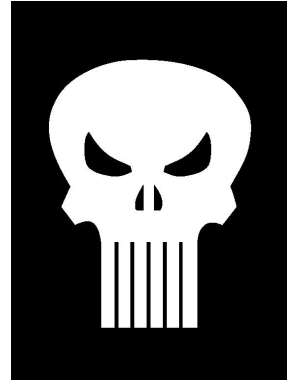

THE MARK CONSISTS OF A STYLIZED DESIGN OF A HUMAN SKULL.

FOR CLOTHING, NAMELY, T-SHIRTS, SWEAT-SHIRTS, SHIRTS, JACKETS, UNDERWEAR, HATS, HEADBANDS, TIES, HALLOWEEN AND MASQUERADE COSTUMES (U.S. CLS. 22 AND 39).

FIRST USE 11-30-1987; IN COMMERCE 11-30-1987.

PAUL F. GAST, EXAMINING ATTORNEY

SN 78-370,100. KENNETH S. DUNN, ATHENS, GA. FILED 2-18-2004.



THE MARK CONSISTS OF A SQUATTING YOUNG MALE WITH A HAT AND BAGGY PANTS, HOLDING A BOOK IN ONE HAND, AND DISPLAYING A PEACE SIGN WITH THE OTHER HAND. THE WORDS STREET MINISTRY ARE OVER THE YOUNG MAN'S CAP, AND OVER THE WORDING IS A CITYSCAPE WITH A SETTING SUN.

FIRST USE 12-10-2003; IN COMMERCE 2-14-2004.
LINDA POWELL, EXAMINING ATTORNEY

SN 78-379,367. MRAS SIGNATURES LLC, LOUISVILLE, KY. FILED 3-5-2004.

EBONICS

THE MARK CONSISTS OF STANDARD CHARACTERS WITHOUT CLAIM TO ANY PARTICULAR FONT, STYLE, SIZE, OR COLOR.

FOR CLOTHING, NAMELY SHIRTS, SWEATERS, SHOES, CAPS, BANDANNAS, SHORTS, SWEAT SHIRTS, PANTS, BELTS FOR CLOTHING, SOCKS, JACKETS, COATS, BLOUSES, DRESSES, FOOTWEAR, SCARVES, HATS, HEAD BANDS (U.S. CLS. 22 AND 39).

FIRST USE 4-0-2001; IN COMMERCE 6-0-2001.

JEFF DEFORD, EXAMINING ATTORNEY

CLASS 25—(Continued).

SN 78-382,608. DISNEY ENTERPRISES, INC, BURBANK, CA.
FILED 3-11-2004.

PISTON CUP

THE MARK CONSISTS OF STANDARD CHARACTERS WITHOUT CLAIM TO ANY PARTICULAR FONT, STYLE, SIZE, OR COLOR.

FOR BATHING SUITS; BEACHWEAR; BELTS; CLOTH BIBS FOR BABIES; UNDERWEAR; SWEATERS; HALLOWEEN COSTUMES; DRESSES; GLOVES; HATS; CAPS; HOSIERY; INFANT WEAR; JACKETS; MITTENS; PAJAMAS; PANTS; SWEAT PANTS; SWEAT SHIRTS; SHIRTS; SHOES; SHORTS; SLEEPERS; SOCKS; T-SHIRTS; TANK TOPS; TIGHTS; VESTS; JERSEYS; SCARVES; NECKTIES; ROBES; NIGHT SHIRTS; NIGHT GOWNS; HEAD BANDS; WRIST BANDS; SKIRTS; COATS; LEOTARDS; LEG WARMERS; STOCKINGS; PANTY HOSE; ATHLETIC SHOES; SLIPPERS; BOOTS; SANDALS; RAINWEAR (U.S. CLS. 22 AND 39).

BRIDGETT SMITH, EXAMINING ATTORNEY

SN 78-382,610. DISNEY ENTERPRISES, INC, BURBANK, CA.
FILED 3-11-2004.

RUST-EZE

THE MARK CONSISTS OF STANDARD CHARACTERS WITHOUT CLAIM TO ANY PARTICULAR FONT, STYLE, SIZE, OR COLOR.

FOR BATHING SUITS; BEACHWEAR; BELTS; CLOTH BIBS FOR BABIES; UNDERWEAR; SWEATERS; HALLOWEEN COSTUMES; DRESSES; GLOVES; HATS; CAPS; HOSIERY; INFANT WEAR; JACKETS; MITTENS; PAJAMAS; PANTS; SWEAT PANTS; SWEAT SHIRTS; SHIRTS; SHOES; SHORTS; SLEEPERS; SOCKS; T-SHIRTS; TANK TOPS; TIGHTS; VESTS; JERSEYS; SCARVES; NECKTIES; ROBES; NIGHT SHIRTS; NIGHT GOWNS; HEAD BANDS; WRIST BANDS; SKIRTS; COATS; LEOTARDS; LEG WARMERS; STOCKINGS; PANTY HOSE; ATHLETIC SHOES; SLIPPERS; BOOTS; SANDALS; RAINWEAR (U.S. CLS. 22 AND 39).

BRIDGETT SMITH, EXAMINING ATTORNEY

CLASS 25—(Continued).

SN 78-383,247. COORS GLOBAL PROPERTIES, INC., DENVER, CO. FILED 3-12-2004.



THE MARK CONSISTS OF CL LOGO.

FOR CLOTHING AND APPAREL; NAMELY, SHIRTS, T-SHIRTS, GOLF SHIRTS, SWEATSHIRTS, BOWLING SHIRTS, DENIM SHIRTS, PANTS, TOPS, SHORTS, DRESSES, SWEAT PANTS, TANK TOPS, JACKETS, WIND RESISTANT JACKETS, PONCHOS, HATS, AND CAPS (U.S. CLS. 22 AND 39).

FIRST USE 1-1-2005; IN COMMERCE 1-1-2005.

STANLEY I. OSBORNE, EXAMINING ATTORNEY

SN 78-386,115. BUNGARD, SARAH, PHOENIX, AZ. FILED 3-17-2004.

IZM

THE MARK CONSISTS OF STANDARD CHARACTERS WITHOUT CLAIM TO ANY PARTICULAR FONT, STYLE, SIZE, OR COLOR.

FOR CLOTHING, NAMELY SHIRTS, T-SHIRTS, PANTS (U.S. CLS. 22 AND 39).

THEODORE MCBRIDE, EXAMINING ATTORNEY

CLASS 25—(Continued).

SN 78-387,001. CJLF, INC., LOS ANGELES, CA. FILED 3-18-2004.



FOR CLOTHING, NAMELY, SHIRTS, BLOUSES, CAMISOLES, TANK TOPS, SWEATERS, JACKETS, SKIRTS, PANTS, CAPRI PANTS, SHORT PANTS, DRESSES, PANTIES, THONG PANTIES, HEAD BANDS, BANDANAS, SCARVES (U.S. CLS. 22 AND 39).
FIRST USE 4-1-2002; IN COMMERCE 4-1-2002.
CHRISTOPHER BUONGIORNO, EXAMINING ATTORNEY

SN 78-393,789. MILLIKEN & COMPANY, SPARTANBURG, SC. FILED 3-31-2004.

ANOTHER SMART
FABRIC BY MILLIKEN

THE MARK CONSISTS OF STANDARD CHARACTERS WITHOUT CLAIM TO ANY PARTICULAR FONT, STYLE, SIZE, OR COLOR.
OWNER OF U.S. REG. NOS. 908,674, 1,710,105 AND OTHERS.
NO CLAIM IS MADE TO THE EXCLUSIVE RIGHT TO USE SMART FABRIC, APART FROM THE MARK AS SHOWN.
FOR APPAREL, NAMELY SUITS, UNIFORMS CLOAKS, COATS, JACKETS, SWEATERS, OVERCOATS, SHIRTS, DRESSES, SKIRTS, PANTS, SHORTS, ROBES, PAJAMAS, UNDERGARMENTS, SWIMWEAR, HATS, HOSE, LEGGINGS, TIGHTS (U.S. CLS. 22 AND 39).
RAUL CORDOVA, EXAMINING ATTORNEY

CLASS 25—(Continued).

SN 78-396,224. NEW ORLEANS ZEPHYRS BASEBALL CLUB, LLC, METAIRIE, LA. FILED 4-5-2004.



THE MARK CONSISTS OF A RODENT WEARING A BASEBALL CAP BEARING THE LETTER "Z" BITING THE WORD "ZEPHYRS."

FOR CLOTHING, NAMELY, APRONS, ATHLETIC UNIFORMS, BANDANAS, BOXER SHORTS, CAPS, CLOTH BABY BIBS, COATS, GOLF SHIRTS, GYM SHORTS, GYM SUITS, HATS, JACKETS, JERSEYS, JOGGING SUITS, KNIT SHIRTS, PAJAMAS, POLO SHIRTS, PONCHOS, PULLOVERS, RAIN COATS, RAINWEAR, SWEATERS, SWEAT PANTS, SWEAT SHIRTS, SWEAT SUITS, SOCKS, SPORT SHIRTS, T-SHIRTS, TANK TOPS, TIES, VISORS, WIND RESISTANT JACKETS AND WRISTBANDS (U.S. CLS. 22 AND 39).
FIRST USE 1-0-2004; IN COMMERCE 2-10-2004.
ALICE BENMAMAN, EXAMINING ATTORNEY

SN 78-396,261. NEW ORLEANS ZEPHYRS BASEBALL CLUB, LLC, METAIRIE, LA. FILED 4-5-2004.



THE MARK CONSISTS OF A RODENT WEARING A BASEBALL CAP BITING THE LETTER "Z".
FOR CLOTHING, NAMELY, APRONS, ATHLETIC UNIFORMS, BANDANAS, BOXER SHORTS, CAPS, CLOTH BABY BIBS, COATS, GOLF SHIRTS, GYM SHORTS, GYM SUITS, HATS, JACKETS, JERSEYS, JOGGING SUITS, KNIT SHIRTS, PAJAMAS, POLO SHIRTS, PONCHOS, PULLOVERS, RAIN COATS, RAINWEAR, SWEATERS, SWEAT PANTS, SWEAT SHIRTS, SWEAT SUITS, SOCKS, SPORT SHIRTS, T-SHIRTS, TANK TOPS, TIES, VISORS, WIND RESISTANT JACKETS AND WRISTBANDS (U.S. CLS. 22 AND 39).
FIRST USE 1-0-2004; IN COMMERCE 2-10-2004.
DEZMONA MIZELLE, EXAMINING ATTORNEY

CLASS 25—(Continued).

SN 78-397,680. ROUND ROCK BASEBALL, INC, ROUND ROCK, TX. FILED 4-7-2004.



NO CLAIM IS MADE TO THE EXCLUSIVE RIGHT TO USE "CORPUS CHRISTI", APART FROM THE MARK AS SHOWN.

THE MARK CONSISTS OF THE WORDING "CORPUS CHRISTI HOOKS" STYLIZED WITH TWO HOOKS.

FOR CLOTHING, NAMELY, APRONS, ATHLETIC UNIFORMS, BANDANAS, BOXER SHORTS, CAPS, CLOTH BABY BIBS, COATS, GOLF SHIRTS, GYM SHORTS, GYM SUITS, HATS, JACKETS, JERSEYS, JOGGING SUITS, KNIT SHIRTS, PAJAMAS, POLO SHIRTS, PONCHOS, PULLOVERS, RAIN COATS, RAINWEAR, SWEATERS, SWEAT PANTS, SWEAT SHIRTS, SWEAT SUITS, SOCKS, SPORT SHIRTS, T-SHIRTS, TANK TOPS, TIES, VISORS, WIND RESISTANT JACKETS AND WRISTBANDS (U.S. CLS. 22 AND 39).

FIRST USE 2-0-2004; IN COMMERCE 3-11-2004.
LANA PHAM, EXAMINING ATTORNEY

CLASS 25—(Continued).

SN 78-400,031. REMANENTS, LLC, COLLINGSWOOD, NJ. FILED 4-12-2004.

REMANENTS

THE MARK CONSISTS OF STANDARD CHARACTERS WITHOUT CLAIM TO ANY PARTICULAR FONT, STYLE, SIZE, OR COLOR.

FOR CLOTHING, NAMELY T-SHIRTS, SWEATSHIRTS, SHORTS, AND SPORTSWEAR IN THE NATURE OF TEAM JERSEYS AND HATS (U.S. CLS. 22 AND 39).

WILLIAM VERHOSEK, EXAMINING ATTORNEY

SN 78-397,847. DIBENEDETTO, TONY E., ROCKY RIVER, OH. FILED 4-7-2004.

OUTER BODY EXPERIENCE

THE MARK CONSISTS OF STANDARD CHARACTERS WITHOUT CLAIM TO ANY PARTICULAR FONT, STYLE, SIZE, OR COLOR.

FOR CLOTHING, NAMELY, PANTS, SHIRTS, SWEATERS, SWEATSHIRTS, T-SHIRTS, GOLF SHIRTS, TURTLENECKS, JERSEYS, TANK TOPS, VESTS, SHORTS, SWIM TRUNKS, SWIMWEAR, BIKINIS, SKIRTS, SWEAT PANTS, WARM-UP SUITS, SPORTCOATS, JEANS, SUITS, OVERALLS, PARKAS, PONCHOS, COATS, JACKETS, BLAZERS, RAINWEAR, WIND RESISTANT JACKETS, SLEEPWEAR, ROBES, UNDERWEAR, LINGERIE, BELTS, TIES, HATS, CAPS, VISORS, SCARVES, HEADBANDS, EAR MUFFS, WRISTBANDS, BOXER SHORTS, PAJAMAS, TIES, IN THE NATURE OF NECK TIES, BOW TIES AND BANDANAS, SOCKS, HOSIERY, SHOES, BOOTS, SNEAKERS, BEACH SHOES, SANDALS, SLIPPERS, GLOVES, AND SUSPENDERS (U.S. CLS. 22 AND 39).

RAMONA ORTIGA, EXAMINING ATTORNEY

SN 78-403,416. REDER, THOMAS, HOUSTON, TX. AND EVANS, DANIEL, HOUSTON, TX. FILED 4-16-2004.

Shanghai Shake

THE MARK CONSISTS OF STANDARD CHARACTERS WITHOUT CLAIM TO ANY PARTICULAR FONT, STYLE, SIZE, OR COLOR.

NO CLAIM IS MADE TO THE EXCLUSIVE RIGHT TO USE "SHANGHAI", APART FROM THE MARK AS SHOWN. FOR SHIRTS, PANTS, SHOES (U.S. CLS. 22 AND 39).

DANIEL BRODY, EXAMINING ATTORNEY

CLASS 25—(Continued).

SN 78-403,492. WORLD WRESTLING ENTERTAINMENT, INC., STAMFORD, CT. FILED 4-16-2004.

MAVEN

THE MARK CONSISTS OF STANDARD CHARACTERS WITHOUT CLAIM TO ANY PARTICULAR FONT, STYLE, SIZE, OR COLOR.

FOR CLOTHING, NAMELY, TANK TOPS, T-SHIRTS, SHIRTS, SPORT SHIRTS, DRESS SHIRTS, POLO SHIRTS, UNDERSHIRTS, SWEATSHIRTS, SWEATERS, PULL-OVERS, BLOUSES, JACKETS, RAINCOATS, OVERCOATS, TOPCOATS, TROUSERS, PANTS, JEAN PANTS, JOGGING SUITS, EXERCISE PANTS, EXERCISE SUITS, SWEATPANTS, SHORTS, UNDERWEAR, BOXER SHORTS, SOCKS, CLOTHING TIES, PAJAMAS, BELTS, GLOVES, HALLOWEEN AND MASQUERADE COSTUMES, WRIST BANDS, BANDANNAS; FOOTWEAR, NAMELY, SHOES, SNEAKERS, BOOTS, SLIPPERS; HEADWEAR, NAMELY, HATS, CAPS (U.S. CLS. 22 AND 39).

ZACHARY BELLO, EXAMINING ATTORNEY

SN 78-405,993. TUSKEGEE AIRMEN, INC., ARLINGTON, VA. FILED 4-21-2004.

TUSKEGEE AIRMEN

THE MARK CONSISTS OF STANDARD CHARACTERS WITHOUT CLAIM TO ANY PARTICULAR FONT, STYLE, SIZE, OR COLOR.

OWNER OF U.S. REG. NO. 2,327,717.
SEC. 2(F).

FOR CLOTHING, NAMELY, SHIRTS, JACKETS, T-SHIRTS, SWEATSHIRTS, SOCKS, TIES, CAPS, SCARVES, JACKETS, AND SWIM-WEAR (U.S. CLS. 22 AND 39).
FIRST USE 2-25-1975; IN COMMERCE 2-25-1975.
MICHELLE S. WISEMAN, EXAMINING ATTORNEY

CLASS 25—(Continued).

SN 78-407,007. VAUNT CLOTHING, BRAWLEY, CA. FILED 4-23-2004.

Vaunt

THE MARK CONSISTS OF STANDARD CHARACTERS WITHOUT CLAIM TO ANY PARTICULAR FONT, STYLE, SIZE, OR COLOR.

FOR HATS, SHIRTS, PANTS, SHOES, BELTS, CAPS, JACKETS, GLOVES, SCARVES, COATS, VESTS, DRESSES, SKIRTS, TOPS, SHORTS, SWIM WEAR (U.S. CLS. 22 AND 39).

FIRST USE 4-15-2003; IN COMMERCE 3-9-2004.
JASON LOTT, EXAMINING ATTORNEY

SN 78-410,119. SURFARI.COM, LLC, PORTSMOUTH, NH. FILED 4-29-2004.

Find your soul.

THE MARK CONSISTS OF STANDARD CHARACTERS WITHOUT CLAIM TO ANY PARTICULAR FONT, STYLE, SIZE, OR COLOR.

FOR SURFING, YOGA, AND ADVENTURE SPORTS INSPIRED APPAREL FOR MEN AND WOMEN, NAMELY, SHORT SLEEVE AND LONG SLEEVE SHIRTS, T-SHIRTS, POLO SHIRTS, KNIT SHIRTS, WOMEN SHIRTS, TANK TOPS, SUITS, NECK TIES, JACKETS, COATS, JOGGING SUITS, SWEAT SHIRTS, SWEAT PANTS, SWEATERS, JERSEYS, BLOUSES, JUMPERS, OVERALLS, UNDERGARMENTS, PAJAMAS, SLEEPWEAR, PANTS, SLACKS, SHORTS, JEANS, SKIRTS, DRESSES, SOCKS, BELTS, SUSPENDERS, CAPS, HATS, VISORS, BANDANAS, HEADBANDS, WRISTBANDS, FOOTWEAR, SCARVES, GLOVES, WETSUITS, RAINWEAR, AND SWIMWEAR (U.S. CLS. 22 AND 39).
JAMES GRIFFIN, EXAMINING ATTORNEY

CLASS 25—(Continued).

SN 78-410,199. C. S. ANDERSON ENTERPRISES, INC., DALLAS, TX. FILED 4-29-2004.



NO CLAIM IS MADE TO THE EXCLUSIVE RIGHT TO USE CALIFORNIA SURF, APART FROM THE MARK AS SHOWN.

FOR CLOTHING BEARING DEFUNCT SPORTS TEAM LOGOS, NAMELY T-SHIRTS, SWEATSHIRTS, JERSEYS, HATS, AND CAPS (U.S. CLS. 22 AND 39).

FIRST USE 9-15-2002; IN COMMERCE 9-15-2002.

JOHN WILKE, EXAMINING ATTORNEY

CLASS 25—(Continued).

SN 78-411,381. BROWN, DAN, EXETER, NH. FILED 4-30-2004.

THE DA VINCI CODE

THE MARK CONSISTS OF STANDARD CHARACTERS WITHOUT CLAIM TO ANY PARTICULAR FONT, STYLE, SIZE, OR COLOR.

FOR CLOTHING NAMELY, CAPS, T-SHIRTS, JACKETS, SWEATSHIRTS, SHIRTS, NECKTIES, PANTS, SWEATERS, BANDANAS, SWEATBANDS AND SCARVES (U.S. CLS. 22 AND 39).

BARNEY CHARLON, EXAMINING ATTORNEY

SN 78-410,580. EDWIN CO., LTD., TOKYO, JAPAN, FILED 4-29-2004.

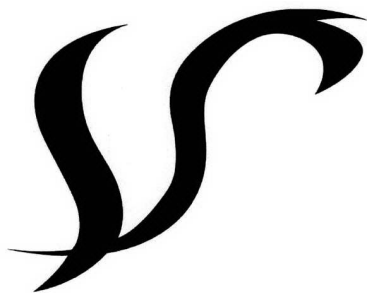

FOR CLOTHING, NAMELY, SHIRTS, POLO SHIRTS, PANTS, SCARVES, PULLOVERS, WAISTCOATS, CAPES, TROUSERS, VESTS, PARKAS, SWEATERS, SWEATSHIRTS, BLAZERS, TUNICS, GAITERS, KNITWEAR, NAMELY, KNITTED SHIRTS, KNITTED CAPS, KNITTED GLOVES AND KNITTED MUFFLERS; LEGGINGS, TIES, BELTS, SUSPENDERS, HEAD BANDS, WRIST BANDS, BLOUSES, SKIRTS, DRESSES, CLOAKS, SOCKS, JEANS, TRACK SUITS, SPORTS TRACKSUITS, EARMUFFS, BANDANAS, COLLARS, JERKINS, SLACKS, SHORTS, MITTENS, TANK TOPS, T-SHIRTS, CARDIGANS, JUMPERS, UNDERWEAR, BRIEFS, KERICHS, BRASSIERES, CORSETS, HOSIERY, PETTICOATS, RAINCOATS, OVERCOATS, ANORAKS, STOCKINGS, PANTYHOSE, SLIPS, BATHING SUITS, BATH ROBES, NIGHTGOWNS, DRESSING GOWNS, PAJAMAS, BODY SUITS, JOGGING SUITS, JUMPSUITS, GLOVES, COATS, JACKETS, SPORTS JACKETS, WIND RESISTANT JACKETS, JERSEYS, FOULARDS; FOOTWEAR, NAMELY, SHOES, SLIPPERS, BOOTS, SANDALS; HEADWEAR, NAMELY, HATS, SUN VISORS, BERETS, CAPS, HOODS (U.S. CLS. 22 AND 39).

DAWN HAN, EXAMINING ATTORNEY

SN 78-412,139. NOMADIC TRADERS, INC, BERKELEY, CA. FILED 5-3-2004.



THE COLOR(S) BLACK AND WHITE IS/ARE CLAIMED AS A FEATURE OF THE MARK.

THE COLOR(S) BLACK AND WHITE IS/ARE CLAIMED AS A FEATURE OF THE MARK.

THE MARK CONSISTS OF THE LETTERS NTCO ARE WHITE IN BLACK BOXES WITH A WHITE BACKGROUND, IN QUADRANT FORM.

THE MARK CONSISTS OF THE LETTERS NTCO ARE WHITE IN BLACK BOXES WITH A WHITE BACKGROUND, IN QUADRANT FORM.

FOR WOMEN'S BLOUSES, TEE-SHIRTS, TANK-TOPS, JACKETS, SKIRTS, DRESSES AND SWEATERS (U.S. CLS. 22 AND 39).

FIRST USE 7-15-1997; IN COMMERCE 8-15-1997.

G. MAYERSCHOFF, EXAMINING ATTORNEY

CLASS 25—(Continued).

SN 78-412,635. SICK BOY, LLC, CUMBERLAND, RI. FILED 5-4-2004.

CLASS 25—(Continued).

SN 78-413,266. DUK, INC., LAGRANGE, GA. FILED 5-5-2004.

SICK CHICK

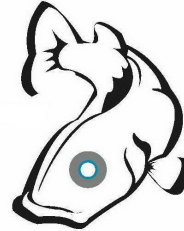

THE MARK CONSISTS OF STANDARD CHARACTERS WITHOUT CLAIM TO ANY PARTICULAR FONT, STYLE, SIZE, OR COLOR.
OWNER OF U.S. REG. NOS. 2,510,347 AND 2,677,793.
FOR SHIRTS, TANK TOPS, T-SHIRTS, SWEATSHIRTS, JACKETS, HATS, UNDERWEAR (U.S. CLS. 22 AND 39).
FIRST USE 6-30-2001; IN COMMERCE 6-30-2001.
CHRISTOPHER ADKINS, EXAMINING ATTORNEY

THE COLOR(S) GREY AND AQUA IS/ARE CLAIMED AS A FEATURE OF THE MARK.
THE MARK CONSISTS OF A FISH WITH A CIRCLE AS THE EYE; THE OUTER CIRCLE IS GREY AND THE INNER CIRCLE IS AQUA.
FOR FOOTWEAR, HEADWEAR, AND CLOTHING, NAMELY SHIRTS, JACKETS, PANTS, SOCKS, UNDERWEAR, SHORTS, OVERALLS, COVERALLS, BELTS (U.S. CLS. 22 AND 39).
DAVID MURRAY, EXAMINING ATTORNEY

SN 78-412,713. DEMOULIN, INC., GREENVILLE, IL. FILED 5-4-2004.

SN 78-415,518. HOOTER HIDERS CO., LOS GATOS, CA. FILED 5-8-2004.



Hooter Hiders

THE COLOR(S) RED AND BLACK IS/ARE CLAIMED AS A FEATURE OF THE MARK.
THE COLOR RED APPEARS AS THE FIRST LETTER V AND AS THE DOT ABOVE THE I. THE COLOR BLACK APPEARS AS THE BOTTOM PORTION OF THE I, THE SECOND LETTER V AND THE LETTERS ACE.
THE FOREIGN WORDING IN THE MARK TRANSLATES INTO ENGLISH AS LIVELY.
FOR CLOTHING, NAMELY BAND UNIFORMS (U.S. CLS. 22 AND 39).
DAWN FELDMAN, EXAMINING ATTORNEY

THE MARK CONSISTS OF STANDARD CHARACTERS WITHOUT CLAIM TO ANY PARTICULAR FONT, STYLE, SIZE, OR COLOR.
FOR NURSING COVER UP (U.S. CLS. 22 AND 39).
FIRST USE 10-1-2003; IN COMMERCE 1-1-2004.
TEJBIR SINGH, EXAMINING ATTORNEY

CLASS 25—(Continued).

SN 78-415,666. JACQUES MORET, INC., NEW YORK, NY. FILED 5-10-2004.

I'M A PRINCESS

THE MARK CONSISTS OF STANDARD CHARACTERS WITHOUT CLAIM TO ANY PARTICULAR FONT, STYLE, SIZE, OR COLOR.

FOR WEARING APPAREL, NAMELY LEOTARDS, LEGGINGS, TOPS, BOTTOMS, TIGHTS, FOOTWEAR, AND BELTS (U.S. CLS. 22 AND 39).

SCOTT BALDWIN, EXAMINING ATTORNEY

CLASS 25—(Continued).

SN 78-417,844. MINTZ, LEEJAY, LOS ANGELES, CA. FILED 5-13-2004.



THE STIPPLING IS FOR SHADING PURPOSES. THE MARK CONSISTS OF AN OLD-FASHIONED FLAT IRON.

FOR CLOTHING FOR MEN, WOMEN AND CHILDREN, NAMELY, DRESSES, SHIRTS, SKIRTS, SHORTS, BATHING SUITS, JACKETS, SCARVES, BELTS, PANTS, T-SHIRTS, BLOUSES, SWEATERS, PONCHOS, JUMPSUITS, SOCKS, VESTS, NECKTIES, GLOVES, AND HATS (U.S. CLS. 22 AND 39).

FIRST USE 5-1-2004; IN COMMERCE 5-1-2004.

ALEXANDER L. POWERS, EXAMINING ATTORNEY

SN 78-416,145. FUSE NETWORKS LLC, JERICHO, NY. FILED 5-10-2004.

FAST, HARD AND HEAVY

THE MARK CONSISTS OF STANDARD CHARACTERS WITHOUT CLAIM TO ANY PARTICULAR FONT, STYLE, SIZE, OR COLOR.

FOR CLOTHING, NAMELY, T-SHIRTS (U.S. CLS. 22 AND 39).

ALLISON HOLTZ, EXAMINING ATTORNEY

SN 78-418,961. MOUNTAIN GEAR, INC., EAST HANOVER, NJ. FILED 5-14-2004.



NO CLAIM IS MADE TO THE EXCLUSIVE RIGHT TO USE GEAR, APART FROM THE MARK AS SHOWN.

THE MARK CONSISTS OF A STYLIZED LETTER M, A CIRCLE, WAVY LINES, AND THE WORDS, MOUNTAIN GEAR.

SEC. 2(F).

FOR FOOTWEAR, NAMELY, HIKING SHOES, HIKING BOOTS, WORK SHOES AND WORK BOOTS (U.S. CLS. 22 AND 39).

FIRST USE 11-25-1995; IN COMMERCE 11-25-1995.

RUSS HERMAN, EXAMINING ATTORNEY

SN 78-417,595. YU, ZU SHENG, HUNTINGTON, NY. FILED 5-12-2004.



THE COLOR(S) RED, GREEN, YELLOW, BLUE AND BLACK IS/ARE CLAIMED AS A FEATURE OF THE MARK.

THE MARK CONSISTS OF A STYLIZED LETTER Z WITH RED AND YELLOW BACKGROUND, A STYLIZED LETTER S WITH YELLOW AND GREEN BACKGROUND, A STYLIZED LETTER Y WITH BLUE AND GREEN BACKGROUND.

FOR SHOES, FOOTWEAR (U.S. CLS. 22 AND 39).

MICHAEL SOUDERS, EXAMINING ATTORNEY

CLASS 25—(Continued).

SN 78-419,701. ALLISON WONDERLAND, INC., LENEXA, KS. FILED 5-17-2004.

CLASS 25—(Continued).

SN 78-421,406. PCMT LLC, WESTON, FL. FILED 5-19-2004.



FOR CLOTHING, NAMELY JACKETS, SHIRTS, SKIRTS, CAPS, HATS, PANTS, UNDERWEAR AND NECKTIES (U.S. CLS. 22 AND 39).
 FIRST USE 12-20-2003; IN COMMERCE 1-19-2004.
 ROBERT COGGINS, EXAMINING ATTORNEY

Lucerna Shoes

THE MARK CONSISTS OF STANDARD CHARACTERS WITHOUT CLAIM TO ANY PARTICULAR FONT, STYLE, SIZE, OR COLOR.
 NO CLAIM IS MADE TO THE EXCLUSIVE RIGHT TO USE SHOES, APART FROM THE MARK AS SHOWN.
 THE ONLY KNOWN TRANSLATION IS LUZERN OR LUCERNE.
 FOR LADIES FOOTWEAR, NAMELY, SHOES (U.S. CLS. 22 AND 39).
 FIRST USE 1-15-2004; IN COMMERCE 1-15-2004.
 DEZMONA MIZELLE, EXAMINING ATTORNEY

SN 78-420,533. VIACOM INTERNATIONAL INC., NEW YORK, NY. FILED 5-18-2004.

SN 78-422,965. MBD FASHION AG, GELSENKIRCHEN, FED REP GERMANY, FILED 5-21-2004.

BLUE'S ROOM DOODLE BOARD

THE MARK CONSISTS OF STANDARD CHARACTERS WITHOUT CLAIM TO ANY PARTICULAR FONT, STYLE, SIZE, OR COLOR.
 FOR CHILDREN'S CLOTHING, NAMELY, BATHING SUITS, BELTS, HALLOWEEN COSTUMES, COATS, SOCKS, CLOTHING BELTS, FOOTWEAR, BANDANNAS, DRESSES, GLOVES, GYM SHORTS, EAR MUFFS, NECK WEAR, JACKETS, PAJAMAS, PANTS, SHIRTS, SHORTS, SKI WEAR, SLACKS, SUN VISORS, SUSPENDERS, SWEATERS, TURTLENECKS, UNDERCLOTHES, VESTS, WARM-UP SUITS, SWEATSHIRTS, HEADWEAR, BATH-ROBES, BEACHWEAR (U.S. CLS. 22 AND 39).
 PATRICIA EVANKO, EXAMINING ATTORNEY

JOYE + FUN

THE MARK CONSISTS OF STANDARD CHARACTERS WITHOUT CLAIM TO ANY PARTICULAR FONT, STYLE, SIZE, OR COLOR.
 OWNER OF FED REP GERMANY REG. NO. 2085422, DATED 11-21-1994, EXPIRES 2-28-2014.
 FOR CLOTHING, NAMELY, PANTS, SHIRTS, T-SHIRTS, SWEATSHIRTS, SHORTS, BELTS, SCARVES, FOOTWEAR AND HEADWEAR (U.S. CLS. 22 AND 39).
 SHARI SHEFFIELD, EXAMINING ATTORNEY

CLASS 25—(Continued).

SN 78-423,505. SOUTHPAW TRADING LTD., CORTLANDT MANOR, NY. FILED 5-23-2004.

CLASS 25—(Continued).

SN 78-424,348. ALLEN'S HAMBURGERS, LLC, ATHENS, GA. FILED 5-25-2004.

OPTIONS from matt totillo

THE MARK CONSISTS OF STANDARD CHARACTERS WITHOUT CLAIM TO ANY PARTICULAR FONT, STYLE, SIZE, OR COLOR.

OWNER OF U.S. REG. NOS. 1,934,220, 2,729,023 AND 2,729,024.

THE NAME(S), PORTRAIT(S), AND/OR SIGNATURE(S) SHOWN IN THE MARK IDENTIFIES MATTHEW TOTILO, WHOSE CONSENT(S) TO REGISTER IS SUBMITTED.

FOR SHIRTS, PANTS, SWEATERS, SPORT JACKETS, SHORTS, UNDERWEAR, TIES, HOSIERY, CAPS (U.S. CLS. 22 AND 39).

FIRST USE 4-12-2004; IN COMMERCE 4-12-2004.
BERYL GARDNER, EXAMINING ATTORNEY

THE MARK CONSISTS OF STANDARD CHARACTERS WITHOUT CLAIM TO ANY PARTICULAR FONT, STYLE, SIZE, OR COLOR.

FOR CLOTHING, NAMELY T-SHIRTS, POLO SHIRTS, GOLF SHIRTS, KNIT SHIRTS, SWEAT SHIRTS, HATS AND CAPS (U.S. CLS. 22 AND 39).

FIRST USE 6-1-1974; IN COMMERCE 6-1-1974.
MAUREEN DALL, EXAMINING ATTORNEY

SN 78-423,883. BATES, BRANDON, LA CONNER, WA. FILED 5-24-2004.

SN 78-425,533. ZAVAROL, THOMAS W., ATLANTA, GA. FILED 5-26-2004.



ZSKINZ

THE MARK CONSISTS OF THE WORDS BEER DRINKING OUTFITTERS IMPRINTED ON THE TOP OF A REPRESENTATION OF A BOTTLE CAP AND IN THE CENTER SECTION THERE IS AN ARTISTIC ACRONYM-LIKE SYMBOL OF THE WORDING OF THE MARK.

FOR CLOTHING, NAMELY, SHIRTS, HATS, SWEATSHIRTS AND SHORTS (U.S. CLS. 22 AND 39).

FIRST USE 2-10-2004; IN COMMERCE 3-27-2004.
MARGERY A. TIERNEY, EXAMINING ATTORNEY

THE MARK CONSISTS OF STANDARD CHARACTERS WITHOUT CLAIM TO ANY PARTICULAR FONT, STYLE, SIZE, OR COLOR.

FOR CLOTHING, NAMELY, SHIRTS, CASUAL SHIRTS, T-SHIRTS, DRESS SHIRTS, PANTS, SKIRTS, SHORTS, DRESSES, COATS, JACKETS, VESTS, APRONS, HATS, CAPS, VISORS, RAINWEAR, SWEAT PANTS, SWEATERS, SWEAT SHIRTS, SHOES, GLOVES, AND UNIFORMS. (U.S. CLS. 22 AND 39).

REBECCA GILBERT, EXAMINING ATTORNEY

CLASS 25—(Continued).

SN 78-425,586. KATHERINE BISHOP II LTD., NEW YORK, NY. FILED 5-26-2004.

**BLESSINGS FROM
HEAVEN**

THE MARK CONSISTS OF STANDARD CHARACTERS WITHOUT CLAIM TO ANY PARTICULAR FONT, STYLE, SIZE, OR COLOR.

FOR SUITS AND HATS (U.S. CLS. 22 AND 39).
FIRST USE 7-0-2004; IN COMMERCE 7-0-2004.
BRIAN NEVILLE, EXAMINING ATTORNEY

SN 78-426,290. HARTWELL INDUSTRIES, INC., HARTWELL, GA. FILED 5-27-2004.

AUBURN SAFETY NET

THE MARK CONSISTS OF STANDARD CHARACTERS WITHOUT CLAIM TO ANY PARTICULAR FONT, STYLE, SIZE, OR COLOR.

OWNER OF U.S. REG. NO. 1,367,757.
NO CLAIM IS MADE TO THE EXCLUSIVE RIGHT TO USE "SAFETY", APART FROM THE MARK AS SHOWN.

FOR SPECIALIZED CONSTRUCTION, TRAFFIC SAFETY, AND EMERGENCY SERVICES SAFETY CLOTHING, NAMELY, HIGH VISIBILITY POLO SHIRTS WITHOUT REFLECTOR STRIPS, HIGH VISIBILITY JACKETS WITH AND WITHOUT REFLECTOR STRIPS, HIGH VISIBILITY WIND-RESISTANT JACKETS WITH AND WITHOUT REFLECTOR STRIPS, HIGH VISIBILITY VESTS WITH REFLECTOR STRIPS, AND HIGH VISIBILITY SHIRTS WITH AND WITHOUT REFLECTOR STRIPS ALL FOR USE IN THE CONSTRUCTION, TRAFFIC SAFETY, AND EMERGENCY SERVICES FIELD (U.S. CLS. 22 AND 39).

FIRST USE 9-30-2002; IN COMMERCE 9-30-2002.
MICHAEL TANNER, EXAMINING ATTORNEY

CLASS 25—(Continued).

SN 78-428,634. BUFFETT, JIMMY, KEY WEST, FL. FILED 6-2-2004.

**THE BEST
MARGARITAS COME
FROM
MARGARITAVILLE**

THE MARK CONSISTS OF STANDARD CHARACTERS WITHOUT CLAIM TO ANY PARTICULAR FONT, STYLE, SIZE, OR COLOR.

OWNER OF U.S. REG. NOS. 1,642,132, 2,805,289 AND OTHERS.

FOR CLOTHING, NAMELY, BEACH COVER-UPS, BANDANAS, BOXER SHORTS, T-SHIRTS, TANK TOPS, SHIRTS, SWEATSHIRTS, GOLF SHIRTS, UNDERSHIRTS, POLO SHIRTS, KNIT SHIRTS, DENIM SHIRTS, NIGHTSHIRTS, COATS, JACKETS, JERSEYS, UNDERGARMENTS, NECKTIES, APRONS, HEADWEAR AND FOOTWEAR. (U.S. CLS. 22 AND 39).

ELISSA GARBER KON, EXAMINING ATTORNEY

SN 78-429,700. FARHAT, JAMEL, BELL, CA. FILED 6-3-2004.



NO CLAIM IS MADE TO THE EXCLUSIVE RIGHT TO USE CLASSIC, APART FROM THE MARK AS SHOWN.

THE MARK CONSISTS OF OVAL SHAPED LOGO WITH "MV2" ON TOP OF "MINERVA" AND ON TOP OF "CLASSIC".

FOR CLOTHING, NAMELY TIES, PANTS, SHIRTS, BOOTS, T-SHIRTS, SUITS, JACKETS, UNDERWEAR, BELTS, SOCKS, HATS, SHOES, SHAWLS, SCARFS, DENIM PANTS AND DENIM JACKETS, SKIRTS, AND SWEATERS (U.S. CLS. 22 AND 39).

FIRST USE 6-1-2001; IN COMMERCE 6-1-2001.
SKYE YOUNG, EXAMINING ATTORNEY

CLASS 25—(Continued).

SN 78-429,914. U.S.A. SANGLAN CO., LIMITED, SPARKS, NV. FILED 6-4-2004.



THE MARK CONSISTS OF THE WORD SANGLAN AND A STYLIZED FLAME DEVICE.

THE WORD SANGLAN IS THE TRANSLITERATION OF A CHINESE SURNAME.

FOR RAINWEAR; SHOES; HATS; CAPS; SOCKS; STOCKINGS; HOSIERY; GLOVES FOR CLOTHING; NECKTIES; LEATHER BELTS FOR CLOTHING; CLOTHING, NAMELY, SHIRTS, PANTS, DRESSES, SUITS; DANCING WEAR, NAMELY, LEOTARDS, DRESSES, SHIRTS, PANTS, BALLET SHOES AND BALLET SLIPPERS; UNDERWEAR; COATS; UNIFORMS; PAJAMAS; JACKETS FOR CLOTHING; READY-MADE CLOTHING, NAMELY, SHIRTS, PANTS, DRESSES, SUITS; SPORT SHIRTS; SPORTSWEAR, NAMELY, SPORT PANTS, SPORT COATS; SWIM WEAR; SWIM TRUNKS; SWIM CAPS; SURF WEAR; CLOTHING FOR RIDING BICYCLES, NAMELY, T-SHIRTS, PANTS, SHORTS; FOOTBALL SHOES; FOOTBALL BOOTS; FOOTBALL SPIKES; GYMNAS TIC SHOES; SPORTS SHOES; SPORTS BOOTS (U.S. CLS. 22 AND 39).

MONIQUE MILLER, EXAMINING ATTORNEY

SN 78-430,337. BURDETTE, GEORGE HENRY, MANVIL, TX. FILED 6-4-2004.

YAO HOO

THE MARK CONSISTS OF STANDARD CHARACTERS WITHOUT CLAIM TO ANY PARTICULAR FONT, STYLE, SIZE, OR COLOR.

FOR T-SHIRT (U.S. CLS. 22 AND 39).

FIRST USE 3-1-2004; IN COMMERCE 3-1-2004.

DAVID MURRAY, EXAMINING ATTORNEY

CLASS 25—(Continued).

SN 78-431,099. SAITEX INTERNATIONAL INC, NEW YORK, NY. FILED 6-7-2004.

LIMERICK

THE MARK CONSISTS OF STANDARD CHARACTERS WITHOUT CLAIM TO ANY PARTICULAR FONT, STYLE, SIZE, OR COLOR.

FOR CLOTHING, NAMELY, TOPS, BOTTOMS, BLOUSES, JEANS, T-SHIRTS, SWEAT SHIRTS, SHIRTS, PANTS, PULLOVERS, JACKETS, SOCKS, BOOTS, SHOES, CAPS, HATS, UNDERWEAR, TROUSERS, PAJAMAS, JOGGING SWEATS, SLIPPERS, COATS, ROBES, GLOVES, SWIMSUITS, SWEATERS, AND FOOTWEAR (U.S. CLS. 22 AND 39).

ASMAT KHAN, EXAMINING ATTORNEY

SN 78-431,946. TAPPIN TOES, CARLSBAD, CA. FILED 6-8-2004.



NO CLAIM IS MADE TO THE EXCLUSIVE RIGHT TO USE "BABY", APART FROM THE MARK AS SHOWN.

FOR BABY AND CHILDREN'S CLOTHES, NAMELY, SHIRTS, ROMPERS, INFANT DIAPER COVERS, HATS, SOCKS, SHOES, PANTS AND SHORTS (U.S. CLS. 22 AND 39).

KHANH LE, EXAMINING ATTORNEY

CLASS 25—(Continued).

SN 78-431,998. KAI CLOTHING, INC., HONOLULU, HI.
FILED 6-8-2004.



THE MARK CONSISTS OF PETROGLYPH OF A PERSON SWINGING A GOLF CLUB.
FOR MEN'S AND WOMEN'S SHIRTS AND T-SHIRTS, SHORTS, PANTS, HATS, CAPS, VISORS, AND WOMEN'S DRESSES (U.S. CLS. 22 AND 39).
FIRST USE 6-7-2004; IN COMMERCE 6-7-2004.
CAROL SPILS, EXAMINING ATTORNEY

CLASS 25—(Continued).

SN 78-435,378. EILDON HILLS, INC, PLEASANTVILLE, NY.
FILED 6-15-2004.

JASON TODD

THE MARK CONSISTS OF STANDARD CHARACTERS WITHOUT CLAIM TO ANY PARTICULAR FONT, STYLE, SIZE, OR COLOR.
"JASON TODD" DOES NOT IDENTIFY A LIVING INDIVIDUAL.
FOR MEN'S AND WOMEN'S CLOTHING NAMELY, SWEATERS, JACKETS, SLACKS, TROUSERS AND PANTS (U.S. CLS. 22 AND 39).
ANN LINNEHAN, EXAMINING ATTORNEY

SN 78-432,868. DAVIS, ROBERT KENT, ANNA MARIA, FL.
FILED 6-10-2004.

MAN VS. MACHINE

THE MARK CONSISTS OF STANDARD CHARACTERS WITHOUT CLAIM TO ANY PARTICULAR FONT, STYLE, SIZE, OR COLOR.
FOR CLOTHING, NAMELY, TOPS, T-SHIRTS, SHIRTS, SWEATSHIRTS, JACKETS, PANTS, EXERCISE SUITS, SWEATPANTS, SHORTS, UNDERWEAR, BOXER SHORTS, SOCKS, NECKTIES, PAJAMAS, MASQUERADE COSTUMES, WRIST BANDS, BANDANNAS; FOOTWEAR, NAMELY, SHOES, SNEAKERS, BOOTS, SLIPPERS; HEADGEAR, NAMELY, HATS, AND CAPS (U.S. CLS. 22 AND 39).
CHRIS WELLS, EXAMINING ATTORNEY

SN 78-435,592. ROMA, HEATHER E, LAKE WORTH, FL.
FILED 6-15-2004.



THE COLOR(S) PINK AND BROWN IS/ARE CLAIMED AS A FEATURE OF THE MARK.
THE MARK CONSISTS OF PINK HEART, BROWN WORDS "HEART STRUNG".
FOR SWIMSUITS, DRESSES, TOPS, SKIRTS, PANTS, JACKETS (U.S. CLS. 22 AND 39).
MIDGE BUTLER, EXAMINING ATTORNEY

CLASS 25—(Continued).

SN 78-436,127. BARRY, KIMBERLY A., THOUSAND OAKS, CA. FILED 6-16-2004.

DIRT CHICKS

THE MARK CONSISTS OF STANDARD CHARACTERS WITHOUT CLAIM TO ANY PARTICULAR FONT, STYLE, SIZE, OR COLOR.

FOR CLOTHING, NAMELY HATS, CAPS, GLOVES, HEADBANDS, SHIRTS, TEE SHIRTS, DRESS SHIRTS, CASUAL SHIRTS, PANTIES, THONGS, BRAS, PANTS, SHORTS, LONG PANTS, JEANS, DRESS PANTS, CASUAL PANTS, SOCKS, SHOES, COATS, BOOTS, JACKETS, SWEATSHIRTS, SWEATPANTS, PAJAMAS (U.S. CLS. 22 AND 39).

FIRST USE 6-16-2004; IN COMMERCE 7-21-2004.
TRICIA THOMPSON, EXAMINING ATTORNEY

CLASS 25—(Continued).

SN 78-438,215. TSENG, ALTA K., SAN FRANCISCO, CA. FILED 6-20-2004.

FEMPIRE

THE MARK CONSISTS OF STANDARD CHARACTERS WITHOUT CLAIM TO ANY PARTICULAR FONT, STYLE, SIZE, OR COLOR.

FOR CLOTHING, NAMELY, T-SHIRTS, TANK TOPS, SHIRTS, SHORTS, SKIRTS, PANTS, DRESSES, TUBE TOPS, SWEATSHIRTS, SWEATPANTS, JEANS, JACKETS, SANDALS, SOCKS, VISORS, SWIMWEAR, BRAS, THONGS, BIKINIS, CAMISOLES, SHOES (U.S. CLS. 22 AND 39).

FIRST USE 1-1-2003; IN COMMERCE 3-29-2004.
APRIL L. RADEMACHER, EXAMINING ATTORNEY

SN 78-438,055. D'ELIA, LOUIS F., PASADENA, CA. FILED 6-18-2004.

HBRC

THE MARK CONSISTS OF STANDARD CHARACTERS WITHOUT CLAIM TO ANY PARTICULAR FONT, STYLE, SIZE, OR COLOR.

FOR CLOTHING, NAMELY SHIRTS, T-SHIRTS, POLO SHIRTS, PANTS, JEANS, SLACKS, SHORTS, JODHPURS, BLOUSES, SOCKS, SHOES, BOOTS, BELTS, HATS, CAPS, SWEATERS, JACKETS, AND DRESSES (U.S. CLS. 22 AND 39).

FIRST USE 8-1-1946; IN COMMERCE 8-1-1946.
CIMMERIAN COLEMAN, EXAMINING ATTORNEY

SN 78-438,400. SMOKESIGNALS, LLC, RONKONKOMA, NY. FILED 6-21-2004.



THE COLOR(S) RED, WHITE, GREEN, YELLOW AND BROWN IS/ARE CLAIMED AS A FEATURE OF THE MARK.

THE COLOR GREEN IS USED IN THE BACKGROUND OF LOGO. THE COLOR YELLOW IS USED ON THE BORDER OF THE LOGO BACKGROUND AND ALSO ON THE BAND OF THE CIGAR IN THE LOGO. THE COLOR RED IS USED ON THE BAND OF THE CIGAR ON THE LOGO. THE COLOR WHITE IS USED FOR THE NAME "SMOKESIGNALS" ON THE LOGO. THE COLOR BROWN IS USED ON THE CIGAR IN THE LOGO.

FOR SHIRTS, HATS (U.S. CLS. 22 AND 39).
WON TEAK OH, EXAMINING ATTORNEY

CLASS 25—(Continued).

SN 78-438,624. PATTON, ANTWAN, ATLANTA, GA. FILED 6-21-2004.

BANNI

THE MARK CONSISTS OF STANDARD CHARACTERS WITHOUT CLAIM TO ANY PARTICULAR FONT, STYLE, SIZE, OR COLOR.

THE WORD "BANNI" TRANSLATES INTO "OUTLAW" IN FRENCH.

FOR CLOTHING FOR MEN, WOMEN AND CHILDREN NAMELY SHIRTS, T-SHIRTS, TOPS, BLOUSES, SWEATERS, CARDIGANS, VESTS, SWEAT SHIRTS, SWEAT PANTS, PANTS, JEANS, CAPRIS, SHORTS, SKIRTS, DRESSES, JUMPERS, OVERALLS, JUMPSUITS, JOGGING SUITS, SUITS, BLAZERS, JEAN JACKETS, SPORT JACKETS, COATS, LEATHER COATS, PARKAS, PULLOVERS, RAINCOATS, RAINWEAR, BATHING SUITS, SWIMWEAR, UNDERWEAR, BOXER SHORTS, LINGERIE, BATHROBES, NIGHTGOWNS, PAJAMAS, LOUNGEWEAR, HOSIERY, SOCKS, TIGHTS, LEGGINGS, HATS, CAPS, BERETS, VISORS, HEADBANDS, EARMUFFS, SWEAT BANDS, WRIST BANDS, BELTS, SUSPENDERS, TIES, BOW TIES, MITTENS, GLOVES, SCARVES, SHAWLS, SHOES, SLIPPERS, BOOTS, SANDALS AND SNEAKERS (U.S. CLS. 22 AND 39).

GLENN CLARK, EXAMINING ATTORNEY

SN 78-438,807. GHACHAM, INC., PARAMOUNT, CA. FILED 6-21-2004.

PLATINI SIGNATURE

THE MARK CONSISTS OF STANDARD CHARACTERS WITHOUT CLAIM TO ANY PARTICULAR FONT, STYLE, SIZE, OR COLOR.

OWNER OF U.S. REG. NO. 2,405,860.
FOR CLOTHING ITEMS, NAMELY JEANS, JACKETS AND SHIRTS (U.S. CLS. 22 AND 39).

FIRST USE 6-30-1998; IN COMMERCE 6-30-1998.
STEVEN R. FOSTER, EXAMINING ATTORNEY

CLASS 25—(Continued).

SN 78-438,901. YURIKA L. SZABO, LOS ALAMITOS, CA. FILED 6-21-2004.

Naughty On Purpose

THE MARK CONSISTS OF STANDARD CHARACTERS WITHOUT CLAIM TO ANY PARTICULAR FONT, STYLE, SIZE, OR COLOR.

FOR CLOTHING, NAMELY— T-SHIRTS, TANK TOPS, SHORTS, BRIEFS, UNDERGARMENTS, JACKETS, HATS, SCARVES, GLOVES, SWEATSUITS, SWEAT-SHIRTS, PANTS, SOCKS, AND BEANIES (U.S. CLS. 22 AND 39).

SUSAN STIGLITZ, EXAMINING ATTORNEY

SN 78-439,703. JIAXING ZHENGQI HI-NEW-TECH TEXTILE MATERIAL BONDING CO., LTD., JIAXING CITY, ZHEJIANG PROVINCE, CHINA, FILED 6-22-2004.

Hi-new-tex

FOR CLOTHING, NAMELY, SHIRTS, PANTS, DRESSES, UNDERWEAR; CLOTHING OF IMITATIONS OF LEATHER, NAMELY, COATS, JACKETS, TROUSERS; WIND RESISTANT JACKETS; WIND SHIRTS; CLOTHING FOR DRIVERS, NAMELY, HATS, SCARVES, UNIFORMS; WET SUITS FOR WATER-SKIING; CLOTHING FOR RIDING BICYCLES, NAMELY, BICYCLE GLOVES, T-SHIRTS, SHORTS; RAINWEAR; FOOTWEAR; HOODS FOR CLOTHING; GLOVES FOR CLOTHING (U.S. CLS. 22 AND 39).

EUGENIA MARTIN, EXAMINING ATTORNEY

SN 78-439,901. YAGOBIAN, JONATHAN ARA, ROYAL OAK, MI. FILED 6-23-2004.



FOR CLOTHING FOR MEN AND WOMEN, NAMELY, TANK TOPS, TEE SHIRTS, JEANS, PANTS, SHIRTS, HATS, SWEAT PANTS, SHOES, SHORTS (U.S. CLS. 22 AND 39).

FIRST USE 8-1-2003; IN COMMERCE 8-1-2004.
KIMBERLY PERRY, EXAMINING ATTORNEY

CLASS 25—(Continued).

SN 78-441,319. MAUI STYLE, LLC, KAHULUI, HI. FILED 6-25-2004.



THE MARK CONSISTS OF FEMALE SYMBOL HOLDING A SURFBOARD WITH A STAR ON IT, ALL WITHIN A CIRCLE, COMBINED WITH WORDS 'SURF GIRL'.

FOR CLOTHING FOR WOMEN, NAMELY T-SHIRTS, BLOUSES, HATS, CAPS, SWIMWEAR, SHORTS, PANTS, BEACHWEAR, JACKETS (U.S. CLS. 22 AND 39).

FIRST USE 11-19-2003; IN COMMERCE 11-19-2003.
DANIEL BRODY, EXAMINING ATTORNEY

CLASS 25—(Continued).

SN 78-446,338. MCCULLERS, BARRY, LAS VEGAS, NV. FILED 7-6-2004.

PIMP CANDY

THE MARK CONSISTS OF STANDARD CHARACTERS WITHOUT CLAIM TO ANY PARTICULAR FONT, STYLE, SIZE, OR COLOR.

FOR CLOTHING, NAMELY, SPORT SHIRTS, SWEATSHIRTS, T-SHIRTS, HATS, JERSEYS, JACKETS, UNDERWEAR, SOCKS, SHORTS, SWEAT PANTS, ATHLETIC SHOES, WRIST BANDS, HEAD BANDS, SWIM WEAR, BRAS, PANTIES, LINGERIE, PANTS, SKIRTS, BLOUSES, SWEATERS AND SCARVES (U.S. CLS. 22 AND 39).

JOHN LINCOSKI, EXAMINING ATTORNEY

SN 78-449,562. PIQI CO, CANTON, MA. FILED 7-12-2004.

SN 78-443,981. ACUFF, RANDALL GARRETT, PHOENIX, AZ. FILED 6-30-2004.

PIQI

BEYETME

THE MARK CONSISTS OF STANDARD CHARACTERS WITHOUT CLAIM TO ANY PARTICULAR FONT, STYLE, SIZE, OR COLOR.

FOR CLOTHING NAMELY T-SHIRTS AND HATS (U.S. CLS. 22 AND 39).

DARRYL SPRUILL, EXAMINING ATTORNEY

THE MARK CONSISTS OF STANDARD CHARACTERS WITHOUT CLAIM TO ANY PARTICULAR FONT, STYLE, SIZE, OR COLOR.

FOR MEN'S, WOMEN'S, AND CHILDREN'S CLOTHING, NAMELY SWEATSHIRTS, SHIRTS, JEANS, JACKETS, COATS, SWEATPANTS, SLACKS, SUITS, HATS, HEADBANDS, VISORS, CAPS, DRESSES, SHOES, SNEAKERS, BOOTS, WRISTBANDS, SOCKS, T-SHIRTS, BELTS, UNDERGARMETS, NECKTIES, DRESS SHIRTS, COLLARED SHIRTS, RUGBY SHIRTS, KNIT SHIRTS, SHORTS AND SANDALS (U.S. CLS. 22 AND 39).

FIRST USE 1-1-2002; IN COMMERCE 7-1-2004.
G. MAYERSCHOFF, EXAMINING ATTORNEY

CLASS 25—(Continued).

SN 78-449,885. OUTDOOR CAP COMPANY, INC., BENTONVILLE, AR. FILED 7-13-2004.

CLASS 25—(Continued).

SN 78-451,119. SCAREDED LLC, PRESCOTT, AZ. FILED 7-15-2004.

Outdoor Cap Pro Series

SCAREDED

THE MARK CONSISTS OF STANDARD CHARACTERS WITHOUT CLAIM TO ANY PARTICULAR FONT, STYLE, SIZE, OR COLOR.

OWNER OF U.S. REG. NO. 2,054,435.
NO CLAIM IS MADE TO THE EXCLUSIVE RIGHT TO USE "CAP" AND "PRO SERIES", APART FROM THE MARK AS SHOWN.

SEC. 2(F).
FOR HEADWEAR (U.S. CLS. 22 AND 39).
FIRST USE 6-1-2000; IN COMMERCE 6-1-2000.
MIDGE BUTLER, EXAMINING ATTORNEY

THE MARK CONSISTS OF STANDARD CHARACTERS WITHOUT CLAIM TO ANY PARTICULAR FONT, STYLE, SIZE, OR COLOR.

FOR CLOTHING, NAMELY, SHOES, SOCKS, UNDERWEAR, SHORTS, PANTS, SKIRTS, DRESSES, BATHING SUITS, SHIRTS, SWEAT SHIRTS, JACKETS AND HATS (U.S. CLS. 22 AND 39).

FIRST USE 7-13-2004; IN COMMERCE 7-13-2004.
JERI J. FICKES, EXAMINING ATTORNEY

SN 78-450,510. THE OAKLAND RAIDERS, ALAMEDA, CA. FILED 7-14-2004.

SN 78-451,208. WEST COAST SHOE CO., SCAPPOOSE, OR. FILED 7-15-2004.

THE TEAM OF THE DECADES

Highliner

THE MARK CONSISTS OF STANDARD CHARACTERS WITHOUT CLAIM TO ANY PARTICULAR FONT, STYLE, SIZE, OR COLOR.

FOR MEN'S, WOMEN'S AND CHILDREN'S CLOTHING, NAMELY T-SHIRTS, SWEATSHIRTS, CAPS, JACKETS; SPORTSWEAR FOR MEN, WOMEN AND CHILDREN, NAMELY SPORTS JACKETS; SPORT SHIRTS, SPORTS PANTS, SPORTS SHORTS (U.S. CLS. 22 AND 39).
DAVID MURRAY, EXAMINING ATTORNEY

THE MARK CONSISTS OF STANDARD CHARACTERS WITHOUT CLAIM TO ANY PARTICULAR FONT, STYLE, SIZE, OR COLOR.

FOR FULLY LINED LEATHER WORK BOOTS FOR LINEMEN AND ARBORISTS (U.S. CLS. 22 AND 39).
FIRST USE 9-1-1985; IN COMMERCE 9-1-1985.
CHRISTOPHER BUONGIORNO, EXAMINING ATTORNEY

CLASS 25—(Continued).

SN 78-453,351. WESTCOAST CONTEMPO FASHIONS LIMITED, BRITISH COLUMBIA, CANADA, FILED 7-20-2004.

MAC & JAC

THE MARK CONSISTS OF STANDARD CHARACTERS WITHOUT CLAIM TO ANY PARTICULAR FONT, STYLE, SIZE, OR COLOR.

OWNER OF U.S. REG. NO. 1,984,545.

FOR MEN'S CLOTHING, NAMELY, SWEATERS, JACKETS, COATS, SHIRTS, T-SHIRTS, SWEATSHIRTS, PANTS, SHORTS, JUMPSUITS, SUITS, VESTS, HATS, GLOVES, SCARVES (U.S. CLS. 22 AND 39).

FIRST USE 8-1-2002; IN COMMERCE 8-1-2002.

PRISCILLA MILTON, EXAMINING ATTORNEY

SN 78-453,875. SPORTSMAN'S WAREHOUSE, INC., MIDVALE, UT. FILED 7-21-2004.

LOST RIVER

THE MARK CONSISTS OF STANDARD CHARACTERS WITHOUT CLAIM TO ANY PARTICULAR FONT, STYLE, SIZE, OR COLOR.

FOR SHIRTS, NAMELY, SHIRTS FOR FISHING (U.S. CLS. 22 AND 39).

FIRST USE 8-31-2004; IN COMMERCE 8-31-2004.

TIMOTHY FINNEGAN, EXAMINING ATTORNEY

CLASS 25—(Continued).

SN 78-454,441. J. THOMAS & ASSOCIATES, INC., PHILADELPHIA, PA. FILED 7-21-2004.



FOR T-SHIRTS, GOLF SHIRTS, SWEAT SUITS, BANDANAS, JEANS, PANTS, JACKETS, BOXER SHORTS, PAJAMAS, CAPS, HATS AND BUTTON-DOWN SHIRTS (U.S. CLS. 22 AND 39).

ROBERT LAVACHE, EXAMINING ATTORNEY

SN 78-459,938. WARNACO SWIMWEAR PRODUCTS, INC., LOS ANGELES, CA. FILED 7-30-2004.

AQUANETICS

THE MARK CONSISTS OF STANDARD CHARACTERS WITHOUT CLAIM TO ANY PARTICULAR FONT, STYLE, SIZE, OR COLOR.

OWNER OF U.S. REG. NO. 2,394,293.

FOR CLOTHING, NAMELY, WOMEN'S AND CHILDREN'S SWIMWEAR, BEACHWEAR, BATHING SUITS, COVER-UPS, TANK TOPS, BOTTOMS, UNITARDS, SHORTS, SHIRTS, SKIRTS, JACKETS, PANTS, SWEATSHIRTS, CROP TOPS, BRA TOPS, AND LEGGINGS (U.S. CLS. 22 AND 39).

JERI J. FICKES, EXAMINING ATTORNEY

SN 78-460,373. MULCAHY, JUSTIN ROBERT, GLOUCESTER, NSW, AUSTRALIA, FILED 8-2-2004.

ABOVE ALL LIMITS

THE MARK CONSISTS OF STANDARD CHARACTERS WITHOUT CLAIM TO ANY PARTICULAR FONT, STYLE, SIZE, OR COLOR.

FOR CASUAL CLOTHING FOR ADULTS AND CHILDREN, NAMELY HATS, SHIRTS, SHORTS, PANTS, PULLOVERS, TRACKSUITS, JACKETS AND SHOES (U.S. CLS. 22 AND 39).

JOHN WILKE, EXAMINING ATTORNEY

CLASS 25—(Continued).

SN 78-463,246. ADAMSON, JODIE L., ANNA, OH. FILED 8-6-2004.



THE MARK CONSISTS OF THE LETTERS "SKINIES" WITH DAISIES DOTTING EACH "I".
FOR CLOTHING, NAMELY, BREASTFEEDING UNDERGARMENTS (U.S. CLS. 22 AND 39).
REBECCA GAN, EXAMINING ATTORNEY

CLASS 25—(Continued).

SN 78-471,726. HEARN, WILLIAM L, FITCHBURG, MA. FILED 8-23-2004.



THE MARK CONSISTS OF STANDARD CHARACTERS WITHOUT CLAIM TO ANY PARTICULAR FONT, STYLE, SIZE, OR COLOR.
OWNER OF U.S. REG. NO. 2,906,702.
NO CLAIM IS MADE TO THE EXCLUSIVE RIGHT TO USE "ORIGINAL WATER CLOGS", APART FROM THE MARK AS SHOWN.
FOR FOOTWEAR (U.S. CLS. 22 AND 39).
FLORENTINA BLANDU, EXAMINING ATTORNEY

SN 78-466,030. URARDI, INC., COMMERCE, CA. FILED 8-11-2004.



THE NAME SHOWN IN THE MARK DOES NOT IDENTIFY A PARTICULAR LIVING INDIVIDUAL.
FOR MEN'S SUITS; MEN'S DRESS JACKETS; MEN'S PANTS; MEN'S DRESS SHIRTS; MEN'S CASUAL SHIRTS; SOCKS; NECKTIES (U.S. CLS. 22 AND 39).
FIRST USE 1-9-2001; IN COMMERCE 1-9-2001.
KHANH LE, EXAMINING ATTORNEY

SN 78-474,358. ONEWORLD APPAREL COMPANY, INC., SOUTH EL MONTE, CA. FILED 8-26-2004.

SN 78-466,647. YUGENGAISHA TOSHIZU MARINE PROJECT, EBINA CITY, KANAGAWAKEN, JAPAN, FILED 8-12-2004.

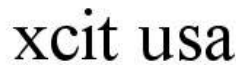

CYBER SHIELD

THE MARK CONSISTS OF STANDARD CHARACTERS WITHOUT CLAIM TO ANY PARTICULAR FONT, STYLE, SIZE, OR COLOR.
OWNER OF JAPAN REG. NO. 4767295, DATED 4-23-2004, EXPIRES 4-23-2014.
FOR CLOTHING, NAMELY WETSUITS (U.S. CLS. 22 AND 39).
FIRST USE 2-4-2004; IN COMMERCE 2-4-2004.
CAROLYN CATALDO, EXAMINING ATTORNEY

THE MARK CONSISTS OF STANDARD CHARACTERS WITHOUT CLAIM TO ANY PARTICULAR FONT, STYLE, SIZE, OR COLOR.
OWNER OF U.S. REG. NOS. 2,952,603 AND 2,957,596.
NO CLAIM IS MADE TO THE EXCLUSIVE RIGHT TO USE "USA", APART FROM THE MARK AS SHOWN.
FOR CLOTHING, NAMELY, SHIRTS, BLOUSES, DRESSES, SKIRTS, SWEATSHIRTS, SWEATPANTS, PANTS, SHORTS, JACKETS, PAJAMAS, JUMPERS, SWEATERS, KNIT TOPS, BELTS, HATS, COATS, SOCKS, AND LOUNGEWEAR (U.S. CLS. 22 AND 39).
FIRST USE 1-30-2004; IN COMMERCE 1-30-2004.
JENNIFER KRISP, EXAMINING ATTORNEY

CLASS 25—(Continued).

SN 78-475,908. TAYLOR SALES, INC., MUTTONTOWN, NY.
FILED 8-30-2004.

SEE YOU LATER ALLIGATOR

THE MARK CONSISTS OF STANDARD CHARACTERS WITHOUT CLAIM TO ANY PARTICULAR FONT, STYLE, SIZE, OR COLOR.

FOR MEN'S, WOMEN'S AND CHILDREN'S APPAREL, NAMELY, SHIRTS, T-SHIRTS, POLO SHIRTS, SHORTS, PANTS, SWIMSUITS, JEANS, OVERALLS, SWEATERS, VESTS, TOPS, BLOUSES, SKIRTS, COATS, SOCKS, BELTS; WORKOUT GEAR, NAMELY, WARM-UP SUITS, SWEAT-SUITS, SWEAT SHORTS, JOGGING SUITS, SWEAT BANDS, TANK TOPS, TRACK PANTS, JERSEYS, SWEATSHIRTS, SWEATPANTS, SPORTS TOPS, SPORTS SHORTS, SPORTS SUITS, SPORTS JACKETS, HEADBANDS; SLEEPWEAR, HATS, CAPS, GLOVES AND SCARVES; OUTERWEAR IN ALL FABRICATIONS NAMELY, CLOTH, DENIM, FLEECE, LEATHER AND SUEDE JACKETS; FOOTWEAR NAMELY SHOES, SNEAKERS, SANDALS AND BOOTS (U.S. CLS. 22 AND 39).

FIRST USE 9-1-2004; IN COMMERCE 9-1-2004.
JEAN IM, EXAMINING ATTORNEY

SN 78-477,086. TAYLOR SALES, INC., MUTTONTOWN, NY.
FILED 9-1-2004.

RETRO FOX

THE MARK CONSISTS OF STANDARD CHARACTERS WITHOUT CLAIM TO ANY PARTICULAR FONT, STYLE, SIZE, OR COLOR.

FOR MEN'S, WOMEN'S AND CHILDREN'S APPAREL, NAMELY, SHIRTS, T-SHIRTS, POLO SHIRTS, SHORTS, PANTS, SWIMSUITS, JEANS, OVERALLS, SWEATERS, VESTS, TOPS, BLOUSES, SKIRTS, COATS, SOCKS, BELTS; SPORTSWEAR, WORKOUT GEAR, NAMELY, WARM-UP SUITS, SWEAT-SUITS, SWEAT SHORTS, JOGGING SUITS, SWEAT BANDS, TANK TOPS, TRACK PANTS, JERSEYS, SWEATSHIRTS, SWEATPANTS, SPORTS TOPS, SPORTS SHORTS, HEADBANDS; SLEEPWEAR, HATS, CAPS, GLOVES AND SCARVES; OUTERWEAR IN ALL FABRICATIONS NAMELY, CLOTH, DENIM, LEATHER AND SUEDE JACKETS; FOOTWEAR NAMELY SHOES, SNEAKERS AND BOOTS (U.S. CLS. 22 AND 39).

FIRST USE 9-1-2004; IN COMMERCE 9-1-2004.
LA TONIA FISHER, EXAMINING ATTORNEY

CLASS 25—(Continued).

SN 78-478,430. JACK SCHWARTZ SHOES, INC., NEW YORK, NY. FILED 9-3-2004.

NEVER FOLD

THE MARK CONSISTS OF STANDARD CHARACTERS WITHOUT CLAIM TO ANY PARTICULAR FONT, STYLE, SIZE, OR COLOR.

FOR CLOTHING, NAMELY, T-SHIRTS, WARM-UP SUITS, JACKETS, SWEATSHIRTS, SWEATPANTS, HATS, GLOVES, BANDANNAS, SOCKS, FOOTWEAR (U.S. CLS. 22 AND 39).

NORA BUCHANAN WILL, EXAMINING ATTORNEY

SN 78-479,541. YOGA SHELTER LLC, FARMINGTON HILLS, MI. FILED 9-7-2004.

Free yourself to be yourself

THE MARK CONSISTS OF STANDARD CHARACTERS WITHOUT CLAIM TO ANY PARTICULAR FONT, STYLE, SIZE, OR COLOR.

FOR CLOTHING, NAMELY, FOOTWEAR, HEADGEAR, NAMELY HATS, CAPS AND VISORS, SHORTS, SWEATPANTS, SHIRTS, LEG AND ARM WARMERS, JACKETS AND SWEATSHIRTS FOR ATHLETIC OR CASUAL ACTIVITIES (U.S. CLS. 22 AND 39).

ODESSA BIBBINS, EXAMINING ATTORNEY

CLASS 25—(Continued).

SN 78-481,436. M. M. AND R. INC., NEW YORK, NY. FILED 9-10-2004.

ECI NEW YORK

THE MARK CONSISTS OF STANDARD CHARACTERS WITHOUT CLAIM TO ANY PARTICULAR FONT, STYLE, SIZE, OR COLOR.

OWNER OF U.S. REG. NO. 2,660,473.

NO CLAIM IS MADE TO THE EXCLUSIVE RIGHT TO USE NEW YORK, APART FROM THE MARK AS SHOWN.

FOR CLOTHING, NAMELY, COATS, DRESSES, BLOUSES, SKIRTS, JACKETS, SLACKS, VESTS, T-SHIRTS, SWEATSHIRTS, TANK TOPS AND KNITWEAR, NAMELY; COATS, DRESSES, BLOUSES, SKIRTS, JACKETS, SLACKS, VESTS, T-SHIRTS, SWEATSHIRTS AND TANK TOPS (U.S. CLS. 22 AND 39).

MICHELLE S. WISEMAN, EXAMINING ATTORNEY

SN 78-481,450. M. M. AND R. INC., NEW YORK, NY. FILED 9-10-2004.

ECI NY

THE MARK CONSISTS OF STANDARD CHARACTERS WITHOUT CLAIM TO ANY PARTICULAR FONT, STYLE, SIZE, OR COLOR.

OWNER OF U.S. REG. NO. 2,660,473.

NO CLAIM IS MADE TO THE EXCLUSIVE RIGHT TO USE NY, APART FROM THE MARK AS SHOWN.

FOR CLOTHING, NAMELY, COATS, DRESSES, BLOUSES, SKIRTS, JACKETS, SLACKS, VESTS, T-SHIRTS, SWEATSHIRTS, TANK TOPS AND KNITWEAR, NAMELY; COATS, DRESSES, BLOUSES, SKIRTS, JACKETS, SLACKS, VESTS, T-SHIRTS, SWEATSHIRTS AND TANK TOPS (U.S. CLS. 22 AND 39).

MICHELLE S. WISEMAN, EXAMINING ATTORNEY

CLASS 25—(Continued).

SN 78-482,004. DROP IN INDUSTRIES, DANA POINT, CA. FILED 9-10-2004.



FOR CLOTHING, FOOTWEAR, AND HEADWEAR, NAMELY, AFTER SKI BOOTS, ALBS, ANKLETS THAT ARE SOCKS, ANORAKS, APRONS, ASCOTS, ATHLETIC UNIFORMS, BABUSHKAS, BABY-BUNTING, BALLOON PANTS, BANDANAS, BANDEAUX, HEADBANDS, NECKBANDS, WRISTBANDS, BASEBALL CAPS, BATHING CAPS, BATHING SUITS, BATHING TRUNKS, BATHROBES, BEACHCOVERUPS, BEACHWEAR, BED JACKETS, GARTER BELTS, MONEY BELTS, BELTS, BERETS, BERMUDA SHORTS, SKI BIBS, BIKINIS, BLAZERS, BLOOMERS, BLOUSES, BLOUSONS, BOAS, BODY SHAPERS, BODY SUITS, BOLEROS, BONNETS, SKI BOOT BAGS, BOOTIES, SKI BOOTS, BOOTS, BOTTOMS, BOW TIES, BOXER SHORTS, TOE BOXES, BRAS, BRASSIERES, BREECHES, BRIEFS, BUSTLERS, CAFTANS, CAMISOLES, CAPES, SHOWER CAPS, CAPS, CARDIGANS, CASSOCKS, CHAPS, CHASUBLES, CHEMISES, CHEMISSETTES, CLEATS FOR ATTACHMENT TO SPORTS SHOES, CLOGS, CLOTH BIBS, CLOTH DIAPERS, FUR COATS, LAB COATS, LEATHER COATS, OVERCOATS, RAINCOATS, SPORT COATS, SUIT COATS, TOP COATS, COATS, COLLARS, COMBINATIONS, COMPETITOR'S NUMBERS OF TEXTILE, CORSELETS, CORSETS, HALLOWEEN COSTUMES, MASQUERADE COSTUMES, COSTUMES AND MASKS SOLD IN CONNECTION THEREWITH, COVERALLS, COVERUPS, CRAVATS, CREEPERS, CUFFS, CULOTTES, CUMMERBUNDS, DICKIES, DRESS SHIELDS, DRESSES, DRESSING GOWNS, DRY SUITS, DUNGAREES, DUSTERS, EAR MUFFS, ESPADRILLES, EVENING GOWNS, FISHING VESTS, FISHING WADERS, FLIGHT SUITS, FOUL WEATHER GEAR, FOUNDATION GARMENTS, FROCKS, FUR JACKETS, FUR STOLEES, GABERDINES, GAITERS, GALOSHES, GAUCHOS, GIRDLES, GLOVES, SKI GLOVES, GOLF SHIRTS, GOLF SHOES, GOWNS, NIGHT GOWNS, WEDDING GOWNS, GREATCOATS, GYM SHORTS, GYM SUITS, HALTER TOPS, HEEL INSERTS, HEELS, HOODS, HOSIERY, HOUSECOATS, INFANT DIAPER COVERS, INFANTWEAR, INNER SOLES, INSOLES, LEATHER JACKETS, WIND RESISTANT JACKETS, JACKETS, JEANS, JERKINS, JERSEYS, JODHPURS, JOGGING SUITS, JUMPERS, JUMPSUITS, KERCHIEFS; KILTS, KIMONOS, KNEE HIGHS, KNICKERS, KNIT SHIRTS, LAYETTES, LEG WARMERS, LEGGINGS, LEOTARDS, LIGHT-REFLECTING COATS, LIGHT-REFLECTING JACKETS, LINGERIE, LOUNGWEAR, MAILLOTS, MANTILLAS, MANTLES, MINISKIRTS, MITTENS, MOCCASINS, MUFFLERS, MUFFS, MUKLUKS, MUU MUUS, NECKERCHIEFS, NECKTIES, NECKWEAR, NEGLIGEEES, NIGHT SHIRTS, OVERALLS, OVERSHOES, SHOULDER PADS FOR CLOTHING, PAJAMAS, PANTALOONS, PANTIES, SKI PANTS, SNOW PANTS, SWEAT PANTS, TAP PANTS, PANTSUITS, PANTYHOSE, PARAMENTS, PAREU, PARKAS, PEDAL PUSHERS, PEIGNOIRS, PELERINES, PELISSES, PETTICOATS, PINAFORES, PLAY SUITS, PLUS FOURS, POCKET SQUARES, POLO SHIRTS, PONCHOS, PULLOVERS, QUILTED VESTS, RAIN SUITS, RAINWEAR, ROBES, ROMPERS, RUBBERS, SANDALS, SARIS, SARONGS, SASHES, SCARVES, SHAWLS, SHIFTS, SPORT SHIRTS, SWEATSHIRTS, UNDERSHIRTS, SHOES, SHORT SETS, SHORT-

CLASS 25—(Continued).

ALLS, SWEAT SHORTS, SHORTS, SINGLETS, SKI MASKS, SKI SUITS, SKI WEAR, SKIRTS, SKORTS, SLACKS, SLEEP MASKS, SLEEPWEAR, SLIPPERS, SLIPS, SMOCKS, SNEAKERS, SNOW SUITS, SNOWBOARD BOOTS, SNOWBOARD GLOVES, SOCKS, THERMAL SOCKS, STOCKINGS, STOLE, SWEAT SUITS, VESTED SUITS, WARM-UP SUITS, WET SUITS, SUITS, SUN VISORS, SUNSUITS, SUSPENDERS, SWADDLING CLOTHES, SWEAT BANDS, TURTLENECK SWEATERS, V-NECK SWEATERS, SWEATERS, SWEATSOCKS, SWIMTRUNKS, SWIM WEAR, SWIMSUITS, T-SHIRTS, TAILLEURS, TANGAS, TANK TOPS, TEDDIES, TENNIS WEAR, THERMAL UNDERWEAR, THONGS, TIES, TIGHTS, TOGAS, TOPS, TOQUES, TRACKSUITS, TROUSERS, TUNICS, TURBANS, TURTLENECKS, TUXEDOS, UNDERCLOTHES, VESTS, VISORS, WAISTCOATS, WATER SOCKS, WINDSHIRTS, WRAPS, ZOOT SUITS, AND ZORI (U.S. CLS. 22 AND 39).

KATRINA EDGE, EXAMINING ATTORNEY

SN 78-482,037. KOFI, MALIBU, CA. FILED 9-11-2004.

THE NEXT BIG THING

THE MARK CONSISTS OF STANDARD CHARACTERS WITHOUT CLAIM TO ANY PARTICULAR FONT, STYLE, SIZE, OR COLOR.

OWNER OF U.S. REG. NOS. 2,418,220 AND 2,657,628.

FOR CLOTHING FOR MEN, WOMEN, AND CHILDREN, NAMELY, SHIRTS, JACKETS, SWEATERS, PANTS, FOOTWEAR, BELTS, T-SHIRTS, SOCKS, COORDINATED SHIRTS, SPORTS JACKETS AND SLACKS, TENNIS SHOES, SWEAT SHIRTS, JERSEYS, SHORTS, JOGGING SUITS, SWEAT PANTS, HATS, CAPS, SCARVES, GLOVES, HOSIERY, NECKTIES, RAINWEAR, PAJAMAS, ROBES, NIGHT SHIRTS, THERMAL UNDERWEAR, HEAD BANDS AND WRIST BANDS (U.S. CLS. 22 AND 39).

FIRST USE 1-1-1994; IN COMMERCE 1-1-1994.

IRENE D. WILLIAMS, EXAMINING ATTORNEY

SN 78-482,135. HOLMES, SCOTT W., LOS ANGELES, CA. FILED 9-12-2004.



THE MARK CONSISTS OF IN PART A STYLIZED EYEBALL OVER THE LETTER "I".

FOR CLOTHING, NAMELY SHIRTS, JERSEYS, HOODS, BELTS, LEATHER BELTS, UNDERWEAR CLOTHING; FOOTWEAR; HEADGEAR, NAMELY CAPS, HATS (U.S. CLS. 22 AND 39).

ALEX KEAM, EXAMINING ATTORNEY

CLASS 25—(Continued).

SN 78-482,833. GINO CORP., LOS ANGELES, CA. FILED 9-13-2004.

SHAKA WEAR

THE MARK CONSISTS OF STANDARD CHARACTERS WITHOUT CLAIM TO ANY PARTICULAR FONT, STYLE, SIZE, OR COLOR.

NO CLAIM IS MADE TO THE EXCLUSIVE RIGHT TO USE "WEAR", APART FROM THE MARK AS SHOWN.

FOR CLOTHING, NAMELY, JACKETS, UNDERSHIRTS, PULLOVERS, SWEATSHIRTS, JUMPERS, TANK-TOPS, BLOUSES, SPORTS PANTS, PANTS, JEANS, SPORTS SHIRTS, AND T-SHIRTS (U.S. CLS. 22 AND 39).

FRED MANDIR, EXAMINING ATTORNEY

SN 78-483,308. GIPPLE, JANICE R., DES MOINES, IA. FILED 9-14-2004.

HUEPHORIA

THE MARK CONSISTS OF STANDARD CHARACTERS WITHOUT CLAIM TO ANY PARTICULAR FONT, STYLE, SIZE, OR COLOR.

FOR ART APPAREL, NAMELY, HANDPAINTED SILK SCARVES AND SHAWLS (U.S. CLS. 22 AND 39).

FIRST USE 7-28-1998; IN COMMERCE 11-0-1998.

STACY WAHLBERG, EXAMINING ATTORNEY

CLASS 25—(Continued).

SN 78-483,957. PAINTBALL ARENA, INC., HUNTINGTON, NY. FILED 9-15-2004.

**Arena Paintball
Gear**

THE MARK CONSISTS OF STANDARD CHARACTERS WITHOUT CLAIM TO ANY PARTICULAR FONT, STYLE, SIZE, OR COLOR.

NO CLAIM IS MADE TO THE EXCLUSIVE RIGHT TO USE "PAINTBALL GEAR", APART FROM THE MARK AS SHOWN.

FOR CLOTHING NAMELY T-SHIRTS, SPORTS JERSEYS, PANTS, HEADBANDS, GLOVES, AND HATS (U.S. CLS. 22 AND 39).

MATTHEW KLINE, EXAMINING ATTORNEY

SN 78-485,466. CLAYTON, KENNETH WAYNE, JR., KNOXVILLE, TN. FILED 9-17-2004.



THE MARK CONSISTS OF A STYLIZED CHOPPER-SLED HAVING THE APPEARANCE OF A MOTORCYCLE AT THE FRONT AND THE APPEARANCE OF A SLED AT THE REAR WITH THE STYLIZED WORDS NORTH POLE ABOVE THE CHOPPER-SLED AND THE STYLIZED WORD CHOPPERS BELOW THE CHOPPER-SLED.

FOR CLOTHING, NAMELY, T-SHIRTS, TANK TOPS, CROP TOPS, SWEATSHIRTS, FLEECE TOPS, POLO SHIRTS, GOLF SHIRTS, ATHLETIC JERSEYS, JACKETS, COATS, VESTS, GLOVES, WOMEN'S BLOUSES AND TOPS, NECKTIES, SOCKS, PANTS, SWEAT PANTS, FLEECE PANTS, UNDERWEAR, LINGERIE, PAJAMAS, NIGHT GOWNS, BELTS, SCARVES, DENIM JEANS AND JACKETS, SWIMSUITS AND COVER-UPS; HEADGEAR, NAMELY, HATS, CAPS, KNIT CAPS, HEAD BANDS, BEANIES, AND BANDANAS (U.S. CLS. 22 AND 39).

LANA PHAM, EXAMINING ATTORNEY

CLASS 25—(Continued).

SN 78-486,442. STRAIN, JAMES R., DBA SHOCKER INC., CALGARY ALBERTA T3K2A8, CANADA, FILED 9-20-2004.



OWNER OF CANADA REG. NO. TMA618,986, DATED 9-9-2004, EXPIRES 9-9-2019.

FOR CLOTHING, NAMELY, T-SHIRTS, BEACHWEAR, BLOUSES, SPORTS SHIRTS, JERSEYS, SWIMWEAR, SWIMTRUNKS, SHORTS, UNDERWEAR, SHIRTS, PANTS, RACING PANTS, SKI AND SNOWBOARD PANTS AND JACKETS, JEANS, VESTS, JACKETS, WETSUITS, SWEATERS, PULLOVERS, COATS, SWEATPANTS, HEADWEAR, NAMELY, HATS, CAPS, VISORS AND FOOTWEAR, NAMELY WETSUIT BOOTIES, SHOES, SANDALS, ATHLETIC FOOTWEAR, ALL PURPOSE SPORTS FOOTWEAR, THONGS AND BOOTS (U.S. CLS. 22 AND 39).

FIRST USE 7-11-1994; IN COMMERCE 7-1-2002.

BILL DAWE, EXAMINING ATTORNEY

SN 78-486,598. ROSIN, KIRK D., MANKATO, MN. FILED 9-20-2004.

**BRANSON STATE
UNIVERSITY**

THE MARK CONSISTS OF STANDARD CHARACTERS WITHOUT CLAIM TO ANY PARTICULAR FONT, STYLE, SIZE, OR COLOR.

FOR COLLEGIATE-TYPE CLOTHING—NAMELY, SWEAT SHIRTS, T-SHIRTS, SWEAT PANTS, JACKETS, JOGGING SHORTS, SWIM TRUNKS, JERSEYS AND HATS (U.S. CLS. 22 AND 39).

ZHALEH DELANEY, EXAMINING ATTORNEY

CLASS 25—(Continued).

SN 78-487,989. GATTEN, MICHAEL D., MEDFORD, OR.
FILED 9-22-2004.

MIRACLE GEAR

THE MARK CONSISTS OF STANDARD CHARACTERS
WITHOUT CLAIM TO ANY PARTICULAR FONT, STYLE,
SIZE, OR COLOR.

NO CLAIM IS MADE TO THE EXCLUSIVE RIGHT TO
USE "GEAR", APART FROM THE MARK AS SHOWN.

FOR CLOTHING, NAMELY, INFANTWEAR. (U.S.
CLS. 22 AND 39).

SANJEEV VOHRA, EXAMINING ATTORNEY

SN 78-489,129. UBERTEASE, INC., RANCHO SANTA FE, CA.
FILED 9-24-2004.

ÜBERTEASE

FOR WEARING APPAREL NAMELY, TANK TOPS,
SHIRTS, T-SHIRTS, PANTS, SHORTS, SWIMWEAR, LIN-
GERIE, SWEATSHIRTS, UNDERWEAR, JACKETS,
DRESSES, SKIRTS, BELTS, SHOES, GLOVES, BASEBALL
CAPS, BEANIES, SKI CAPS AND WRISTBANDS (U.S.
CLS. 22 AND 39).

PAM WILLIS, EXAMINING ATTORNEY

SN 78-489,502. NORDSTROM, INC., SEATTLE, WA. FILED 9-
24-2004.

BP. SHOES

THE MARK CONSISTS OF STANDARD CHARACTERS
WITHOUT CLAIM TO ANY PARTICULAR FONT, STYLE,
SIZE, OR COLOR.

NO CLAIM IS MADE TO THE EXCLUSIVE RIGHT TO
USE SHOES, APART FROM THE MARK AS SHOWN.

FOR FOOTWEAR (U.S. CLS. 22 AND 39).
FIRST USE 0-0-1992; IN COMMERCE 0-0-1992.

BRIAN NEVILLE, EXAMINING ATTORNEY

CLASS 25—(Continued).

SN 78-490,289. B M C SPORTSWEAR INC., NEW YORK, NY.
FILED 9-27-2004.

NU SOUL

THE MARK CONSISTS OF STANDARD CHARACTERS
WITHOUT CLAIM TO ANY PARTICULAR FONT, STYLE,
SIZE, OR COLOR.

FOR MEN'S ACTIVE WEAR, NAMELY, PANTS, TOPS,
JACKETS, SHORTS, JERSEYS (U.S. CLS. 22 AND 39).

RICHARD WHITE, EXAMINING ATTORNEY

SN 78-490,403. KUHLMAN, DAVE, LOMBARD, IL. AND
LUTZ, STEVE, GLEN ELLYN, IL. FILED 9-28-2004.

OYL

THE MARK CONSISTS OF STANDARD CHARACTERS
WITHOUT CLAIM TO ANY PARTICULAR FONT, STYLE,
SIZE, OR COLOR.

FOR CLOTHING, NAMELY, TEE-SHIRTS, SWEAT-
SHIRTS, HATS, AND SHORTS (U.S. CLS. 22 AND 39).

PRISCILLA MILTON, EXAMINING ATTORNEY

CLASS 25—(Continued).

SN 78-490,404. KUHLMAN, DAVE, LOMBARD, IL. AND LUTZ, STEVE, GLEN ELLYN, IL. FILED 9-28-2004.

CLASS 25—(Continued).

SN 78-491,670. RUBIE'S COSTUME CO., INC., RICHMOND HILL, NY. FILED 9-29-2004.

5 MILE CO

RUBIE'S

THE MARK CONSISTS OF STANDARD CHARACTERS WITHOUT CLAIM TO ANY PARTICULAR FONT, STYLE, SIZE, OR COLOR.

NO CLAIM IS MADE TO THE EXCLUSIVE RIGHT TO USE "CO", APART FROM THE MARK AS SHOWN.

FOR CLOTHING, NAMELY, TEE-SHIRTS, SWEAT-SHIRTS, HATS, AND SHORTS (U.S. CLS. 22 AND 39).
PRISCILLA MILTON, EXAMINING ATTORNEY

THE MARK CONSISTS OF STANDARD CHARACTERS WITHOUT CLAIM TO ANY PARTICULAR FONT, STYLE, SIZE, OR COLOR.

OWNER OF U.S. REG. NOS. 2,599,287, 2,853,098 AND OTHERS.

FOR ADULT AND CHILDREN, HALLOWEEN, MASQUERADE AND THEATRICAL COSTUMES (U.S. CLS. 22 AND 39).

FIRST USE 12-31-1972; IN COMMERCE 12-31-1972.
LINDA MICKLEBURGH, EXAMINING ATTORNEY

SN 78-491,598. STUBBLEFIELD, ELWOOD T., WOODBRIDGE, VA. FILED 9-29-2004.

SN 78-494,810. LESSARD & LESSARD, INC., OSAGE, IA. FILED 10-5-2004.

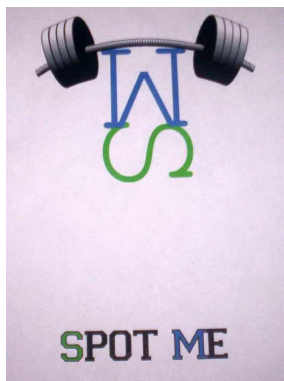

**AXT ADVENTURE
CROSS TRAINING**

THE COLOR(S) BLUE, BLACK AND GREEN IS/ARE CLAIMED AS A FEATURE OF THE MARK.

THE MARK CONSISTS OF THE LETTER "S" IN SPOT WHICH IS OUTLINED IN BLACK AND SHADED THE COLOR GREEN. THE LETTER "M" IN ME IS OUTLINED IN BLACK AND SHADED THE COLOR BLUE. THE UPSIDE DOWN "M" AND THE "S" THAT HOLDS THE BARBELL AT THE TOP OF THE MARK ARE BLUE AND GREEN RESPECTIVELY.

FOR MEN'S, WOMEN'S AND CHILDREN'S CLOTHING AND FASHION ACCESSORIES, NAMELY SHIRTS, T-SHIRTS AND SWEATSHIRTS, SWEATERS, JACKETS, KNIT TOPS, TANK TOPS, WIND RESISTANT JACKETS, JOGGING SUITS, SWEATPANTS, SCARVES, HEAD BANDS, WRIST BANDS; FOOTWEAR, HEADWEAR, CAPS AND HATS (U.S. CLS. 22 AND 39).
SHARI SHEFFIELD, EXAMINING ATTORNEY

THE MARK CONSISTS OF STANDARD CHARACTERS WITHOUT CLAIM TO ANY PARTICULAR FONT, STYLE, SIZE, OR COLOR.

NO CLAIM IS MADE TO THE EXCLUSIVE RIGHT TO USE "CROSS TRAINING", APART FROM THE MARK AS SHOWN.

FOR SOCKS (U.S. CLS. 22 AND 39).
FIRST USE 11-3-2003; IN COMMERCE 11-3-2003.
THEODORE MCBRIDE, EXAMINING ATTORNEY

CLASS 25—(Continued).

SN 78-495,180. WORLD WRESTLING ENTERTAINMENT, INC., STAMFORD, CT. FILED 10-6-2004.

RANDY WEAR

THE MARK CONSISTS OF STANDARD CHARACTERS WITHOUT CLAIM TO ANY PARTICULAR FONT, STYLE, SIZE, OR COLOR.

NO CLAIM IS MADE TO THE EXCLUSIVE RIGHT TO USE "WEAR", APART FROM THE MARK AS SHOWN.

FOR CLOTHING, NAMELY, TANK TOPS, T-SHIRTS, SHIRTS, SPORT SHIRTS, DRESS SHIRTS, POLO SHIRTS, UNDERSHIRTS, SWEATSHIRTS, SWEATERS, PULL-OVERS, BLOUSES, JACKETS, RAINCOATS, OVERCOATS, TOPCOATS, TROUSERS, PANTS, JEAN PANTS, JOGGING SUITS, EXERCISE PANTS, EXERCISE SUITS, SWEATPANTS, SHORTS, UNDERWEAR, BOXER SHORTS, SOCKS, CLOTHING TIES, PAJAMAS, BELTS, GLOVES, HALLOWEEN AND MASQUERADE COSTUMES, WRIST BANDS, BANDANNAS; FOOTWEAR, NAMELY, SHOES, SNEAKERS, BOOTS, SLIPPERS; HEADGEAR, NAMELY, HATS, CAPS (U.S. CLS. 22 AND 39).

ELLEN PERKINS, EXAMINING ATTORNEY

SN 78-495,202. SRL, INC., LEXINGTON, MA. FILED 10-6-2004.

CRYSTALUNA

THE MARK CONSISTS OF STANDARD CHARACTERS WITHOUT CLAIM TO ANY PARTICULAR FONT, STYLE, SIZE, OR COLOR.

FOR FOOTWEAR (U.S. CLS. 22 AND 39).

MICHAEL KAZAZIAN, EXAMINING ATTORNEY

CLASS 25—(Continued).

SN 78-495,470. RLJ BASKETBALL, LLC, CHARLOTTE, NC. FILED 10-6-2004.



THE MARK CONSISTS OF THE HEAD OF A BOBCAT OVER A BASKETBALL.

FOR CLOTHING, NAMELY HOSIERY, FOOTWEAR, BASKETBALL SHOES, BASKETBALL SNEAKERS, T-SHIRTS, SHIRTS, SWEATSHIRTS, SWEATPANTS, PANTS, TANK TOPS, JERSEYS, SHORTS, PAJAMAS, SPORT SHIRTS, RUGBY SHIRTS, SWEATERS, BELTS, TIES, NIGHTSHIRTS, HATS, CAPS, WARM-UP SUITS, WARM-UP PANTS, WARM-UP TOPS, JACKETS, WIND RESISTANT JACKETS, PARKAS, COATS, CLOTH BABY BIBS, HEAD BANDS, WRIST BANDS, APRONS, BOXER SHORTS, SLACKS, CAPS, EAR MUFFS, GLOVES, MITTENS, SCARVES, WOVEN AND KNIT SHIRTS, DRESSES, CHEERLEADING DRESSES AND UNIFORMS (U.S. CLS. 22 AND 39).

AMOS T. MATTHEWS, JR., EXAMINING ATTORNEY

SN 78-495,584. WORLD WRESTLING ENTERTAINMENT, INC., STAMFORD, CT. FILED 10-6-2004.

NO CLAIM IS MADE TO THE EXCLUSIVE RIGHT TO USE "WEAR", APART FROM THE MARK AS SHOWN.

FOR CLOTHING, NAMELY, TANK TOPS, T-SHIRTS, SHIRTS, SPORT SHIRTS, DRESS SHIRTS, POLO SHIRTS, UNDERSHIRTS, SWEATSHIRTS, SWEATERS, PULL-OVERS, BLOUSES, JACKETS, RAINCOATS, OVERCOATS, TOPCOATS, TROUSERS, PANTS, JEAN PANTS, JOGGING SUITS, EXERCISE PANTS, EXERCISE SUITS, SWEATPANTS, SHORTS, UNDERWEAR, BOXER SHORTS, SOCKS, CLOTHING TIES, PAJAMAS, BELTS, GLOVES, HALLOWEEN AND MASQUERADE COSTUMES, WRIST BANDS, BANDANNAS; FOOTWEAR, NAMELY, SHOES, SNEAKERS, BOOTS, SLIPPERS; HEADGEAR, NAMELY, HATS, CAPS (U.S. CLS. 22 AND 39).

ELLEN PERKINS, EXAMINING ATTORNEY

CLASS 25—(Continued).

SN 78-495,731. MINTY FRESH, INC., CHICAGO, IL. FILED 10-6-2004.

CLASS 25—(Continued).

SN 78-496,150. KGR KIDS, INC., DBA LIFE IS GAY, LITTLE FERRY, NJ. FILED 10-7-2004.

ROADKILL COMMANDOES

Life is Gay

THE MARK CONSISTS OF STANDARD CHARACTERS WITHOUT CLAIM TO ANY PARTICULAR FONT, STYLE, SIZE, OR COLOR.

FOR CLOTHING, NAMELY SHIRTS, T-SHIRTS, SWEATSHIRTS, SWEATERS, VESTS, JACKETS, ROBES, PANTS SHORTS, BELTS, DRESSES, OVERALLS, INFANTWEAR, PLAYSUITS, CLOTH BABY BIBS, HEADWEAR, HATS, FOOTWEAR, SHOES, SOCKS TIGHTS, BEACHWEAR, SWIMSUITS, SWIMWEAR, RAINWARE, COATS, SUN VISORS, NECKWEAR, PAJAMAS, NIGHTSHIRTS, NIGHTGOWNS, UNDERGARMENTS, APRONS (U.S. CLS. 22 AND 39).

JAMES A. RAUEN, EXAMINING ATTORNEY

THE MARK CONSISTS OF STANDARD CHARACTERS WITHOUT CLAIM TO ANY PARTICULAR FONT, STYLE, SIZE, OR COLOR.

FOR SHIRTS, PANTS, HATS, APRONS, AND SHORTS (U.S. CLS. 22 AND 39).

KRISTINA KLOIBER, EXAMINING ATTORNEY

SN 78-495,830. BELLISIMO-BELARDINELLI EFFECTS, INC., CANYON COUNTRY, CA. FILED 10-6-2004.

SN 78-497,378. PAMELA L. HENRIKSEN-OSUNA, ALISO VIEJO, CA. FILED 10-9-2004.

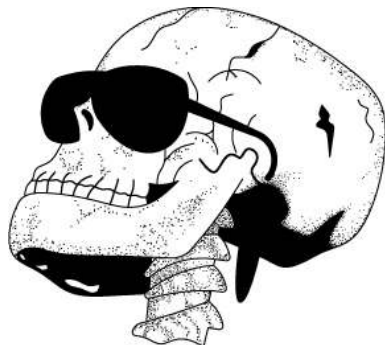

Soul of the Sea

THE MARK CONSISTS OF A SKULL DESIGN, FOR CLOTHING, NAMELY T-SHIRTS, CAPS, AND HATS (U.S. CLS. 22 AND 39).

FIRST USE 12-1-1985; IN COMMERCE 12-1-1985. KIMBERLY PERRY, EXAMINING ATTORNEY

THE MARK CONSISTS OF STANDARD CHARACTERS WITHOUT CLAIM TO ANY PARTICULAR FONT, STYLE, SIZE, OR COLOR.

FOR ACTION AND LIFESTYLE CLOTHING FOR SURFING AND RELATED ACTION SPORTS; NAMELY, SHORTS, T-SHIRTS, SWEATSHIRTS, SURF TRUNKS, PANTS, SKIRTS, TANK TOPS, SWIM WEAR, HATS, BELTS, JACKETS AND SWEATERS (U.S. CLS. 22 AND 39).

RONALD MCMORROW, EXAMINING ATTORNEY

CLASS 25—(Continued).

SN 78-497,924. UN-THINKABLE, INC, NEW YORK, NY.
FILED 10-11-2004.

ITW

CLASS 25—(Continued).

SN 78-497,928. UN-THINKABLE, INC, NEW YORK, NY.
FILED 10-11-2004.

IN THE WASH

THE MARK CONSISTS OF STANDARD CHARACTERS WITHOUT CLAIM TO ANY PARTICULAR FONT, STYLE, SIZE, OR COLOR.

FOR CLOTHING AND SPORTSWEAR FOR WOMEN, NAMELY, BERMUDA SHORTS, BLAZERS, BLOUSES, CAMISOLES, CAPRI PANTS, COATS, DRESSES, GOLF SHIRTS, GOLF SHORTS, GYM SHIRTS, GYM SHORTS, GYM SUITS, JACKETS, JEANS, JOGGING SUITS, JUMPSUITS, KNIT SHIRTS, OVERALLS, OVERCOATS, PANTALOONS, PANTS, POLO SHIRTS, PULLOVERS, RAINCOATS, SCOOP-NECK SWEATERS, SHIRTS, SKIRTS, SLACKS, SPORT SHIRTS, SPORT COATS, SWEAT PANTS, SWEAT SHORTS, SWEAT SUITS, SWEATERS, SUITS, SUIT JACKETS, PANT SUITS, SKIRT SUITS, DRESS SUITS, TANK TOPS, TROUSERS, T-SHIRTS, TUNICS, TURTLENECK SWEATERS, VESTS, AND V-NECK SWEATERS; SLEEPWEAR (U.S. CLS. 22 AND 39).

FIRST USE 12-31-1998; IN COMMERCE 12-31-1998.
SUSAN HAYASH, EXAMINING ATTORNEY

SN 78-497,929. UN-THINKABLE, INC, NEW YORK, NY.
FILED 10-11-2004.

CHATTERPRINTZ

THE MARK CONSISTS OF STANDARD CHARACTERS WITHOUT CLAIM TO ANY PARTICULAR FONT, STYLE, SIZE, OR COLOR.

FOR CLOTHING AND SPORTSWEAR FOR WOMEN, NAMELY, BERMUDA SHORTS, BLAZERS, BLOUSES, CAMISOLES, CAPRI PANTS, COATS, DRESSES, GOLF SHIRTS, GOLF SHORTS, GYM SHIRTS, GYM SHORTS, GYM SUITS, JACKETS, JEANS, JOGGING SUITS, JUMPSUITS, KNIT SHIRTS, OVERALLS, OVERCOATS, PANTALOONS, PANTS, POLO SHIRTS, PULLOVERS, RAINCOATS, SCOOP-NECK SWEATERS, SHIRTS, SKIRTS, SLACKS, SPORT SHIRTS, SPORT COATS, SWEAT PANTS, SWEAT SHORTS, SWEAT SUITS, SWEATERS, SUITS, SUIT JACKETS, PANT SUITS, SKIRT SUITS, DRESS SUITS, TANK TOPS, TROUSERS, T-SHIRTS, TUNICS, TURTLENECK SWEATERS, VESTS, AND V-NECK SWEATERS; SLEEPWEAR (U.S. CLS. 22 AND 39).

FIRST USE 12-31-1999; IN COMMERCE 12-31-1999.
SUSAN HAYASH, EXAMINING ATTORNEY

THE MARK CONSISTS OF STANDARD CHARACTERS WITHOUT CLAIM TO ANY PARTICULAR FONT, STYLE, SIZE, OR COLOR.

FOR CLOTHING AND SPORTSWEAR FOR WOMEN, NAMELY, BERMUDA SHORTS, BLAZERS, BLOUSES, CAMISOLES, CAPRI PANTS, COATS, DRESSES, GOLF SHIRTS, GOLF SHORTS, GYM SHIRTS, GYM SHORTS, GYM SUITS, JACKETS, JEANS, JOGGING SUITS, JUMPSUITS, KNIT SHIRTS, OVERALLS, OVERCOATS, PANTALOONS, PANTS, POLO SHIRTS, PULLOVERS, RAINCOATS, SCOOP-NECK SWEATERS, SHIRTS, SKIRTS, SLACKS, SPORT SHIRTS, SPORT COATS, SWEAT PANTS, SWEAT SHORTS, SWEAT SUITS, SWEATERS, SUITS, SUIT JACKETS, PANT SUITS, SKIRT SUITS, DRESS SUITS, TANK TOPS, TROUSERS, T-SHIRTS, TUNICS, TURTLENECK SWEATERS, VESTS, AND V-NECK SWEATERS; SLEEPWEAR (U.S. CLS. 22 AND 39).

FIRST USE 1-31-2004; IN COMMERCE 1-31-2004.
SUSAN HAYASH, EXAMINING ATTORNEY

CLASS 25—(Continued).

SN 78-498,159. SEATTLE PACIFIC INDUSTRIES, INC., SEATTLE, WA. FILED 10-12-2004.

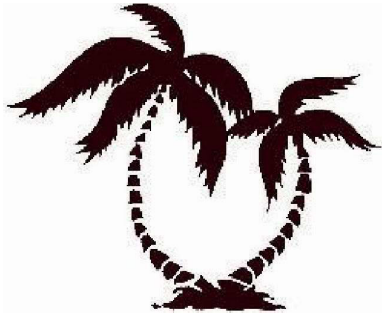

THE MARK CONSISTS OF TWO CONNECTED PALM TREES.

FOR MEN'S, WOMEN'S AND CHILDREN'S CLOTHING AND ACCESSORIES, NAMELY, JEANS, BLOUSES, SHIRTS, JACKETS, BELTS, BOTTOMS, UNDERWEAR, COATS, DRESSES, FOOTWEAR, HEAD WEAR, GLOVES, SLEEPWEAR, ROBES, PANTS, SKIRTS, SWEATERS, TOPS, AND SWIM WEAR (U.S. CLS. 22 AND 39).

FIRST USE 8-2-2004; IN COMMERCE 8-2-2004.
TARAH HARDY, EXAMINING ATTORNEY

CLASS 25—(Continued).

SN 78-498,654. CHYI RA, INC., WEST HOLLYWOOD, CA. FILED 10-12-2004.

Custom Made By
Jesus

THE MARK CONSISTS OF STANDARD CHARACTERS WITHOUT CLAIM TO ANY PARTICULAR FONT, STYLE, SIZE, OR COLOR.

NO CLAIM IS MADE TO THE EXCLUSIVE RIGHT TO USE CUSTOM MADE, APART FROM THE MARK AS SHOWN.

FOR CLOTHING AND ACCESSORIES FOR MEN, WOMEN AND CHILDREN, NAMELY INNER WEAR NAMELY LINGERIE, UNDERWEAR AND UNDERGARMENTS; OUTERWEAR NAMELY TOPS, COVERUPS, T-SHIRTS, JACKETS, COATS, SWEATERS, BLOUSES, PANTS AND BOTTOMS; HEADWEAR NAMELY HATS, BEANIES, CAPS, HEADBANDS; FOOTWEAR NAMELY SOCKS, SHOES, SANDALS, SHOELACES; AND ACCESSORIES NAMELY SCARVES, SHAWLS, GLOVES, WRISTBANDS AND SASHES (U.S. CLS. 22 AND 39).

FIRST USE 5-1-2004; IN COMMERCE 6-1-2004.
SCOTT OSLICK, EXAMINING ATTORNEY

SN 78-498,434. BLEE, SIDNEY JANE, PALOS VERDES ESTATES, CA. FILED 10-12-2004.

AQUA-BABE

THE MARK CONSISTS OF STANDARD CHARACTERS WITHOUT CLAIM TO ANY PARTICULAR FONT, STYLE, SIZE, OR COLOR.

FOR CLOTHING, NAMELY, SHIRTS, SHORTS, HATS, SHOES, SWIMWEAR, SURFWEAR, AND SWEATSHIRTS (U.S. CLS. 22 AND 39).

HEATHER THOMPSON, EXAMINING ATTORNEY

SN 78-498,704. SINGH, BHALIN, VENICE, CA. FILED 10-12-2004.

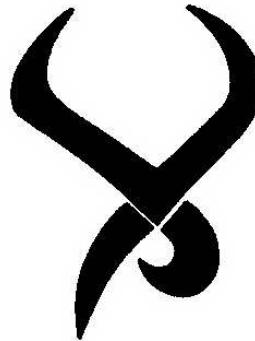

FOR CLOTHING, NAMELY, MEN'S AND WOMEN'S SHIRTS, TEE SHIRTS, PANTS, SHORTS, SOCKS, CAMISOLES, BLOUSES, HALTERS, TIES, SCARVES, SUITS, AND SKIRTS (U.S. CLS. 22 AND 39).

FIRST USE 8-24-2002; IN COMMERCE 10-2-2002.
GWEN STOKOLS, EXAMINING ATTORNEY

CLASS 25—(Continued).

SN 78-499,099. ELEVATION ENTERTAINMENT, LLC, LOS ANGELES, CA. FILED 10-13-2004.

Orchestrated

THE MARK CONSISTS OF STANDARD CHARACTERS WITHOUT CLAIM TO ANY PARTICULAR FONT, STYLE, SIZE, OR COLOR.

FOR CLOTHING, NAMELY T-SHIRTS, SHIRTS, GOLF SHIRTS, SWEATSHIRTS, HATS, CAPS (U.S. CLS. 22 AND 39).

ESTHER BELENKER, EXAMINING ATTORNEY

CLASS 25—(Continued).

SN 78-499,519. WOLVERINE OUTDOORS, INC., ROCKFORD, MI. FILED 10-14-2004.



THE COLOR(S) LIGHT TAN, ORANGE, AND CHARCOAL IS/ARE CLAIMED AS A FEATURE OF THE MARK.

THE MARK CONSISTS OF A LIGHT TAN LETTER M WITHIN AN ORANGE CIRCLE WITH A DARK CHARCOAL-COLORED BORDER.

FOR FOOTWEAR (U.S. CLS. 22 AND 39).
FIRST USE 11-30-2002; IN COMMERCE 11-30-2002.
MARK T. MULLEN, EXAMINING ATTORNEY

SN 78-499,324. MIZUNO USA, INC., NORCROSS, GA. FILED 10-13-2004.

RUNBIRD



THE MARK CONSISTS OF STANDARD CHARACTERS WITHOUT CLAIM TO ANY PARTICULAR FONT, STYLE, SIZE, OR COLOR.

FOR CLOTHING, NAMELY, SOCKS, GLOVES, TOPS, AND SHOES (U.S. CLS. 22 AND 39).

FIRST USE 10-0-1982; IN COMMERCE 12-6-1982.
BRIAN NEVILLE, EXAMINING ATTORNEY

THE COLOR(S) WHITE, YELLOW, YELLOW-ORANGE, ORANGE-RED, AND DEEP RED IS/ARE CLAIMED AS A FEATURE OF THE MARK.

THE MARK CONSISTS OF A SEQUENCE OF COLORED BARS ALONG A SPECTRUM, IN WHITE, YELLOW, YELLOW-ORANGE, ORANGE-RED, AND DEEP RED, FOLLOWED BY THE WORD CONTINUUM.

FOR FOOTWEAR (U.S. CLS. 22 AND 39).
FIRST USE 11-18-2003; IN COMMERCE 2-5-2004.
TRACY WHITAKER-BOWN, EXAMINING ATTORNEY

CLASS 25—(Continued).

SN 78-499,916. EMMETT LONDON, LONDON, UNITED KINGDOM, FILED 10-14-2004.

EMMETT LONDON

THE MARK CONSISTS OF STANDARD CHARACTERS WITHOUT CLAIM TO ANY PARTICULAR FONT, STYLE, SIZE, OR COLOR.

NO CLAIM IS MADE TO THE EXCLUSIVE RIGHT TO USE "LONDON", APART FROM THE MARK AS SHOWN.

FOR SHIRTS, TIES, SOCKS AND UNDERGARMENTS (U.S. CLS. 22 AND 39).

FIRST USE 2-28-1997; IN COMMERCE 2-28-1997.
JULIE WATSON, EXAMINING ATTORNEY

SN 78-499,923. STRATEGIC PARTNERS, INC., PACOIMA, CA. FILED 10-14-2004.

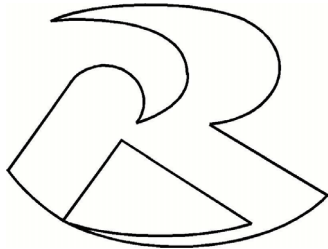

THE MARK CONSISTS OF A DESIGN OF THE LETTER "R".

FOR FOOTWEAR (U.S. CLS. 22 AND 39).
FIRST USE 1-31-2000; IN COMMERCE 1-31-2000.
KARLA PERKINS, EXAMINING ATTORNEY

SN 78-499,982. WEYCO GROUP, INC., MILWAUKEE, WI. FILED 10-14-2004.

NUNN BUSH

THE MARK CONSISTS OF STANDARD CHARACTERS WITHOUT CLAIM TO ANY PARTICULAR FONT, STYLE, SIZE, OR COLOR.

OWNER OF U.S. REG. NO. 603,049.
FOR SHOES (U.S. CLS. 22 AND 39).
FIRST USE 6-21-1912; IN COMMERCE 6-21-1912.
RAUL CORDOVA, EXAMINING ATTORNEY

CLASS 25—(Continued).

SN 78-499,991. DEUTSCHE TELEKOM AG, BONN, FED REP GERMANY, FILED 10-14-2004.

T-Systems

THE MARK CONSISTS OF STANDARD CHARACTERS WITHOUT CLAIM TO ANY PARTICULAR FONT, STYLE, SIZE, OR COLOR.

PRIORITY CLAIMED UNDER SEC. 44(D) ON FED REP GERMANY APPLICATION NO. 30421580535, FILED 4-15-2004, REG. NO. 30421580, DATED 9-9-2004, EXPIRES 4-30-2014.

OWNER OF U.S. REG. NOS. 2,448,571, 2,880,613 AND OTHERS.

FOR CLOTHING, NAMELY, SHIRTS, DRESSES, PANTS, JACKETS, COATS, T-SHIRTS, SHORTS; HEADWEAR, NAMELY, CAPS AND HATS; FOOTWEAR (U.S. CLS. 22 AND 39).

SKYE YOUNG, EXAMINING ATTORNEY

SN 78-500,027. DEUTSCHE TELEKOM AG, BONN, FED REP GERMANY, FILED 10-14-2004.



PRIORITY CLAIMED UNDER SEC. 44(D) ON FED REP GERMANY APPLICATION NO. 30421579135, FILED 4-15-2004, REG. NO. 30421579, DATED 9-9-2004, EXPIRES 4-30-2014.

OWNER OF U.S. REG. NOS. 2,448,571, 2,880,613 AND OTHERS.

THE COLOR(S) MAGENTA AND GREY IS/ARE CLAIMED AS A FEATURE OF THE MARK.

THE COLOR MAGENTA APPEARS IN THE LETTER "T" IN THE MARK; THE REMAINDER OF THE MARK APPEARS IN THE COLOR GREY.

FOR CLOTHING, NAMELY, SHIRTS, DRESSES, PANTS, JACKETS, COATS, T-SHIRTS, SHORTS; HEADWEAR, NAMELY, CAPS AND HATS; FOOTWEAR (U.S. CLS. 22 AND 39).

SKYE YOUNG, EXAMINING ATTORNEY

CLASS 25—(Continued).

SN 78-500,318. FERRARA, DEAN J, WILLISTON, VT. FILED 10-15-2004.



THE MARK CONSISTS OF THE X IS PEPITA MT FONT, IT IS FLIPPED AND THEN ROTATED. CAP IS PERPETUA FONT.

FOR HATS, VISORS, AND CAPS (U.S. CLS. 22 AND 39).

FIRST USE 6-10-2003; IN COMMERCE 9-1-2003.
REBECCA SMITH, EXAMINING ATTORNEY

SN 78-500,652. RUSSELL, CHRISTY L., CHICAGO, IL. FILED 10-15-2004.

CHERUB SHOES

THE MARK CONSISTS OF STANDARD CHARACTERS WITHOUT CLAIM TO ANY PARTICULAR FONT, STYLE, SIZE, OR COLOR.

NO CLAIM IS MADE TO THE EXCLUSIVE RIGHT TO USE "SHOES", APART FROM THE MARK AS SHOWN.

FOR FOOTWEAR INTENDED FOR INFANTS AND TODDLERS (U.S. CLS. 22 AND 39).

FIRST USE 10-1-2004; IN COMMERCE 11-1-2004.
KATRINA EDGE, EXAMINING ATTORNEY

SN 78-501,372. PITAYA, INC., INDIANAPOLIS, IN. FILED 10-18-2004.

PITAYA

THE MARK CONSISTS OF STANDARD CHARACTERS WITHOUT CLAIM TO ANY PARTICULAR FONT, STYLE, SIZE, OR COLOR.

FOR CLOTHING, NAMELY, SKIRTS, SHIRTS AND JACKETS (U.S. CLS. 22 AND 39).

FIRST USE 12-31-1990; IN COMMERCE 12-31-1990.
JOHN LINCOSKI, EXAMINING ATTORNEY

CLASS 25—(Continued).

SN 78-501,426. GRUJEVSKI, ZORAN, TUSTIN, CA. FILED 10-18-2004.

ETHNIK

THE MARK CONSISTS OF STANDARD CHARACTERS WITHOUT CLAIM TO ANY PARTICULAR FONT, STYLE, SIZE, OR COLOR.

FOR MEN'S AND WOMEN'S CLOTHING, NAMELY CONSISTING OF SHIRTS, PANTS, JACKETS, BASEBALL HATS, BEANIES, TANK TOPS, JERSEYS, SOCKS, SWEATERS, SWEATSHIRTS, UNDERWEAR (U.S. CLS. 22 AND 39).

FIRST USE 1-3-1998; IN COMMERCE 12-9-2000.
KEVON CHISOLM, EXAMINING ATTORNEY

SN 78-501,626. ES US (DEL) DBA EARNEST SEWN, NEW YORK, NY. FILED 10-18-2004.

EARNEST SEWN

THE MARK CONSISTS OF STANDARD CHARACTERS WITHOUT CLAIM TO ANY PARTICULAR FONT, STYLE, SIZE, OR COLOR.

FOR CLOTHING, NAMELY, MENS' AND WOMENS' DENIM JEANS AND PANTS, AND SKIRTS (U.S. CLS. 22 AND 39).

FIRST USE 4-1-2004; IN COMMERCE 4-1-2004.
ANGELA M. MICHELI, EXAMINING ATTORNEY

CLASS 25—(Continued).

SN 78-501,660. BRASSERIE DE TAHITI S.A., PAPEETE, TAHITI, FRENCH POLYNESIA, FILED 10-18-2004.

TARAVANA

THE MARK CONSISTS OF STANDARD CHARACTERS WITHOUT CLAIM TO ANY PARTICULAR FONT, STYLE, SIZE, OR COLOR.

FOR CLOTHING, NAMELY, PANTS, SHORTS, T-SHIRTS, SHIRTS, POLO SHIRTS, JACKETS, SWEATSHIRTS, NECKTIES, BLOUSES, SWIMWEAR, SHOES, HEAD WEAR (U.S. CLS. 22 AND 39).

ALEX KEAM, EXAMINING ATTORNEY

CLASS 25—(Continued).

SN 78-502,571. ANHEUSER-BUSCH, INCORPORATED, ST. LOUIS, MO. FILED 10-20-2004.

9TH STREET MARKET

THE MARK CONSISTS OF STANDARD CHARACTERS WITHOUT CLAIM TO ANY PARTICULAR FONT, STYLE, SIZE, OR COLOR.

FOR CLOTHING, NAMELY SHIRTS AND HEADWEAR (U.S. CLS. 22 AND 39).

FIRST USE 11-30-2004; IN COMMERCE 11-30-2004.
KELLEY WELLS, EXAMINING ATTORNEY

SN 78-502,056. NINE WEST DEVELOPMENT CORPORATION, WILMINGTON, DE. FILED 10-19-2004.

Comfort²

OWNER OF U.S. REG. NO. 2,497,528.
THE MARK CONSISTS OF THE NUMERIC "2" IN THE DESIGN IS SHOWN IN SUPERSCRIPIT TO REPRESENT THE MATHEMATICAL TERM "SQUARED".

FOR FOOTWEAR (U.S. CLS. 22 AND 39).
FIRST USE 3-31-2004; IN COMMERCE 3-31-2004.
ELLEN B. AWRICH, EXAMINING ATTORNEY

SN 78-503,266. WARNER BROS. ENTERTAINMENT INC., BURBANK, CA. FILED 10-20-2004.

NYMPHADORA TONKS

SN 78-502,504. BULLINS, TYRONE C., MADISON, NC. FILED 10-19-2004.

RACE PRINCESS

THE MARK CONSISTS OF STANDARD CHARACTERS WITHOUT CLAIM TO ANY PARTICULAR FONT, STYLE, SIZE, OR COLOR.

FOR T-SHIRTS, POLO SHIRTS, NIGHTSHIRTS, SWEAT SHIRTS, TANK TOPS, PANTS, SWEATPANTS, HALTER TOPS, SHORTS, JACKETS, HATS, VISORS, BANDANAS (U.S. CLS. 22 AND 39).

FIRST USE 11-15-2002; IN COMMERCE 11-15-2002.
RUSS HERMAN, EXAMINING ATTORNEY

THE MARK CONSISTS OF STANDARD CHARACTERS WITHOUT CLAIM TO ANY PARTICULAR FONT, STYLE, SIZE, OR COLOR.

THE NAME NYMPHADORA TONKS IS PURELY FANCIFUL AND DOES NOT IDENTIFY A LIVING INDIVIDUAL.

FOR CLOTHING FOR MEN, WOMEN AND CHILDREN - NAMELY, SHIRTS, T-SHIRTS, SWEATSHIRTS, JOGGING SUITS, TROUSERS, PANTS, SHORTS, TANK TOPS, RAINWEAR, CLOTH BABY BIBS, SKIRTS, BLOUSES, DRESSES, SUSPENDERS, SWEATERS, JACKETS, COATS, RAINCOATS, SNOW SUITS, TIES, ROBES, HATS, CAPS, SUNVISORS, BELTS, SCARVES, SLEEPWEAR, PAJAMAS, LINGERIE, UNDERWEAR, BOOTS, SHOES, SNEAKERS, SANDALS, BOOTIES, SLIPPER SOCKS, SWIMWEAR AND MASQUERADE AND HALLOWEEN COSTUMES AND MASKS SOLD IN CONNECTION THEREWITH (U.S. CLS. 22 AND 39).

RICHARD WHITE, EXAMINING ATTORNEY

CLASS 25—(Continued).

SN 78-504,395. CHIHO TIANDE USA INC., NEW YORK, NY. FILED 10-22-2004.



THE MARK IS NOT IN COLOR. THE GRAY IN THE MARK IS FOR SHADING PURPOSES ONLY.

FOR CLOTHING, NAMELY, T-SHIRTS, SWEATSHIRTS, TANK TOPS, JACKETS, SWEATERS, JEANS; SCARVES, SHAWLS; FOOTWEAR, BOOTS, SHOES, SLIPPERS, SANDALS, SOCKS; HEADWEAR, NAMELY, HATS AND CAPS; HEADBANDS; ARMBANDS; BELTS; TIES; INTIMATE APPAREL AND FIGURE-ENHANCING GARMENTS, NAMELY, BRAS, PANTIES, UNDERWEAR, UNDERPANTS, UNDERGARMENTS, UNDERCLOTHES, TEDDIES, SLIPS, SARONGS, NEGLIGEEES, LINGERIE, FOUNDATION GARMENTS, GIRDLES, CORSETS, CAMISOLES, BODY SLIPS AND BODY SUITS, SLEEPWEAR AND NIGHTGOWNS (U.S. CLS. 22 AND 39).

FIRST USE 10-1-2004; IN COMMERCE 10-1-2004.
JENNIFER KRISP, EXAMINING ATTORNEY

SN 78-504,685. STYLE INTERNATIONAL SOURCE, LLC, TORRENCE, CA. FILED 10-22-2004.

THE NAME(S), PORTRAIT(S), AND/OR SIGNATURE(S) SHOWN IN THE MARK DOES NOT IDENTIFY A PARTICULAR LIVING INDIVIDUAL.

FOR CLOTHING; NAMELY, JEANS, SHIRTS, PANTS, DRESSES, SKIRTS, T-SHIRTS, SLEEPWEAR, COATS, SWEATERS, SHOES, FOOTWEAR, HATS, HEADBANDS, SWEATPANTS, SWEATSHIRTS (U.S. CLS. 22 AND 39).

FIRST USE 10-5-2004; IN COMMERCE 10-5-2004.
MARIA-VICTORIA SUAREZ, EXAMINING ATTORNEY

CLASS 25—(Continued).

SN 78-505,090. RADIO CITY TRADEMARKS, LLC, NEW YORK, NY. FILED 10-25-2004.

RADIO CITY MUSIC HALL

THE MARK CONSISTS OF STANDARD CHARACTERS WITHOUT CLAIM TO ANY PARTICULAR FONT, STYLE, SIZE, OR COLOR.

FOR SWEATSHIRTS, SHIRTS AND ROBES (U.S. CLS. 22 AND 39).

FIRST USE 0-0-1997; IN COMMERCE 0-0-1997.

MONTIA G. PRESSEY, EXAMINING ATTORNEY

SN 78-505,390. TRIMFOOT CO., LLC, FARMINGTON, MO. FILED 10-25-2004.

DANCE CLASS

THE MARK CONSISTS OF STANDARD CHARACTERS WITHOUT CLAIM TO ANY PARTICULAR FONT, STYLE, SIZE, OR COLOR.

NO CLAIM IS MADE TO THE EXCLUSIVE RIGHT TO USE "DANCE", APART FROM THE MARK AS SHOWN. FOR FOOTWEAR FOR DANCING (U.S. CLS. 22 AND 39).

FIRST USE 1-1-2004; IN COMMERCE 1-1-2004.

ELISSA GARBER KON, EXAMINING ATTORNEY

SN 78-506,848. BLUESPEED, LLC, GRAYSLAKE, IL. FILED 10-27-2004.

HYBRID PERFORMANCE APPAREL FOR EVERY DEGREE

THE MARK CONSISTS OF STANDARD CHARACTERS WITHOUT CLAIM TO ANY PARTICULAR FONT, STYLE, SIZE, OR COLOR.

FOR ATHLETIC APPAREL, NAMELY, TOPS, SHORTS, PANTS AND VESTS (U.S. CLS. 22 AND 39).

FIRST USE 2-0-2004; IN COMMERCE 4-0-2004.

EDWARD NELSON, EXAMINING ATTORNEY

CLASS 25—(Continued).

SN 78-506,883. CAVS/GUND ARENA COMPANY, CLEVELAND, OH. FILED 10-27-2004.

**CLEVELAND
CAVALIERS**

THE MARK CONSISTS OF STANDARD CHARACTERS WITHOUT CLAIM TO ANY PARTICULAR FONT, STYLE, SIZE, OR COLOR.

OWNER OF U.S. REG. NOS. 2,924,255 AND 2,926,580. SEC. 2(F) AS TO "CLEVELAND".

FOR CLOTHING, NAMELY HOSIERY, FOOTWEAR, BASKETBALL SHOES, BASKETBALL SNEAKERS, T-SHIRTS, SHIRTS, POLO SHIRTS, SWEATSHIRTS, SWEATPANTS, PANTS, TANK TOPS, JERSEYS, SHORTS, PAJAMAS, SPORT SHIRTS, RUGBY SHIRTS, SWEATERS, BELTS, TIES, NIGHTSHIRTS, HATS, CAPS, VISORS, WARM-UP SUITS, WARM-UP PANTS, WARM-UP TOPS/SHOOTING SHIRTS, JACKETS, WIND RESISTANT JACKETS, PARKAS, COATS, BABY BIBS NOT OF PAPER, HEAD BANDS, WRIST BANDS, APRONS, UNDERGARMENTS, BOXER SHORTS, SLACKS, CAPS, EAR MUFFS, GLOVES, MITTENS, SCARVES, WOVEN AND KNIT SHIRTS, JERSEY DRESSES, DRESSES, CHEERLEADING DRESSES AND UNIFORMS, SWIM WEAR, BATHING SUITS, SWIMSUITS, BIKINIS, TANKINIS, SWIM TRUNKS, BATHING TRUNKS, BOARD SHORTS, WET SUITS, BEACH COVER-UPS, BATHING SUIT COVER-UPS, BATHING SUIT WRAPS, SANDALS, BEACH SANDALS, BEACH HATS, SUN VISORS, SWIM CAPS, BATHING CAPS, NOVELTY HEADWEAR WITH WIGS (U.S. CLS. 22 AND 39).

FIRST USE 10-31-1970; IN COMMERCE 10-31-1970. GEOFFREY FOSDICK, EXAMINING ATTORNEY

SN 78-509,759. HECK, MICHAEL, SARATOGA SPRINGS, NY. FILED 11-2-2004.

DREAM DANCER

THE MARK CONSISTS OF STANDARD CHARACTERS WITHOUT CLAIM TO ANY PARTICULAR FONT, STYLE, SIZE, OR COLOR.

NO CLAIM IS MADE TO THE EXCLUSIVE RIGHT TO USE "DANCER", APART FROM THE MARK AS SHOWN.

FOR DANCE STUDENT KITS CONSISTING PRIMARILY OF LEOTARD, TIGHTS, TUTU, COSTUME, SHOES, AND PROVIDED THEREWITH ARE COSTUME JEWELRY, MAKEUP, TIARA, PHOTO ALBUM, COMPACT DISC CONTAINING MUSIC, HAIR RIBBON, PONYTAIL HOLDER, HAIR PINS, HAIR NET, HAIR CLIPS, BUNS, AND/OR ADD-IN AND ADD-ON HAIR ACCESSORIES CONSTRUCTED PRIMARILY OF SYNTHETIC HAIR (U.S. CLS. 22 AND 39).

FIRST USE 11-9-2004; IN COMMERCE 6-13-2005. DARRYL SPRUILL, EXAMINING ATTORNEY

CLASS 25—(Continued).

SN 78-510,489. SUMMIT RIDGE CORPORATION, NEW YORK, NY. FILED 11-3-2004.

CO & CO

THE MARK CONSISTS OF STANDARD CHARACTERS WITHOUT CLAIM TO ANY PARTICULAR FONT, STYLE, SIZE, OR COLOR.

FOR APPAREL, NAMELY, SUITS, SKIRTS, JACKETS, SLACKS, PANTS, BLOUSES, SHIRTS, SHORTS, T-SHIRTS AND COATS (U.S. CLS. 22 AND 39).

FIRST USE 10-30-2004; IN COMMERCE 10-30-2004. TARAH HARDY, EXAMINING ATTORNEY

SN 78-510,648. ALEX GAINES, LLC, NEW YORK, NY. FILED 11-3-2004.

ALEX GAINES

THE MARK CONSISTS OF STANDARD CHARACTERS WITHOUT CLAIM TO ANY PARTICULAR FONT, STYLE, SIZE, OR COLOR.

THE NAME(S), PORTRAIT(S), AND/OR SIGNATURE(S) SHOWN IN THE MARK IDENTIFIES ALEX GAINES, WHOSE CONSENT(S) TO REGISTER IS SUBMITTED.

FOR CLOTHING, NAMELY, COATS, JACKETS, VESTS, PANTS, SKIRTS, DRESSES, TANK TOPS, KNIT TOPS, SWEATERS, BLOUSES, SHIRTS (U.S. CLS. 22 AND 39).

FIRST USE 3-1-2004; IN COMMERCE 3-1-2004. JULIE WATSON, EXAMINING ATTORNEY

CLASS 25—(Continued).

SN 78-512,918. PIERPONT, CIA MARIE, SANTA BARBARA, CA. FILED 11-8-2004.

CLASS 25—(Continued).

SN 78-513,745. VALDES, JODI, LONG BEACH, CA. FILED 11-9-2004.

DIMR'S

CONVIVIAL

THE MARK CONSISTS OF STANDARD CHARACTERS WITHOUT CLAIM TO ANY PARTICULAR FONT, STYLE, SIZE, OR COLOR.

FOR SELF-ADHESIVE NIPPLE COVERS FOR BREASTS (U.S. CLS. 22 AND 39).

FIRST USE 12-22-2004; IN COMMERCE 12-22-2004.
KELLY CHOE, EXAMINING ATTORNEY

THE MARK CONSISTS OF STANDARD CHARACTERS WITHOUT CLAIM TO ANY PARTICULAR FONT, STYLE, SIZE, OR COLOR.

FOR CLOTHING, NAMELY, SHIRTS, T-SHIRTS, TANK TOPS, SWEATSHIRTS, SHORTS, PANTS, SNOW-BOARDING PANTS, HATS, VISORS, CAPS, KNIT CAPS, SKI CAPS, GLOVES, JACKETS, COATS, VESTS, SCARVES, SOCKS, JOGGING OUTFITS, AND JOGGING BRAS (U.S. CLS. 22 AND 39).

TEJBIR SINGH, EXAMINING ATTORNEY

SN 78-513,157. JOHNSON, JANE, DIAMOND BAR, CA. FILED 11-8-2004.

SN 78-515,185. VANITY FAIR, INC., WILMINGTON, DE. FILED 11-11-2004.

**The Fire
Connection**



THE MARK CONSISTS OF STANDARD CHARACTERS WITHOUT CLAIM TO ANY PARTICULAR FONT, STYLE, SIZE, OR COLOR.

NO CLAIM IS MADE TO THE EXCLUSIVE RIGHT TO USE FIRE, APART FROM THE MARK AS SHOWN.

FOR LOGO PRODUCTS, NAMELY T-SHIRTS, SWEATSHIRTS, SWEATPANTS, SHORTS, POLO SHIRTS, JACKETS, SHIRTS, BATHING SUITS AND HEADWEAR (U.S. CLS. 22 AND 39).

FIRST USE 4-1-1997; IN COMMERCE 4-1-1997.
KAREN K. BUSH, EXAMINING ATTORNEY

FOR LINGERIE, SLEEPWEAR AND HOSIERY (U.S. CLS. 22 AND 39).

HENRY S. ZAK, EXAMINING ATTORNEY

CLASS 25—(Continued).

SN 78-515,213. BRUNETTE, THOMAS H., HUGO, MN. FILED 11-11-2004.

FIGHT TOWN USA

THE MARK CONSISTS OF STANDARD CHARACTERS WITHOUT CLAIM TO ANY PARTICULAR FONT, STYLE, SIZE, OR COLOR.

NO CLAIM IS MADE TO THE EXCLUSIVE RIGHT TO USE "USA", APART FROM THE MARK AS SHOWN.

FOR CLOTHING, NAMELY T-SHIRTS, SWEATSHIRTS, SHIRTS, BLOUSES, SKIRTS, PULLOVERS, SWEATERS, PANTS, SHORTS, TANK TOPS, JACKETS, COATS, VESTS, CAPS, HATS, STOCKING CAPS, SWEATBANDS, SWEAT PANTS, WARM-UP SUITS, GYM SUITS, WRIST BANDS, SPORTS BRAS, LEOTARDS, SOCKS, TIGHTS, UNDERWEAR, ROBES, PAJAMAS, SLIPPERS, SHOES, BOOTS, GLOVES, MITTENS, SCARVES, EARMUFFS, BELTS, UNIFORMS, JERSEYS AND TIES (U.S. CLS. 22 AND 39).

ELISSA GARBER KON, EXAMINING ATTORNEY

CLASS 25—(Continued).

SN 78-515,577. TUCCI, JIM, PALMDALE, CA. FILED 11-11-2004.

Clothing Representing American People

THE MARK CONSISTS OF STANDARD CHARACTERS WITHOUT CLAIM TO ANY PARTICULAR FONT, STYLE, SIZE, OR COLOR.

FOR MEN'S, WOMEN'S, AND CHILDREN'S CLOTHING, NAMELY, BELTS, SHIRTS, SPORT SHIRTS, KNIT SHIRTS, GOLF SHIRTS, TANK TOPS, T-SHIRTS, SWEAT SHIRTS AND SWEAT PANTS, JOGGING SUITS, PANTS, JEANS AND OVERALLS, SWEATERS, SHORTS, FLEECE PULLOVERS, COATS AND JACKETS, BATHING SUITS AND SWIM WEAR, HATS AND CAPS, VISORS, BANDANAS, WRIST BANDS, SOCKS, PAJAMAS AND UNDERGARMENTS, ATHLETIC SHOES, DRESS SHOES, BOOTS, INFANT WARE AND TODDLER WARE (U.S. CLS. 22 AND 39).

PAM WILLIS, EXAMINING ATTORNEY

SN 78-515,415. PRESIDENT AND BOARD OF TRUSTEES OF SANTA CLARA COLLEGE, THE, SANTA CLARA, CA. FILED 11-11-2004.



THE MARK CONSISTS OF THE LETTERS SC IN STYLIZED FORMAT.

FOR APPAREL OFFERED AND SOLD TO PERSONS AT SANTA CLARA UNIVERSITY-CONTROLLED OUTLETS, NAMELY HATS (U.S. CLS. 22 AND 39).

FIRST USE 1-1-1988; IN COMMERCE 1-1-1988.

SUSAN STIGLITZ, EXAMINING ATTORNEY

SN 78-516,262. REAL EXPOSED INC., BOCA RATON, FL. FILED 11-12-2004.

Soul Pimp

THE MARK CONSISTS OF STANDARD CHARACTERS WITHOUT CLAIM TO ANY PARTICULAR FONT, STYLE, SIZE, OR COLOR.

FOR SHIRTS, HATS, JERSEYS, JACKETS, UNDERWEAR, CLOTHING PATCHES, SOCKS, SHORTS, SWEAT PANTS, SHOES, SNEAKERS, WRIST BANDS, HEAD BANDS, SWIM WEAR, LINGERIE, PANTS, JEANS, BRAS, SKIRTS, BLOUSES, SUITS, GLOVES, SWEATERS, BELTS, BELT BUCKLES AND SCARVES (U.S. CLS. 22 AND 39).

PATRICIA EVANKO, EXAMINING ATTORNEY

CLASS 25—(Continued).

SN 78-516,553. WILSON, RODNEY, CHICAGO, IL. FILED 11-14-2004.

**Go Back Where?
Jersey**

THE MARK CONSISTS OF STANDARD CHARACTERS WITHOUT CLAIM TO ANY PARTICULAR FONT, STYLE, SIZE, OR COLOR.

NO CLAIM IS MADE TO THE EXCLUSIVE RIGHT TO USE "JERSEY", APART FROM THE MARK AS SHOWN. FOR SHIRTS AND HATS (U.S. CLS. 22 AND 39). ROBERT LAVACHE, EXAMINING ATTORNEY



SN 78-517,211. MONTGOMERY J GRAY 4TH AND NICOLAS R MAKRIS PARTNERSHIP, THE, COLLEGE PARK, MD. FILED 11-15-2004.

Testicleicious

THE MARK CONSISTS OF STANDARD CHARACTERS WITHOUT CLAIM TO ANY PARTICULAR FONT, STYLE, SIZE, OR COLOR.

FOR SHIRTS, PANTS, HATS, COATS, SWEATSHIRTS (U.S. CLS. 22 AND 39). SCOTT OSLICK, EXAMINING ATTORNEY

CLASS 25—(Continued).

SN 78-518,050. ENSALACO, SANDRA L, HOFFMAN ES-TATES, IL. FILED 11-16-2004.

Uniq2me

THE MARK CONSISTS OF STANDARD CHARACTERS WITHOUT CLAIM TO ANY PARTICULAR FONT, STYLE, SIZE, OR COLOR.

FOR TEE SHIRTS, HATS, SHIRTS, SWEATSHIRTS (U.S. CLS. 22 AND 39). ELIZABETH J. WINTER, EXAMINING ATTORNEY



SN 78-518,468. FERNANDES, NILTON E., SOMERVILLE, MA. FILED 11-17-2004.



blank w/o the brand

FOR MEN AND WOMEN T-SHIRTS, PANTS, JACKETS, SWEATERS, SUITS, SOCKS, SHORTS, UNDERWEARS, AND SHOES (U.S. CLS. 22 AND 39). ASMAT KHAN, EXAMINING ATTORNEY



SN 78-518,801. TURNBULL, LISA A., MAPLE GROVE, MN. AND TURNBULL, RICHARD A., MAPLE GROVE, MN. FILED 11-17-2004.

**GOSP GIRLS ONLY
SLUMBER PARTY**

THE MARK CONSISTS OF STANDARD CHARACTERS WITHOUT CLAIM TO ANY PARTICULAR FONT, STYLE, SIZE, OR COLOR.

FOR CHILDREN'S AND LADIES SLEEPWEAR AND SLIPPERS, SWEATSHIRTS, T-SHIRTS, NIGHT SHIRTS, NIGHT CAPS, PAJAMAS INCLUDING BOXER SHORTS WITH MATCHING SHORT AND LONG SLEEVE TOPS, AND LONG PAJAMA PANTS WITH MATCHING SHORT AND LONG SLEEVE TOPS, AND SOCKS (U.S. CLS. 22 AND 39). BRIAN NEVILLE, EXAMINING ATTORNEY

CLASS 25—(Continued).

SN 78-519,071. SARA LEE CORPORATION, WINSTON-SALEM, NC. FILED 11-18-2004.

**UNCOMPROMISING
BEAUTY**

THE MARK CONSISTS OF STANDARD CHARACTERS WITHOUT CLAIM TO ANY PARTICULAR FONT, STYLE, SIZE, OR COLOR.

FOR BRAS, PANTIES, CAMISOLES, TANK TOPS AND GARMENTS THAT SHAPE THE BODY, NAMELY BRIEFS, BODY BRIEFERS, THIGH SHAPERS, WAIST SHAPERS AND SHAPING TOPS (U.S. CLS. 22 AND 39).
CHRISTOPHER ADKINS, EXAMINING ATTORNEY

SN 78-519,084. SARA LEE CORPORATION, WINSTON-SALEM, NC. FILED 11-18-2004.

**REDEFINE YOUR
CURVES**

THE MARK CONSISTS OF STANDARD CHARACTERS WITHOUT CLAIM TO ANY PARTICULAR FONT, STYLE, SIZE, OR COLOR.

FOR GARMENTS WHICH SHAPE THE BODY, NAMELY GIRDLES, BODY SUITS, THIGH SHAPERS, LEG SHAPERS AND BRIEFS (U.S. CLS. 22 AND 39).
BRENDAN MCCAULEY, EXAMINING ATTORNEY

SN 78-519,623. LOLLIPOP APPAREL INC, NEW YORK, NY. FILED 11-18-2004.

LAZY DAISY

THE MARK CONSISTS OF STANDARD CHARACTERS WITHOUT CLAIM TO ANY PARTICULAR FONT, STYLE, SIZE, OR COLOR.

FOR APPAREL, NAMELY, SWEATERS, JACKETS, SKIRTS, PANTS, JEANS, DRESSES, TOPS, BOTTOMS, SHORTS, WARM UP SUITS, SUITS, SCARVES, HATS, EAR-MUFFS, GLOVES AND LEG WARMERS (U.S. CLS. 22 AND 39).
RAUL CORDOVA, EXAMINING ATTORNEY

CLASS 25—(Continued).

SN 78-519,630. LOLLIPOP APPAREL INC, NEW YORK, NY. FILED 11-18-2004.

CANDY POP

THE MARK CONSISTS OF STANDARD CHARACTERS WITHOUT CLAIM TO ANY PARTICULAR FONT, STYLE, SIZE, OR COLOR.

FOR APPAREL, NAMELY, SWEATERS, JACKETS, SKIRTS, PANTS, JEANS, DRESSES, TOPS, BOTTOMS, SHORTS, WARM UP SUITS, SUITS, SCARVES, HATS, EAR-MUFFS, GLOVES AND LEG WARMERS (U.S. CLS. 22 AND 39).
RAUL CORDOVA, EXAMINING ATTORNEY

SN 78-520,582. ISLAND TRADITIONS OF HAWAII, HONOLULU, HI. FILED 11-20-2004.

ISLAND TRADITIONS

THE MARK CONSISTS OF STANDARD CHARACTERS WITHOUT CLAIM TO ANY PARTICULAR FONT, STYLE, SIZE, OR COLOR.

FOR MEN'S, LADIES, BOYS AND GIRLS CLOTHING, NAMELY SHIRTS, SHORTS, PANTS, DRESSES, BLOUSES, SWIMWEAR, SHOES, ROBES (U.S. CLS. 22 AND 39).
FIRST USE 2-12-1995; IN COMMERCE 2-12-1995.
RONALD MCMORROW, EXAMINING ATTORNEY

SN 78-520,675. CAPUA, ROBERT M., WINFIELD, IL. AND CARSON, SCOTT M., VALRICO, FL. FILED 11-21-2004.

**LESS THINKING MORE
DRINKING**

THE MARK CONSISTS OF STANDARD CHARACTERS WITHOUT CLAIM TO ANY PARTICULAR FONT, STYLE, SIZE, OR COLOR.

FOR WEARING APPAREL, NAMELY, SHIRTS, HATS, PANTS, BLOUSES, SKIRTS, UNDERGARMENTS, SHOES, SWIMWEAR, SHORTS, SLEEPWEAR, AND SWEATWEAR, NAMELY, SWEAT SHORTS, SWEAT JACKETS, SWEAT SHIRTS, AND SWEAT SHORTS (U.S. CLS. 22 AND 39).
ANNE FARRELL, EXAMINING ATTORNEY

CLASS 25—(Continued).

SN 78-521,988. A.H. SCHREIBER COMPANY, INC., NEW YORK, NY. FILED 11-23-2004.

TOTAL CONTROL

THE MARK CONSISTS OF STANDARD CHARACTERS WITHOUT CLAIM TO ANY PARTICULAR FONT, STYLE, SIZE, OR COLOR.

FOR CLOTHING, NAMELY, SWIMWEAR (U.S. CLS. 22 AND 39).

BRIAN PINO, EXAMINING ATTORNEY

CLASS 25—(Continued).

SN 78-523,664. EPSTEIN, JOE, LONG BEACH, NY. FILED 11-29-2004.

VIDANIS

THE MARK CONSISTS OF STANDARD CHARACTERS WITHOUT CLAIM TO ANY PARTICULAR FONT, STYLE, SIZE, OR COLOR.

FOR WEARING APPAREL, NAMELY, SHIRTS, PANTS; UNDERWEAR AND OUTERWEAR, NAMELY, COATS, JACKETS (U.S. CLS. 22 AND 39).

LINDA M. KING, EXAMINING ATTORNEY

SN 78-522,384. NAVY EXCHANGE SERVICE COMMAND ("NEXCOM"), A NONAPPROPRIATED FUND INSTRUMENTALITY UNDER THE DEPT. OF NAVY, AN AGENCY OF THE UNITED STATES OF AMERICA, VIRGINIA BEACH, VA. FILED 11-24-2004.

SN 78-524,293. ODIBI, DICKSON, BURTONSVILLE, MD. FILED 11-30-2004.

**Y.U.P.Y. MW**

OWNER OF U.S. REG. NO. 2,902,912. THE COLOR(S) YELLOW, RED, AND WHITE IS/ARE CLAIMED AS A FEATURE OF THE MARK.

THE COLOR(S) YELLOW FLAMES RISING FROM A RED BASE; RED CENTRAL ELLIPTICAL GRID; AND WHITE THREE-PRONGED ELEMENTS AND LOOPS AROUND GRID IS/ARE CLAIMED AS A FEATURE OF THE MARK.

FOR BOY'S AND YOUNG MEN'S CLOTHING, NAMELY KNIT SHIRTS, TEES, DENIM JEANS, TWILL SLACKS AND SHORTS, WOVEN AND KNIT SHIRTS, AND SWIMWEAR (U.S. CLS. 22 AND 39).

FIRST USE 1-31-1998; IN COMMERCE 1-31-1998. SHAUNIA WALLACE, EXAMINING ATTORNEY

THE MARK CONSISTS OF STANDARD CHARACTERS WITHOUT CLAIM TO ANY PARTICULAR FONT, STYLE, SIZE, OR COLOR.

FOR CLOTHING FOR MEN, WOMEN AND CHILDREN, NAMELY, SHIRTS, TOPS, BLOUSES, SWEATERS, VESTS, PANTS, SLACKS, TROUSERS, SHORTS, COATS, JACKETS, SUITS, HATS, CAPS, VISORS, NECKWEAR, SCARVES, TIES, HOSIERY, SOCKS, PANTYHOSE, TIGHTS, UNDERWEAR, SLEEPWEAR, PAJAMAS, LINGERIE, ROBES, SWIMWEAR, GLOVES, BELTS, DRESSES, SKIRTS, FOOTWEAR, NAMELY, SHOES, SANDALS, SNEAKERS, BOOTS, CLOTHING FOR SPORTS, NAMELY, JOGGING SUITS, SWEAT SUITS, T-SHIRTS, JERSEYS, WARM UP SUITS AND HEADBANDS (U.S. CLS. 22 AND 39).

LOURDES AYALA, EXAMINING ATTORNEY

CLASS 25—(Continued).

SN 78-524,402. LYNCH, WILLIAM, CANYON COUNTRY, CA. FILED 11-30-2004.

CLASS 25—(Continued).

SN 78-524,818. TAKENAGA, KERRY, YORBA LINDA, CA. FILED 11-30-2004.



FOR T-SHIRTS, HOODED SWEATSHIRTS, HATS, KNIT CAPS, GLOVES, AND MOTOCROSS JERSEYS (U.S. CLS. 22 AND 39).
KIMBERLY FRYE, EXAMINING ATTORNEY

FOREVER PEP

THE MARK CONSISTS OF STANDARD CHARACTERS WITHOUT CLAIM TO ANY PARTICULAR FONT, STYLE, SIZE, OR COLOR.

NO CLAIM IS MADE TO THE EXCLUSIVE RIGHT TO USE "PEP", APART FROM THE MARK AS SHOWN.

FOR HEADWEAR, NAMELY, HATS; AND CLOTHING, NAMELY, TOPS, T-SHIRTS, PANTS, SHORTS, SKIRTS, SWEATSHIRTS, SWEATPANTS, JACKETS, PULLOVERS, JERSEYS, BODY SUITS, JUMPERS, LEOTARDS, WARM-UP SUITS, BRIEFS, SOCKS, PAJAMAS, GLOVES, AND UNIFORMS FOR PEP SQUADS, MASCOTS, BANDS AND BOOSTER CLUBS (U.S. CLS. 22 AND 39).

DANIEL BRODY, EXAMINING ATTORNEY

SN 78-524,815. TAKENAGA, KERRY, YORBA LINDA, CA. FILED 11-30-2004.

SN 78-524,819. HATTON, JEFF, NAPLES, FL. FILED 11-30-2004.

FOREVER CHEER

THE MARK CONSISTS OF STANDARD CHARACTERS WITHOUT CLAIM TO ANY PARTICULAR FONT, STYLE, SIZE, OR COLOR.

NO CLAIM IS MADE TO THE EXCLUSIVE RIGHT TO USE "CHEER", APART FROM THE MARK AS SHOWN.

FOR HEADWEAR, NAMELY, HATS; AND CLOTHING, NAMELY, TOPS, T-SHIRTS, PANTS, SHORTS, SKIRTS, SWEATSHIRTS, SWEATPANTS, JACKETS, PULLOVERS, JERSEYS, BODY SUITS, JUMPERS, LEOTARDS, WARM-UP SUITS, GLOVES, BRIEFS, SOCKS, PAJAMAS, AND UNIFORMS FOR CHEERLEADING AND POM PON SQUADS, MASCOTS, BANDS AND BOOSTER CLUBS (U.S. CLS. 22 AND 39).

DANIEL BRODY, EXAMINING ATTORNEY

CACOA

THE MARK CONSISTS OF STANDARD CHARACTERS WITHOUT CLAIM TO ANY PARTICULAR FONT, STYLE, SIZE, OR COLOR.

FOR CLOTHING ITEMS, NAMELY, T-SHIRTS, SWIM TRUNKS, SHORTS, SWEAT SHIRTS, JACKETS, AND HATS (U.S. CLS. 22 AND 39).

BILL DAWE, EXAMINING ATTORNEY

CLASS 25—(Continued).

SN 78-524,834. TAKENAGA, KERRY, YORBA LINDA, CA. FILED 11-30-2004.

FOREVER DANCE

THE MARK CONSISTS OF STANDARD CHARACTERS WITHOUT CLAIM TO ANY PARTICULAR FONT, STYLE, SIZE, OR COLOR.

NO CLAIM IS MADE TO THE EXCLUSIVE RIGHT TO USE "DANCE", APART FROM THE MARK AS SHOWN.

FOR HEADWEAR, NAMELY, HATS; AND CLOTHING, NAMELY, TOPS, T-SHIRTS, PANTS, SHORTS, SKIRTS, DRESSES, SWEATSHIRTS, SWEATPANTS, JACKETS, PULLOVERS, JERSEYS, BODY SUITS, JUMPERS, LEOTARDS, UNITARDS, GLOVES, WARM-UP SUITS, SOCKS, BRIEFS, PAJAMAS, AND UNIFORMS FOR DANCE AND DRILL TEAM SQUADS (U.S. CLS. 22 AND 39).

DANIEL BRODY, EXAMINING ATTORNEY

CLASS 25—(Continued).

SN 78-525,238. SARA LEE CORPORATION, WINSTON-SALEM, NC. FILED 12-1-2004.

DIGI-POCKET

THE MARK CONSISTS OF STANDARD CHARACTERS WITHOUT CLAIM TO ANY PARTICULAR FONT, STYLE, SIZE, OR COLOR.

FOR SHIRTS, SWEATSHIRTS, JACKETS, PANTS, SWEATPANTS, SHORTS (U.S. CLS. 22 AND 39).

DORITT L. CARROLL, EXAMINING ATTORNEY

SN 78-526,265. JACKSON, DAMION R., WALDORF, MD. FILED 12-2-2004.

THOROUGH MINDS

THE MARK CONSISTS OF STANDARD CHARACTERS WITHOUT CLAIM TO ANY PARTICULAR FONT, STYLE, SIZE, OR COLOR.

FOR MEN'S WOMEN'S AND CHILDREN'S CLOTHING AND FASHION ACCESSORIES, NAMELY, DRESSES, COATS, SHORTS, SHIRTS, DRESS SHIRTS, PANTS, DRESS PANTS, JEANS, SMOCK TOPS, VESTS, WIND RESISTANT JACKETS, JOGGING SUITS, SWEATSHIRTS, SWEATPANTS, SKI JACKETS, SKI PANTS, MUFFLERS, HEAD BANDS, BELTS, GLOVES, SHAWLS, SCARVES, PONCHOS, PAJAMAS, ROBES, NIGHTGOWNS, PANTIES, BRAS, UNDERWEAR, UNDERSHIRTS, RAINWEAR, RAINCOATS, SWIMWEAR, BATHING SUITS, COVER-UPS, WOMEN'S LINGERIE, FOOTWEAR, HEADWEAR, TIES, CAPS, HATS, SKIRTS, SLACKS, LEATHER JACKETS, PANTS, BATHROBES, SLIPPERS, UNDERSHORTS, AND SOCKS (U.S. CLS. 22 AND 39).

SONYA STEPHENS, EXAMINING ATTORNEY

SN 78-525,226. NEXT, INC., WABASH, IN. FILED 12-1-2004.

LADY CADRE

THE MARK CONSISTS OF STANDARD CHARACTERS WITHOUT CLAIM TO ANY PARTICULAR FONT, STYLE, SIZE, OR COLOR.

THE NAME IN THE MARK DOES NOT IDENTIFY A LIVING INDIVIDUAL.

FOR MEN, WOMEN AND CHILDREN CLOTHING; NAMELY, TOPS, SPORT SHIRTS AND T-SHIRTS, BOTTOMS, NAMELY, PANTS, SHORTS AND HEADWEAR (U.S. CLS. 22 AND 39).

KAREN K. BUSH, EXAMINING ATTORNEY

CLASS 25—(Continued).

SN 78-528,816. REPUBLIC CLOTHING CORPORATION,
NEW YORK, NY. FILED 12-8-2004.

CLASS 25—(Continued).

SN 78-532,140. MCBRIDE-IRBY, STACEY, GARDENA, CA.
FILED 12-14-2004.

PROMINENCE

THE MARK CONSISTS OF STANDARD CHARACTERS WITHOUT CLAIM TO ANY PARTICULAR FONT, STYLE, SIZE, OR COLOR.

FOR WOMEN'S SPORTSWEAR NAMELY, BLOUSES, PANTS, JACKETS, SKIRTS, KNIT TOPS, CARDIGANS AND SWEATERS (U.S. CLS. 22 AND 39).

FIRST USE 0-0-2002; IN COMMERCE 0-0-2002.
PAULA MAHONEY, EXAMINING ATTORNEY

Asian Soul
Soulful Designs with
Asian Influence

SN 78-530,727. ROBINSON, DEMETRIUS, SCOTTSDALE, AZ.
FILED 12-10-2004.

NO CLAIM IS MADE TO THE EXCLUSIVE RIGHT TO USE "ASIAN", APART FROM THE MARK AS SHOWN.

FOR CLOTHING, NAMELY, BABY T-SHIRTS AND UNISEX KIMONOS FOR BABIES AND KIDS, ALL FEATURING CHINESE ZODIAC SYMBOLS (U.S. CLS. 22 AND 39).

FIRST USE 8-4-2004; IN COMMERCE 11-6-2004.
ATTIYA MALIK, EXAMINING ATTORNEY

CALIFORNIA ♥

NO CLAIM IS MADE TO THE EXCLUSIVE RIGHT TO USE CALIFORNIA, APART FROM THE MARK AS SHOWN.

FOR T-SHIRTS (U.S. CLS. 22 AND 39).
HOWARD SMIGA, EXAMINING ATTORNEY

SN 78-533,273. GIZZY POP DESIGNS LLC, HOUSTON, TX.
FILED 12-15-2004.

SN 78-531,543. CGE ENTERPRISES, LLC, WESTON, VT.
FILED 12-13-2004.



ZIP AND DASH

THE MARK CONSISTS OF STANDARD CHARACTERS WITHOUT CLAIM TO ANY PARTICULAR FONT, STYLE, SIZE, OR COLOR.

FOR CLOTHING, NAMELY, SHIRTS, SKIRTS, PANTS, T-SHIRTS, BLOUSES, SHORTS, DRESSES, JACKETS, COATS, PAJAMAS, SHOES, BELTS AND HATS (U.S. CLS. 22 AND 39).

DAWN FELDMAN, EXAMINING ATTORNEY

THE COLOR(S) BLACK AND GREEN IS/ARE CLAIMED AS A FEATURE OF THE MARK.

THE STYLIZED LETTERS ARE IN THE COLOR BLACK AND THE FLOWER DESIGN IS IN BLACK AND GREEN, FOR CLOTHING, NAMELY T-SHIRTS AND TOPS FOR WOMEN AND GIRLS (U.S. CLS. 22 AND 39).

FIRST USE 12-31-2003; IN COMMERCE 12-31-2003.
WON TEAK OH, EXAMINING ATTORNEY

CLASS 25—(Continued).

SN 78-533,341. BLOOD, SWEAT AND BLING LLC, TOWACO, NJ. FILED 12-15-2004.

CLASS 25—(Continued).

SN 78-534,999. GULF BARAKA APPAREL W.L.L., MANAMA, BAHRAIN, FILED 12-18-2004.

Blood, Sweat and Bling

D-104

THE MARK CONSISTS OF STANDARD CHARACTERS WITHOUT CLAIM TO ANY PARTICULAR FONT, STYLE, SIZE, OR COLOR.

FOR CLOTHING, NAMELY— SHIRTS, SHORT-SLEEVED AND LONG-SLEEVED T-SHIRTS, TANK TOPS, PANTS, SLEEP SHIRTS, SPORT SHIRTS, SWEAT PANTS, SWEAT BANDS, SWEAT SHIRTS, UNDER-SHIRTS, JACKETS, PANTIES, SHORTS AND BRIEFS AND HEADGEAR, NAMELY, HATS AND CAPS (U.S. CLS. 22 AND 39).

FIRST USE 4-1-2004; IN COMMERCE 4-1-2004.
WON TEAK OH, EXAMINING ATTORNEY

THE MARK CONSISTS OF STANDARD CHARACTERS WITHOUT CLAIM TO ANY PARTICULAR FONT, STYLE, SIZE, OR COLOR.

FOR CLOTHING, NAMELY JEANS, T-SHIRTS, SHIRTS, JACKETS, PANTS, AND SWEATERS (U.S. CLS. 22 AND 39).

DOMINICK J. SALEMI, EXAMINING ATTORNEY

SN 78-534,091. BOYNE MOUNTAIN RECREATION, L.L.C., BUFFALO GROVE, IL. FILED 12-16-2004.

SN 78-535,285. OXFORD INDUSTRIES, INC., ATLANTA, GA. FILED 12-20-2004.



**Veri Cool Be
Active Stay Cool**

FOR CLOTHING, NAMELY, SHIRTS, SWEATSHIRTS, PANTS, JACKETS, SWEATER, JUMPSUITS, COVERALLS, AND BELTS; AND FOOTWEAR, NAMELY, SPORT SHOES; AND HEADWEAR, COMPRISING HATS AND CAPS (U.S. CLS. 22 AND 39).

JENNIFER KRISP, EXAMINING ATTORNEY

THE MARK CONSISTS OF STANDARD CHARACTERS WITHOUT CLAIM TO ANY PARTICULAR FONT, STYLE, SIZE, OR COLOR.

FOR MEN'S SHIRTS (U.S. CLS. 22 AND 39).
FIRST USE 9-1-2004; IN COMMERCE 9-1-2004.

RAUL CORDOVA, EXAMINING ATTORNEY

CLASS 25—(Continued).

SN 78-535,641. BUR-TEX HOSIERY, INC., FYFFE, AL. FILED 12-20-2004.

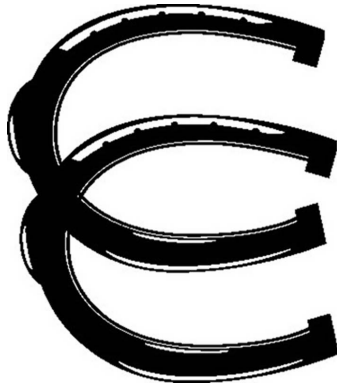

FOR SOCKS, SHIRTS, JACKETS (U.S. CLS. 22 AND 39).
JASON ROTH, EXAMINING ATTORNEY

CLASS 25—(Continued).

SN 78-535,779. EATON, STEVEN, ROSEVILLE, CA. FILED 12-20-2004.

Sentral

THE MARK CONSISTS OF STANDARD CHARACTERS WITHOUT CLAIM TO ANY PARTICULAR FONT, STYLE, SIZE, OR COLOR.

FOR T-SHIRTS, SWEATSHIRTS, HATS, JACKETS (U.S. CLS. 22 AND 39).

MARK RADEMACHER, EXAMINING ATTORNEY

SN 78-536,182. PALIS LLC, NEW YORK, NY. FILED 12-21-2004.

SN 78-535,717. MILLER, CRAIG P., WOODLAND HILLS, CA. FILED 12-20-2004.

7 OCEANS Clothing
Company

THE MARK CONSISTS OF STANDARD CHARACTERS WITHOUT CLAIM TO ANY PARTICULAR FONT, STYLE, SIZE, OR COLOR.

NO CLAIM IS MADE TO THE EXCLUSIVE RIGHT TO USE "CLOTHING COMPANY", APART FROM THE MARK AS SHOWN.

FOR CLOTHING, NAMELY, T-SHIRTS, JERSEYS, SWEATSHIRTS, JACKETS, VESTS, BLOUSES, SHIRTS, SWEATERS, PANTS, JEANS, SHORTS, SWIM WEAR, SOCKS, FOOTWEAR, HATS, CAPS (U.S. CLS. 22 AND 39).

DAWN HAN, EXAMINING ATTORNEY

PALIS

THE MARK CONSISTS OF STANDARD CHARACTERS WITHOUT CLAIM TO ANY PARTICULAR FONT, STYLE, SIZE, OR COLOR.

FOR CLOTHING, NAMELY, SHORTS, SHIRTS, BLAZERS, SWEATERS, PULLOVERS, JEANS, JACKETS, KNIT PANTS, KNIT TOPS, TANK TOPS, T-SHIRTS, POLO SHIRTS, DENIM JACKETS AND HEADWEAR (U.S. CLS. 22 AND 39).

FIRST USE 1-16-2003; IN COMMERCE 6-6-2003.

EUGENIA MARTIN, EXAMINING ATTORNEY

CLASS 25—(Continued).

SN 78-536,452. SAKHRANI N PREMKUMAR, LOS ANGELES, CA. FILED 12-21-2004.

4 ACES

THE MARK CONSISTS OF STANDARD CHARACTERS WITHOUT CLAIM TO ANY PARTICULAR FONT, STYLE, SIZE, OR COLOR.

FOR MEN'S, LADIES AND CHILDREN'S CLOTHING, NAMELY, DRESSES, BLOUSES, SHORTS, BOXER SHORTS, CARGO SHORTS, BERMUDA SHORTS, JEANS, PANTS, SLACKS, JOGGING SUITS, BLAZERS, SHIRTS, T-SHIRTS, SKIRTS, 2 PIECE SKIRT SETS, 3 PIECE SKIRT SETS, TANK TOPS, HALTER TOPS, JACKETS, SWEAT SHIRTS, SWEAT SHORTS, SWEAT SUITS, SWEAT PANTS, SWEATERS, BRAS, BUSTIERS, PANTIES, GIRDLES, UNDERPANTS, UNDERSHIRTS, UNDERWEAR, VESTS, TIGHTS, BIKINIS, BATHING SUITS, SWIMWEAR, SWIMSUITS, BEACHWEAR, LINGERIE, CAMISOLES, BEACH COVER-UPS, LEOTARDS, PANTYHOSE, STOCKINGS, SOCKS, TIGHTS, SCARVES, KNIT SHIRTS, WOVEN SHIRTS, KNIT TOPS, WOVEN TOPS, SUITS, 2 PIECE SUIT SET, 3 PIECE SUIT SET, SLEEP WEAR, GOWNS, NIGHT GOWNS, 1 PIECE NIGHT DRESS, 2 PIECE NIGHT DRESS SET, 3 PIECE NIGHT DRESS SET, BATHROBES, TEDDIES, TIES, 1 PIECE DRESS, 2 PIECE DRESS SET, 3 PIECE DRESS SET, BELTS, SUSPENDERS, HATS, GLOVES, HEADBANDS, VISORS, CAPS, COATS, RAIN COATS (U.S. CLS. 22 AND 39).

LOURDES AYALA, EXAMINING ATTORNEY

SN 78-536,492. MCINTOSH, KELLI, NORTHVILLE, MI. FILED 12-21-2004.

ANJEL BARON

THE MARK CONSISTS OF STANDARD CHARACTERS WITHOUT CLAIM TO ANY PARTICULAR FONT, STYLE, SIZE, OR COLOR.

THE NAME ANJEL BARON DOES NOT IDENTIFY A LIVING INDIVIDUAL.

FOR CLOTHING AND HEADGEAR, NAMELY, JEANS, CASUAL PANTS, DRESS PANTS, CASUAL SHIRTS, DRESS SHIRTS, SHORTS, SHIRTS, DRESSES, T-SHIRTS, POLO SHIRTS, SWEATERS, BLAZERS, UNDERWEAR, HATS, GLOVES, BELTS, AND FOOTWEAR; ACTIVE WEAR, NAMELY, SWEAT SHIRTS, STRETCH PANTS, AND TRACK SUITS (U.S. CLS. 22 AND 39).

LINDA POWELL, EXAMINING ATTORNEY

CLASS 25—(Continued).

SN 78-537,440. SENIZERGUES, PIERRE ANDRE, NEWPORT BEACH, CA. FILED 12-22-2004.

This is Skateboarding

THE MARK CONSISTS OF STANDARD CHARACTERS WITHOUT CLAIM TO ANY PARTICULAR FONT, STYLE, SIZE, OR COLOR.

FOR CLOTHING, NAMELY T-SHIRTS, POLO SHIRTS, PANTS, SHORTS, JACKETS, SWEATSHIRTS, SOCKS, HATS, CAPS, BELTS, SHOES AND SANDALS (U.S. CLS. 22 AND 39).

FIRST USE 12-15-2002; IN COMMERCE 12-15-2002.

TRICIA SONNEBORN, EXAMINING ATTORNEY

SN 78-537,485. EXPERIENCE LEARNING COMMUNITY, SEATTLE, WA. FILED 12-22-2004.



THE MARK CONSISTS OF A THREE-LEGGED WINGED CREATURE CENTERED OVER THE STYLIZED LETTERS SFM.

FOR CLOTHING, NAMELY JACKETS, TANK TOPS, SWEATSHIRTS, UNIFORMS, SWEAT PANTS, SWEAT SUITS, SHORTS, PANTS, SWEATERS, POLO SHIRTS, SCARVES, TIES, AND VESTS (U.S. CLS. 22 AND 39).

FIRST USE 6-18-2004; IN COMMERCE 6-18-2004.

ROBERT LORENZO, EXAMINING ATTORNEY

CLASS 25—(Continued).

SN 78-537,487. EXPERIENCE LEARNING COMMUNITY, SEATTLE, WA. FILED 12-22-2004.

CLASS 25—(Continued).

SN 78-537,601. MDO DEVELOPMENT CORPORATION, NEW YORK, NY. FILED 12-23-2004.

**SCIENCE FICTION
MUSEUM AND HALL
OF FAME**

THE WATER CLUB

THE MARK CONSISTS OF STANDARD CHARACTERS WITHOUT CLAIM TO ANY PARTICULAR FONT, STYLE, SIZE, OR COLOR.

FOR CLOTHING, NAMELY JACKETS, TANK TOPS, SWEATSHIRTS, UNIFORMS, SWEAT PANTS, SWEAT SUITS, SHORTS, PANTS, SWEATERS, POLO SHIRTS, SCARVES, TIES, AND VESTS (U.S. CLS. 22 AND 39).

FIRST USE 6-18-2004; IN COMMERCE 6-18-2004.
ROBERT LORENZO, EXAMINING ATTORNEY

THE MARK CONSISTS OF STANDARD CHARACTERS WITHOUT CLAIM TO ANY PARTICULAR FONT, STYLE, SIZE, OR COLOR.

FOR CLOTHING, NAMELY GOLF SHIRTS AND HATS (U.S. CLS. 22 AND 39).

FIRST USE 1-31-1984; IN COMMERCE 1-31-1984.
RENEE MCCRAY, EXAMINING ATTORNEY

SN 78-537,488. LAFORGA, EDDY, MILILANI, HI. FILED 12-22-2004.

SN 78-537,733. BYER CALIFORNIA, SAN FRANCISCO, CA. FILED 12-23-2004.

SELF-TAUGHT

BYLINE

THE MARK CONSISTS OF STANDARD CHARACTERS WITHOUT CLAIM TO ANY PARTICULAR FONT, STYLE, SIZE, OR COLOR.

FOR T-SHIRTS, SWEAT SHIRTS, SHORTS, JACKETS, GLOVES, PAJAMAS, SWIMSUITS, SKIRTS, DRESSES, TANK TOPS, PANTS, COATS, SWEATERS, SOCKS, BELTS, FOOTWEAR AND HEADWEAR (U.S. CLS. 22 AND 39).

KATHRYN COWARD, EXAMINING ATTORNEY

THE MARK CONSISTS OF STANDARD CHARACTERS WITHOUT CLAIM TO ANY PARTICULAR FONT, STYLE, SIZE, OR COLOR.

FOR CLOTHING, NAMELY, DRESSES, SKIRTS, BLOUSES, SKORTS, SHORTS, SHIRTS, PANTS, JACKETS, SWEATERS, VESTS AND JUMPSUITS (U.S. CLS. 22 AND 39).

ELLEN BURNS, EXAMINING ATTORNEY

CLASS 25—(Continued).

SN 78-537,775. ROBINSON, LANCE, DBA TEAM LOCO,
MESA, AZ. FILED 12-23-2004.



THE MARK CONSISTS OF SKULL WITHIN A SCARAB.
FOR CLOTHING, NAMELY, T-SHIRTS, HATS AND
JACKETS (U.S. CLS. 22 AND 39).
FIRST USE 12-1-1998; IN COMMERCE 12-1-1998.
MICHELE SWAIN, EXAMINING ATTORNEY

SN 78-537,950. YARMOLOVICH, ALEXANDER J., TUCSON,
AZ. FILED 12-23-2004.

KNOW YOUR FOE

THE MARK CONSISTS OF STANDARD CHARACTERS
WITHOUT CLAIM TO ANY PARTICULAR FONT, STYLE,
SIZE, OR COLOR.
FOR CLOTHING ITEMS, NAMELY T-SHIRTS,
SWEATSHIRTS, SWEATERS, JACKETS, HATS, CAPS,
AND VISORS (U.S. CLS. 22 AND 39).
KATHY DE JONGE, EXAMINING ATTORNEY

CLASS 25—(Continued).

SN 78-538,164. FAIR DEVELOPMENT COMPANY LIMITED,
KWAI CHUNG, NEW TERRITORIES, HONG KONG,
FILED 12-23-2004.

ALPSKY

THE MARK CONSISTS OF THE WORD ALPSKY WHICH
IS AN INVENTED WORD AND HAS NO MEANING OR
SIGNIFICANCE IN THE RELEVANT TRADE OR IN ANY
LANGUAGES.

FOR CLOTHING FOR MEN, WOMEN AND CHILDREN,
NAMELY, COATS, RAINCOATS, BELTS, BRACES,
SHIRTS, T-SHIRTS, BLOUSES, PULLOVERS,
OVERALLS, JACKETS, CARDIGANS, PANTS, SHORTS,
SKIRTS, DRESSES, SUITS, SWEATERS, UNDERWEAR,
BRASSIERES, SOCKS AND STOCKINGS, GLOVES, TIES,
SCARVES, SHAWLS, SWIMWEAR, PAJAMAS, BATHING
SUITS, APRONS, INFANT WEAR, HATS AND CAPS,
BOOTS, SHOES AND SLIPPERS (U.S. CLS. 22 AND 39).
FIRST USE 1-31-2001; IN COMMERCE 6-30-2002.
JEFF DEFORD, EXAMINING ATTORNEY

SN 78-538,233. LUNA INTERNATIONAL USA, INC., HAUP-
PAUGE, NY. FILED 12-24-2004.

WADDLERS

THE MARK CONSISTS OF STANDARD CHARACTERS
WITHOUT CLAIM TO ANY PARTICULAR FONT, STYLE,
SIZE, OR COLOR.
OWNER OF U.S. REG. NO. 1,815,990.
FOR CHILDREN'S SHOES (U.S. CLS. 22 AND 39).
FIRST USE 2-15-1990; IN COMMERCE 2-15-1990.
JILL PRATER, EXAMINING ATTORNEY

CLASS 25—(Continued).

SN 78-539,208. BLACK & WHITE TV, INC., LOS ANGELES, CA. FILED 12-28-2004.

WEARABLE WORD

THE MARK CONSISTS OF STANDARD CHARACTERS WITHOUT CLAIM TO ANY PARTICULAR FONT, STYLE, SIZE, OR COLOR.

NO CLAIM IS MADE TO THE EXCLUSIVE RIGHT TO USE WEARABLE, APART FROM THE MARK AS SHOWN. FOR MEN'S, WOMEN'S AND CHILDREN'S CLOTHING, NAMELY, T-SHIRTS, BLOUSES, JACKETS AND SHIRTS (U.S. CLS. 22 AND 39).
FIRST USE 1-24-2005; IN COMMERCE 1-24-2005.
ANDREW BENZMILLER, EXAMINING ATTORNEY



SN 78-539,470. ADIDAS-SALOMON AG, D-91074 HERZOGENAURACH, FED REP GERMANY, FILED 12-29-2004.

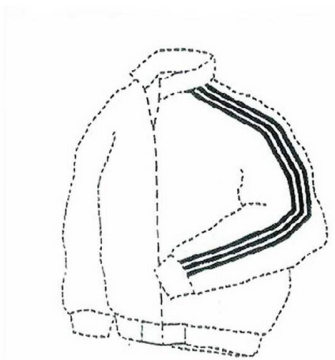

OWNER OF U.S. REG. NOS. 870,136, 2,016,963 AND 2,058,619.

THE MARK CONSISTS OF THREE PARALLEL STRIPES RUNNING ALONG THE SLEEVE OF A SHIRT, T-SHIRT, SWEATSHIRT, JACKET OR COAT. THE DOTTED OUTLINE OF THE GARMENT IS NOT CLAIMED AS PART OF THE MARK AND IS INTENDED ONLY TO SHOW THE POSITION OF THE MARK.

SEC. 2(F).
FOR CLOTHING, NAMELY, T-SHIRTS, SWEATSHIRTS, JACKETS AND COATS (U.S. CLS. 22 AND 39).
FIRST USE 2-3-1967; IN COMMERCE 8-3-1967.
BARNEY CHARLON, EXAMINING ATTORNEY

CLASS 25—(Continued).

SN 78-539,629. ADIDAS-SALOMON AG, D-91074 HERZOGENAURACH, FED REP GERMANY, FILED 12-29-2004.

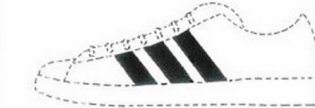

THE MARK CONSISTS OF THREE PARALLEL STRIPES APPLIED TO FOOTWEAR, THE STRIPES ARE POSITIONED ON THE FOOTWEAR UPPER IN THE AREA BETWEEN THE LACES AND THE SOLE. THE DOTTED OUTLINE OF THE FOOTWEAR IS NOT CLAIMED AS PART OF THE MARK AND IS INTENDED ONLY TO SHOW THE POSITION OF THE MARK.

SEC. 2(F).
FOR FOOTWEAR (U.S. CLS. 22 AND 39).
FIRST USE 1-1-1952; IN COMMERCE 1-1-1952.
ALINA MORRIS, EXAMINING ATTORNEY



SN 78-539,734. ADIDAS-SALOMON AG, D-91074 HERZOGENAURACH, FED REP GERMANY, FILED 12-29-2004.



THE MARK CONSISTS OF THREE PARALLEL STRIPES WITH SERRATED EDGES APPLIED TO FOOTWEAR, THE STRIPES ARE POSITIONED ON THE FOOTWEAR UPPER IN THE AREA BETWEEN THE LACES AND THE SOLE. THE DOTTED OUTLINE OF THE FOOTWEAR IS NOT CLAIMED AS PART OF THE MARK AND IS INTENDED ONLY TO SHOW THE POSITION OF THE MARK.

SEC. 2(F).
FOR FOOTWEAR (U.S. CLS. 22 AND 39).
FIRST USE 1-1-1952; IN COMMERCE 1-1-1952.
ALINA MORRIS, EXAMINING ATTORNEY



SN 78-539,771. KEANE, WILLIAM W., FAYETVILLE, NC. FILED 12-29-2004.



THE MARK CONSISTS OF A VAMPIRE SKULL WITH MISSING FRONT TOOTH.
FOR CLOTHING, NAMELY T-SHIRTS (U.S. CLS. 22 AND 39).

FIRST USE 10-27-2004; IN COMMERCE 10-27-2004.
STEVEN JACKSON, EXAMINING ATTORNEY

CLASS 25—(Continued).

SN 78-549,728. JONES INVESTMENT CO. INC., WILMINGTON, DE. FILED 1-19-2005.

JONES NEW YORK PLATINUM

THE MARK CONSISTS OF STANDARD CHARACTERS WITHOUT CLAIM TO ANY PARTICULAR FONT, STYLE, SIZE, OR COLOR.

OWNER OF U.S. REG. NOS. 941,013, 1,399,556 AND OTHERS.

NO CLAIM IS MADE TO THE EXCLUSIVE RIGHT TO USE "NEW YORK", APART FROM THE MARK AS SHOWN.

FOR APPAREL, NAMELY JACKETS, SKIRTS, PANTS AND DRESSES (U.S. CLS. 22 AND 39).

FIRST USE 4-30-2003; IN COMMERCE 4-30-2003.

WILLIAM BRECKENFELD, EXAMINING ATTORNEY

SN 78-564,906. BERY BERY GUD TO ME, LLC, LOS ANGELES, CA. FILED 2-10-2005.



NO CLAIM IS MADE TO THE EXCLUSIVE RIGHT TO USE "OREM", APART FROM THE MARK AS SHOWN.

THE MARK CONSISTS OF AN OWL WITH BASEBALL STITCHES ON THE HEAD CARRYING TWO BATS.

FOR CLOTHING, NAMELY, APRONS, ATHLETIC UNIFORMS, BANDANAS, BOXER SHORTS, CAPS, CLOTH BABY BIBS, COATS, GOLF SHIRTS, GYM SHORTS, GYM SUITS, HATS, JACKETS, JERSEYS, JOGGING SUITS, KNIT SHIRTS, PAJAMAS, POLO SHIRTS, PONCHOS, PULLOVERS, RAIN COATS, RAINWEAR, SWEATERS, SWEAT PANTS, SWEAT SHIRTS, SWEAT SUITS, SOCKS, SPORT SHIRTS, T-SHIRTS, TANK TOPS, TIES, VISORS, WIND RESISTANT JACKETS AND WRISTBANDS (U.S. CLS. 22 AND 39).

FIRST USE 12-6-2004; IN COMMERCE 2-1-2005.

GRETTA YAO, EXAMINING ATTORNEY

CLASS 25—(Continued).

SN 78-609,186. JOSEPH ZACCAI AND MARC ZACCAI JOINT VENTURE, THE, BROOKLYN, NY. FILED 4-14-2005.

PILLAR

THE MARK CONSISTS OF STANDARD CHARACTERS WITHOUT CLAIM TO ANY PARTICULAR FONT, STYLE, SIZE, OR COLOR.

FOR MEN'S, WOMEN'S AND CHILDREN'S WEARING APPAREL, NAMELY JACKETS, COATS, PANTS, VESTS, SHIRTS, SKIRTS, DRESSES, HATS AND UNDERWEAR (U.S. CLS. 22 AND 39).

JASON ROTH, EXAMINING ATTORNEY

SN 78-975,995. YAKIRA, LLC, SOUTH RIVER, NJ. FILED 3-22-2004.

OWNER OF U.S. REG. NOS. 2,516,030 AND 2,516,031. THE NAME MARC ECKO IDENTIFIES A LIVING INDIVIDUAL WHOSE CONSENT IS OF RECORD.

THE MARK CONSISTS OF MARC ECKO IN STYLIZED FORM WITH A SCISSORS AND STITCHING DESIGN.

FOR APPAREL AND CLOTHING OF ALL TYPES, NAMELY PANTS, SHIRTS, JEANS, COATS, JACKETS, OVERCOATS AND SWEATERS (U.S. CLS. 22 AND 39).

FIRST USE 7-0-2004; IN COMMERCE 7-0-2004.

NANCY CLARKE, EXAMINING ATTORNEY

SN 79-000,259. DYAG STOCK SA, F-93170 BAGNOLET, FRANCE, FILED 11-20-2003.

FRANCO DI MARCO

THE MARK CONSISTS OF STANDARD CHARACTERS WITHOUT CLAIM TO ANY PARTICULAR FONT, STYLE, SIZE, OR COLOR.

OWNER OF INTERNATIONAL REGISTRATION 0815889 DATED 11-20-2003, EXPIRES 11-20-2013.

"FRANCO DI MARCO" DOES NOT IDENTIFY A LIVING INDIVIDUAL

THE TRANSLATION OF THE MARK IS FRANCO OF MARK.

FOR CLOTHING NAMELY SHIRTS, T-SHIRTS, JACKETS; FOOTWEAR AND HEADWEAR (U.S. CLS. 22 AND 39).

TERESA M. RUPP, EXAMINING ATTORNEY

CLASS 25—(Continued).

SN 79-000,661. DON FRANCISCO SANCHIS BUSQUIER, SPAIN, FILED 11-25-2003.

CHIE MIHARA

OWNER OF INTERNATIONAL REGISTRATION 0791311 DATED 10-17-2002, EXPIRES 10-17-2012.
FOR CLOTHING, NAMELY FOOTWEAR AND HEADGEAR, NAMELY, HATS AND CAPS (U.S. CLS. 22 AND 39).

EDWARD NELSON, EXAMINING ATTORNEY

SN 79-001,573. FALKE KG, D-57392 SCHMALLENBERG, FED REP GERMANY, FILED 2-6-2004.

make up your legs

THE MARK CONSISTS OF STANDARD CHARACTERS WITHOUT CLAIM TO ANY PARTICULAR FONT, STYLE, SIZE, OR COLOR.

PRIORITY DATE OF 9-30-2003 IS CLAIMED.

OWNER OF INTERNATIONAL REGISTRATION 0821246 DATED 2-6-2004, EXPIRES 2-6-2014.

FOR CLOTHING, NAMELY HOSIERY, SHOES AND HEADWEAR (U.S. CLS. 22 AND 39).

TRACY WHITAKER-BOWN, EXAMINING ATTORNEY

SN 79-002,116. HUMEAU BEAUPREAU SAS, FRANCE, FILED 3-23-2004.

BOPY

OWNER OF INTERNATIONAL REGISTRATION 0481195 DATED 10-17-1983, EXPIRES 10-17-2013.

OWNER OF U.S. REG. NO. 2,842,695.

THE STIPPLING IS FOR SHADING PURPOSES.

FOR BOOTS, SHOES, SLIPPERS AND SANDALS (U.S. CLS. 22 AND 39).

JULIA HARDY COFIELD, EXAMINING ATTORNEY

SN 79-002,417. CALZADOS COLL, S.A., SPAIN, FILED 1-23-2004.

V E L E T T O

THE MARK CONSISTS OF STANDARD CHARACTERS WITHOUT CLAIM TO ANY PARTICULAR FONT, STYLE, SIZE, OR COLOR.

OWNER OF INTERNATIONAL REGISTRATION 0718035 DATED 7-9-1999, EXPIRES 7-9-2009.

FOR FOOTWEAR (EXCLUDING ORTHOPEDIC FOOTWEAR) (U.S. CLS. 22 AND 39).

AMOS T. MATTHEWS, JR., EXAMINING ATTORNEY

CLASS 25—(Continued).

SN 79-002,761. "DR. MARTENS" INTERNATIONAL; TRADING GMBH, FED REP GERMANY, AND "DR. MAERTENS" MARKETING GMBH, FED REP GERMANY, FILED 3-18-2004.

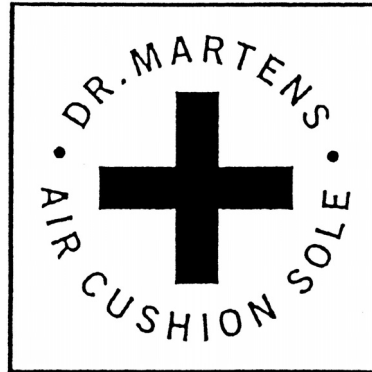

PRIORITY DATE OF 12-8-2003 IS CLAIMED.
OWNER OF INTERNATIONAL REGISTRATION 0825531 DATED 3-18-2004, EXPIRES 3-18-2014.

OWNER OF U.S. REG. NOS. 1,454,323, 2,747,178 AND OTHERS.

NO CLAIM IS MADE TO THE EXCLUSIVE RIGHT TO USE "AIR CUSHION SOLE", APART FROM THE MARK AS SHOWN.

THE NAME(S), PORTRAIT(S), AND/OR SIGNATURE(S) SHOWN IN THE MARK DOES NOT IDENTIFY A PARTICULAR LIVING INDIVIDUAL.

FOR FOOTWEAR AND PARTS THEREOF (U.S. CLS. 22 AND 39).

STEVEN JACKSON, EXAMINING ATTORNEY

SN 79-003,339. MEPHISTO S.A. (SOCIÉTÉ ANONYME À DIRECTOIRE ET CONSEIL DE SURVEILLANCE), FRANCE, FILED 6-4-2004.

NATURE IS FUTURE

THE MARK CONSISTS OF STANDARD CHARACTERS WITHOUT CLAIM TO ANY PARTICULAR FONT, STYLE, SIZE, OR COLOR.

OWNER OF INTERNATIONAL REGISTRATION 0608164 DATED 10-21-1993, EXPIRES 10-21-2013.

FOR FOOTWEAR; CLOTHING, NAMELY, SHIRTS, SOCKS, JACKETS, TROUSERS, POLO SHIRTS AND PULLOVERS; BELTS (U.S. CLS. 22 AND 39).

DAVID C. REIHNER, EXAMINING ATTORNEY

CLASS 25—(Continued).

SN 79-003,495. MIRIAM OCARIZ MIGUEL, SPAIN, FILED 5-19-2004.

Miriam Ocariz

OWNER OF INTERNATIONAL REGISTRATION 0827810 DATED 5-19-2004, EXPIRES 5-19-2014.

FOR CLOTHING, NAMELY, SHORTS, SHIRTS, T-SHIRTS, SWIMSUITS, BLOUSES, SKIRTS, SCARVES, GLOVES, PANTS, SWEATERS, JERSEYS, SOCKS, JACKETS, SUITS, TRAINING SUITS, VESTS, NECKTIES, BELTS, SUSPENDERS, DRESSES, COATS, RAINCOATS, OVERCOATS, SMOCKS, UNDERWEAR, PAJAMAS, BRASSIERES, CORSETS, SLIPS, LINGERIE; HEADWEAR, NAMELY, HATS, CAPS AND BERETS; FOOTWEAR, NAMELY, BOOTS, SANDALS, SHOES AND SLIPPERS (U.S. CLS. 22 AND 39).

LINDA MICKLEBURGH, EXAMINING ATTORNEY

SN 79-004,686. TERNAY, SOCIÉTÉ ANONYME, FRANCE, FILED 6-25-2004.

CARLING

OWNER OF INTERNATIONAL REGISTRATION 0536773 DATED 3-28-1989, EXPIRES 3-28-2009.

FOR CLOTHING, NAMELY, UNDERWEAR, SHIRTS, POLO-SHIRTS, JACKETS, TROUSERS, DRESSES, SKIRTS, COATS, SCARVES, BELTS, SOCKS, NIGHTWEAR, LOUNGE WEAR, KNITTED WEAR, NAMELY, SHIRTS, POLO-SHIRTS AND DRESSES; FOOTWEAR; HEADWEAR (U.S. CLS. 22 AND 39).

KEVON CHISOLM, EXAMINING ATTORNEY

SN 79-005,176. PUMA AKTIENGESELLSCHAFT; RUDOLF DASSLER SPORT, FED REP GERMANY, FILED 7-19-2004.

UniQT

THE MARK CONSISTS OF STANDARD CHARACTERS WITHOUT CLAIM TO ANY PARTICULAR FONT, STYLE, SIZE, OR COLOR.

PRIORITY DATE OF 2-10-2004 IS CLAIMED.

OWNER OF INTERNATIONAL REGISTRATION 0832859 DATED 7-19-2004, EXPIRES 7-19-2014.

FOR CLOTHING, NAMELY SPORTS WEAR IN THE NATURE OF SHIRTS, T-SHIRTS, TRAINING SUITS, PANTS, SWEATERS, JERSEYS AND TRICOT SHIRTS, FOOTBALL SHIRTS AND FOOTBALL PANTS, GYM SUITS, ALL WEATHER SUITS, STOCKINGS AND SOCKS; FOOTWEAR, NAMELY SPORTS AND LEISURE SHOES; HEADGEAR, NAMELY HATS, CAPS, HEADBANDS FOR SPORT PURPOSES (U.S. CLS. 22 AND 39).

MAUREEN DALL, EXAMINING ATTORNEY

CLASS 25—(Continued).

SN 79-006,188. ARENA DISTRIBUTION S.A., SWITZERLAND, FILED 9-27-2004.



PRIORITY DATE OF 7-12-2004 IS CLAIMED. OWNER OF INTERNATIONAL REGISTRATION 0835654 DATED 9-27-2004, EXPIRES 9-27-2014.

FOR SHOES AND FOOTWEAR (U.S. CLS. 22 AND 39). MICHAEL HALL, EXAMINING ATTORNEY

SN 79-008,767. LINDA SHARON MANNING, UNITED KINGDOM, FILED 10-18-2004.

THE MEEK

THE MARK CONSISTS OF STANDARD CHARACTERS WITHOUT CLAIM TO ANY PARTICULAR FONT, STYLE, SIZE, OR COLOR.

OWNER OF INTERNATIONAL REGISTRATION 0842902 DATED 10-18-2004, EXPIRES 10-18-2014.

FOR CLOTHING, NAMELY, T-SHIRTS AND FOOTWEAR AND HEADWEAR (U.S. CLS. 22 AND 39).

CHRISTOPHER BUONGIORNO, EXAMINING ATTORNEY

CLASS 26—FANCY GOODS

SN 76-585,655. DOLLAR TREE STORES, INC., CHESAPEAKE, VA. FILED 4-7-2004.

FLORAL GARDEN

THE MARK CONSISTS OF STANDARD CHARACTERS WITHOUT CLAIM TO ANY PARTICULAR FONT, STYLE, SIZE, OR COLOR.

NO CLAIM IS MADE TO THE EXCLUSIVE RIGHT TO USE "FLORAL", APART FROM THE MARK AS SHOWN.

FOR ARTIFICIAL FLOWERS AND ARTIFICIAL PLANTS (U.S. CLS. 37, 39, 40, 42 AND 50).

FIRST USE 10-8-1998; IN COMMERCE 10-8-1998.

SHARI SHEFFIELD, EXAMINING ATTORNEY

CLASS 26—(Continued).

SN 76-595,451. INSPIRED CHRISTIAN WORKS, HOUSTON, TX. FILED 6-1-2004.



THE COLORS BLUE, GREEN, PURPLE, YELLOW AND BEIGE ARE CLAIMED AS A FEATURE OF THE MARK.
 THE COLOR BLUE APPEARS IN THE GLOBE IN THE BACKGROUND AS THE WATER. THE COLOR GREEN APPEARS IN THE GLOBE IN THE BACKGROUND AS THE LAND. THE COLOR PURPLE APPEARS IN THE CUFFS OF THE PRAYING HANDS. THE COLOR YELLOW APPEARS IN THE STYLIZED HUMANS IN THE BACKGROUND AND IN THE WORD "PRAY" IN THE CUFFS IN THE FOREGROUND, AND THE COLOR BEIGE APPEARS AS THE SKIN COLOR OF THE HUMAN HANDS.

FOR EMBROIDERED EMBLEM DEPICTING PRAYING HANDS WITH A CHAIN OF STYLIZED HUMANS AND GLOBE IN THE BACKGROUND. (U.S. CLS. 37, 39, 40, 42 AND 50).

HEATHER THOMPSON, EXAMINING ATTORNEY

SN 76-601,021. HAIR ZEST INT'L INC., PARAMOUNT, CA. FILED 7-6-2004.

First Impression.

THE MARK CONSISTS OF STANDARD CHARACTERS WITHOUT CLAIM TO ANY PARTICULAR FONT, STYLE, SIZE, OR COLOR.

FOR WIGS AND HAIR PIECES (U.S. CLS. 37, 39, 40, 42 AND 50).

FIRST USE 1-1-2004; IN COMMERCE 1-1-2004.
 MICHAEL ENGEL, EXAMINING ATTORNEY

SN 76-601,023. HAIR ZEST INT'L INC., PARAMOUNT, CA. FILED 7-6-2004.

Blooming.

THE MARK CONSISTS OF STANDARD CHARACTERS WITHOUT CLAIM TO ANY PARTICULAR FONT, STYLE, SIZE, OR COLOR.

FOR WIGS AND HAIR PIECES (U.S. CLS. 37, 39, 40, 42 AND 50).

FIRST USE 1-1-2004; IN COMMERCE 1-1-2004.
 MICHAEL ENGEL, EXAMINING ATTORNEY

CLASS 26—(Continued).

SN 78-329,014. BIL-BOW CORPORATION, ODESSA, TX. FILED 11-17-2003.

VI-ZO

THE MARK CONSISTS OF STANDARD CHARACTERS WITHOUT CLAIM TO ANY PARTICULAR FONT, STYLE, SIZE, OR COLOR.

FOR ORNAMENTAL NOVELTY BASEBALL CAP BILL CLIP (U.S. CLS. 37, 39, 40, 42 AND 50).
 SEAN DWYER, EXAMINING ATTORNEY

SN 78-337,387. JAMES, JEANNE C., MASSILLON, OH. FILED 12-6-2003.

Spoolies

THE MARK CONSISTS OF STANDARD CHARACTERS WITHOUT CLAIM TO ANY PARTICULAR FONT, STYLE, SIZE, OR COLOR.

FOR NON-ELECTRIC HAIR CURLERS (U.S. CLS. 37, 39, 40, 42 AND 50).

JOHN SCHUYLER YARD, EXAMINING ATTORNEY

CLASS 26—(Continued).

SN 78-498,969. SCOVILL FASTENERS INC., CLARKESVILLE, GA. FILED 10-13-2004.

DURAMARK

THE MARK CONSISTS OF STANDARD CHARACTERS WITHOUT CLAIM TO ANY PARTICULAR FONT, STYLE, SIZE, OR COLOR.

FOR SNAP FASTENERS; BUTTONS FOR CLOTHING; RIVET BUTTONS (U.S. CLS. 37, 39, 40, 42 AND 50).
FIRST USE 8-0-1998; IN COMMERCE 8-0-1998.
JOHN HWANG, EXAMINING ATTORNEY



SN 78-499,301. MINK HAIR, LTD., DBA SENSUAL, RIDGEFIELD, NJ. FILED 10-13-2004.

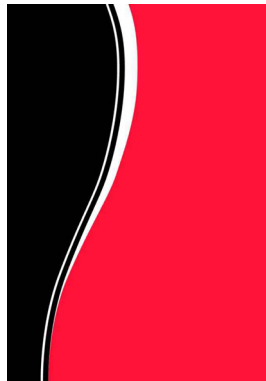

THE COLOR(S) BLACK, WHITE, AND RED IS/ARE CLAIMED AS A FEATURE OF THE MARK.

THE MARK CONSISTS OF A BLACK PORTION ON THE LEFT AND A RED PORTION ON THE RIGHT AND CURVED BLACK AND WHITE LINES BETWEEN THE BLACK AND RED PORTIONS.

FOR WIGS, HAIR PIECES AND HAIR EXTENSIONS (U.S. CLS. 37, 39, 40, 42 AND 50).
FIRST USE 12-0-1998; IN COMMERCE 12-0-1998.
JOANNA DUKOVIC, EXAMINING ATTORNEY

CLASS 26—(Continued).

SN 78-525,227. JULIO'S EXPORT & IMPORT, INC., LOS ANGELES, CA. FILED 12-1-2004.

JULIETTE

THE MARK CONSISTS OF STANDARD CHARACTERS WITHOUT CLAIM TO ANY PARTICULAR FONT, STYLE, SIZE, OR COLOR.

FOR HAIR ACCESSORIES, NAMELY CLIPS, TWISTERS, BANDS, BOWS, BUCKLES, ORNAMENTS, PINS (U.S. CLS. 37, 39, 40, 42 AND 50).
FIRST USE 11-30-2003; IN COMMERCE 11-30-2003.
KAREN K. BUSH, EXAMINING ATTORNEY



SN 78-609,587. BRAZABRA CORPORATION, LEE, MA. FILED 4-15-2005.

FLASH TAPE

THE MARK CONSISTS OF STANDARD CHARACTERS WITHOUT CLAIM TO ANY PARTICULAR FONT, STYLE, SIZE, OR COLOR.

NO CLAIM IS MADE TO THE EXCLUSIVE RIGHT TO USE "TAPE", APART FROM THE MARK AS SHOWN.

FOR BODY AND CLOTHING TAPE, NAMELY, ADHESIVE TAPE TO KEEP CLOTHING IN PLACE (U.S. CLS. 37, 39, 40, 42 AND 50).
DOUGLAS LEE, EXAMINING ATTORNEY

CLASS 27—FLOOR COVERINGS

SN 76-611,808. BLISS ROAD INCORPORATED, MISHAWA-KA, IN. FILED 9-13-2004.

SNAPP DRAGON

THE MARK CONSISTS OF STANDARD CHARACTERS WITHOUT CLAIM TO ANY PARTICULAR FONT, STYLE, SIZE, OR COLOR.

FOR RUBBER WEED MATS FOR PREVENTING PLANT GROWTH AROUND MAILBOXES, FENCES, AND TREES (U.S. CLS. 19, 20, 37, 42 AND 50).

FIRST USE 4-5-2004; IN COMMERCE 4-5-2004.
DAHLIA GEORGE, EXAMINING ATTORNEY

CLASS 27—(Continued).

SN 78-417,625. WRIGHT, JASON D, ATLANTIC, IA. FILED 5-12-2004.

Racemat

THE MARK CONSISTS OF STANDARD CHARACTERS WITHOUT CLAIM TO ANY PARTICULAR FONT, STYLE, SIZE, OR COLOR.

FOR MATS AND MATTING, NAMELY, PORTABLE VINYL FLOORMATTING FOR COVERING EXISTING FLOOR OR FLOORING FOR USE WITH MOTORIZED OR SELF PROPELLED VEHICLES (U.S. CLS. 19, 20, 37, 42 AND 50).

FIRST USE 12-10-2001; IN COMMERCE 9-3-2002.
ALICE BENMAMAN, EXAMINING ATTORNEY

SN 76-622,019. MSM INDUSTRIES, SMYRNA, TN. FILED 11-24-2004.

RELAX-A-BATH

THE MARK CONSISTS OF STANDARD CHARACTERS WITHOUT CLAIM TO ANY PARTICULAR FONT, STYLE, SIZE, OR COLOR.

FOR BATH PILLOWS SOLD AS A COMPONENT OF BATH MATS (U.S. CLS. 19, 20, 37, 42 AND 50).

FIRST USE 10-0-2003; IN COMMERCE 3-0-2004.
TONI HICKEY, EXAMINING ATTORNEY

SN 78-426,655. SLIPP-NOTT CORP., LOS ANGELES, CA. FILED 5-27-2004.

Trac Mate

SN 78-398,414. JANITEX RUG SERVICE CORP., BELTSVILLE, MD. FILED 4-8-2004.

Z-STEP

THE MARK CONSISTS OF STANDARD CHARACTERS WITHOUT CLAIM TO ANY PARTICULAR FONT, STYLE, SIZE, OR COLOR.

FOR FLOOR MATS FOR COMMERCIAL USE (U.S. CLS. 19, 20, 37, 42 AND 50).

FIRST USE 2-28-2003; IN COMMERCE 2-28-2003.
NORA BUCHANAN WILL, EXAMINING ATTORNEY

THE MARK CONSISTS OF STANDARD CHARACTERS WITHOUT CLAIM TO ANY PARTICULAR FONT, STYLE, SIZE, OR COLOR.

FOR ADHESIVE FLOOR MAT DESIGNED TO REMOVE DUST, DIRT AND PARTICULATE FROM SHOE SOLES (U.S. CLS. 19, 20, 37, 42 AND 50).

FIRST USE 2-3-1999; IN COMMERCE 5-13-1999.
G. MAYERSCHOFF, EXAMINING ATTORNEY

CLASS 27—(Continued).

SN 78-431,140. CHESAPEAKE WALLCOVERINGS CORPORATION, UPPER MARLBORO, MD. FILED 6-7-2004.

CLASS 27—(Continued).

SN 78-500,932. ROYALTY CARPET MILLS, INC., IRVINE, CA. FILED 10-15-2004.

HANGS IN MINUTES,
REMOVES IN
SECONDS



THE MARK CONSISTS OF STANDARD CHARACTERS WITHOUT CLAIM TO ANY PARTICULAR FONT, STYLE, SIZE, OR COLOR.
FOR WALLCOVERINGS (U.S. CLS. 19, 20, 37, 42 AND 50).
ALICE SUE CARRUTHERS, EXAMINING ATTORNEY

OWNER OF U.S. REG. NOS. 1,111,835 AND 1,687,949.
FOR RESIDENTIAL AND COMMERCIAL TUFTED CARPET AND RUGS (U.S. CLS. 19, 20, 37, 42 AND 50).
FIRST USE 2-0-2000; IN COMMERCE 2-0-2000.
DORITT L. CARROLL, EXAMINING ATTORNEY

SN 78-498,201. K2 GLOBAL TRADING, LLC, RIDGEFIELD, NJ. FILED 10-12-2004.

SN 78-503,141. SYNTHETIC LAWNS INTERNATIONAL, INC., DALTON, GA. FILED 10-20-2004.

LumiLuxe

SYNFLIELD

THE MARK CONSISTS OF STANDARD CHARACTERS WITHOUT CLAIM TO ANY PARTICULAR FONT, STYLE, SIZE, OR COLOR.
FOR CARPETS, RUGS, BATH RUGS, MATS AND MATTING FOR COVERING EXISTING FLOORS (U.S. CLS. 19, 20, 37, 42 AND 50).
FIRST USE 4-1-2004; IN COMMERCE 4-1-2004.
PAULA MAHONEY, EXAMINING ATTORNEY

THE MARK CONSISTS OF STANDARD CHARACTERS WITHOUT CLAIM TO ANY PARTICULAR FONT, STYLE, SIZE, OR COLOR.
FOR ARTIFICIAL TURF (U.S. CLS. 19, 20, 37, 42 AND 50).
FIRST USE 5-1-2004; IN COMMERCE 5-1-2004.
KATHY DE JONGE, EXAMINING ATTORNEY

CLASS 27—(Continued).

SN 78-503,164. SYNTHETIC LAWNs INTERNATIONAL, INC., DALTON, GA. FILED 10-20-2004.

SYNPLAY

THE MARK CONSISTS OF STANDARD CHARACTERS WITHOUT CLAIM TO ANY PARTICULAR FONT, STYLE, SIZE, OR COLOR.
FOR ARTIFICIAL TURF (U.S. CLS. 19, 20, 37, 42 AND 50).
FIRST USE 5-1-2004; IN COMMERCE 5-1-2004.
JASON LOTT, EXAMINING ATTORNEY

CLASS 27—(Continued).

SN 78-511,633. JERRY GARCIA ESTATE LLC, SAUSALITO, CA. FILED 11-4-2004.



OWNER OF U.S. REG. NOS. 2,298,506 AND 2,302,439.
THE MARK CONSISTS OF DECEASED MUSICIAN AND ARTIST JERRY GARCIA'S OWN INDIVIDUAL HAND-PRINT WITH A MISSING MIDDLE FINGER AND SHOWING JERRY GARCIA'S DISTINCTIVE FINGER PRINTS, PALM PRINT AND LIFE LINES.
FOR RUGS (U.S. CLS. 19, 20, 37, 42 AND 50).
JOHN LINCOSKI, EXAMINING ATTORNEY

SN 78-530,798. HOMER TLC, INC., CLAYMONT, DE. FILED 12-10-2004.

SN 78-508,999. DOMFOAM INTERNATIONAL INC., ST. LEONARD QUEBEC H1P 2C9, CANADA, FILED 11-1-2004.

NORTHERN TREASURE

THE MARK CONSISTS OF STANDARD CHARACTERS WITHOUT CLAIM TO ANY PARTICULAR FONT, STYLE, SIZE, OR COLOR.
OWNER OF CANADA REG. NO. TMA638221, DATED 4-25-2005, EXPIRES 4-25-2020.
FOR CARPET CUSHION AND UNDERPADDING FOR CARPETS (U.S. CLS. 19, 20, 37, 42 AND 50).
FIRST USE 5-31-2004; IN COMMERCE 5-31-2004.
DAYNA BROWNE, EXAMINING ATTORNEY

TrafficMaster

THE MARK CONSISTS OF STANDARD CHARACTERS WITHOUT CLAIM TO ANY PARTICULAR FONT, STYLE, SIZE, OR COLOR.
OWNER OF U.S. REG. NOS. 2,321,766 AND 2,730,350.
FOR VINYL FLOOR COVERINGS, CARPETING, AREA RUGS, FLOOR MATS, WALLPAPER (U.S. CLS. 19, 20, 37, 42 AND 50).
WON TEAK OH, EXAMINING ATTORNEY

CLASS 27—(Continued).

SN 78-568,677. RETAIL BRAND ALLIANCE, INC., ENFIELD, CT. FILED 2-16-2005.

BROOKS BROTHERS

THE MARK CONSISTS OF STANDARD CHARACTERS WITHOUT CLAIM TO ANY PARTICULAR FONT, STYLE, SIZE, OR COLOR.

OWNER OF U.S. REG. NOS. 1,835,478, 1,839,876 AND OTHERS.

FOR WALLPAPER (U.S. CLS. 19, 20, 37, 42 AND 50).

FIRST USE 3-0-2005; IN COMMERCE 3-0-2005.

JIM RINGLE, EXAMINING ATTORNEY

CLASS 28—(Continued).

SN 76-536,753. LAGATTUTA, MICHAEL R., FOUNTAIN VALLEY, CA. FILED 7-21-2003.



NO CLAIM IS MADE TO THE EXCLUSIVE RIGHT TO USE "FOREARM," ".COM", APART FROM THE MARK AS SHOWN.

THE COLOR(S) RED, GRAY AND BLUE IS/ARE CLAIMED AS A FEATURE OF THE MARK.

THE COLOR BLUE APPEARS IN A BLUE OVAL RING GENERALLY CONTAINING THE BLUE LETTERS FOREARM BLASTER AND A PAIR OF BLUE FOREARMS GRASPING A CYLINDRICAL EXERCISE DEVICE HAVING A BLUE CORD, THE COLOR RED APPEARS IN THE OUTLINE AND THE LETTERS .COM AND THE COLOR GRAY APPEARS IN THE GRAY WEIGHT HUNG FROM A LOWER END OF THE CORD.

FOR EXERCISE APPARATUS FOR MANUALLY EXERCISING FOREARMS, WRISTS AND HANDS, NAMELY A CYLINDER HAVING DEPENDING RADIALLY THEREFROM A CORD AND FASTENER ATTACHABLE TO A WEIGHT (U.S. CLS. 22, 23, 38 AND 50).

FIRST USE 1-30-2003; IN COMMERCE 4-4-2003.

ALLISON HOLTZ, EXAMINING ATTORNEY

CLASS 28—TOYS AND SPORTING GOODS

SN 76-520,925. WILSON SPORTING GOODS CO., CHICAGO, IL. FILED 5-15-2003.

NANO TECHNOLOGY

FOR GOLF CLUB SHAFTS (U.S. CLS. 22, 23, 38 AND 50).

JASON TURNER, EXAMINING ATTORNEY

SN 76-520,927. WILSON SPORTING GOODS CO., CHICAGO, IL. FILED 5-15-2003.

NANO MATRIX

FOR SPORTS EQUIPMENT NAMELY, GOLF CLUB SHAFTS. (U.S. CLS. 22, 23, 38 AND 50).

JASON TURNER, EXAMINING ATTORNEY

SN 76-563,543. TAIWAN POWCO LTD., TAIPEI, TAIWAN, FILED 11-28-2003.

MAX SPORTS

THE MARK CONSISTS OF STANDARD CHARACTERS WITHOUT CLAIM TO ANY PARTICULAR FONT, STYLE, SIZE, OR COLOR.

NO CLAIM IS MADE TO THE EXCLUSIVE RIGHT TO USE "SPORTS", APART FROM THE MARK AS SHOWN.

FOR SPORTS TOYS, NAMELY- SPORT BALLS OF ALL TYPES; ARCHERY SETS COMPRISED OF BOWS, ARROWS, TARGETS WITH STANDS, AND ACCESSORIES RELATED THERETO, NAMELY, QUIVERS FOR ARROWS, BLOW TUBES AND BLOW DARTS; TENNIS SETS COMPRISED OF RACKETS, BALLS, AND NET, AND TENNIS ACCESSORIES RELATED THERETO, NAMELY BRACKETS AND POLES FOR MOUNTING NETS; BATTING STAND AND BAT, AND BASEBALL ACCESSORIES RELATED THERETO, NAMELY, BALLS OF VARIOUS CONSTRUCTION; BOWLING SETS COMPRISED OF BOWLING PINS OF VARIOUS SIZES AND BOWLING BALLS OF VARIOUS CONSTRUCTION, AND FRAMES FOR SETTING PINS; GOLF SETS AND GOLF ACCESSORIES RELATED THERETO, NAMELY, GOLF CLUBS, BALLS OF VARIOUS CONSTRUCTION, HOLES, FLAGS AND GREENS; PADDLE BALL AND PADDLES, AND PADDLE BALL ACCESSORIES RELATED THERETO, NAMELY, RUBBER BALLS OF VARIOUS SIZES, RUBBER BANDS AND PADDLES; BAT AND DRUM RACKET GAME AND BAT AND DRUM ACCESSORIES RELATED THERETO, NAMELY, BALLS OF VARIOUS CONSTRUCTION AND

CLASS 28—(Continued).

SHUTTLE COCKS; BASKETBALL SET COMPRISED OF BALLS, HOOPS, STANDS, AND BASKETBALL ACCESSORIES RELATED THERETO, NAMELY, WEIGHTED BASES AND BACKBOARDS AND CLAMPS FOR SAME; FLYING DISCS; TABLE TENNIS SETS COMPRISED OF RACKETS, BALLS, NETS, AND TABLE TENNIS ACCESSORIES RELATED THERETO, NAMELY, BRACKETS AND OTHER MOUNTING EQUIPMENT; JUMP ROPES AND CHINESE SKIPPING ROPES; SOCCER SETS COMPRISED OF SOCCER BALLS AND GOALS; BADMINTON SETS COMPRISED OF RACKETS, BIRDIES, NETS, AND BADMINTON ACCESSORIES RELATED THERETO, NAMELY, POLES AND MOUNTING BRACKETS FOR NETS, BAGS FOR STORING RACKETS AND EQUIPMENT; VOLLEYBALL SETS COMPRISED OF BALLS, NETS, STANDS, AND VOLLEYBALL ACCESSORIES RELATED THERETO, NAMELY, POLES AND MOUNTING BRACKETS FOR NETS, AND BAGS FOR STORING EQUIPMENT; AND BEACH GAMES IN THE NATURE OF VOLLEYBALL AND RACKET GAMES (U.S. CLS. 22, 23, 38 AND 50).

BRENDAN REGAN, EXAMINING ATTORNEY

SN 76-572,505. HASBRO, INC., PAWTUCKET, RI. FILED 1-26-2004.

HEATHER WINDS

THE MARK CONSISTS OF STANDARD CHARACTERS WITHOUT CLAIM TO ANY PARTICULAR FONT, STYLE, SIZE, OR COLOR.

FOR TOY PONIES AND ACCESSORIES FOR USE THEREWITH (U.S. CLS. 22, 23, 38 AND 50).

KHANH LE, EXAMINING ATTORNEY

SN 76-576,039. ASHTON-DRAKE GALLERIES, LTD., THE, NILES, IL. FILED 2-17-2004.

SO TRULY REAL

FOR DOLLS, DOLL CLOTHING AND DOLL ACCESSORIES (U.S. CLS. 22, 23, 38 AND 50).

FIRST USE 3-31-2003; IN COMMERCE 3-31-2003.

STANLEY I. OSBORNE, EXAMINING ATTORNEY

CLASS 28—(Continued).

SN 76-580,139. ROCHELEAU, JOHN C., SUDBURY, ONTARIO P3E 5P5, CANADA, FILED 3-10-2004.

POOL REF

THE MARK CONSISTS OF STANDARD CHARACTERS WITHOUT CLAIM TO ANY PARTICULAR FONT, STYLE, SIZE, OR COLOR.

NO CLAIM IS MADE TO THE EXCLUSIVE RIGHT TO USE "POOL", APART FROM THE MARK AS SHOWN.

FOR MARKER TO BE PLACED ON THE EDGE OF A POOL TABLE BY A PERSON, DESIGNATING THE ORDER OF PLAY (U.S. CLS. 22, 23, 38 AND 50).

FIRST USE 4-22-1997; IN COMMERCE 4-22-1997.

BRENDAN MCCAULEY, EXAMINING ATTORNEY

SN 76-588,072. DISNEY ENTERPRISES, INC., BURBANK, CA. FILED 4-19-2004.



OWNER OF U.S. REG. NO. 2,704,888.

FOR GAMES, NAMELY, ACTION SKILL GAMES, BOARD GAMES, MANIPULATIVE GAMES, ACTION-TYPE TARGET GAMES, PLAYTHINGS, NAMELY, RUBBER BALLS, ACTION FIGURES AND ACCESSORIES THEREFOR, BEAN BAG DOLLS, PLUSH TOYS, BALLOONS, BATH TOYS, BUILDING BLOCKS, EQUIPMENT SOLD AS A UNIT FOR PLAYING CARD GAMES, DOLLS AND DOLL CLOTHING, DOLL PLAYSETS, CHILDREN'S PLAY COSMETICS, CRIB TOYS, ELECTRIC ACTION TOYS, JIGSAW PUZZLES, KITES, MOBILES, MUSIC BOX TOYS, PARTY FAVORS IN THE NATURE OF SMALL TOYS, INFLATABLE POOL TOYS, MULTIPLE ACTIVITY TOYS, WIND-UP TOYS, DISC-TYPE TOSS TOYS, TOY BOWS AND ARROWS, TOY VEHICLES, TOY CARS, TOY TRUCKS, TOY BUCKET AND SHOVEL SETS, ROLLER SKATES, TOY MODEL HOBBY CRAFT KITS, TOY ROCKETS, TOY GUNS, TOY HOLSTERS, MUSICAL TOYS, BUBBLE MAKING WANDS AND SOLUTION SETS, TOY FIGURINES, TOY BANKS, PUPPETS, YO-YOS, TOY SCOOTERS, SKATEBOARDS, FACE MASKS, PLAYING CARDS, HAND-HELD UNITS FOR PLAYING ELECTRONIC GAMES; SPORTING ARTICLES, NAMELY, GOLF BALLS, TENNIS BALLS, GOLF GLOVES, GOLF BALL MARKERS, BADMINTON SETS; CHRISTMAS TREE ORNAMENTS; AND CHRISTMAS DECORATIONS, NAMELY, CHRISTMAS STOCKINGS (U.S. CLS. 22, 23, 38 AND 50).

NELSON SNYDER, EXAMINING ATTORNEY

CLASS 28—(Continued).

SN 76-590,054. SHELTON, DAVID, PINSON, AL. FILED 4-30-2004.

Dinner Dice

THE MARK CONSISTS OF STANDARD CHARACTERS WITHOUT CLAIM TO ANY PARTICULAR FONT, STYLE, SIZE, OR COLOR.

NO CLAIM IS MADE TO THE EXCLUSIVE RIGHT TO USE "DICE", APART FROM THE MARK AS SHOWN.

FOR BOARD GAME, NAMELY, A GAME OF CHANCE USING DICE (U.S. CLS. 22, 23, 38 AND 50).

RAMONA ORTIGA, EXAMINING ATTORNEY

SN 76-590,055. SHELTON, DAVID, PINSON, AL. FILED 4-30-2004.

Dinner-Dice

THE MARK CONSISTS OF STANDARD CHARACTERS WITHOUT CLAIM TO ANY PARTICULAR FONT, STYLE, SIZE, OR COLOR.

FOR BOARD GAME, NAMELY, A GAME OF CHANCE USING DICE (U.S. CLS. 22, 23, 38 AND 50).

RAMONA ORTIGA, EXAMINING ATTORNEY

SN 76-592,492. GLOBAL SOURCING SOLUTIONS, LLC, REDMOND, WA. FILED 5-17-2004.

WORLD SKI LINES

NO CLAIM IS MADE TO THE EXCLUSIVE RIGHT TO USE "SKI LINES", APART FROM THE MARK AS SHOWN.

FOR WATER SKIS AND WATER SKI ACCESSORIES, NAMELY WATER SKI CARRYING CASES, TOW ROPES, GLOVES, BINDINGS, VESTS, TOW HARNESSSES, SHIN GUARDS, AND RECREATIONAL WATER FLOATS (U.S. CLS. 22, 23, 38 AND 50).

FIRST USE 1-1-1996; IN COMMERCE 1-1-1996.

SUSAN LESLIE DUBOIS, EXAMINING ATTORNEY

CLASS 28—(Continued).

SN 76-592,493. GLOBAL SOURCING SOLUTIONS, LLC, REDMOND, WA. FILED 5-17-2004.

BEACON

FOR SPORTING GOODS, NAMELY, SNOWBOARDS, SNOWBOARD STRAPS AND BINDING, AND SNOWBOARD BAGS (U.S. CLS. 22, 23, 38 AND 50).

FIRST USE 1-20-2004; IN COMMERCE 1-20-2004.

SUSAN LESLIE DUBOIS, EXAMINING ATTORNEY

SN 76-593,859. BRUNSWICK BOWLING & BILLIARDS CORPORATION, LAKE FOREST, IL. FILED 5-25-2004.

BRUNSWICK

OWNER OF U.S. REG. NO. 2,395,558.

FOR BILLIARD EQUIPMENT, NAMELY, BILLIARD TABLES, BALLS, BALL RACKS, CUES, CUE CASES, CUE TIPS, BRIDGES AND CHALK; GAME TABLES FOR USE WITH GLIDING SURFACE PROJECTILES, SURFACE PROJECTILES FOR SAME; AND MANUALLY HELD PROJECTILE STRIKING DISCS (U.S. CLS. 22, 23, 38 AND 50).

FIRST USE 0-0-1960; IN COMMERCE 0-0-1960.

LESLEY LAMOTHE, EXAMINING ATTORNEY

SN 76-595,252. THE PILOT INK CO., LTD., NAGOYA-SHI, AICHI, JAPAN, FILED 6-3-2004.

BATH DOODLE

THE MARK CONSISTS OF STANDARD CHARACTERS WITHOUT CLAIM TO ANY PARTICULAR FONT, STYLE, SIZE, OR COLOR.

PRIORITY CLAIMED UNDER SEC. 44(D) ON JAPAN APPLICATION NO. 2004-000716, FILED 1-7-2004, REG. NO. 4786404, DATED 7-16-2004, EXPIRES 7-16-2014.

NO CLAIM IS MADE TO THE EXCLUSIVE RIGHT TO USE BATH, APART FROM THE MARK AS SHOWN.

FOR DRAWING TOYS (U.S. CLS. 22, 23, 38 AND 50).

STEPHANIE DAVIS, EXAMINING ATTORNEY

CLASS 28—(Continued).

SN 76-595,493. BANANANANA LLC, PLANO, TX. FILED 6-1-2004.

A-DOOR-NIMALS

THE MARK CONSISTS OF STANDARD CHARACTERS WITHOUT CLAIM TO ANY PARTICULAR FONT, STYLE, SIZE, OR COLOR.

FOR STUFFED ANIMALS AND DOLLS HOLDING A HEART MADE OF FELT AND LAMINATE, WHICH CAN BE WRITTEN ON WITH A DRY ERASE MARKER FOR BIRTH ANNOUNCEMENTS, OR ANY MESSAGE; CAN BE DISPLAYED ON A HOSPITAL DOOR, NURSERY, CHILD'S ROOM, NURSING HOME (U.S. CLS. 22, 23, 38 AND 50).

FIRST USE 4-1-2004; IN COMMERCE 4-18-2004.
KARANENDRA S. CHHINA, EXAMINING ATTORNEY

CLASS 28—(Continued).

SN 76-611,314. JACOBS, DEBORAH A., DENVER, CO. FILED 8-4-2004.

SIMPLY SCANDALOUS

THE MARK CONSISTS OF STANDARD CHARACTERS WITHOUT CLAIM TO ANY PARTICULAR FONT, STYLE, SIZE, OR COLOR.

FOR PLAYING CARDS; ROLE PLAYING CARDS IN THE NATURE OF RACIAL, CULTURAL AND DISABLED PREJUDICE, LANGUAGE, MATH, ENGLISH, SPELLING, COMMUNICATION, LISTENING, RELATIONSHIPS AND GENERAL KNOWLEDGE (U.S. CLS. 22, 23, 38 AND 50).

FIRST USE 7-4-1993; IN COMMERCE 7-4-1993.
ANGELA M. MICHELI, EXAMINING ATTORNEY

SN 76-598,056. PENN FISHING TACKLE MANUFACTURING CO., PHILADELPHIA, PA. FILED 6-15-2004.

CAPTIVA

THE MARK CONSISTS OF STANDARD CHARACTERS WITHOUT CLAIM TO ANY PARTICULAR FONT, STYLE, SIZE, OR COLOR.

FOR FISHING TACKLE, NAMELY FISHING RODS AND REELS (U.S. CLS. 22, 23, 38 AND 50).

FIRST USE 2-0-2004; IN COMMERCE 2-0-2004.
CATHERINE FAINT, EXAMINING ATTORNEY

SN 76-613,827. BABY ABUELITA PRODUCTIONS, INC., MIAMI, FL. FILED 9-30-2004.

BABY ABUELITA

THE MARK CONSISTS OF STANDARD CHARACTERS WITHOUT CLAIM TO ANY PARTICULAR FONT, STYLE, SIZE, OR COLOR.

NO CLAIM IS MADE TO THE EXCLUSIVE RIGHT TO USE "BABY", APART FROM THE MARK AS SHOWN.

THE ENGLISH TRANSLATION OF ABUELITA IS LITTLE GRANDMOTHER.

FOR TOY DOLLS CAPABLE OF SINGING ETHNIC LULLABY SONGS IN THEIR ORIGINAL LANGUAGE (U.S. CLS. 22, 23, 38 AND 50).

FIRST USE 5-19-2005; IN COMMERCE 5-19-2005.
KIMBERLY FRYE, EXAMINING ATTORNEY

SN 76-598,761. HALL, RUSTY, DBA NET BURNER ATHLETICS, WINCHESTER, OH. FILED 6-21-2004.

SCORCHER

THE MARK CONSISTS OF STANDARD CHARACTERS WITHOUT CLAIM TO ANY PARTICULAR FONT, STYLE, SIZE, OR COLOR.

FOR BACKBOARDS FOR BASKETBALL; BASKETBALL GOAL SETS; BASKETBALL GOALS; BASKETBALL NETS (U.S. CLS. 22, 23, 38 AND 50).

FIRST USE 9-1-2003; IN COMMERCE 3-15-2004.
PATRICIA EVANKO, EXAMINING ATTORNEY

SN 76-614,632. BOUNDLESS PLAYGROUNDS, INC., BLOOMFIELD, CT. FILED 10-6-2004.

BOUNDLESS

THE MARK CONSISTS OF STANDARD CHARACTERS WITHOUT CLAIM TO ANY PARTICULAR FONT, STYLE, SIZE, OR COLOR.

OWNER OF U.S. REG. NO. 2,616,714.
FOR PLUSH TOYS AND DOLLS (U.S. CLS. 22, 23, 38 AND 50).

SUNG IN, EXAMINING ATTORNEY

CLASS 28—(Continued).

SN 76-615,207. HASBRO, INC., PAWTUCKET, RI. FILED 10-12-2004.

RUSS Q. MI

THE MARK CONSISTS OF STANDARD CHARACTERS WITHOUT CLAIM TO ANY PARTICULAR FONT, STYLE, SIZE, OR COLOR.

FOR TOY VEHICLES AND ACCESSORIES FOR USE THEREWITH (U.S. CLS. 22, 23, 38 AND 50).

BARBARA A. LOUGHRAN, EXAMINING ATTORNEY

SN 76-615,249. HASBRO, INC., PAWTUCKET, RI. FILED 10-12-2004.

REESE Q. COPTER

THE MARK CONSISTS OF STANDARD CHARACTERS WITHOUT CLAIM TO ANY PARTICULAR FONT, STYLE, SIZE, OR COLOR.

FOR TOY VEHICLES AND ACCESSORIES FOR USE THEREWITH (U.S. CLS. 22, 23, 38 AND 50).

BARBARA A. LOUGHRAN, EXAMINING ATTORNEY

SN 76-615,497. THE HARTZ MOUNTAIN CORPORATION, SECAUCUS, NJ. FILED 10-7-2004.

GRUMLERS

FOR PET TOYS (U.S. CLS. 22, 23, 38 AND 50).

HENRY S. ZAK, EXAMINING ATTORNEY

SN 76-615,549. SPIRIT PRODUCTS, LTD., HAVERHILL, MA. FILED 10-4-2004.

CRAZY 'BOUT CRITTERS

THE MARK CONSISTS OF STANDARD CHARACTERS WITHOUT CLAIM TO ANY PARTICULAR FONT, STYLE, SIZE, OR COLOR.

FOR TOYS, NAMELY STUFFED ANIMAL TOYS, AND PLUSH ANIMAL TOYS, WITH COLLEGIATE LOGOS TO BE SOLD EXCLUSIVELY TO CAMPUS BASED RETAILERS (U.S. CLS. 22, 23, 38 AND 50).

FIRST USE 1-10-2005; IN COMMERCE 1-10-2005.

RUDY R. SINGLETON, EXAMINING ATTORNEY

CLASS 28—(Continued).

SN 76-615,573. B&B COMPANY, LOS ANGELES, CA. FILED 10-13-2004.

I SEE DEAD PEOPLE

THE MARK CONSISTS OF STANDARD CHARACTERS WITHOUT CLAIM TO ANY PARTICULAR FONT, STYLE, SIZE, OR COLOR.

FOR TARGET GAMES, BOARD GAMES AND CARD GAMES; KITES; TOY ACTION FIGURES; DISC-TYPE TOSS TOYS; TOY BOWS AND ARROWS; FOOTBALLS AND BASEBALLS; DOLLS, DOLL PLAY SETS, PLUSH TOYS; TOY VEHICLES, TOY CARS, TOY TRUCKS, TOY BUCKET AND SHOVEL SETS, ROLLER SKATES, TOY MODEL HOBBY CRAFT KITS, TOY ROCKETS, TOY GUNS, TOY HOLSTERS, MUSICAL TOYS, JIGSAW PUZZLES, BADMINTON SETS, BUBBLE MAKING WANDS AND SOLUTION SETS, TOY BANKS, PUPPETS, TOY BALLOONS, SKATEBOARDS, TOY SCOOTERS, STAND ALONE VIDEO GAME MACHINES; LCD GAME MACHINES; HAND HELD UNIT FOR PLAYING ELECTRONIC GAMES (U.S. CLS. 22, 23, 38 AND 50).

BARBARA GAYNOR, EXAMINING ATTORNEY

SN 76-615,614. PLAYMATES TOYS INC., COSTA MESA, CA. FILED 10-13-2004.

COLD NOSE KISSES

THE MARK CONSISTS OF STANDARD CHARACTERS WITHOUT CLAIM TO ANY PARTICULAR FONT, STYLE, SIZE, OR COLOR.

FOR PLUSH TOYS AND RELATED PLUSH TOY ACCESSORIES (U.S. CLS. 22, 23, 38 AND 50).

H. M. FISHER, EXAMINING ATTORNEY

SN 76-615,721. WINSLOW, ANDREW R., WESTWOOD, MA. FILED 10-13-2004.

ROUGHNEX

THE MARK CONSISTS OF STANDARD CHARACTERS WITHOUT CLAIM TO ANY PARTICULAR FONT, STYLE, SIZE, OR COLOR.

FOR CHILDREN'S TOYS, NAMELY, TOY ACTION FIGURES (U.S. CLS. 22, 23, 38 AND 50).

PAM WILLIS, EXAMINING ATTORNEY

CLASS 28—(Continued).

SN 76-616,071. HASBRO, INC., PAWTUCKET, RI. FILED 10-14-2004.

E. M. TEE

THE MARK CONSISTS OF STANDARD CHARACTERS WITHOUT CLAIM TO ANY PARTICULAR FONT, STYLE, SIZE, OR COLOR.
FOR TOY VEHICLES AND ACCESSORIES FOR USE THEREWITH (U.S. CLS. 22, 23, 38 AND 50).
RICHARD WHITE, EXAMINING ATTORNEY

SN 76-616,353. DAIWA SEIKO, INC., TOKYO, JAPAN, FILED 10-18-2004.

TEAM DAIWA ADVANTAGE

THE MARK CONSISTS OF STANDARD CHARACTERS WITHOUT CLAIM TO ANY PARTICULAR FONT, STYLE, SIZE, OR COLOR.
OWNER OF U.S. REG. NOS. 808,820, 2,292,682 AND OTHERS.
THE ENGLISH TRANSLATION OF THE WORD DAIWA IN THE MARK IS GREAT PEACE.
FOR FISHING REELS, FISHING RODS, FISHING LURES, FISHING SINKERS, FISHING FLOATS, FISHING TACKLE BOXES AND FISHING LINES (U.S. CLS. 22, 23, 38 AND 50).
FIRST USE 4-0-2003; IN COMMERCE 4-0-2003.
KELLEY WELLS, EXAMINING ATTORNEY

SN 76-617,657. GRAPHITE DESIGN INTERNATIONAL, INC., SAN DIEGO, CA. FILED 10-25-2004.

YS - 5

THE MARK CONSISTS OF STANDARD CHARACTERS WITHOUT CLAIM TO ANY PARTICULAR FONT, STYLE, SIZE, OR COLOR.
FOR GOLF CLUB SHAFTS (U.S. CLS. 22, 23, 38 AND 50).
FIRST USE 1-17-2003; IN COMMERCE 2-13-2003.
MATTHEW KLINE, EXAMINING ATTORNEY

CLASS 28—(Continued).

SN 76-622,426. INSIGHT FOR LIVING, PLANO, TX. FILED 11-26-2004.

PAWS & TALES

THE MARK CONSISTS OF STANDARD CHARACTERS WITHOUT CLAIM TO ANY PARTICULAR FONT, STYLE, SIZE, OR COLOR.
FOR TOYS, NAMELY, PLUSH TOYS (U.S. CLS. 22, 23, 38 AND 50).
GLENN CLARK, EXAMINING ATTORNEY

SN 76-623,095. RICKO INTERNATIONAL LIMITED, KWUN TONG, KOWLOON, HONG KONG, FILED 12-3-2004.

RICKO LIMITED

THE MARK CONSISTS OF STANDARD CHARACTERS WITHOUT CLAIM TO ANY PARTICULAR FONT, STYLE, SIZE, OR COLOR.
NO CLAIM IS MADE TO THE EXCLUSIVE RIGHT TO USE "LIMITED", APART FROM THE MARK AS SHOWN.
FOR SCALE MODEL REPLICAS OF VEHICLES (U.S. CLS. 22, 23, 38 AND 50).
FIRST USE 12-0-2002; IN COMMERCE 12-0-2002.
SCOTT OSLICK, EXAMINING ATTORNEY

SN 76-624,382. HASBRO, INC., PAWTUCKET, RI. FILED 12-13-2004.

CHUTES AND LADDERS

THE MARK CONSISTS OF STANDARD CHARACTERS WITHOUT CLAIM TO ANY PARTICULAR FONT, STYLE, SIZE, OR COLOR.
OWNER OF U.S. REG. NOS. 601,835, 2,580,171 AND 2,692,687.
FOR BOARD GAMES (U.S. CLS. 22, 23, 38 AND 50).
FIRST USE 12-31-1943; IN COMMERCE 12-31-1943.
ELISSA GARBER KON, EXAMINING ATTORNEY

CLASS 28—(Continued).

SN 76-625,732. REVELL-MONOGRAM, LLC, NORTH-BROOK, IL. FILED 12-21-2004.



NO CLAIM IS MADE TO THE EXCLUSIVE RIGHT TO USE "CUSTOM", APART FROM THE MARK AS SHOWN. FOR PLASTIC TOY MODEL HOBBYCRAFT KITS; PLASTIC TOY MODEL KIT CARS; AND DIE CAST TOYS, NAMELY, TOY VEHICLES (U.S. CLS. 22, 23, 38 AND 50).

MICHELLE S. WISEMAN, EXAMINING ATTORNEY

SN 76-625,736. REVELL-MONOGRAM, LLC, NORTH-BROOK, IL. FILED 12-21-2004.



NO CLAIM IS MADE TO THE EXCLUSIVE RIGHT TO USE "SLOT CAR RACING", APART FROM THE MARK AS SHOWN.

FOR TOY MODEL SLOT CARS (U.S. CLS. 22, 23, 38 AND 50).

MICHELLE S. WISEMAN, EXAMINING ATTORNEY

SN 76-626,002. PRIMOS, INC., FLORA, MS. FILED 12-27-2004.

BOOM BOX

THE MARK CONSISTS OF STANDARD CHARACTERS WITHOUT CLAIM TO ANY PARTICULAR FONT, STYLE, SIZE, OR COLOR.

FOR GAME CALLS (U.S. CLS. 22, 23, 38 AND 50).

IRENE D. WILLIAMS, EXAMINING ATTORNEY

CLASS 28—(Continued).

SN 76-626,419. JA FITNESS INCORPORATED, MARINA DEL REY, CA. FILED 12-28-2004.

BUN & THIGH DOER

THE MARK CONSISTS OF STANDARD CHARACTERS WITHOUT CLAIM TO ANY PARTICULAR FONT, STYLE, SIZE, OR COLOR.

OWNER OF U.S. REG. NO. 2,654,616.

NO CLAIM IS MADE TO THE EXCLUSIVE RIGHT TO USE BUN & THIGH, APART FROM THE MARK AS SHOWN.

FOR MANUALLY OPERATED EXERCISE EQUIPMENT; EXERCISE MACHINES (U.S. CLS. 22, 23, 38 AND 50).

MELVIN AXILBUND, EXAMINING ATTORNEY

SN 78-144,297. DOGTOYS.COM, INC., WEST CHESTER, PA. FILED 7-16-2002.

BECAUSE EVERY DOG NEEDS DOG TOYS

FOR DOG TOYS (U.S. CLS. 22, 23, 38 AND 50).

FIRST USE 11-17-1997; IN COMMERCE 11-17-1997.

MICHELE SWAIN, EXAMINING ATTORNEY

SN 78-282,270. MICROSOFT CORPORATION, REDMOND, WA. FILED 8-1-2003.

IDENTITY ZERO

FOR TOYS AND GAMES, NAMELY, ACTION FIGURES AND ACCESSORIES THEREFOR; BALLOONS; BATHTUB TOYS; TOY BUILDING BLOCKS; DOLLS AND ACCESSORIES THEREFOR; DOLL CLOTHING; BOARD GAMES; CARD GAMES; PLAY COSMETICS FOR CHILDREN; COSTUME MASKS; MINIATURE DIE CAST VEHICLES; TOY AIRPLANES AND HELICOPTERS; BATTERY OPERATED REMOTE CONTROLLED TOY VEHICLES; FLYING DISCS; INFLATABLE VINYL FIGURES; JIGSAW PUZZLES; KITES; MARBLES; INDOOR SLUMBER AND PLAY TENTS; PLUSH TOYS; HAND-HELD PUPPETS; SIT-IN AND RIDE-ON TOY VEHICLES; TRAIN SETS; PLAY SHAVING KITS; SKATEBOARDS; ROLLER SKATES; TOY BANKS; WATER SQUIRTING TOYS; TOY PISTOLS; CHRISTMAS TREE ORNAMENTS; PINBALL AND ARCADE GAME MACHINES; HAND-HELD UNITS FOR PLAYING ELECTRONIC GAMES; MODEL CRAFT KITS OF TOY FIGURES; PLAYGROUND BALLS; SPORT BALLS; BASKETBALLS; GOLF BALLS; GOLF BALL MARKERS; TENNIS BALLS; BASEBALLS; RUBBER ACTION BALLS; RUBBER SPORTS BALLS; RUBBER PLAYING BALLS; SQUEEZABLE BALLS USED TO RELIEVE STRESS; BAGS FOR CARRYING GOLF EQUIPMENT; BAGS FOR CARRYING BASKETBALL EQUIPMENT; BAGS FOR CARRYING BASEBALL EQUIPMENT; BAGS FOR CARRYING TENNIS EQUIPMENT; MANIPULATIVE PUZZLES AND CONSTRUCTION TOYS; CRIB MOBILES; MOBILES FOR CHILDREN; TARGET SETS CONSISTING OF A TARGET, RUBBER SUCTION DARTS AND TOY DART GUN; PLAYING CARDS (U.S. CLS. 22, 23, 38 AND 50).

JENNIFER KRISP, EXAMINING ATTORNEY

CLASS 28—(Continued).

SN 78-322,074. ROCO MODELLSPIELWAREN GESELLSCHAFT MIT BESCHRANKTER HAFTUNG, SALZBURG, AUSTRIA, FILED 11-3-2003.

CLASS 28—(Continued).

SN 78-368,633. TIMELINE SKATEBOARDS CO., COCOA BEACH, FL. FILED 2-16-2004.

PLATIN

**TIMELINE
SKATEBOARDS**

THE MARK CONSISTS OF STANDARD CHARACTERS WITHOUT CLAIM TO ANY PARTICULAR FONT, STYLE, SIZE, OR COLOR.

PRIORITY CLAIMED UNDER SEC. 44(D) ON AUSTRIA APPLICATION NO. AM3050/2003, FILED 5-6-2003, REG. NO. 211783, DATED 8-26-2003, EXPIRES 8-31-2013.

FOR MODEL TRAINS, PARTICULARLY, ENGINES, RAILWAY CARRIAGES, TRAMS; RAIL MATERIALS FOR MODEL VEHICLES, PARTICULARLY, MODEL TRAINS AND MODEL CARS; MODEL OF ARMY VEHICLES, PARTICULARLY, TANKS, HEAVY GOODS VEHICLES, SHIPS, AIRCRAFTS; TOY RAILWAYS; RAIL SYSTEMS FOR ECLECTICALLY DRIVEN MODEL VEHICLES, PARTICULARLY, MOTOR VEHICLES; STEAM GENERATORS FOR MODEL VEHICLES, WITH STEAM-DRIVEN MODELS OF RAIL AND ROAD VEHICLES; MODEL BUILDINGS; MODELS OF LIGHTING AND SIGNALING EQUIPMENT (U.S. CLS. 22, 23, 38 AND 50).
KATHERINE STOIDES, EXAMINING ATTORNEY

THE MARK CONSISTS OF STANDARD CHARACTERS WITHOUT CLAIM TO ANY PARTICULAR FONT, STYLE, SIZE, OR COLOR.

NO CLAIM IS MADE TO THE EXCLUSIVE RIGHT TO USE "SKATEBOARDS", APART FROM THE MARK AS SHOWN.

FOR SKATEBOARDS AND WHEELS FOR SKATEBOARDS (U.S. CLS. 22, 23, 38 AND 50).
FIRST USE 2-13-2004; IN COMMERCE 2-13-2004.
MARIA-VICTORIA SUAREZ, EXAMINING ATTORNEY

SN 78-340,033. GFM PRODUCTIONS, LLC., CHICAGO, IL. FILED 12-12-2003.

SN 78-369,469. MATTEL, INC., EL SEGUNDO, CA. FILED 2-17-2004.

TURF

CYBER RACER

THE MARK CONSISTS OF STANDARD CHARACTERS WITHOUT CLAIM TO ANY PARTICULAR FONT, STYLE, SIZE, OR COLOR.

FOR TOYS, NAMELY, TOY VEHICLES (U.S. CLS. 22, 23, 38 AND 50).
NICHOLAS ALTREE, EXAMINING ATTORNEY

THE MARK CONSISTS OF STANDARD CHARACTERS WITHOUT CLAIM TO ANY PARTICULAR FONT, STYLE, SIZE, OR COLOR.

FOR TOYS, GAMES AND PLAYTHINGS, NAMELY, TOY ACTION FIGURES AND ACCESSORIES THEREFOR (U.S. CLS. 22, 23, 38 AND 50).
HENRY S. ZAK, EXAMINING ATTORNEY

CLASS 28—(Continued).

SN 78-372,665. JABLONSKI, XAVIER ANDREW, NEWPORT, VICTORIA 3015, AUSTRALIA, FILED 2-23-2004.

FliWire

THE MARK CONSISTS OF STANDARD CHARACTERS WITHOUT CLAIM TO ANY PARTICULAR FONT, STYLE, SIZE, OR COLOR.

PRIORITY CLAIMED UNDER SEC. 44(D) ON AUSTRALIA APPLICATION NO. 969323, FILED 9-8-2003, REG. NO. 969323, DATED 9-8-2003, EXPIRES 9-8-2013.

FOR TOY NOVELTY JEWELRY, NAMELY, LIGHT ILLUMINATED AND SOUND SENSITIVE BRACELETS, NECKLACES, BANDS AND WRISTBANDS (U.S. CLS. 22, 23, 38 AND 50).

ROBERT C. CLARK JR., EXAMINING ATTORNEY

SN 78-381,582. HARRAH'S OPERATING COMPANY, INC., LAS VEGAS, NV. FILED 3-10-2004.

GIGI PARIS

THE MARK CONSISTS OF STANDARD CHARACTERS WITHOUT CLAIM TO ANY PARTICULAR FONT, STYLE, SIZE, OR COLOR.

FOR PLUSH TOYS, STUFFED ANIMALS, STUFFED TOYS (U.S. CLS. 22, 23, 38 AND 50).

FIRST USE 5-31-2000; IN COMMERCE 5-31-2000.

DAVID ELTON, EXAMINING ATTORNEY

CLASS 28—(Continued).

SN 78-382,989. THE LEATHER FACTORY, INC., FORT WORTH, TX. FILED 3-12-2004.

Adventure Crafts

THE MARK CONSISTS OF STANDARD CHARACTERS WITHOUT CLAIM TO ANY PARTICULAR FONT, STYLE, SIZE, OR COLOR.

NO CLAIM IS MADE TO THE EXCLUSIVE RIGHT TO USE "CRAFTS", APART FROM THE MARK AS SHOWN.

FOR LEATHER CRAFT KITS COMPRISING PIECES OF LEATHER, THREAD, AND NEEDLE (U.S. CLS. 22, 23, 38 AND 50).

FIRST USE 2-4-2004; IN COMMERCE 2-4-2004.

JILL C. ALT, EXAMINING ATTORNEY

SN 78-383,234. MATTEL, INC., EL SEGUNDO, CA. FILED 3-12-2004.

HOLIDAY

THE MARK CONSISTS OF STANDARD CHARACTERS WITHOUT CLAIM TO ANY PARTICULAR FONT, STYLE, SIZE, OR COLOR.

OWNER OF U.S. REG. NOS. 2,131,239 AND 2,350,795. FOR TOYS, GAMES AND PLAYTHINGS, NAMELY, DOLLS, DOLL CLOTHING AND DOLL ACCESSORIES (U.S. CLS. 22, 23, 38 AND 50).

DAVID ELTON, EXAMINING ATTORNEY

CLASS 28—(Continued).

SN 78-383,276. MATTEL, INC., EL SEGUNDO, CA. FILED 3-12-2004.

CLASS 28—(Continued).

SN 78-385,106. LASH'S LESSONS, LLC, SCIENCE HILL, KY. FILED 3-16-2004.

MILK MOO-VER

THE MARK CONSISTS OF STANDARD CHARACTERS WITHOUT CLAIM TO ANY PARTICULAR FONT, STYLE, SIZE, OR COLOR.

FOR TOYS, GAMES AND PLAYTHINGS, NAMELY, TOY VEHICLES AND ACCESSORIES THEREFOR (U.S. CLS. 22, 23, 38 AND 50).

KENNETH D. BATTLE, EXAMINING ATTORNEY



SN 78-383,281. MATTEL, INC., EL SEGUNDO, CA. FILED 3-12-2004.

STARTER SET

CALYPSO

THE MARK CONSISTS OF STANDARD CHARACTERS WITHOUT CLAIM TO ANY PARTICULAR FONT, STYLE, SIZE, OR COLOR.

FOR TOYS, GAMES AND PLAYTHINGS, NAMELY, TOY VEHICLE TRACK SETS AND ACCESSORIES, TOY VEHICLES AND ACCESSORIES THEREFOR (U.S. CLS. 22, 23, 38 AND 50).

KENNETH D. BATTLE, EXAMINING ATTORNEY



SN 78-385,100. LASH'S LESSONS, LLC, SCIENCE HILL, KY. FILED 3-16-2004.

KIRKWOOD MACMOOWAN

THE MARK CONSISTS OF STANDARD CHARACTERS WITHOUT CLAIM TO ANY PARTICULAR FONT, STYLE, SIZE, OR COLOR.

KIRKWOOD MACMOOWAN DOES NOT IDENTIFY A PARTICULAR LIVING INDIVIDUAL.

FOR TOYS, GAMES, AND PLAYTHINGS, NAMELY, TOY ACTION FIGURES AND ACCESSORIES THEREFOR, STUFFED AND PLUSH TOY ANIMALS, INCLUDING WITH SOUND EFFECTS (U.S. CLS. 22, 23, 38 AND 50).

DAWN HAN, EXAMINING ATTORNEY

THE MARK CONSISTS OF STANDARD CHARACTERS WITHOUT CLAIM TO ANY PARTICULAR FONT, STYLE, SIZE, OR COLOR.

FOR TOYS, GAMES, AND PLAYTHINGS RELATING TO HORSES NAMELY, TOY ACTION FIGURES IN THE FORM OF HORSES AND ACCESSORIES THEREFOR, STUFFED AND PLUSH TOY ANIMALS, NAMELY HORSES; STUFFED AND PLUSH TOY ANIMALS WITH SOUND EFFECTS (U.S. CLS. 22, 23, 38 AND 50).

GIANCARLO CASTRO, EXAMINING ATTORNEY

CLASS 28—(Continued).

SN 78-385,997. WORLD WRESTLING ENTERTAINMENT, INC., STAMFORD, CT. FILED 3-17-2004.

CHRIS BENOIT

THE MARK CONSISTS OF STANDARD CHARACTERS WITHOUT CLAIM TO ANY PARTICULAR FONT, STYLE, SIZE, OR COLOR.

THE NAME(S), PORTRAIT(S), AND/OR SIGNATURE(S) SHOWN IN THE MARK IDENTIFIES CHRIS BENOIT, WHOSE CONSENT(S) TO REGISTER IS SUBMITTED.

FOR TOY ACTION FIGURES AND ACCESSORIES THEREFOR; CASES FOR ACTION FIGURES; TOY VEHICLES; BOARD GAMES; PLAYING CARDS; TOY SPINNING TOPS; STAND ALONE VIDEO OUTPUT GAME MACHINES FEATURING WRESTLING; ARCADE GAMES RELATED TO WRESTLING; PINBALL GAMES RELATED TO WRESTLING; HAND-HELD UNITS FOR PLAYING ELECTRONIC GAME; TABLETOP ACTION SKILL GAMES RELATED TO WRESTLING; JIGSAW PUZZLES; KITES; TOY WRESTLING RINGS; DOLLS; PUPPETS; STUFFED TOY ANIMALS; CARD GAMES; TOY GUITARS; WATER GUNS; VINYL POOL PRODUCTS FOR PLAYING, NAMELY—PILLOW BACK LOUNGE CHAIR; ONE AND TWO-MAN INFLATABLE BOATS; RAFTS; INNER TUBES; AND FOOT PUMPS; CHRISTMAS TREE DECORATIONS; COSTUME MASKS; TOY BELTS, DOLL FURNITURE; PARTY FAVORS IN THE NATURE OF CRACKERS AND NOISE-MAKERS; SKATEBOARDS; BOWLING BALLS AND ACCESSORIES, NAMELY, BOWLING GLOVES, WRIST SUPPORTS, BOWLING BALL BAGS; WINDUP TOYS; TOY SCOOTERS; BOWLING PINS; KNEE AND ELBOW PADS FOR ATHLETIC USE; YO-YO'S; PLASTIC MODEL KITS FOR MAKING TOY VEHICLES; POOL CUES; NOVELTY TOYS, NAMELY, TOY BANKS MADE OF TIN; TOY GUM MACHINES; TOY CANDY BOWL MECHANICAL DISPENSERS; TOY STICK GUM DISPENSERS; TOY GUM FIGURE MAKERS; CONFETTI (U.S. CLS. 22, 23, 38 AND 50).

CURTIS FRENCH, EXAMINING ATTORNEY

SN 78-386,626. MATTEL, INC., EL SEGUNDO, CA. FILED 3-18-2004.

STREET STYLE

THE MARK CONSISTS OF STANDARD CHARACTERS WITHOUT CLAIM TO ANY PARTICULAR FONT, STYLE, SIZE, OR COLOR.

FOR TOYS, GAMES AND PLAYTHINGS, NAMELY, DOLLS, DOLL CLOTHING AND DOLL ACCESSORIES (U.S. CLS. 22, 23, 38 AND 50).

JASON TURNER, EXAMINING ATTORNEY

CLASS 28—(Continued).

SN 78-387,039. MATTEL, INC., EL SEGUNDO, CA. FILED 3-18-2004.

SUPERFAST

THE MARK CONSISTS OF STANDARD CHARACTERS WITHOUT CLAIM TO ANY PARTICULAR FONT, STYLE, SIZE, OR COLOR.

FOR TOYS, GAMES AND PLAYTHINGS, NAMELY TOY VEHICLES AND ACCESSORIES THEREFOR (U.S. CLS. 22, 23, 38 AND 50).

DAWN HAN, EXAMINING ATTORNEY

SN 78-387,040. MATTEL, INC., EL SEGUNDO, CA. FILED 3-18-2004.

2 SHOP STOP

THE MARK CONSISTS OF STANDARD CHARACTERS WITHOUT CLAIM TO ANY PARTICULAR FONT, STYLE, SIZE, OR COLOR.

FOR TOYS, GAMES AND PLAYTHINGS, NAMELY, DOLLS, DOLL CLOTHING AND DOLL ACCESSORIES (U.S. CLS. 22, 23, 38 AND 50).

DAWN HAN, EXAMINING ATTORNEY

SN 78-387,050. MATTEL, INC., EL SEGUNDO, CA. FILED 3-18-2004.

GLAMOUR LOUNGE

THE MARK CONSISTS OF STANDARD CHARACTERS WITHOUT CLAIM TO ANY PARTICULAR FONT, STYLE, SIZE, OR COLOR.

FOR TOYS, GAMES AND PLAYTHINGS, NAMELY, DOLLS, DOLL CLOTHING AND DOLL ACCESSORIES, DOLL PLAYSETS AND ACCESSORIES (U.S. CLS. 22, 23, 38 AND 50).

DAVID ELTON, EXAMINING ATTORNEY

CLASS 28—(Continued).

SN 78-389,143. KIRKBI AG, CH-6340 BAAR, SWITZERLAND, FILED 3-23-2004.



OWNER OF U.S. REG. NO. 2,572,021.
NO CLAIM IS MADE TO THE EXCLUSIVE RIGHT TO USE "BABY", APART FROM THE MARK AS SHOWN.
THE COLOR(S) YELLOW, BROWN, GREEN, BLUE AND RED IS/ARE CLAIMED AS A FEATURE OF THE MARK.
THE MARK CONSISTS OF THE WORD "BABY" IN YELLOW AND THE DESIGN OF A BEAR CUB IN LIGHT BROWN. THE CIRCLE INSIDE THE FIRST "B" IS GREEN. THE CIRCLE INSIDE THE "A" IS BLUE. THE CIRCLE INSIDE THE SECOND "B" IS RED.
FOR STACKING TOYS; TOY BUILDING BLOCKS; BATH TOYS; BABY MULTIPLE ACTIVITY TOYS; PULL TOYS; CRIB TOYS; INFANT TOYS; CONSTRUCTION TOYS; TOY BUILDING BLOCKS CAPABLE OF INTER-CONNECTION; TOY CONSTRUCTION SETS; TOY BUILDINGS; TOY FIGURES; TOY VEHICLES, PLANES, TRAINS AND BOATS; RATTLES; AND BABY RATTLES INCORPORATING TEETHING RINGS (U.S. CLS. 22, 23, 38 AND 50).
FIRST USE 6-0-2004; IN COMMERCE 6-0-2004.
KELLY CHOE, EXAMINING ATTORNEY

SN 78-390,735. MATTEL, INC., EL SEGUNDO, CA. FILED 3-25-2004.

COREY

THE MARK CONSISTS OF STANDARD CHARACTERS WITHOUT CLAIM TO ANY PARTICULAR FONT, STYLE, SIZE, OR COLOR.
FOR TOYS, GAMES AND PLAYTHINGS, NAMELY, TOY ACTION FIGURES AND ACCESSORIES THEREFOR (U.S. CLS. 22, 23, 38 AND 50).
DAVID ELTON, EXAMINING ATTORNEY

CLASS 28—(Continued).

SN 78-393,268. CHAPEL GOLF, INC., NORTH PALM BEACH, FL. FILED 3-30-2004.

**SEAMLESS FEEL
TRANSFER**

THE MARK CONSISTS OF STANDARD CHARACTERS WITHOUT CLAIM TO ANY PARTICULAR FONT, STYLE, SIZE, OR COLOR.
NO CLAIM IS MADE TO THE EXCLUSIVE RIGHT TO USE "SEAMLESS", APART FROM THE MARK AS SHOWN.
FOR GOLF CLUBS (U.S. CLS. 22, 23, 38 AND 50).
ARETHA SOMERVILLE, EXAMINING ATTORNEY

SN 78-395,144. PLACE, THOMAS E., RIVER FALLS, WI. FILED 4-1-2004.



NO CLAIM IS MADE TO THE EXCLUSIVE RIGHT TO USE "HORN HOLSTER", APART FROM THE MARK AS SHOWN.
THE MARK CONSISTS OF UPSIDE DOWN ANTLERS CONNECTED BY A BELT AT THE BASE.
FOR HUNTING UTILITY BELT USED FOR CARRYING GAME HORNS AND GAME CALLS (U.S. CLS. 22, 23, 38 AND 50).
MELISSA SHELLA, EXAMINING ATTORNEY

CLASS 28—(Continued).

SN 78-395,735. HUGHES, JOHN H., CARLSBAD, CA. FILED 4-2-2004.

WHAT

THE MARK CONSISTS OF STANDARD CHARACTERS WITHOUT CLAIM TO ANY PARTICULAR FONT, STYLE, SIZE, OR COLOR.

FOR SKATEBOARDS AND PARTS THEREOF (U.S. CLS. 22, 23, 38 AND 50).

FIRST USE 3-9-2004; IN COMMERCE 3-9-2004.
MARLENE BELL, EXAMINING ATTORNEY

CLASS 28—(Continued).

SN 78-397,665. PINNACLE SPORTS EQUIPMENT, INC., STATEN ISLAND, NY. FILED 4-7-2004.

**QUADCORE
TECHNOLOGY**

THE MARK CONSISTS OF STANDARD CHARACTERS WITHOUT CLAIM TO ANY PARTICULAR FONT, STYLE, SIZE, OR COLOR.

NO CLAIM IS MADE TO THE EXCLUSIVE RIGHT TO USE TECHNOLOGY, APART FROM THE MARK AS SHOWN.

FOR BASEBALL BATS (U.S. CLS. 22, 23, 38 AND 50).
FIRST USE 6-0-2002; IN COMMERCE 6-0-2002.
ERNEST SHOSHO, EXAMINING ATTORNEY

SN 78-398,827. SPIRITS & SPICE CIGARS, LLC, BOWLING GREEN, KY. FILED 4-8-2004.

BITCH WHIFFS

THE MARK CONSISTS OF STANDARD CHARACTERS WITHOUT CLAIM TO ANY PARTICULAR FONT, STYLE, SIZE, OR COLOR.

FOR GOLF ACCESSORIES, NAMELY, GOLF CLUB COVERS, GOLF BALLS, GOLF TEES AND GOLF BALL MARK REPAIR TOOLS (U.S. CLS. 22, 23, 38 AND 50).

LA TONIA FISHER, EXAMINING ATTORNEY

SN 78-397,525. SHUGART, ROBERT E, DELANCO, NJ. FILED 4-7-2004.



THE COLOR(S) RED, BLUE, ORANGE, YELLOW, BLACK IS/ARE CLAIMED AS A FEATURE OF THE MARK.

THE MARK CONSISTS OF ALL STYIZED MARKS ARE OUTLINED IN BLACK, THE LETTERS CAT ARE RED, THE CAT IN THE LETTER C IS YELLOW, THE NAP IS BLUE, AND THE LETTER P HAS A YELLOW CATS HEAD IN IT'S CENTER. THE T, I, N, S ARE IN ORANGE, WITH A YELLOW CAT LAYING ON THE LETTER T. THE O IS TWO GEARS IN BLUE.

FOR CAT TOYS (U.S. CLS. 22, 23, 38 AND 50).
FIRST USE 11-1-2003; IN COMMERCE 11-1-2003.
DOMINIC J. FERRAIUOLO, EXAMINING ATTORNEY

SN 78-398,831. SPIRITS & SPICE CIGARS, LLC, BOWLING GREEN, KY. FILED 4-8-2004.

**MYRTLE BEACH CIGAR
FACTORY**

THE MARK CONSISTS OF STANDARD CHARACTERS WITHOUT CLAIM TO ANY PARTICULAR FONT, STYLE, SIZE, OR COLOR.

NO CLAIM IS MADE TO THE EXCLUSIVE RIGHT TO USE "MYRTLE BEACH", APART FROM THE MARK AS SHOWN.

FOR GOLF ACCESSORIES, NAMELY, GOLF CLUB COVERS, GOLF BALLS, GOLF TEES AND GOLF BALL MARK REPAIR TOOLS (U.S. CLS. 22, 23, 38 AND 50).

LA TONIA FISHER, EXAMINING ATTORNEY

CLASS 28—(Continued).

SN 78-399,383. ARMON LIMITED, GENEVA 3, SWITZERLAND, FILED 4-9-2004.



OWNER OF U.S. REG. NOS. 1,285,960 AND 2,386,070.
THE MARK CONSISTS OF THE WORD MACLAREN INSIDE A LARGE SQUARE ON THE LEFT HALF OF THE DESIGN. ON THE RIGHT HALF OF THE DESIGN ARE TWO SMALLER SQUARES AND TWO CIRCLES.
FOR TOY PUSHCHAIRS FOR DOLLS; TOY PERAMBULATORS FOR DOLLS; TOY FURNITURE (U.S. CLS. 22, 23, 38 AND 50).
MAUREEN DALL, EXAMINING ATTORNEY

SN 78-403,203. RAGTYME DOLLS, LLC, SAVANNAH, TN. FILED 4-16-2004.



NO CLAIM IS MADE TO THE EXCLUSIVE RIGHT TO USE "DOLLS", APART FROM THE MARK AS SHOWN.
FOR RAG DOLLS (U.S. CLS. 22, 23, 38 AND 50).
FIRST USE 10-29-2003; IN COMMERCE 10-29-2003.
KARLA PERKINS, EXAMINING ATTORNEY

CLASS 28—(Continued).

SN 78-404,627. CALLAWAY GOLF COMPANY, CARLSBAD, CA. FILED 4-20-2004.

SLICKOTE

THE MARK CONSISTS OF STANDARD CHARACTERS WITHOUT CLAIM TO ANY PARTICULAR FONT, STYLE, SIZE, OR COLOR.
FOR ANTI-HOOK AND ANTI-SLICE GOLF BALL COVER COMPOSITION, SOLD AS A COMPONENT FEATURE OF GOLF BALLS (U.S. CLS. 22, 23, 38 AND 50).
FIRST USE 1-1-2004; IN COMMERCE 1-1-2004.
JOHN SCHUYLER YARD, EXAMINING ATTORNEY

SN 78-405,416. MATTEL, INC., EL SEGUNDO, CA. FILED 4-21-2004.

FIRST CRUSH

THE MARK CONSISTS OF STANDARD CHARACTERS WITHOUT CLAIM TO ANY PARTICULAR FONT, STYLE, SIZE, OR COLOR.
FOR TOYS, GAMES AND PLAYTHINGS, NAMELY, DOLLS, DOLL CLOTHING AND DOLL ACCESSORIES (U.S. CLS. 22, 23, 38 AND 50).
DAVID ELTON, EXAMINING ATTORNEY

CLASS 28—(Continued).

SN 78-405,590. NORTHLAND FISHING TACKLE, INC.,
BEMIDJI, MN. FILED 4-21-2004.

CLASS 28—(Continued).

SN 78-408,155. MINDFIELD ENTERTAINMENT LLC, PA-
TERSON, NJ. FILED 4-26-2004.

INNER TUBE

THE MARK CONSISTS OF STANDARD CHARACTERS
WITHOUT CLAIM TO ANY PARTICULAR FONT, STYLE,
SIZE, OR COLOR.

FOR FISHING TACKLE (U.S. CLS. 22, 23, 38 AND 50).
FIRST USE 7-1-2003; IN COMMERCE 7-1-2003.
ELLEN B. AWRICH, EXAMINING ATTORNEY

BBORGZ

THE MARK CONSISTS OF STANDARD CHARACTERS
WITHOUT CLAIM TO ANY PARTICULAR FONT, STYLE,
SIZE, OR COLOR.

FOR ACTION FIGURES, STUFFED TOYS (U.S. CLS.
22, 23, 38 AND 50).
AMOS T. MATTHEWS, JR., EXAMINING ATTORNEY

SN 78-405,738. WORLD WRESTLING ENTERTAINMENT,
INC., STAMFORD, CT. FILED 4-21-2004.

BUBBA RAY DUDLEY

THE MARK CONSISTS OF STANDARD CHARACTERS
WITHOUT CLAIM TO ANY PARTICULAR FONT, STYLE,
SIZE, OR COLOR.

THE NAME(S), PORTRAIT(S), AND/OR SIGNATURE(S)
SHOWN IN THE MARK DOES NOT IDENTIFY A PARTI-
CULAR LIVING INDIVIDUAL.

FOR TOY ACTION FIGURES AND ACCESSORIES
THEREFOR; CASES FOR ACTION FIGURES; TOY
VEHICLES; BOARD GAMES; PLAYING CARDS; TOY
SPINNING TOPS; STAND ALONE VIDEO OUTPUT
GAME MACHINES FEATURING WRESTLING; AR-
CADE GAMES RELATED TO WRESTLING; PINBALL
GAMES RELATED TO WRESTLING; HAND-HELD
UNITS FOR PLAYING ELECTRONIC GAME; TABLE-
TOP ACTION SKILL GAMES RELATED TO WRES-
TLING; JIGSAW PUZZLES; KITES; TOY WRESTLING
RINGS; DOLLS; PUPPETS; STUFFED TOY ANIMALS;
CARD GAMES; TOY GUITARS; WATER GUNS;
CHRISTMAS TREE DECORATIONS; COSTUME MASKS;
TOY BELTS, DOLL FURNITURE; PARTY FAVORS IN
THE NATURE OF CRACKERS AND NOISEMAKERS;
SKATEBOARDS; BOWLING BALLS AND ACCESSORIES,
NAMELY, BOWLING GLOVES, WRIST SUPPORTS,
BOWLING BALL BAGS; WINDUP TOYS; TOY SCOO-
TERS; BOWLING PINS; KNEE AND ELBOW PADS FOR
ATHLETIC USE; YO-YO'S; PLASTIC MODEL KITS FOR
MAKING TOY VEHICLES; POOL CUES; NOVELTY
TOYS, NAMELY, TOY BANKS MADE OF TIN; TOY
GUM MACHINES; TOY CANDY BOWL MECHANICAL
DISPENSERS; TOY STICK GUM DISPENSERS; TOY
GUM FIGURE MAKERS; CONFETTI (U.S. CLS. 22, 23,
38 AND 50).
ZACHARY BELLO, EXAMINING ATTORNEY

SN 78-408,852. CHRISTMAS BY KREBS CORP., ROSWELL,
NM. FILED 4-27-2004.

CHRISTMAS BY KREBS

THE MARK CONSISTS OF STANDARD CHARACTERS
WITHOUT CLAIM TO ANY PARTICULAR FONT, STYLE,
SIZE, OR COLOR.

NO CLAIM IS MADE TO THE EXCLUSIVE RIGHT TO
USE "CHRISTMAS", APART FROM THE MARK AS
SHOWN.

FOR CHRISTMAS TREE ORNAMENTS MADE OF
GLASS (U.S. CLS. 22, 23, 38 AND 50).
FIRST USE 1-2-1978; IN COMMERCE 1-2-1978.
KATHY DE JONGE, EXAMINING ATTORNEY

CLASS 28—(Continued).

SN 78-409,679. D'ANTONIO, DENNIS P., ROYAL OAK, MI. FILED 4-28-2004.

COLOREOLE

THE MARK CONSISTS OF STANDARD CHARACTERS WITHOUT CLAIM TO ANY PARTICULAR FONT, STYLE, SIZE, OR COLOR.

FOR BOARD GAMES, SPINNERS FOR GAMES, CARDS FOR GAMES, GAME PIECES FOR GAMES, INSTRUCTIONS FOR GAMES SOLD WITH THE RELEVANT GAMES (U.S. CLS. 22, 23, 38 AND 50).
MICHELE SWAIN, EXAMINING ATTORNEY

CLASS 28—(Continued).

SN 78-413,583. STRETCH N' CRUNCH, INC., LIVONIA, MI. FILED 5-5-2004.

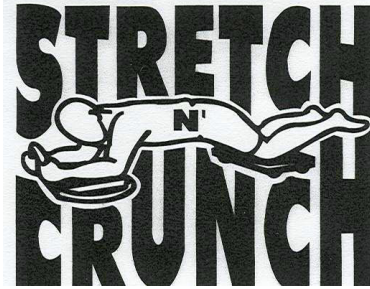

NO CLAIM IS MADE TO THE EXCLUSIVE RIGHT TO USE "STRETCH AND CRUNCH", APART FROM THE MARK AS SHOWN.

THE MARK CONSISTS OF THE WORD STRETCH OVER A PRONE FIGURE LYING OVER THE WORD CRUNCH, WITH THE CONJUNCTION N' ON THE FIGURE.

FOR MANUALLY OPERATED EXERCISE EQUIPMENT (U.S. CLS. 22, 23, 38 AND 50).
FIRST USE 10-3-2003; IN COMMERCE 10-3-2003.
TARAH HARDY, EXAMINING ATTORNEY

SN 78-414,056. MATTEL, INC., EL SEGUNDO, CA. FILED 5-6-2004.

SN 78-411,401. AMERICAN BIO-COMPATIBLE HEALTH SYSTEMS, INC., MALIBU, CA. FILED 4-30-2004.

THE FREEDOM SPRING SYSTEM

THE MARK CONSISTS OF STANDARD CHARACTERS WITHOUT CLAIM TO ANY PARTICULAR FONT, STYLE, SIZE, OR COLOR.

NO CLAIM IS MADE TO THE EXCLUSIVE RIGHT TO USE "SPRING SYSTEM", APART FROM THE MARK AS SHOWN.

FOR EXERCISE EQUIPMENT, NAMELY, A MINI-TRAMPOLINE USED IN COMBINATION WITH AN OVERHEAD RESISTANCE SYSTEM (U.S. CLS. 22, 23, 38 AND 50).
FIRST USE 3-1-2002; IN COMMERCE 1-1-2003.
ELIZABETH J. WINTER, EXAMINING ATTORNEY

CHICANE

THE MARK CONSISTS OF STANDARD CHARACTERS WITHOUT CLAIM TO ANY PARTICULAR FONT, STYLE, SIZE, OR COLOR.

FOR TOYS, GAMES AND PLAYTHINGS, NAMELY, TOY VEHICLES AND ACCESSORIES THEREFOR (U.S. CLS. 22, 23, 38 AND 50).
PRISCILLA MILTON, EXAMINING ATTORNEY

CLASS 28—(Continued).

SN 78-414,268. NOBLE, DAVID E., SEWICKLEY, PA. FILED 5-6-2004.

HEALTHY BUGGS

THE MARK CONSISTS OF STANDARD CHARACTERS WITHOUT CLAIM TO ANY PARTICULAR FONT, STYLE, SIZE, OR COLOR.

NO CLAIM IS MADE TO THE EXCLUSIVE RIGHT TO USE "BUGS", APART FROM THE MARK AS SHOWN. FOR STUFFED TOY ANIMALS AND CHARACTERS (U.S. CLS. 22, 23, 38 AND 50).

MICHELE SWAIN, EXAMINING ATTORNEY

CLASS 28—(Continued).

SN 78-418,565. MATTEL, INC., EL SEGUNDO, CA. FILED 5-13-2004.

**SNACK TIME WITH
COOKIE**

THE MARK CONSISTS OF STANDARD CHARACTERS WITHOUT CLAIM TO ANY PARTICULAR FONT, STYLE, SIZE, OR COLOR.

OWNER OF U.S. REG. NO. 2,474,477.

FOR TOYS, GAMES AND PLAYTHINGS, NAMELY, DOLLS, DOLL CLOTHING AND DOLL ACCESSORIES, DOLL PLAYSETS AND ACCESSORIES (U.S. CLS. 22, 23, 38 AND 50).

ZACHARY BELLO, EXAMINING ATTORNEY

SN 78-414,534. MATTEL, INC., EL SEGUNDO, CA. FILED 5-6-2004.

RAT-IFIED

THE MARK CONSISTS OF STANDARD CHARACTERS WITHOUT CLAIM TO ANY PARTICULAR FONT, STYLE, SIZE, OR COLOR.

FOR TOYS, GAMES AND PLAYTHINGS, NAMELY, TOY VEHICLES AND ACCESSORIES THEREFOR (U.S. CLS. 22, 23, 38 AND 50).

GENE MACIOL, EXAMINING ATTORNEY

SN 78-418,815. THE CREATIVE TRAIN COMPANY, LLC, BEVERLY HILLS, CA. FILED 5-14-2004.

LEGACY

THE MARK CONSISTS OF STANDARD CHARACTERS WITHOUT CLAIM TO ANY PARTICULAR FONT, STYLE, SIZE, OR COLOR.

FOR SCALE-MODEL COLLECTOR'S TRAINS SOLD PRIMARILY IN SPECIALTY MODEL-TRAIN SHOPS, HOBBY SHOPS, MODEL-TRAIN DEPARTMENTS OF TOY STORES, AND THROUGH WEBSITES SPECIALIZING IN SCALE-MODEL TRAINS (U.S. CLS. 22, 23, 38 AND 50).

JOANNA DUKOVIC, EXAMINING ATTORNEY

CLASS 28—(Continued).

SN 78-420,521. MATTEL, INC., EL SEGUNDO, CA. FILED 5-18-2004.

CLASS 28—(Continued).

SN 78-423,839. MOOSE ENTERPRISE PTY LTD, EAST BENTLEIGH, VICTORIA, AUSTRALIA, FILED 5-24-2004.

STREET BREED

THE MARK CONSISTS OF STANDARD CHARACTERS WITHOUT CLAIM TO ANY PARTICULAR FONT, STYLE, SIZE, OR COLOR.

FOR TOYS, GAMES AND PLAYTHINGS, NAMELY, TOY VEHICLES AND ACCESSORIES THEREFOR (U.S. CLS. 22, 23, 38 AND 50).

WILLIAM P. SHANAHAN, EXAMINING ATTORNEY



SN 78-421,838. MATTEL, INC., EL SEGUNDO, CA. FILED 5-19-2004.

FISTFUL OF POWER

THE MARK CONSISTS OF STANDARD CHARACTERS WITHOUT CLAIM TO ANY PARTICULAR FONT, STYLE, SIZE, OR COLOR.

FOR TOY ACTION FIGURES AND ACCESSORIES THEREFOR; TOY FIGURES; WIND-UP TOYS; ELECTRIC ACTION TOYS; BATTERY OPERATED ACTION TOYS; MECHANICAL ACTION TOYS (U.S. CLS. 22, 23, 38 AND 50).

GEOFFREY FOSDICK, EXAMINING ATTORNEY

ROYAL WEDDING



THE MARK CONSISTS OF STANDARD CHARACTERS WITHOUT CLAIM TO ANY PARTICULAR FONT, STYLE, SIZE, OR COLOR.

FOR TOYS, GAMES AND PLAYTHINGS, NAMELY, DOLLS, DOLL CLOTHING AND DOLL ACCESSORIES (U.S. CLS. 22, 23, 38 AND 50).

WILLIAM P. SHANAHAN, EXAMINING ATTORNEY



SN 78-422,457. LUCAS, CINDY, STEUBENVILLE, OH. FILED 5-20-2004.

SN 78-425,261. STAGING LANE PRODUCTIONS, INC., MONROVIA, CA. FILED 5-26-2004.

TURBO TUNERS

Kayleebug Miniature Wardrobe

THE MARK CONSISTS OF STANDARD CHARACTERS WITHOUT CLAIM TO ANY PARTICULAR FONT, STYLE, SIZE, OR COLOR.

NO CLAIM IS MADE TO THE EXCLUSIVE RIGHT TO USE MINIATURE WARDROBE, APART FROM THE MARK AS SHOWN.

FOR DOLL CLOTHING (U.S. CLS. 22, 23, 38 AND 50).
AMY HELLA, EXAMINING ATTORNEY

THE MARK CONSISTS OF STANDARD CHARACTERS WITHOUT CLAIM TO ANY PARTICULAR FONT, STYLE, SIZE, OR COLOR.

NO CLAIM IS MADE TO THE EXCLUSIVE RIGHT TO USE "TUNERS", APART FROM THE MARK AS SHOWN.

FOR TOYS NAMELY DIECAST CARS (U.S. CLS. 22, 23, 38 AND 50).
HEATHER THOMPSON, EXAMINING ATTORNEY

CLASS 28—(Continued).

SN 78-425,327. IKARUS-USA, LLC, FT. MYERS, FL. FILED 5-26-2004.

CLASS 28—(Continued).

SN 78-426,479. TSA CORPORATE SERVICES, INC., ENGLEWOOD, CO. FILED 5-27-2004.

TOUR COLLECTION**Shock Flyer**

THE MARK CONSISTS OF STANDARD CHARACTERS WITHOUT CLAIM TO ANY PARTICULAR FONT, STYLE, SIZE, OR COLOR.

NO CLAIM IS MADE TO THE EXCLUSIVE RIGHT TO USE "FLYER", APART FROM THE MARK AS SHOWN.

FOR REMOTE CONTROL MODEL AIRPLANE (U.S. CLS. 22, 23, 38 AND 50).

JILL C. ALT, EXAMINING ATTORNEY

THE MARK CONSISTS OF STANDARD CHARACTERS WITHOUT CLAIM TO ANY PARTICULAR FONT, STYLE, SIZE, OR COLOR.

OWNER OF U.S. REG. NO. 2,900,519.

NO CLAIM IS MADE TO THE EXCLUSIVE RIGHT TO USE "COLLECTION", APART FROM THE MARK AS SHOWN.

FOR GOLF CLUBS (U.S. CLS. 22, 23, 38 AND 50).

FIRST USE 8-0-2003; IN COMMERCE 8-0-2003.

SKYE YOUNG, EXAMINING ATTORNEY

SN 78-428,735. BRUERE, CARL T., JR., ALBUQUERQUE, NM. AND BRUERE, JORDAN L., RIO RANCHO, NM. AND BRUERE, EASTON SCOTT, RIO RANCHO, NM. FILED 6-2-2004.

SN 78-426,399. GRIFFITH, BRENDA M., COLORADO SPRINGS, CO. FILED 5-27-2004.

HOLLYWOOD MANIA

THE MARK CONSISTS OF STANDARD CHARACTERS WITHOUT CLAIM TO ANY PARTICULAR FONT, STYLE, SIZE, OR COLOR.

FOR EDUCATIONAL GAMES AND TOYS, NAMELY BOARD GAMES, LANGUAGE ARTS GAMES, BRAINSTORMING GAMES, ROLE-PLAYING GAMES AND MATERIALS SOLD AS A UNIT, LEARNING ACTIVITY SETS COMPRISED OF CARDS, PROPS, AND AUDIO VISUAL AND AUDIO MEDIA, AND INTERACTIVE MULTIMEDIA ELECTRONIC VIDEO GAMES (U.S. CLS. 22, 23, 38 AND 50).

THEODORE MCBRIDE, EXAMINING ATTORNEY



THE COLOR(S) RED, YELLOW, AND BLUE IS/ARE CLAIMED AS A FEATURE OF THE MARK.

THE MARK CONSISTS OF A VERTICAL RECTANGLE DIVIDED INTO THREE COLORED ZONES AND DISPLAYED WITHOUT A BORDER ON THE PERIMETER. CENTERED IN THE MARK IS A STYLIZED BLACK QUESTION MARK, WITHIN WHICH ARE THE STYLIZED WORDS, KNOW WHAT, IN A BLACK AND WHITE COLORATION. THE SURROUNDING BACKGROUND OF THE QUESTION MARK IS IN THREE EQUAL HORIZONTAL AREAS OF COLOR, WITH THE UPPER 1/3 AREA BEING RED, THE MIDDLE 1/3 AREA BEING YELLOW, AND THE LOWER 1/3 AREA BEING BLUE.

FOR EDUCATIONAL CARD GAME (U.S. CLS. 22, 23, 38 AND 50).

JOHN LINCOSKI, EXAMINING ATTORNEY

CLASS 28—(Continued).

SN 78-435,166. LES ENTREPRISES AIGUISSO-PRO INC., QUEBEC, CANADA, FILED 6-15-2004.

CLASS 28—(Continued).

SN 78-436,000. MATTEL, INC., EL SEGUNDO, CA. FILED 6-16-2004.

X-BLADES

SECRET ANGELS

THE MARK CONSISTS OF STANDARD CHARACTERS WITHOUT CLAIM TO ANY PARTICULAR FONT, STYLE, SIZE, OR COLOR.

PRIORITY CLAIMED UNDER SEC. 44(D) ON CANADA APPLICATION NO. 1219782, FILED 6-9-2004, REG. NO. TMA642472, DATED 6-20-2005, EXPIRES 6-20-2020.

FOR HIGH PERFORMANCE REPLACEMENT BLADES FOR ICE HOCKEY SKATES (U.S. CLS. 22, 23, 38 AND 50).

CATHERINE FAINT, EXAMINING ATTORNEY

THE MARK CONSISTS OF STANDARD CHARACTERS WITHOUT CLAIM TO ANY PARTICULAR FONT, STYLE, SIZE, OR COLOR.

FOR TOYS, GAMES AND PLAYTHINGS, NAMELY, DOLLS, DOLL CLOTHING AND DOLL ACCESSORIES (U.S. CLS. 22, 23, 38 AND 50).

ASMAT KHAN, EXAMINING ATTORNEY

SN 78-435,980. MATTEL, INC., EL SEGUNDO, CA. FILED 6-16-2004.

SN 78-436,006. MATTEL, INC., EL SEGUNDO, CA. FILED 6-16-2004.

TRIA

TOOTH TIME

THE MARK CONSISTS OF STANDARD CHARACTERS WITHOUT CLAIM TO ANY PARTICULAR FONT, STYLE, SIZE, OR COLOR.

FOR TOYS, GAMES AND PLAYTHINGS, NAMELY, DOLLS, DOLL CLOTHING AND DOLL ACCESSORIES (U.S. CLS. 22, 23, 38 AND 50).

BARBARA A. GOLD, EXAMINING ATTORNEY

THE MARK CONSISTS OF STANDARD CHARACTERS WITHOUT CLAIM TO ANY PARTICULAR FONT, STYLE, SIZE, OR COLOR.

FOR TOYS, GAMES AND PLAYTHINGS, NAMELY, DOLLS, DOLL CLOTHING AND DOLL ACCESSORIES, DOLL PLAYSETS AND ACCESSORIES THEREFOR (U.S. CLS. 22, 23, 38 AND 50).

ASMAT KHAN, EXAMINING ATTORNEY

CLASS 28—(Continued).

SN 78-436,209. PLAN-IT PLAY, INC., KENNESAW, GA. FILED 6-16-2004.

BUY THE KIT. BUILD IT YOURSELF.

THE MARK CONSISTS OF STANDARD CHARACTERS WITHOUT CLAIM TO ANY PARTICULAR FONT, STYLE, SIZE, OR COLOR.

NO CLAIM IS MADE TO THE EXCLUSIVE RIGHT TO USE "KIT" AND "BUILD IT YOURSELF", APART FROM THE MARK AS SHOWN.

FOR KITS FOR BUILDING OUTDOOR PLAY EQUIPMENT (U.S. CLS. 22, 23, 38 AND 50).

FIRST USE 5-10-2004; IN COMMERCE 5-10-2004.
PRISCILLA MILTON, EXAMINING ATTORNEY

SN 78-437,181. CORFIT PERSONAL TRAINING CENTER, INC., EVANSTON, IL. FILED 6-17-2004.

CORFIT ABS TRAINER

THE MARK CONSISTS OF STANDARD CHARACTERS WITHOUT CLAIM TO ANY PARTICULAR FONT, STYLE, SIZE, OR COLOR.

NO CLAIM IS MADE TO THE EXCLUSIVE RIGHT TO USE "ABS TRAINER", APART FROM THE MARK AS SHOWN.

FOR EXERCISE EQUIPMENT, NAMELY A DEVICE TO FACILITATE EXERCISES DESIGNED TO STRENGTHEN ABDOMINAL MUSCLES (U.S. CLS. 22, 23, 38 AND 50).

HEATHER THOMPSON, EXAMINING ATTORNEY

SN 78-437,391. MATTEL, INC., EL SEGUNDO, CA. FILED 6-17-2004.

PRINCESS OF THE KOREAN COURT

THE MARK CONSISTS OF STANDARD CHARACTERS WITHOUT CLAIM TO ANY PARTICULAR FONT, STYLE, SIZE, OR COLOR.

FOR TOYS, GAMES AND PLAYTHINGS, NAMELY, DOLLS, DOLL CLOTHING AND DOLL ACCESSORIES (U.S. CLS. 22, 23, 38 AND 50).

CHRISIE B. KING, EXAMINING ATTORNEY

CLASS 28—(Continued).

SN 78-437,392. MATTEL, INC., EL SEGUNDO, CA. FILED 6-17-2004.

PRINCESS OF RENAISSANCE ITALY

THE MARK CONSISTS OF STANDARD CHARACTERS WITHOUT CLAIM TO ANY PARTICULAR FONT, STYLE, SIZE, OR COLOR.

FOR TOYS, GAMES AND PLAYTHINGS, NAMELY, DOLLS, DOLL CLOTHING AND DOLL ACCESSORIES (U.S. CLS. 22, 23, 38 AND 50).

CHRISIE B. KING, EXAMINING ATTORNEY

SN 78-441,674. WHAM-O, INC., EMERYVILLE, CA. FILED 6-25-2004.

WAVE RIDER

THE MARK CONSISTS OF STANDARD CHARACTERS WITHOUT CLAIM TO ANY PARTICULAR FONT, STYLE, SIZE, OR COLOR.

FOR WATERSLIDES (U.S. CLS. 22, 23, 38 AND 50).

FIRST USE 11-0-1998; IN COMMERCE 11-0-1998.

DAVID MURRAY, EXAMINING ATTORNEY

SN 78-442,654. WILD PLANET TOYS, INC., SAN FRANCISCO, CA. FILED 6-28-2004.

LIQUIFREAKS

THE MARK CONSISTS OF STANDARD CHARACTERS WITHOUT CLAIM TO ANY PARTICULAR FONT, STYLE, SIZE, OR COLOR.

FOR TOYS, NAMELY AN INTERACTIVE TOY CONSISTING OF A TOY CHARACTER IN A SEALED DOME WITH BUTTONS TO PRESS FOR INTERACTIVE FUNCTIONS (U.S. CLS. 22, 23, 38 AND 50).

ROBERT C. CLARK JR., EXAMINING ATTORNEY

CLASS 28—(Continued).

SN 78-443,684. DANSKIN, INC., NEW YORK, NY. FILED 6-30-2004.

CLASS 28—(Continued).

SN 78-449,411. TRIANGLE SYSTEMS, INC., CARLSBAD, CA. FILED 7-12-2004.

DANSKIN NOW

THE MARK CONSISTS OF STANDARD CHARACTERS WITHOUT CLAIM TO ANY PARTICULAR FONT, STYLE, SIZE, OR COLOR.

OWNER OF U.S. REG. NOS. 772,356, 2,017,878 AND OTHERS.

FOR BODY BUILDING, PHYSICAL FITNESS AND EXERCISE EQUIPMENT, NAMELY, BARS, BARBELLS, DUMBBELL BARS, DUMBBELLS, WEIGHTED BALLS, STABILITY BALLS, STRETCH CORDS, HAND GRIPPERS, JUMP ROPES, HEAD STRAPS, EXERCISE BENCHES, PERSONAL EXERCISE MATS, YOGA MATS, EXPANSION CABLES AND STRAPS (U.S. CLS. 22, 23, 38 AND 50).

FRED MANDIR, EXAMINING ATTORNEY

ARIAKON

THE MARK CONSISTS OF STANDARD CHARACTERS WITHOUT CLAIM TO ANY PARTICULAR FONT, STYLE, SIZE, OR COLOR.

FOR PAINT BALL GUNS (U.S. CLS. 22, 23, 38 AND 50). FIRST USE 6-28-2004; IN COMMERCE 6-28-2004.

JOHN DALIER, EXAMINING ATTORNEY

SN 78-443,700. DANSKIN, INC., NEW YORK, NY. FILED 6-30-2004.

SN 78-449,438. WADDELL, DAN, FREMONT, CA. FILED 7-12-2004.

NOW

THE MARK CONSISTS OF STANDARD CHARACTERS WITHOUT CLAIM TO ANY PARTICULAR FONT, STYLE, SIZE, OR COLOR.

FOR BODY BUILDING, PHYSICAL FITNESS AND EXERCISE EQUIPMENT, NAMELY, BARS, BARBELLS, DUMBBELL BARS, DUMBBELLS, WEIGHTED BALLS, STABILITY BALLS, STRETCH CORDS, HAND GRIPPERS, JUMP ROPES, HEAD STRAPS, EXERCISE BENCHES, PERSONAL EXERCISE MATS, EXPANSION CABLES, STRAPS, AND YOGA MATS (U.S. CLS. 22, 23, 38 AND 50).

PRISCILLA MILTON, EXAMINING ATTORNEY

FAT BAIT

THE MARK CONSISTS OF STANDARD CHARACTERS WITHOUT CLAIM TO ANY PARTICULAR FONT, STYLE, SIZE, OR COLOR.

NO CLAIM IS MADE TO THE EXCLUSIVE RIGHT TO USE "BAIT", APART FROM THE MARK AS SHOWN, FOR ARTIFICIAL FISHING LURES (U.S. CLS. 22, 23, 38 AND 50).

FIRST USE 6-30-2003; IN COMMERCE 12-28-2003. KAREN BRACEY, EXAMINING ATTORNEY

CLASS 28—(Continued).

SN 78-451,677. EVANS MARKETING GROUP, INC., CHAUTAQUA, NY. FILED 7-16-2004.

SOLO BOARD

THE MARK CONSISTS OF STANDARD CHARACTERS WITHOUT CLAIM TO ANY PARTICULAR FONT, STYLE, SIZE, OR COLOR.

OWNER OF U.S. REG. NO. 1,913,487.

NO CLAIM IS MADE TO THE EXCLUSIVE RIGHT TO USE "BOARD", APART FROM THE MARK AS SHOWN.

FOR SNOW EQUIPMENT, NAMELY SKIS, SNOWBOARD, POLES, BRAKES, AND BINDINGS AND PARTS THEREOF (U.S. CLS. 22, 23, 38 AND 50).

TANYA AMOS, EXAMINING ATTORNEY

SN 78-452,740. FUJIKURA RUBBER LTD., SHINAGAWA-KU, JAPAN, FILED 7-19-2004.

NBL

THE MARK CONSISTS OF STANDARD CHARACTERS WITHOUT CLAIM TO ANY PARTICULAR FONT, STYLE, SIZE, OR COLOR.

PRIORITY CLAIMED UNDER SEC. 44(D) ON JAPAN APPLICATION NO. 200462933, FILED 7-7-2004, REG. NO. 4839786, DATED 2-18-2005, EXPIRES 2-18-2015.

FOR SPORTING AND GYMNAS TIC IMPLEMENTS NAMELY GOLF CLUB SHAFTS (U.S. CLS. 22, 23, 38 AND 50).

MICHAEL TANNER, EXAMINING ATTORNEY

CLASS 28—(Continued).

SN 78-455,293. ZABALA, ANDRES J., SANTIAGO RM 751-0338, CHILE, FILED 7-22-2004.

GOLF ONE

THE MARK CONSISTS OF STANDARD CHARACTERS WITHOUT CLAIM TO ANY PARTICULAR FONT, STYLE, SIZE, OR COLOR.

PRIORITY CLAIMED UNDER SEC. 44(D) ON CHILE APPLICATION NO. 653751, FILED 7-16-2004, REG. NO. 723,175, DATED 4-15-2005, EXPIRES 4-15-2015.

NO CLAIM IS MADE TO THE EXCLUSIVE RIGHT TO USE GOLF, APART FROM THE MARK AS SHOWN.

FOR GOLF PLAYING EQUIPMENT, NAMELY, GOLF CLUBS, GOLF BALLS, GOLF CLUB BAGS AND GOLF CLUB COMPONENTS, NAMELY, GOLF CLUB HEADS, GOLF CLUB SHAFTS, GOLF CLUB GRIPS (U.S. CLS. 22, 23, 38 AND 50).

STEVEN JACKSON, EXAMINING ATTORNEY

SN 78-456,814. PAMELA DRAKE INCORPORATED, BERKELEY, CA. FILED 7-26-2004.

SEW 'N' SEW

THE COLOR(S) RED IS/ARE CLAIMED AS A FEATURE OF THE MARK.

THE MARK CONSISTS OF RED WRITING IN FINK CONDENSED FONT.

FOR WOODEN DEVELOPMENTAL ACTIVITY TOY (U.S. CLS. 22, 23, 38 AND 50).

FIRST USE 6-0-1988; IN COMMERCE 6-0-1988.

ANGELA M. MICHELI, EXAMINING ATTORNEY

CLASS 28—(Continued).

SN 78-459,966. PROTT INC., RHODES, MI. FILED 7-30-2004.



NO CLAIM IS MADE TO THE EXCLUSIVE RIGHT TO USE TROLLING SYSTEMS, LLC, APART FROM THE MARK AS SHOWN.

FOR FISHING LURES (U.S. CLS. 22, 23, 38 AND 50).
FIRST USE 5-1-2004; IN COMMERCE 5-1-2004.
BARNEY CHARLON, EXAMINING ATTORNEY

CLASS 28—(Continued).

SN 78-461,798. PT CENTRAL SARANA PANCING, KEC CIKUPA, TANGERANG, BANTEN, INDONESIA, FILED 8-4-2004.



FOR FISHING GEAR; NAMELY, ARTIFICIAL FISHING BAIT, FISHING TACKLE BITE INDICATOR, FISHING TACKLE BITE SENSOR, FISHING CREEL, DECOYS FOR FISHING, FISH HOOK, FISHING TACKLE, FLOAT FOR FISHING, FISHING LINE, HOOK, REEL FOR FISHING, ROD FOR FISHING, FISHING BAG, FISHING TACKLE FLOAT SWIVEL (U.S. CLS. 22, 23, 38 AND 50).
FIRST USE 10-1-2003; IN COMMERCE 4-1-2004.
JOHN DALIER, EXAMINING ATTORNEY

SN 78-460,025. ARLEN NESS ENTERPRISES, INC., DUBLIN, CA. FILED 7-31-2004.

ARLEN NESS

THE MARK CONSISTS OF STANDARD CHARACTERS WITHOUT CLAIM TO ANY PARTICULAR FONT, STYLE, SIZE, OR COLOR.

OWNER OF U.S. REG. NO. 1,833,774.

THE NAME(S), PORTRAIT(S), AND/OR SIGNATURE(S) SHOWN IN THE MARK IDENTIFIES ARLEN NESS, WHOSE CONSENT(S) TO REGISTER IS SUBMITTED.

FOR MODELED PLASTIC TOY FIGURINES, RADIO CONTROLLED MODEL VEHICLES, RADIO CONTROLLED TOY VEHICLES, TOY MODEL CARS, TOY MODEL MOTORCYCLES, TOY MODEL HOBBY CRAFT KITS, TOY MODEL KIT CARS, TOY MODEL KIT MOTORCYCLES, TOY MODEL VEHICLES AND RELATED ACCESSORIES SOLD AS UNITS, SKATEBOARDS, SKATEBOARD TRUCKS, SKATEBOARD WHEELS, SNOWBOARDS, SNOWBOARD BINDINGS, WAKE BOARDS, KNEE PADS FOR ATHLETIC USE, ELBOW PADS FOR ATHLETIC USE, SURFBOARDS, BATTERY OPERATED ACTION TOYS, ACTION FIGURES, ACTION FIGURES AND ACCESSORIES THEREFOR, ACTION SKILL GAMES, ACTION TARGET GAMES, ACTION-TYPE TARGET GAMES, COLLECTIBLE TOY FIGURES (U.S. CLS. 22, 23, 38 AND 50).
FIRST USE 1-1-2004; IN COMMERCE 1-15-2004.

WILLIAM P. SHANAHAN, EXAMINING ATTORNEY

SN 78-463,703. BAD GIRL SWIRL, INC., SAN FRANCISCO, CA. FILED 8-6-2004.

BAD GIRL'S GUIDE

THE MARK CONSISTS OF STANDARD CHARACTERS WITHOUT CLAIM TO ANY PARTICULAR FONT, STYLE, SIZE, OR COLOR.

FOR BOARD GAMES AND JIGSAW PUZZLES (U.S. CLS. 22, 23, 38 AND 50).
ASMAT KHAN, EXAMINING ATTORNEY

SN 78-464,908. SHAW BROTHERS CO., INC, NEW ALBANY, IN. FILED 8-10-2004.

**SHAW BROTHERS CO.,
INC.**

THE MARK CONSISTS OF STANDARD CHARACTERS WITHOUT CLAIM TO ANY PARTICULAR FONT, STYLE, SIZE, OR COLOR.

NO CLAIM IS MADE TO THE EXCLUSIVE RIGHT TO USE "CO., INC.", APART FROM THE MARK AS SHOWN. SEC. 2(F) AS TO "SHAW BROTHERS".

FOR PLUSH TOYS, NAMELY, EASTER BUNNIES, SANTAS, SNOWMEN, AND WITCHES (U.S. CLS. 22, 23, 38 AND 50).

FIRST USE 1-1-1979; IN COMMERCE 8-1-1980.
DORITT L. CARROLL, EXAMINING ATTORNEY

CLASS 28—(Continued).

SN 78-474,146. FRANKLIN SPORTS, INC., STOUGHTON, MA. FILED 8-26-2004.

INTELLI-FLEX

THE MARK CONSISTS OF STANDARD CHARACTERS WITHOUT CLAIM TO ANY PARTICULAR FONT, STYLE, SIZE, OR COLOR.

FOR BASEBALL BATTING GLOVES AND HOCKEY EQUIPMENT, NAMELY, ATHLETIC PROTECTIVE PADDING FOR HAND, ARM, ELBOW, SHOULDER, CHEST, STOMACH, BACK AND SPINE, AND SHIN GUARDS FOR ATHLETIC USE (U.S. CLS. 22, 23, 38 AND 50).

PRISCILLA MILTON, EXAMINING ATTORNEY

CLASS 28—(Continued).

SN 78-482,740. BLANK, ARTHUR, DOYLESTOWN, PA. FILED 9-13-2004.

TRU-FLO

THE MARK CONSISTS OF STANDARD CHARACTERS WITHOUT CLAIM TO ANY PARTICULAR FONT, STYLE, SIZE, OR COLOR.

FOR FISHING ROD ATTACHMENT IN THE NATURE OF A FISHING LINE GUIDE (U.S. CLS. 22, 23, 38 AND 50).

FIRST USE 9-17-1999; IN COMMERCE 4-25-2001.
KIM SAITO, EXAMINING ATTORNEY

SN 78-479,845. AMAZING GOODS LLC, AUSTIN, TX. FILED 9-7-2004.

CORE SCULPTOR PLUS

THE MARK CONSISTS OF STANDARD CHARACTERS WITHOUT CLAIM TO ANY PARTICULAR FONT, STYLE, SIZE, OR COLOR.

FOR MANUALLY-OPERATED EXERCISE EQUIPMENT (U.S. CLS. 22, 23, 38 AND 50).

FIRST USE 3-19-2005; IN COMMERCE 3-19-2005.
SHARI SHEFFIELD, EXAMINING ATTORNEY

SN 78-485,595. TEAM PLAY, INC., ELK GROVE VILLAGE, IL. FILED 9-17-2004.

BOPPER BALL

THE MARK CONSISTS OF STANDARD CHARACTERS WITHOUT CLAIM TO ANY PARTICULAR FONT, STYLE, SIZE, OR COLOR.

NO CLAIM IS MADE TO THE EXCLUSIVE RIGHT TO USE "BALL", APART FROM THE MARK AS SHOWN.

FOR VIDEO ARCADE GAMES (U.S. CLS. 22, 23, 38 AND 50).

BILL DAWE, EXAMINING ATTORNEY

CLASS 28—(Continued).

SN 78-486,105. ROCKWOOD, CLIFF, WESTFORD, MA. FILED 9-20-2004.



NO CLAIM IS MADE TO THE EXCLUSIVE RIGHT TO USE "TALKING BIBLE DOLL", APART FROM THE MARK AS SHOWN.
FOR DOLLS (U.S. CLS. 22, 23, 38 AND 50).
FIRST USE 9-14-2004; IN COMMERCE 9-14-2004.
KAREN BRACEY, EXAMINING ATTORNEY

SN 78-493,224. POLLARD, OWEN CRAIG, VISTA, CA. FILED 10-1-2004.

SPORT CUVER

THE MARK CONSISTS OF STANDARD CHARACTERS WITHOUT CLAIM TO ANY PARTICULAR FONT, STYLE, SIZE, OR COLOR.
NO CLAIM IS MADE TO THE EXCLUSIVE RIGHT TO USE "COVER", APART FROM THE MARK AS SHOWN.
FOR GOLF CLUB HEAD COVERS (U.S. CLS. 22, 23, 38 AND 50).
FIRST USE 5-5-1995; IN COMMERCE 8-19-1995.
MARK SPARACINO, EXAMINING ATTORNEY

SN 78-493,359. POLLARD, OWEN CRAIG, VISTA, CA. FILED 10-1-2004.

DINGIS.COM

THE MARK CONSISTS OF STANDARD CHARACTERS WITHOUT CLAIM TO ANY PARTICULAR FONT, STYLE, SIZE, OR COLOR.
FOR STUFFED TOY CHARACTER (U.S. CLS. 22, 23, 38 AND 50).
FIRST USE 7-1-2000; IN COMMERCE 7-1-2000.
GEORGE LORENZO, EXAMINING ATTORNEY

CLASS 28—(Continued).

SN 78-493,369. POLLARD, OWEN CRAIG, VISTA, CA. FILED 10-1-2004.

EDDIE-EYE-CON

THE MARK CONSISTS OF STANDARD CHARACTERS WITHOUT CLAIM TO ANY PARTICULAR FONT, STYLE, SIZE, OR COLOR.
FOR STUFFED TOY CHARACTER (U.S. CLS. 22, 23, 38 AND 50).
FIRST USE 7-1-2000; IN COMMERCE 7-1-2000.
HOWARD SMIGA, EXAMINING ATTORNEY

SN 78-494,565. VONCO PRODUCTS, INC., LAKE VILLA, IL. FILED 10-5-2004.

RALLYSTIX

THE MARK CONSISTS OF STANDARD CHARACTERS WITHOUT CLAIM TO ANY PARTICULAR FONT, STYLE, SIZE, OR COLOR.
FOR PLASTIC BALLOONS, FOIL BALLOONS, TOY INFLATABLE PLASTIC STRUCTURES, TOY INFLATABLE FOIL STRUCTURES, NAMELY INFLATABLE PLASTIC NOISEMAKERS AND INFLATABLE FOIL NOISEMAKERS (U.S. CLS. 22, 23, 38 AND 50).
KIMBERLY FRYE, EXAMINING ATTORNEY

SN 78-494,707. FRANKLIN SPORTS, INC., STOUGHTON, MA. FILED 10-5-2004.

GROOVE

THE MARK CONSISTS OF STANDARD CHARACTERS WITHOUT CLAIM TO ANY PARTICULAR FONT, STYLE, SIZE, OR COLOR.
FOR BASKETBALLS (U.S. CLS. 22, 23, 38 AND 50).
FIRST USE 9-1-2003; IN COMMERCE 9-1-2003.
ALICE BENMAMAN, EXAMINING ATTORNEY

CLASS 28—(Continued).

SN 78-494,712. ALL SEASON TOYS, INC., MALIBU, CA.
FILED 10-5-2004.

CLASS 28—(Continued).

SN 78-495,213. FRANKLIN SPORTS, INC., STOUGHTON,
MA. FILED 10-6-2004.

GHOSTFORMERS

THE MARK CONSISTS OF STANDARD CHARACTERS
WITHOUT CLAIM TO ANY PARTICULAR FONT, STYLE,
SIZE, OR COLOR.

FOR MECHANICAL ACTION TOYS, ELECTRICAL
ACTION TOYS, CASES FOR ACTION FIGURES, CASES
FOR PLAY ACCESSORIES, CASES FOR TOY VEHICLES,
TOY GLIDERS, TOY TARGET LAUNCHERS, WIND-UP
WALKING TOYS, ACTION FIGURES AND ACTION
FIGURE ACCESSORIES, TOY VEHICLES, PLAYSETS
FOR ACTION FIGURES, MINIATURE PLAYSETS FOR
ACTION FIGURES, ROBOTIC PLAY FIGURES, INFLA-
TABLE TOYS SHOWING DECORATIVE PICTURES, TOY
GUNS, PLUSH TOYS, ANIMATED PLUSH TOYS, ME-
CHANICAL PLUSH TOYS (U.S. CLS. 22, 23, 38 AND 50).
BARBARA A. LOUGHRAN, EXAMINING ATTORNEY

SPIRALACE

THE MARK CONSISTS OF STANDARD CHARACTERS
WITHOUT CLAIM TO ANY PARTICULAR FONT, STYLE,
SIZE, OR COLOR.

FOR FOOTBALLS (U.S. CLS. 22, 23, 38 AND 50).
FIRST USE 11-1-1998; IN COMMERCE 11-1-1998.
DANIEL CAPSHAW, EXAMINING ATTORNEY

SN 78-495,041. WILD PLANET TOYS, INC., SAN FRANCIS-
CO, CA. FILED 10-5-2004.

SN 78-495,301. CALLAWAY GOLF COMPANY, CARLSBAD,
CA. FILED 10-6-2004.

RIP RIDERS

THE MARK CONSISTS OF STANDARD CHARACTERS
WITHOUT CLAIM TO ANY PARTICULAR FONT, STYLE,
SIZE, OR COLOR.

FOR TOYS, NAMELY A SMALL TOY BICYCLE AND
ATTACHED FIGURE THAT ARE PROPELLED ACROSS
THE FLOOR USING A PULL CORD (U.S. CLS. 22, 23, 38
AND 50).

KEVIN DINALLO, EXAMINING ATTORNEY

**BLISTERING
DISTANCE**

THE MARK CONSISTS OF STANDARD CHARACTERS
WITHOUT CLAIM TO ANY PARTICULAR FONT, STYLE,
SIZE, OR COLOR.

NO CLAIM IS MADE TO THE EXCLUSIVE RIGHT TO
USE DISTANCE, APART FROM THE MARK AS SHOWN.
FOR GOLF BALLS (U.S. CLS. 22, 23, 38 AND 50).

WILLIAM VERHOSEK, EXAMINING ATTORNEY

CLASS 28—(Continued).

SN 78-495,475. RLJ BASKETBALL, LLC, CHARLOTTE, NC.
FILED 10-6-2004.

CLASS 28—(Continued).

SN 78-495,580. ABC DEVELOPMENT, INC. OF CENTRAL
FLORIDA, WINTER PARK, FL. FILED 10-6-2004.

TAG-IT



THE MARK CONSISTS OF STANDARD CHARACTERS WITHOUT CLAIM TO ANY PARTICULAR FONT, STYLE, SIZE, OR COLOR.

FOR TOYS, NAMELY, INFANT TOYS, PLUSH TOYS, TOY BUILDING BLOCKS, CONSTRUCTION TOYS, CHILDREN'S MULTIPLE ACTIVITY TOYS, CARD AND BOARD GAMES, ACTION SKILL GAMES, ACTION TARGET GAMES, PUZZLES, ELECTRIC ACTION TOYS, MUSICAL TOYS, MECHANICAL TOYS, BATHTUB TOYS, BATTERY OPERATED ACTION TOYS, INFANT DEVELOPMENT TOYS, INFANT ACTION CRIB TOYS, ELECTRONIC PRESCHOOL LEARNING TOYS, SOFT SCULPTURE TOYS, TALKING TOYS, DRAWING TOYS, WIND UP TOYS, ARTS AND HOBBY CRAFTS KITS COMPRISING TOY MODEL KIT CARS, TOY MODEL TRAIN SETS, TOY PRISM GLASSES, TOY PUTTY, AND TOY STAMPS; MAGNETIC TOYS CONSISTING OF LETTERS, SHAPES, NUMBERS AND CHARACTERS (U.S. CLS. 22, 23, 38 AND 50).

DAWN FELDMAN, EXAMINING ATTORNEY

THE MARK CONSISTS OF THE HEAD OF A BOBCAT OVER A BASKETBALL.

FOR TOYS, GAMES AND SPORTING GOODS, NAMELY BASKETBALLS, GOLF BALLS, PLAYGROUND BALLS, SPORTS BALLS, RUBBER ACTION BALLS AND FOAM ACTION BALLS, PLUSH BALLS, BASKETBALL NETS, BASKETBALL BACKBOARDS, PUMPS FOR INFLATING BASKETBALLS, AND NEEDLES THEREFOR, GOLF CLUBS, GOLF BAGS, GOLF PUTTERS, GOLF ACCESSORIES, NAMELY, DIVOT REPAIR TOOLS, TEES, BALL MARKERS, GOLF BAG COVERS, CLUB HEAD COVERS, GOLF GLOVES, GOLF BALL SLEEVES, ELECTRONIC BASKETBALL TABLE TOP GAMES, BASKETBALL TABLE TOP GAMES, BASKETBALL BOARD GAMES, ACTION SKILL GAMES, ADULT'S AND CHILDREN'S PARTY GAMES, TRIVIA INFORMATION GAMES AND ELECTRONIC VIDEO ARCADE GAME MACHINES, BASKETBALL KIT COMPRISED OF A NET AND WHISTLE, DOLLS, DECORATIVE DOLLS, COLLECTIBLE DOLLS, TOY ACTION FIGURES, BOBBLEHEAD ACTION FIGURES, STUFFED TOYS, JIGSAW PUZZLES AND CHRISTMAS TREE ORNAMENTS, CHRISTMAS STOCKINGS; TOY VEHICLES IN THE NATURE OF CARS, TRUCKS AND VANS, ALL CONTAINING BASKETBALL THEMES, TOY FINGERS, CARD GAMES, PLAYING CARDS (U.S. CLS. 22, 23, 38 AND 50).

AMOS T. MATTHEWS, JR., EXAMINING ATTORNEY

SN 78-495,624. FRANKLIN SPORTS, INC., STOUGHTON,
MA. FILED 10-6-2004.

FIELD MASTER

THE MARK CONSISTS OF STANDARD CHARACTERS WITHOUT CLAIM TO ANY PARTICULAR FONT, STYLE, SIZE, OR COLOR.

FOR BASEBALL FIELDING GLOVES AND SPORTS BALLS (U.S. CLS. 22, 23, 38 AND 50).

FIRST USE 1-1-1990; IN COMMERCE 1-1-1990.

GINA FINK, EXAMINING ATTORNEY

CLASS 28—(Continued).

SN 78-495,764. MINTY FRESH, INC., CHICAGO, IL. FILED 10-6-2004.

ROADKILL COMMANDOES

THE MARK CONSISTS OF STANDARD CHARACTERS WITHOUT CLAIM TO ANY PARTICULAR FONT, STYLE, SIZE, OR COLOR.

FOR TOY ACTION FIGURES AND ACCESSORIES THEREFORE (U.S. CLS. 22, 23, 38 AND 50).
JAMES A. RAUEN, EXAMINING ATTORNEY

CLASS 28—(Continued).

SN 78-497,156. TOP FLOOR CREATIONS, INC., NEW CA-NAAN, CT. FILED 10-8-2004.

ESTHER BUNNY

THE MARK CONSISTS OF STANDARD CHARACTERS WITHOUT CLAIM TO ANY PARTICULAR FONT, STYLE, SIZE, OR COLOR.

NO CLAIM IS MADE TO THE EXCLUSIVE RIGHT TO USE "BUNNY", APART FROM THE MARK AS SHOWN.

FOR DOLLS AND DOLL ACCESSORIES (U.S. CLS. 22, 23, 38 AND 50).

GINA FINK, EXAMINING ATTORNEY

SN 78-496,998. STREET PLAYERS HOLDING, LOS AN-GELES, CA. FILED 10-8-2004.



NO CLAIM IS MADE TO THE EXCLUSIVE RIGHT TO USE "BEARS", APART FROM THE MARK AS SHOWN.

THE COLOR(S) GREEN, RED, ORANGE, BLUE-ISH PURPLE IS/ARE CLAIMED AS A FEATURE OF THE MARK.

THE MARK CONSISTS OF GREEN G, RED U, BLUE-ISH PURPLE M, ORANGE M, GREEN Y. GREEN OUTLINE AROUND WHITE BEARS.

FOR TOYS AND PLAYTHINGS, NAMELY, BOARD GAMES, STUFFED ANIMALS, INFANT TOYS, AND MUSICAL TOYS (U.S. CLS. 22, 23, 38 AND 50).

FIRST USE 9-1-2004; IN COMMERCE 9-1-2004.
BRIAN PINO, EXAMINING ATTORNEY

SN 78-497,683. WORKING CHEMICAL SOLUTIONS, INC., EL DORADO, AR. FILED 10-11-2004.

RC'S

THE MARK CONSISTS OF STANDARD CHARACTERS WITHOUT CLAIM TO ANY PARTICULAR FONT, STYLE, SIZE, OR COLOR.

FOR CHEMICAL GAME ANIMAL ATTRACTANT AND SCENT MASKING AGENT IN THE NATURE OF HUNTER'S SCENT CAMOUFLAGE (U.S. CLS. 22, 23, 38 AND 50).

BRIAN PINO, EXAMINING ATTORNEY

CLASS 28—(Continued).

SN 78-497,863. MCCAFFERTY, JAMES R., SANTA ANA, CA.
FILED 10-11-2004.

SKWEEBEEZ

THE MARK CONSISTS OF STANDARD CHARACTERS WITHOUT CLAIM TO ANY PARTICULAR FONT, STYLE, SIZE, OR COLOR.

FOR TOYS, NAMELY, TOY ACTION FIGURES AND ACCESSORIES THEREFOR; BOARD GAMES, CARD GAMES, PINBALL GAMES, YO-YOS, PARLOR GAMES, TOY VEHICLES AND ACCESSORIES THEREFOR; MULTIPLE ACTIVITY TOYS FOR INFANTS AND CHILDREN; DOLLS, DOLL CLOTHING AND DOLL ACCESSORIES; COMPACT CASES CONTAINING PLAY ENVIRONMENTS SOLD WITH MINIATURE DOLLS, TOY FIGURES, AND ACCESSORIES THEREFOR; TOY MOLDING COMPOUNDS AND ACCESSORIES THEREFOR; ELECTRONIC AND MECHANICALLY OPERATED EDUCATIONAL, ENTERTAINMENT TOYS WHICH GENERATE NATURAL SOUNDS, MELODIES AND/OR SPOKEN WORDS; PLUSH TOYS, STUFFED TOYS, CHILDREN'S RIDE-ON TOY VEHICLES; RADIO-CONTROLLED TOY VEHICLES; JIGSAW PUZZLES, MANIPULATIVE PUZZLES, INFLATABLE TOYS, HAND-HELD UNIT FOR PLAYING VIDEO GAMES, CHRISTMAS TREE ORNAMENTS, TOY MODEL HOBBYCRAFT KITS, MECHANICAL TOYS, WIND-UP TOYS, FLYING DISCS, WATER SQUIRTING TOYS, PUPPETS, ROLE-PLAYING GAMES, MUSICAL TOYS (U.S. CLS. 22, 23, 38 AND 50).

GINA HAYES, EXAMINING ATTORNEY

SN 78-497,871. LINK DIRECT CORP., CLEARWATER, FL.
FILED 10-11-2004.

GEMPHONE

THE MARK CONSISTS OF STANDARD CHARACTERS WITHOUT CLAIM TO ANY PARTICULAR FONT, STYLE, SIZE, OR COLOR.

FOR CRAFT SETS FOR USE IN DECORATING CELLULAR TELEPHONES (U.S. CLS. 22, 23, 38 AND 50).

RONALD AIKENS, EXAMINING ATTORNEY

CLASS 28—(Continued).

SN 78-498,139. INNOVATION DEVELOPMENT GROUP, INC., KANSAS CITY, MO. FILED 10-12-2004.

CHORD

THE MARK CONSISTS OF STANDARD CHARACTERS WITHOUT CLAIM TO ANY PARTICULAR FONT, STYLE, SIZE, OR COLOR.

FOR HUNTING GAME CALLS (U.S. CLS. 22, 23, 38 AND 50).

TARAH HARDY, EXAMINING ATTORNEY

SN 78-498,329. GREAT LAKES DART MFG., INC., MUSKEGO, WI. FILED 10-12-2004.

CASINO BOSS

THE MARK CONSISTS OF STANDARD CHARACTERS WITHOUT CLAIM TO ANY PARTICULAR FONT, STYLE, SIZE, OR COLOR.

FOR GAMING AND CASINO PRODUCTS, NAMELY, POKER CHIPS, PLAYING CARDS, CHIP CASES, CHIP TRAYS, AND POKER TABLES (U.S. CLS. 22, 23, 38 AND 50).

KIMBERLY FRYE, EXAMINING ATTORNEY

CLASS 28—(Continued).

SN 78-498,446. ST. PIERRE, TRACY M., WAKEFIELD, MA.
FILED 10-12-2004.

How smart is your
dog?

THE MARK CONSISTS OF STANDARD CHARACTERS
WITHOUT CLAIM TO ANY PARTICULAR FONT, STYLE,
SIZE, OR COLOR.

FOR PET TOYS (U.S. CLS. 22, 23, 38 AND 50).
NORA BUCHANAN WILL, EXAMINING ATTORNEY

SN 78-498,823. PRO-LURE, LLC, MIAMI, FL. FILED 10-13-
2004.

PRO-LURE ITS

THE MARK CONSISTS OF STANDARD CHARACTERS
WITHOUT CLAIM TO ANY PARTICULAR FONT, STYLE,
SIZE, OR COLOR.

FOR FISHING LURES (U.S. CLS. 22, 23, 38 AND 50).
SEAN DWYER, EXAMINING ATTORNEY

SN 78-499,087. WARE, BROCK, BOZEMAN, MT. FILED 10-
13-2004.

ELBOWS UP!

THE MARK CONSISTS OF STANDARD CHARACTERS
WITHOUT CLAIM TO ANY PARTICULAR FONT, STYLE,
SIZE, OR COLOR.

FOR ACTION SKILL GAME (U.S. CLS. 22, 23, 38 AND
50).
REBECCA SMITH, EXAMINING ATTORNEY

CLASS 28—(Continued).

SN 78-499,995. SLINGSHOT SPORTS LLC, WHITE SALMON,
WA. FILED 10-14-2004.

ONE PUMP

THE MARK CONSISTS OF STANDARD CHARACTERS
WITHOUT CLAIM TO ANY PARTICULAR FONT, STYLE,
SIZE, OR COLOR.

FOR INFLATABLE KITE (U.S. CLS. 22, 23, 38 AND 50).
FIRST USE 4-1-2003; IN COMMERCE 4-1-2003.
KARLA PERKINS, EXAMINING ATTORNEY

SN 78-500,031. DEUTSCHE TELEKOM AG, BONN, FED REP
GERMANY, FILED 10-14-2004.

T Systems

PRIORITY CLAIMED UNDER SEC. 44(D) ON FED REP
GERMANY APPLICATION NO. 30421579135, FILED 4-15-
2004, REG. NO. 30421579, DATED 9-9-2004, EXPIRES 4-30-
2014.

OWNER OF U.S. REG. NOS. 2,448,571, 2,880,613 AND
OTHERS.

THE COLOR(S) MAGENTA AND GREY IS/ARE
CLAIMED AS A FEATURE OF THE MARK.

THE COLOR MAGENTA APPEARS IN THE LETTER "T"
IN THE MARK; THE REMAINDER OF THE MARK
APPEARS IN THE COLOR GREY.

FOR TOYS, NAMELY, BOARD GAMES, PARLOR
GAMES, CARD GAMES, TOY ACTION FIGURES,
WIND-UP TOYS, STUFFED TOYS, ELECTRICAL AND
MECHANICAL ACTION TOYS, GYMNAS TIC APPARA-
TUS AND SPORTING ARTICLES, NAMELY, CYCLING
EQUIPMENT AND ACCESSORIES, NAMELY STATION-
ARY CYCLES, FOOTBALL EQUIPMENT AND ACCES-
SORIES, NAMELY, FOOTBALLS, FOOTBALL
SHOULDER PADS, FOOTBALL GIRDLES, FOOTBALL
BODY PROTECTORS, FOOTBALL KNEE, ELBOW,
CHEST AND LEG PADS, SOCCER EQUIPMENT AND
ACCESSORIES, NAMELY, SOCCER BALLS, SOCCER
BALL GOAL NETS, SOCCER BALL KNEE PADS, BASE-
BALL EQUIPMENT AND ACCESSORIES, NAMELY
BASEBALLS, BASEBALL BATS, BASEBALL BASES,
BASEBALL MITTS, BASEBALL GLOVES, BASKETBALL
EQUIPMENT AND ACCESSORIES, NAMELY, BASKET-
BALLS, BASKETBALL GOALS, BASKETBALL NETS,
AND ALL PARTS RELATED THERETO (U.S. CLS. 22,
23, 38 AND 50).

SKYE YOUNG, EXAMINING ATTORNEY

CLASS 28—(Continued).

SN 78-500,444. BASS PRO TRADEMARKS, L.L.C., SPRINGFIELD, MO. FILED 10-15-2004.

SLING JIG

THE MARK CONSISTS OF STANDARD CHARACTERS WITHOUT CLAIM TO ANY PARTICULAR FONT, STYLE, SIZE, OR COLOR.

NO CLAIM IS MADE TO THE EXCLUSIVE RIGHT TO USE JIG, APART FROM THE MARK AS SHOWN.

FOR FISHING LURES (U.S. CLS. 22, 23, 38 AND 50).
WILLIAM VERHOSEK, EXAMINING ATTORNEY

SN 78-500,464. DAVIS, SPENCER G., LAS VEGAS, NV. FILED 10-15-2004.

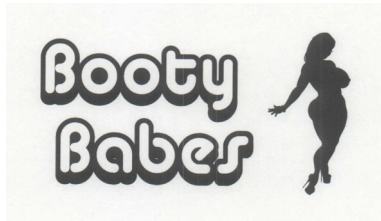

OWNER OF U.S. REG. NO. 2,789,578.
FOR DOLLS, TOY FIGURES (U.S. CLS. 22, 23, 38 AND 50).

FIRST USE 10-1-2004; IN COMMERCE 10-7-2004.
CAROLYN CATALDO, EXAMINING ATTORNEY

SN 78-501,274. THE KONG COMPANY, LLC, GOLDEN, CO. FILED 10-18-2004.

BELLY BABIES

THE MARK CONSISTS OF STANDARD CHARACTERS WITHOUT CLAIM TO ANY PARTICULAR FONT, STYLE, SIZE, OR COLOR.

FOR PET TOYS (U.S. CLS. 22, 23, 38 AND 50).
FIRST USE 10-1-2004; IN COMMERCE 10-1-2004.
CAROLYN GRAY, EXAMINING ATTORNEY

CLASS 28—(Continued).

SN 78-502,120. DEVELOPMENT ASSOCIATES, INC., NORTH KINGSTOWN, RI. FILED 10-19-2004.

SURE SHOT

THE MARK CONSISTS OF STANDARD CHARACTERS WITHOUT CLAIM TO ANY PARTICULAR FONT, STYLE, SIZE, OR COLOR.

FOR GOLF PUTTING AIDS, NAMELY ADHESIVE BACKED URETHANE PADS FOR PUTTER CLUB FACES (U.S. CLS. 22, 23, 38 AND 50).

FIRST USE 10-1-2004; IN COMMERCE 10-1-2004.
SUSAN LESLIE DUBOIS, EXAMINING ATTORNEY

SN 78-502,791. JUGUETES VERCOR, S. A., IBI (ALICANTE), SPAIN, FILED 10-20-2004.



THE MARK CONSISTS OF THE STYOLIZED TERM VERCOR WITH A STAR ABOVE THE LATTER PART OF THE TERM.

FOR TOYS FOR CHILDREN, NAMELY, STROLLERS, CARRIAGES, BEDS, BUNK BEDS, BASSINETS, BABY BATH TUBS, HIGH CHAIRS, PLAYPENS, CAR SEATS, SWINGS, IRONS AND IRONING BOARDS, PORTABLE CLOTHESLINES, CARRYALLS, PORTABLE SHOPPING TROLLEYS ON WHEELS, DESK SETS, TABLE AND CHAIR SETS, BLACK-BOARDS, DRAWING BOARDS, MAGNETIC BOARDS, WITH AND WITHOUT STANDS; BASKETBALL SET COMPRISING BACK-BOARD, HOOP AND NET (U.S. CLS. 22, 23, 38 AND 50).

FIRST USE 3-9-1993; IN COMMERCE 3-9-1993.
MARGERY A. TIERNEY, EXAMINING ATTORNEY

CLASS 28—(Continued).

SN 78-505,911. SALVETA, DONNA, PORTLAND, OR. FILED 10-26-2004.

CLASS 28—(Continued).

SN 78-507,139. AKADEMA INC., GARFIELD, NJ. FILED 10-27-2004.

BEARY ELEGANT

THE MARK CONSISTS OF STANDARD CHARACTERS WITHOUT CLAIM TO ANY PARTICULAR FONT, STYLE, SIZE, OR COLOR.

FOR STUFFED AND PLUSH TOYS AND DOLLS (U.S. CLS. 22, 23, 38 AND 50).

FIRST USE 3-0-1990; IN COMMERCE 1-0-1991.

DORITT L. CARROLL, EXAMINING ATTORNEY

Ken-Wel

THE MARK CONSISTS OF STANDARD CHARACTERS WITHOUT CLAIM TO ANY PARTICULAR FONT, STYLE, SIZE, OR COLOR.

FOR SPORTS EQUIPMENT, NAMELY BASEBALL FIELDING GLOVES AND WOODEN BASEBALL BATS (U.S. CLS. 22, 23, 38 AND 50).

FIRST USE 10-10-2004; IN COMMERCE 10-27-2004.

GEORGE LORENZO, EXAMINING ATTORNEY

SN 78-506,567. LENOX, INCORPORATED, LAWRENCEVILLE, NJ. FILED 10-27-2004.

SN 78-508,279. BECKETT COMMERCE, LOS ANGELES, CA. FILED 10-29-2004.

LENOX CLASSICS

THE MARK CONSISTS OF STANDARD CHARACTERS WITHOUT CLAIM TO ANY PARTICULAR FONT, STYLE, SIZE, OR COLOR.

OWNER OF U.S. REG. NOS. 2,218,756 AND 2,268,582. FOR CHRISTMAS TREE ORNAMENTS MADE OF CHINA OR CRYSTAL (U.S. CLS. 22, 23, 38 AND 50).

FIRST USE 3-31-2000; IN COMMERCE 3-31-2000.

CHARLES L. JENKINS, EXAMINING ATTORNEY



NO CLAIM IS MADE TO THE EXCLUSIVE RIGHT TO USE TEDDY, APART FROM THE MARK AS SHOWN.

FOR CUSTOM STUFFED PLUSH TOYS INCLUDING TEDDY BEARS, CATS, DOGS, RABBITS, MOOSE, PIGS, FROGS AND COWS (U.S. CLS. 22, 23, 38 AND 50).

AMY GEARIN, EXAMINING ATTORNEY

CLASS 28—(Continued).

SN 78-509,493. NEW LINE PRODUCTIONS, INC., NEW YORK, NY. FILED 11-1-2004.

CLASS 28—(Continued).

SN 78-513,153. BCI BURKE COMPANY, FOND DU LAC, WI. FILED 11-8-2004.

DOCTOR EVIL

THE MARK CONSISTS OF STANDARD CHARACTERS WITHOUT CLAIM TO ANY PARTICULAR FONT, STYLE, SIZE, OR COLOR.

OWNER OF U.S. REG. NO. 2,239,565.
FOR TOYS AND SPORTING GOODS, INCLUDING GAMES AND PLAYTHINGS—NAMESLY, ACTION FIGURES AND ACCESSORIES THEREFOR; PLUSH TOYS; BALLOONS; BATHTUB TOYS; RIDE-ON TOYS; EQUIPMENT SOLD AS A UNIT FOR PLAYING CARD GAMES; TOY VEHICLES; DOLLS; FLYING DISCS; ELECTRONIC HAND-HELD GAME UNIT; GAME EQUIPMENT SOLD AS A UNIT FOR PLAYING A BOARD GAME, A CARD GAME, A MANIPULATIVE GAME, A PARLOR GAME AND AN ACTION TYPE TARGET GAME; STAND ALONE VIDEO OUTPUT GAME MACHINES; JIGSAW AND MANIPULATIVE PUZZLES; PAPER FACE MASKS; SKATEBOARDS; ICE SKATES; WATER SQUIRTING TOYS; BALLS—NAMESLY, PLAYGROUND BALLS, SOCCER BALLS, BASEBALLS, BASKETBALLS; BASEBALL GLOVES; SWIMMING FLOATS FOR RECREATIONAL USE; KICKBOARD FLOTATION DEVICES FOR RECREATIONAL USE; SURFBOARDS; SWIM BOARDS FOR RECREATIONAL USE; SWIM FINS; TOY BAKEWARE AND TOY COOKWARE; TOY BANKS; TOY SNOW GLOBES; AND CHRISTMAS TREE ORNAMENTS (U.S. CLS. 22, 23, 38 AND 50).

LINDA E. BLOHM, EXAMINING ATTORNEY

NATURE PLAY

THE MARK CONSISTS OF STANDARD CHARACTERS WITHOUT CLAIM TO ANY PARTICULAR FONT, STYLE, SIZE, OR COLOR.

FOR HEAVY DUTY PLAYGROUND EQUIPMENT, NAMESLY PLAY STRUCTURES, CLIMBING UNITS, SLIDES AND SLIDING POLES, SWINGS, SWING SETS, SEE SAWS, JUNGLE GYMS, ROCKING RIDING TOYS, CAROUSELS, PLATFORMS AND ROOFS, HANDRAILS, PLAY STAIRS AND STEPS, BRIDGES, TURNING BARS, STEERING WHEELS, BARRIERS, SHAPED SEATS, FREE STANDING PLAY ENCLOSURES, FREE STANDING PLAY STRUCTURES, TUNNEL AND TUBE UNITS, PLAY PANELS, LADDERS, TUNNEL STRUCTURES IN THE FORM OF CAPSULES, BALANCE BEAMS, AND PARALLEL BARS (U.S. CLS. 22, 23, 38 AND 50).
FIRST USE 5-1-2004; IN COMMERCE 9-7-2004.
KAREN K. BUSH, EXAMINING ATTORNEY

SN 78-514,314. JOHNSON, LANNY L., OKEMOS, MI. FILED 11-10-2004.

SN 78-511,748. ARTIS, KENNETH J., BLACK RIVER FALLS, WI. FILED 11-5-2004.

TRANQUILIZER

BUBBLE GENIE

THE MARK CONSISTS OF STANDARD CHARACTERS WITHOUT CLAIM TO ANY PARTICULAR FONT, STYLE, SIZE, OR COLOR.

NO CLAIM IS MADE TO THE EXCLUSIVE RIGHT TO USE "BUBBLE", APART FROM THE MARK AS SHOWN.
FOR BUBBLE SOLUTION AND BUBBLE FORMING IMPLEMENTS (U.S. CLS. 22, 23, 38 AND 50).
KIMBERLY FRYE, EXAMINING ATTORNEY

THE MARK CONSISTS OF STANDARD CHARACTERS WITHOUT CLAIM TO ANY PARTICULAR FONT, STYLE, SIZE, OR COLOR.

FOR GOLF CLUBS AND RELATED GOLFING EQUIPMENT, NAMESLY, GOLF BAG TAGS, GOLF BALL MARKERS, GOLF GLOVES, GOLF CLUB GRIPS, GOLF BALL RETRIEVERS, DIVOT REPAIR TOOLS, GOLF CLUB INSERTS, GOLF BALLS, GOLF CLUB BAGS, GOLF CLUB HEAD COVERS, GOLF TEES, AND SWING ENHANCEMENT DEVICES (U.S. CLS. 22, 23, 38 AND 50).
ALICE SUE CARRUTHERS, EXAMINING ATTORNEY

CLASS 28—(Continued).

SN 78-514,585. MOOSE MOUNTAIN TOYMAKERS LTD.,
KOWLOON, HONG KONG, FILED 11-10-2004.

**FLASH N' CRASH
SPEEDWAY**

THE MARK CONSISTS OF STANDARD CHARACTERS
WITHOUT CLAIM TO ANY PARTICULAR FONT, STYLE,
SIZE, OR COLOR.

NO CLAIM IS MADE TO THE EXCLUSIVE RIGHT TO
USE "SPEEDWAY", APART FROM THE MARK AS SHOWN.

FOR TOYS, NAMELY A TOY RACEWAY SET COM-
POSED OF TOY VEHICLES, RACETRACKS AND TOY
ACCESSORIES FOR USE THEREWITH (U.S. CLS. 22, 23,
38 AND 50).

RAUL CORDOVA, EXAMINING ATTORNEY

SN 78-514,801. DARON WORLDWIDE TRADING INC.,
FAIRFIELD, NJ. FILED 11-10-2004.

DARON

THE MARK CONSISTS OF STANDARD CHARACTERS
WITHOUT CLAIM TO ANY PARTICULAR FONT, STYLE,
SIZE, OR COLOR.

FOR TOYS, NAMELY, MODEL AIRPLANES, MODEL
VEHICLES, MODEL TANKS, MODEL MOTORCYCLES,
MODEL POLICE CARS, MODEL FIRE ENGINES, MOD-
EL TRAINS, MODEL HELICOPTERS, MODEL ROCK-
ETS, MODEL TRUCKS, MODEL BOATS, MODEL
SPACESHIPS, MODEL BUSES; MODEL RACE CAR
TRACKS; GARAGES, AIRPORTS; RADIO AND REMOTE
CONTROLLED TOY VEHICLES; DIE CAST VEHICLES;
TOY TOPS; ACTION FIGURES; DOLLS; ROBOTS; LU-
NAR, MARTIAN, AND SPACE ROVERS AND VEHI-
CLES; KITES; SELF-PROPELLED AIRPLANES; TOY
KEY CHAINS (U.S. CLS. 22, 23, 38 AND 50).

FIRST USE 10-0-1987; IN COMMERCE 10-0-1987.

KATHRYN COWARD, EXAMINING ATTORNEY

CLASS 28—(Continued).

SN 78-515,644. ELIZABETH L. HOMZA, DBA ALPHABET
CATS, GRIFFITH, IN. FILED 11-11-2004.

KirbyStick

THE MARK CONSISTS OF STANDARD CHARACTERS
WITHOUT CLAIM TO ANY PARTICULAR FONT, STYLE,
SIZE, OR COLOR.

FOR CATNIP-FILLED CAT TOY SHAPED LIKE A
STICK (U.S. CLS. 22, 23, 38 AND 50).

FIRST USE 10-1-2002; IN COMMERCE 10-22-2002.

THEODORE MCBRIDE, EXAMINING ATTORNEY

SN 78-515,795. EVANS, KEVIN J., CRANSTON, RI. FILED 11-
12-2004.

**ALL STAR SPORTS
BANK**

THE MARK CONSISTS OF STANDARD CHARACTERS
WITHOUT CLAIM TO ANY PARTICULAR FONT, STYLE,
SIZE, OR COLOR.

NO CLAIM IS MADE TO THE EXCLUSIVE RIGHT TO
USE "BANK", APART FROM THE MARK AS SHOWN.

FOR TOY BANKS (U.S. CLS. 22, 23, 38 AND 50).

KRISTINA KLOIBER, EXAMINING ATTORNEY

CLASS 28—(Continued).

SN 78-519,040. JOHNSON, LANNY L., OKEMOS, MI. FILED 11-18-2004.

MULTIPLE VITAMIN

THE MARK CONSISTS OF STANDARD CHARACTERS WITHOUT CLAIM TO ANY PARTICULAR FONT, STYLE, SIZE, OR COLOR.

FOR GOLF CLUBS AND RELATED GOLFING EQUIPMENT NAMELY, GOLF BAG TAGS, GOLF BALL MARKERS, GOLF GLOVES, GOLF CLUB GRIPS, GOLF BALL RETRIEVERS, DIVOT REPAIR TOOLS, GOLF CLUB INSERTS, GOLF BALLS, GOLF CLUB BAGS, GOLF CLUB HEAD COVERS, GOLF TEES AND SWING ENHANCEMENT DEVICES (U.S. CLS. 22, 23, 38 AND 50).
MARGERY A. TIERNEY, EXAMINING ATTORNEY

CLASS 28—(Continued).

SN 78-519,154. NANODYNAMICS, INC., BUFFALO, NY. FILED 11-18-2004.

NDMX

THE MARK CONSISTS OF STANDARD CHARACTERS WITHOUT CLAIM TO ANY PARTICULAR FONT, STYLE, SIZE, OR COLOR.

FOR GOLF BALLS AND GOLF BALL CORES (U.S. CLS. 22, 23, 38 AND 50).
MIDGE BUTLER, EXAMINING ATTORNEY

SN 78-519,059. JOHNSON, LANNY L., OKEMOS, MI. FILED 11-18-2004.

**OUT OF THE BOX
INTO THE HOLE**

THE MARK CONSISTS OF STANDARD CHARACTERS WITHOUT CLAIM TO ANY PARTICULAR FONT, STYLE, SIZE, OR COLOR.

FOR GOLF CLUBS AND RELATED GOLFING EQUIPMENT NAMELY, GOLF BAG TAGS, GOLF BALL MARKERS, GOLF GLOVES, GOLF CLUB GRIPS, GOLF BALL RETRIEVERS, DIVOT REPAIR TOOLS, GOLF CLUB INSERTS, GOLF BALLS, GOLF CLUB BAGS, GOLF CLUB HEAD COVERS AND GOLF TEES (U.S. CLS. 22, 23, 38 AND 50).
WON TEAK OH, EXAMINING ATTORNEY

SN 78-519,240. HOBBY PRODUCTS INTERNATIONAL HOLDINGS, INC., FOOTHILL RANCH, CA. FILED 11-18-2004.

MINIZILLA

THE MARK CONSISTS OF STANDARD CHARACTERS WITHOUT CLAIM TO ANY PARTICULAR FONT, STYLE, SIZE, OR COLOR.

FOR TOYS, NAMELY, REMOTE CONTROLLED VEHICLE KITS AND PARTS THEREFORE (U.S. CLS. 22, 23, 38 AND 50).
ANN LINNEHAN, EXAMINING ATTORNEY

CLASS 28—(Continued).

SN 78-521,581. WILSON SPORTING GOODS CO., CHICAGO, IL. FILED 11-23-2004.

CLASS 28—(Continued).

SN 78-521,590. WILSON SPORTING GOODS CO., CHICAGO, IL. FILED 11-23-2004.

F3

THE MARK CONSISTS OF STANDARD CHARACTERS WITHOUT CLAIM TO ANY PARTICULAR FONT, STYLE, SIZE, OR COLOR.
FOR BASEBALL BATS, SOFTBALL BATS (U.S. CLS. 22, 23, 38 AND 50).
ALINA MORRIS, EXAMINING ATTORNEY



SN 78-521,587. WILSON SPORTING GOODS CO., CHICAGO, IL. FILED 11-23-2004.

F4

THE MARK CONSISTS OF STANDARD CHARACTERS WITHOUT CLAIM TO ANY PARTICULAR FONT, STYLE, SIZE, OR COLOR.
THE MARK IS PRESENTED IN STANDARD CHARACTERS, WITHOUT CLAIM TO ANY PARTICULAR FONT, STYLE, SIZE OR COLOR
FOR BASEBALL BATS, SOFTBALL BATS (U.S. CLS. 22, 23, 38 AND 50).
ALINA MORRIS, EXAMINING ATTORNEY

F5

THE MARK CONSISTS OF STANDARD CHARACTERS WITHOUT CLAIM TO ANY PARTICULAR FONT, STYLE, SIZE, OR COLOR.
FOR BASEBALL BATS, SOFTBALL BATS (U.S. CLS. 22, 23, 38 AND 50).
ALINA MORRIS, EXAMINING ATTORNEY



SN 78-522,373. GOLDBERG, ROBERT BARRY, CHICAGO, IL. FILED 11-24-2004.

GEEK

THE MARK CONSISTS OF STANDARD CHARACTERS WITHOUT CLAIM TO ANY PARTICULAR FONT, STYLE, SIZE, OR COLOR.
FOR BOARD GAMES (U.S. CLS. 22, 23, 38 AND 50).
LEIGH CAROLINE CASE, EXAMINING ATTORNEY

CLASS 28—(Continued).

SN 78-523,357. THE ORVIS COMPANY, INC., MANCHESTER, VT. FILED 11-28-2004.

CLASS 28—(Continued).

SN 78-524,299. GREYBEARDS, INC., DUBUQUE, IA. FILED 11-30-2004.

MACH

THE MARK CONSISTS OF STANDARD CHARACTERS WITHOUT CLAIM TO ANY PARTICULAR FONT, STYLE, SIZE, OR COLOR.
FOR FISHING TACKLE, FISHING REELS (U.S. CLS. 22, 23, 38 AND 50).
FIRST USE 1-0-2004; IN COMMERCE 1-0-2004.
CAROLYN GRAY, EXAMINING ATTORNEY

ARCHER'S SELECT

THE MARK CONSISTS OF STANDARD CHARACTERS WITHOUT CLAIM TO ANY PARTICULAR FONT, STYLE, SIZE, OR COLOR.
FOR DEER LURE FOR USE IN LURING DEER TOWARD HUNTERS, FARMERS AND MUNICIPAL PLANNERS (U.S. CLS. 22, 23, 38 AND 50).
TARAH HARDY, EXAMINING ATTORNEY

SN 78-524,006. MATTEL, INC., EL SEGUNDO, CA. FILED 11-29-2004.

SN 78-528,716. INFINIFIELD, INC., BUFFALO GROVE, IL. FILED 12-7-2004.

PIN HEDZ

THE MARK CONSISTS OF STANDARD CHARACTERS WITHOUT CLAIM TO ANY PARTICULAR FONT, STYLE, SIZE, OR COLOR.
FOR TOYS, GAMES AND PLAYTHINGS, NAMELY, TOY VEHICLES AND ACCESSORIES THEREFOR (U.S. CLS. 22, 23, 38 AND 50).
MELISSA SHELLA, EXAMINING ATTORNEY

Infinifield

THE MARK CONSISTS OF STANDARD CHARACTERS WITHOUT CLAIM TO ANY PARTICULAR FONT, STYLE, SIZE, OR COLOR.
FOR BOARD GAMES (U.S. CLS. 22, 23, 38 AND 50).
FIRST USE 10-1-2004; IN COMMERCE 10-16-2004.
MICHAEL TANNER, EXAMINING ATTORNEY

CLASS 28—(Continued).

SN 78-528,897. MATTEL, INC., EL SEGUNDO, CA. FILED 12-8-2004.

HYPERSTUNT MANIA

THE MARK CONSISTS OF STANDARD CHARACTERS WITHOUT CLAIM TO ANY PARTICULAR FONT, STYLE, SIZE, OR COLOR.

FOR TOYS, GAMES AND PLAYTHINGS, NAMELY, TOY FIGURES, PLAY FIGURES, ACTION FIGURES, DOLLS, DOLL CLOTHING, DOLL STYLING HEADS, TOY VEHICLES, TOY VEHICLE TRACK SETS, AND PLAY SETS, ACCESSORIES AND CASES FOR ALL OF THE FOREGOING; BOARD GAMES, CARD GAMES, PARLOR GAMES, ACTION SKILL GAMES, ARCADE GAMES, LCD GAME MACHINES; EQUIPMENT SOLD AS A UNIT FOR PLAYING BOARD GAMES, CARD GAMES AND MEMORY GAMES; PLUSH TOYS, STUFFED TOYS, BENDABLE TOYS, BATH TOYS, CHILDREN'S MULTIPLE-ACTIVITY TOYS, CONSTRUCTION TOYS, DRAWING TOYS, ELECTRIC ACTION TOYS, FANTASY CHARACTER TOYS, INFANT TOYS, INFLATABLE TOYS, MECHANICAL TOYS, MUSICAL TOYS, POP-UP TOYS, PULL TOYS, PUSH TOYS, RIDE-ON TOYS, SAND TOYS, SQUEEZE TOYS, TALKING TOYS, LEVER ACTION TOYS, TOY BOXES, TOY FURNITURE, PUPPETS, CHILDREN'S PLAY COSMETICS, CHRISTMAS TREE DECORATIONS, JUMP ROPES, SPORT BALLS (U.S. CLS. 22, 23, 38 AND 50).

ALICE SUE CARRUTHERS, EXAMINING ATTORNEY

SN 78-530,368. CHI AN INTERNATIONAL, INC., CITY OF INDUSTRY, CA. FILED 12-10-2004.

pipe

THE MARK CONSISTS OF STANDARD CHARACTERS WITHOUT CLAIM TO ANY PARTICULAR FONT, STYLE, SIZE, OR COLOR.

FOR GOLF EQUIPMENT, NAMELY, GOLF CLUBS AND GOLF CLUB COVERS (U.S. CLS. 22, 23, 38 AND 50).
PAULA MAHONEY, EXAMINING ATTORNEY

CLASS 28—(Continued).

SN 78-534,486. ARROW INTERNATIONAL, INC., BROOKLYN, OH. FILED 12-17-2004.

Basic

THE MARK CONSISTS OF STANDARD CHARACTERS WITHOUT CLAIM TO ANY PARTICULAR FONT, STYLE, SIZE, OR COLOR.

FOR BINGO GAME PAPER (U.S. CLS. 22, 23, 38 AND 50).

FIRST USE 10-14-2004; IN COMMERCE 10-14-2004.
JOSETTE BEVERLY, EXAMINING ATTORNEY

SN 78-534,559. CASCA, CRAIG, CAMARILLO, CA. AND FERRO, MIKE, OAK VIEW, CA. AND ITO, DARYL, OXNARD, CA. FILED 12-17-2004.

COWBOY GOLF

THE MARK CONSISTS OF STANDARD CHARACTERS WITHOUT CLAIM TO ANY PARTICULAR FONT, STYLE, SIZE, OR COLOR.

FOR ACTION SKILL GAMES, TARGET GAMES, ACTION-TYPE TARGET GAMES, ARCADE GAMES, EQUIPMENT SOLD AS A UNIT FOR PLAYING ACTION TYPE TARGET GAMES, OUTDOOR ACTIVITY GAMES IN THE NATURE OF TARGET AND SKILL GAMES, PARLOR GAMES, PARTY GAMES, AND LASSO GAMES, NONE OF WHICH FEATURE OR INCLUDE THE TRADITIONAL GAME OF GOLF (U.S. CLS. 22, 23, 38 AND 50).

PATRICIA EVANKO, EXAMINING ATTORNEY

CLASS 28—(Continued).

SN 78-536,129. MARK L. PAHLOW, SEATTLE, WA. FILED 12-21-2004.



NO CLAIM IS MADE TO THE EXCLUSIVE RIGHT TO USE "CUBES", APART FROM THE MARK AS SHOWN. THE COLOR(S) GRAY AND BLUE IS/ARE CLAIMED AS A FEATURE OF THE MARK. THE COLOR GRAY APPEARS IN THE WORDING, AND THE COLOR BLUE OUTLINES EACH LETTER. FOR PLASTIC TOY PLAY SETS FEATURING AN OFFICE ENVIRONMENT CONSISTING OF INTERCHANGEABLE FIGURES, CUBICLES AND ACCESSORIES (U.S. CLS. 22, 23, 38 AND 50). FIRST USE 12-13-2004; IN COMMERCE 12-13-2004. LAURA KOVAISKY, EXAMINING ATTORNEY

CLASS 28—(Continued).

SN 78-539,375. MILLER, ROSS, ALLSTON, MA. FILED 12-29-2004.



THE MARK CONSISTS OF STANDARD CHARACTERS WITHOUT CLAIM TO ANY PARTICULAR FONT, STYLE, SIZE, OR COLOR. FOR SOFT SCULPTURE TOY (U.S. CLS. 22, 23, 38 AND 50). FIRST USE 10-4-1980; IN COMMERCE 10-4-1980. APRIL L. RADEMACHER, EXAMINING ATTORNEY

SN 78-536,702. STANDARD PROJECT LIMITED, TSUEN WAN, N.T., HONG KONG, FILED 12-21-2004.



FOR JIGSAW PUZZLES, PUZZLES, PLAYING CARDS, CARD GAMES, BOARD GAMES, PLUSH TOYS, TOY FIGURES, TOY BOXES, CHRISTMAS TREE DECORATIONS (U.S. CLS. 22, 23, 38 AND 50). FIRST USE 1-1-1990; IN COMMERCE 1-1-2002. JENNIFER DIXON, EXAMINING ATTORNEY

SN 78-540,673. WILLIAMS, KEN B., LOS ANGELES, CA. FILED 12-31-2004.



THE MARK CONSISTS OF STANDARD CHARACTERS WITHOUT CLAIM TO ANY PARTICULAR FONT, STYLE, SIZE, OR COLOR. FOR EQUIPMENT SOLD AS A UNIT FOR PLAYING A BOARD GAME (U.S. CLS. 22, 23, 38 AND 50). FIRST USE 3-10-1995; IN COMMERCE 3-1-1996. JILL C. ALT, EXAMINING ATTORNEY

CLASS 28—(Continued).

SN 78-585,615. KING PAR CORPORATION, FLUSHING, MI.
FILED 3-11-2005.

H830

THE MARK CONSISTS OF STANDARD CHARACTERS
WITHOUT CLAIM TO ANY PARTICULAR FONT, STYLE,
SIZE, OR COLOR.

FOR GOLF CLUBS (U.S. CLS. 22, 23, 38 AND 50).
FIRST USE 1-10-2005; IN COMMERCE 1-10-2005.
RONALD AIKENS, EXAMINING ATTORNEY

SN 79-003,335. EDDY CO., LTD., TOKYO 154-0002, JAPAN,
FILED 6-21-2004.

RA

THE MARK CONSISTS OF STANDARD CHARACTERS
WITHOUT CLAIM TO ANY PARTICULAR FONT, STYLE,
SIZE, OR COLOR.

OWNER OF INTERNATIONAL REGISTRATION 0485666
DATED 6-20-1984, EXPIRES 6-20-2014.

FOR SPORTS TACKLE, IN PARTICULAR INSTALLA-
TIONS FOR SPORTS AND GAMES, NAMELY DEVICES
FOR MEASURING THE FLEXIBILITY OF THE FRAMES
AND STRINGS OF TENNIS RACKETS (U.S. CLS. 22, 23,
38 AND 50).

SUSAN STIGLITZ, EXAMINING ATTORNEY

CLASS 28—(Continued).

SN 79-005,258. OXBOW INTERNATIONAL, FRANCE, FILED
8-5-2004.

OXBOW

OWNER OF INTERNATIONAL REGISTRATION 0555651
DATED 6-11-1990, EXPIRES 6-11-2010.

OWNER OF U.S. REG. NOS. 1,535,373, 1,733,271 AND
2,349,528.

FOR SPORTS AND GYMNASTICS DEVICES, IN PAR-
TICULAR, SNOWBOARDS (U.S. CLS. 22, 23, 38 AND 50).
ROBERT COGGINS, EXAMINING ATTORNEY

SN 79-008,458. MARUMAN & CO., LTD., JAPAN, FILED 10-
25-2004.

METABIO

THE MARK CONSISTS OF STANDARD CHARACTERS
WITHOUT CLAIM TO ANY PARTICULAR FONT, STYLE,
SIZE, OR COLOR.

OWNER OF INTERNATIONAL REGISTRATION 0842079
DATED 10-25-2004, EXPIRES 10-25-2014.

FOR GOLF CLUBS, GOLF BAGS WITH OR WITHOUT
WHEELS, GOLF GLOVES, GOLF BALLS, GOLF TEES,
HEAD COVERS FOR GOLF CLUBS; GOLF BALL MAR-
KERS (U.S. CLS. 22, 23, 38 AND 50).

LINDA M. KING, EXAMINING ATTORNEY

CLASS 29—MEATS AND PROCESSED FOODS

SN 76-527,739. A. LAFLEUR, INC., ST-HENRI DE LEVIS,
QUEBEC, CANADA, FILED 7-3-2003.

MINIMAX

FOR SMOKED, CURED OR NON-SALTED MEAT
PRODUCTS, NAMELY, SAUSAGE, FRANKFURTERS,
SMOKED AND COOKED HAM BACON AND CRETON
MEAT SPREAD; SOUPS; PREPARED MEALS CONSIST-
ING PRIMARILY OF MEAT, POULTRY OR VEGETA-
BLES (U.S. CL. 46).

FIRST USE 4-8-2003; IN COMMERCE 4-8-2003.

KELLY BOULTON, EXAMINING ATTORNEY

CLASS 29—(Continued).

SN 76-537,005. TOPCO HOLDINGS, INC., SKOKIE, IL. FILED 8-12-2003.

WORLD CLASSICS TRADING COMPANY

OWNER OF U.S. REG. NOS. 1,690,372, 2,014,460 AND OTHERS.

NO CLAIM IS MADE TO THE EXCLUSIVE RIGHT TO USE "TRADING COMPANY", APART FROM THE MARK AS SHOWN.

FOR COOKING OILS, CHEESES, FROZEN AND REFRIGERATED ENTREES, NAMELY, ENTREES CONSISTING PRIMARILY OF MEAT, FISH, POULTRY OR VEGETABLES, CANNED, JARRED AND FROZEN VEGETABLES, JAMS, DRIED FRUIT, REFRIGERATED AND FROZEN MEAT AND SEAFOOD, SOUPS, OLIVES AND ANTIPASTO (U.S. CL. 46).

ELIZABETH J. WINTER, EXAMINING ATTORNEY



SN 76-546,513. SOMERVILLE, CONROE F., TAYLOR, MI. AND ADAMS, KEVIN O., TAYLOR, MI. FILED 9-23-2003.

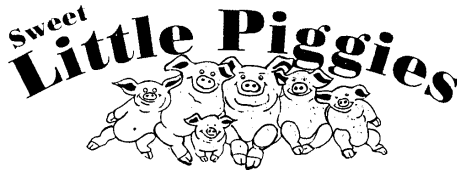

FOR BOTTLED OR CANNED VEGETABLES; PICKLED AND SEASONED VEGETABLES, NAMELY, OLIVES, PEPPERS, CAULIFLOWER, CARROTS, CELERY, ONIONS, GARLIC CLOVES, CORN, BROCCOLI, BEANS AND TOMATOES (U.S. CL. 46).

FIRST USE 7-15-2003; IN COMMERCE 8-20-2003.
APRIL L. RADEMACHER, EXAMINING ATTORNEY



SN 76-578,324. ROBERT'S AMERICAN GOURMET, SEA CLIFF, NY. FILED 2-27-2004.

SMART CRISPS

THE MARK CONSISTS OF STANDARD CHARACTERS WITHOUT CLAIM TO ANY PARTICULAR FONT, STYLE, SIZE, OR COLOR.

OWNER OF U.S. REG. NO. 1,841,453.
NO CLAIM IS MADE TO THE EXCLUSIVE RIGHT TO USE "CRISPS", APART FROM THE MARK AS SHOWN.

FOR SOY BASED SNACK FOOD (U.S. CL. 46).
FIRST USE 6-11-2003; IN COMMERCE 6-11-2003.
SAMUEL E. SHARPER JR., EXAMINING ATTORNEY

CLASS 29—(Continued).

SN 76-582,241. TKM2 SALES SOLUTIONS LLC, BOISE, ID. FILED 3-19-2004.

HAILEY'S HARVEST

THE MARK CONSISTS OF STANDARD CHARACTERS WITHOUT CLAIM TO ANY PARTICULAR FONT, STYLE, SIZE, OR COLOR.

FOR FROZEN FRUITS, VEGETABLES, ONION RINGS, AND FRENCH FRIED POTATOES (U.S. CL. 46).

DAWN HAN, EXAMINING ATTORNEY



SN 76-584,248. P & G TRADING COMPANY, INC., TRENTON, NJ. FILED 3-31-2004.

SEA RAGE

NO CLAIM IS MADE TO THE EXCLUSIVE RIGHT TO USE "SEA", APART FROM THE MARK AS SHOWN.

FOR SEA FOOD, NAMELY CANNED AND FRESH CRABMEAT AND SHELL FISH AND FROZEN SQUID AND FISH (U.S. CL. 46).

AMOS T. MATTHEWS, JR., EXAMINING ATTORNEY



SN 76-584,572. RAINSWEEP, INC., SALEM, OR. FILED 4-2-2004.

BERRY EXTREMES

THE MARK CONSISTS OF STANDARD CHARACTERS WITHOUT CLAIM TO ANY PARTICULAR FONT, STYLE, SIZE, OR COLOR.

NO CLAIM IS MADE TO THE EXCLUSIVE RIGHT TO USE BERRY, APART FROM THE MARK AS SHOWN.

FOR FROZEN BERRIES (U.S. CL. 46).
FIRST USE 5-0-2004; IN COMMERCE 5-0-2004.
ARETHA SOMERVILLE, EXAMINING ATTORNEY

CLASS 29—(Continued).

SN 76-586,368. ILLINOIS TRADING COMPANY, INC., CHICAGO, IL. FILED 4-6-2004.

ALLEN-DALE

THE MARK CONSISTS OF STANDARD CHARACTERS WITHOUT CLAIM TO ANY PARTICULAR FONT, STYLE, SIZE, OR COLOR.

FOR FROZEN, REFRIGERATED AND DRIED VEGETABLES AND MEATS, EXCLUDING SOY-BASED VEGETABLE PRODUCTS (U.S. CL. 46).

FIRST USE 9-1-1979; IN COMMERCE 9-1-1979.
CHARLES JOYNER, EXAMINING ATTORNEY

SN 76-587,560. MIYASAKA BREWERY CO., LTD., TOKYO, JAPAN, FILED 4-20-2004.

MIKO BRAND

THE MARK CONSISTS OF STANDARD CHARACTERS WITHOUT CLAIM TO ANY PARTICULAR FONT, STYLE, SIZE, OR COLOR.

NO CLAIM IS MADE TO THE EXCLUSIVE RIGHT TO USE "BRAND", APART FROM THE MARK AS SHOWN.

FOR SOYBEAN PASTE INSTANT SOUP (U.S. CL. 46).
FIRST USE 12-0-1998; IN COMMERCE 12-0-1998.
BARBARA BROWN, EXAMINING ATTORNEY

SN 76-588,112. DISNEY ENTERPRISES, INC., BURBANK, CA. FILED 4-19-2004.



OWNER OF U.S. REG. NO. 2,700,619.

FOR FRUIT PRESERVES; FRUIT-BASED SNACK FOOD; JAMS; JELLIES; POTATO CHIPS; NUTS, NAMELY, ROASTED AND SHELLED NUTS; MILK AND MILK PRODUCTS EXCLUDING ICE CREAM, ICE MILK AND FROZEN YOGURT (U.S. CL. 46).

WILLIAM BRECKENFELD, EXAMINING ATTORNEY

CLASS 29—(Continued).

SN 76-590,229. TERFLOTH TRADE MARKS LTD., HAMILTON HM LX, BERMUDA, FILED 5-4-2004.



FOR CANNED COOKED MEAT, NAMELY, LUNCHEON MEAT, CORNED BEEF AND VIENNA SAUSAGES; POULTRY; FROZEN MEATS; MEAT EXTRACTS; PRESERVED, DRIED AND COOKED CANNED FRUITS AND CANNED VEGETABLES; CANNED AND PREPARED FROZEN FISH, NAMELY, TUNA, MACKEREL, SARDINES, HERRING AND SALMON; CANNED SEAFOOD, NAMELY, SHRIMP, OYSTERS, CRAB AND LOBSTER; SOUPS, NAMELY, CHICKEN NOODLE SOUP, CANNED SOUPS, SOUP MIXES AND DRIED SOUPS; JAMS; JELLIES; MARMALADES; DAIRY DERIVED PRODUCTS, NAMELY, PROCESSED CHEESE AND BUTTER; SOUR CREAM; WHIPPING CREAM; YOGURT; MILK PRODUCTS, NAMELY, MILK, CONDENSED MILK AND EVAPORATED MILK; MILK BASED DRINKS, NAMELY, FLAVORED MILK; PEANUT BUTTER; COCONUT MILK; COCONUT CREAM; EDIBLE OILS AND FATS, NAMELY, OLIVE OIL AND CANOLA OIL; PASTES, NAMELY, FRUIT PASTES, VEGETABLE PASTES, MEAT PASTES, TOMATO PASTE AND HOT PEPPER PASTE; PROCESSED PULSES, NAMELY, LENTILS, PEAS AND BEANS; PICKLES; FRUIT SAUCES, NAMELY, CRANBERRY SAUCE, APPLESAUCE; CANNED CORN, NAMELY, WHOLE KERNEL CORN AND CORN ON THE COB; POTATO CRISPS AND POTATO CHIPS; NUT MEATS; HOT PEPPER OIL EXTRACTS; FROZEN, PREPARED AND PACKAGED READY TO EAT MEALS CONSISTING PRIMARILY OF MEAT, FISH, POULTRY AND/OR VEGETABLES (U.S. CL. 46).

LEIGH LOWRY, EXAMINING ATTORNEY

SN 76-591,214. MITOLO HOLDINGS PTY LTD, SOUTH AUSTRALIA 5120, AUSTRALIA, FILED 5-10-2004.

OLLO

THE MARK CONSISTS OF STANDARD CHARACTERS WITHOUT CLAIM TO ANY PARTICULAR FONT, STYLE, SIZE, OR COLOR.

PRIORITY CLAIMED UNDER SEC. 44(D) ON AUSTRALIA APPLICATION NO. 978602, FILED 11-14-2003, REG. NO. 978602, DATED 11-14-2003, EXPIRES 11-14-2013.

FOR PRESERVED, DRIED, COOKED AND FROZEN FRUITS AND VEGETABLES, NAMELY, OLIVES AND PICKLES; JELLIES AND JAMS; EDIBLE OILS AND FATS, NAMELY, OLIVE OIL; PRESERVES (U.S. CL. 46).

KELLY CHOE, EXAMINING ATTORNEY

CLASS 29—(Continued).

SN 76-599,642. EAST COAST OLIVE OIL CORPORATION,
UTICA, NY. FILED 6-29-2004.

CLIO

FOR COOKING OIL (U.S. CL. 46).
FIRST USE 0-0-1948; IN COMMERCE 0-0-1948.
CAROL SPILS, EXAMINING ATTORNEY

SN 76-600,483. NUOVA CASTELLI S.P.A., 42100 REGGIO
EMILIA, ITALY, FILED 7-2-2004.



OWNER OF ERPN CMNTY TM OFC REG. NO. 3290137,
DATED 7-30-2003, EXPIRES 7-30-2013.

NO CLAIM IS MADE TO THE EXCLUSIVE RIGHT TO
USE "DAL 1892, BUTTER OF PARMA", "SELEZIONE",
"INDUSTRIE ALIMENTARI S.P.A.", "REGGIO EMILIA"
AND "SPECIALITA CASEARIE", APART FROM THE
MARK AS SHOWN.

THE ENGLISH TRANSLATION OF THE WORD DAL 1892,
SELEZIONE, INDUSTRIE ALIMENTARI, AND SPECIALI-
TA CASEARIE IN THE MARK IS SINCE 1892, SELECTION,
FOOD INDUSTRY AND DAIRY SPECIALTIES.

FOR BUTTER (U.S. CL. 46).
ANGELA M. MICHELI, EXAMINING ATTORNEY

SN 76-607,982. PIONEER SNACKS, INC., FARMINGTON
HILLS, MI. FILED 8-12-2004.

PIONEER

THE MARK CONSISTS OF STANDARD CHARACTERS
WITHOUT CLAIM TO ANY PARTICULAR FONT, STYLE,
SIZE, OR COLOR.

OWNER OF U.S. REG. NOS. 1,930,358, 2,620,937 AND
2,857,291.

FOR SNACK FOODS, NAMELY DRIED FRUIT AND
NUTS (U.S. CL. 46).

PRISCILLA MILTON, EXAMINING ATTORNEY

CLASS 29—(Continued).

SN 76-609,167. NATIONAL PACKING CORP., BRONX, NY.
FILED 8-25-2004.

BENNY'S BRAND

THE MARK CONSISTS OF STANDARD CHARACTERS
WITHOUT CLAIM TO ANY PARTICULAR FONT, STYLE,
SIZE, OR COLOR.

NO CLAIM IS MADE TO THE EXCLUSIVE RIGHT TO
USE BRAND, APART FROM THE MARK AS SHOWN.

FOR MEAT PRODUCTS, NAMELY COOKED SAU-
SAGES (U.S. CL. 46).

FIRST USE 6-11-1991; IN COMMERCE 6-11-1991.
TANYA AMOS, EXAMINING ATTORNEY

SN 76-615,110. F. WARDYNSKI & SONS, INC., BUFFALO,
NY. FILED 10-6-2004.

SHELLY BRAND

THE MARK CONSISTS OF STANDARD CHARACTERS
WITHOUT CLAIM TO ANY PARTICULAR FONT, STYLE,
SIZE, OR COLOR.

NO CLAIM IS MADE TO THE EXCLUSIVE RIGHT TO
USE "BRAND", APART FROM THE MARK AS SHOWN.

FOR SAUSAGE, SMOKED MEATS, FROZEN POUL-
TRY, CANNED MEATS, FRESH, FROZEN AND CURED
BEEF, FRESH PORK, AND LARD (U.S. CL. 46).

MICHAEL ENGEL, EXAMINING ATTORNEY

SN 76-615,145. SPARBOE AGRICULTURAL CORP., LITCH-
FIELD, MN. FILED 10-8-2004.

OMEGA PLUS

THE MARK CONSISTS OF STANDARD CHARACTERS
WITHOUT CLAIM TO ANY PARTICULAR FONT, STYLE,
SIZE, OR COLOR.

NO CLAIM IS MADE TO THE EXCLUSIVE RIGHT TO
USE "OMEGA", APART FROM THE MARK AS SHOWN.

FOR EGGS (U.S. CL. 46).

FIRST USE 1-15-2004; IN COMMERCE 1-15-2004.

MONTIA G. PRESSEY, EXAMINING ATTORNEY

CLASS 29—(Continued).

SN 76-621,254. AZUMA FOODS INTERNATIONAL, INC., HAYWARD, CA. FILED 11-19-2004.

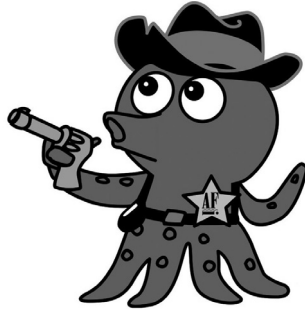

THE MARK CONSISTS, IN PART, OF THE LETTERS, AFI, WITH THE "I" SHOWN HORIZONTALLY, THE FANCIFUL DESIGN OF AN OCTOPUS WEARING A HAT AND SHERIFF'S BADGE, AND HOLDING A GUN, AND DESIGN.

FOR PACKAGED OCTOPUS (U.S. CL. 46).
FIRST USE 1-15-1991; IN COMMERCE 1-15-1991.
BARBARA A. GOLD, EXAMINING ATTORNEY

SN 76-623,341. MR. DELL FOODS, INC., KEARNEY, MO. FILED 12-6-2004.

MR. DELL'S

THE MARK CONSISTS OF STANDARD CHARACTERS WITHOUT CLAIM TO ANY PARTICULAR FONT, STYLE, SIZE, OR COLOR.

OWNER OF U.S. REG. NO. 1,111,026.
FOR PROCESSED POTATOES (U.S. CL. 46).
FIRST USE 1-1-1990; IN COMMERCE 1-1-1990.
ALEX KEAM, EXAMINING ATTORNEY

SN 76-624,821. SONOMA FOODS, INC., SONOMA, CA. FILED 12-15-2004.

PRIMOSA

THE MARK CONSISTS OF STANDARD CHARACTERS WITHOUT CLAIM TO ANY PARTICULAR FONT, STYLE, SIZE, OR COLOR.

FOR CHEESE (U.S. CL. 46).
FIRST USE 6-14-2004; IN COMMERCE 6-14-2004.
MARLENE BELL, EXAMINING ATTORNEY

CLASS 29—(Continued).

SN 76-626,093. FUNSTER NATURAL FOODS, INC., LONDON, ONTARIO, CANADA, FILED 12-27-2004.

FUNSTER

THE MARK CONSISTS OF STANDARD CHARACTERS WITHOUT CLAIM TO ANY PARTICULAR FONT, STYLE, SIZE, OR COLOR.

FOR FROZEN POTATOES AND FROZEN VEGETABLES (U.S. CL. 46).
TRACY WHITAKER-BOWN, EXAMINING ATTORNEY

SN 76-626,506. VIENNA BEEF LTD., CHICAGO, IL. FILED 12-30-2004.



OWNER OF U.S. REG. NO. 1,448,725.
NO CLAIM IS MADE TO THE EXCLUSIVE RIGHT TO USE "SOUPS", APART FROM THE MARK AS SHOWN.

THE COLOR(S) GREEN, ORANGE, AND WHITE IS/ARE CLAIMED AS A FEATURE OF THE MARK.

THE MARK CONSISTS OF THE WORDS BISTRO SOUPS, WITH BISTRO IN GREEN AGAINST AN ORANGE TRIANGULAR BACKGROUND OUTLINED IN GREEN AND SOUPS IN WHITE AGAINST A GREEN RIBBON-TYPE BACKGROUND, OUTLINED IN ORANGE. THERE ARE ALSO GREEN DESIGN ELEMENTS ABOVE AND BE- NEATH THE WORD BISTRO.

FOR SOUPS (U.S. CL. 46).
FIRST USE 9-20-1984; IN COMMERCE 9-20-1984.
INGA ERVIN, EXAMINING ATTORNEY

SN 78-216,051. SARA LEE FOODS, INC., CINCINNATI, OH. FILED 2-18-2003.

BALL PARK SINGLES

OWNER OF U.S. REG. NOS. 1,807,761 AND 2,366,105.
FOR HOT DOGS (U.S. CL. 46).
FIRST USE 9-30-1998; IN COMMERCE 9-30-1998.
MICHAEL ENGEL, EXAMINING ATTORNEY

CLASS 29—(Continued).

SN 78-267,531. PRAIRIE ORCHARD FARMS, INC., WINNIPEG, CANADA, FILED 6-26-2003.

JUST PORK

OWNER OF CANADA REG. NO. TMA608590, DATED 4-26-2004, EXPIRES 4-26-2019.
NO CLAIM IS MADE TO THE EXCLUSIVE RIGHT TO USE "PORK", APART FROM THE MARK AS SHOWN.
FOR PORK (U.S. CL. 46).
BERYL GARDNER, EXAMINING ATTORNEY

SN 78-278,539. BREEDEN COMPANY, THE, WAUCONDA, IL. FILED 7-24-2003.

WAUCONDA ORCHARDS

SEC. 2(F).
FOR FRUIT PRESERVES, JELLIES, APPLE BUTTER AND APPLE SAUCE (U.S. CL. 46).
FIRST USE 9-15-1959; IN COMMERCE 9-15-1959.
CHRISTOPHER BUONGIORNO, EXAMINING ATTORNEY

SN 78-278,573. THE BREEDEN COMPANY, WAUCONDA, IL. FILED 7-24-2003.



SEC. 2(F).
FOR FRUIT PRESERVES, JELLIES, APPLE BUTTER AND APPLE SAUCE (U.S. CL. 46).
FIRST USE 9-15-1959; IN COMMERCE 9-15-1959.
CHRISTOPHER BUONGIORNO, EXAMINING ATTORNEY

CLASS 29—(Continued).

SN 78-326,942. OMEGA BEEF CORPORATION, BROWNFIELD, TX. FILED 11-12-2003.



NO CLAIM IS MADE TO THE EXCLUSIVE RIGHT TO USE "BEEF", APART FROM THE MARK AS SHOWN.
THE MARK CONSISTS OF THE WORDS "OMEGA BEEF" IN STYLIZED FORMAT WITH THE FIRST LETTER OF "OMEGA" FORMED BY A CAPITAL GREEK OMEGA WHICH CONTINUES TO FORM THE FIRST LETTER OF "BEEF".
FOR BEEF FOR HUMAN CONSUMPTION (U.S. CL. 46).
FIRST USE 5-1-2003; IN COMMERCE 5-1-2003.
MARK T. MULLEN, EXAMINING ATTORNEY

SN 78-330,628. FRITO-LAY NORTH AMERICA, INC., PLANO, TX. FILED 11-20-2003.

SABRITAS

THE MARK CONSISTS OF STANDARD CHARACTERS WITHOUT CLAIM TO ANY PARTICULAR FONT, STYLE, SIZE, OR COLOR.
OWNER OF U.S. REG. NOS. 739,115, 2,595,728 AND 2,759,708.
FOR PROCESSED NUTS (U.S. CL. 46).
DEZMONA MIZELLE, EXAMINING ATTORNEY

CLASS 29—(Continued).

SN 78-330,629. FRITO-LAY NORTH AMERICA, INC., PLANO, TX. FILED 11-20-2003.



OWNER OF U.S. REG. NOS. 739,115, 2,595,728 AND 2,759,708.
 THE LINING IS A FEATURE OF THE MARK AND DOES NOT INDICATE COLOR.
 FOR PROCESSED NUTS (U.S. CL. 46).
 DEZMONA MIZELLE, EXAMINING ATTORNEY

SN 78-353,994. CARGILL MEAT SOLUTIONS CORPORATION, WICHITA, KS. FILED 1-20-2004.

TENDER CHOICE

THE MARK CONSISTS OF STANDARD CHARACTERS WITHOUT CLAIM TO ANY PARTICULAR FONT, STYLE, SIZE, OR COLOR.
 OWNER OF U.S. REG. NO. 1,818,629.
 SEC. 2(F).
 FOR MEAT (U.S. CL. 46).
 FIRST USE 2-12-1993; IN COMMERCE 2-12-1993.
 KAREN K. BUSH, EXAMINING ATTORNEY

SN 78-357,350. DYNASEA CORPORATION, DEL MAR, CA. FILED 1-26-2004.



NO CLAIM IS MADE TO THE EXCLUSIVE RIGHT TO USE ORIGINAL, APART FROM THE MARK AS SHOWN, FOR READY TO SERVE PRE-PACKAGED SHRIMP COCKTAIL (U.S. CL. 46).
 FIRST USE 4-3-2003; IN COMMERCE 4-3-2003.
 ANDREW BENZMILLER, EXAMINING ATTORNEY

CLASS 29—(Continued).

SN 78-373,211. WISE KOSHER NATURAL POULTRY, INC., BROOKLYN, NY. FILED 2-24-2004.

EAT HEALTHY EAT WISE

THE MARK CONSISTS OF STANDARD CHARACTERS WITHOUT CLAIM TO ANY PARTICULAR FONT, STYLE, SIZE, OR COLOR.
 FOR ORGANIC CHICKEN, ORGANIC TURKEY, ORGANIC EGGS, CHICKEN FRANKFURTERS, CHICKEN BROTH, TURKEY STEW (U.S. CL. 46).
 FIRST USE 1-0-1996; IN COMMERCE 1-0-1996.
 YONG KIM, EXAMINING ATTORNEY

SN 78-392,707. QUANTUM FOODS, INC., BOLINGBROOK, IL. FILED 3-29-2004.



OWNER OF U.S. REG. NOS. 2,234,075 AND 2,321,948.
 NO CLAIM IS MADE TO THE EXCLUSIVE RIGHT TO USE "ANGUS" OR "BRAND", APART FROM THE MARK AS SHOWN.
 THE MARK CONSISTS OF AN OVAL WITH A SILHOUETTE OF A BULL STANDING IN THE MIDDLE.
 SEC. 2(F) AS TO MIDWESTERN.
 FOR PROCESSED MEAT, NAMELY, BEEF AND PORK; MEAT PRODUCTS, NAMELY, BEEF AND PORK; POULTRY AND SEAFOOD (U.S. CL. 46).
 BRIAN PINO, EXAMINING ATTORNEY

CLASS 29—(Continued).

SN 78-395,790. HEB GROCERY COMPANY, L.P., SAN ANTONIO, TX. FILED 4-2-2004.

**IT'S REAL MILK,
ONLY BETTER!**

THE MARK CONSISTS OF STANDARD CHARACTERS WITHOUT CLAIM TO ANY PARTICULAR FONT, STYLE, SIZE, OR COLOR.

FOR MILK; YOGURT; BUTTER; AND YOGURT-BASED BEVERAGES (U.S. CL. 46).

AMOS T. MATTHEWS, JR., EXAMINING ATTORNEY

SN 78-401,865. SEA-MEX CO. INC., MAYWOOD, CA. FILED 4-14-2004.



NO CLAIM IS MADE TO THE EXCLUSIVE RIGHT TO USE "MARISCOS SEAFOOD THE BEST...FROM THE SEA", APART FROM THE MARK AS SHOWN.

THE FOREIGN WORDING IN THE MARK TRANSLATES INTO ENGLISH AS SEAFOOD.

FOR SEAFOOD, NAMELY, SALMON, SNOW CRAB, OYSTERS, SHRIMP, FISH, SQUID, AND GREEN MUSSELS (U.S. CL. 46).

MATTHEW KLINE, EXAMINING ATTORNEY

SN 78-406,670. ENERDRINKS NOROESTE S.L., 150705 LA CORUNA, SPAIN, FILED 4-22-2004.

O₃ Dietolive

THE MARK CONSISTS OF STANDARD CHARACTERS WITHOUT CLAIM TO ANY PARTICULAR FONT, STYLE, SIZE, OR COLOR.

FOR EDIBLE OILS AND EDIBLE FATS; OLIVE OIL (U.S. CL. 46).

DAVID MURRAY, EXAMINING ATTORNEY

CLASS 29—(Continued).

SN 78-408,771. STARBUCKS U.S. BRANDS, LLC, MINDEN, NV. FILED 4-27-2004.

STARBUCKS

THE MARK CONSISTS OF STANDARD CHARACTERS WITHOUT CLAIM TO ANY PARTICULAR FONT, STYLE, SIZE, OR COLOR.

FOR MILK AND MILK PRODUCTS, NAMELY POWDERED MILK, CONDENSED MILK, STERILIZED MILK, EVAPORATED MILK, MALTED MILK FOR FOOD, CREAM, WHIPPING CREAM, DAIRY OR NON-DAIRY BASED WHIPPED TOPPING, NON-DAIRY COFFEE CREAMER (U.S. CL. 46).

TIMOTHY FINNEGAN, EXAMINING ATTORNEY

SN 78-416,089. WOODSTOCK WATER BUFFALO COMPANY LLC, SOUTH WOODSTOCK, VT. FILED 5-10-2004.

BUFFALO BUDDIES

THE MARK CONSISTS OF STANDARD CHARACTERS WITHOUT CLAIM TO ANY PARTICULAR FONT, STYLE, SIZE, OR COLOR.

FOR DAIRY PRODUCTS EXCLUDING ICE CREAM, ICE MILK, AND FROZEN YOGURT. (U.S. CL. 46).

SKYE YOUNG, EXAMINING ATTORNEY

SN 78-421,751. CANADIAN FISH EXPORTERS, INC., WATERTOWN, MA. FILED 5-19-2004.



THE ENGLISH TRANSLATION OF THE TERMS APPEARING IN THE MARK IS "ISLAND BREEZE".

FOR FISH (U.S. CL. 46).

GENE MACIOL, EXAMINING ATTORNEY

CLASS 29—(Continued).

SN 78-423,662. CHEEZWHESE.COM, INC., ARMONK, NY.
FILED 5-24-2004.

THE WORLD'S BEST CHEESES

THE MARK CONSISTS OF STANDARD CHARACTERS WITHOUT CLAIM TO ANY PARTICULAR FONT, STYLE, SIZE, OR COLOR.

NO CLAIM IS MADE TO THE EXCLUSIVE RIGHT TO USE "CHEESES", APART FROM THE MARK AS SHOWN. SEC. 2(F).

FOR CHEESE (U.S. CL. 46).
FIRST USE 3-0-1987; IN COMMERCE 3-0-1987.
NANCY CLARKE, EXAMINING ATTORNEY

SN 78-424,414. LUISSIER, VIROFLAY, FRANCE, FILED 5-25-2004.

GRAND ADOUR

THE MARK CONSISTS OF STANDARD CHARACTERS WITHOUT CLAIM TO ANY PARTICULAR FONT, STYLE, SIZE, OR COLOR.

OWNER OF FRANCE REG. NO. 93464820, DATED 4-16-1993, RENEWED AS REG. NO. 93464820, DATED 4-16-2003, EXPIRES 4-16-2013.

THE TRANSLATION OF GRAND IS "GREAT." FOR MEAT AND GAME, MEAT EXTRACTS; HAM, LIVER PATE, POTTED MINCE; SAUSAGE; EDIBLE OILS (U.S. CL. 46).

NORA BUCHANAN WILL, EXAMINING ATTORNEY

SN 78-429,021. COLEMAN NATURAL PRODUCTS, INC., GOLDEN, CO. FILED 6-2-2004.

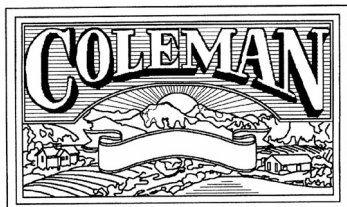

OWNER OF U.S. REG. NOS. 1,484,448, 2,463,451 AND OTHERS.

THE LINING IN THE DRAWING IS A FEATURE OF THE MARK.

FOR FRESH, FROZEN AND PROCESSED MEATS (U.S. CL. 46).

FIRST USE 5-0-2003; IN COMMERCE 5-0-2003.
MELISSA SHELLA, EXAMINING ATTORNEY

CLASS 29—(Continued).

SN 78-431,376. INNER MONGOLIA MENGNIU MILK INDUSTRY (GROUP) CO., LTD., HUHNOT, INNER MONGOLIA, CHINA, FILED 6-7-2004.



THE MARK CONSISTS OF TWO CHINESE CHARACTERS AND A BLACK SQUARE DEVICE WITH A LINE SEPARATING A MOON DEVICE AND A WORD MENGNIU BEING THE TRANSLITERATION OF THE TWO CHINESE CHARACTERS.

THE NON-LATIN CHARACTER(S) IN THE MARK TRANSLITERATES INTO MENGNIU, AND THIS MEANS COVER AND COW IN ENGLISH.

FOR ALBUMEN FOR FOOD; PROCESSED NUTS; UNFLAVORED AND UNSWEETENED GELATINS FOR FOOD; FRUIT SALADS; VEGETABLE-SALADS; EDIBLE FATS; COCOA BUTTER FOR FOOD PURPOSES; BUTTER; CHEESE IN GENERAL; MILK; YOGURT; MILK BEVERAGES, NAMELY, KOUMISS, KEFIR, FERMENTED MARE AND CAMEL MILK; DAIRY-BASED BEVERAGES; WHEY; DAIRY PRODUCTS EXCLUDING ICE CREAM, ICE MILK AND FROZEN YOGURT; MARGARINE; CASEIN FOR FOOD; MILK-BASED BEVERAGES CONTAINING TEA; MILK-BASED BEVERAGES CONTAINING COCOA; ACIDOPHILUS MILK; EGGS; FROZEN VEGETABLES; TOMATO PUREE; FROZEN FRUITS; JAMS; MEAT; FISH IN GENERAL FOR FOOD PURPOSES; CANNED FRUITS; CREAM; SAUSAGES (U.S. CL. 46).

ANNE MADDEN, EXAMINING ATTORNEY

SN 78-437,706. CLOVERDALE FOODS COMPANY, MANDAN, ND. FILED 6-18-2004.



Joe Cheezer

FOR FOOD PACKAGE COMBINATIONS CONSISTING PRIMARILY OF CHEESE, MEAT AND/OR PROCESSED FRUIT (U.S. CL. 46).

MICHAEL WEBSTER, EXAMINING ATTORNEY

CLASS 29—(Continued).

SN 78-437,886. SUPREME OIL COMPANY, ENGLEWOOD, NJ. FILED 6-18-2004.

CLASS 29—(Continued).

SN 78-439,433. JUSTIN WILSON HOLDINGS, INC., BATON ROUGE, LA. FILED 6-22-2004.

PAN WHIZ

THE MARK CONSISTS OF STANDARD CHARACTERS WITHOUT CLAIM TO ANY PARTICULAR FONT, STYLE, SIZE, OR COLOR.

NO CLAIM IS MADE TO THE EXCLUSIVE RIGHT TO USE PAN, APART FROM THE MARK AS SHOWN.

FOR EDIBLE OILS (U.S. CL. 46).
SHARON MEIER, EXAMINING ATTORNEY

WICKED CAJUN

THE MARK CONSISTS OF STANDARD CHARACTERS WITHOUT CLAIM TO ANY PARTICULAR FONT, STYLE, SIZE, OR COLOR.

NO CLAIM IS MADE TO THE EXCLUSIVE RIGHT TO USE "CAJUN", APART FROM THE MARK AS SHOWN.

FOR PICKLES (U.S. CL. 46).
FIRST USE 1-31-2002; IN COMMERCE 1-31-2002.
CHARLES L. JENKINS, EXAMINING ATTORNEY

SN 78-438,589. ARCADE INDUSTRIES, INC., DBA ARCADE SNACKS, NORTHBORO, MA. FILED 6-21-2004.

SN 78-440,156. DFO, INC., SPARTANBURG, SC. FILED 6-23-2004.

THE 19TH HOLE SNACK

THE MARK CONSISTS OF STANDARD CHARACTERS WITHOUT CLAIM TO ANY PARTICULAR FONT, STYLE, SIZE, OR COLOR.

NO CLAIM IS MADE TO THE EXCLUSIVE RIGHT TO USE "SNACK", APART FROM THE MARK AS SHOWN.

FOR SNACK MIXES CONSISTING PRIMARILY OF NUTS, AND VEGETABLE, CORN AND SESAME BASED FOODS (U.S. CL. 46).

FIRST USE 3-1-1999; IN COMMERCE 3-18-1999.
MICHAEL TANNER, EXAMINING ATTORNEY

Cucumber Craverz

THE MARK CONSISTS OF STANDARD CHARACTERS WITHOUT CLAIM TO ANY PARTICULAR FONT, STYLE, SIZE, OR COLOR.

NO CLAIM IS MADE TO THE EXCLUSIVE RIGHT TO USE CUCUMBER, APART FROM THE MARK AS SHOWN.

FOR CHILDREN'S MENU SIDE ITEM CONSISTING OF CUCUMBER SLICES AND RANCH DRESSING (U.S. CL. 46).

FIRST USE 1-12-2004; IN COMMERCE 1-12-2004.
BRIDGETT SMITH, EXAMINING ATTORNEY

CLASS 29—(Continued).

SN 78-440,162. DFO, INC., SPARTANBURG, SC. FILED 6-23-2004.

Potato Volcano

THE MARK CONSISTS OF STANDARD CHARACTERS WITHOUT CLAIM TO ANY PARTICULAR FONT, STYLE, SIZE, OR COLOR.

NO CLAIM IS MADE TO THE EXCLUSIVE RIGHT TO USE POTATO, APART FROM THE MARK AS SHOWN.

FOR CHILDREN'S MENU SIDE ITEM CONSISTING OF MASHED POTATOES WITH GRAVY (U.S. CL. 46). FIRST USE 1-12-2004; IN COMMERCE 1-12-2004. BRIDGETT SMITH, EXAMINING ATTORNEY

SN 78-448,360. BOJANGLES' INTERNATIONAL LLC, CHARLOTTE, NC. FILED 7-9-2004.



OWNER OF U.S. REG. NOS. 1,177,496, 1,426,710 AND OTHERS.

NO CLAIM IS MADE TO THE EXCLUSIVE RIGHT TO USE "FAMOUS" AND "CHICKEN'N BISCUITS", APART FROM THE MARK AS SHOWN.

THE COLOR(S) RED AND BLACK IS/ARE CLAIMED AS A FEATURE OF THE MARK.

THE COLOR RED APPEARS IN THE WORD BOJANGLES AND IN THE TWO STARS. THE COLOR BLACK APPEARS IN THE OUTER EDGES OF THE WORD BOJANGLES, AND IN THE WORDS FAMOUS AND CHICKEN N'BISCUITS. THE COLOR BLACK ALSO APPEARS WITHIN THE CURVED LINES THAT APPEAR BEFORE AND AFTER THE WORD FAMOUS.

FOR CHICKEN FOR CONSUMPTION ON OR OFF THE PREMISES (U.S. CL. 46).

FIRST USE 9-26-2003; IN COMMERCE 9-26-2003. EVELYN BRADLEY, EXAMINING ATTORNEY

CLASS 29—(Continued).

SN 78-449,214. SUPREME FOODS, INC., SUFFOLK, VA. FILED 7-12-2004.

JESSE'S BEST DELI

THE MARK CONSISTS OF STANDARD CHARACTERS WITHOUT CLAIM TO ANY PARTICULAR FONT, STYLE, SIZE, OR COLOR.

NO CLAIM IS MADE TO THE EXCLUSIVE RIGHT TO USE "BEST DELI", APART FROM THE MARK AS SHOWN. FOR MEATS, CHESES AND PICKLES (U.S. CL. 46). THEODORE MCBRIDE, EXAMINING ATTORNEY

SN 78-449,893. FRITO-LAY NORTH AMERICA, INC., PLANO, TX. FILED 7-13-2004.



OWNER OF U.S. REG. NOS. 739,115, 2,595,728 AND 2,759,708.

NO CLAIM IS MADE TO THE EXCLUSIVE RIGHT TO USE "BRAND", APART FROM THE MARK AS SHOWN.

FOR PROCESSED PEANUTS (U.S. CL. 46). RAMONA ORTIGA, EXAMINING ATTORNEY

SN 78-450,024. ACH FOOD COMPANIES, INC., MEMPHIS, TN. FILED 7-13-2004.

CAPULLO DE MAZOLA

THE MARK CONSISTS OF STANDARD CHARACTERS WITHOUT CLAIM TO ANY PARTICULAR FONT, STYLE, SIZE, OR COLOR.

OWNER OF U.S. REG. NOS. 83,639, 721,414 AND 1,172,467. THE ENGLISH TRANSLATION OF THE MARK CAPULLO DE MAZOLA IS "COCOON OR FLOWER BUD OF MAZOLA."

FOR EDIBLE OILS, SHORTENING, AND MARGARINE (U.S. CL. 46).

KAREN K. BUSH, EXAMINING ATTORNEY

CLASS 29—(Continued).

SN 78-451,494. ACH FOOD COMPANIES, INC., MEMPHIS, TN. FILED 7-15-2004.



OWNER OF U.S. REG. NOS. 721,414, 1,172,467 AND OTHERS.

THE COLORS RED, GREEN AND GOLD ARE CLAIMED AS A FEATURE OF THE MARK.

THE COLOR RED APPEARS IN THE FLOWER AND THE WORDING CAPULLO DE. THE COLOR GREEN APPEARS IN THE LEAVES AND THE WORD MAZOLA. THE COLOR GOLD APPEARS IN THE OUTLINE OF THE WORD MAZOLA.

THE ENGLISH TRANSLATION OF THE WORD CAPULLO IN THE MARK IS "COCOON OR FLOWER BUD."

FOR EDIBLE OILS, SHORTENINGS, AND MARGARINES (U.S. CL. 46).

JOHN SCHUYLER YARD, EXAMINING ATTORNEY



SN 78-452,369. WILKINSON, PAUL, LOS GATOS, CA. FILED 7-18-2004.

Mayo Is Boring

THE MARK CONSISTS OF STANDARD CHARACTERS WITHOUT CLAIM TO ANY PARTICULAR FONT, STYLE, SIZE, OR COLOR.

NO CLAIM IS MADE TO THE EXCLUSIVE RIGHT TO USE MAYO, APART FROM THE MARK AS SHOWN.

FOR DIPS (U.S. CL. 46).

PRISCILLA MILTON, EXAMINING ATTORNEY

CLASS 29—(Continued).

SN 78-452,734. AGRICOLA EL TRONCO S.A., SANTIAGO, CHILE. FILED 7-19-2004.



NO CLAIM IS MADE TO THE EXCLUSIVE RIGHT TO USE "PATAGONIA" AND "CHEESE", APART FROM THE MARK AS SHOWN.

THE COLORS BROWN, BLUE, YELLOW, WHITE, ORANGE AND RED ARE CLAIMED AS A FEATURE OF THE MARK.

THE TOP BORDER, THE WORDING CHEESE AND THE SHADING OF THE WORDING PATAGONIA ARE IN YELLOW. THE SKY IS RED. THE SUN RAYS ARE ORANGE. THE DETAIL IN THE MOUNTAINS AND THE WORDING PANQUEHUE ARE IN BLUE. THE WORDING PATAGONIA IS IN BROWN.

THE MARK CONSISTS OF THREE MOUNTAINS AND A SUNRISE.

THE ENGLISH TRANSLATION OF "PANQUEHUE" IS "PLACE OF GRASS".

FOR CHEESE (U.S. CL. 46).

LA TONIA FISHER, EXAMINING ATTORNEY



SN 78-459,419. WELLS' DAIRY, INC., LEMARS, IA. FILED 7-30-2004.

SWIRL SENSATIONS

THE MARK CONSISTS OF STANDARD CHARACTERS WITHOUT CLAIM TO ANY PARTICULAR FONT, STYLE, SIZE, OR COLOR.

NO CLAIM IS MADE TO THE EXCLUSIVE RIGHT TO USE "SWIRL", APART FROM THE MARK AS SHOWN.

FOR YOGURT (U.S. CL. 46).

GRETTA YAO, EXAMINING ATTORNEY

CLASS 29—(Continued).

SN 78-467,007. J.G VAN HOLTEN & SONE, INC., WATER-
LOO, WI. FILED 8-13-2004.



FOR PICKLE (U.S. CL. 46).
FIRST USE 7-1-2002; IN COMMERCE 7-1-2002.
MIDGE BUTLER, EXAMINING ATTORNEY

SN 78-467,358. ALASKA FRESH SEAFOODS, INC., DBA
OCEAN FRESH SEAFOODS, INC., SEATTLE, WA. FILED
8-13-2004.

ALASKA FRESH

THE MARK CONSISTS OF STANDARD CHARACTERS
WITHOUT CLAIM TO ANY PARTICULAR FONT, STYLE,
SIZE, OR COLOR.
OWNER OF U.S. REG. NO. 1,266,463.
NO CLAIM IS MADE TO THE EXCLUSIVE RIGHT TO
USE "FRESH", APART FROM THE MARK AS SHOWN.
SEC. 2(F).
FOR SEAFOOD (U.S. CL. 46).
FIRST USE 10-5-1978; IN COMMERCE 1-11-1979.
SANI KHOURI, EXAMINING ATTORNEY

CLASS 29—(Continued).

SN 78-473,157. CLOVERDALE FOODS COMPANY, MAN-
DAN, ND. FILED 8-25-2004.

BACON EASY

THE MARK CONSISTS OF STANDARD CHARACTERS
WITHOUT CLAIM TO ANY PARTICULAR FONT, STYLE,
SIZE, OR COLOR.
NO CLAIM IS MADE TO THE EXCLUSIVE RIGHT TO
USE "BACON", APART FROM THE MARK AS SHOWN.
FOR BACON (U.S. CL. 46).
RONALD MCMORROW, EXAMINING ATTORNEY

SN 78-474,782. GENGLER, PETER J., CALEDONIA, MN.
AND GENGLER, NICHOLAS R., CALEDONIA, MN.
FILED 8-27-2004.

SNO PAC

THE MARK CONSISTS OF STANDARD CHARACTERS
WITHOUT CLAIM TO ANY PARTICULAR FONT, STYLE,
SIZE, OR COLOR.
NO CLAIM IS MADE TO THE EXCLUSIVE RIGHT TO
USE "PACK", APART FROM THE MARK AS SHOWN.
FOR FROZEN FOOD; NAMELY, FRUITS AND VEGE-
TABLES (U.S. CL. 46).
FIRST USE 12-31-1945; IN COMMERCE 12-31-1946.
GISELLE AGOSTO, EXAMINING ATTORNEY

CLASS 29—(Continued).

SN 78-477,252. PRODUCTOS LA AGUADILLANA, INC., AGUADILLA, PUERTO RICO, FILED 9-1-2004.



NO CLAIM IS MADE TO THE EXCLUSIVE RIGHT TO USE "PRODUCTOS", APART FROM THE MARK AS SHOWN.

THE COLOR(S) RED, YELLOW AND BLUE IS/ARE CLAIMED AS A FEATURE OF THE MARK.

THE MARK CONSISTS OF A YELLOW SEMICIRCLE WITH RED OUTLINE FOLLOWED BY A BLUE OUTER OUTLINE CONTAINING THE WORDS PRODUCTOS ON TOP OF A PIE DIVIDED IN THREE PORTIONS. FROM LEFT TO RIGHT THE FIRST PORTION CONTAINING A CHICKEN, THE SECOND A COW, AND THE THIRD A PIG DESIGN. UNEDERNEATH THE ANIMAL DESINGS A YELLOW BANNER WITH RED OUTLINE CONTAINING THE WORDS LA AGUADILLANA ALSO IN RED.

THE FOREIGN WORDING IN THE MARK TRANSLATES INTO ENGLISH AS WOMAN FROM AGUADILLA.

FOR MEATS AND BREADED MEAT FOOD PRODUCTS, NAMELY, BREADED CHICKEN FILLET, BREADED CHICKEN BREAST, BREADED BEEFSTEAK, BREADED TURKEY BREAST, BREADED FISH FILLET, CHICKEN NUGGETS, TURKEY NUGGETS, FISH NUGGETS AND CHICKEN CORDON BLEU (U.S. CL. 46).

FIRST USE 1-1-1965; IN COMMERCE 1-1-1989.
KEVON CHISOLM, EXAMINING ATTORNEY

CLASS 29—(Continued).

SN 78-481,471. A&W RESTAURANTS, INC., LOUISVILLE, KY. FILED 9-10-2004.



NO CLAIM IS MADE TO THE EXCLUSIVE RIGHT TO USE "WISCONSIN FRESH" AND "CHEESE CURDS", APART FROM THE MARK AS SHOWN.

FOR FRIED CHEESE BALLS (U.S. CL. 46).
FIRST USE 3-1-2004; IN COMMERCE 3-1-2004.
SKYE YOUNG, EXAMINING ATTORNEY

SN 78-480,166. PAINTED HILLS NATURAL BEEF, INC., FOSSIL, OR. FILED 9-8-2004.

**Painted Hills
Natural Beef**

THE MARK CONSISTS OF STANDARD CHARACTERS WITHOUT CLAIM TO ANY PARTICULAR FONT, STYLE, SIZE, OR COLOR.

NO CLAIM IS MADE TO THE EXCLUSIVE RIGHT TO USE "NATURAL BEEF", APART FROM THE MARK AS SHOWN.

FOR BEEF PRODUCTS, NAMELY, BEEF, PRIMAL CUTS OF BEEF, STEAKS, ROASTS, AND VALUE-ADDED PRODUCTS, NAMELY HOTDOGS, BEEF JERKY, BACON, GROUND BEEF, HAMBURGER PATTIES, SAUSAGES, ENTREES CONSISTING PRIMARILY OF BEEF, LUNCHEON MEATS, NAMELY PASTRAMI, CORNED BEEF, ROAST BEEF (U.S. CL. 46).

FIRST USE 6-1-1999; IN COMMERCE 7-1-1999.
TRICIA SONNEBORN, EXAMINING ATTORNEY

SN 78-482,899. KULP, NED K., CHALFONT, PA. FILED 9-13-2004.

Chipzels

THE MARK CONSISTS OF STANDARD CHARACTERS WITHOUT CLAIM TO ANY PARTICULAR FONT, STYLE, SIZE, OR COLOR.

FOR POTATO CHIPS (U.S. CL. 46).
KENNETH D. BATTLE, EXAMINING ATTORNEY

CLASS 29—(Continued).

SN 78-488,120. 200 KELSEY ASSOCIATES, LLC, NEW ROCHELLE, NY. FILED 9-22-2004.

FROST PAK

THE MARK CONSISTS OF STANDARD CHARACTERS WITHOUT CLAIM TO ANY PARTICULAR FONT, STYLE, SIZE, OR COLOR.

NO CLAIM IS MADE TO THE EXCLUSIVE RIGHT TO USE "PAK", APART FROM THE MARK AS SHOWN.

FOR FROZEN FOODS, NAMELY FROZEN MEALS CONSISTING PRIMARILY OF MEAT, FISH, POULTRY OR VEGETABLES (U.S. CL. 46).

WON TEAK OH, EXAMINING ATTORNEY

CLASS 29—(Continued).

SN 78-496,521. SOROKIN, VITALIY, ALBANY, NY. FILED 10-7-2004.

SUN BOUNTY

NO CLAIM IS MADE TO THE EXCLUSIVE RIGHT TO USE "SUN", APART FROM THE MARK AS SHOWN.

THE MARK CONSISTS OF THE WORDS "SUN BOUNTY", WHERE THE LETTER "O" CAN BE REPRESENTED BY THE DESIGN OF AN APPLE. THE MARK IS NOT IN COLOR.

FOR PROCESSED VEGETABLES, FRUITS, AND BERRIES, NAMELY— CUCUMBER PICKLES AND OTHER PICKLED VEGETABLES, VEGETABLE MEDLEYS, VEGETABLE RAGOUTS, VEGETABLE PUREES, STUFFED VEGETABLES; PROCESSED FOREST MUSHROOMS, PROCESSED FRUITS AND BERRIES, SUCH AS FRUIT AND BERRY PRESERVES, JAMS, JELLIES (U.S. CL. 46).

FIRST USE 5-7-2002; IN COMMERCE 5-7-2002.
MARK T. MULLEN, EXAMINING ATTORNEY

SN 78-497,937. CCD FRESH, LLC, SAN FRANCISCO, CA. FILED 10-11-2004.

SN 78-488,815. MEDURI FARMS, INC., DALLAS, OR. FILED 9-23-2004.

**MEDURI WORLD
DELIGHT**

STEAMCUISINE

NO CLAIM IS MADE TO THE EXCLUSIVE RIGHT TO USE "STEAM CUISINE", APART FROM THE MARK AS SHOWN.

THE MARK CONSISTS OF THE LETTERS STEAMCUISINE WITH THREE WAVY LINES APPEARING AT THE TOP OF THE LETTER "C".

FOR PREPARED REFRIGERATED FOODS, NAMELY MEALS CONSISTING PRIMARILY OF FISH, VEGETABLES OR POULTRY (U.S. CL. 46).

FIRST USE 10-11-2004; IN COMMERCE 10-11-2004.
MARGERY A. TIERNEY, EXAMINING ATTORNEY

THE MARK CONSISTS OF STANDARD CHARACTERS WITHOUT CLAIM TO ANY PARTICULAR FONT, STYLE, SIZE, OR COLOR.

FOR FRUIT-BASED SNACK FOODS (U.S. CL. 46).
BRIAN NEVILLE, EXAMINING ATTORNEY

CLASS 29—(Continued).

SN 78-499,831. GEMSA ENTERPRISES, LLC, LA MIRADA, CA. FILED 10-14-2004.

ALBERGO

THE MARK CONSISTS OF STANDARD CHARACTERS WITHOUT CLAIM TO ANY PARTICULAR FONT, STYLE, SIZE, OR COLOR.

THE ENGLISH TRANSLATION OF THE ITALIAN WORD "ALBERGO" IN THE MARK IS "HOTEL".

FOR CANOLA OIL, SUNFLOWER OIL, SOY BEAN OIL, EXTRA VIRGIN OLIVE OIL, CORN OIL, GRAPESEED OIL, PEANUT OIL, BLENDED VEGETABLE OIL AND BLENDED OLIVE OIL (U.S. CL. 46).

FIRST USE 6-14-1996; IN COMMERCE 6-14-1996.
DOMINIC J. FERRAIUOLO, EXAMINING ATTORNEY

SN 78-500,165. MACKIE, JILL S., CLE ELUM, WA. FILED 10-14-2004.

KING VALLEY BEEF

THE MARK CONSISTS OF STANDARD CHARACTERS WITHOUT CLAIM TO ANY PARTICULAR FONT, STYLE, SIZE, OR COLOR.

NO CLAIM IS MADE TO THE EXCLUSIVE RIGHT TO USE "BEEF", APART FROM THE MARK AS SHOWN.

FOR MEAT (U.S. CL. 46).
FIRST USE 12-0-2002; IN COMMERCE 12-0-2002.
BRENDAN REGAN, EXAMINING ATTORNEY

CLASS 29—(Continued).

SN 78-501,630. APPLEBEE'S INTERNATIONAL, INC., OVERLAND PARK, KS. FILED 10-18-2004.



OWNER OF U.S. REG. NO. 1,963,385.

NO CLAIM IS MADE TO THE EXCLUSIVE RIGHT TO USE "RIBLETS" AND "ORIGINAL", APART FROM THE MARK AS SHOWN.

FOR MEATS, NAMELY, BARBECUE RIB TIPS (U.S. CL. 46).

FIRST USE 8-16-2004. THE MARK WAS FIRST USED ANYWHERE IN A DIFFERENT FORM OTHER THAN THAT SOUGHT TO BE REGISTERED ON 08/00/1994, AND IN COMMERCE ON 08/00/1994; IN COMMERCE 8-16-2004.
ELLEN PERKINS, EXAMINING ATTORNEY

SN 78-501,865. AFR, LLC, NASHVILLE, NC. FILED 10-19-2004.

MAN IN THE MOON

THE MARK CONSISTS OF STANDARD CHARACTERS WITHOUT CLAIM TO ANY PARTICULAR FONT, STYLE, SIZE, OR COLOR.

FOR CHEESE PRODUCTS, NAMELY, CHEESE (U.S. CL. 46).

BRIAN PINO, EXAMINING ATTORNEY

SN 78-505,159. TYSON DELI, INC., SPRINGDALE, AR. FILED 10-25-2004.

HONEY OF A HAM

THE MARK CONSISTS OF STANDARD CHARACTERS WITHOUT CLAIM TO ANY PARTICULAR FONT, STYLE, SIZE, OR COLOR.

NO CLAIM IS MADE TO THE EXCLUSIVE RIGHT TO USE "HONEY" AND "HAM", APART FROM THE MARK AS SHOWN.

FOR PROCESSED MEATS, NAMELY, HAM (U.S. CL. 46).

FIRST USE 11-0-1985; IN COMMERCE 11-0-1985.
JEAN IM, EXAMINING ATTORNEY

CLASS 29—(Continued).

SN 78-509,437. THE HARRIS SOUP COMPANY, PORTLAND, OR. FILED 11-1-2004.

CLASS 29—(Continued).

SN 78-518,890. VENTURA FOODS, LLC, BREA, CA. FILED 11-17-2004.

BAD JACK'S

PERFECTO

THE MARK CONSISTS OF STANDARD CHARACTERS WITHOUT CLAIM TO ANY PARTICULAR FONT, STYLE, SIZE, OR COLOR.

THE NAME(S), PORTRAIT(S), AND/OR SIGNATURE(S) SHOWN IN THE MARK DOES NOT IDENTIFY A PARTICULAR LIVING INDIVIDUAL.

FOR SOUP, NAMELY CHILI (U.S. CL. 46).
FIRST USE 4-30-2002; IN COMMERCE 4-30-2002.
INGA ERVIN, EXAMINING ATTORNEY

THE MARK CONSISTS OF STANDARD CHARACTERS WITHOUT CLAIM TO ANY PARTICULAR FONT, STYLE, SIZE, OR COLOR.

OWNER OF U.S. REG. NOS. 614,002 AND 973,541.
FOR SHORTENING (U.S. CL. 46).
CYNTHIA SLOAN, EXAMINING ATTORNEY

SN 78-519,181. RIVIANA FOODS INC., HOUSTON, TX. FILED 11-18-2004.

SN 78-517,363. DEL MONTE CORPORATION, PITTSBURGH, PA. FILED 11-16-2004.

SOUP ON THE RUN

SUCCESS

THE MARK CONSISTS OF STANDARD CHARACTERS WITHOUT CLAIM TO ANY PARTICULAR FONT, STYLE, SIZE, OR COLOR.

NO CLAIM IS MADE TO THE EXCLUSIVE RIGHT TO USE "SOUP", APART FROM THE MARK AS SHOWN.
FOR SOUP (U.S. CL. 46).
MARGERY A. TIERNEY, EXAMINING ATTORNEY

THE MARK CONSISTS OF STANDARD CHARACTERS WITHOUT CLAIM TO ANY PARTICULAR FONT, STYLE, SIZE, OR COLOR.

OWNER OF U.S. REG. NOS. 909,247, 1,844,958 AND 2,071,545.
FOR EDIBLE OILS (U.S. CL. 46).
ROBERT LAVACHE, EXAMINING ATTORNEY

CLASS 29—(Continued).

SN 78-522,823. TWO CHEFS ON A ROLL, INC., CARSON, CA. FILED 11-24-2004.

CLASS 29—(Continued).

SN 78-525,749. AMERICAN SEAFOODS GROUP LLC, SEATTLE, WA. FILED 12-2-2004.

**YOU LOOK THIN.
EAT.**



THE MARK CONSISTS OF STANDARD CHARACTERS WITHOUT CLAIM TO ANY PARTICULAR FONT, STYLE, SIZE, OR COLOR.

FOR SAVORY FOOD ITEMS, NAMELY, CRAB DIP (U.S. CL. 46).

FIRST USE 4-1-2003; IN COMMERCE 4-1-2003.

LEIGH CAROLINE CASE, EXAMINING ATTORNEY

NO CLAIM IS MADE TO THE EXCLUSIVE RIGHT TO USE "CATFISH", APART FROM THE MARK AS SHOWN.

THE MARK CONSISTS OF THE WORDS "CLEAR LAKES CATFISH" IN STYLIZED LETTERS, WITH DESIGN CONSISTING OF A LAKE WITH TWO MOUNTAIN PEAKS IN THE BACKGROUND AND A TREE FOREST TO THE LEFT OF THE LAKE AREA.

FOR CATFISH, NAMELY FILLETS BOTH BREADED AND PLAIN, WHOLE FISH BOTH BREADED AND PLAIN, SMOKED, STUFFED, SEASONED, AND BREADED NUGGETS (U.S. CL. 46).

BILL DAWE, EXAMINING ATTORNEY

SN 78-525,521. ACH FOOD COMPANIES, INC., CORDOVA, TN. FILED 12-1-2004.

SN 78-534,042. FRESH EXPRESS INCORPORATED, SALINAS, CA. FILED 12-16-2004.

WHIRL ZT



THE MARK CONSISTS OF STANDARD CHARACTERS WITHOUT CLAIM TO ANY PARTICULAR FONT, STYLE, SIZE, OR COLOR.

OWNER OF U.S. REG. NO. 590,876.

FOR EDIBLE OILS, EDIBLE OIL-BASED COOKING SPRAYS, AND SHORTENING (U.S. CL. 46).

JASON TURNER, EXAMINING ATTORNEY

OWNER OF U.S. REG. NOS. 2,323,851, 2,346,673 AND 2,569,875.

NO CLAIM IS MADE TO THE EXCLUSIVE RIGHT TO USE "FRESH", APART FROM THE MARK AS SHOWN.

FOR PRECUT FRESH PACKAGED FRUITS AND VEGETABLES, SALAD KITS CONSISTING OF PRECUT VEGETABLES OR FRUITS AND SALAD DRESSINGS (U.S. CL. 46).

FIRST USE 2-8-1999; IN COMMERCE 2-8-1999.

BILL DAWE, EXAMINING ATTORNEY

CLASS 29—(Continued).

SN 78-534,247. BRAKEBUSH BROTHERS, INC., WEST-FIELD, WI. FILED 12-17-2004.

CHIK'N JR'S

THE MARK CONSISTS OF STANDARD CHARACTERS WITHOUT CLAIM TO ANY PARTICULAR FONT, STYLE, SIZE, OR COLOR.

NO CLAIM IS MADE TO THE EXCLUSIVE RIGHT TO USE CHICKEN, APART FROM THE MARK AS SHOWN, FOR FURTHER PROCESSED CHICKEN (U.S. CL. 46).
SHARON MEIER, EXAMINING ATTORNEY

SN 78-534,438. FOODS GONE WILD, INC., NEW YORK, NY. FILED 12-17-2004.

PUT SOMETHING WILD IN YOUR MOUTH

THE MARK CONSISTS OF STANDARD CHARACTERS WITHOUT CLAIM TO ANY PARTICULAR FONT, STYLE, SIZE, OR COLOR.

FOR POTATO CHIPS; FRUIT CHIPS; FRUIT-BASED SNACK FOOD; SNACK FOOD DIPS; CANDIED FRUIT SNACKS; SNACK MIX CONSISTING PRIMARILY OF PROCESSED FRUITS, PROCESSED NUTS AND/OR RAISINS (U.S. CL. 46).
SUNG IN, EXAMINING ATTORNEY

CLASS 29—(Continued).

SN 78-536,265. SARA LEE FOODS, INC., CINCINNATI, OH. FILED 12-21-2004.

DELI SELECT

THE MARK CONSISTS OF STANDARD CHARACTERS WITHOUT CLAIM TO ANY PARTICULAR FONT, STYLE, SIZE, OR COLOR.

OWNER OF U.S. REG. NO. 1,804,638.

SEC. 2(F).

FOR CHEESE (U.S. CL. 46).

FIRST USE 7-18-2004; IN COMMERCE 7-18-2004.

JOHN E. MICHOS, EXAMINING ATTORNEY

SN 78-536,296. HIGH LINER FOODS (USA) INC., PORTSMOUTH, NH. FILED 12-21-2004.

FUN BUCKET

THE MARK CONSISTS OF STANDARD CHARACTERS WITHOUT CLAIM TO ANY PARTICULAR FONT, STYLE, SIZE, OR COLOR.

NO CLAIM IS MADE TO THE EXCLUSIVE RIGHT TO USE "BUCKET", APART FROM THE MARK AS SHOWN.

FOR PACKAGED FROZEN APPETIZER COMBINATIONS CONSISTING PRIMARILY OF SEAFOOD, VEGETABLES AND CHEESE (U.S. CL. 46).

FIRST USE 8-31-2004; IN COMMERCE 8-31-2004.

KRISTINA KLOIBER, EXAMINING ATTORNEY

CLASS 29—(Continued).

SN 78-536,366. HIGH LINER FOODS (USA) INC., PORTSMOUTH, NH. FILED 12-21-2004.

3 IN 1 SEAFOOD FUN BUCKET

THE MARK CONSISTS OF STANDARD CHARACTERS WITHOUT CLAIM TO ANY PARTICULAR FONT, STYLE, SIZE, OR COLOR.

NO CLAIM IS MADE TO THE EXCLUSIVE RIGHT TO USE "3 IN 1 SEAFOOD" OR "BUCKET", APART FROM THE MARK AS SHOWN.

FOR PACKAGED FROZEN APPETIZER COMBINATIONS CONSISTING PRIMARILY OF SEAFOOD, VEGETABLES AND CHEESE (U.S. CL. 46).

FIRST USE 8-31-2004; IN COMMERCE 8-31-2004.
KRISTINA KLOIBER, EXAMINING ATTORNEY

CLASS 29—(Continued).

SN 78-538,163. KIM SENG COMPANY, MONTEBELLO, CA. FILED 12-23-2004.

QUE HUONG

THE MARK CONSISTS OF STANDARD CHARACTERS WITHOUT CLAIM TO ANY PARTICULAR FONT, STYLE, SIZE, OR COLOR.

OWNER OF U.S. REG. NOS. 2,099,092 AND 2,311,982.
THE FOREIGN WORDING IN THE MARK TRANSLATES INTO ENGLISH AS "ONE'S NATIVE LAND" OR "COUNTRY", OR "ONE'S FATHERLAND".

FOR PICKLES, PICKLED RADISH, PICKLED VEGETABLE, PICKLED EGGPLANT, PICKLED CHILI, PICKLED RED PEPPERS, PICKLED SMALL CRAB, PICKLED GARLIC, PICKLED LEEK, PICKLED PAPAYA, PICKLED LEMON, PICKLED LOTUS ROOT, PICKLED GINGER, PICKLED FISH (U.S. CL. 46).

FIRST USE 9-8-1996; IN COMMERCE 9-8-1996.
JEFF DEFORD, EXAMINING ATTORNEY

SN 79-004,642. LIDL STIFTUNG & CO. KG, FED REP GERMANY, FILED 5-19-2004.

Fischerstolz

THE MARK CONSISTS OF STANDARD CHARACTERS WITHOUT CLAIM TO ANY PARTICULAR FONT, STYLE, SIZE, OR COLOR.

OWNER OF INTERNATIONAL REGISTRATION 0831330 DATED 5-19-2004, EXPIRES 5-19-2014.

FOR FISH, RAW AND PREPARED, NAMELY—SMOKED FISH, FISH CROQUETTES, FISH MOUSSE, FISH SAUSAGES, FISH PRESERVES, FISH MARINADES, FISH SALADS, FISH JELLIES; CAVIAR; SHELLFISH; CRUSTACEANS AND MOLLUSKS, RAW, PREPARED OR PRESERVED; PICKLES (U.S. CL. 46).

GRETTA YAO, EXAMINING ATTORNEY

SN 78-537,742. VITASOY INTERNATIONAL HOLDINGS LIMITED, NEW TERRITORIES, HONG KONG, FILED 12-23-2004.



The logo for Vitasoy features the word "Vitasoy" in a bold, sans-serif font. The letter "o" in "Vitasoy" is replaced by a stylized leaf or plant icon.

OWNER OF U.S. REG. NOS. 1,868,942, 2,765,529 AND OTHERS.

FOR SOY-BASED FOOD BEVERAGE USED AS A MILK SUBSTITUTE (U.S. CL. 46).

FIRST USE 9-30-2004; IN COMMERCE 9-30-2004.
ANGELA M. MICHELI, EXAMINING ATTORNEY

SN 79-006,146. BONGRAIN S.A. (SOCIÉTÉ ANONYME), FRANCE, FILED 8-30-2004.

LE DÉLICE DU CRÉMIER

THE MARK CONSISTS OF STANDARD CHARACTERS WITHOUT CLAIM TO ANY PARTICULAR FONT, STYLE, SIZE, OR COLOR.

PRIORITY DATE OF 3-5-2004 IS CLAIMED.

OWNER OF INTERNATIONAL REGISTRATION 0835492 DATED 8-30-2004, EXPIRES 8-30-2014.

THE ENGLISH TRANSLATION OF THE WORDING "LE DÉLICE DU CRÉMIER" IS "THE DELIGHT OF THE DAIRYMAN".

FOR MILK, CHEESE AND DAIRY PRODUCTS, EXCLUDING ICE CREAM, ICE MILK AND FROZEN YOGURT (U.S. CL. 46).

HEATHER THOMPSON, EXAMINING ATTORNEY

CLASS 30—STAPLE FOODS

SN 76-327,938. SHERWOOD BRANDS, LLC, ROCKVILLE, MD. FILED 10-19-2001.

24 CARROT

FOR CANDY (U.S. CL. 46).
FIRST USE 1-0-1998; IN COMMERCE 1-0-1998.
ROBERT LORENZO, EXAMINING ATTORNEY

SN 76-327,939. SHERWOOD BRANDS, LLC, ROCKVILLE, MD. FILED 10-19-2001.

18 CARROT

FOR CANDY (U.S. CL. 46).
FIRST USE 1-0-1998; IN COMMERCE 1-0-1998.
ROBERT LORENZO, EXAMINING ATTORNEY

SN 76-536,909. JOE RAGAN'S COFFEE, LTD., SPRINGFIELD, VA. FILED 7-25-2003.

NEW YORK MICROROAST

NO CLAIM IS MADE TO THE EXCLUSIVE RIGHT TO USE "MICROROAST", APART FROM THE MARK AS SHOWN.

FOR COFFEE AND COFFEE BEANS (U.S. CL. 46).
FIRST USE 1-18-1996; IN COMMERCE 1-18-1996.
MARC LEIPZIG, EXAMINING ATTORNEY

SN 76-550,392. RUIZ FOOD PRODUCTS, INC., DINUBA, CA. FILED 9-22-2003.

EL MONTEREY TOASTER TACOS

OWNER OF U.S. REG. NOS. 1,932,924 AND 1,935,183.
NO CLAIM IS MADE TO THE EXCLUSIVE RIGHT TO USE "TOASTER TACOS", APART FROM THE MARK AS SHOWN.

THE ENGLISH TRANSLATION OF THE WORD EL MONTEREY IN THE MARK IS THE MOUNTAIN KING.

FOR FROZEN MEXICAN-STYLE FOOD PRODUCTS, NAMELY, ENCHILADAS, TAMALES, BURRITOS, CHIMICHANGAS, TAQUITOS, QUESADILLAS, AND SOFT TACOS; PREPARED MEXICAN APPETIZERS, NAMELY, TACOS, MINI TACOS, TAQUITOS, FLAUTAS, MINI BURRITOS, AND MINI CHIMICHANGAS (U.S. CL. 46).
LINDA E. BLOHM, EXAMINING ATTORNEY

CLASS 30—(Continued).

SN 76-553,765. DILETTANTE CHOCOLATES, INC., SEATTLE, WA. FILED 10-23-2003.

FRUIT CRAVINGS

NO CLAIM IS MADE TO THE EXCLUSIVE RIGHT TO USE "FRUIT", APART FROM THE MARK AS SHOWN.
FOR FRUIT DIPPED OR COATED IN CHOCOLATE, FRUIT DIPPED OR COATED IN CARAMEL (U.S. CL. 46).

FIRST USE 9-1-2003; IN COMMERCE 9-1-2003.
LINDA MICKLEBURGH, EXAMINING ATTORNEY

SN 76-567,916. SAFEWAY INC., PLEASANTON, CA. FILED 12-19-2003.

DICKENS' TOFFEE

THE MARK CONSISTS OF STANDARD CHARACTERS WITHOUT CLAIM TO ANY PARTICULAR FONT, STYLE, SIZE, OR COLOR.

NO CLAIM IS MADE TO THE EXCLUSIVE RIGHT TO USE TOFFEE, APART FROM THE MARK AS SHOWN.

FOR COFFEE (U.S. CL. 46).
FIRST USE 12-31-1994; IN COMMERCE 12-31-1994.
JENNIFER MARTIN, EXAMINING ATTORNEY

SN 76-572,100. CONFISERIE VAN DAMME N.V., B-9230 WETTEREN, BELGIUM, FILED 1-20-2004.

VAN DAMME

THE MARK CONSISTS OF STANDARD CHARACTERS WITHOUT CLAIM TO ANY PARTICULAR FONT, STYLE, SIZE, OR COLOR.

THE WORD VAN DAMME IS THE LAST NAME OF THE LIVING INDIVIDUAL, VAN DAMME, WHOSE CONSENT TO REGISTRATION IS ATTACHED TO THIS APPLICATION. "DAMME" IS THE NAME OF A TOWN IN THE WESTERN PART OF BELGIUM AND "VAN DAMME" MEANS A PERSON WHO COMES FROM THE TOWN OF DAMME, BELGIUM.

FOR CANDY; SWEETS, NAMELY MINTS, MARZIPAN, FUDGE, BUBBLE GUM, CARAMELS, AND NOUGAT; CONFECTIONERY, NAMELY MARSHMALLOWS, CHOCOLATE COVERED MARSHMALLOWS, CHOCOLATES, SOFT CANDIES AND BONBONS (U.S. CL. 46).

FIRST USE 5-0-1990; IN COMMERCE 6-0-2002.
ARETHA SOMERVILLE, EXAMINING ATTORNEY

CLASS 30—(Continued).

SN 76-577,909. PARIS GOURMET OF NEW YORK INC., CARLSTADT, NJ. FILED 2-25-2004.

DE CHOIX

THE MARK CONSISTS OF STANDARD CHARACTERS WITHOUT CLAIM TO ANY PARTICULAR FONT, STYLE, SIZE, OR COLOR.

OWNER OF U.S. REG. NO. 2,207,747.
 THE ENGLISH TRANSLATION OF THE WORD "DE CHOIX" IN THE MARK IS "OF CHOICE".
 SEC. 2(F).
 FOR VINEGARS AND SPICES (U.S. CL. 46).
 FIRST USE 0-0-1958; IN COMMERCE 0-0-1958.
 RUSS HERMAN, EXAMINING ATTORNEY

SN 76-581,594. SABORMEX, S.A. DE C.V., COL. APATLACO, MEXICO D.F., MEXICO, FILED 3-17-2004.



OWNER OF U.S. REG. NOS. 2,667,779 AND 2,878,875.
 NO CLAIM IS MADE TO THE EXCLUSIVE RIGHT TO USE "CAFE DE GRANO", APART FROM THE MARK AS SHOWN.

AN ENGLISH TRANSLATION OF THE WORDS "CAFE DE GRANO" IS "GRAIN COFFEE".
 FOR COFFEE (U.S. CL. 46).
 STEVEN JACKSON, EXAMINING ATTORNEY

SN 76-583,241. LA CANASTA MEXICAN FOODS PRODUCTS, INC., PHOENIX, AZ. FILED 3-25-2004.



SUBJECT TO CONCURRENT USE PROCEEDING WITH U.S. REGISTRATION NOS. 2,401,166; 1,942,466; AND 1,852,517; APPLICANT CLAIMS THE EXCLUSIVE RIGHT TO USE THE MARK IN THE AREA COMPRISING IN THE

CLASS 30—(Continued).

EXACT TERRITORY OF THE UNITED STATES, COMPRISING ONLY, THE STATES OF ALASKA, ARIZONA, CALIFORNIA, COLORADO, IDAHO, MONTANA, NEVADA, NEW MEXICO, OKLAHOMA, OREGON, TEXAS, UTAH, AND WYOMING. SEE CONCURRENT USE PROCEEDING NO. 1117, ORIGINALLY MAILED JULY 17, 1998, AND NOTE THE ADMISSIONS TO SUCH, AND AN AGREEMENT REFERENCED FOR SUCH BY THE THEN-CONCURRENT USER, LA CANASTA OF MINNESOTA, INC., AND NOW SPARTA FOODS, INC.

OWNER OF U.S. REG. NO. 1,434,854.
 NO CLAIM IS MADE TO THE EXCLUSIVE RIGHT TO USE "TORTILLAS", APART FROM THE MARK AS SHOWN.
 THE ENGLISH TRANSLATION OF THE WORDS LA CANASTA IN THE MARK IS "THE BASKET".

FOR TORTILLAS (U.S. CL. 46).
 FIRST USE 0-0-1987; IN COMMERCE 0-0-1987.
 ROBERT C. CLARK JR., EXAMINING ATTORNEY

SN 76-583,349. FREEZONE FOODS, INC., LAS VEGAS, NV. FILED 3-25-2004.

BEYOND SORBET

THE MARK CONSISTS OF STANDARD CHARACTERS WITHOUT CLAIM TO ANY PARTICULAR FONT, STYLE, SIZE, OR COLOR.

NO CLAIM IS MADE TO THE EXCLUSIVE RIGHT TO USE "SORBET", APART FROM THE MARK AS SHOWN.
 FOR FROZEN DESSERT PRODUCTS, NAMELY SORBET (U.S. CL. 46).
 GEOFFREY FOSDICK, EXAMINING ATTORNEY

SN 76-584,050. CARAVAN PRODUCTS CO., INC., TOTOWA, NJ. FILED 3-30-2004.

TRIM CARB

THE MARK CONSISTS OF STANDARD CHARACTERS WITHOUT CLAIM TO ANY PARTICULAR FONT, STYLE, SIZE, OR COLOR.

NO CLAIM IS MADE TO THE EXCLUSIVE RIGHT TO USE "CARB", APART FROM THE MARK AS SHOWN.
 FOR MIXES FOR PIZZA CRUSTS, BAGELS AND BREAD; CAKE MIXES; AND INSTANT DOUGHNUT MIXES (U.S. CL. 46).
 FIRST USE 9-26-2003; IN COMMERCE 9-26-2003.
 BERYL GARDNER, EXAMINING ATTORNEY

CLASS 30—(Continued).

SN 76-584,333. PANOLA PEPPER CORPORATION, LAKE PROVIDENCE, LA. FILED 4-1-2004.

SOUTHERN COUNTRY

THE MARK CONSISTS OF STANDARD CHARACTERS WITHOUT CLAIM TO ANY PARTICULAR FONT, STYLE, SIZE, OR COLOR.

FOR PEPPER SAUCE SEASONING FOR FOOD AND DRINK (U.S. CL. 46).

ANDREA K. NADELMAN, EXAMINING ATTORNEY

CLASS 30—(Continued).

SN 76-585,541. RITA'S PROPERTIES, INC., BENSALEM, PA. FILED 4-7-2004.

RITA'S SQUEEZERS

THE MARK CONSISTS OF STANDARD CHARACTERS WITHOUT CLAIM TO ANY PARTICULAR FONT, STYLE, SIZE, OR COLOR.

OWNER OF U.S. REG. NOS. 2,614,810, 2,666,458 AND 2,892,411.

FOR FROZEN CONFECTIONS (U.S. CL. 46).

EUGENIA MARTIN, EXAMINING ATTORNEY

SN 76-585,145. BRUEGGER'S ENTERPRISES, INC., BURLINGTON, VT. FILED 4-1-2004.

Brew for the Crew

THE MARK CONSISTS OF STANDARD CHARACTERS WITHOUT CLAIM TO ANY PARTICULAR FONT, STYLE, SIZE, OR COLOR.

FOR COFFEE (U.S. CL. 46).

C. DIONNE CLYBURN, EXAMINING ATTORNEY

SN 76-585,611. CHOCOLATES GAROTO S.A., VELHA, ESPÍRITO SANTO, BRAZIL, FILED 4-8-2004.

GAROTO BATON

THE MARK CONSISTS OF STANDARD CHARACTERS WITHOUT CLAIM TO ANY PARTICULAR FONT, STYLE, SIZE, OR COLOR.

OWNER OF U.S. REG. NOS. 1,226,096, 2,594,882 AND OTHERS.

THE FOREIGN WORDING IN THE MARK TRANSLATES INTO ENGLISH AS "KID" FOR GAROTO AND "LIPSTICK" FOR BATON.

FOR CHOCOLATES AND BONBONS (U.S. CL. 46).

FIRST USE 12-27-1982; IN COMMERCE 11-7-1989.

TRACY FLETCHER, EXAMINING ATTORNEY

SN 76-585,452. RUDI'S ORGANIC BAKERY, LLC, BOULDER, CO. FILED 4-5-2004.

RUDI'S ORGANIC BAKERY

THE MARK CONSISTS OF STANDARD CHARACTERS WITHOUT CLAIM TO ANY PARTICULAR FONT, STYLE, SIZE, OR COLOR.

OWNER OF U.S. REG. NO. 1,913,592.

NO CLAIM IS MADE TO THE EXCLUSIVE RIGHT TO USE ORGANIC BAKERY, APART FROM THE MARK AS SHOWN.

THE NAME RUDI DOES NOT IDENTIFY A LIVING INDIVIDUAL.

FOR BAKERY PRODUCTS FOR THE NATURAL FOOD, HEALTH FOOD, FOOD SERVICE AND RETAIL MARKETS (U.S. CL. 46).

FIRST USE 11-0-2001; IN COMMERCE 11-0-2001.

MICHAEL HALL, EXAMINING ATTORNEY

SN 76-586,083. TOYO SUISAN KABUSHIKI KAISHA, DBA TOYO SUISAN KAISHA, LTD., TOKYO, JAPAN, FILED 4-12-2004.

**maruchan's
FRESH
YAKI-SOBA**

OWNER OF U.S. REG. NO. 2,071,423.

NO CLAIM IS MADE TO THE EXCLUSIVE RIGHT TO USE "FRESH YAKI-SOBA", APART FROM THE MARK AS SHOWN.

THE ENGLISH TRANSLATION OF THE WORDING "YAKI-SOBA" IN THE MARK IS "FRIED NOODLES".

FOR INSTANT OR PRECOOKED CHINESE NOODLES AND UNCOOKED CHINESE NOODLES (U.S. CL. 46).

FIRST USE 0-0-1984; IN COMMERCE 0-0-1984.

JASON LOTT, EXAMINING ATTORNEY

CLASS 30—(Continued).

SN 76-586,084. TOYO SUISAN KABUSHIKI KAISHA, DBA TOYO SUISAN KAISHA, LTD., TOKYO, JAPAN, FILED 4-12-2004.



OWNER OF U.S. REG. NOS. 2,071,423 AND 2,181,000.
 NO CLAIM IS MADE TO THE EXCLUSIVE RIGHT TO USE "FRESH YAKI-SOBA RAW YAKI-SOBA STIR FRY NOODLES WITH SEASONING SAUCE BASE MAKES 3 SINGLE SERVINGS 5.6 OZ. EACH NET WT. 17 OZ. (1LB. 1OZ.) KEEP REFRIGERATED", APART FROM THE MARK AS SHOWN.

THE ENGLISH TRANSLATION OF THE WORDING "YAKI-SOBA" IN THE MARK IS "FRIED NOODLES."

THE NON-LATIN CHARACTERS IN THE MARK TRANSLITERATE TO "NAMA YAKI-SOBA" AND THIS MEANS "RAW FRIED NOODLES" IN ENGLISH.

FOR INSTANT OR PRECOOKED CHINESE NOODLES AND UNCOOKED CHINESE NOODLES (U.S. CL. 46).

FIRST USE 0-0-1984; IN COMMERCE 0-0-1984.

JASON LOTT, EXAMINING ATTORNEY

CLASS 30—(Continued).

SN 76-587,905. PROCAFFE' SPA, 32100 BELLUNO, ITALY, FILED 4-20-2004.



NO CLAIM IS MADE TO THE EXCLUSIVE RIGHT TO USE CAFFE AND TORINO 1920, APART FROM THE MARK AS SHOWN.

THE FOREIGN WORDING IN THE MARK TRANSLATES INTO ENGLISH AS COFFEE.

FOR COFFEE, COFFEE EXTRACTS; BEVERAGES MADE WITH A BASE OF COFFEE, NAMELY, MILK-SHAKES, ICE CREAM, SHERBET, SORBET, FLAVORED ICES AND FROZEN CONFECTIONS (U.S. CL. 46).

MARIA-VICTORIA SUAREZ, EXAMINING ATTORNEY

SN 76-588,070. DISNEY ENTERPRISES, INC., BURBANK, CA. FILED 4-19-2004.

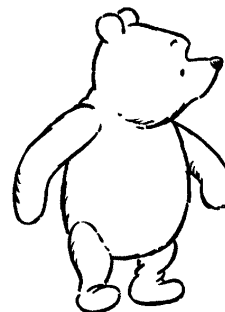

FOR CONFECTIONERY, NAMELY, CHIPS FOR BAKING AND FRUIT JELLIES; FROZEN CONFECTIONS; CANDY; ICE CREAM; FROZEN YOGURT; CHEWING GUM; COFFEE; TEA; COCOA; COCOA MIXES; BREAKFAST CEREALS AND PREPARATIONS MADE FROM CEREALS; CEREAL BARS; BREAD; MUFFINS; MUFFIN BARS; PASTRIES; WAFFLES; PANCAKES; COOKIES; CRACKERS; BISCUITS; PASTAS; CHOCOLATE; POP-CORN; CORN CHIPS; PRETZELS; PUDDINGS (U.S. CL. 46).

RICHARD WHITE, EXAMINING ATTORNEY

ORIGINAL CITY ROAST

THE MARK CONSISTS OF STANDARD CHARACTERS WITHOUT CLAIM TO ANY PARTICULAR FONT, STYLE, SIZE, OR COLOR.

NO CLAIM IS MADE TO THE EXCLUSIVE RIGHT TO USE "CITY ROAST", APART FROM THE MARK AS SHOWN.

SEC. 2(F).

FOR COFFEE (U.S. CL. 46).

FIRST USE 3-0-1995; IN COMMERCE 3-0-1995.

STEVEN JACKSON, EXAMINING ATTORNEY

SN 76-588,497. BIG MIKE'S BBQ, LLC, DENVER, CO. FILED 4-23-2004.

BIG MIKE'S ORIGINAL RECIPE BARBEQUE SAUCE

THE MARK CONSISTS OF STANDARD CHARACTERS WITHOUT CLAIM TO ANY PARTICULAR FONT, STYLE, SIZE, OR COLOR.

NO CLAIM IS MADE TO THE EXCLUSIVE RIGHT TO USE "ORIGINAL RECIPE BARBECUE SAUCE", APART FROM THE MARK AS SHOWN.

FOR FOOD PREPARATIONS, NAMELY, BARBECUE SAUCE (U.S. CL. 46).

FIRST USE 7-0-1998; IN COMMERCE 7-0-1998.

GIANCARLO CASTRO, EXAMINING ATTORNEY

CLASS 30—(Continued).

SN 76-588,500. BIG MIKE'S BBQ, LLC, DENVER, CO. FILED 4-23-2004.



NO CLAIM IS MADE TO THE EXCLUSIVE RIGHT TO USE "ORIGINAL RECIPE BARBECUE SAUCE", APART FROM THE MARK AS SHOWN.

THE NAME "MIKE" AND THE PERSON PICTURED IN THE MARK REPRESENT MIKE MCCREA, A LIVING INDIVIDUAL WHOSE CONSENT IS OF RECORD.

DRAWING CONSISTS OF THE WORDS "BIG MIKE'S" ABOVE A CIRCULAR DESIGN CONTAINING THE PICTURE OF A CHEF HOLDING A SPOON AS THOUGH HE IS STIRRING THE CONTENTS OF A POT THAT HE ALSO HOLDS, AND THE WORDS "ORIGINAL RECIPE BARBECUE SAUCE" BELOW THE CIRCULAR DESIGN.

FOR FOOD PREPARATIONS, NAMELY, BARBECUE SAUCE. (U.S. CL. 46).

FIRST USE 3-1-1999; IN COMMERCE 3-1-1999.

GIANCARLO CASTRO, EXAMINING ATTORNEY

CLASS 30—(Continued).

SN 76-591,181. ECO FOODS, INC., ST. CHARLES, IL. FILED 5-10-2004.

Pure. Paradise.

THE MARK CONSISTS OF STANDARD CHARACTERS WITHOUT CLAIM TO ANY PARTICULAR FONT, STYLE, SIZE, OR COLOR.

FOR READY-TO-EAT GRAIN BASED FOODS BARS (U.S. CL. 46).

FIRST USE 5-17-2004; IN COMMERCE 5-17-2004.

GEORGE LORENZO, EXAMINING ATTORNEY

SN 76-592,698. WMGA, INC., POTOMAC, MD. FILED 5-17-2004.

FROM OUR PLANTATION TO YOUR CUP

THE MARK CONSISTS OF STANDARD CHARACTERS WITHOUT CLAIM TO ANY PARTICULAR FONT, STYLE, SIZE, OR COLOR.

FOR COFFEE (U.S. CL. 46).

FIRST USE 1-1-2003; IN COMMERCE 1-1-2003.

TIMOTHY FINNEGAN, EXAMINING ATTORNEY

SN 76-588,650. KING CAR FOOD INDUSTRIAL CO., LTD., TAIPEI, TAIWAN, FILED 4-23-2004.



FOR TEA, GREEN TEA, LEMON TEA, ICED TEA, PREPARED TEA-BASED DRINKS, COFFEE, COFFEE BEANS, COFFEE BAGS CONTAINING COFFEE, COFFEE POWDER, INSTANT COFFEE, PREPARED COFFEE-BASED DRINKS, CHOCOLATE DRINKS MIX, COCOA-BASED DRINKS, CHEWING GUM, COFFEE CANDIES, CANDIES, POPCORN, CAKES, INSTANT NOODLES, NOODLES (U.S. CL. 46).

FIRST USE 3-5-1986; IN COMMERCE 12-15-1990.

SUE LAWRENCE, EXAMINING ATTORNEY

SN 76-594,582. TAILGATOR BBQ, LLC, KANSAS CITY, MO. FILED 5-25-2004.



NO CLAIM IS MADE TO THE EXCLUSIVE RIGHT TO USE "BARBEQUE", APART FROM THE MARK AS SHOWN. THE MARK CONSISTS OF THE LITERAL ELEMENTS DESCRIBED ABOVE AND AN ALLIGATOR CHARACTER.

FOR BARBEQUE SAUCE, RUBS, MARINADES, AND SPICE BLENDS (U.S. CL. 46).

FIRST USE 4-15-2003; IN COMMERCE 4-15-2003.

MARCIE MILONE, EXAMINING ATTORNEY

CLASS 30—(Continued).

SN 76-595,537. CAROLINA INGREDIENTS, INC., PINEVILLE, NC. FILED 6-3-2004.



NO CLAIM IS MADE TO THE EXCLUSIVE RIGHT TO USE "INGREDIENTS", APART FROM THE MARK AS SHOWN.

THE MARK CONSISTS OF THREE PRONGED STAR. FOR FOOD ADDITIVES FOR NON-NUTRITIONAL PURPOSES FOR USE AS A FLAVORING, INGREDIENT OR FILLER; SEASONINGS; MARINADES; AND GRAVY (U.S. CL. 46).

FIRST USE 5-1-2000; IN COMMERCE 5-1-2000.
KHANH LE, EXAMINING ATTORNEY

CLASS 30—(Continued).

SN 76-597,696. GUAN SHENG YUAN (GROUP) CO., LTD., SHANGHAI, CHINA, FILED 6-16-2004.



FOR CONDIMENTS, NAMELY, MONOSODIUM GLUTAMATE; SEASONINGS; RELISH (U.S. CL. 46).
FIRST USE 1-0-1980; IN COMMERCE 5-0-1990.
RUSS HERMAN, EXAMINING ATTORNEY

SN 76-597,368. LEE, ADAM, PORTER RANCH, CA. FILED 6-14-2004.



NO CLAIM IS MADE TO THE EXCLUSIVE RIGHT TO USE TEAS, APART FROM THE MARK AS SHOWN.

FOR TEA; HERBAL TEA FOR FOOD PURPOSES, TEA BASED BEVERAGES WITH FRUIT FLAVORING, TEABAGS, FLAVORED TEA, GREEN TEA (U.S. CL. 46).

FIRST USE 9-7-2004; IN COMMERCE 9-7-2004.
MIDGE BUTLER, EXAMINING ATTORNEY

SN 76-599,103. CARPEDIEM MANAGEMENT COMPANY, DBA RAX, NEW ALBANY, OH. FILED 6-24-2004.



THE MARK CONSISTS OF STANDARD CHARACTERS WITHOUT CLAIM TO ANY PARTICULAR FONT, STYLE, SIZE, OR COLOR.

SEC. 2(F). FOR BEEF, BACON AND CHEESE SANDWICH FOR CONSUMPTION ON OR OFF THE PREMISES (U.S. CL. 46).

FIRST USE 3-3-1980; IN COMMERCE 3-3-1980.
LA TONIA FISHER, EXAMINING ATTORNEY

CLASS 30—(Continued).

SN 76-600,507. COFFEE DISTRIBUTING CORP., GARDEN CITY PARK, NY. FILED 7-2-2004.



NO CLAIM IS MADE TO THE EXCLUSIVE RIGHT TO USE SELECT AND THREE BEAN, APART FROM THE MARK AS SHOWN.

FOR COFFEE (U.S. CL. 46).

FIRST USE 0-0-1996; IN COMMERCE 0-0-1996.

GWEN STOKOLS, EXAMINING ATTORNEY

SN 76-600,533. BURGER KING BRANDS, INC., MIAMI, FL. FILED 7-2-2004.

TENDERCRISP

THE MARK CONSISTS OF STANDARD CHARACTERS WITHOUT CLAIM TO ANY PARTICULAR FONT, STYLE, SIZE, OR COLOR.

FOR CHICKEN SANDWICHES SOLD IN RESTAURANTS FOR CONSUMPTION ON OR OFF THE PREMISES (U.S. CL. 46).

FIRST USE 4-12-2004; IN COMMERCE 4-12-2004.

MARK T. MULLEN, EXAMINING ATTORNEY

SN 76-605,241. SAFEWAY INC., PLEASANTON, CA. FILED 8-2-2004.

SAFEWAY SELECT VERDI

THE MARK CONSISTS OF STANDARD CHARACTERS WITHOUT CLAIM TO ANY PARTICULAR FONT, STYLE, SIZE, OR COLOR.

OWNER OF U.S. REG. NOS. 866,537, 2,695,052 AND OTHERS.

NO CLAIM IS MADE TO THE EXCLUSIVE RIGHT TO USE "SELECT VERDI", APART FROM THE MARK AS SHOWN.

THE FOREIGN WORDING IN THE MARK TRANSLATES INTO ENGLISH AS GREEN.

FOR PASTA, PASTA SHELLS, PIZZA, LASAGNA, FROZEN ENTREES CONSISTING PRIMARILY OF PASTA, PASTA AND COOKING SAUCE (U.S. CL. 46).

FIRST USE 7-31-1999; IN COMMERCE 7-31-1999.

ROBIN CHOSID, EXAMINING ATTORNEY

CLASS 30—(Continued).

SN 76-607,208. WING HOP FUNG GINSENG INC., LOS ANGELES, CA. FILED 8-9-2004.

一一高山岩茶

NO CLAIM IS MADE TO THE EXCLUSIVE RIGHT TO USE THE CHINESE CHARACTER THAT TRANSLITERATES TO "CHA" AND TRANSLATE INTO ENGLISH AS "TEA", APART FROM THE MARK AS SHOWN.

THE MARK CONSISTS OF THE FIVE CHINESE CHARACTERS, AND THE FANCY CHINESE CHARACTER-LIKE SYMBOL, WHICH IS A COINED DERIVATIVE OF THE CHINESE CHARACTER.

THE ENGLISH TRANSLATION OF THE WORD MARK TRANSLATE GENERALLY TO "EACH AND EVERY HIGH MOUNTAIN ROCK" (THE TERM "YI YI" IN CHINESE IS A COLLECTIVE TERM, MEANING "EACH AND EVERY"). THE LAST SYMBOL IS A PARODY OF THE CHINESE WORD (WHICH TRANSLITERATES TO "CHA" IN MANDARIN, AND WHICH MEANS "TEA") - IT HAS THE TWO "+" WORD PARTS ON THE TOP OF THE WORD FOR "CHA" EACH REPLACED BY THE CHINESE SYMBOL (WHICH MEANS "MOUNTAIN"). APPLICANT BELIEVES THAT THIS COINED CHINESE CHARACTER-LIKE SYMBOL CANNOT BE FOUND IN A CHINESE DICTIONARY.

THE FIRST FIVE CHINESE CHARACTERS TRANSLITERATE IN MANDARIN TO "YI YI GAO SHAN AI".

FOR TEAS, AND HERB TEAS (U.S. CL. 46).

FIRST USE 2-15-2001; IN COMMERCE 7-23-2002.

RONALD MCMORROW, EXAMINING ATTORNEY

SN 76-610,295. LUMPKIN, JOHNNY, CAMDEN, NJ. FILED 9-7-2004.

MANN & HONEY SOUTHERN STYLE BBQ SAUCE

THE MARK CONSISTS OF STANDARD CHARACTERS WITHOUT CLAIM TO ANY PARTICULAR FONT, STYLE, SIZE, OR COLOR.

NO CLAIM IS MADE TO THE EXCLUSIVE RIGHT TO USE "SOUTHERN STYLE BBQ SAUCE", APART FROM THE MARK AS SHOWN.

FOR STAPLE FOODS, NAMELY BARBEQUE SAUCES (U.S. CL. 46).

LA TONIA FISHER, EXAMINING ATTORNEY

SN 76-614,295. ND LABS, INC. GREAT NECK, NY. FILED 9-29-2004.

Chips To Go

THE MARK CONSISTS OF STANDARD CHARACTERS WITHOUT CLAIM TO ANY PARTICULAR FONT, STYLE, SIZE, OR COLOR.

NO CLAIM IS MADE TO THE EXCLUSIVE RIGHT TO USE "CHIPS", APART FROM THE MARK AS SHOWN.

FOR HIGH FIBER COOKIES (U.S. CL. 46).

FIRST USE 8-17-1998; IN COMMERCE 11-1-1998.

HEATHER THOMPSON, EXAMINING ATTORNEY

CLASS 30—(Continued).

SN 76-614,867. PATTCO, INC., SALINE, MI. FILED 10-4-2004.

FLAX~IN

THE MARK CONSISTS OF STANDARD CHARACTERS WITHOUT CLAIM TO ANY PARTICULAR FONT, STYLE, SIZE, OR COLOR.

FOR PREPARED FOODS; NAMELY, BAKERY GOODS, BREADS AND SANDWICHES (U.S. CL. 46).
MICHELLE DUBOIS, EXAMINING ATTORNEY

SN 76-615,051. OMEGA FOODS, INC., HOUSTON, TX. FILED 10-12-2004.



THE ENGLISH TRANSLATION OF "RAJ MAHAL" IS "ROYAL PALACE".

FOR BREAD (U.S. CL. 46).
FIRST USE 4-10-1996; IN COMMERCE 7-11-1996.
ZACHARY BELLO, EXAMINING ATTORNEY

SN 76-615,457. JEL SERT CO., THE, WEST CHICAGO, IL. FILED 10-12-2004.

POP-ICE

THE MARK CONSISTS OF STANDARD CHARACTERS WITHOUT CLAIM TO ANY PARTICULAR FONT, STYLE, SIZE, OR COLOR.

OWNER OF U.S. REG. NOS. 738,048 AND 1,341,187.
FOR FROZEN CONFECTIONS, NAMELY, FREEZER POPS (U.S. CL. 46).
FIRST USE 1-0-1960; IN COMMERCE 1-0-1960.
RUDY R. SINGLETON, EXAMINING ATTORNEY

CLASS 30—(Continued).

SN 76-615,536. HOSPITALITY MINTS LLC, BOONE, NC. FILED 10-4-2004.



FOR CANDY (U.S. CL. 46).
FIRST USE 7-15-2004; IN COMMERCE 7-15-2004.
RUDY R. SINGLETON, EXAMINING ATTORNEY

SN 76-616,088. MORRIS NATIONAL, INC., AZUSA, CA. FILED 10-15-2004.

SIPS

THE MARK CONSISTS OF STANDARD CHARACTERS WITHOUT CLAIM TO ANY PARTICULAR FONT, STYLE, SIZE, OR COLOR.

FOR CANDY (U.S. CL. 46).
RICHARD A. STRASER, EXAMINING ATTORNEY

SN 76-616,456. WESTERN PENNSYLVANIA CONSERVANCY, PITTSBURGH, PA. FILED 10-13-2004.

FALLINGWATER

THE MARK CONSISTS OF STANDARD CHARACTERS WITHOUT CLAIM TO ANY PARTICULAR FONT, STYLE, SIZE, OR COLOR.

OWNER OF U.S. REG. NOS. 1,940,514, 2,657,589 AND 2,765,344.

FOR CANDY (U.S. CL. 46).
FIRST USE 8-12-2004; IN COMMERCE 8-12-2004.
DAVID TAYLOR, EXAMINING ATTORNEY

SN 76-616,827. ORIGINAL HOMESTEAD RESTAURANT, INC., NEW YORK, NY. FILED 10-20-2004.

OLD HOMESTEAD STEAK HOUSE STEAK SAUCE

THE MARK CONSISTS OF STANDARD CHARACTERS WITHOUT CLAIM TO ANY PARTICULAR FONT, STYLE, SIZE, OR COLOR.

OWNER OF U.S. REG. NO. 2,527,517.
NO CLAIM IS MADE TO THE EXCLUSIVE RIGHT TO USE "STEAK HOUSE STEAK SAUCE", APART FROM THE MARK AS SHOWN.

FOR STEAK SAUCE (U.S. CL. 46).
FIRST USE 0-0-1998; IN COMMERCE 0-0-1998.
GISELLE AGOSTO, EXAMINING ATTORNEY

CLASS 30—(Continued).

SN 76-617,107. MYERS, GAYLE, GLENDALE, CA. FILED 10-20-2004.

ALMOND GLORY

THE MARK CONSISTS OF STANDARD CHARACTERS WITHOUT CLAIM TO ANY PARTICULAR FONT, STYLE, SIZE, OR COLOR.

NO CLAIM IS MADE TO THE EXCLUSIVE RIGHT TO USE "ALMOND", APART FROM THE MARK AS SHOWN.

FOR BAKERY GOODS MADE FROM ALMOND MEAL, NAMELY, MUFFINS, SCONES, BREADS, COOKIES, CRACKERS, TORTES, PIES, BAGELS, BREADS, WAFFLES, PANCAKES, AND PASTA (U.S. CL. 46).

FIRST USE 9-30-2004; IN COMMERCE 9-30-2004.

BRENDAN MCCAULEY, EXAMINING ATTORNEY

CLASS 30—(Continued).

SN 76-617,443. HERBAL BREW INC., VALLEY STREAM, NY. FILED 10-25-2004.



FOR HERBAL FOOD BEVERAGES (U.S. CL. 46).

FIRST USE 7-21-2001; IN COMMERCE 7-21-2001.

MATTHEW KLINE, EXAMINING ATTORNEY

SN 76-617,316. LIC MANUFACTURING, LLC, OWINGS MILLS, MD. FILED 10-20-2004.

LEE'S ICE CREAM

THE MARK CONSISTS OF STANDARD CHARACTERS WITHOUT CLAIM TO ANY PARTICULAR FONT, STYLE, SIZE, OR COLOR.

NO CLAIM IS MADE TO THE EXCLUSIVE RIGHT TO USE ICE CREAM, APART FROM THE MARK AS SHOWN.

FOR ICE CREAM, ICE CREAM SANDWICHES, ICE CREAM CONES, ICE CREAM CAKES, ICE CREAM PIES, ICE CREAM COOKIES AND FROZEN CONFECTIONS, ALL FOR CONSUMPTION ON OR OFF THE PREMISES (U.S. CL. 46).

FIRST USE 3-15-1979; IN COMMERCE 3-15-1979.

DAVID MURRAY, EXAMINING ATTORNEY

SN 76-617,831. COFFEE TRADERS, INC., DBA TEXAS COFFEE TRADERS, AUSTIN, TX. FILED 10-27-2004.

TEXAS COFFEE TRADERS

THE MARK CONSISTS OF STANDARD CHARACTERS WITHOUT CLAIM TO ANY PARTICULAR FONT, STYLE, SIZE, OR COLOR.

NO CLAIM IS MADE TO THE EXCLUSIVE RIGHT TO USE "COFFEE", APART FROM THE MARK AS SHOWN.

SEC. 2(F).

FOR COFFEE, TEA AND CANDY (U.S. CL. 46).

FIRST USE 3-0-1994; IN COMMERCE 3-0-1994.

ELLEN B. AWRICH, EXAMINING ATTORNEY

SN 76-617,440. HERBAL BREW INC., VALLEY STREAM, NY. FILED 10-25-2004.



FOR HERBAL FOOD BEVERAGES (U.S. CL. 46).

FIRST USE 7-21-2001; IN COMMERCE 7-21-2001.

ANN LINNEHAN, EXAMINING ATTORNEY

SN 76-618,153. BLACK HAWK GRILL INC., CLINTON, PA. FILED 10-28-2004.

TWISTEDCOWBOY

THE MARK CONSISTS OF STANDARD CHARACTERS WITHOUT CLAIM TO ANY PARTICULAR FONT, STYLE, SIZE, OR COLOR.

FOR SANDWICH OF VIRGINIA HAM, SWISS CHEESE, LETTUCE, TOMATO ON SOFT PRETZEL (U.S. CL. 46).

FIRST USE 1-14-2004; IN COMMERCE 1-14-2004.

JULIE GUTTADAURO, EXAMINING ATTORNEY

CLASS 30—(Continued).

SN 76-624,158. SHANGRI-LA TEA CO., INC., SANTA FE SPRINGS, CA. FILED 12-13-2004.

RHAPSODY

THE MARK CONSISTS OF STANDARD CHARACTERS WITHOUT CLAIM TO ANY PARTICULAR FONT, STYLE, SIZE, OR COLOR.
 FOR CHINA BLACK TEA PACKAGED IN BULK FOR SALE TO RESTAURANTS (U.S. CL. 46).
 FIRST USE 11-11-1991; IN COMMERCE 3-12-1992.
 NAAKWAMA ANKRAH, EXAMINING ATTORNEY

SN 76-624,947. HOSPITALITY MINTS, LLC, BOONE, NC. FILED 12-17-2004.

Hospitality Mints 

OWNER OF U.S. REG. NOS. 2,273,353 AND 2,273,365. FOR CANDY (U.S. CL. 46).
 FIRST USE 12-3-2001; IN COMMERCE 12-3-2001.
 PAM WILLIS, EXAMINING ATTORNEY

SN 76-625,115. PIAO I ENTERPRISE CO., LTD., PU LI CHEN NAN TOU HSIEN, TAIWAN, FILED 12-20-2004.

Shen's Tea

NO CLAIM IS MADE TO THE EXCLUSIVE RIGHT TO USE "TEA", APART FROM THE MARK AS SHOWN.
 THE NON-LATIN CHARACTERS IN THE MARK TRANSLITERATE TO "PIAO-I" AND THIS MEANS "BEING ELEGANT AND TENDER" IN ENGLISH.
 FOR TEA; TEA BAGS; CANDY; TEA CANDY (U.S. CL. 46).
 FIRST USE 6-27-2004; IN COMMERCE 6-27-2004.
 JEAN IM, EXAMINING ATTORNEY

CLASS 30—(Continued).

SN 76-625,200. LA TAPATIA TORTILLERIA, INC., FRESNO, CA. FILED 12-20-2004.



SUBJECT TO CONCURRENT USE WITH LA TAPATIA NORCAL, INC., A CORPORATION OF CALIFORNIA, DOING BUSINESS AT 23423 CABOT BLVD. HAWYARD, CA. APPLICANT CLAIMS EXCLUSIVE RIGHT TO USE THE MARK IN THE AREA COMPRISING THE ENTIRE UNITED STATES EXCEPT THAT PART OF THE STATE OF CALIFORNIA NORTH OF A LINE GENERALLY DESCRIBED AS BEGINNING AT THE CALIFORNIA/NEVADA STATE LINE AND RUNNING DUE WEST FROM THE NEVADA BORDER TO THE INTERSECTION OF STATE HIGHWAY 99 AND MONTE VISTA AVENUE, THEN IN A GENERALLY SOUTHWEST DIRECTION IN A STRAIGHT LINE TO THE INTERSECTION OF INTERSTATE HIGHWAY 5 AND FINK ROAD, THEN IN A GENERALLY SOUTHEAST DIRECTION ALONG HIGHWAY 5, THEN DUE WEST THROUGH THE INTERSECTION OF COUNTY ROAD G13 AND STATE HIGHWAY 25 TO THE PACIFIC OCEAN; AND THE CITY OF TURLOCK, CALIFORNIA, AS IS NOW AND HERE-AFTER LEGALLY BOUNDED.

MISCELLANEOUS DESIGN OF A WOMAN WITH A BASKET OF CORN
 FOR MEXICAN FOOD PRODUCTS, NAMELY- CORN AND FLOUR TORTILLAS, TORTILLA CHIPS (U.S. CL. 46).
 FIRST USE 6-1-2004; IN COMMERCE 6-1-2004.
 PRISCILLA MILTON, EXAMINING ATTORNEY

SN 76-625,895. THE CHURCH CANDY COMPANY, L.L.C., ROCKWOOD, MI. FILED 12-27-2004.

Church Candy

NO CLAIM IS MADE TO THE EXCLUSIVE RIGHT TO USE CHURCH CANDY, APART FROM THE MARK AS SHOWN.
 FOR CANDY, CANDY BARS, CANDY MINTS, CHOCOLATE CANDIES, CANDIES, PEPPERMINT CANDY SUGARLESS CANDIES, ICE CANDIES, CANDY WITH COCOA, CANDY WITH CARAMEL, CANDY COATED POPCORN, CANDY COATED APPLES, STARCH-BASED CANDIES (U.S. CL. 46).
 FIRST USE 7-9-2004; IN COMMERCE 7-9-2004.
 TRACY FLETCHER, EXAMINING ATTORNEY

CLASS 30—(Continued).

SN 76-626,043. BARTL, GARY, PALM BEACH, FL. FILED 12-27-2004.

WANING MOON

THE MARK CONSISTS OF STANDARD CHARACTERS WITHOUT CLAIM TO ANY PARTICULAR FONT, STYLE, SIZE, OR COLOR.

FOR TEAS (U.S. CL. 46).
FIRST USE 2-0-1998; IN COMMERCE 2-0-1998.
TRACY WHITAKER-BOWN, EXAMINING ATTORNEY

SN 76-626,090. BARTL, GARY, PALM BEACH, FL. FILED 12-27-2004.

WAXING MOON

THE MARK CONSISTS OF STANDARD CHARACTERS WITHOUT CLAIM TO ANY PARTICULAR FONT, STYLE, SIZE, OR COLOR.

FOR TEAS (U.S. CL. 46).
FIRST USE 2-0-1998; IN COMMERCE 2-0-1998.
TRACY WHITAKER-BOWN, EXAMINING ATTORNEY

SN 76-626,313. NO END, INC., HOLBROOK, MA. FILED 12-29-2004.



FOR SALAD DRESSINGS (U.S. CL. 46).
FIRST USE 12-1-2004; IN COMMERCE 12-1-2004.
DAVID H. STINE, EXAMINING ATTORNEY

CLASS 30—(Continued).

SN 76-626,451. NO END, INC., HOLBROOK, MA. FILED 12-29-2004.



THE MARK CONSISTS OF STANDARD CHARACTERS WITHOUT CLAIM TO ANY PARTICULAR FONT, STYLE, SIZE, OR COLOR.

FOR SALAD DRESSINGS (U.S. CL. 46).
FIRST USE 12-1-2004; IN COMMERCE 12-1-2004.
DAVID H. STINE, EXAMINING ATTORNEY

SN 76-977,537. DEVIL'S FOOD, LLC, DENVER, CO. FILED 7-8-2004.



NO CLAIM IS MADE TO THE EXCLUSIVE RIGHT TO USE "DEVIL'S FOOD", APART FROM THE MARK AS SHOWN.

FOR BAKERY PRODUCTS, INCLUDING BREADS, QUICHES, BREAKFAST ROLLS, PASTRIES, BROWNIES, DESSERTS, CAKES, PIES, CHOCOLATE, CANDY, AND CARAMELS (U.S. CL. 46).

FIRST USE 4-20-2001; IN COMMERCE 4-20-2001.
CHARLES JOYNER, EXAMINING ATTORNEY

SN 78-154,876. FLAVOR BURST CO., L.L.P., DANVILLE, IN. FILED 8-16-2002.

JAVA LATTE

FOR FROZEN FOOD CONFECTIONS AND FLAVORING SYRUPS (U.S. CL. 46).
IRENE D. WILLIAMS, EXAMINING ATTORNEY

SN 78-207,350. SEGAL FOODS, INC., ENCINO, CA. FILED 1-27-2003.

LIQUID SWEET

NO CLAIM IS MADE TO THE EXCLUSIVE RIGHT TO USE "LIQUID", APART FROM THE MARK AS SHOWN.

FOR SUCROSE-BASED NATURAL SWEETENER (U.S. CL. 46).

NORA BUCHANAN WILL, EXAMINING ATTORNEY

CLASS 30—(Continued).

SN 78-248,961. STALLONS, MARK K., FORT WORTH, TX.
FILED 5-13-2003.

WILD ABOUT FOOD

FOR SAUCES AND SALSA (U.S. CL. 46).
FIRST USE 3-1-2003; IN COMMERCE 3-1-2003.
SUE LAWRENCE, EXAMINING ATTORNEY

SN 78-290,928. S&S BRANDS, INC., WILMINGTON, DE.
FILED 8-22-2003.

**THE GREAT SNACKIN'
CRACKER**

NO CLAIM IS MADE TO THE EXCLUSIVE RIGHT TO
USE GREAT AND CRACKER, APART FROM THE MARK
AS SHOWN.
FOR CRACKERS (U.S. CL. 46).
FIRST USE 12-0-2003; IN COMMERCE 12-0-2003.
ZHALEH DELANEY, EXAMINING ATTORNEY

SN 78-301,625. BRADFORD COFFEE, LOS ANGELES, CA.
FILED 9-17-2003.



NO CLAIM IS MADE TO THE EXCLUSIVE RIGHT TO
USE "COFFEE ROASTERS", APART FROM THE MARK AS
SHOWN.
FOR COFFEE (U.S. CL. 46).
FIRST USE 8-3-2000; IN COMMERCE 6-11-2001.
STEPHANIE DAVIS, EXAMINING ATTORNEY

CLASS 30—(Continued).

SN 78-322,197. WM. WRIGLEY JR. COMPANY, CHICAGO,
IL. FILED 11-3-2003.



OWNER OF U.S. REG. NOS. 1,307,342, 1,317,201 AND
OTHERS.
FOR CONFECTIONERY, NAMELY, CHEWING GUM,
CANDY AND MINTS (U.S. CL. 46).
FIRST USE 2-28-2003; IN COMMERCE 2-28-2003.
DAHLIA GEORGE, EXAMINING ATTORNEY

SN 78-328,295. PROMARK BRANDS INC., MERIDIAN, ID.
FILED 11-14-2003.



OWNER OF U.S. REG. NO. 2,883,354.
NO CLAIM IS MADE TO THE EXCLUSIVE RIGHT TO
USE "EASY MARINADER", APART FROM THE MARK AS
SHOWN.
THE MARK CONSISTS OF THE LETTERS "EZ" IN A
CIRCULAR DESIGN AND THE WORD "MARINADER" IN
A SWIRL BANNER DESIGN.
FOR POUCH CONTAINING MARINADES AND/OR
SPICES FOR MARINATING MEATS, FISH, POULTRY,
AND/OR VEGETABLES (U.S. CL. 46).
FIRST USE 4-23-2003; IN COMMERCE 4-23-2003.
BARBARA GAYNOR, EXAMINING ATTORNEY

SN 78-331,898. CLIFF & BUSTER LIMITED, CHICAGO, IL.
FILED 11-23-2003.



CLIFF & BUSTER

THE MARK CONSISTS OF STYLIZED FLEUR DE LIS
ACCOMPANYING STYLIZED WORDING "CLIFF & BUS-
TER".
FOR BAKERY GOODS, NAMELY COOKIES, BROW-
NIES, PASTRIES, PIES, AND CAKES (U.S. CL. 46).
FIRST USE 4-1-2001; IN COMMERCE 4-1-2001.
MARLENE BELL, EXAMINING ATTORNEY

CLASS 30—(Continued).

SN 78-333,458. HUNG, LE, THANH, HO CHI MINH, VIETNAM, FILED 11-26-2003.



OWNER OF VIETNAM REG. NO. 36433, DATED 2-21-2001, EXPIRES 2-21-2011.

THE FOREIGN WORDING IN THE MARK TRANSLATES INTO ENGLISH AS STRONG DEVELOPMENT.

FOR COFFEE, TEA, COCOA, SUGAR, RICE, TAPIOCA, SAGO, ARTIFICIAL COFFEE; FLOUR AND PREPARATIONS MADE FROM CEREALS, BREAD, PASTRY, FROZEN CONFECTION, FAVOR ICES; HONEY, TREACLE; YEAST, BAKING-POWDER; SALT, MUSTARD; VINEGAR, SAUCES (U.S. CL. 46).

GIANCARLO CASTRO, EXAMINING ATTORNEY

SN 78-336,504. NAVY EXCHANGE SERVICE COMMAND ("NEXCOM"), A NONAPPROPRIATED FUND INSTRUMENTALITY UNDER THE DEPT. OF NAVY, AN AGENCY OF THE UNITED STATES OF AMERICA, VIRGINIA BEACH, VA. FILED 12-4-2003.

Patriot's Choice

THE MARK CONSISTS OF STANDARD CHARACTERS WITHOUT CLAIM TO ANY PARTICULAR FONT, STYLE, SIZE, OR COLOR.

FOR PRETZELS, CANDY NAMELY HARD CANDY AND GUMMY CANDY; CHEESE FLAVORED PUFFED CORN SNACKS AND CHEESE CURLS (U.S. CL. 46).

FIRST USE 4-1-1999; IN COMMERCE 4-1-1999.

TRICIA THOMPSON, EXAMINING ATTORNEY

CLASS 30—(Continued).

SN 78-337,192. KIM SENG COMPANY, MONTEBELLO, CA. FILED 12-5-2003.



THE COLORS GREEN, RED AND YELLOW ARE CLAIMED AS A FEATURE OF THE MARK.

THE COLORS GREEN AND YELLOW APPEAR IN THE CHINESE CHARACTER AND THE WORD YUEN AND SURROUNDING OVAL DESIGN. THE COLORS RED AND YELLOW APPEAR IN THE LOTUS BLOOM DESIGN.

THE MARK CONSISTS OF ONE CHINESE CHARACTER, WHICH TRANSLITERATES IN CANTONESE TO "YUEN," AND WHICH MEANS, GENERALLY "CHARM OR GRACE," AND A STYLIZATION OF A RED AND YELLOW LOTUS BLOOM.

THE MARK CONSISTS OF ONE CHINESE CHARACTER, WHICH TRANSLITERATES IN CANTONESE TO "YUEN," AND WHICH MEANS, GENERALLY "CHARM OR GRACE. THE NON-LATIN CHARACTER(S) IN THE MARK TRANSLITERATES INTO YUEN, AND THIS MEANS ONE'S FATE TO BE WITH SOMEONE IN ENGLISH.

FOR VEGETARIAN SEASONING, MUSHROOM SEASONING, VEGETABLE CONCENTRATES USED FOR SEASONING (U.S. CL. 46).

FIRST USE 7-15-2003; IN COMMERCE 7-15-2003.

JAMES A. RAUEN, EXAMINING ATTORNEY

SN 78-341,696. OUR KIDZ CANDY COMPANY, INC., TORONTO, ONTARIO, CANADA, FILED 12-16-2003.

WACKLES

THE MARK CONSISTS OF STANDARD CHARACTERS WITHOUT CLAIM TO ANY PARTICULAR FONT, STYLE, SIZE, OR COLOR.

PRIORITY CLAIMED UNDER SEC. 44(D) ON CANADA APPLICATION NO. 1185793, FILED 7-24-2003, REG. NO. TMA641405, DATED 6-6-2005, EXPIRES 6-6-2020.

FOR CANDY (U.S. CL. 46).

ALLISON HOLTZ, EXAMINING ATTORNEY

CLASS 30—(Continued).

SN 78-373,966. PET INCORPORATED, MINNEAPOLIS, MN. FILED 2-25-2004.

STAND 'N STUFF

THE MARK CONSISTS OF STANDARD CHARACTERS WITHOUT CLAIM TO ANY PARTICULAR FONT, STYLE, SIZE, OR COLOR.

FOR TACO SHELLS; TACO DINNER KITS CONSISTING OF TACO SHELLS, SALSA AND DRY TACO SEASONING MIX (U.S. CL. 46).

CHERYL CLAYTON, EXAMINING ATTORNEY

CLASS 30—(Continued).

SN 78-381,575. BLUE MOON LICENSING, LLC, NEW LEXINGTON, OH. FILED 3-10-2004.



THE STIPPLING SHOWN IN THE DRAWING IS TO INDICATE SHADING AND IS NOT CLAIMED AS A FEATURE OF THE MARK.

THE COLOR BLUE IS CLAIMED AS A FEATURE OF THE MARK.

THE MARK CONSISTS OF A CIRCULAR DESIGN OF A MOON WITH A STYLIZED SMILING FACE. THE MARK CONTAINS VARYING DEGREES OF BLUE SHADING, WHICH SERVE TO DEFINE THE SHAPE AND EXPRESSION OF THE FACE.

FOR PREPARED FOODS, NAMELY, PIZZAS (U.S. CL. 46).

FIRST USE 1-31-2003; IN COMMERCE 8-8-2003.

MARK SPARACINO, EXAMINING ATTORNEY

SN 78-374,490. FOOD EUPHORIA, INC., TUCSON, AZ. FILED 2-26-2004.

**BIBLICAL SEASONING
OF MYRRH**

THE MARK CONSISTS OF STANDARD CHARACTERS WITHOUT CLAIM TO ANY PARTICULAR FONT, STYLE, SIZE, OR COLOR.

NO CLAIM IS MADE TO THE EXCLUSIVE RIGHT TO USE "SEASONING OF MYRRH", APART FROM THE MARK AS SHOWN.

FOR SPICES, NAMELY MYRRH (U.S. CL. 46).

FIRST USE 1-1-2003; IN COMMERCE 8-1-2003.

HOWARD B. LEVINE, EXAMINING ATTORNEY

SN 78-382,570. BEATRICE BAKERY COMPANY, BEATRICE, NE. FILED 3-11-2004.

**BEATRICE BAKERY
CO.**

THE MARK CONSISTS OF STANDARD CHARACTERS WITHOUT CLAIM TO ANY PARTICULAR FONT, STYLE, SIZE, OR COLOR.

NO CLAIM IS MADE TO THE EXCLUSIVE RIGHT TO USE BAKERY CO., APART FROM THE MARK AS SHOWN. FOR BAKERY PRODUCTS NAMELY CAKES, FRUIT CAKES, NUT CAKES, RUM CAKES (U.S. CL. 46).

FIRST USE 4-0-2003; IN COMMERCE 4-0-2003.

AISHA CLARKE, EXAMINING ATTORNEY

CLASS 30—(Continued).

SN 78-386,999. SAINT HONORE BAKERY, INC., PORTLAND, OR. FILED 3-18-2004.

MICHE BANAL

THE MARK CONSISTS OF STANDARD CHARACTERS WITHOUT CLAIM TO ANY PARTICULAR FONT, STYLE, SIZE, OR COLOR.

NO CLAIM IS MADE TO THE EXCLUSIVE RIGHT TO USE "MICHE", APART FROM THE MARK AS SHOWN.

THE ENGLISH TRANSLATION OF THE FRENCH WORD MICHE IN THE MARK IS ROUND LOAF.

FOR BREAD, BREAD STICKS, ROLLS, SANDWICHES (U.S. CL. 46).

FIRST USE 12-3-2003; IN COMMERCE 12-3-2003.
CHRISTOPHER BUONGIORNO, EXAMINING ATTORNEY

CLASS 30—(Continued).

SN 78-391,968. SOCIÉTÉ DE FABRICATION ET DE DISTRIBUTION DE PRODUITS ALIMENTAIRES PATIS-FRANCE, RUNGIS, FRANCE, FILED 3-27-2004.

DECOFONDANT

THE MARK CONSISTS OF STANDARD CHARACTERS WITHOUT CLAIM TO ANY PARTICULAR FONT, STYLE, SIZE, OR COLOR.

OWNER OF FRANCE REG. NO. 96621681, DATED 4-18-1996, EXPIRES 4-18-2006.

FOR EDIBLE CAKE DECORATIONS FOR PASTRY USE; SUGAR PASTE FOR CAKE WRAPPING (U.S. CL. 46).

FIRST USE 3-0-1992; IN COMMERCE 3-0-1992.
VIVIAN MICZNIK FIRST, EXAMINING ATTORNEY

SN 78-389,228. DAXEN, INC., WALNUT, CA. FILED 3-23-2004.

SPICA TEA

THE MARK CONSISTS OF STANDARD CHARACTERS WITHOUT CLAIM TO ANY PARTICULAR FONT, STYLE, SIZE, OR COLOR.

NO CLAIM IS MADE TO THE EXCLUSIVE RIGHT TO USE "TEA", APART FROM THE MARK AS SHOWN.

FOR TEA SPECIALLY FORMULATED WITH NATURAL CHINESE HERBS INCLUDING GANODERMA, LUCIDUM AND RADIX GLYCYRRHIZAE (U.S. CL. 46).

FIRST USE 3-1-2003; IN COMMERCE 3-1-2003.
RON FAIRBANKS, EXAMINING ATTORNEY

SN 78-391,999. SOCIÉTÉ DE FABRICATION ET DE DISTRIBUTION DE PRODUITS ALIMENTAIRES PATIS-FRANCE, RUNGIS, FRANCE, FILED 3-27-2004.

VICTOR

THE MARK CONSISTS OF STANDARD CHARACTERS WITHOUT CLAIM TO ANY PARTICULAR FONT, STYLE, SIZE, OR COLOR.

FOR CAKE AND PASTRY GLAZES (U.S. CL. 46).
FIRST USE 3-0-1992; IN COMMERCE 3-0-1992.
STEVEN JACKSON, EXAMINING ATTORNEY

CLASS 30—(Continued).

SN 78-392,054. SYMPATHY FOR THE KETTLE, LLC, NEW YORK, NY. FILED 3-27-2004.

CLASS 30—(Continued).

SN 78-394,317. CHANNEL ISLANDS ROASTING COMPANY, CARPINTERIA, CA. FILED 3-31-2004.

Kettle Teas

CHANNEL ISLANDS ROASTING COMPANY

THE MARK CONSISTS OF STANDARD CHARACTERS WITHOUT CLAIM TO ANY PARTICULAR FONT, STYLE, SIZE, OR COLOR.

NO CLAIM IS MADE TO THE EXCLUSIVE RIGHT TO USE "TEAS", APART FROM THE MARK AS SHOWN.

FOR LOOSE TEAS SOLD VIA RETAIL AND ONLINE CHANNELS OF TRADE (U.S. CL. 46).

CHRISTOPHER ADKINS, EXAMINING ATTORNEY

THE MARK CONSISTS OF STANDARD CHARACTERS WITHOUT CLAIM TO ANY PARTICULAR FONT, STYLE, SIZE, OR COLOR.

NO CLAIM IS MADE TO THE EXCLUSIVE RIGHT TO USE "ROASTING COMPANY", APART FROM THE MARK AS SHOWN.

FOR COFFEE (U.S. CL. 46).
FIRST USE 6-2-2004; IN COMMERCE 6-2-2004.
DOUGLAS LEE, EXAMINING ATTORNEY

SN 78-393,718. CHATAM INTERNATIONAL INCORPORATED, WILMINGTON, DE. FILED 3-31-2004.

SN 78-395,785. CHANNEL ISLANDS ROASTING COMPANY, CARPINTERIA, CA. FILED 4-2-2004.



OWNER OF U.S. REG. NOS. 2,192,578, 2,778,580 AND OTHERS.

NO CLAIM IS MADE TO THE EXCLUSIVE RIGHT TO USE "FRANCE, IN FIRST COLD PRESSED, EXTRA VIRGIN OLIVE OIL, FOR PASTA & VEGETABLES, FRENCH GOURMET CUISINE, PRODUCT OF FRANCE, 100% NATURAL INGREDIENTS AND HERBS", APART FROM THE MARK AS SHOWN.

THE GRAY TONES ARE FOR SHADING PURPOSES ONLY AND DO NOT INDICATE COLOR.

FOR MARINADE (U.S. CL. 46).
FIRST USE 4-17-2003; IN COMMERCE 4-17-2003.
AMY HELLA, EXAMINING ATTORNEY

NO CLAIM IS MADE TO THE EXCLUSIVE RIGHT TO USE "ROASTING CO.", APART FROM THE MARK AS SHOWN.

THE MARK CONSISTS OF THE STYLIZED WORDS "CHANNEL ISLANDS ROASTING CO." AND A COFFEE CUP DESIGN.

FOR COFFEE (U.S. CL. 46).
FIRST USE 6-2-2004; IN COMMERCE 6-2-2004.
DOUGLAS LEE, EXAMINING ATTORNEY

CLASS 30—(Continued).

SN 78-398,043. SALINAS, LOUIE JR, MONTEBELLO, CA. FILED 4-7-2004.

AY QUE SALSA

THE MARK CONSISTS OF STANDARD CHARACTERS WITHOUT CLAIM TO ANY PARTICULAR FONT, STYLE, SIZE, OR COLOR.
 NO CLAIM IS MADE TO THE EXCLUSIVE RIGHT TO USE "SALSA", APART FROM THE MARK AS SHOWN.
 THE FOREIGN WORDING IN THE MARK TRANSLATES INTO ENGLISH AS OH WHAT.
 FOR HOT SAUCES (U.S. CL. 46).
 FIRST USE 4-9-2004; IN COMMERCE 4-9-2004.
 ANNE E. GUSTASON, EXAMINING ATTORNEY

CLASS 30—(Continued).

SN 78-403,823. GOLD CHOICE FOOD INDUSTRIES SDN BHD, PENANG, MALAYSIA, FILED 4-19-2004.



PRIORITY CLAIMED UNDER SEC. 44(D) ON MALAYSIA APPLICATION NO. 04-03973, FILED 3-29-2004.
 FOR INSTANT BEVERAGES MADE OF COFFEE, NAMELY, 2-IN-1 BLACK COFFEE IN BAGS, 3-IN-1 INSTANT COFFEE MIX; CAPPUCCINO; COFFEE, NAMELY WHITE COFFEE AND GROUND AND WHOLE BEAN COFFEE; COFFEE MIXTURE BAGS, NAMELY PACKETS OF COMBINED COFFEE AND SUGAR, FLAVORING ADDITIVES FOR COFFEE BEANS; BREAKFAST CEREALS, NAMELY INSTANT NUTRITIOUS CEREAL; RICE, NAMELY INSTANT COARSE RICE; TEA, NAMELY TEA EXTRACTS; BISCUITS (U.S. CL. 46).
 FIRST USE 3-0-2004; IN COMMERCE 3-0-2004.
 SOPHIA S. KIM, EXAMINING ATTORNEY

SN 78-402,208. FRITOS ENCANTO DE MONTERREY, S.A. DE C.V., MONTERREY, NUEVO LEON, MEXICO, FILED 4-15-2004.

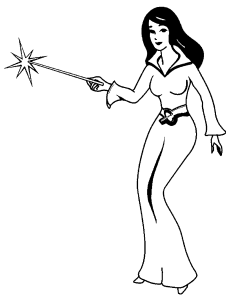

THE STIPPLING IS FOR SHADING PURPOSES ONLY.
 THE MARK CONSISTS OF AN IMAGE OF FAIRY WITH A WAND AND STAR AT THE END OF THE WAND.
 FOR CORN CHIPS AND TORTILLA CHIPS (U.S. CL. 46).
 FIRST USE 12-31-1997; IN COMMERCE 12-31-1997.
 MICHELE SWAIN, EXAMINING ATTORNEY

SN 78-407,385. LOS ANGELES SEED CO., INC., LOS ANGELES, CA. FILED 4-23-2004.



OWNER OF U.S. REG. NO. 1,945,958.
 THE STIPPLING IS A FEATURE OF THE MARK.
 THE MARK CONSISTS OF THE DESIGN OF A RISING SUN ABOVE THE WORDS "VIA NUEVA".
 THE FOREIGN WORDING IN THE MARK TRANSLATES INTO ENGLISH AS "NEW WAY".
 FOR MEXICAN SPICES AND SAUCES (U.S. CL. 46).
 FIRST USE 9-28-1992; IN COMMERCE 9-28-1992.
 JEAN IM, EXAMINING ATTORNEY

CLASS 30—(Continued).

SN 78-407,595. MCCALLA, CLINTON L., MARTINEZ, GA.
FILED 4-25-2004.



"JACKLE M'S" IDENTIFIES A LIVING INDIVIDUAL
WHOSE CONSENT IS OF RECORD.
FOR BAKERY DESSERTS (U.S. CL. 46).
FIRST USE 9-1-2001; IN COMMERCE 1-22-2002.
SEAN DWYER, EXAMINING ATTORNEY

SN 78-407,828. MAMMOTH PACIFIC, INC., DBA BABYSOFT
INTERNATIONAL CO., LOS ANGELES, CA. FILED 4-26-
2004.



NO CLAIM IS MADE TO THE EXCLUSIVE RIGHT TO
USE "SINCE 1984", "THE ORIGINAL", "DOEN JANG", AND
"JIN JJA", APART FROM THE MARK AS SHOWN.

THE MARK CONSISTS OF TWO CONCENTRIC CIRCLES
WITH THE WORDS "SINCE 1984" AND "THE ORIGINAL"
APPEARING WITHIN THE BORDER CREATED BY THE
TWO CIRCLES. THE WORDS "POT" AND THE KOREAN
CHARACTERS MEANING "ROYAL COURT SOYBEAN
PASTE" AND "THE REAL THING" APPEAR IN THE
CENTER OF THE MARK WITHIN BOTH CIRCLES.

THE FOREIGN WORDING IN THE MARK TRANSLATES
INTO ENGLISH AS "ROYAL COURT SOYBEAN PASTE"
AND "THE REAL THING".

THE NON-LATIN CHARACTER(S) IN THE MARK
TRANSLITERATES INTO "GUNG JUNG DOEN JANG"
AND "JIN JJA", AND THIS MEANS "ROYAL COURT
SOYBEAN PASTE" AND "THE REAL THING" IN ENGLISH.
FOR FOOD PRODUCT, NAMELY SOY BEAN PASTE
(U.S. CL. 46).

FIRST USE 9-9-1984; IN COMMERCE 9-9-1984.
HEATHER THOMPSON, EXAMINING ATTORNEY

CLASS 30—(Continued).

SN 78-408,481. NISSIN SHOKUJIN KABUSHIKI KAISHA,
DBA NISSIN FOOD PRODUCTS CO., LTD., OSAKA,
JAPAN, FILED 4-27-2004.



OWNER OF U.S. REG. NOS. 2,112,381 AND 2,389,574.
NO CLAIM IS MADE TO THE EXCLUSIVE RIGHT TO
USE "NOODLES" AND "MEAL", APART FROM THE MARK
AS SHOWN.

THE STIPPLING IS A FEATURE OF THE MARK AND
DOES NOT INDICATE COLOR.

THE MARK CONSISTS OF THE WORDS CUP NOODLES
SOUPER MEAL WRITTEN IN A STYLIZED FONT.

SEC. 2(F).

FOR INSTANT NOODLE SOUPS CONSISTING OF
PRIMARILY OF DRIED NOODLES AND SOUP MIXES
SOLD IN A DISPOSABLE CONTAINER (U.S. CL. 46).

FIRST USE 9-0-2004; IN COMMERCE 9-0-2004.

JOHN E. MICHOS, EXAMINING ATTORNEY

SN 78-414,139. RICH PRODUCTS MANUFACTURING COR-
PORATION, BUFFALO, NY. FILED 5-6-2004.



OWNER OF U.S. REG. NOS. 1,150,576, 1,441,367 AND
1,841,972.

NO CLAIM IS MADE TO THE EXCLUSIVE RIGHT TO
USE "DESSERTS", APART FROM THE MARK AS SHOWN.

THE NAME(S), PORTRAIT(S), AND/OR SIGNATURE(S)
SHOWN IN THE MARK DOES NOT IDENTIFY A PARTI-
CULAR LIVING INDIVIDUAL.

THE MARK CONSISTS OF DRAWING OF A MAN
WEARING A CHEF'S HAT AND GARMENT, ABOVE THE
WORDS JON DONAIRE, ABOVE THE WORD DESSERT.

FOR FROZEN DESSERTS, NAMELY CHEESECAKES,
MOUSSECAKES, TORTES, ICE CREAM CAKES, LAYER
CAKES, SHEET CAKES, SPECIALTY CAKES, AND
BROWNIES; FROZEN DESSERTS IN A PORTION PACK
CONTAINER, NAMELY BROWNIES, CHEESECAKES,
AND TORTES; FROZEN TOPPING AND ICINGS (U.S.
CL. 46).

FIRST USE 12-0-1990; IN COMMERCE 12-0-1990.
EVELYN BRADLEY, EXAMINING ATTORNEY

CLASS 30—(Continued).

SN 78-416,540. JENNY'S COUNTRY KITCHEN, INC., DOVER, MN. FILED 5-11-2004.



NO CLAIM IS MADE TO THE EXCLUSIVE RIGHT TO USE "GENERAL STORE", APART FROM THE MARK AS SHOWN.

FOR INSTANT FLAVORED COFFEE AND COCOA BEVERAGE MIXES (U.S. CL. 46).

FIRST USE 1-1-2003; IN COMMERCE 1-1-2003.

FRED MANDIR, EXAMINING ATTORNEY

SN 78-419,933. FRITO-LAY NORTH AMERICA, INC., PLANO, TX. FILED 5-17-2004.

NACHO CHEESIER!

THE MARK CONSISTS OF STANDARD CHARACTERS WITHOUT CLAIM TO ANY PARTICULAR FONT, STYLE, SIZE, OR COLOR.

OWNER OF U.S. REG. NOS. 1,843,101 AND 2,743,565.

NO CLAIM IS MADE TO THE EXCLUSIVE RIGHT TO USE "NACHO", APART FROM THE MARK AS SHOWN.

FOR CRACKERS (U.S. CL. 46).

FIRST USE 1-1-1999; IN COMMERCE 1-1-1999.

SOPHIA S. KIM, EXAMINING ATTORNEY

SN 78-421,309. SARA LEE FOODS, INC., CINCINNATI, OH. FILED 5-19-2004.

HILLSHIRE FARM

THE MARK CONSISTS OF STANDARD CHARACTERS WITHOUT CLAIM TO ANY PARTICULAR FONT, STYLE, SIZE, OR COLOR.

OWNER OF U.S. REG. NOS. 970,878, 2,783,330 AND OTHERS.

FOR SANDWICHES MADE OF BEEF, CHICKEN, PORK AND CHEESE IN COMBINATION OR SEPARATELY (U.S. CL. 46).

LINDA POWELL, EXAMINING ATTORNEY

CLASS 30—(Continued).

SN 78-422,279. CLAIRE'S CORNER COPIA, INC., NEW HAVEN, CT. FILED 5-20-2004.

LITHUANIAN COFFEE CAKE

THE MARK CONSISTS OF STANDARD CHARACTERS WITHOUT CLAIM TO ANY PARTICULAR FONT, STYLE, SIZE, OR COLOR.

NO CLAIM IS MADE TO THE EXCLUSIVE RIGHT TO USE COFFEE CAKE, APART FROM THE MARK AS SHOWN. SEC. 2(F).

FOR CAKES (U.S. CL. 46).

FIRST USE 12-31-1975; IN COMMERCE 12-31-1984.

CHRISTOPHER BUONGIORNO, EXAMINING ATTORNEY

SN 78-422,433. PINNACLE FOODS GROUP INC., MOUNTAIN LAKES, NJ. FILED 5-20-2004.

CARB-METER

THE MARK CONSISTS OF STANDARD CHARACTERS WITHOUT CLAIM TO ANY PARTICULAR FONT, STYLE, SIZE, OR COLOR.

FOR PREPARED BAKING MIXES, NAMELY, CAKE MIXES, PANCAKE MIXES, MUFFIN MIXES, PIE MIXES, BROWNIE MIXES, AND KITS CONTAINING A BAKING MIX PLUS A FILLING MIX FOR MAKING SWEET BAKERY PRODUCTS, NAMELY, PIES AND CAKES (U.S. CL. 46).

LA TONIA FISHER, EXAMINING ATTORNEY

CLASS 30—(Continued).

SN 78-424,616. CATHOLIC TRADING LTD., CARSON CITY, NV. FILED 5-25-2004.



**CATHOLIC
COFFEE**

Coffee with a Calling

NO CLAIM IS MADE TO THE EXCLUSIVE RIGHT TO USE "COFFEE", APART FROM THE MARK AS SHOWN. FOR COFFEE BEANS AND COFFEE (U.S. CL. 46). FIRST USE 5-25-2004; IN COMMERCE 5-25-2004. ELIZABETH J. WINTER, EXAMINING ATTORNEY

CLASS 30—(Continued).

SN 78-425,885. FIREHOUSE RESTAURANT GROUP, INC., JACKSONVILLE, FL. FILED 5-27-2004.



OWNER OF U.S. REG. NOS. 1,903,135, 2,606,263 AND OTHERS. NO CLAIM IS MADE TO THE EXCLUSIVE RIGHT TO USE "SUBS", APART FROM THE MARK AS SHOWN. FOR CEREAL BASED SNACK FOODS; FOODS, NAMELY COOKIES AND BROWNIES (U.S. CL. 46). FIRST USE 12-31-1998; IN COMMERCE 12-31-1998. ALEX KEAM, EXAMINING ATTORNEY

SN 78-425,884. FIREHOUSE RESTAURANT GROUP, INC., JACKSONVILLE, FL. FILED 5-27-2004.

FIREHOUSE SUBS

THE MARK CONSISTS OF STANDARD CHARACTERS WITHOUT CLAIM TO ANY PARTICULAR FONT, STYLE, SIZE, OR COLOR. OWNER OF U.S. REG. NOS. 1,903,135, 2,606,263 AND OTHERS. NO CLAIM IS MADE TO THE EXCLUSIVE RIGHT TO USE "SUBS", APART FROM THE MARK AS SHOWN. FOR CEREAL BASED SNACK FOODS; FOODS, NAMELY COOKIES AND BROWNIES (U.S. CL. 46). FIRST USE 12-31-1998; IN COMMERCE 12-31-1998. ALEX KEAM, EXAMINING ATTORNEY

SN 78-426,393. NOURY, RICHARD J., LAHAINA, HI. AND NOURY, NATHALIE Z., LAHAINA, HI. FILED 5-27-2004.

HAWAII-LICIOUS

THE MARK CONSISTS OF STANDARD CHARACTERS WITHOUT CLAIM TO ANY PARTICULAR FONT, STYLE, SIZE, OR COLOR. FOR COOKIES, CAKES, PASTRIES, CRACKERS, CROUTONS, BREAD-STICKS, CORN CHIPS, PRETZELS, READY TO EAT FORTIFIED WHOLE GRAIN CEREAL BARS, CHOCOLATE, CANDY BARS, FROZEN CONFECTIONS, BISCOTTI, SAUCES, MARINADES, SALSA, SPICES, COFFEE (U.S. CL. 46). THEODORE MCBRIDE, EXAMINING ATTORNEY

CLASS 30—(Continued).

SN 78-429,982. RESER'S FINE FOODS, INC., BEAVERTON, OR. FILED 6-4-2004.



OWNER OF U.S. REG. NOS. 1,183,136 AND 1,276,407.
NO CLAIM IS MADE TO THE EXCLUSIVE RIGHT TO USE "ITALIAN FOODS", APART FROM THE MARK AS SHOWN.

THE STIPPLING IS FOR SHADING PURPOSES ONLY.
THE MARK CONSISTS OF A BUNDLE OF WHEAT SURROUNDED BY EGGS IN THE CENTER OF AN OVAL DEPICTED OVER A HORIZONTAL RIBBON RUNNING ACROSS THE CENTER OF THE OVAL, AND A BANNER OVERLAPPING AT THE TOP OF THE OVAL.

FOR PASTA, NAMELY FRESH AND FROZEN PASTA (U.S. CL. 46).

FIRST USE 6-0-1991; IN COMMERCE 6-0-1991.

MATTHEW PAPPAS, EXAMINING ATTORNEY

CLASS 30—(Continued).

SN 78-436,320. USA COFFEE COMPANY LLC, LAFARGE, WI. FILED 6-16-2004.



NO CLAIM IS MADE TO THE EXCLUSIVE RIGHT TO USE "USA COFFEE COMPANY", APART FROM THE MARK AS SHOWN.

THE COLOR(S) GRAY IS/ARE CLAIMED AS A FEATURE OF THE MARK.

THE COLOR GRAY APPEARS AS STEAM ABOVE THE COFFEE CUP.

THE MARK CONSISTS OF THE WORDS USA COFFEE COMPANY AND THE FANCIFUL REPRESENTATION OF A CUP AND STARS.

FOR COFFEE, TEA, AND SPECIALTY COFFEE (U.S. CL. 46).

DANIEL CAPSHAW, EXAMINING ATTORNEY

SN 78-435,528. MONOGRAMME CONFECTIONS COMPANY, INC., SAINT LOUIS, MO. FILED 6-15-2004.

RAINFORST CRUNCH

THE MARK CONSISTS OF STANDARD CHARACTERS WITHOUT CLAIM TO ANY PARTICULAR FONT, STYLE, SIZE, OR COLOR.

OWNER OF U.S. REG. NO. 1,605,820.

NO CLAIM IS MADE TO THE EXCLUSIVE RIGHT TO USE "CRUNCH", APART FROM THE MARK AS SHOWN.

FOR CANDY-NUT BRITTLE (U.S. CL. 46).

FIRST USE 8-9-1989; IN COMMERCE 8-9-1989.

KIMBERLY PERRY, EXAMINING ATTORNEY

SN 78-437,190. KARABETIAN IMPORT & DISTRIBUTION, INC., LOS ANGELES, CA. FILED 6-17-2004.



OWNER OF U.S. REG. NO. 2,574,695.

THE MARK CONSISTS OF THE WORD TAZAH ENCLOSED IN ONE OR MORE HEXAGONS.

THE FOREIGN WORDING IN THE MARK TRANSLATES INTO ENGLISH AS FRESH.

FOR CANNED AND PACKAGED CANDIES; CHOCOLATE TRUFFLES; RICE; TEA; COFFEE; LICORICE; JELLY FOR FOOD PURPOSES; TURKISH DELIGHT; BAKLAVA; HALVAH; TAHINA; FOOD PACKAGE COMBINATIONS CONSISTING PRIMARILY OF BREAD, CRACKERS, AND COOKIES (U.S. CL. 46).

FIRST USE 1-1-1996; IN COMMERCE 1-1-1996.

LINDA MICKLEBURGH, EXAMINING ATTORNEY

CLASS 30—(Continued).

SN 78-440,812. KINNIKINNICK FOODS INC., EDMONTON ALBERTA, CANADA, FILED 6-24-2004.

KINNI-KWIK

THE MARK CONSISTS OF STANDARD CHARACTERS WITHOUT CLAIM TO ANY PARTICULAR FONT, STYLE, SIZE, OR COLOR.

PRIORITY CLAIMED UNDER SEC. 44(D) ON CANADA APPLICATION NO. 1,218,096, FILED 5-26-2004, REG. NO. TMA637698, DATED 4-19-2005, EXPIRES 4-19-2020.

FOR MIXES FOR BAKERY GOODS, NAMELY, DRY MIXES FOR BREAD, BUNS, COOKIES, CAKES, PANCAKES AND PIZZA CRUST; COATING MIXES FOR MEAT, FISH AND VEGETABLES; PIZZA CRUSTS, READY TO BAKE COOKIES, BUNS, MUFFINS AND FROZEN ENTREES CONSISTING PRIMARILY OF PASTA (U.S. CL. 46).

FIRST USE 5-1-2001; IN COMMERCE 5-1-2001.
INGA ERVIN, EXAMINING ATTORNEY

CLASS 30—(Continued).

SN 78-443,456. SUGAR FOODS CORP., NEW YORK, NY. FILED 6-29-2004.

PRETZEL POPPERS

THE MARK CONSISTS OF STANDARD CHARACTERS WITHOUT CLAIM TO ANY PARTICULAR FONT, STYLE, SIZE, OR COLOR.

NO CLAIM IS MADE TO THE EXCLUSIVE RIGHT TO USE "PRETZEL", APART FROM THE MARK AS SHOWN. FOR PRETZEL-RELATED SNACK FOODS (U.S. CL. 46).

FIRST USE 1-0-2005; IN COMMERCE 1-0-2005.
TRICIA SONNEBORN, EXAMINING ATTORNEY

SN 78-443,251. DERECKTOR, DEBORAH, BELFAST, ME. FILED 6-29-2004.

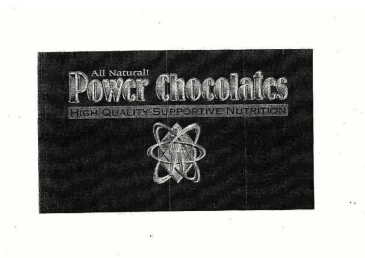

NO CLAIM IS MADE TO THE EXCLUSIVE RIGHT TO USE ALL NATURAL! OR CHOCOLATES OR HIGH QUALITY SUPPORTIVE NUTRITION, APART FROM THE MARK AS SHOWN.

THE COLORS GOLD, BROWN AND RED ARE CLAIMED AS FEATURES OF THE MARK.

THE COLOR GOLD APPEARS IN THE WORDING ALL NATURAL! POWER CHOCOLATES AND IN THE ATOMIC SYMBOL. THE COLOR RED APPEARS IN THE RECTANGULAR CARRIER FOR THE WORDING HIGH QUALITY SUPPORTIVE NUTRITION. THE COLOR BROWN APPEARS IN THE BACKGROUND OF THE MARK.

THE MARK CONSISTS OF GOLD LETTERS ON PRODUCT NAME AND LOGO, RED BANNER WITH REVERSED SUBHEAD.

FOR CHOCOLATES (U.S. CL. 46).
FIRST USE 11-18-2003; IN COMMERCE 12-23-2003.
SCOTT OSCLICK, EXAMINING ATTORNEY

SN 78-458,635. SANCHIS MIRA, S.A., JJONA (ALICANTE), SPAIN, FILED 7-29-2004.

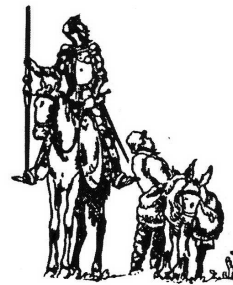
**EL QUIJOTE**

OWNER OF SPAIN REG. NO. 245961, DATED 10-4-1951, EXPIRES 4-3-2011.

THE MARK CONSISTS OF A KNIGHT SEATED ON HIS HORSE BESIDE A MAN STANDING NEXT TO A DONKEY. FOR NOUGATS (U.S. CL. 46).

JOHN DWYER, EXAMINING ATTORNEY

CLASS 30—(Continued).

SN 78-464,472. FRATERNITE NOTRE DAME, INC., CHICAGO, IL. FILED 8-9-2004.

ST ROGER ABBEY

THE MARK CONSISTS OF STANDARD CHARACTERS WITHOUT CLAIM TO ANY PARTICULAR FONT, STYLE, SIZE, OR COLOR.

FOR PASTRIES, CAKES, PIES, CHOUX, COOKIES, BISCUITS, ALMOND PASTE, BAKERY GOODS, BREAD, BREAD ROLLS, BRIOCHES, CANDY, CARAMELS, CHOCOLATES, CHOCOLATE TRUFFLES, CREPES, FRUIT PIES, HONEY, SANDWICHES, MINT CANDY, QUICHES, WAFERS, WAFFLES; BAKED DESSERTS, DESSERT SOUFFLÉS, MOUSSES, PUDDINGS, NAMELY, ÉCLAIRS, GALETTES, RIZ AU LAIT, CREMES BRULEES, PAINS AU CHOCOLAT, PAINS AUX RAISINS, PAINS AU LAIT, CHAUSSONS, AUX POMMES, CROISSANTS, CROISSANTS AUX AMANDES, PAIN PERDU, PETITS FOURS, FOUGASSES, MERVEILLES, BOTEREAUX, OREILLETES, BEIGNETS, JESUITES, FLANS AU LAIT, FLANS AU CHOCOLAT, AND SABLES (U.S. CL. 46).

FIRST USE 7-1-2003; IN COMMERCE 7-1-2003.
CHERYL CLAYTON, EXAMINING ATTORNEY

CLASS 30—(Continued).

SN 78-466,691. ROYAL GYPSY TEA COMPANY, OJAI, CA. FILED 8-12-2004.



FOR TEA (U.S. CL. 46).
FIRST USE 10-0-2002; IN COMMERCE 10-0-2002.
DANIEL BRODY, EXAMINING ATTORNEY

SN 78-464,515. FRATERNITE NOTRE DAME, INC., CHICAGO, IL. FILED 8-9-2004.



NO CLAIM IS MADE TO THE EXCLUSIVE RIGHT TO USE "FRENCH STYLE QUALITY PATISSERIES", APART FROM THE MARK AS SHOWN.

FOR PASTRIES, CAKES, PIES, CHOUX, COOKIES, BISCUITS, ALMOND PASTE, BAKERY GOODS, BREAD, BREAD ROLLS, BRIOCHES, CANDY, CARAMELS, CHOCOLATES, CHOCOLATE TRUFFLES, CREPES, FRUIT PIES, HONEY, SANDWICHES, MINTS CANDY, QUICHES, WAFERS, WAFFLES BAKED DESSERTS, DESSERT SOUFFLÉS, MOUSSES, PUDDINGS, NAMELY, ÉCLAIRS, GALETTES, RIZ AU LAIT, CREMES BRULEES, PAINS AU CHOCOLAT, PAINS AUX RAISINS, PAINS AU LAIT, CHAUSSONS, AUX POMMES, CROISSANTS, CROISSANTS AUX AMANDES, PAIN PERDU, PETITS FOURS, FOUGASSES, MERVEILLES, BOTEREAUX, OREILLETES, BEIGNETS, JESUITES, FLANS AU LAIT, FLANS AU CHOCOLAT, AND SABLES (U.S. CL. 46).

FIRST USE 7-1-2003; IN COMMERCE 7-1-2003.
CHERYL CLAYTON, EXAMINING ATTORNEY

SN 78-471,465. FRANCIS P. DRAB, RYDAL, PA. FILED 8-21-2004.

**THE GUMMI FIRST
AID KIT**

THE MARK CONSISTS OF STANDARD CHARACTERS WITHOUT CLAIM TO ANY PARTICULAR FONT, STYLE, SIZE, OR COLOR.

NO CLAIM IS MADE TO THE EXCLUSIVE RIGHT TO USE GUMMI, APART FROM THE MARK AS SHOWN.
FOR CANDY (U.S. CL. 46).
BRIDGETT SMITH, EXAMINING ATTORNEY

CLASS 30—(Continued).

SN 78-472,882. HAWAII KAI CORPORATION, LAGUNA HILLS, CA. FILED 8-24-2004.



THE COLOR(S) BLUE AND PURPLE IS/ARE CLAIMED AS A FEATURE OF THE MARK.

THE COLOR BLUE APPEARS IN THE UPPER PORTION OF THE BACKGROUND OF THE MARK. THE COLOR PURPLE APPEARS IN THE LOWER PORTION OF THE WORD VOLCANO.

FOR GOURMET NATURAL SEA SALT (U.S. CL. 46).
FIRST USE 8-16-1999; IN COMMERCE 8-16-1999.
SCOTT OSICK, EXAMINING ATTORNEY

SN 78-474,108. SUZANNE'S SPECIALTIES, INC., NEW BRUNSWICK, NJ. FILED 8-26-2004.

RICEMELLOW

THE MARK CONSISTS OF STANDARD CHARACTERS WITHOUT CLAIM TO ANY PARTICULAR FONT, STYLE, SIZE, OR COLOR.

FOR AERATED RICE BASED CREAMS AND CONFECTIONS (U.S. CL. 46).
MATTHEW PAPPAS, EXAMINING ATTORNEY

SN 78-474,877. COOLBRANDS INTERNATIONAL INC., RONKONKOMA, NY. FILED 8-27-2004.

BETTER FOR KIDS

THE MARK CONSISTS OF STANDARD CHARACTERS WITHOUT CLAIM TO ANY PARTICULAR FONT, STYLE, SIZE, OR COLOR.

FOR FROZEN CONFECTIONS (U.S. CL. 46).
SUSAN STIGLITZ, EXAMINING ATTORNEY

CLASS 30—(Continued).

SN 78-475,706. COLLINS, DONALD W., HEREFORD, AZ. FILED 8-30-2004.

SALSA TIME SALSA

THE MARK CONSISTS OF STANDARD CHARACTERS WITHOUT CLAIM TO ANY PARTICULAR FONT, STYLE, SIZE, OR COLOR.

NO CLAIM IS MADE TO THE EXCLUSIVE RIGHT TO USE "SALSA", APART FROM THE MARK AS SHOWN. FOR SALSA (U.S. CL. 46).

FIRST USE 4-25-2004; IN COMMERCE 6-28-2004.
FLORENTINA BLANDU, EXAMINING ATTORNEY

SN 78-475,745. LI, CHUN WAI, HONG KONG, HONG KONG, FILED 8-30-2004.

TOUCH ORGANIC

THE MARK CONSISTS OF STANDARD CHARACTERS WITHOUT CLAIM TO ANY PARTICULAR FONT, STYLE, SIZE, OR COLOR.

NO CLAIM IS MADE TO THE EXCLUSIVE RIGHT TO USE "ORGANIC", APART FROM THE MARK AS SHOWN.

FOR ORGANIC FOODS AND BEVERAGES NAMELY ORGANIC TEA, HERBAL TEA, GREEN TEA, JASMINE TEA, OOLONG TEA, BUCKWHEAT NOODLES, RICE NOODLES, WHEAT NOODLES, ROYAL JELLY AND HONEY (U.S. CL. 46).

MARK RADEMACHER, EXAMINING ATTORNEY

SN 78-479,184. ACH FOOD COMPANIES, INC., MEMPHIS, TN. FILED 9-6-2004.



OWNER OF U.S. REG. NOS. 102,064, 2,860,259 AND OTHERS.

NO CLAIM IS MADE TO THE EXCLUSIVE RIGHT TO USE "OVER 100 YEARS OF QUALITY", APART FROM THE MARK AS SHOWN.

FOR CORN STARCH (U.S. CL. 46).

MELISSA VALLILLO, EXAMINING ATTORNEY

CLASS 30—(Continued).

SN 78-482,977. TODD'S SNAX, INC., DBA SHULTZ FOODS COMPANY, HANOVER, PA. FILED 9-14-2004.

JAKE BAKED

THE MARK CONSISTS OF STANDARD CHARACTERS WITHOUT CLAIM TO ANY PARTICULAR FONT, STYLE, SIZE, OR COLOR.

NO CLAIM IS MADE TO THE EXCLUSIVE RIGHT TO USE "BAKED", APART FROM THE MARK AS SHOWN.

JAKE BAKED DOES NOT IDENTIFY A PARTICULAR LIVING INDIVIDUAL.

FOR PRETZELS (U.S. CL. 46).

FIRST USE 3-31-1981; IN COMMERCE 3-31-1981.

SALLY SHIH, EXAMINING ATTORNEY

CLASS 30—(Continued).

SN 78-486,076. GLAXOSMITHKLINE CONSUMER HEALTH-CARE L.P., WILMINGTON, DE. FILED 9-20-2004.

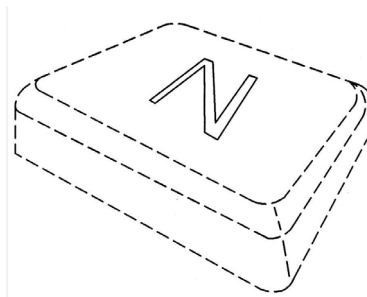

OWNER OF U.S. REG. NOS. 992,648 AND 1,186,363.

THE MARK CONSISTS OF A SQUARE IN THE FORM A PIECE OF GUM WITH THE LETTER "N" IN THE CENTER. THE MATTER SHOWN IN THE DOTTED LINES DOES NOT FORM PART OF THE MARK, BUT MERELY SERVES TO SHOW THE PLACEMENT THEREOF.

FOR CHEWING GUM (U.S. CL. 46).

ROBERT LAVACHE, EXAMINING ATTORNEY

SN 78-485,370. UNIQUE PRODUCTS, LTD., EAST HAVEN, CT. FILED 9-17-2004.

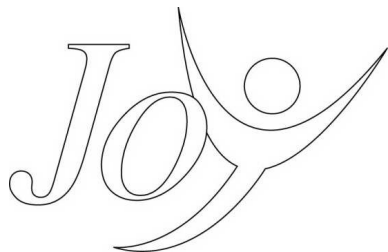

THE MARK CONSISTS IN PART OF THE STYLIZED WORD JOY WITH A CIRCLE OVER THE LETTER "Y".

FOR TEA (U.S. CL. 46).

FIRST USE 9-2-2004; IN COMMERCE 9-2-2004.

EDWARD NELSON, EXAMINING ATTORNEY

SN 78-487,342. NEW ORLEANS HAMBURGER & SEAFOOD COMPANY, INC., METAIRIE, LA. FILED 9-21-2004.

THE ORIGINAL ONE-HANDED POBOY

THE MARK CONSISTS OF STANDARD CHARACTERS WITHOUT CLAIM TO ANY PARTICULAR FONT, STYLE, SIZE, OR COLOR.

NO CLAIM IS MADE TO THE EXCLUSIVE RIGHT TO USE "POBOY", APART FROM THE MARK AS SHOWN.

FOR SANDWICH TO BE CONSUMED ON OF OFF PREMISES (U.S. CL. 46).

FIRST USE 10-1-2004; IN COMMERCE 10-1-2004.

JAMES A. RAUEN, EXAMINING ATTORNEY

CLASS 30—(Continued).

SN 78-487,831. VILLAGE PIZZERIA ENTERPRISES, LLC,
LANGLEY, WA. FILED 9-22-2004.



THE COLORS RED, GREEN, YELLOW ARE CLAIMED AS
A FEATURE OF THE MARK.

THE COLOR RED APPEARS IN THE LETTERS OF THE
WORDS VILLAGE, PIZZERIA, AND WHIDBEY ISLAND.
THE COLOR GREEN APPEARS AS THE OUTLINE ON THE
WORDS "VILLAGE PIZZERIA," THE CIRCLES, AND GRA-
PHIC FLOURISH. THE COLOR YELLOW APPEARS IN THE
CIRCLE BACKGROUND.

SEC. 2(F).

FOR PIZZA, PIZZA CRUST, PIZZA SAUCE, SALAD
DRESSING (U.S. CL. 46).

FIRST USE 9-22-1984; IN COMMERCE 9-22-1984.
LINDA E. BLOHM, EXAMINING ATTORNEY

CLASS 30—(Continued).

SN 78-489,844. BABY'S PLACE COFFEE BAR, INC., MIAMI,
FL. FILED 9-27-2004.

BABY'S HAVANA ROAST

THE MARK CONSISTS OF STANDARD CHARACTERS
WITHOUT CLAIM TO ANY PARTICULAR FONT, STYLE,
SIZE, OR COLOR.

OWNER OF U.S. REG. NOS. 1,791,798, 2,630,898 AND
OTHERS.

NO CLAIM IS MADE TO THE EXCLUSIVE RIGHT TO
USE "ROAST", APART FROM THE MARK AS SHOWN.

SEC. 2(F) AS TO BABY'S HAVANA.

FOR COFFEE (U.S. CL. 46).

FIRST USE 12-15-1993; IN COMMERCE 12-15-1993.

MARY ROSSMAN, EXAMINING ATTORNEY

SN 78-491,521. ITO EN (NORTH AMERICA) INC., BROOK-
LYN, NY. FILED 9-29-2004.

SN 78-488,600. MY FAVORITE COMPANY, INC., LOS
ANGELES, CA. FILED 9-23-2004.

SENCHA SHOT

JOLLY GOURMET

THE MARK CONSISTS OF STANDARD CHARACTERS
WITHOUT CLAIM TO ANY PARTICULAR FONT, STYLE,
SIZE, OR COLOR.

NO CLAIM IS MADE TO THE EXCLUSIVE RIGHT TO
USE "GOURMET", APART FROM THE MARK AS SHOWN.

FOR CANDY, BISCUITS, PACKAGED NUTS,
NAMELY CHOCOLATE COVERED NUTS. (U.S. CL. 46).

RICHARD WHITE, EXAMINING ATTORNEY

THE MARK CONSISTS OF STANDARD CHARACTERS
WITHOUT CLAIM TO ANY PARTICULAR FONT, STYLE,
SIZE, OR COLOR.

NO CLAIM IS MADE TO THE EXCLUSIVE RIGHT TO
USE "SENCHA", APART FROM THE MARK AS SHOWN.

THE ENGLISH TRANSLATION OF SENCHA IS GREEN
TEA.

FOR TEAS (U.S. CL. 46).

KEVIN DINALLO, EXAMINING ATTORNEY

CLASS 30—(Continued).

SN 78-494,298. SWAPTHOUGHTS, LLC, NASHVILLE, TN.
FILED 10-4-2004.

SwapThoughts

THE MARK CONSISTS OF STANDARD CHARACTERS
WITHOUT CLAIM TO ANY PARTICULAR FONT, STYLE,
SIZE, OR COLOR.

FOR COOKIES AND CANDY (U.S. CL. 46).
FIRST USE 5-13-2004; IN COMMERCE 6-16-2004.
DOMINIC J. FERRAIUOLO, EXAMINING ATTORNEY

SN 78-495,168. HACIENDA SAN JOSE', GENOVA, ITALY,
FILED 10-6-2004.

Hacienda San José

THE MARK CONSISTS OF STANDARD CHARACTERS
WITHOUT CLAIM TO ANY PARTICULAR FONT, STYLE,
SIZE, OR COLOR.

FOR COCOA, CANDY BARS, CHOCOLATE, CHOCOLATE
CANDIES (U.S. CL. 46).
FIRST USE 0-0-2004; IN COMMERCE 0-0-2004.
SUE LAWRENCE, EXAMINING ATTORNEY

CLASS 30—(Continued).

SN 78-495,187. DOMORI, GENOVA, ITALY, FILED 10-6-2004.

chacao

THE MARK CONSISTS OF STANDARD CHARACTERS
WITHOUT CLAIM TO ANY PARTICULAR FONT, STYLE,
SIZE, OR COLOR.

FOR COCOA, CHOCOLATE, CHOCOLATE BARS,
CHOCOLATE CANDIES (U.S. CL. 46).
FIRST USE 0-0-2004; IN COMMERCE 0-0-2004.
MICHAEL KAZAZIAN, EXAMINING ATTORNEY

SN 78-496,081. SAHARKHIZ SAFFRON AGRICULTURAL
PRODUCTION COMPANY INC., MASHAD, IRAN, FILED
10-7-2004.

سحر خيز

THE MARK CONSISTS OF THE WORD SAHARKHIZ IN
ARABIC SCRIPT.

THE NON-LATIN CHARACTER(S) IN THE MARK
TRANSLITERATES INTO SAHARKHIZ , AND THIS
MEANS A PARTICULAR FAMILY NAME IN ENGLISH.

FOR SPICES; SAFFRON (U.S. CL. 46).
SHAUNIA WALLACE, EXAMINING ATTORNEY

SN 78-498,228. BEN & JERRY'S HOMEMADE HOLDINGS,
INC., BURLINGTON, VT. FILED 10-12-2004.

THE FLAVOR YOU
CAN'T REFUSE

THE MARK CONSISTS OF STANDARD CHARACTERS
WITHOUT CLAIM TO ANY PARTICULAR FONT, STYLE,
SIZE, OR COLOR.

FOR ICE CREAM AND FROZEN CONFECTIONS (U.S.
CL. 46).
PAM WILLIS, EXAMINING ATTORNEY

CLASS 30—(Continued).

SN 78-498,855. HBINNOVATIONS INTERNATIONAL, LLC, OKEMOS, MI. FILED 10-13-2004.



NO CLAIM IS MADE TO THE EXCLUSIVE RIGHT TO USE "TRADING COMPANY", APART FROM THE MARK AS SHOWN.

FOR SPICES, SEASONINGS, PROCESSED HERBS, FLAVORINGS FOR USE IN FOODS, AND SPICES AND SEASONINGS IN OIL FORM FOR USE IN BEVERAGES (U.S. CL. 46).

MONTIA G. PRESSEY, EXAMINING ATTORNEY

CLASS 30—(Continued).

SN 78-499,850. MCALPIN, WILLIAM J., BAR HARBOR, ME. FILED 10-14-2004.

LA MINITA TARRAZU

THE MARK CONSISTS OF STANDARD CHARACTERS WITHOUT CLAIM TO ANY PARTICULAR FONT, STYLE, SIZE, OR COLOR.

THE FOREIGN WORDING IN THE MARK TRANSLATES INTO ENGLISH AS THE LITTLE MINE.

FOR COFFEE BEANS (U.S. CL. 46).

FIRST USE 2-1-1988; IN COMMERCE 2-1-1988.

CURTIS FRENCH, EXAMINING ATTORNEY

SN 78-499,187. THE AMALGAMATED SUGAR COMPANY, LLC, OGDEN, UT. FILED 10-13-2004.



FOR STAPLE FOODS; NAMELY SUGAR (U.S. CL. 46). FIRST USE 0-0-1972; IN COMMERCE 0-0-1972. DAVID MURRAY, EXAMINING ATTORNEY

SN 78-500,215. TEA GROUP INC., CHICAGO, IL. FILED 10-14-2004.

**Cultivating
Consciousness**

THE MARK CONSISTS OF STANDARD CHARACTERS WITHOUT CLAIM TO ANY PARTICULAR FONT, STYLE, SIZE, OR COLOR.

FOR TEA, COFFEE, SPICES, PROCESSED HERBS, HERBAL INFUSIONS, HERBAL FOOD BEVERAGES, TISANES, COCOA, CHOCOLATE, RICE (U.S. CL. 46).

FIRST USE 10-13-2004; IN COMMERCE 10-13-2004.

JOHN DWYER, EXAMINING ATTORNEY

SN 78-499,295. THE AMALGAMATED SUGAR COMPANY, LLC, OGDEN, UT. FILED 10-13-2004.



FOR GRANULATED SUGAR, POWDERED SUGAR, CUBED SUGAR, FINE GRANULATED SUGAR, BROWN SUGAR, AND CONFECTIONER'S SUGAR (U.S. CL. 46). FIRST USE 7-15-1921; IN COMMERCE 7-15-1921. DAVID MURRAY, EXAMINING ATTORNEY

SN 78-500,473. BREAKTHROUGH ENGINEERED NUTRITION, INC., LARGO, FL. FILED 10-15-2004.

**YOU WON'T BELIEVE
IT'S NOT SUGAR**

THE MARK CONSISTS OF STANDARD CHARACTERS WITHOUT CLAIM TO ANY PARTICULAR FONT, STYLE, SIZE, OR COLOR.

FOR CANDY (U.S. CL. 46).

FIRST USE 8-31-2004; IN COMMERCE 8-31-2004.

CHRISTOPHER ADKINS, EXAMINING ATTORNEY

CLASS 30—(Continued).

SN 78-500,966. MARK'S FEED STORES OF KENTUCKY, LLC, LOUISVILLE, KY. FILED 10-16-2004.

MARK'S

THE MARK CONSISTS OF STANDARD CHARACTERS WITHOUT CLAIM TO ANY PARTICULAR FONT, STYLE, SIZE, OR COLOR.

OWNER OF U.S. REG. NO. 1,858,762.
FOR SAUCES AND SPICES (U.S. CL. 46).
FIRST USE 4-0-1988; IN COMMERCE 4-0-1988.
KIMBERLY PERRY, EXAMINING ATTORNEY

CLASS 30—(Continued).

SN 78-501,278. HERSHEY CHOCOLATE & CONFECTIONERY CORPORATION, WHEAT RIDGE, DE. FILED 10-18-2004.

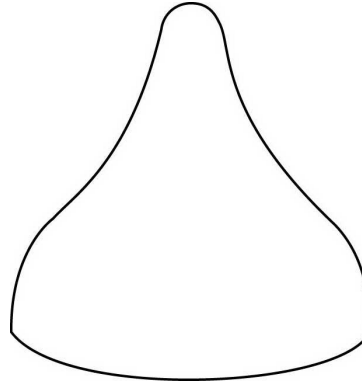

OWNER OF U.S. REG. NOS. 1,986,822, 2,187,189 AND OTHERS.

THE MARK CONSISTS OF THE CONFIGURATION OF A CONICALLY-SHAPED CHOCOLATE PIECE APPROXIMATELY 12-16 MM HIGH AS MEASURED FROM THE BASE TO THE PINNACLE AND 14-18 MM IN DIAMETER AS MEASURED AT THE BASE OF THE CHOCOLATE PIECE.

SEC. 2(F).
FOR CANDY; CONFECTIONERY BITS FOR BAKING (U.S. CL. 46).
FIRST USE 7-26-1995; IN COMMERCE 7-26-1995.
PAUL F. GAST, EXAMINING ATTORNEY

SN 78-501,039. LAMILL INC., ALHAMBRA, CA. FILED 10-16-2004.

LA MILL COFFEE

THE MARK CONSISTS OF STANDARD CHARACTERS WITHOUT CLAIM TO ANY PARTICULAR FONT, STYLE, SIZE, OR COLOR.

OWNER OF U.S. REG. NO. 2,739,707.
NO CLAIM IS MADE TO THE EXCLUSIVE RIGHT TO USE "COFFEE", APART FROM THE MARK AS SHOWN.
FOR COFFEE AND TEA (U.S. CL. 46).
FIRST USE 1-1-1997; IN COMMERCE 3-1-1997.
CAROLYN CATALDO, EXAMINING ATTORNEY

SN 78-502,765. SCHWAN'S IP, LLC, MARSHALL, MN. FILED 10-20-2004.

TACO-QUITO

THE MARK CONSISTS OF STANDARD CHARACTERS WITHOUT CLAIM TO ANY PARTICULAR FONT, STYLE, SIZE, OR COLOR.

FOR MEXICAN FOOD, NAMELY, ROLLED TORTILLAS FILLED WITH BEEF, CHEESE, CHICKEN, RICE AND/OR BEANS (U.S. CL. 46).
FIRST USE 5-1-1997; IN COMMERCE 5-1-1997.
MARGERY A. TIERNEY, EXAMINING ATTORNEY

CLASS 30—(Continued).

SN 78-503,470. THE RESTAURANT COMPANY, RICHMOND, VA. FILED 10-21-2004.

CLASS 30—(Continued).

SN 78-504,645. BAUMER FOODS, INC., NEW ORLEANS, LA. FILED 10-22-2004.

WRAPADILLAS



THE MARK CONSISTS OF STANDARD CHARACTERS WITHOUT CLAIM TO ANY PARTICULAR FONT, STYLE, SIZE, OR COLOR.
FOR FOOD ITEMS, NAMELY, SANDWICH WRAPS (U.S. CL. 46).
FIRST USE 3-28-2005; IN COMMERCE 3-28-2005.
ERNEST SHOSHO, EXAMINING ATTORNEY

NO CLAIM IS MADE TO THE EXCLUSIVE RIGHT TO USE "FLAVOR", APART FROM THE MARK AS SHOWN.
FOR SAUCES AND MARINADES (U.S. CL. 46).
FIRST USE 0-0-1983; IN COMMERCE 0-0-1983.
MARK T. MULLEN, EXAMINING ATTORNEY

SN 78-504,078. DR. OETKER LTD., MISSISSAUGA, CANADA, FILED 10-21-2004.

SN 78-505,713. THE RAIN CREEK BAKING COMPANY, FRESNO, CA. FILED 10-26-2004.

WHIP IT



THE MARK CONSISTS OF STANDARD CHARACTERS WITHOUT CLAIM TO ANY PARTICULAR FONT, STYLE, SIZE, OR COLOR.
FOR STABILIZER, NAMELY PRECOOKED STARCH, FOR USE IN THE PREPARATION OF WHIPPED CREAM (U.S. CL. 46).
FIRST USE 10-0-1972; IN COMMERCE 10-0-1972.
DANIEL BRODY, EXAMINING ATTORNEY

NO CLAIM IS MADE TO THE EXCLUSIVE RIGHT TO USE "SWEETS", APART FROM THE MARK AS SHOWN.
FOR PASTRIES (U.S. CL. 46).
FIRST USE 7-1-2001; IN COMMERCE 7-1-2001.
MONTIA G. PRESSEY, EXAMINING ATTORNEY

CLASS 30—(Continued).

SN 78-505,843. PAHNAS S.A. DE C.V., SAN SALVADOR, EL SALVADOR, FILED 10-26-2004.

EL COMALITO

THE MARK CONSISTS OF STANDARD CHARACTERS WITHOUT CLAIM TO ANY PARTICULAR FONT, STYLE, SIZE, OR COLOR.

THE FOREIGN WORDING IN THE MARK TRANSLATES INTO ENGLISH AS GRIDDLE; OR A FLAT CLAY DISH FOR MAKING TORTILLAS AND CORN CAKES, TYPICAL IN EL SALVADOR.

FOR TORTILLAS STUFFED WITH MEAT, CHEESE AND/OR VEGETABLES NAMELY "PUPUSAS" (U.S. CL. 46).

FIRST USE 9-15-2004; IN COMMERCE 9-15-2004,
TRACY WHITAKER-BOWN, EXAMINING ATTORNEY

SN 78-510,868. KELLOGG NORTH AMERICA COMPANY, BATTLE CREEK, MI. FILED 11-3-2004.

CHEEZ-IT FIESTA

THE MARK CONSISTS OF STANDARD CHARACTERS WITHOUT CLAIM TO ANY PARTICULAR FONT, STYLE, SIZE, OR COLOR.

OWNER OF U.S. REG. NOS. 151,785, 2,416,368 AND OTHERS.

FOR CRACKERS (U.S. CL. 46).
REBECCA SMITH, EXAMINING ATTORNEY

CLASS 30—(Continued).

SN 78-510,975. WARNER BROS. ENTERTAINMENT INC., BURBANK, CA. FILED 11-3-2004.

SPEEDY GONZALES

THE MARK CONSISTS OF STANDARD CHARACTERS WITHOUT CLAIM TO ANY PARTICULAR FONT, STYLE, SIZE, OR COLOR.

OWNER OF U.S. REG. NOS. 1,869,768, 2,057,614 AND OTHERS.

FOR COOKIES, BASES FOR MAKING MILKSHAKES, BREAKFAST CEREAL, BUBBLE GUM, CAKE DECORATIONS MADE OF CANDY, CHEWING GUM, FROZEN CONFECTIONS, CRACKERS, FROZEN YOGURT, ICE CREAM, FRUIT GELS, PRETZELS, PEANUT BUTTER CONFECTIONERY CHIPS, MALT FOR FOOD; SOY-BEAN MALT; MALT BISCUITS; SUGAR CONFECTIONERY, NAMELY CANDY, CANDY BARS, CANDY MINTS, CANDY COATED AND CARAMEL POPCORN, AND CANDY DECORATIONS FOR CAKES; EDIBLE DECORATIONS FOR CAKE; RICE CAKES; PASTILLES; PASTRIES; BISCUITS AND BREAD; COFFEE BEVERAGES WITH MILK; COCOA BEVERAGES WITH MILK, CHOCOLATE-BASED BEVERAGES, COFFEE AND COFFEE-BASED BEVERAGES, COCOA AND COCOA-BASED BEVERAGES; TEA, NAMELY, GINSENG TEA, BLACK TEA, OOLONG TEA, BARLEY AND BARLEY-LEAF TEA; MEAT TENDERIZERS FOR HOUSEHOLD PURPOSES; BINDING AGENTS FOR ICE-CREAM (U.S. CL. 46).

FIRST USE 10-31-2003; IN COMMERCE 10-31-2003,
MARK RADEMACHER, EXAMINING ATTORNEY

SN 78-514,273. MISTER COOKIE FACE, INC, LAKEWOOD, NJ. FILED 11-10-2004.

SLENDER REWARDS

THE MARK CONSISTS OF STANDARD CHARACTERS WITHOUT CLAIM TO ANY PARTICULAR FONT, STYLE, SIZE, OR COLOR.

FOR ICE CREAM SANDWICHES (U.S. CL. 46).
G. MAYERSCHOFF, EXAMINING ATTORNEY

CLASS 30—(Continued).

SN 78-515,341. RAO'S SPECIALTY FOODS, INC., NEW YORK, NY. FILED 11-11-2004.

UPGRADE TO FIRST CLASS

THE MARK CONSISTS OF STANDARD CHARACTERS WITHOUT CLAIM TO ANY PARTICULAR FONT, STYLE, SIZE, OR COLOR.
FOR PASTA, PASTA SAUCES, VINEGARETTE SALAD DRESSINGS, WINE VINEGARS (U.S. CL. 46).
CHRIS WELLS, EXAMINING ATTORNEY

SN 78-515,549. MISS MERINGUE COOKIES, LLC, SAN MARCOS, CA. FILED 11-11-2004.



NO CLAIM IS MADE TO THE EXCLUSIVE RIGHT TO USE "PROVENCE", APART FROM THE MARK AS SHOWN.
FOR COOKIES AND MADELEINES (U.S. CL. 46).
BRENDAN REGAN, EXAMINING ATTORNEY

SN 78-517,944. THE SPICE DEPOT, INC., LAS VEGAS, NV. FILED 11-16-2004.



NO CLAIM IS MADE TO THE EXCLUSIVE RIGHT TO USE "SPICE", APART FROM THE MARK AS SHOWN.
FOR PROCESSED HERBS AND SPICES (U.S. CL. 46).
ROBERT LORENZO, EXAMINING ATTORNEY

CLASS 30—(Continued).

SN 78-517,989. CAVANAGH COMPANY, GREENVILLE, RI. FILED 11-16-2004.

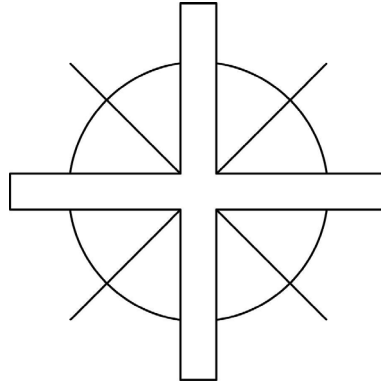

THE MARK CONSISTS OF TWO INTERSECTING LINES WITH RAYS EMANATING FROM THE INTERSECTION POINT THEREOF AND SURROUNDED BY A CIRCLE.
FOR ALTAR BREADS (U.S. CL. 46).
CATHERINE CAIN, EXAMINING ATTORNEY

SN 78-518,754. IMPACT CONFECTIONS, INC., COLORADO SPRINGS, CO. FILED 11-17-2004.



OWNER OF U.S. REG. NOS. 1,747,878, 2,827,481 AND OTHERS.
FOR CANDY (U.S. CL. 46).
GRETTA YAO, EXAMINING ATTORNEY

CLASS 30—(Continued).

SN 78-519,127. INNOVATIVE PRODUCT DEVELOPMENT, INC, DBA "LITTLE I", BLAINE, WA. FILED 11-18-2004.

CLASS 30—(Continued).

SN 78-524,968. MASTER FUNDRAISING, LLC, JACKSON, WI. FILED 12-1-2004.

POODLES

**AMERICA'S YOUTH
Fundraising Bar**

THE MARK CONSISTS OF STANDARD CHARACTERS WITHOUT CLAIM TO ANY PARTICULAR FONT, STYLE, SIZE, OR COLOR.
FOR CANDY, BREATH MINTS (U.S. CL. 46).
SKYE YOUNG, EXAMINING ATTORNEY

THE MARK CONSISTS OF STANDARD CHARACTERS WITHOUT CLAIM TO ANY PARTICULAR FONT, STYLE, SIZE, OR COLOR.
NO CLAIM IS MADE TO THE EXCLUSIVE RIGHT TO USE AMERICA'S AND FUNDRAISING BAR, APART FROM THE MARK AS SHOWN.
FOR CANDY BARS (U.S. CL. 46).
JOHN HWANG, EXAMINING ATTORNEY

SN 78-524,766. MUNCH-N-MEMORIES, LLC, GOLDEN, CO. FILED 11-30-2004.

SN 78-525,811. CHOWDHARY, MILAN, MASPETH, NY. FILED 12-2-2004.

Candid Cookies

ROOPALEE BRAND

THE MARK CONSISTS OF STANDARD CHARACTERS WITHOUT CLAIM TO ANY PARTICULAR FONT, STYLE, SIZE, OR COLOR.
NO CLAIM IS MADE TO THE EXCLUSIVE RIGHT TO USE "COOKIES", APART FROM THE MARK AS SHOWN.
FOR FOOD, NAMELY COOKIES (U.S. CL. 46).
JEAN IM, EXAMINING ATTORNEY

THE MARK CONSISTS OF STANDARD CHARACTERS WITHOUT CLAIM TO ANY PARTICULAR FONT, STYLE, SIZE, OR COLOR.
NO CLAIM IS MADE TO THE EXCLUSIVE RIGHT TO USE "BRAND", APART FROM THE MARK AS SHOWN.
FOR RICE (U.S. CL. 46).
FIRST USE 1-5-2004; IN COMMERCE 1-5-2004.
KAREN BRACEY, EXAMINING ATTORNEY

CLASS 30—(Continued).

SN 78-528,880. RAGUS HOLDINGS, INC., WILMINGTON, DE. FILED 12-8-2004.



OWNER OF U.S. REG. NOS. 729,535, 970,907 AND OTHERS.

NO CLAIM IS MADE TO THE EXCLUSIVE RIGHT TO USE "SINCE 1843" AND "SUGAR", APART FROM THE MARK AS SHOWN.

THE MARK CONSISTS OF THE WORDING "IMPERIAL SUGAR" AND DESIGN OF A CROWN AND LIGHT RAYS WITH THE WORDS "SINCE 1843".

FOR SUGAR, FLAVORED SUGAR, AND POWDERED SUGAR (U.S. CL. 46).

FIRST USE 7-11-2003; IN COMMERCE 7-11-2003. DAVID C. REIHNER, EXAMINING ATTORNEY

CLASS 30—(Continued).

SN 78-531,548. ENERGY KITCHEN INC., NEW YORK, NY. FILED 12-13-2004.

**ENERGY KITCHEN
ENERGY BURGER**

THE MARK CONSISTS OF STANDARD CHARACTERS WITHOUT CLAIM TO ANY PARTICULAR FONT, STYLE, SIZE, OR COLOR.

OWNER OF U.S. REG. NO. 2,891,673.

NO CLAIM IS MADE TO THE EXCLUSIVE RIGHT TO USE "BURGER", APART FROM THE MARK AS SHOWN.

FOR HAMBURGER SANDWICH FOR CONSUMPTION ON OR OFF THE PREMISES (U.S. CL. 46).

FIRST USE 3-1-2002; IN COMMERCE 3-1-2002.

DAWN FELDMAN, EXAMINING ATTORNEY

SN 78-531,401. CARVEL CORPORATION, ATLANTA, GA. FILED 12-13-2004.

NUTTY THE GHOST

THE MARK CONSISTS OF STANDARD CHARACTERS WITHOUT CLAIM TO ANY PARTICULAR FONT, STYLE, SIZE, OR COLOR.

NO CLAIM IS MADE TO THE EXCLUSIVE RIGHT TO USE "GHOST", APART FROM THE MARK AS SHOWN.

THE NAME IN THE MARK DOES NOT IDENTIFY ANY PARTICULAR LIVING INDIVIDUAL.

FOR CAKES MADE OF ICE CREAM AND COMBINATIONS OF ICE CREAM AND FROZEN CONFECTI (U.S. CL. 46).

FIRST USE 10-1-1979; IN COMMERCE 10-1-1979. ELISSA GARBER KON, EXAMINING ATTORNEY

SN 78-531,557. ENERGY KITCHEN INC, NEW YORK, NY. FILED 12-13-2004.

**ENERGY KITCHEN
BISON CHEESTEAK**

THE MARK CONSISTS OF STANDARD CHARACTERS WITHOUT CLAIM TO ANY PARTICULAR FONT, STYLE, SIZE, OR COLOR.

OWNER OF U.S. REG. NO. 2,891,673.

NO CLAIM IS MADE TO THE EXCLUSIVE RIGHT TO USE "KITCHEN BISON CHEESESTEAK", APART FROM THE MARK AS SHOWN.

FOR SANDWICH FOR CONSUMPTION ON OR OFF THE PREMISES (U.S. CL. 46).

FIRST USE 3-1-2002; IN COMMERCE 3-1-2002.

LEIGH CAROLINE CASE, EXAMINING ATTORNEY

CLASS 30—(Continued).

SN 78-532,640. COOKIES ON CALL, LLC, SAUGATUCK, MI.
FILED 12-15-2004.

COOKIES ON CALL!
THE BEST
CHOCOLATE CHUNK
COOKIES MADE
WITH LOVE IN
FRANNYLAND.

THE MARK CONSISTS OF STANDARD CHARACTERS
WITHOUT CLAIM TO ANY PARTICULAR FONT, STYLE,
SIZE, OR COLOR.

NO CLAIM IS MADE TO THE EXCLUSIVE RIGHT TO
USE "COOKIES" AND "THE BEST CHOCOLATE CHUNK
COOKIES", APART FROM THE MARK AS SHOWN.

FOR COOKIES (U.S. CL. 46).

FIRST USE 4-30-2002; IN COMMERCE 4-30-2002.

ALICE SUE CARRUTHERS, EXAMINING ATTORNEY

CLASS 30—(Continued).

SN 78-533,655. CERRETA CANDY COMPANY, INC., GLEN-
DALE, AZ. FILED 12-16-2004.

PECAÑERO

THE MARK CONSISTS OF STANDARD CHARACTERS
WITHOUT CLAIM TO ANY PARTICULAR FONT, STYLE,
SIZE, OR COLOR.

FOR CANDY, NAMELY, PECAN BUTTER CRISPS
(U.S. CL. 46).

FIRST USE 12-31-1973; IN COMMERCE 12-31-1973.

VERNA BETH RIRIE, EXAMINING ATTORNEY

SN 78-534,262. CRYSTAL FALLS FOODS, LLC, DALLAS, TX.
FILED 12-17-2004.

OUT OF A FLOWER

THE MARK CONSISTS OF STANDARD CHARACTERS
WITHOUT CLAIM TO ANY PARTICULAR FONT, STYLE,
SIZE, OR COLOR.

FOR FROZEN DESSERTS; NAMELY, ICE CREAMS,
AND SORBETS (U.S. CL. 46).

FIRST USE 9-1-2004; IN COMMERCE 9-1-2004.

STEPHANIE DAVIS, EXAMINING ATTORNEY

SN 78-533,082. MINECO CORPORATION, GARDEN GROVE,
CA. FILED 12-15-2004.

MINECO

SN 78-535,190. CHOCOLATE MOOSE CANDY COMPANY,
ANCHORAGE, AK. FILED 12-20-2004.

MOSQUITO BITES

THE MARK CONSISTS OF STANDARD CHARACTERS
WITHOUT CLAIM TO ANY PARTICULAR FONT, STYLE,
SIZE, OR COLOR.

FOR CANDY, BUBBLE GUM, GUM SWEETS, CHOCO-
LATE, GELATIN CANDY, JELLY LOLLIPOPS, CONFE-
CTIONERY IN THE NATURE OF PECTIN JELLY AND
GELATIN JELLY, AND CANDY DECORATIONS FOR
CAKES (U.S. CL. 46).

MARK RADEMACHER, EXAMINING ATTORNEY

THE MARK CONSISTS OF STANDARD CHARACTERS
WITHOUT CLAIM TO ANY PARTICULAR FONT, STYLE,
SIZE, OR COLOR.

FOR CANDY, BOXED CANDY, CANDY BAR,
BAGGED CANDY (U.S. CL. 46).

FIRST USE 11-14-2004; IN COMMERCE 12-1-2004.

MATTHEW PAPPAS, EXAMINING ATTORNEY

CLASS 30—(Continued).

SN 78-536,051. BRAD BARRY COMPANY, LTD., CHINO, CA. FILED 12-21-2004.

LA GRANDE CAPPUCCINO

THE MARK CONSISTS OF STANDARD CHARACTERS WITHOUT CLAIM TO ANY PARTICULAR FONT, STYLE, SIZE, OR COLOR.

OWNER OF U.S. REG. NO. 1,283,871.

NO CLAIM IS MADE TO THE EXCLUSIVE RIGHT TO USE "CAPPUCCINO", APART FROM THE MARK AS SHOWN.

THE ENGLISH TRANSLATION OF THE WORDING "LA GRANDE CAPPUCCINO" IS "THE GRAND CAPPUCCINO." SEC. 2(F).

FOR COFFEE (U.S. CL. 46).

FIRST USE 5-1-1981; IN COMMERCE 5-1-1981.

ANDREA K. NADELMAN, EXAMINING ATTORNEY

SN 78-536,212. SCHWAN'S IP, LLC, MARSHALL, MN. FILED 12-21-2004.

GOLD EDITION

THE MARK CONSISTS OF STANDARD CHARACTERS WITHOUT CLAIM TO ANY PARTICULAR FONT, STYLE, SIZE, OR COLOR.

FOR FROZEN PIZZA; FROZEN PIZZA SNACKS AND HAND-HELD APPETIZERS CONSISTING OF ENROBED DOUGH FILLED WITH SAUCE, MEAT, AND VEGETABLES WITH OR WITHOUT CHEESE (U.S. CL. 46).

JILL PRATER, EXAMINING ATTORNEY

SN 78-536,752. ALLIED DOMECQ ESPANA, S.A., 28043 MADRID, SPAIN, FILED 12-22-2004.

PALOMINO & VERGARA

THE MARK CONSISTS OF STANDARD CHARACTERS WITHOUT CLAIM TO ANY PARTICULAR FONT, STYLE, SIZE, OR COLOR.

FOR VINEGAR (U.S. CL. 46).

FIRST USE 0-0-1999; IN COMMERCE 0-0-1999.

DAVID YONTEF, EXAMINING ATTORNEY

CLASS 30—(Continued).

SN 78-537,428. CLUSTER SOLUTIONS, INC., RANCHO SANTA MARGARITA, CA. FILED 12-22-2004.

MR. Solution L-200

THE MARK CONSISTS OF STANDARD CHARACTERS WITHOUT CLAIM TO ANY PARTICULAR FONT, STYLE, SIZE, OR COLOR.

NO CLAIM IS MADE TO THE EXCLUSIVE RIGHT TO USE L-200, APART FROM THE MARK AS SHOWN.

FOR ULTRA HYDRATING BEVERAGE CONCENTRATE CONSISTING PRIMARILY OF TEAS AND PROCESSED HERBS (U.S. CL. 46).

FIRST USE 1-10-1996; IN COMMERCE 1-10-1996.

LINDA POWELL, EXAMINING ATTORNEY

SN 78-538,042. CHOCOLATE MOOSE CANDY COMPANY, LLC, ANCHORAGE, AK. FILED 12-23-2004.



THE MARK CONSISTS OF A MOOSE HEAD WITH SQUARE DESIGN.

FOR CANDY (U.S. CL. 46).

FIRST USE 3-15-1996; IN COMMERCE 5-15-1996.

ANDREW BENZMILLER, EXAMINING ATTORNEY

CLASS 30—(Continued).

SN 78-538,337. RUBIN, EDWARD S., LOS ANGELES, CA.
FILED 12-25-2004.

Stench Wrench

THE MARK CONSISTS OF STANDARD CHARACTERS
WITHOUT CLAIM TO ANY PARTICULAR FONT, STYLE,
SIZE, OR COLOR.
FOR CANDY MINTS (U.S. CL. 46).
MARGERY A. TIERNEY, EXAMINING ATTORNEY

SN 78-543,250. COOKIES ON CALL, LLC, SAUGATUCK, MI.
FILED 1-6-2005.

COOKIES ON CALL!

THE MARK CONSISTS OF STANDARD CHARACTERS
WITHOUT CLAIM TO ANY PARTICULAR FONT, STYLE,
SIZE, OR COLOR.
NO CLAIM IS MADE TO THE EXCLUSIVE RIGHT TO
USE "COOKIES", APART FROM THE MARK AS SHOWN.
FOR COOKIES (U.S. CL. 46).
FIRST USE 4-30-2002; IN COMMERCE 4-30-2002.
ALICE SUE CARRUTHERS, EXAMINING ATTORNEY

SN 78-557,834. WM. WRIGLEY JR. COMPANY, CHICAGO,
IL. FILED 2-1-2005.

DOUBLE YOUR FUN

THE MARK CONSISTS OF STANDARD CHARACTERS
WITHOUT CLAIM TO ANY PARTICULAR FONT, STYLE,
SIZE, OR COLOR.
OWNER OF U.S. REG. NO. 1,004,342.
FOR CONFECTIONERY, NAMELY CHEWING GUM,
BUBBLE GUM, CANDY AND MINTS (U.S. CL. 46).
JOHN HWANG, EXAMINING ATTORNEY

CLASS 30—(Continued).

SN 78-589,139. SARA LEE FOODS, INC., CINCINNATI, OH.
FILED 3-17-2005.

DELI-BAKES

THE MARK CONSISTS OF STANDARD CHARACTERS
WITHOUT CLAIM TO ANY PARTICULAR FONT, STYLE,
SIZE, OR COLOR.
SEC. 2(F).
FOR BAGEL ENROBED MEAT AND CHEESE (U.S. CL.
46).
FIRST USE 4-30-1995; IN COMMERCE 4-30-1995.
JOHN E. MICHOS, EXAMINING ATTORNEY

SN 78-609,044. THE COCA-COLA COMPANY, ATLANTA,
GA. FILED 4-14-2005.

FANTA FREEZE

THE MARK CONSISTS OF STANDARD CHARACTERS
WITHOUT CLAIM TO ANY PARTICULAR FONT, STYLE,
SIZE, OR COLOR.
OWNER OF U.S. REG. NOS. 513,565 AND 616,935.
NO CLAIM IS MADE TO THE EXCLUSIVE RIGHT TO
USE "FREEZE", APART FROM THE MARK AS SHOWN.
FOR FROZEN CONFECTIONS (U.S. CL. 46).
FIRST USE 4-4-2005; IN COMMERCE 4-4-2005.
REBECCA GAN, EXAMINING ATTORNEY

SN 78-627,292. SARA LEE / DE N.V., 3532 AD UTRECHT,
NETHERLANDS, FILED 5-11-2005.

**INSPIRING COFFEE CULTURE
SINCE 1753**

THE MARK CONSISTS OF STANDARD CHARACTERS
WITHOUT CLAIM TO ANY PARTICULAR FONT, STYLE,
SIZE, OR COLOR.
FOR COFFEE (U.S. CL. 46).
FIRST USE 1-31-2005; IN COMMERCE 1-31-2005.
JOHN E. MICHOS, EXAMINING ATTORNEY

CLASS 30—(Continued).

SN 79-000,096. A. KUSTER SIROCCO-KAFFEE AG, SWITZERLAND, FILED 11-27-2003.

SIROCCO

THE MARK CONSISTS OF STANDARD CHARACTERS WITHOUT CLAIM TO ANY PARTICULAR FONT, STYLE, SIZE, OR COLOR.

OWNER OF INTERNATIONAL REGISTRATION 0741883 DATED 8-29-2000, EXPIRES 8-29-2010.

THE TERM SIROCCO IS DEFINED AS "A HOT DUST-LADEN WIND FROM THE LIBYAN DESERTS THAT BLOWS ON THE NORTHERN MEDITERRANEAN COAST CHIEFLY IN ITALY, MALTA AND SICILY."

FOR COFFEE, TEA, COCOA, SUGAR, RICE, TAPIOCA, SAGO, ARTIFICIAL COFFEE; INSTANT COFFEE, POWDERED COFFEE MIXES; FLOUR AND PREPARATIONS MADE FROM CEREALS, BREAD, PASTRY AND CONFECTIONARY, NAMELY, BREAKFAST CEREALS, BREAD, PASTRIES, CONFECTIONARY CHIPS FOR BAKING, COCOA-BASED INGREDIENT IN CONFECTIONARY PRODUCTS; EDIBLE ICE; HONEY, TREATMENT; YEAST, BAKING POWDER; SALT, MUSTARD; VINEGAR, CONDIMENT SAUCES; SPICES; ICE FOR REFRESHMENT (U.S. CL. 46).

GWEN STOKOLS, EXAMINING ATTORNEY

SN 79-003,920. THE JACOB'S BAKERY LIMITED, UNITED KINGDOM, FILED 4-20-2004.



OWNER OF INTERNATIONAL REGISTRATION 0829115 DATED 4-20-2004, EXPIRES 4-20-2014.

OWNER OF U.S. REG. NOS. 998,275, 1,029,694 AND OTHERS.

THE APPLICANT CLAIMS THE COLOURS ORANGE AND BLACK AS FEATURES OF THE MARK.

THE COLOR ORANGE APPEARS IN THE OUTLINE OF THE DIAMOND CONTAINER AND IN THE LEAVES. THE INTERIOR OF THE RECTANGLE IS THE COLOR BLACK.

FOR BISCUITS, COOKIES, CRACKERS, RUSKS, CRISPBREADS, RICE CAKES; SHORTBREAD, MUFFINS; CAKES AND PASTRIES; CHOCOLATE-COATED BISCUITS AND CAKES; BISCUITS AND CAKES MADE FROM RICE AND CEREALS; BAKERY PRODUCTS; PUDDINGS; AND CEREAL AND WHEAT BASED SNACK FOODS (U.S. CL. 46).

TINA L. SNAPP, EXAMINING ATTORNEY

CLASS 30—(Continued).

SN 79-004,497. LIDL STIFTUNG & CO. KG, NECKARSULM, FED REP GERMANY, FILED 7-8-2004.

Catago

THE MARK CONSISTS OF STANDARD CHARACTERS WITHOUT CLAIM TO ANY PARTICULAR FONT, STYLE, SIZE, OR COLOR.

OWNER OF INTERNATIONAL REGISTRATION 0830880 DATED 7-8-2004, EXPIRES 7-8-2014.

FOR LONG-KEEPING PASTRY (U.S. CL. 46). DANIEL BRODY, EXAMINING ATTORNEY

SN 79-005,762. DONGGUAN KAMTAI FOODS CO., LTD.; (DONGGUAN JINTAI SHIPIN; YOUXIAN GONGSI), HUANGCUN AREA.; DONGGUAN CITY; GUANGDONG, CHINA, FILED 8-4-2004.



OWNER OF INTERNATIONAL REGISTRATION 0834439 DATED 8-4-2004, EXPIRES 8-4-2014.

THE FIRST CHINESE CHARACTER MEANS "THINK"; THE SECOND CHINESE CHARACTER MEANS "BRIGHT"; THE COMBINATION OF THE TWO CHINESE CHARACTERS HAS NO MEANING.

THE TRANSLITERATION OF THE CHINESE CHARACTERS IS "SI LANG".

FOR FROZEN CONFECTIONS, BREAD, PASTRIES, BISCUITS, INSTANT NOODLES; CONDIMENTS, NAMELY, SOY SAUCE; STARCH FOR FOOD (U.S. CL. 46).

ANGELA M. MICHELI, EXAMINING ATTORNEY

SN 79-006,372. DETHLEFSEN & BALK GMBH, FED REP GERMANY, FILED 8-23-2004.



OWNER OF INTERNATIONAL REGISTRATION 0836203 DATED 8-23-2004, EXPIRES 8-23-2014.

FOR TEA, COFFEE, CONFECTIONERY, NAMELY COOKIES, CHOCOLATES, CRACKERS, CANDIES, BOILED SWEETS, AND PASTRY (U.S. CL. 46).

MICHAEL WEBSTER, EXAMINING ATTORNEY

CLASS 30—(Continued).

SN 79-006,761. STICHTING UTZ KAPEH, NL-1012 TM AMSTERDAM, NETHERLANDS, FILED 6-10-2004.



PRIORITY DATE OF 5-28-2004 IS CLAIMED.
OWNER OF INTERNATIONAL REGISTRATION 0837285 DATED 6-10-2004, EXPIRES 6-10-2014.

NO CLAIM IS MADE TO THE EXCLUSIVE RIGHT TO USE "UTZ KAPEH CERTIFIED RESPONSIBLE COFFEE", APART FROM THE MARK AS SHOWN.

THE FOREIGN WORDING IN THE MARK TRANSLATES INTO ENGLISH AS GOOD COFFEE.

FOR COFFEE; ARTIFICIAL COFFEE; FLAVOURINGS, OTHER THAN ESSENTIAL OILS; AROMATIC PREPARATIONS FOR FOOD PURPOSES NAMELY, COFFEE EXTRACT; COFFEE BASED BEVERAGES (U.S. CL. 46).
DANIEL BRODY, EXAMINING ATTORNEY

SN 79-007,369. CAFFÈ DOMENICO GIOIA S.R.L., ITALY, FILED 11-5-2004.

OWNER OF INTERNATIONAL REGISTRATION 0839036 DATED 11-5-2004, EXPIRES 11-5-2014.

FOR COFFEE, TEA, COCOA, ARTIFICIAL COFFEE, SUGAR (U.S. CL. 46).

DANIEL CAPSHAW, EXAMINING ATTORNEY

CLASS 31—NATURAL AGRICULTURAL PRODUCTS

SN 76-537,006. TOPCO HOLDINGS, INC., SKOKIE, IL. FILED 8-12-2003.

WORLD CLASSICS TRADING COMPANY

OWNER OF U.S. REG. NOS. 1,690,372, 2,014,460 AND OTHERS.

NO CLAIM IS MADE TO THE EXCLUSIVE RIGHT TO USE "TRADING COMPANY", APART FROM THE MARK AS SHOWN.

FOR PRODUCE, NAMELY, UNPROCESSED, RAW AND FRESH FRUITS, FRESH AND RAW VEGETABLES, HERBS AND NUTS. (U.S. CLS. 1 AND 46).

ELIZABETH J. WINTER, EXAMINING ATTORNEY

CLASS 31—(Continued).

SN 76-567,818. INNOVATION CONCEPTS, INC., CHESTER, NY. FILED 12-31-2003.

NO CLAIM IS MADE TO THE EXCLUSIVE RIGHT TO USE THE DESIGN OF A DOG, APART FROM THE MARK AS SHOWN.

THE MARK CONSISTS OF WORD "POOCHIE" WITH A DRAWING OF A PUPPY CONTAINED IN THE LETTER "C".

FOR EDIBLE DOG TREATS (U.S. CLS. 1 AND 46).

FIRST USE 10-1-2000; IN COMMERCE 10-1-2000.

DAVID C. REIHNER, EXAMINING ATTORNEY

SN 76-594,703. BALL HORTICULTURAL COMPANY, WEST CHICAGO, IL. FILED 5-27-2004.

OWNER OF U.S. REG. NO. 1,544,747.

THE ENGLISH TRANSLATION OF THE WORD BELLA IS "BEAUTIFUL".

FOR LIVE LAVENDER PLANTS (U.S. CLS. 1 AND 46).

FIRST USE 4-0-2003; IN COMMERCE 7-0-2003.

BARBARA A. GOLD, EXAMINING ATTORNEY

SN 76-598,780. BOUQUET COLLECTION, INC., MIAMI, FL. FILED 6-21-2004.

SPEAK THE LANGUAGE OF ROSES

THE MARK CONSISTS OF STANDARD CHARACTERS WITHOUT CLAIM TO ANY PARTICULAR FONT, STYLE, SIZE, OR COLOR.

NO CLAIM IS MADE TO THE EXCLUSIVE RIGHT TO USE "ROSES", APART FROM THE MARK AS SHOWN.

FOR FRESH CUT FLOWERS, FLOWER BOUQUETS AND ARRANGEMENTS (U.S. CLS. 1 AND 46).

FIRST USE 4-26-2004; IN COMMERCE 4-26-2004.

RUSS HERMAN, EXAMINING ATTORNEY

CLASS 31—(Continued).

SN 76-600,716. SEMINIS VEGETABLE SEEDS, INC., OXNARD, CA. FILED 7-6-2004.



FOR FRESH, RAW AND UNPROCESSED VEGETABLES; FRESH, RAW AND UNPROCESSED FRUITS; AGRICULTURAL SEEDS (U.S. CLS. 1 AND 46).
FIRST USE 10-0-2002; IN COMMERCE 10-0-2002.
JOHN LINCOSKI, EXAMINING ATTORNEY

SN 76-602,058. JUST DOGS! BARKERY, INC., BIRMINGHAM, AL. FILED 7-14-2004.



NO CLAIM IS MADE TO THE EXCLUSIVE RIGHT TO USE "DOGS" AND "GOURMET", APART FROM THE MARK AS SHOWN.
FOR PET FOOD, NAMELY, DOG BISCUITS AND GOURMET EDIBLE PET TREATS (U.S. CLS. 1 AND 46).
FIRST USE 2-0-2004; IN COMMERCE 2-0-2004.
SUELLEN HICKEY, EXAMINING ATTORNEY

SN 76-613,910. GARCIA, GUY, WINTERS, CA. FILED 9-30-2004.

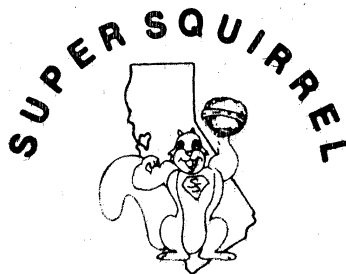

FOR FRESH NUTS (U.S. CLS. 1 AND 46).
DEBRA LEE, EXAMINING ATTORNEY

CLASS 31—(Continued).

SN 76-614,180. WORLDWIDE RECLAMATION, INC., RICHARDSON, TX. FILED 9-30-2004.

CHARLES' CHOICE

THE MARK CONSISTS OF STANDARD CHARACTERS WITHOUT CLAIM TO ANY PARTICULAR FONT, STYLE, SIZE, OR COLOR.

FOR ANIMAL FEED ADDITIVES FOR NON-NUTRITIONAL PURPOSES, NAMELY, LIQUID FLAVORING GRAVY FOR ADDITION TO DRY PET FOODS (U.S. CLS. 1 AND 46).

PATRICIA EVANKO, EXAMINING ATTORNEY

SN 76-614,203. JUNGLE LABORATORIES CORPORATION, CIBOLO, TX. FILED 10-1-2004.

PEPSO FOOD

THE MARK CONSISTS OF STANDARD CHARACTERS WITHOUT CLAIM TO ANY PARTICULAR FONT, STYLE, SIZE, OR COLOR.

NO CLAIM IS MADE TO THE EXCLUSIVE RIGHT TO USE "FOOD", APART FROM THE MARK AS SHOWN.

FOR FISH FOOD (U.S. CLS. 1 AND 46).
FIRST USE 0-0-1971; IN COMMERCE 0-0-1971.
WENDY GOODMAN, EXAMINING ATTORNEY

SN 76-614,784. OWEN & MANDEVILLE PET PRODUCTS, INC., OXFORD, CT. FILED 10-5-2004.

TRIM & ACTIVE

THE MARK CONSISTS OF STANDARD CHARACTERS WITHOUT CLAIM TO ANY PARTICULAR FONT, STYLE, SIZE, OR COLOR.

FOR PET FOOD FOR DOGS (U.S. CLS. 1 AND 46).
FIRST USE 4-1-1998; IN COMMERCE 4-1-1998.
JENNIFER KRISP, EXAMINING ATTORNEY

SN 76-616,900. LEBANON CHEMICAL CORPORATION, LEBANON, PA. FILED 10-20-2004.

LYRIC

THE MARK CONSISTS OF STANDARD CHARACTERS WITHOUT CLAIM TO ANY PARTICULAR FONT, STYLE, SIZE, OR COLOR.

OWNER OF U.S. REG. NOS. 190,726, 2,463,595 AND 2,714,345.

FOR BIRD SEED (U.S. CLS. 1 AND 46).
FIRST USE 6-17-1924; IN COMMERCE 6-17-1924.
TARAH HARDY, EXAMINING ATTORNEY

CLASS 31—(Continued).

SN 78-213,536. PAWNEE BUTTES SEED INC., GREELEY, CO.
FILED 2-11-2003.

ARAPAHOE

FOR BROWN MIDRIB SORGHUM-SUDANGRASS HY-
BRID SEED (U.S. CLS. 1 AND 46).
FIRST USE 10-14-2002; IN COMMERCE 12-15-2002.
CURTIS FRENCH, EXAMINING ATTORNEY

CLASS 31—(Continued).

SN 78-390,451. HAZERA GENETICS LTD., M. P. SHIKMIM,
ISRAEL, FILED 3-25-2004.

NUTRAZERA

SN 78-214,058. PAWNEE BUTTES SEED INC., GREELEY, CO.
FILED 2-12-2003.

ARIKAREE

FOR BROWN MIDRIB SORGHUM-SUDANGRASS HY-
BRID SEED (U.S. CLS. 1 AND 46).
FIRST USE 10-14-2002; IN COMMERCE 12-15-2002.
CURTIS FRENCH, EXAMINING ATTORNEY

THE MARK CONSISTS OF STANDARD CHARACTERS
WITHOUT CLAIM TO ANY PARTICULAR FONT, STYLE,
SIZE, OR COLOR.

PRIORITY CLAIMED UNDER SEC. 44(D) ON ISRAEL
APPLICATION NO. 168820, FILED 11-27-2003, REG. NO.
168820, DATED 3-11-2004, EXPIRES 11-27-2010.

FOR LIVING PLANTS, PLANT PROPAGATING MA-
TERIAL NAMELY, SEEDS OF PLANTS WHICH ARE
EDIBLE OR PRODUCE EDIBLE FRUIT, AND FRESH
FRUIT (U.S. CLS. 1 AND 46).

BRIDGETT SMITH, EXAMINING ATTORNEY

SN 78-372,809. DAD'S PRODUCTS CO., INC., DBA DAD'S
PET CARE, MEADVILLE, PA. FILED 2-24-2004.

CAT SOOSHI

THE MARK CONSISTS OF STANDARD CHARACTERS
WITHOUT CLAIM TO ANY PARTICULAR FONT, STYLE,
SIZE, OR COLOR.

NO CLAIM IS MADE TO THE EXCLUSIVE RIGHT TO
USE "CAT", APART FROM THE MARK AS SHOWN.

FOR TREATS AND SNACKS FOR CATS (U.S. CLS. 1
AND 46).

TRACY CROSS, EXAMINING ATTORNEY

SN 78-401,734. BARENBRUG USA, INC., TANGENT, OR.
FILED 4-14-2004.

TURF BLUE

THE MARK CONSISTS OF STANDARD CHARACTERS
WITHOUT CLAIM TO ANY PARTICULAR FONT, STYLE,
SIZE, OR COLOR.

OWNER OF U.S. REG. NOS. 640,226, 1,527,246 AND
1,941,107.

NO CLAIM IS MADE TO THE EXCLUSIVE RIGHT TO
USE "TURF", APART FROM THE MARK AS SHOWN.

FOR GRASS SEED (U.S. CLS. 1 AND 46).
FIRST USE 9-0-2004; IN COMMERCE 9-0-2004.

BRIAN PINO, EXAMINING ATTORNEY

CLASS 31—(Continued).

SN 78-405,792. MARS, INCORPORATED, MC LEAN, VA. FILED 4-21-2004.

SEAFOOD SELECTIONS

THE MARK CONSISTS OF STANDARD CHARACTERS WITHOUT CLAIM TO ANY PARTICULAR FONT, STYLE, SIZE, OR COLOR.

NO CLAIM IS MADE TO THE EXCLUSIVE RIGHT TO USE "SEAFOOD", APART FROM THE MARK AS SHOWN. FOR CAT FOOD (U.S. CLS. 1 AND 46). FIRST USE 10-0-2004; IN COMMERCE 10-0-2004. KATHERINE STOIDES, EXAMINING ATTORNEY

SN 78-411,930. BELLE PROVENANCE VINEYARD, LLC, SALEM, OR. FILED 5-3-2004.



NO CLAIM IS MADE TO THE EXCLUSIVE RIGHT TO USE "VINEYARD", APART FROM THE MARK AS SHOWN. FOR UNPROCESSED GRAPES USED IN THE MAKING OF WINE (U.S. CLS. 1 AND 46). FIRST USE 10-15-2002; IN COMMERCE 3-1-2003. JEFF DEFORD, EXAMINING ATTORNEY

SN 78-418,498. GRANT FAMILY FARMS, INC., WELLINGTON, CO. FILED 5-13-2004.



NO CLAIM IS MADE TO THE EXCLUSIVE RIGHT TO USE "FAMILY FARMS COLORADO'S FINEST BRAND", APART FROM THE MARK AS SHOWN. FOR FRESH PRODUCE, NAMELY, VEGETABLES AND HERBS (U.S. CLS. 1 AND 46). FIRST USE 1-1-1994; IN COMMERCE 1-1-1994. WENDY GOODMAN, EXAMINING ATTORNEY

CLASS 31—(Continued).

SN 78-418,522. GRANT FAMILY FARMS, INC., WELLINGTON, CO. FILED 5-13-2004.



NO CLAIM IS MADE TO THE EXCLUSIVE RIGHT TO USE FAMILY FARMS CERTIFIED ORGANIC COLORADO AND BRAND, APART FROM THE MARK AS SHOWN. FOR ORGANICALLY GROWN FRESH VEGETABLES AND HERBS (U.S. CLS. 1 AND 46). FIRST USE 1-1-1994; IN COMMERCE 1-1-1994. ASMAT KHAN, EXAMINING ATTORNEY

SN 78-422,781. NATURE'S EARTH PRODUCTS, INC., WEST PALM BEACH, FL. FILED 5-21-2004.

FELINE PINE SCOOP

THE MARK CONSISTS OF STANDARD CHARACTERS WITHOUT CLAIM TO ANY PARTICULAR FONT, STYLE, SIZE, OR COLOR.

OWNER OF U.S. REG. NOS. 2,102,410 AND 2,291,647. NO CLAIM IS MADE TO THE EXCLUSIVE RIGHT TO USE FELINE PINE, APART FROM THE MARK AS SHOWN. FOR ENVIRONMENTAL CAT LITTER AND ANIMAL BEDDING PRODUCTS MADE FROM CHOPPED, SHREDDED AND PULVERIZED WOOD CHIPS WITH AN ADDED AGENT WHICH PROMOTES CLUMPING (U.S. CLS. 1 AND 46). FIRST USE 2-1-2003; IN COMMERCE 1-1-2004. JACQUELINE A. LAVINE, EXAMINING ATTORNEY

CLASS 31—(Continued).

SN 78-423,994. EUROFRESH INC., WILLCOX, AZ. FILED 5-24-2004.

CLASS 31—(Continued).

SN 78-429,382. SEMINIS VEGETABLE SEEDS, INC., OXNARD, CA. FILED 6-3-2004.

SWEET STAR

FRENCH KISS

THE MARK CONSISTS OF STANDARD CHARACTERS WITHOUT CLAIM TO ANY PARTICULAR FONT, STYLE, SIZE, OR COLOR.

NO CLAIM IS MADE TO THE EXCLUSIVE RIGHT TO USE "SWEET", APART FROM THE MARK AS SHOWN.

FOR PRODUCE, NAMELY, FRESH TOMATOES (U.S. CLS. 1 AND 46).

FIRST USE 2-0-1993; IN COMMERCE 2-0-1993.
DAVID MURRAY, EXAMINING ATTORNEY

THE MARK CONSISTS OF STANDARD CHARACTERS WITHOUT CLAIM TO ANY PARTICULAR FONT, STYLE, SIZE, OR COLOR.

FOR FRESH, RAW AND UNPROCESSED VEGETABLES; FRESH, RAW AND UNPROCESSED FRUITS; AGRICULTURAL SEEDS (U.S. CLS. 1 AND 46).

INGRID C. EULIN, EXAMINING ATTORNEY

SN 78-428,423. MARS, INCORPORATED, MC LEAN, VA. FILED 6-2-2004.

SN 78-434,398. VILLAGE FARMS, L.P., EATONTOWN, NJ. FILED 6-13-2004.

2X EASIER TO CRUNCH

BIG BENDS

THE MARK CONSISTS OF STANDARD CHARACTERS WITHOUT CLAIM TO ANY PARTICULAR FONT, STYLE, SIZE, OR COLOR.

FOR PET FOOD (U.S. CLS. 1 AND 46).
HEATHER THOMPSON, EXAMINING ATTORNEY

THE MARK CONSISTS OF STANDARD CHARACTERS WITHOUT CLAIM TO ANY PARTICULAR FONT, STYLE, SIZE, OR COLOR.

FOR FRESH FRUITS AND VEGETABLES (U.S. CLS. 1 AND 46).
KIMBERLY PERRY, EXAMINING ATTORNEY

CLASS 31—(Continued).

SN 78-444,979. VITOR PTY, LTD., RENMARK, SOUTH AUSTRALIA 5341, AUSTRALIA, FILED 7-1-2004.

KANGELO

THE MARK CONSISTS OF STANDARD CHARACTERS WITHOUT CLAIM TO ANY PARTICULAR FONT, STYLE, SIZE, OR COLOR.

FOR FRESH CITRUS, NAMELY FRESH ORANGES AND FRESH TANGELOS (U.S. CLS. 1 AND 46).
MARIA-VICTORIA SUAREZ, EXAMINING ATTORNEY

SN 78-451,196. J.R. SIMPLOT COMPANY, BOISE, ID. FILED 7-15-2004.



OWNER OF U.S. REG. NO. 618,022.
NO CLAIM IS MADE TO THE EXCLUSIVE RIGHT TO USE "BENTS", APART FROM THE MARK AS SHOWN.
FOR GRASS SEEDS (U.S. CLS. 1 AND 46).
FIRST USE 9-0-2003; IN COMMERCE 9-0-2003.
MARY BOAGNI, EXAMINING ATTORNEY

SN 78-453,898. S&M NUTEC, LLC, NORTH KANSAS CITY, MO. FILED 7-21-2004.

THE ORIGINAL GREEN SMART-TREAT

THE MARK CONSISTS OF STANDARD CHARACTERS WITHOUT CLAIM TO ANY PARTICULAR FONT, STYLE, SIZE, OR COLOR.

OWNER OF U.S. REG. NO. 2,610,402.
NO CLAIM IS MADE TO THE EXCLUSIVE RIGHT TO USE "THE ORIGINAL GREEN", APART FROM THE MARK AS SHOWN.
FOR PET FOOD AND PET TREATS (U.S. CLS. 1 AND 46).
FIRST USE 11-17-2003; IN COMMERCE 3-15-2004.
ELLEN B. AWRICH, EXAMINING ATTORNEY

CLASS 31—(Continued).

SN 78-462,568. MCKAY NURSERY CO., WATERLOO, WI. FILED 8-5-2004.

AMERICAN SENTRY

THE MARK CONSISTS OF STANDARD CHARACTERS WITHOUT CLAIM TO ANY PARTICULAR FONT, STYLE, SIZE, OR COLOR.

NO CLAIM IS MADE TO THE EXCLUSIVE RIGHT TO USE "AMERICAN", APART FROM THE MARK AS SHOWN.
FOR LIVE TREES AND SHRUBS (U.S. CLS. 1 AND 46).
FIRST USE 9-1-2004; IN COMMERCE 10-6-2004.
KIMBERLY PERRY, EXAMINING ATTORNEY

SN 78-468,125. SYNGENTA PARTICIPATIONS AG, BASEL, SWITZERLAND, FILED 8-16-2004.

A CUT ABOVE

THE MARK CONSISTS OF STANDARD CHARACTERS WITHOUT CLAIM TO ANY PARTICULAR FONT, STYLE, SIZE, OR COLOR.

FOR LIVE FLOWERS, NAMELY, FLOWER CUTTINGS, FLOWER SEEDS, LIVING YOUNG FLOWERS AND OTHER FLOWER MATERIAL WHICH IS SUITABLE FOR MULTIPLICATION (U.S. CLS. 1 AND 46).
FIRST USE 10-1-2004; IN COMMERCE 10-1-2004.
MARK SPARACINO, EXAMINING ATTORNEY

SN 78-493,084. JENKINS, MAXINE R., WASHINGTON, OK. FILED 10-1-2004.

LIL' BALE FARMS

THE MARK CONSISTS OF STANDARD CHARACTERS WITHOUT CLAIM TO ANY PARTICULAR FONT, STYLE, SIZE, OR COLOR.

FOR ANIMAL FEED (U.S. CLS. 1 AND 46).
RICHARD WHITE, EXAMINING ATTORNEY

CLASS 31—(Continued).

SN 78-493,611. COHEN, SCOTT B, RANCHO SANTA FE, CA. FILED 10-3-2004.

CLASS 31—(Continued).

SN 78-493,848. DATESAND LIMITED, GREATER MANCHESTER, UNITED KINGDOM, FILED 10-4-2004.

Need A Date?

NESTPAKS

THE MARK CONSISTS OF STANDARD CHARACTERS WITHOUT CLAIM TO ANY PARTICULAR FONT, STYLE, SIZE, OR COLOR.

FOR LIVE TREES, NAMELY, PHOENIX DACTYLIFERA, COMMONLY KNOWN AS DATE PALM (U.S. CLS. 1 AND 46).

ATTIYA MALIK, EXAMINING ATTORNEY

THE MARK CONSISTS OF STANDARD CHARACTERS WITHOUT CLAIM TO ANY PARTICULAR FONT, STYLE, SIZE, OR COLOR.

SEC. 2(F).
FOR WOOD SHAVINGS FOR ANIMAL BEDDING (U.S. CLS. 1 AND 46).

FIRST USE 6-2-2000; IN COMMERCE 6-2-2000.
INGRID C. EULIN, EXAMINING ATTORNEY



SN 78-493,721. LAND O'LAKES PURINA FEED LLC, SHOREVIEW, MN. FILED 10-4-2004.

SN 78-494,516. BLUE SEAL FEEDS, INC., LONDONDERRY, NH. FILED 10-5-2004.

LAKE COUNTRY

OrganicLife

THE MARK CONSISTS OF STANDARD CHARACTERS WITHOUT CLAIM TO ANY PARTICULAR FONT, STYLE, SIZE, OR COLOR.

FOR ANIMAL FEED, NAMELY, HORSE FEED (U.S. CLS. 1 AND 46).

NICHOLAS ALTREE, EXAMINING ATTORNEY

THE MARK CONSISTS OF STANDARD CHARACTERS WITHOUT CLAIM TO ANY PARTICULAR FONT, STYLE, SIZE, OR COLOR.

FOR LIVESTOCK AND POULTRY FEEDS AND FEEDS FOR SMALL ANIMALS (U.S. CLS. 1 AND 46).

MONIQUE MILLER, EXAMINING ATTORNEY

CLASS 31—(Continued).

SN 78-498,144. BERNARD EGAN & COMPANY, FT. PIERCE, FL. FILED 10-12-2004.

CLASS 31—(Continued).

SN 78-499,685. DOGSWELL, LLC, SAN FRANCISCO, CA. FILED 10-14-2004.

OCEAN PRIDE

BREATHIES

THE MARK CONSISTS OF STANDARD CHARACTERS WITHOUT CLAIM TO ANY PARTICULAR FONT, STYLE, SIZE, OR COLOR.
FOR FRESH FRUIT (U.S. CLS. 1 AND 46).
TARAH HARDY, EXAMINING ATTORNEY

THE MARK CONSISTS OF STANDARD CHARACTERS WITHOUT CLAIM TO ANY PARTICULAR FONT, STYLE, SIZE, OR COLOR.
FOR EDIBLE DOG TREATS TO HELP MAINTAIN FRESH BREATH AND HEALTHY TEETH (U.S. CLS. 1 AND 46).
FIRST USE 3-11-2004; IN COMMERCE 3-11-2004.
ANNE E. GUSTASON, EXAMINING ATTORNEY

SN 78-498,691. WESTERN FAMILY FOODS, INC., PORTLAND, OR. FILED 10-12-2004.

SN 78-499,825. DOGSWELL, LLC, SAN FRANCISCO, CA. FILED 10-14-2004.

PLENTIFUL

MELLOW MUT

THE MARK CONSISTS OF STANDARD CHARACTERS WITHOUT CLAIM TO ANY PARTICULAR FONT, STYLE, SIZE, OR COLOR.
FOR DOG FOOD (U.S. CLS. 1 AND 46).
NANCY CLARKE, EXAMINING ATTORNEY

THE MARK CONSISTS OF STANDARD CHARACTERS WITHOUT CLAIM TO ANY PARTICULAR FONT, STYLE, SIZE, OR COLOR.
FOR EDIBLE DOG TREATS FOR A HEALTHY LIFESTYLE (U.S. CLS. 1 AND 46).
FIRST USE 3-11-2004; IN COMMERCE 3-11-2004.
DOMINIC J. FERRAIUOLO, EXAMINING ATTORNEY

CLASS 31—(Continued).

SN 78-499,841. DOGSWELL, LLC, SAN FRANCISCO, CA.
FILED 10-14-2004.

HAPPY HEART

THE MARK CONSISTS OF STANDARD CHARACTERS WITHOUT CLAIM TO ANY PARTICULAR FONT, STYLE, SIZE, OR COLOR.

NO CLAIM IS MADE TO THE EXCLUSIVE RIGHT TO USE "HEART", APART FROM THE MARK AS SHOWN.

FOR EDIBLE DOG TREATS TO HELP MAINTAIN A HEALTHY HEART (U.S. CLS. 1 AND 46).

FIRST USE 3-11-2004; IN COMMERCE 3-11-2004.
CHRISTOPHER ADKINS, EXAMINING ATTORNEY

CLASS 31—(Continued).

SN 78-500,317. BARENBRUG USA, INC., TANGENT, OR.
FILED 10-15-2004.

HAYMASTER

THE MARK CONSISTS OF STANDARD CHARACTERS WITHOUT CLAIM TO ANY PARTICULAR FONT, STYLE, SIZE, OR COLOR.

FOR GRASS SEED (U.S. CLS. 1 AND 46).

KATHLEEN M. VANSTON, EXAMINING ATTORNEY

SN 78-499,852. DOGSWELL, LLC, SAN FRANCISCO, CA.
FILED 10-14-2004.

HAPPY HIPS

THE MARK CONSISTS OF STANDARD CHARACTERS WITHOUT CLAIM TO ANY PARTICULAR FONT, STYLE, SIZE, OR COLOR.

NO CLAIM IS MADE TO THE EXCLUSIVE RIGHT TO USE "HIPS", APART FROM THE MARK AS SHOWN.

FOR EDIBLE DOG TREATS TO HELP MAINTAIN HEALTHY JOINTS (U.S. CLS. 1 AND 46).

FIRST USE 3-11-2004; IN COMMERCE 3-11-2004.
CURTIS FRENCH, EXAMINING ATTORNEY

SN 78-502,457. FRESKA PRODUCE INTERNATIONAL, LLC,
VENTURA, CA. FILED 10-19-2004.

MANGO PRO

THE MARK CONSISTS OF STANDARD CHARACTERS WITHOUT CLAIM TO ANY PARTICULAR FONT, STYLE, SIZE, OR COLOR.

NO CLAIM IS MADE TO THE EXCLUSIVE RIGHT TO USE "MANGO", APART FROM THE MARK AS SHOWN.

FOR FRESH FRUITS, NAMELY MANGOS (U.S. CLS. 1 AND 46).

FIRST USE 9-3-2004; IN COMMERCE 9-4-2004.
BRENDAN MCCAULEY, EXAMINING ATTORNEY

CLASS 31—(Continued).

SN 78-503,289. CHERBEY'S LLC, SEATTLE, WA. FILED 10-20-2004.

CLASS 31—(Continued).

SN 78-516,451. TRES TOROS LLC, WESTLAKE VILLAGE, CA. FILED 11-13-2004.

Fishcotti

THE MARK CONSISTS OF STANDARD CHARACTERS WITHOUT CLAIM TO ANY PARTICULAR FONT, STYLE, SIZE, OR COLOR.

FOR FOODSTUFF FOR ANIMALS, SPECIFICALLY DOG (CANINE) PET TREATS USING FISH IN THE BISCUITS/ BISCOTTI (U.S. CLS. 1 AND 46).

FIRST USE 7-28-2004; IN COMMERCE 7-28-2004.
ODESSA BIBBINS, EXAMINING ATTORNEY

VEGGIE RAWHIDE

THE MARK CONSISTS OF STANDARD CHARACTERS WITHOUT CLAIM TO ANY PARTICULAR FONT, STYLE, SIZE, OR COLOR.

NO CLAIM IS MADE TO THE EXCLUSIVE RIGHT TO USE "VEGGIE", APART FROM THE MARK AS SHOWN.

FOR EDIBLE CHEWS FOR ANIMALS (U.S. CLS. 1 AND 46).

FIRST USE 4-18-2003; IN COMMERCE 5-23-2003.
KIMBERLY PERRY, EXAMINING ATTORNEY

SN 78-513,777. BALL HORTICULTURAL COMPANY, WEST CHICAGO, IL. FILED 11-9-2004.

SN 78-519,218. OMS INVESTMENTS, INC., LOS ANGELES, CA. FILED 11-18-2004.

SERENA

THE MARK CONSISTS OF STANDARD CHARACTERS WITHOUT CLAIM TO ANY PARTICULAR FONT, STYLE, SIZE, OR COLOR.

FOR LIVE ANGELONIA PLANTS AND ANGELONIA PLANT SEEDS (U.S. CLS. 1 AND 46).

FIRST USE 5-1-2005; IN COMMERCE 5-1-2005.
KIMBERLY FRYE, EXAMINING ATTORNEY

LAWN PRO

THE MARK CONSISTS OF STANDARD CHARACTERS WITHOUT CLAIM TO ANY PARTICULAR FONT, STYLE, SIZE, OR COLOR.

OWNER OF U.S. REG. NOS. 757,264 AND 1,135,940.
NO CLAIM IS MADE TO THE EXCLUSIVE RIGHT TO USE "LAWN", APART FROM THE MARK AS SHOWN.

FOR GRASS SEED (U.S. CLS. 1 AND 46).
MIDGE BUTLER, EXAMINING ATTORNEY

CLASS 31—(Continued).

SN 78-523,093. JACKSON, AUZVILLE JR., RICHMOND, VA.
FILED 11-26-2004.

CHINQUANUT

THE MARK CONSISTS OF STANDARD CHARACTERS
WITHOUT CLAIM TO ANY PARTICULAR FONT, STYLE,
SIZE, OR COLOR.

FOR SEEDLINGS; LIVING PLANTS; PLANT SEEDS;
FRESH FRUITS (U.S. CLS. 1 AND 46).

KRISTINA KLOIBER, EXAMINING ATTORNEY

CLASS 31—(Continued).

SN 78-528,240. EXPORTADORA ACONCAGUA LIMITADA,
SANTIAGO, CHILE, FILED 12-7-2004.

**ACONEX SWEET
DREAMS**

THE MARK CONSISTS OF STANDARD CHARACTERS
WITHOUT CLAIM TO ANY PARTICULAR FONT, STYLE,
SIZE, OR COLOR.

FOR FRESH ONIONS (U.S. CLS. 1 AND 46).

FRED MANDIR, EXAMINING ATTORNEY

SN 78-525,292. SUNNY VALLEY INTERNATIONAL, INC.,
GLASSBORO, NJ. FILED 12-1-2004.

NORTH ATLANTIC

THE MARK CONSISTS OF STANDARD CHARACTERS
WITHOUT CLAIM TO ANY PARTICULAR FONT, STYLE,
SIZE, OR COLOR.

OWNER OF U.S. REG. NO. 2,919,961.

FOR FRESH FRUITS AND FRESH VEGETABLES (U.S.
CLS. 1 AND 46).

LINDA ESTRADA, EXAMINING ATTORNEY

SN 78-528,442. BALL HORTICULTURAL COMPANY, WEST
CHICAGO, IL. FILED 12-7-2004.

SN 78-528,239. BALL HORTICULTURAL COMPANY, WEST
CHICAGO, IL. FILED 12-7-2004.

SNOWBIRD**EARTHABLES**

THE MARK CONSISTS OF STANDARD CHARACTERS
WITHOUT CLAIM TO ANY PARTICULAR FONT, STYLE,
SIZE, OR COLOR.

FOR LIVE PLANTS; LIVE PLANTS SOLD IN BIODE-
GRADABLE CONTAINERS (U.S. CLS. 1 AND 46).

MATTHEW PAPPAS, EXAMINING ATTORNEY

THE MARK CONSISTS OF STANDARD CHARACTERS
WITHOUT CLAIM TO ANY PARTICULAR FONT, STYLE,
SIZE, OR COLOR.

FOR LIVE PLANTS (U.S. CLS. 1 AND 46).

MATTHEW PAPPAS, EXAMINING ATTORNEY

CLASS 31—(Continued).

SN 78-528,952. WILBUR-ELLIS COMPANY, SAN FRANCISCO, CA. FILED 12-8-2004.



OWNER OF U.S. REG. NOS. 1,800,349 AND 1,967,902.
FOR AGRICULTURAL SEEDS, NAMELY, CORN,
ALFALFA, FORAGE GRASSES, SOYBEANS, OATS,
AND WHEAT (U.S. CLS. 1 AND 46).
YONG KIM, EXAMINING ATTORNEY

SN 78-530,427. SKY MAYA, MORGANTON, NC. FILED 12-10-2004.

MISTY MOUNTAIN

THE MARK CONSISTS OF STANDARD CHARACTERS
WITHOUT CLAIM TO ANY PARTICULAR FONT, STYLE,
SIZE, OR COLOR.
FOR LIVING PLANTS, DRIED PLANTS, PLANT
SEEDS, LIVING FRUIT PLANTS, LIVE FLOWERING
PLANTS (U.S. CLS. 1 AND 46).
LEIGH LOWRY, EXAMINING ATTORNEY

SN 78-533,319. PETSPOUR USA, INC., PITTSBURG, CA.
FILED 12-15-2004.

SUPERMUTTS

THE MARK CONSISTS OF STANDARD CHARACTERS
WITHOUT CLAIM TO ANY PARTICULAR FONT, STYLE,
SIZE, OR COLOR.
FOR PET FOODS AND EDIBLE PET TREATS (U.S.
CLS. 1 AND 46).
WON TEAK OH, EXAMINING ATTORNEY

CLASS 31—(Continued).

SN 78-536,346. ALTA PRODUCE SALES, INC., DELANO, CA.
FILED 12-21-2004.

SUN GODDESS

THE MARK CONSISTS OF STANDARD CHARACTERS
WITHOUT CLAIM TO ANY PARTICULAR FONT, STYLE,
SIZE, OR COLOR.
FOR FRESH TABLE GRAPES (U.S. CLS. 1 AND 46).
FIRST USE 1-1-1999; IN COMMERCE 1-1-1999.
MARLENE BELL, EXAMINING ATTORNEY

SN 78-536,409. EUROPEAN VEGETABLE SPECIALTIES
FARMS, INC., SALINAS, CA. FILED 12-21-2004.

**WHAT'S A SALAD
WITHOUT
RADICCHIO?**

THE MARK CONSISTS OF STANDARD CHARACTERS
WITHOUT CLAIM TO ANY PARTICULAR FONT, STYLE,
SIZE, OR COLOR.
FOR FRESH RADICCHIO (U.S. CLS. 1 AND 46).
FIRST USE 5-3-2004; IN COMMERCE 5-3-2004.
JULIE WATSON, EXAMINING ATTORNEY

SN 78-539,681. SALYER AMERICAN FRESH FOODS, SALI-
NAS, CA. FILED 12-29-2004.



OWNER OF U.S. REG. NO. 1,446,692.
FOR FRESH VEGETABLES (U.S. CLS. 1 AND 46).
FIRST USE 10-20-1986; IN COMMERCE 10-20-1986.
CURTIS FRENCH, EXAMINING ATTORNEY

CLASS 31—(Continued).

SN 78-581,430. KRAFT FOODS HOLDINGS, INC., NORTH-FIELD, IL. FILED 3-7-2005.

**GET MILK-BONE
HAPPY**

THE MARK CONSISTS OF STANDARD CHARACTERS WITHOUT CLAIM TO ANY PARTICULAR FONT, STYLE, SIZE, OR COLOR.

OWNER OF U.S. REG. NOS. 72,501, 218,468 AND 2,534,344. FOR PET FOOD AND PET SNACKS (U.S. CLS. 1 AND 46).

DAVID MURRAY, EXAMINING ATTORNEY

SN 78-596,263. LAND O'LAKES PURINA FEED LLC, SHOREVIEW, MN. FILED 3-28-2005.

LAKE COUNTRY

THE MARK CONSISTS OF STANDARD CHARACTERS WITHOUT CLAIM TO ANY PARTICULAR FONT, STYLE, SIZE, OR COLOR.

FOR ANIMAL FEED EXCLUDING HORSE FEED; PET FOOD (U.S. CLS. 1 AND 46).

NICHOLAS ALTREE, EXAMINING ATTORNEY

SN 79-002,137. DE GROOT & SLOT BEHEER B.V., NETHERLANDS, FILED 3-22-2004.



OWNER OF INTERNATIONAL REGISTRATION 0820682 DATED 1-16-2004, EXPIRES 1-16-2014.

THE MARK CONSISTS OF THE PHRASE "DE GROOT EN SLOT" SUPERIMPOSED ON THE DESIGN OF THE LETTERS "GS" AND ENCLOSED IN A RECTANGULAR BOX.

THE ENGLISH TRANSLATION OF THE MARK AS A WHOLE IS "DE GROOT AND SLOT".

FOR AGRICULTURAL SEEDS, HORTICULTURAL AND FORESTRY SEEDS AND GRAINS FOR PLANTING; PRODUCTS TO BE USED FOR OUTDOOR FIELD CULTIVATION, ESPECIALLY OF THE SPECIES ALLIUM, IN THE NATURE OF SEEDS, CLOVES AND YOUNG PLANTS, IN-VITRO PROPAGATION MATERIAL, ESPECIALLY OF THE SPECIES ALLIUM, NAMELY, BULBS, TUBERS AND SMALL PLANTS (U.S. CLS. 1 AND 46).

PAULA MAYS, EXAMINING ATTORNEY

CLASS 31—(Continued).

SN 79-005,536. DENKAVIT INTERNATIONAAL B.V., NETHERLANDS, FILED 7-7-2004.

DENKAVIT

OWNER OF INTERNATIONAL REGISTRATION 0206738 DATED 1-22-1958, EXPIRES 1-22-2008.

FOR ANIMAL FEED AND VITAMIN PREPARATIONS FOR MIXING IN ANIMAL FEED (U.S. CLS. 1 AND 46). AMY GEARIN, EXAMINING ATTORNEY

CLASS 32—LIGHT BEVERAGES

SN 75-511,127. EAGLE FAMILY FOODS, INC., TARRY-TOWN, NY. FILED 6-30-1998.

REALEMONADE

OWNER OF U.S. REG. NOS. 605,910, 641,099 AND 656,534. SEC. 2(F).

FOR BEVERAGES, NAMELY, FRUIT JUICES, FRUIT JUICE-BASED AND FRUIT JUICE-FLAVORED SOFT DRINKS; FRUIT JUICE CONCENTRATES (U.S. CLS. 45, 46 AND 48).

FIRST USE 2-9-1999; IN COMMERCE 2-9-1999.

ZHALEH DELANEY, EXAMINING ATTORNEY

SN 76-351,328. SHENZHEN DANCUN FOODSTUFF & BEVERAGE CO., LTD., TIANAN, FUTIAN DISTRICT, SHENZHEN, CHINA, FILED 12-19-2001.

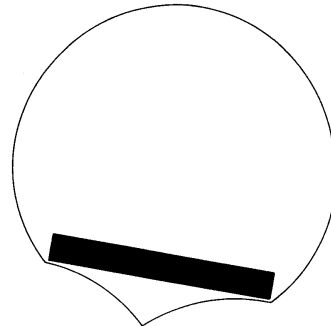

OWNER OF CHINA REG. NO. 633954, DATED 3-20-1993, EXPIRES 3-19-2013.

THE COLOR(S) BLUE AND RED IS/ARE CLAIMED AS A FEATURE OF THE MARK.

THE MARK CONSISTS OF A DESIGN ONLY COMPRISED OF A BLUE CIRCLE WITH TWO SCALLOPS AT THE BOTTOM ABOVE WHICH IS A RED RECTANGLE.

FOR MINERAL WATER, CARBONATED DRINKS, FRUIT JUICES, SOFT DRINKS, NON-ALCOHOLIC JUICES; AND NON-ALCOHOLIC DRINKS, NAMELY, NON-ALCOHOLIC FRUIT DRINKS (U.S. CLS. 45, 46 AND 48).

ANDREW LAWRENCE, EXAMINING ATTORNEY

CLASS 32—(Continued).

SN 76-389,924. ROADSIDE BEVERAGE, L.L.C., GORDONSVILLE, VA. FILED 3-29-2002.

CLASS 32—(Continued).

SN 76-544,667. MINERALBRUNNEN UEBERKINGEN-TEINACH AG AND ACB MARKEN GMBH, 73334 BAD UEBERKINGEN, FED REP GERMANY, FILED 9-15-2003.

GET YOUR LIPS ON ROOT 66

OWNER OF U.S. REG. NO. 2,498,523.
FOR ROOT BEER; SOFT DRINKS (U.S. CLS. 45, 46 AND 48).
FIRST USE 1-0-1997; IN COMMERCE 1-0-1997.
BRENDAN MCCAULEY, EXAMINING ATTORNEY

SN 76-413,248. CAPPUCINO AMERICANA CORPORATION, BENSENVILLE, IL. FILED 5-23-2002.



FOR NON-ALCOHOLIC BEVERAGES, NAMELY, HERBAL AND FRUIT ENERGY DRINKS; POWDERS AND SYRUPS FOR MAKING HERBAL AND FRUIT ENERGY DRINKS (U.S. CLS. 45, 46 AND 48).
FIRST USE 5-1-2001; IN COMMERCE 5-1-2001.
SAMUEL E. SHARPER JR., EXAMINING ATTORNEY

SN 76-537,010. TOPCO HOLDINGS, INC., SKOKIE, IL. FILED 8-12-2003.

WORLD CLASSICS TRADING COMPANY

OWNER OF U.S. REG. NOS. 1,690,372, 2,014,460 AND OTHERS.
NO CLAIM IS MADE TO THE EXCLUSIVE RIGHT TO USE "TRADING COMPANY", APART FROM THE MARK AS SHOWN.
FOR NON-ALCOHOLIC COCKTAIL MIXERS, SODAS, NAMELY, REGULAR AND LOW-CALORIE CARBONATED AND NON-CARBONATED FLAVORED AND UNFLAVORED SOFT DRINKS AND FRUIT AND VEGETABLE JUICES (U.S. CLS. 45, 46 AND 48).
ELIZABETH J. WINTER, EXAMINING ATTORNEY

OWNER OF ERPN CMNTY TM OFC REG. NO. 000264218, DATED 4-27-1999, EXPIRES 10-24-2007.
THE THREE-DIMENSIONAL TRADEMARK CONSISTS OF A SLENDER BOTTLE WITH TWO CONCAVE CAVITIES OPPOSITE EACH OTHER IN THE MIDDLE OF THE BOTTLE. THE BOTTLE TAPERS SLIGHTLY JUST ABOVE ITS BASE AND IS ALSO TAPERED AT THE NECK.
FOR BEER, ALE AND PORTER; FRUIT DRINKS AND FRUIT JUICES; SPRING, MINERAL AND AERATED WATERS; NON-ALCOHOLIC BEVERAGES, NAMELY, SOFT DRINKS, COLAS, FRUIT DRINKS, FRUIT JUICES, FRUIT-FLAVORED DRINKS AND SPORTS DRINKS; SYRUPS AND OTHER PREPARATIONS FOR MAKING BEVERAGES, NAMELY, SOFT DRINKS, COLAS, FRUIT DRINKS, FRUIT JUICES, FRUIT-FLAVORED DRINKS AND SPORTS DRINKS, ALL THE AFOREMENTIONED GOODS PRODUCED WITH THE USE OF COLA EXTRACT (U.S. CLS. 45, 46 AND 48).
SCOTT BALDWIN, EXAMINING ATTORNEY

CLASS 32—(Continued).

SN 76-580,340. VITALON FOODS CO., LTD., TAICHUNG, TAIWAN, FILED 3-11-2004.



THE CHINESE CHARACTERS IN THE MARK TRANSLITERATE TO "WEI TA LU" AND THIS MEANS "TO HOLD TOGETHER, TO MAINTAIN," "HE, HIM, A THIRD PERSON" AND "DEW, TO REVEAL" IN ENGLISH.

FOR AERATED WATER; DRINKING WATER; SPORTS DRINKS CONSISTING OF SUGARS, VITAMINS, MINERALS, ACIDS, SALTS AND FRUIT FLAVORS; SOFT DRINK, NAMELY, COLAS; FRUIT DRINKS; FRUIT JUICES; MIXED FRUIT JUICES; FRUIT PUNCH; FRUIT-BASED SOFT DRINKS FLAVORED WITH TEA; TOMATO JUICE; AERATED FRUIT JUICES; VEGETABLE JUICES; FRUIT JUICES IN GENERAL; LEMONADE; MALT WORT; MINERAL WATER; SELTZER WATER; SODA WATER; FRUIT FLAVORED SOFT DRINKS; SYRUPS FOR MAKING SOFT DRINKS; SARSAPARILLA; NON-ALCOHOLIC PUNCHES; AND NON-ALCOHOLIZED WINES (U.S. CLS. 45, 46 AND 48).

FIRST USE 12-18-1990; IN COMMERCE 12-18-1990.

MARIA-VICTORIA SUAREZ, EXAMINING ATTORNEY

SN 76-584,894. BOWMAN FRUIT SALES, LLC, MOUNT JACKSON, VA. FILED 4-1-2004.

SKYLINE DRIVE

OWNER OF U.S. REG. NO. 2,511,082.

FOR BEVERAGES, NAMELY, DRINKING WATERS, BOTTLED DRINKING WATER, FLAVORED WATERS, MINERAL AND AERATED WATERS; AND OTHER NON-ALCOHOLIC BEVERAGES, NAMELY CARBONATED AND NON-CARBONATED SOFT DRINKS; FRUIT DRINKS AND FRUIT JUICES; SYRUPS, CONCENTRATES AND POWDERS FOR MAKING BEVERAGES, NAMELY, MINERAL AND AERATED WATERS, SOFT DRINKS, FRUIT DRINKS, NECTARS AND FRUIT JUICES (U.S. CLS. 45, 46 AND 48).

SKYE YOUNG, EXAMINING ATTORNEY

CLASS 32—(Continued).

SN 76-589,573. SECO & GOLDEN "100" INC., DELAND, FL. FILED 4-20-2004.

FIESTA SOL

THE MARK CONSISTS OF STANDARD CHARACTERS WITHOUT CLAIM TO ANY PARTICULAR FONT, STYLE, SIZE, OR COLOR.

THE ENGLISH TRANSLATION OF THE WORD FIESTA SOL IN THE MARK IS "SUN PARTY".

FOR FRUIT DRINKS AND CONCENTRATES FOR MAKING FRUIT DRINKS (U.S. CLS. 45, 46 AND 48).

MICHAEL HALL, EXAMINING ATTORNEY

SN 76-606,578. AGROS NOVA SPOLKA Z O.O., WARSAW, POLAND, FILED 8-3-2004.

POETRY OF TASTE

THE MARK CONSISTS OF STANDARD CHARACTERS WITHOUT CLAIM TO ANY PARTICULAR FONT, STYLE, SIZE, OR COLOR.

FOR NON-ALCOHOLIC BEVERAGES; FRUIT, VEGETABLE AND FRUIT-VEGETABLE DRINKS, JUICES AND NECTARS; SYRUPS FOR MAKING FRUIT DRINKS; FRUIT JUICE AND/OR JUICE BASED CONCENTRATES; AND OTHER PREPARATIONS FOR MAKING FRUIT AND VEGETABLE BEVERAGES (U.S. CLS. 45, 46 AND 48).

FIRST USE 4-3-1998; IN COMMERCE 4-17-2001.

ELLEN BURNS, EXAMINING ATTORNEY

SN 76-613,516. MIRA INTERNATIONAL FOODS, INC., EAST BRUNSWICK, NJ. FILED 9-23-2004.

MIRA

THE MARK CONSISTS OF STANDARD CHARACTERS WITHOUT CLAIM TO ANY PARTICULAR FONT, STYLE, SIZE, OR COLOR.

OWNER OF U.S. REG. NO. 2,195,395.

THE FOREIGN WORDING IN THE MARK TRANSLATES INTO ENGLISH AS "HE/SHE LOOKS". THE WORD MIRA CAN ALSO TRANSLATE INTO "WONDERFUL" OR "AMAZING".

FOR FRUIT JUICES, NECTARS, FRUIT DRINKS AND FRUIT SYRUPS FOR BEVERAGES (U.S. CLS. 45, 46 AND 48).

FIRST USE 2-0-1985; IN COMMERCE 2-0-1985.

JOHN DALIER, EXAMINING ATTORNEY

CLASS 32—(Continued).

SN 76-614,611. DOGFISH HEAD MARKETING, LLC, MILTON, DE. FILED 10-5-2004.

INDIAN BROWN ALE

THE MARK CONSISTS OF STANDARD CHARACTERS WITHOUT CLAIM TO ANY PARTICULAR FONT, STYLE, SIZE, OR COLOR.

NO CLAIM IS MADE TO THE EXCLUSIVE RIGHT TO USE "BROWN ALE", APART FROM THE MARK AS SHOWN.

FOR BEER (U.S. CLS. 45, 46 AND 48).
FIRST USE 12-10-1999; IN COMMERCE 12-10-1999.
CARRIE ACHEN, EXAMINING ATTORNEY

CLASS 32—(Continued).

SN 76-615,216. WEIDER HEALTH AND FITNESS, WOODLAND HILLS, CA. FILED 10-12-2004.

MASTER BLASTER

THE MARK CONSISTS OF STANDARD CHARACTERS WITHOUT CLAIM TO ANY PARTICULAR FONT, STYLE, SIZE, OR COLOR.

FOR BEVERAGES, NAMELY SPORT DRINKS, ENERGY DRINKS, FRUIT JUICES AND WATER (U.S. CLS. 45, 46 AND 48).

HEATHER THOMPSON, EXAMINING ATTORNEY

SN 76-614,622. DOGFISH HEAD MARKETING, LLC, MILTON, DE. FILED 10-5-2004.

FESTINALENTE

THE ENGLISH TRANSLATION OF THE LATIN WORD FESTINALENTE IN THE MARK IS MAKE HASTE SLOWLY.

FOR BEER (U.S. CLS. 45, 46 AND 48).
FIRST USE 11-12-2003; IN COMMERCE 11-12-2003.
ANGELA M. MICHELI, EXAMINING ATTORNEY

SN 76-616,410. MIXMASTER BEVERAGE COMPANY LLC, LAKE TAHOE, NV. FILED 10-19-2004.

SN 76-614,623. DOGFISH HEAD MARKETING, LLC, MILTON, DE. FILED 10-5-2004.

OLDE SCHOOL

THE MARK CONSISTS OF STANDARD CHARACTERS WITHOUT CLAIM TO ANY PARTICULAR FONT, STYLE, SIZE, OR COLOR.

FOR BEER (U.S. CLS. 45, 46 AND 48).
FIRST USE 10-24-2002; IN COMMERCE 10-24-2002.
ANGELA M. MICHELI, EXAMINING ATTORNEY



SN 76-614,624. DOGFISH HEAD MARKETING, LLC, MILTON, DE. FILED 10-5-2004.

IMMORT ALE

NO CLAIM IS MADE TO THE EXCLUSIVE RIGHT TO USE ALE, APART FROM THE MARK AS SHOWN.

FOR BEER (U.S. CLS. 45, 46 AND 48).
FIRST USE 7-16-1997; IN COMMERCE 7-16-1997.
ANGELA M. MICHELI, EXAMINING ATTORNEY

THE MARK CONSISTS OF A FLAMING SKULL FOR ENERGY DRINKS (U.S. CLS. 45, 46 AND 48).
FIRST USE 10-1-2004; IN COMMERCE 10-1-2004.
MICHAEL KAZAZIAN, EXAMINING ATTORNEY

CLASS 32—(Continued).

SN 76-618,765. ROOS FOODS INC., KENTON, DE. FILED 11-1-2004.



NO CLAIM IS MADE TO THE EXCLUSIVE RIGHT TO USE "PURPLE CORN CIDER" AND "CHICHA MORADA" AND "BRAND", APART FROM THE MARK AS SHOWN.

THE COLOR(S) THE COLORS PURPLE, ORANGE, YELLOW, RED, BLUE AND BROWN ARE CLAIMED AS A FEATURE OF THE MARK IS/ARE CLAIMED AS A FEATURE OF THE MARK.

THE COLOR PURPLE APPEARS IN THE CORN, THE COLOR ORANGE APPEARS IN THE WOMAN'S HAT AND IN THE WORDING THE INCAS DRINK, THE COLOR YELLOW APPEARS IN THE PINEAPPLE, THE CORN HUSK, AND THE WOMAN'S EARRINGS, THE COLOR RED APPEARS IN THE APPLE AND IN THE WORDING CHOLA BRAND, AND THE COLOR BLUE APPEARS IN THE OVAL BEHIND THE WOMAN, THE COLOR BROWN APPEARS IN THE WOMAN'S FACE AND IN THE WOMAN'S HAIR.

THE FOREIGN WORDING IN THE MARK TRANSLATES INTO ENGLISH AS SOFT DRINK MADE OF PURPLE CORN AND FEMALE OF SPANISH AND INDIAN ANCESTRY.

FOR SOFT DRINK, NAMELY PURPLE CORN CIDER (U.S. CLS. 45, 46 AND 48).

FIRST USE 11-1-1987; IN COMMERCE 11-1-1987.
ANNE E. GUSTASON, EXAMINING ATTORNEY

CLASS 32—(Continued).

SN 78-373,191. MACRO GROUP HANDELS GMBH, DBA MACRO GROUP HANDELS GMBH, VIENNA, AUSTRIA, FILED 2-24-2004.

THE BEAST

THE MARK CONSISTS OF STANDARD CHARACTERS WITHOUT CLAIM TO ANY PARTICULAR FONT, STYLE, SIZE, OR COLOR.

FOR NON-ALCOHOLIC BEVERAGES, NAMELY, CARBONATED BEVERAGES CONTAINING TAURINE, NOT INTENDED AS A NUTRITIONAL SUPPLEMENT (U.S. CLS. 45, 46 AND 48).

ASMAT KHAN, EXAMINING ATTORNEY

SN 78-380,950. CARLSBERG BREWERIES A/S, DK-1760 COPENHAGEN V, DENMARK, FILED 3-9-2004.

SN 78-333,459. XTZ INDUSTRIES, INC., EDMONDS, WA. FILED 11-26-2003.



NO CLAIM IS MADE TO THE EXCLUSIVE RIGHT TO USE "SODA", APART FROM THE MARK AS SHOWN.

FOR LIGHT BEVERAGES, NAMELY, CARBONATED, NON-ALCOHOLIC DRINKS (U.S. CLS. 45, 46 AND 48).

FIRST USE 10-24-2003; IN COMMERCE 10-28-2003.
MICHAEL HALL, EXAMINING ATTORNEY



OWNER OF DENMARK REG. NO. VR200400119, DATED 1-9-2004, EXPIRES 1-9-2014.

THE STIPPLING IS FOR SHADING PURPOSES. FOR BEER (U.S. CLS. 45, 46 AND 48).

SUE LAWRENCE, EXAMINING ATTORNEY

CLASS 32—(Continued).

SN 78-380,961. CARLSBERG BREWERIES A/S, DK-1760 COPENHAGEN V, DENMARK, FILED 3-9-2004.

CLASS 32—(Continued).

SN 78-403,049. BBC BRANDS, LLC, BOSTON, MA. FILED 4-16-2004.

THE TASTE OF TIME

SKOL

THE MARK CONSISTS OF STANDARD CHARACTERS WITHOUT CLAIM TO ANY PARTICULAR FONT, STYLE, SIZE, OR COLOR.

FOR BEER AND ALE (U.S. CLS. 45, 46 AND 48).
FIRST USE 3-29-2004; IN COMMERCE 3-29-2004.
GLENN CLARK, EXAMINING ATTORNEY

SN 78-427,322. CORR, ROBERT, BLUE ISLAND, IL. FILED 5-28-2004.

THE MARK CONSISTS OF STANDARD CHARACTERS WITHOUT CLAIM TO ANY PARTICULAR FONT, STYLE, SIZE, OR COLOR.

OWNER OF DENMARK REG. NO. VR199800479, DATED 1-30-1998, EXPIRES 1-30-2008.

FOR BEER (U.S. CLS. 45, 46 AND 48).
IRA J. GOODSID, EXAMINING ATTORNEY

cherry rush cola

SN 78-392,826. LEBANESE ARAK CORPORATION, GLENDALE, CA. FILED 3-29-2004.

THE MARK CONSISTS OF STANDARD CHARACTERS WITHOUT CLAIM TO ANY PARTICULAR FONT, STYLE, SIZE, OR COLOR.

NO CLAIM IS MADE TO THE EXCLUSIVE RIGHT TO USE "CHERRY" AND "COLA", APART FROM THE MARK AS SHOWN.

FOR SOFT DRINKS (U.S. CLS. 45, 46 AND 48).
RON FAIRBANKS, EXAMINING ATTORNEY

SN 78-428,866. MAD MEALS, LLC, BEDFORD, NY. FILED 6-2-2004.

Rio de Janeiro

MMM-MANGO

THE MARK CONSISTS OF STANDARD CHARACTERS WITHOUT CLAIM TO ANY PARTICULAR FONT, STYLE, SIZE, OR COLOR.

THE ENGLISH TRANSLATION OF "RIO DE JANEIRO" IS "RIVER OF JANUARY."

FOR BEER (U.S. CLS. 45, 46 AND 48).
ANNE FARRELL, EXAMINING ATTORNEY

THE MARK CONSISTS OF STANDARD CHARACTERS WITHOUT CLAIM TO ANY PARTICULAR FONT, STYLE, SIZE, OR COLOR.

FOR FRUIT SMOOTHIES (U.S. CLS. 45, 46 AND 48).
SUSAN STIGLITZ, EXAMINING ATTORNEY

CLASS 32—(Continued).

SN 78-432,679. TCBY SYSTEMS, LLC, SALT LAKE CITY, UT.
FILED 6-9-2004.

PEACHY LEAN

THE MARK CONSISTS OF STANDARD CHARACTERS WITHOUT CLAIM TO ANY PARTICULAR FONT, STYLE, SIZE, OR COLOR.

NO CLAIM IS MADE TO THE EXCLUSIVE RIGHT TO USE "PEACHY", APART FROM THE MARK AS SHOWN.
FOR SMOOTHIE (U.S. CLS. 45, 46 AND 48).

FIRST USE 3-1-2004; IN COMMERCE 3-1-2004.
C. DIONNE CLYBURN, EXAMINING ATTORNEY

SN 78-435,561. ALL BEVERAGE CORP., OLD BETHPAGE,
NY. FILED 6-15-2004.

THURST BURST

THE MARK CONSISTS OF STANDARD CHARACTERS WITHOUT CLAIM TO ANY PARTICULAR FONT, STYLE, SIZE, OR COLOR.

FOR NON-CARBONATED FRUIT FLAVORED BEVERAGES (U.S. CLS. 45, 46 AND 48).

FIRST USE 4-19-2004; IN COMMERCE 4-19-2004.
KATHLEEN M. VANSTON, EXAMINING ATTORNEY

SN 78-437,077. BBC BRANDS LLC, BOSTON, MA. FILED 6-17-2004.

SAMUEL ADAMS BREW HOUSE

THE MARK CONSISTS OF STANDARD CHARACTERS WITHOUT CLAIM TO ANY PARTICULAR FONT, STYLE, SIZE, OR COLOR.

OWNER OF U.S. REG. NOS. 1,987,062, 1,987,344 AND 2,288,190.

NO CLAIM IS MADE TO THE EXCLUSIVE RIGHT TO USE "BREW HOUSE", APART FROM THE MARK AS SHOWN.

THE NAME SAMUEL ADAMS SHOWN IN THE MARK DOES NOT IDENTIFY A PARTICULAR LIVING INDIVIDUAL.

FOR BEVERAGES, NAMELY BEER AND ALE (U.S. CLS. 45, 46 AND 48).

FIRST USE 6-15-2004; IN COMMERCE 6-15-2004.
MARK SPARACINO, EXAMINING ATTORNEY

CLASS 32—(Continued).

SN 78-437,268. ENFISSION, INC., MILL CREEK, WA. FILED 6-17-2004.



THE MARK CONSISTS OF A CONTAINER THAT IS OF A GENERALLY TUBULAR CONFIGURATION AND A GENERALLY UNIFORM COLOR, AND A LABEL ON THE EXTERIOR OF THE CONTAINER, WHICH LABEL HAS A DOMINANT COLOR THAT IS SIMILAR TO AND COMPLIMENTS THE CONTAINER COLOR. NO CLAIM IS MADE TO ANY SPECIFIC COLOR.

SEC. 2(F).
FOR ENERGY DRINK MIX (U.S. CLS. 45, 46 AND 48).

FIRST USE 1-2-2004; IN COMMERCE 1-2-2004.
RICHARD A. STRASER, EXAMINING ATTORNEY

SN 78-444,082. ANANDAMAYA INC, CALGARY, CANADA,
FILED 6-30-2004.

ASTRAYA

THE MARK CONSISTS OF STANDARD CHARACTERS WITHOUT CLAIM TO ANY PARTICULAR FONT, STYLE, SIZE, OR COLOR.

FOR ALL NATURAL FLAVOURED FRUIT JUICES (U.S. CLS. 45, 46 AND 48).

FIRST USE 11-1-2002; IN COMMERCE 11-1-2002.
SHARI SHEFFIELD, EXAMINING ATTORNEY

CLASS 32—(Continued).

SN 78-453,026. JANTARACH, VASANA, SRIRACHA, CHON-BURI, THAILAND, FILED 7-19-2004.

COCO LOTO

THE MARK CONSISTS OF STANDARD CHARACTERS WITHOUT CLAIM TO ANY PARTICULAR FONT, STYLE, SIZE, OR COLOR.

NO CLAIM IS MADE TO THE EXCLUSIVE RIGHT TO USE "COCO", APART FROM THE MARK AS SHOWN.

FOR COCONUT JUICE, COCONUT JUICE WITH PULP (U.S. CLS. 45, 46 AND 48).

FIRST USE 7-1-2002; IN COMMERCE 7-1-2002.

PATRICIA EVANKO, EXAMINING ATTORNEY

SN 78-469,186. WATER DEPOT INC., BARRIE, CANADA, FILED 8-18-2004.



OWNER OF U.S. REG. NO. 2,737,565.

NO CLAIM IS MADE TO THE EXCLUSIVE RIGHT TO USE "WATER" AND THE DESIGN OF THE WATER DROPLET, APART FROM THE MARK AS SHOWN.

FOR BOTTLED WATER (U.S. CLS. 45, 46 AND 48).

FIRST USE 5-0-1999; IN COMMERCE 5-0-1999.

CAROLINE WOOD, EXAMINING ATTORNEY

SN 78-471,807. JUICE IT UP FRANCHISE CORP., IRVINE, CA. FILED 8-23-2004.

CONGO LIME

THE MARK CONSISTS OF STANDARD CHARACTERS WITHOUT CLAIM TO ANY PARTICULAR FONT, STYLE, SIZE, OR COLOR.

NO CLAIM IS MADE TO THE EXCLUSIVE RIGHT TO USE "LIME", APART FROM THE MARK AS SHOWN.

FOR SMOOTHIES (U.S. CLS. 45, 46 AND 48).

FIRST USE 12-1-1997; IN COMMERCE 12-1-1997.

MONTIA G. PRESSEY, EXAMINING ATTORNEY

CLASS 32—(Continued).

SN 78-479,147. TRIDENT MARKETING, COLUMBUS, GA. FILED 9-6-2004.



NO CLAIM IS MADE TO THE EXCLUSIVE RIGHT TO USE "JUICE", APART FROM THE MARK AS SHOWN.

THE COLOR(S) BLUE, BLACK, ORANGE, GREEN IS/ARE CLAIMED AS A FEATURE OF THE MARK.

THE MARK CONSISTS OF JUICE WRITTEN IN BLUE, ALIVE WRITTEN IN BLACK, THE WATER DROPLETS COMING FROM THE "E" IN ALIVE ARE IN BLUE. THE ORANGE IMAGE IS IN THE COLOR ORANGE AND THE LEAF AT THE TOP OF THE ORANGE IS GREEN.

FOR JUICE BASED CONCENTRATES (U.S. CLS. 45, 46 AND 48).

FIRST USE 8-10-2004; IN COMMERCE 9-30-2004.

RUSS HERMAN, EXAMINING ATTORNEY

SN 78-480,722. ALLIANT FOODSERVICE, INC., COLUMBIA, MD. FILED 9-9-2004.



OWNER OF U.S. REG. NOS. 2,109,738 AND 2,668,593. FOR FRUIT JUICE, FRUIT JUICE CONCENTRATE, FRUIT-FLAVORED DRINKS, SOFT DRINKS, SPRING WATER, SPORTS DRINKS, NON-ALCOHOLIC COCKTAIL MIXES (U.S. CLS. 45, 46 AND 48).

FIRST USE 12-1-1996; IN COMMERCE 12-1-1996.

KIMBERLY FRYE, EXAMINING ATTORNEY

CLASS 32—(Continued).

SN 78-496,934. MAGPIE FOODS, INC., LAFAYETTE, LA. FILED 10-8-2004.

Skinny Rita

THE MARK CONSISTS OF STANDARD CHARACTERS WITHOUT CLAIM TO ANY PARTICULAR FONT, STYLE, SIZE, OR COLOR.
FOR FRUIT-FLAVORED BEVERAGES (U.S. CLS. 45, 46 AND 48).
FIRST USE 9-23-2004; IN COMMERCE 10-6-2004.
ADA HAN, EXAMINING ATTORNEY

CLASS 32—(Continued).

SN 78-497,718. THE DANNON COMPANY, INC., TARRY-TOWN, NY. FILED 10-11-2004.

LIGHT 'N FIT

THE MARK CONSISTS OF STANDARD CHARACTERS WITHOUT CLAIM TO ANY PARTICULAR FONT, STYLE, SIZE, OR COLOR.
OWNER OF U.S. REG. NOS. 2,720,798 AND 2,762,174.
FOR SMOOTHIES (U.S. CLS. 45, 46 AND 48).
FIRST USE 4-12-2003; IN COMMERCE 4-12-2003.
BARBARA A. LOUGHRAN, EXAMINING ATTORNEY

SN 78-498,398. FRUGOSA, S.A. DE C.V., X55340 XALOSTOC, ESTADO DE MEXICO, MEXICO, FILED 10-12-2004.

SN 78-497,477. MOUCKA, JERRY J., WOODLAND HILLS, CA. FILED 10-10-2004.

BROUCZECH

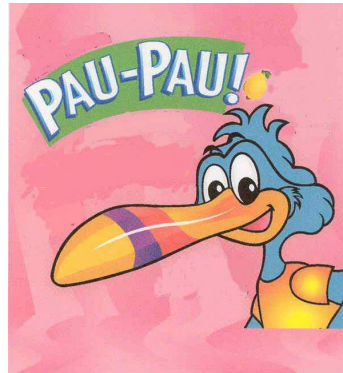

THE MARK CONSISTS OF STANDARD CHARACTERS WITHOUT CLAIM TO ANY PARTICULAR FONT, STYLE, SIZE, OR COLOR.
SEC. 2(F).
FOR BEER (U.S. CLS. 45, 46 AND 48).
FIRST USE 4-10-1999; IN COMMERCE 4-10-1999.
WON TEAK OH, EXAMINING ATTORNEY

THE COLOR(S) PINK, PURPLE, ORANGE, BLUE, GREEN, AND YELLOW IS/ARE CLAIMED AS A FEATURE OF THE MARK.
THE MARK CONSISTS OF A BACKGROUND IN SHADES OF PINK, WITH A YELLOW STYLIZED LEMON WITH GREEN STEM LEAF NEXT TO THE WORDS PAU-PAU! IN WHITE AND BLUE ON A GREEN BANNER BACKGROUND WITH A STYLIZED BIRD IN BLUE, WITH AN ORANGE SHIRT AND AN ORANGE, BLUE AND PURPLE BEAK.
FOR FRUIT DRINKS (U.S. CLS. 45, 46 AND 48).
THEODORE MCBRIDE, EXAMINING ATTORNEY

CLASS 32—(Continued).

SN 78-498,415. FRUGOSA, S.A. DE C.V., X55340 XALOSTOC, ESTADO DE MEXICO, MEXICO, FILED 10-12-2004.

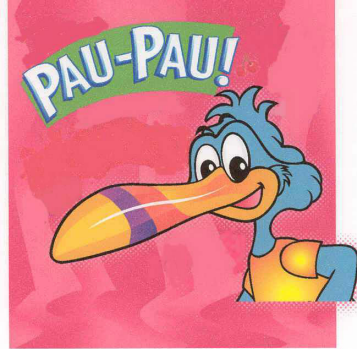

THE COLOR(S) PINK, RED, PURPLE, ORANGE, BLUE AND GREEN IS/ARE CLAIMED AS A FEATURE OF THE MARK.

THE MARK CONSISTS OF A BACKGROUND IN SHADES OF RED AND PINK, WITH A RED STYLIZED CHERRY WITH BROWN STEM NEXT TO THE WORDS PAU-PAU! IN WHITE AND BLUE ON A GREEN BANNER BACKGROUND WITH A STYLIZED BIRD IN BLUE, WITH AN ORANGE SHIRT AND AN ORANGE, BLUE AND PURPLE BEAK.

FOR FRUIT DRINKS (U.S. CLS. 45, 46 AND 48).
THEODORE MCBRIDE, EXAMINING ATTORNEY

CLASS 32—(Continued).

SN 78-498,432. FRUGOSA, S.A. DE C.V., X55340 XALOSTOC, ESTADO DE MEXICO, MEXICO, FILED 10-12-2004.

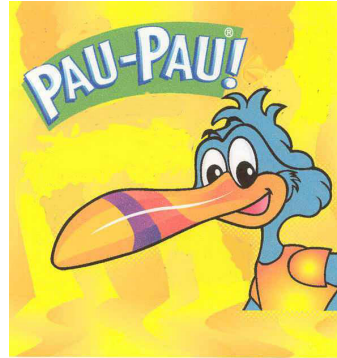

THE COLOR(S) PURPLE, ORANGE, BLUE AND GREEN IS/ARE CLAIMED AS A FEATURE OF THE MARK.

THE MARK CONSISTS OF A BACKGROUND IN SHADES OF YELLOW, WITH A YELLOW STYLIZED MANGO NEXT TO THE WORDS PAU-PAU! IN WHITE AND BLUE ON A GREEN BANNER BACKGROUND WITH A STYLIZED BIRD IN BLUE, WITH AN ORANGE SHIRT AND AN ORANGE, BLUE AND PURPLE BEAK.

FOR FRUIT DRINKS (U.S. CLS. 45, 46 AND 48).
THEODORE MCBRIDE, EXAMINING ATTORNEY

SN 78-498,426. FRUGOSA, S.A. DE C.V., X55340 XALOSTOC, ESTADO DE MEXICO, MEXICO, FILED 10-12-2004.

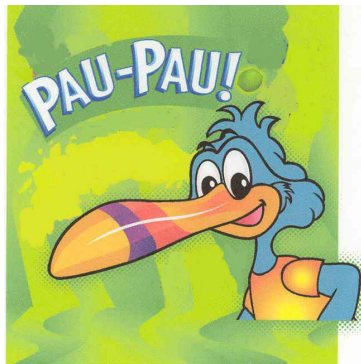

THE COLOR(S) PURPLE, ORANGE, BLUE, AND GREEN IS/ARE CLAIMED AS A FEATURE OF THE MARK.

THE MARK CONSISTS OF A BACKGROUND IN SHADES OF GREEN, WITH A GREEN STYLIZED LIME NEXT TO THE WORDS PAU-PAU! IN WHITE AND BLUE ON A GREEN BANNER BACKGROUND WITH A STYLIZED BIRD IN BLUE, WITH AN ORANGE SHIRT AND AN ORANGE, BLUE AND PURPLE BEAK.

FOR FRUIT DRINKS (U.S. CLS. 45, 46 AND 48).
THEODORE MCBRIDE, EXAMINING ATTORNEY

SN 78-499,216. RED DIAMOND, INC., BIRMINGHAM, AL. FILED 10-13-2004.

RED DIAMOND

THE MARK CONSISTS OF STANDARD CHARACTERS WITHOUT CLAIM TO ANY PARTICULAR FONT, STYLE, SIZE, OR COLOR.

OWNER OF U.S. REG. NOS. 636,917, 2,007,551 AND OTHERS.

FOR LEMONADE (U.S. CLS. 45, 46 AND 48).
FIRST USE 5-0-2004; IN COMMERCE 5-0-2004.
RONALD MCMORROW, EXAMINING ATTORNEY

CLASS 32—(Continued).

SN 78-499,220. DIAGEO NORTH AMERICA, INC., NORWALK, CT. FILED 10-13-2004.

**STE PIERRE
SMIRNOFF FLS**

THE MARK CONSISTS OF STANDARD CHARACTERS WITHOUT CLAIM TO ANY PARTICULAR FONT, STYLE, SIZE, OR COLOR.

OWNER OF U.S. REG. NOS. 623,237, 2,874,402 AND OTHERS.

FOR FLAVORED BREWED MALT BEVERAGE (U.S. CLS. 45, 46 AND 48).

FIRST USE 5-19-2000; IN COMMERCE 5-19-2000.
IRA J. GOODSaid, EXAMINING ATTORNEY

SN 78-499,297. RED DIAMOND, INC., BIRMINGHAM, AL. FILED 10-13-2004.

RED DIAMOND

THE MARK CONSISTS OF STANDARD CHARACTERS WITHOUT CLAIM TO ANY PARTICULAR FONT, STYLE, SIZE, OR COLOR.

OWNER OF U.S. REG. NOS. 636,917, 2,007,551 AND OTHERS.

FOR ARTESIAN MINERAL AND SPRING WATER (U.S. CLS. 45, 46 AND 48).

FIRST USE 5-0-2004; IN COMMERCE 5-0-2004.
JOANNA DUKOVIC, EXAMINING ATTORNEY

CLASS 32—(Continued).

SN 78-499,998. DEUTSCHE TELEKOM AG, BONN, FED REP GERMANY, FILED 10-14-2004.

T-Systems

THE MARK CONSISTS OF STANDARD CHARACTERS WITHOUT CLAIM TO ANY PARTICULAR FONT, STYLE, SIZE, OR COLOR.

PRIORITY CLAIMED UNDER SEC. 44(D) ON FED REP GERMANY APPLICATION NO. 30421580535, FILED 4-15-2004, REG. NO. 30421580, DATED 9-9-2004, EXPIRES 4-30-2014.

OWNER OF U.S. REG. NOS. 2,448,571, 2,880,613 AND OTHERS.

FOR BEERS, MINERAL AND AERATED WATERS, SOFT DRINKS, FRUIT DRINKS AND FRUIT JUICES; SYRUPS AND PREPARATIONS FOR MAKING SOFT DRINKS, FRUIT DRINKS AND FRUIT JUICES (U.S. CLS. 45, 46 AND 48).

SKYE YOUNG, EXAMINING ATTORNEY

SN 78-500,035. DEUTSCHE TELEKOM AG, BONN, FED REP GERMANY, FILED 10-14-2004.

T · Systems

PRIORITY CLAIMED UNDER SEC. 44(D) ON FED REP GERMANY APPLICATION NO. 30421579135, FILED 4-15-2004, REG. NO. 30421579, DATED 9-9-2004, EXPIRES 4-30-2014.

OWNER OF U.S. REG. NOS. 2,448,571, 2,880,613 AND OTHERS.

THE COLOR(S) MAGENTA AND GREY IS/ARE CLAIMED AS A FEATURE OF THE MARK.

THE COLOR MAGENTA APPEARS IN THE LETTER "T" IN THE MARK; THE REMAINDER OF THE MARK APPEARS IN THE COLOR GREY.

FOR BEERS, MINERAL AND AERATED WATERS, SOFT DRINKS, FRUIT DRINKS AND FRUIT JUICES; SYRUPS AND PREPARATIONS FOR MAKING SOFT DRINKS, FRUIT DRINKS AND FRUIT JUICES (U.S. CLS. 45, 46 AND 48).

SKYE YOUNG, EXAMINING ATTORNEY

CLASS 32—(Continued).

SN 78-501,663. BRASSERIE DE TAHITI S.A., PAPEETE, TAHITI, FRENCH POLYNESIA, FILED 10-18-2004.

TARAVANA

THE MARK CONSISTS OF STANDARD CHARACTERS WITHOUT CLAIM TO ANY PARTICULAR FONT, STYLE, SIZE, OR COLOR.

FOR FRUIT JUICE CONCENTRATES, FRUIT JUICES, FRUIT AND FRUIT FLAVORED DRINKS, SYRUPS AND POWDERS USED TO PREPARE FRUIT AND FRUIT FLAVORED DRINKS AND SEMI-FROZEN DRINKS, FRUIT JUICE BASES, BOTTLED AND DRINKING WATER, FERMENTED BEVERAGES, NAMELY, BEER AND ALE (U.S. CLS. 45, 46 AND 48).
ALEX KEAM, EXAMINING ATTORNEY

SN 78-503,858. AGUAS DEL SUR S.A., SANTIAGO, CHILE, FILED 10-21-2004.

EL BURRITO

THE MARK CONSISTS OF STANDARD CHARACTERS WITHOUT CLAIM TO ANY PARTICULAR FONT, STYLE, SIZE, OR COLOR.

PRIORITY CLAIMED UNDER SEC. 44(D) ON CHILE APPLICATION NO. 651412, FILED 6-29-2004, REG. NO. 703.525, DATED 9-16-2004, EXPIRES 9-16-2014.
FOR BEER (U.S. CLS. 45, 46 AND 48).
RICHARD WHITE, EXAMINING ATTORNEY

CLASS 32—(Continued).

SN 78-508,637. O WATERS, LLC, MESA, AZ. FILED 10-29-2004.



THE MARK CONSISTS OF A WATER DROP IN AN OVAL CIRCLE.

FOR BOTTLED WATER (U.S. CLS. 45, 46 AND 48).
FIRST USE 2-1-2004; IN COMMERCE 2-1-2004.
YONG KIM, EXAMINING ATTORNEY

SN 78-513,005. MADDOCK DOUGLAS, INC., ELMHURST, IL. FILED 11-8-2004.

**WAIT 'TIL NEXT
BEER**

THE MARK CONSISTS OF STANDARD CHARACTERS WITHOUT CLAIM TO ANY PARTICULAR FONT, STYLE, SIZE, OR COLOR.

NO CLAIM IS MADE TO THE EXCLUSIVE RIGHT TO USE "BEER", APART FROM THE MARK AS SHOWN.
FOR BEER (U.S. CLS. 45, 46 AND 48).
MARGERY A. TIERNEY, EXAMINING ATTORNEY

SN 78-514,628. C.B.I. INTERNATIONAL, INC., MIAMI, FL. FILED 11-10-2004.



NO CLAIM IS MADE TO THE EXCLUSIVE RIGHT TO USE "THE REPRESENTATION OF EL SALVADOR" AND "CHAMPAN", APART FROM THE MARK AS SHOWN.

THE MARK CONSISTS OF THE REPRESENTATION OF THE COUNTRY EL SALVADOR WITH A BANNER ACROSS THE COUNTRY WITH THE WORDS TROPI CHAMPAN INSIDE THE BANNER.

THE ENGLISH TRANSLATION OF CHAMPAN IS CHAMPAGNE.

FOR SOFT DRINKS (U.S. CLS. 45, 46 AND 48).
FIRST USE 11-2-1999; IN COMMERCE 11-2-1999.
TARAH HARDY, EXAMINING ATTORNEY

CLASS 32—(Continued).

SN 78-516,355. TOP DOGG UNLIMITED, LLC, HIGLEY, AZ.
FILED 11-12-2004.

Top Dawg

THE MARK CONSISTS OF STANDARD CHARACTERS WITHOUT CLAIM TO ANY PARTICULAR FONT, STYLE, SIZE, OR COLOR.

FOR NON-ALCOHOLIC SPORTS AND ENERGY DRINK (U.S. CLS. 45, 46 AND 48).
PRISCILLA MILTON, EXAMINING ATTORNEY

CLASS 32—(Continued).

SN 78-523,332. SUPER CHILL BEVERAGE GROUP, INC.,
PRINCETON, NJ. FILED 11-28-2004.

Chiller-X

THE MARK CONSISTS OF STANDARD CHARACTERS WITHOUT CLAIM TO ANY PARTICULAR FONT, STYLE, SIZE, OR COLOR.

FOR FRUIT JUICE DRINKS CONTAINING WATER AND JUICE (U.S. CLS. 45, 46 AND 48).
BRIAN NEVILLE, EXAMINING ATTORNEY

SN 78-532,956. ANHEUSER-BUSCH, INCORPORATED, ST. LOUIS, MO. FILED 12-15-2004.

THIS IS YOUR BEER

THE MARK CONSISTS OF STANDARD CHARACTERS WITHOUT CLAIM TO ANY PARTICULAR FONT, STYLE, SIZE, OR COLOR.

FOR BEER (U.S. CLS. 45, 46 AND 48).
LANA PHAM, EXAMINING ATTORNEY

SN 78-534,831. RAGINGBULL MEDIA, INC., YORBA LINDA, CA. FILED 12-17-2004.

SCREAMING COW

THE MARK CONSISTS OF STANDARD CHARACTERS WITHOUT CLAIM TO ANY PARTICULAR FONT, STYLE, SIZE, OR COLOR.

FOR ENERGY DRINKS, SPORTS DRINKS, SMOOTHIES, FRUIT-FLAVORED BEVERAGES, VEGETABLE JUICES, FROZEN FRUIT-BASED BEVERAGES, FRUIT PUNCH, SOFT DRINKS IN GENERAL, NON-ALCOHOLIC COCKTAIL MIXES, SYRUPS FOR MAKING SOFT DRINKS (U.S. CLS. 45, 46 AND 48).
BARNEY CHARLON, EXAMINING ATTORNEY

SN 78-517,471. C.B.I. INTERNATIONAL, INC., MIAMI, FL.
FILED 11-16-2004.



OWNER OF U.S. REG. NOS. 2,375,219, 2,463,527 AND OTHERS.

NO CLAIM IS MADE TO THE EXCLUSIVE RIGHT TO USE "CHAMPAN", APART FROM THE MARK AS SHOWN. THE MARK CONSISTS OF THE WORDS "DISFRUTE" AND A BANNER WITH THE WORDS "TROPI CHAMPAN" ALL ENCLOSED IN A REPRESENTATION OF EL SALVADOR.

THE ENGLISH TRANSLATION OF THE WORD "DISFRUTE" IN THE MARK IS "ENJOY" AND THE ENGLISH TRANSLATION OF THE WORD "CHAMPAN" IN THE MARK IS "CHAMPAGNE".

FOR SOFT DRINKS (U.S. CLS. 45, 46 AND 48).
FIRST USE 11-2-1999; IN COMMERCE 11-2-1999.
MARIAM MAHMOUDI, EXAMINING ATTORNEY

CLASS 32—(Continued).

SN 78-537,545. KAW, INC., CHARLESTON, SC. FILED 12-23-2004.

SOUTHERN HARMONY

THE MARK CONSISTS OF STANDARD CHARACTERS WITHOUT CLAIM TO ANY PARTICULAR FONT, STYLE, SIZE, OR COLOR.
FOR TEA (U.S. CLS. 45, 46 AND 48).
FIRST USE 10-1-2004; IN COMMERCE 10-1-2004.
WON TEAK OH, EXAMINING ATTORNEY

SN 78-537,975. VARA FOOD & DRINK CO., LTD., BANGKOK, THAILAND, FILED 12-23-2004.



OWNER OF U.S. REG. NO. 1,500,672.
NO CLAIM IS MADE TO THE EXCLUSIVE RIGHT TO USE "BRAND", APART FROM THE MARK AS SHOWN.
THE MARK CONSISTS OF THE STYLIZED WORDS TASCO BRAND IN COMBINATION WITH A DESIGN OF A MAN WITH A MOUSTACHE IN A CHEF'S HAT, WEARING A BOW TIE.
FOR NON-ALCOHOLIC BEVERAGES, NAMELY, COCONUT JUICE (U.S. CLS. 45, 46 AND 48).
JASON ROTH, EXAMINING ATTORNEY

SN 78-538,043. CALIFORNIA QUIVERS INC., SAN DIEGO, CA. FILED 12-23-2004.

CALIFORNIA QUIVERS

THE MARK CONSISTS OF STANDARD CHARACTERS WITHOUT CLAIM TO ANY PARTICULAR FONT, STYLE, SIZE, OR COLOR.
NO CLAIM IS MADE TO THE EXCLUSIVE RIGHT TO USE "CALIFORNIA", APART FROM THE MARK AS SHOWN.
FOR ICED FRUIT DRINKS (U.S. CLS. 45, 46 AND 48).
FIRST USE 4-11-1997; IN COMMERCE 4-11-1997.
DEBRA LEE, EXAMINING ATTORNEY

CLASS 32—(Continued).

SN 78-538,615. VARA FOOD & DRINK CO., LTD., BANGKOK, THAILAND, FILED 12-27-2004.



OWNER OF U.S. REG. NO. 1,500,672.
NO CLAIM IS MADE TO THE EXCLUSIVE RIGHT TO USE "BRAND", APART FROM THE MARK AS SHOWN.
THE MARK CONSISTS OF THE STYLIZED WORDS TASCO BRAND INSIDE TWO OVALS.
FOR NON-ALCOHOLIC BEVERAGES, NAMELY, COCONUT JUICE (U.S. CLS. 45, 46 AND 48).
FIRST USE 1-0-2000; IN COMMERCE 1-0-2000.
JASON ROTH, EXAMINING ATTORNEY

SN 78-601,194. ANHEUSER-BUSCH, INCORPORATED, ST. LOUIS, MO. FILED 4-4-2005.

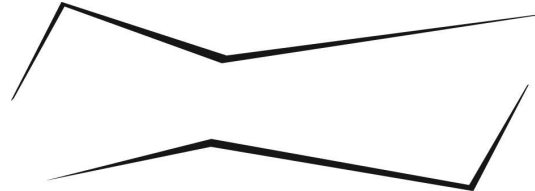

OWNER OF U.S. REG. NOS. 261,103, 2,296,922 AND OTHERS.
THE MARK CONSISTS OF BOWTIE.
FOR BEER (U.S. CLS. 45, 46 AND 48).
FIRST USE 2-17-2005; IN COMMERCE 2-17-2005.
LANA PHAM, EXAMINING ATTORNEY

SN 78-617,641. ANHEUSER-BUSCH, INCORPORATED, ST. LOUIS, MO. FILED 4-27-2005.

BEER WITH SOMETHING EXTRA

THE MARK CONSISTS OF STANDARD CHARACTERS WITHOUT CLAIM TO ANY PARTICULAR FONT, STYLE, SIZE, OR COLOR.
FOR FLAVORED BEER (U.S. CLS. 45, 46 AND 48).
FIRST USE 10-14-2004; IN COMMERCE 10-14-2004.
LANA PHAM, EXAMINING ATTORNEY

CLASS 32—(Continued).

SN 78-975,930. SOCIETE ANONYME DES EAUX MINER-ALES D'EVIAN, EVIAN LES BAINS, FRANCE, FILED 7-13-2000.

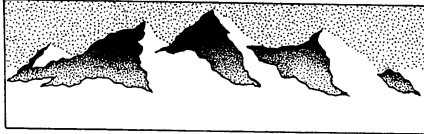

THE STIPPLING IS A FEATURE OF THE MARK. FOR STILL MINERAL WATER (U.S. CLS. 45, 46 AND 48).

FIRST USE 0-0-1973; IN COMMERCE 0-0-1973.
KIMBERLY PERRY, EXAMINING ATTORNEY

SN 79-003,225. CARLTON AND UNITED BEVERAGES LIMITED, AUSTRALIA, FILED 5-26-2004.

BIERE LARUE

THE MARK CONSISTS OF STANDARD CHARACTERS WITHOUT CLAIM TO ANY PARTICULAR FONT, STYLE, SIZE, OR COLOR.

PRIORITY DATE OF 11-26-2003 IS CLAIMED. OWNER OF INTERNATIONAL REGISTRATION 0826909 DATED 5-26-2004, EXPIRES 5-26-2014.

NO CLAIM IS MADE TO THE EXCLUSIVE RIGHT TO USE "BIERE", APART FROM THE MARK AS SHOWN.

THE APPLICANT ADVISES THAT THE ENGLISH TRANSLATION OF THE FRENCH WORDS BIERE LARUE APPEARING IN THE TRADE MARK IS BEER THE STREET. FOR BEERS (U.S. CLS. 45, 46 AND 48).

DORITT L. CARROLL, EXAMINING ATTORNEY

SN 79-003,393. BIOTTA AG, SWITZERLAND, FILED 5-27-2004.

BREUSS VEGETABLE JUICE

THE MARK CONSISTS OF STANDARD CHARACTERS WITHOUT CLAIM TO ANY PARTICULAR FONT, STYLE, SIZE, OR COLOR.

PRIORITY DATE OF 3-18-2004 IS CLAIMED. OWNER OF INTERNATIONAL REGISTRATION 0827558 DATED 5-27-2004, EXPIRES 5-27-2014.

OWNER OF U.S. REG. NO. 2,132,784. NO CLAIM IS MADE TO THE EXCLUSIVE RIGHT TO USE VEGETABLE JUICE, APART FROM THE MARK AS SHOWN.

FOR VEGETABLE JUICES (U.S. CLS. 45, 46 AND 48).
ROBERT C. CLARK JR., EXAMINING ATTORNEY

CLASS 32—(Continued).

SN 79-004,847. KELTEREI POSSMANN GMBH & CO. KG, FED REP GERMANY, FILED 7-7-2004.

Landappel

THE MARK CONSISTS OF STANDARD CHARACTERS WITHOUT CLAIM TO ANY PARTICULAR FONT, STYLE, SIZE, OR COLOR.

OWNER OF INTERNATIONAL REGISTRATION 0831908 DATED 7-7-2004, EXPIRES 7-7-2014.

FOR NON-ALCOHOLIC DRINKS, NAMELY, FRUIT JUICE (U.S. CLS. 45, 46 AND 48).

ANN LINNEHAN, EXAMINING ATTORNEY

SN 79-004,862. FIREFLY TONICS LIMITED, UNITED KINGDOM, FILED 4-1-2004.

FIREFLY

THE MARK CONSISTS OF STANDARD CHARACTERS WITHOUT CLAIM TO ANY PARTICULAR FONT, STYLE, SIZE, OR COLOR.

OWNER OF INTERNATIONAL REGISTRATION 0831946 DATED 4-1-2004, EXPIRES 4-1-2014.

FOR MINERAL AND AERATED WATERS; NON-ALCOHOLIC BEVERAGES, NAMELY, NON-ALCOHOLIC BEVERAGES CONTAINING FRUIT JUICES AND CARBONATED BEVERAGES; FRUIT DRINKS AND FRUIT JUICES; SYRUPS FOR BEVERAGES, PREPARATIONS FOR MAKING BEVERAGES, NAMELY, FRUIT DRINKS (U.S. CLS. 45, 46 AND 48).

ASMAT KHAN, EXAMINING ATTORNEY

SN 79-008,539. SOCIÉTÉ ANONYME DES EAUX MINÉRALES; D'EVIAN, SOCIÉTÉ ANONYME, FRANCE, FILED 12-22-2004.

BADOIT

OWNER OF INTERNATIONAL REGISTRATION 0425381 DATED 8-31-1976, EXPIRES 8-31-2006.

FOR NATURAL CARBONATED MINERAL WATER (U.S. CLS. 45, 46 AND 48).

ROBERT LORENZO, EXAMINING ATTORNEY

CLASS 33—WINES AND SPIRITS

SN 76-474,035. AZIENDA VINICOLA FALESCO S.R.L., 05014 CASTEL VISCARDO (TERNI), ITALY, FILED 12-4-2002.



PRIORITY CLAIMED UNDER SEC. 44(D) ON ITALY APPLICATION NO. TO2002C00328, FILED 11-8-2002. FOR WINES (U.S. CLS. 47 AND 49). FIRST USE 12-31-2001; IN COMMERCE 12-31-2001. INGA ERVIN, EXAMINING ATTORNEY

SN 76-542,579. LE MACIE S.P.A., MOTI IN CHIANTI, SIENNA, ITALY, FILED 9-5-2003.

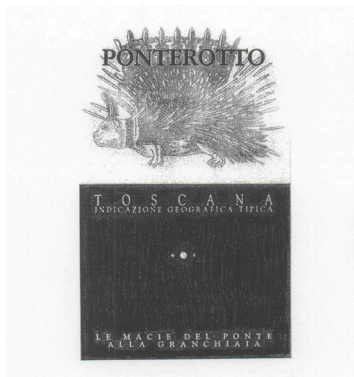

PRIORITY CLAIMED UNDER SEC. 44(D) ON ERPN CMNTY TM OFC APPLICATION NO. 003326709, FILED 8-25-2003, REG. NO. 3326709, DATED 11-18-2004, EXPIRES 8-25-2013.

OWNER OF U.S. REG. NO. 2,712,798. NO CLAIM IS MADE TO THE EXCLUSIVE RIGHT TO USE TOSCANA OR INDICAZIONE GEOGRATIC, APART FROM THE MARK AS SHOWN.

THE TRANSLATION OF THE MARK WORDS ARE PONTEROTTO TUSCANY, TYPICAL GEOGRAPHICAL INDICATION LE MACIE DEL PONTE ALLA GRANCHIAIA.

FOR ALCOHOLIC DRINKS, NAMELY, WINE (U.S. CLS. 47 AND 49).

GEORGIA CARTY, EXAMINING ATTORNEY

CLASS 33—(Continued).

SN 76-552,683. GARACAMA PROPRIETRY LIMITED, PIAN-GIL, VICTORIA, 3597, AUSTRALIA, FILED 10-20-2003.

MASTERPEACE

PRIORITY CLAIMED UNDER SEC. 44(D) ON AUSTRALIA APPLICATION NO. 969712, FILED 9-9-2003, REG. NO. 969712, DATED 9-9-2003, EXPIRES 9-9-2013. FOR WINE (U.S. CLS. 47 AND 49). MICHAEL ENGEL, EXAMINING ATTORNEY

SN 76-557,478. SUMMIT IMPORT CORPORATION, JERSEY CITY, NJ. FILED 10-20-2003.



OWNER OF U.S. REG. NOS. 1,538,332 AND 1,559,191. NO CLAIM IS MADE TO THE EXCLUSIVE RIGHT TO USE BRAND, APART FROM THE MARK AS SHOWN.

THE MARK CONSISTS OF A DESIGN ELEMENT WHICH CONSISTS OF THE TRADITIONAL ORIENTAL SYMBOL FOR LUCK AND PROSPERITY DERIVED FROM A GOOD LUCK CHARM CARRIED BY OFFICIALS IN ANCIENT CHINA.

THE CHINESE WORDING IN THE MARK MAY BE TRANSLATED AS "EVERYTHING GOES YOUR WAY" IN ENGLISH.

THE NON-LATIN CHARACTERS IN THE MARK TRANSLITERATE TO YU YEE AND THIS MEANS "EVERYTHING GOES YOUR WAY" IN ENGLISH.

FOR COOKING WINE, SEASONED COOKING WINE, RICE COOKING WINE (U.S. CLS. 47 AND 49).

FIRST USE 12-31-1990; IN COMMERCE 12-31-1990.

ANDREW BENZMILLER, EXAMINING ATTORNEY

SN 76-579,836. HUNTINGTON WINE CELLARS, LLC, NAPA, CA. FILED 3-8-2004.

HUNTINGTON

THE MARK CONSISTS OF STANDARD CHARACTERS WITHOUT CLAIM TO ANY PARTICULAR FONT, STYLE, SIZE, OR COLOR.

FOR WINE (U.S. CLS. 47 AND 49).

FIRST USE 9-1-1992; IN COMMERCE 9-1-1992.

ALICE BENMAMAN, EXAMINING ATTORNEY

CLASS 33—(Continued).

SN 76-580,194. PASTERNAK WINE IMPORTS, GREENWICH, CT. FILED 3-5-2004.



FOR WINE (U.S. CLS. 47 AND 49).
FIRST USE 8-7-2003; IN COMMERCE 8-7-2003.
KAREN K. BUSH, EXAMINING ATTORNEY

SN 76-581,457. MARTHA CLARA VINEYARDS, LLC, RIVERHEAD, NY. FILED 3-17-2004.

6025 NORTH FORK

THE MARK CONSISTS OF STANDARD CHARACTERS WITHOUT CLAIM TO ANY PARTICULAR FONT, STYLE, SIZE, OR COLOR.
FOR WINES (U.S. CLS. 47 AND 49).
FIRST USE 3-0-2003; IN COMMERCE 3-0-2003.
TINA L. SNAPP, EXAMINING ATTORNEY

SN 76-581,859. CONTROLADORA DE MARCAS INTERNACIONALES, S.A., PANAMA CITY, PANAMA, FILED 3-18-2004.

PORFIDIO

THE MARK CONSISTS OF STANDARD CHARACTERS WITHOUT CLAIM TO ANY PARTICULAR FONT, STYLE, SIZE, OR COLOR.
FOR ALCOHOLIC BEVERAGES, NAMELY, RUM AND SPIRITS DISTILLED FROM AGAVE (U.S. CLS. 47 AND 49).
FIRST USE 10-26-1992; IN COMMERCE 10-26-1992.
DAVID TAYLOR, EXAMINING ATTORNEY

CLASS 33—(Continued).

SN 76-589,892. POLISH HONEY VODKA, BOZEMAN, MT. FILED 5-3-2004.

MEDOS

THE MARK CONSISTS OF STANDARD CHARACTERS WITHOUT CLAIM TO ANY PARTICULAR FONT, STYLE, SIZE, OR COLOR.
FOR ALCOHOLIC BEVERAGES, NAMELY VODKA (U.S. CLS. 47 AND 49).
FIRST USE 7-0-2001; IN COMMERCE 7-0-2001.
DAWN FELDMAN, EXAMINING ATTORNEY

SN 76-589,893. POLISH HONEY VODKA, BOZEMAN, MT. FILED 5-3-2004.

MEDOS HONEY VODKA

THE MARK CONSISTS OF STANDARD CHARACTERS WITHOUT CLAIM TO ANY PARTICULAR FONT, STYLE, SIZE, OR COLOR.
NO CLAIM IS MADE TO THE EXCLUSIVE RIGHT TO USE "HONEY VODKA", APART FROM THE MARK AS SHOWN.
FOR ALCOHOLIC BEVERAGES, NAMELY VODKA (U.S. CLS. 47 AND 49).
FIRST USE 7-0-2001; IN COMMERCE 7-0-2001.
DAWN FELDMAN, EXAMINING ATTORNEY

SN 76-592,844. MATEU DE ARIZU, ESPERANZA ALICIA, MENDOZA, ARGENTINA, FILED 5-18-2004.

VINA ALICIA CUARZO

THE MARK CONSISTS OF STANDARD CHARACTERS WITHOUT CLAIM TO ANY PARTICULAR FONT, STYLE, SIZE, OR COLOR.
NO CLAIM IS MADE TO THE EXCLUSIVE RIGHT TO USE "VINA", APART FROM THE MARK AS SHOWN.
THE TERM "CUARZO" MEANS "QUARTZ", A MINERAL WITH NO RELATION OF WINE. THE MARK TRANSLATES TO "ALICE QUARTZ VINEYARD".
FOR WINES (U.S. CLS. 47 AND 49).
CAROLYN GRAY, EXAMINING ATTORNEY

CLASS 33—(Continued).

SN 76-598,446. MURAKAMI, AKIRA, SAKYO-KU, KYOTO, JAPAN, FILED 6-21-2004.

DADDY SMILE

THE MARK CONSISTS OF STANDARD CHARACTERS WITHOUT CLAIM TO ANY PARTICULAR FONT, STYLE, SIZE, OR COLOR.

OWNER OF JAPAN REG. NO. 2411966, DATED 5-29-1992, EXPIRES 5-29-2012.

FOR JAPANESE WHITE LIQUOR (SHOCHU); DISTILLED SPIRITS OF RICE (AAWAMORI); CHINESE BREWED LIQUOR (LAOJIOU); CHINESE WHITE LIQUOR (BAIGANR); WHISKY; BOURBON; VODKA; TEQUILA; GIN; BRANDY (U.S. CLS. 47 AND 49).

ALICE SUE CARRUTHERS, EXAMINING ATTORNEY

SN 76-603,493. VIÑA UNDURRAGA S.A., SANTIAGO, CHILE, FILED 7-22-2004.

LAZO

THE MARK CONSISTS OF STANDARD CHARACTERS WITHOUT CLAIM TO ANY PARTICULAR FONT, STYLE, SIZE, OR COLOR.

THE FOREIGN WORDING IN THE MARK TRANSLATES INTO ENGLISH AS ROPE.

FOR WINES (U.S. CLS. 47 AND 49).

FIRST USE 9-0-2003; IN COMMERCE 9-0-2003.

JOSETTE BEVERLY, EXAMINING ATTORNEY

SN 76-610,479. KINGSTON FAMILY VINEYARDS, LLC, PORTOLA VALLEY, CA. FILED 9-1-2004.

TOBIANO

THE MARK CONSISTS OF STANDARD CHARACTERS WITHOUT CLAIM TO ANY PARTICULAR FONT, STYLE, SIZE, OR COLOR.

FOR WINES (U.S. CLS. 47 AND 49).

FIRST USE 8-2-2004; IN COMMERCE 8-2-2004.

RUSS HERMAN, EXAMINING ATTORNEY

CLASS 33—(Continued).

SN 76-613,620. SUTTER HOME WINERY, INC., DBA TRINCHERO FAMILY ESTATES, ST. HELENA, CA. FILED 9-23-2004.

TRINCHERO

THE MARK CONSISTS OF STANDARD CHARACTERS WITHOUT CLAIM TO ANY PARTICULAR FONT, STYLE, SIZE, OR COLOR.

OWNER OF U.S. REG. NOS. 2,235,191, 2,671,176 AND 2,729,881.

SEC. 2(F).

FOR WINE (U.S. CLS. 47 AND 49).

FIRST USE 3-23-1998; IN COMMERCE 3-23-1998.

CIMMERIAN COLEMAN, EXAMINING ATTORNEY

SN 76-614,102. DAVID BRUCE WINERY, INC., LOS GATOS, CA. FILED 9-30-2004.

DAVID & GOLIATH

THE MARK CONSISTS OF STANDARD CHARACTERS WITHOUT CLAIM TO ANY PARTICULAR FONT, STYLE, SIZE, OR COLOR.

FOR WINES (U.S. CLS. 47 AND 49).

FIRST USE 4-1-1991; IN COMMERCE 4-1-1991.

LEIGH LOWRY, EXAMINING ATTORNEY

SN 76-615,701. BRONCO WINE COMPANY, CERES, CA. FILED 10-14-2004.

MIDNIGHT MILLENIUM

THE MARK CONSISTS OF STANDARD CHARACTERS WITHOUT CLAIM TO ANY PARTICULAR FONT, STYLE, SIZE, OR COLOR.

FOR WINES (U.S. CLS. 47 AND 49).

WILLIAM VERHOSEK, EXAMINING ATTORNEY

SN 76-616,132. T. EDWARD WINES LTD., NEW YORK, NY. FILED 10-13-2004.

HOOP DE DOO

THE MARK CONSISTS OF STANDARD CHARACTERS WITHOUT CLAIM TO ANY PARTICULAR FONT, STYLE, SIZE, OR COLOR.

FOR WINES (U.S. CLS. 47 AND 49).

BARBARA A. LOUGHRAN, EXAMINING ATTORNEY

CLASS 33—(Continued).

SN 76-616,134. T. EDWARD WINES LTD., NEW YORK, NY.
FILED 10-13-2004.

CINQUANTE-CINQ

THE MARK CONSISTS OF STANDARD CHARACTERS WITHOUT CLAIM TO ANY PARTICULAR FONT, STYLE, SIZE, OR COLOR.

APPLICANT STATES THAT THE FOREIGN WORDING IN THE MARK TRANSLATES AS "FIFTY-FIVE".
FOR WINES (U.S. CLS. 47 AND 49).
FIRST USE 6-28-1999; IN COMMERCE 6-28-1999.
JOSETTE BEVERLY, EXAMINING ATTORNEY

SN 76-616,135. T. EDWARD WINES LTD., NEW YORK, NY.
FILED 10-13-2004.

D. BOSLER

THE MARK CONSISTS OF STANDARD CHARACTERS WITHOUT CLAIM TO ANY PARTICULAR FONT, STYLE, SIZE, OR COLOR.

FOR WINES (U.S. CLS. 47 AND 49).
FIRST USE 1-3-2001; IN COMMERCE 1-3-2001.
JOSETTE BEVERLY, EXAMINING ATTORNEY

SN 76-616,148. E.T. VINEYARDS, LLC, MENLO PARK, CA.
FILED 10-12-2004.

SOPHIE'S CHOICE

THE MARK CONSISTS OF STANDARD CHARACTERS WITHOUT CLAIM TO ANY PARTICULAR FONT, STYLE, SIZE, OR COLOR.

FOR WINE (U.S. CLS. 47 AND 49).
EUGENIA MARTIN, EXAMINING ATTORNEY

CLASS 33—(Continued).

SN 76-616,313. GAMBA VINEYARDS & WINERY, LLC,
FULTON, CA. FILED 10-7-2004.

GAMBA

THE MARK CONSISTS OF STANDARD CHARACTERS WITHOUT CLAIM TO ANY PARTICULAR FONT, STYLE, SIZE, OR COLOR.

FOR WINE (U.S. CLS. 47 AND 49).
FIRST USE 11-0-1996; IN COMMERCE 11-0-1996.
JENNIFER KRISP, EXAMINING ATTORNEY

SN 76-616,369. DR. ING. H.C. F. PORSCHE AG, 70435
STUTTGART-ZUFFENHAUSEN, FED REP GERMANY,
FILED 10-18-2004.



OWNER OF FED REP GERMANY REG. NO. 1036804,
DATED 8-9-1982, EXPIRES 4-30-2012.

OWNER OF U.S. REG. NOS. 618,932, 2,197,889 AND
OTHERS.

NO CLAIM IS MADE TO THE EXCLUSIVE RIGHT TO
USE "STUTTGART", APART FROM THE MARK AS
SHOWN.

FOR WINES (U.S. CLS. 47 AND 49).
FRED MANDIR, EXAMINING ATTORNEY

SN 76-617,674. T. EDWARD WINES LTD., NEW YORK, NY.
FILED 10-22-2004.

SANDY COVE

THE MARK CONSISTS OF STANDARD CHARACTERS WITHOUT CLAIM TO ANY PARTICULAR FONT, STYLE, SIZE, OR COLOR.

FOR WINES (U.S. CLS. 47 AND 49).
FIRST USE 8-6-2001; IN COMMERCE 8-6-2001.
TINA L. SNAPP, EXAMINING ATTORNEY

CLASS 33—(Continued).

SN 76-619,343. WATTS TRANSPORTATION LLC, WALNUT GROVE, CA. FILED 11-4-2004.

WATTS

THE MARK CONSISTS OF STANDARD CHARACTERS WITHOUT CLAIM TO ANY PARTICULAR FONT, STYLE, SIZE, OR COLOR.

SEC. 2(F).

FOR WINES (U.S. CLS. 47 AND 49).

FIRST USE 6-0-2000; IN COMMERCE 6-0-2000.

MELVIN AXILBUND, EXAMINING ATTORNEY

CLASS 33—(Continued).

SN 76-625,857. DOMAINE DE LA TERRE ROUGE, LTD., FIDDLTOWN, CA. FILED 12-27-2004.

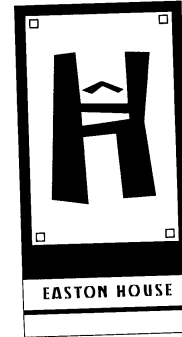

SN 76-622,469. WINE SUPPLY PTY LTD., POKOLBIN, NEW SOUTH WALES, 2320, AUSTRALIA, FILED 11-29-2004.

TOUCHWOOD

THE MARK CONSISTS OF STANDARD CHARACTERS WITHOUT CLAIM TO ANY PARTICULAR FONT, STYLE, SIZE, OR COLOR.

FOR WINE (U.S. CLS. 47 AND 49).

SONYA STEPHENS, EXAMINING ATTORNEY

NO CLAIM IS MADE TO THE EXCLUSIVE RIGHT TO USE HOUSE, APART FROM THE MARK AS SHOWN.

FOR WINE (U.S. CLS. 47 AND 49).

FIRST USE 10-1-2004; IN COMMERCE 10-1-2004.

AMY GEARIN, EXAMINING ATTORNEY

SN 76-628,622. DEBAN INVESTMENTS NO. 9 (PTY) LTD., CAPE TOWN, SOUTH AFRICA, FILED 9-27-2004.

SN 76-625,847. COTE D'OR MARKETING LLC, BOSTON, MA. FILED 12-27-2004.

ALEX GAMBAL



THE MARK CONSISTS OF STANDARD CHARACTERS WITHOUT CLAIM TO ANY PARTICULAR FONT, STYLE, SIZE, OR COLOR.

THE NAME ALEX GAMBAL IDENTIFIES A LIVING INDIVIDUAL WHOSE CONSENT IS OF RECORD.

FOR RED AND WHITE WINES (U.S. CLS. 47 AND 49).

FIRST USE 12-1-1998; IN COMMERCE 12-1-1998.

BRENDAN MCCAULEY, EXAMINING ATTORNEY

FOR WINE (U.S. CLS. 47 AND 49).

FIRST USE 3-0-2004; IN COMMERCE 3-0-2004.

ALICE SUE CARRUTHERS, EXAMINING ATTORNEY

CLASS 33—(Continued).

SN 76-977,571. FANTESCA LLC, MINNEAPOLIS, MN. FILED 1-23-2004.

FANTESCA

THE MARK CONSISTS OF STANDARD CHARACTERS WITHOUT CLAIM TO ANY PARTICULAR FONT, STYLE, SIZE, OR COLOR.

THE ENGLISH TRANSLATION OF THE ITALIAN WORD "FANTESCA" IN THE MARK IS A MAIDSERVANT, IN PARTICULAR THE FEMALE SERVANT CHARACTER USED IN COMMEDIA DELL'ARTE BEGINNING IN THE ITALIAN RENAISSANCE.

FOR WINE (U.S. CLS. 47 AND 49).
FIRST USE 2-20-2004; IN COMMERCE 2-20-2004.
MICHAEL HALL, EXAMINING ATTORNEY

CLASS 33—(Continued).

SN 78-296,758. BARTON BRANDS, LTD., CHICAGO, IL. FILED 9-5-2003.



SN 78-203,187. JACKSON FAMILY FARMS, LLC, SANTA ROSA, CA. FILED 1-14-2003.

LA JOIE

THE FOREIGN WORDING IN THE MARK TRANSLATES INTO ENGLISH AS THE JOY.

FOR WINE (U.S. CLS. 47 AND 49).
FIRST USE 5-3-2002; IN COMMERCE 5-21-2002.
THEODORE MCBRIDE, EXAMINING ATTORNEY

OWNER OF U.S. REG. NO. 1,115,780.
NO CLAIM IS MADE TO THE EXCLUSIVE RIGHT TO USE "MEZCAL", APART FROM THE MARK AS SHOWN.

THE MARK CONSISTS OF DESIGN OF A WORM WITH A MOUSTACHE AND WEARING A HAT BEARING THE WORDS "MONTE ALBAN MEZCAL".

FOR ALCOHOLIC BEVERAGES, NAMELY MEZCAL (U.S. CLS. 47 AND 49).

FIRST USE 6-1-1996; IN COMMERCE 6-1-1996.
CAROLYN CATALDO, EXAMINING ATTORNEY

SN 78-280,108. SPAGNOL'S WINE & BEER MAKING SUPPLIES LTD., NIAGARA FALLS, ONTARIO, CANADA, FILED 7-29-2003.

CRU SELECT

NO CLAIM IS MADE TO THE EXCLUSIVE RIGHT TO USE CRU, APART FROM THE MARK AS SHOWN.

FOR KIT FOR MAKING WINE COMPOSED OF A MIXTURE CONTAINING YEASTS, ACIDS AND GRAPE CONCENTRATES. (U.S. CLS. 47 AND 49).

ALICE BENMAMAN, EXAMINING ATTORNEY

SN 78-318,939. CAIN VINEYARD AND WINERY, ST. HELENA, CA. FILED 10-27-2003.

CAIN

SEC. 2(F).
FOR WINE (U.S. CLS. 47 AND 49).
FIRST USE 3-1-1983; IN COMMERCE 3-1-1983.
BARNEY CHARLON, EXAMINING ATTORNEY

CLASS 33—(Continued).

SN 78-327,756. LUZHOU LAO JIAO CO., LTD., LUZHOU SICHUAN, CHINA, FILED 11-13-2003.



THE NON-LATIN CHARACTERS IN THE MARK TRANSLITERATE TO "YONG SHENG SHAO FANG", AND THIS CREATED COMBINATION, WHEN READ TOGETHER, CONVEYS NO MEANING IN ENGLISH AND CHINESE.

FOR EXTRACTS OF SPIRITOUS LIQUORS, ALCOHOLIC BITTERS, ALCOHOLIC APERITIF BITTERS, APERITIF WINES, APERITIFS WITH A DISTILLED ALCOHOLIC LIQUOR BASE, APERITIFS WITH A WINE BASE, ARRACK, WINE IN GENERAL, LIQUEURS, BRANDY SPIRITS, DISTILLED SPIRITS, POTABLE SPIRITS, ALCOHOLIC BEVERAGE PRODUCED FROM A BREWED MALT BASE WITH NATURAL FLAVORS, ALCOHOLIC COFFEE-BASED BEVERAGE, ALCOHOLIC MALT COOLERS, ALCOHOLIC PUNCH, ALCOHOLIC TEA-BASED BEVERAGE, PREPARED ALCOHOLIC COCKTAIL, FRUIT WINE, AND DISTILLED SPIRITS OF RICE (U.S. CLS. 47 AND 49).

MARGERY A. TIERNEY, EXAMINING ATTORNEY

SN 78-328,825. BLAKES DRINKS IRELAND LIMITED, DUBLIN 2, IRELAND, FILED 11-17-2003.

**SIBERIAN GOLD
VODKA**

THE MARK CONSISTS OF STANDARD CHARACTERS WITHOUT CLAIM TO ANY PARTICULAR FONT, STYLE, SIZE, OR COLOR.

NO CLAIM IS MADE TO THE EXCLUSIVE RIGHT TO USE SIBERIAN AND VODKA, APART FROM THE MARK AS SHOWN.

FOR DISTILLED SPIRITS, NAMELY VODKA (U.S. CLS. 47 AND 49).

CHRISIE B. KING, EXAMINING ATTORNEY

CLASS 33—(Continued).

SN 78-380,423. DIAGEO NORTH AMERICA, INC., NORWALK, CT. FILED 3-8-2004.



OWNER OF U.S. REG. NOS. 1,159,373, 2,409,799 AND OTHERS.

NO CLAIM IS MADE TO THE EXCLUSIVE RIGHT TO USE "VINEYARD" OR "ESTATES", APART FROM THE MARK AS SHOWN.

THE FOREIGN WORDING IN THE MARK TRANSLATES INTO ENGLISH AS BEAUTIFUL PLACE.

FOR ALCOHOLIC BEVERAGES, NAMELY, WINES (U.S. CLS. 47 AND 49).

FIRST USE 12-22-2003; IN COMMERCE 12-22-2003.

KIMBERLY FRYE, EXAMINING ATTORNEY

SN 78-382,650. VINA VALDIVIESO S.A., SANTIAGO, CHILE, FILED 3-11-2004.

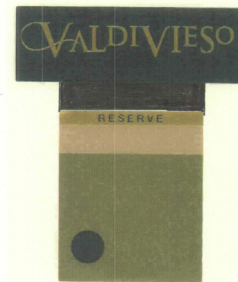

OWNER OF U.S. REG. NOS. 2,414,560, 2,422,003 AND 2,581,268.

NO CLAIM IS MADE TO THE EXCLUSIVE RIGHT TO USE "RESERVE", APART FROM THE MARK AS SHOWN.

THE COLOR(S) BLACK, GOLD, BROWN AND OLIVE GREEN IS/ARE CLAIMED AS A FEATURE OF THE MARK.

THE WORD "VALDIVIESO" IS IN THE COLOR GOLD ON A BLACK BACKGROUND. THE WORD "RESERVE" IS IN THE COLOR BLACK ON A GOLD BACKGROUND. THERE IS A BROWN RECTANGULAR STRIPE IN THE MIDDLE OF THE DESIGN. BELOW THE BROWN STRIPE, THERE IS A SQUARE COLORED OLIVE GREEN. THERE IS ALSO A BLACK CIRCLE IN THE LOWER LEFT CORNER OF THE DESIGN.

FOR WINE (U.S. CLS. 47 AND 49).

BARBARA GAYNOR, EXAMINING ATTORNEY

CLASS 33—(Continued).

SN 78-382,659. VINA VALDIVIESO S.A., SANTIAGO, CHILE, FILED 3-11-2004.

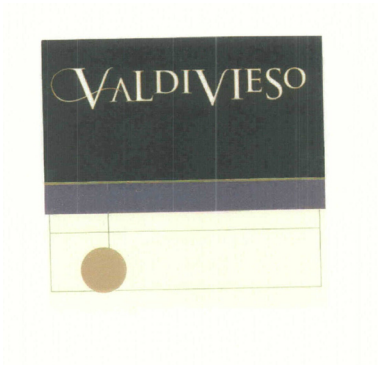

OWNER OF U.S. REG. NOS. 2,414,560, 2,422,003 AND 2,581,268.

THE COLOR(S) BLACK, PURPLE, GOLD AND WHITE IS/ARE CLAIMED AS A FEATURE OF THE MARK.

THE MARK CONSISTS OF THE WORD "VALDIVIESO" IN THE COLOR WHITE WITH A GOLD OUTLINE ON A BLACK BACKGROUND. BELOW THE BLACK BACKGROUND IS A PURPLE STRIPE. BELOW THE PURPLE STRIPE IS ANOTHER STRIPE OF MANILA WHITE COLOR SECTIONED OFF INTO RECTANGLES BY BLACK LINES. THERE IS ALSO A GOLD CIRCLE IN THE LOWER LEFT CORNER OF THE DESIGN.

FOR WINE (U.S. CLS. 47 AND 49).

BARBARA GAYNOR, EXAMINING ATTORNEY

CLASS 33—(Continued).

SN 78-394,084. CONDAL IMPORTS, INC., BRONX, NY. FILED 3-31-2004.



THE MARK CONSISTS OF THE PHRASE EXTRACTO DE MALTA AND A DESIGN OF GRAIN STALKS SURROUNDED BY RAYS ALL WITHIN A TRIPLE FRAME WHICH IS TRAPEZOIDAL SHAPED.

THE ENGLISH TRANSLATION OF "EXTRACTO DE MALTA" IN THE MARK IS "MALT EXTRACTS".

SEC. 2(F) AS TO "EXTRACTO DE MALTA". FOR ALCOHOLIC MALT BEVERAGES (U.S. CLS. 47 AND 49).

FIRST USE 12-31-1978; IN COMMERCE 12-31-1978. ODESSA BIBBINS, EXAMINING ATTORNEY

SN 78-382,667. VINA VALDIVIESO S.A., SANTIAGO, CHILE, FILED 3-11-2004.

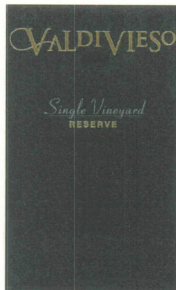

OWNER OF U.S. REG. NOS. 2,414,560, 2,422,003 AND 2,581,268.

NO CLAIM IS MADE TO THE EXCLUSIVE RIGHT TO USE "SINGLE VINEYARD RESERVE", APART FROM THE MARK AS SHOWN.

THE COLOR(S) BLACK, GOLD AND GREY IS/ARE CLAIMED AS A FEATURE OF THE MARK.

THE MARK CONSISTS OF THE WORDS "VALDIVIESO SINGLE VINEYARD RESERVE" ON A BLACK BACKGROUND. THE WORDS "VALDIVIESO" AND "RESERVE" ARE COLORED GOLD. THE WORDS "SINGLE VINEYARD" ARE GREY.

FOR WINE (U.S. CLS. 47 AND 49).

BARBARA GAYNOR, EXAMINING ATTORNEY

SN 78-403,166. BUERGER, WILLIAM MICHAEL, CHARLOTTE, NC. FILED 4-16-2004.



THE MARK CONSISTS OF STYLIZED LETTERS THAT MAKE UP THE NAME "SNAKEBYTE". THE STYLIZED FONT IS BETRUM LET REGULAR. THE S AND B ARE CAPITALIZED IN THE NAME "SNAKEBYTE". ALL OF THE LETTERS IN THE NAME "SNAKEBYTE" HAVE A SHADOWED EFFECT. ADDITIONALLY, THE ENTIRE NAME "SNAKEBYTE" IS OUTLINED IN WHITE FOR ADDED DRAMATIC EFFECT.

FOR FLAVORED BREWED MALT BEVERAGE (U.S. CLS. 47 AND 49).

FIRST USE 7-24-2003; IN COMMERCE 1-15-2004. GEORGIA CARTY, EXAMINING ATTORNEY

CLASS 33—(Continued).

SN 78-404,710. AGRO DE BAZAN, VILANOVA DE AROUSA, SPAIN, FILED 4-20-2004.

CLASS 33—(Continued).

SN 78-410,900. PLOMARI OUZO DISTILLERY ISSIDOROS ARVANITIS S.A., ISLAND OF LESBOS, GREECE, FILED 4-30-2004.



THE FOREIGN WORDING IN THE MARK TRANSLATES INTO ENGLISH AS MANSION OF BAZAN. FOR WINES (U.S. CLS. 47 AND 49). FIRST USE 1-1-1905; IN COMMERCE 1-1-1905. RONALD MCMORROW, EXAMINING ATTORNEY



SN 78-410,414. DIAGEO NORTH AMERICA, INC., NORWALK, CT. FILED 4-29-2004.



THE MARK CONSISTS OF A SHIP WITH SAILS. FOR ALCOHOLIC BEVERAGES, NAMELY DISTILLED SPIRITS (U.S. CLS. 47 AND 49). STEPHANIE DAVIS, EXAMINING ATTORNEY

NO CLAIM IS MADE TO THE EXCLUSIVE RIGHT TO USE "OUZO PLOMARI" "ESTABLISHED 1894" "PRODUCED AND BOTTLED BY" "S.A." "PLOMARI, LESVOS, GREECE" "PRODUCT OF GREECE" "200 ML" AND "42% ALC./VOL.", APART FROM THE MARK AS SHOWN. ISSIDOROS ARVANITIS DOES NOT IDENTIFY A LIVING INDIVIDUAL.

THE COLOR(S) BLUE, WHITE, GOLD, BEIGE, RED, AND BLACK IS/ARE CLAIMED AS A FEATURE OF THE MARK.

THE MARK CONSISTS OF A DESIGN WITH A SEMICIRCULAR UPPER PORTION; A RECTANGULAR LOWER PORTION; A BLUE OUTER BORDER; A WHITE SECONDARY BORDER; A GOLD TERTIARY BORDER; A BEIGE BACKGROUND; A CIRCULAR DESIGN WITH A RED BORDER, A BLUE BACKGROUND, A WHITE TRIANGLE, A ROUND GOLD AND WHITE OBJECT WITH GOLD WINGS ATOP A GROUP OF BLACK CIRCULAR OBJECTS, AND GREEK LETTERING IN BLACK; THE WORDS "OUZO PLOMARI" IN BLUE; A DESIGN OF TWO LEAVES IN GOLD AND BLACK; THE WORD "BY" IN BLUE AND THE WORDS "ISSIDOROS ARVANITIS" IN RED; AND THE WORDS "ESTABLISHED 1894 PRODUCED AND BOTTLED BY ISSIDOROS ARVANITIS S.A. PLOMARI, LESVOS, GREECE PRODUCT OF GREECE 200 ML 42% ALC./VOL." IN BLACK.

FOR OUZO (U.S. CLS. 47 AND 49). FIRST USE 12-31-1995; IN COMMERCE 8-31-2002. TARAH HARDY, EXAMINING ATTORNEY

CLASS 33—(Continued).

SN 78-411,743. PEARL WINES LLC, YOUNTVILLE, CA.
FILED 5-1-2004.

Marelle

THE MARK CONSISTS OF STANDARD CHARACTERS WITHOUT CLAIM TO ANY PARTICULAR FONT, STYLE, SIZE, OR COLOR.

THE NAME(S), PORTRAIT(S), AND/OR SIGNATURE(S) SHOWN IN THE MARK DOES NOT IDENTIFY A PARTICULAR LIVING INDIVIDUAL.

THE FOREIGN WORDING IN THE MARK TRANSLATES INTO ENGLISH AS HOPSCOTCH.

FOR WINE (U.S. CLS. 47 AND 49).

FIRST USE 5-12-2003; IN COMMERCE 4-29-2004.
G. MAYERSCHOFF, EXAMINING ATTORNEY

SN 78-417,052. SIGNATURE WINE CELLARS, INC., HAYWARD, CA. FILED 5-11-2004.

DOMAINE-M

THE MARK CONSISTS OF STANDARD CHARACTERS WITHOUT CLAIM TO ANY PARTICULAR FONT, STYLE, SIZE, OR COLOR.

FOR WINES (U.S. CLS. 47 AND 49).

FIRST USE 10-1-2003; IN COMMERCE 10-1-2003.
ELLEN B. AWRICH, EXAMINING ATTORNEY

CLASS 33—(Continued).

SN 78-421,496. BUIL & GINÉ, S.L., FALSET, TARRAGONA, SPAIN, FILED 5-19-2004.

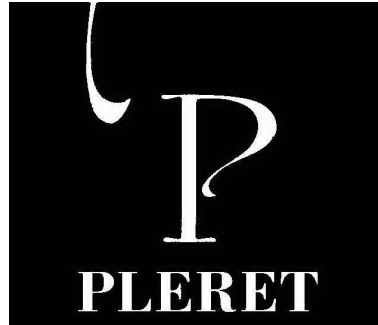

THE MARK CONSISTS OF A STYLIZED "P" CENTERED ABOVE THE WORD "PLERET" APPEARING IN STYLIZED LETTERING HAVING A GRAPHIC AT THE UPPER RIGHT-HAND CORNER OF THE "P" ALL APPEARING ON A BLACK BACKGROUND.

THE FOREIGN WORDING IN THE MARK TRANSLATES INTO ENGLISH AS A BIT.

FOR ALCOHOLIC BEVERAGES, NAMELY, WINES (U.S. CLS. 47 AND 49).

FIRST USE 4-1-1999; IN COMMERCE 7-6-1999.
SALLY SHIH, EXAMINING ATTORNEY

SN 78-422,780. DIAGEO SCOTLAND LIMITED, EDINBURGH, SCOTLAND, FILED 5-21-2004.

CAOL ILA

THE MARK CONSISTS OF STANDARD CHARACTERS WITHOUT CLAIM TO ANY PARTICULAR FONT, STYLE, SIZE, OR COLOR.

OWNER OF UNITED KINGDOM REG. NO. 2312633, DATED 10-9-2002, EXPIRES 10-9-2012.

THE SOUND OF ISLAY IS A BODY OF WATER LOCATED IN THE SCOTTISH ISLES. THIS BODY OF WATER IS NOT COMMONLY REFERRED TO OR KNOWN AS "CAOL ILA".

CAOL ILA IS THE GAELIC TRANSLATION FOR "SOUND OF ISLAY".

FOR ALCOHOLIC BEVERAGES, NAMELY WHISKY (U.S. CLS. 47 AND 49).

DARRYL SPRUILL, EXAMINING ATTORNEY

CLASS 33—(Continued).

SN 78-424,365. J&L GROUP, LLC, STATELINE, NV. FILED 5-25-2004.

COCKTAILS BY JENN

THE MARK CONSISTS OF STANDARD CHARACTERS WITHOUT CLAIM TO ANY PARTICULAR FONT, STYLE, SIZE, OR COLOR.

NO CLAIM IS MADE TO THE EXCLUSIVE RIGHT TO USE "COCKTAILS", APART FROM THE MARK AS SHOWN.

FOR PREPARED ALCOHOLIC COCKTAIL (U.S. CLS. 47 AND 49).

FIRST USE 9-15-2004; IN COMMERCE 9-15-2004.
MARK SPARACINO, EXAMINING ATTORNEY

SN 78-430,081. VINEDOS DE BASANDA, S.L., PAMPLONA, NAVARRA, SPAIN, FILED 6-4-2004.



THE ENGLISH TRANSLATION OF THE WORD FINCA IN THE MARK IS PROPERTY, REAL ESTATE, COUNTRY HOUSE OR COUNTRY ESTATE.

FOR WINES, DISTILLED SPIRITS AND LIQUORS (U.S. CLS. 47 AND 49).

FIRST USE 4-29-2004; IN COMMERCE 9-28-2004.
MARGERY A. TIERNEY, EXAMINING ATTORNEY

SN 78-431,512. SOCIETE DES PRODUITS MARNIER- LA-POSTOLLE, PARIS, FRANCE, FILED 6-8-2004.



House of Grand Marnier

OWNER OF U.S. REG. NOS. 2,356,897, 2,694,692 AND 2,697,131.

NO CLAIM IS MADE TO THE EXCLUSIVE RIGHT TO USE "HOUSE OF", APART FROM THE MARK AS SHOWN. FOR LIQUEURS (U.S. CLS. 47 AND 49).

LEIGH CAROLINE CASE, EXAMINING ATTORNEY

CLASS 33—(Continued).

SN 78-432,989. LIGHTNING RIDGE INVESTMENTS, LLC, PORT ANGELES, WA. FILED 6-10-2004.

ROSÉ THE RIVETER

THE MARK CONSISTS OF STANDARD CHARACTERS WITHOUT CLAIM TO ANY PARTICULAR FONT, STYLE, SIZE, OR COLOR.

THE NAME IN THE MARK DOES NOT IDENTIFY A LIVING INDIVIDUAL.

FOR BOTTLED WINE (U.S. CLS. 47 AND 49).

FIRST USE 5-21-2004; IN COMMERCE 5-21-2004.

ANDREW RHIM, EXAMINING ATTORNEY

SN 78-435,627. UVAS DEL VALLE, SALTA, ARGENTINA, FILED 6-15-2004.



THE MARK CONSISTS OF THE TERM LABORUM AND A GEOMETRICALLY SHAPED CROSS.

THE FOREIGN WORDING IN THE MARK TRANSLATES INTO ENGLISH AS FROM WORK AND DEDICATION.

FOR ALCOHOLIC DRINKS, NAMELY, WINES, PORT WINES, LIQUEURS, AND SPARKLING WINES (U.S. CLS. 47 AND 49).

KAREN K. BUSH, EXAMINING ATTORNEY

SN 78-439,352. STRONG SPIRITS, LLC, NEW YORK, NY, FILED 6-22-2004.

FLOOT

THE MARK CONSISTS OF STANDARD CHARACTERS WITHOUT CLAIM TO ANY PARTICULAR FONT, STYLE, SIZE, OR COLOR.

FOR CANNED CARBONATED WINE, CANNED SPARKLING WINE, CANNED CHAMPAGNE (U.S. CLS. 47 AND 49).

FIRST USE 2-1-2005; IN COMMERCE 3-1-2005.

KIMBERLY FRYE, EXAMINING ATTORNEY

CLASS 33—(Continued).

SN 78-445,600. NOBILO WINE GROUP LIMITED, HUAPAI, AUCKLAND, NEW ZEALAND, FILED 7-2-2004.

CLASS 33—(Continued).

SN 78-453,262. R & A BAILEY & CO, DUBLIN 12, IRELAND, FILED 7-20-2004.

CASTLE CLIFFS

THE MARK CONSISTS OF STANDARD CHARACTERS WITHOUT CLAIM TO ANY PARTICULAR FONT, STYLE, SIZE, OR COLOR.

OWNER OF NEW ZEALAND REG. NO. 639853, DATED 6-15-2001, EXPIRES 6-15-2008.

FOR ALCOHOLIC BEVERAGES, NAMELY, WINE (U.S. CLS. 47 AND 49).

ARETHA SOMERVILLE, EXAMINING ATTORNEY

BAILEYS SWIRL

THE MARK CONSISTS OF STANDARD CHARACTERS WITHOUT CLAIM TO ANY PARTICULAR FONT, STYLE, SIZE, OR COLOR.

OWNER OF U.S. REG. NOS. 1,185,090, 2,075,828 AND OTHERS.

FOR ALCOHOLIC BEVERAGES, NAMELY, LIQUEURS, LIQUEUR-BASED BEVERAGES, LIQUEUR-FLAVORED BEVERAGES, WHISKEY-BASED BEVERAGES AND FLAVORED BREWED MALT BEVERAGES (U.S. CLS. 47 AND 49).

ANDREA K. NADELMAN, EXAMINING ATTORNEY

SN 78-451,757. BODEGAS CARO S.A., MENDOZA, ARGENTINA, FILED 7-16-2004.

SN 78-453,375. INVERSIONES PUERTO SOFIA LTDA., SANTIAGO, CHILE, FILED 7-20-2004.

ARUMA

THE MARK CONSISTS OF STANDARD CHARACTERS WITHOUT CLAIM TO ANY PARTICULAR FONT, STYLE, SIZE, OR COLOR.

THE ENGLISH TRANSLATION OF THE WORDING "ARUMA" IS "NIGHT".

FOR WINES (U.S. CLS. 47 AND 49).

STEPHANIE DAVIS, EXAMINING ATTORNEY

OWNER OF U.S. REG. NO. 2,906,298.

THE COLOR(S) BLUE IS/ARE CLAIMED AS A FEATURE OF THE MARK.

THE MARK CONSISTS OF THE WORD AMAYNA FOLLOWED BY A BLUE SWIRL DESIGN.

FOR WINES (U.S. CLS. 47 AND 49).

RONALD MCMORROW, EXAMINING ATTORNEY

CLASS 33—(Continued).

SN 78-455,990. A.V.V. WINERY CO., LLC, HEALDSBURG, CA. FILED 7-23-2004.



NO CLAIM IS MADE TO THE EXCLUSIVE RIGHT TO USE "2000", APART FROM THE MARK AS SHOWN.

THE LINING SHOWN IN THE DRAWING IS A FEATURE OF THE MARK. THE STIPPLING IN THE DRAWING IS FOR SHADING PURPOSES ONLY.

THE COLOR(S) PURPLE, YELLOW, GREEN, BLACK AND BROWN IS/ARE CLAIMED AS A FEATURE OF THE MARK.

THE MARK CONSISTS OF THE WORDING "CYRUS" ABOVE THE NUMBER "2000", BOTH OF WHICH ARE BLACK. A DESIGN ELEMENT CONSISTING OF GRAPES, GRAPE LEAVES AND GRAPE VINES INSIDE A RECTANGULAR CARRIER APPEARS DIRECTLY ABOVE THE TERM "CYRUS". THE GRAPES ARE PURPLE. THE GRAPES VINES ARE BROWN. THE GRAPE LEAVES ARE GREEN AND YELLOW. THE RECTANGULAR CARRIER DESIGN IS SHADED BLACK AND YELLOW.

FOR WINES (U.S. CLS. 47 AND 49).
FIRST USE 7-1-1999; IN COMMERCE 7-1-1999.
NELSON SNYDER, EXAMINING ATTORNEY

CLASS 33—(Continued).

SN 78-471,950. WILSON CREEK WINERY & VINEYARDS, L.L.C., TEMECULA, CA. FILED 8-23-2004.

WC

THE MARK CONSISTS OF STANDARD CHARACTERS WITHOUT CLAIM TO ANY PARTICULAR FONT, STYLE, SIZE, OR COLOR.

FOR WINE (U.S. CLS. 47 AND 49).
FIRST USE 0-0-1997; IN COMMERCE 0-0-1997.
ESTHER A. BORSUK, EXAMINING ATTORNEY

SN 78-473,453. SSC INTERNATIONAL, INC., S. EL MONTE, CA. FILED 8-25-2004.

SN 78-463,822. JACOBSON, PAUL NOEL, ALEXANDRA, NEW ZEALAND, FILED 8-7-2004.

Judge Rock



NO CLAIM IS MADE TO THE EXCLUSIVE RIGHT TO USE THE DESIGN OF THE ISLAND OF TAIWAN, APART FROM THE MARK AS SHOWN.

THE MARK CONSISTS OF TWO CHINESE CHARACTERS TRANSLITERATED TO "HONG BIAU" OVERLAID IN THE ISLAND SHAPE OF TAIWAN.

THE FOREIGN WORDING IN THE MARK TRANSLATES INTO ENGLISH AS RED SEAL OR RED MARK.

THE NON-LATIN CHARACTER(S) IN THE MARK TRANSLITERATES INTO HONG BIAU, AND THIS MEANS RED SEAL OR RED MARK IN ENGLISH.

FOR WINE AND LIQUOR (U.S. CLS. 47 AND 49).
FIRST USE 1-1-2003; IN COMMERCE 1-1-2003.
MARK SPARACINO, EXAMINING ATTORNEY

THE MARK CONSISTS OF STANDARD CHARACTERS WITHOUT CLAIM TO ANY PARTICULAR FONT, STYLE, SIZE, OR COLOR.

OWNER OF AUSTRALIA REG. NO. 714882, DATED 6-30-2004, EXPIRES 6-30-2014.

FOR WINE (U.S. CLS. 47 AND 49).
FIRST USE 6-1-2001; IN COMMERCE 6-6-2002.
ALINA MORRIS, EXAMINING ATTORNEY

CLASS 33—(Continued).

SN 78-475,622. TRIVENTO BODEGAS Y VINEDOS S.A., MENDOZA, ARGENTINA, FILED 8-30-2004.

CLASS 33—(Continued).

SN 78-478,773. MUSSI SAFFIE, KARIM CHARBEL, MENDOZA, ARGENTINA, FILED 9-3-2004.

TRIBU

THE MARK CONSISTS OF STANDARD CHARACTERS WITHOUT CLAIM TO ANY PARTICULAR FONT, STYLE, SIZE, OR COLOR.

THE ENGLISH TRANSLATION OF "TRIBU" IS "TRIBE." FOR WINES AND SPARKLING WINES (U.S. CLS. 47 AND 49).

CARRIE ACHEN, EXAMINING ATTORNEY

Altocedro

THE MARK CONSISTS OF STANDARD CHARACTERS WITHOUT CLAIM TO ANY PARTICULAR FONT, STYLE, SIZE, OR COLOR.

THE TRANSLATION OF ALTOCEDRO IS "TALL CEDAR."

FOR WINE (U.S. CLS. 47 AND 49).

AMY HELLA, EXAMINING ATTORNEY

SN 78-477,439. CLINE CELLARS, INC., SONOMA, CA. FILED 9-1-2004.

SN 78-479,590. VODKA SLAVIANSKAYA LIMITED, LONDON, UNITED KINGDOM, FILED 9-7-2004.

WHITE TRUCK

SLAVIANSKAYA SPIRIT OF RUSSIA

THE MARK CONSISTS OF STANDARD CHARACTERS WITHOUT CLAIM TO ANY PARTICULAR FONT, STYLE, SIZE, OR COLOR.

FOR WINE (U.S. CLS. 47 AND 49).

ADA HAN, EXAMINING ATTORNEY

THE MARK CONSISTS OF STANDARD CHARACTERS WITHOUT CLAIM TO ANY PARTICULAR FONT, STYLE, SIZE, OR COLOR.

OWNER OF UNITED KINGDOM REG. NO. 2349054, DATED 6-4-2004, EXPIRES 11-17-2013.

NO CLAIM IS MADE TO THE EXCLUSIVE RIGHT TO USE RUSSIA, APART FROM THE MARK AS SHOWN.

FOR WINES, DISTILLED SPIRITS, LIQUEURS AND PREPARED ALCOHOLIC COCKTAILS (U.S. CLS. 47 AND 49).

MICHELE SWAIN, EXAMINING ATTORNEY

CLASS 33—(Continued).

SN 78-482,512. BARTON & GUESTIER, S.A., BLANQUEFORT, FRANCE, FILED 9-13-2004.



THE MARK CONSISTS OF DESIGN WITH STYLIZED LETTERS B&G.
FOR ALCOHOLIC BEVERAGES, NAMELY, WINES (U.S. CLS. 47 AND 49).
FIRST USE 6-0-2003; IN COMMERCE 6-0-2003.
MICHAEL ENGEL, EXAMINING ATTORNEY

SN 78-482,513. BARTON & GUESTIER, S.A., BLANQUEFORT, FRANCE, FILED 9-13-2004.

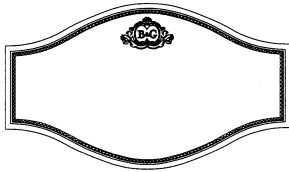

OWNER OF U.S. REG. NOS. 318,330 AND 1,977,965.
THE MARK CONSISTS OF A LABEL WITH STYLIZED LETTERS B&G.
FOR ALCOHOLIC BEVERAGES, NAMELY, WINES (U.S. CLS. 47 AND 49).
FIRST USE 6-0-2003; IN COMMERCE 6-0-2003.
STEVEN R. FINE, EXAMINING ATTORNEY

SN 78-483,550. TRADICIONES JALISCIENSES SA DE CV, GUADALAJARA, JALISCO, MEXICO, FILED 9-14-2004.

TEQUILA CLIMAX

THE MARK CONSISTS OF STANDARD CHARACTERS WITHOUT CLAIM TO ANY PARTICULAR FONT, STYLE, SIZE, OR COLOR.
NO CLAIM IS MADE TO THE EXCLUSIVE RIGHT TO USE "TEQUILA", APART FROM THE MARK AS SHOWN.
FOR ALCOHOLIC BEVERAGES, NAMELY, TEQUILA (U.S. CLS. 47 AND 49).
FIRST USE 5-9-2005; IN COMMERCE 5-9-2005.
DAWN FELDMAN, EXAMINING ATTORNEY

CLASS 33—(Continued).

SN 78-488,415. SOUTHCORP BRANDS PTY LIMITED, ARTARMON, AUSTRALIA, FILED 9-23-2004.

SECRET STONE

THE MARK CONSISTS OF STANDARD CHARACTERS WITHOUT CLAIM TO ANY PARTICULAR FONT, STYLE, SIZE, OR COLOR.
PRIORITY CLAIMED UNDER SEC. 44(D) ON AUSTRALIA APPLICATION NO. 1011769, FILED 7-20-2004, REG. NO. 1011769, DATED 7-20-2004, EXPIRES 7-20-2014.
FOR WINES (U.S. CLS. 47 AND 49).
KEVIN DINALLO, EXAMINING ATTORNEY

SN 78-489,017. DIAGEO NORTH AMERICA, INC., NORWALK, CT. FILED 9-24-2004.

CONTEMPO CELLARS

THE MARK CONSISTS OF STANDARD CHARACTERS WITHOUT CLAIM TO ANY PARTICULAR FONT, STYLE, SIZE, OR COLOR.
NO CLAIM IS MADE TO THE EXCLUSIVE RIGHT TO USE "CELLARS", APART FROM THE MARK AS SHOWN.
FOR ALCOHOLIC BEVERAGES, NAMELY, WINE AND WINE-BASED BEVERAGES (U.S. CLS. 47 AND 49).
GEOFFREY FOSDICK, EXAMINING ATTORNEY

SN 78-492,068. MIDNIGHT CELLARS, INC., PASO ROBLES, CA. FILED 9-30-2004.

FULL MOON

THE MARK CONSISTS OF STANDARD CHARACTERS WITHOUT CLAIM TO ANY PARTICULAR FONT, STYLE, SIZE, OR COLOR.
FOR WINE (U.S. CLS. 47 AND 49).
FIRST USE 10-28-1999; IN COMMERCE 10-28-1999.
MICHAEL TANNER, EXAMINING ATTORNEY

CLASS 33—(Continued).

SN 78-494,697. VINTAGE EPICURE, LLC, PORT WASHINGTON, NY. FILED 10-5-2004.

LE PETIT COQ

THE MARK CONSISTS OF STANDARD CHARACTERS WITHOUT CLAIM TO ANY PARTICULAR FONT, STYLE, SIZE, OR COLOR.

THE ENGLISH TRANSLATION OF THE FRENCH TERMS "PETIT COQ" IS "SMALL ROOSTER".

FOR WINE; DISTILLED SPIRITS; LIQUEURS (U.S. CLS. 47 AND 49).

FIRST USE 11-1-2003; IN COMMERCE 11-1-2003.
JUDITH HELFMAN, EXAMINING ATTORNEY

SN 78-495,640. BROKENWOOD WINES PTY LTD, NEW SOUTH WALES, AUSTRALIA, FILED 10-6-2004.

CRICKET PITCH

THE MARK CONSISTS OF STANDARD CHARACTERS WITHOUT CLAIM TO ANY PARTICULAR FONT, STYLE, SIZE, OR COLOR.

FOR WINE (U.S. CLS. 47 AND 49).
HENRY S. ZAK, EXAMINING ATTORNEY

SN 78-497,549. DIAGEO NORTH AMERICA, INC., NORWALK, CT. FILED 10-11-2004.



FOR ALCOHOLIC BEVERAGES, NAMELY LIQUEURS (U.S. CLS. 47 AND 49).
ALEX KEAM, EXAMINING ATTORNEY

CLASS 33—(Continued).

SN 78-497,629. ROBERT MONDAVI WINERY, NAPA, CA. FILED 10-11-2004.

REPARTEE

THE MARK CONSISTS OF STANDARD CHARACTERS WITHOUT CLAIM TO ANY PARTICULAR FONT, STYLE, SIZE, OR COLOR.

FOR WINE (U.S. CLS. 47 AND 49).
KATRINA EDGE, EXAMINING ATTORNEY

SN 78-498,487. SMEATON ESTATE WINES, ATHENS, GA. FILED 10-12-2004.

SILVERWEBS

THE MARK CONSISTS OF STANDARD CHARACTERS WITHOUT CLAIM TO ANY PARTICULAR FONT, STYLE, SIZE, OR COLOR.

FOR WINES (U.S. CLS. 47 AND 49).
GINA FINK, EXAMINING ATTORNEY

CLASS 33—(Continued).

SN 78-498,819. SIDNEY FRANK IMPORTING CO., INC.,
NEW ROCHELLE, NY. FILED 10-13-2004.

CLASS 33—(Continued).

SN 78-500,871. THE CATON WINE ORGANIZATION, LLC,
SONOMA, CA. FILED 10-15-2004.

BLACK BELT

Racchus

THE MARK CONSISTS OF STANDARD CHARACTERS
WITHOUT CLAIM TO ANY PARTICULAR FONT, STYLE,
SIZE, OR COLOR.
FOR SAKE (U.S. CLS. 47 AND 49).
SEAN DWYER, EXAMINING ATTORNEY

THE MARK CONSISTS OF STANDARD CHARACTERS
WITHOUT CLAIM TO ANY PARTICULAR FONT, STYLE,
SIZE, OR COLOR.
FOR WINE (U.S. CLS. 47 AND 49).
FIRST USE 5-1-2005; IN COMMERCE 5-1-2005.
ALLISON HOLTZ, EXAMINING ATTORNEY

SN 78-499,560. DIAGEO NORTH AMERICA, INC., NOR-
WALK, CT. FILED 10-14-2004.

SN 78-502,761. SUPERVALU INC., EDEN PRAIRIE, MN.
FILED 10-20-2004.

**DISFRUTA EL PLACER
DE COMPARTIR**

**BLUFF COUNTRY
WINERY**

THE MARK CONSISTS OF STANDARD CHARACTERS
WITHOUT CLAIM TO ANY PARTICULAR FONT, STYLE,
SIZE, OR COLOR.
THE FOREIGN WORDING IN THE MARK TRANSLATES
INTO ENGLISH AS EXPERIENCE THE PLEASURE OF
SHARING.
FOR ALCOHOLIC BEVERAGES, NAMELY, LI-
QUEURS (U.S. CLS. 47 AND 49).
MARK T. MULLEN, EXAMINING ATTORNEY

THE MARK CONSISTS OF STANDARD CHARACTERS
WITHOUT CLAIM TO ANY PARTICULAR FONT, STYLE,
SIZE, OR COLOR.
NO CLAIM IS MADE TO THE EXCLUSIVE RIGHT TO
USE "WINERY", APART FROM THE MARK AS SHOWN.
FOR WINE (U.S. CLS. 47 AND 49).
FIRST USE 12-14-2004; IN COMMERCE 12-14-2004.
MARGERY A. TIERNEY, EXAMINING ATTORNEY

CLASS 33—(Continued).

SN 78-503,830. TOBIN, SCOTT A, TEMPLETON, CA. FILED 10-21-2004.

CLASS 33—(Continued).

SN 78-507,850. MCCLLOUD, JENNIFER L., MIDDLEBURG, VA. FILED 10-28-2004.

Scott Aaron

The Real American
Grape!

THE MARK CONSISTS OF STANDARD CHARACTERS WITHOUT CLAIM TO ANY PARTICULAR FONT, STYLE, SIZE, OR COLOR.
FOR WINE (U.S. CLS. 47 AND 49).
SUSAN HAYASH, EXAMINING ATTORNEY

THE MARK CONSISTS OF STANDARD CHARACTERS WITHOUT CLAIM TO ANY PARTICULAR FONT, STYLE, SIZE, OR COLOR.
FOR WINE (U.S. CLS. 47 AND 49).
BARBARA GAYNOR, EXAMINING ATTORNEY

SN 78-505,860. D.J. MARAGAS WINE CO., BEND, OR. FILED 10-26-2004.

SN 78-511,563. PETER MATT & CO., INC., DBA MATT BROTHERS, ARMONK, NY. FILED 11-4-2004.

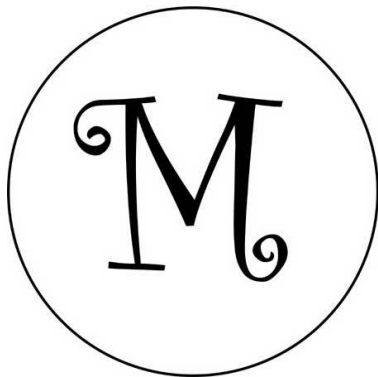

FOR WINE (U.S. CLS. 47 AND 49).
FIRST USE 8-21-2001; IN COMMERCE 12-13-2004.
WILLIAM P. SHANAHAN, EXAMINING ATTORNEY

NO CLAIM IS MADE TO THE EXCLUSIVE RIGHT TO USE "CELLARS", APART FROM THE MARK AS SHOWN.
FOR WINE (U.S. CLS. 47 AND 49).
SHARI SHEFFIELD, EXAMINING ATTORNEY

CLASS 33—(Continued).

SN 78-513,255. HERON, LAELY, SAN FRANCISCO, CA. FILED 11-8-2004.

CLASS 33—(Continued).

SN 78-518,057. LAWER FAMILY WINERY, INC., ANCHORAGE, AK. FILED 11-16-2004.

3WAY

HOOKER

THE MARK CONSISTS OF STANDARD CHARACTERS WITHOUT CLAIM TO ANY PARTICULAR FONT, STYLE, SIZE, OR COLOR.

FOR WINES (U.S. CLS. 47 AND 49).
ELIZABETH J. WINTER, EXAMINING ATTORNEY

THE MARK CONSISTS OF STANDARD CHARACTERS WITHOUT CLAIM TO ANY PARTICULAR FONT, STYLE, SIZE, OR COLOR.

FOR WINES (U.S. CLS. 47 AND 49).
ADA HAN, EXAMINING ATTORNEY

SN 78-521,911. EARLY TIMES DISTILLERS COMPANY, LOUISVILLE, KY. FILED 11-23-2004.

SN 78-517,433. TENNESSEE DICKEL DISTILLING CO., TULLAHOMA, TN. FILED 11-16-2004.

George A Dickel

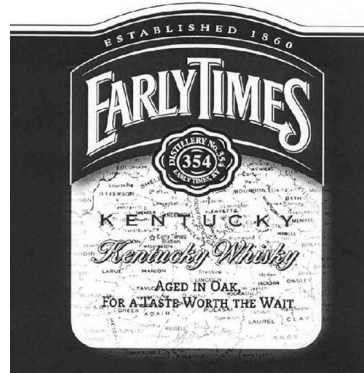

OWNER OF U.S. REG. NOS. 1,953,221, 2,547,255 AND OTHERS.

NO CLAIM IS MADE TO THE EXCLUSIVE RIGHT TO USE "ESTABLISHED 1860," "KENTUCKY," "KENTUCKY WHISKY," "DISTILLERY NO. 354," AND "AGED IN OAK", APART FROM THE MARK AS SHOWN.

THE MARK CONSISTS OF THE WORDS EARLY TIMES ESTABLISHED 1860 IN AN ARCH POSITIONED OVER AN ANTIQUE MAP WITH A SEAL WITH THE WORDS DISTILLERY NO. 354 EARLY TIMES, KY AND THE NUMBER 354 IN AN INNER CIRCLE AND THE WORD KENTUCKY WHISKY AGED IN OAK, FOR A TASTE WORTH THE WAIT.

FOR ALCOHOLIC BEVERAGES, NAMELY DISTILLED SPIRITS (U.S. CLS. 47 AND 49).
FIRST USE 9-20-2004; IN COMMERCE 9-20-2004.
ELLEN B. AWRICH, EXAMINING ATTORNEY

OWNER OF U.S. REG. NOS. 30,156, 44,513 AND 803,535. THE NAME IN THE MARK REFERS TO A DECEASED INDIVIDUAL.

THE MARK CONSISTS OF THE STYLIZED WORDS GEORGE A DICKEL.
FOR ALCOHOLIC BEVERAGES, NAMELY, DISTILLED SPIRITS (U.S. CLS. 47 AND 49).
FIRST USE 0-0-1964; IN COMMERCE 0-0-1964.
PAUL F. GAST, EXAMINING ATTORNEY

CLASS 33—(Continued).

SN 78-525,010. SIDNEY FRANK IMPORTING CO., INC.,
NEW ROCHELLE, NY. FILED 12-1-2004.

CLASS 33—(Continued).

SN 78-533,855. DUBOIS, MICHAEL R, SAN ANSELMO, CA.
FILED 12-16-2004.

MICK COLLINS

THE MARK CONSISTS OF STANDARD CHARACTERS
WITHOUT CLAIM TO ANY PARTICULAR FONT, STYLE,
SIZE, OR COLOR.

MICK COLLINS DOES NOT IDENTIFY A LIVING IN-
DIVIDUAL.

FOR IRISH WHISKEY (U.S. CLS. 47 AND 49).
BRENDAN MCCAULEY, EXAMINING ATTORNEY

SHORELINE

THE MARK CONSISTS OF STANDARD CHARACTERS
WITHOUT CLAIM TO ANY PARTICULAR FONT, STYLE,
SIZE, OR COLOR.

FOR TABLE WINES (U.S. CLS. 47 AND 49).
FIRST USE 10-14-2004; IN COMMERCE 10-14-2004.
MICHAEL WEBSTER, EXAMINING ATTORNEY

SN 78-525,043. SIDNEY FRANK IMPORTING CO., INC.,
NEW ROCHELLE, NY. FILED 12-1-2004.

MICKEY COLLINS

THE MARK CONSISTS OF STANDARD CHARACTERS
WITHOUT CLAIM TO ANY PARTICULAR FONT, STYLE,
SIZE, OR COLOR.

MICKEY COLLINS DOES NOT IDENTIFY A LIVING
INDIVIDUAL.

FOR IRISH WHISKEY (U.S. CLS. 47 AND 49).
BRENDAN MCCAULEY, EXAMINING ATTORNEY

SN 78-533,883. AMY HOFFMAN AND DAVID HOFFMAN
PARTNERSHIP, THE, PENN YAN, NY. FILED 12-16-2004.

SN 78-526,251. JONES, PATRICIA ANN, WENATCHEE, WA.
FILED 12-2-2004.

Rooster Hill**JONES OF
WASHINGTON**

THE MARK CONSISTS OF STANDARD CHARACTERS
WITHOUT CLAIM TO ANY PARTICULAR FONT, STYLE,
SIZE, OR COLOR.

NO CLAIM IS MADE TO THE EXCLUSIVE RIGHT TO
USE "WASHINGTON", APART FROM THE MARK AS
SHOWN.

FOR WINES (U.S. CLS. 47 AND 49).
DAVID YONTEF, EXAMINING ATTORNEY

THE MARK CONSISTS OF STANDARD CHARACTERS
WITHOUT CLAIM TO ANY PARTICULAR FONT, STYLE,
SIZE, OR COLOR.

FOR ALCOHOLIC BEVERAGE OF FRUIT AND WINE
(U.S. CLS. 47 AND 49).

FIRST USE 10-10-2001; IN COMMERCE 7-27-2002.
JOHN GARTNER, EXAMINING ATTORNEY

CLASS 33—(Continued).

SN 78-537,348. CONTROLADORA DE MARCAS INTERNACIONALES, S.A., PANAMA CITY, PANAMA, FILED 12-22-2004.

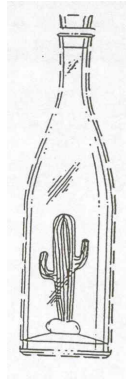

OWNER OF U.S. REG. NO. 1,869,868.
 THE MARK CONSISTS OF A MAGUEY FIGURE INSIDE OF A GLASS BOTTLE
 FOR ALCOHOLIC BEVERAGES, NAMELY, SPIRITS DISTILLED FROM AGAVE (U.S. CLS. 47 AND 49).
 FIRST USE 2-21-2003; IN COMMERCE 2-21-2003.
 NAAKWAMA ANKRAH, EXAMINING ATTORNEY

CLASS 33—(Continued).

SN 78-538,118. HIGGINBOTHAM, RICHARD D., BURIEN, WA. AND MILLER, SHERRILL A., BURIEN, WA. FILED 12-23-2004.



THE MARK CONSISTS OF A CREST IN THE SHAPE OF A SLANTED SHIELD WITH THREE SCRIPT INITIALS THAT OVERLAP AND EXTEND OUTSIDE OF THE SHIELD, WITH SEVERAL SHORT HORIZONTAL LINES OF VARYING THICKNESSES ADJACENT TO THE RIGHT SIDE OF THE SHIELD. COLOR IS NOT CLAIMED AS PART OF THE MARK.
 FOR WINE (U.S. CLS. 47 AND 49).
 FIRST USE 2-0-1995; IN COMMERCE 5-0-1995.
 ALLISON SCHRODY, EXAMINING ATTORNEY

SN 78-537,564. SIDNEY FRANK IMPORTING CO., INC., NEW ROCHELLE, NY. FILED 12-23-2004.

SN 78-538,986. SCHIEFFELIN & CO., NEW YORK, NY. FILED 12-28-2004.

GOLDEN LADDER

THE MARK CONSISTS OF STANDARD CHARACTERS WITHOUT CLAIM TO ANY PARTICULAR FONT, STYLE, SIZE, OR COLOR.
 FOR WINE (U.S. CLS. 47 AND 49).
 MARIA-VICTORIA SUAREZ, EXAMINING ATTORNEY

DOMAINE CHANDON

THE MARK CONSISTS OF STANDARD CHARACTERS WITHOUT CLAIM TO ANY PARTICULAR FONT, STYLE, SIZE, OR COLOR.
 OWNER OF U.S. REG. NOS. 1,113,762, 1,696,676 AND 1,841,998.
 THE TRANSLATION OF THE MARK WORD "DOMAINE" TRANSLATES INTO ENGLISH AS "ESTATE."
 FOR WINES (U.S. CLS. 47 AND 49).
 FIRST USE 7-0-2000; IN COMMERCE 7-0-2000.
 JILL C. ALT, EXAMINING ATTORNEY

CLASS 33—(Continued).

SN 78-538,997. SCHIEFFELIN & CO., NEW YORK, NY.
FILED 12-28-2004.



OWNER OF U.S. REG. NO. 2,632,064.
FOR WINES (U.S. CLS. 47 AND 49).
FIRST USE 7-0-2000; IN COMMERCE 7-0-2000.
ANDREA K. NADELMAN, EXAMINING ATTORNEY

SN 78-539,024. LASCOMBES HOLDINGS SA, MARGAUX,
FRANCE, FILED 12-28-2004.

CHATEAU LASCOMBES

THE MARK CONSISTS OF STANDARD CHARACTERS
WITHOUT CLAIM TO ANY PARTICULAR FONT, STYLE,
SIZE, OR COLOR.
PRIORITY DATE OF 9-16-2003 IS CLAIMED.
OWNER OF U.S. REG. NO. 775,509.
FOR WINES (U.S. CLS. 47 AND 49).
FIRST USE 0-0-1855; IN COMMERCE 2-10-1953.
YSA DEJESUS, EXAMINING ATTORNEY

SN 79-000,207. FRANZ WILHELM LANGGUTH ERBEN;
GMBH & CO KG, FED REP GERMANY, FILED 11-4-2003.

SASSY

THE MARK CONSISTS OF STANDARD CHARACTERS
WITHOUT CLAIM TO ANY PARTICULAR FONT, STYLE,
SIZE, OR COLOR.
PRIORITY DATE OF 5-5-2003 IS CLAIMED.
OWNER OF INTERNATIONAL REGISTRATION 0815471
DATED 11-4-2003, EXPIRES 11-4-2013.
FOR ALCOHOLIC BEVERAGES, NAMELY WINE,
WINE-BASED FRUIT DRINKS, AND WINE COCKTAILS
(U.S. CLS. 47 AND 49).
DAVID H. STINE, EXAMINING ATTORNEY

CLASS 33—(Continued).

SN 79-001,462. KOMPANIA SPIRYTUSOWA "WRATISLA-
VIA"; POLMOS WROCLAW SA, POLAND, FILED 2-6-2004.

Krakus

THE MARK CONSISTS OF STANDARD CHARACTERS
WITHOUT CLAIM TO ANY PARTICULAR FONT, STYLE,
SIZE, OR COLOR.

OWNER OF INTERNATIONAL REGISTRATION 0820937
DATED 2-6-2004, EXPIRES 2-6-2014.

OWNER OF U.S. REG. NO. 796,087.
FOR ALCOHOLIC BEVERAGES, NAMELY, VODKA
(U.S. CLS. 47 AND 49).

JOHN GARTNER, EXAMINING ATTORNEY

SN 79-002,087. STELLA BELLA WINES PTY LTD, AUSTRALIA,
FILED 3-16-2004.

SKUTTLEBUTT

THE MARK CONSISTS OF STANDARD CHARACTERS
WITHOUT CLAIM TO ANY PARTICULAR FONT, STYLE,
SIZE, OR COLOR.

PRIORITY DATE OF 9-16-2003 IS CLAIMED.
OWNER OF INTERNATIONAL REGISTRATION 0823194
DATED 3-16-2004, EXPIRES 3-16-2014.

FOR WINES (U.S. CLS. 47 AND 49).
CHRISTOPHER ADKINS, EXAMINING ATTORNEY

SN 79-002,256. CAPETTA I.V.I.P. S.P.A.; INDUSTRIA VINI-
COLA PIEMONTESE, ITALY, FILED 2-13-2004.

LA BAUDRIA

THE MARK CONSISTS OF STANDARD CHARACTERS
WITHOUT CLAIM TO ANY PARTICULAR FONT, STYLE,
SIZE, OR COLOR.

OWNER OF INTERNATIONAL REGISTRATION 0823820
DATED 2-13-2004, EXPIRES 2-13-2014.

FOR ALCOHOLIC BEVERAGES, NAMELY, WINES
AND BARBERA WINE (U.S. CLS. 47 AND 49).
LINDA M. KING, EXAMINING ATTORNEY

CLASS 33—(Continued).

SN 79-002,465. CAPETTA I.V.I.P. S.P.A.; INDUSTRIA VINI-COLA PIEMONTESE, ITALY, FILED 3-31-2004.

BALBI SOPRANI



PRIORITY DATE OF 10-3-2003 IS CLAIMED.
OWNER OF INTERNATIONAL REGISTRATION 0824488
DATED 3-31-2004, EXPIRES 3-31-2014.

BALBI SOPRANI DOES NOT IDENTIFY A PARTICULAR LIVING INDIVIDUAL.

THE TRADEMARK CONSISTS OF A LABEL; AT THE TOP OF THE LABEL THERE ARE THE WORDS "BALBI SOPRANI" IN PARTICULAR LETTERS ABOVE THE DESIGN OF A CIRCLE CONTAINING A STYLIZED CROWN AND, PARALLEL TO THE CIRCUMFERENCE, THE WORDS "CORTE DEI BALBI SOPRANI" IN PARTICULAR LETTERS.

THE FOREIGN WORDING IN THE MARK TRANSLATES TO COURT OF BALBI SOPRANI.

FOR WINES, SPARKLING WINES, RED WINES, WHITE WINES, DRY WINES (U.S. CLS. 47 AND 49).

GEOFFREY FOSDICK, EXAMINING ATTORNEY

CLASS 33—(Continued).

SN 79-002,863. PIPER-HEIDSIECK - ANCIENNE MAISON; HEIDSIECK FONDEE EN 1785.; COMPAGNIE CHAMPE-NOISE, FRANCE, FILED 4-30-2004.



PRIORITY DATE OF 11-7-2003 IS CLAIMED.
OWNER OF INTERNATIONAL REGISTRATION 0825800
DATED 4-30-2004, EXPIRES 4-30-2014.

OWNER OF U.S. REG. NOS. 575,785 AND 2,787,997.

NO CLAIM IS MADE TO THE EXCLUSIVE RIGHT TO USE "CHAMPAGNE BLANC DE BLANC", "BRUT", "A REIMS-FRANCE", "PRODUIT DE FRANCE PRODUCT OF FRANCE", "ELABORE PAR CHAMPAGNES P. & C. HEIDSIECK S.A. A REIMS-FRANCE", "ALC. 12% VOL.", "750 ML E" AND "MAISON FONDEE EN 1785", APART FROM THE MARK AS SHOWN.

THE COLORS SILVER, GOLD AND BLACK ARE CLAIMED AS FEATURES OF THE MARK.

THE COLOR GOLD APPEARS IN THE RECTANGULAR BACKGROUND BEHIND AND IN THE RECTANGULAR OUTLINE AROUND THE WORDS PIPER-HEIDSIECK AND IN THE WORD BRUT. THE COLOR SILVER APPEARS IN THE BACKGROUND OF THE ENTIRE MARK AND THE BACKGROUND INSIDE THE CREST. THE COLOR BLACK APPEARS IN THE DESIGN PORTION OF THE CREST AND IN ALL THE WORDING EXCEPT FOR THE WORD BRUT WHICH IS GOLD.

THE WORDS "MAISON FONDEE EN 1785" MEAN "HOUSE ESTABLISHED IN 1785 IN ENGLISH"; "CHAMPAGNE BLANC DE BLANC" MEANS "CHAMPAGNE WHITE OF WHITES" IN ENGLISH; "BRUT" MEANS "DRY" IN ENGLISH; "A REIMS-FRANCE PRODUIT DE FRANCE" MEANS "IN REIMS, FRANCE PRODUCT OF FRANCE" IN ENGLISH; AND "ELABORE PAR CHAMPAGNES P. & C. HEIDSIECK S.A. A REIMS-FRANCE" MEANS "ELABORATED BY CHAMPAGNES P. & C. HEIDSIECK S.A. IN REIMS FRANCE" IN ENGLISH.

FOR WINES WITH CHAMPAGNE PROTECTED LABEL OF ORIGIN (U.S. CLS. 47 AND 49).

CHRISIE B. KING, EXAMINING ATTORNEY

SN 79-002,864. PERNOD RICARD, FRANCE, FILED 4-30-2004.

DJANGO

THE MARK CONSISTS OF STANDARD CHARACTERS WITHOUT CLAIM TO ANY PARTICULAR FONT, STYLE, SIZE, OR COLOR.

PRIORITY DATE OF 11-19-2003 IS CLAIMED.
OWNER OF INTERNATIONAL REGISTRATION 0825800
DATED 4-30-2004, EXPIRES 4-30-2014.

FOR WINES, LIQUEURS, EAUX-DE-VIE, DISTILLED SPIRITS AND PREPARED ALCOHOLIC COCKTAILS (U.S. CLS. 47 AND 49).

CHRISIE B. KING, EXAMINING ATTORNEY

CLASS 33—(Continued).

SN 79-003,482. MADDENS RISE PTY LTD, COLDSTREAM VIC 3770, AUSTRALIA, FILED 6-15-2004.

MADDENS RISE

THE MARK CONSISTS OF STANDARD CHARACTERS WITHOUT CLAIM TO ANY PARTICULAR FONT, STYLE, SIZE, OR COLOR.

PRIORITY DATE OF 12-15-2003 IS CLAIMED.
OWNER OF INTERNATIONAL REGISTRATION 0827758 DATED 6-15-2004, EXPIRES 6-15-2014.
FOR WINES, PORT WINES AND LIQUEURS (U.S. CLS. 47 AND 49).
LOURDES AYALA, EXAMINING ATTORNEY

SN 79-004,401. DOMAINE DU SOLEIL, FRANCE, FILED 6-29-2004.

LOS 3 BANDIDOS

PRIORITY DATE OF 1-13-2004 IS CLAIMED.
OWNER OF INTERNATIONAL REGISTRATION 0830592 DATED 6-29-2004, EXPIRES 6-29-2014.
THE ENGLISH TRANSLATION OF "LOS 3 BANDIDOS" IS "THE THREE BANDITS."
FOR WINE (U.S. CLS. 47 AND 49).
KIMBERLY PERRY, EXAMINING ATTORNEY

SN 79-004,818. MGM - MONDO DEL VINO S.R.L., I-47100 FORLI', ITALY, FILED 4-20-2004.

MEZZOMONDO

THE MARK CONSISTS OF STANDARD CHARACTERS WITHOUT CLAIM TO ANY PARTICULAR FONT, STYLE, SIZE, OR COLOR.
OWNER OF INTERNATIONAL REGISTRATION 0810295 DATED 7-10-2003, EXPIRES 7-10-2013.
"MEZZO" MEANS "HALF" AND "MONDO" MEANS "WORLD" IN ITALIAN.
FOR APERITIF WINE, COOKING WINE, FRUIT WINE, RED WINE, WHITE WINE, ROSÉ WINE, PREPARED WINE COCKTAIL (U.S. CLS. 47 AND 49).
JIM RINGLE, EXAMINING ATTORNEY

SN 79-005,373. GRANT BURGE WINES PTY LTD, AUSTRALIA, FILED 9-8-2004.

GRANT BURGE HUNDRED OF BAROSSA

THE MARK CONSISTS OF STANDARD CHARACTERS WITHOUT CLAIM TO ANY PARTICULAR FONT, STYLE, SIZE, OR COLOR.
PRIORITY DATE OF 3-23-2004 IS CLAIMED.
OWNER OF INTERNATIONAL REGISTRATION 0833469 DATED 9-8-2004, EXPIRES 9-8-2014.
OWNER OF U.S. REG. NOS. 2,653,184 AND 2,694,559.
NO CLAIM IS MADE TO THE EXCLUSIVE RIGHT TO USE "HUNDRED OF BAROSSA", APART FROM THE MARK AS SHOWN.
THE NAME(S), PORTRAIT(S), AND/OR SIGNATURE(S) SHOWN IN THE MARK IDENTIFIES GRANT BURGE, WHOSE CONSENT(S) TO REGISTER IS SUBMITTED.
FOR WINES; DISTILLED SPIRITS; LIQUEURS (U.S. CLS. 47 AND 49).
STEVEN PEREZ, EXAMINING ATTORNEY

CLASS 33—(Continued).

SN 79-005,984. TENIMENTI ASSOCIATI S.R.L., ITALY, FILED 5-27-2004.

MURANELLO

THE MARK CONSISTS OF STANDARD CHARACTERS WITHOUT CLAIM TO ANY PARTICULAR FONT, STYLE, SIZE, OR COLOR.
PRIORITY DATE OF 3-24-2004 IS CLAIMED.
OWNER OF INTERNATIONAL REGISTRATION 0835044 DATED 5-27-2004, EXPIRES 5-27-2014.
FOR WINES, SPARKLING WINES, GRAPPA, DISTILLED SPIRITS; WHISKY, ALCOHOLIC BITTERS, EAUX-DE-VIE, RUM, VODKA (U.S. CLS. 47 AND 49).
KELLY BOULTON, EXAMINING ATTORNEY

SN 79-006,400. TENUTA PODERNOVO SOCIETA' AGRICOLA S.R.L., ITALY, FILED 6-1-2004.

ALIOOTTO

THE MARK CONSISTS OF STANDARD CHARACTERS WITHOUT CLAIM TO ANY PARTICULAR FONT, STYLE, SIZE, OR COLOR.
PRIORITY DATE OF 6-1-2004 IS CLAIMED.
OWNER OF INTERNATIONAL REGISTRATION 0836301 DATED 6-1-2004, EXPIRES 6-1-2014.
THE TRADEMARK CONSISTS OF THE WORD ALIOOTTO, FOR ALCOHOLIC BEVERAGES EXCEPT BEERS, NAMELY WINE, SPARKLING WINE AND GRAPPA AS A DISTILLATE (U.S. CLS. 47 AND 49).
KEVON CHISOLM, EXAMINING ATTORNEY

SN 79-008,487. RIGAL SAS, FRANCE, FILED 12-17-2004.

RIGAL

THE MARK CONSISTS OF STANDARD CHARACTERS WITHOUT CLAIM TO ANY PARTICULAR FONT, STYLE, SIZE, OR COLOR.
OWNER OF INTERNATIONAL REGISTRATION 0842162 DATED 12-17-2004, EXPIRES 12-17-2014.
FOR WINES (U.S. CLS. 47 AND 49).
DAWN HAN, EXAMINING ATTORNEY

CLASS 34—SMOKERS' ARTICLES

SN 76-577,860. MARKETING GROUP USA, LA MESA, CA. FILED 2-26-2004.



OWNER OF U.S. REG. NO. 2,089,606.
FOR CIGARETTES (U.S. CLS. 2, 8, 9 AND 17).
FIRST USE 10-0-2001; IN COMMERCE 10-0-2001.
DOUGLAS LEE, EXAMINING ATTORNEY

CLASS 34—(Continued).

SN 78-342,672. COMPANIA CERILLERA LA CENTRAL, S.A. DE C.V., MEXICO, D.F., MEXICO, FILED 12-18-2003.



OWNER OF MEXICO REG. NO. 568458, DATED 1-28-1998, EXPIRES 1-28-2008.

THE FOREIGN WORDING IN THE MARK TRANSLATES INTO ENGLISH AS FLASH OF LIGHTNING AND IMPERIAL QUALITY.
FOR MATCHES (U.S. CLS. 2, 8, 9 AND 17).
JOHN WILKE, EXAMINING ATTORNEY

SN 76-614,830. SUNRISE TOBACCO, INC., PHOENIX, AZ. FILED 10-7-2004.

HYP & HENNY

THE MARK CONSISTS OF STANDARD CHARACTERS WITHOUT CLAIM TO ANY PARTICULAR FONT, STYLE, SIZE, OR COLOR.

FOR TOBACCO PRODUCTS, NAMELY, FLAVORED TOBACCO, CIGARS, CIGAR WRAPS AND CIGARETTES (U.S. CLS. 2, 8, 9 AND 17).
REBECCA GAN, EXAMINING ATTORNEY

SN 78-367,466. EWESTERN INC., COLVILLE, WA. FILED 2-13-2004.



SN 76-614,843. SUNRISE TOBACCO, INC., PHOENIX, AZ. FILED 10-7-2004.

BU BONIC

THE MARK CONSISTS OF STANDARD CHARACTERS WITHOUT CLAIM TO ANY PARTICULAR FONT, STYLE, SIZE, OR COLOR.

FOR TOBACCO PRODUCTS, NAMELY, FLAVORED TOBACCO, CIGARS, CIGAR WRAPS AND CIGARETTES (U.S. CLS. 2, 8, 9 AND 17).
LAURA KOVAISKY, EXAMINING ATTORNEY

THE COLOR(S) RED AND GREEN ARE CLAIMED AS A FEATURE OF THE MARK.

THE LETTERING APPEARS IN RED AND THE TWO ARCHES APPEAR IN GREEN.
FOR HUMIDORS, SMOKING PIPES, ASHTRAYS AND LIGHTERS FOR SMOKERS (U.S. CLS. 2, 8, 9 AND 17).
JAMES GRIFFIN, EXAMINING ATTORNEY

CLASS 34—(Continued).

SN 78-390,812. SPIRITS & SPICE CIGARS, LLC, BOWLING GREEN, KY. FILED 3-25-2004.

BITCH WHIFFS

THE MARK CONSISTS OF STANDARD CHARACTERS WITHOUT CLAIM TO ANY PARTICULAR FONT, STYLE, SIZE, OR COLOR.

NO CLAIM IS MADE TO THE EXCLUSIVE RIGHT TO USE "WHIFFS", APART FROM THE MARK AS SHOWN.

FOR CIGARS, HUMIDORS, CIGAR CUTTERS, ASH-TRAYS, LIGHTERS FOR SMOKERS NOT IN LAND VEHICLES (U.S. CLS. 2, 8, 9 AND 17).

LA TONIA FISHER, EXAMINING ATTORNEY

CLASS 34—(Continued).

SN 78-410,076. BRITISH AMERICAN TOBACCO (BRANDS) LIMITED, LONDON, UNITED KINGDOM, FILED 4-29-2004.

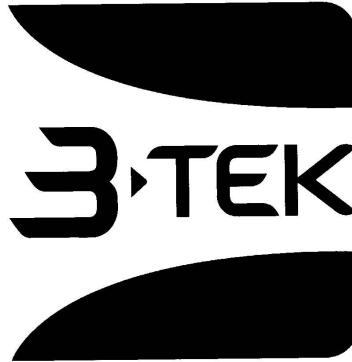

THE MARK CONSISTS OF THE WORDS 3-TEK IN STYLIZED LETTERING BETWEEN SIDEWAYS WING SHAPE DESIGN.

FOR CIGARETTES, TOBACCO, CIGARETTE FILTERS, SMOKERS' ARTICLES, NAMELY, LIGHTERS NOT OF PRECIOUS METALS AND MATCHES (U.S. CLS. 2, 8, 9 AND 17).

RONALD AIKENS, EXAMINING ATTORNEY

SN 78-406,378. EXTREME CIGARS INTERNATIONAL, INC., WELLINGTON, FL. FILED 4-22-2004.

Montserrat

THE MARK CONSISTS OF STANDARD CHARACTERS WITHOUT CLAIM TO ANY PARTICULAR FONT, STYLE, SIZE, OR COLOR.

FOR CIGARS (U.S. CLS. 2, 8, 9 AND 17).

MARK SPARACINO, EXAMINING ATTORNEY

SN 78-415,637. SANTA CLARA, INC., WHIPPANY, NJ. FILED 5-10-2004.

Casa de Puros

THE MARK CONSISTS OF STANDARD CHARACTERS WITHOUT CLAIM TO ANY PARTICULAR FONT, STYLE, SIZE, OR COLOR.

NO CLAIM IS MADE TO THE EXCLUSIVE RIGHT TO USE PUROS, APART FROM THE MARK AS SHOWN.

THE FOREIGN WORDING IN THE MARK TRANSLATES INTO ENGLISH AS HOUSE OF CIGARS.

FOR CIGARS (U.S. CLS. 2, 8, 9 AND 17).

ASMAT KHAN, EXAMINING ATTORNEY

CLASS 34—(Continued).

SN 78-415,639. SANTA CLARA, INC., WHIPPANY, NJ. FILED 5-10-2004.

CLASS 34—(Continued).

SN 78-468,018. QUINN, PATRICK D., EUCLID, OH. FILED 8-16-2004.

Cava de Puros

PERSEO

THE MARK CONSISTS OF STANDARD CHARACTERS WITHOUT CLAIM TO ANY PARTICULAR FONT, STYLE, SIZE, OR COLOR.

NO CLAIM IS MADE TO THE EXCLUSIVE RIGHT TO USE "PUROS", APART FROM THE MARK AS SHOWN.

THE FOREIGN WORDING IN THE MARK TRANSLATES INTO ENGLISH AS "WINE CELLAR OF CIGARS."

FOR CIGARS (U.S. CLS. 2, 8, 9 AND 17).
MICHAEL HALL, EXAMINING ATTORNEY

THE MARK CONSISTS OF STANDARD CHARACTERS WITHOUT CLAIM TO ANY PARTICULAR FONT, STYLE, SIZE, OR COLOR.

FOR CIGARS (U.S. CLS. 2, 8, 9 AND 17).
THEODORE MCBRIDE, EXAMINING ATTORNEY

SN 78-474,564. MARYJANE CIGARETTE CO., INC., MIAMI, FL. FILED 8-27-2004.

SN 78-463,709. CALICO BRANDS, INC., ONTARIO, CA. FILED 8-6-2004.



MARYJANE

THE COLOR(S) WHITE, GRAY, BLACK, AND BROWN IS/ ARE CLAIMED AS A FEATURE OF THE MARK.

THE LETTERS ARE WHITE, THE SKULLS ARE GRAY, AND THE BACKGROUND WOOD PATTERN IS BROWN AND BLACK.

FOR CIGARETTE LIGHTERS, NOT OF PRECIOUS METAL (U.S. CLS. 2, 8, 9 AND 17).

FIRST USE 8-6-2004; IN COMMERCE 8-6-2004.
YSA DEJESUS, EXAMINING ATTORNEY

THE MARK CONSISTS OF STANDARD CHARACTERS WITHOUT CLAIM TO ANY PARTICULAR FONT, STYLE, SIZE, OR COLOR.

FOR CIGARETTES (U.S. CLS. 2, 8, 9 AND 17).
PAULA MAYS, EXAMINING ATTORNEY

CLASS 34—(Continued).

SN 78-478,023. GOLD LEAF DISTRIBUTORS, INC., TAMPA, FL. FILED 9-2-2004.



NO CLAIM IS MADE TO THE EXCLUSIVE RIGHT TO USE "100% NATURAL TOBACCO DOMINICAN REPUBLIC" AND "HAND MADE FLAVORED CIGARS", APART FROM THE MARK AS SHOWN.

THE STIPLING IS FOR SHADING PURPOSES ONLY. THE NAME(S), PORTRAIT(S), AND/OR SIGNATURE(S) SHOWN IN THE MARK DOES NOT IDENTIFY A PARTICULAR LIVING INDIVIDUAL.

THE COLOR(S) BLUE, RED, GOLD, WHITE, BLACK, BROWN, GREEN, TAN IS/ARE CLAIMED AS A FEATURE OF THE MARK.

THE MARK CONSISTS OF A BROWN-HAIRED PIRATE WOMAN WEARING A RED JACKET WITH GOLD TRIM, BLACK BOOTS, BLACK PIRATE HAT AND BLACK EYE-PATCH, HOLDING A BROWN CIGAR AND SITTING UPON A BROWN AND GOLD TREASURE CHEST OVERLOOKING A BLUE SEA WITH WHITE AND YELLOW CLOUDS AND A BROWN PIRATE SHIP WITH WHITE SAILS IN THE BACKGROUND WITH THE WORDING 100% NATURAL TOBACCO DOMINICAN REPUBLIC APPEARING BELOW THE SHIP WRITTEN ACROSS THE OCEAN; THE PIRATE PICTURE IS BORDERED BY A BROWN AND TAN PIRATE MAP.

FOR CIGAR, CIGARILLOS, SMOKERS' ARTICLES NOT OF PRECIOUS METAL, NAMELY CASES FOR CIGARS, CIGARETTES AND MATCHES, BOXES FOR CIGARS AND CIGARETTES, CIGAR CUTTERS, CIGAR HOLDERS AND CIGARETTE HOLDERS, ASHTRAYS, PARTS FOR ALL OF THE AFOREMENTIONED GOODS (U.S. CLS. 2, 8, 9 AND 17).

FIRST USE 8-20-2004; IN COMMERCE 8-20-2004. DARRYL SPRUILL, EXAMINING ATTORNEY

SN 78-494,888. RBJ SALES, INC., DRESDEN, TN. FILED 10-5-2004.

OUR PRIDE

THE MARK CONSISTS OF STANDARD CHARACTERS WITHOUT CLAIM TO ANY PARTICULAR FONT, STYLE, SIZE, OR COLOR.

FOR TOBACCO (U.S. CLS. 2, 8, 9 AND 17). FIRST USE 9-1-1989; IN COMMERCE 9-1-1989. ELISSA GARBER KON, EXAMINING ATTORNEY

CLASS 34—(Continued).

SN 78-496,274. SANTA CLARA, INC., WHIPPANY, NJ. FILED 10-7-2004.

MAGNUM FORCE

THE MARK CONSISTS OF STANDARD CHARACTERS WITHOUT CLAIM TO ANY PARTICULAR FONT, STYLE, SIZE, OR COLOR.

NO CLAIM IS MADE TO THE EXCLUSIVE RIGHT TO USE "MAGNUM", APART FROM THE MARK AS SHOWN. FOR CIGARS (U.S. CLS. 2, 8, 9 AND 17).

FIRST USE 3-1-2004; IN COMMERCE 3-1-2004. SANJEEV VOHRA, EXAMINING ATTORNEY

SN 78-498,158. SMOKER FRIENDLY INTERNATIONAL LLC, DENVER, CO. FILED 10-12-2004.

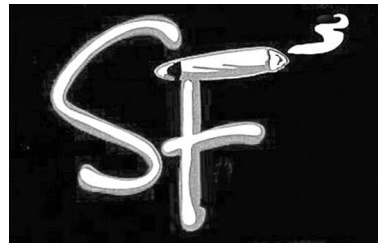

FOR CIGARETTES, CIGARS, ASHTRAYS, CIGARETTE CASES NOT OF PRECIOUS METAL, CHEWING TOBACCO, CIGAR CUTTERS, CIGARETTE HOLDERS NOT OF PRECIOUS METAL, CIGARETTE LIGHTERS, CIGARILLOS, FLINTS FOR LIGHTERS, HERBS FOR SMOKING, POCKET MACHINES FOR ROLLING CIGARETTES, MATCHES, SMOKING PIPE CLEANERS, TOBACCO POUCHES, SMOKELESS TOBACCO, SMOKING TOBACCO, SNUFF, SNUFF BOXES NOT OF PRECIOUS METAL AND SPITOONS (U.S. CLS. 2, 8, 9 AND 17).

FIRST USE 6-1-2004; IN COMMERCE 6-1-2004. TARAH HARDY, EXAMINING ATTORNEY

CLASS 34—(Continued).

SN 78-506,432. BBK TOBACCO & FOODS, PHOENIX, AZ. FILED 10-26-2004.

BRASS MONKEY

THE MARK CONSISTS OF STANDARD CHARACTERS WITHOUT CLAIM TO ANY PARTICULAR FONT, STYLE, SIZE, OR COLOR.

FOR CIGARETTE ROLLING PAPERS, TOBACCO IN THE FORM OF LEAVES, CIGARS (U.S. CLS. 2, 8, 9 AND 17).

FIRST USE 10-2-2003; IN COMMERCE 10-2-2003.
SUSAN LESLIE DUBOIS, EXAMINING ATTORNEY

CLASS 34—(Continued).

SN 78-522,467. EWESTERN INC., COLVILLE, WA. FILED 11-24-2004.

SANDA
PRO

THE COLORS BLUE AND RED ARE CLAIMED AS A FEATURE OF THE MARK.

THE TERM "SANDA" IS BLUE, AND "PRO" IS RED. FOR CIGARETTE FILTERS; CIGAR PIPES; ASH-TRAYS (U.S. CLS. 2, 8, 9 AND 17).

IRA J. GOODSaid, EXAMINING ATTORNEY

SN 78-512,689. BANC ENTERPRISES CORPORATION, MIAMI, FL. FILED 11-7-2004.

FACTOR

THE MARK CONSISTS OF STANDARD CHARACTERS WITHOUT CLAIM TO ANY PARTICULAR FONT, STYLE, SIZE, OR COLOR.

FOR CIGARETTES, MENTHOL CIGARETTES, LIGHT CIGARETTES, LITTLE CIGARS AND CIGARS (U.S. CLS. 2, 8, 9 AND 17).

FIRST USE 11-7-2004; IN COMMERCE 11-7-2004.
SHARON MEIER, EXAMINING ATTORNEY

SN 78-524,369. COMPAÑIA INDUSTRIAL DE TABACOS MONTE-PAZ S.A., MONTEVIDEO, URUGUAY, FILED 11-30-2004.



OWNER OF U.S. REG. NO. 2,277,634.

THE COLORS BLUE, WHITE, RED, LIGHT BLUE, AND YELLOW ARE CLAIMED AS A FEATURE OF THE MARK.

THE MARK CONSISTS OF A LIGHT BLUE ANCHOR WITH A BLUE OUTLINE AND A LIGHT BLUE ROPE WITH A BLUE OUTLINE IN THE FOREGROUND BEHIND A RECTANGULAR BOX WITH A THICK BLUE OUTLINE, A WHITE OUTLINE AND A THIN BLUE OUTLINE. IN THE RECTANGULAR BOX ARE THE WORDS ARK IN RED WITH A WHITE BACKGROUND, AND ROYAL IN WHITE WITH A RED BACKGROUND. DIRECTLY ABOVE THE BOX AND TO THE LEFT OF THE ANCHOR ARE FIVE (5) BLUE STARS, AND DIRECTLY BELOW THE BOX AND TO THE RIGHT OF THE ANCHOR ARE FIVE (5) BLUE STARS. THE BACKGROUND IS WHITE WITH YELLOW STRIPES.

FOR TOBACCO AND CIGARETTES (U.S. CLS. 2, 8, 9 AND 17).

JUDITH HELFMAN, EXAMINING ATTORNEY

CLASS 34—(Continued).

SN 79-004,025. JOHANNES NIEBOER, NETHERLANDS,
FILED 4-21-2004.

ROADHOUSE

THE MARK CONSISTS OF STANDARD CHARACTERS
WITHOUT CLAIM TO ANY PARTICULAR FONT, STYLE,
SIZE, OR COLOR.

OWNER OF INTERNATIONAL REGISTRATION 0765796
DATED 8-8-2001, EXPIRES 8-8-2011.

FOR TOBACCO; MATCHES (U.S. CLS. 2, 8, 9 AND 17).
ZHALEH DELANEY, EXAMINING ATTORNEY

SN 79-004,534. DAVIDOFF & CIE SA, CH-1200 GENÈVE,
SWITZERLAND, FILED 6-30-2004.

ZINO PLATINUM CROWN SERIES BARREL

THE MARK CONSISTS OF STANDARD CHARACTERS
WITHOUT CLAIM TO ANY PARTICULAR FONT, STYLE,
SIZE, OR COLOR.

PRIORITY DATE OF 5-21-2004 IS CLAIMED.
OWNER OF INTERNATIONAL REGISTRATION 0831023
DATED 6-30-2004, EXPIRES 6-30-2014.

OWNER OF U.S. REG. NOS. 2,725,768, 2,915,337 AND
OTHERS.

NO CLAIM IS MADE TO THE EXCLUSIVE RIGHT TO
USE "SERIES", APART FROM THE MARK AS SHOWN.

FOR CIGARS (U.S. CLS. 2, 8, 9 AND 17).
BRIDGETT SMITH, EXAMINING ATTORNEY

SN 79-005,588. CHUXIONG CIGARETTE FACTORY., YUN-
NAN HONGTA GROUP, CHINA, FILED 7-9-2004.

国宾

OWNER OF INTERNATIONAL REGISTRATION 0833884
DATED 7-9-2004, EXPIRES 7-9-2014.

THE NON-LATIN CHARACTERS IN THE MARK TRANS-
LITERATE TO GUO BIN AND THIS MEANS STATE
GUESTS IN ENGLISH.

FOR CIGARETTES, CIGARS, LIGHTERS FOR SMO-
KERS, MATCHES, ASHTRAYS, NOT OF PRECIOUS
METAL, FOR SMOKERS (U.S. CLS. 2, 8, 9 AND 17).

LEIGH LOWRY, EXAMINING ATTORNEY

CLASS 34—(Continued).

SN 79-006,938. DAVIDOFF & CIE SA, CH-1200 GENÈVE,
SWITZERLAND, FILED 8-24-2004.

ZINO PLATINUM SCEPTER SERIES BULLET

THE MARK CONSISTS OF STANDARD CHARACTERS
WITHOUT CLAIM TO ANY PARTICULAR FONT, STYLE,
SIZE, OR COLOR.

PRIORITY DATE OF 7-1-2004 IS CLAIMED.

OWNER OF INTERNATIONAL REGISTRATION 0837816
DATED 8-24-2004, EXPIRES 8-24-2014.

OWNER OF U.S. REG. NOS. 2,725,768, 2,915,337 AND
OTHERS.

NO CLAIM IS MADE TO THE EXCLUSIVE RIGHT TO
USE SERIES, APART FROM THE MARK AS SHOWN.

FOR CIGARS (U.S. CLS. 2, 8, 9 AND 17).

BRIDGETT SMITH, EXAMINING ATTORNEY

SERVICE MARKS**CLASS 35—ADVERTISING AND BUSINESS**

SN 75-689,162. IMAGENET ASSOCIATES, INC. LLC, DAL-
LAS, TX. FILED 4-21-1999.

IMAGELABS

FOR PROVIDING PERSONNEL AND OFFICE EQUIP-
MENT FOR THE COPYING OF DOCUMENTS FOR
OTHERS (U.S. CLS. 100, 101 AND 102).

RONALD AIKENS, EXAMINING ATTORNEY

SN 75-778,403. AUTOMATIC RAIN COMPANY, TEMPE, AZ.
FILED 8-19-1999.



FOR DISTRIBUTORSHIPS IN THE FIELD OF TURF
IRRIGATION AND MAINTENANCE EQUIPMENT FOR
PROFESSIONAL AND INSTITUTIONAL LANDSCAPE
INSTALLATION AND UPKEEP (U.S. CLS. 100, 101 AND
102).

FIRST USE 1-0-1998; IN COMMERCE 1-31-1998.

BRENDAN REGAN, EXAMINING ATTORNEY

CLASS 35—(Continued).

SN 75-982,349. NEXTPRACTICE GMBH, BREMEN, FED REP GERMANY, FILED 7-10-2001.

NEXTPRACTICE

PRIORITY CLAIMED UNDER SEC. 44(D) ON FED REP GERMANY APPLICATION NO. 30102220.8, FILED 1-15-2001, REG. NO. 30102220.8, DATED 4-26-2001, EXPIRES 1-31-2011, FOR BUSINESS AND MANAGEMENT CONSULTATION (U.S. CLS. 100, 101 AND 102).
BILL DAWE, EXAMINING ATTORNEY

SN 76-255,419. TEKSYSTEMS, INC., COLUMBIA, MD. FILED 5-11-2001.

ITC

FOR BUSINESS CONSULTING AND OUTSOURCING SERVICES FOR OTHERS RELATING TO THE TEMPORARY AND PERMANENT PLACEMENT OF PERSONNEL IN THE FIELD OF INFORMATION SYSTEMS (U.S. CLS. 100, 101 AND 102).
MARK T. MULLEN, EXAMINING ATTORNEY

SN 76-265,922. TEXAS ASSOCIATION OF SCHOOL BOARDS, INC, AUSTIN, TX. FILED 6-4-2001.

BUYBOARD

FOR COMPUTERIZED, ON-LINE ORDERING SERVICE USED BY EDUCATIONAL INSTITUTIONS, MUNICIPALITIES, COUNTIES, AND NON-PROFIT ORGANIZATIONS TO PURCHASE ATHLETIC EQUIPMENT AND SPORTSWEAR; TOOLS AND EQUIPMENT USED FOR BUILDING MAINTENANCE, REPAIR AND OPERATION; COMPUTER HARDWARE AND SOFTWARE; ELECTRONICS AND AUDIO VISUAL EQUIPMENT; MEDICAL SUPPLIES AND EQUIPMENT; FLOOR COVERINGS; TOOLS AND EQUIPMENT USED IN FOOD SERVICES; FURNITURE; TOOLS AND EQUIPMENT USED IN GROUNDSKEEPING AND LANDSCAPING; TEACHING SUPPLIES; OFFICE SUPPLIES; SCHOOL SUPPLIES; BOOKS; MODULAR BUILDINGS; MUSICAL INSTRUMENTS AND ACCESSORIES THEREFOR; PAPER PRODUCTS; MOTOR VEHICLES; NON-MOTORIZED VEHICLES; CLOTHING; TOOLS AND EQUIPMENT USED FOR MAINTENANCE, REPAIR, AND OPERATION OF PARKS AND RECREATION AREAS; AND TOOLS AND EQUIPMENT USED FOR MAINTENANCE, REPAIR, AND OPERATION OF PUBLIC WORKS (U.S. CLS. 100, 101 AND 102).
FIRST USE 0-0-1997; IN COMMERCE 0-0-1997.
MARY BOAGNI, EXAMINING ATTORNEY

CLASS 35—(Continued).

SN 76-284,213. LULU GUINNESS LIMITED, LONDON WIN 5FT, UNITED KINGDOM, FILED 7-12-2001.

LULU GUINNESS

THE NAME "LULU GUINNESS" IDENTIFIES A LIVING INDIVIDUAL WHOSE CONSENT IS OF RECORD, FOR RETAIL STORE SERVICES, RETAIL MAIL ORDER SERVICES AND ON-LINE RETAIL STORE SERVICES FEATURING CLOTHING AND FASHION ACCESSORIES (U.S. CLS. 100, 101 AND 102).
JEFFERY COWARD, EXAMINING ATTORNEY

SN 76-306,400. ADVISORY BOARD COMPANY, THE, WASHINGTON, DC. FILED 8-29-2001.

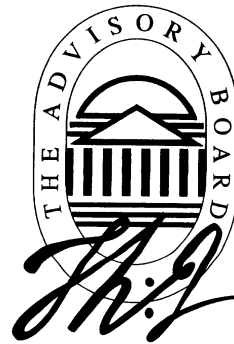

OWNER OF U.S. REG. NOS. 2,106,050, 2,106,489 AND 2,699,618.

NO CLAIM IS MADE TO THE EXCLUSIVE RIGHT TO USE BOARD, APART FROM THE MARK AS SHOWN.

SEC. 2(F) AS TO "THE ADVISORY BOARD".
FOR BUSINESS RESEARCH SERVICES FOR OTHERS ON THE SUBJECTS OF STRATEGIC ISSUES AND DEVELOPMENTS RELATING TO THE HEALTH CARE INDUSTRY AND OPERATIONS MANAGEMENT OF HOSPITALS AND HEALTH CARE ORGANIZATIONS, PHARMACEUTICAL, BIOTECHNOLOGY, MEDICAL DEVICES AND OTHER INDUSTRIES IN THE HEALTH CARE SYSTEM (U.S. CLS. 100, 101 AND 102).
FIRST USE 0-0-1988; IN COMMERCE 0-0-1988.

REBECCA GILBERT, EXAMINING ATTORNEY

SN 76-324,474. ACTIVE WALLACE GROUP, INC., DBA ACTIVE RIDE SHOP, CHINO, CA. FILED 10-11-2001.

ACTIVE

FOR RETAIL STORE, CATALOG AND MAIL-ORDER SERVICES IN THE FIELD OF RECREATIONAL BOARD SPORT RELATED ITEMS, NAMELY SHOES, SKATE DECKS, PRE-ASSEMBLED DECKS, WHEELS, TRUCKS, BEARINGS, HARDWARE, RISERS, GRIPS, HELMETS, BANNERS, PATCHES, WAXES, WALLET, BELTS, SOCKS, HATS, T-SHIRTS, CLOTHING, SHOES, BACKPACKS, WATCHES, VIDEOS, AND ACCESSORIES (U.S. CLS. 100, 101 AND 102).

FIRST USE 6-0-1989; IN COMMERCE 8-0-1999.
JAMES A. RAUEN, EXAMINING ATTORNEY

CLASS 35—(Continued).

SN 76-354,282. MEDIACOM COMMUNICATIONS CORPORATION, MIDDLETOWN, NY. FILED 1-3-2002.

ONMEDIA

FOR ADVERTISING AND MARKETING CONSULTING SERVICES, NAMELY, ADVERTISING AND BUSINESS MARKETING CONSULTING SERVICES (U.S. CLS. 100, 101 AND 102).

FIRST USE 8-1-2001; IN COMMERCE 8-1-2001.
YSA DEJESUS, EXAMINING ATTORNEY

SN 76-384,854. TELEFONICA, S.A., 28013 MADRID, SPAIN, FILED 3-18-2002.

TELEFONICA MOVISTAR

OWNER OF SPAIN REG. NO. 2,291,409, DATED 9-5-2000, EXPIRES 2-16-2010.

OWNER OF U.S. REG. NOS. 2,692,008, 2,790,106 AND 2,806,932.

THE ENGLISH TRANSLATION OF "TELEFONICA" IS "TELEPHONIC."

SEC. 2(F) AS TO THE TERM "TELEFONICA".

FOR PUBLICITY AGENTS; PUBLICITY SERVICES, NAMELY, ADVERTISING SERVICES, NAMELY PROVIDING ADVERTISING SPACE IN A PERIODICAL; DISPLAYING ADVERTISEMENTS FOR OTHERS; DISSEMINATION OF ADVERTISING FOR OTHERS VIA THE INTERNET; DISSEMINATION OF ADVERTISING MATTER; ELECTRONIC BILLBOARD ADVERTISING; PROVIDING SPACE AT A WEB SITE FOR THE ADVERTISEMENT OF THE GOODS AND SERVICES OF OTHERS; RENTAL OF ADVERTISING SPACE; BUSINESS MANAGEMENT; BUSINESS MANAGEMENT AND CONSULTATION (U.S. CLS. 100, 101 AND 102).

STEPHANIE DAVIS, EXAMINING ATTORNEY

SN 76-443,183. STAFF QUEST, INC., WOODSTOCK, MD. FILED 8-23-2002.



SUBJECT TO CONCURRENT USE PROCEEDING WITH 75375804, OWNED BY STAFFQUEST, INC., A CALIFORNIA CORPORATION WITH OFFICES AT 2031 CAMDEN AVENUE, SAN JOSE, CALIFORNIA 95124. APPLICANT CLAIMS EXCLUSIVE USE OF THE MARK IN THE AREA COMPRISING MARYLAND, VIRGINIA, PENNSYLVANIA AND THE DISTRICT OF COLUMBIA.

NO CLAIM IS MADE TO THE EXCLUSIVE RIGHT TO USE "STAFF", APART FROM THE MARK AS SHOWN.

FOR TEMPORARY AND CONTRACT EMPLOYMENT PLACEMENT AND STAFFING SERVICES (U.S. CLS. 100, 101 AND 102).

FIRST USE 5-5-1997; IN COMMERCE 5-5-1997.
MARY I. SPARROW, EXAMINING ATTORNEY

CLASS 35—(Continued).

SN 76-501,057. HOBOKEN WEB SERVICES, LLC, HOBOKEN, NJ. FILED 3-26-2003.

HOBOKENI.COM

SEC. 2(F).

FOR PROMOTING BUSINESS AND TOURISM BY PROVIDING ON-LINE INFORMATION RELATING TO THE MILE SQUARE CITY OF HOBOKEN, NEW JERSEY, INCLUDING BUT NOT LIMITED TO HOTELS, RESTAURANTS AND RELATED SERVICES (U.S. CLS. 100, 101 AND 102).

FIRST USE 1-0-1996; IN COMMERCE 6-0-1997.
PRISCILLA MILTON, EXAMINING ATTORNEY

SN 76-515,399. NEW BALANCE ATHLETIC SHOE, INC., BOSTON, MA. FILED 4-24-2003.

PROCARE

OWNER OF U.S. REG. NO. 2,462,821.

FOR BUSINESS CONSULTATION, BUSINESS MARKETING CONSULTATION, AND OFFERING TECHNICAL ASSISTANCE IN THE OPERATION OF RETAIL FOOTWEAR STORES (U.S. CLS. 100, 101 AND 102).

FIRST USE 9-1-2000; IN COMMERCE 9-1-2000.
ROBERT LAVACHE, EXAMINING ATTORNEY

SN 76-520,648. VERISPAN, L.L.C., NEWTOWN, PA. FILED 5-19-2003.

VECTOR ONE

FOR BUSINESS SERVICES FOR OTHERS, NAMELY, PROVIDING PATIENT, PRESCRIPTION AND RELATED STATISTICAL AND DEMOGRAPHIC INFORMATION IN ORDER TO FACILITATE EFFICIENT SALES, MARKETING AND RELATED BUSINESS ACTIVITIES IN THE HEALTH CARE, PHARMACEUTICAL, VETERINARY, PHARMACOGENOMIC, BIOTECHNICAL AND MEDICAL INDUSTRIES, AS WELL AS PROVIDING CUSTOMIZED STATISTICAL AND STRATEGIC ANALYSES OF PATIENT AND PRESCRIPTION ACTIVITY AND RELATED BUSINESS CONSULTING AND BUSINESS AUDITING SERVICES TO ORGANIZATIONS IN THESE INDUSTRIES (U.S. CLS. 100, 101 AND 102).

FIRST USE 5-6-2003; IN COMMERCE 5-6-2003.
REBECCA GILBERT, EXAMINING ATTORNEY

SN 76-531,639. GANNETT SATELLITE INFORMATION NETWORK, INC., MCLEAN, VA. FILED 7-23-2003.

LOYAL CUSTOMER CLUB

FOR ADVERTISING SERVICES, NAMELY PROVIDING DIRECT ELECTRONIC MAIL ADVERTISING SERVICES FOR OTHERS (U.S. CLS. 100, 101 AND 102).

FIRST USE 4-1-2002; IN COMMERCE 6-1-2002.
ADA HAN, EXAMINING ATTORNEY

CLASS 35—(Continued).

SN 76-536,434. ZAVEN KAZAN ENTERPRISES, INC., PALM BEACH GARDENS, FL. FILED 7-30-2003.

ZAVEN KAZAN

FOR RETAIL STORE SERVICES FEATURING HAIR AND NAIL PRODUCTS (U.S. CLS. 100, 101 AND 102).
FIRST USE 1-31-1983; IN COMMERCE 1-31-1983.
MICHAEL WEBSTER, EXAMINING ATTORNEY

SN 76-539,316. ATEL CAPITAL GROUP, SAN FRANCISCO, CA. FILED 8-11-2003.



**ATEL
Capital Group**

OWNER OF U.S. REG. NO. 2,146,955.
NO CLAIM IS MADE TO THE EXCLUSIVE RIGHT TO USE CAPITAL GROUP, APART FROM THE MARK AS SHOWN.

THE MARK CONSISTS OF STYLIZED SUNBURST DESIGN IN GOLD AND THE WORDS ATEL CAPITAL GROUP. FOR BUSINESS MANAGEMENT AND BUSINESS MANAGEMENT PLANNING FOR SUBSIDIARY COMPANIES AND AFFILIATES (U.S. CLS. 100, 101 AND 102).
FIRST USE 1-15-2003; IN COMMERCE 1-15-2003.
KELLY BOULTON, EXAMINING ATTORNEY

SN 76-545,029. ALM PROPERTIES, INC., NEWARK, DE. FILED 9-2-2003.

LAWJOBS.COM

SEC. 2(F).
FOR PROVIDING ON-LINE INFORMATION IN THE FIELDS OF EMPLOYMENT, RECRUITMENT, CAREERS, PERSONAL ISSUES RELATED TO CAREERS AND WORK LIFE, JOB RESOURCES, JOB LISTINGS AND RESUMES; PROVIDING ON-LINE INTERACTIVE EMPLOYMENT COUNSELING AND RECRUITMENT SERVICES; PROVIDING ON-LINE EMPLOYMENT PLACEMENT SERVICES, NAMELY, RESUME MATCHING SERVICES VIA A GLOBAL COMPUTER NETWORK (U.S. CLS. 100, 101 AND 102).
FIRST USE 9-0-1996; IN COMMERCE 9-0-1996.
CHERYL CLAYTON, EXAMINING ATTORNEY

CLASS 35—(Continued).

SN 76-545,390. VINA MEDITERRANEAN LLC, UPPER MARLBORO, MD. FILED 9-4-2003.



THE MARK CONSISTS IN PART OF A STYLIZED, ANTIQUE MAP OF THE MEDITERRANEAN REGION WHICH INCLUDES MOUNTAINS AND SAILING SHIPS. THE ENGLISH TRANSLATION OF "VINA" IN THE MARK IS "VINEYARD".
FOR WHOLESALE DISTRIBUTORSHIPS FEATURING WINE (U.S. CLS. 100, 101 AND 102).
FIRST USE 10-0-2000; IN COMMERCE 10-0-2000.
CHRISTOPHER ADKINS, EXAMINING ATTORNEY

SN 76-545,429. AIS MEDIA, INC., ATLANTA, GA. FILED 9-17-2003.

EBSP

FOR LICENSING OF WEB, WEB DESIGN, WEB HOSTING, AND WEB DEVELOPMENT SERVICES (U.S. CLS. 100, 101 AND 102).
FIRST USE 1-31-2002; IN COMMERCE 1-31-2002.
APRIL L. RADEMACHER, EXAMINING ATTORNEY

SN 76-556,813. GIVE AND GO PREPARED FOODS CORP., TORONTO, ONTARIO M9W 5Y6, CANADA, FILED 10-20-2003.



GIVE & GO

PRIORITY CLAIMED UNDER SEC. 44(D) ON CANADA APPLICATION NO. 1,186,520, FILED 8-13-2003, REG. NO. TMA631139, DATED 1-26-2005, EXPIRES 1-26-2020.
FOR (BASED ON 44(E)) PRIORITY APPLICATION) OPERATION OF A BAKERY; DISTRIBUTORSHIPS IN THE FIELD OF BAKED GOODS; WHOLESALE DISTRIBUTORSHIPS FEATURING BAKED GOODS (BASED ON USE IN COMMERCE) DISTRIBUTORSHIPS IN THE FIELD OF BAKED GOODS; WHOLESALE DISTRIBUTORSHIPS FEATURING BAKED GOODS (U.S. CLS. 100, 101 AND 102).
FIRST USE 3-0-2000; IN COMMERCE 3-0-2000.
ALICE SUE CARRUTHERS, EXAMINING ATTORNEY

CLASS 35—(Continued).

SN 76-557,778. THE REVNEW GROUP, INC., ST. CHARLES, IL. FILED 10-20-2003.



NO CLAIM IS MADE TO THE EXCLUSIVE RIGHT TO USE "THE REVENUE GROUP, INC.", APART FROM THE MARK AS SHOWN.

FOR BUSINESS MANAGEMENT AND CONSULTATION IN THE FIELD OF CLIENT LOYALTY DEVELOPMENT, RELATIONSHIP DEVELOPMENT AND SALES EFFECTIVENESS (U.S. CLS. 100, 101 AND 102).

WILLIAM BRECKENFELD, EXAMINING ATTORNEY

SN 76-561,804. GABLE, TERRI, CHARLOTTESVILLE, VA. FILED 11-24-2003.

BABOO

THE MARK CONSISTS OF STANDARD CHARACTERS WITHOUT CLAIM TO ANY PARTICULAR FONT, STYLE, SIZE, OR COLOR.

FOR RETAIL STORE FEATURING SUPPLIES FOR BEADING AND CRAFT SUPPLIES FOR MAKING ORNAMENTAL AND UTILITARIAN JEWELRY, CLOTHING, ACCESSORIES AND HOUSEHOLD ITEMS (U.S. CLS. 100, 101 AND 102).

FIRST USE 9-1-1994; IN COMMERCE 9-1-1994.

MARY ROSSMAN, EXAMINING ATTORNEY

SN 76-562,386. PERFORMANCE CENTER WHOLESAL, INC., IRVINE, CA. FILED 12-1-2003.

PERFORMANCE CENTER WHOLESAL

OWNER OF U.S. REG. NOS. 262,220 AND 2,682,220. NO CLAIM IS MADE TO THE EXCLUSIVE RIGHT TO USE CENTER WHOLESAL, APART FROM THE MARK AS SHOWN.

FOR DISTRIBUTORSHIP SERVICES IN THE FIELD OF AUTOMOTIVE PARTS (U.S. CLS. 100, 101 AND 102).

FIRST USE 7-0-2001; IN COMMERCE 7-0-2001.

AMY GEARIN, EXAMINING ATTORNEY

CLASS 35—(Continued).

SN 76-562,528. ADAMS, NASH & HASKELL, INC., FT. WRIGHT, KY. FILED 11-19-2003.

POWERSHARING

THE MARK CONSISTS OF STANDARD CHARACTERS WITHOUT CLAIM TO ANY PARTICULAR FONT, STYLE, SIZE, OR COLOR.

SEC. 2(F).

FOR BUSINESS MANAGEMENT CONSULTATION SERVICES (U.S. CLS. 100, 101 AND 102).

FIRST USE 0-0-1980; IN COMMERCE 0-0-1980.

APRIL L. RADEMACHER, EXAMINING ATTORNEY

SN 76-564,680. RYAN & COMPANY, INC., DALLAS, TX. FILED 12-11-2003.

RYAN SALT GATEWAY

THE MARK CONSISTS OF STANDARD CHARACTERS WITHOUT CLAIM TO ANY PARTICULAR FONT, STYLE, SIZE, OR COLOR.

OWNER OF U.S. REG. NO. 2,676,976.

SEC. 2(F) AS TO "SALT GATEWAY".

FOR PROVIDING A COMPREHENSIVE DIRECTORY OF STATE AND LOCAL TAX RELATED INFORMATION ON THE WORLD WIDE WEB, INCLUDING LINKS TO TAXING AUTHORITIES AND OTHER GOVERNMENT AGENCIES, COURTS, STATUTES AND REGULATIONS, ARTICLES, AND RELATED MATERIALS AS WELL AS LINKS TO ORGANIZATIONS FOR TAX PROFESSIONALS, TAX RELATED SOFTWARE, AND RESEARCH AIDS VIA A GLOBAL COMPUTER NETWORK (U.S. CLS. 100, 101 AND 102).

FIRST USE 8-30-1999; IN COMMERCE 8-30-1999.

GINNY ISAACSON, EXAMINING ATTORNEY

CLASS 35—(Continued).

SN 76-569,359. BIG BOB'S NEW & USED CARPET OF AMERICA, INC., SHAWNEE MISSION, KS. FILED 1-12-2004.



OWNER OF U.S. REG. NOS. 1,993,231, 2,531,935 AND OTHERS.

NO CLAIM IS MADE TO THE EXCLUSIVE RIGHT TO USE FLOORING OUTLET, APART FROM THE MARK AS SHOWN.

FOR FRANCHISING, NAMELY TECHNICAL ASSISTANCE IN THE ESTABLISHMENT AND/OR OPERATION OF RETAIL STORE SERVICES FOR THE SALE OF NEW AND USED CARPET AND FLOOR COVERING, RETAIL STORE SERVICES IN THE FIELD OF NEW AND USED CARPET AND FLOOR COVERING (U.S. CLS. 100, 101 AND 102).

FIRST USE 12-1-2003; IN COMMERCE 12-1-2003.
BRIDGETT SMITH, EXAMINING ATTORNEY

SN 76-569,924. DIMENSION ONE SPAS, INC, VISTA, CA. FILED 1-2-2004.

IMMERSED IN THE SCIENCE OF SMILES

THE MARK CONSISTS OF STANDARD CHARACTERS WITHOUT CLAIM TO ANY PARTICULAR FONT, STYLE, SIZE, OR COLOR.

FOR RETAIL STORE SERVICES IN THE FIELD OF SPAS IN THE NATURE OF HEATED POOLS, WHIRLPOOLS, BATHTUBS, HOT TUBS, WHIRLPOOL BATHS, AND RECREATIONAL POOLS (U.S. CLS. 100, 101 AND 102).

FIRST USE 9-24-2002; IN COMMERCE 9-24-2002.
KIM SAITO, EXAMINING ATTORNEY

SN 76-573,496. SKILLSNET CORPORATION, WAXAHACHIE, TX. FILED 2-2-2004.

SKILLOBJECTS

THE MARK CONSISTS OF STANDARD CHARACTERS WITHOUT CLAIM TO ANY PARTICULAR FONT, STYLE, SIZE, OR COLOR.

FOR DEVELOPMENT AND ANALYSIS OF OCCUPATIONAL, WORKFORCE AND EMPLOYMENT STANDARDS RELATING TO SKILLS, STANDARDS, ASSESSMENTS AND CERTIFICATIONS, NAMELY, WORK ANALYSIS TO DETERMINE WORKER SKILL SETS AND OTHER WORKER REQUIREMENTS; JOB PROFILING, NAMELY, TESTING TO DETERMINE JOB COMPETENCY; AND SKILL MANAGEMENT, NAMELY, TESTING TO DETERMINE EMPLOYMENT SKILLS-ALL SERVICES PROVIDED IN PERSON AND ONLINE VIA THE INTERNET (U.S. CLS. 100, 101 AND 102).

FIRST USE 12-0-1997; IN COMMERCE 12-0-1997.
ALICE SUE CARRUTHERS, EXAMINING ATTORNEY

CLASS 35—(Continued).

SN 76-575,529. SOLEMATES LLC, WASHINGTON, DC. FILED 2-13-2004.

SIMPLYSOLES

THE MARK CONSISTS OF STANDARD CHARACTERS WITHOUT CLAIM TO ANY PARTICULAR FONT, STYLE, SIZE, OR COLOR.

FOR RETAIL STORE SERVICES FEATURING CLOTHING, SHOES, HOSIERY, SOCKS, AND ACCESSORIES, NAMELY, HANDBAGS, JEWELRY, HATS, SCARVES AND BELTS; ON-LINE RETAIL STORE SERVICES FEATURING CLOTHING, SHOES, HOSIERY, SOCKS, AND ACCESSORIES, NAMELY, HANDBAGS, JEWELRY, HATS, SCARVES AND BELTS; AND MAIL ORDER CATALOG SERVICES FEATURING CLOTHING, SHOES, HOSIERY, SOCKS, AND ACCESSORIES, NAMELY, HANDBAGS, JEWELRY, HATS, SCARVES AND BELTS (U.S. CLS. 100, 101 AND 102).

FIRST USE 2-2-2004; IN COMMERCE 8-20-2004.
FRED MANDIR, EXAMINING ATTORNEY

SN 76-576,020. BOARD SPORTS MANAGEMENT, INC., INDIALANTIC, FL. FILED 2-17-2004.



NO CLAIM IS MADE TO THE EXCLUSIVE RIGHT TO USE BOARDSPORTS MANAGEMENT, APART FROM THE MARK AS SHOWN.

THE MARK CONSISTS OF LOWERCASE LETTERS FORMING WORDS "BOARDSPORTS MANAGEMENT" WITH AN ARCHED LINE FLOWING FROM TOP OF LETTER "B" ACROSS WORD "BOARDSPORTS" IN THE MARK AND ENDING IN A MODIFIED ARROW AT THE LETTER "S" IN THE WORD "BOARDSPORTS". TWO PARALLEL CURVED LINES FLOW BACKWARDS FROM BOTTOM OF "B" IN THE WORD "BOARDSPORTS," CONSISTING OF ABOUT 1/3 OF THE SIZE OF THE ENTIRE MARK. THE TOP OF THE TWO PARALLEL CURVED LINES IS SLIGHTLY DARKER THAN THE BOTTOM PARALLEL CURVED LINE.

FOR MANAGEMENT OF PROFESSIONAL ATHLETES (U.S. CLS. 100, 101 AND 102).
FIRST USE 1-1-2004; IN COMMERCE 1-1-2004.
STANLEY I. OSBORNE, EXAMINING ATTORNEY

CLASS 35—(Continued).

SN 76-576,833. JORDAN ANDERSON INCORPORATED, NEW YORK, NY. FILED 2-23-2004.



NO CLAIM IS MADE TO THE EXCLUSIVE RIGHT TO USE "PRODUCT", APART FROM THE MARK AS SHOWN. FOR ADVERTISING AND BUSINESS MARKETING CONSULTING SERVICES, NAMELY CREATING CORPORATE AND BRAND IDENTITY FOR OTHERS THAT FEATURES CREATING PERSONAL PROFILES FOR THE PURPOSE OF INTERNAL AND/OR EXTERNAL BRANDING THROUGH A CUSTOMIZED PROCESS (U.S. CLS. 100, 101 AND 102).
FIRST USE 11-5-2001; IN COMMERCE 4-11-2003.
TANYA AMOS, EXAMINING ATTORNEY

SN 76-576,844. THE MHA GROUP, INC., IRVING, TX. FILED 2-23-2004.

THE MHA GROUP

THE MARK CONSISTS OF STANDARD CHARACTERS WITHOUT CLAIM TO ANY PARTICULAR FONT, STYLE, SIZE, OR COLOR.
NO CLAIM IS MADE TO THE EXCLUSIVE RIGHT TO USE "GROUP", APART FROM THE MARK AS SHOWN. FOR MEDICAL STAFFING SERVICES IN THE HEALTHCARE FIELD (U.S. CLS. 100, 101 AND 102).
FIRST USE 7-0-1997; IN COMMERCE 7-0-1997.
MONIQUE MILLER, EXAMINING ATTORNEY

SN 76-579,586. JOHNSON, MARY SEAN, DBA ORGANIZED BLISS, MT. PLEASANT, SC. FILED 3-8-2004.

ORGANIZED BLISS

THE MARK CONSISTS OF STANDARD CHARACTERS WITHOUT CLAIM TO ANY PARTICULAR FONT, STYLE, SIZE, OR COLOR.
FOR PROFESSIONAL ORGANIZING SERVICES FOR INDIVIDUALS AT HOME, IN HOME OFFICES AND IN BUSINESS OFFICES (U.S. CLS. 100, 101 AND 102).
FIRST USE 4-0-2003; IN COMMERCE 4-0-2003.
DOMINICK J. SALEMI, EXAMINING ATTORNEY

CLASS 35—(Continued).

SN 76-580,039. MUÑOZ, OSCAR, CHICAGO, IL. FILED 3-9-2004.



NO CLAIM IS MADE TO THE EXCLUSIVE RIGHT TO USE "FOOD PRODUCTS, INC.", APART FROM THE MARK AS SHOWN. FOR WHOLESALE DISTRIBUTORSHIP IN THE FIELD OF FOOD PRODUCTS (U.S. CLS. 100, 101 AND 102).
FIRST USE 1-0-1996; IN COMMERCE 1-0-1996.
CHRISIE B. KING, EXAMINING ATTORNEY

SN 76-581,199. PAWSENCLAWS & CO, LLC, HEWLETT, NY. FILED 3-16-2004.



OWNER OF U.S. REG. NOS. 2,686,098, 2,706,715 AND OTHERS.
THE MARK CONSISTS OF THE WORDS "PAWS XPRESS" WITH THE FACE OF A BEAR AND A PAW PRINT INSIDE THE LETTER "W" IN "PAWS" AND INSIDE THE LETTER "X" IN "XPRESS".
FOR RETAIL STORE SERVICES FEATURING STUFFED TOYS CUSTOM-MADE BY CHILDREN AND ADULTS, AND ACCESSORIES THEREFORE; RETAIL STORE SERVICES FEATURING PARTIES DURING WHICH CHILDREN AND ADULTS CUSTOM MAKE STUFFED TOYS (U.S. CLS. 100, 101 AND 102).
FIRST USE 6-1-2003; IN COMMERCE 6-1-2003.
MARCIE MILONE, EXAMINING ATTORNEY

SN 76-581,376. METAL MASTER SALES CORPORATION, GLENDALE HEIGHTS, IL. FILED 3-15-2004.

METAL MASTER

THE MARK CONSISTS OF STANDARD CHARACTERS WITHOUT CLAIM TO ANY PARTICULAR FONT, STYLE, SIZE, OR COLOR.
NO CLAIM IS MADE TO THE EXCLUSIVE RIGHT TO USE "METAL", APART FROM THE MARK AS SHOWN. FOR PROCUREMENT AND DISTRIBUTORSHIPS IN THE FIELD OF STEEL PRODUCTS TO THIRD PARTIES FOR GENERAL INDUSTRIAL, CONSTRUCTION, AND AGRICULTURAL USE (U.S. CLS. 100, 101 AND 102).
FIRST USE 6-1-1989; IN COMMERCE 6-1-1989.
JAMES A. RAUEN, EXAMINING ATTORNEY

CLASS 35—(Continued).

SN 76-581,768. MEDIMPACT HEALTHCARE SYSTEMS, INC., SAN DIEGO, CA. FILED 3-18-2004.

CLASS 35—(Continued).

SN 76-584,262. AUTOWARE, INC, POMPANO BEACH, FL. FILED 3-29-2004.



GET ROLLING

NO CLAIM IS MADE TO THE EXCLUSIVE RIGHT TO USE "AMERICA'S PHARMACY", APART FROM THE MARK AS SHOWN.

THE COLORS RED, WHITE AND BLUE ARE CLAIMED AS A FEATURE OF THE MARK.

THE CURVED STRIPES SHOW THE COLORS RED, WHITE AND BLUE FROM THE TOP TO BOTTOM. THE STAR AND THE WORDING AMERICA'S PHARMACY POWERED BY MEDIMPACT APPEAR IN BLUE.

FOR ADMINISTRATION OF A PROGRAM FOR ENABLING CONSUMERS TO PARTICIPATE IN PHARMACY REIMBURSEMENT PROGRAMS THROUGH THE USE OF A MEMBERSHIP CARD; ADMINISTERING PHARMACY REIMBURSEMENT PROGRAMS AND SERVICES (U.S. CLS. 100, 101 AND 102).

FIRST USE 1-29-2004; IN COMMERCE 1-29-2004.
AMY ALFIERI, EXAMINING ATTORNEY

THE MARK CONSISTS OF STANDARD CHARACTERS WITHOUT CLAIM TO ANY PARTICULAR FONT, STYLE, SIZE, OR COLOR.

FOR PRODUCT MARKETING SERVICES FOR OTHERS FOR THE SALE OF VEHICLE ACCESSORY PACKAGES BASED ON CONSUMER LIFESTYLES AND DRIVING HABITS OFFERED THROUGH PARTICIPATING NEW AND USED CAR DEALERSHIPS (U.S. CLS. 100, 101 AND 102).

FIRST USE 1-2-2003; IN COMMERCE 1-2-2003.
ERNEST SHOSHO, EXAMINING ATTORNEY

SN 76-584,245. DAR COURT, ERNESTO, BELL, CA. FILED 3-31-2004.

SN 76-584,263. AUTOWARE, INC, POMPANO BEACH, FL. FILED 3-29-2004.



GET TINTED

THE DESIGN FEATURE OF THE MARK IS A FANCIFUL REPRESENTATION OF THE LETTER M.

FOR RETAIL STORE SERVICES FEATURING PHONE-IN ORDER, RETAIL STORE, MAIL ORDER, MAIL ORDER CATALOG, COMPUTERIZED ON-LINE ORDERING AND WHOLESALE SERVICES FEATURING CLOTHING, WATCHES, HOUSEHOLD ITEMS, HAND CRAFT ITEMS, TOYS, ARTWORKS, MUSICAL GIFTS, GIFT BASKETS, FLOWERS, KITCHENWARE, AND PARTY SUPPLIES; IMPORT AND EXPORT SERVICES (U.S. CLS. 100, 101 AND 102).

AMOS T. MATTHEWS, JR., EXAMINING ATTORNEY

THE MARK CONSISTS OF STANDARD CHARACTERS WITHOUT CLAIM TO ANY PARTICULAR FONT, STYLE, SIZE, OR COLOR.

NO CLAIM IS MADE TO THE EXCLUSIVE RIGHT TO USE "TINTED", APART FROM THE MARK AS SHOWN.

FOR PRODUCT MARKETING SERVICES FOR OTHERS FOR THE SALE OF VEHICLE ACCESSORY PACKAGES BASED ON CONSUMER LIFESTYLES AND DRIVING HABITS OFFERED THROUGH PARTICIPATING NEW AND USED CAR DEALERSHIPS (U.S. CLS. 100, 101 AND 102).

FIRST USE 3-4-2004; IN COMMERCE 3-4-2004.
ERNEST SHOSHO, EXAMINING ATTORNEY

CLASS 35—(Continued).

SN 76-584,404. GEO. W. PARK SEED COMPANY, INC., GREENWOOD, SC. FILED 4-1-2004.



OWNER OF U.S. REG. NOS. 1,722,271, 1,846,411 AND 2,102,255.

NO CLAIM IS MADE TO THE EXCLUSIVE RIGHT TO USE "SEED WHOLESALE", APART FROM THE MARK AS SHOWN.

FOR WHOLESALE AND ON-LINE WHOLESALE DISTRIBUTORSHIPS FEATURING LIVE GOODS, NAMELY, SEEDS, PLANTS, BULBS AND WHOLESALE AND ON-LINE WHOLESALE DISTRIBUTORSHIPS FEATURING ACCESSORY HARD GOODS, NAMELY, FLORIST SUPPLIES, SEED-STARTING SUPPLIES, FERTILIZER, SOIL MIX, POTS, BASKETS, INSERTS, FLATS, TRAYS AND GREENHOUSES AND SUPPLIES THEREFOR, SEEDING TOOLS AND EQUIPMENT, IRRIGATION EQUIPMENT AND SUPPLIES, SPRAYERS, PROTECTIVE GLOVES AND CLOTHING, AND REFERENCE BOOKS (U.S. CLS. 100, 101 AND 102).

FIRST USE 2-28-1985; IN COMMERCE 2-28-1985.
JENNIFER CHICOSKI, EXAMINING ATTORNEY

SN 76-584,862. CALIFORNIA MILK PROCESSOR BOARD, AKA CALIFORNIA FLUID MILK PROCESSOR ADVISORY BOARD, BERKELEY, CA. FILED 4-5-2004.

GOT LICUADOS?

THE MARK CONSISTS OF STANDARD CHARACTERS WITHOUT CLAIM TO ANY PARTICULAR FONT, STYLE, SIZE, OR COLOR.

OWNER OF U.S. REG. NO. 1,903,870.

THE FOREIGN WORDING IN THE MARK TRANSLATES INTO ENGLISH AS A MILK AND FRUIT BASED BEVERAGE SIMILAR TO A SMOOTHIE.

FOR ASSOCIATION SERVICES PROVIDED TO MILK PROCESSORS, NAMELY, ADVERTISING AND PROMOTING THE SALE, USE AND CONSUMPTION OF MILK-BASED BEVERAGES (U.S. CLS. 100, 101 AND 102).

CATHERINE CAIN, EXAMINING ATTORNEY

CLASS 35—(Continued).

SN 76-585,983. ALLIANCE DIRECT MARKETING, INC., DBA AUTOMOTIVE ALLIANCE, INC., CAMARILLO, CA. FILED 4-9-2004.

4 STAR CERTIFIED CONSUMER ALLIANCE

THE MARK CONSISTS OF STANDARD CHARACTERS WITHOUT CLAIM TO ANY PARTICULAR FONT, STYLE, SIZE, OR COLOR.

NO CLAIM IS MADE TO THE EXCLUSIVE RIGHT TO USE "CERTIFIED CONSUMER ALLIANCE", APART FROM THE MARK AS SHOWN.

FOR AUTOMOBILE BUYING PROGRAMS, NAMELY, PROMOTING THE SALE OF AUTOMOBILES THROUGH THE ADMINISTRATION OF INCENTIVE AWARD PROGRAMS (U.S. CLS. 100, 101 AND 102).

FIRST USE 3-17-2004; IN COMMERCE 3-17-2004.
RENEE MCCRAY, EXAMINING ATTORNEY

SN 76-586,081. SPECIAL LIBRARIES ASSOCIATION, INC., WASHINGTON, DC. FILED 4-12-2004.

SLA

THE MARK CONSISTS OF STANDARD CHARACTERS WITHOUT CLAIM TO ANY PARTICULAR FONT, STYLE, SIZE, OR COLOR.

FOR ASSOCIATION SERVICES, NAMELY PROMOTING THE INTERESTS OF INFORMATION PROFESSIONALS, SPECIAL LIBRARIANS AND OTHER INFORMATION RESOURCE EXPERTS (U.S. CLS. 100, 101 AND 102).

FIRST USE 2-27-2004; IN COMMERCE 2-27-2004.
MATTHEW PAPPAS, EXAMINING ATTORNEY

SN 76-586,116. OMNI AUTOMOTIVE SOUTH, INC., BOCA RATON, FL. FILED 4-12-2004.

SAMMY THE SLASHER

THE MARK CONSISTS OF STANDARD CHARACTERS WITHOUT CLAIM TO ANY PARTICULAR FONT, STYLE, SIZE, OR COLOR.

FOR ADVERTISING SERVICES, NAMELY, PROMOTING THE GOODS AND SERVICES OF MOTOR VEHICLE DEALERSHIPS (U.S. CLS. 100, 101 AND 102).

FIRST USE 1-22-2004; IN COMMERCE 1-22-2004.
ELLEN B. AWRICH, EXAMINING ATTORNEY

CLASS 35—(Continued).

SN 76-586,191. AMERICAN BLIND AND WALLPAPER FACTORY, INC., PLYMOUTH, MI. FILED 4-12-2004.

AMERICAN BLINDS

OWNER OF U.S. REG. NOS. 1,463,548 AND 2,022,925.
NO CLAIM IS MADE TO THE EXCLUSIVE RIGHT TO USE "BLINDS", APART FROM THE MARK AS SHOWN.
FOR MAIL ORDER CATALOG SERVICES AND ON-LINE ORDERING SERVICES FEATURING BLINDS, DRAPERIES, WALL AND WINDOW COVERINGS, AND HOME FURNISHINGS (U.S. CLS. 100, 101 AND 102).
INGA ERVIN, EXAMINING ATTORNEY

SN 76-586,711. CORNERSTONE RELOCATION GROUP, LLC, EVANSVILLE, IN. FILED 4-14-2004.

**Cornerstone Relocation Group**

NO CLAIM IS MADE TO THE EXCLUSIVE RIGHT TO USE RELOCATION GROUP, APART FROM THE MARK AS SHOWN.

THE MARK CONSISTS OF AN INCOMPLETE SQUARE AND LETTER C DESIGN.
FOR CORPORATE RELOCATION SERVICES (U.S. CLS. 100, 101 AND 102).
FIRST USE 1-1-1990; IN COMMERCE 1-1-1990.
ZHALEH DELANEY, EXAMINING ATTORNEY

SN 76-586,839. DEREMATE.COM, INC., MIAMI, FL. FILED 4-15-2004.

LA COMUNIDAD LIDER EN COMPRA Y VENTA

THE MARK CONSISTS OF STANDARD CHARACTERS WITHOUT CLAIM TO ANY PARTICULAR FONT, STYLE, SIZE, OR COLOR.

NO CLAIM IS MADE TO THE EXCLUSIVE RIGHT TO USE COMPRA Y VENTA, APART FROM THE MARK AS SHOWN.

THE FOREIGN WORDING IN THE MARK TRANSLATES INTO ENGLISH AS "THE LEADING COMMUNITY FOR BUYING AND SELLING."

FOR AUCTIONS CONDUCTED VIA GLOBAL COMPUTER NETWORKS; ON-LINE TRADING SERVICES IN WHICH A SELLER WILL POST ITEMS TO BE SOLD AND POTENTIAL BUYERS SUBMIT THEIR OFFERS TO PURCHASE THE ITEMS ELECTRONICALLY IN AN AUCTION FORMAT, AND PROVIDING A FORUM FOR EVALUATIVE FEEDBACK AND RATINGS BY USERS OF THE SERVICES, FOR (I) SELLERS' GOODS AND SERVICES, (II) THE VALUE AND PRICES OF SELLERS' GOODS, AND (III) BUYERS' AND SELLERS' PERFORMANCE, DELIVERY AND OVERALL TRADING EXPERIENCE IN CONNECTION THEREWITH (U.S. CLS. 100, 101 AND 102).

FIRST USE 3-0-2003; IN COMMERCE 3-0-2003.
TRACY WHITAKER-BOWN, EXAMINING ATTORNEY

CLASS 35—(Continued).

SN 76-586,946. MIDTOWN COMICS, INC., DBA MIDTOWN COMICS, NEW YORK, NY. FILED 4-13-2004.



OWNER OF U.S. REG. NO. 2,827,263.
NO CLAIM IS MADE TO THE EXCLUSIVE RIGHT TO USE "COMICS" AND "NYC", APART FROM THE MARK AS SHOWN.

FOR RETAIL STORE SERVICES FEATURING COMIC BOOKS, BOOKS RELATED TO COMIC BOOKS, GRAPHIC NOVELS, TRADE PAPERBACKS AND ANTHOLOGIES OF COMICS, TOYS, ACTION FIGURES, STATUES, PRERECORDED VIDEOTAPES AND DIGITAL VIDEO DISCS FEATURING COMIC BOOK CHARACTERS, MODEL KITS FEATURING COMIC BOOK CHARACTERS, PROTECTIVE COVERINGS FOR COMIC BOOKS, AND T-SHIRTS; ONLINE ORDERING SERVICES FEATURING COMIC BOOKS, BOOKS RELATED TO COMIC BOOKS, GRAPHIC NOVELS, TRADE PAPERBACKS AND ANTHOLOGIES OF COMICS, TOYS, ACTION FIGURES, STATUES, PRERECORDED VIDEOTAPES AND DIGITAL VIDEO DISCS FEATURING COMIC BOOK CHARACTERS, MODEL KITS FEATURING COMIC BOOK CHARACTERS, PROTECTIVE COVERINGS FOR COMIC BOOKS, AND T-SHIRTS (U.S. CLS. 100, 101 AND 102).

FIRST USE 3-1-2004; IN COMMERCE 3-1-2004.
KATHLEEN M. VANSTON, EXAMINING ATTORNEY

SN 76-587,811. MARCO DESTIN, INC., MIAMI, FL. FILED 4-20-2004.

ALVIN'S ISLAND

THE MARK CONSISTS OF STANDARD CHARACTERS WITHOUT CLAIM TO ANY PARTICULAR FONT, STYLE, SIZE, OR COLOR.

FOR RETAIL CLOTHING, GIFT AND SOUVENIR STORE SERVICES (U.S. CLS. 100, 101 AND 102).
FIRST USE 6-0-1965; IN COMMERCE 6-0-1965.
ELLEN PERKINS, EXAMINING ATTORNEY

CLASS 35—(Continued).

SN 76-587,812. MARCO DESTIN, INC., MIAMI, FL. FILED 4-20-2004.

ALVIN'S ISLAND TROPICAL DEPARTMENT STORES

THE MARK CONSISTS OF STANDARD CHARACTERS WITHOUT CLAIM TO ANY PARTICULAR FONT, STYLE, SIZE, OR COLOR.

NO CLAIM IS MADE TO THE EXCLUSIVE RIGHT TO USE "DEPARTMENT STORES", APART FROM THE MARK AS SHOWN.

FOR RETAIL CLOTHING, GIFT AND SOUVENIR STORE SERVICES (U.S. CLS. 100, 101 AND 102).

FIRST USE 4-0-1974; IN COMMERCE 4-0-1974.

MARIA-VICTORIA SUAREZ, EXAMINING ATTORNEY

SN 76-587,813. MARCO DESTIN, INC., MIAMI, FL. FILED 4-20-2004.

ALVIN'S

THE MARK CONSISTS OF STANDARD CHARACTERS WITHOUT CLAIM TO ANY PARTICULAR FONT, STYLE, SIZE, OR COLOR.

FOR RETAIL CLOTHING, GIFT AND SOUVENIR STORE SERVICES (U.S. CLS. 100, 101 AND 102).

FIRST USE 6-3-1950; IN COMMERCE 6-3-1950.

MARIA-VICTORIA SUAREZ, EXAMINING ATTORNEY

SN 76-589,122. CIRCLE COMPANY ASSOCIATES, INC., BOSTON, MA. FILED 4-28-2004.

CIRCLES

THE MARK CONSISTS OF STANDARD CHARACTERS WITHOUT CLAIM TO ANY PARTICULAR FONT, STYLE, SIZE, OR COLOR.

OWNER OF U.S. REG. NO. 2,192,300.
FOR BUSINESS MARKETING SERVICES (U.S. CLS. 100, 101 AND 102).

FIRST USE 3-1-1997; IN COMMERCE 3-1-1997.

G. MAYERSCHOFF, EXAMINING ATTORNEY

CLASS 35—(Continued).

SN 76-589,640. WOODWARD COMMUNICATIONS, INC., DUBUQUE, IA. FILED 4-23-2004.

SHOP TALK

THE MARK CONSISTS OF STANDARD CHARACTERS WITHOUT CLAIM TO ANY PARTICULAR FONT, STYLE, SIZE, OR COLOR.

FOR PROVIDING ADVERTISING SPACE IN A PERIODICAL REGARDING METAL WORKING MACHINES AND PRODUCTS (U.S. CLS. 100, 101 AND 102).

FIRST USE 9-1-1974; IN COMMERCE 9-1-1974.

G. MAYERSCHOFF, EXAMINING ATTORNEY

SN 76-589,651. ARTHO CORPORATION, RIVERSIDE, IL. FILED 4-23-2004.

THE NERDY WORM

THE MARK CONSISTS OF STANDARD CHARACTERS WITHOUT CLAIM TO ANY PARTICULAR FONT, STYLE, SIZE, OR COLOR.

FOR ON LINE EXCHANGE SERVICES NAMELY BARTERING OF BOOKS FOR OTHERS (U.S. CLS. 100, 101 AND 102).

FIRST USE 4-22-2004; IN COMMERCE 4-22-2004.

HENRY S. ZAK, EXAMINING ATTORNEY

SN 76-590,256. NEL-CO DEVELOPMENT, INC., GOLDEN EAGLE, IL. FILED 5-4-2004.

eVILLA

FOR REAL ESTATE ADVERTISING SERVICES; REAL ESTATE SALES MANAGEMENT (U.S. CLS. 100, 101 AND 102).

FIRST USE 5-2-2004; IN COMMERCE 5-2-2004.

ELISSA GARBER KON, EXAMINING ATTORNEY

CLASS 35—(Continued).

SN 76-590,258. WORLD LEADERSHIP GROUP, INC., SUWANEE, GA. FILED 5-4-2004.

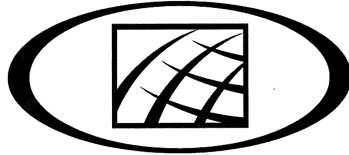

DESIGN OF A PARTIAL GLOBE DEPICTING LINES OF LONGITUDE AND LATITUDE INSIDE A SQUARE SURROUNDED BY AN OVAL.

FOR MULTI-LEVEL MARKETING BUSINESS SERVICES, NAMELY, THE PROMOTION OF SALES OF FINANCIAL, INTERNET, AND TELEPHONY PRODUCTS AND SERVICES OF OTHERS BY OR THROUGH THE INTERNET, DISTRIBUTION OF PRINTED AND AUDIO PROMOTIONAL MATERIALS, AND BY RENDERING SALES PROMOTION ADVICE (U.S. CLS. 100, 101 AND 102).

FIRST USE 3-26-1992; IN COMMERCE 3-26-1992.
ESTHER A. BORSUK, EXAMINING ATTORNEY

SN 76-591,085. AMC, INC., ATLANTA, GA. FILED 5-7-2004.

A-FACTOR

THE MARK CONSISTS OF STANDARD CHARACTERS WITHOUT CLAIM TO ANY PARTICULAR FONT, STYLE, SIZE, OR COLOR.

FOR ADVERTISING, PROMOTION, AND MARKETING SERVICES PROVIDED TO THIRD PARTIES IN THE GIFT AND HOME FURNISHINGS INDUSTRIES IN CONNECTION WITH THEIR EXHIBITION OF GOODS AT TRADE SHOWS (U.S. CLS. 100, 101 AND 102).

BARBARA BROWN, EXAMINING ATTORNEY

SN 76-591,273. CANAMERICO CORPORATION, BROWNSVILLE, TX. FILED 5-10-2004.

THE UNIFORM BOYS

THE MARK CONSISTS OF STANDARD CHARACTERS WITHOUT CLAIM TO ANY PARTICULAR FONT, STYLE, SIZE, OR COLOR.

NO CLAIM IS MADE TO THE EXCLUSIVE RIGHT TO USE "UNIFORM", APART FROM THE MARK AS SHOWN.

FOR RETAIL STORE SERVICES, ONLINE RETAIL STORE SERVICES AND MAIL ORDER CATALOG SERVICES, ALL FEATURING UNIFORMS (U.S. CLS. 100, 101 AND 102).

RONALD MCMORROW, EXAMINING ATTORNEY

CLASS 35—(Continued).

SN 76-591,681. INDIAN ROCK VINEYARDS, MURPHYS, CA. FILED 5-12-2004.

INDIAN ROCK VINEYARDS

THE MARK CONSISTS OF STANDARD CHARACTERS WITHOUT CLAIM TO ANY PARTICULAR FONT, STYLE, SIZE, OR COLOR.

NO CLAIM IS MADE TO THE EXCLUSIVE RIGHT TO USE "VINEYARDS", APART FROM THE MARK AS SHOWN.

FOR WINERY SERVICES, NAMELY, A RETAIL STORE FEATURING WINE AND OFFERING SAMPLES OF WINE (U.S. CLS. 100, 101 AND 102).

ANDREA SAUNDERS, EXAMINING ATTORNEY

SN 76-592,490. MARCO OPHTHALMIC, INC., JACKSONVILLE, FL. FILED 5-17-2004.

THE LEADER IN VISION DIAGNOSTICS

NO CLAIM IS MADE TO THE EXCLUSIVE RIGHT TO USE VISION DIAGNOSTICS, APART FROM THE MARK AS SHOWN.

FOR RETAIL SERVICES BY DIRECT SOLICITATION BY SALES AGENTS IN THE FIELD OF OPHTHALMOLOGIC EQUIPMENT AND ONLINE RETAIL STORE SERVICES AND MAIL ORDER SERVICES FEATURING OPHTHALMOLOGIC EQUIPMENT (U.S. CLS. 100, 101 AND 102).

FIRST USE 4-12-2003; IN COMMERCE 4-12-2003.
SUSAN LESLIE DUBOIS, EXAMINING ATTORNEY

CLASS 35—(Continued).

SN 76-594,087. I2 TECHNOLOGIES US, INC., DALLAS, TX.
FILED 5-26-2004.



OWNER OF U.S. REG. NOS. 1,943,519, 2,508,786 AND OTHERS.

NO CLAIM IS MADE TO THE EXCLUSIVE RIGHT TO USE "USER GROUP", APART FROM THE MARK AS SHOWN.

FOR ASSOCIATION SERVICES, NAMELY, PROMOTING THE INTERESTS OF CUSTOMERS, PARTNERS, VENDORS, EMPLOYEES, DEVELOPERS AND CONSULTANTS BY VOLUNTEERS WHO SHARE AND PROMOTE KNOWLEDGE AND INFORMATION REGARDING THE FOLLOWING SUBJECTS— INSTALLATION AND REPAIR OF COMPUTER SOFTWARE AND DATABASE CONTENT, SUPPORT AND MAINTENANCE OF COMPUTER SOFTWARE AND DATABASE CONTENT IN THE FIELDS OF SCHEDULING, PLANNING, PRODUCT DEVELOPMENT, SALES AND MARKETING, CUSTOMER SERVICES, WORKFORCE PLANNING, PROJECT MANAGEMENT, SUPPLY CHAIN MANAGEMENT, CUSTOMER MANAGEMENT, STRATEGIC PLANNING, DATABASE MANAGEMENT, SYNCHRONIZATION OF OPERATIONAL ACTIVITIES, PRODUCT LIFE-CYCLE MANAGEMENT AND SUPPLY CHAIN MANAGEMENT PROCESSES, FOR THE SELECTION, IMPLEMENTATION AND EFFECTIVE USE BY EMPLOYEES, USERS, VENDORS, CUSTOMERS AND CONSULTANTS (U.S. CLS. 100, 101 AND 102).

FIRST USE 3-0-2001; IN COMMERCE 3-0-2001.

NORA BUCHANAN WILL, EXAMINING ATTORNEY

SN 76-594,119. ABM OFFICE SUPPLY CO., INC., SAINT CHARLES, MO. FILED 5-25-2004.

WWW.ABMSUPPLIES.COM

THE MARK CONSISTS OF STANDARD CHARACTERS WITHOUT CLAIM TO ANY PARTICULAR FONT, STYLE, SIZE, OR COLOR.

OWNER OF U.S. REG. NOS. 2,548,789, 2,557,644 AND 2,755,615.

FOR DISTRIBUTORSHIP SERVICES IN THE FIELD OF COMPUTER RELATED SUPPLIES (U.S. CLS. 100, 101 AND 102).

FIRST USE 0-0-1999; IN COMMERCE 0-0-1999.

TINA L. SNAPP, EXAMINING ATTORNEY

CLASS 35—(Continued).

SN 76-594,265. GIULIANI, RUDOLPH W., NEW YORK, NY.
FILED 5-21-2004.

GIULIANI PARTNERS

THE MARK CONSISTS OF STANDARD CHARACTERS WITHOUT CLAIM TO ANY PARTICULAR FONT, STYLE, SIZE, OR COLOR.

NO CLAIM IS MADE TO THE EXCLUSIVE RIGHT TO USE PARTNERS, APART FROM THE MARK AS SHOWN.

FOR BUSINESS CONSULTING SERVICES IN THE FIELD OF SAFETY AND SECURITY, AND GOVERNMENT CONSULTING SERVICES (U.S. CLS. 100, 101 AND 102).

FIRST USE 1-0-2002; IN COMMERCE 1-0-2002.

CHERYL STEPLIGHT, EXAMINING ATTORNEY

SN 76-594,698. RADIN, STACEY, NEW YORK, NY. AND LEVINE, JAMIE, WESTON, CT. FILED 5-28-2004.

MOMATHON

THE MARK CONSISTS OF STANDARD CHARACTERS WITHOUT CLAIM TO ANY PARTICULAR FONT, STYLE, SIZE, OR COLOR.

FOR ARRANGING AND CONDUCTING TRADE SHOWS AND PROVIDING CONSUMER INFORMATION ABOUT PRODUCTS AND SERVICES FOR AND CONCERNING PREGNANT WOMEN AND MOTHERS OF BABIES AND PRESCHOOLERS (U.S. CLS. 100, 101 AND 102).

FIRST USE 5-8-2004; IN COMMERCE 5-8-2004.

LA TONIA FISHER, EXAMINING ATTORNEY

SN 76-595,013. MARATHON FINANCIAL GROUP, LTD., GARDEN CITY, NY. FILED 6-1-2004.



NO CLAIM IS MADE TO THE EXCLUSIVE RIGHT TO USE "PAYROLL SERVICES", APART FROM THE MARK AS SHOWN.

FOR PROVIDING COMPUTING, DATA, AND PROFESSIONAL SERVICES TO EMPLOYERS, NAMELY, PAYROLL PROCESSING, TAX DEPOSIT FILING AND REPORTING, HUMAN RESOURCES, MANAGEMENT, EMPLOYEE TIME AND ATTENDANCE RECORD KEEPING AND BUSINESS MANAGEMENT CONSULTING; MANAGEMENT CONSULTING IN THE FIELDS OF ACCOUNTING (U.S. CLS. 100, 101 AND 102).

FIRST USE 12-0-2002; IN COMMERCE 12-0-2002.

BRIAN NEVILLE, EXAMINING ATTORNEY

CLASS 35—(Continued).

SN 76-595,326. MARATHON FINANCIAL GROUP, LTD., GARDEN CITY, NY. FILED 6-2-2004.



NO CLAIM IS MADE TO THE EXCLUSIVE RIGHT TO USE "CONSULTING", APART FROM THE MARK AS SHOWN.

FOR PROVIDING TAX PREPARATION, TAX PLANNING, BUSINESS PLANS, COMPUTING, DATA, AND PROFESSIONAL SERVICES TO EMPLOYERS, NAMELY, PAYROLL PROCESSING, TAX DEPOSIT FILING AND REPORTING, HUMAN RESOURCES, MANAGEMENT, EMPLOYEE TIME AND ATTENDANCE RECORD KEEPING AND BUSINESS MANAGEMENT CONSULTING; MANAGEMENT CONSULTING IN THE FIELDS OF ACCOUNTING, INVENTORY CONTROL, SCHEDULING, LEASING, SALES, SERVICING, MARKETING, CREDIT PROCESSING (U.S. CLS. 100, 101 AND 102).

FIRST USE 1-4-2003; IN COMMERCE 1-4-2003.
BRIAN NEVILLE, EXAMINING ATTORNEY

SN 76-596,300. CORPORATION FOR INTERNATIONAL BUSINESS, BARRINGTON, IL. FILED 6-7-2004.

BOOMERANG FREIGHT

THE MARK CONSISTS OF STANDARD CHARACTERS WITHOUT CLAIM TO ANY PARTICULAR FONT, STYLE, SIZE, OR COLOR.

NO CLAIM IS MADE TO THE EXCLUSIVE RIGHT TO USE "FREIGHT", APART FROM THE MARK AS SHOWN.

FOR CUSTOMS CLEARANCE SERVICES FOR TEMPORARY EXPORTS IN THE NATURE OF ARRANGING FOR ATA CARNETS, COMMONLY KNOWN AS A PASSPORT FOR GOODS TRAVELING BETWEEN NATIONS, ARRANGING FOR FREIGHT TRANSFER AND TRANSPORTATION OF GOODS, AND MANAGING THE LOGISTICS RELATING TO IMPORT/EXPORT OF GOODS BETWEEN NATIONS (U.S. CLS. 100, 101 AND 102).

FIRST USE 5-5-2003; IN COMMERCE 5-5-2003.
MARK RADEMACHER, EXAMINING ATTORNEY

CLASS 35—(Continued).

SN 76-597,423. NORTH TREE ENTERPRISES, INC., MARINA, CA. FILED 6-16-2004.

FIRE CAMP CLERICAL

THE MARK CONSISTS OF STANDARD CHARACTERS WITHOUT CLAIM TO ANY PARTICULAR FONT, STYLE, SIZE, OR COLOR.

NO CLAIM IS MADE TO THE EXCLUSIVE RIGHT TO USE "CLERICAL", APART FROM THE MARK AS SHOWN.

FOR BUSINESS MANAGEMENT OF BEHIND THE SCENES EMERGENCY INCIDENTS, NAMELY THE COMPILATION OF DOCUMENTATION FOR THE FINAL AFTER ACTION NARRATIVE REPORT; WORD PROCESSING FOR DAMAGE ASSESSMENT TEAMS, INCIDENT ACTION PLANS, MEDIA STATEMENTS AND INDIVIDUAL NARRATIVES IN RELATION TO EMERGENCY INCIDENTS (U.S. CLS. 100, 101 AND 102).

FIRST USE 1-1-1997; IN COMMERCE 1-1-1997.
DAVID MURRAY, EXAMINING ATTORNEY

SN 76-598,109. CSM WORLDWIDE, INC., FARMINGTON HILLS, MI. FILED 6-18-2004.

csm | worldwide

NO CLAIM IS MADE TO THE EXCLUSIVE RIGHT TO USE "WORLDWIDE", APART FROM THE MARK AS SHOWN.

FOR BUSINESS RESEARCH SERVICES PROVIDED TO THE AUTOMOTIVE INDUSTRY, NAMELY, MARKET ANALYSIS, RESEARCH, AND DATA COMPILATION, ECONOMIC FORECASTING, ANALYSIS, AND DATA COMPILATION, PROFIT SURVEY, ANALYSIS, AND DATA COMPILATION, AND CORPORATE AND MARKET COMPETITIVE ANALYSIS SERVICES (U.S. CLS. 100, 101 AND 102).

FIRST USE 12-22-1998; IN COMMERCE 12-22-1998.
SCOTT BALDWIN, EXAMINING ATTORNEY

SN 76-598,184. CIGNA INTELLECTUAL PROPERTY, INC., CLAYMONT, DE. FILED 6-18-2004.

CIGNA DENTAL NETWORK ACCESS

THE MARK CONSISTS OF STANDARD CHARACTERS WITHOUT CLAIM TO ANY PARTICULAR FONT, STYLE, SIZE, OR COLOR.

OWNER OF U.S. REG. NOS. 1,270,224, 1,542,890 AND 1,926,164.

NO CLAIM IS MADE TO THE EXCLUSIVE RIGHT TO USE "DENTAL NETWORK ACCESS", APART FROM THE MARK AS SHOWN.

FOR PROVIDING BENEFIT PLAN SPONSORS WITH ACCESS TO CONTRACTED DENTAL PROVIDERS BY ADMINISTERING A DENTAL INSURANCE AND DENTAL DISCOUNT PROGRAM FOR ENABLING PARTICIPANTS TO OBTAIN DENTAL SERVICES AND DISCOUNTS ON DENTAL SERVICES PROVIDED BY CONTRACTED DENTAL PROVIDERS THROUGH USE OF A MEMBERSHIP CARD (U.S. CLS. 100, 101 AND 102).

FIRST USE 6-23-2003; IN COMMERCE 6-23-2003.
WILLIAM BRECKENFELD, EXAMINING ATTORNEY

CLASS 35—(Continued).

SN 76-598,411. HONG, JOSEPH, SANTA ANA, CA. FILED 6-21-2004.

GRAND MOTORS

THE MARK CONSISTS OF STANDARD CHARACTERS WITHOUT CLAIM TO ANY PARTICULAR FONT, STYLE, SIZE, OR COLOR.

NO CLAIM IS MADE TO THE EXCLUSIVE RIGHT TO USE "MOTORS", APART FROM THE MARK AS SHOWN.

FOR AUTOMOBILE DEALERSHIPS (U.S. CLS. 100, 101 AND 102).

FIRST USE 2-1-1998; IN COMMERCE 2-1-1998.

JOANNA DUKOVIC, EXAMINING ATTORNEY

CLASS 35—(Continued).

SN 76-599,025. NATIONAL COUNCIL OF YOUNG MEN'S CHRISTIAN ASSOCIATIONS OF THE UNITED STATES OF AMERICA, CHICAGO, IL. FILED 6-24-2004.

**OPERATION
KID·COMFORT**

FOR CHARITABLE SERVICES, NAMELY, ORGANIZING AND CONDUCTING VOLUNTEER PROGRAMS AND COMMUNITY SERVICE PROJECTS DESIGNED TO PROMOTE THE PHYSICAL, MENTAL, EMOTIONAL, AND SPIRITUAL DEVELOPMENT OF CHILDREN WITH FAMILY MEMBERS SERVING IN THE MILITARY (U.S. CLS. 100, 101 AND 102).

FIRST USE 10-0-2003; IN COMMERCE 10-0-2003.

GRETTA YAO, EXAMINING ATTORNEY

SN 76-598,443. QTOPIA, INC., DBA DATA ARMOR AND AMERICAN DATA ARMOR, CHICAGO, IL. FILED 6-21-2004.

DATA ARMOR

THE MARK CONSISTS OF STANDARD CHARACTERS WITHOUT CLAIM TO ANY PARTICULAR FONT, STYLE, SIZE, OR COLOR.

FOR BUSINESS MANAGEMENT AND CONSULTING SERVICES IN THE FIELD OF PROVIDING BUSINESS AND BUSINESS TECHNOLOGY SOLUTIONS FOR OTHERS (U.S. CLS. 100, 101 AND 102).

FIRST USE 11-0-2001; IN COMMERCE 11-0-2001.

ALICE SUE CARRUTHERS, EXAMINING ATTORNEY

SN 76-599,281. THE TEACHING COMPANY LIMITED PARTNERSHIP, DBA THE TEACHING COMPANY, CHANTILLY, VA. FILED 6-25-2004.

THE TEACHING COMPANY

THE MARK CONSISTS OF STANDARD CHARACTERS WITHOUT CLAIM TO ANY PARTICULAR FONT, STYLE, SIZE, OR COLOR.

OWNER OF U.S. REG. NOS. 1,947,801 AND 2,717,476.

NO CLAIM IS MADE TO THE EXCLUSIVE RIGHT TO USE "COMPANY", APART FROM THE MARK AS SHOWN.

FOR ONLINE RETAIL SERVICES AND MAIL ORDER CATALOG SERVICES FEATURING PRERECORDED VIDEOTAPES, AUDIOTAPES, CD-ROM'S AND DVD'S OF NON-CREDIT COURSES OF INSTRUCTION ON THE SUBJECTS OF SOCIAL SCIENCES, PSYCHOLOGY, HISTORY, LAW, LITERATURE, FINE ARTS, COSMOLOGY, PHYSICAL SCIENCE, BIOLOGICAL SCIENCE, PHILOSOPHY, THEOLOGY, LINGUISTICS, RELIGION, MATHEMATICS, MUSIC AND PERFORMING ARTS, AND RELATED COURSE TRANSCRIPTS, OUTLINES AND GUIDEBOOKS (U.S. CLS. 100, 101 AND 102).

FIRST USE 11-1-1990; IN COMMERCE 11-1-1990.

WARREN L. OLANDRIA, EXAMINING ATTORNEY

SN 76-598,950. SOFTSTONE TECHNOLOGY INC., WESTPORT, CT. FILED 6-22-2004.

SOFTSTONE

THE MARK CONSISTS OF STANDARD CHARACTERS WITHOUT CLAIM TO ANY PARTICULAR FONT, STYLE, SIZE, OR COLOR.

FOR COMPUTERIZED DATABASE MANAGEMENT PROVIDED TO DIRECT MARKETING BUSINESSES (U.S. CLS. 100, 101 AND 102).

FIRST USE 1-0-2000; IN COMMERCE 1-0-2000.

CIMMERIAN COLEMAN, EXAMINING ATTORNEY

SN 76-599,353. NATIONAL COUNCIL OF YOUNG MEN'S CHRISTIAN ASSOCIATIONS OF THE UNITED STATES OF AMERICA, CHICAGO, IL. FILED 6-24-2004.

OPERATION KID COMFORT

THE MARK CONSISTS OF STANDARD CHARACTERS WITHOUT CLAIM TO ANY PARTICULAR FONT, STYLE, SIZE, OR COLOR.

FOR CHARITABLE SERVICES, NAMELY, ORGANIZING AND CONDUCTING VOLUNTEER PROGRAMS AND COMMUNITY SERVICE PROJECTS DESIGNED TO PROMOTE THE PHYSICAL, MENTAL, EMOTIONAL, AND SPIRITUAL DEVELOPMENT OF CHILDREN WITH FAMILY MEMBERS SERVING IN THE MILITARY (U.S. CLS. 100, 101 AND 102).

FIRST USE 10-0-2003; IN COMMERCE 10-0-2003.

GRETTA YAO, EXAMINING ATTORNEY

CLASS 35—(Continued).

SN 76-599,706. NATIONAL ASSOCIATION OF MUSIC MERCHANTS, INC., CARLSBAD, CA. FILED 6-28-2004.

NAMM Music and Sound Expo

OWNER OF U.S. REG. NOS. 1,554,019, 2,822,564 AND OTHERS.

NO CLAIM IS MADE TO THE EXCLUSIVE RIGHT TO USE "MUSIC AND SOUND EXPO", APART FROM THE MARK AS SHOWN.

FOR ORGANIZING AND CONDUCTING TRADE SHOWS AND EXHIBITIONS IN THE MUSIC PRODUCTS INDUSTRY (U.S. CLS. 100, 101 AND 102).

FIRST USE 6-19-2003; IN COMMERCE 6-19-2003.
BILL DAWE, EXAMINING ATTORNEY

SN 76-600,013. COVER YOUR AD, LLC, SAN DIEGO, CA. FILED 6-28-2004.

COVER YOUR AD

THE MARK CONSISTS OF STANDARD CHARACTERS WITHOUT CLAIM TO ANY PARTICULAR FONT, STYLE, SIZE, OR COLOR.

FOR WEB-BASED ADVERTISING SERVICES, NAMELY, PROVIDING LEGALLY COMPLIANT ADVERTISEMENTS FOR THE AUTOMOBILE INDUSTRY (U.S. CLS. 100, 101 AND 102).

FIRST USE 3-31-2003; IN COMMERCE 3-31-2003.
BRENDAN REGAN, EXAMINING ATTORNEY

SN 76-600,061. ANNE TAINTOR, INC., YOUNGSVILLE, NM. FILED 7-1-2004.

ANNE TAINTOR

THE MARK CONSISTS OF STANDARD CHARACTERS WITHOUT CLAIM TO ANY PARTICULAR FONT, STYLE, SIZE, OR COLOR.

THE NAME ANNE TAINTOR IDENTIFIES A LIVING INDIVIDUAL WHOSE CONSENT IS OF RECORD.

FOR ONLINE RETAIL STORE SERVICES, MAIL ORDER CATALOG SERVICES, WHOLESALE DISTRIBUTORSHIP SERVICES, AND WHOLESALE ORDERING SERVICES ALL FEATURING MAGNETS, INVITATIONS, NOTEPADS, NOTE CARDS, BLANK CARDS, GIFT CARDS, VALENTINES, POST CARDS, NAPKINS, FACIAL TISSUE, PHOTO ALBUMS, PRINTS, FRAMED PRINTS, COASTERS, CANDLES, MUGS, PERSONAL CARE AND BATH PRODUCTS, GIFT ITEMS, TOWELS, AND CLOTHING (U.S. CLS. 100, 101 AND 102).

FIRST USE 1-31-2000; IN COMMERCE 1-31-2000.
SONYA STEPHENS, EXAMINING ATTORNEY

CLASS 35—(Continued).

SN 76-600,320. CARPÉDIA INTERNATIONAL LTD., OAKVILLE, ONTARIO, CANADA, FILED 6-30-2004.

RESULTS NOT REPORTS

THE MARK CONSISTS OF STANDARD CHARACTERS WITHOUT CLAIM TO ANY PARTICULAR FONT, STYLE, SIZE, OR COLOR.

FOR BUSINESS MANAGEMENT AND CONSULTING SERVICES, NAMELY, BUSINESS CONSULTING SERVICES IN THE FIELD OF PHYSICALLY IMPLEMENTING PRODUCT, PROCESS, MANAGEMENT SYSTEM AND ORGANIZATIONAL BEHAVIOUR CHANGES IN ORGANIZATIONS THAT RESULT IN POSITIVE FINANCIAL IMPROVEMENT (U.S. CLS. 100, 101 AND 102).

FIRST USE 7-0-1997; IN COMMERCE 7-0-1997.
DOMINIC J. FERRAIUOLO, EXAMINING ATTORNEY

SN 76-600,725. DI RAIMONDO, LOUIS, DBA ALL AMERICAN HOT DOG COMPANY, MIAMI BEACH, FL. FILED 7-6-2004.



ALL AMERICAN HOT DOG CARTS

Home of America's Hot Dog Hotties

NO CLAIM IS MADE TO THE EXCLUSIVE RIGHT TO USE "AMERICA'S HOT DOG" AND "HOT DOG CARTS", APART FROM THE MARK AS SHOWN.

FOR RETAIL STORE SERVICES FEATURING VENDING CARTS FOR FOOD, NAMELY, HOT DOGS, PRETZELS, AND LEMONADE; RENTAL OF VENDING CARTS FOR FOOD, NAMELY, HOT DOGS, PRETZELS, AND LEMONADE (U.S. CLS. 100, 101 AND 102).

FIRST USE 5-2-2005; IN COMMERCE 5-2-2005.
JOHN LINCOSKI, EXAMINING ATTORNEY

SN 76-603,417. SANTA MONICA CONVENTION & VISITORS BUREAU, SANTA MONICA, CA. FILED 7-22-2004.



OWNER OF U.S. REG. NOS. 2,182,952 AND 2,214,325.
NO CLAIM IS MADE TO THE EXCLUSIVE RIGHT TO USE "VISITOR CENTER" OR "I", APART FROM THE MARK AS SHOWN.

SEC. 2(F) "SANTA MONICA".
FOR CHAMBER OF COMMERCE SERVICES, NAMELY, PROMOTING BUSINESS AND TOURISM IN SANTA MONICA (U.S. CLS. 100, 101 AND 102).

FIRST USE 8-9-2002; IN COMMERCE 8-9-2002.
ROBERT COGGINS, EXAMINING ATTORNEY

CLASS 35—(Continued).

SN 76-603,602. METAVANTE CORPORATION, BROWN DEER, WI. FILED 7-23-2004.

THE MARK CONSISTS OF STANDARD CHARACTERS WITHOUT CLAIM TO ANY PARTICULAR FONT, STYLE, SIZE, OR COLOR.

SEC. 2(F).
FOR FINANCIAL SERVICES, NAMELY, ELECTRONIC BILL PRESENTMENT AND PAYMENT SERVICES (U.S. CLS. 100, 101 AND 102).

FIRST USE 8-2-1999; IN COMMERCE 8-2-1999.
CHERYL CLAYTON, EXAMINING ATTORNEY

SN 76-603,928. KEYNETICS, INC., BOISE, ID. FILED 7-26-2004.

CLICKBANK

FOR ONLINE RETAIL STORE SERVICES FEATURING REPORTS, BOOKS, MUSIC, IMAGES, VIDEO CLIPS, FILMS, COMPUTER PROGRAMS, AND GRAPHIC DESIGNS DELIVERED TO CUSTOMERS VIA TRANSMISSION OVER A GLOBAL COMPUTER NETWORK, OR VIA SHIPPING OF PRINTED PAPER, COMPACT DISCS, DIGITAL VIDEO DISCS, AND SIMILAR MEDIA (U.S. CLS. 100, 101 AND 102).

FIRST USE 8-1-2002; IN COMMERCE 8-1-2002.
AISHA CLARKE, EXAMINING ATTORNEY

CLASS 35—(Continued).

SN 76-604,066. H.O. GERNGROSS & COMPANY, INC., NEW YORK, NY. FILED 7-26-2004.

PUBLIC NEW YORK

THE MARK CONSISTS OF STANDARD CHARACTERS WITHOUT CLAIM TO ANY PARTICULAR FONT, STYLE, SIZE, OR COLOR.

NO CLAIM IS MADE TO THE EXCLUSIVE RIGHT TO USE NEW YORK, APART FROM THE MARK AS SHOWN.

FOR ADVERTISING AND MARKETING CONSULTATION SERVICES PROMOTING GOODS AND SERVICES OF OTHERS; NAMELY PREPARING AND PLACING ADVERTISING AND DISSEMINATING ADVERTISING MATTER; PREPARING AUDIO AND VISUAL PRESENTATIONS FOR USE IN ADVERTISING AND PUBLIC RELATIONS VIA PRINT MEDIA, RADIO, TELEVISION AND ELECTRONIC COMMUNICATION NETWORKS AND VIA OTHER MEDIA CUSTOMARY FOR SUCH PRESENTATIONS; BUSINESS AND MARKETING CONSULTATION OF FOCUS GROUP AND CONSUMER SURVEYS OF DEMOGRAPHIC DATA AND CONSUMER PREFERENCES; ARRANGING AND PRESENTING TRADE SHOW EXHIBITS; PUBLIC RELATIONS; PUBLIC INFORMATION CAMPAIGNS, NAMELY PROMOTING PUBLIC AWARENESS OF THE NEED FOR RACIAL AND RELIGION TOLERANCE, PROMOTING PUBLIC AWARENESS OF THE NEED FOR VOTING IN ELECTIONS, PROMOTING PUBLIC AWARENESS OF THE NEED FOR EATING A HEALTHY DIET, PROMOTING PUBLIC AWARENESS OF THE NEED FOR MAINTAINING ONES APPEARANCE, PROMOTING PUBLIC AWARENESS OF THE NEED FOR PEOPLE TO STOP SMOKING, PROMOTING PUBLIC AWARENESS OF THE NEED FOR CONSERVATION OF PUBLIC PARKS, AND PROMOTING PUBLIC AWARENESS OF THE NEED FOR BEHAVING POLITELY IN PUBLIC; BUSINESS ACQUISITION CONSULTING; ARRANGING RENTAL OF MAILING, TELEPHONE AND WEBSITE LISTINGS; AND DIRECT MAIL ADVERTISING SERVICES (U.S. CLS. 100, 101 AND 102).

MITCHELL FRONT, EXAMINING ATTORNEY

SN 76-604,086. HANOHOV, BOAZ, WOODLAND HILLS, CA. FILED 7-26-2004.

USALUXURY

THE MARK CONSISTS OF STANDARD CHARACTERS WITHOUT CLAIM TO ANY PARTICULAR FONT, STYLE, SIZE, OR COLOR.

FOR RETAIL STORE SERVICES AND ONLINE RETAIL STORE SERVICES FEATURING JEWELRY, DIAMONDS, WATCHES AND CLOCKS AND WATCH STRAPS AND BANDS (U.S. CLS. 100, 101 AND 102).

FIRST USE 12-0-2003; IN COMMERCE 12-0-2003.
FLORENTINA BLANDU, EXAMINING ATTORNEY

CLASS 35—(Continued).

SN 76-604,361. BIRCH, JOHN N., JR., NEW YORK, NY. FILED 7-26-2004.

WYETH

THE MARK CONSISTS OF STANDARD CHARACTERS WITHOUT CLAIM TO ANY PARTICULAR FONT, STYLE, SIZE, OR COLOR.

SEC. 2(F).
FOR RETAIL STORE SERVICES IN THE FIELDS OF FURNITURE, ART AND HOME DÉCOR (U.S. CLS. 100, 101 AND 102).

FIRST USE 1-0-1994; IN COMMERCE 1-0-1994.
STACY WAHLBERG, EXAMINING ATTORNEY

SN 76-604,684. EASTERN MOUNTAIN SPORTS, INC., PETERBOROUGH, NH. FILED 7-29-2004.

WE MAKE WEATHER NERVOUS

THE MARK CONSISTS OF STANDARD CHARACTERS WITHOUT CLAIM TO ANY PARTICULAR FONT, STYLE, SIZE, OR COLOR.

FOR RETAIL STORE SERVICES FEATURING OUTERWEAR AND OTHER CLOTHING, BACKPACKS, CLIMBING GEAR, SLEEPING BAGS, TENTS, SKIS, SNOWBOARDS, SNOW SHOES, KAYAKS AND CANOES (U.S. CLS. 100, 101 AND 102).

SUSAN HAYASH, EXAMINING ATTORNEY

SN 76-606,720. AMERICAN RECRUITERS CONSOLIDATED, INC., FORT LAUDERDALE, FL. FILED 8-12-2004.



OWNER OF U.S. REG. NOS. 2,350,042 AND 2,350,043.
NO CLAIM IS MADE TO THE EXCLUSIVE RIGHT TO USE "AMERICAN MEDICAL RECRUITERS", APART FROM THE MARK AS SHOWN.

FOR EMPLOYMENT RECRUITMENT AND PLACEMENT SERVICES IN THE MEDICAL FIELD (U.S. CLS. 100, 101 AND 102).

FIRST USE 5-1-2004; IN COMMERCE 5-1-2004.
ESTHER A. BORSUK, EXAMINING ATTORNEY

CLASS 35—(Continued).

SN 76-607,186. ODIMO ACQUISITION CORP., SUNRISE, FL. FILED 8-16-2004.



OWNER OF U.S. REG. NO. 2,454,068.
FOR RETAIL STORE SERVICES AND ONLINE RETAIL STORE SERVICES VIA THE INTERNET FEATURING LUXURY GOODS, NAMELY, WATCHES, WATCH WINDERS, WATCHBANDS, CLOCKS, DIAMONDS, JEWELRY, HAIR ORNAMENTS, BELTS, WRITING ACCESSORIES, LEATHER GOODS, SUNGLASSES, HANDBAGS, TIES, CUMMERBUNDS, CUFFLINKS, SCARVES, FRAGRANCES, BATH AND BODY PRODUCTS, CANDLES, POCKET KNIVES, CRYSTAL ITEMS, CHINA, BARWARE, BAR ACCESSORIES, DISHES, FOOD SERVICE PIECES, CANDLEHOLDERS, ARTWORK, PICTURE FRAMES, PICTURE ALBUMS, SILVER AND PEWTER PIECES (U.S. CLS. 100, 101 AND 102).

FIRST USE 9-0-1999; IN COMMERCE 9-0-1999.
GWEN STOKOLS, EXAMINING ATTORNEY

SN 76-607,930. MANATT, PHELPS & PHILLIPS, LLP, LOS ANGELES, CA. FILED 8-17-2004.

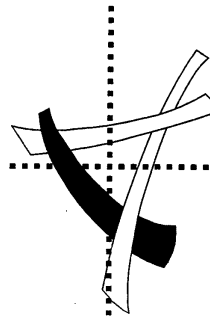

FOR CONSULTING SERVICES IN THE FIELDS OF BUSINESS STRUCTURE AND MARKETING, TAXATION, AND INTERNATIONAL ALLIANCES (U.S. CLS. 100, 101 AND 102).

FIRST USE 5-20-2004; IN COMMERCE 5-20-2004.
BARBARA BROWN, EXAMINING ATTORNEY

CLASS 35—(Continued).

SN 76-608,621. THE CARMEN GROUP INC., WASHINGTON, DC. FILED 8-25-2004.

PROVEN PROCESS. PROVEN RESULTS.

THE MARK CONSISTS OF STANDARD CHARACTERS WITHOUT CLAIM TO ANY PARTICULAR FONT, STYLE, SIZE, OR COLOR.

FOR LOBBYING AND GOVERNMENT RELATIONS SERVICES, NAMELY, PROMOTING THE INTERESTS OF OTHERS IN THE FIELDS OF POLITICS, LEGISLATION, AND REGULATION OF DEFENSE, EDUCATION, HEALTHCARE, HOMELAND SECURITY, INTERNATIONAL TRADE, MARKETING, PROCUREMENT, POSTAL ISSUES, AND TRANSPORTATION (U.S. CLS. 100, 101 AND 102).

FIRST USE 8-30-2002; IN COMMERCE 8-30-2002.
MICHELLE DUBOIS, EXAMINING ATTORNEY

SN 76-608,842. ELLIS, NICHOLA, BURBANK, CA. FILED 8-26-2004.

THE LIGHTHOUSE COMPANY ILLUMINATING THE DELIGHT IN LIGHT

THE MARK CONSISTS OF STANDARD CHARACTERS WITHOUT CLAIM TO ANY PARTICULAR FONT, STYLE, SIZE, OR COLOR.

NO CLAIM IS MADE TO THE EXCLUSIVE RIGHT TO USE COMPANY, APART FROM THE MARK AS SHOWN.

FOR PUBLIC RELATIONS AND BUSINESS MARKETING SERVICES DIRECTED TO THE FILM INDUSTRY (U.S. CLS. 100, 101 AND 102).

FIRST USE 1-1-1994; IN COMMERCE 1-1-1994.
WILLIAM VERHOSEK, EXAMINING ATTORNEY

SN 76-609,466. RAS RETAIL GROUP, INC., DBA VANITY, NORTH MYRTLE BEACH, SC. FILED 8-25-2004.



THE MARK CONSISTS OF THE WORD "VANITY" TO THE LEFT OF A DESIGN OF A WOMAN SITTING ON A STOOL AND HOLDING A MIRROR WHICH SHOWS HER REFLECTION, ALL WITHIN AN OVAL DESIGN.

FOR RETAIL JEWELRY STORES SERVICES (U.S. CLS. 100, 101 AND 102).

FIRST USE 3-1-2004; IN COMMERCE 3-1-2004.
LAURA KOVAISKY, EXAMINING ATTORNEY

CLASS 35—(Continued).

SN 76-609,554. ROOFERS BUGGY, LLC, GAP, PA. FILED 9-1-2004.

NEW ROOF NO MESS

THE MARK CONSISTS OF STANDARD CHARACTERS WITHOUT CLAIM TO ANY PARTICULAR FONT, STYLE, SIZE, OR COLOR.

NO CLAIM IS MADE TO THE EXCLUSIVE RIGHT TO USE "ROOF", APART FROM THE MARK AS SHOWN.

FOR RETAIL STORE, MAIL ORDER RETAIL, AND ON-LINE STORE SERVICES FEATURING ROOFER'S EQUIPMENT (U.S. CLS. 100, 101 AND 102).

FIRST USE 6-1-2004; IN COMMERCE 6-1-2004.
ALLISON HOLTZ, EXAMINING ATTORNEY

SN 76-610,535. THE SPORTSMAN'S GUIDE, INC., SOUTH ST. PAUL, MN. FILED 9-3-2004.

THE LOWEST PRICES, THE BEST QUALITY, GUARANTEED!

THE MARK CONSISTS OF STANDARD CHARACTERS WITHOUT CLAIM TO ANY PARTICULAR FONT, STYLE, SIZE, OR COLOR.

FOR CATALOG MAIL-ORDER SERVICES, ON-LINE RETAIL STORE SERVICES AND RETAIL STORE SERVICES ALL FEATURING FOOTWEAR, CLOTHING AND ACCESSORIES, HUNTING AND SHOOTING SUPPLIES AND ACCESSORIES, CAMPING, FISHING AND OUTDOOR RECREATION PRODUCTS, OPTICS, AMMUNITION, GOVERNMENT SURPLUS, HOME AND GARDEN, DOMESTICS, NOVELTIES AND COLLECTIBLES, ELECTRONICS, FURNITURE, COOKWARE, UTENSILS, HARDWARE, KNIVES, TOOLS, AUTOMOTIVE AND MARINE PRODUCTS AND ACCESSORIES, ELECTRONICS, TOYS, PET SUPPLIES, AND OTHER CONSUMER PRODUCTS (U.S. CLS. 100, 101 AND 102).

FIRST USE 9-0-2000; IN COMMERCE 9-0-2000.
TINA L. SNAPP, EXAMINING ATTORNEY

SN 76-611,239. OMTRAC LICENSING CORPORATION, BRIDGETON, MO. FILED 9-9-2004.

OMTRAC

THE MARK CONSISTS OF STANDARD CHARACTERS WITHOUT CLAIM TO ANY PARTICULAR FONT, STYLE, SIZE, OR COLOR.

FOR ADVERTISING SERVICES, NAMELY, PROMOTING THE GOODS AND SERVICES OF OTHER BY MEANS OF MOBILE BILLBOARDS (U.S. CLS. 100, 101 AND 102).

MIDGE BUTLER, EXAMINING ATTORNEY

CLASS 35—(Continued).

SN 76-612,170. CHICAGO UNITED, CHICAGO, IL. FILED 9-15-2004.



NO CLAIM IS MADE TO THE EXCLUSIVE RIGHT TO USE "CHICAGO", APART FROM THE MARK AS SHOWN.
 FOR ASSOCIATION SERVICES, NAMELY, PROMOTING THE INTERESTS OF MINORITIES BY DEVELOPING PROGRAMS AND ADVOCATING POLICIES THAT BUILD BUSINESS LEADERSHIP RELATIONSHIPS ACROSS RACIAL GROUPS, FOSTERING CONDITIONS OF EQUAL ACCESS TO OPPORTUNITIES IN EXECUTIVE LEVEL MANAGEMENT AND CORPORATE GOVERNANCE, AND COLLABORATING IN ACTIVITIES THAT ENHANCE A DIVERSE BUSINESS AND SOCIAL CLIMATE (U.S. CLS. 100, 101 AND 102).
 FIRST USE 11-0-2000; IN COMMERCE 1-0-2001.
 STEVEN PEREZ, EXAMINING ATTORNEY

SN 76-612,729. WATERS OF LIFE, LTD., BELIZE CITY, BELIZE, FILED 9-24-2004.

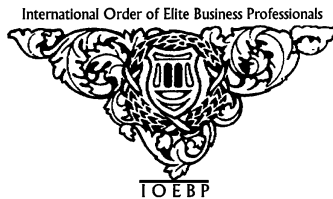

NO CLAIM IS MADE TO THE EXCLUSIVE RIGHT TO USE "INTERNATIONAL ORDER OF ELITE BUSINESS PROFESSIONALS", APART FROM THE MARK AS SHOWN.
 THE MARK CONSISTS OF A DESIGN ELEMENT COMPRISED OF VARIOUS INTERTWINED LEAVES IN AN OVERALL SHAPE OF A TRIANGLE POINTED DOWN. IN THE MIDDLE OF THE TRIANGLE IS A SHIELD OR CREST. BELOW THE DESIGN ELEMENT IS THE LETTERING "IOEBP". ABOVE THE DESIGN ELEMENT IS THE WORDING INTERNATIONAL ORDER OF ELITE BUSINESS PROFESSIONALS.
 FOR BUSINESS CONSULTING, NAMELY, BUSINESS STRATEGY CONSULTING; BUSINESS MANAGEMENT, SERVICES; AND BUSINESS MARKETING CONSULTING SERVICES (U.S. CLS. 100, 101 AND 102).
 FIRST USE 7-0-2004; IN COMMERCE 7-0-2004.
 MICHAEL TANNER, EXAMINING ATTORNEY

CLASS 35—(Continued).

SN 76-612,907. GLOBALTRANZ ENTERPRISES, LLC, PHOENIX, AZ. FILED 9-27-2004.

GLOBALTRANZ

THE MARK CONSISTS OF STANDARD CHARACTERS WITHOUT CLAIM TO ANY PARTICULAR FONT, STYLE, SIZE, OR COLOR.
 FOR TRANSPORTATION LOGISTICS SERVICES, NAMELY ARRANGING TRANSPORTATION OF GOODS FOR OTHERS IN CONNECTION WITH THE INTERNATIONAL MOVEMENT OF COMMERCIAL FREIGHT, OFFICE EQUIPMENT AND FURNITURE, HOUSEHOLD GOODS, AND PERSONAL EFFECTS (U.S. CLS. 100, 101 AND 102).
 RICHARD WHITE, EXAMINING ATTORNEY

SN 76-613,563. THE MARKETING STORE WORLDWIDE, L.P., OAKBROOK TERRACE, IL. FILED 9-30-2004.

BARMIND

THE MARK CONSISTS OF STANDARD CHARACTERS WITHOUT CLAIM TO ANY PARTICULAR FONT, STYLE, SIZE, OR COLOR.
 FOR BUSINESS MARKETING CONSULTATION SERVICES AND ADVERTISING SERVICES IN THE FIELD OF ALCOHOL RELATED INDUSTRIES (U.S. CLS. 100, 101 AND 102).
 SHARI SHEFFIELD, EXAMINING ATTORNEY

SN 76-613,784. MATHOG & MONIELLO COMPANIES, INC., THE, EAST HAVEN, CT. FILED 9-28-2004.

CSN

THE MARK CONSISTS OF STANDARD CHARACTERS WITHOUT CLAIM TO ANY PARTICULAR FONT, STYLE, SIZE, OR COLOR.
 FOR HEALTH CARE COST CONTAINMENT SERVICES (U.S. CLS. 100, 101 AND 102).
 FIRST USE 1-1-1992; IN COMMERCE 1-1-1992.
 SALLY SHIH, EXAMINING ATTORNEY

CLASS 35—(Continued).

SN 76-614,237. BAER SUPPLY CO., VERNON HILLS, IL. FILED 10-1-2004.

POWER OF MANY CONVENIENCE OF ONE

THE MARK CONSISTS OF STANDARD CHARACTERS WITHOUT CLAIM TO ANY PARTICULAR FONT, STYLE, SIZE, OR COLOR.

FOR DISTRIBUTORSHIP SERVICES IN THE FIELD OF FUNCTIONAL AND DECORATIVE WOODWORKING SUPPLIES AND ACCESSORIES FOR THE WOODWORKING INDUSTRY (U.S. CLS. 100, 101 AND 102).

FIRST USE 8-1-2004; IN COMMERCE 8-1-2004.
JEAN IM, EXAMINING ATTORNEY

SN 76-614,957. STATE EMPLOYEES ASSOCIATION POLITICAL ACTION COMMITTEE, MONTGOMERY, AL. FILED 10-4-2004.

SEA-PAC

FOR ASSOCIATION SERVICES, NAMELY, PROMOTING THE INTERESTS OF ALABAMA STATE EMPLOYEES; AND POLITICAL ACTION COMMITTEE SERVICES, NAMELY, PROMOTING THE INTERESTS OF ALABAMA STATE EMPLOYEES IN THE FIELD OF STATE POLITICS (U.S. CLS. 100, 101 AND 102).

FIRST USE 1-14-1988; IN COMMERCE 7-1-2002.
ANGELA M. MICHELI, EXAMINING ATTORNEY

SN 76-615,027. ALLIANCE RUBBER COMPANY, HOT SPRINGS, AR. FILED 10-6-2004.

ADBANDS

THE MARK CONSISTS OF STANDARD CHARACTERS WITHOUT CLAIM TO ANY PARTICULAR FONT, STYLE, SIZE, OR COLOR.

SEC. 2(F).
FOR PREPARATION OF CUSTOM PROMOTIONAL PRODUCTS FOR OTHERS (U.S. CLS. 100, 101 AND 102).
FIRST USE 2-0-1988; IN COMMERCE 2-0-1988.
KATHRYN COWARD, EXAMINING ATTORNEY

CLASS 35—(Continued).

SN 76-615,152. ENTERTAINMART, LP., DALLAS, TX. FILED 10-8-2004.



NO CLAIM IS MADE TO THE EXCLUSIVE RIGHT TO USE BUY SELL TRADE RENT, APART FROM THE MARK AS SHOWN.

RED, GREEN, YELLOW, BLUE AND BLACK
THE COLOR RED APPEARS IN THE WORD ENTERTAIN. THE COLOR YELLOW APPEARS IN THE WORD MART. THE COLOR BLACK IS USED AS A BORDER AND SHADOW FOR THE LETTERS MAKING UP THE TERM ENTERTAINMART. THE DESIGN FEATURE POSITIONED ABOVE THE WORD ENTERTAINMART HAS AS ITS PRIMARY COLOR BLACK WITH THIN COLOR INSERTS INCORPORATING THE COLORS RED, GREEN, YELLOW, AND BLUE.

FOR RETAIL STORE SERVICES FEATURING NEW AND USED COMPACT DISCS, DVDS, GAMES, VIDEO GAMES, VIDEOTAPES, BOOKS, AND RELATED MERCHANDISE (U.S. CLS. 100, 101 AND 102).

FIRST USE 2-27-2004; IN COMMERCE 2-27-2004.
RUSS HERMAN, EXAMINING ATTORNEY

SN 76-615,363. WISE PASSAGE, INC., FOXFIELD, CO. FILED 10-6-2004.

WISE PASSAGE

THE MARK CONSISTS OF STANDARD CHARACTERS WITHOUT CLAIM TO ANY PARTICULAR FONT, STYLE, SIZE, OR COLOR.

FOR ONLINE RETAIL STORE SERVICES FOR BOOKS, PERIODICALS, VITAMINS AND NUTRITIONAL SUPPLEMENTS (U.S. CLS. 100, 101 AND 102).

FIRST USE 8-5-2004; IN COMMERCE 8-5-2004.
SANJEEV VOHRA, EXAMINING ATTORNEY

SN 76-615,385. INGLES MARKETS, INC., ASHEVILLE, NC. FILED 10-6-2004.

ELMER'S FRESH

THE MARK CONSISTS OF STANDARD CHARACTERS WITHOUT CLAIM TO ANY PARTICULAR FONT, STYLE, SIZE, OR COLOR.

NO CLAIM IS MADE TO THE EXCLUSIVE RIGHT TO USE "FRESH", APART FROM THE MARK AS SHOWN.

FOR RETAIL PRODUCE SERVICES, NAMELY, OPERATION OF RETAIL PRODUCE SERVICES AS A DEPARTMENT OF RETAIL GROCERY STORES (U.S. CLS. 100, 101 AND 102).

DAYNA BROWNE, EXAMINING ATTORNEY

CLASS 35—(Continued).

SN 76-615,506. ARTFORTE, LLC, KIRKLAND, WA. FILED 10-12-2004.

ARTFORTE

THE MARK CONSISTS OF STANDARD CHARACTERS WITHOUT CLAIM TO ANY PARTICULAR FONT, STYLE, SIZE, OR COLOR.
 FOR ART GALLERY SERVICES (U.S. CLS. 100, 101 AND 102).
 FIRST USE 10-13-1999; IN COMMERCE 10-13-1999.
 REGINA DRUMMOND, EXAMINING ATTORNEY

SN 76-615,691. UTAH DEPARTMENT OF AGRICULTURE AND FOOD, SALT LAKE CITY, UT. FILED 10-13-2004.



FOR PROMOTING THE LOCALLY GROWN AND MANUFACTURED PRODUCTS OF THE STATE OF UTAH (U.S. CLS. 100, 101 AND 102).
 FIRST USE 12-31-2002; IN COMMERCE 12-31-2002.
 DAVID ELTON, EXAMINING ATTORNEY

SN 76-615,713. MY3IA INTERNATIONAL HOLDING (CAYMAN) LTD., JUNGHE, TAIPEI 235, TAIWAN, FILED 10-14-2004.



FOR IMPORT AND EXPORT AGENCY SERVICES IN THE FIELD OF COMPUTER HARDWARE AND PERIPHERALS, COMPUTER SOFTWARE AND PROGRAMS; PROVIDING INTERNATIONAL TRADE INFORMATION (U.S. CLS. 100, 101 AND 102).
 CAROLYN CATALDO, EXAMINING ATTORNEY

CLASS 35—(Continued).

SN 76-615,795. KICKER FISH BAIT COMPANY, DEER PARK, TX. FILED 10-14-2004.

KICKER FISH BAIT CO

THE MARK CONSISTS OF STANDARD CHARACTERS WITHOUT CLAIM TO ANY PARTICULAR FONT, STYLE, SIZE, OR COLOR.
 NO CLAIM IS MADE TO THE EXCLUSIVE RIGHT TO USE "FISH BAIT CO.", APART FROM THE MARK AS SHOWN.
 FOR WHOLESALE, RETAIL AND ONLINE FISHING STORE SERVICES FEATURING LURES, BAIT, KEY CHAINS, DECALS, DRINK HOLDERS, SUNGLASS HOLDERS, VISORS, HATS, JERSEYS AND T-SHIRTS (U.S. CLS. 100, 101 AND 102).
 FIRST USE 3-5-2002; IN COMMERCE 3-5-2002.
 PATRICIA EVANKO, EXAMINING ATTORNEY

SN 76-616,028. STRATEGIC OUTSOURCING CORPORATION, RICHARDSON, TX. FILED 10-15-2004.

STRAIGHTSOURCE

THE MARK CONSISTS OF STANDARD CHARACTERS WITHOUT CLAIM TO ANY PARTICULAR FONT, STYLE, SIZE, OR COLOR.
 FOR PERSONNEL RECRUITMENT SERVICES FOR BUSINESSES AND INSTITUTIONS (U.S. CLS. 100, 101 AND 102).
 RICHARD A. STRASER, EXAMINING ATTORNEY

SN 76-616,143. DBL PRODUCTS, INC., FT. LAUDERDALE, FL. FILED 10-12-2004.

PADDLE WERKS

THE MARK CONSISTS OF STANDARD CHARACTERS WITHOUT CLAIM TO ANY PARTICULAR FONT, STYLE, SIZE, OR COLOR.
 NO CLAIM IS MADE TO THE EXCLUSIVE RIGHT TO USE PADDLE, APART FROM THE MARK AS SHOWN.
 FOR RETAIL STORE SERVICES FEATURING PRODUCTS FOR AN ALTERNATIVE LIFESTYLE, NAMELY, PADDLES, TOYS, CANES, LUBES, ARM BANDS (U.S. CLS. 100, 101 AND 102).
 FIRST USE 10-16-2003; IN COMMERCE 11-13-2003.
 BRIDGETT SMITH, EXAMINING ATTORNEY

CLASS 35—(Continued).

SN 76-616,229. HACKMAN, RUTH, LAKE GENEVA, WI.
FILED 10-15-2004.

AERIAL STUNT KITES

THE MARK CONSISTS OF STANDARD CHARACTERS WITHOUT CLAIM TO ANY PARTICULAR FONT, STYLE, SIZE, OR COLOR.

NO CLAIM IS MADE TO THE EXCLUSIVE RIGHT TO USE "STUNT KITES", APART FROM THE MARK AS SHOWN.

SEC. 2(F).

FOR RETAIL STORE SERVICES AND ON-LINE RETAIL STORE SERVICES FEATURING WIND CHIMES, WINDSOCKS, WHIRLIGIGS, HELIX, KITES, BANNERS, BOOMERANGS, BRAIN GAMES, PUZZLES AND NEW INVENTIONS (U.S. CLS. 100, 101 AND 102).

FIRST USE 2-29-1992; IN COMMERCE 4-1-1992.
EVELYN BRADLEY, EXAMINING ATTORNEY

CLASS 35—(Continued).

SN 76-616,695. MANHEIM AUCTIONS, INC., ATLANTA, GA.
FILED 10-18-2004.

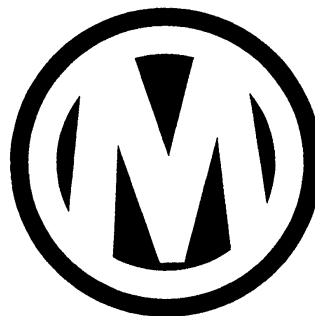

OWNER OF U.S. REG. NO. 2,274,320.
THE MARK CONSISTS OF A SOLID CIRCLE WITH TWO OUTER RINGS. THE LETTER M IS SUPERIMPOSED OVER THE CIRCLE.

FOR AUTOMOBILE AUCTION SERVICES (U.S. CLS. 100, 101 AND 102).

FIRST USE 9-0-2003; IN COMMERCE 9-0-2003.
STEVEN R. FINE, EXAMINING ATTORNEY

SN 76-616,696. MANHEIM AUCTIONS, INC., ATLANTA, GA.
FILED 10-18-2004.

SN 76-616,240. GRAIN FOODS FOUNDATION, RIDGWAY, CO. FILED 10-15-2004.

BREAD. IT'S ESSENTIAL

THE MARK CONSISTS OF STANDARD CHARACTERS WITHOUT CLAIM TO ANY PARTICULAR FONT, STYLE, SIZE, OR COLOR.

NO CLAIM IS MADE TO THE EXCLUSIVE RIGHT TO USE "BREAD", APART FROM THE MARK AS SHOWN.

FOR ADVERTISING SERVICES AND PROMOTION SERVICES AND RELATED CONSULTING, IN THE FIELD OF GRAIN-BASED FOODS; ADVERTISING SERVICES, NAMELY, PROMOTING THE GOODS AND SERVICES OF OTHERS IN THE FIELD OF GRAIN-BASED FOODS; PROMOTING PUBLIC AWARENESS OF THE NEED FOR THE CONSUMPTION OF GRAIN-BASED FOODS; CONSULTATION IN THE FIELD OF PROMOTING PUBLIC AWARENESS OF THE NEED FOR THE CONSUMPTION OF GRAIN-BASED FOODS (U.S. CLS. 100, 101 AND 102).

FIRST USE 8-0-2004; IN COMMERCE 8-0-2004.
ANDREA K. NADELMAN, EXAMINING ATTORNEY



OWNER OF U.S. REG. NO. 2,278,946.
NO CLAIM IS MADE TO THE EXCLUSIVE RIGHT TO USE ONLINE, APART FROM THE MARK AS SHOWN.

THE MARK CONSISTS IN PART OF A STYLIZED REPRESENTATION OF THE LETTER "M".

FOR ONLINE AUTOMOBILE AUCTION SERVICES (U.S. CLS. 100, 101 AND 102).

FIRST USE 2-0-2001; IN COMMERCE 2-0-2001.
STEVEN R. FINE, EXAMINING ATTORNEY

CLASS 35—(Continued).

SN 76-616,781. FLORIDA'S RESEARCH COAST ECONOMIC DEVELOPMENT COALITION, VERO BEACH, FL. FILED 10-20-2004.

FLORIDA'S RESEARCH COAST

THE MARK CONSISTS OF STANDARD CHARACTERS WITHOUT CLAIM TO ANY PARTICULAR FONT, STYLE, SIZE, OR COLOR.

NO CLAIM IS MADE TO THE EXCLUSIVE RIGHT TO USE "FLORIDA'S", APART FROM THE MARK AS SHOWN.

FOR BUSINESS DEVELOPMENT CONSULTING SERVICES, NAMELY, PROVIDING START-UP SUPPORT FOR BUSINESSES OF OTHERS; BUSINESS RELOCATION CONSULTING; CONDUCTING BUSINESS RESEARCH AND SURVEYS FOR OTHERS; CHAMBER OF COMMERCE SERVICES, NAMELY, PROMOTING BUSINESS IN, AND THE ECONOMIC DEVELOPMENT OF, MARTIN COUNTY, FLORIDA, ST; LUCIE COUNTY, FLORIDA AND INDIAN RIVER COUNTY, FLORIDA; PROVIDING ECONOMIC FORECASTING AND ANALYSIS INFORMATION TO OTHERS (U.S. CLS. 100, 101 AND 102).

FIRST USE 2-25-2004; IN COMMERCE 2-25-2004.
MICHAEL TANNER, EXAMINING ATTORNEY

SN 76-616,987. GALLERY OF THE MASTERS, INC., DBA KODNER GALLERY OF THE MASTERS, ST. LOUIS, MO. FILED 10-21-2004.



OWNER OF U.S. REG. NOS. 1,567,501 AND 1,977,963. FOR ART GALLERY SERVICES (U.S. CLS. 100, 101 AND 102).

FIRST USE 11-0-1992; IN COMMERCE 11-0-1992.
MICHAEL WEBSTER, EXAMINING ATTORNEY

SN 76-616,988. GALLERY OF THE MASTERS, INC., DBA KODNER GALLERY OF THE MASTERS, ST. LOUIS, MO. FILED 10-21-2004.

KODNER GALLERY

THE MARK CONSISTS OF STANDARD CHARACTERS WITHOUT CLAIM TO ANY PARTICULAR FONT, STYLE, SIZE, OR COLOR.

OWNER OF U.S. REG. NO. 1,977,963.

NO CLAIM IS MADE TO THE EXCLUSIVE RIGHT TO USE GALLERY, APART FROM THE MARK AS SHOWN.

FOR ART GALLERY SERVICES (U.S. CLS. 100, 101 AND 102).

FIRST USE 12-0-1979; IN COMMERCE 12-0-1979.
MICHAEL WEBSTER, EXAMINING ATTORNEY

CLASS 35—(Continued).

SN 76-617,132. FRED MEYER STORES, INC., PORTLAND, OR. FILED 10-22-2004.

SPOOKYVILLE

THE MARK CONSISTS OF STANDARD CHARACTERS WITHOUT CLAIM TO ANY PARTICULAR FONT, STYLE, SIZE, OR COLOR.

FOR RETAIL GROCERY STORE SERVICES AND RETAIL DEPARTMENT STORE SERVICES (U.S. CLS. 100, 101 AND 102).

FIRST USE 10-0-2003; IN COMMERCE 10-0-2003.
ANN LINNEHAN, EXAMINING ATTORNEY

SN 76-617,140. ADAMS BROWN PERSONNEL, LLC, CHERY HILL, NJ. FILED 10-22-2004.

ADAMS BROWN

THE MARK CONSISTS OF STANDARD CHARACTERS WITHOUT CLAIM TO ANY PARTICULAR FONT, STYLE, SIZE, OR COLOR.

THE MARK ADAMS BROWN DOES NOT IDENTIFY THE NAME OF A KNOWN LIVING INDIVIDUAL

FOR EMPLOYMENT HIRING, RECRUITING, PLACEMENT, STAFFING AND CAREER NETWORKING SERVICES; TEMPORARY AND PERMANENT EMPLOYMENT AGENCY SERVICES; EMPLOYMENT COUNSELING AND RECRUITING SERVICES; AND TESTING TO DETERMINE EMPLOYMENT SKILLS (U.S. CLS. 100, 101 AND 102).

FIRST USE 5-1-1998; IN COMMERCE 5-1-1998.
ANDREA SAUNDERS, EXAMINING ATTORNEY

SN 76-617,344. FRONTRUNNER RESOURCES, INC., CORONADO, CA. FILED 10-15-2004.

FRONTRUNNER

THE MARK CONSISTS OF STANDARD CHARACTERS WITHOUT CLAIM TO ANY PARTICULAR FONT, STYLE, SIZE, OR COLOR.

FOR MARKETING AND ADVERTISING SERVICES; SPECIFICALLY, THE CREATION AND DISTRIBUTION OF ADVERTISING AND MARKETING MATERIALS FOR MORTGAGE PROFESSIONALS, BOTH PRINTED AND ON COMPUTER DISKS (U.S. CLS. 100, 101 AND 102).

FIRST USE 12-7-1995; IN COMMERCE 12-7-1995.
GRETTA YAO, EXAMINING ATTORNEY

CLASS 35—(Continued).

SN 76-617,498. ADVERTISERS MAILING SERVICE, INC., DBA AMS RESPONSE, PARAMOUNT, CA. FILED 10-25-2004.

GOVALUES

FOR PROMOTIONAL MAILING SERVICES TO ADDRESSEES ON A PROPRIETARY DATABASE AND THE PREPARATION OF PROMOTIONAL LITERATURE FOR SUCH MAILINGS (U.S. CLS. 100, 101 AND 102).
FIRST USE 9-11-2003; IN COMMERCE 1-8-2004.
JILL C. ALT, EXAMINING ATTORNEY

SN 76-617,631. RESOURCE VENTURES, LTD., COLUMBUS, OH. FILED 10-26-2004.

shop & tell

THE MARK CONSISTS OF STANDARD CHARACTERS WITHOUT CLAIM TO ANY PARTICULAR FONT, STYLE, SIZE, OR COLOR.
FOR MARKET RESEARCH; MARKETING CONSULTING (U.S. CLS. 100, 101 AND 102).
FIRST USE 10-6-2004; IN COMMERCE 10-6-2004.
IRA J. GOODSAD, EXAMINING ATTORNEY

SN 76-617,709. REISS, LADY, DBA THE BLUES JEAN BAR, SAN FRANCISCO, CA. FILED 10-25-2004.

BELLY UP TO THE BAR AND WE'LL COVER YOUR ASS

THE MARK CONSISTS OF STANDARD CHARACTERS WITHOUT CLAIM TO ANY PARTICULAR FONT, STYLE, SIZE, OR COLOR.
FOR RETAIL CLOTHING STORE SERVICES (U.S. CLS. 100, 101 AND 102).
FIRST USE 8-10-2004; IN COMMERCE 8-10-2004.
ELISSA GARBER KON, EXAMINING ATTORNEY

CLASS 35—(Continued).

SN 76-618,193. VARONA, ORTON, DALLAS, TX. FILED 10-26-2004.

PREMIUM 93

THE MARK CONSISTS OF STANDARD CHARACTERS WITHOUT CLAIM TO ANY PARTICULAR FONT, STYLE, SIZE, OR COLOR.
FOR RETAIL CLOTHING STORE (U.S. CLS. 100, 101 AND 102).
FIRST USE 4-1-2004; IN COMMERCE 4-1-2004.
ELLEN B. AWRICH, EXAMINING ATTORNEY

SN 76-619,202. ON YOUR TOES, INC., WILMINGTON, DE. FILED 11-2-2004.

**Benjamin Lovell
Shoes**

THE MARK CONSISTS OF STANDARD CHARACTERS WITHOUT CLAIM TO ANY PARTICULAR FONT, STYLE, SIZE, OR COLOR.
OWNER OF U.S. REG. NOS. 2,242,886 AND 2,247,841.
NO CLAIM IS MADE TO THE EXCLUSIVE RIGHT TO USE "SHOES", APART FROM THE MARK AS SHOWN.
THE NAME(S), PORTRAIT(S), AND/OR SIGNATURE(S) SHOWN IN THE MARK IDENTIFIES BENJAMIN LOVELL, WHOSE CONSENT TO REGISTER IS OF RECORD.
FOR RETAIL STORE SERVICES FEATURING FOOTWEAR AND SHOES (U.S. CLS. 100, 101 AND 102).
FIRST USE 5-24-1988; IN COMMERCE 5-24-1988.
SKYE YOUNG, EXAMINING ATTORNEY

SN 76-619,929. LIFEWAY CHRISTIAN RESOURCES OF THE SOUTHERN BAPTIST CONVENTION, NASHVILLE, TN. FILED 11-9-2004.

CROSSBOOKS

THE MARK CONSISTS OF STANDARD CHARACTERS WITHOUT CLAIM TO ANY PARTICULAR FONT, STYLE, SIZE, OR COLOR.
FOR COMPUTERIZED ON-LINE RETAIL STORE SERVICES IN THE FIELD OF BIBLE STUDY RELATED BOOKS, PRINTED MATERIALS, MUSIC AND PRERECORDED AUDIO PRODUCTS (U.S. CLS. 100, 101 AND 102).
FIRST USE 5-7-2004; IN COMMERCE 5-7-2004.
FRED MANDIR, EXAMINING ATTORNEY

CLASS 35—(Continued).

SN 76-620,016. MONEY, EVAN, TORRANCE, CA. FILED 11-10-2004.



FOR INSURANCE REFERRALS IN THE FIELD OF PAINTBALL GAMING (U.S. CLS. 100, 101 AND 102).
FIRST USE 3-1-1993; IN COMMERCE 3-1-1993.
YONG KIM, EXAMINING ATTORNEY

SN 76-620,200. FOSSIL, INC., RICHARDSON, TX. FILED 11-12-2004.

WATCH BAR

THE MARK CONSISTS OF STANDARD CHARACTERS WITHOUT CLAIM TO ANY PARTICULAR FONT, STYLE, SIZE, OR COLOR.

NO CLAIM IS MADE TO THE EXCLUSIVE RIGHT TO USE "WATCH", APART FROM THE MARK AS SHOWN.

FOR RETAIL STORE SERVICES FEATURING WATCHES (U.S. CLS. 100, 101 AND 102).

FIRST USE 8-15-2004; IN COMMERCE 8-15-2004.
DAVID TAYLOR, EXAMINING ATTORNEY

SN 76-620,604. ROCK 'N' ROLL MARATHON, INC., SAN DIEGO, CA. FILED 11-12-2004.



NO CLAIM IS MADE TO THE EXCLUSIVE RIGHT TO USE "KIDS", APART FROM THE MARK AS SHOWN.
THE MARK IS NOT IN COLOR.

FOR ORGANIZING COMMUNITY FAIRS FOR COMMERCIAL OR ADVERTISING PURPOSES, NAMELY VENDOR BOOTHS OF FOOD AND FOOT-RACE-RELATED SPORTING GOODS (U.S. CLS. 100, 101 AND 102).

FIRST USE 9-20-2004; IN COMMERCE 9-20-2004.
BRENDAN REGAN, EXAMINING ATTORNEY

CLASS 35—(Continued).

SN 76-622,333. GUARDIAN PROTECTION SERVICES, INC., PITTSBURGH, PA. FILED 11-26-2004.

GUARDIANGENIE

THE MARK CONSISTS OF STANDARD CHARACTERS WITHOUT CLAIM TO ANY PARTICULAR FONT, STYLE, SIZE, OR COLOR.

OWNER OF U.S. REG. NO. 2,151,624.
FOR PROVIDING A WEBSITE WHICH ALLOWS CUSTOMERS TO VIEW ACCOUNT INFORMATION (U.S. CLS. 100, 101 AND 102).

ALICE SUE CARRUTHERS, EXAMINING ATTORNEY

SN 76-624,770. G.E. THOMPSON DEVELOPMENT CORP., FRASER, MI. FILED 12-17-2004.

One Name...A Million Resources

THE MARK CONSISTS OF STANDARD CHARACTERS WITHOUT CLAIM TO ANY PARTICULAR FONT, STYLE, SIZE, OR COLOR.

FOR WEB-BASED DIRECTORY OF MOVING, RELOCATION AND GEOGRAPHICALLY LOCATED BUSINESSES SERVICES (U.S. CLS. 100, 101 AND 102).

FIRST USE 11-2-2004; IN COMMERCE 11-2-2004.
ROBIN CHOSID, EXAMINING ATTORNEY

SN 76-624,876. TEAMSTAFF, INC., SOMERSET, NJ. FILED 12-15-2004.

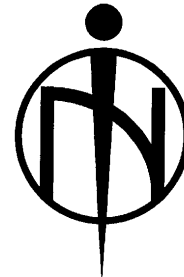

FOR TEMPORARY AND PERMANENT PLACEMENT OF HEALTHCARE EMPLOYEES (U.S. CLS. 100, 101 AND 102).

FIRST USE 5-27-2002; IN COMMERCE 5-27-2002.
MARLENE BELL, EXAMINING ATTORNEY

CLASS 35—(Continued).

SN 76-625,643. STEPHAN ENTERPRISES, INC., PIERCETON, IN. FILED 12-27-2004.

STEPHAN BABY

THE MARK CONSISTS OF STANDARD CHARACTERS WITHOUT CLAIM TO ANY PARTICULAR FONT, STYLE, SIZE, OR COLOR.

NO CLAIM IS MADE TO THE EXCLUSIVE RIGHT TO USE "BABY", APART FROM THE MARK AS SHOWN.

FOR ONLINE RETAIL STORE SERVICES AND MAIL ORDER CATALOGUE SERVICES FEATURING TOYS, BABY CLOTHING, BLANKETS AND NURSERY ITEMS (U.S. CLS. 100, 101 AND 102).

ESTHER A. BORSUK, EXAMINING ATTORNEY

SN 76-625,874. BRAND VELOCITY, INC., ATLANTA, GA. FILED 12-27-2004.



GeoVISION

FOR MARKET RESEARCH, MARKET ANALYSIS, AND CONDUCTING MARKETING AND DEMOGRAPHIC STUDIES AND ANALYSES, FOR DEVELOPING COMPETITIVE MARKETING STRATEGIES BASED ON GEOGRAPHIC SALES, PROFITABILITY AND DEMOGRAPHIC DATA, AND CONSULTATION PROVIDED IN CONNECTION THEREWITH (U.S. CLS. 100, 101 AND 102).

FIRST USE 12-15-2004; IN COMMERCE 12-15-2004.
BARBARA A. GOLD, EXAMINING ATTORNEY

SN 76-625,975. BUY MY BIKES INC., SAN JUAN CAPISTRANO, CA. FILED 12-29-2004.

BUY MY BIKES

THE MARK CONSISTS OF STANDARD CHARACTERS WITHOUT CLAIM TO ANY PARTICULAR FONT, STYLE, SIZE, OR COLOR.

FOR RETAIL STORE SERVICES IN THE FIELD OF BICYCLES, BICYCLE ACCESSORIES AND BICYCLE RELATED CLOTHING (U.S. CLS. 100, 101 AND 102).

FIRST USE 6-0-1992; IN COMMERCE 6-0-1992.
DANIEL CAPSHAW, EXAMINING ATTORNEY

CLASS 35—(Continued).

SN 76-626,115. FAIRCLOTH & ASSOCIATES, LLC, CHICAGO, IL. FILED 12-29-2004.

TAXPLANATIONS

THE MARK CONSISTS OF STANDARD CHARACTERS WITHOUT CLAIM TO ANY PARTICULAR FONT, STYLE, SIZE, OR COLOR.

FOR PROVIDING TAXATION INFORMATION, NAMELY, TAX ADVISORY SERVICES AND EXPLANATORY SERVICES TO OTHERS (U.S. CLS. 100, 101 AND 102).

FIRST USE 11-15-2004; IN COMMERCE 11-15-2004.
DORITT L. CARROLL, EXAMINING ATTORNEY

SN 76-626,143. AMC, INC., ATLANTA, GA. FILED 12-27-2004.

MUSEUM OF INTRODUCTIONS

THE MARK CONSISTS OF STANDARD CHARACTERS WITHOUT CLAIM TO ANY PARTICULAR FONT, STYLE, SIZE, OR COLOR.

FOR ORGANIZING, ARRANGING AND CONDUCTING TRADE SHOWS IN THE FIELD OF RUGS, CARPETS, AND OTHER FLOOR COVERINGS (U.S. CLS. 100, 101 AND 102).

ALLISON HOLTZ, EXAMINING ATTORNEY

SN 76-626,590. IBIS CONSULTING, INC., PROVIDENCE, RI. FILED 12-30-2004.

CONTROL YOUR DATA

THE MARK CONSISTS OF STANDARD CHARACTERS WITHOUT CLAIM TO ANY PARTICULAR FONT, STYLE, SIZE, OR COLOR.

FOR COMPUTER DATABASE MANAGEMENT OF DOCUMENTS; PROVIDING CONSULTING SERVICES IN THE FIELD OF REGULATORY COMPLIANCE FOR INSURANCE AND FINANCIAL BUSINESSES (U.S. CLS. 100, 101 AND 102).

FIRST USE 5-18-2001; IN COMMERCE 5-18-2001.
SUSAN HAYASH, EXAMINING ATTORNEY

CLASS 35—(Continued).

SN 76-626,593. IBIS CONSULTING, INC., PROVIDENCE, RI. FILED 12-30-2004.

IBIS

THE MARK CONSISTS OF STANDARD CHARACTERS WITHOUT CLAIM TO ANY PARTICULAR FONT, STYLE, SIZE, OR COLOR.

FOR COMPUTER DATABASE MANAGEMENT OF DOCUMENTS; PROVIDING CONSULTING SERVICES IN THE FIELD OF REGULATORY COMPLIANCE FOR INSURANCE AND FINANCIAL BUSINESSES (U.S. CLS. 100, 101 AND 102).

FIRST USE 8-3-1992; IN COMMERCE 8-3-1992.
SUSAN HAYASH, EXAMINING ATTORNEY

SN 76-626,672. WHITE PINE GRAPHICS, INC., PLYMOUTH, MN. FILED 1-3-2005.

LIFE IS A PHOTO OPP

THE MARK CONSISTS OF STANDARD CHARACTERS WITHOUT CLAIM TO ANY PARTICULAR FONT, STYLE, SIZE, OR COLOR.

FOR ADVERTISING AGENCY AND BUSINESS MARKETING CONSULTING SERVICES, INCLUDING PREPARATION AND PLACEMENT OF COMMERCIAL ARTWORK (U.S. CLS. 100, 101 AND 102).

DAVID H. STINE, EXAMINING ATTORNEY

SN 76-627,903. SKILLFORCE INC., OWINGS MILLS, MD. FILED 4-8-2004.



THE MARK CONSISTS OF A MAN IN A HARD HAT WITHIN AN OVAL BORDER.

FOR PLACEMENT OF TEMPORARY PERSONNEL IN THE CONSTRUCTION INDUSTRY (U.S. CLS. 100, 101 AND 102).

FIRST USE 10-1-2003; IN COMMERCE 10-1-2003.
LEIGH LOWRY, EXAMINING ATTORNEY

CLASS 35—(Continued).

SN 76-635,850. BOB'S STORES CORP., FRAMINGHAM, MA. FILED 4-8-2005.

I AM BOB'S

THE MARK CONSISTS OF STANDARD CHARACTERS WITHOUT CLAIM TO ANY PARTICULAR FONT, STYLE, SIZE, OR COLOR.

OWNER OF U.S. REG. NOS. 1,531,396, 2,875,473 AND OTHERS.

FOR RETAIL STORE SERVICES FEATURING CLOTHING, FOOTWEAR, SPORTSWEAR, EYEWEAR, HANDBAGS, AND ACCESSORIES (U.S. CLS. 100, 101 AND 102).

FIRST USE 10-4-2004; IN COMMERCE 10-4-2004.
DARRYL SPRUILL, EXAMINING ATTORNEY

SN 76-977,243. SMARTCLIXX LLC, BOCA RATON, FL. FILED 10-22-2003.

SMARTCLIXX

FOR LICENSING OF COMPUTER SOFTWARE FOR GIFT CARD, GIFT CERTIFICATE AND OTHER STORED VALUE CARD SOFTWARE APPLICATIONS (U.S. CLS. 100, 101 AND 102).

FIRST USE 3-11-2001; IN COMMERCE 6-8-2001.
MICHELE SWAIN, EXAMINING ATTORNEY

SN 78-031,921. BROOKS, LINDA ROBERTSON, SHERMAN OAKS, CA. FILED 10-23-2000.

FINANCIAL JOB NETWORK

SEC. 2(F).

FOR PROVIDING AN ON-LINE ELECTRONIC DATABASE ON GLOBAL COMPUTER NETWORKS FEATURING FINANCIAL JOB LISTINGS, RESUMES OF POTENTIAL CANDIDATES FOR JOBS IN FINANCE AND INFORMATION ABOUT JOBS IN FINANCE (U.S. CLS. 100, 101 AND 102).

FIRST USE 7-27-1996; IN COMMERCE 1-3-1997.
KELLY BOULTON, EXAMINING ATTORNEY

SN 78-094,159. SECURE ASSET REPORTING SERVICES, INC., BELLEVUE, WA. FILED 11-19-2001.

SARS

FOR TRACKING, LOCATING, AND MONITORING OF VEHICLES, MARITIME VESSELS, AIRCRAFT, ROLLING RAILROAD STOCK, CARGO CONTAINERS, AND LIQUIDS STORED IN BULK (U.S. CLS. 100, 101 AND 102).

FIRST USE 10-29-2001; IN COMMERCE 10-29-2001.
MICHELE SWAIN, EXAMINING ATTORNEY

CLASS 35—(Continued).

SN 78-157,317. AMENITY HOME HEALTH CARE, SEATTLE, WA. FILED 8-23-2002.



NO CLAIM IS MADE TO THE EXCLUSIVE RIGHT TO USE "HOME HEALTH CARE", APART FROM THE MARK AS SHOWN.

THE MARK CONSISTS OF THE WORDING AMENITY HOME HEALTH CARE "COMMITTED TO YOUR SATISFACTION & QUALITY OF CARE" AND DESIGN, NAMELY, HUMAN HANDS SUPPORTING A GLOBE CONTAINING HUMAN FIGURES, ALL ABOVE A STYLIZED REPRESENTATION OF THE LETTERS A, H AND C, SURROUNDED BY A SEMICIRCLE OF ARROWS.

FOR PERSONNEL SERVICES SPECIALIZING IN PROVIDING NURSES AND OTHER MEDICAL EMPLOYEES, NAMELY, HOME HEALTH AIDES, PHYSICAL, OCCUPATIONAL AND SPEECH THERAPISTS TO NURSING FACILITIES AND TO INDIVIDUALS IN THEIR HOMES (U.S. CLS. 100, 101 AND 102).

FIRST USE 4-26-1995; IN COMMERCE 4-26-1995.
WANDA KAY PRICE, EXAMINING ATTORNEY

SN 78-182,072. NATIONAL CASA ASSOCIATION, SEATTLE, WA. FILED 11-5-2002.

COURT APPOINTED SPECIAL ADVOCATE

NO CLAIM IS MADE TO THE EXCLUSIVE RIGHT TO USE "COURT APPOINTED", APART FROM THE MARK AS SHOWN.

SEC. 2(F) AS TO NATIONAL CASA ASSOCIATION.

FOR PROMOTION OF PUBLIC AWARENESS OF THE NEED FOR THE COURT TO APPOINT ADVOCATES TO REPRESENT IN COURT THE BEST INTERESTS OF CHILDREN (U.S. CLS. 100, 101 AND 102).

FIRST USE 12-31-1984; IN COMMERCE 12-31-1984.
CHERYL CLAYTON, EXAMINING ATTORNEY

SN 78-227,462. WILDLIFE IN NEED, INC., LOMPOC, CA. FILED 3-19-2003.

WILDLIFE IN NEED

NO CLAIM IS MADE TO THE EXCLUSIVE RIGHT TO USE WILDLIFE, APART FROM THE MARK AS SHOWN.

FOR ASSOCIATION SERVICES, NAMELY, PROMOTING THE INTERESTS OF THOSE CONCERNED WITH WILDLIFE AND ENVIRONMENTAL AWARENESS, CONSERVATION AND HABITAT IMPROVEMENT THROUGH THE DEVELOPMENT OF INNOVATIVE SOLUTIONS TO ANIMAL MANAGEMENT PROBLEMS (U.S. CLS. 100, 101 AND 102).

FIRST USE 4-17-1999; IN COMMERCE 11-15-2000.
AMOS T. MATTHEWS, JR., EXAMINING ATTORNEY

CLASS 35—(Continued).

SN 78-242,194. LUNDE, BRADLEY K., LAS VEGAS, NV. FILED 4-25-2003.

AUDIO UNDERGROUND

NO CLAIM IS MADE TO THE EXCLUSIVE RIGHT TO USE "AUDIO", APART FROM THE MARK AS SHOWN.

FOR BUSINESS MARKETING; RETAIL STORE SERVICES FEATURING PROFESSIONAL AUDIO EQUIPMENT FOR THE BROADCAST, RECORDING, LIVE SOUND AND MUSICAL INSTRUMENT INDUSTRIES, PROMOTING AND CONDUCTING TRADESHOWS IN THE FIELD SHOWS OF AUDIO EQUIPMENT (U.S. CLS. 100, 101 AND 102).

RONALD AIKENS, EXAMINING ATTORNEY

SN 78-252,214. IMAGE.NET LIMITED, LONDON EC1R 4RB, UNITED KINGDOM, FILED 5-20-2003.

IMAGE.NET

PRIORITY CLAIMED UNDER SEC. 44(D) ON UNITED KINGDOM APPLICATION NO. 2316449, FILED 11-20-2002, REG. NO. 2316449, DATED 11-20-2002, EXPIRES 11-20-2009.

FOR PROMOTING THE GOODS AND SERVICES OF OTHERS BY PROVIDING HYPERTEXT LINKS TO THE WEB SITES OF OTHERS; PROMOTING THE SALE OF THE GOODS AND SERVICES OF OTHERS, NAMELY, COMPUTER-GENERATED GRAPHICS, PHOTOGRAPHS, DIGITAL PHOTOGRAPHS, ARTWORK, VIDEO AND AUDIO RECORDINGS AND PUBLICATIONS THROUGH THE DISTRIBUTION OF WRITTEN ADVERTISING AND PROMOTIONAL AND PUBLICITY MATERIAL; DISSEMINATION OF ADVERTISING AND PROMOTIONAL MATTER, NAMELY, THE DISTRIBUTION OVER THE INTERNET OF ADVERTISING AND PROMOTIONAL MATERIAL RELATING TO AWARDS, FESTIVALS, CINEMATOGRAPHIC FILMS, TELEVISION PROGRAMS, THE ARTS, PHOTOGRAPHY, MUSIC AND VIDEO AND COMPUTER GAMES; ELECTRONIC PUBLISHING SERVICES, NAMELY, PUBLICATION OF TEXT AND GRAPHIC WORKS OF OTHERS ON-LINE FEATURING PUBLICATION OF ADVERTISING, PROMOTIONAL AND PUBLICITY TEXTS, COMPUTER-GENERATED GRAPHICS, PHOTOGRAPHS, DIGITAL PHOTOGRAPHS, ARTWORK, VIDEO AND AUDIO RECORDINGS; COMPUTERIZED DATABASE MANAGEMENT IN THE NATURE OF THE UPDATING OF ADVERTISING AND PROMOTIONAL MATERIAL ON A COMPUTER DATABASE AND THE COLLECTION OF ADVERTISING, PROMOTIONAL AND PUBLICITY MATERIAL, INCLUDING COMPILATION OF SUCH MATERIAL INTO COMPUTER DATABASES FOR ACCESS OVER THE INTERNET; ADVERTISING, PROMOTIONAL AND PUBLICITY AGENCY SERVICES; DOCUMENT REPRODUCTION IN THE NATURE OF REPRODUCING ADVERTISING, PROMOTIONAL AND PUBLICITY DOCUMENTS FOR OTHERS; MARKET ANALYSIS IN THE NATURE OF ANALYSIS OF ADVERTISING AND PROMOTIONAL RESPONSE, INCLUDING THE COMPILATION OF STATISTICS RELATING TO ADVERTISING AND PROMOTION; COMPILATION OF DIRECT MAILING LISTS FOR OTHERS; AND BUSINESS MARKETING AND DIRECT MAIL CONSULTING SERVICES (U.S. CLS. 100, 101 AND 102).

MARK T. MULLEN, EXAMINING ATTORNEY

CLASS 35—(Continued).

SN 78-264,470. PEACOCK GOLF PRODUCTS, INC., RUSSELLVILLE, AR. FILED 6-19-2003.

PEACOCK GOLF

NO CLAIM IS MADE TO THE EXCLUSIVE RIGHT TO USE "GOLF", APART FROM THE MARK AS SHOWN.

FOR RETAIL ONLINE ORDERING SERVICES IN THE FIELD OF SPORTING GOODS; CATALOG MAIL ORDER AND TELEPHONE RETAIL ORDERING SERVICES IN THE FIELD OF SPORTING GOODS; RETAIL STORES FEATURING SPORTING GOODS (U.S. CLS. 100, 101 AND 102).

FIRST USE 4-30-1995; IN COMMERCE 2-1-1996.
HOWARD B. LEVINE, EXAMINING ATTORNEY

SN 78-271,151. AUBURN ALUMNI ASSOCIATION, INC., AUBURN, AL. FILED 7-7-2003.



NO CLAIM IS MADE TO THE EXCLUSIVE RIGHT TO USE ALUM AND ALUMNI ASSOCIATION, APART FROM THE MARK AS SHOWN.

THE LINING IS A FEATURE OF THE MARK.

THE COLOR(S) ORANGE, WHITE AND BLUE IS/ARE CLAIMED AS A FEATURE OF THE MARK.

THE COLOR(S) ORANGE, WHITE AND BLUE ARE CLAIMED AS A FEATURE OF THE MARK. THE COLOR ORANGE APPEARS IN THE LETTERS A AND U IN THE ALUM PORTION OF THE MARK. THE COLOR WHITE APPEARS IN THE LETTERS L AND M IN THE ALUM PORTION OF THE MARK. THE RECTANGLE CONTAINING THE WORD ALUM, THE WORDING AUBURN ALUMNI ASSOCIATION, THE HORIZONTAL LINES ABOVE AND BELOW AUBURN ALUMNI ASSOCIATION ARE BLUE.

FOR ASSOCIATION SERVICES, NAMELY, PROMOTING THE INTERESTS OF THE ALUMNI OF A UNIVERSITY IN ALABAMA (U.S. CLS. 100, 101 AND 102).

FIRST USE 7-1-1997; IN COMMERCE 7-1-1997.
KIM SAITO, EXAMINING ATTORNEY

SN 78-276,838. 10960ACQUISITION, LTD., HOUSTON, TX. FILED 7-21-2003.

**THE BEST WAY TO BUY
BLINDS ONLINE**

NO CLAIM IS MADE TO THE EXCLUSIVE RIGHT TO USE "BLINDS", APART FROM THE MARK AS SHOWN. SEC. 2(F).

FOR ONLINE RETAIL STORE SERVICES FEATURING WINDOW BLINDS, WINDOW SHADES, AND INTERIOR WINDOW SHUTTERS (U.S. CLS. 100, 101 AND 102).

FIRST USE 3-21-2000; IN COMMERCE 3-21-2000.
TONI HICKEY, EXAMINING ATTORNEY

CLASS 35—(Continued).

SN 78-290,083. CORRECT RX PHARMACY SERVICES, INC., LINTHICUM, MD. FILED 8-20-2003.



NO CLAIM IS MADE TO THE EXCLUSIVE RIGHT TO USE PHARMACY SERVICES, APART FROM THE MARK AS SHOWN.

FOR PHARMACY SERVICES, NAMELY INSTITUTIONAL PHARMACY SERVICES (U.S. CLS. 100, 101 AND 102).

FIRST USE 6-5-2003; IN COMMERCE 6-17-2003.
KAREN K. BUSH, EXAMINING ATTORNEY

SN 78-307,103. SPAR TRADEMARKS, INC., TARRYTOWN, NY. FILED 9-30-2003.



NO CLAIM IS MADE TO THE EXCLUSIVE RIGHT TO USE "OPENINGS", APART FROM THE MARK AS SHOWN. FOR BUSINESS MARKETING AND MERCHANDISING CONSULTATION, FORECASTING AND ANALYSIS SERVICES (U.S. CLS. 100, 101 AND 102).

FIRST USE 11-0-2002; IN COMMERCE 11-0-2002.
MICHELE SWAIN, EXAMINING ATTORNEY

SN 78-307,479. BENNETT INTERNATIONAL GROUP, INC., MCDONOUGH, GA. FILED 9-30-2003.

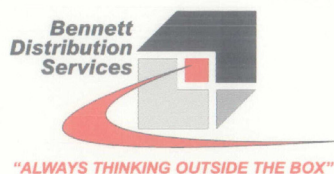

NO CLAIM IS MADE TO THE EXCLUSIVE RIGHT TO USE DISTRIBUTION SERVICES, APART FROM THE MARK AS SHOWN.

THE COLOR(S) RED, GRAY, LIGHT GRAY, BLACK AND WHITE IS/ARE CLAIMED AS A FEATURE OF THE MARK. RED APPEARS IN THE SQUARE LOCATED IN THE CENTER OF THE MARK. ADDITIONALLY, RED APPEARS IN THE SWOOSH WHICH BEGINS IN THE CENTER OF

CLASS 35—(Continued).

THE MARK AND CONTINUES ACROSS THE BOTTOM OF THE MARK. FURTHERMORE, THE QUOTES, WORDS AND PUNCTUATION IN THE LOGO "ALWAYS THINKING OUTSIDE THE BOX" APPEAR IN RED. GRAY APPEARS IN A TRIANGLE LOCATED BELOW AND TO THE RIGHT OF THE RED SQUARE IN THE CENTER OF THE MARK. THIS GRAY TRIANGLE IS THE BOTTOM RIGHT CORNER OF THE OUTSIDE BOX DEPICTED IN THE MARK. LIGHT GRAY APPEARS IN THE L SHAPED BLOCK WHICH FORMS THE BOTTOM LEFT CORNER OF THE OUTSIDE BOX DEPICTED IN THE MARK. BLACK APPEARS IN THE TOP RIGHT CORNER OF THE OUTSIDE BOX DEPICTED IN THE MARK. ADDITIONALLY, BLACK BORDERS ALL OTHER COLOR IN THE MARK WITH THE EXCEPTION OF THE LOGO "ALWAYS THINKING OUTSIDE THE BOX." WHITE APPEARS AS THE BACKGROUND FOR THE MARK.

FOR INVENTORY CONTROL AND MANAGEMENT IN THE FIELD OF TRUCKING, TRANSPORTATION AND DISTRIBUTION (U.S. CLS. 100, 101 AND 102).

FIRST USE 1-23-2002; IN COMMERCE 1-23-2002.

KATHLEEN M. VANSTON, EXAMINING ATTORNEY

SN 78-308,414. TM ACQUISITION CORP., LAS VEGAS, NV. FILED 10-2-2003.

BIDTIME

FOR PROVIDING SPACE AT A WEB SITE FOR THE ADVERTISEMENTS OF THE GOODS AND SERVICES OF OTHERS IN THE FIELDS OF REAL ESTATE, RESORTS, TIME-SHARING, TRAVEL AND VACATIONS (U.S. CLS. 100, 101 AND 102).

FIRST USE 7-14-2003; IN COMMERCE 7-14-2003.

JULIE WATSON, EXAMINING ATTORNEY

SN 78-321,847. ALBION INTERACTIVE, LLC, NEEDHAM, MA. FILED 10-31-2003.

CAREERS FOR LIFE.

FOR EMPLOYMENT HIRING, RECRUITING, PLACEMENT, STAFFING AND CAREER NETWORKING SERVICES FOR THE HEALTH CARE INDUSTRY (U.S. CLS. 100, 101 AND 102).

FIRST USE 3-0-2003; IN COMMERCE 10-19-2003.

MICHAEL ENGEL, EXAMINING ATTORNEY

CLASS 35—(Continued).

SN 78-322,479. OSCEOLA COUNTY, FLORIDA, BOARD OF COUNTY COMMISSIONERS, KISSIMMEE, FL. FILED 11-3-2003.



NO CLAIM IS MADE TO THE EXCLUSIVE RIGHT TO USE "KISSIMMEE", "ST. CLOUD", AND "FLORIDA", APART FROM THE MARK AS SHOWN.

THE COLOR(S) RED, BLUE AND BLACK IS/ARE CLAIMED AS A FEATURE OF THE MARK.

THE COLOR RED APPEARS IN THE STARS, FLAG AND LETTERS K, I, S, S, I, E, E AND ST. CLOUD. THE COLOR BLUE APPEARS IN THE LETTERS MM OF THE WORDING KISSIMMEE, AND THE COLOR BLACK APPEARS IN THE WORDING FLORIDA.

FOR CONVENTION AND VISITORS BUREAU SERVICES, NAMELY, PROMOTING BUSINESS, TOURISM AND THE HOLDING OF CONVENTIONS IN THE GREATER OSCEOLA COUNTY, FLORIDA AREA (U.S. CLS. 100, 101 AND 102).

FIRST USE 4-1-2000; IN COMMERCE 4-1-2000.

RENEE MCCRAY, EXAMINING ATTORNEY

SN 78-323,785. GLOBAL MOTORSPORT GROUP, INC., MORGAN HILL, CA. FILED 11-5-2003.

GMG

THE MARK CONSISTS OF STANDARD CHARACTERS WITHOUT CLAIM TO ANY PARTICULAR FONT, STYLE, SIZE, OR COLOR.

FOR WHOLESALE DISTRIBUTORSHIP SERVICES FEATURING THE GOODS OF OTHERS IN THE FIELD OF MOTOR VEHICLE PARTS, MOTORCYCLE KITS FOR BUILDING MOTORCYCLES, MOTORCYCLE ADDITIVES, CLEANERS AND LUBRICANTS, TIRE AND PRESSURE GAUGES, HELMETS, GOGGLES, BAGS, CLOTHING AND ACCESSORIES (U.S. CLS. 100, 101 AND 102).

SCOTT OSLICK, EXAMINING ATTORNEY

CLASS 35—(Continued).

SN 78-325,874. MCRAE, S. GALE, IRVING, TX. FILED 11-11-2003.

CLASS 35—(Continued).

SN 78-336,361. TAYLOR OF OLD BOND STREET LIMITED, ST. JAMES, LONDON, ENGLAND, FILED 12-4-2003.

HealthSteps

TAYLOR OF OLD BOND
STREET

THE MARK CONSISTS OF STANDARD CHARACTERS WITHOUT CLAIM TO ANY PARTICULAR FONT, STYLE, SIZE, OR COLOR.

FOR COST MANAGEMENT FOR THE HEALTH BENEFIT PLANS OF OTHERS (U.S. CLS. 100, 101 AND 102). FIRST USE 10-11-2003; IN COMMERCE 10-11-2003. TONJA GASKINS, EXAMINING ATTORNEY

SN 78-330,562. INSURANCE AUTO AUCTIONS, INC., SCHAUMBURG, IL. FILED 11-20-2003.

INSURANCE AUTO AUCTIONS

THE MARK CONSISTS OF STANDARD CHARACTERS WITHOUT CLAIM TO ANY PARTICULAR FONT, STYLE, SIZE, OR COLOR.

OWNER OF U.S. REG. NO. 1,839,138. NO CLAIM IS MADE TO THE EXCLUSIVE RIGHT TO USE "AUTO AUCTIONS", APART FROM THE MARK AS SHOWN.

SEC. 2(F). FOR HOLDING AUTOMOBILE AUCTIONS OF SALVAGED AND SEVERELY DAMAGED VEHICLES EXCLUSIVELY FOR REGISTERED BUYERS COMPOSED PRINCIPALLY OF LICENSED AUTOMOBILE DEALERS AND AUTOMOBILE DISMANTLERS (U.S. CLS. 100, 101 AND 102).

FIRST USE 1-0-1990; IN COMMERCE 1-0-1990. RENEE MCCRAY, EXAMINING ATTORNEY

THE MARK CONSISTS OF STANDARD CHARACTERS WITHOUT CLAIM TO ANY PARTICULAR FONT, STYLE, SIZE, OR COLOR.

PRIORITY CLAIMED UNDER SEC. 44(D) ON ERP N CMNTY TM OFC APPLICATION NO. 3354479, FILED 9-9-2003, REG. NO. 003354479, DATED 11-4-2004, EXPIRES 9-9-2013.

OWNER OF U.S. REG. NOS. 1,607,938 AND 2,134,181. FOR RETAIL STORE SERVICES AND MAIL ORDER SERVICES FEATURING NON-MEDICATED TOILET PREPARATIONS, HAIR PREPARATIONS, SKIN PREPARATIONS, SOAPS AND SHAMPOOS, PERFUMERY, COSMETICS, DENTIFRICES, SHAVING SOAP AND CREAM, AFTER SHAVE LOTION AND COLOGNE, BATH SOAP, SHOWER GEL, DEODORANT, BATH OIL, PUMICE STONE, MOUSTACHE WAX, HAND CREAM AND LOTION, CUTICLE OIL, SKIN CREAM, HAIR SHAMPOO, HAIR SPRAY, HAIR CONDITIONER, HAIR MOISTURISER, HAND TOOLS AND IMPLEMENTS, RAZORS, RAZOR BLADES, MANICURE SETS, HAIR TRIMMERS, NASAL AND MOUSTACHE HAIR TRIMMERS, TWEEZERS, SCISSORS, NAIL CLIPPERS, EYELASH CURLERS, PARTS AND FITTINGS FOR ALL THE AFORESAID GOODS, COMBS, SPONGES, BRUSHES, HOUSEHOLD AND KITCHEN UTENSILS, BOWLS, COSMETIC AND TOILET ARTICLES, TOILET CASES, VANITY CASES, HAIR BRUSHES, HAIR COMBS, SHAVING BRUSHES, TOOTH BRUSHES, NAIL BRUSHES, BODY CLEANING SPONGES, SHOE HORNS, CLOTHES BRUSHES, POWER BRUSHES, MAKE-UP BRUSHES, STANDS FOR SHAVING BRUSHES; MAIL ORDER CATALOG SERVICES FEATURING PERSONAL HYGIENE AND GROOMING PRODUCTS, ON-LINE RETAIL STORE SERVICES FEATURING PERSONAL HYGIENE AND GROOMING PRODUCTS, RETAIL STORE SERVICES, AVAILABLE THROUGH COMPUTER COMMUNICATIONS AND INTERACTIVE TELEVISION, FEATURING PERSONAL HYGIENE AND GROOMING PRODUCTS (U.S. CLS. 100, 101 AND 102).

DAVID MURRAY, EXAMINING ATTORNEY

CLASS 35—(Continued).

SN 78-340,805. MOSAICA EDUCATION, INC., NEW YORK CITY, NY. FILED 12-15-2003.

CLASS 35—(Continued).

SN 78-344,471. RSL INTERACTIVE, INC., SEATTLE, WA. FILED 12-22-2003.

Spectra Services



THE MARK CONSISTS OF STANDARD CHARACTERS WITHOUT CLAIM TO ANY PARTICULAR FONT, STYLE, SIZE, OR COLOR.

NO CLAIM IS MADE TO THE EXCLUSIVE RIGHT TO USE SERVICES, APART FROM THE MARK AS SHOWN.

FOR ADMINISTRATION OF EDUCATIONAL PROGRAMS AND MANAGEMENT OF KINDERGARTEN THROUGH 12TH GRADE SCHOOLS AND PROGRAMS FOR COMPLIANCE WITH THE NO CHILD LEFT BEHIND ACT (U.S. CLS. 100, 101 AND 102).

RON FAIRBANKS, EXAMINING ATTORNEY

SN 78-343,853. SEARCHNET TECHNOLOGIES LLC, SCOTTSDALE, AZ. FILED 12-19-2003.

AuctionHarbor

THE MARK CONSISTS OF STANDARD CHARACTERS WITHOUT CLAIM TO ANY PARTICULAR FONT, STYLE, SIZE, OR COLOR.

FOR ON-LINE TRADING SERVICES IN WHICH SELLER POSTS ITEMS TO BE SOLD IN AN AUCTION-STYLE OR FIXED PRICE FORMAT AND BIDDING OR BUYING IS DONE ELECTRONICALLY (U.S. CLS. 100, 101 AND 102).

FIRST USE 11-15-2003; IN COMMERCE 11-16-2003.
SUE LAWRENCE, EXAMINING ATTORNEY

OWNER OF U.S. REG. NO. 2,253,006.

NO CLAIM IS MADE TO THE EXCLUSIVE RIGHT TO USE "FESTIVALS.COM", APART FROM THE MARK AS SHOWN.

THE MARK CONSISTS OF THE STYLIZED UNDERLINED WORDS "FESTIVALS.COM" WITH A SUNBURST DESIGN OVER THE "I".

SEC. 2(F).

FOR PROVIDING ON-LINE ADVERTISEMENTS AND ADVERTISING FOR THE GOODS AND SERVICES OF FESTIVAL AND EVENT SPONSORS, SUPPLIERS, PERFORMERS AND PRODUCERS; PROVIDING ON-LINE DIRECTORY INFORMATION SERVICES FOR FESTIVAL AND EVENT SPONSORS, SUPPLIERS, PERFORMERS AND PRODUCERS; PROMOTING THE GOODS AND SERVICES OF FESTIVAL AND EVENT SPONSORS, SUPPLIERS, PERFORMERS AND PRODUCERS; PROVIDING AN ON-LINE COMPUTER DATABASE FEATURING TRADE INFORMATION IN THE FIELD OF FESTIVALS AND EVENTS; PROVIDING ON-LINE BUSINESS DIRECTORIES FEATURING EVENT AND FESTIVAL SPONSORS, SUPPLIERS, PERFORMERS AND PRODUCERS; DEVELOPING PROMOTIONAL CAMPAIGNS FOR FESTIVAL AND EVENT PROMOTERS IN THE FIELD OF NATIONAL AND INTERNATIONAL FESTIVALS AND EVENTS; PROMOTING THE GOODS AND SERVICES OF OTHERS BY CREATING MARKETING AND ADVERTISING OPPORTUNITIES FOR SPONSORS TO AFFILIATE THEIR GOODS AND SERVICES WITH FESTIVALS AND EVENTS; PROVIDING BUSINESS MARKETING INFORMATION; BUSINESS MARKETING CONSULTING SERVICES; DISSEMINATION OF ADVERTISING FOR OTHERS VIA THE INTERNET, RADIO AND TELEVISION; PRODUCTION AND DISTRIBUTION OF RADIO AND TELEVISION COMMERCIALS; PROMOTING THE FESTIVALS AND OTHER ENTERTAINMENT EVENTS OF OTHERS, NAMELY, PREPARATION OF CUSTOM ADVERTISEMENTS AND CUSTOM PROMOTIONAL PRODUCTS FOR FESTIVALS AND OTHER ENTERTAINMENT EVENTS OF OTHERS (U.S. CLS. 100, 101 AND 102).

FIRST USE 9-25-2003; IN COMMERCE 9-25-2003.
GIANCARLO CASTRO, EXAMINING ATTORNEY

CLASS 35—(Continued).

SN 78-347,403. COMPUTER MEDICS OF AMERICA, INC., EAGLE RIVER, AK. FILED 1-2-2004.

CLASS 35—(Continued).

SN 78-353,781. MILLION MAN MERCH, INC., NASHVILLE, TN. FILED 1-19-2004.

COMPUTER MEDICS OF AMERICA, INC.

THE MARK CONSISTS OF STANDARD CHARACTERS WITHOUT CLAIM TO ANY PARTICULAR FONT, STYLE, SIZE, OR COLOR.

NO CLAIM IS MADE TO THE EXCLUSIVE RIGHT TO USE "COMPUTER" AND "AMERICA, INC", APART FROM THE MARK AS SHOWN.

FOR FRANCHISING, NAMELY, OFFERING TECHNICAL ASSISTANCE IN THE ESTABLISHMENT AND/OR OPERATION OF MOBILE COMPUTER REPAIR SERVICE BUSINESSES (U.S. CLS. 100, 101 AND 102).

FIRST USE 1-1-2003; IN COMMERCE 1-1-2003.
JEAN IM, EXAMINING ATTORNEY

MILLION MAN MERCH

THE MARK CONSISTS OF STANDARD CHARACTERS WITHOUT CLAIM TO ANY PARTICULAR FONT, STYLE, SIZE, OR COLOR.

FOR PREPARING PROMOTIONAL AND MERCHANDISING MATERIAL FOR OTHERS; PREPARATION OF CUSTOM ADVERTISEMENTS AND PROMOTIONAL AND MERCHANDISING MATERIALS FOR OTHERS; MERCHANDISING SERVICES FOR INDUCING THE PURCHASING PUBLIC TO BUY THE GOODS OF OTHERS ON TOURS AND AT FESTIVALS, PROMOTING THE CONCERTS, MERCHANDISE, AND SERVICES OF OTHERS IN THE MUSIC AND ENTERTAINMENT INDUSTRIES THROUGH THE DISTRIBUTION OF PRINTED AND AUDIO PROMOTIONAL MATERIALS AND BY RENDERING SALES PROMOTION ADVICE; MERCHANDISING DISPLAY SERVICES; DEVELOPING PROMOTIONAL MERCHANDISING CAMPAIGNS FOR BUSINESS; DISSEMINATION OF ADVERTISING FOR OTHERS VIA THE INTERNET (U.S. CLS. 100, 101 AND 102).

FIRST USE 4-0-2003; IN COMMERCE 4-0-2003.
VERNA BETH RIRIE, EXAMINING ATTORNEY

SN 78-347,789. MARKET FORCE, INC., RALEIGH, NC. FILED 1-5-2004.

SN 78-354,643. VISAGE SOLUTIONS, LLC, RALEIGH, NC. FILED 1-21-2004.

MATRIX
MARKETING • PROGRAM

NO CLAIM IS MADE TO THE EXCLUSIVE RIGHT TO USE "MARKETING PROGRAM", APART FROM THE MARK AS SHOWN.

THE MARK CONSISTS OF THE WORD MATRIX IN THE GALANT FONT. THE WORDS MARKETING PROGRAM ARE IN THE MYRIAD FONT.

FOR BUSINESS CONSULTATION AND MARKETING SERVICES, NAMELY, HELPING ECONOMIC DEVELOPMENT ORGANIZATIONS RECRUIT BUSINESSES AND INDUSTRIES TO THEIR AREAS OF THE COUNTRY (U.S. CLS. 100, 101 AND 102).

FIRST USE 11-4-2003; IN COMMERCE 11-4-2003.
DAVID TAYLOR, EXAMINING ATTORNEY



THE COLOR(S) BLUE IS/ARE CLAIMED AS A FEATURE OF THE MARK.

THE COLOR BLUE APPEARS ON THE ENTIRE MARK. FOR BUSINESS CONSULTING SERVICES, NAMELY, SERVICES THAT ALLOW COMPANIES TO COMPLY, MINIMIZE COMPLIANCE AND ONGOING AUDITING COSTS WHILE SUPPLING MANAGEMENT WITH BETTER INFORMATION THAT ALLOW THEM RUN THEIR BUSINESS MORE EFFECTIVELY (U.S. CLS. 100, 101 AND 102).

FIRST USE 12-15-2003; IN COMMERCE 1-9-2004.
GEORGIA CARTY, EXAMINING ATTORNEY

CLASS 35—(Continued).

SN 78-355,095. INTEREP NATIONAL RADIO SALES, INC., NEW YORK, NY. FILED 1-21-2004.



OWNER OF U.S. REG. NOS. 1,502,570, 2,641,653 AND OTHERS.

NO CLAIM IS MADE TO THE EXCLUSIVE RIGHT TO USE RADIO GROUP AND COMPANY, APART FROM THE MARK AS SHOWN.

FOR BUSINESS CONSULTING SERVICES TO COMPANIES BUYING RADIO TIME FOR OTHERS RELATED TO BUSINESS RESEARCH, MARKETING AND SALES DEVELOPMENT (U.S. CLS. 100, 101 AND 102).

FIRST USE 1-31-2004; IN COMMERCE 1-31-2004.
BRIDGETT SMITH, EXAMINING ATTORNEY

CLASS 35—(Continued).

SN 78-358,250. COMMUNITY PROFIT GROUP LLC, NEW-ARK, DE. FILED 1-27-2004.



NO CLAIM IS MADE TO THE EXCLUSIVE RIGHT TO USE A COMMUNITY PROFIT ORGANIZATION, APART FROM THE MARK AS SHOWN.

FOR EMPLOYMENT HIRING AND RECRUITING OF INDEPENDENT SALES REPRESENTATIVES IN THE FIELD OF ACCOUNTS RECEIVABLE (U.S. CLS. 100, 101 AND 102).

FIRST USE 6-2-2003; IN COMMERCE 6-5-2003.
TARAH HARDY, EXAMINING ATTORNEY

SN 78-355,096. TEA ASSOCIATION OF THE U.S.A., INC., NEW YORK, NY. FILED 1-21-2004.



NO CLAIM IS MADE TO THE EXCLUSIVE RIGHT TO USE "TEA TEA COUNCIL OF THE USA, INC.", APART FROM THE MARK AS SHOWN.

FOR ASSOCIATION SERVICES, NAMELY, PROMOTING THE INTERESTS OF TEA MANUFACTURERS, DEVELOPERS, DISTRIBUTORS, SELLERS, PACKERS, IMPORTERS, PRODUCING COUNTRIES, AND ALLIED INDUSTRIES IN THE DOMESTIC AND INTERNATIONAL TEA INDUSTRY (U.S. CLS. 100, 101 AND 102).

FIRST USE 1-0-1992; IN COMMERCE 1-0-1992.
BRIDGETT SMITH, EXAMINING ATTORNEY

SN 78-358,574. MARSHALLS OF NEVADA, INC., NORTH LAS VEGAS, NV. FILED 1-28-2004.

**MARSHALLS SHOE
MEGASHOP**

THE MARK CONSISTS OF STANDARD CHARACTERS WITHOUT CLAIM TO ANY PARTICULAR FONT, STYLE, SIZE, OR COLOR.

OWNER OF U.S. REG. NOS. 1,066,952, 2,720,765 AND OTHERS.

NO CLAIM IS MADE TO THE EXCLUSIVE RIGHT TO USE "SHOE", APART FROM THE MARK AS SHOWN.

FOR RETAIL CLOTHING, FOOTWEAR, DOMESTIC GOODS AND GIFTWARE STORES SERVICES (U.S. CLS. 100, 101 AND 102).

CIMMERIAN COLEMAN, EXAMINING ATTORNEY

CLASS 35—(Continued).

SN 78-359,731. MOTOROLA, INC., SCHAUMBURG, IL. FILED 1-29-2004.

TRYMEMOTO

THE MARK CONSISTS OF STANDARD CHARACTERS WITHOUT CLAIM TO ANY PARTICULAR FONT, STYLE, SIZE, OR COLOR.

FOR PROVIDING A WEBSITE FOR A CONSUMER FEEDBACK PROGRAM ON NEW PRODUCT INTRODUCTION RELATIVE TO CELLULAR PHONES AND ACCESSORIES FOR CELLULAR PHONES (U.S. CLS. 100, 101 AND 102).

DARRYL SPRUILL, EXAMINING ATTORNEY

CLASS 35—(Continued).

SN 78-363,171. MOSTOFIZADEH, KAMBIZ, SAN JOSE, CA. FILED 2-5-2004.

SilkRoadβ2β

THE MARK CONSISTS OF SILKROADB2B WITH THE B2B WRITTEN IN GREEK STYLE.

FOR OPERATING ON-LINE BUSINESS TO BUSINESS MARKETPLACES FOR SELLERS OF GOODS AND/OR SERVICES THAT ALLOWS USERS TO BUY AND SELL USING AUCTIONS AND REQUEST FOR QUOTES THROUGH USE OF A BUILT-IN E-BUSINESS SUITE (U.S. CLS. 100, 101 AND 102).

FIRST USE 6-15-2002; IN COMMERCE 6-15-2002.

CHRISTOPHER ADKINS, EXAMINING ATTORNEY

SN 78-361,967. NORDSTROM, INC., SEATTLE, WA. FILED 2-3-2004.

**NORDSTROM TRAVEL
CONNECTION. QUALITY.
STYLE. PERFORMANCE.**

THE MARK CONSISTS OF STANDARD CHARACTERS WITHOUT CLAIM TO ANY PARTICULAR FONT, STYLE, SIZE, OR COLOR.

OWNER OF U.S. REG. NOS. 1,280,785, 1,409,938 AND OTHERS.

NO CLAIM IS MADE TO THE EXCLUSIVE RIGHT TO USE "QUALITY. STYLE.", APART FROM THE MARK AS SHOWN.

FOR RETAIL STORE, MAIL ORDER AND ONLINE RETAIL STORE SERVICES IN THE FIELD OF SMALL LEATHER GOODS, NAMELY, SUITCASES, EXPANDABLE ROLLING LUGGAGE, CARRY-ON LUGGAGE, WHEELED WARDROBES, BRIEFCASES, TOTES, GARMENT BAGS AND TOILETRY KITS (U.S. CLS. 100, 101 AND 102).

KHANH LE, EXAMINING ATTORNEY

SN 78-364,157. DUDA AND ASSOCIATES, INC., MARK DAMIAN, HARRISONBURG, VA. FILED 2-6-2004.

Responsive Management



THE COLOR(S) BLUE AND BROWN IS/ARE CLAIMED AS A FEATURE OF THE MARK.

THE COLOR(S) "RESPONSIVE MANAGEMENT" IS IN BROWN; THE DEER, MOUNTAINS, LAND, AND TREES ARE BROWN; THE PEOPLE, THE SKY AND WATER ARE IN SKY BLUE IS/ARE CLAIMED AS A FEATURE OF THE MARK.

SEC. 2(F).

FOR CONDUCTING BUSINESS AND MARKET RESEARCH SURVEYS (U.S. CLS. 100, 101 AND 102).

FIRST USE 1-1-1989; IN COMMERCE 1-1-1990.

RICHARD WHITE, EXAMINING ATTORNEY

CLASS 35—(Continued).

SN 78-365,293. ANDROID INDUSTRIES, LLC, FLINT, MI. FILED 2-10-2004.

Ai

THE MARK CONSISTS OF STANDARD CHARACTERS WITHOUT CLAIM TO ANY PARTICULAR FONT, STYLE, SIZE, OR COLOR.

FOR LOGISTICS INVENTORY MANAGEMENT IN THE FIELD OF AUTOMOTIVE ASSEMBLY (U.S. CLS. 100, 101 AND 102).

FIRST USE 3-1-1990; IN COMMERCE 3-1-1990.
PAUL F. GAST, EXAMINING ATTORNEY

CLASS 35—(Continued).

SN 78-365,895. DR. HOTDOG, LOS ANGELES, CA. FILED 2-10-2004.



THE MARK CONSISTS OF A DOG DRESSED AS A HOTDOG. THE DOG IS ALSO WEARING A DOCTOR'S STETHOSCOPE.

FOR RETAIL STORE SERVICES FEATURING T-SHIRTS (U.S. CLS. 100, 101 AND 102).

FIRST USE 11-1-2003; IN COMMERCE 12-1-2003.
ARETHA SOMERVILLE, EXAMINING ATTORNEY

SN 78-366,448. CITY OF SUN PRAIRIE, SUN PRAIRIE, WI. FILED 2-11-2004.

SN 78-365,749. LUXSTONE USA, INC., DEERFIELD, FL. FILED 2-10-2004.

LUXSTONE



THE MARK CONSISTS OF STANDARD CHARACTERS WITHOUT CLAIM TO ANY PARTICULAR FONT, STYLE, SIZE, OR COLOR.

FOR IMPORT AND EXPORT AGENCY IN THE FIELD OF MARBLE AND GRANITE; WHOLESALE AND RETAIL DISTRIBUTORSHIPS IN THE FIELD OF MARBLE, GRANITE, AND MARBLE AND GRANITE PRODUCTS (U.S. CLS. 100, 101 AND 102).

FIRST USE 1-0-2001; IN COMMERCE 8-0-2003.
JOHN DWYER, EXAMINING ATTORNEY

NO CLAIM IS MADE TO THE EXCLUSIVE RIGHT TO USE "CITY OF SUN PRAIRIE", APART FROM THE MARK AS SHOWN.

THE MARK CONSISTS OF THE TOP OF A SUNBURST ON ROLLING HILLS ON A BACKGROUND WITH THE WORDS "CITY OF SUN PRAIRIE" ON TOP OF A LINE.

FOR ASSOCIATION SERVICES, NAMELY, PROMOTING THE INTERESTS OF THE MUNICIPALITY OF THE CITY OF SUN PRAIRIE, WI (U.S. CLS. 100, 101 AND 102).

FIRST USE 1-1-1993; IN COMMERCE 1-1-1993.
DANIEL CAPSHAW, EXAMINING ATTORNEY

CLASS 35—(Continued).

SN 78-369,289. SUREPREP, LLC, NEWPORT BEACH, CA.
FILED 2-17-2004.



OWNER OF U.S. REG. NO. 2,787,419.
THE COLOR(S) RED AND BLACK IS/ARE CLAIMED AS
A FEATURE OF THE MARK.

THE MARK CONSISTS OF RED "S" LOGO DESIGN AND
THE WORD "SUREPREP" IN STYLIZED FONT.

FOR PROVIDING OUTSOURCED ACCOUNTING AND
TAX SERVICES, NAMELY TAX PREPARATION AND
TAX CONSULTING TO SMALL AND MEDIUM SIZED
BUSINESSES (U.S. CLS. 100, 101 AND 102).

FIRST USE 8-1-2002; IN COMMERCE 8-1-2002.
SCOTT OSICK, EXAMINING ATTORNEY

CLASS 35—(Continued).

SN 78-376,182. P. I., INC., ATHENS, TN. FILED 3-1-2004.

SWEETWATER STEPS

THE MARK CONSISTS OF STANDARD CHARACTERS
WITHOUT CLAIM TO ANY PARTICULAR FONT, STYLE,
SIZE, OR COLOR.

NO CLAIM IS MADE TO THE EXCLUSIVE RIGHT TO
USE "STEPS", APART FROM THE MARK AS SHOWN.

FOR RETAIL STORE SERVICES FEATURING SWIM-
MING POOL ACCESSORIES (U.S. CLS. 100, 101 AND
102).

FIRST USE 12-31-1997; IN COMMERCE 12-31-1997.
C. DIONNE CLYBURN, EXAMINING ATTORNEY

SN 78-371,861. CAMPUS ENTERPRISES, INC., MILWAU-
KEE, WI. FILED 2-21-2004.



NO CLAIM IS MADE TO THE EXCLUSIVE RIGHT TO
USE "CAREPACKAGE .NET", APART FROM THE MARK
AS SHOWN.

THE COLOR(S) RED, WHITE AND BLUE IS/ARE
CLAIMED AS A FEATURE OF THE MARK.

THE COLOR BLUE APPEARS IN THE GIFT PACKAGE
DESIGN; THE COLOR RED APPEARS IN THE BACK-
GROUND AND THE COLOR WHITE APPEARS IN THE
WORDING PORTION OF THE MARK.

FOR DIRECT MAIL AND ONLINE RETAIL STORE
SERVICES FEATURING CUSTOM CARE PACKAGES
CONTAINING PREPACKAGED FOODS, GENERAL NO-
VELTY ITEMS AND OTHER GIFT ITEMS (U.S. CLS. 100,
101 AND 102).

FIRST USE 1-1-2003; IN COMMERCE 1-1-2003.
PATRICIA EVANKO, EXAMINING ATTORNEY

SN 78-376,861. AMERICASPEAKS CORPORATION, WA-
SHINGTON, DC. FILED 3-2-2004.

**AMERICASPEAKS
ENGAGING CITIZENS IN
GOVERNANCE**

THE MARK CONSISTS OF STANDARD CHARACTERS
WITHOUT CLAIM TO ANY PARTICULAR FONT, STYLE,
SIZE, OR COLOR.

FOR PUBLIC POLICY MEETING PLANNING SER-
VICES, NAMELY, ORGANIZING, ARRANGING, CON-
DUCTING AND FACILITATING MEETINGS OF
CITIZENS ON PUBLIC POLICY AND PLANNING, AND
UTILIZING COMPUTERS AND TECHNOLOGY TO
MANAGE THE INTERACTION AND IDENTIFY THE
PUBLIC'S PRIORITIES (U.S. CLS. 100, 101 AND 102).

FIRST USE 8-13-1996; IN COMMERCE 8-13-1996.
MICHAEL HALL, EXAMINING ATTORNEY

CLASS 35—(Continued).

SN 78-378,238. INTERNATIONAL LEVERAGE, LLC, INDIANAPOLIS, IN. FILED 3-4-2004.

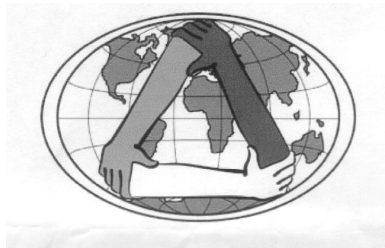

THE STIPPLING IS A FEATURE OF THE MARK.
THE COLOR(S) GRAY IS/ARE CLAIMED AS A FEATURE OF THE MARK.

THE COLOR GRAY APPEARS IN THE GLOBE/MAP AND IN TWO OF THE ARMS SEEN IN THE LOGO, SYMBOLIZING PEOPLE OF DIFFERENT RACES.

FOR MARKET RESEARCH, FUNDING RESOURCES, NAMELY BUSINESS SERVICES IN THE NATURE OF MATCHING POTENTIAL INVESTORS WITH ENTREPRENEURS NEEDING FUNDING; INTERNATIONAL BUSINESS DEVELOPMENT, NAMELY PROVIDING START-UP SUPPORT FOR NEW AND EXISTING BUSINESSES; STRATEGIC CONSULTING SERVICES FOR PRODUCT DISTRIBUTION AND OPERATIONS MANAGEMENT; BUSINESS CONSULTATION IN THE FIELD OF COMMERCIALIZATION OF NEW TECHNOLOGIES; BUSINESS MANAGEMENT CONSULTING IN THE FIELD OF EXECUTIVE AND LEADERSHIP DEVELOPMENT (U.S. CLS. 100, 101 AND 102).

FIRST USE 2-0-2000; IN COMMERCE 1-0-2002.
DAVID TAYLOR, EXAMINING ATTORNEY

CLASS 35—(Continued).

SN 78-379,573. QUALITY CANDY SHOPPES/BUDDY SQUIRREL OF WISCONSIN, INC., MILWAUKEE, WI. FILED 3-5-2004.

Buddy Squirrel
THE PREMIER NUT SHOP

NO CLAIM IS MADE TO THE EXCLUSIVE RIGHT TO USE "THE PREMIER NUT SHOP", APART FROM THE MARK AS SHOWN.

FOR RETAIL STORES FEATURING CANDY AND SNACK FOODS; WHOLESALE DISTRIBUTORSHIPS FEATURING CANDY AND SNACK FOODS (U.S. CLS. 100, 101 AND 102).

FIRST USE 0-0-1954; IN COMMERCE 0-0-1954.
ANGELA M. MICHELLI, EXAMINING ATTORNEY

SN 78-379,624. KARLA SCHIKORE & ASSOCS, LLC, DBA HAUS FORTUNA, PETALUMA, CA. FILED 3-5-2004.

Haus Fortuna



SN 78-378,766. MAJOR LEAGUE UMPIRES INDEPENDENT ORGANIZING COMMITTEE, TIMONIUM, MD. FILED 3-4-2004.

OWNER OF U.S. REG. NO. 2,505,650.
NO CLAIM IS MADE TO THE EXCLUSIVE RIGHT TO USE WORLD UMPIRES ASSOCIATION, APART FROM THE MARK AS SHOWN.

THE COLOR(S) BLUE, WHITE, BLACK AND RED IS/ARE CLAIMED AS A FEATURE OF THE MARK.

THE MARK CONSISTS OF AN ELLIPTICAL BLUE GLOBE CONTAINING WHITE CONTINENTS AND WHITE LONGITUDINAL AND LATITUDINAL LINES, EN-CIRCLED BY TWO BLACK LINE, AND A WHITE BASEBALL WITH RED SEAMS.

FOR LABOR UNION COMPRISED OF MAJOR LEAGUE BASEBALL UMPIRES (U.S. CLS. 100, 101 AND 102).
FIRST USE 1-1-2003; IN COMMERCE 1-1-2003.
TRACY CROSS, EXAMINING ATTORNEY

THE MARK CONSISTS OF STANDARD CHARACTERS WITHOUT CLAIM TO ANY PARTICULAR FONT, STYLE, SIZE, OR COLOR.

THE FOREIGN WORDING IN THE MARK TRANSLATES INTO ENGLISH AS "BLESSED HOME" OR "LUCKY HOME".

FOR RETAIL GIFT SHOPS AND RETAIL SHOPS FEATURING FOREIGN AND DOMESTIC HOUSEWARES AND PERSONAL ITEMS, NAMELY ITALIAN HAND PAINTED CERAMIC KITCHEN AND DINNING ITEMS, WHICH INCLUDES DINNING PLATES, PLATTERS, PITCHERS, AND VASES, OTHER FEATURED ITEMS INCLUDE TABLECLOTHES AND CLOTH NAPKINS, SERVING AND COOKING UTENSILS AND VESSELS, DRINKING GLASSES AND OTHER ITEMS COMMONLY ASSOCIATED WITH PREPARING AND SERVING FOOD IN A PRIVATE HOME (U.S. CLS. 100, 101 AND 102).

FIRST USE 9-25-2001; IN COMMERCE 9-25-2001.
BARBARA BROWN, EXAMINING ATTORNEY

CLASS 35—(Continued).

SN 78-380,541. HARLEE MEDICAL TECHNOLOGIES, INC., HOUSTON, TX. FILED 3-8-2004.



NO CLAIM IS MADE TO THE EXCLUSIVE RIGHT TO USE "PAIN, MEDICAL TECHNOLOGIES, INC., SPECIALTIES FOR PAIN MANAGEMENT, AND THE REPRESENTATION OF THE INTERNATIONAL PROHIBITION SYMBOL", APART FROM THE MARK AS SHOWN.

THE COLOR(S) RED IS/ARE CLAIMED AS A FEATURE OF THE MARK.

THE COLOR RED APPEARS IN THE INTERNATIONAL PROHIBITION SYMBOL AND THE WORD "PAIN".

FOR RETAIL STORE SERVICES, ON-LINE RETAIL STORE SERVICES, AND WHOLESALE DISTRIBUTORSHIP SERVICES FEATURING MEDICAL EQUIPMENT AND SUPPLIES (U.S. CLS. 100, 101 AND 102).

FIRST USE 0-0-1999; IN COMMERCE 0-0-1999.
CHRIS WELLS, EXAMINING ATTORNEY

SN 78-381,100. STAPLES THE OFFICE SUPERSTORE, LLC, FRAMINGHAM, MA. FILED 3-9-2004.

SIMPLY

THE MARK CONSISTS OF STANDARD CHARACTERS WITHOUT CLAIM TO ANY PARTICULAR FONT, STYLE, SIZE, OR COLOR.

FOR RETAIL STORE SERVICES, MAIL ORDER CATALOG SERVICES, AND COMPUTERIZED ONLINE RETAIL STORE SERVICES FEATURING OFFICE SUPPLIES, OFFICE EQUIPMENT, INCLUDING COMPUTER HARDWARE, COPIERS AND TELEPHONES, AND OFFICE FURNITURE (U.S. CLS. 100, 101 AND 102).

MICHAEL WEBSTER, EXAMINING ATTORNEY

CLASS 35—(Continued).

SN 78-381,716. STETSON, ROBERT J., DALLAS, TX. FILED 3-10-2004.

Common Sense Party

THE MARK CONSISTS OF STANDARD CHARACTERS WITHOUT CLAIM TO ANY PARTICULAR FONT, STYLE, SIZE, OR COLOR.

NO CLAIM IS MADE TO THE EXCLUSIVE RIGHT TO USE "PARTY", APART FROM THE MARK AS SHOWN.

FOR POLITICAL PARTY SERVICES, NAMELY PROMOTING THE INTERESTS OF A POLITICAL PARTY (U.S. CLS. 100, 101 AND 102).

SOPHIA S. KIM, EXAMINING ATTORNEY

SN 78-381,717. STETSON, ROBERT J., DALLAS, TX. FILED 3-10-2004.

COMMON SENSE COALITION

THE MARK CONSISTS OF STANDARD CHARACTERS WITHOUT CLAIM TO ANY PARTICULAR FONT, STYLE, SIZE, OR COLOR.

NO CLAIM IS MADE TO THE EXCLUSIVE RIGHT TO USE "COALITION", APART FROM THE MARK AS SHOWN.

FOR PROVIDING INFORMATION REGARDING POLITICAL AND GOVERNMENTAL ISSUES (U.S. CLS. 100, 101 AND 102).

SOPHIA S. KIM, EXAMINING ATTORNEY

SN 78-383,562. TOTAL CLERICAL SERVICES, INC., WALTHAM, MA. FILED 3-12-2004.



Total Clerical Services, Inc.
Total Solutions Meeting Your Staffing Needs

NO CLAIM IS MADE TO THE EXCLUSIVE RIGHT TO USE "CLERICAL SERVICES, INC.", APART FROM THE MARK AS SHOWN.

FOR PERSONNEL AGENCY SERVICES FOR PROVIDING TEMPORARY AND PERMANENT PERSONNEL TO INDUSTRY AND GOVERNMENT, INCLUDING PROVIDING CONTRACT LABOR TO INDUSTRY AND GOVERNMENT (U.S. CLS. 100, 101 AND 102).

FIRST USE 3-14-1994; IN COMMERCE 3-14-1994.
STEPHANIE DAVIS, EXAMINING ATTORNEY

CLASS 35—(Continued).

SN 78-383,843. GLOBAL NETWORK COMMUNICATIONS, INC., ROSEVILLE, MI. FILED 3-12-2004.



NO CLAIM IS MADE TO THE EXCLUSIVE RIGHT TO USE "WIRELESS", APART FROM THE MARK AS SHOWN. THE MARK CONSISTS OF ARCS EMANATING FROM LETTER "I" REPRESENTING RADIO SIGNALS EMANATING FROM AN ANTENNA.

FOR RETAIL STORE SERVICES FEATURING ELECTRONICS; AND ONLINE RETAIL STORE SERVICES FEATURING ELECTRONICS (U.S. CLS. 100, 101 AND 102).

FIRST USE 1-31-2004; IN COMMERCE 1-31-2004.
TONI HICKEY, EXAMINING ATTORNEY

CLASS 35—(Continued).

SN 78-384,978. IBEX OUTDOOR CLOTHING, LLC, WOODSTOCK, VT. FILED 3-16-2004.

IBEX

THE MARK CONSISTS OF STANDARD CHARACTERS WITHOUT CLAIM TO ANY PARTICULAR FONT, STYLE, SIZE, OR COLOR.

FOR ELECTRONIC AND MAIL ORDER CATALOG SERVICE AND ON-LINE RETAIL STORE SERVICES FEATURING CLOTHING, NAMELY, COATS, SHIRTS, PANTS, GLOVES, LONG UNDERWEAR, HEADWEAR, JACKETS, PULLOVERS AND VESTS (U.S. CLS. 100, 101 AND 102).

FIRST USE 12-24-1996; IN COMMERCE 6-1-1997.
EDWARD NELSON, EXAMINING ATTORNEY

SN 78-386,253. KONNEN GLASHAUS, INC., MORRISON, CO. FILED 3-17-2004.

Konnen

COMPUTER MARKETING CORPORATION

SN 78-384,716. COMPUTER MARKETING CORPORATION, SALT LAKE CITY, UT. FILED 3-15-2004.

THE MARK CONSISTS OF STANDARD CHARACTERS WITHOUT CLAIM TO ANY PARTICULAR FONT, STYLE, SIZE, OR COLOR.

NO CLAIM IS MADE TO THE EXCLUSIVE RIGHT TO USE "CORPORATION", APART FROM THE MARK AS SHOWN.

SEC. 2(F).
FOR DATA PROCESSING AND MANAGEMENT ASSISTANCE FOR CREDIT UNIONS (U.S. CLS. 100, 101 AND 102).

FIRST USE 2-28-1978; IN COMMERCE 2-28-1978.
G. MAYERSCHOFF, EXAMINING ATTORNEY

THE MARK CONSISTS OF STANDARD CHARACTERS WITHOUT CLAIM TO ANY PARTICULAR FONT, STYLE, SIZE, OR COLOR.

THE ENGLISH TRANSLATION OF "KONNEN" IS "TO KNOW".

FOR RETAIL STORE SERVICES, ONLINE RETAIL STORE SERVICES AND WHOLESALE STORE SERVICES FEATURING IMPORTED CUSTOM WINDOWS SOLD TO CUSTOM HOMEBUILDERS (U.S. CLS. 100, 101 AND 102).

FIRST USE 8-1-2001; IN COMMERCE 8-1-2001.
MONTIA G. PRESSEY, EXAMINING ATTORNEY

CLASS 35—(Continued).

SN 78-388,684. INTERNATIONAL ASSOCIATION OF EXHIBITION MANAGEMENT, INC., DALLAS, TX. FILED 3-22-2004.



NO CLAIM IS MADE TO THE EXCLUSIVE RIGHT TO USE "CERTIFIED IN EXHIBITION MANAGEMENT", APART FROM THE MARK AS SHOWN.

FOR PROMOTING PUBLIC AWARENESS OF THE NEED FOR EXHIBITION ORGANIZERS AND SUPPLIERS; AND ASSOCIATION SERVICES, NAMELY, PROMOTING THE INTERESTS OF PRACTITIONERS IN THE FIELD OF EXHIBITION ORGANIZATION AND SUPPLY (U.S. CLS. 100, 101 AND 102).

FIRST USE 6-1-2001; IN COMMERCE 6-1-2001.
AMY ALFIERI, EXAMINING ATTORNEY

SN 78-390,662. RUTGERS, THE STATE UNIVERSITY OF NEW JERSEY, NEW BRUNSWICK, NJ. FILED 3-25-2004.

FRIENDS OF RUTGERS

THE MARK CONSISTS OF STANDARD CHARACTERS WITHOUT CLAIM TO ANY PARTICULAR FONT, STYLE, SIZE, OR COLOR.

FOR ASSOCIATION SERVICES, NAMELY, PROMOTING THE INTERESTS OF A STATE UNIVERSITY AND ITS RELATED ENTITIES THROUGH A NETWORK OF INDIVIDUALS AND CORPORATIONS SUPPORTING EDUCATION, RESEARCH, AND PUBLIC SERVICE (U.S. CLS. 100, 101 AND 102).

FIRST USE 2-11-2004; IN COMMERCE 2-11-2004.
JASON LOTT, EXAMINING ATTORNEY

CLASS 35—(Continued).

SN 78-390,883. MARSTEL-DAY, LLC, FREDERICKSBURG, VA. FILED 3-25-2004.



THE COLORS PURPLE AND BLACK ARE CLAIMED AS A FEATURE OF THE MARK.

THE COLOR PURPLE APPEARS IN THE TREE-HILLSIDE-STAR-WATER IMAGE. THE COLOR BLACK APPEARS IN THE WORDING AND UNDERLINING.

THE MARK CONSISTS IN PART OF A TREE-HILLSIDE-STAR-WATER IMAGE AND THE SLOGAN, CONSERVATION AND CONSULTING FROM SEA TO STARS.

SEC. 2(F).

FOR BUSINESS CONSULTATION SERVICES IN THE FIELDS OF ENVIRONMENTAL MANAGEMENT AND CONSERVATION (U.S. CLS. 100, 101 AND 102).

FIRST USE 4-1-2003; IN COMMERCE 4-15-2003.
STEVEN R. FINE, EXAMINING ATTORNEY

SN 78-391,298. LAGUNA BEACH PROPERTIES, INC., NEWPORT BEACH, CA. FILED 3-26-2004.

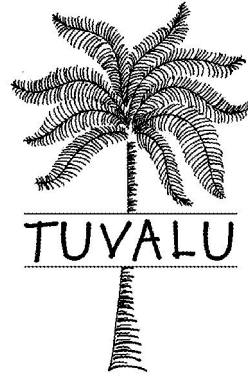

NO CLAIM IS MADE TO THE EXCLUSIVE RIGHT TO USE "TUVALU", APART FROM THE MARK AS SHOWN.

FOR RETAIL STORE SERVICES FEATURING HOME FURNISHINGS, HOUSEHOLD UTENSILS, FURNITURE, DECORATIVE ITEMS, GIFTS, KITCHEN ACCESSORIES, PICTURE FRAMES, FLOWERS, PLANTS, SEA SHELLS, GLASSWARE, BEDROOM FURNISHINGS, RUGS, ANTIQUES, BOOKS, JOURNALS, PAPER GOODS, ARTWORK, BATH AND BODY PRODUCTS, CANDLES, CANDLESTICKS, GAMES, JEWELRY, CHILDREN'S ACCESSORIES, LIGHTING PRODUCTS, GARDEN MERCHANDISE, OUTDOOR MERCHANDISE, PET SUPPLIES, HOME ACCENTS, HOLIDAY-RELATED MERCHANDISE, WEDDING PRODUCTS, BAR ACCESSORIES (U.S. CLS. 100, 101 AND 102).

FIRST USE 8-21-2003; IN COMMERCE 9-1-2003.
SALLY SHIH, EXAMINING ATTORNEY

CLASS 35—(Continued).

SN 78-391,641. SEYMOUR, MATTHEW R., DOWNING-TOWN, PA. FILED 3-26-2004.

CLASS 35—(Continued).

SN 78-392,326. HRINTERAX, INC., NEWTOWN, CT. FILED 3-29-2004.

INSIGHT OUT

ProFolio

THE MARK CONSISTS OF STANDARD CHARACTERS WITHOUT CLAIM TO ANY PARTICULAR FONT, STYLE, SIZE, OR COLOR.
FOR HEALTHCARE MARKETING SERVICES SPECIALIZING IN PATIENT MOTIVATION (U.S. CLS. 100, 101 AND 102).
ANNE FARRELL, EXAMINING ATTORNEY

THE MARK CONSISTS OF STANDARD CHARACTERS WITHOUT CLAIM TO ANY PARTICULAR FONT, STYLE, SIZE, OR COLOR.
FOR PERSONNEL PLACEMENT AND RECRUITMENT MANAGEMENT SERVICES (U.S. CLS. 100, 101 AND 102).
FIRST USE 10-7-2001; IN COMMERCE 12-6-2001.
RAMONA ORTIGA, EXAMINING ATTORNEY

SN 78-392,115. KAFCO, INC., CHICAGO, IL. FILED 3-28-2004.

SN 78-393,384. MAX CRUISE, LLC, FREEHOLD, NJ. FILED 3-30-2004.

Cheap. Easy. Fun.

MAX CRUISE

THE MARK CONSISTS OF STANDARD CHARACTERS WITHOUT CLAIM TO ANY PARTICULAR FONT, STYLE, SIZE, OR COLOR.
FOR RETAIL SHOPS FEATURING WINE (U.S. CLS. 100, 101 AND 102).
FIRST USE 8-15-2003; IN COMMERCE 8-15-2003.
CHRISTOPHER BUONGIORNO, EXAMINING ATTORNEY

THE MARK CONSISTS OF STANDARD CHARACTERS WITHOUT CLAIM TO ANY PARTICULAR FONT, STYLE, SIZE, OR COLOR.
"MAX CRUISE" DOES NOT IDENTIFY A LIVING INDIVIDUAL.
FOR TALENT AGENCY SERVICES; PROMOTING THE CONCERTS OF OTHERS (U.S. CLS. 100, 101 AND 102).
FIRST USE 7-27-2002; IN COMMERCE 7-27-2002.
JASON LOTT, EXAMINING ATTORNEY

CLASS 35—(Continued).

SN 78-394,553. ZACHO SPORTS CENTER, INC., CHIPPEWA FALLS, WI. FILED 4-1-2004.

CLASS 35—(Continued).

SN 78-394,805. FENDERLIMITATORS, INC., MERRITT ISLAND, FL. FILED 4-1-2004.

BRAND NAMES YOU
TRUST...FROM PEOPLE WHO
CARE

THE MARK CONSISTS OF STANDARD CHARACTERS WITHOUT CLAIM TO ANY PARTICULAR FONT, STYLE, SIZE, OR COLOR.

FOR BOAT DEALERSHIP (U.S. CLS. 100, 101 AND 102). FIRST USE 1-1-2002; IN COMMERCE 1-1-2002. ANDREW RHIM, EXAMINING ATTORNEY

SN 78-394,781. PITNEY BOWES INC., STAMFORD, CT. FILED 4-1-2004.

INTELLIGENT
DOCUMENT FACTORY

THE MARK CONSISTS OF STANDARD CHARACTERS WITHOUT CLAIM TO ANY PARTICULAR FONT, STYLE, SIZE, OR COLOR.

NO CLAIM IS MADE TO THE EXCLUSIVE RIGHT TO USE "INTELLIGENT DOCUMENT", APART FROM THE MARK AS SHOWN.

FOR MAIL SORTING, HANDLING AND RECEIVING, NAMELY, DOCUMENT AND MAIL PROCESSING INCLUDING COLLATING, SORTING, FEEDING AND INSERTING OF MAIL PIECES, PAPER HANDLING FOR BATCH FEEDING OF MULTIPLE SIZE MAIL PIECES, ADDRESS VERIFICATION AND PRE-SORTING OF MAIL; MONITORING MAIL AND PAPER SORTING, HANDLING AND RECEIVING AND PROVIDING ALERT TRACKING SERVICES THERETO; ELECTRONIC BILLING, INVOICING, AND STATEMENT PRESENTMENT. (U.S. CLS. 100, 101 AND 102). MATTHEW PAPPAS, EXAMINING ATTORNEY

FENDERLIMITATOR

THE MARK CONSISTS OF STANDARD CHARACTERS WITHOUT CLAIM TO ANY PARTICULAR FONT, STYLE, SIZE, OR COLOR.

FOR WHOLESALE AND RETAIL MAIL ORDER CATALOG SERVICES PERMITTING ORDERS VIA MAIL, TELEPHONE, FACSIMILE AND ONLINE IN THE FIELD OF MOTORCYCLE PARTS AND ACCESSORIES, NAMELY, LIGHTING FOR VEHICLES, NAMELY, MARKER LIGHTS, VANITY LIGHTS, FORK LIGHTS, CORNERING LIGHTS, TAIL LIGHTS, VEHICLE TURN SIGNAL LIGHTS, DECORATIVE LIGHTS, REFLECTORS, REPLACEMENT INCANDESCENT AND HALOGEN BULBS, LICENSE PLATE FRAMES AND HOLDERS, LIGHT BARS AND SPOILERS, TURN SIGNAL VISORS, TURN SIGNALS FOR VEHICLES, EMBLEMS, FRONT FENDER ACCENTS, LIGHT BRACKETS, TURN SIGNAL GRILLE SETS, KITS TO REPLACE FENDERS WITH BRACKETS AND FRAMES FOR HOLDING LICENSE PLATES AND TURN SIGNAL LIGHTS (U.S. CLS. 100, 101 AND 102).

FIRST USE 3-26-2004; IN COMMERCE 3-26-2004. MIDGE BUTLER, EXAMINING ATTORNEY

SN 78-396,375. CREDIT EXCHANGE CORPORATION, COSTA MESA, CA. FILED 4-5-2004.

THE CREDIT
EXCHANGE

THE MARK CONSISTS OF STANDARD CHARACTERS WITHOUT CLAIM TO ANY PARTICULAR FONT, STYLE, SIZE, OR COLOR.

NO CLAIM IS MADE TO THE EXCLUSIVE RIGHT TO USE CREDIT, APART FROM THE MARK AS SHOWN.

FOR PROMOTING OTHERS' CREDIT COUNSELING SERVICES AND OTHERS' DEBT CONSOLIDATION SERVICES BY TELEPHONE CALLS TO POTENTIAL CUSTOMERS (U.S. CLS. 100, 101 AND 102). FIRST USE 10-1-2000; IN COMMERCE 10-1-2000. ARETHA SOMERVILLE, EXAMINING ATTORNEY

CLASS 35—(Continued).

SN 78-396,953. SUMMIT ELECTRIC SUPPLY COMPANY, INC., ALBUQUERQUE, NM. FILED 4-6-2004.

SOS SUMMIT ONSITE

THE MARK CONSISTS OF STANDARD CHARACTERS WITHOUT CLAIM TO ANY PARTICULAR FONT, STYLE, SIZE, OR COLOR.

OWNER OF U.S. REG. NOS. 2,440,973 AND 2,850,559. NO CLAIM IS MADE TO THE EXCLUSIVE RIGHT TO USE "ONSITE", APART FROM THE MARK AS SHOWN. FOR DISTRIBUTORSHIP IN THE FIELD OF ELECTRICAL AND INDUSTRIAL MRO (MAINTENANCE, REPAIR AND OPERATION) SUPPLIES AND EQUIPMENT (U.S. CLS. 100, 101 AND 102). FIRST USE 8-31-1994; IN COMMERCE 10-31-1995. JASON TURNER, EXAMINING ATTORNEY

CLASS 35—(Continued).

SN 78-397,891. 3SG CORPORATION, DUBLIN, OH. FILED 4-7-2004.

3SG Corporation

THE MARK CONSISTS OF STANDARD CHARACTERS WITHOUT CLAIM TO ANY PARTICULAR FONT, STYLE, SIZE, OR COLOR.

NO CLAIM IS MADE TO THE EXCLUSIVE RIGHT TO USE CORPORATION, APART FROM THE MARK AS SHOWN. FOR DATA PROCESSING SERVICES; BUSINESS CONSULTING SERVICES IN THE FIELD OF STAFF AUGMENTATION (U.S. CLS. 100, 101 AND 102). FIRST USE 2-29-2000; IN COMMERCE 2-29-2000. CURTIS FRENCH, EXAMINING ATTORNEY

SN 78-397,209. STS JEWELS, INC., LONG ISLAND CITY, NY. FILED 4-6-2004.



OWNER OF U.S. REG. NO. 2,895,711. NO CLAIM IS MADE TO THE EXCLUSIVE RIGHT TO USE JEWELS, INC. APART FROM THE MARK AS SHOWN. THE COLOR(S) BLACK, YELLOW, BLUE, RED, GREEN IS/ARE CLAIMED AS A FEATURE OF THE MARK. THE MARK CONSISTS OF YELLOW, BLUE, GREEN TRIANGULAR CONFETTI AND RED WAVY STRING CONFETTI. FOR WHOLESALE DISTRIBUTORSHIP FEATURING JEWELRY (U.S. CLS. 100, 101 AND 102). FIRST USE 6-1-1996; IN COMMERCE 6-1-1996. KIMBERLY PERRY, EXAMINING ATTORNEY

SN 78-397,917. 3SG CORPORATION, DUBLIN, OH. FILED 4-7-2004.

QUICKACCOUNTANT

THE MARK CONSISTS OF STANDARD CHARACTERS WITHOUT CLAIM TO ANY PARTICULAR FONT, STYLE, SIZE, OR COLOR.

SEC. 2(F). FOR BUSINESS OUTSOURCING IN THE FIELD OF ACCOUNTING; TAX RETURN PREPARATION; AND BOOKKEEPING (U.S. CLS. 100, 101 AND 102). FIRST USE 9-3-1998; IN COMMERCE 9-3-1998. TARAH HARDY, EXAMINING ATTORNEY

CLASS 35—(Continued).

SN 78-397,998. FIDUCIAL FRANCHISES, INC., COLUMBIA, MD. FILED 4-7-2004.

**E.K. Williams &
CO.**

THE MARK CONSISTS OF STANDARD CHARACTERS WITHOUT CLAIM TO ANY PARTICULAR FONT, STYLE, SIZE, OR COLOR.

OWNER OF U.S. REG. NOS. 1,702,672 AND 1,709,566.

NO CLAIM IS MADE TO THE EXCLUSIVE RIGHT TO USE & CO., APART FROM THE MARK AS SHOWN.

THE NAME E.K. WILLIAMS DOES NOT IDENTIFY A LIVING INDIVIDUAL.

FOR BUSINESS AND INDIVIDUAL SERVICES FOR OTHERS, NAMELY, BOOKKEEPING, TAX PREPARATION, TAX CONSULTING, BUSINESS RESEARCH, BUSINESS MARKETING, HUMAN RESOURCES RECRUITMENT, PAYROLL PREPARATION; ACCOUNTING SERVICES; BUSINESS MANAGEMENT CONSULTING; CONDUCTING MARKETING STUDIES (U.S. CLS. 100, 101 AND 102).

FIRST USE 11-1-2000; IN COMMERCE 11-1-2000.

JOHN E. MICHOS, EXAMINING ATTORNEY

CLASS 35—(Continued).

SN 78-400,404. AR'TASIA INTERNATIONAL, LLC, CHANHASSEN, MN. FILED 4-12-2004.

AR'TASIA

THE MARK CONSISTS OF STANDARD CHARACTERS WITHOUT CLAIM TO ANY PARTICULAR FONT, STYLE, SIZE, OR COLOR.

FOR ASSOCIATION SERVICES, NAMELY, PROMOTING THE INTERESTS OF INDIVIDUALS, GROUPS AND VENUES IN THE ART AND ENTERTAINMENT FIELDS; PROVIDING ON-LINE COMMERCIAL INFORMATION IN THE ART AND ENTERTAINMENT FIELDS; BUSINESS CONSULTATION AND ADVICE IN THE ART AND ENTERTAINMENT FIELDS; PUBLIC RELATIONS SERVICES; ADVERTISING AND PROMOTION SERVICES AND RELATED CONSULTING (U.S. CLS. 100, 101 AND 102).

FIRST USE 12-31-2001; IN COMMERCE 12-31-2001.

JASON LOTT, EXAMINING ATTORNEY

SN 78-399,829. FOUR QUADRANTS, LLC, EDMOND, OK. FILED 4-10-2004.

FOUR QUADRANTS

THE MARK CONSISTS OF STANDARD CHARACTERS WITHOUT CLAIM TO ANY PARTICULAR FONT, STYLE, SIZE, OR COLOR.

FOR BUSINESS MANAGEMENT CONSULTING WITH RELATION TO STRATEGY, MARKETING, PRODUCTION, PERSONNEL AND RETAIL SALE MATTERS (U.S. CLS. 100, 101 AND 102).

ROBERT LORENZO, EXAMINING ATTORNEY

SN 78-402,158. WAIFE & ASSOCIATES, INC., NEEDHAM, MA. FILED 4-15-2004.

WAIFE & ASSOCIATES

THE MARK CONSISTS OF STANDARD CHARACTERS WITHOUT CLAIM TO ANY PARTICULAR FONT, STYLE, SIZE, OR COLOR.

NO CLAIM IS MADE TO THE EXCLUSIVE RIGHT TO USE & ASSOCIATES, APART FROM THE MARK AS SHOWN.

SEC. 2(F).

FOR BUSINESS CONSULTING SERVICES IN THE FIELD OF BUSINESS MANAGEMENT RELATING TO CLINICAL RESEARCH TECHNOLOGY (U.S. CLS. 100, 101 AND 102).

FIRST USE 7-1-1993; IN COMMERCE 7-1-1993.

LINDA POWELL, EXAMINING ATTORNEY

CLASS 35—(Continued).

SN 78-403,587. DEBRA S. WOOD, L.L.C., LITTLE ROCK, AR. FILED 4-16-2004.



NO CLAIM IS MADE TO THE EXCLUSIVE RIGHT TO USE "ARTSPACE", APART FROM THE MARK AS SHOWN. THE MARK CONSISTS OF THE WORDS RIVER MARKET IN STANDARD TYPEFACE. THE WORD ARTSPACE (ONE WORD WITH A CAPITAL "S") IN CALLIGRAPHY. FOR ART GALLERY (U.S. CLS. 100, 101 AND 102). FIRST USE 11-14-2003; IN COMMERCE 11-14-2003. JENNIFER CHICOSKI, EXAMINING ATTORNEY

CLASS 35—(Continued).

SN 78-403,829. HOSPITAL REFERRAL SERVICES, INC., BEACHWOOD, OH. FILED 4-19-2004.



NO CLAIM IS MADE TO THE EXCLUSIVE RIGHT TO USE "HOSPITAL REFERRAL SERVICES", APART FROM THE MARK AS SHOWN.

THE COLOR(S) GRAY IS/ARE CLAIMED AS A FEATURE OF THE MARK.

THE GRAY TONES ARE IN FACT INTENDED TO INDICATE THE COLOR GRAY. THE COLOR GRAY APPEARS IN EACH WORD HOSPITAL REFERRAL SERVICES, AND OUR SUBMITTED MARK.

FOR MANAGEMENT ASSISTANCE, NAMELY, PROVIDING ASSISTANCE TO HOSPITALS AND MEDICAL PROVIDERS IN REGISTERING PATIENTS FOR MEDICAID ELIGIBILITY, MEDICAL INSURANCE BILLING AND PROCESSING, AND SECRETARIAL OFFICE SUPPORT WORK (U.S. CLS. 100, 101 AND 102). SOPHIA S. KIM, EXAMINING ATTORNEY

SN 78-403,607. KOSMAN, GARY LEE, MISSION HILLS, CA. FILED 4-17-2004.



FOR PROVIDING A WEB-BASED HUMAN RESOURCES PERFORMANCE MEASUREMENT THAT COLLECTS DATA ON HUMAN RESOURCES' ACTIVITIES AND RECOMMENDS STRATEGIES TO HUMAN RESOURCES SO THAT HUMAN RESOURCES MAY OVERCOME CHALLENGES AND ACHIEVE GOALS (U.S. CLS. 100, 101 AND 102). FIRST USE 12-15-2000; IN COMMERCE 10-15-2001. CYNTHIA SLOAN, EXAMINING ATTORNEY

SN 78-405,543. VOIGHT, CRAIG, SAN JOSE, CA. FILED 4-21-2004.

REMEMBER FOR YOU

THE MARK CONSISTS OF STANDARD CHARACTERS WITHOUT CLAIM TO ANY PARTICULAR FONT, STYLE, SIZE, OR COLOR.

FOR ONLINE ORDERING SERVICES FEATURING FLOWERS, CANDY, GREETING CARDS AND GIFT ITEMS (U.S. CLS. 100, 101 AND 102).

JEFFERY COWARD, EXAMINING ATTORNEY

CLASS 35—(Continued).

SN 78-406,173. TRI-COUNTY TRUCK TOPS, INC., ALGONQUIN, IL. FILED 4-22-2004.

**Tri-County Truck
Accessories**

THE MARK CONSISTS OF STANDARD CHARACTERS WITHOUT CLAIM TO ANY PARTICULAR FONT, STYLE, SIZE, OR COLOR.

NO CLAIM IS MADE TO THE EXCLUSIVE RIGHT TO USE "TRUCK ACCESSORIES", APART FROM THE MARK AS SHOWN.

FOR RETAIL STORES SERVICES FEATURING LIGHT DUTY TRUCK ACCESSORIES (U.S. CLS. 100, 101 AND 102).

FIRST USE 4-1-2000; IN COMMERCE 4-1-2000.
LOURDES AYALA, EXAMINING ATTORNEY

CLASS 35—(Continued).

SN 78-406,384. FG SYNDROME FAMILY ALLIANCE, INC., CORVALLIS, OR. FILED 4-22-2004.

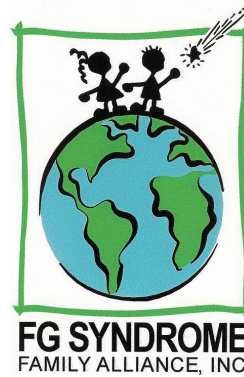

NO CLAIM IS MADE TO THE EXCLUSIVE RIGHT TO USE "FG SYNDROME FAMILY ALLIANCE, INC.", APART FROM THE MARK AS SHOWN.

THE COLOR(S) GREEN, BLACK, BLUE AND WHITE IS/ARE CLAIMED AS A FEATURE OF THE MARK.

THE MARK CONSISTS OF A GIRL AND A BOY, WHO IS CATCHING A SHOOTING STAR, ALL IN BLACK, ARE STANDING ON THE EARTH, OUTLINED IN BLACK WITH GREEN LANDFORMS AND BLUE OCEANS, OUTLINED IN BLACK, SURROUNDED BY A GREEN, WAVY RECTANGLE, WITH THE WORDS "FG SYNDROME FAMILY ALLIANCE, INC." BELOW THE RECTANGLE AND IN BLACK LETTERING.

FOR PROMOTING PUBLIC AWARENESS OF THE INTERESTS OF INDIVIDUALS AND FAMILIES AFFECTED BY FG SYNDROME OR RELATED DISORDERS (U.S. CLS. 100, 101 AND 102).

FIRST USE 0-0-1999; IN COMMERCE 0-0-2000.
MARK SPARACINO, EXAMINING ATTORNEY

SN 78-406,342. PACFOLIO LLC, LINCOLNWOOD, IL. FILED 4-22-2004.

**TOTAL QUANTITY
ADVANTAGE**

THE MARK CONSISTS OF STANDARD CHARACTERS WITHOUT CLAIM TO ANY PARTICULAR FONT, STYLE, SIZE, OR COLOR.

FOR DISTRIBUTORSHIP SERVICES IN THE FIELD OF PACKAGING MATERIALS OF OTHERS (U.S. CLS. 100, 101 AND 102).

FIRST USE 8-0-2004; IN COMMERCE 8-0-2004.
STEVEN R. FOSTER, EXAMINING ATTORNEY

SN 78-406,488. GODFREY, KRISTINE F., GREENSBORO, NC. FILED 4-22-2004.



NO CLAIM IS MADE TO THE EXCLUSIVE RIGHT TO USE "PETS" AND THE SHAPE OF THE AWNING, APART FROM THE MARK AS SHOWN.

THE COLOR(S) GREEN, RED, TAN, WHITE AND BLACK IS/ARE CLAIMED AS A FEATURE OF THE MARK.

THE MARK CONSISTS OF A GREEN AWNING WITH A WHITE AND TAN STRIP CONTAINING THE WORDS "ALL PETS CONSIDERED", WITH TWO BLACK PAW PRINTS ON THE RIGHT AND LEFT OF THE STRIP. THE LETTERING IS RED. THE DRAWING SHOWS POSITIONING OF THE ELEMENTS OF THE MARK ON THE AWNING.

FOR RETAIL PET SUPPLIES STORES (U.S. CLS. 100, 101 AND 102).

FIRST USE 8-6-1992; IN COMMERCE 8-6-1992.
TRACY WHITAKER-BOWN, EXAMINING ATTORNEY

CLASS 35—(Continued).

SN 78-406,889. BULLDOG NEW YORK, LLC, NEW YORK, NY. FILED 4-23-2004.

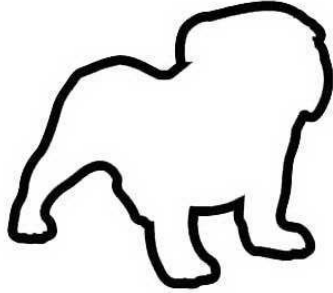

THE MARK CONSISTS OF A DESIGN OF A BULL DOG. FOR MARKETING AND CONSULTING SERVICES CONSISTING OF THE DEVELOPMENT OF BUSINESS PROCESS MODELS, GENERAL STRATEGIC MARKET-ING CONSULTING SERVICES, DEVELOPMENT OF OVERALL STRATEGIC AND TACTICAL MARKETING AND COMMUNICATION PLANS, DEVELOPMENT OF STRATEGIC AND TACTICAL MARKETING CONSULT-ING SERVICES FOR SPECIFIC CLIENT PRODUCTS, BUSINESS LINES, AND INITIATIVES, ADVERTISING COPY DEVELOPMENT FOR ALL TYPES OF MEDIA (BROADCAST, PRINT, INTERACTIVE), MEDIA PLAN-NING, PROMOTION PLANNING, INTERACTIVE MAR-KETING PLATFORM DEVELOPMENT, MEDIA PLAN IMPLEMENTATION AND BUYING, ADVERTISING PLATFORM SPECIFICATIONS AND PRODUCTION, AND THE IMPLEMENTATION OF PROMOTIONS AND OTHER MARKETING INITIATIVES. (U.S. CLS. 100, 101 AND 102).

IRENE D. WILLIAMS, EXAMINING ATTORNEY

SN 78-407,555. MARCATUS, INC., NORTH HILLS, CA. FILED 4-24-2004.

**Sewing Machine
WAREHOUSE** 

NO CLAIM IS MADE TO THE EXCLUSIVE RIGHT TO USE "SEWING MACHINE WAREHOUSE", APART FROM THE MARK AS SHOWN.

THE MARK CONSISTS OF THE TERM SEWING MA-CHINE WAREHOUSE WITH A STYLIZED DESIGN OF A SEWING MACHINE.

FOR RETAIL STORE SERVICES FEATURING SEW-ING MACHINES (U.S. CLS. 100, 101 AND 102).

FIRST USE 1-1-1990; IN COMMERCE 1-1-1990.
JENNIFER MARTIN, EXAMINING ATTORNEY

CLASS 35—(Continued).

SN 78-407,691. GLOBAL ENTERPRISE ARCHITECTURE ORGANISATION INCORPORATED, WAIKANAE, NEW ZEALAND, FILED 4-26-2004.



OWNER OF NEW ZEALAND REG. NO. 672129, DATED 1-27-2003, EXPIRES 1-1-2010.

NO CLAIM IS MADE TO THE EXCLUSIVE RIGHT TO USE "ENTERPRISE ARCHITECTURE ORGANISATION", APART FROM THE MARK AS SHOWN.

THE COLOR(S) GLOBE BLUE PANTONE 280 CVC - TEXT BLUE PANTONE 280 CVC - GREY LINES PANTONE 422 CVC IS/ARE CLAIMED AS A FEATURE OF THE MARK.

THE MARK CONSISTS OF A BLUE GLOBE WITH GREY LINES AT TOP, BOTTOM, LEFT, AND RIGHT. LITERAL ELEMENT AT RIGHT HAND SIDE OF GLOBE.

FOR ASSOCIATION SERVICES, NAMELY, PROMOT-ING THE INTERESTS OF ENTERPRISE ARCHITEC-TURE PROFESSIONALS (U.S. CLS. 100, 101 AND 102).

RONALD AIKENS, EXAMINING ATTORNEY

SN 78-407,693. GLOBAL ENTERPRISE ARCHITECTURE ORGANISATION INCORPORATED, WAIKANAE, NEW ZEALAND, FILED 4-26-2004.

GEAO

THE MARK CONSISTS OF STANDARD CHARACTERS WITHOUT CLAIM TO ANY PARTICULAR FONT, STYLE, SIZE, OR COLOR.

OWNER OF NEW ZEALAND REG. NO. 672130, DATED 1-27-2003, EXPIRES 1-1-2010.

FOR ASSOCIATION SERVICES, NAMELY, PROMOT-ING THE INTERESTS OF ENTERPRISE ARCHITEC-TURE PROFESSIONALS (U.S. CLS. 100, 101 AND 102).

RONALD AIKENS, EXAMINING ATTORNEY

CLASS 35—(Continued).

SN 78-408,051. OFFERINGS, LLC, PUTNEY, VT. FILED 4-26-2004.

CLASS 35—(Continued).

SN 78-410,040. PAYLESS SHOESOURCE WORLDWIDE, INC., TOPEKA, KS. FILED 4-29-2004.

OFFERINGS

THE MARK CONSISTS OF STANDARD CHARACTERS WITHOUT CLAIM TO ANY PARTICULAR FONT, STYLE, SIZE, OR COLOR.

FOR RETAIL JEWELRY STORE SERVICES; COMPUTERIZED ON-LINE RETAIL STORE SERVICES IN THE FIELD OF JEWELRY; JEWELRY HOME SHOPPING SERVICES BY TELEVISION (U.S. CLS. 100, 101 AND 102).

FIRST USE 8-0-1993; IN COMMERCE 8-0-1993.

WARREN L. OLANDRIA, EXAMINING ATTORNEY

TEENY TOES

THE MARK CONSISTS OF STANDARD CHARACTERS WITHOUT CLAIM TO ANY PARTICULAR FONT, STYLE, SIZE, OR COLOR.

FOR RETAIL SHOE STORE SERVICES (U.S. CLS. 100, 101 AND 102).

FIRST USE 4-14-2004; IN COMMERCE 4-14-2004.

LESLEY LAMOTHE, EXAMINING ATTORNEY

SN 78-411,567. SITE FOUNDATION, NEW YORK, NY. FILED 4-30-2004.

SN 78-409,393. BENHAM, ROGER A., SAN DIEGO, CA. FILED 4-28-2004.

SITE FOUNDATION MOTIVATION INDEX

Action Sports Food

THE MARK CONSISTS OF STANDARD CHARACTERS WITHOUT CLAIM TO ANY PARTICULAR FONT, STYLE, SIZE, OR COLOR.

NO CLAIM IS MADE TO THE EXCLUSIVE RIGHT TO USE "FOOD", APART FROM THE MARK AS SHOWN.

FOR DISTRIBUTORSHIPS IN THE FIELD OF FOOD (U.S. CLS. 100, 101 AND 102).

RICHARD WHITE, EXAMINING ATTORNEY

THE MARK CONSISTS OF STANDARD CHARACTERS WITHOUT CLAIM TO ANY PARTICULAR FONT, STYLE, SIZE, OR COLOR.

NO CLAIM IS MADE TO THE EXCLUSIVE RIGHT TO USE "FOUNDATION MOTIVATION INDEX", APART FROM THE MARK AS SHOWN.

FOR BUSINESS RESEARCH AND ANALYSIS CONCERNING THE RELATIONSHIP BETWEEN MOTIVATION AND BUSINESS OUTCOMES; PROVIDING INFORMATION TO OTHERS CONCERNING THE RELATIONSHIP BETWEEN MOTIVATION AND BUSINESS OUTCOMES (U.S. CLS. 100, 101 AND 102).

TRACY CROSS, EXAMINING ATTORNEY

CLASS 35—(Continued).

SN 78-411,697. LONG BEACH POLICE MOTOR PATROL ASSOCIATION, INC., LONG BEACH, CA. FILED 4-30-2004.



NO CLAIM IS MADE TO THE EXCLUSIVE RIGHT TO USE "LONG BEACH POLICE" AND "MOTOR PATROL" AND "ASSOCIATION", APART FROM THE MARK AS SHOWN.

FOR ASSOCIATION SERVICES, NAMELY, A MEMBERSHIP ORGANIZATION DEDICATED TO PROMOTING THE INTERESTS OF, FOSTERING CAMARADERIE BETWEEN, AND PROVIDING ASSISTANCE TO THE POLICE OFFICERS FOR AND THE RESIDENTS OF THE CITY OF LONG BEACH (U.S. CLS. 100, 101 AND 102).

FIRST USE 0-0-1934; IN COMMERCE 0-0-1934.
ROBIN CHOSID, EXAMINING ATTORNEY

SN 78-411,996. THOMSON, DAVID G., OVERLAND PARK, KS. FILED 5-3-2004.

MARQUEE CUSTOMER

THE MARK CONSISTS OF STANDARD CHARACTERS WITHOUT CLAIM TO ANY PARTICULAR FONT, STYLE, SIZE, OR COLOR.

FOR BUSINESS MANAGEMENT AND CONSULTING SERVICES (U.S. CLS. 100, 101 AND 102).
GEORGE LORENZO, EXAMINING ATTORNEY

SN 78-413,038. SCHAUB, BENSON L., PHOENIX, AZ. FILED 5-4-2004.

**FAMILY FOUNDATION
ADVANTAGE**

THE MARK CONSISTS OF STANDARD CHARACTERS WITHOUT CLAIM TO ANY PARTICULAR FONT, STYLE, SIZE, OR COLOR.

NO CLAIM IS MADE TO THE EXCLUSIVE RIGHT TO USE "FAMILY FOUNDATION", APART FROM THE MARK AS SHOWN.

FOR CHARITABLE SERVICES, NAMELY PROVIDING MANAGERIAL AND OPERATIONAL ASSISTANCE TO FOUNDATIONS AND CHARITABLE TRUSTS. (U.S. CLS. 100, 101 AND 102).
RON FAIRBANKS, EXAMINING ATTORNEY

CLASS 35—(Continued).

SN 78-413,050. JOBSTER, INC., SEATTLE, WA. FILED 5-4-2004.

JOBSTER

THE MARK CONSISTS OF STANDARD CHARACTERS WITHOUT CLAIM TO ANY PARTICULAR FONT, STYLE, SIZE, OR COLOR.

FOR PROVIDING ON-LINE REFERRAL NETWORKS AND RELATED SEARCH AND CONTACT MANAGEMENT FOR THE DISTRIBUTION OF INFORMATION ABOUT EMPLOYMENT OPPORTUNITIES AND THE POTENTIAL CANDIDATES TO FILL THEM (U.S. CLS. 100, 101 AND 102).

BARBARA BROWN, EXAMINING ATTORNEY

SN 78-413,078. CONFECCIONES LEONISA S.A., MEDELLIN, COLOMBIA, FILED 5-4-2004.

**CLUB DE COMPRAS
LEONISA**

THE MARK CONSISTS OF STANDARD CHARACTERS WITHOUT CLAIM TO ANY PARTICULAR FONT, STYLE, SIZE, OR COLOR.

THE ENGLISH TRANSLATION OF THE WORDING "CLUB DE COMPRAS LEONISA" IS "LEONISA'S BUYING CLUB".

FOR BUSINESS CONSULTATION AND PUBLICITY SERVICES (U.S. CLS. 100, 101 AND 102).
GIANCARLO CASTRO, EXAMINING ATTORNEY

CLASS 35—(Continued).

SN 78-413,826. WTC-TRADE MART, L.P., DALLAS, TX.
FILED 5-5-2004.

DALLAS SAMPLE SALE

THE MARK CONSISTS OF STANDARD CHARACTERS WITHOUT CLAIM TO ANY PARTICULAR FONT, STYLE, SIZE, OR COLOR.

NO CLAIM IS MADE TO THE EXCLUSIVE RIGHT TO USE "SAMPLE SALE", APART FROM THE MARK AS SHOWN.

SEC. 2(F).

FOR ORGANIZING WHOLESALE EXHIBITORS FOR PROVIDING SAMPLES TO THE GENERAL PUBLIC IN THE FIELDS OF APPAREL, FLORAL, GIFT AND HOME ACCESSORIES, JEWELRY, FRAGRANCES, HANDBAGS, LUGGAGE, NOVELTIES, TOYS, FURNITURE, AND RELIGIOUS ITEMS (U.S. CLS. 100, 101 AND 102).

FIRST USE 2-0-1996; IN COMMERCE 2-0-1996.
BRENDAN REGAN, EXAMINING ATTORNEY

SN 78-414,120. MEAL EXCHANGE, TORONTO, CANADA,
FILED 5-6-2004.

CLEAR THE SHELVES

THE MARK CONSISTS OF STANDARD CHARACTERS WITHOUT CLAIM TO ANY PARTICULAR FONT, STYLE, SIZE, OR COLOR.

FOR CHARITABLE SERVICES, NAMELY, THE ORGANIZATION, PROMOTION AND OPERATION OF NON-DENOMINATIONAL VOLUNTEER PROGRAMS AND COMMUNITY SERVICE PROJECTS DESIGNED TO ENCOURAGE AND PROMOTE CIVIC INVOLVEMENT AND VOLUNTEERISM IN YOUTH ENROLLED IN SECONDARY AND POST-SECONDARY INSTITUTIONS FOR THE PURPOSES OF ALLEVIATING SOCIAL MISFORTUNE AND THE REDUCTION OF HUNGER IN THEIR COMMUNITIES; CHARITABLE SERVICES, NAMELY, THE COORDINATION, COLLECTION, PROCUREMENT, AND DISTRIBUTION OF FOOD DONATIONS FROM MANUFACTURERS, WHOLESALERS, RETAILERS, AND GOVERNMENT AGENCIES TO ORGANIZATIONS PROVIDING FREE FOOD TO NEEDY PEOPLE; CHARITABLE SERVICES, NAMELY ORGANIZING AND CONDUCTING CORPORATE SPONSORSHIP PROGRAMS TO PROMOTE PUBLIC AWARENESS OF HUNGER AND SOCIAL MISFORTUNE ISSUES. (U.S. CLS. 100, 101 AND 102).

MICHAEL TANNER, EXAMINING ATTORNEY

CLASS 35—(Continued).

SN 78-414,550. MASTER CRAFT TOOL COMPANY, LLC,
MINNETONKA, MN. FILED 5-6-2004.

**BUILDING SMARTER
TOOLS FOR YOU**

THE MARK CONSISTS OF STANDARD CHARACTERS WITHOUT CLAIM TO ANY PARTICULAR FONT, STYLE, SIZE, OR COLOR.

FOR ON-LINE RETAIL STORE SERVICES, MAIL ORDER CATALOG SERVICES AND TELEPHONE ORDER RETAIL STORE SERVICES FEATURING TOOLS, HAND TOOLS, POWER TOOLS, TOOL SETS AND KITS, POWER OPERATED AUTO DEVICES, PNEUMATIC TOOLS, GARDEN TOOLS, POWER LAWN AND GARDEN TOOLS, LAWN MOWERS, METAL TOOL BOXES, METAL TOOL CASES, METAL TOOL CHESTS, METAL FASTENERS, ROLLER CABINETS, LAWN SHEDS, TOOL CASES, TOOL BAGS, TOOL CONTAINERS, BARBECUE UTENSILS, FUSES, BOOSTER CABLES, ELECTRIC PEST REPELLERS, ANTIFREEZE TESTERS, GOGGLES, SAFETY GLASSES, PROTECTIVE WORK GLOVES, LEVELS, MEASURING TAPES, HIGHWAY EMERGENCY KITS AND PARTS AND ACCESSORIES FOR ALL OF THE ABOVE (U.S. CLS. 100, 101 AND 102).

GENE MACIOL, EXAMINING ATTORNEY

SN 78-414,634. USENTIO, LLC, ATLANTA, GA. FILED 5-6-2004.

Usentio

THE MARK CONSISTS OF STANDARD CHARACTERS WITHOUT CLAIM TO ANY PARTICULAR FONT, STYLE, SIZE, OR COLOR.

FOR BUSINESS MARKETING CONSULTING SERVICES (U.S. CLS. 100, 101 AND 102).

LEIGH LOWRY, EXAMINING ATTORNEY

CLASS 35—(Continued).

SN 78-414,793. MONSANTO TECHNOLOGY LLC, ST. LOUIS, MO. FILED 5-7-2004.

WE BUY ALL CORN, ALL YEAR.

THE MARK CONSISTS OF STANDARD CHARACTERS WITHOUT CLAIM TO ANY PARTICULAR FONT, STYLE, SIZE, OR COLOR.

FOR PROVIDING BUSINESS MARKETING INFORMATION IN THE FIELD OF OPTIONS FOR BIOTECH TRAITS TO GROWERS OF GRAIN (U.S. CLS. 100, 101 AND 102).

FIRST USE 3-1-2004; IN COMMERCE 3-1-2004.
WINSTON FOLMAR, EXAMINING ATTORNEY

CLASS 35—(Continued).

SN 78-415,394. GARZA, ALVARO, IRVING, TX. FILED 5-7-2004.

SNACKING 101

THE MARK CONSISTS OF STANDARD CHARACTERS WITHOUT CLAIM TO ANY PARTICULAR FONT, STYLE, SIZE, OR COLOR.

NO CLAIM IS MADE TO THE EXCLUSIVE RIGHT TO USE SNACKING, APART FROM THE MARK AS SHOWN.

FOR DISTRIBUTORSHIPS IN THE FIELD OF HEALTHY SNACK FOODS; VENDING MACHINE SERVICES (U.S. CLS. 100, 101 AND 102).

STANLEY I. OSBORNE, EXAMINING ATTORNEY

SN 78-416,851. HILLMAN THOMPSON, INC., CHICAGO, IL. FILED 5-11-2004.

HILLMAN THOMPSON

THE MARK CONSISTS OF STANDARD CHARACTERS WITHOUT CLAIM TO ANY PARTICULAR FONT, STYLE, SIZE, OR COLOR.

FOR RETAIL STORE AND ON-LINE DISTRIBUTION SERVICES FEATURING HAIR CARE PRODUCTS, NAMELY, SHAMPOOS, CONDITIONERS, SPRAY AND SCULPTING GELS, SKIN CARE PREPARATIONS, TOTAL BODY CLEANING PREPARATION, TOILET WATER, PERFUMES AND COLOGNES, MASSAGE OILS AND LOTIONS, SKIN CRÈMES, SKIN LOTIONS, SKIN EMOLLIENTS, MOISTURIZING BODY OILS AND LOTIONS, AND CLOTHING (U.S. CLS. 100, 101 AND 102).

DAVID C. REIHNER, EXAMINING ATTORNEY

SN 78-415,284. COORS GLOBAL PROPERTIES, INC., LAKEWOOD, CO. FILED 5-7-2004.

MEXICALI CERVEZA

THE MARK CONSISTS OF STANDARD CHARACTERS WITHOUT CLAIM TO ANY PARTICULAR FONT, STYLE, SIZE, OR COLOR.

OWNER OF U.S. REG. NOS. 2,093,334 AND 2,187,900.

NO CLAIM IS MADE TO THE EXCLUSIVE RIGHT TO USE CERVEZA, APART FROM THE MARK AS SHOWN.

THE ENGLISH TRANSLATION OF THE WORD "CERVEZA" IN THE MARK IS "BEER".

FOR PROVIDING BEER CONSUMER INFORMATION IN THE FIELD OF BEER VIA THE INTERNET (U.S. CLS. 100, 101 AND 102).

FIRST USE 9-10-2004; IN COMMERCE 9-10-2004.
SAMUEL E. SHARPER JR., EXAMINING ATTORNEY

SN 78-417,599. H&R BLOCK DIGITAL TAX SOLUTIONS, INC., KANSAS CITY, MO. FILED 5-12-2004.

swifttax.com
Ready. Set. E-file.

FOR ONLINE PREPARATION OF TAX RETURNS FOR OTHERS (U.S. CLS. 100, 101 AND 102).

FIRST USE 2-3-2004; IN COMMERCE 2-3-2004.
MICHAEL SOUDERS, EXAMINING ATTORNEY

CLASS 35—(Continued).

SN 78-418,549. CDS INTERNATIONAL HOLDINGS, INC., DELRAY BEACH, FL. FILED 5-13-2004.



THE MARK CONSISTS OF A LION SUPERIMPOSED ON THE LETTERS CDS.

FOR MAIL ORDER CATALOG SERVICES FEATURING MEN'S CLOTHING AND MEN'S CLOTHING ACCESSORIES; AND COMPUTERIZED ON-LINE ORDERING SERVICES VIA A GLOBAL COMPUTER NETWORK FEATURING MEN'S CLOTHING AND MEN'S CLOTHING ACCESSORIES (U.S. CLS. 100, 101 AND 102).

FIRST USE 6-0-2004; IN COMMERCE 6-0-2004.
ANDREW RHIM, EXAMINING ATTORNEY

CLASS 35—(Continued).

SN 78-420,891. AMERICANS FOR SECURE RETIREMENT, WASHINGTON, DC. FILED 5-18-2004.



NO CLAIM IS MADE TO THE EXCLUSIVE RIGHT TO USE "AMERICANS FOR SECURE RETIREMENT", APART FROM THE MARK AS SHOWN.

FOR ASSOCIATION SERVICES, NAMELY, PROMOTING THE INTERESTS OF INDIVIDUALS AND ORGANIZATIONS INTERESTED IN ENSURING RETIREMENT SECURITY FOR EVERY AMERICAN (U.S. CLS. 100, 101 AND 102).

MARTHA FROMM, EXAMINING ATTORNEY

SN 78-418,819. WOODELL, VAN, G., MATOACA, VA. FILED 5-14-2004.



NO CLAIM IS MADE TO THE EXCLUSIVE RIGHT TO USE "AUTOMOTIVE AND TRUCK ACCESSORIES", APART FROM THE MARK AS SHOWN.

THE COLOR(S) RED, WHITE, BLACK, YELLOW, SILVER, AND GRAY IS/ARE CLAIMED AS A FEATURE OF THE MARK.

THE WORDING "TRUX STUFF" APPEARS IN RED ON TOP OF A BLACK AND WHITE CHECKERED FLAG WHICH IS ON TOP OF A YELLOW CIRCLE WITH 3 VEHICLES DRIVING THROUGH IT AND THE WORDS "AUTOMOTIVE AND TRUCK ACCESSORIES" ACROSS THE BOTTOM IN WHITE ON A RED BANNER; THE COLORS BLACK, WHITE, SILVER, RED, AND YELLOW APPEAR IN THE 3 VEHICLES; THE COLOR GRAY APPEARS AS THE BACKGROUND COLOR BEHIND THE VEHICLES.

FOR RETAIL STORES AND DISTRIBUTORSHIPS FEATURING AUTOMOTIVE AND TRUCK ACCESSORIES (U.S. CLS. 100, 101 AND 102).

FIRST USE 1-1-2000; IN COMMERCE 1-1-2000.
JOANNA DUKOVIC, EXAMINING ATTORNEY

SN 78-421,950. ELLISON, CARLOS D., SHERMAN OAKS, CA. FILED 5-19-2004.



THE COLOR(S) BLACK AND BURGUNDY IS/ARE CLAIMED AS A FEATURE OF THE MARK.

THE TERM CACKLEBERRY APPEARS IN BLACK, WITH THREE BANDED REGIONS ABOVE SUCH TERM APPEARING IN LIGHT BURGUNDY, AND TWO BANDED REGIONS BELOW SUCH TERM IN A DARKER BURGUNDY.

THE MARK CONSISTS OF THE WORD CACKLEBERRY THAT DIVIDES AN EGG THAT IS, ITSELF, SEPARATED AND APPEARS TO BE 3 DIMENSIONAL.

FOR PROVIDING BUSINESS MANAGEMENT, ACCOUNTING, BOOKKEEPING, INVOICING, ACCOUNTS PAYABLE SERVICES, NAMELY, ARRANGING FOR THE PAYMENT OF INVOICES OF THIRD PARTIES, AND THE COMPLETION OF BUDGETS FOR TOURING AND MAKING RECORDS (U.S. CLS. 100, 101 AND 102).

BRIAN NEVILLE, EXAMINING ATTORNEY

CLASS 35—(Continued).

SN 78-422,389. SILPADA DESIGNS, INC., LENEXA, KS.
FILED 5-20-2004.

DESIGN YOUR OWN FUTURE

THE MARK CONSISTS OF STANDARD CHARACTERS WITHOUT CLAIM TO ANY PARTICULAR FONT, STYLE, SIZE, OR COLOR.

FOR RETAIL MERCHANDISING OF PRODUCTS, DISTRIBUTORSHIP SERVICES, RETAIL SERVICES BY DIRECT SOLICITATION BY INDEPENDENT SALES REPRESENTATIVES, TELEPHONE SHOP AT HOME SERVICES, MAIL ORDER CATALOG SERVICES, INTERACTIVE RETAIL STORE SERVICES RENDERED BY MEANS OF A GLOBAL COMPUTER INFORMATION NETWORK, AND RETAIL SHOP-AT-HOME PARTY SERVICES, ALL IN THE FIELD OF JEWELRY, GIFT ITEMS, HANDBAGS, WATCHES, BELTS, AND OTHER FASHION ACCESSORIES; AND ADMINISTRATION OF PROGRAMS THAT PROVIDE INCENTIVES TO PEOPLE TO CONDUCT HOME PRODUCT SALES PARTIES, ALL IN THE FIELDS OF JEWELRY, GIFT ITEMS, HANDBAGS, WATCHES, BELTS, AND OTHER FASHION ACCESSORIES (U.S. CLS. 100, 101 AND 102).

FIRST USE 9-0-2002; IN COMMERCE 9-0-2002.

STEVEN R. FOSTER, EXAMINING ATTORNEY

SN 78-422,778. THE APEX TECHNOLOGY GROUP, INC.,
CRANSTON, RI. FILED 5-21-2004.

PERSONAL CIO

THE MARK CONSISTS OF STANDARD CHARACTERS WITHOUT CLAIM TO ANY PARTICULAR FONT, STYLE, SIZE, OR COLOR.

NO CLAIM IS MADE TO THE EXCLUSIVE RIGHT TO USE "CIO", APART FROM THE MARK AS SHOWN.

FOR EMPLOYMENT STAFFING SERVICES, OUTSOURCING SERVICES ALL IN THE INFORMATION TECHNOLOGY FIELD (U.S. CLS. 100, 101 AND 102).

FIRST USE 0-0-1998; IN COMMERCE 0-0-1998.

DARRYL SPRUILL, EXAMINING ATTORNEY

CLASS 35—(Continued).

SN 78-422,821. MIDWEST TROPHY MFG. CO., INC., DEL
CITY, OK. FILED 5-21-2004.

MTM Recognition

THE MARK CONSISTS OF STANDARD CHARACTERS WITHOUT CLAIM TO ANY PARTICULAR FONT, STYLE, SIZE, OR COLOR.

NO CLAIM IS MADE TO THE EXCLUSIVE RIGHT TO USE "RECOGNITION", APART FROM THE MARK AS SHOWN.

FOR CONDUCTING EMPLOYEE INCENTIVE AWARDS PROGRAMS TO PROMOTE AND RECOGNIZE SAFETY, QUALITY, PRODUCTIVITY, TENURE, SERVICE, PERFORMANCE, AFFILIATION, AND SALES (U.S. CLS. 100, 101 AND 102).

FIRST USE 12-31-2002; IN COMMERCE 12-31-2002.

CYNTHIA SLOAN, EXAMINING ATTORNEY

SN 78-424,389. IPARAMETRICS, LLC, ALPHARETTA, GA.
FILED 5-25-2004.

Mining Your Business

THE MARK CONSISTS OF STANDARD CHARACTERS WITHOUT CLAIM TO ANY PARTICULAR FONT, STYLE, SIZE, OR COLOR.

FOR TAX CONSULTING SERVICES INCLUDING COST SEGREGATION, ASSET VALUATION AND ASSET OPTIMIZATION, AND MERGER AND ACQUISITION CONSULTING (U.S. CLS. 100, 101 AND 102).

FIRST USE 1-1-2004; IN COMMERCE 1-1-2004.

BARNEY CHARLON, EXAMINING ATTORNEY

CLASS 35—(Continued).

SN 78-426,345. GOLLAHER, GREGORY S., DBA GOLLAHER CONSULTING GROUP, ELK GROVE, CA. FILED 5-27-2004.

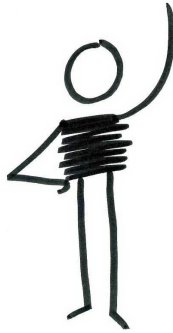

FOR BUSINESS ORGANIZATIONAL CONSULTATION; BUSINESS MANAGEMENT CONSULTATION IN THE FIELD OF EXECUTIVE AND LEADERSHIP DEVELOPMENT; SERVICES COMPRISING THE RECORDING, TRANSCRIPTION, COMPOSITION, COMPILATION AND SYSTEMIZATION OF WRITTEN COMMUNICATIONS AND RECORDINGS, AS WELL AS THE COMPILATION OF MATHEMATICAL OR STATISTICAL DATA. (U.S. CLS. 100, 101 AND 102).
ALEXANDER L. POWERS, EXAMINING ATTORNEY

CLASS 35—(Continued).

SN 78-427,177. REAL ESTATE ONE, INC., SOUTHFIELD, MI. FILED 5-28-2004.



OWNER OF U.S. REG. NOS. 1,922,352 AND 1,950,100.
NO CLAIM IS MADE TO THE EXCLUSIVE RIGHT TO USE "RELOCATION", APART FROM THE MARK AS SHOWN.
THE MARK CONSISTS OF A FANCIFUL DESIGN OF A HOUSE PARTIALLY TO THE LEFT AND ABOVE THE WORDS RELOCATION AMERICA.
SEC. 2(F) AS TO "AMERICA".
FOR BUSINESS AND EMPLOYEE RELOCATION SERVICES AND INFORMATION (U.S. CLS. 100, 101 AND 102).
FIRST USE 1-31-2004; IN COMMERCE 1-31-2004.
ROBERT LORENZO, EXAMINING ATTORNEY

SN 78-427,419. HOSSBACH, JOHN GREG, DALLAS, TX. FILED 5-29-2004.

SN 78-427,079. THE SKUNKWORKS, INC., MANCHESTER CENTER, VT. FILED 5-28-2004.

TruSpeed Computers

RE-IMAGINE!

THE MARK CONSISTS OF STANDARD CHARACTERS WITHOUT CLAIM TO ANY PARTICULAR FONT, STYLE, SIZE, OR COLOR.
FOR BUSINESS MANAGEMENT CONSULTING SERVICES; BUSINESS STRATEGY CONSULTING SERVICES (U.S. CLS. 100, 101 AND 102).
JANICE L. MCMORROW, EXAMINING ATTORNEY

THE MARK CONSISTS OF STANDARD CHARACTERS WITHOUT CLAIM TO ANY PARTICULAR FONT, STYLE, SIZE, OR COLOR.
NO CLAIM IS MADE TO THE EXCLUSIVE RIGHT TO USE "COMPUTERS", APART FROM THE MARK AS SHOWN.
FOR RETAIL STORE SERVICES FEATURING COMPUTER HARDWARE, SOFTWARE AND COMPUTER SYSTEMS (U.S. CLS. 100, 101 AND 102).
FIRST USE 11-15-2003; IN COMMERCE 1-13-2004.
CHRIS WELLS, EXAMINING ATTORNEY

CLASS 35—(Continued).

SN 78-427,554. GROOM STAR LLC, COLORADO SPRINGS, CO. FILED 5-31-2004.

CLASS 35—(Continued).

SN 78-428,010. PARTSSOURCE LLC, TWINSBURG, OH. FILED 6-1-2004.

GroomStar

The Answer Is Yes!

THE MARK CONSISTS OF STANDARD CHARACTERS WITHOUT CLAIM TO ANY PARTICULAR FONT, STYLE, SIZE, OR COLOR.

THE MARK IS PRESENTED IN STANDARD CHARACTERS, WITHOUT CLAIM TO ANY PARTICULAR FONT, STYLE, SIZE OR COLOR

FOR WHOLESALE DISTRIBUTORSHIPS FEATURING PET GROOMING PRODUCTS (U.S. CLS. 100, 101 AND 102).

FIRST USE 4-1-2003; IN COMMERCE 4-1-2003.
CAROL SPILS, EXAMINING ATTORNEY

THE MARK CONSISTS OF STANDARD CHARACTERS WITHOUT CLAIM TO ANY PARTICULAR FONT, STYLE, SIZE, OR COLOR.

FOR ORDER FULFILLMENT SERVICES; PROCUREMENT SERVICES, NAMELY, PURCHASING MEDICAL EQUIPMENT AND PARTS FOR OTHERS (U.S. CLS. 100, 101 AND 102).

FIRST USE 2-0-2004; IN COMMERCE 2-0-2004.
CAROL SPILS, EXAMINING ATTORNEY

SN 78-428,282. ASSOCIATION FOR THE TREATMENT OF SEXUAL ABUSERS, BEAVERTON, OR. FILED 6-1-2004.

SN 78-427,742. MCGRAW-HILL COMPANIES, INC., THE, NEW YORK, NY. FILED 6-1-2004.

INVESTOR TO ISSUER INSIGHT

ASSOCIATION FOR THE TREATMENT OF SEXUAL ABUSERS

THE MARK CONSISTS OF STANDARD CHARACTERS WITHOUT CLAIM TO ANY PARTICULAR FONT, STYLE, SIZE, OR COLOR.

NO CLAIM IS MADE TO THE EXCLUSIVE RIGHT TO USE "INVESTOR TO ISSUER", APART FROM THE MARK AS SHOWN.

FOR BUSINESS CONSULTING SERVICES, NAMELY, CONDUCTING SURVEYS OF INVESTOR OPINIONS FOR FINANCE TRANSACTION ISSUERS (U.S. CLS. 100, 101 AND 102).

FIRST USE 10-7-2004; IN COMMERCE 10-7-2004.
DOMINIC J. FERRAIUOLO, EXAMINING ATTORNEY

THE MARK CONSISTS OF STANDARD CHARACTERS WITHOUT CLAIM TO ANY PARTICULAR FONT, STYLE, SIZE, OR COLOR.

NO CLAIM IS MADE TO THE EXCLUSIVE RIGHT TO USE "ASSOCIATION", APART FROM THE MARK AS SHOWN.

SEC. 2(F).
FOR ASSOCIATIONAL SERVICES, NAMELY, PROMOTING THE INTERESTS OF PROFESSIONALS INVOLVED IN THE RESEARCH, ASSESSMENT AND TREATMENT OF SEXUAL ABUSE (U.S. CLS. 100, 101 AND 102).

FIRST USE 7-1-1990; IN COMMERCE 7-1-1990.
CIMMERIAN COLEMAN, EXAMINING ATTORNEY

CLASS 35—(Continued).

SN 78-428,477. CAPGEMINI U.S. LLC, NEW YORK, NY. FILED 6-2-2004.

**CAPGEMINI
GOVERNMENT
SOLUTIONS**

THE MARK CONSISTS OF STANDARD CHARACTERS WITHOUT CLAIM TO ANY PARTICULAR FONT, STYLE, SIZE, OR COLOR.

NO CLAIM IS MADE TO THE EXCLUSIVE RIGHT TO USE "GOVERNMENT SOLUTIONS", APART FROM THE MARK AS SHOWN.

FOR BUSINESS MANAGEMENT CONSULTING SERVICES IN THE FIELDS OF CUSTOMER RELATIONSHIP MANAGEMENT, SUPPLY CHAIN MANAGEMENT, CHANGE MANAGEMENT, ORGANIZATIONAL TRANSFORMATION, ARCHITECTURE SERVICES, SYSTEMS INTEGRATION, INFRASTRUCTURE SERVICES, BUSINESS OUTSOURCING, IT OUTSOURCING AND INFORMATION TECHNOLOGY (U.S. CLS. 100, 101 AND 102).

FIRST USE 4-15-2004; IN COMMERCE 4-15-2004.
REBECCA GILBERT, EXAMINING ATTORNEY

CLASS 35—(Continued).

SN 78-429,608. VALUEVISION MEDIA, INC., EDEN PRAIRIE, MN. FILED 6-3-2004.

TODAY'S BEST

THE MARK CONSISTS OF STANDARD CHARACTERS WITHOUT CLAIM TO ANY PARTICULAR FONT, STYLE, SIZE, OR COLOR.

NO CLAIM IS MADE TO THE EXCLUSIVE RIGHT TO USE "BEST", APART FROM THE MARK AS SHOWN.

FOR PROVIDING HOME SHOPPING SERVICES FEATURING GENERAL MERCHANDISE BY MEANS OF TELEVISION AND VIA A GLOBAL COMPUTER NETWORK (U.S. CLS. 100, 101 AND 102).

DAVID MURRAY, EXAMINING ATTORNEY

SN 78-429,321. DECISIVE ENVIRONMENT, LLC, SALT LAKE CITY, UT. FILED 6-3-2004.

GLOBAL DECISIONS

THE MARK CONSISTS OF STANDARD CHARACTERS WITHOUT CLAIM TO ANY PARTICULAR FONT, STYLE, SIZE, OR COLOR.

FOR BUSINESS CONSULTING SERVICES, NAMELY, ADVISING BUSINESSES ON MANAGING INFORMATION RELATING TO INTERNATIONAL ENVIRONMENTAL, HEALTH AND SAFETY LAWS, REGULATIONS, STANDARDS, COMPLIANCE AND PROCEDURES; CONSULTANCY SERVICES REGARDING BUSINESS STRATEGIES RELATED TO INTERNATIONAL ENVIRONMENTAL, HEALTH AND SAFETY ISSUES, AND DEVELOPING, ANALYZING AND IMPLEMENTING INTERNATIONAL ENVIRONMENTAL, HEALTH AND SAFETY INFORMATION MANAGEMENT, REPORTING AND COMPLIANCE SYSTEMS AND PROCEDURES; BUSINESS MANAGEMENT AND CONSULTATION; BUSINESS ACQUISITION, MERGER AND ORGANIZATIONAL CONSULTATION (U.S. CLS. 100, 101 AND 102).

ANGELA M. MICHELI, EXAMINING ATTORNEY

SN 78-430,980. BROKERS INTERNATIONAL, LTD., PANORA, IA. FILED 6-7-2004.

**BROKERS
INTERNATIONAL, LTD.**

THE MARK CONSISTS OF STANDARD CHARACTERS WITHOUT CLAIM TO ANY PARTICULAR FONT, STYLE, SIZE, OR COLOR.

NO CLAIM IS MADE TO THE EXCLUSIVE RIGHT TO USE "BROKERS" OR "LTD", APART FROM THE MARK AS SHOWN.

SEC. 2(F).
FOR BUSINESS MARKETING SERVICES RELATING TO THE FIELD OF INSURANCE BROKERAGE (U.S. CLS. 100, 101 AND 102).

FIRST USE 6-10-1983; IN COMMERCE 6-10-1983.
FRED MANDIR, EXAMINING ATTORNEY

CLASS 35—(Continued).

SN 78-431,518. EZBAYER, LLC, BELLAIRE, TX. FILED 6-8-2004.



THE COLORS DARK BLUE, LIGHT BLUE, RED, BLACK AND WHITE ARE CLAIMED AS FEATURES OF THE MARK.

THE COLOR DARK BLUE APPEARS IN THE LETTERS E AND B, AND THE ARMS, LEGS AND FEET; THE COLOR RED APPEARS IN THE RECTANGLE SURROUNDING THE LETTER Z, THE HANDS AND THE LETTERS Y AND R; THE COLOR LIGHT BLUE APPEARS IN THE ANTENNAE, THE FEET AND THE LETTER A; THE COLOR BLACK APPEARS IN THE EYES AND ANTENNAE; THE COLOR WHITE APPEARS IN THE EYES AND THE LETTER Z.

FOR ARRANGING FOR THE SALE OF GOODS AND SERVICES OF OTHERS, NAMELY, BUSINESSES, INDIVIDUALS AND CHARITIES, VIA ONLINE AUCTION SITES (U.S. CLS. 100, 101 AND 102).

FIRST USE 8-1-2003; IN COMMERCE 9-1-2003.
LEIGH LOWRY, EXAMINING ATTORNEY

SN 78-433,653. HAVRILLA GROUP, INC., LANCASTER, PA. FILED 6-11-2004.

**Havrilla Group.
We Get It.**

THE MARK CONSISTS OF STANDARD CHARACTERS WITHOUT CLAIM TO ANY PARTICULAR FONT, STYLE, SIZE, OR COLOR.

NO CLAIM IS MADE TO THE EXCLUSIVE RIGHT TO USE "GROUP", APART FROM THE MARK AS SHOWN.

FOR BUSINESS SALES AND MARKETING CONSULTING SERVICES; AND ADVERTISING AND DESIGN SERVICES, NAMELY, CREATING LOGOS AND CORPORATE AND BRAND IDENTITY FOR OTHERS THROUGH SALES COLLATERAL, MEDIA PLANNING AND PLACEMENT, PUBLIC RELATIONS, SALES INCENTIVES AND PROMOTION, WEB SITE DEVELOPMENT, INTERNET, PRINT, TELEVISION, OUTDOOR AND RADIO ADVERTISING (U.S. CLS. 100, 101 AND 102).

CATHERINE FAINT, EXAMINING ATTORNEY

CLASS 35—(Continued).

SN 78-433,943. ERGOSOURCE, INC., MINNETONKA, MN. FILED 6-11-2004.

ERGOSOURCE

THE MARK CONSISTS OF STANDARD CHARACTERS WITHOUT CLAIM TO ANY PARTICULAR FONT, STYLE, SIZE, OR COLOR.

FOR MAIL ORDER AND DISTRIBUTORSHIP SERVICES IN THE FIELD OF ERGONOMIC PRODUCTS FOR COMMERCIAL, INDUSTRIAL, HOME AND OFFICE USE (U.S. CLS. 100, 101 AND 102).

FIRST USE 6-11-2004; IN COMMERCE 6-11-2004.
JIM RINGLE, EXAMINING ATTORNEY

SN 78-434,769. EMERGENT MEDICAL STAFFING, INC., MILBANK, SD. FILED 6-14-2004.



THE COLOR GRAY IS CLAIMED AS A FEATURE OF THE MARK.

THE COLOR GRAY APPEARS IN DIFFERENT SHADES IN THE ANTLERS, HEAD, NECK, BODY, LEGS AND HOVES OF THE ELK.

FOR MEDICAL STAFFING FOR EMERGENCY ROOMS, HOSPITAL, AND FAMILY CLINIC FACILITIES (U.S. CLS. 100, 101 AND 102).

FIRST USE 5-1-1995; IN COMMERCE 5-1-1995.
CHRISTOPHER BUONGIORNO, EXAMINING ATTORNEY

SN 78-435,016. RYAN, JANET L., FREDERICKSBURG, VA. FILED 6-14-2004.

**Global Artisan
SHOWCASE**

NO CLAIM IS MADE TO THE EXCLUSIVE RIGHT TO USE "SHOWCASE", APART FROM THE MARK AS SHOWN. FOR ONLINE RETAIL STORE SERVICES FEATURING HANDMADE CRAFTS FEATURING WOOD, JEWELRY, CERAMICS, GLASS, TABLEWARE, AND LIGHTING (U.S. CLS. 100, 101 AND 102).

FIRST USE 6-7-2001; IN COMMERCE 6-7-2001.
LESLEY LAMOTHE, EXAMINING ATTORNEY

CLASS 35—(Continued).

SN 78-435,413. HARD ROCK HOTEL, INC., LAS VEGAS, NV. FILED 6-15-2004.

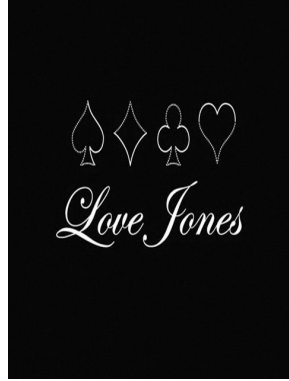

THE MARK CONSISTS OF STYLIZED LETTERS BELOW PLAYING CARD SUITS.
FOR RETAIL LINGERIE STORE (U.S. CLS. 100, 101 AND 102).
FIRST USE 8-0-2003; IN COMMERCE 8-0-2003.
MICHAEL ENGEL, EXAMINING ATTORNEY

CLASS 35—(Continued).

SN 78-436,512. MEGAOUTDOORS, LTD., BENBROOK, TX. FILED 6-16-2004.

MegaOutdoors

THE MARK CONSISTS OF STANDARD CHARACTERS WITHOUT CLAIM TO ANY PARTICULAR FONT, STYLE, SIZE, OR COLOR.
FOR PROMOTING THE GOODS AND SERVICES OF OTHERS IN THE FIELD OF OUTDOOR SPORTING AND RECREATIONAL ACTIVITIES BY MEANS OF A WEB SITE PORTAL OFFERING NEWS AND ARTICLES, ON-LINE DISCUSSION FORUMS, ADVERTISEMENTS FOR THE GOODS AND SERVICES OF OTHERS, AND HYPERTEXT LINKS TO THE WEB SITES OF OTHERS; ARRANGING TELEVISION AND OTHER MEDIA SPONSORSHIPS, PLACING ADVERTISEMENTS ON MOBILE BILLBOARDS FOR GOODS AND SERVICES OF OTHERS; AND DISTRIBUTION OF BROCHURES AND OTHER MARKETING ITEMS AT PUBLIC EVENTS (U.S. CLS. 100, 101 AND 102).
FIRST USE 1-31-2003; IN COMMERCE 1-31-2003.
LINDA MICKLEBURGH, EXAMINING ATTORNEY

SN 78-436,432. EXPERIENCIA, LLC, CHICAGO, IL. FILED 6-16-2004.



NO CLAIM IS MADE TO THE EXCLUSIVE RIGHT TO USE "INTEGRATED HISPANIC EVENT MARKETING", APART FROM THE MARK AS SHOWN.
THE COLOR(S) ORANGE, BLACK AND WHITE IS/ARE CLAIMED AS A FEATURE OF THE MARK.
THE COLOR ORANGE APPEARS IN THE LARGE "X", IN THE WORD "EXPERIECIA", AND IN A CURVED LINE FROM THE RIGHT TIP OF THE "I" TO THE LETTER "X" IN THE SAME WORD; THE COLOR BLACK APPEARS OUTLINING THE ORANGE LETTER "X" AND IN ALL OF THE OTHER WORDING IN THE MARK; THE COLOR WHITE APPEARS AS BACKGROUND TO THE ENTIRE MARK.
THE ENGLISH TRANSLATION OF THE WORD "EXPERIENCIA" IN THE MARK IS "EXPERIENCE".
FOR ARRANGING AND CONDUCTING MARKETING PROMOTIONAL EVENTS FOR OTHERS AS WELL AS ADVERTISING AND PROMOTION SERVICES AND RELATED CONSULTING FOR CONSUMERS INTERESTED IN MARKETING TO THE HISPANIC POPULATION (U.S. CLS. 100, 101 AND 102).
FIRST USE 3-28-2004; IN COMMERCE 3-28-2004.
JILL C. ALT, EXAMINING ATTORNEY

SN 78-436,671. JAYMAD CORPORATION, ALLISON PARK, PA. FILED 6-17-2004.



THE COLORS WHITE, BLACK, BLUE, AND GOLD ARE CLAIMED AS A FEATURE OF THE MARK.
THE COLORS BLUE, BLACK AND WHITE APPEAR IN THE LETTERING; THE COLORS WHITE AND GOLD APPEAR IN THE LIGHT STREAM DESIGN; THE COLOR BLACK APPEARS IN THE BACKGROUND; THE COLORS WHITE, BLUE, AND BLACK APPEAR IN THE GLOBE DESIGN.
SEC. 2(F) AS TO TSBN.
FOR BUSINESS MARKETING, CONSULTING SERVICES, AND BUSINESS NETWORKING (U.S. CLS. 100, 101 AND 102).
FIRST USE 5-1-1997; IN COMMERCE 5-1-1997.
JOANNA DUKOVIC, EXAMINING ATTORNEY

CLASS 35—(Continued).

SN 78-436,741. WINCHESTER CARPET & RUG CO., WINCHESTER, VA. FILED 6-17-2004.

We make good
floors great.

THE MARK CONSISTS OF STANDARD CHARACTERS WITHOUT CLAIM TO ANY PARTICULAR FONT, STYLE, SIZE, OR COLOR.

FOR RETAIL AND WHOLESALE STORE SERVICES FEATURING AREA RUGS AND RUG ACCESSORIES; COMPUTERIZED ON-LINE RETAIL AND WHOLESALE ORDERING SERVICES PROVIDED VIA THE INTERNET FEATURING AREA RUGS AND RUG ACCESSORIES; CATALOG ORDERING SERVICES FEATURING AREA RUGS AND RUG ACCESSORIES (U.S. CLS. 100, 101 AND 102).

FIRST USE 1-21-2004; IN COMMERCE 1-21-2004.
MELISSA SHELLA, EXAMINING ATTORNEY

CLASS 35—(Continued).

SN 78-438,396. TOP DOG NOZZLE AND CALIBRATION LLC, RIGEWOOD, NJ. FILED 6-21-2004.

NOZZLE DEPOT

THE MARK CONSISTS OF STANDARD CHARACTERS WITHOUT CLAIM TO ANY PARTICULAR FONT, STYLE, SIZE, OR COLOR.

NO CLAIM IS MADE TO THE EXCLUSIVE RIGHT TO USE "NOZZLE", APART FROM THE MARK AS SHOWN.

FOR RETAIL STORE SERVICES AND MAIL ORDER SERVICES FOR GAS STATIONS FEATURING PETROLEUM DISPENSING EQUIPMENT, NAMELY, NOZZLES, HOSES, SWIVELS, BREAKAWAYS, VALVES, PIPING, FILTERS AND RELATED PARTS (U.S. CLS. 100, 101 AND 102).

FIRST USE 5-26-2004; IN COMMERCE 5-26-2004.
KELLY BOULTON, EXAMINING ATTORNEY

SN 78-437,742. APNA BAZAR CASH & CARRY INC., JACKSON HEIGHTS, NY. FILED 6-18-2004.

APNA BAZAR

THE MARK CONSISTS OF STANDARD CHARACTERS WITHOUT CLAIM TO ANY PARTICULAR FONT, STYLE, SIZE, OR COLOR.

NO CLAIM IS MADE TO THE EXCLUSIVE RIGHT TO USE BAZAR, APART FROM THE MARK AS SHOWN.

THE FOREIGN WORDING IN THE MARK TRANSLATES INTO ENGLISH AS OUR MARKET.

FOR RETAIL AND WHOLESALE GROCERY STORE SERVICES (U.S. CLS. 100, 101 AND 102).

FIRST USE 3-1-1996; IN COMMERCE 3-1-1996.
STEPHANIE DAVIS, EXAMINING ATTORNEY

SN 78-438,453. MARTIN SCOTT WINES, LTD., LAKE SUCCESS, NY. FILED 6-21-2004.

MARTIN SCOTT WINES

THE MARK CONSISTS OF STANDARD CHARACTERS WITHOUT CLAIM TO ANY PARTICULAR FONT, STYLE, SIZE, OR COLOR.

NO CLAIM IS MADE TO THE EXCLUSIVE RIGHT TO USE "WINES", APART FROM THE MARK AS SHOWN.

THE NAME(S), PORTRAIT(S), AND/OR SIGNATURE(S) SHOWN IN THE MARK DOES NOT IDENTIFY A PARTICULAR LIVING INDIVIDUAL.

FOR IMPORT AND DISTRIBUTORSHIP SERVICES IN THE FIELD OF WINE (U.S. CLS. 100, 101 AND 102).

FIRST USE 12-0-1989; IN COMMERCE 1-2-1990.
MICHAEL HALL, EXAMINING ATTORNEY

CLASS 35—(Continued).

SN 78-438,472. NATIONAL FIRE PROTECTION ASSOCIATION, INC., QUINCY, MA. FILED 6-21-2004.



OWNER OF U.S. REG. NO. 2,716,427.
 FOR PROMOTING PUBLIC AWARENESS FOR FIRE PREVENTION BY ORGANIZING, MANAGING AND SPONSORING A RECOGNITION PROGRAM FOR COMMUNITIES WHICH HAVE TAKEN SPECIFIC MEASURES TO PREPARE FOR AND MITIGATE RISKS ASSOCIATED WITH WILDFIRES (U.S. CLS. 100, 101 AND 102).
 FIRST USE 0-0-2003; IN COMMERCE 0-0-2003.
 RAUL CORDOVA, EXAMINING ATTORNEY

SN 78-438,483. NATIONAL FIRE PROTECTION ASSOCIATION, INC., QUINCY, MA. FILED 6-21-2004.

**FIREWISE
 COMMUNITIES/USA**

THE MARK CONSISTS OF STANDARD CHARACTERS WITHOUT CLAIM TO ANY PARTICULAR FONT, STYLE, SIZE, OR COLOR.
 OWNER OF U.S. REG. NO. 2,716,427.
 FOR PROMOTING PUBLIC AWARENESS FOR FIRE PREVENTION BY ORGANIZING, MANAGING AND SPONSORING A RECOGNITION PROGRAM FOR COMMUNITIES WHICH HAVE TAKEN SPECIFIC MEASURES TO PREPARE FOR AND MITIGATE RISKS ASSOCIATED WITH WILDFIRES (U.S. CLS. 100, 101 AND 102).
 FIRST USE 0-0-2003; IN COMMERCE 0-0-2003.
 RAUL CORDOVA, EXAMINING ATTORNEY

CLASS 35—(Continued).

SN 78-438,491. NATIONAL FIRE PROTECTION ASSOCIATION, INC., QUINCY, MA. FILED 6-21-2004.

FIREWISE

THE MARK CONSISTS OF STANDARD CHARACTERS WITHOUT CLAIM TO ANY PARTICULAR FONT, STYLE, SIZE, OR COLOR.
 OWNER OF U.S. REG. NO. 2,716,427.
 FOR PROMOTING PUBLIC AWARENESS FOR FIRE PREVENTION BY ORGANIZING, MANAGING AND SPONSORING A RECOGNITION PROGRAM FOR COMMUNITIES WHICH HAVE TAKEN SPECIFIC MEASURES TO PREPARE FOR AND MITIGATE RISKS ASSOCIATED WITH WILDFIRES (U.S. CLS. 100, 101 AND 102).
 FIRST USE 2-0-1993; IN COMMERCE 2-0-1993.
 RAUL CORDOVA, EXAMINING ATTORNEY

SN 78-438,923. TAVIANI, FERDINANDO, METAIRIE, LA. FILED 6-21-2004.

**Kangaroos Big Ass
 Wines**

THE MARK CONSISTS OF STANDARD CHARACTERS WITHOUT CLAIM TO ANY PARTICULAR FONT, STYLE, SIZE, OR COLOR.
 NO CLAIM IS MADE TO THE EXCLUSIVE RIGHT TO USE "WINES", APART FROM THE MARK AS SHOWN.
 FOR WHOLESALE DISTRIBUTORSHIP SERVICES IN THE FIELD OF RED AND WHITE WINES (U.S. CLS. 100, 101 AND 102).
 FIRST USE 1-1-2004; IN COMMERCE 4-15-2005.
 JILL C. ALT, EXAMINING ATTORNEY

CLASS 35—(Continued).

SN 78-439,225. CHANNEL INTELLIGENCE, INC., CELEBRATION, FL. FILED 6-22-2004.

CLASS 35—(Continued).

SN 78-440,158. KENNETH COLE PRODUCTIONS (LIC), INC., NASSAU, BAHAMAS, FILED 6-23-2004.

ARE YOU PUTTING US ON?

SELLPATH

THE MARK CONSISTS OF STANDARD CHARACTERS WITHOUT CLAIM TO ANY PARTICULAR FONT, STYLE, SIZE, OR COLOR.

FOR BUSINESS SERVICES, NAMELY, PROVIDING WEB LINKS WHEREBY MANUFACTURERS, DEALERS AND CONSUMERS ARE LINKED FOR BUYING AND SELLING TRANSACTIONS (U.S. CLS. 100, 101 AND 102).
FIRST USE 5-24-2004; IN COMMERCE 5-24-2004.
DAWN FELDMAN, EXAMINING ATTORNEY

THE MARK CONSISTS OF STANDARD CHARACTERS WITHOUT CLAIM TO ANY PARTICULAR FONT, STYLE, SIZE, OR COLOR.

FOR RETAIL STORE, CATALOG AND ONLINE RETAIL STORE SERVICES VIA THE INTERNET AND OTHER LOCAL OR WIDE AREA COMPUTER NETWORKS, WIRELESS COMMUNICATION NETWORKS, GLOBAL COMPUTER INFORMATION NETWORKS AND OTHER ELECTRONIC COMMUNICATION NETWORKS FEATURING FOOTWEAR, CLOTHING, WEARING APPAREL, LUGGAGE, HANDBAGS, SMALL LEATHER GOODS, BUSINESS CASES, EYEWEAR, JEWELRY AND WATCHES, BELTS, SCARVES AND NECKWEAR, FRAGRANCES AND ACCESSORIES; DEMONSTRATION OF GOODS, NAMELY, FOOTWEAR, CLOTHING, WEARING APPAREL, LUGGAGE, HANDBAGS, SMALL LEATHER GOODS, BUSINESS CASES, EYEWEAR, JEWELRY AND WATCHES, BELTS, SCARVES AND NECKWEAR, FRAGRANCES AND ACCESSORIES (U.S. CLS. 100, 101 AND 102).
FIRST USE 2-6-2004; IN COMMERCE 2-6-2004.
BRIDGETT SMITH, EXAMINING ATTORNEY

SN 78-441,503. ECAPITAL FINANCIAL CORP., SANTA MONICA, CA. FILED 6-25-2004.

SN 78-439,469. WENHAM ENTERPRISES, LLC, WARWICK, RI. FILED 6-22-2004.

MAKING LUXURY AFFORDABLE

WHITE FACETS

THE MARK CONSISTS OF STANDARD CHARACTERS WITHOUT CLAIM TO ANY PARTICULAR FONT, STYLE, SIZE, OR COLOR.

FOR ONLINE RETAIL STORE SERVICES FEATURING JEWELRY (U.S. CLS. 100, 101 AND 102).
MATTHEW PAPPAS, EXAMINING ATTORNEY

THE MARK CONSISTS OF STANDARD CHARACTERS WITHOUT CLAIM TO ANY PARTICULAR FONT, STYLE, SIZE, OR COLOR.

FOR DISTRIBUTORSHIP SERVICES IN THE FIELD OF COMPUTER AND COMPUTER PERIPHERALS AND IN THE FIELD OF TECHNOLOGY PRODUCTS, NAMELY, MP3 PLAYERS, RADIOS, AUDIO CASSETTE RECORDERS, AUDIO SPEAKERS, ELECTRONIC MUSICAL KEYBOARDS, CD PLAYERS, DIGITAL CAMERAS AND CAMCORDERS, PDAS, TELEPHONE ANSWERING MACHINES, WIRELESS TELEPHONES, HANDS-FREE DEVICES FOR USE WITH WIRELESS TELEPHONES, MONITOR TELEVISIONS, FLAT PANEL TELEVISION AND DISPLAY MONITORS, PLASMA DISPLAYS, PROJECTION TELEVISIONS, HIGH DEFINITION PROJECTION TELEVISIONS, TELEVISION SETS, DIGITAL VIDEO RECORDERS, VIDEO MONITORS, VIDEO OUTPUT GAME MACHINES FOR USE WITH TELEVISIONS, DVD MACHINES; AND DIRECT MARKETING ADVERTISING FOR OTHERS IN THE FIELD OF TECHNOLOGY (U.S. CLS. 100, 101 AND 102).
BILL DAWE, EXAMINING ATTORNEY

CLASS 35—(Continued).

SN 78-441,870. NUTRITIONAL WORLD, INC., NEW KENSINGTON, PA. FILED 6-26-2004.



NO CLAIM IS MADE TO THE EXCLUSIVE RIGHT TO USE "NUTRITIONAL", APART FROM THE MARK AS SHOWN.

THE MARK CONSISTS OF A HORIZONTALLY STRETCHED WORLD GLOBE WITH THE WORDS "NUTRITIONAL WORLD" PLACED IN FRONT OF/OVER THE FACE OF THE GLOBE

FOR RETAIL STORE SERVICES, AVAILABLE THROUGH COMPUTER COMMUNICATIONS AND INTERACTIVE TELEVISION, FEATURING NUTRITIONAL SUPPLEMENTS (U.S. CLS. 100, 101 AND 102).

FIRST USE 2-7-2004; IN COMMERCE 3-23-2004.
 NAAKWAMA ANKRAH, EXAMINING ATTORNEY

CLASS 35—(Continued).

SN 78-442,133. FEDERAL BUSINESS PRODUCTS, INC., CLIFTON, NJ. FILED 6-28-2004.

Franchise Ease

THE MARK CONSISTS OF STANDARD CHARACTERS WITHOUT CLAIM TO ANY PARTICULAR FONT, STYLE, SIZE, OR COLOR.

NO CLAIM IS MADE TO THE EXCLUSIVE RIGHT TO USE "FRANCHISE", APART FROM THE MARK AS SHOWN.

FOR DIRECT MAIL PRODUCTION SERVICES FOR FRANCHISES AND ONLINE ORDERING SERVICES OF FORMS FOR FRANCHISES (U.S. CLS. 100, 101 AND 102).

FIRST USE 6-9-2004; IN COMMERCE 6-9-2004.
 STEVEN JACKSON, EXAMINING ATTORNEY

SN 78-442,135. RFH INTERNATIONAL, INC., FLUSHING, NY. FILED 6-28-2004.

SN 78-441,943. RAHMANKHAH, GHOLAMALI, CORAL SPRINGS, FL. FILED 6-26-2004.



THE COLOR(S) BLACK AND RED IS/ARE CLAIMED AS A FEATURE OF THE MARK.

THE MARK CONSISTS OF THE COLOR RED APPEARS IN THE WORDING E-BAME WITH THE LETTERS SHADOWED IN BLACK.

FOR OPERATING ONLINE MARKETPLACES FOR SELLERS OF GOODS AND SERVICES; EXCHANGE SERVICES, NAMELY, BARTERING OF GOODS FOR OTHERS (U.S. CLS. 100, 101 AND 102).

FIRST USE 6-2-2004; IN COMMERCE 6-2-2004.
 KAREN BRACEY, EXAMINING ATTORNEY

Magic jewelry

THE MARK CONSISTS OF STANDARD CHARACTERS WITHOUT CLAIM TO ANY PARTICULAR FONT, STYLE, SIZE, OR COLOR.

OWNER OF U.S. REG. NOS. 2,346,381 AND 2,877,283.
 NO CLAIM IS MADE TO THE EXCLUSIVE RIGHT TO USE "JEWELRY", APART FROM THE MARK AS SHOWN.

FOR RETAIL STORES FEATURING JEWELRY MADE OF CRYSTALS; AND BUSINESS CONSULTATION IN THE FIELD OF FENG SHUI (U.S. CLS. 100, 101 AND 102).

FIRST USE 5-1-2002; IN COMMERCE 5-1-2002.
 STEVEN JACKSON, EXAMINING ATTORNEY

CLASS 35—(Continued).

SN 78-442,348. PERSHING INVESTMENTS LLC, NEWARK, DE. FILED 6-28-2004.

CLASS 35—(Continued).

SN 78-442,542. HUNTING WORLD LLC, RENO, NV. FILED 6-28-2004.

OMNIMETRICS

THE MARK CONSISTS OF STANDARD CHARACTERS WITHOUT CLAIM TO ANY PARTICULAR FONT, STYLE, SIZE, OR COLOR.

FOR BUSINESS RESEARCH AND CONSULTATION SERVICES, NAMELY MONITORING, TRACKING, EVALUATING AND DISPLAYING IN GRAPH FORM QUALITY CONTROL ASPECTS OF BUSINESS OPERATIONS TO MEASURE ENTERPRISE PERFORMANCE FUNCTIONS (U.S. CLS. 100, 101 AND 102).
SCOTT OSCLICK, EXAMINING ATTORNEY

Keep the Adventure Alive

THE MARK CONSISTS OF STANDARD CHARACTERS WITHOUT CLAIM TO ANY PARTICULAR FONT, STYLE, SIZE, OR COLOR.

FOR RETAIL DEPARTMENT STORE SERVICES (U.S. CLS. 100, 101 AND 102).
FIRST USE 11-15-1990; IN COMMERCE 11-15-1990.
INGA ERVIN, EXAMINING ATTORNEY

SN 78-442,465. BRENDA J. MIZE, PFLUGERVILLE, TX. FILED 6-28-2004.

SN 78-442,709. MASRI SWEETS,LLC, DEARBORN, MI. FILED 6-28-2004.



NO CLAIM IS MADE TO THE EXCLUSIVE RIGHT TO USE "COLLECTIBLES", APART FROM THE MARK AS SHOWN.

THE COLOR(S) LIGHT BLUE, RED, YELLOW, GREY, BLACK, GOLD, WHITE, AND DARK BLUE IS/ARE CLAIMED AS A FEATURE OF THE MARK.

THE MARK CONSISTS OF A MUTED LIGHTHOUSE IMAGE ON THE LEFT-HAND SIDE OF THE IMAGE WHOSE COLORS ARE BLACK, SHADES OF GRAY, WHITE, RED, AND YELLOW. THE BACKGROUND COLOR OF THE OVERALL IMAGE IS LIGHT BLUE. THE LOGO IMAGE WHICH APPEARS AT THE TOP OF THE IMAGE CENTERED CONTAINS THE COLOR GOLD FOR "BEACON'S GLOW" WITH A BACKGROUND RECTANGLE OF DARK BLUE, AND THE REMAINDER OF THE LOGO IMAGE "COLLECTIBLES TO CHERISH. . ." LOCATED DIRECTLY BENEATH "BEACON'S GLOW" IS IN DARK BLUE.

FOR ONLINE RETAIL STORE FEATURING COLLECTIBLES AND GIFTS - DOLLS, TEDDY BEARS, GIFT BASKETS, AND CANDLES (U.S. CLS. 100, 101 AND 102).
FIRST USE 11-17-2003; IN COMMERCE 11-17-2003.
LINDA ESTRADA, EXAMINING ATTORNEY



NO CLAIM IS MADE TO THE EXCLUSIVE RIGHT TO USE SWEETS, APART FROM THE MARK AS SHOWN.

THE COLORS ORANGE AND GREEN ARE FEATURES OF THE MARK.

THE COLOR ORANGE APPEARS IN THE WORDING MASRI SWEETS AND IN THE FRUIT SHOWN IN THE MARK; THE COLOR GREEN APPEARS AS LIGHT GREEN IN THE SHADING AND RINGS AROUND THE FRUIT AND AS DARK GREEN IN THE LEAVES AND THE BACKGROUND COLORING OF THE MARK.

FOR RETAIL STORES, WHOLESALE DISTRIBUTORSHIPS, ONLINE RETAIL STORE SERVICES AND MAIL ORDER SERVICES ALL FEATURING MIDDLE EASTERN PASTRIES, CAKES AND CONFECTIONS (U.S. CLS. 100, 101 AND 102).

JOHN SCHUYLER YARD, EXAMINING ATTORNEY

CLASS 35—(Continued).

SN 78-442,728. CARRICO, SANDRA L, MOUNTAIN VIEW, CA. FILED 6-29-2004.

www.auction-dog.com

THE MARK CONSISTS OF STANDARD CHARACTERS WITHOUT CLAIM TO ANY PARTICULAR FONT, STYLE, SIZE, OR COLOR.
FOR INTERNET COOPERATIVE ADVERTISING AND MARKETING (U.S. CLS. 100, 101 AND 102).
FIRST USE 5-15-2004; IN COMMERCE 5-15-2004.
ANDREW BENZMILLER, EXAMINING ATTORNEY

CLASS 35—(Continued).

SN 78-445,704. CHINESE INFORMATION & NETWORKING ASSOCIATION, SANTA CLARA, CA. FILED 7-2-2004.

CINA

THE MARK CONSISTS OF STANDARD CHARACTERS WITHOUT CLAIM TO ANY PARTICULAR FONT, STYLE, SIZE, OR COLOR.
FOR PREPARING AUDIO-VISUAL PRESENTATIONS FOR USE IN ADVERTISING (U.S. CLS. 100, 101 AND 102).
CURTIS FRENCH, EXAMINING ATTORNEY

SN 78-445,707. CHINESE INFORMATION & NETWORKING ASSOCIATION, SANTA CLARA, CA. FILED 7-2-2004.

SN 78-443,225. ANIXTER-REAL ESTATE, INC., GLENVIEW, IL. FILED 6-29-2004.

ANIXTER FASTENERS

THE MARK CONSISTS OF STANDARD CHARACTERS WITHOUT CLAIM TO ANY PARTICULAR FONT, STYLE, SIZE, OR COLOR.
NO CLAIM IS MADE TO THE EXCLUSIVE RIGHT TO USE "FASTENERS", APART FROM THE MARK AS SHOWN.
FOR DISTRIBUTORSHIP SERVICES IN THE FIELD OF FASTENERS, NUTS, BOLTS, WASHERS, AND OTHER SMALL PARTS (U.S. CLS. 100, 101 AND 102).
DAVID C. REIHNER, EXAMINING ATTORNEY

CINA

THE MARK CONSISTS OF STANDARD CHARACTERS WITHOUT CLAIM TO ANY PARTICULAR FONT, STYLE, SIZE, OR COLOR.
FOR ASSOCIATION SERVICES, NAMELY, PROMOTING THE INTERESTS OF BUSINESS PROFESSIONALS AND ENTREPRENEURS; ADVERTISING AGENCIES, NAMELY, PROMOTING THE GOODS AND SERVICES OF OTHERS IN THE US AND AMONG ASIA PACIFIC RIM COUNTRIES IN THE FIELDS OF HIGH TECHNOLOGY, BIOTECHNOLOGY, BIOINFORMATICS, COMPUTER SOFTWARE, CONTENT AND MEDIA TECHNOLOGY, INFORMATION TECHNOLOGY, INTERNET INFORMATION TECHNOLOGY, COMPUTER AND COMMUNICATIONS NETWORKING; ARRANGING AND CONDUCTING BUSINESS CONFERENCES; BUSINESS NETWORKING; PROVIDING FACILITIES FOR BUSINESS MEETINGS; ASSOCIATION SERVICES, NAMELY, PROMOTING COOPERATION AND COLLABORATION AMONG CHINESE BUSINESS PROFESSIONAL ASSOCIATIONS; CONSULTING SERVICES IN THE FIELD PROFESSIONAL CAREER DEVELOPMENT (U.S. CLS. 100, 101 AND 102).
CURTIS FRENCH, EXAMINING ATTORNEY

CLASS 35—(Continued).

SN 78-446,172. THE HARTFIEL COMPANY, EDEN PRAIRIE, MN. FILED 7-6-2004.



THE COLOR(S) RED AND WHITE. IS/ARE CLAIMED AS A FEATURE OF THE MARK.

THE COLOR RED APPEARS ON THE LOWER LEFT PORTION OF THE MARK, SHADING UPWARDS AND FORMING THE CONTOUR OF THE CIRCLE. THE COLOR WHITE APPEARS IN THE UPPER RIGHT PORTION OF THE CIRCLE, SPREADING INTO THE CENTER OF THE MARK.

THE MARK CONSISTS OF A STYLIZED WHITE CIRCLE SHADED WITH RED.

FOR DISTRIBUTORSHIPS IN THE FIELD OF AUTOMATION AND MOTION CONTROL MACHINERY AND EQUIPMENT (U.S. CLS. 100, 101 AND 102).

FIRST USE 0-0-1992; IN COMMERCE 0-0-1992.
NELSON SNYDER, EXAMINING ATTORNEY

SN 78-446,309. JENKINS, JEFF, OLATHE, KS. FILED 7-6-2004.

THINKFIT

THE MARK CONSISTS OF STANDARD CHARACTERS WITHOUT CLAIM TO ANY PARTICULAR FONT, STYLE, SIZE, OR COLOR.

FOR PROMOTING PUBLIC AWARENESS OF THE NEED FOR DISEASE PREVENTION (U.S. CLS. 100, 101 AND 102).

FIRST USE 3-1-2002; IN COMMERCE 4-1-2003.
KAREN K. BUSH, EXAMINING ATTORNEY

CLASS 35—(Continued).

SN 78-446,471. SOUTHERN UNITED STATES TRADE ASSOCIATION, NEW ORLEANS, LA. FILED 7-6-2004.



NO CLAIM IS MADE TO THE EXCLUSIVE RIGHT TO USE "SOUTHERN UNITED STATES TRADE ASSOCIATION", APART FROM THE MARK AS SHOWN.

FOR MARKETING SERVICES, NAMELY, ADVERTISING AND MARKETING ON BEHALF OF SOUTHERN UNITED STATES EXPORTERS TO ASSIST IN THE PROMOTION AND EXPORT OF THEIR FOOD AND AGRICULTURAL PRODUCTION; ASSOCIATION SERVICES, NAMELY, PROMOTING THE INTERESTS OF SOUTHERN UNITED STATES FOOD AND AGRICULTURAL EXPORTERS REGARDING COMMERCIAL TRADE FROM THE SOUTHERN UNITED STATES AREA TO OVERSEAS MARKETS (U.S. CLS. 100, 101 AND 102).

FIRST USE 1-0-1990; IN COMMERCE 1-0-1990.
ANDREW RHIM, EXAMINING ATTORNEY

SN 78-447,081. HOLLYWOOD CHAMBER OF COMMERCE, HOLLYWOOD, CA. FILED 7-7-2004.

HOLLYWOOD

OWNER OF U.S. REG. NOS. 1,565,809, 2,138,098 AND OTHERS.

THE MARK CONSISTS OF THE WORD, "HOLLYWOOD," IN STAGGERED CAPITAL LETTERS.

SEC. 2(F).

FOR ADVERTISING SERVICES, NAMELY PROVIDING SIGNAGE AND STAGE PROPS AND SET DRESSING FOR USE BY OTHERS IN PROMOTING THEIR OWN GOODS AND SERVICES (U.S. CLS. 100, 101 AND 102).

FIRST USE 3-28-1995; IN COMMERCE 3-28-1995.
RICHARD A. STRASER, EXAMINING ATTORNEY

CLASS 35—(Continued).

SN 78-447,706. AGENT 77, INC., MINNEAPOLIS, MN. FILED 7-8-2004.

Libretto: Sensible
HR

THE MARK CONSISTS OF STANDARD CHARACTERS WITHOUT CLAIM TO ANY PARTICULAR FONT, STYLE, SIZE, OR COLOR.

NO CLAIM IS MADE TO THE EXCLUSIVE RIGHT TO USE "HR", APART FROM THE MARK AS SHOWN.

FOR HUMAN RESOURCES CONSULTATION SERVICE NAMELY, PROVIDING AN INTERNET-BASED HUMAN RESOURCES INFORMATION SOURCE FOR SMALL TO MID-SIZED COMPANIES CONSISTING OF AN ASSESSMENT OF SIMPLE MULTIPLE-CHOICE QUESTIONS, TAILORED RECOMMENDATIONS FOR COMPLIANCE AND BEST PRACTICES IMPROVEMENT RECOMMENDATIONS, AND SOLUTIONS RELATED TO THESE RECOMMENDATIONS SUCH AS FORMS AND TOOLKITS FOR COMPLIANCE AND HUMAN RESOURCES BEST PRACTICES (U.S. CLS. 100, 101 AND 102).

FIRST USE 6-1-2004; IN COMMERCE 6-22-2004.
PAM WILLIS, EXAMINING ATTORNEY

CLASS 35—(Continued).

SN 78-449,467. JACK DANIEL'S PROPERTIES, INC., SAN RAFAEL, CA. FILED 7-12-2004.

STUDIO NO. 7

THE MARK CONSISTS OF STANDARD CHARACTERS WITHOUT CLAIM TO ANY PARTICULAR FONT, STYLE, SIZE, OR COLOR.

NO CLAIM IS MADE TO THE EXCLUSIVE RIGHT TO USE "STUDIO", APART FROM THE MARK AS SHOWN.

FOR ENTERTAINMENT SERVICES IN THE FIELD OF CONCERT PROMOTIONS, NAMELY, PROMOTING THE CONCERTS OF OTHERS. (U.S. CLS. 100, 101 AND 102).
CAROLYN CATALDO, EXAMINING ATTORNEY

SN 78-448,452. AMAIT ABASTECEDORES TURISTICOS, A.C., COLINIA SAN ISIDRO, MEXICO, FILED 7-9-2004.



OWNER OF MEXICO REG. NO. 361082, DATED 12-20-1988, EXPIRES 12-20-2013.

THE MARK CONSISTS OF A KEY DESIGN WITH AN AZTEC TEMPLE FORMING THE HEAD OF THE KEY AND A MEXICAN VILLAGE FORMING THE BODY OF THE KEY.

THE FOREIGN WORDING IN THE MARK TRANSLATES INTO ENGLISH AS THE KEY OF PROGRESS.

FOR ARRANGING AND CONDUCTING TRADE SHOW EXHIBITIONS FOR THE TOURIST AND HOSPITALITY INDUSTRIES (U.S. CLS. 100, 101 AND 102).

KATHRYN COWARD, EXAMINING ATTORNEY

SN 78-449,660. NAVY EXCHANGE SERVICE COMMAND ("NEXCOM"), A NONAPPROPRIATED FUND INSTRUMENTALITY UNDER THE DEPT. OF NAVY, AN AGENCY OF THE UNITED STATES OF AMERICA, VIRGINIA BEACH, VA. FILED 7-13-2004.



THE COLORS GREEN, RED AND BLUE ARE CLAIMED AS FEATURES OF THE MARK.

THE MARK CONSISTS OF THE WORD "AUTOPOINT" WITH WAVES EXTENDING UP FROM THE BOTTOM INTO THE U AND T IN THE WORD AND THE SECOND O AND R. THE COLOR BLUE APPEARS IN THE BACKGROUND OF THE WORDING AUTOPOINT. THE GREEN APPEARS IN THE CENTER OF THE FIRST LETTER O. THE COLOR RED APPEARS IN THE CENTER OF THE SECOND LETTER O AND THE LINE UNDERNEATH THE WORDING AUTOPOINT.

FOR RETAIL GASOLINE SUPPLY SERVICES AND RETAIL STORES FEATURING GASOLINE, CONVENIENCE STORE ITEMS, AUTOMOBILE PARTS AND ACCESSORIES (U.S. CLS. 100, 101 AND 102).

FIRST USE 4-30-1993; IN COMMERCE 4-30-1993.
SOPHIA S. KIM, EXAMINING ATTORNEY

CLASS 35—(Continued).

SN 78-449,754. BREX AMERICA, LLC, MIAMI, FL. FILED 7-13-2004.



NO CLAIM IS MADE TO THE EXCLUSIVE RIGHT TO USE AMERICA BRAZILIAN QUALITY PRODUCTS, APART FROM THE MARK AS SHOWN.

THE COLORS BLUE, YELLOW, GREEN AND BLACK ARE CLAIMED AS A FEATURE OF THE MARK.

THE MARK CONSISTS OF A BLUE CIRCLE REPRESENTING THE PLANET EARTH, OVER A YELLOW FLOATING AND ONDULATED SURFACE. TO THE RIGHT OF THESE ELEMENTS, THE WORDS 'BREX AMERICA' IN STYLIZED FONT, IN GREEN, TO THE BOTTOM OF THE WORDS 'BREX AMERICA', THE WORDS 'BRAZILIAN QUALITY PRODUCTS' IN BLACK.

FOR DISTRIBUTORSHIP OF WHOLESALE FOOD AND BEVERAGE PRODUCTS (U.S. CLS. 100, 101 AND 102).

FIRST USE 10-31-2003; IN COMMERCE 10-31-2003.
LINDA POWELL, EXAMINING ATTORNEY

CLASS 35—(Continued).

SN 78-451,727. DMT SOLUTIONS, INC., PALM CITY, FL. FILED 7-16-2004.

PSOFTPROS

THE MARK CONSISTS OF STANDARD CHARACTERS WITHOUT CLAIM TO ANY PARTICULAR FONT, STYLE, SIZE, OR COLOR.

FOR EMPLOYMENT HIRING, RECRUITING, PLACEMENT, STAFFING AND CAREER NETWORKING SERVICES, ALL PROVIDED VIA THE INTERNET (U.S. CLS. 100, 101 AND 102).

FIRST USE 7-1-2004; IN COMMERCE 7-1-2004.
ALEXANDER L. POWERS, EXAMINING ATTORNEY

SN 78-452,051. FAI PO JEWELLERY INC., NEW YORK, NY. FILED 7-16-2004.

SN 78-450,856. EIFRID, JOSEPH, DECATUR, GA. FILED 7-14-2004.

MyConsumerID

THE MARK CONSISTS OF STANDARD CHARACTERS WITHOUT CLAIM TO ANY PARTICULAR FONT, STYLE, SIZE, OR COLOR.

FOR CUSTOMER RELATIONSHIP MANAGEMENT SERVICE THAT PROMOTES THE GOODS AND SERVICES OF OTHERS BY ADMINISTRATING A BENEFIT PROGRAM WHICH ALLOWS PURCHASERS TO USE A UNIQUE IDENTIFICATION NUMBER TO BETTER ATTRACT MORE RELEVANT OFFERINGS FROM PARTICIPATING MERCHANTS BASED ON PAST PURCHASING HISTORY. (U.S. CLS. 100, 101 AND 102).

KELLY BOULTON, EXAMINING ATTORNEY

FP

THE MARK CONSISTS OF STANDARD CHARACTERS WITHOUT CLAIM TO ANY PARTICULAR FONT, STYLE, SIZE, OR COLOR.

"FP" DOES NOT IDENTIFY A LIVING INDIVIDUAL. FOR WHOLESALE STORES FEATURING JEWELRY, NAMELY, RINGS, NECKLACES, BRACELETS, PINS, EARRINGS, CUFFLINK FOR MEN, LOOSE STONES (U.S. CLS. 100, 101 AND 102).

FIRST USE 0-0-1989; IN COMMERCE 1-2-1999.
FRED MANDIR, EXAMINING ATTORNEY

CLASS 35—(Continued).

SN 78-453,468. AC NIELSEN (US), INC., SCHAUMBURG, IL. AND MARKETING TECHNOLOGY SOLUTIONS, INC., EDISON, NJ. FILED 7-20-2004.

THERAScore

THE MARK CONSISTS OF STANDARD CHARACTERS WITHOUT CLAIM TO ANY PARTICULAR FONT, STYLE, SIZE, OR COLOR.

FOR MARKET RESEARCH SERVICES; MARKET AND SURVEY RESEARCH IN THE PHARMACEUTICAL AND HEALTHCARE INDUSTRIES, AND NUTRITIONAL PRODUCTS AND MEDICAL DEVICES, NAMELY, THE COLLECTION AND DISSEMINATION OF PATIENT DEMOGRAPHICS, PSYCHOGRAPHICS, ATTITUDES AND PURCHASING BEHAVIOR INFORMATION VIA A GLOBAL COMPUTER NETWORK, DIAL-UP COMPUTER, OR OTHER COMPUTER NETWORK (U.S. CLS. 100, 101 AND 102).

FIRST USE 3-30-2004; IN COMMERCE 9-21-2004.
AISHA CLARKE, EXAMINING ATTORNEY

CLASS 35—(Continued).

SN 78-453,859. KAPPA DELTA SORORITY, INCORPORATED, MEMPHIS, TN. FILED 7-21-2004.



THE COLOR(S) YELLOW, RED, BLUE AND PURPLE IS/ ARE CLAIMED AS A FEATURE OF THE MARK.

THE MARK CONSISTS OF A YELLOW ROSE WITH A RED HEART CENTER POSITIONED IN A SQUARE HAVING BLUE/PURPLE STYLIZED FILLER AROUND THE ROSE, AND THE FIRST TWO WORDS OF THE MARK SEPARATED BY A DOT OVER THE SQUARE, AND THE LAST TWO WORDS SEPARATED BY A DOT UNDER THE SQUARE, ALL IN LOWER CASE LETTERING.

SEC. 2(F) AS TO "NATIONAL WOMEN'S FRIENDSHIP DAY".

FOR PROMOTING THE ADVANCEMENT AND CELEBRATION OF FRIENDSHIPS BETWEEN WOMEN (U.S. CLS. 100, 101 AND 102).

FIRST USE 9-17-1997; IN COMMERCE 9-17-1997.
REBECCA GILBERT, EXAMINING ATTORNEY

SN 78-453,576. CAREER GROUP, INC., LOS ANGELES, CA. FILED 7-20-2004.



OWNER OF U.S. REG. NO. 1,718,611.
NO CLAIM IS MADE TO THE EXCLUSIVE RIGHT TO USE "GROUP, INC.", APART FROM THE MARK AS SHOWN.

THE MARK CONSISTS OF STYLIZED LETTERS CG AND THE WORDS CAREER GROUP INC..

SEC. 2(F) AS TO CAREER GROUP INC..
FOR PERMANENT AND TEMPORARY PERSONNEL PLACEMENT SERVICES (U.S. CLS. 100, 101 AND 102).

FIRST USE 9-29-1980; IN COMMERCE 9-29-1980.
ELLEN PERKINS, EXAMINING ATTORNEY

SN 78-454,820. THE EDUCATION TRUST, INC., WASHINGTON, DC. FILED 7-22-2004.

THE EDUCATION TRUST

THE MARK CONSISTS OF STANDARD CHARACTERS WITHOUT CLAIM TO ANY PARTICULAR FONT, STYLE, SIZE, OR COLOR.

NO CLAIM IS MADE TO THE EXCLUSIVE RIGHT TO USE "EDUCATION", APART FROM THE MARK AS SHOWN.

SEC. 2(F).
FOR EDUCATIONAL SERVICES, NAMELY ADVOCATING THE BENEFITS OF KINDERGARTEN THROUGH 12 GRADE EDUCATION AT THE STATE AND FEDERAL LEVELS (U.S. CLS. 100, 101 AND 102).

FIRST USE 1-0-1993; IN COMMERCE 1-0-1993.
MONTIA G. PRESSEY, EXAMINING ATTORNEY

CLASS 35—(Continued).

SN 78-455,692. PHILMONT STAFF ASSOCIATION, CIMARON, NM. FILED 7-23-2004.

PHILMONT STAFF ASSOCIATION

THE MARK CONSISTS OF STANDARD CHARACTERS WITHOUT CLAIM TO ANY PARTICULAR FONT, STYLE, SIZE, OR COLOR.

NO CLAIM IS MADE TO THE EXCLUSIVE RIGHT TO USE "STAFF ASSOCIATION", APART FROM THE MARK AS SHOWN.

FOR ASSOCIATION SERVICES, NAMELY, PROMOTING THE INTERESTS OF A PROPRIETARY RANCH AND STAFF MEMBERS THEREOF (U.S. CLS. 100, 101 AND 102).

FIRST USE 9-15-1973; IN COMMERCE 9-15-1973.
TRACY CROSS, EXAMINING ATTORNEY

CLASS 35—(Continued).

SN 78-456,862. ANGELSTAR INSPIRED PRODUCTS, INC., MORGAN HILL, CA. FILED 7-26-2004.

SERENITY HEART

THE MARK CONSISTS OF STANDARD CHARACTERS WITHOUT CLAIM TO ANY PARTICULAR FONT, STYLE, SIZE, OR COLOR.

FOR WHOLESALE DISTRIBUTORSHIP, ONLINE RETAIL AND WHOLESALE STORE SERVICES, AND RETAIL STORE SERVICES, ALL FEATURING FIGURINES, STATUES, STATUETTES, GARDEN SCULPTURES, HOLIDAY ORNAMENTS, TRINKET BOXES, FUNERAL URNS, AND ORNAMENTAL CROSSES AND ANGELS (U.S. CLS. 100, 101 AND 102).

FIRST USE 1-15-1997; IN COMMERCE 1-15-1997.
JENNIFER KRISP, EXAMINING ATTORNEY

SN 78-456,160. EVERYTHING YOGA, INC., PENSACOLA, FL. FILED 7-24-2004.

MINDBODYBLISS

THE MARK CONSISTS OF STANDARD CHARACTERS WITHOUT CLAIM TO ANY PARTICULAR FONT, STYLE, SIZE, OR COLOR.

FOR ONLINE RETAIL STORE SERVICES FEATURING YOGA RELATED GOODS, NAMELY, YOGA CLOTHING INCLUDING SHIRTS, PANTS, SHORTS, T-SHIRTS, BLOUSES, SKIRTS, AND DRESSES, YOGA ACCESSORIES, NAMELY, HOME DECORATIONS, NAMELY, BED SPREADS, PILLOW CASES, STATUES, AND INCENSE BURNERS, AND YOGA GEAR, NAMELY, MATS, BLOCKS, STRAPS AND BAGS (U.S. CLS. 100, 101 AND 102).

FIRST USE 7-13-2004; IN COMMERCE 7-13-2004.
ALEX KEAM, EXAMINING ATTORNEY

SN 78-458,104. MALEK, MARTIN, BROOKLYN, NY. FILED 7-28-2004.



THE MARK CONSISTS OF THE FIGURE OF A PERSON WHO IS WALKING.

FOR PROVIDING ADVERTISING SERVICES TO OTHERS (U.S. CLS. 100, 101 AND 102).

TRACY FLETCHER, EXAMINING ATTORNEY

CLASS 35—(Continued).

SN 78-458,137. AZOFF, IRVING, LOS ANGELES, CA. FILED 7-28-2004.



FOR TICKET AGENCY SERVICES FOR MUSICAL CONCERTS AND OTHER ENTERTAINMENT EVENTS; PROMOTING ENTERTAINMENT EVENTS BY ARRANGING FOR PACKAGED ENTERTAINMENT EVENTS, NAMELY, PROVIDING CONCERT TICKETS, BACK-STAGE ACCESS TO ARTISTS, EXCLUSIVE EVENT-, ARTIST- AND/OR PERFORMANCE- RELATED MERCHANDISING GIFTS, "MEET AND GREET" OPPORTUNITIES WITH ARTISTS, AND ARTIST- AND EVENT-RELATED PREMIUMS (U.S. CLS. 100, 101 AND 102).
DOMINICK J. SALEMI, EXAMINING ATTORNEY

CLASS 35—(Continued).

SN 78-460,720. BLACK FOREST DECOR, LLC, TULSA, OK. FILED 8-2-2004.



NO CLAIM IS MADE TO THE EXCLUSIVE RIGHT TO USE "BLACK FOREST DECOR", APART FROM THE MARK AS SHOWN.

THE MARK CONSISTS OF THE WORDS "BLACK FOREST DECOR" WITH A BEAR'S FACE IN THE BACKGROUND.

FOR ON-LINE RETAIL STORE SERVICES FEATURING FURNITURE AND ACCESSORIES (U.S. CLS. 100, 101 AND 102).

FIRST USE 7-15-2002; IN COMMERCE 7-15-2002.
VERNA BETH RIRIE, EXAMINING ATTORNEY

SN 78-460,026. BACH, ALFONS, MILTON, FL. FILED 7-31-2004.

BACH ROXXX

THE MARK CONSISTS OF STANDARD CHARACTERS WITHOUT CLAIM TO ANY PARTICULAR FONT, STYLE, SIZE, OR COLOR.

FOR RETAIL STORE SERVICES FEATURING MUSICAL EQUIPMENT (U.S. CLS. 100, 101 AND 102).

FIRST USE 6-1-1993; IN COMMERCE 6-1-1993.
KELLEY WELLS, EXAMINING ATTORNEY

SN 78-461,165. STRATEGYN, INC., LANTANA, FL. FILED 8-3-2004.

**OUTCOME-DRIVEN
INNOVATION**

THE MARK CONSISTS OF STANDARD CHARACTERS WITHOUT CLAIM TO ANY PARTICULAR FONT, STYLE, SIZE, OR COLOR.

NO CLAIM IS MADE TO THE EXCLUSIVE RIGHT TO USE "OUTCOME-DRIVEN", APART FROM THE MARK AS SHOWN.

FOR BUSINESS CONSULTATION, NAMELY OPTIMIZING BUSINESS PERFORMANCE, MARKETING, AND PRODUCT DEVELOPMENT THROUGH THE PROCESS OF STRATEGIC THINKING AND COMPUTER SOFTWARE APPLICATIONS (U.S. CLS. 100, 101 AND 102).

FIRST USE 6-15-2002; IN COMMERCE 6-15-2002.
EDWARD NELSON, EXAMINING ATTORNEY

CLASS 35—(Continued).

SN 78-463,164. GLOBAL HOLDINGS USA, INC., DAYTONA BEACH, FL. FILED 8-6-2004.



NO CLAIM IS MADE TO THE EXCLUSIVE RIGHT TO USE MARKET, APART FROM THE MARK AS SHOWN. THE MARK CONSISTS OF A STYLIZED G OVERLAYING A CIRCLE WITH THE WORDS "GLOBAL MARKET" INSIDE THE OUTER EDGE OF THE CIRCLE. FOR RETAIL STORE SERVICES FEATURING CONVENIENCE STORE ITEMS AND GASOLINE (U.S. CLS. 100, 101 AND 102). FIRST USE 5-1-2004; IN COMMERCE 5-1-2004. ERNEST SHOSHO, EXAMINING ATTORNEY

CLASS 35—(Continued).

SN 78-463,209. EDUCATION TRUST, INC., THE, WASHINGTON, DC. FILED 8-6-2004.



THE MARK CONSISTS OF A PARTIAL SUN AND TWO STICK FIGURES. FOR ADVOCACY SERVICES, NAMELY PROMOTING THE BENEFITS OF HIGH QUALITY PRE-KINDERGARTEN EDUCATION AT THE STATE AND FEDERAL LEVELS (U.S. CLS. 100, 101 AND 102). FIRST USE 2-1-2002; IN COMMERCE 2-1-2002. TIMOTHY FINNEGAN, EXAMINING ATTORNEY

SN 78-463,200. EDUCATION TRUST, INC., THE, WASHINGTON, DC. FILED 8-6-2004.

SN 78-464,038. BIG TEX ENTERPRISES, INC., COLUMBUS, TX. FILED 8-9-2004.

TEE



THE MARK CONSISTS OF STANDARD CHARACTERS WITHOUT CLAIM TO ANY PARTICULAR FONT, STYLE, SIZE, OR COLOR. FOR ADVOCACY SERVICES, NAMELY PROMOTING THE BENEFITS OF HIGH QUALITY PRE-KINDERGARTEN EDUCATION AT THE STATE AND FEDERAL LEVELS (U.S. CLS. 100, 101 AND 102). FIRST USE 2-1-2002; IN COMMERCE 2-1-2002. TIMOTHY FINNEGAN, EXAMINING ATTORNEY

NO CLAIM IS MADE TO THE EXCLUSIVE RIGHT TO USE THE REPRESENTATION OF THE DESIGN OF THE STATE OF TEXAS, APART FROM THE MARK AS SHOWN. THE MARK CONSISTS OF DESIGN OF A COWBOY WITH BIG TEX. FOR RETAIL STORE SERVICES FEATURING CONVENIENCE STORE ITEMS AND GASOLINE (U.S. CLS. 100, 101 AND 102). FIRST USE 12-7-2004; IN COMMERCE 12-7-2004. MONIQUE MILLER, EXAMINING ATTORNEY

CLASS 35—(Continued).

SN 78-464,222. MORAVEC ENTERPRISE, INC., HONOLULU, HI. FILED 8-9-2004.

CLASS 35—(Continued).

SN 78-465,232. ESELL ONLINE SERVICES, PLANO, TX. FILED 8-10-2004.



FOR RETAIL STORE FEATURING CLOTHING (U.S. CLS. 100, 101 AND 102).
FIRST USE 9-1-2001; IN COMMERCE 9-1-2001.
BRIAN NEVILLE, EXAMINING ATTORNEY

NO CLAIM IS MADE TO THE EXCLUSIVE RIGHT TO USE "ONLINE SERVICES", APART FROM THE MARK AS SHOWN.

FOR PROVIDE ONLINE ADVERTISING AND MARKETING SERVICES; OPERATING AN ONLINE MARKETPLACE FOR SELLERS OF GOODS AND SERVICES; ONLINE BUSINESS DIRECTORIES FEATURING LISTINGS OF ANTIQUES AND COLLECTIBLES, ONLINE LISTING SERVICES FOR BUYERS AND SELLERS OF ANTIQUES AND COLLECTIBLES, LOGISTICS MANAGEMENT IN THE FIELD OF WAREHOUSING AND SHIPPING; ADVERTISING SERVICES, NAMELY, PREPARING AND PLACING ADVERTISEMENTS ON THE INTERNET FOR BOTH CONSUMERS AND BUSINESSES (U.S. CLS. 100, 101 AND 102).

FIRST USE 8-7-2004; IN COMMERCE 8-7-2004.
SUE LAWRENCE, EXAMINING ATTORNEY

SN 78-465,182. VITAL PHARMACEUTICALS, INC., DAVIE, FL. FILED 8-10-2004.

SN 78-466,299. DIRECT ADVERTISING OF FLORIDA, LLC, PUNTA GORDA, FL. FILED 8-12-2004.



NO CLAIM IS MADE TO THE EXCLUSIVE RIGHT TO USE "NUTRITION", APART FROM THE MARK AS SHOWN.

FOR RETAIL STORE SERVICES IN THE FIELD OF HEALTH, NUTRITION, AND EXERCISE, NAMELY, DRINKS, SHAKES, SUPPLEMENTS, VITAMINS, AND T-SHIRTS (U.S. CLS. 100, 101 AND 102).

FIRST USE 6-6-2001; IN COMMERCE 6-6-2001.
TIMOTHY FINNEGAN, EXAMINING ATTORNEY

FOR RETAIL STORE SERVICES FEATURING HOME ENTERTAINMENT AND HOME FURNISHING PRODUCTS, NAMELY, GLASS AND CRYSTAL DINNERWARE, CANDLES, SOAP AND WINES (U.S. CLS. 100, 101 AND 102).

FIRST USE 11-14-2003; IN COMMERCE 11-14-2003.
SUNG IN, EXAMINING ATTORNEY

CLASS 35—(Continued).

SN 78-467,686. ARANN, SUSAN, STATEN ISLAND, NY.
FILED 8-15-2004.



NO CLAIM IS MADE TO THE EXCLUSIVE RIGHT TO USE "BRIDAL REGISTRY" AND "A DIVISION OF" AND "AMERICAN INTERNATIONAL" AND "INC.", APART FROM THE MARK AS SHOWN.

THE COLOR(S) PURPLE, BLUE AND BLACK IS/ARE CLAIMED AS A FEATURE OF THE MARK.

THE MARK CONSISTS OF DESIGNER'S IS PURPLE AND IN FONT ITC BASKERVILLE, EYE IS BLUE AND IN FONT ITC BASKERVILLE, AND BRIDAL REGISTRY IS BLACK AND IN FONT APPLE CHANCERY.

FOR BRIDAL REGISTRY SERVICES (U.S. CLS. 100, 101 AND 102).

FIRST USE 3-1-2004; IN COMMERCE 3-1-2004.

PAM WILLIS, EXAMINING ATTORNEY

CLASS 35—(Continued).

SN 78-468,819. A CHILD'S DELIGHT, SAN RAPHAEL, CA.
FILED 8-17-2004.

A CHILD'S DELIGHT

THE MARK CONSISTS OF STANDARD CHARACTERS WITHOUT CLAIM TO ANY PARTICULAR FONT, STYLE, SIZE, OR COLOR.

FOR RETAIL AND ONLINE RETAIL DISTRIBUTORSHIP OF TOYS, GIFTS AND PRODUCTS FOR CHILDREN (U.S. CLS. 100, 101 AND 102).

FIRST USE 10-0-1994; IN COMMERCE 10-0-1994.

FLORENTINA BLANDU, EXAMINING ATTORNEY

SN 78-468,105. ALLOVER MEDIA FRANCHISING, INC.,
MAPLE GROVE, MN. FILED 8-16-2004.

ALLOVER MEDIA

THE MARK CONSISTS OF STANDARD CHARACTERS WITHOUT CLAIM TO ANY PARTICULAR FONT, STYLE, SIZE, OR COLOR.

NO CLAIM IS MADE TO THE EXCLUSIVE RIGHT TO USE "MEDIA", APART FROM THE MARK AS SHOWN.

FOR ADVERTISING SERVICES, NAMELY, BUSINESS MARKETING CONSULTATION AND CREATION, PREPARATION AND DISSEMINATION OF ADVERTISING MATERIALS PROMOTING THE SALE OF GOODS AND SERVICES OF OTHERS; FRANCHISING, NAMELY, OFFERING TECHNICAL ASSISTANCE IN THE ESTABLISHMENT AND OPERATION OF BUSINESSES OFFERING ADVERTISING DEVELOPMENT AND PLACEMENT SERVICES (U.S. CLS. 100, 101 AND 102).

FIRST USE 12-1-2002; IN COMMERCE 12-1-2002.

MARK SPARACINO, EXAMINING ATTORNEY

SN 78-469,213. EXPOSERVE MANAGEMENT CORPORATION, TULSA, OK. FILED 8-18-2004.

EXPOSERVE

THE MARK CONSISTS OF STANDARD CHARACTERS WITHOUT CLAIM TO ANY PARTICULAR FONT, STYLE, SIZE, OR COLOR.

FOR BUSINESS MANAGEMENT SUPERVISION AND BUSINESS ADMINISTRATION CONSULTANCY FOR CATERING SERVICE PROVIDERS AND FOOD AND BEVERAGE SERVICE PROVIDERS (U.S. CLS. 100, 101 AND 102).

FIRST USE 1-27-2004; IN COMMERCE 3-18-2004.

MICHAEL TANNER, EXAMINING ATTORNEY

CLASS 35—(Continued).

SN 78-469,992. AMEN, SISTER!, LLC, ATLANTA, GA. FILED 8-19-2004.

CLASS 35—(Continued).

SN 78-471,256. DEUTSCHE TELEKOM AG, BONN, FED REP GERMANY, FILED 8-20-2004.

Touched by the Hand of God

THE MARK CONSISTS OF STANDARD CHARACTERS WITHOUT CLAIM TO ANY PARTICULAR FONT, STYLE, SIZE, OR COLOR.

FOR PROVIDING CONSUMER INFORMATION IN THE FIELD OF SPIRITUALITY (U.S. CLS. 100, 101 AND 102).

FIRST USE 1-22-2004; IN COMMERCE 1-22-2004.
JIM RINGLE, EXAMINING ATTORNEY



SN 78-470,713. SPEECE, MARK E., ATLANTA, GA. FILED 8-20-2004.

800 Degrees

THE MARK CONSISTS OF STANDARD CHARACTERS WITHOUT CLAIM TO ANY PARTICULAR FONT, STYLE, SIZE, OR COLOR.

FOR BRANDING SERVICES, NAMELY, CREATING BRAND IDENTITY FOR CORPORATIONS AND NON-PROFIT ORGANIZATIONS, CREATING BRAND STRATEGIES, AND CREATING PRODUCT AND CORPORATE TRADEMARKS (U.S. CLS. 100, 101 AND 102).

FIRST USE 12-2-2003; IN COMMERCE 1-3-2004.
SUE LAWRENCE, EXAMINING ATTORNEY

OWNER OF FED REP GERMANY REG. NO. 30360238, DATED 1-9-2004, EXPIRES 11-30-2013.

OWNER OF U.S. REG. NOS. 2,712,615, 2,833,572 AND OTHERS.

THE COLOR(S) MAGENTA AND GREY IS/ARE CLAIMED AS A FEATURE OF THE MARK.

THE COLOR MAGENTA APPEARS IN THE LETTER "T" AND THE BACKGROUND OF THE MARK; THE WORD "SYSTEMS" AND THE INTERIOR STYLIZATION OF THE MARK APPEARS IN THE COLOR GREY.

FOR TELEPHONE DIRECTORY ASSISTANCE SERVICES; ADVERTISING SERVICES, NAMELY, PREPARING AND PLACING ADVERTISEMENTS FOR OTHERS PROMOTING THE GOODS AND SERVICES OF OTHERS THROUGH PRINTED ADVERTISING, PRINTED DIRECTORIES, THROUGH ENCODED MEDIA, THROUGH THE DISSEMINATION OF PROMOTIONAL MATERIALS, THROUGH DIRECT MAIL ADVERTISING, THROUGH ELECTRONIC BILLBOARD ADVERTISING, PREPARING AUDIO-VISUAL PRESENTATIONS FOR USE IN ADVERTISING; BUSINESS MANAGEMENT SERVICES, NAMELY, BUSINESS APPRAISALS, BUSINESS AUDITING, PROVIDING BUSINESS INFORMATION, NAMELY, PREPARING BUSINESS REPORTS AND CONDUCTING BUSINESS RESEARCH, ANALYSIS AND SURVEYS, BUSINESS MANAGEMENT PLANNING, BUSINESS MANAGEMENT CONSULTATION, BUSINESS MANAGEMENT SUPERVISION, CONDUCTING BUSINESS NETWORKING FOR OTHERS; BUSINESS MANAGEMENT AND CONSULTING SERVICES, EXCLUDING AGRICULTURAL BUSINESS MANAGEMENT AND CONSULTING SERVICES; PROVIDING INFORMATION VIA THE TELEPHONE AND THE GLOBAL COMMUNICATION NETWORKS IN THE FIELD OF ADVERTISING AND BUSINESS MARKETING; PROFESSIONAL CONSULTANCY IN THE FIELD OF DATA PROCESSING (U.S. CLS. 100, 101 AND 102).

SKYE YOUNG, EXAMINING ATTORNEY

CLASS 35—(Continued).

SN 78-472,098. NORTHERN TOOL & EQUIPMENT COMPANY, INC. BURNSVILLE, MN. FILED 8-23-2004.



NO CLAIM IS MADE TO THE EXCLUSIVE RIGHT TO USE "TOOL & EQUIPMENT", APART FROM THE MARK AS SHOWN.

FOR RETAIL STORE SERVICES, ON-LINE RETAIL SERVICES, MAIL ORDER CATALOG SERVICES AND TELEPHONE SHOP AT HOME SERVICES, ALL FEATURING HAND TOOLS; ELECTRIC POWER TOOLS; AIR-POWERED TOOLS; MACHINERY; HYDRAULIC PUMPS AND PARTS AND ACCESSORIES THEREFOR; HYDRAULIC PRESSES AND PARTS AND ACCESSORIES THEREFOR; GAS ENGINES AND GENERATORS AND PARTS AND ACCESSORIES THEREFOR; DIESEL ENGINES AND GENERATORS AND PARTS AND ACCESSORIES THEREFOR; ELECTRIC MOTORS AND PARTS AND ACCESSORIES THEREFOR; AIR COMPRESSORS AND PARTS AND ACCESSORIES THEREFOR; INVERTERS; WIND TURBINES; LOG SPLITTERS, LOG WEDGES AND PARTS AND ACCESSORIES THEREFOR; LOGGING EQUIPMENT AND PARTS AND ACCESSORIES THEREFOR; AGRICULTURAL AND LANDSCAPE EQUIPMENT AND PARTS AND ACCESSORIES THEREFOR; CONSTRUCTION EQUIPMENT AND PARTS AND ACCESSORIES THEREFOR; SKID-STEER LOADERS AND PARTS AND ACCESSORIES THEREFOR; FORKLIFTS AND PARTS AND ACCESSORIES THEREFOR; ELECTRICAL EQUIPMENT AND PARTS AND ACCESSORIES THEREFOR; SOLAR LIGHTS AND PANELS; MATERIAL HANDLING EQUIPMENT AND PRODUCTS AND PARTS AND ACCESSORIES THEREFOR; FUEL TRANSFER EQUIPMENT AND PARTS AND ACCESSORIES THEREFOR; LUBRICATION EQUIPMENT AND PARTS AND ACCESSORIES THEREFOR; KEROSENE, PROPANE AND ELECTRIC HEATERS; CHAINSAWS; PET AND PEST CONTROL PRODUCTS; LAWN AND GARDEN PRODUCTS; WORK CLOTHING; GLOVES; TARPAULINS; GARAGES, CANOPIES, SHELTERS AND SHEDS; AIR COMPRESSORS, PARTS AND ACCESSORIES; PARTS WASHERS; SAND-BLASTING TOOLS AND ACCESSORIES; WELDERS AND WELDING PARTS AND ACCESSORIES THEREFOR; INDUSTRIAL, COMMERCIAL AND INDUSTRIAL LIGHTING PRODUCTS; METAL FABRICATION EQUIPMENT AND PARTS AND ACCESSORIES THEREFOR; PAINTING PRODUCTS; PROPANE PRODUCTS; OUTDOOR, CAMPING, HUNTING AND RECREATIONAL PRODUCTS AND CLOTHING PRODUCTS THEREFOR; TWO-WAY RADIOS; GO-KARTS AND PARTS AND ACCESSORIES THEREFOR; ALL TERRAIN VEHICLE AND RECREATIONAL VEHICLE PRODUCTS, PARTS AND ACCESSORIES THEREFOR; AUTOMOTIVE PRODUCTS, PARTS AND ACCESSORIES THEREFOR; WATER PUMPS AND PARTS AND ACCESSORIES THEREFOR; PRESSURE WASHERS, AND PARTS AND ACCESSORIES THEREFOR; TIRES, MAINTENANCE AND TESTING EQUIPMENT; TRAILERS, AND PARTS AND ACCESSORIES THEREFOR; FOOD PROCESSING EQUIPMENT AND PARTS AND ACCESSORIES THEREFOR; TOWING ACCESSORIES; CLEANING SUPPLIES; MOTOR OIL; STORAGE PRODUCTS; DUFFEL BAGS, UTILITY BAGS AND TOOL AND EQUIPMENT HOLDERS AND HOLSTERS; GAUGES; WINCHES; VEHICLE LIFTS; CASTERS; STRAPS, TIE-DOWNS AND TOW STRAPS (U.S. CLS. 100, 101 AND 102).

JUDITH HELFMAN, EXAMINING ATTORNEY

CLASS 35—(Continued).

SN 78-472,560. BURCH ASSOCIATES, INC, LOUISVILLE, KY. FILED 8-24-2004.

Building Briefs

THE MARK CONSISTS OF STANDARD CHARACTERS WITHOUT CLAIM TO ANY PARTICULAR FONT, STYLE, SIZE, OR COLOR.

FOR ADVERTISING SERVICES, BUSINESS MANAGEMENT, BUSINESS ADMINISTRATION, AND PROVIDING OFFICE FUNCTIONS (U.S. CLS. 100, 101 AND 102).

FIRST USE 0-0-1981; IN COMMERCE 0-0-1981.

WARREN L. OLANDRIA, EXAMINING ATTORNEY

SN 78-473,356. ERHCO, INC., MILWAUKIE, OR. FILED 8-25-2004.

SHOE MILL

THE MARK CONSISTS OF STANDARD CHARACTERS WITHOUT CLAIM TO ANY PARTICULAR FONT, STYLE, SIZE, OR COLOR.

NO CLAIM IS MADE TO THE EXCLUSIVE RIGHT TO USE "SHOE", APART FROM THE MARK AS SHOWN.

FOR RETAIL STORE SERVICES FEATURING FOOTWEAR AND RELATED ACCESSORIES (U.S. CLS. 100, 101 AND 102).

FIRST USE 9-1-1997; IN COMMERCE 12-1-1997.

KIMBERLY FRYE, EXAMINING ATTORNEY

CLASS 35—(Continued).

SN 78-473,393. AWEBER SYSTEMS, INC., NEWTOWN, PA. FILED 8-25-2004.

AWEBER

THE MARK CONSISTS OF STANDARD CHARACTERS WITHOUT CLAIM TO ANY PARTICULAR FONT, STYLE, SIZE, OR COLOR.

FOR ADVERTISING AND COMMERCIAL INFORMATION SERVICES, VIA THE INTERNET (U.S. CLS. 100, 101 AND 102).

FIRST USE 8-5-1998; IN COMMERCE 8-8-1998.
GWEN STOKOLS, EXAMINING ATTORNEY

CLASS 35—(Continued).

SN 78-473,580. FINANCIAL OPERATIONS NETWORKS LLC, ATLANTA, GA. FILED 8-25-2004.

**THE LOGISTICS
CHANNEL**

THE MARK CONSISTS OF STANDARD CHARACTERS WITHOUT CLAIM TO ANY PARTICULAR FONT, STYLE, SIZE, OR COLOR.

NO CLAIM IS MADE TO THE EXCLUSIVE RIGHT TO USE "LOGISTICS", APART FROM THE MARK AS SHOWN.

FOR INTERNET SUBSCRIPTION WEBSITE SERVICES FEATURING INFORMATION IN THE FIELD OF BUSINESS MANAGEMENT AND ORGANIZATION, ORDER FULFILLMENT SERVICES, AND TRANSPORTATION LOGISTICS MANAGEMENT, NAMELY, PLANNING AND SCHEDULING SHIPMENTS FOR USERS OF TRANSPORTATION SERVICES (U.S. CLS. 100, 101 AND 102).

GWEN STOKOLS, EXAMINING ATTORNEY

SN 78-473,463. ROYNETTE INC, MILFORD, CT. FILED 8-25-2004.

**Quality
Price
Service**  **Contractors Direct**

NO CLAIM IS MADE TO THE EXCLUSIVE RIGHT TO USE "QUALITY PRICE SERVICE"; "CONTRACTORS DIRECT" AND THE OUTLINE OF THE MAP OF UNITED STATES, APART FROM THE MARK AS SHOWN.

THE COLORS RED, WHITE AND BLUE ARE CLAIMED AS A FEATURE OF THE MARK.

THE COLOR RED APPEARS IN THE WORDING AND MAP OF THE UNITED STATES, AND THE COLORS BLUE AND WHITE APPEAR IN THE MAP OF THE UNITED STATES.

FOR WHOLESALE DISTRIBUTORSHIP, RETAIL STORE, AND MAIL ORDER FEATURING HAND AND POWER TOOLS FOR CONSTRUCTION INDUSTRY (U.S. CLS. 100, 101 AND 102).

FIRST USE 5-15-1995; IN COMMERCE 5-15-1995.
ROBERT LORENZO, EXAMINING ATTORNEY

SN 78-474,070. ENVIROTRON LIMITED, ROCKEFELLER STATION, NY. FILED 8-26-2004.

 **CHAINSTAR USA**

NO CLAIM IS MADE TO THE EXCLUSIVE RIGHT TO USE USA, APART FROM THE MARK AS SHOWN.

THE MARK CONSISTS OF CHAINSTAR USA AND STAR DESIGN.

FOR BUSINESS SERVICES, NAMELY, FACILITIES MANAGEMENT OF MAINTENANCE OPERATIONS (U.S. CLS. 100, 101 AND 102).

FIRST USE 6-15-2002; IN COMMERCE 6-15-2002.
MATTHEW PAPPAS, EXAMINING ATTORNEY

CLASS 35—(Continued).

SN 78-474,251. TASA GROUP, INC., THE, BLUE BELL, PA. FILED 8-26-2004.



OWNER OF U.S. REG. NOS. 1,168,797, 1,446,908 AND OTHERS.

NO CLAIM IS MADE TO THE EXCLUSIVE RIGHT TO USE "MED", APART FROM THE MARK AS SHOWN.

FOR COMPUTERIZED REFERRAL SERVICES PROVIDING TECHNICAL AND SCIENTIFIC EXPERT CONSULTANTS TO ATTORNEYS AND INSURANCE COMPANIES TO AID IN THE PREPARATION OF LEGAL CASES, AND TO BUSINESS, INDUSTRY AND GOVERNMENTAL AGENCIES FOR TECHNICAL AND SCIENTIFIC CONSULTATION IN THE MEDICAL FIELD (U.S. CLS. 100, 101 AND 102).

FIRST USE 5-0-2002; IN COMMERCE 5-0-2002.

RUDY R. SINGLETON, EXAMINING ATTORNEY

SN 78-474,408. S.A. CORP, CHANTILLY, VA. FILED 8-26-2004.



NO CLAIM IS MADE TO THE EXCLUSIVE RIGHT TO USE ".COM", APART FROM THE MARK AS SHOWN.

FOR RETAIL STORE SERVICES FEATURING VACUUM CLEANERS, VACUUM CLEANER BAGS, VACUUM CLEANER SUPPLIES, VACUUM CLEANER PARTS, AIR CLEANERS, AIR CLEANER FILTERS, SEWING MACHINES AND SEWING MACHINE SUPPLIES (U.S. CLS. 100, 101 AND 102).

FIRST USE 1-1-2002; IN COMMERCE 1-1-2002.

CHERYL CLAYTON, EXAMINING ATTORNEY

CLASS 35—(Continued).

SN 78-474,555. MURDICO, DAVID LAWRENCE, ESCONDI-DO, CA. FILED 8-27-2004.

THE SPOT TO BE SEEN

THE MARK CONSISTS OF STANDARD CHARACTERS WITHOUT CLAIM TO ANY PARTICULAR FONT, STYLE, SIZE, OR COLOR.

FOR PRODUCTION AND DISTRIBUTION OF RADIO, TELEVISION AND INTERNET COMMERCIALS; ADVERTISING, NAMELY, CREATING CORPORATE LOGOS, CREATING CORPORATE AND BRAND IDENTITY; PUBLIC RELATIONS; CONCEPTUAL CREATIVE CONSULTING, BUSINESS CONSULTING, BUSINESS MANAGEMENT CONSULTING; BUSINESS PLANNING; BUSINESS MARKETING CONSULTING; BUSINESS MERGERS AND ACQUISITIONS CONSULTATION; BUSINESS RESEARCH; PERSONNEL MANAGEMENT AND COMPENSATION CONSULTATION; CONSULTATION SERVICES FOR THE EVALUATION AND MANAGEMENT OF EMPLOYEES; HUMAN RESOURCES CONSULTATION; PSYCHOLOGICAL TESTING FOR THE SELECTION OF PERSONNEL; CREATIVE BUSINESS CONSULTING, NAMELY, ENSURING CLIENTS HAVE A MESSAGE CONSISTENT WITH THEIR BUSINESS PLAN (U.S. CLS. 100, 101 AND 102).

FIRST USE 8-1-2004; IN COMMERCE 8-1-2004.

JENNIFER KRISP, EXAMINING ATTORNEY

SN 78-475,149. INTELLI-SOURCE LLC, DBA HIRESUITE.-COM, HOUSTON, TX. FILED 8-27-2004.

HireSuite

THE MARK CONSISTS OF STANDARD CHARACTERS WITHOUT CLAIM TO ANY PARTICULAR FONT, STYLE, SIZE, OR COLOR.

FOR BUSINESS PROCESS OUTSOURCING IN THE FIELD OF HUMAN RESOURCES, SERVING AS A HUMAN RESOURCES DEPARTMENT FOR OTHERS (U.S. CLS. 100, 101 AND 102).

FIRST USE 5-1-2003; IN COMMERCE 5-1-2003.

MIDGE BUTLER, EXAMINING ATTORNEY

CLASS 35—(Continued).

SN 78-475,669. WHERE THE LOCALS GO, INC, MERRITT ISLAND, FL. FILED 8-30-2004.

CLASS 35—(Continued).

SN 78-476,943. BESTMARK, INC., MINNETONKA, MN. FILED 9-1-2004.

**WHERE THE LOCALS
GO**

**DELIGHT MANAGEMENT
SYSTEMS**

THE MARK CONSISTS OF STANDARD CHARACTERS WITHOUT CLAIM TO ANY PARTICULAR FONT, STYLE, SIZE, OR COLOR.

FOR DIRECT MARKETING SERVICES FOR SERVICES INDUSTRIES AND LOCAL BUSINESSES FEATURING THE DISTRIBUTION OF COUPONS OVER THE INTERNET AND DIRECT MARKETING ADVERTISING (U.S. CLS. 100, 101 AND 102).

FIRST USE 2-1-2003; IN COMMERCE 2-1-2003.
DANIEL BRODY, EXAMINING ATTORNEY

THE MARK CONSISTS OF STANDARD CHARACTERS WITHOUT CLAIM TO ANY PARTICULAR FONT, STYLE, SIZE, OR COLOR.

NO CLAIM IS MADE TO THE EXCLUSIVE RIGHT TO USE "MARKETING SYSTEMS", APART FROM THE MARK AS SHOWN.

FOR MARKET RESEARCH SERVICES (U.S. CLS. 100, 101 AND 102).

FIRST USE 7-0-2004; IN COMMERCE 7-0-2004.
GEORGIA CARTY, EXAMINING ATTORNEY

SN 78-476,938. ALLPOINTS RESEARCH, INC., WINSTON-SALEM, NC. FILED 9-1-2004.

SN 78-476,976. ESI INTERNATIONAL, ARLINGTON, VA. FILED 9-1-2004.

**360° Discovery
Process**

PMESSENTIALS

THE MARK CONSISTS OF STANDARD CHARACTERS WITHOUT CLAIM TO ANY PARTICULAR FONT, STYLE, SIZE, OR COLOR.

NO CLAIM IS MADE TO THE EXCLUSIVE RIGHT TO USE "PROCESS", APART FROM THE MARK AS SHOWN.

FOR MARKET RESEARCH SERVICES IN THE FORM OF A STRUCTURED PROCESS TO COLLECT AND ANALYZE DATA IN THE AREAS OF PRODUCT PRICING, PRODUCT STRENGTHS AND WEAKNESSES, CUSTOMER SATISFACTION AND COMPETITIVE POSITIONING (U.S. CLS. 100, 101 AND 102).

FIRST USE 7-21-2004; IN COMMERCE 7-21-2004.
ROBERT C. CLARK JR., EXAMINING ATTORNEY

THE MARK CONSISTS OF STANDARD CHARACTERS WITHOUT CLAIM TO ANY PARTICULAR FONT, STYLE, SIZE, OR COLOR.

OWNER OF U.S. REG. NOS. 2,356,080 AND 2,459,429.

FOR PROVIDING AN ONLINE, SEARCHABLE BUSINESS INFORMATION DATABASE OF INFORMATION, REPORTS, RESOURCES, TRAINING TOOLS, GLOSSARY OF PROJECT MANAGEMENT TERMS, AND SIMULATED WEB SITES, ALL IN THE FIELD OF BUSINESS PROJECT MANAGEMENT (U.S. CLS. 100, 101 AND 102).

FIRST USE 5-1-2004; IN COMMERCE 5-1-2004.
ANNE E. GUSTASON, EXAMINING ATTORNEY

CLASS 35—(Continued).

SN 78-478,450. ESPN, INC., BRISTOL, CT. FILED 9-3-2004.

ESPN SHOP

THE MARK CONSISTS OF STANDARD CHARACTERS WITHOUT CLAIM TO ANY PARTICULAR FONT, STYLE, SIZE, OR COLOR.

OWNER OF U.S. REG. NOS. 1,437,972, 2,393,477 AND OTHERS.

NO CLAIM IS MADE TO THE EXCLUSIVE RIGHT TO USE "SHOP", APART FROM THE MARK AS SHOWN.

FOR AUCTIONEERING; AUTOMATED AND COMPUTERIZED TRADING OF GOODS AND SERVICES FOR OTHERS PROVIDED OVER A GLOBAL COMMUNICATION INFORMATION NETWORK; ONLINE RETAIL STORE SERVICES FEATURING SPORTING GOODS AND EQUIPMENT, CLOTHING, JEWELRY, VIDEO GAMES, CDS, VIDEOTAPES, DVDS, ELECTRONICS, BOOKS, MUSIC, CALENDARS, MUGS, DISHES AND GLASSWARE, HOME DECOR, LAWN AND GARDEN SUPPLIES, TOYS AND GAMES, FOOD AND SNACKS (U.S. CLS. 100, 101 AND 102).

LANA PHAM, EXAMINING ATTORNEY

CLASS 35—(Continued).

SN 78-478,598. GOLDENBERG ROSENTHAL, LLP, JENKINTOWN, PA. FILED 9-3-2004.

**Perfect Fit.
Perfect Focus.**

THE MARK CONSISTS OF STANDARD CHARACTERS WITHOUT CLAIM TO ANY PARTICULAR FONT, STYLE, SIZE, OR COLOR.

FOR ACCOUNTING SERVICES (U.S. CLS. 100, 101 AND 102).

FIRST USE 1-1-2003; IN COMMERCE 1-1-2003.

NORA BUCHANAN WILL, EXAMINING ATTORNEY

SN 78-478,618. RALPH, WILLIAM J., APPLETON, WI. FILED 9-3-2004.



NO CLAIM IS MADE TO THE EXCLUSIVE RIGHT TO USE "THE COMMUNITY PAGE.COM", APART FROM THE MARK AS SHOWN.

THE COLOR(S) BLUE, YELLOW, RED, ORANGE, GREEN, BLACK AND WHITE IS/ARE CLAIMED AS A FEATURE OF THE MARK.

THE MARK CONSISTS FOUR CARTOON-LIKE SKYSCRAPERS AS FOLLOWS— A BLUE SKYSCRAPER ON THE LEFT WITH A YELLOW SKYSCRAPER TO THE RIGHT OF IT, A RED SKYSCRAPER TO THE RIGHT OF THE YELLOW SKYSCRAPER AND AN ORANGE SKYSCRAPER TO THE RIGHT OF THE RED SKYSCRAPER. THE WINDOWS IN ALL EACH OF THE SKYSCRAPERS ARE LIGHT BLUE WITH A BLACK FRAME. THE SKYSCRAPERS ARE ENCIRCLED BY A BLACK BAND WITH WHITE LETTERS. THE LETTERS SPELL THE WORDS THE COMMUNITY PAGE.COM. THERE ARE TWO CARTOON-LIKE HOUSES IN FRONT OF THE SKYSCRAPERS, A GREEN HOUSE ON THE LEFT AND A BLUE HOUSE ON THE RIGHT. THE GREEN HOUSE HAS AN ORANGE DOOR AND THE BLUE HOUSE HAS A YELLOW DOOR. THERE IS AN ORANGE TRIANGLE OVER THE YELLOW DOOR. THE WINDOWS IN BOTH HOUSES ARE LIGHT BLUE. THERE ARE YELLOW CURTAINS IN THE WINDOW OF THE GREEN HOUSE. THERE IS A RED TRIANGLE OVER THE TOP WINDOW IN THE GREEN HOUSE.

FOR PROVIDING AN ONLINE COMMERCIAL INFORMATION DIRECTORY ON THE INTERNET ADVERTISING AND COMMERCIAL INFORMATION SERVICES, VIA THE INTERNET (U.S. CLS. 100, 101 AND 102).

FIRST USE 2-25-2002; IN COMMERCE 5-23-2002.

JAMES GRIFFIN, EXAMINING ATTORNEY

SN 78-478,547. RODMAN, DAVID C, CHICAGO, IL. FILED 9-3-2004.



THE COLOR(S) GREEN, ORANGE AND MAROON IS/ARE CLAIMED AS A FEATURE OF THE MARK.

THE MARK CONSISTS OF A GREEN AND ORANGE FROG SITTING ON A COMPUTER MOUSE, TO THE LEFT OF THE STYLIZED WORDS LINKDINK.COM, IN MAROON, UNDERLINED BY THE MOUSE CORD.

FOR BUSINESS ADVICE AND INFORMATION AND BUSINESS MANAGEMENT CONSULTATION SERVICES PROVIDED ONLINE VIA THE INTERNET (U.S. CLS. 100, 101 AND 102).

FIRST USE 3-13-2004; IN COMMERCE 3-13-2004.

ELISSA GARBER KON, EXAMINING ATTORNEY

CLASS 35—(Continued).

SN 78-478,657. BEVERLY HILLS MUTT CLUB, BEVERLY HILLS, CA. FILED 9-3-2004.



NO CLAIM IS MADE TO THE EXCLUSIVE RIGHT TO USE "THE BEVERLY HILLS MUTT CLUB", APART FROM THE MARK AS SHOWN.

THE COLOR(S) YELLOW, RED, AND BLACK IS/ARE CLAIMED AS A FEATURE OF THE MARK. THE YELLOW APPEARS IN THE LETTERING " THE BEVERLY HILLS MUTT CLUB", THE CROWN, THE BORDER OF THE CREST, THE DOG BONE IN THE CREST AND THE LETTERING ON THE DOG BONE "BHMC". THE RED COLOR APPEARS IN THE BACKGROUND OF THE CREST. THE COLOR BLACK OUTLINES THE CROWN.

THE YELLOW APPEARS IN THE LETTERING "THE BEVERLY HILLS MUTT CLUB", THE CROWN, THE BORDER OF THE CREST, THE DOG BONE IN THE CREST AND THE LETTERING ON THE DOG BONE "BHMC". THE RED COLOR APPEARS IN THE BACKGROUND OF THE CREST. THE COLOR BLACK OUTLINES THE CROWN.

FOR ON-LINE RETAIL STORE SERVICES FEATURING PET PRODUCTS (U.S. CLS. 100, 101 AND 102).

FIRST USE 7-1-2004; IN COMMERCE 7-1-2004.

MARIAM MAHMOUDI, EXAMINING ATTORNEY

SN 78-478,663. CONOCOPHILLIPS COMPANY, HOUSTON, TX. FILED 9-3-2004.

CONOCOPHILLIPS

THE MARK CONSISTS OF STANDARD CHARACTERS WITHOUT CLAIM TO ANY PARTICULAR FONT, STYLE, SIZE, OR COLOR.

OWNER OF U.S. REG. NOS. 2,830,752, 2,861,495 AND 2,872,701.

FOR ADMINISTRATION OF A DISCOUNT PROGRAM FOR ENABLING PARTICIPANTS TO OBTAIN DISCOUNTS ON GOODS AND SERVICES THROUGH USE OF A DISCOUNT MEMBERSHIP CARD; ADMINISTRATION OF A BONUS INCENTIVE PROGRAM FOR PARTICIPANTS TO OBTAIN DISCOUNTS OR FREE GOODS AND SERVICES THROUGH USE OF A CREDIT CARD, DEBIT CARD OR CASH CARD; BUSINESS CONSULTING SERVICES. (U.S. CLS. 100, 101 AND 102).

FLORENTINA BLANDU, EXAMINING ATTORNEY

CLASS 35—(Continued).

SN 78-478,670. CONOCOPHILLIPS COMPANY, HOUSTON, TX. FILED 9-3-2004.



OWNER OF U.S. REG. NOS. 2,830,752, 2,861,495 AND 2,872,701.

FOR ADMINISTRATION OF A DISCOUNT PROGRAM FOR ENABLING PARTICIPANTS TO OBTAIN DISCOUNTS ON GOODS AND SERVICES THROUGH USE OF A DISCOUNT MEMBERSHIP CARD; ADMINISTRATION OF A BONUS INCENTIVE PROGRAM FOR PARTICIPANTS TO OBTAIN DISCOUNTS OR FREE GOODS AND SERVICES THROUGH USE OF A CREDIT CARD, DEBIT CARD OR CASH CARD; BUSINESS CONSULTING SERVICES. (U.S. CLS. 100, 101 AND 102).

FLORENTINA BLANDU, EXAMINING ATTORNEY

SN 78-478,749. WORLDWIDE OUTDOOR SUPPLIES COMPANY, LLC, CHAMBERSBURG, PA. FILED 9-3-2004.

SIMPLY BACKYARDS

THE MARK CONSISTS OF STANDARD CHARACTERS WITHOUT CLAIM TO ANY PARTICULAR FONT, STYLE, SIZE, OR COLOR.

NO CLAIM IS MADE TO THE EXCLUSIVE RIGHT TO USE "BACKYARDS", APART FROM THE MARK AS SHOWN.

FOR MAIL ORDER AND ONLINE CATALOGUE SERVICES FEATURING OUTDOOR FURNITURE, BIRD FEEDERS, BIRD BATHS, YARD ORNAMENTS AND GARDENING TOOLS (U.S. CLS. 100, 101 AND 102).

FIRST USE 4-1-2005; IN COMMERCE 4-1-2005.

ERNEST SHOSHO, EXAMINING ATTORNEY

SN 78-479,671. EUREKA DISCOUNT FOODS, INC., EUREKA, MO. FILED 9-7-2004.

“Your Hometown Grocery Store”

THE MARK CONSISTS OF STANDARD CHARACTERS WITHOUT CLAIM TO ANY PARTICULAR FONT, STYLE, SIZE, OR COLOR.

NO CLAIM IS MADE TO THE EXCLUSIVE RIGHT TO USE "GROCERY STORE", APART FROM THE MARK AS SHOWN.

FOR RETAIL GROCERY STORE AND SUPERMARKET SERVICES (U.S. CLS. 100, 101 AND 102).

FIRST USE 5-0-1995; IN COMMERCE 5-0-1995.

DAHLIA GEORGE, EXAMINING ATTORNEY

CLASS 35—(Continued).

SN 78-479,779. OPFER MEDIA LLC, ELMHURST, IL. FILED 9-7-2004.

CLASS 35—(Continued).

SN 78-482,098. SWIFT, LINDA A., MEQUON, WI. FILED 9-11-2004.

Connect with your
audience.



THE MARK CONSISTS OF STANDARD CHARACTERS WITHOUT CLAIM TO ANY PARTICULAR FONT, STYLE, SIZE, OR COLOR.

FOR ADVERTISING SERVICES FOR OTHERS, NAMELY, PROVIDING ADVERTISING SPACE BY ELECTRONIC MEANS AND GLOBAL INFORMATION NETWORKS (U.S. CLS. 100, 101 AND 102).

FIRST USE 2-1-2004; IN COMMERCE 2-1-2004.
ANDREW RHIM, EXAMINING ATTORNEY

NO CLAIM IS MADE TO THE EXCLUSIVE RIGHT TO USE "TAX SERVICE", APART FROM THE MARK AS SHOWN.

THE COLOR(S) BLACK, RED, AND WHITE IS/ARE CLAIMED AS A FEATURE OF THE MARK.

THE MARK CONSISTS OF A SQUARE - .79 X.83, STAR IN THE UPPER LEFT-HAND CORNER, AND DOUBLE RED BORDER AROUND THE SQUARE.

FOR TAX PREPARATION SERVICES FOR INDIVIDUALS, SMALL BUSINESSES, AND NON-PROFITS (U.S. CLS. 100, 101 AND 102).

BRIAN NEVILLE, EXAMINING ATTORNEY

SN 78-479,928. PROFESSIONAL SYSTEMS CORPORATION, SOUTHFIELD, MI. FILED 9-8-2004.

SN 78-482,277. ADVANCED INTERNET TECHNOLOGIES, INC., FAYETTEVILLE, NC. FILED 9-13-2004.

MinutePay

GOVTIDE

THE MARK CONSISTS OF STANDARD CHARACTERS WITHOUT CLAIM TO ANY PARTICULAR FONT, STYLE, SIZE, OR COLOR.

FOR PAYROLL PREPARATION SERVICES (U.S. CLS. 100, 101 AND 102).

MARY ROSSMAN, EXAMINING ATTORNEY

THE MARK CONSISTS OF STANDARD CHARACTERS WITHOUT CLAIM TO ANY PARTICULAR FONT, STYLE, SIZE, OR COLOR.

FOR JOB AND PERSONNEL PLACEMENT AND RECRUITMENT NAMELY PROVIDING ON-LINE JOB VACANCY, PERSONNEL RECRUITMENT AND JOB SEARCH INFORMATION, PERSONNEL AVAILABILITY AND SKILLS MATCHING SERVICES, PERSONNEL CONTRACTING, SUB-CONTRACTING, AND RELATED ADVERTISING SOLICITATIONS, AND VENDOR-BUYER MATCHING SERVICES VIA A GLOBAL COMPUTER NETWORK (U.S. CLS. 100, 101 AND 102).

FIRST USE 4-23-2004; IN COMMERCE 4-23-2004.
JEFF DEFORD, EXAMINING ATTORNEY

CLASS 35—(Continued).

SN 78-483,007. DIAL-A-MATRESS OPERATING CORP., LONG ISLAND CITY, NY. FILED 9-14-2004.

CLASS 35—(Continued).

SN 78-483,185. KINNEY + KINSELLA, INC., NEW YORK, NY. FILED 9-14-2004.

1-800-SU-COLCHON

Kinney + Kinsella

THE MARK CONSISTS OF STANDARD CHARACTERS WITHOUT CLAIM TO ANY PARTICULAR FONT, STYLE, SIZE, OR COLOR.

OWNER OF U.S. REG. NOS. 1,589,453 AND 2,580,514. THE FOREIGN WORDING IN THE MARK TRANSLATES INTO ENGLISH AS YOUR MATTRESS.

FOR TELEPHONE SHOP-AT-HOME RETAIL SERVICES, ONLINE RETAIL STORE SERVICES AND RETAIL STORE SERVICES IN THE FIELD OF MATTRESSES, BEDS AND BEDDING (U.S. CLS. 100, 101 AND 102).

FIRST USE 1-7-2005; IN COMMERCE 1-7-2005.
ANDREA K. NADELMAN, EXAMINING ATTORNEY

THE MARK CONSISTS OF STANDARD CHARACTERS WITHOUT CLAIM TO ANY PARTICULAR FONT, STYLE, SIZE, OR COLOR.

THE NAME(S), PORTRAIT(S), AND/OR SIGNATURE(S) SHOWN IN THE MARK IDENTIFIES KINNEY AND KINSELLA, WHOSE CONSENT(S) TO REGISTER IS SUBMITTED.

FOR ADVERTISING SERVICES, NAMELY, CREATING CORPORATE AND BRAND IDENTITY FOR OTHERS, MARKETING CONSULTING, PUBLIC RELATIONS (U.S. CLS. 100, 101 AND 102).

FIRST USE 2-1-2001; IN COMMERCE 2-1-2001.
DOMINIC J. FERRAIUOLO, EXAMINING ATTORNEY

SN 78-483,182. KINNEY + KINSELLA, INC., NEW YORK, NY. FILED 9-14-2004.

SN 78-483,206. CUSTER OFFICE ENVIRONMENTS, INC., GRAND RAPIDS, MI. FILED 9-14-2004.



CUSTER

FOR ADVERTISING SERVICES, NAMELY, CREATING CORPORATE AND BRAND IDENTITY FOR OTHERS, MARKETING CONSULTING, PUBLIC RELATIONS (U.S. CLS. 100, 101 AND 102).

FIRST USE 2-1-2001; IN COMMERCE 2-1-2001.
DOMINIC J. FERRAIUOLO, EXAMINING ATTORNEY

THE MARK CONSISTS OF STANDARD CHARACTERS WITHOUT CLAIM TO ANY PARTICULAR FONT, STYLE, SIZE, OR COLOR.

FOR RETAIL STORE SERVICES FEATURING OFFICE FURNITURE (U.S. CLS. 100, 101 AND 102).

FIRST USE 3-17-1981; IN COMMERCE 3-17-1981.
DOMINIC J. FERRAIUOLO, EXAMINING ATTORNEY

CLASS 35—(Continued).

SN 78-483,251. POTOKEK, ELAINE S., CASTINE, ME. FILED 9-14-2004.

CLASS 35—(Continued).

SN 78-484,911. PASTI, DAVID N., ROCKVILLE, MD. FILED 9-16-2004.

**INTERLOQUI**

THE MARK CONSISTS OF STANDARD CHARACTERS WITHOUT CLAIM TO ANY PARTICULAR FONT, STYLE, SIZE, OR COLOR.

OWNER OF U.S. REG. NO. 1,339,442.

FOR BUSINESS CONSULTING SERVICES IN THE FIELDS OF BUSINESS ORGANIZATIONAL DESIGN, ORGANIZATIONAL LEARNING AND BEHAVIOR, HUMAN RESOURCE MANAGEMENT, INTERNATIONAL MARKETING AND COMMUNICATIONS AND PROMOTIONAL DEVELOPMENT (U.S. CLS. 100, 101 AND 102).

FIRST USE 5-14-1993; IN COMMERCE 5-14-1993.

DAVID H. STINE, EXAMINING ATTORNEY

NO CLAIM IS MADE TO THE EXCLUSIVE RIGHT TO USE "BASEBALL GROUP", APART FROM THE MARK AS SHOWN.

THE COLOR(S) GRAY AND RED IS/ARE CLAIMED AS A FEATURE OF THE MARK.

THE MARK CONSISTS OF THE COLOR GRAY FOR THE WORD "DIAKON" WITH THE LETTER "O" IN DIAKON BEING IN THE SHAPE OF A BASEBALL AND IN THE COLOR RED. THE WORDS "BASEBALL GROUP" ARE UNDER THE WORD DIAKON AND SLIGHTLY TO THE RIGHT IN PLACEMENT AND IN THE COLOR RED. THE COLORS, STYLIZED LETTERS, LAYOUT AND DESIGN OF THE MARK ARE CLAIMED AS A DISTINCTIVE FEATURE OF THE MARK.

THE FOREIGN WORDING IN THE MARK TRANSLATES INTO ENGLISH AS SERVICE FROM THE LATIN WORD DIAKON.

FOR MANAGEMENT OF PROFESSIONAL ATHLETES, SPECIFICALLY REPRESENTATION OF BASEBALL PLAYERS INCLUDING CONTRACT NEGOTIATIONS, ARRANGING FOR SPONSORSHIPS AND ENDORSEMENTS OF PLAYERS AND ASSISTANCE WITH PLAYER DEVELOPMENT (U.S. CLS. 100, 101 AND 102).

FIRST USE 12-12-2003; IN COMMERCE 12-20-2003.

SOPHIA S. KIM, EXAMINING ATTORNEY

SN 78-485,175. SUPERVALU INC., EDEN PRAIRIE, MN. FILED 9-17-2004.

SN 78-483,412. THE KROGER CO. OF MICHIGAN, LIVONIA, MI. FILED 9-14-2004.



OWNER OF U.S. REG. NOS. 434,669, 813,182 AND OTHERS.

SEC. 2(F).

FOR RETAIL GROCERY STORE AND PHARMACY SERVICES (U.S. CLS. 100, 101 AND 102).

FIRST USE 0-0-1883; IN COMMERCE 0-0-1883.

ANDREW RHIM, EXAMINING ATTORNEY

THE MARK CONSISTS OF STYLIZED LETTERS WITH A GASOLINE PUMP HANDLE DESIGN.

FOR RETAIL STORE SERVICES FEATURING GROCERIES AND GASOLINE; ADMINISTRATION OF A DISCOUNT PROGRAM FOR ENABLING PARTICIPANTS TO OBTAIN DISCOUNTS ON GOODS AND SERVICES THROUGH USE OF A DISCOUNT MEMBERSHIP CARD (U.S. CLS. 100, 101 AND 102).

FIRST USE 9-12-2004; IN COMMERCE 9-12-2004.

ROBERT LAVACHE, EXAMINING ATTORNEY

CLASS 35—(Continued).

SN 78-485,177. SUPERVALU INC., EDEN PRAIRIE, MN.
FILED 9-17-2004.

CLASS 35—(Continued).

SN 78-485,393. BABY GOES VINTAGE, MIDDLESEX, NJ.
FILED 9-17-2004.



BABY GOES VINTAGE

THE MARK CONSISTS OF STYLIZED LETTERS AND DESIGN OF A GASOLINE PUMP HANDLE.

FOR RETAIL STORE SERVICES FEATURING GROCERIES AND GASOLINE; ADMINISTRATION OF A DISCOUNT PROGRAM FOR ENABLING PARTICIPANTS TO OBTAIN DISCOUNTS ON GASOLINE (U.S. CLS. 100, 101 AND 102).

FIRST USE 9-12-2004; IN COMMERCE 9-12-2004.
RICHARD WHITE, EXAMINING ATTORNEY

THE MARK CONSISTS OF STANDARD CHARACTERS WITHOUT CLAIM TO ANY PARTICULAR FONT, STYLE, SIZE, OR COLOR.

NO CLAIM IS MADE TO THE EXCLUSIVE RIGHT TO USE "BABY" AND "VINTAGE", APART FROM THE MARK AS SHOWN.

FOR RETAIL STORE SERVICES FEATURING ANTIQUE AND VINTAGE ITEMS, NAMELY BABY AND CHILDREN'S TOYS, GAMES, BOOKS, DECOR, LIGHTING AND FURNITURE (U.S. CLS. 100, 101 AND 102).

FIRST USE 4-15-2003; IN COMMERCE 4-15-2003.
JIM RINGLE, EXAMINING ATTORNEY

SN 78-485,853. WOLMUTH, SCOTT, SANTA ROSA, CA.
FILED 9-18-2004.

SN 78-485,190. IVOCLAR VIVADENT, INC., AMHERST, NY.
FILED 9-17-2004.

COVER MODEL MANIA!

**PAR PER PLAY
TARGETED
ADVERTISING
DIRECTORY
ASSISTANCE**

THE MARK CONSISTS OF STANDARD CHARACTERS WITHOUT CLAIM TO ANY PARTICULAR FONT, STYLE, SIZE, OR COLOR.

NO CLAIM IS MADE TO THE EXCLUSIVE RIGHT TO USE "COVER MODEL", APART FROM THE MARK AS SHOWN.

FOR ARRANGING AND CONDUCTING A MODEL SEARCH CONTEST TO PROMOTE THE SALE OF PRODUCTS USED IN PRODUCING DENTAL RESTORATIONS (U.S. CLS. 100, 101 AND 102).

RICHARD WHITE, EXAMINING ATTORNEY

THE MARK CONSISTS OF STANDARD CHARACTERS WITHOUT CLAIM TO ANY PARTICULAR FONT, STYLE, SIZE, OR COLOR.

NO CLAIM IS MADE TO THE EXCLUSIVE RIGHT TO USE "TARGETED ADVERTISING DIRECTORY ASSISTANCE", APART FROM THE MARK AS SHOWN.

FOR TELEPHONE DIRECTORY ASSISTANCE SERVICES (U.S. CLS. 100, 101 AND 102).

ROBERT LAVACHE, EXAMINING ATTORNEY

CLASS 35—(Continued).

SN 78-486,323. THIS WON'T HURT, LLC, STAMFORD, CT. FILED 9-20-2004.

THIS WON'T HURT

THE MARK CONSISTS OF STANDARD CHARACTERS WITHOUT CLAIM TO ANY PARTICULAR FONT, STYLE, SIZE, OR COLOR.

FOR DIRECT MAIL ADVERTISING OF PERMANENT AND TEMPORARY EMPLOYMENT POSITIONS (U.S. CLS. 100, 101 AND 102).

FIRST USE 4-26-2004; IN COMMERCE 4-26-2004.
JULIE WATSON, EXAMINING ATTORNEY

SN 78-486,916. TALENDEX CORPORATION, LOS ANGELES, CA. FILED 9-21-2004.

Talendex

THE MARK CONSISTS OF STANDARD CHARACTERS WITHOUT CLAIM TO ANY PARTICULAR FONT, STYLE, SIZE, OR COLOR.

FOR GENERAL HUMAN RESOURCE CONSULTING SERVICES THAT TARGET THE VALUATION OF A COMPANY'S HUMAN CAPITAL BASED UPON ITS CORRESPONDING BUSINESS AND MANAGEMENT PRACTICES (U.S. CLS. 100, 101 AND 102).

FIRST USE 3-31-2003; IN COMMERCE 6-14-2004.
HOWARD FRIEDMAN, EXAMINING ATTORNEY

CLASS 35—(Continued).

SN 78-487,450. BAG 'N SAVE, INC., OMAHA, NE. FILED 9-22-2004.

BAG 'N SAVE

THE MARK CONSISTS OF STANDARD CHARACTERS WITHOUT CLAIM TO ANY PARTICULAR FONT, STYLE, SIZE, OR COLOR.

FOR RETAIL GROCERY STORE SERVICES (U.S. CLS. 100, 101 AND 102).

FIRST USE 6-7-1981; IN COMMERCE 7-27-1982.
RENEE MCCRAY, EXAMINING ATTORNEY

SN 78-487,528. GLOBAL PARTNER MANAGEMENT, LLC, EARTH CITY, MO. FILED 9-22-2004.

s ä v v i
F O R M A L W E A R

NO CLAIM IS MADE TO THE EXCLUSIVE RIGHT TO USE "FORMALWEAR", APART FROM THE MARK AS SHOWN.

THE MARK CONSISTS OF THE WORD SAVVI WITH DOTS ABOVE EACH LETTER AND THE WORD FORMALWEAR IN SMALLER FONT BELOW THE WORD SAVVI.

FOR RETAIL STORE SERVICES FEATURING TUXEDOS, BRIDAL AND FORMALWEAR AND RELATED ACCESSORIES (U.S. CLS. 100, 101 AND 102).

FIRST USE 5-1-2004; IN COMMERCE 5-1-2004.
GIANCARLO CASTRO, EXAMINING ATTORNEY

SN 78-487,618. MCGEEVER, LLC, PAINESVILLE, OH. FILED 9-22-2004.

**Sales
Force4Hire**
A McGeever
Company

NO CLAIM IS MADE TO THE EXCLUSIVE RIGHT TO USE "SALES FORCE 4 HIRE" AND "COMPANY", APART FROM THE MARK AS SHOWN.

THE MARK CONSISTS OF WORDS ARE IN A FANCIFUL FONT WITH THE "O" IN THE WORD "FORCE" APPEARING AS CROSSHAIRS ON A TARGET.

FOR PROFESSIONAL SALESPERSON SERVICES, NAMELY, PROVIDING QUALITY SALES PROFESSIONALS TO INDUSTRY ON A CONTRACT BASIS (U.S. CLS. 100, 101 AND 102).

FIRST USE 7-1-2004; IN COMMERCE 7-1-2004.
RENEE MCCRAY, EXAMINING ATTORNEY

CLASS 35—(Continued).

SN 78-487,783. TRS QUALITY, INC., FORT WORTH, TX. FILED 9-22-2004.

STOREONE

THE MARK CONSISTS OF STANDARD CHARACTERS WITHOUT CLAIM TO ANY PARTICULAR FONT, STYLE, SIZE, OR COLOR.

FOR FLAGSHIP RETAIL STORE WITH SERVICES IN THE FIELD OF CONSUMER ELECTRONICS (U.S. CLS. 100, 101 AND 102).

MICHELLE S. WISEMAN, EXAMINING ATTORNEY

SN 78-488,432. OAKLEY, INC., FOOTHILL RANCH, CA. FILED 9-23-2004.

SUNGLASS CLUB

NO CLAIM IS MADE TO THE EXCLUSIVE RIGHT TO USE "SUNGLASS CLUB", APART FROM THE MARK AS SHOWN.

FOR RETAIL STORE AND ONLINE RETAIL STORE SERVICES FEATURING EYEWEAR, REPLACEMENT LENSES, EYEWEAR NOSE PIECES, APPAREL, BACK PACKS AND STICKERS (U.S. CLS. 100, 101 AND 102).

FIRST USE 5-8-2004; IN COMMERCE 5-8-2004.
ALLISON SCHRODY, EXAMINING ATTORNEY

SN 78-488,444. E4MATION, MORRISVILLE, NC. FILED 9-23-2004.

4mation

FOR DATA PROCESSING SERVICES, NAMELY, CREATION AND COLLATION OF MEANINGFUL FORM DATA FOR INDIVIDUALS AND CORPORATIONS. (U.S. CLS. 100, 101 AND 102).

BRENDAN MCCAULEY, EXAMINING ATTORNEY

CLASS 35—(Continued).

SN 78-489,415. POINTS OF LIGHT FOUNDATION, WASHINGTON, DC. FILED 9-24-2004.

**POINTS OF LIGHT
FOUNDATION &
VOLUNTEER CENTER
NATIONAL
NETWORK**

THE MARK CONSISTS OF STANDARD CHARACTERS WITHOUT CLAIM TO ANY PARTICULAR FONT, STYLE, SIZE, OR COLOR.

OWNER OF U.S. REG. NO. 1,827,820.

NO CLAIM IS MADE TO THE EXCLUSIVE RIGHT TO USE "FOUNDATION & VOLUNTEER CENTER NATIONAL NETWORK", APART FROM THE MARK AS SHOWN.

FOR PROMOTING PUBLIC AWARENESS OF THE NEED FOR CITIZENS TO VOLUNTEER FOR COMMUNITY SERVICES; AND ORGANIZING VOLUNTEERS FOR COMMUNITY SERVICE (U.S. CLS. 100, 101 AND 102).

FIRST USE 12-31-2000; IN COMMERCE 12-31-2000.
MELISSA SHELLA, EXAMINING ATTORNEY

SN 78-489,701. DELLUNA LLC, PORT WASHINGTON, WI. FILED 9-26-2004.



NO CLAIM IS MADE TO THE EXCLUSIVE RIGHT TO USE "POKER", APART FROM THE MARK AS SHOWN.

THE COLOR(S) GREEN, YELLOW, BLUE, WHITE AND BLACK IS/ARE CLAIMED AS A FEATURE OF THE MARK.

THE MARK CONSISTS OF A YELLOW AND GREEN ALLIGATOR PLACED ABOVE THE WORD "POKERGURUS". THE WORD "POKERGURUS" IS YELLOW. "POKERGURUS" AND THE ALLIGATOR ARE PLACED IN FRONT OF A BLUE RECTANGLE. THE BLUE RECTANGLE IS IN FRONT OF A GREEN CIRCLE WITH A BLACK BORDER. THE BLUE RECTANGLE OBSTRUCTS THE LOWER PORTION OF THE GREEN CIRCLE FROM VIEW. THE ALLIGATOR OBSTRUCTS THE TOP CORNER OF THE RECTANGLE FROM VIEW. THE CHARACTERS ".COM" APPEARS IN WHITE BELOW THE WORD "POKERGURUS", AND IN FRONT OF THE BLUE RECTANGLE.

FOR ONLINE ORDERING SERVICES IN THE FIELD OF BOOKS (U.S. CLS. 100, 101 AND 102).

FIRST USE 8-4-2003; IN COMMERCE 2-3-2004.
MARK SPACINO, EXAMINING ATTORNEY

CLASS 35—(Continued).

SN 78-489,859. NATIONAL ALLIANCE FOR YOUTH SPORTS, WEST PALM BEACH, FL. FILED 9-27-2004.



NO CLAIM IS MADE TO THE EXCLUSIVE RIGHT TO USE "NATIONAL YOUTH SPORTS COACHES ASSOCIATION", APART FROM THE MARK AS SHOWN, FOR ASSOCIATION SERVICES PROMOTING THE INTERESTS OF YOUTH SPORTS (U.S. CLS. 100, 101 AND 102).
 FIRST USE 12-16-1997; IN COMMERCE 12-21-1997.
 MICHAEL WEBSTER, EXAMINING ATTORNEY

CLASS 35—(Continued).

SN 78-489,883. NATIONAL ALLIANCE FOR YOUTH SPORTS, WEST PALM BEACH, FL. FILED 9-27-2004.



NO CLAIM IS MADE TO THE EXCLUSIVE RIGHT TO USE "NATIONAL YOUTH SPORTS ADMINISTRATORS ASSOCIATION", APART FROM THE MARK AS SHOWN, FOR ASSOCIATION SERVICES PROMOTING THE INTERESTS OF YOUTH SPORTS (U.S. CLS. 100, 101 AND 102).
 FIRST USE 11-18-1998; IN COMMERCE 11-21-1998.
 PAM WILLIS, EXAMINING ATTORNEY

SN 78-489,874. NATIONAL ALLIANCE FOR YOUTH SPORTS, WEST PALM BEACH, FL. FILED 9-27-2004.



NO CLAIM IS MADE TO THE EXCLUSIVE RIGHT TO USE "NATIONAL YOUTH SPORTS OFFICIALS ASSOCIATION", APART FROM THE MARK AS SHOWN, FOR ASSOCIATION SERVICES PROMOTING THE INTEREST OF YOUTH SPORTS (U.S. CLS. 100, 101 AND 102).
 FIRST USE 11-18-1997; IN COMMERCE 11-21-1997.
 MICHAEL WEBSTER, EXAMINING ATTORNEY

SN 78-489,988. MICHBIO, ANN ARBOR, MI. FILED 9-27-2004.

BioConnections

THE MARK CONSISTS OF STANDARD CHARACTERS WITHOUT CLAIM TO ANY PARTICULAR FONT, STYLE, SIZE, OR COLOR.
 FOR EMPLOYMENT HIRING, RECRUITING, PLACEMENT, STAFFING, AND CAREER NETWORKING SERVICES; EXECUTIVE SEARCH AND PLACEMENT SERVICES; INTERNSHIP SEARCH AND PLACEMENT SERVICES (U.S. CLS. 100, 101 AND 102).
 FIRST USE 10-24-2002; IN COMMERCE 10-24-2002.
 HENRY S. ZAK, EXAMINING ATTORNEY

CLASS 35—(Continued).

SN 78-490,019. GRANVILLE AREA CHAMBER OF COMMERCE, GRANVILLE, OH. FILED 9-27-2004.



NO CLAIM IS MADE TO THE EXCLUSIVE RIGHT TO USE "GRANVILLE OH", APART FROM THE MARK AS SHOWN.

FOR CHAMBER OF COMMERCE SERVICES, NAMELY, PROMOTING BUSINESS, TOURISM AND CIVIC INTERESTS IN GRANVILLE, OHIO (U.S. CLS. 100, 101 AND 102).

FIRST USE 10-31-2003; IN COMMERCE 10-31-2003.
TRICIA SONNEBORN, EXAMINING ATTORNEY

CLASS 35—(Continued).

SN 78-491,097. NUTRITION EXPRESS CORP., TORRANCE, CA. FILED 9-28-2004.

Nutrition Express

THE MARK CONSISTS OF STANDARD CHARACTERS WITHOUT CLAIM TO ANY PARTICULAR FONT, STYLE, SIZE, OR COLOR.

OWNER OF U.S. REG. NO. 2,116,354.

NO CLAIM IS MADE TO THE EXCLUSIVE RIGHT TO USE "NUTRITION", APART FROM THE MARK AS SHOWN.

FOR CATALOG SERVICES FEATURING GROCERY PRODUCTS, COSMETICS, BOOKS, CLOTHING, AND DIETARY AND NUTRITIONAL SUPPLEMENTS; COMPUTERIZED ON-LINE ORDERING AND RETAIL STORE SERVICES IN THE FIELDS OF GROCERY PRODUCTS, COSMETICS, BOOKS, CLOTHING, AND DIETARY AND NUTRITIONAL SUPPLEMENTS (U.S. CLS. 100, 101 AND 102).

FIRST USE 12-23-1985; IN COMMERCE 12-23-1985.
INGA ERVIN, EXAMINING ATTORNEY

SN 78-490,115. APOTHEPET, LLC, WASHINGTON, DC. FILED 9-27-2004.



FOR FULL-SERVICE PRESCRIPTION PHARMACY SERVICES FOR VETERINARIANS - NAMELY, PROVIDING PRESCRIPTION DRUGS AND REMEDIES TO VETERINARIANS AND VETERINARY CLINICS (U.S. CLS. 100, 101 AND 102).

FIRST USE 4-28-2004; IN COMMERCE 4-28-2004.
DAWN FELDMAN, EXAMINING ATTORNEY

SN 78-491,650. NICHE COMMERCE, INC., OMAHA, NE. FILED 9-29-2004.



NO CLAIM IS MADE TO THE EXCLUSIVE RIGHT TO USE "BAKERSRACKS.COM", APART FROM THE MARK AS SHOWN.

THE MARK CONSISTS OF A BAKERS RACK THEN THE LITERAL ELEMENT BAKERSRACKS.COM BESIDE THE RACK.

FOR ON-LINE RETAIL STORE SERVICES FEATURING BAKERS RACKS AND RELATED GOODS (U.S. CLS. 100, 101 AND 102).

FIRST USE 3-1-2004; IN COMMERCE 3-1-2004.
DANIEL BRODY, EXAMINING ATTORNEY

CLASS 35—(Continued).

SN 78-492,131. LIFESTYLE CUSTOM CYCLES, LLC, VILLA PARK, CA. FILED 9-30-2004.

LIFESTYLE CUSTOM CYCLES

THE MARK CONSISTS OF STANDARD CHARACTERS WITHOUT CLAIM TO ANY PARTICULAR FONT, STYLE, SIZE, OR COLOR.

NO CLAIM IS MADE TO THE EXCLUSIVE RIGHT TO USE "CUSTOM CYCLES", APART FROM THE MARK AS SHOWN.

FOR RETAIL STORE SERVICES FEATURING MOTORCYCLES, MOTORCYCLE PARTS, MOTORCYCLE ACCESSORIES, AND CLOTHING (U.S. CLS. 100, 101 AND 102).

FIRST USE 3-0-2000; IN COMMERCE 3-0-2000.
ANGELA M. MICHELI, EXAMINING ATTORNEY

CLASS 35—(Continued).

SN 78-492,468. DEUTSCHE TELEKOM AG, BONN, FED REP GERMANY, FILED 9-30-2004.

t-search

SN 78-492,185. PUBLIC HEALTH INSTITUTE, OAKLAND, CA. FILED 9-30-2004.



NO CLAIM IS MADE TO THE EXCLUSIVE RIGHT TO USE "CALIFORNIA" AND "LEADERS ENCOURAGING ACTIVITY AND NUTRITION", APART FROM THE MARK AS SHOWN.

THE COLOR(S) RED AND GREEN IS/ARE CLAIMED AS A FEATURE OF THE MARK.

THE MARK CONSISTS OF RED CUTLERY FLOWERS (KNIFE, FORK AND SPOON WITH LEAVES) INSIDE A RED BOX WITH A FADING GREEN BACKGROUND. THE WORD "CALIFORNIA" IN WHITE AT THE TOP. THE WORD "PROJECT" IN RED BELOW WITH THE WORD "LEAN" NEXT TO IT IN GREEN. THE WORDS "LEADERS ENCOURAGING" IN GREEN BELOW THAT. THE WORDS "ACTIVITY AND NUTRITION" ON THE LAST LINE BELOW THAT.

FOR DEVELOPING PROMOTIONAL CAMPAIGNS FOR BUSINESS, NAMELY, PROMOTING HEALTH EATING (U.S. CLS. 100, 101 AND 102).

FIRST USE 2-1-1992; IN COMMERCE 2-1-1992.
INGA ERVIN, EXAMINING ATTORNEY

THE MARK CONSISTS OF STANDARD CHARACTERS WITHOUT CLAIM TO ANY PARTICULAR FONT, STYLE, SIZE, OR COLOR.

OWNER OF FED REP GERMANY REG. NO. 30418464, DATED 5-10-2004, EXPIRES 4-30-2014.

OWNER OF U.S. REG. NOS. 2,910,801, 2,941,959 AND OTHERS.

FOR TELEPHONE DIRECTORY ASSISTANCE SERVICES; ADVERTISING SERVICES, NAMELY, PREPARING AND PLACING ADVERTISEMENTS FOR OTHERS PROMOTING THE GOODS AND SERVICES OF OTHERS THROUGH PRINTED ADVERTISING, PRINTED DIRECTORIES, THROUGH ENCODED MEDIA, THROUGH THE DISSEMINATION OF PROMOTIONAL MATERIALS, THROUGH DIRECT MAIL ADVERTISING, THROUGH ELECTRONIC BILLBOARD ADVERTISING, PREPARING AUDIO-VISUAL PRESENTATIONS FOR USE IN ADVERTISING; BUSINESS MANAGEMENT SERVICES, NAMELY, BUSINESS APPRAISALS, BUSINESS AUDITING, PROVIDING BUSINESS INFORMATION, NAMELY, PREPARING BUSINESS REPORTS AND CONDUCTING BUSINESS RESEARCH, ANALYSIS AND SURVEYS, BUSINESS MANAGEMENT PLANNING, BUSINESS MANAGEMENT CONSULTATION, BUSINESS MANAGEMENT SUPERVISION, CONDUCTING BUSINESS NETWORKING FOR OTHERS; BUSINESS MANAGEMENT AND CONSULTING SERVICES, EXCLUDING AGRICULTURAL BUSINESS MANAGEMENT AND CONSULTING SERVICES; PROVIDING INFORMATION VIA THE TELEPHONE AND THE GLOBAL COMMUNICATION NETWORKS IN THE FIELD OF ADVERTISING AND BUSINESS MARKETING; PROFESSIONAL CONSULTANCY IN THE FIELD OF DATA PROCESSING; RENTAL OF DATA PROCESSING EQUIPMENT (U.S. CLS. 100, 101 AND 102).

MICHAEL TANNER, EXAMINING ATTORNEY

CLASS 35—(Continued).

SN 78-492,535. KUJERATI, LLC, NEW YORK, NY. FILED 9-30-2004.



NO CLAIM IS MADE TO THE EXCLUSIVE RIGHT TO USE "LLC", APART FROM THE MARK AS SHOWN. THE COLOR(S) PURPLE, LAVENDER AND WHITE IS/ARE CLAIMED AS A FEATURE OF THE MARK.

THE MARK CONSISTS OF THE COLORS PURPLE, LAVENDER AND WHITE WHICH APPEAR IN THE DESIGN ELEMENT. THE TEXT APPEARS IN WHITE. THE MISCELLANEOUS LOWER OVAL SHAPED DESIGN ELEMENT APPEAR IN PURPLE AND THE UPPER MISCELLANEOUS OVAL SHAPED DESIGN ELEMENT APPEAR IN LAVENDER.

FOR ON-LINE RETAIL STORE SERVICES FEATURING SALON AND HOLISTIC SPA PRODUCTS SUCH AS SKIN CARE SHOWERHEAD, SKIN CLEANSER, MOISTURIZER, CONDITIONER, COLOGNE, PERFUME, SOAP, MASK, EXFOLIATOR, LIPOSOME, MOUSSE, BATH CRYSTALS, ESSENTIAL OILS, GEL, LOTION, POMADE, CREAM, SHAMPOO, CONDITIONER, FOUNDATION, POWDER, CONCEALER, BLUSH, EYESHADOW, LIPSTICK, LIP GLOSS, MASCARA, EYE AND LIP LINERS, COSMETIC BRUSHES, COSMETIC PENCIL SHARPENER, COSMETIC SPONGES AND BRUSH CLEANER, CDS AND DVDS FOR YOGA, CONTEMPLATION AND RELAXATION, WATER FILTERS AND FENG SHUI PRODUCTS; PROMOTING THE GOODS AND SERVICES OF SALONS SUCH AS HAIR CUTS, HAIR COLOR, HAIR STRAIGHTENING, HAIR TREATMENTS, PERMS, HIGHLIGHTS, HAIR EXTENSIONS AND LUXURY HAIR PRODUCTS; PROMOTING SPA SERVICES SUCH AS FACIAL TREATMENTS, BODY TREATMENTS, AYURVEDIC SKIN CARE, AROMATHERAPY, NATURAL MAKEUP APPLICATION AND BODYWORK (U.S. CLS. 100, 101 AND 102).

FIRST USE 6-10-2004; IN COMMERCE 6-10-2004.
INGRID C. EULIN, EXAMINING ATTORNEY

SN 78-492,760. TULLY, JAMES R., III, FRANKLIN, TN. FILED 9-30-2004.

SOUTHBOUND TRAINS

THE MARK CONSISTS OF STANDARD CHARACTERS WITHOUT CLAIM TO ANY PARTICULAR FONT, STYLE, SIZE, OR COLOR.

NO CLAIM IS MADE TO THE EXCLUSIVE RIGHT TO USE "TRAINS", APART FROM THE MARK AS SHOWN.

FOR RETAIL STORE SERVICES IN THE FIELD OF ELECTRIC TOY HOBBY TRAINS (U.S. CLS. 100, 101 AND 102).

FIRST USE 9-1-2004; IN COMMERCE 9-1-2004.
MICHAEL TANNER, EXAMINING ATTORNEY

CLASS 35—(Continued).

SN 78-492,821. BARKLEY ENTERPRISES, INC., ONEONTA, NY. FILED 10-1-2004.

PRIVATE DRAWERS

THE MARK CONSISTS OF STANDARD CHARACTERS WITHOUT CLAIM TO ANY PARTICULAR FONT, STYLE, SIZE, OR COLOR.

FOR RETAIL SHOPS FEATURING LINGERIE, PERFUME, PERSONAL CARE PRODUCTS, HOME FURNISHINGS, ANTIQUES AND ART; COMPUTERIZED ON-LINE RETAIL STORE SERVICES IN THE FIELD OF LINGERIE, PERFUME, PERSONAL CARE PRODUCTS, HOME FURNISHINGS, ANTIQUES AND ART (U.S. CLS. 100, 101 AND 102).

FIRST USE 5-1-2003; IN COMMERCE 8-10-2003.
TEJBIR SINGH, EXAMINING ATTORNEY

SN 78-493,061. BALANCED MANAGEMENT INCORPORATED, YORKTOWN, VA. FILED 10-1-2004.



Balanced Management

NO CLAIM IS MADE TO THE EXCLUSIVE RIGHT TO USE "BALANCED MANAGEMENT", APART FROM THE MARK AS SHOWN.

THE MARK CONSISTS OF A CIRCLE SITTING ON A TRIANGLE AND THE WORDS "BALANCED MANAGEMENT".

FOR BUSINESS MANAGEMENT CONSULTATION, NAMELY ORGANIZATIONAL DEVELOPMENT CONSULTING SERVICES (U.S. CLS. 100, 101 AND 102).

FIRST USE 9-22-1993; IN COMMERCE 9-22-1993.
JENNIFER KRISP, EXAMINING ATTORNEY

CLASS 35—(Continued).

SN 78-493,295. DEUTSCHE TELEKOM AG, BONN, FED REP GERMANY, FILED 10-1-2004.

T-Mobile Sound Alarm

THE MARK CONSISTS OF STANDARD CHARACTERS WITHOUT CLAIM TO ANY PARTICULAR FONT, STYLE, SIZE, OR COLOR.

PRIORITY CLAIMED UNDER SEC. 44(D) ON FED REP GERMANY APPLICATION NO. 30418517538, FILED 4-2-2004, REG. NO. 30418517, DATED 4-22-2004, EXPIRES 4-30-2014.

OWNER OF U.S. REG. NO. 2,282,432.

FOR TELEPHONE DIRECTORY ASSISTANCE SERVICES; ADVERTISING SERVICES, NAMELY, PREPARING AND PLACING ADVERTISEMENTS FOR OTHERS, PROMOTING THE GOODS AND SERVICES OF OTHERS THROUGH PRINTED ADVERTISING, PRINTED DIRECTORIES, THROUGH ENCODED MEDIA, THROUGH THE DISSEMINATION OF PROMOTIONAL MATERIALS, THROUGH DIRECT MAIL ADVERTISING, THROUGH ELECTRONIC BILLBOARD ADVERTISING, PREPARING AUDIO-VISUAL PRESENTATIONS FOR USE IN ADVERTISING; BUSINESS MANAGEMENT SERVICES, NAMELY, BUSINESS APPRAISALS, BUSINESS AUDITING, PROVIDING BUSINESS INFORMATION, NAMELY, PREPARING BUSINESS REPORTS AND CONDUCTING BUSINESS RESEARCH, ANALYSIS AND SURVEYS, BUSINESS MANAGEMENT PLANNING, BUSINESS MANAGEMENT CONSULTATION, BUSINESS MANAGEMENT SUPERVISION, CONDUCTING BUSINESS NETWORKING FOR OTHERS; BUSINESS MANAGEMENT AND CONSULTING SERVICES, EXCLUDING AGRICULTURAL BUSINESS MANAGEMENT AND CONSULTING SERVICES; PROVIDING INFORMATION VIA THE TELEPHONE AND THE GLOBAL COMMUNICATION NETWORKS IN THE FIELD OF ADVERTISING AND BUSINESS MARKETING; PROFESSIONAL CONSULTANCY IN THE FIELD OF DATA PROCESSING; RENTAL OF AUTOMATIC VENDING MACHINES; RENTAL OF DATA PROCESSING EQUIPMENT; ORGANIZING JOB FAIRS (U.S. CLS. 100, 101 AND 102).

FLORENTINA BLANDU, EXAMINING ATTORNEY

CLASS 35—(Continued).

SN 78-493,328. DEUTSCHE TELEKOM AG, BONN, FED REP GERMANY, FILED 10-1-2004.

T-Mobile multimedia experience

THE MARK CONSISTS OF STANDARD CHARACTERS WITHOUT CLAIM TO ANY PARTICULAR FONT, STYLE, SIZE, OR COLOR.

PRIORITY CLAIMED UNDER SEC. 44(D) ON FED REP GERMANY APPLICATION NO. 304185108/38, FILED 4-2-2004, REG. NO. 30418510, DATED 4-22-2004, EXPIRES 4-30-2014.

OWNER OF U.S. REG. NO. 2,282,432.

NO CLAIM IS MADE TO THE EXCLUSIVE RIGHT TO USE "MULTIMEDIA", APART FROM THE MARK AS SHOWN.

FOR TELEPHONE DIRECTORY ASSISTANCE SERVICES; ADVERTISING SERVICES, NAMELY, PREPARING AND PLACING ADVERTISEMENTS FOR OTHERS, PROMOTING THE GOODS AND SERVICES OF OTHERS THROUGH PRINTED ADVERTISING, PRINTED DIRECTORIES, THROUGH ENCODED MEDIA, THROUGH THE DISSEMINATION OF PROMOTIONAL MATERIALS, THROUGH DIRECT MAIL ADVERTISING, THROUGH ELECTRONIC BILLBOARD ADVERTISING, PREPARING AUDIO-VISUAL PRESENTATIONS FOR USE IN ADVERTISING; BUSINESS MANAGEMENT SERVICES, NAMELY, BUSINESS APPRAISALS, BUSINESS AUDITING, PROVIDING BUSINESS INFORMATION, NAMELY, PREPARING BUSINESS REPORTS AND CONDUCTING BUSINESS RESEARCH, ANALYSIS AND SURVEYS, BUSINESS MANAGEMENT PLANNING, BUSINESS MANAGEMENT CONSULTATION, BUSINESS MANAGEMENT SUPERVISION, CONDUCTING BUSINESS NETWORKING FOR OTHERS; BUSINESS MANAGEMENT AND CONSULTING SERVICES, EXCLUDING AGRICULTURAL BUSINESS MANAGEMENT AND CONSULTING SERVICES; PROVIDING INFORMATION VIA THE TELEPHONE AND THE GLOBAL COMMUNICATION NETWORKS IN THE FIELD OF ADVERTISING AND BUSINESS MARKETING; PROFESSIONAL CONSULTANCY IN THE FIELD OF DATA PROCESSING; RENTAL OF AUTOMATIC VENDING MACHINES; RENTAL OF DATA PROCESSING EQUIPMENT; ORGANIZING JOB FAIRS (U.S. CLS. 100, 101 AND 102).

FLORENTINA BLANDU, EXAMINING ATTORNEY

CLASS 35—(Continued).

SN 78-493,387. SUNLIGHT SAUNAS, INC., LENEXA, KS. FILED 10-1-2004.



FOR RETAIL STORE SERVICES AND ONLINE RETAIL STORE SERVICES, FEATURING BATH AND BEAUTY PRODUCTS, AROMATHERAPY PRODUCTS, SAUNAS, AND HEAT AND FAR INFRARED TREATMENT PADS (U.S. CLS. 100, 101 AND 102). FIRST USE 1-29-2004; IN COMMERCE 1-29-2004. MIDGE BUTLER, EXAMINING ATTORNEY

CLASS 35—(Continued).

SN 78-493,583. SHOEMAKER, ALVIN A., III, BETHLEHEM, PA. FILED 10-2-2004.

THE TWISTED TULIP

THE MARK CONSISTS OF STANDARD CHARACTERS WITHOUT CLAIM TO ANY PARTICULAR FONT, STYLE, SIZE, OR COLOR.

NO CLAIM IS MADE TO THE EXCLUSIVE RIGHT TO USE TULIP, APART FROM THE MARK AS SHOWN.

FOR RETAIL FLORAL AND GIFT SHOP SERVICES; ON-LINE RETAIL STORE SERVICES FEATURING PLANTS, FLOWERS AND GIFTS (U.S. CLS. 100, 101 AND 102).

FIRST USE 2-26-2001; IN COMMERCE 2-26-2001. NANCY CLARKE, EXAMINING ATTORNEY

SN 78-493,742. DORENE TAYLOR STUDIOS, LLC, HILLIARD, OH. FILED 10-4-2004.



NO CLAIM IS MADE TO THE EXCLUSIVE RIGHT TO USE "GROUP", APART FROM THE MARK AS SHOWN.

THE COLOR(S) ORANGE AND BLACK IS/ARE CLAIMED AS A FEATURE OF THE MARK.

THE MARK CONSISTS OF THREE SPHERES IN ORANGE, CONNECTED BY BLACK LINES. THE WORD "DIGITAL" IN BLACK, "FUSION" IN ORANGE, AND "GROUP" IN BLACK.

FOR BUSINESS MARKETING SERVICES (U.S. CLS. 100, 101 AND 102).

KEVIN DINALLO, EXAMINING ATTORNEY

SN 78-493,499. HENRY, MAXIME, ROMANS SUR ISERE, FRANCE, FILED 10-1-2004.

CHaINA

THE MARK CONSISTS OF STANDARD CHARACTERS WITHOUT CLAIM TO ANY PARTICULAR FONT, STYLE, SIZE, OR COLOR.

FOR BUSINESS CONSULTING AND BUSINESS INFORMATION SERVICES (U.S. CLS. 100, 101 AND 102).

G. MAYERSCHOFF, EXAMINING ATTORNEY

SN 78-493,796. S&S BRANDS, INC., WILMINGTON, DE. FILED 10-4-2004.



OWNER OF U.S. REG. NOS. 1,690,656, 2,278,312 AND OTHERS.

THE COLOR(S) RED, GREEN AND BLACK IS/ARE CLAIMED AS A FEATURE OF THE MARK.

THE COLOR RED APPEARS IN THE TOP CIRCLE, THE COLOR GREEN APPEARS IN THE BOTTOM CIRCLE, AND THE COLOR BLACK APPEARS IN THE WORDS STOP & SHOP.

FOR RETAIL SUPERMARKET SERVICES (U.S. CLS. 100, 101 AND 102).

FIRST USE 9-15-2002; IN COMMERCE 9-15-2002. MITCHELL FRONT, EXAMINING ATTORNEY

CLASS 35—(Continued).

SN 78-493,839. TWO LITTLE HANDS PRODUCTIONS, LLC,
SALT LAKE CITY, UT. FILED 10-4-2004.

CLASS 35—(Continued).

SN 78-494,005. DEUTSCHE TELEKOM AG, BONN, FED REP
GERMANY, FILED 10-4-2004.

T-Mobile
mms&messaging

SIGNING TIME

THE MARK CONSISTS OF STANDARD CHARACTERS WITHOUT CLAIM TO ANY PARTICULAR FONT, STYLE, SIZE, OR COLOR.

PRIORITY CLAIMED UNDER SEC. 44(D) ON FED REP GERMANY APPLICATION NO. 30418512438, FILED 4-2-2004, REG. NO. 30418512, DATED 4-22-2004, EXPIRES 4-22-2014.

OWNER OF U.S. REG. NO. 2,282,432.

NO CLAIM IS MADE TO THE EXCLUSIVE RIGHT TO USE "MMS&MESSAGING", APART FROM THE MARK AS SHOWN.

FOR TELEPHONE DIRECTORY ASSISTANCE SERVICES; ADVERTISING SERVICES, NAMELY, PREPARING AND PLACING ADVERTISEMENTS FOR OTHERS, PROMOTING THE GOODS AND SERVICES OF OTHERS THROUGH PRINTED ADVERTISING, PRINTED DIRECTORIES, THROUGH ENCODED MEDIA, THROUGH THE DISSEMINATION OF PROMOTIONAL MATERIALS, THROUGH DIRECT MAIL ADVERTISING, THROUGH ELECTRONIC BILLBOARD ADVERTISING, PREPARING AUDIO-VISUAL PRESENTATIONS FOR USE IN ADVERTISING; BUSINESS MANAGEMENT SERVICES, NAMELY, BUSINESS APPRAISALS, BUSINESS AUDITING, PROVIDING BUSINESS INFORMATION, NAMELY, PREPARING BUSINESS REPORTS AND CONDUCTING BUSINESS RESEARCH, ANALYSIS AND SURVEYS, BUSINESS MANAGEMENT PLANNING, BUSINESS MANAGEMENT CONSULTATION, BUSINESS MANAGEMENT SUPERVISION, CONDUCTING BUSINESS NETWORKING FOR OTHERS; BUSINESS MANAGEMENT AND CONSULTING SERVICES, EXCLUDING AGRICULTURAL BUSINESS MANAGEMENT AND CONSULTING SERVICES; PROVIDING INFORMATION VIA THE TELEPHONE AND THE GLOBAL COMMUNICATION NETWORKS IN THE FIELD OF ADVERTISING AND BUSINESS MARKETING; PROFESSIONAL CONSULTANCY IN THE FIELD OF DATA PROCESSING; RENTAL OF AUTOMATIC VENDING MACHINES; RENTAL OF DATA PROCESSING EQUIPMENT; ORGANIZING JOB FAIRS (U.S. CLS. 100, 101 AND 102).

FLORENTINA BLANDU, EXAMINING ATTORNEY

THE MARK CONSISTS OF STANDARD CHARACTERS WITHOUT CLAIM TO ANY PARTICULAR FONT, STYLE, SIZE, OR COLOR.

OWNER OF U.S. REG. NO. 2,796,102.

NO CLAIM IS MADE TO THE EXCLUSIVE RIGHT TO USE "SIGNING", APART FROM THE MARK AS SHOWN.

FOR ONLINE RETAIL STORE SERVICES FEATURING CD'S, BOOKS, DVD'S, VIDEOS, FLASH CARDS, ACTIVITY BOOKS, TOYS, AND CLOTHING (U.S. CLS. 100, 101 AND 102).

FIRST USE 4-10-2001; IN COMMERCE 4-10-2001.

KRISTINA KLOIBER, EXAMINING ATTORNEY

CLASS 35—(Continued).

SN 78-494,042. DEUTSCHE TELEKOM AG, BONN, FED REP GERMANY, FILED 10-4-2004.

CLASS 35—(Continued).

SN 78-494,116. DEUTSCHE TELEKOM AG, BONN, FED REP GERMANY, FILED 10-4-2004.

**T-Mobile
email&chat**

**T-Mobile
multimedia netcard**

THE MARK CONSISTS OF STANDARD CHARACTERS WITHOUT CLAIM TO ANY PARTICULAR FONT, STYLE, SIZE, OR COLOR.

PRIORITY CLAIMED UNDER SEC. 44(D) ON FED REP GERMANY APPLICATION NO. 30418465938, FILED 4-2-2004, REG. NO. 30418465, DATED 5-7-2004, EXPIRES 4-30-2014.

OWNER OF U.S. REG. NO. 2,282,432.

NO CLAIM IS MADE TO THE EXCLUSIVE RIGHT TO USE "EMAIL&CHAT", APART FROM THE MARK AS SHOWN.

FOR TELEPHONE DIRECTORY ASSISTANCE SERVICES; ADVERTISING SERVICES, NAMELY, PREPARING AND PLACING ADVERTISEMENTS FOR OTHERS, PROMOTING THE GOODS AND SERVICES OF OTHERS THROUGH PRINTED ADVERTISING, PRINTED DIRECTORIES, THROUGH ENCODED MEDIA, THROUGH THE DISSEMINATION OF PROMOTIONAL MATERIALS, THROUGH DIRECT MAIL ADVERTISING, THROUGH ELECTRONIC BILLBOARD ADVERTISING, PREPARING AUDIO-VISUAL PRESENTATIONS FOR USE IN ADVERTISING; BUSINESS MANAGEMENT SERVICES, NAMELY, BUSINESS APPRAISALS, BUSINESS AUDITING, PROVIDING BUSINESS INFORMATION, NAMELY, PREPARING BUSINESS REPORTS AND CONDUCTING BUSINESS RESEARCH, ANALYSIS AND SURVEYS, BUSINESS MANAGEMENT PLANNING, BUSINESS MANAGEMENT CONSULTATION, BUSINESS MANAGEMENT SUPERVISION, CONDUCTING BUSINESS NETWORKING FOR OTHERS; BUSINESS MANAGEMENT AND CONSULTING SERVICES, EXCLUDING AGRICULTURAL BUSINESS MANAGEMENT AND CONSULTING SERVICES; PROVIDING INFORMATION VIA THE TELEPHONE AND THE GLOBAL COMMUNICATION NETWORKS IN THE FIELD OF ADVERTISING AND BUSINESS MARKETING; PROFESSIONAL CONSULTANCY IN THE FIELD OF DATA PROCESSING; RENTAL OF AUTOMATIC VENDING MACHINES; RENTAL OF DATA PROCESSING EQUIPMENT; ORGANIZING JOB FAIRS (U.S. CLS. 100, 101 AND 102).

FLORENTINA BLANDU, EXAMINING ATTORNEY

THE MARK CONSISTS OF STANDARD CHARACTERS WITHOUT CLAIM TO ANY PARTICULAR FONT, STYLE, SIZE, OR COLOR.

PRIORITY CLAIMED UNDER SEC. 44(D) ON FED REP GERMANY APPLICATION NO. 30418509438, FILED 4-2-2004, REG. NO. 30418509, DATED 4-22-2004, EXPIRES 4-22-2014.

OWNER OF U.S. REG. NO. 2,282,432.

NO CLAIM IS MADE TO THE EXCLUSIVE RIGHT TO USE "MULTIMEDIA NETCARD", APART FROM THE MARK AS SHOWN.

FOR TELEPHONE DIRECTORY ASSISTANCE SERVICES; ADVERTISING SERVICES, NAMELY, PREPARING AND PLACING ADVERTISEMENTS FOR OTHERS, PROMOTING THE GOODS AND SERVICES OF OTHERS THROUGH PRINTED ADVERTISING, PRINTED DIRECTORIES, THROUGH ENCODED MEDIA, THROUGH THE DISSEMINATION OF PROMOTIONAL MATERIALS, THROUGH DIRECT MAIL ADVERTISING, THROUGH ELECTRONIC BILLBOARD ADVERTISING, PREPARING AUDIO-VISUAL PRESENTATIONS FOR USE IN ADVERTISING; BUSINESS MANAGEMENT SERVICES, NAMELY, BUSINESS APPRAISALS, BUSINESS AUDITING, PROVIDING BUSINESS INFORMATION, NAMELY, PREPARING BUSINESS REPORTS AND CONDUCTING BUSINESS RESEARCH, ANALYSIS AND SURVEYS, BUSINESS MANAGEMENT PLANNING, BUSINESS MANAGEMENT CONSULTATION, BUSINESS MANAGEMENT SUPERVISION, CONDUCTING BUSINESS NETWORKING FOR OTHERS; BUSINESS MANAGEMENT AND CONSULTING SERVICES, EXCLUDING AGRICULTURAL BUSINESS MANAGEMENT AND CONSULTING SERVICES; PROVIDING INFORMATION VIA THE TELEPHONE AND THE GLOBAL COMMUNICATION NETWORKS IN THE FIELD OF ADVERTISING AND BUSINESS MARKETING; PROFESSIONAL CONSULTANCY IN THE FIELD OF DATA PROCESSING; RENTAL OF AUTOMATIC VENDING MACHINES; RENTAL OF DATA PROCESSING EQUIPMENT; ORGANIZING JOB FAIRS (U.S. CLS. 100, 101 AND 102).

FLORENTINA BLANDU, EXAMINING ATTORNEY

CLASS 35—(Continued).

SN 78-494,172. DEUTSCHE TELEKOM AG, BONN, FED REP GERMANY, FILED 10-4-2004.

T-Mobile screen
styles

THE MARK CONSISTS OF STANDARD CHARACTERS WITHOUT CLAIM TO ANY PARTICULAR FONT, STYLE, SIZE, OR COLOR.

PRIORITY CLAIMED UNDER SEC. 44(D) ON FED REP GERMANY APPLICATION NO. 30418515938, FILED 4-2-2004, REG. NO. 30418515, DATED 4-22-2004, EXPIRES 4-30-2014.

OWNER OF U.S. REG. NO. 2,282,432.

NO CLAIM IS MADE TO THE EXCLUSIVE RIGHT TO USE "SCREEN STYLES", APART FROM THE MARK AS SHOWN.

FOR TELEPHONE DIRECTORY ASSISTANCE SERVICES; ADVERTISING SERVICES, NAMELY, PREPARING AND PLACING ADVERTISEMENTS FOR OTHERS, PROMOTING THE GOODS AND SERVICES OF OTHERS THROUGH PRINTED ADVERTISING, PRINTED DIRECTORIES, THROUGH ENCODED MEDIA, THROUGH THE DISSEMINATION OF PROMOTIONAL MATERIALS, THROUGH DIRECT MAIL ADVERTISING, THROUGH ELECTRONIC BILLBOARD ADVERTISING, PREPARING AUDIO-VISUAL PRESENTATIONS FOR USE IN ADVERTISING; BUSINESS MANAGEMENT SERVICES, NAMELY, BUSINESS APPRAISALS, BUSINESS AUDITING, PROVIDING BUSINESS INFORMATION, NAMELY, PREPARING BUSINESS REPORTS AND CONDUCTING BUSINESS RESEARCH, ANALYSIS AND SURVEYS, BUSINESS MANAGEMENT PLANNING, BUSINESS MANAGEMENT CONSULTATION, BUSINESS MANAGEMENT SUPERVISION, CONDUCTING BUSINESS NETWORKING FOR OTHERS; BUSINESS MANAGEMENT AND CONSULTING SERVICES, EXCLUDING AGRICULTURAL BUSINESS MANAGEMENT AND CONSULTING SERVICES; PROVIDING INFORMATION VIA THE TELEPHONE AND THE GLOBAL COMMUNICATION NETWORKS IN THE FIELD OF ADVERTISING AND BUSINESS MARKETING; PROFESSIONAL CONSULTANCY IN THE FIELD OF DATA PROCESSING; RENTAL OF AUTOMATIC VENDING MACHINES; RENTAL OF DATA PROCESSING EQUIPMENT; ORGANIZING JOB FAIRS (U.S. CLS. 100, 101 AND 102).

FLORENTINA BLANDU, EXAMINING ATTORNEY

CLASS 35—(Continued).

SN 78-494,490. GENERAL ELECTRIC COMPANY, SCHECTADY, NY. FILED 10-5-2004.

**Health by
Numbers**
051025

FOR SERVICES PROMOTING PUBLIC AWARENESS OF THE NEED FOR BETTER HEALTH AND NUTRITION (U.S. CLS. 100, 101 AND 102).

APRIL L. RADEMACHER, EXAMINING ATTORNEY

SN 78-494,636. FREE RANGE ENTERPRISES, OAK PARK, CA. FILED 10-5-2004.

LIME GREEN LULLABY

THE MARK CONSISTS OF STANDARD CHARACTERS WITHOUT CLAIM TO ANY PARTICULAR FONT, STYLE, SIZE, OR COLOR.

FOR ON-LINE RETAIL STORE SERVICES IN THE FIELD OF BABY T-SHIRTS WITH SILK SCREEN DESIGNS ON THEM (U.S. CLS. 100, 101 AND 102).

FIRST USE 9-1-2003; IN COMMERCE 9-1-2003.

STEVEN R. FINE, EXAMINING ATTORNEY

CLASS 35—(Continued).

SN 78-494,760. BOWTIE, INC., IRVINE, CA. FILED 10-5-2004.

CLASS 35—(Continued).

SN 78-494,874. THE CORPORATE EXECUTIVE BOARD COMPANY, WASHINGTON, DC. FILED 10-5-2004.

RSG

**LEARNING AND
DEVELOPMENT
ROUNDTABLE**

THE MARK CONSISTS OF STANDARD CHARACTERS WITHOUT CLAIM TO ANY PARTICULAR FONT, STYLE, SIZE, OR COLOR.

FOR MARKET RESEARCH AND ANALYSIS SERVICES (U.S. CLS. 100, 101 AND 102).

REGINA DRUMMOND, EXAMINING ATTORNEY

THE MARK CONSISTS OF STANDARD CHARACTERS WITHOUT CLAIM TO ANY PARTICULAR FONT, STYLE, SIZE, OR COLOR.

NO CLAIM IS MADE TO THE EXCLUSIVE RIGHT TO USE "LEARNING AND DEVELOPMENT", APART FROM THE MARK AS SHOWN.

FOR PROVIDING BUSINESS RESEARCH SERVICES AND INFORMATION FOR OTHERS, DELIVERED VIA A GLOBAL COMPUTER NETWORK, IN THE FIELD OF STRATEGIC AND TACTICAL RESEARCH AND INSIGHT RELATING TO BUSINESS LEARNING AND DEVELOPMENT (U.S. CLS. 100, 101 AND 102).

FIRST USE 9-1-2001; IN COMMERCE 12-1-2001.

KARANENDRA S. CHHINA, EXAMINING ATTORNEY

SN 78-494,844. GLOBAL MARKET INSITE, INC., MERCER ISLAND, WA. FILED 10-5-2004.

SN 78-494,893. GLOBAL MARKET INSITE, INC., MERCER ISLAND, WA. FILED 10-5-2004.

NET-MR



THE MARK CONSISTS OF STANDARD CHARACTERS WITHOUT CLAIM TO ANY PARTICULAR FONT, STYLE, SIZE, OR COLOR.

FOR BUSINESS SERVICES, NAMELY PROVIDING COMPUTER DATABASES REGARDING THE COLLECTION, MANAGEMENT, ANALYSIS AND REPORTING OF COMPANY, BUSINESS SECTOR AND INDUSTRY DATA AND RESEARCH; CONSULTATION SERVICES IN THE FIELD OF COMPANY, BUSINESS SECTOR AND INDUSTRY DATA AND RESEARCH (U.S. CLS. 100, 101 AND 102).

FIRST USE 6-30-2000; IN COMMERCE 6-30-2000.

DAVID TAYLOR, EXAMINING ATTORNEY

FOR BUSINESS SERVICES, NAMELY PROVIDING COMPUTER DATABASES REGARDING THE COLLECTION, MANAGEMENT, ANALYSIS AND REPORTING OF COMPANY, BUSINESS SECTOR AND INDUSTRY DATA AND RESEARCH; CONSULTATION SERVICES IN THE FIELD OF COMPANY, BUSINESS SECTOR AND INDUSTRY DATA AND RESEARCH (U.S. CLS. 100, 101 AND 102).

FIRST USE 6-30-2000; IN COMMERCE 6-30-2000.

TEJBIR SINGH, EXAMINING ATTORNEY

CLASS 35—(Continued).

SN 78-494,898. NCM ASSOCIATES, INC., OVERLAND PARK, KS. FILED 10-5-2004.

NCM

THE MARK CONSISTS OF STANDARD CHARACTERS WITHOUT CLAIM TO ANY PARTICULAR FONT, STYLE, SIZE, OR COLOR.

OWNER OF U.S. REG. NO. 2,893,255.
FOR PROVIDING INFORMATION ABOUT AUTOMOTIVE DEALERSHIPS (U.S. CLS. 100, 101 AND 102).
FIRST USE 12-31-1989; IN COMMERCE 12-31-1989.
TEJBIR SINGH, EXAMINING ATTORNEY

SN 78-495,226. TERRY'S TIRE TOWN, INC., ALLIANCE, OH. FILED 10-6-2004.

**NORTHCOASTTUNER.
COM**

THE MARK CONSISTS OF STANDARD CHARACTERS WITHOUT CLAIM TO ANY PARTICULAR FONT, STYLE, SIZE, OR COLOR.

FOR RETAIL STORE AND ONLINE RETAIL STORE FEATURING AUTOMOBILE PARTS AND ACCESSORIES (U.S. CLS. 100, 101 AND 102).
MITCHELL FRONT, EXAMINING ATTORNEY

SN 78-495,259. TERRY'S TIRE TOWN, INC., ALLIANCE, OH. FILED 10-6-2004.

**NORTHCOASTTRUCK.
COM**

THE MARK CONSISTS OF STANDARD CHARACTERS WITHOUT CLAIM TO ANY PARTICULAR FONT, STYLE, SIZE, OR COLOR.

FOR RETAIL STORE AND ONLINE RETAIL STORE FEATURING AUTOMOBILE PARTS AND ACCESSORIES (U.S. CLS. 100, 101 AND 102).
JENNIFER MARTIN, EXAMINING ATTORNEY

CLASS 35—(Continued).

SN 78-495,632. BORER FINANCIAL COMMUNICATIONS, LLC, POMPANO BEACH, FL. FILED 10-6-2004.

WITZ END

THE MARK CONSISTS OF STANDARD CHARACTERS WITHOUT CLAIM TO ANY PARTICULAR FONT, STYLE, SIZE, OR COLOR.

FOR DIRECT MARKETING SERVICES (U.S. CLS. 100, 101 AND 102).
LINDA MICKLEBURGH, EXAMINING ATTORNEY

SN 78-495,767. ADBRITE, INC., NEW YORK, NY. FILED 10-6-2004.

BRIGHTADS

THE MARK CONSISTS OF STANDARD CHARACTERS WITHOUT CLAIM TO ANY PARTICULAR FONT, STYLE, SIZE, OR COLOR.

FOR ADVERTISING AGENCIES; ADVERTISING AGENCIES, NAMELY, PROMOTING THE GOODS AND SERVICES OF OTHERS; RENTAL OF ADVERTISING SPACE ON WEB SITES (U.S. CLS. 100, 101 AND 102).
SKYE YOUNG, EXAMINING ATTORNEY

CLASS 35—(Continued).

SN 78-495,965. COUPONCABIN, INC., HOFFMAN ESTATES, IL. FILED 10-7-2004.

CouponCabin

THE MARK CONSISTS OF STANDARD CHARACTERS WITHOUT CLAIM TO ANY PARTICULAR FONT, STYLE, SIZE, OR COLOR.

FOR ADVERTISING THE GOODS AND SERVICES OF OTHERS VIA A GLOBAL COMPUTER NETWORK, NAMELY PROVIDING A WEBSITE WITH A LISTING OF LINKS TO ONLINE DISCOUNTS AND COUPONS (U.S. CLS. 100, 101 AND 102).

FIRST USE 2-26-2002; IN COMMERCE 3-26-2002.
RUDY R. SINGLETON, EXAMINING ATTORNEY

CLASS 35—(Continued).

SN 78-496,193. PR~LINK PUBLIC RELATIONS, LLC, CINCINNATI, OH. FILED 10-7-2004.

PR~Link Public Relations

THE MARK CONSISTS OF STANDARD CHARACTERS WITHOUT CLAIM TO ANY PARTICULAR FONT, STYLE, SIZE, OR COLOR.

NO CLAIM IS MADE TO THE EXCLUSIVE RIGHT TO USE "PUBLIC RELATIONS", APART FROM THE MARK AS SHOWN.

FOR PUBLIC RELATIONS SERVICES, NAMELY, PROVIDING CONSULTING SERVICES TO BUSINESSES REGARDING THEIR ISSUES RELATING TO PUBLIC RELATIONS, IMAGE, AND CUSTOMER DEVELOPMENT (U.S. CLS. 100, 101 AND 102).

FIRST USE 5-0-1999; IN COMMERCE 5-0-1999.
MICHAEL TANNER, EXAMINING ATTORNEY

SN 78-496,233. TWIST MANAGEMENT, LLC, ROCKVILLE, MD. FILED 10-7-2004.

SN 78-496,146. DE LORENZO, RICARDO AUGUSTO, SAO PAULO, BRAZIL, FILED 10-7-2004.

 beltmedia

THE MARK CONSISTS OF THE WORD BELTMEDIA WITH A CIRCLE INSIDE A SQUARE TO THE LEFT OF THE WORD.

FOR ADVERTISEMENT SERVICES, NAMELY, PREPARING AND PLACING PRINTED ADVERTISEMENTS FOR OTHERS THROUGH PRINTED PROMOTIONAL MATERIALS; RENTAL OF ADVERTISING SPACE (U.S. CLS. 100, 101 AND 102).

SUNG IN, EXAMINING ATTORNEY

SPLURGE

THE MARK CONSISTS OF STANDARD CHARACTERS WITHOUT CLAIM TO ANY PARTICULAR FONT, STYLE, SIZE, OR COLOR.

FOR RETAIL STORE SERVICES FEATURING FOOD (U.S. CLS. 100, 101 AND 102).

GENE MACIOL, EXAMINING ATTORNEY

CLASS 35—(Continued).

SN 78-496,407. STOYKE, G., EDMONTON ALBERTA, CANADA, FILED 10-7-2004.

Building a green
future!

THE MARK CONSISTS OF STANDARD CHARACTERS WITHOUT CLAIM TO ANY PARTICULAR FONT, STYLE, SIZE, OR COLOR.

FOR BUSINESS CONSULTATION IN THE FIELD OF ENERGY AND THE ENVIRONMENT; ENERGY AUDITING (U.S. CLS. 100, 101 AND 102).

EVELYN BRADLEY, EXAMINING ATTORNEY

CLASS 35—(Continued).

SN 78-496,969. HUMANA INC., LOUISVILLE, KY. FILED 10-8-2004.



PlanPALS

Peers Assisting and Lending Support

THE MARK CONSISTS OF A HIGHLY STYLIZED COMPASS SUPERIMPOSED OVER A CIRCLE WITH THE LITERAL ELEMENT "PLANPROFESSOR" APPEARING OUTSIDE THE BOTTOM RIGHT QUADRANT OF THE CIRCLE. THE WORDS PLANPALS APPEAR TO THE RIGHT OF THE COMPASS DESIGN ELEMENT IN A LARGE STYLIZED FONT, UNDER WHICH ARE THE WORDS "PEERS ASSISTING AND LENDING SUPPORT".

FOR PROVIDING CONSUMER INFORMATION IN THE FIELD OF HEALTH CARE SERVICES, DENTAL AND VISION PLANS (U.S. CLS. 100, 101 AND 102).

FIRST USE 6-30-2003; IN COMMERCE 6-30-2003.

ELLEN BURNS, EXAMINING ATTORNEY

SN 78-496,938. PROVISIO, INC., CHICAGO, IL. FILED 10-8-2004.

APPRENTICESHIP
ACCELERATOR

THE MARK CONSISTS OF STANDARD CHARACTERS WITHOUT CLAIM TO ANY PARTICULAR FONT, STYLE, SIZE, OR COLOR.

NO CLAIM IS MADE TO THE EXCLUSIVE RIGHT TO USE "APPRENTICESHIP", APART FROM THE MARK AS SHOWN.

FOR CONSULTING IN THE FIELD OF WORKFORCE DEVELOPMENT (U.S. CLS. 100, 101 AND 102).

FIRST USE 11-30-2003; IN COMMERCE 11-30-2003.

ADA HAN, EXAMINING ATTORNEY

SN 78-497,304. HAMMER TECHNOLOGIES, VANCOUVER, WA. FILED 10-8-2004.



FOR BUSINESS CONSULTATION IN THE FIELDS OF CURRENT PHARMACY OPERATIONS, THIRD PARTY REIMBURSEMENTS, DRUG PURCHASING, WORKFLOW PROCESSES, MANPOWER DEPLOYMENT, PRODUCTIVITY, AUTOMATION, AND INFORMATION MANAGEMENT FOR THE PURPOSE OF STREAMLINING COST SAVINGS, IMPROVING OPERATIONS AND MAXIMIZING PROFITABILITY; AND COMPUTERIZED ACCOUNTING SERVICES, NAMELY, ACCOUNTING RECONCILIATION FOR PHARMACIES (U.S. CLS. 100, 101 AND 102).

FIRST USE 4-22-2002; IN COMMERCE 4-22-2002.

ELLEN B. AWRICH, EXAMINING ATTORNEY

CLASS 35—(Continued).

SN 78-497,428. EDWARDS, JOSEPH F., COOKEVILLE, TN. FILED 10-9-2004.

CLASS 35—(Continued).

SN 78-497,770. LEASING STRATEGIES, LLC, ROCHESTER HILLS, MI. FILED 10-11-2004.

READMORE

Residual Value Workbench

THE MARK CONSISTS OF STANDARD CHARACTERS WITHOUT CLAIM TO ANY PARTICULAR FONT, STYLE, SIZE, OR COLOR.

FOR DISSEMINATION OF ADVERTISING FOR OTHERS VIA THE INTERNET (U.S. CLS. 100, 101 AND 102).

FIRST USE 6-29-2002; IN COMMERCE 6-29-2002.
JOSETTE BEVERLY, EXAMINING ATTORNEY

THE MARK CONSISTS OF STANDARD CHARACTERS WITHOUT CLAIM TO ANY PARTICULAR FONT, STYLE, SIZE, OR COLOR.

NO CLAIM IS MADE TO THE EXCLUSIVE RIGHT TO USE "RESIDUAL VALUE", APART FROM THE MARK AS SHOWN.

FOR COMPILATION, ANALYSIS AND EXPLOITATION OF MATHEMATICAL AND/OR STATISTICAL DATA REGARDING AUTOMOTIVE RESIDUAL VALUES AND LEASE PORTFOLIOS (U.S. CLS. 100, 101 AND 102).

FIRST USE 2-15-2004; IN COMMERCE 4-21-2004.
LINDA ESTRADA, EXAMINING ATTORNEY

SN 78-497,743. FORUM COMMUNICATIONS COMPANY, FARGO, ND. FILED 10-11-2004.

SN 78-497,906. HONEY WEST, LLC, PRINCETON, NJ. FILED 10-11-2004.

APARTMENTSHQ

HONEY WEST

THE MARK CONSISTS OF STANDARD CHARACTERS WITHOUT CLAIM TO ANY PARTICULAR FONT, STYLE, SIZE, OR COLOR.

FOR DISSEMINATION OF ADVERTISING OF APARTMENTS FOR OTHERS VIA AN ONLINE COMMUNICATIONS NETWORK ON THE INTERNET (U.S. CLS. 100, 101 AND 102).

FIRST USE 9-21-2004; IN COMMERCE 9-21-2004.
LINDA M. KING, EXAMINING ATTORNEY

THE MARK CONSISTS OF STANDARD CHARACTERS WITHOUT CLAIM TO ANY PARTICULAR FONT, STYLE, SIZE, OR COLOR.

THE NAME HONEY WEST DOES NOT IDENTIFY AN INDIVIDUAL.

FOR ONLINE RETAIL AND RETAIL STORE SERVICES FEATURING CLOTHING (U.S. CLS. 100, 101 AND 102).

FIRST USE 9-22-2004; IN COMMERCE 9-22-2004.
SUSAN HAYASH, EXAMINING ATTORNEY

CLASS 35—(Continued).

SN 78-498,288. MATULL, FRANK, DBA STUDY ABROAD LINKS, SAN FRANCISCO, CA. FILED 10-12-2004.

CAMPUSLANE

THE MARK CONSISTS OF STANDARD CHARACTERS WITHOUT CLAIM TO ANY PARTICULAR FONT, STYLE, SIZE, OR COLOR.

FOR PROVIDING ONLINE DIRECTORY INFORMATION SERVICES FEATURING SCHOOLS OF ALL TYPES WORLDWIDE AND ALSO FEATURING HYPERLINKS TO OTHER WEBSITES (U.S. CLS. 100, 101 AND 102).

FIRST USE 5-0-2002; IN COMMERCE 5-0-2002.
JERI J. FICKES, EXAMINING ATTORNEY

CLASS 35—(Continued).

SN 78-498,943. THE LAB COMPANIES, INC., JERSEY CITY, NJ. FILED 10-13-2004.

The Lab Companies

THE MARK CONSISTS OF STANDARD CHARACTERS WITHOUT CLAIM TO ANY PARTICULAR FONT, STYLE, SIZE, OR COLOR.

NO CLAIM IS MADE TO THE EXCLUSIVE RIGHT TO USE "COMPANIES", APART FROM THE MARK AS SHOWN.

FOR BUSINESS CONSULTING SERVICES; BUSINESS CONSULTING SERVICES IN THE NATURE OF BUSINESS OPERATIONS CONSULTING; BUSINESS MANAGEMENT CONSULTING IN THE NATURE OF OPERATIONS CONSULTING, BUSINESS MANAGEMENT CONSULTING (U.S. CLS. 100, 101 AND 102).

FIRST USE 0-0-1999; IN COMMERCE 0-0-1999.
ESTHER BELENKER, EXAMINING ATTORNEY

SN 78-498,963. THE LAB COMPANIES, INC., JERSEY CITY, NJ. FILED 10-13-2004.

SN 78-498,512. AFTERMARKET AUTO PARTS ALLIANCE, INC., SAN ANTONIO, TX. FILED 10-12-2004.



Class I

OWNER OF U.S. REG. NOS. 1,247,356, 2,308,588 AND OTHERS.

NO CLAIM IS MADE TO THE EXCLUSIVE RIGHT TO USE AUTO AND MOTORSPORTS, APART FROM THE MARK AS SHOWN.

FOR RETAIL STORE SERVICES AND WHOLESALE DISTRIBUTORSHIP SERVICES IN THE FIELD OF AUTOMOTIVE PARTS AND ACCESSORIES (U.S. CLS. 100, 101 AND 102).

FIRST USE 4-15-2004; IN COMMERCE 4-15-2004.
MARY BOAGNI, EXAMINING ATTORNEY

THE MARK CONSISTS OF STANDARD CHARACTERS WITHOUT CLAIM TO ANY PARTICULAR FONT, STYLE, SIZE, OR COLOR.

FOR BUSINESS CONSULTING SERVICES; BUSINESS CONSULTING SERVICES IN THE NATURE OF BUSINESS OPERATIONS CONSULTING; MANAGEMENT CONSULTING (U.S. CLS. 100, 101 AND 102).

FIRST USE 0-0-2000; IN COMMERCE 0-0-2000.
JOHN HWANG, EXAMINING ATTORNEY

CLASS 35—(Continued).

SN 78-498,977. PPC MARKETING, LTD., PITTSBURGH, TX. FILED 10-13-2004.

CLASS 35—(Continued).

SN 78-499,325. BABBLEBEE, INC., CHICAGO, IL. FILED 10-13-2004.

PFS

**Where the Buzz is
About Your
Business**

THE MARK CONSISTS OF STANDARD CHARACTERS WITHOUT CLAIM TO ANY PARTICULAR FONT, STYLE, SIZE, OR COLOR.
FOR DISTRIBUTORSHIP IN THE FIELD OF FOOD (U.S. CLS. 100, 101 AND 102).
FIRST USE 1-2-1984; IN COMMERCE 1-2-1984.
JOHN HWANG, EXAMINING ATTORNEY

THE MARK CONSISTS OF STANDARD CHARACTERS WITHOUT CLAIM TO ANY PARTICULAR FONT, STYLE, SIZE, OR COLOR.
FOR PROVIDING INFORMATION VIA A GLOBAL COMPUTER NETWORK IN THE FIELD OF BUSINESS DEVELOPMENT AND NETWORKING (U.S. CLS. 100, 101 AND 102).
FIRST USE 7-25-2004; IN COMMERCE 7-25-2004.
BRIAN NEVILLE, EXAMINING ATTORNEY

SN 78-499,067. IFORMAPAK, INC., MIAMI, FL. FILED 10-13-2004.

SN 78-499,509. LMPERFORMANCE, INC., DESTIN, FL. FILED 10-14-2004.

IFORMAPAK

LMPerformance

THE MARK CONSISTS OF STANDARD CHARACTERS WITHOUT CLAIM TO ANY PARTICULAR FONT, STYLE, SIZE, OR COLOR.
FOR PACKAGING ARTICLES TO THE ORDER AND SPECIFICATION OF OTHERS (U.S. CLS. 100, 101 AND 102).
FIRST USE 9-8-2004; IN COMMERCE 9-8-2004.
NAAKWAMA ANKRAH, EXAMINING ATTORNEY

THE MARK CONSISTS OF STANDARD CHARACTERS WITHOUT CLAIM TO ANY PARTICULAR FONT, STYLE, SIZE, OR COLOR.
FOR ONLINE RETAIL STORE SERVICES FEATURING AUTOMOBILE PERFORMANCE PARTS (U.S. CLS. 100, 101 AND 102).
FLORENTINA BLANDU, EXAMINING ATTORNEY

CLASS 35—(Continued).

SN 78-499,515. PENNSYLVANIA INSTITUTE OF CERTIFIED PUBLIC ACCOUNTANTS, PHILADELPHIA, PA. FILED 10-14-2004.

CLASS 35—(Continued).

SN 78-500,002. DEUTSCHE TELEKOM AG, BONN, FED REP GERMANY, FILED 10-14-2004.

CPA ZONE

THE MARK CONSISTS OF STANDARD CHARACTERS WITHOUT CLAIM TO ANY PARTICULAR FONT, STYLE, SIZE, OR COLOR.

NO CLAIM IS MADE TO THE EXCLUSIVE RIGHT TO USE "CPA", APART FROM THE MARK AS SHOWN.

FOR PROMOTING PUBLIC AWARENESS OF THE NEED FOR AND VALUE OF THE PROFESSION OF ACCOUNTING (U.S. CLS. 100, 101 AND 102).

FIRST USE 10-1-2001; IN COMMERCE 10-1-2001.

ELLEN B. AWRICH, EXAMINING ATTORNEY

T-Systems

THE MARK CONSISTS OF STANDARD CHARACTERS WITHOUT CLAIM TO ANY PARTICULAR FONT, STYLE, SIZE, OR COLOR.

PRIORITY CLAIMED UNDER SEC. 44(D) ON FED REP GERMANY APPLICATION NO. 30421580535, FILED 4-15-2004, REG. NO. 30421580, DATED 9-9-2004, EXPIRES 4-30-2014.

OWNER OF U.S. REG. NOS. 2,448,571, 2,880,613 AND OTHERS.

FOR TELEPHONE DIRECTORY ASSISTANCE SERVICES; ADVERTISING SERVICES, NAMELY, PREPARING AND PLACING ADVERTISEMENTS FOR OTHERS PROMOTING THE GOODS AND SERVICES OF OTHERS THROUGH PRINTED ADVERTISING, PRINTED DIRECTORIES, THROUGH ENCODED MEDIA, THROUGH THE DISSEMINATION OF PROMOTIONAL MATERIALS, THROUGH DIRECT MAIL ADVERTISING, THROUGH ELECTRONIC BILLBOARD ADVERTISING, PREPARING AUDIO-VISUAL PRESENTATIONS FOR USE IN ADVERTISING; BUSINESS MANAGEMENT SERVICES, NAMELY, BUSINESS APPRAISALS, BUSINESS AUDITING, PROVIDING BUSINESS INFORMATION, NAMELY, PREPARING BUSINESS REPORTS AND CONDUCTING BUSINESS RESEARCH, ANALYSIS AND SURVEYS, BUSINESS MANAGEMENT PLANNING, BUSINESS MANAGEMENT CONSULTATION, BUSINESS MANAGEMENT SUPERVISION, CONDUCTING BUSINESS NETWORKING FOR OTHERS; BUSINESS MANAGEMENT AND CONSULTING SERVICES, EXCLUDING AGRICULTURAL BUSINESS MANAGEMENT AND CONSULTING SERVICES; PROVIDING INFORMATION VIA THE TELEPHONE AND THE GLOBAL COMMUNICATION NETWORKS IN THE FIELD OF ADVERTISING AND BUSINESS MARKETING; PROFESSIONAL CONSULTANCY IN THE FIELD OF DATA PROCESSING; ORGANIZING JOB FAIRS (U.S. CLS. 100, 101 AND 102).

SKYE YOUNG, EXAMINING ATTORNEY

SN 78-499,945. CORPCARE ASSOCIATES, INC., ATLANTA, GA. FILED 10-14-2004.

CORPCARE

THE MARK CONSISTS OF STANDARD CHARACTERS WITHOUT CLAIM TO ANY PARTICULAR FONT, STYLE, SIZE, OR COLOR.

FOR EMPLOYEE ASSISTANCE PROGRAMS, NAMELY REFERRAL SERVICES TO ASSIST EMPLOYEES WITH PERSONAL AND WORK-RELATED PROBLEMS (U.S. CLS. 100, 101 AND 102).

FIRST USE 11-1-1991; IN COMMERCE 11-1-1991.

WILLIAM VERHOSEK, EXAMINING ATTORNEY

CLASS 35—(Continued).

SN 78-500,043. DEUTSCHE TELEKOM AG, BONN, FED REP GERMANY, FILED 10-14-2004.

CLASS 35—(Continued).

SN 78-500,087. NEUISYS, LLC, GREENSBORO, NC. FILED 10-14-2004.

NEUISYS



THE MARK CONSISTS OF STANDARD CHARACTERS WITHOUT CLAIM TO ANY PARTICULAR FONT, STYLE, SIZE, OR COLOR.

FOR RETAIL SERVICES BY DIRECT SOLICITATION BY SALE AGENTS IN THE FIELD OF IMAGING SYSTEMS (U.S. CLS. 100, 101 AND 102).

FIRST USE 10-10-2004; IN COMMERCE 10-10-2004.
JULIE WATSON, EXAMINING ATTORNEY

PRIORITY CLAIMED UNDER SEC. 44(D) ON FED REP GERMANY APPLICATION NO. 30421579135, FILED 4-15-2004, REG. NO. 30421579, DATED 9-9-2004, EXPIRES 4-30-2014.

OWNER OF U.S. REG. NOS. 2,448,571, 2,880,613 AND OTHERS.

THE COLORS MAGENTA AND GREY ARE CLAIMED AS A FEATURE OF THE MARK.

THE COLOR MAGENTA APPEARS IN THE LETTER "T" IN THE MARK; THE REMAINDER OF THE MARK APPEARS IN THE COLOR GREY

FOR TELEPHONE DIRECTORY ASSISTANCE SERVICES; ADVERTISING SERVICES, NAMELY, PREPARING AND PLACING ADVERTISEMENTS FOR OTHERS PROMOTING THE GOODS AND SERVICES OF OTHERS THROUGH PRINTED ADVERTISING, PRINTED DIRECTORIES, THROUGH ENCODED MEDIA, THROUGH THE DISSEMINATION OF PROMOTIONAL MATERIALS, THROUGH DIRECT MAIL ADVERTISING, THROUGH ELECTRONIC BILLBOARD ADVERTISING, PREPARING AUDIO-VISUAL PRESENTATIONS FOR USE IN ADVERTISING; BUSINESS MANAGEMENT SERVICES, NAMELY, BUSINESS APPRAISALS, BUSINESS AUDITING, PROVIDING BUSINESS INFORMATION, NAMELY, PREPARING BUSINESS REPORTS AND CONDUCTING BUSINESS RESEARCH, ANALYSIS AND SURVEYS, BUSINESS MANAGEMENT PLANNING, BUSINESS MANAGEMENT CONSULTATION, BUSINESS MANAGEMENT SUPERVISION, CONDUCTING BUSINESS NETWORKING FOR OTHERS; BUSINESS MANAGEMENT AND CONSULTING SERVICES, EXCLUDING AGRICULTURAL BUSINESS MANAGEMENT AND CONSULTING SERVICES; PROVIDING INFORMATION VIA THE TELEPHONE AND THE GLOBAL COMMUNICATION NETWORKS IN THE FIELD OF ADVERTISING AND BUSINESS MARKETING; PROFESSIONAL CONSULTANCY IN THE FIELD OF DATA PROCESSING; ORGANIZING JOB FAIRS (U.S. CLS. 100, 101 AND 102).
SKYE YOUNG, EXAMINING ATTORNEY

SN 78-500,126. THIRD WAY FOUNDATION, WASHINGTON, DC. FILED 10-14-2004.

PPI

THE MARK CONSISTS OF STANDARD CHARACTERS WITHOUT CLAIM TO ANY PARTICULAR FONT, STYLE, SIZE, OR COLOR.

FOR ASSOCIATION SERVICES, NAMELY, PROMOTING PUBLIC DIALOGUE AND DEBATE WITHIN THE GENERAL PUBLIC ABOUT NATIONAL, ECONOMIC, SOCIAL AND POLITICAL ISSUES (U.S. CLS. 100, 101 AND 102).

FIRST USE 12-23-1988; IN COMMERCE 12-23-1988.
KAREN K. BUSH, EXAMINING ATTORNEY

CLASS 35—(Continued).

SN 78-500,436. BASS PRO TRADEMARKS, L.L.C., SPRINGFIELD, MO. FILED 10-15-2004.

CLASS 35—(Continued).

SN 78-500,575. COMPENSATION DESIGN GROUP, INC., TIBURON, CA. FILED 10-15-2004.

OUTDOOR REWARDS

THE MARK CONSISTS OF STANDARD CHARACTERS WITHOUT CLAIM TO ANY PARTICULAR FONT, STYLE, SIZE, OR COLOR.

NO CLAIM IS MADE TO THE EXCLUSIVE RIGHT TO USE REWARDS, APART FROM THE MARK AS SHOWN.

FOR INCENTIVE PROGRAMS FOR RETAIL STORE PATRONS, NAMELY, PROMOTING THE SALE OF CREDIT CARD ACCOUNTS THROUGH THE ADMINISTRATION OF INCENTIVE AWARDS PROGRAMS (U.S. CLS. 100, 101 AND 102).

FIRST USE 11-6-1997; IN COMMERCE 11-6-1997.

MATTHEW KLINE, EXAMINING ATTORNEY

SCA

THE MARK CONSISTS OF STANDARD CHARACTERS WITHOUT CLAIM TO ANY PARTICULAR FONT, STYLE, SIZE, OR COLOR.

FOR MANAGEMENT CONSULTING IN THE FIELDS OF COMPENSATION, BENEFITS, HUMAN RESOURCES, CAPITAL MARKETS, AND ORGANIZATIONAL STRATEGY (U.S. CLS. 100, 101 AND 102).

LESLEY LAMOTHE, EXAMINING ATTORNEY

SN 78-500,524. MORRIS, KEVIN C., SUWANEE, GA. FILED 10-15-2004.

SN 78-500,601. HAHN, LYNN, RUGERS, AR. FILED 10-15-2004.

TRANSGLOBAL ENERGY

THE MARK CONSISTS OF STANDARD CHARACTERS WITHOUT CLAIM TO ANY PARTICULAR FONT, STYLE, SIZE, OR COLOR.

NO CLAIM IS MADE TO THE EXCLUSIVE RIGHT TO USE "ENERGY", APART FROM THE MARK AS SHOWN.

FOR PLACEMENT SERVICES, NAMELY, PROVIDING TECHNICAL CONSULTANTS ON A CONTRACT OR PERMANENT BASIS TO FIRMS WHICH PERFORM ENGINEERING, PROCUREMENT, CONSTRUCTION, STARTUP, OPERATIONS AND MAINTENANCE OF POWER AND HYDROCARBON FACILITIES (U.S. CLS. 100, 101 AND 102).

FIRST USE 11-20-2003; IN COMMERCE 11-20-2003.

ELLEN BURNS, EXAMINING ATTORNEY

Copyright Cop

THE MARK CONSISTS OF STANDARD CHARACTERS WITHOUT CLAIM TO ANY PARTICULAR FONT, STYLE, SIZE, OR COLOR.

NO CLAIM IS MADE TO THE EXCLUSIVE RIGHT TO USE "COPYRIGHT", APART FROM THE MARK AS SHOWN.

FOR BUSINESS INVESTIGATIONS, EVALUATIONS, INFORMATION AND RESEARCH SERVICES IN THE FIELD OF ONLINE COPYRIGHT AND TRADEMARK INFRINGEMENT (U.S. CLS. 100, 101 AND 102).

FIRST USE 9-4-2004; IN COMMERCE 9-4-2004.

KRISTINA KLOIBER, EXAMINING ATTORNEY

CLASS 35—(Continued).

SN 78-500,606. HILTON HOSPITALITY, INC., BEVERLY HILLS, CA. FILED 10-15-2004.



OWNER OF U.S. REG. NO. 2,490,760.
 THE STIPLING IS A FEATURE OF THE MARK.
 THE MARK IS NOT IN COLOR.
 FOR CHARITABLE SERVICES; NAMELY ORGANIZING AND PROVIDING VOLUNTEER RESTORATION SERVICES TO HISTORICAL ATTRACTIONS (U.S. CLS. 100, 101 AND 102).
 FIRST USE 10-23-2001; IN COMMERCE 10-23-2001.
 JENNIFER KRISP, EXAMINING ATTORNEY

CLASS 35—(Continued).

SN 78-500,826. COLORADO GARDEN SHOW, INC., LITTLETON, CO. FILED 10-15-2004.

COLORADO GARDEN & HOME SHOW

THE MARK CONSISTS OF STANDARD CHARACTERS WITHOUT CLAIM TO ANY PARTICULAR FONT, STYLE, SIZE, OR COLOR.
 NO CLAIM IS MADE TO THE EXCLUSIVE RIGHT TO USE "GARDEN & HOME SHOW", APART FROM THE MARK AS SHOWN.
 SEC. 2(F).
 FOR ARRANGING AND CONDUCTING TRADE SHOW EXHIBITIONS IN THE FIELD OF HOME IMPROVEMENT, DECORATING, CONSTRUCTION, GARDENING, AND LANDSCAPING (U.S. CLS. 100, 101 AND 102).
 FIRST USE 2-1-1958; IN COMMERCE 2-1-1958.
 BARBARA BROWN, EXAMINING ATTORNEY

SN 78-500,748. NINE WEST DEVELOPMENT CORPORATION, WILMINGTON, DE. FILED 10-15-2004.

TREO

THE MARK CONSISTS OF STANDARD CHARACTERS WITHOUT CLAIM TO ANY PARTICULAR FONT, STYLE, SIZE, OR COLOR.
 OWNER OF U.S. REG. NO. 1,480,164.
 FOR RETAIL STORE SERVICES IN THE FIELD OF APPAREL, FOOTWEAR, ACCESSORIES, EYEWEAR, HOSIERY, BELTS, BAGS, LEATHER GOODS, WATCHES AND JEWELRY (U.S. CLS. 100, 101 AND 102).
 DAWN FELDMAN, EXAMINING ATTORNEY

SN 78-501,151. PREVO'S FAMILY MARKET'S, INC., GRAND RAPIDS, MI. FILED 10-18-2004.

GLEN'S

THE MARK CONSISTS OF STANDARD CHARACTERS WITHOUT CLAIM TO ANY PARTICULAR FONT, STYLE, SIZE, OR COLOR.
 FOR RETAIL SUPERMARKET SERVICES AND RETAIL STORE SERVICES FEATURING CONVENIENCE STORE ITEMS AND GASOLINE (U.S. CLS. 100, 101 AND 102).
 FIRST USE 0-0-1951; IN COMMERCE 0-0-1951.
 MARTHA FROMM, EXAMINING ATTORNEY

CLASS 35—(Continued).

SN 78-501,152. FAMILY FARE, LLC, GRAND RAPIDS, MI.
FILED 10-18-2004.

FAMILY FARE

THE MARK CONSISTS OF STANDARD CHARACTERS WITHOUT CLAIM TO ANY PARTICULAR FONT, STYLE, SIZE, OR COLOR.

OWNER OF U.S. REG. NOS. 785,308 AND 2,445,517.
FOR RETAIL STORE SERVICES FEATURING CONVENIENCE STORE ITEMS AND GASOLINE (U.S. CLS. 100, 101 AND 102).

FIRST USE 12-13-2004; IN COMMERCE 12-13-2004.
MARTHA FROMM, EXAMINING ATTORNEY

CLASS 35—(Continued).

SN 78-501,390. MARTIN, OLIVIER, SAN FRANCISCO, CA.
FILED 10-18-2004.

CALIEAGLE

THE MARK CONSISTS OF STANDARD CHARACTERS WITHOUT CLAIM TO ANY PARTICULAR FONT, STYLE, SIZE, OR COLOR.

FOR DISTRIBUTORSHIP SERVICES FEATURING OUTDOOR APPAREL, NAMELY, BOOTS, SHOES, TROUSERS, AND JACKETS (U.S. CLS. 100, 101 AND 102).

FIRST USE 9-1-2004; IN COMMERCE 9-1-2004.
DARRYL SPRUILL, EXAMINING ATTORNEY

SN 78-501,246. PITAYA, INC., INDIANAPOLIS, IN. FILED 10-18-2004.

PITAYA

THE MARK CONSISTS OF STANDARD CHARACTERS WITHOUT CLAIM TO ANY PARTICULAR FONT, STYLE, SIZE, OR COLOR.

FOR RETAIL STORE SERVICES AND ONLINE RETAIL STORE SERVICES FEATURING YOUNG WOMEN'S APPAREL AND ACCESSORIES (U.S. CLS. 100, 101 AND 102).

FIRST USE 12-31-1990; IN COMMERCE 12-31-1990.
JOHN LINCOSKI, EXAMINING ATTORNEY

SN 78-501,446. DIONYSATOS, HARRY, NEW YORK, NY.
FILED 10-18-2004.



NO CLAIM IS MADE TO THE EXCLUSIVE RIGHT TO USE "THE BREADSTICKS CAFE," "FINE FOOD" AND "EST. 1999", APART FROM THE MARK AS SHOWN.

FOR RETAIL BAKERY SHOPS; RETAIL STORES FEATURING FOOD AND BEVERAGES; RETAIL AND WHOLESALE DISTRIBUTORSHIPS FEATURING FOOD AND BEVERAGES (U.S. CLS. 100, 101 AND 102).

FIRST USE 11-20-2003; IN COMMERCE 11-20-2003.
LINDA ESTRADA, EXAMINING ATTORNEY

CLASS 35—(Continued).

SN 78-502,183. USA COUTURE, INC, BEVERLY HILLS, CA. FILED 10-19-2004.

CLASS 35—(Continued).

SN 78-502,371. BATES, DOUGLAS O, SALT LAKE CITY, UT. FILED 10-19-2004.

Divine Boutique

THE MARK CONSISTS OF STANDARD CHARACTERS WITHOUT CLAIM TO ANY PARTICULAR FONT, STYLE, SIZE, OR COLOR.

NO CLAIM IS MADE TO THE EXCLUSIVE RIGHT TO USE BOUTIQUE, APART FROM THE MARK AS SHOWN.

FOR RETAIL CLOTHING STORE SERVICES (U.S. CLS. 100, 101 AND 102).

FIRST USE 10-15-2002; IN COMMERCE 10-15-2002.
JANICE L. MCMORROW, EXAMINING ATTORNEY

Bringing you Home.

THE MARK CONSISTS OF STANDARD CHARACTERS WITHOUT CLAIM TO ANY PARTICULAR FONT, STYLE, SIZE, OR COLOR.

FOR INTERNET ADVERTISING OF REAL ESTATE LISTINGS (U.S. CLS. 100, 101 AND 102).

FIRST USE 8-1-2004; IN COMMERCE 8-5-2004.
CYNTHIA SLOAN, EXAMINING ATTORNEY

SN 78-502,459. AMERICAN TRANSPORTATION MARKET-ING GROUP, INC., JACKSONVILLE, FL. FILED 10-19-2004.

SN 78-502,212. AT PROMISE INCORPORATED, BLAINE, WA. FILED 10-19-2004.

ATM/GROUP

THE MARK CONSISTS OF STANDARD CHARACTERS WITHOUT CLAIM TO ANY PARTICULAR FONT, STYLE, SIZE, OR COLOR.

FOR MARKETING AND ADVERTISING SERVICES RELATED TO THE AUTOMOTIVE INDUSTRY (U.S. CLS. 100, 101 AND 102).

FIRST USE 7-31-2002; IN COMMERCE 7-31-2002.
ZHALEH DELANEY, EXAMINING ATTORNEY

ZAPGEAR

THE MARK CONSISTS OF STANDARD CHARACTERS WITHOUT CLAIM TO ANY PARTICULAR FONT, STYLE, SIZE, OR COLOR.

FOR CATALOG ORDER SERVICES RENDERED VIA A GLOBAL COMPUTER NETWORK IN THE FIELD OF APPAREL, BOOKS, CALENDARS, POSTERS, DECALS, BUMPER STICKERS, BOOK MARKS, POST CARDS, NOTE PADS, PENCILS, PENS, STATIONARY, GREETING CARDS, BOOK COVERS, PRE-RECORDED VIDEO TAPES, DVD'S AND AUTO CASSETTE TAPES, GAMES, TOYS, MUGS, CUPS, BACKPACKS, BAGS, SACHELS, APPAREL AND OTHER MERCHANDISE (U.S. CLS. 100, 101 AND 102).

FIRST USE 11-0-2003; IN COMMERCE 11-0-2003.
JENNIFER MARTIN, EXAMINING ATTORNEY

SN 78-502,479. AMERICAN TRANSPORTATION MARKET-ING GROUP, INC., JACKSONVILLE, FL. FILED 10-19-2004.



THE MARK CONSISTS OF THE STYLIZED LETTERS "ATM" FOLLOWED BY A FORWARD SLASH AND A STYLIZED LETTER "G".

FOR MARKETING AND ADVERTISING SERVICES RELATED TO THE AUTOMOTIVE INDUSTRY (U.S. CLS. 100, 101 AND 102).

FIRST USE 7-31-2002; IN COMMERCE 7-31-2002.
ZHALEH DELANEY, EXAMINING ATTORNEY

CLASS 35—(Continued).

SN 78-502,503. GUGGENHEIM INVESTMENTS, INC., MIA-
MI, FL. FILED 10-19-2004.

CLASS 35—(Continued).

SN 78-502,743. PERFORMANCE STAFFING, INC., SUMTER,
SC. FILED 10-20-2004.

Parcel Points

IN A MARKET THAT
IS THE SAME, OUR
PRODUCT AND
SERVICE WILL NOT
BE.

THE MARK CONSISTS OF STANDARD CHARACTERS
WITHOUT CLAIM TO ANY PARTICULAR FONT, STYLE,
SIZE, OR COLOR.

NO CLAIM IS MADE TO THE EXCLUSIVE RIGHT TO
USE POINTS, APART FROM THE MARK AS SHOWN.

FOR CUSTOMER LOYALTY SERVICES AND CUSTO-
MER CLUB SERVICES, FOR COMMERCIAL, PROMO-
TIONAL AND/OR ADVERTISING PURPOSES (U.S. CLS.
100, 101 AND 102).

FIRST USE 10-15-2004; IN COMMERCE 10-15-2004.
RUSS HERMAN, EXAMINING ATTORNEY

THE MARK CONSISTS OF STANDARD CHARACTERS
WITHOUT CLAIM TO ANY PARTICULAR FONT, STYLE,
SIZE, OR COLOR.

FOR TEMPORARY STAFFING AGENCY, ACCOUNT-
ING SERVICES FOR SMALL BUSINESSES, PERSONAL
AND BUSINESS INCOME TAX PREPARATION (U.S.
CLS. 100, 101 AND 102).

FIRST USE 10-18-2004; IN COMMERCE 10-18-2004.
CHARLES JOYNER, EXAMINING ATTORNEY

SN 78-502,769. CUSTOMER OPERATIONS PERFORMANCE
CENTER INC., AMHERST, NY. FILED 10-20-2004.

SN 78-502,660. JESKE, RAINER, LAS VEGAS, NV. FILED 10-
20-2004.

PEOPLE ARE THE NEW MEDIA

SMARTMOVE

THE MARK CONSISTS OF STANDARD CHARACTERS
WITHOUT CLAIM TO ANY PARTICULAR FONT, STYLE,
SIZE, OR COLOR.

FOR BUSINESS MANAGEMENT CONSULTING WITH
RELATION TO STRATEGY, MARKETING, AND PER-
SONNEL (U.S. CLS. 100, 101 AND 102).

FIRST USE 10-12-2004; IN COMMERCE 10-12-2004.
EDWARD NELSON, EXAMINING ATTORNEY

THE MARK CONSISTS OF STANDARD CHARACTERS
WITHOUT CLAIM TO ANY PARTICULAR FONT, STYLE,
SIZE, OR COLOR.

FOR CONSULTING SERVICES FOR CALL CENTER
OUTSOURCING (U.S. CLS. 100, 101 AND 102).

FIRST USE 5-13-2002; IN COMMERCE 5-13-2002.
TEJBIR SINGH, EXAMINING ATTORNEY

CLASS 35—(Continued).

SN 78-502,816. NOVON CONSULTING CORP., MINNEAPOLIS, MN. FILED 10-20-2004.

CLASS 35—(Continued).

SN 78-503,191. LUCY ACTIVEWEAR, INC., PORTLAND, OR. FILED 10-20-2004.

**WHERE STYLE MEETS
SPORT**

Novon

THE MARK CONSISTS OF STANDARD CHARACTERS WITHOUT CLAIM TO ANY PARTICULAR FONT, STYLE, SIZE, OR COLOR.

FOR RETAIL STORE SERVICES FEATURING ATHLETIC CLOTHING AND SPORT BAGS; ONLINE ORDERING SERVICES FEATURING ATHLETIC CLOTHING AND SPORT BAGS (U.S. CLS. 100, 101 AND 102).

FIRST USE 7-0-2002; IN COMMERCE 7-0-2002.
RUSS HERMAN, EXAMINING ATTORNEY

THE MARK CONSISTS OF STANDARD CHARACTERS WITHOUT CLAIM TO ANY PARTICULAR FONT, STYLE, SIZE, OR COLOR.

FOR PROFESSIONAL BUSINESS CONSULTING SERVICES TO FINANCIAL COMPANIES (U.S. CLS. 100, 101 AND 102).

FIRST USE 7-1-1997; IN COMMERCE 7-1-1997.
LEIGH CAROLINE CASE, EXAMINING ATTORNEY

SN 78-503,213. ITRASH, INC., NEW YORK, NY. FILED 10-20-2004.

ITRASH

SN 78-502,903. NOVON CONSULTING CORP, MINNEAPOLIS, MN. FILED 10-20-2004.

Novon Consulting

THE MARK CONSISTS OF STANDARD CHARACTERS WITHOUT CLAIM TO ANY PARTICULAR FONT, STYLE, SIZE, OR COLOR.

OWNER OF U.S. REG. NO. 2,867,325.
FOR COMPUTERIZED ON-LINE RETAIL STORE SERVICES IN THE FIELD OF FOOD, GROCERY AND OFFICE PRODUCTS; RETAIL STORE SERVICES, AVAILABLE THROUGH COMPUTER COMMUNICATIONS AND INTERACTIVE APPLIANCES, FEATURING FOOD, GROCERY AND OFFICE PRODUCTS; COMPUTERIZED ONLINE ORDERING FEATURING GENERAL MERCHANDISE AND GENERAL CONSUMER GOODS; BUSINESS INFORMATION MANAGEMENT SERVICES, NAMELY, TRACKING CONSUMPTION AND RECYCLING HABITS OF CONSUMERS OVER COMPUTER NETWORKS, INTRANETS AND INTERNETS; PROVIDING ELECTRONIC BUSINESS TRACKING OF CONSUMPTION AND RECYCLING HABITS OF CONSUMERS TO OTHERS; PROVIDING AN ON-LINE COMPUTER DATABASE FEATURING TRADE INFORMATION IN THE FIELD OF CONSUMPTION AND RECYCLING HABITS OF CONSUMERS; PROVIDING CONSUMER INFORMATION IN THE FIELD OF PRODUCT SAMPLES, PRODUCT SUBSTITUTION AND RECYCLING; PROVIDING CONSUMER PRODUCT INFORMATION VIA THE INTERNET; ADVICE ON THE ANALYSIS OF CONSUMER BUYING HABITS AND NEEDS PROVIDED WITH THE HELP OF SEN-

THE MARK CONSISTS OF STANDARD CHARACTERS WITHOUT CLAIM TO ANY PARTICULAR FONT, STYLE, SIZE, OR COLOR.

NO CLAIM IS MADE TO THE EXCLUSIVE RIGHT TO USE CONSULTING, APART FROM THE MARK AS SHOWN.

FOR PROFESSIONAL BUSINESS CONSULTING SERVICES FOR FINANCIAL SERVICES COMPANIES (U.S. CLS. 100, 101 AND 102).

FIRST USE 7-1-1997; IN COMMERCE 7-1-1997.
LEIGH CAROLINE CASE, EXAMINING ATTORNEY

CLASS 35—(Continued).

SORY, QUALITY AND QUANTITY-RELATED DATA; PROVIDING INFORMATION ABOUT THE GOODS AND SERVICES OF OTHERS VIA THE GLOBAL COMPUTER NETWORK; SHOPPERS' GUIDE INFORMATION; DISSEMINATION OF ADVERTISEMENTS AND OF ADVERTISING MATERIAL INCLUDING FLYERS, BROCHURES, LEAFLETS, COUPONS AND SAMPLES VIA THE INTERNET; DISTRIBUTION OF SAMPLES FOR PUBLICITY PURPOSES; COMMERCIAL INFORMATION AGENCY SERVICES PROVIDING BUSINESS INFORMATION IN THE FIELD OF MARKETING OR DEMOGRAPHIC DATA RELATING TO CONSUMPTION AND RECYCLING HABITS OF CONSUMERS; INVENTORY CONTROL; ON-LINE SERVICES, NAMELY, ORDERING AND INVENTORY MONITORING FOR FOOD, GROCERY AND OFFICE PRODUCTS; PROMOTING THE GOODS AND SERVICES OF OTHERS THROUGH ON-LINE ORDERING AND CATALOGING OF THOSE GOODS AND SERVICES; ORGANIZATION, ARRANGING AND CONDUCTION OF INTERNET AUCTIONS (U.S. CLS. 100, 101 AND 102).

TANYA AMOS, EXAMINING ATTORNEY

SN 78-503,409. TELEVOX SOFTWARE, INC., MOBILE, AL. FILED 10-21-2004.

SMARTAPPEND

THE MARK CONSISTS OF STANDARD CHARACTERS WITHOUT CLAIM TO ANY PARTICULAR FONT, STYLE, SIZE, OR COLOR.

FOR DATABASE MANAGEMENT SERVICES, NAMELY, UPDATING, CORRECTING, AND ENHANCING COMPUTER DATABASES OF OTHERS TO INCLUDE UP-TO-DATE AND MORE ACCURATE CUSTOMER CONTACT INFORMATION (U.S. CLS. 100, 101 AND 102).

FIRST USE 10-1-2004; IN COMMERCE 10-1-2004.
CAROLYN GRAY, EXAMINING ATTORNEY

SN 78-503,714. MEDUSIND SOLUTIONS INDIA PVT LTD, MUMBAI, HUHASRASHTIA, INDIA, FILED 10-21-2004.

Medusind Solutions

THE MARK CONSISTS OF STANDARD CHARACTERS WITHOUT CLAIM TO ANY PARTICULAR FONT, STYLE, SIZE, OR COLOR.

FOR OUTSOURCING IN THE FIELDS OF HEALTH-CARE BUSINESS PROCESS OUTSOURCING (U.S. CLS. 100, 101 AND 102).

FIRST USE 12-31-2002; IN COMMERCE 12-31-2002.
LEIGH CAROLINE CASE, EXAMINING ATTORNEY

CLASS 35—(Continued).

SN 78-503,838. SOFTVU, LLC, LEAWOOD, KS. FILED 10-21-2004.

RELAY

THE MARK CONSISTS OF STANDARD CHARACTERS WITHOUT CLAIM TO ANY PARTICULAR FONT, STYLE, SIZE, OR COLOR.

OWNER OF U.S. REG. NO. 2,921,468.

FOR COMMERCIAL INFORMATION SERVICES, NAMELY, PROVIDING INFORMATION ON THE GLOBAL COMPUTER NETWORK IN A MANNER THAT PERMITS THE TRACKING AND REPORTING OF WHEN, HOW OFTEN AND BY WHICH EMAIL CLIENTS SUCH INFORMATION HAS BEEN RETRIEVED OR VIEWED; PROVIDING REPORTS AND ANALYSIS REGARDING THE EFFECTIVENESS OF TARGETED EMAIL COMMUNICATIONS; BUSINESS CONSULTATION IN THE FIELD OF COMMERCIAL EMAIL COMMUNICATIONS AND MANAGEMENT (U.S. CLS. 100, 101 AND 102).

FIRST USE 1-18-2002; IN COMMERCE 7-15-2002.
SUSAN HAYASH, EXAMINING ATTORNEY

SN 78-504,351. MINDFIRE HOLDINGS, LLC, NEWTON, MA. FILED 10-22-2004.

BE FOUND.

FOR ASSOCIATED WITH OUR AGENCY THAT PROVIDES SEARCH ENGINE MARKETING SERVICES, INTERNET ADVERTISING SERVICES, AND PRINT ADVERTISING SERVICES (U.S. CLS. 100, 101 AND 102).

FIRST USE 8-15-2004; IN COMMERCE 8-15-2004.
JILL C. ALT, EXAMINING ATTORNEY

CLASS 35—(Continued).

SN 78-504,478. INDIGO BLUE, LLC, SARASOTA, FL. FILED 10-22-2004.

INDIGO BLUE

THE MARK CONSISTS OF STANDARD CHARACTERS WITHOUT CLAIM TO ANY PARTICULAR FONT, STYLE, SIZE, OR COLOR.
FOR ADVERTISING AND PUBLIC RELATIONS SERVICES (U.S. CLS. 100, 101 AND 102).
FIRST USE 3-9-2003; IN COMMERCE 3-9-2003.
RONALD AIKENS, EXAMINING ATTORNEY

CLASS 35—(Continued).

SN 78-504,502. PARK MANAGEMENT GROUP, INC., SMYRNA, GA. FILED 10-22-2004.

PARK MANAGEMENT GROUP

THE MARK CONSISTS OF STANDARD CHARACTERS WITHOUT CLAIM TO ANY PARTICULAR FONT, STYLE, SIZE, OR COLOR.
NO CLAIM IS MADE TO THE EXCLUSIVE RIGHT TO USE "MANAGEMENT GROUP", APART FROM THE MARK AS SHOWN.
FOR HOTEL MANAGEMENT FOR OTHERS (U.S. CLS. 100, 101 AND 102).
FIRST USE 1-1-1996; IN COMMERCE 1-1-1996.
VIVIAN MICZNIK FIRST, EXAMINING ATTORNEY

SN 78-505,016. CUSTOM CABLE CORP., WESTBURY, NY. FILED 10-25-2004.



NO CLAIM IS MADE TO THE EXCLUSIVE RIGHT TO USE "CUSTOM CABLE CORP.", APART FROM THE MARK AS SHOWN.
THE MARK CONSISTS OF THE STYLIZED WORDS "CUSTOM CABLE CORP." IN BLOCK LETTERS THAT ARE BLANK INSIDE, WITH A THREE-DIMENSIONAL IMAGE OF A PIECE OF CABLE WIRE TO THE LEFT OF THE WORDS.
FOR DISTRIBUTORSHIPS IN THE FIELD OF CUSTOMIZED ELECTRONIC AND ELECTRICAL WIRE AND CABLE (U.S. CLS. 100, 101 AND 102).
FIRST USE 8-1-1974; IN COMMERCE 8-1-1974.
ROBERT LORENZO, EXAMINING ATTORNEY

SN 78-504,486. CORPORATE EXECUTIVE BOARD COMPANY, THE, WASHINGTON, DC. FILED 10-22-2004.

CLC METRICS

THE MARK CONSISTS OF STANDARD CHARACTERS WITHOUT CLAIM TO ANY PARTICULAR FONT, STYLE, SIZE, OR COLOR.
FOR BUSINESS CONSULTATION IN THE FIELD OF INFORMATION TECHNOLOGY AND HUMAN RESOURCES COMPUTER SOLUTIONS RELATING TO HUMAN RESOURCES (U.S. CLS. 100, 101 AND 102).
FIRST USE 9-1-2003; IN COMMERCE 9-1-2003.
RONALD AIKENS, EXAMINING ATTORNEY

SN 78-505,026. CUNA MUTUAL INSURANCE SOCIETY, MADISON, WI. FILED 10-25-2004.

TEAMmarketing

FOR DEVELOPING MARKETING AND ADVERTISING MATERIALS FOR FINANCIAL INSTITUTIONS TO USE IN PROMOTING THEIR PRODUCTS AND SERVICES TO THEIR CUSTOMERS (U.S. CLS. 100, 101 AND 102).
FIRST USE 8-24-1996; IN COMMERCE 8-24-1996.
ROBERT LORENZO, EXAMINING ATTORNEY

CLASS 35—(Continued).

SN 78-505,036. LIFE SCIENCE COMPUTING, LLC, BRIDGEPORT, CT. FILED 10-25-2004.

CLASS 35—(Continued).

SN 78-505,520. WALLIS OIL COMPANY, INC., CUBA, MO. FILED 10-25-2004.



THE PORTION OF THE MARK COMPRISED OF A CROSS DESIGN IN NOT DISPLAYED IN THE COLOR RED. APPLICANT DOES NOT USE AND WILL NOT USE THE CROSS DESIGN THAT APPEARS IN ITS MARK IN THE COLOR RED.

FOR MEDICAL TRANSCRIPTION SERVICES PROVIDED OVER THE INTERNET AND TELEPHONE; INTERACTIVE RECORD-KEEPING SERVICES FOR USE IN RISK MANAGEMENT AND REGULATORY COMPLIANCE BY INSURERS AND PROFESSIONALS IN THE MEDICAL FIELD; MEDICAL BILLING SERVICES PROVIDED OVER THE INTERNET; CONSULTING SERVICES PROVIDED TO MEDICAL OFFICES IN THE FIELDS OF TRACKING AND MONITORING INSURANCE COMPLIANCE AND ADMINISTRATION OF PATIENT INSURANCE REIMBURSEMENT PROGRAMS (U.S. CLS. 100, 101 AND 102).

KHANH LE, EXAMINING ATTORNEY

Make It
convenient.

FOR RETAIL CONVENIENCE STORE SERVICES (U.S. CLS. 100, 101 AND 102).
FIRST USE 3-29-2002; IN COMMERCE 3-29-2002.
KATRINA EDGE, EXAMINING ATTORNEY

SN 78-505,265. M & Z, LLP, MONROE, IN. FILED 10-25-2004.

SN 78-505,687. CARMAX BUSINESS SERVICES, LLC, GLEN ALLEN, VA. FILED 10-25-2004.



**SAVE BIG WITH
POWERBUYS!**

OWNER OF U.S. REG. NOS. 2,407,449 AND 2,493,161.
NO CLAIM IS MADE TO THE EXCLUSIVE RIGHT TO USE "BEST" AND "TIRE & SERVICE", APART FROM THE MARK AS SHOWN.

THE MARK CONSISTS OF THE STANDARD CHARACTERS OF BEST ONE TIRE & SERVICE WITH THE "O" OF ONE REPLACED BY THE DESIGN OF AN ANIMATED TIRE WITH HUMAN FEATURES, NAMELY AN ARM, TWO EYES, AND A MOUTH, WEARING A BASEBALL CAP.

FOR RETAIL AND WHOLESALE TIRE STORE SERVICES (U.S. CLS. 100, 101 AND 102).
FIRST USE 4-5-1999; IN COMMERCE 4-5-1999.
KARLA PERKINS, EXAMINING ATTORNEY

THE MARK CONSISTS OF STANDARD CHARACTERS WITHOUT CLAIM TO ANY PARTICULAR FONT, STYLE, SIZE, OR COLOR.

FOR RETAIL STORE SERVICES FEATURING AUTOMOBILES AND TRUCKS (U.S. CLS. 100, 101 AND 102).
FIRST USE 5-14-1999; IN COMMERCE 5-14-1999.
JAMES A. RAUEN, EXAMINING ATTORNEY

CLASS 35—(Continued).

SN 78-505,819. TALKING BOOK WORLD CORPORATION, LAKE BARRINGTON, IL. FILED 10-26-2004.

TBW

THE MARK CONSISTS OF STANDARD CHARACTERS WITHOUT CLAIM TO ANY PARTICULAR FONT, STYLE, SIZE, OR COLOR.

FOR COMPUTERIZED ONLINE RETAIL STORE SERVICES IN THE FIELD OF BOOKS RECORDED ON AUDIO CASSETTE TAPES, COMPACT DISCS, AND DVDS; RETAIL STORE SERVICES IN THE FIELD OF BOOKS RECORDED ON AUDIO CASSETTE TAPES, COMPACT DISCS, AND DVDS; AND RENDERING TECHNICAL AID AND ASSISTANCE IN THE ESTABLISHMENT AND OPERATION OF COMPUTERIZED ONLINE RETAIL STORE SERVICES AND RETAIL STORE SERVICES IN THE FIELD OF BOOKS RECORDED ON AUDIO CASSETTE TAPES, COMPACT DISCS, AND DVDS (U.S. CLS. 100, 101 AND 102).

FIRST USE 5-19-1994; IN COMMERCE 5-19-1994.
CHERYL STEPLIGHT, EXAMINING ATTORNEY

SN 78-506,954. ECOLAB INC. POLITICAL ACTION COMMITTEE, SAINT PAUL, MN. FILED 10-27-2004.



THE MARK CONSISTS OF ECOPAC WITH A STYLIZED LETTER "A".

FOR POLITICAL ACTION COMMITTEE SERVICES, NAMELY PROMOTING CORPORATE AND EMPLOYEE INTERESTS IN THE FIELD OF POLITICS; PROVIDING INFORMATION REGARDING POLITICAL ISSUES (U.S. CLS. 100, 101 AND 102).

FIRST USE 1-1-1992; IN COMMERCE 1-1-1992.
PAM WILLIS, EXAMINING ATTORNEY

CLASS 35—(Continued).

SN 78-509,146. BLASTER COMMUNICATIONS INC., ALTA LOMA, CA. FILED 11-1-2004.



NO CLAIM IS MADE TO THE EXCLUSIVE RIGHT TO USE "COMMUNICATIONS,INC.", APART FROM THE MARK AS SHOWN.

FOR TRACKING CONTROLLED DRUGS AND EQUIPMENT ON ALL FIRE ENGINES AND PARAMEDIC VEHICLES; TRACKING ALL INVENTORY IN FIRE AND POLICE STATIONS (U.S. CLS. 100, 101 AND 102).

DOMINIC J. FERRAIUOLO, EXAMINING ATTORNEY

SN 78-509,883. DISNEY ENTERPRISES, INC., BURBANK, CA. FILED 11-2-2004.

**DISNEY STORE
OUTLET**

THE MARK CONSISTS OF STANDARD CHARACTERS WITHOUT CLAIM TO ANY PARTICULAR FONT, STYLE, SIZE, OR COLOR.

OWNER OF U.S. REG. NO. 1,536,967.

NO CLAIM IS MADE TO THE EXCLUSIVE RIGHT TO USE "STORE OUTLET", APART FROM THE MARK AS SHOWN.

FOR RETAIL STORE SERVICES FEATURING CLOTHING, TOYS, DVDS, CDS, COMPUTER GAMES, ARTWORK, FIGURINES, HOUSEWARES, HOUSEHOLD LINENS, CONSUMER ELECTRONICS, WATCHES, JEWELRY, PINS, COSTUMES, CHRISTMAS TREE ORNAMENTS, BOOKS, LUGGAGE, PURSES, SUNGLASSES, SNOWGLOBES AND COLLECTIBLE FIGURINES (U.S. CLS. 100, 101 AND 102).

MATTHEW PAPPAS, EXAMINING ATTORNEY

CLASS 35—(Continued).

SN 78-509,990. DEUTSCHE TELEKOM AG, BONN, FED REP GERMANY, FILED 11-2-2004.

CLASS 35—(Continued).

SN 78-512,403. TRADE PRESS PUBLISHING CORPORATION, MILWAUKEE, WI. FILED 11-5-2004.

WALKING THE GREEN TALK

TeleWay

THE MARK CONSISTS OF STANDARD CHARACTERS WITHOUT CLAIM TO ANY PARTICULAR FONT, STYLE, SIZE, OR COLOR.

FOR ARRANGING AND CONDUCTING TRADE SHOW EXHIBITIONS IN THE FIELD OF ENVIRONMENTALLY CONSCIOUS BUILDING TECHNOLOGY (U.S. CLS. 100, 101 AND 102).

FIRST USE 3-9-2004; IN COMMERCE 3-9-2004.
AMY GEARIN, EXAMINING ATTORNEY

SN 78-512,481. VOIP REVIEW, LLC, LAKEWOOD, CO. FILED 11-5-2004.

THE MARK CONSISTS OF STANDARD CHARACTERS WITHOUT CLAIM TO ANY PARTICULAR FONT, STYLE, SIZE, OR COLOR.

PRIORITY CLAIMED UNDER SEC. 44(D) ON FED REP GERMANY APPLICATION NO. 30424197038, FILED 5-3-2004, REG. NO. 30424197, DATED 10-4-2004, EXPIRES 5-31-2014.

FOR TELEPHONE DIRECTORY ASSISTANCE SERVICES; ADVERTISING SERVICES, NAMELY, PREPARING AND PLACING ADVERTISEMENTS FOR OTHERS PROMOTING THE GOODS AND SERVICES OF OTHERS THROUGH PRINTED ADVERTISING, PRINTED DIRECTORIES, THROUGH ENCODED MEDIA, THROUGH THE DISSEMINATION OF PROMOTIONAL MATERIALS, THROUGH DIRECT MAIL ADVERTISING, THROUGH ELECTRONIC BILLBOARD ADVERTISING, PREPARING AUDIO-VISUAL PRESENTATIONS FOR USE IN ADVERTISING; BUSINESS MANAGEMENT SERVICES, NAMELY, BUSINESS APPRAISALS, BUSINESS AUDITING, PROVIDING BUSINESS INFORMATION, NAMELY, PREPARING BUSINESS REPORTS AND CONDUCTING BUSINESS RESEARCH, ANALYSIS AND SURVEYS, BUSINESS MANAGEMENT PLANNING, BUSINESS MANAGEMENT CONSULTATION, BUSINESS MANAGEMENT SUPERVISION, CONDUCTING BUSINESS NETWORKING FOR OTHERS; BUSINESS MANAGEMENT AND CONSULTING SERVICES, EXCLUDING AGRICULTURAL BUSINESS MANAGEMENT AND CONSULTING SERVICES; PROVIDING INFORMATION VIA THE TELEPHONE AND THE GLOBAL COMMUNICATION NETWORKS IN THE FIELD OF ADVERTISING AND BUSINESS MARKETING; PROFESSIONAL CONSULTANCY IN THE FIELD OF DATA PROCESSING; RENTAL OF AUTOMATIC VENDING MACHINES; RENTAL OF DATA PROCESSING EQUIPMENT; ORGANIZING JOB FAIRS (U.S. CLS. 100, 101 AND 102).

ALINA MORRIS, EXAMINING ATTORNEY

Voip Review

THE MARK CONSISTS OF STANDARD CHARACTERS WITHOUT CLAIM TO ANY PARTICULAR FONT, STYLE, SIZE, OR COLOR.

NO CLAIM IS MADE TO THE EXCLUSIVE RIGHT TO USE "VOIP", APART FROM THE MARK AS SHOWN.

FOR BROADBAND PHONE SERVICE LISTINGS, NAMELY, DIRECTORY INFORMATION (U.S. CLS. 100, 101 AND 102).

FIRST USE 10-1-2003; IN COMMERCE 12-1-2003.

TRACY WHITAKER-BOWN, EXAMINING ATTORNEY

CLASS 35—(Continued).

SN 78-512,532. A.D.D. MARKETING, INC., LOS ANGELES, CA. FILED 11-5-2004.

CLASS 35—(Continued).

SN 78-512,875. TA LICENSING, INC., WILMINGTON, DE. FILED 11-8-2004.

"CONSUMERS HAVE
SHORT ATTENTION
SPANS, COMMUNICATE
WISELY"

GOASIS

THE MARK CONSISTS OF STANDARD CHARACTERS WITHOUT CLAIM TO ANY PARTICULAR FONT, STYLE, SIZE, OR COLOR.

FOR ADVERTISING AND MARKETING SERVICES; ADVERTISING AGENCY SERVICES (U.S. CLS. 100, 101 AND 102).

FIRST USE 4-1-2004; IN COMMERCE 4-1-2004.
GIANCARLO CASTRO, EXAMINING ATTORNEY

THE MARK CONSISTS OF STANDARD CHARACTERS WITHOUT CLAIM TO ANY PARTICULAR FONT, STYLE, SIZE, OR COLOR.

FOR RETAIL STORE SERVICES FEATURING CONVENIENCE STORE ITEMS AND VEHICLE FUEL (U.S. CLS. 100, 101 AND 102).

JULIE GUTTADAURO, EXAMINING ATTORNEY

SN 78-512,598. PARAGON SOLUTION NETWORK, INC., CHATSWORTH, CA. FILED 11-5-2004.

SN 78-513,122. BFS BRANDS, LLC, NASHVILLE, TN. FILED 11-8-2004.

LOGINK.COM

THE LEADER IN THE
FOREST

THE MARK CONSISTS OF STANDARD CHARACTERS WITHOUT CLAIM TO ANY PARTICULAR FONT, STYLE, SIZE, OR COLOR.

FOR ONLINE RETAIL STORE SERVICES FEATURING NEW AND RECYCLED/REMANUFACTURED TONER CARTRIDGES AND INK JET CARTRIDGES, AND INK CARTRIDGE REFILL SUPPLIES, FOR PRINTERS, PHOTOCOPIERS, FACSIMILE MACHINES AND MULTI-FUNCTION OFFICE MACHINES (U.S. CLS. 100, 101 AND 102).

FIRST USE 10-20-2004; IN COMMERCE 10-20-2004.
CARRIE ACHEN, EXAMINING ATTORNEY

THE MARK CONSISTS OF STANDARD CHARACTERS WITHOUT CLAIM TO ANY PARTICULAR FONT, STYLE, SIZE, OR COLOR.

FOR RETAIL STORE SERVICES FEATURING COMMERCIAL, INDUSTRIAL, AND ORIGINAL EQUIPMENT TIRES (U.S. CLS. 100, 101 AND 102).

FIRST USE 0-0-1993; IN COMMERCE 0-0-1993.
SCOTT OSLICK, EXAMINING ATTORNEY

CLASS 35—(Continued).

SN 78-513,574. GAMESTOP, INC., GRAPEVINE, TX. FILED 11-9-2004.

SAVE NOW. TRADE
LATER. PLAY MORE.

THE MARK CONSISTS OF STANDARD CHARACTERS WITHOUT CLAIM TO ANY PARTICULAR FONT, STYLE, SIZE, OR COLOR.

OWNER OF U.S. REG. NOS. 1,982,962 AND 2,813,787.

FOR RETAIL STORE SERVICES AND ONLINE RETAIL STORE SERVICES PROVIDED VIA A GLOBAL COMPUTER NETWORK FEATURING NEW AND USED COMPUTER, VIDEO AND ELECTRONIC GAMES, VIDEOS, DVDS, MOVIES, BOOKS, MAGAZINES, STRATEGY GUIDES, COMPUTER HARDWARE, COMPUTER ACCESSORIES, TOYS AND ACTION FIGURES; PROMOTING THE SALE OF NEW AND USED COMPUTER, VIDEO AND ELECTRONIC GAMES, VIDEOS, DVDS, MOVIES, BOOKS, MAGAZINES, STRATEGY GUIDES, COMPUTER HARDWARE, COMPUTER ACCESSORIES, TOYS AND ACTION FIGURES THROUGH THE ADMINISTRATION OF A CUSTOMER INCENTIVE AWARD AND DISCOUNT PROGRAM (U.S. CLS. 100, 101 AND 102).

FIRST USE 1-1-2002; IN COMMERCE 4-28-2002.
EVELYN BRADLEY, EXAMINING ATTORNEY

SN 78-513,910. BLACK DIAMOND MEDIA, INC., SOUTH-BURY, CT. FILED 11-9-2004.



THE COLOR(S) GREEN IS/ARE CLAIMED AS A FEATURE OF THE MARK.

THE MARK CONSISTS OF THE MARK CONSISTS OF GEOMETRIC SHAPE IN GREEN WITH A DOLLAR SYMBOL AND A LARGE DOT

FOR ADVERTISING, INCLUDING PROMOTION RELATING TO THE SALE OF ARTICLES AND SERVICES FOR THIRD PARTIES BY THE TRANSMISSION OF ADVERTISING MATERIAL AND THE DISSEMINATION OF ADVERTISING MESSAGES ON COMPUTER NETWORKS (U.S. CLS. 100, 101 AND 102).

FIRST USE 9-1-2004; IN COMMERCE 9-1-2004.
HOWARD SMIGA, EXAMINING ATTORNEY

CLASS 35—(Continued).

SN 78-514,164. SWANNIE, MARK, MILILANI, HI. FILED 11-9-2004.

Q Automotive
Solutions

THE MARK CONSISTS OF STANDARD CHARACTERS WITHOUT CLAIM TO ANY PARTICULAR FONT, STYLE, SIZE, OR COLOR.

NO CLAIM IS MADE TO THE EXCLUSIVE RIGHT TO USE "AUTOMOTIVE SOLUTIONS", APART FROM THE MARK AS SHOWN.

FOR WHOLESALE TELEPHONE ORDERING SERVICES, INDEPENDENT SALES REPRESENTATIVES, AND MANUFACTURER REPRESENTATIVES ALL IN THE FIELD OF ORIGINAL EQUIPMENT MANUFACTURERS' PARTS, AFTER-MARKET PARTS, AND COMPONENTS FOR THE AUTOMOBILE INDUSTRY (U.S. CLS. 100, 101 AND 102).

PAUL F. GAST, EXAMINING ATTORNEY

SN 78-514,424. DUNKIN' DONUTS USA, INC., CANTON, MA. FILED 11-10-2004.

DUNKIN' BRANDS

OWNER OF U.S. REG. NOS. 748,901, 2,465,531 AND OTHERS.

NO CLAIM IS MADE TO THE EXCLUSIVE RIGHT TO USE BRANDS, APART FROM THE MARK AS SHOWN.

THE COLOR(S) ESPRESSO BROWN AND CARAMEL IS/ARE CLAIMED AS A FEATURE OF THE MARK.

THE MARK CONSISTS OF THE WORDS 'DUNKIN' BRANDS, WITH 'DUNKIN' BEING IN LARGER, THICKER LETTERING IN A CARAMEL COLOR EXCEPT FOR THE LETTER "U" WHICH IS ESPRESSO BROWN. THE WORD BRANDS IS IN ESPRESSO BROWN.

THE MARK CONSISTS OF THE WORDS 'DUNKIN' BRANDS, WITH 'DUNKIN' BEING IN LARGER, THICKER LETTERING IN A CARAMEL COLOR EXCEPT FOR THE LETTER "U" WHICH IS ESPRESSO BROWN. THE WORD BRANDS IS IN ESPRESSO BROWN.

FOR FRANCHISING SERVICES, NAMELY, TECHNICAL ASSISTANCE IN THE ESTABLISHMENT AND OPERATION OF FRANCHISED RESTAURANTS, DONUT AND COFFEE SHOPS, SANDWICH SHOPS AND ICE CREAM AND FROZEN CONFECTION PARLORS (U.S. CLS. 100, 101 AND 102).

PATRICIA EVANKO, EXAMINING ATTORNEY

CLASS 35—(Continued).

SN 78-515,103. SPDEE, INC., LAS VEGAS, NV. FILED 11-11-2004.

CLASS 35—(Continued).

SN 78-515,764. YONOSS, INC., WOODBRIDGE, VA. FILED 11-12-2004.



THE COLORS BLUE, GREEN, ORANGE AND YELLOW ARE CLAIMED AS FEATURES OF THE MARK.

THE "S" IN THE MARK IS BLUE, THE "P" IS GREEN, "D" IS ORANGE, THE TWO LETTERS "E" ARE YELLOW, THE DOT IS ORANGE, AND THE "COM" IS BLUE.

FOR ADVERTISING SERVICES, NAMELY, PROMOTING THE GOODS AND SERVICES OF BUSINESSES VIA ON-LINE INFORMATION DIRECTORY LISTINGS RELATED THERETO; PROVIDING A SEARCHABLE ON-LINE BUSINESS DIRECTORY FEATURING THE GOODS AND SERVICES OF OTHERS (U.S. CLS. 100, 101 AND 102).

ALICE SUE CARRUTHERS, EXAMINING ATTORNEY



SN 78-515,220. WORLD PUBLICATIONS LLC, WINTER PARK, FL. FILED 11-11-2004.

LiveBrochure
bringing images to
life

THE MARK CONSISTS OF STANDARD CHARACTERS WITHOUT CLAIM TO ANY PARTICULAR FONT, STYLE, SIZE, OR COLOR.

FOR PROVIDING MARKETING AND ADVERTISING SERVICES; NAMELY BRANDED PROMOTIONAL PRODUCTS OFFERED THROUGH PRINT, EMAIL AND ONLINE PROGRAMS (U.S. CLS. 100, 101 AND 102).

FIRST USE 8-4-2004; IN COMMERCE 8-4-2004.
MICHAEL HALL, EXAMINING ATTORNEY



OWNER OF U.S. REG. NO. 2,137,559.
NO CLAIM IS MADE TO THE EXCLUSIVE RIGHT TO USE STORE, APART FROM THE MARK AS SHOWN.

FOR RETAIL STORE SERVICES FEATURING CLOCKS, JEWELRY, WATCHES AND RELATED ACCESSORIES (U.S. CLS. 100, 101 AND 102).

PRISCILLA MILTON, EXAMINING ATTORNEY



SN 78-516,729. THE LIFE SETTLEMENT ALLIANCE, INC, FORT LAUDERDALE, FL. FILED 11-15-2004.

Creating Financial
Solutions

THE MARK CONSISTS OF STANDARD CHARACTERS WITHOUT CLAIM TO ANY PARTICULAR FONT, STYLE, SIZE, OR COLOR.

FOR CREATING AND UPDATING ADVERTISING MATERIAL (U.S. CLS. 100, 101 AND 102).

MARIAM MAHMOUDI, EXAMINING ATTORNEY

CLASS 35—(Continued).

SN 78-517,362. A TO T LAMPS, INC., LEWISVILLE, TX.
FILED 11-16-2004.



NO CLAIM IS MADE TO THE EXCLUSIVE RIGHT TO USE "LIGHT BULB LAND", APART FROM THE MARK AS SHOWN.

THE MARK CONSISTS OF A LIGHTBULB WITH RAYS OF LIGHT EMANATING FROM IT AND THE WORDS LIGHTBULBLAND.

FOR ON-LINE RETAIL STORE SERVICES FEATURING LIGHT BULBS AND BALLASTS; RETAIL SHOP FEATURING BULBS AND BALLASTS (U.S. CLS. 100, 101 AND 102).

FIRST USE 11-4-2004; IN COMMERCE 11-4-2004.
MARGERY A. TIERNEY, EXAMINING ATTORNEY

SN 78-517,365. A TO T LAMPS, INC., LEWISVILLE, TX.
FILED 11-16-2004.



NO CLAIM IS MADE TO THE EXCLUSIVE RIGHT TO USE "LAMPS", "LIGHT BULB", AND "BALLAST", APART FROM THE MARK AS SHOWN.

THE MARK CONSISTS OF THE WORDS "A TO T LAMPS" WITH RAYS OF LIGHT EMANATING FROM BEHIND THE WORD "TO", ABOVE THE WORDS "YOUR LIGHT BULB AND BALLAST SOURCE".

FOR ON-LINE RETAIL STORE SERVICES FEATURING LIGHT BULBS AND BALLASTS; RETAIL SHOP FEATURING LIGHT BULBS AND BALLASTS (U.S. CLS. 100, 101 AND 102).

FIRST USE 11-4-2004; IN COMMERCE 11-4-2004.
MARGERY A. TIERNEY, EXAMINING ATTORNEY

CLASS 35—(Continued).

SN 78-517,853. EQUINE EVENT, LLC, TIMONIUM, MD.
FILED 11-16-2004.



NO CLAIM IS MADE TO THE EXCLUSIVE RIGHT TO USE "EQUINE EVENT EAST" AND "MID-ATLANTIC'S PREMIERE EQUINE EXPOSITION", APART FROM THE MARK AS SHOWN.

THE MARK CONSISTS OF THREE HORSEHEAD PROFILES OVER A BANNER.

FOR ARRANGING AND CONDUCTING TRADE-SHOW EXHIBITIONS IN THE FIELD OF HORSES (U.S. CLS. 100, 101 AND 102).

FIRST USE 12-31-2002; IN COMMERCE 1-31-2003.
JIM RINGLE, EXAMINING ATTORNEY

SN 78-518,317. LANCET SOFTWARE DEVELOPMENT, INC.,
BURNSVILLE, MN. FILED 11-17-2004.

APERITY

THE MARK CONSISTS OF STANDARD CHARACTERS WITHOUT CLAIM TO ANY PARTICULAR FONT, STYLE, SIZE, OR COLOR.

FOR CONSULTING SERVICES IN THE FIELD OF BUSINESS BRAND MANAGEMENT (U.S. CLS. 100, 101 AND 102).

KIMBERLY FRYE, EXAMINING ATTORNEY

CLASS 35—(Continued).

SN 78-518,753. MAPET INTERNATIONAL FOUNDATION, INC., CORAL GABLES, FL. FILED 11-17-2004.



NO CLAIM IS MADE TO THE EXCLUSIVE RIGHT TO USE "PROYECTO AMAZONAS" AND "AMAZON PROJECT", APART FROM THE MARK AS SHOWN.
THE FOREIGN WORDING IN THE MARK TRANSLATES INTO ENGLISH AS AMAZON PROJECT.
FOR PROMOTING PUBLIC AWARENESS OF THE NEED FOR PRESERVATION OF THE AMAZON FOREST AND ENVIRONMENT (U.S. CLS. 100, 101 AND 102).
FIRST USE 11-1-2004; IN COMMERCE 11-1-2004.
GRETTA YAO, EXAMINING ATTORNEY

SN 78-518,811. THE SUPPORTING CAST, INC., NEW YORK, NY. FILED 11-17-2004.

ANSER TEAM

THE MARK CONSISTS OF STANDARD CHARACTERS WITHOUT CLAIM TO ANY PARTICULAR FONT, STYLE, SIZE, OR COLOR.
NO CLAIM IS MADE TO THE EXCLUSIVE RIGHT TO USE "TEAM", APART FROM THE MARK AS SHOWN.
FOR ASSOCIATION SERVICES, NAMELY PROMOTING THE INTERESTS OF INDEPENDENTLY OWNED AND OPERATED EMPLOYMENT AGENCIES, EACH PROVIDING HIRING, COUNSELING, RECRUITING, TEMPORARY AND PERMANENT PLACEMENT, STAFFING AND CAREER NETWORKING SERVICES AND OUTPLACEMENT SERVICES (U.S. CLS. 100, 101 AND 102).
BARBARA A. GOLD, EXAMINING ATTORNEY

CLASS 35—(Continued).

SN 78-519,780. CLX, LLC, ROSWELL, GA. FILED 11-18-2004.

It pays to be
smart

THE MARK CONSISTS OF STANDARD CHARACTERS WITHOUT CLAIM TO ANY PARTICULAR FONT, STYLE, SIZE, OR COLOR.
FOR WIRELESS PUBLIC OPINION POLLING SERVICE (U.S. CLS. 100, 101 AND 102).
FIRST USE 9-1-2003; IN COMMERCE 9-1-2003.
CATHERINE FAINT, EXAMINING ATTORNEY

SN 78-522,064. SPAINIT, LLC, EDINA, MN. FILED 11-23-2004.



NO CLAIM IS MADE TO THE EXCLUSIVE RIGHT TO USE "SPAIN", APART FROM THE MARK AS SHOWN.
THE MARK CONSISTS OF THE WORDS IN FANCIFUL LETTERING.
FOR ON-LINE RETAIL STORE FEATURING CERAMIC SERVING PLATTERS, CERAMIC DISHES AND PLATES, BEVERAGE GLASSWARE AND BARWARE (U.S. CLS. 100, 101 AND 102).
FIRST USE 10-9-2004; IN COMMERCE 10-9-2004.
CURTIS FRENCH, EXAMINING ATTORNEY

CLASS 35—(Continued).

SN 78-522,657. BUTSCHER, JEFFREY, MANHATTAN BEACH, CA. FILED 11-24-2004.

CLASS 35—(Continued).

SN 78-523,333. KALK, ROBERT H., HAVRE DE GRACE, MD. FILED 11-28-2004.

entertainx

THE MARK CONSISTS OF STANDARD CHARACTERS WITHOUT CLAIM TO ANY PARTICULAR FONT, STYLE, SIZE, OR COLOR.

FOR BUSINESS SERVICES, NAMELY PROVIDING ON-LINE COMPUTER DATABASES SO THAT PEOPLE WITHIN THE ENTERTAINMENT COMMUNITY CAN MARKET THEMSELVES AND THEIR SERVICES TO OTHER SECTORS OF THE ENTERTAINMENT COMMUNITY (U.S. CLS. 100, 101 AND 102).

LEIGH CAROLINE CASE, EXAMINING ATTORNEY

Rep Force One (1)

THE MARK CONSISTS OF STANDARD CHARACTERS WITHOUT CLAIM TO ANY PARTICULAR FONT, STYLE, SIZE, OR COLOR.

FOR INDEPENDENT SALES REPRESENTATIVES IN THE FIELD OF WORKFORCE DEVELOPMENT (U.S. CLS. 100, 101 AND 102).

BRIAN NEVILLE, EXAMINING ATTORNEY

SN 78-523,889. EXECUTIVE HEALTH & WEALTH INSTITUTE, INC., MIAMI SHORES, FL. FILED 11-29-2004.

SN 78-523,203. TRENDY REPEATS, LLC, PADUCAH, KY. FILED 11-26-2004.

Trendy Repeats

NEW LIFE BUSINESS PLAN

THE MARK CONSISTS OF STANDARD CHARACTERS WITHOUT CLAIM TO ANY PARTICULAR FONT, STYLE, SIZE, OR COLOR.

FOR RETAIL CONSIGNMENT STORES FEATURING CLOTHING, JEWELRY, HOUSEHOLD ITEMS, AND FURNITURE (U.S. CLS. 100, 101 AND 102).

LEIGH CAROLINE CASE, EXAMINING ATTORNEY

THE MARK CONSISTS OF STANDARD CHARACTERS WITHOUT CLAIM TO ANY PARTICULAR FONT, STYLE, SIZE, OR COLOR.

NO CLAIM IS MADE TO THE EXCLUSIVE RIGHT TO USE BUSINESS PLAN, APART FROM THE MARK AS SHOWN.

FOR BUSINESS MANAGEMENT AND CONSULTING (U.S. CLS. 100, 101 AND 102).

FIRST USE 12-1-2002; IN COMMERCE 2-1-2003.

TONI HICKEY, EXAMINING ATTORNEY

CLASS 35—(Continued).

SN 78-524,353. SURVIVOR TECHNOLOGIES, INC., HILLSIDE, NJ. FILED 11-30-2004.

CLASS 35—(Continued).

SN 78-525,191. DEUTSCHE TELEKOM AG, BONN, FED REP GERMANY, FILED 12-1-2004.

SIZE-RITE

THE MARK CONSISTS OF STANDARD CHARACTERS WITHOUT CLAIM TO ANY PARTICULAR FONT, STYLE, SIZE, OR COLOR.

FOR ON-LINE COMPUTERIZED ORDERING SYSTEM FOR VINYL DOORS AND WINDOWS (U.S. CLS. 100, 101 AND 102).

LOURDES AYALA, EXAMINING ATTORNEY

T-Mobile SMS Manager

SN 78-525,091. BUREAU INTERNATIONAL DE MEDECINS SANS FRONTIERES, GENEVE 21, SWITZERLAND, FILED 12-1-2004.



OWNER OF U.S. REG. NO. 1,156,743.

THE COLOR(S) RED, BLACK AND WHITE ARE CLAIMED AS A FEATURE OF THE MARK.

THE WORDING "MEDECINS SANS FRONTIERES DOCTORS WITHOUT BORDERS" APPEARS IN BLACK. THE LINE SEPARATING THE WORDING AND THE HEAD, ARMS, AND BACKGROUND BEHIND THE MAN RUNNING APPEAR IN RED. THE LEGS OF THE MAN RUNNING APPEAR IN WHITE.

THE ENGLISH TRANSLATION OF MEDECINS SANS FRONTIERES IS DOCTORS WITHOUT BORDERS.

FOR RECRUITMENT SERVICES FOR MEDICAL PROFESSIONALS TO PARTICIPATE IN INTERNATIONAL RELIEF PROJECTS; PROMOTING PUBLIC AWARENESS OF POPULATIONS AT RISK (U.S. CLS. 100, 101 AND 102).

FIRST USE 12-0-1971; IN COMMERCE 10-0-2001.

APRIL L. RADEMACHER, EXAMINING ATTORNEY

THE MARK CONSISTS OF STANDARD CHARACTERS WITHOUT CLAIM TO ANY PARTICULAR FONT, STYLE, SIZE, OR COLOR.

PRIORITY CLAIMED UNDER SEC. 44(D) ON FED REP GERMANY APPLICATION NO. 30431982138, FILED 6-2-2004, REG. NO. 30431982, DATED 9-9-2004, EXPIRES 6-30-2014.

OWNER OF U.S. REG. NOS. 2,282,432 AND 2,889,632.

NO CLAIM IS MADE TO THE EXCLUSIVE RIGHT TO USE "SMS MANAGER", APART FROM THE MARK AS SHOWN.

FOR ADVERTISING SERVICES, NAMELY, PREPARING AND PLACING ADVERTISEMENTS FOR OTHERS PROMOTING THE GOODS AND SERVICES OF OTHERS THROUGH PRINTED ADVERTISING, PRINTED DIRECTORIES, THROUGH ENCODED MEDIA, THROUGH THE DISSEMINATION OF PROMOTIONAL MATERIALS, THROUGH DIRECT MAIL ADVERTISING, THROUGH ELECTRONIC BILLBOARD ADVERTISING, PREPARING AUDIO-VISUAL PRESENTATIONS FOR USE IN ADVERTISING; BUSINESS MANAGEMENT SERVICES, NAMELY, BUSINESS APPRAISALS, BUSINESS AUDITING, PROVIDING BUSINESS INFORMATION, NAMELY, PREPARING BUSINESS REPORTS AND CONDUCTING BUSINESS RESEARCH, ANALYSIS AND SURVEYS, BUSINESS MANAGEMENT PLANNING, BUSINESS MANAGEMENT CONSULTATION, BUSINESS MANAGEMENT SUPERVISION, CONDUCTING BUSINESS NETWORKING FOR OTHERS; BUSINESS MANAGEMENT AND CONSULTING SERVICES, EXCLUDING AGRICULTURAL BUSINESS MANAGEMENT AND CONSULTING SERVICES; PROVIDING INFORMATION VIA THE TELEPHONE AND THE GLOBAL COMMUNICATION NETWORKS IN THE FIELD OF ADVERTISING AND BUSINESS MARKETING; PROFESSIONAL CONSULTANCY IN THE FIELD OF DATA PROCESSING (U.S. CLS. 100, 101 AND 102).

Laurie Mayes, Examining Attorney

CLASS 35—(Continued).

SN 78-525,475. WENZEL, KENNETH G., VENTURA, CA. FILED 12-1-2004.

CLASS 35—(Continued).

SN 78-525,763. CITICORP, NEW YORK, NY. FILED 12-2-2004.

TONALLI

THANKYOU

THE MARK CONSISTS OF STANDARD CHARACTERS WITHOUT CLAIM TO ANY PARTICULAR FONT, STYLE, SIZE, OR COLOR.

FOR RETAIL GROCERY STORE SERVICES (U.S. CLS. 100, 101 AND 102).
CAROLINE WOOD, EXAMINING ATTORNEY

THE MARK CONSISTS OF STANDARD CHARACTERS WITHOUT CLAIM TO ANY PARTICULAR FONT, STYLE, SIZE, OR COLOR.

OWNER OF U.S. REG. NOS. 2,923,492, 2,923,493 AND 2,926,291.

FOR PROMOTING THE GOODS AND SERVICES OF OTHERS THROUGH CREDIT CARD CUSTOMER LOYALTY, REWARD AND REDEMPTION PROGRAMS (U.S. CLS. 100, 101 AND 102).

SUE LAWRENCE, EXAMINING ATTORNEY

SN 78-525,801. TRADEDEPOT, INC., PASADENA, CA. FILED 12-2-2004.

SN 78-525,643. ABIOMED, INC., DANVERS, MA. FILED 12-2-2004.

BRIDGE TO ABIOMED

TRADEDEPOT

THE MARK CONSISTS OF STANDARD CHARACTERS WITHOUT CLAIM TO ANY PARTICULAR FONT, STYLE, SIZE, OR COLOR.

FOR CONSULTING SERVICES IN THE MANAGEMENT OF HEALTH CARE FACILITIES; CONSULTING SERVICES ON ADMINISTRATION OF REIMBURSEMENT PROGRAMS (U.S. CLS. 100, 101 AND 102).
ALICE BENMAMAN, EXAMINING ATTORNEY

THE MARK CONSISTS OF STANDARD CHARACTERS WITHOUT CLAIM TO ANY PARTICULAR FONT, STYLE, SIZE, OR COLOR.

FOR BUSINESS MANAGEMENT ASSISTANCE AND PARTICULARLY CARRYING OUT TASKS REQUIRED FOR THE SMOOTH CONDUCT OF SALES BY AUCTION (U.S. CLS. 100, 101 AND 102).

FIRST USE 3-30-2004; IN COMMERCE 5-1-2004.
DAWN FELDMAN, EXAMINING ATTORNEY

CLASS 35—(Continued).

SN 78-526,371. SKAGSETH-BRYANT, INC., MIAMI, FL. FILED 12-2-2004.

CLASS 35—(Continued).

SN 78-526,923. DEUTSCHE TELEKOM AG, BONN, FED REP GERMANY, FILED 12-3-2004.

T-Mobile M2M Connect

SKAGS

THE MARK CONSISTS OF STANDARD CHARACTERS WITHOUT CLAIM TO ANY PARTICULAR FONT, STYLE, SIZE, OR COLOR.

FOR ONLINE AND RETAIL STORE SERVICES IN THE FIELD OF OFFICE SUPPLIES AND OFFICE FURNITURE (U.S. CLS. 100, 101 AND 102).

FIRST USE 12-31-1922; IN COMMERCE 12-31-1922.
SCOTT OSCLICK, EXAMINING ATTORNEY

THE MARK CONSISTS OF STANDARD CHARACTERS WITHOUT CLAIM TO ANY PARTICULAR FONT, STYLE, SIZE, OR COLOR.

PRIORITY CLAIMED UNDER SEC. 44(D) ON FED REP GERMANY APPLICATION NO. 30433156238, FILED 6-7-2004, REG. NO. 30433156, DATED 7-20-2004, EXPIRES 6-30-2014.

OWNER OF U.S. REG. NOS. 2,282,432 AND 2,889,632.

FOR ADVERTISING SERVICES, NAMELY, PREPARING AND PLACING ADVERTISEMENTS FOR OTHERS PROMOTING THE GOODS AND SERVICES OF OTHERS THROUGH PRINTED ADVERTISING, PRINTED DIRECTORIES, THROUGH ENCODED MEDIA, THROUGH THE DISSEMINATION OF PROMOTIONAL MATERIALS, THROUGH DIRECT MAIL ADVERTISING, THROUGH ELECTRONIC BILLBOARD ADVERTISING, PREPARING AUDIO-VISUAL PRESENTATIONS FOR USE IN ADVERTISING; BUSINESS MANAGEMENT SERVICES, NAMELY, BUSINESS APPRAISALS, BUSINESS AUDITING, PROVIDING BUSINESS INFORMATION, NAMELY, PREPARING BUSINESS REPORTS AND CONDUCTING BUSINESS RESEARCH, ANALYSIS AND SURVEYS, BUSINESS MANAGEMENT PLANNING, BUSINESS MANAGEMENT CONSULTATION, BUSINESS MANAGEMENT SUPERVISION, CONDUCTING BUSINESS NETWORKING FOR OTHERS; BUSINESS MANAGEMENT AND CONSULTING SERVICES, EXCLUDING AGRICULTURAL BUSINESS MANAGEMENT AND CONSULTING SERVICES; PROVIDING INFORMATION VIA THE TELEPHONE AND THE GLOBAL COMMUNICATION NETWORKS IN THE FIELD OF ADVERTISING AND BUSINESS MARKETING; PROFESSIONAL CONSULTANCY IN THE FIELD OF DATA PROCESSING (U.S. CLS. 100, 101 AND 102).

LAURIE MAYES, EXAMINING ATTORNEY

SN 78-526,813. SARA LEE DE/N.V., 3532 AD UTRECHT, NETHERLANDS, FILED 12-3-2004.

SN 78-527,412. ISUPPLI CORP., EL SEGUNDO, CA. FILED 12-6-2004.

SENSEO

COMPETITIVE PRESSURE INDEX

THE MARK CONSISTS OF STANDARD CHARACTERS WITHOUT CLAIM TO ANY PARTICULAR FONT, STYLE, SIZE, OR COLOR.

FOR ON-LINE RETAIL STORE SERVICES FEATURING COFFEE, COFFEE MAKERS AND BEVERAGE ACCESSORIES (U.S. CLS. 100, 101 AND 102).

GIANCARLO CASTRO, EXAMINING ATTORNEY

THE MARK CONSISTS OF STANDARD CHARACTERS WITHOUT CLAIM TO ANY PARTICULAR FONT, STYLE, SIZE, OR COLOR.

NO CLAIM IS MADE TO THE EXCLUSIVE RIGHT TO USE "INDEX", APART FROM THE MARK AS SHOWN.

FOR PROVIDING MARKET SHARE ANALYSIS AND PROJECTIONS AND MARKET FORECASTING DATA BY DEVELOPING CUSTOM MAPS FOR INDIVIDUAL CLIENTS AND PRODUCT AREAS DELIVERED ON A CUSTOM BASIS (U.S. CLS. 100, 101 AND 102).

TIMOTHY FINNEGAN, EXAMINING ATTORNEY

CLASS 35—(Continued).

SN 78-528,392. MARKETING AND COMMUNICATION STRATEGIES, INC., CEDAR RAPIDS, IA. FILED 12-7-2004.

MCS

THE MARK CONSISTS OF STANDARD CHARACTERS WITHOUT CLAIM TO ANY PARTICULAR FONT, STYLE, SIZE, OR COLOR.

OWNER OF U.S. REG. NO. 2,233,944.
FOR BUSINESS CONSULTATION IN THE FIELDS OF PUBLIC RELATIONS, ADVERTISING AND MARKETING (U.S. CLS. 100, 101 AND 102).

FIRST USE 9-0-1994; IN COMMERCE 9-0-1994.
MATTHEW PAPPAS, EXAMINING ATTORNEY

CLASS 35—(Continued).

SN 78-531,629. COORS GLOBAL PROPERTIES, INC., LAKEWOOD, CO. FILED 12-13-2004.

GD=GT

THE MARK CONSISTS OF STANDARD CHARACTERS WITHOUT CLAIM TO ANY PARTICULAR FONT, STYLE, SIZE, OR COLOR.

FOR PROMOTING PUBLIC AWARENESS OF THE NEED FOR SAFETY ON THE SLOPES AND HIGHWAYS (U.S. CLS. 100, 101 AND 102).

FIRST USE 2-28-2002; IN COMMERCE 2-28-2002.
MARK SPARACINO, EXAMINING ATTORNEY

SN 78-531,192. GDPWW, INCORPORATED, LAKELAND, FL. FILED 12-13-2004.

GDPWW

THE MARK CONSISTS OF STANDARD CHARACTERS WITHOUT CLAIM TO ANY PARTICULAR FONT, STYLE, SIZE, OR COLOR.

FOR DISTRIBUTORSHIPS IN THE FIELD OF PUMPS (U.S. CLS. 100, 101 AND 102).

FIRST USE 1-1-1995; IN COMMERCE 1-1-2000.
TRACY WHITAKER-BOWN, EXAMINING ATTORNEY

SN 78-532,033. STATE OF FLORIDA DEPARTMENT OF CITRUS, LAKELAND, FL. FILED 12-14-2004.

FRESH IS BEST

THE MARK CONSISTS OF STANDARD CHARACTERS WITHOUT CLAIM TO ANY PARTICULAR FONT, STYLE, SIZE, OR COLOR.

FOR PROMOTING THE USE OF FRESH FLORIDA SQUEEZED ORANGE JUICE AND FRESH CITRUS FRUITS UTILIZED IN PRODUCTION OF SAME, THROUGH ADVERTISING IN PRINT, RADIO, TELEVISION, OUTDOOR SIGNS AND ELECTRONIC MEDIA (U.S. CLS. 100, 101 AND 102).

FIRST USE 10-28-2004; IN COMMERCE 10-28-2004.
ANNE MADDEN, EXAMINING ATTORNEY

CLASS 35—(Continued).

SN 78-532,458. GREENTARGET GLOBAL GROUP, LLC, CHICAGO, IL. FILED 12-14-2004.

GREENTARGET

THE MARK CONSISTS OF STANDARD CHARACTERS WITHOUT CLAIM TO ANY PARTICULAR FONT, STYLE, SIZE, OR COLOR.
FOR PUBLIC RELATIONS AND COMMUNICATIONS MANAGEMENT SERVICES (U.S. CLS. 100, 101 AND 102).
FIRST USE 4-1-2005; IN COMMERCE 4-1-2005.
SEAN DWYER, EXAMINING ATTORNEY

CLASS 35—(Continued).

SN 78-532,935. NEWS AMERICA MARKETING PROPERTIES, INC., CHICAGO, IL. FILED 12-15-2004.

**SMARTSOURCE
AUDIOINK**

THE MARK CONSISTS OF STANDARD CHARACTERS WITHOUT CLAIM TO ANY PARTICULAR FONT, STYLE, SIZE, OR COLOR.
OWNER OF U.S. REG. NOS. 2,186,735, 2,554,497 AND OTHERS.
FOR PROVISION OF ADVERTISING FOR OTHERS VIA SOUND DELIVERY OF IN-STORE ADVERTISING (U.S. CLS. 100, 101 AND 102).
FIRST USE 9-0-2004; IN COMMERCE 9-0-2004.
TEJBIR SINGH, EXAMINING ATTORNEY

SN 78-533,866. APPLIED INDUSTRIAL TECHNOLOGIES, INC., CLEVELAND, OH. FILED 12-16-2004.

SN 78-532,831. PIZZA HUT, INC., DALLAS, TX. FILED 12-15-2004.



FOR PROVIDING A CUSTOMER LOYALTY INCENTIVE PROGRAM WHEREBY PARTICIPANTS ACCUMULATE VALUE FROM PURCHASES WHICH CAN BE REDEEMED AGAINST FUTURE PURCHASES (U.S. CLS. 100, 101 AND 102).
FIRST USE 11-17-2004; IN COMMERCE 11-17-2004.
KATRINA EDGE, EXAMINING ATTORNEY

**MAINTENANCE NEVER
ENDS. WE NEVER
QUIT.**

THE MARK CONSISTS OF STANDARD CHARACTERS WITHOUT CLAIM TO ANY PARTICULAR FONT, STYLE, SIZE, OR COLOR.
FOR DISTRIBUTORSHIP SERVICES IN THE FIELD OF INDUSTRIAL COMPONENTS, NAMELY, BEARINGS, POWER TRANSMISSION DEVICES, RUBBER PRODUCTS IN THE NATURE OF CONVEYOR BELTING AND ACCESSORIES, HYDRAULIC HOSE FITTINGS AND EQUIPMENT, AND INDUSTRIAL HOSE AND FITTINGS, ELECTRICAL PRODUCTS, LINEAR PRODUCTS, SPECIALTY PRODUCTS IN THE NATURE OF FLUID SEALING PRODUCTS, GENERAL INDUSTRIAL/MILL SUPPLIES, PRECISION MECHANICAL COMPONENTS, SPINDLES, LIVE/DEAD CENTERS, AND UNIVERSAL JOINTS, MAINTENANCE, ANALYTICAL TOOLS AND ACCESSORIES IN FLUID POWER PRODUCTS (U.S. CLS. 100, 101 AND 102).
CARRIE ACHEN, EXAMINING ATTORNEY

CLASS 35—(Continued).

SN 78-534,010. ADAMS-GABBERT & ASSOCIATES, INC.,
LEE'S SUMMIT, MO. FILED 12-16-2004.

CLASS 35—(Continued).

SN 78-534,614. MICHAEL C. FINA COMPANY, NEW YORK,
NY. FILED 12-17-2004.

**RIGHT SOLUTIONS.
RIGHT PEOPLE.**

MAGIC BOX

THE MARK CONSISTS OF STANDARD CHARACTERS
WITHOUT CLAIM TO ANY PARTICULAR FONT, STYLE,
SIZE, OR COLOR.

FOR BUSINESS CONSULTING SERVICES RELATING
TO PRODUCT DISTRIBUTION, OPERATIONS MAN-
AGEMENT SERVICES, LOGISTICS, REVERSE LOGIS-
TICS, SUPPLY CHAIN, AND PRODUCTION SYSTEMS
AND DISTRIBUTION SOLUTIONS (U.S. CLS. 100, 101
AND 102).

FIRST USE 5-1-2004; IN COMMERCE 5-1-2004.
NAAKWAMA ANKRAH, EXAMINING ATTORNEY

THE MARK CONSISTS OF STANDARD CHARACTERS
WITHOUT CLAIM TO ANY PARTICULAR FONT, STYLE,
SIZE, OR COLOR.

FOR CONDUCTING EMPLOYEE RECOGNITION
AWARD PROGRAMS FOR OTHERS TO PROMOTE JOB
QUALITY AND LONGEVITY (U.S. CLS. 100, 101 AND
102).

FIRST USE 11-15-1996; IN COMMERCE 11-15-1996.
STEVEN R. FINE, EXAMINING ATTORNEY

SN 78-534,553. CASTANO, FRANCESCO, LANCASTER, PA.
FILED 12-17-2004.

SN 78-535,670. CBS BROADCASTING INC., NEW YORK, NY.
FILED 12-20-2004.

IncrediBody

THE COURIER

THE MARK CONSISTS OF STANDARD CHARACTERS
WITHOUT CLAIM TO ANY PARTICULAR FONT, STYLE,
SIZE, OR COLOR.

FOR ONLINE RETAIL STORE SERVICE FEATURING
WEIGHT LOSS AND BODY BUILDING PRODUCTS (U.S.
CLS. 100, 101 AND 102).

FIRST USE 1-1-1997; IN COMMERCE 1-1-1997.
PATRICIA EVANKO, EXAMINING ATTORNEY

THE MARK CONSISTS OF STANDARD CHARACTERS
WITHOUT CLAIM TO ANY PARTICULAR FONT, STYLE,
SIZE, OR COLOR.

FOR PRODUCTION AND DISTRIBUTION OF A SER-
IES OF INTERSTITIAL TELEVISION COMMERCIAL
SEGMENTS (U.S. CLS. 100, 101 AND 102).

EVELYN BRADLEY, EXAMINING ATTORNEY

CLASS 35—(Continued).

SN 78-536,014. CLEAN COMMODITIES LLC, NORTHBOROUGH, MA. FILED 12-21-2004.

UNDO YOUR CO2

THE MARK CONSISTS OF STANDARD CHARACTERS WITHOUT CLAIM TO ANY PARTICULAR FONT, STYLE, SIZE, OR COLOR.

FOR PROMOTING THE GOODS AND SERVICES OF OTHERS THROUGH THE DISTRIBUTION OF MEMBERSHIP CARDS, PASSES, AND PROMOTIONAL MATERIAL IN THE NATURE OF AFFINITY PRODUCTS, AND THE ADMINISTRATION OF A CLUB MEMBERSHIP PROGRAM FOR ENABLING PARTICIPANTS TO PURCHASE EMISSION REDUCTIONS AND MAKE CONTRIBUTIONS TO RENEWABLE ENERGY COMPANIES FOR THE PURPOSES OF PROMOTING RENEWABLE ENERGY AND/OR REDUCING GREENHOUSE GAS EMISSIONS THAT CONTRIBUTE TO GLOBAL WARMING AND CLIMATE CHANGE, AND OBTAIN DISCOUNTS AND SPECIAL INCENTIVES ON GOODS AND SERVICES FROM PARTICIPATING ENTITIES THROUGH USE OF A MEMBERSHIP CARD, PASS OR AFFINITY PRODUCT (U.S. CLS. 100, 101 AND 102).

FIRST USE 12-18-2004; IN COMMERCE 12-18-2004.
REBECCA GILBERT, EXAMINING ATTORNEY

SN 78-536,044. TSRC, INC., ASHLAND, VA. FILED 12-21-2004.

MEGA OFFICE SAVER

THE MARK CONSISTS OF STANDARD CHARACTERS WITHOUT CLAIM TO ANY PARTICULAR FONT, STYLE, SIZE, OR COLOR.

OWNER OF U.S. REG. NOS. 2,147,682 AND 2,149,330.
NO CLAIM IS MADE TO THE EXCLUSIVE RIGHT TO USE "OFFICE", APART FROM THE MARK AS SHOWN.

FOR RETAIL AND WHOLESALE STORE SERVICES FEATURING OFFICE FURNITURE, OFFICE SUPPLIES, PAPER GOODS, OFFICE MACHINES, COMPUTER EQUIPMENT AND COMPUTER SUPPLIES; MAIL ORDER CATALOG SERVICES FEATURING OFFICE FURNITURE, OFFICE SUPPLIES, PAPER GOODS, OFFICE MACHINES, COMPUTER EQUIPMENT AND COMPUTER SUPPLIES; ONLINE RETAIL STORE FEATURING OFFICE FURNITURE, OFFICE SUPPLIES, PAPER GOODS, OFFICE MACHINES, COMPUTER EQUIPMENT AND COMPUTER SUPPLIES (U.S. CLS. 100, 101 AND 102).

KEVIN DINALLO, EXAMINING ATTORNEY

CLASS 35—(Continued).

SN 78-536,375. BLOCKBUSTER INC., DALLAS, TX. FILED 12-21-2004.

RHINO VIDEO GAMES

THE MARK CONSISTS OF STANDARD CHARACTERS WITHOUT CLAIM TO ANY PARTICULAR FONT, STYLE, SIZE, OR COLOR.

OWNER OF U.S. REG. NO. 2,485,098.

NO CLAIM IS MADE TO THE EXCLUSIVE RIGHT TO USE "VIDEO GAMES", APART FROM THE MARK AS SHOWN.

FOR RETAIL STORE, ONLINE RETAIL STORE AND ELECTRONIC CATALOGUE SERVICES FEATURING AUDIO-VIDEO RECORDINGS OF FILMS, MOVIES, PRE-RECORDED VIDEO CASSETTES, DIGITAL VERSATILE DISCS OR DVDS, ELECTRONIC AND COMPUTERIZED VIDEO GAMES AND ASSOCIATED ELECTRONIC EQUIPMENT AND ACCESSORIES, GAME BOOKS, MAGAZINES, TOYS, FOODSTUFFS, CLOTHING FEATURING T-SHIRTS AND HEADGEAR, COMPUTER SOFTWARE AND HARDWARE, AND RELATED HOME ENTERTAINMENT PRODUCTS AND EQUIPMENT; RETAIL STORE AND ON-LINE RETAIL STORE SERVICES FEATURING NEW AND USED FILMS, MOVIES, DVDS, ELECTRONIC AND COMPUTERIZED VIDEO GAMES; RETAIL STORE AND ON-LINE RETAIL STORE SERVICES FEATURING DVD, VIDEO AND COMPUTER GAME TRADING (U.S. CLS. 100, 101 AND 102).

FIRST USE 4-15-1999; IN COMMERCE 12-31-1999.
GRETTA YAO, EXAMINING ATTORNEY

SN 78-536,503. SINGLE THROW INC., WALL, NJ. FILED 12-21-2004.

**From Search to
Success**

THE MARK CONSISTS OF STANDARD CHARACTERS WITHOUT CLAIM TO ANY PARTICULAR FONT, STYLE, SIZE, OR COLOR.

FOR INTERNET MARKETING CONSULTING (U.S. CLS. 100, 101 AND 102).

FIRST USE 1-1-2003; IN COMMERCE 9-1-2003.

JENNIFER WILLISTON, EXAMINING ATTORNEY

CLASS 35—(Continued).

SN 78-536,735. TROPHIES2GO.COM, ISSAQUAH, WA.
FILED 12-22-2004.

CLASS 35—(Continued).

SN 78-537,054. YUBILL, INC., JENKINTOWN, PA. FILED
12-22-2004.

Member Solutions

CHIPCHAMPION

THE MARK CONSISTS OF STANDARD CHARACTERS WITHOUT CLAIM TO ANY PARTICULAR FONT, STYLE, SIZE, OR COLOR.

FOR ELECTRONIC RETAILING SERVICES VIA COMPUTER, ON-LINE RETAIL STORE SERVICES, TELEPHONE RETAIL SERVICES AND RETAIL STORE SERVICES, ALL IN THE FIELDS OF AWARDS, TROPHIES, PLAQUES, TABLETS, MEDALS, MEDALLIONS, PINS, RIBBONS, CERTIFICATES, BOWLS, DESK SETS, CLOCKS, NAME IDENTIFICATION ITEMS, CRYSTALS, MONEY CLIPS, ASH TRAYS, LICENSE PLATE FRAMES, CIGAR HOLDERS, CIGAR CUTTERS, DISPLAY CASES, APPAREL, HATS, WHISTLES, CLIPBOARDS, MUGS, CUPS, GLASSES, PENS, MARTINI SHAKERS AND NOVELTY GIFTS (U.S. CLS. 100, 101 AND 102).

ROBERT C. CLARK JR., EXAMINING ATTORNEY

THE MARK CONSISTS OF STANDARD CHARACTERS WITHOUT CLAIM TO ANY PARTICULAR FONT, STYLE, SIZE, OR COLOR.

NO CLAIM IS MADE TO THE EXCLUSIVE RIGHT TO USE "MEMBER", APART FROM THE MARK AS SHOWN.

FOR PROVIDING BUSINESS SERVICES, NAMELY, ONLINE BILLING, AND MEMBERSHIP MANAGEMENT FOR OTHERS, NAMELY, BUSINESS ADMINISTRATION AND MANAGEMENT FOR OTHERS (U.S. CLS. 100, 101 AND 102).

FIRST USE 4-1-2005; IN COMMERCE 4-1-2005.

ANDREA K. NADELMAN, EXAMINING ATTORNEY

SN 78-537,086. RADIATOR WORLD INC., PORTLAND, OR.
FILED 12-22-2004.

RadiatorWorld.com

SN 78-536,958. HEALTHY PETS, INC., HAYWARD, CA.
FILED 12-22-2004.

FOR RETAIL STORE AND ONLINE RETAIL STORE SERVICES FEATURING RADIATORS, CONDENSERS, AND OTHER AUTOMOTIVE REPLACEMENT PARTS RELATED TO AUTOMOTIVE HEATING, COOLING, AND AIR CONDITIONING (U.S. CLS. 100, 101 AND 102).

FIRST USE 1-1-2003; IN COMMERCE 3-1-2004.

DAWN HAN, EXAMINING ATTORNEY

SN 78-537,107. HERE'S THE DEAL, LLC, CHARLESTON, SC.
FILED 12-22-2004.

ENTIRELYPETS

THE MARK CONSISTS OF STANDARD CHARACTERS WITHOUT CLAIM TO ANY PARTICULAR FONT, STYLE, SIZE, OR COLOR.

FOR ONLINE RETAIL STORE SERVICES FEATURING PET SUPPLIES AND PRODUCTS (U.S. CLS. 100, 101 AND 102).

FIRST USE 6-30-2000; IN COMMERCE 6-30-2000.

JUDITH HELFMAN, EXAMINING ATTORNEY

THE MARK CONSISTS OF STANDARD CHARACTERS WITHOUT CLAIM TO ANY PARTICULAR FONT, STYLE, SIZE, OR COLOR.

FOR PROVIDING CONSUMER PRODUCT INFORMATION VIA THE INTERNET (U.S. CLS. 100, 101 AND 102).

FIRST USE 8-1-2004; IN COMMERCE 8-1-2004.

DAVID MURRAY, EXAMINING ATTORNEY

HERE'S THE DEAL

CLASS 35—(Continued).

SN 78-537,141. BOOKS GALORE AND MORE, L.L.C., MCKINNEY, TX. FILED 12-22-2004.

NOT JUST BOOKS

THE MARK CONSISTS OF STANDARD CHARACTERS WITHOUT CLAIM TO ANY PARTICULAR FONT, STYLE, SIZE, OR COLOR.

FOR ONLINE RETAIL STORE SERVICES FEATURING BOOKS, CDS, MOVIES AND GAMING SOFTWARE (U.S. CLS. 100, 101 AND 102).

FIRST USE 12-20-2004; IN COMMERCE 12-20-2004.
RAUL CORDOVA, EXAMINING ATTORNEY

SN 78-537,312. BKD, LLP, SPRINGFIELD, MO. FILED 12-22-2004.



OWNER OF U.S. REG. NO. 2,724,123.
FOR ACCOUNTING SERVICES, BUSINESS INFORMATION AND ACCOUNTING ADVISORY SERVICES; TAX ADVISORY, PREPARATION, CONSULTATION AND PLANNING SERVICES (U.S. CLS. 100, 101 AND 102).

FIRST USE 6-0-2001; IN COMMERCE 6-0-2001.
CHARLES L. JENKINS, EXAMINING ATTORNEY

SN 78-537,431. UTAH LEAGUE OF CREDIT UNIONS, SALT LAKE CITY, UT. FILED 12-22-2004.

**THE CREDIT UNION
GUY**

THE MARK CONSISTS OF STANDARD CHARACTERS WITHOUT CLAIM TO ANY PARTICULAR FONT, STYLE, SIZE, OR COLOR.

NO CLAIM IS MADE TO THE EXCLUSIVE RIGHT TO USE CREDIT UNION, APART FROM THE MARK AS SHOWN.

FOR PROMOTION OF CREDIT UNION SERVICES (U.S. CLS. 100, 101 AND 102).

LINDA POWELL, EXAMINING ATTORNEY

CLASS 35—(Continued).

SN 78-537,509. TROPHIES2GO.COM, ISSAQUAH, WA. FILED 12-23-2004.

ChipChampion

FOR ELECTRONIC RETAILING SERVICES VIA COMPUTER, ON-LINE RETAIL STORE SERVICES, TELEPHONE RETAIL SERVICES AND RETAIL STORE SERVICES, ALL IN THE FIELDS OF AWARDS, TROPHIES, PLAQUES, TABLETS, MEDALS, MEDALLIONS, PINS, RIBBONS, CERTIFICATES, BOWLS, DESK SETS, CLOCKS, NAME IDENTIFICATION ITEMS, CRYSTALS, MONEY CLIPS, ASH TRAYS, LICENSE PLATE FRAMES, CIGAR HOLDERS, CIGAR CUTTERS, DISPLAY CASES, APPAREL, HATS, WHISTLES, CLIPBOARDS, MUGS, CUPS, GLASSES, PENS, MARTINI SHAKERS AND NOVELTY GIFTS (U.S. CLS. 100, 101 AND 102).

ROBERT C. CLARK JR., EXAMINING ATTORNEY

SN 78-537,604. MICHIGAN INFRASTRUCTURE & TRANSPORTATION ASSOCIATION, INC., OKEMOS, MI. FILED 12-23-2004.



FOR ASSOCIATION SERVICES, NAMELY PROMOTING THE INTERESTS OF CONSTRUCTION COMPANIES, SUPPORT SERVICE FIRMS AND SUPPLIERS (U.S. CLS. 100, 101 AND 102).

FIRST USE 1-0-1997; IN COMMERCE 1-0-1997.
ROBERT C. CLARK JR., EXAMINING ATTORNEY

SN 78-537,676. ECOMPANYSTORE, INC., ALPHARETTA, GA. FILED 12-23-2004.

CONNECT YOUR BRAND

THE MARK CONSISTS OF STANDARD CHARACTERS WITHOUT CLAIM TO ANY PARTICULAR FONT, STYLE, SIZE, OR COLOR.

NO CLAIM IS MADE TO THE EXCLUSIVE RIGHT TO USE BRAND, APART FROM THE MARK AS SHOWN.

FOR ON-LINE ORDERING SERVICES IN THE FIELD OF GENERAL MERCHANDISE, CLOTHING AND GENERAL PROMOTIONAL CONSUMER PRODUCTS FOR USE BY OTHERS FOR BRAND MARKETING PROGRAMS, INCENTIVE PROGRAMS, BUSINESS GIFTS AND UNIFORMS (U.S. CLS. 100, 101 AND 102).

FIRST USE 1-12-2004; IN COMMERCE 1-12-2004.
WILLIAM VERHOSEK, EXAMINING ATTORNEY

CLASS 35—(Continued).

SN 78-537,761. LAUGHING MONKEY CORPORATION,
VAIL, CO. FILED 12-23-2004.

LAUGHING MONKEY

THE MARK CONSISTS OF STANDARD CHARACTERS WITHOUT CLAIM TO ANY PARTICULAR FONT, STYLE, SIZE, OR COLOR.

FOR RETAIL STORES FEATURING APPAREL, CLOTHING, HEADGEAR, JEWELRY, LUGGAGE, HOME FURNISHINGS, DECORATIVE ITEMS, ARTIFACTS, CRAFTS, ARTWORK AND GIFT ITEMS (U.S. CLS. 100, 101 AND 102).

FIRST USE 6-9-1992; IN COMMERCE 6-9-1992.
ROBERT COGGINS, EXAMINING ATTORNEY

SN 78-537,791. NIHC, INC., PORTLAND, OR. FILED 12-23-2004.

NORDSTROM

THE MARK CONSISTS OF STANDARD CHARACTERS WITHOUT CLAIM TO ANY PARTICULAR FONT, STYLE, SIZE, OR COLOR.

OWNER OF U.S. REG. NOS. 2,378,940, 2,747,163 AND OTHERS.
SEC. 2(F).

FOR PRE-PAID GIFT CARD SERVICES, NAMELY ISSUING GIFT CARD CERTIFICATES THAT MAY BE REDEEMED FOR GOODS OR SERVICES; RETAIL STORE, MAIL ORDER AND ONLINE RETAIL STORE SERVICES IN THE FIELDS OF CLOTHING, APPAREL, OUTERWEAR, FASHION ACCESSORIES, HEADWEAR, SMALL LEATHER GOODS, BELTS, GLOVES, SCARVES, HOSIERY, FOOTWEAR, EYEWEAR, FRAGRANCES, COSMETICS, PERSONAL CARE PRODUCTS, BATH AND BODY PRODUCTS, JEWELRY, WATCHES, HAIR ACCESSORIES, GIFTS, FOOD ITEMS, HOUSEWARES, FURNITURE, BEDDING AND HOME LIGHTING PRODUCTS (U.S. CLS. 100, 101 AND 102).

FIRST USE 11-0-1972; IN COMMERCE 12-0-1972.
SUSAN HAYASH, EXAMINING ATTORNEY

CLASS 35—(Continued).

SN 78-537,906. KENTSHIRE GALLERIES LTD., NEW YORK,
NY. FILED 12-23-2004.

KENTSHIRE

THE MARK CONSISTS OF STANDARD CHARACTERS WITHOUT CLAIM TO ANY PARTICULAR FONT, STYLE, SIZE, OR COLOR.

FOR RETAIL STORE SERVICES FEATURING LATE 17TH THROUGH 19TH CENTURY ENGLISH AND CONTINENTAL ANTIQUE FURNITURE, FURNISHINGS, ACCESSORIES AND JEWELRY; COMPUTERIZED ONLINE RETAIL STORE SERVICES FEATURING LATE 17TH THROUGH 19TH CENTURY ENGLISH AND CONTINENTAL ANTIQUE FURNITURE, FURNISHINGS, ACCESSORIES AND JEWELRY (U.S. CLS. 100, 101 AND 102).

FIRST USE 12-31-1960; IN COMMERCE 12-31-1960.
ESTHER BELENKER, EXAMINING ATTORNEY

SN 78-537,907. KENTSHIRE GALLERIES LTD., NEW YORK,
NY. FILED 12-23-2004.

**KENTSHIRE
GALLERIES**

THE MARK CONSISTS OF STANDARD CHARACTERS WITHOUT CLAIM TO ANY PARTICULAR FONT, STYLE, SIZE, OR COLOR.

NO CLAIM IS MADE TO THE EXCLUSIVE RIGHT TO USE "GALLERIES", APART FROM THE MARK AS SHOWN. FOR RETAIL STORE SERVICES FEATURING LATE 17TH THROUGH 19TH CENTURY ENGLISH AND CONTINENTAL ANTIQUE FURNITURE, FURNISHINGS, ACCESSORIES AND JEWELRY; COMPUTERIZED RETAIL STORE SERVICES FEATURING LATE 17TH THROUGH 19TH CENTURY ENGLISH AND CONTINENTAL ANTIQUE FURNITURE, FURNISHINGS, ACCESSORIES AND JEWELRY (U.S. CLS. 100, 101 AND 102).

FIRST USE 12-31-1960; IN COMMERCE 12-31-1960.
ESTHER BELENKER, EXAMINING ATTORNEY

CLASS 35—(Continued).

SN 78-537,936. E ELEMENT LLC, CHICAGO, IL. FILED 12-23-2004.

CLASS 35—(Continued).

SN 78-538,276. SPISAKOVA, MONIKA, SAN DIEGO, CA. FILED 12-24-2004.



Gift Of Crystal

NO CLAIM IS MADE TO THE EXCLUSIVE RIGHT TO USE "E AUCTIONS", APART FROM THE MARK AS SHOWN.

FOR BUSINESS SERVICES, NAMELY, ONLINE INTERNATIONAL AUCTION SERVICES (U.S. CLS. 100, 101 AND 102).

FIRST USE 11-1-2004; IN COMMERCE 11-15-2004.
MICHELE SWAIN, EXAMINING ATTORNEY

THE MARK CONSISTS OF STANDARD CHARACTERS WITHOUT CLAIM TO ANY PARTICULAR FONT, STYLE, SIZE, OR COLOR.

NO CLAIM IS MADE TO THE EXCLUSIVE RIGHT TO USE "CRYSTAL", APART FROM THE MARK AS SHOWN. FOR ONLINE RETAIL GIFT SHOP (U.S. CLS. 100, 101 AND 102).

FIRST USE 1-19-2004; IN COMMERCE 3-1-2004.
CYNTHIA SLOAN, EXAMINING ATTORNEY

SN 78-538,044. UNITED CAR CARE, INC., GREENWOOD VILLAGE, CO. FILED 12-23-2004.

SN 78-538,462. TAMALE SOFTWARE, INC., BOSTON, MA. FILED 12-27-2004.

"Down the road,
We're there for you!"



THE MARK CONSISTS OF STANDARD CHARACTERS WITHOUT CLAIM TO ANY PARTICULAR FONT, STYLE, SIZE, OR COLOR.

FOR DISTRIBUTORSHIPS IN THE FIELD OF PUBLICITY MATERIALS SUCH AS FLYERS, PROSPECTUSES, BROCHURES AND SAMPLES (U.S. CLS. 100, 101 AND 102).

ANDREW BENZMILLER, EXAMINING ATTORNEY

THE MARK CONSISTS OF A STYLIZED PEPPER. FOR BUSINESS SERVICES IN THE NATURE OF BUSINESS RESEARCH (U.S. CLS. 100, 101 AND 102).

FIRST USE 2-16-2005; IN COMMERCE 2-16-2005.
RENEE MCCRAY, EXAMINING ATTORNEY

CLASS 35—(Continued).

SN 78-538,560. TR GRACE, LLC, SIMSBURY, CT. FILED 12-27-2004.

TR GRACE

THE MARK CONSISTS OF STANDARD CHARACTERS WITHOUT CLAIM TO ANY PARTICULAR FONT, STYLE, SIZE, OR COLOR.

FOR TEMPORARY AND PERMANENT STAFFING SERVICES FOR LAWYERS AND PARALEGALS (U.S. CLS. 100, 101 AND 102).

FIRST USE 11-21-2001; IN COMMERCE 11-21-2001.
JENNIFER WILLISTON, EXAMINING ATTORNEY

SN 78-538,866. LOGONATION, INC., MOORESVILLE, NC. FILED 12-28-2004.

LOGONATION

THE MARK CONSISTS OF STANDARD CHARACTERS WITHOUT CLAIM TO ANY PARTICULAR FONT, STYLE, SIZE, OR COLOR.

FOR ADVERTISING SERVICES, NAMELY, PROMOTING THE GOODS AND SERVICES OF OTHERS BY AFFIXING TRADEMARKS, TRADE NAMES, LOGOS, AND SERVICE MARKS OF OTHERS TO A WIDE VARIETY OF PROMOTIONAL GOODS AND SERVICES (U.S. CLS. 100, 101 AND 102).

FIRST USE 12-7-1999; IN COMMERCE 12-7-1999.
ATTIYA MALIK, EXAMINING ATTORNEY

CLASS 35—(Continued).

SN 78-538,893. INTERNET AUTO RENT & SALES, RENO, NV. FILED 12-28-2004.

WHY PAY THE
DIFFERENCE?! IF YOU
CAN'T TELL THE
DIFFERENCE.

THE MARK CONSISTS OF STANDARD CHARACTERS WITHOUT CLAIM TO ANY PARTICULAR FONT, STYLE, SIZE, OR COLOR.

FOR RETAIL STORE SERVICES FEATURING NEW AND USED VEHICLES (U.S. CLS. 100, 101 AND 102).

FIRST USE 2-1-1997; IN COMMERCE 2-1-1997.
DAVID MURRAY, EXAMINING ATTORNEY

SN 78-539,340. REVEL LEVER, LLC, MINNEAPOLIS, MN. FILED 12-28-2004.

REVEL LEVER

THE MARK CONSISTS OF THE WORD REVEL READING FORWARD AND THE WORD LEVEL READING LIKE A MIRROR REFLECTION OF THE WORD REVEL, SO THAT THE LETTERS IN LEVER APPEAR BACKWARDS.

FOR BUSINESS CONSULTATION AND MANAGEMENT OF PERFORMING ARTISTS (U.S. CLS. 100, 101 AND 102).

FIRST USE 7-8-2004; IN COMMERCE 7-8-2004.
CAROLINE WOOD, EXAMINING ATTORNEY

CLASS 35—(Continued).

SN 78-539,683. FISHER SCIENTIFIC COMPANY L.L.C., HAMPTON, NH. FILED 12-29-2004.

CLASS 35—(Continued).

SN 78-539,818. TROPICAL SHIPPING AND CONSTRUCTION COMPANY LIMITED, RIVIERA BEACH, FL. FILED 12-29-2004.

SCIENCEVILLE

COME BACK AND STAY IN THE CARIBBEAN

THE MARK CONSISTS OF STANDARD CHARACTERS WITHOUT CLAIM TO ANY PARTICULAR FONT, STYLE, SIZE, OR COLOR.

FOR DISTRIBUTORSHIPS AND ON-LINE STORE SERVICES IN THE FIELDS OF SCIENCE, MATH, ASTRONOMY, GEOLOGY, CHEMISTRY, BIOLOGY TEACHING PRODUCTS AND LABORATORY PRODUCTS AND SUPPLIES (U.S. CLS. 100, 101 AND 102).

FIRST USE 12-0-2004; IN COMMERCE 12-0-2004.
RICHARD A. STRASER, EXAMINING ATTORNEY

THE MARK CONSISTS OF STANDARD CHARACTERS WITHOUT CLAIM TO ANY PARTICULAR FONT, STYLE, SIZE, OR COLOR.

FOR PROMOTING BUSINESS AND TOURISM IN THE CARIBBEAN (U.S. CLS. 100, 101 AND 102).

FIRST USE 4-0-2001; IN COMMERCE 4-0-2001.
KARANENDRA S. CHHINA, EXAMINING ATTORNEY

SN 78-539,742. BRUBAKER, STEVEN J., FRISCO, TX. FILED 12-29-2004.

SN 78-540,160. THE FRISCO SISTERS AND A PRAYER LLC, FRISCO, TX. FILED 12-30-2004.

PHARMNET RX

EXTRAVAGANT NECESSITIES

THE MARK CONSISTS OF STANDARD CHARACTERS WITHOUT CLAIM TO ANY PARTICULAR FONT, STYLE, SIZE, OR COLOR.

NO CLAIM IS MADE TO THE EXCLUSIVE RIGHT TO USE "RX", APART FROM THE MARK AS SHOWN.

FOR ELECTRONIC RETAILING VIA THE INTERNET IN THE FIELD OF PRESCRIPTION AND NON-PRESCRIPTION DRUGS, VITAMINS, NUTRITIONAL SUPPLEMENTS AND DURABLE MEDICAL EQUIPMENT; RETAIL STORES FEATURING PRESCRIPTION AND NON-PRESCRIPTION DRUGS, VITAMINS, NUTRITIONAL SUPPLEMENTS AND DURABLE MEDICAL EQUIPMENT (U.S. CLS. 100, 101 AND 102).

FIRST USE 5-0-1999; IN COMMERCE 5-0-1999.
MICHAEL KEATING, EXAMINING ATTORNEY

THE MARK CONSISTS OF STANDARD CHARACTERS WITHOUT CLAIM TO ANY PARTICULAR FONT, STYLE, SIZE, OR COLOR.

FOR RETAIL GIFT STORES FEATURING GIFTS, ACCESSORIES, AND JEWELRY (U.S. CLS. 100, 101 AND 102).

FIRST USE 8-4-2003; IN COMMERCE 8-4-2003.
ALLISON SCHRODY, EXAMINING ATTORNEY

CLASS 35—(Continued).

SN 78-540,357. HIGHER AIM, INC., FRESNO, CA. FILED 12-30-2004.

SERMONSPICE

THE MARK CONSISTS OF STANDARD CHARACTERS WITHOUT CLAIM TO ANY PARTICULAR FONT, STYLE, SIZE, OR COLOR.

FOR ON LINE RETAIL STORE SERVICES FEATURING DOWNLOADABLE PRE-RECORDED AUDIO-VISUAL VIDEOS AND OTHER RELATED RELIGIOUS GOODS PROVIDED VIA INTERNET FOR USE IN COMMUNICATING RELIGIOUS MESSAGES (U.S. CLS. 100, 101 AND 102).

FIRST USE 7-9-2004; IN COMMERCE 7-9-2004.
JEAN IM, EXAMINING ATTORNEY

CLASS 35—(Continued).

SN 78-540,567. BCBSM, INC., ST. PAUL, MN. FILED 12-31-2004.



THE MARK CONSISTS OF A STYLIZED HUMAN FIGURE EXERCISING.

FOR DISCOUNT PROGRAM FOR ENABLING PARTICIPANTS TO OBTAIN DISCOUNTS AT HEALTH AND FITNESS FACILITIES (U.S. CLS. 100, 101 AND 102).

FIRST USE 2-1-2005; IN COMMERCE 2-1-2005.
KAREN BRACEY, EXAMINING ATTORNEY

SN 78-541,086. SITTERCITY, INC., CHICAGO, IL. FILED 1-3-2005.

SN 78-540,544. KLS ACQUISITION CORP., WAUKEGAN, IL. FILED 12-31-2004.

**WE'RE CHEAP AND
PROUD OF IT!!**

THE MARK CONSISTS OF STANDARD CHARACTERS WITHOUT CLAIM TO ANY PARTICULAR FONT, STYLE, SIZE, OR COLOR.

FOR RETAIL OUTLET STORE SERVICES IN THE FIELD OF HOME IMPROVEMENT PRODUCTS AND HOME FURNISHINGS (U.S. CLS. 100, 101 AND 102).

FIRST USE 6-0-1996; IN COMMERCE 6-0-1996.
SCOTT OSLICK, EXAMINING ATTORNEY

SITTERCITY

THE MARK CONSISTS OF STANDARD CHARACTERS WITHOUT CLAIM TO ANY PARTICULAR FONT, STYLE, SIZE, OR COLOR.

FOR REFERRALS IN THE FIELDS OF CHILD CARE, NEWBORN CARE, ELDER CARE, PET CARE, AND HOUSE MONITORING AND CARE (U.S. CLS. 100, 101 AND 102).

FIRST USE 9-15-2001; IN COMMERCE 9-15-2001.
ANGELA M. MICHELI, EXAMINING ATTORNEY

CLASS 35—(Continued).

SN 78-541,092. SITTERCITY, INC., CHICAGO, IL. FILED 1-3-2005.

sittercity

THE MARK CONSISTS OF THE CHARACTERS "SITTERCITY" IN A SERIF FONT, WITH THE DOUBLE "T" ("TT") MADE UP OF TWO STYLIZED HUMAN FIGURES HOLDING HANDS, ONE LARGER THAN THE OTHER, SUGGESTING AN ADULT AND A CHILD.

FOR REFERRALS IN THE FIELDS OF CHILD CARE, NEWBORN CARE, ELDER CARE, PET CARE, AND HOUSE MONITORING AND CARE (U.S. CLS. 100, 101 AND 102).

FIRST USE 10-1-2004; IN COMMERCE 10-1-2004.
JASON ROTH, EXAMINING ATTORNEY

SN 78-557,847. WM. WRIGLEY JR. COMPANY, CHICAGO, IL. FILED 2-1-2005.

DOUBLE YOUR FUN

THE MARK CONSISTS OF STANDARD CHARACTERS WITHOUT CLAIM TO ANY PARTICULAR FONT, STYLE, SIZE, OR COLOR.

OWNER OF U.S. REG. NO. 1,004,342.

FOR ADVERTISEMENT AND PROMOTIONAL SERVICES FOR THE SALE OF CHEWING GUM (U.S. CLS. 100, 101 AND 102).

JOHN HWANG, EXAMINING ATTORNEY

SN 78-557,870. WM. WRIGLEY JR. COMPANY, CHICAGO, IL. FILED 2-1-2005.

**DOUBLE YOUR
PLEASURE**

THE MARK CONSISTS OF STANDARD CHARACTERS WITHOUT CLAIM TO ANY PARTICULAR FONT, STYLE, SIZE, OR COLOR.

OWNER OF U.S. REG. NO. 1,004,342.

FOR ADVERTISEMENT AND PROMOTIONAL SERVICES FOR THE SALE OF CHEWING GUM (U.S. CLS. 100, 101 AND 102).

JOHN HWANG, EXAMINING ATTORNEY

CLASS 35—(Continued).

SN 78-652,850. ANHEUSER-BUSCH, INCORPORATED, ST. LOUIS, MO. FILED 6-17-2005.

BUD SELECT

THE MARK CONSISTS OF STANDARD CHARACTERS WITHOUT CLAIM TO ANY PARTICULAR FONT, STYLE, SIZE, OR COLOR.

OWNER OF U.S. REG. NOS. 666,367, 2,517,238 AND OTHERS.

FOR PROMOTING THE CONCERTS OF OTHERS (U.S. CLS. 100, 101 AND 102).

FIRST USE 6-16-2005; IN COMMERCE 6-16-2005.
LANA PHAM, EXAMINING ATTORNEY

SN 79-000,998. MARTIN JOHN BOHLING, UNITED KINGDOM, FILED 1-27-2004.

COURLAND

THE MARK CONSISTS OF STANDARD CHARACTERS WITHOUT CLAIM TO ANY PARTICULAR FONT, STYLE, SIZE, OR COLOR.

PRIORITY DATE OF 11-5-2003 IS CLAIMED.

OWNER OF INTERNATIONAL REGISTRATION 0818944 DATED 1-27-2004, EXPIRES 1-27-2014.

FOR BUSINESS MANAGEMENT, BUSINESS CONSULTANCY, BUSINESS ADMINISTRATION; BUSINESS APPRAISALS, BUSINESS RESEARCH; PERSONNEL RECRUITMENT SERVICES; SELECTION AND PLACEMENT OF EXECUTIVES; BUSINESS CONSULTANCY SERVICES FOR THE AUTOMOTIVE INDUSTRY; CONSULTANCY, INFORMATION AND ADVICE IN RELATION TO ALL THE FOREGOING; ALL OF THE FOREGOING BEING SERVICES FOR THE AUTOMOTIVE INDUSTRY (U.S. CLS. 100, 101 AND 102).

MARIA-VICTORIA SUAREZ, EXAMINING ATTORNEY

CLASS 36—INSURANCE AND FINANCIAL

SN 76-001,168. ABN AMRO NORTH AMERICA, INC., CHICAGO, IL. FILED 3-16-2000.

SPEEDTRADE

FOR PROVIDING SECURITIES BROKERAGE SERVICES VIA A GLOBAL COMPUTER NETWORK (U.S. CLS. 100, 101 AND 102).

FIRST USE 8-1-1999; IN COMMERCE 8-1-1999.

JULIA HARDY COFIELD, EXAMINING ATTORNEY

CLASS 36—(Continued).

SN 76-034,067. CONNECTS FEDERAL CREDIT UNION, RICHMOND, VA. FILED 4-25-2000.



NO CLAIM IS MADE TO THE EXCLUSIVE RIGHT TO USE "FEDERAL CREDIT UNION", APART FROM THE MARK AS SHOWN.

FOR CREDIT UNION SERVICES (U.S. CLS. 100, 101 AND 102).

FIRST USE 3-17-2000; IN COMMERCE 3-17-2000.
TRACY CROSS, EXAMINING ATTORNEY

SN 76-315,052. UNITED COMMUNITY INSURANCE SERVICES, INC., BLAIRSVILLE, GA. FILED 9-20-2001.

UNITED COMMUNITY INSURANCE SERVICES

NO CLAIM IS MADE TO THE EXCLUSIVE RIGHT TO USE "INSURANCE SERVICES", APART FROM THE MARK AS SHOWN.

FOR INSURANCE BROKERAGE AND INSURANCE UNDERWRITING SERVICES FOR ALL TYPES OF INSURANCE (U.S. CLS. 100, 101 AND 102).

FIRST USE 5-5-2004; IN COMMERCE 5-5-2004.
BERYL GARDNER, EXAMINING ATTORNEY

SN 76-436,612. MIDWEST BANC HOLDINGS, INC., MEL-ROSE PARK, IL. FILED 8-1-2002.

MIDWEST BANC

NO CLAIM IS MADE TO THE EXCLUSIVE RIGHT TO USE "BANC", APART FROM THE MARK AS SHOWN.

FOR BANK HOLDING COMPANY SERVICES, NAMELY, PROVIDING OWNERSHIP, FINANCIAL CONTROL AND RECORDING SERVICES FOR ONE OR MORE FINANCIAL INSTITUTIONS AND ENGAGING IN THE ACTIVITIES OF A BANK HOLDING COMPANY (U.S. CLS. 100, 101 AND 102).

FIRST USE 2-27-1998; IN COMMERCE 2-27-1998.
INGRID C. EULIN, EXAMINING ATTORNEY

SN 76-443,529. THE LENDING CONNECTION, INC., COSTA MESA, CA. FILED 8-26-2002.

THE LENDING CONNECTION

SEC. 2(F).
FOR LOAN BROKERAGE AND MORTGAGE LENDING (U.S. CLS. 100, 101 AND 102).

FIRST USE 7-7-1995; IN COMMERCE 7-7-1995.
JOHN LINCOSKI, EXAMINING ATTORNEY

CLASS 36—(Continued).

SN 76-445,201. DUTCHESS COUNTY ASSOCIATION OF REALTORS, INC., POUGHKEEPSIE, NY. FILED 6-26-2002.



NO CLAIM IS MADE TO THE EXCLUSIVE RIGHT TO USE THE DESIGN OF THE HOUSE, "EQUAL HOUSING OPPORTUNITY", "DUTCHESS COUNTY", AND "MULTIPLE LISTING SERVICE", APART FROM THE MARK AS SHOWN.

FOR PROVIDING INFORMATION IN THE FIELD OF REAL ESTATE BY DISSEMINATING MULTIPLE LISTINGS OF REAL PROPERTY (U.S. CLS. 100, 101 AND 102).

FIRST USE 11-0-2001; IN COMMERCE 11-0-2001.
MIDGE BUTLER, EXAMINING ATTORNEY

SN 76-510,386. CLARENDON SERVICES, INC., FORMERLY, CLARENDON ASSET MANAGEMENT CO., ARLINGTON, VA. FILED 4-29-2003.

CLARENDON

OWNER OF U.S. REG. NO. 2,009,397.

FOR INVESTMENT ADVISORY SERVICES; SECURITIES BROKERAGE SERVICES; SALES OF INVESTMENT SECURITIES (U.S. CLS. 100, 101 AND 102).

FIRST USE 4-21-2003; IN COMMERCE 4-21-2003.
MARLENE BELL, EXAMINING ATTORNEY

SN 76-517,392. FIRST INDEPENDENT BANK, VANCOUVER, WA. FILED 5-28-2003.

FIRST INDEPENDENT MORTGAGE

NO CLAIM IS MADE TO THE EXCLUSIVE RIGHT TO USE "INDEPENDENT MORTGAGE", APART FROM THE MARK AS SHOWN.

FOR MORTGAGE ORIGINATION AND LENDING SERVICES (U.S. CLS. 100, 101 AND 102).

FIRST USE 12-0-1997; IN COMMERCE 12-0-1997.
EUGENIA MARTIN, EXAMINING ATTORNEY

CLASS 36—(Continued).

SN 76-521,372. TIERONE BANK, FORMERLY FIRST FEDERAL LINCOLN BANK, LONCOLN, NE. FILED 6-9-2003.

TELELOAN

SEC. 2(F).
FOR FINANCIAL SERVICES, NAMELY, TAKING APPLICATIONS FOR PERSONAL LOANS AND PERSONAL LOAN SERVICES VIA TELEPHONE (U.S. CLS. 100, 101 AND 102).

FIRST USE 7-9-1998; IN COMMERCE 7-9-1998.
JAMES GRIFFIN, EXAMINING ATTORNEY

SN 76-528,085. THE MILLS LIMITED PARTNERSHIP, ARLINGTON, VA. FILED 6-27-2003.

GALLERIA
WHITE PLAINS

NO CLAIM IS MADE TO THE EXCLUSIVE RIGHT TO USE GALLERIA, APART FROM THE MARK AS SHOWN.
SEC. 2(F).

FOR SHOPPING CENTER SERVICES AND LEASING OF SHOPPING MALL SPACE (U.S. CLS. 100, 101 AND 102).

FIRST USE 4-1-2001; IN COMMERCE 4-1-2001.
DOMINIC J. FERRAIUOLO, EXAMINING ATTORNEY

SN 76-540,636. BB&T CORPORATION, WINSTON-SALEM, NC. FILED 8-28-2003.

BB&T EASYACCESS

OWNER OF U.S. REG. NOS. 624,104, 2,607,976 AND OTHERS.

NO CLAIM IS MADE TO THE EXCLUSIVE RIGHT TO USE "EASYACCESS", APART FROM THE MARK AS SHOWN.

FOR BANKING AND RELATED FINANCIAL SERVICES (U.S. CLS. 100, 101 AND 102).

FIRST USE 2-13-2003; IN COMMERCE 2-13-2003.
GENE MACIOL, EXAMINING ATTORNEY

SN 76-546,139. MIAMI LIGHTHOUSE FOR THE BLIND AND VISUALLY IMPAIRED, INC., MIAMI, FL. FILED 9-8-2003.

MIAMI LIGHTHOUSE FOR THE BLIND

NO CLAIM IS MADE TO THE EXCLUSIVE RIGHT TO USE "MIAMI" AND "BLIND", APART FROM THE MARK AS SHOWN.

FOR CHARITABLE FUNDRAISING SERVICES FOR THE BENEFIT OF BLIND AND VISUALLY IMPAIRED PERSONS (U.S. CLS. 100, 101 AND 102).

FIRST USE 4-21-1936; IN COMMERCE 1-1-1945.
DAVID TAYLOR, EXAMINING ATTORNEY

CLASS 36—(Continued).

SN 76-547,062. OUTCALT & JOHNSON RETAIL STRATEGISTS, LLC, SEATTLE, WA. FILED 9-25-2003.

THE RETAIL OWNERS INSTITUTE

NO CLAIM IS MADE TO THE EXCLUSIVE RIGHT TO USE INSTITUTE, APART FROM THE MARK AS SHOWN.
SEC. 2(F).

FOR FINANCIAL MANAGEMENT INFORMATION FOR RETAIL BUSINESS OWNERS AND BUSINESSES PROVIDED VIA AN INTERACTIVE WEBSITE FEATURING EDUCATIONAL ARTICLES AND ONLINE NEWSLETTERS (U.S. CLS. 100, 101 AND 102).

FIRST USE 6-0-1997; IN COMMERCE 6-0-1997.
SUSAN LESLIE DUBOIS, EXAMINING ATTORNEY

SN 76-552,014. EDISON PROPERTIES, LLC, NEWARK, NJ. FILED 10-15-2003.

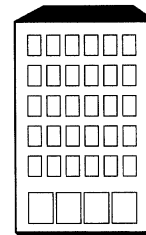
**EXECUTIVE WORKSPACE**

NO CLAIM IS MADE TO THE EXCLUSIVE RIGHT TO USE "WORKSPACE", APART FROM THE MARK AS SHOWN.

THE MARK IS NOT LINED FOR COLOR.

THE DESIGN OF A BUILDING DEPICTED IN THE MARK IS SHADED TO EVOKE A THREE-DIMENSIONAL EFFECT.

FOR REAL ESTATE LEASING SERVICES (U.S. CLS. 100, 101 AND 102).

FIRST USE 4-0-2003; IN COMMERCE 4-0-2003.
SOPHIA S. KIM, EXAMINING ATTORNEY

CLASS 36—(Continued).

SN 76-552,706. ALTAMIRA INVESTMENT SERVICES INC., TORONTO, ONTARIO M5X 1L9, CANADA, FILED 10-20-2003.



OWNER OF CANADA REG. NO. 463831, DATED 9-27-1996, EXPIRES 9-27-2011.
 THE ENGLISH TRANSLATION OF "ALTAMIRA" IS "HIGH VISION".
 FOR INVESTMENT SERVICES, NAMELY MANAGEMENT OF INVESTMENTS IN THE NATURE OF INVESTMENTS OF FUNDS FOR OTHERS (U.S. CLS. 100, 101 AND 102).
 NANCY CLARKE, EXAMINING ATTORNEY

SN 76-562,464. CAMERON STATION COMMUNITY ASSOCIATION, INC., ALEXANDRIA, VA. FILED 11-10-2003.



THE MARK CONSISTS OF IN PART, OF A FANCIFUL DESIGN.
 FOR HOMEOWNERS ASSOCIATION SERVICES, NAMELY, MANAGEMENT OF COMMON GROUNDS AND AMENITIES (U.S. CLS. 100, 101 AND 102).
 FIRST USE 0-0-1998; IN COMMERCE 0-0-1998.
 BARBARA RUTLAND, EXAMINING ATTORNEY

SN 76-565,556. R.W.ROGE & COMPANY, INC., BOHEMIA, NY. FILED 12-16-2003.

THE UNIQUE WEALTH MANAGEMENT PROCESS

THE MARK CONSISTS OF STANDARD CHARACTERS WITHOUT CLAIM TO ANY PARTICULAR FONT, STYLE, SIZE, OR COLOR.
 NO CLAIM IS MADE TO THE EXCLUSIVE RIGHT TO USE "WEALTH MANAGEMENT PROCESS", APART FROM THE MARK AS SHOWN.
 FOR INVESTMENT AND WEALTH MANAGEMENT SERVICES (U.S. CLS. 100, 101 AND 102).
 FIRST USE 3-30-2003; IN COMMERCE 3-30-2003.
 GINNY ISAACSON, EXAMINING ATTORNEY

CLASS 36—(Continued).

SN 76-565,557. R.W.ROGE & COMPANY, INC., BOHEMIA, NY. FILED 12-16-2003.

THE UNIQUE WEALTH MANAGEMENT EXPERIENCE

THE MARK CONSISTS OF STANDARD CHARACTERS WITHOUT CLAIM TO ANY PARTICULAR FONT, STYLE, SIZE, OR COLOR.
 NO CLAIM IS MADE TO THE EXCLUSIVE RIGHT TO USE "WEALTH MANAGEMENT", APART FROM THE MARK AS SHOWN.
 FOR INVESTMENT AND WEALTH MANAGEMENT SERVICES (U.S. CLS. 100, 101 AND 102).
 FIRST USE 3-3-2003; IN COMMERCE 3-3-2003.
 GINNY ISAACSON, EXAMINING ATTORNEY

SN 76-571,291. WALTONKRAMER ADVISORS LTD., DEERFIELD, IL. FILED 1-13-2004.

CONFIDENT STRATEGIES

THE MARK CONSISTS OF STANDARD CHARACTERS WITHOUT CLAIM TO ANY PARTICULAR FONT, STYLE, SIZE, OR COLOR.
 NO CLAIM IS MADE TO THE EXCLUSIVE RIGHT TO USE "STRATEGIES", APART FROM THE MARK AS SHOWN.
 FOR FINANCIAL AND INVESTMENT ADVISORY SERVICE (U.S. CLS. 100, 101 AND 102).
 FIRST USE 11-11-2003; IN COMMERCE 11-11-2003.
 KARLA PERKINS, EXAMINING ATTORNEY

SN 76-572,481. ALTAMIRA INVESTMENT SERVICES INC., TORONTO, ONTARIO M5X 1L9, CANADA, FILED 1-26-2004.

ALTAMIRA

THE MARK CONSISTS OF STANDARD CHARACTERS WITHOUT CLAIM TO ANY PARTICULAR FONT, STYLE, SIZE, OR COLOR.
 OWNER OF CANADA REG. NO. 463830, DATED 9-27-1996, EXPIRES 9-27-2011.
 THE ENGLISH TRANSLATION OF "ALTAMIRA" IS "HIGH VISION".
 FOR INVESTMENT SERVICES, NAMELY MANAGEMENT OF INVESTMENTS IN THE NATURE OF INVESTMENTS OF FUNDS FOR OTHERS (U.S. CLS. 100, 101 AND 102).
 NANCY CLARKE, EXAMINING ATTORNEY

CLASS 36—(Continued).

SN 76-575,302. LINK2GOV CORP., NASHVILLE, TN. FILED 2-12-2004.

PAYING TAXES JUST GOT A LITTLE EASIER

THE MARK CONSISTS OF STANDARD CHARACTERS WITHOUT CLAIM TO ANY PARTICULAR FONT, STYLE, SIZE, OR COLOR.

FOR FINANCIAL SERVICES, NAMELY, PROCESSING AND PAYMENT OF INDIVIDUAL FEDERAL INCOME TAXES FOR OTHERS (U.S. CLS. 100, 101 AND 102).

FIRST USE 1-10-2003; IN COMMERCE 1-10-2003.
TERESA M. RUPP, EXAMINING ATTORNEY

SN 76-575,370. WEITZMAN GROUP, INC., DALLAS, TX. FILED 2-13-2004.

WE HAVE A PASSION FOR SERVICE

THE MARK CONSISTS OF STANDARD CHARACTERS WITHOUT CLAIM TO ANY PARTICULAR FONT, STYLE, SIZE, OR COLOR.

FOR REAL ESTATE BROKERAGE SERVICES, PROPERTY MANAGEMENT SERVICES, AND COMMERCIAL REAL ESTATE DEVELOPMENT SERVICES (U.S. CLS. 100, 101 AND 102).

FIRST USE 1-9-2004; IN COMMERCE 1-9-2004.
THEODORE MCBRIDE, EXAMINING ATTORNEY

SN 76-577,646. WESBANCO, INC., WHEELING, WV. FILED 2-25-2004.

WESBANCO MONEY CARD

THE MARK CONSISTS OF STANDARD CHARACTERS WITHOUT CLAIM TO ANY PARTICULAR FONT, STYLE, SIZE, OR COLOR.

OWNER OF U.S. REG. NO. 1,763,242.

NO CLAIM IS MADE TO THE EXCLUSIVE RIGHT TO USE "MONEY CARD", APART FROM THE MARK AS SHOWN.

FOR FINANCIAL SERVICES, NAMELY, ELECTRONIC CHECK, CREDIT CARD, SMART CARD, AND DEBIT CARD SERVICES (U.S. CLS. 100, 101 AND 102).

FIRST USE 8-20-2002; IN COMMERCE 8-20-2002.
SEAN DWYER, EXAMINING ATTORNEY

CLASS 36—(Continued).

SN 76-582,680. GLOBAL FUTURES & FOREX, LTD., ADA, MI. FILED 3-23-2004.

BASE 10 TRADING

THE MARK CONSISTS OF STANDARD CHARACTERS WITHOUT CLAIM TO ANY PARTICULAR FONT, STYLE, SIZE, OR COLOR.

NO CLAIM IS MADE TO THE EXCLUSIVE RIGHT TO USE TRADING, APART FROM THE MARK AS SHOWN.

FOR STOCK BROKERAGE AND FOREIGN CURRENCY DERIVATIVE TRADING (U.S. CLS. 100, 101 AND 102).

AMY ALFIERI, EXAMINING ATTORNEY

SN 76-583,285. INTERNATIONAL INSURANCE BROKERS, LTD., LLC, TULSA, OK. FILED S.R. 3-25-2004; AM. P.R. 4-12-2005.



INTERNATIONAL INSURANCE BROKERS, LTD.

NO CLAIM IS MADE TO THE EXCLUSIVE RIGHT TO USE "INTERNATIONAL INSURANCE BROKERS LTD", APART FROM THE MARK AS SHOWN.

FOR RISK MANAGEMENT SERVICES, NAMELY, DESIGN AND DEVELOPMENT OF RISK MANAGEMENT PROGRAMS FOR NATIONAL AND INTERNATIONAL CORPORATIONS AND INDIVIDUALS AND THE TRANSFER OR RISK THROUGH PLACEMENT OF INSURANCE AND OTHER MEANS (U.S. CLS. 100, 101 AND 102).

FIRST USE 4-18-2003; IN COMMERCE 4-18-2003.
CHARLES JOYNER, EXAMINING ATTORNEY

SN 76-584,063. CAPITAL AUTOMOTIVE, INC., CHARLOTTE, NC. FILED 3-30-2004.

FLEX PRO

THE MARK CONSISTS OF STANDARD CHARACTERS WITHOUT CLAIM TO ANY PARTICULAR FONT, STYLE, SIZE, OR COLOR.

FOR FINANCIAL SERVICES, NAMELY ARRANGING FINANCING THROUGH A FINANCIAL INSTITUTION FOR VEHICLES SOLD BY A DEALER FOR A FEE, AND INSURANCE SERVICES, NAMELY UNDERWRITING EXTENDED WARRANTY CONTRACTS FOR AUTOMOBILES, CREDIT INSURANCE AND GAP INSURANCE, THESE SERVICES BEING AVAILABLE TO AND THROUGH AUTOMOTIVE DEALERSHIPS (U.S. CLS. 100, 101 AND 102).

FIRST USE 11-17-2003; IN COMMERCE 11-17-2003.
SALLY SHIH, EXAMINING ATTORNEY

CLASS 36—(Continued).

SN 76-584,591. MERRILL LYNCH & CO., INC., NEW YORK, NY. FILED 4-2-2004.

THE LAMBDA FINANCIAL GROUP

NO CLAIM IS MADE TO THE EXCLUSIVE RIGHT TO USE "FINANCIAL GROUP", APART FROM THE MARK AS SHOWN.

FOR FINANCIAL SERVICES, NAMELY, FINANCIAL INVESTMENT CONSULTATION AND ADVICE (U.S. CLS. 100, 101 AND 102).

FIRST USE 6-0-2003; IN COMMERCE 6-0-2003.

DORITT L. CARROLL, EXAMINING ATTORNEY

SN 76-587,055. 3 PHASES ENERGY SERVICES, RENO, NV. FILED 4-16-2004.

3PHASES ENERGY SERVICES

THE MARK CONSISTS OF STANDARD CHARACTERS WITHOUT CLAIM TO ANY PARTICULAR FONT, STYLE, SIZE, OR COLOR.

NO CLAIM IS MADE TO THE EXCLUSIVE RIGHT TO USE "ENERGY SERVICES", APART FROM THE MARK AS SHOWN.

FOR ENERGY BROKERAGE SERVICES, NAMELY BUYING, SELLING, AND TRADING ENERGY AND ENERGY CERTIFICATES (U.S. CLS. 100, 101 AND 102).

FIRST USE 11-30-1999; IN COMMERCE 7-30-2002.

AMY HELLA, EXAMINING ATTORNEY

SN 76-587,056. 3 PHASES ENERGY SERVICES, RENO, NV. FILED 4-16-2004.

BE PROUD OF YOUR POWER

THE MARK CONSISTS OF STANDARD CHARACTERS WITHOUT CLAIM TO ANY PARTICULAR FONT, STYLE, SIZE, OR COLOR.

FOR ENERGY BROKERAGE SERVICES, NAMELY BUYING, SELLING, AND TRADING ENERGY AND ENERGY CERTIFICATES (U.S. CLS. 100, 101 AND 102).

FIRST USE 3-14-2003; IN COMMERCE 3-14-2003.

AMY HELLA, EXAMINING ATTORNEY

CLASS 36—(Continued).

SN 76-587,184. CYSTIC FIBROSIS FOUNDATION, BETHESDA, MD. FILED 4-16-2004.



OWNER OF U.S. REG. NO. 2,194,800.
FOR CHARITABLE FUND-RAISING SERVICES (U.S. CLS. 100, 101 AND 102).

FIRST USE 10-0-2001; IN COMMERCE 10-0-2001.

DOUGLAS LEE, EXAMINING ATTORNEY

SN 76-587,311. THE CLEARING HOUSE SERVICE COMPANY L.L.C., NEW YORK, NY. FILED 4-19-2004.

CHIPS

THE MARK CONSISTS OF STANDARD CHARACTERS WITHOUT CLAIM TO ANY PARTICULAR FONT, STYLE, SIZE, OR COLOR.

FOR SERVICES FOR ADMINISTERING TRANSFER OF FUNDS AND SETTling OF FINANCIAL TRANSACTIONS AMONG FINANCIAL AND OTHER INSTITUTIONS (U.S. CLS. 100, 101 AND 102).

FIRST USE 6-9-1970; IN COMMERCE 6-9-1970.

SHAUNIA WALLACE, EXAMINING ATTORNEY

SN 76-590,241. TEACHERS INSURANCE AND ANNUITY ASSOCIATION, NEW YORK, NY. FILED 5-3-2004.

PROCEEDS PLUS

THE MARK CONSISTS OF STANDARD CHARACTERS WITHOUT CLAIM TO ANY PARTICULAR FONT, STYLE, SIZE, OR COLOR.

NO CLAIM IS MADE TO THE EXCLUSIVE RIGHT TO USE "PROCEEDS", APART FROM THE MARK AS SHOWN.

FOR INSURANCE ADMINISTRATION, NAMELY PROVIDING TO BENEFICIARIES OF LIFE INSURANCE AND ANNUITIES A SETTLEMENT OPTION CONSISTING OF A LUMP SUM PAYMENT OF DEATH BENEFITS INTO AN INTEREST-BEARING BANK-LIKE CHECKING ACCOUNT (U.S. CLS. 100, 101 AND 102).

FIRST USE 6-1-1995; IN COMMERCE 12-14-1994.

TIMOTHY FINNEGAN, EXAMINING ATTORNEY

CLASS 36—(Continued).

SN 76-590,854. METAVANTE CORPORATION, BROWN DEER, WI. FILED 5-6-2004.

WEALTHCOMPARE

THE MARK CONSISTS OF STANDARD CHARACTERS WITHOUT CLAIM TO ANY PARTICULAR FONT, STYLE, SIZE, OR COLOR.

FOR FINANCIAL SERVICES, NAMELY, GATHERING AND COMPILING INFORMATION FROM INSTITUTIONS WITH WEALTH MANAGEMENT ORGANIZATIONS AND PROVIDING REPORTS TO HELP FIRMS ESTABLISH WEALTH MANAGEMENT BENCHMARKS (U.S. CLS. 100, 101 AND 102).

FIRST USE 4-30-2004; IN COMMERCE 4-30-2004.

ALEXANDER L. POWERS, EXAMINING ATTORNEY

SN 76-591,987. UNIVERSITY AND STATE EMPLOYEES CREDIT UNION, SAN DIEGO, CA. FILED 5-13-2004.



OWNER OF U.S. REG. NOS. 2,402,225 AND 2,433,334.
NO CLAIM IS MADE TO THE EXCLUSIVE RIGHT TO USE "CREDIT UNION", APART FROM THE MARK AS SHOWN.

FOR CREDIT UNION SERVICES AND CONSUMER AND COMMERCIAL LENDING SERVICES (U.S. CLS. 100, 101 AND 102).

ANN E. SAPPENFIELD, EXAMINING ATTORNEY

SN 76-593,124. AMERICA'S CHRISTIAN CREDIT UNION, BREA, CA. FILED 5-19-2004.



NO CLAIM IS MADE TO THE EXCLUSIVE RIGHT TO USE "AMERICA'S CHRISTIAN CREDIT UNION", APART FROM THE MARK AS SHOWN.

FOR CREDIT UNION SERVICES, CONSUMER AND COMMERCIAL LENDING SERVICES (U.S. CLS. 100, 101 AND 102).

FIRST USE 10-14-2003; IN COMMERCE 10-14-2003.

CHERYL CLAYTON, EXAMINING ATTORNEY

CLASS 36—(Continued).

SN 76-594,439. MANI BROTHERS, LLC, LOS ANGELES, CA. FILED 5-27-2004.

PRESTIGIOUS WORKSPACE

THE MARK CONSISTS OF STANDARD CHARACTERS WITHOUT CLAIM TO ANY PARTICULAR FONT, STYLE, SIZE, OR COLOR.

NO CLAIM IS MADE TO THE EXCLUSIVE RIGHT TO USE "WORKSPACE", APART FROM THE MARK AS SHOWN.

FOR REAL ESTATE LEASING, REAL ESTATE ACQUISITION, REAL ESTATE INVESTMENT AND REAL ESTATE MANAGEMENT SERVICES (U.S. CLS. 100, 101 AND 102).

IRENE D. WILLIAMS, EXAMINING ATTORNEY

SN 76-594,505. FAMILY CARE SOLUTIONS, PHILADELPHIA, PA. FILED 5-27-2004.

FAMILY CARE SOLUTIONS

THE MARK CONSISTS OF STANDARD CHARACTERS WITHOUT CLAIM TO ANY PARTICULAR FONT, STYLE, SIZE, OR COLOR.

NO CLAIM IS MADE TO THE EXCLUSIVE RIGHT TO USE FAMILY CARE, APART FROM THE MARK AS SHOWN.

FOR CHARITABLE SERVICES NAMELY, PROVIDING CHILDCARE RESOURCES IN THE NATURE OF FINANCIAL CONTRIBUTIONS (U.S. CLS. 100, 101 AND 102).

FIRST USE 12-1-1999; IN COMMERCE 1-1-2000.

SKYE YOUNG, EXAMINING ATTORNEY

SN 76-595,327. MARATHON FINANCIAL GROUP, LTD., GARDEN CITY, NY. FILED 6-2-2004.



NO CLAIM IS MADE TO THE EXCLUSIVE RIGHT TO USE "CONSULTING", APART FROM THE MARK AS SHOWN.

FOR COMPUTING, DATA, AND PROFESSIONAL SERVICES TO EMPLOYERS, NAMELY, BENEFITS ADMINISTRATION; PENSION RECORD KEEPING, AND UNEMPLOYMENT COMPENSATION MANAGEMENT SERVICES (U.S. CLS. 100, 101 AND 102).

FIRST USE 1-4-2003; IN COMMERCE 1-4-2003.

BRIAN NEVILLE, EXAMINING ATTORNEY

CLASS 36—(Continued).

SN 76-596,180. GREATER KANSAS CITY COMMUNITY FOUNDATION, KANSAS CITY, MO. FILED 6-4-2004.



NO CLAIM IS MADE TO THE EXCLUSIVE RIGHT TO USE FOUNDATION, APART FROM THE MARK AS SHOWN.

SEC. 2(F).
FOR ACCEPTING AND ADMINISTERING MONETARY CHARITABLE CONTRIBUTIONS; CHARITABLE FUND RAISING (U.S. CLS. 100, 101 AND 102).

FIRST USE 1-1-1998; IN COMMERCE 1-1-1998.
HOWARD SMIGA, EXAMINING ATTORNEY

SN 76-598,815. GMAC MORTGAGE CORPORATION, HORSHAM, PA. FILED 6-23-2004.

SETTLE AMERICA

THE MARK CONSISTS OF STANDARD CHARACTERS WITHOUT CLAIM TO ANY PARTICULAR FONT, STYLE, SIZE, OR COLOR.

NO CLAIM IS MADE TO THE EXCLUSIVE RIGHT TO USE "AMERICA", APART FROM THE MARK AS SHOWN.
FOR REAL ESTATE MORTGAGE BANKING AND LENDING SERVICES; LOAN ORIGINATION AND FINANCING VIA A GLOBAL COMMUNICATIONS NETWORK (U.S. CLS. 100, 101 AND 102).

FIRST USE 4-28-2003; IN COMMERCE 4-28-2003.
CHRIS WELLS, EXAMINING ATTORNEY

SN 76-599,304. REALSURE, INC., ALISO VIEJO, CA. FILED 6-25-2004.

THE REAL ESTATE APPRENTICE

THE MARK CONSISTS OF STANDARD CHARACTERS WITHOUT CLAIM TO ANY PARTICULAR FONT, STYLE, SIZE, OR COLOR.

NO CLAIM IS MADE TO THE EXCLUSIVE RIGHT TO USE "REAL ESTATE", APART FROM THE MARK AS SHOWN.

FOR FINANCING SERVICES, NAMELY, PROVIDING GRANTS TO INDIVIDUALS SEEKING A CAREER IN REAL ESTATE (U.S. CLS. 100, 101 AND 102).

FIRST USE 6-1-2004; IN COMMERCE 6-1-2004.
RAMONA ORTIGA, EXAMINING ATTORNEY

CLASS 36—(Continued).

SN 76-600,674. MVP GROUP INTERNATIONAL, INC., CHARLESTON, SC. FILED 7-2-2004.

MVP FUNDRAISING

THE MARK CONSISTS OF STANDARD CHARACTERS WITHOUT CLAIM TO ANY PARTICULAR FONT, STYLE, SIZE, OR COLOR.

NO CLAIM IS MADE TO THE EXCLUSIVE RIGHT TO USE "FUNDRAISING", APART FROM THE MARK AS SHOWN.

FOR CHARITABLE FUND RAISING SERVICES FOR PUBLIC AND PRIVATE ENTITIES (U.S. CLS. 100, 101 AND 102).

FIRST USE 1-5-2004; IN COMMERCE 1-5-2004.
GINA FINK, EXAMINING ATTORNEY

SN 76-600,678. ST. LOUIS CAPITAL, LLC, ST. LOUIS, MO. FILED 7-1-2004.

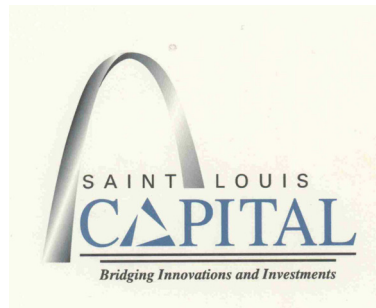

THE COLOR(S) PURPLE AND BLACK IS/ARE CLAIMED AS A FEATURE OF THE MARK.

THE COLOR PURPLE APPEARS IN THE WORD CAPITAL AND THE COLOR GRAY APPEARS IN THE ARCH GRAPHIC.

FOR FINANCIAL ANALYSIS AND CONSULTATION (U.S. CLS. 100, 101 AND 102).

FIRST USE 10-14-2003; IN COMMERCE 12-17-2003.
FLORENTINA BLANDU, EXAMINING ATTORNEY

SN 76-601,001. UTILITY CHOICE, L.P., DBA UTILITY CHOICE ELECTRIC, HOUSTON, TX. FILED 7-6-2004.

UCE

THE MARK CONSISTS OF STANDARD CHARACTERS WITHOUT CLAIM TO ANY PARTICULAR FONT, STYLE, SIZE, OR COLOR.

FOR ENERGY BROKERAGE SERVICES, NAMELY TRADING, BUYING AND SELLING OF ENERGY FOR OTHERS (U.S. CLS. 100, 101 AND 102).

FIRST USE 8-1-2002; IN COMMERCE 8-1-2002.
ESTHER A. BORSUK, EXAMINING ATTORNEY

CLASS 36—(Continued).

SN 76-602,247. WCI COMMUNITIES, INC., BONITA SPRINGS, FL. FILED 7-13-2004.

WCI LIFESTYLES BEYOND EXPECTATIONS

THE MARK CONSISTS OF STANDARD CHARACTERS WITHOUT CLAIM TO ANY PARTICULAR FONT, STYLE, SIZE, OR COLOR.

OWNER OF U.S. REG. NOS. 2,561,231, 2,701,343 AND OTHERS.

FOR REAL ESTATE MANAGEMENT; REAL ESTATE BROKERAGE SERVICES FOR HOMES, LAND PARCELS AND LOTS, LEASING OF REAL ESTATE; AND REAL ESTATE PROPERTY MANAGEMENT (U.S. CLS. 100, 101 AND 102).

FIRST USE 1-0-2004; IN COMMERCE 1-0-2004.
ROBERT C. CLARK JR., EXAMINING ATTORNEY

SN 76-602,962. CHITNIS, JAY K., ATLANTA, GA. FILED 7-16-2004.

YIELDQUEST

THE MARK CONSISTS OF STANDARD CHARACTERS WITHOUT CLAIM TO ANY PARTICULAR FONT, STYLE, SIZE, OR COLOR.

OWNER OF U.S. REG. NO. 2,363,007.

FOR FINANCIAL SERVICES, NAMELY INVESTMENT ADVISORY BROKERAGE AND MANAGEMENT (U.S. CLS. 100, 101 AND 102).

FIRST USE 5-0-1998; IN COMMERCE 5-0-1998.
RENEE MCCRAY, EXAMINING ATTORNEY

SN 76-608,061. CORPORATE PARTNERS LLC, NEW YORK, NY. FILED 8-20-2004.

INVESTING IN SOLUTIONS

THE MARK CONSISTS OF STANDARD CHARACTERS WITHOUT CLAIM TO ANY PARTICULAR FONT, STYLE, SIZE, OR COLOR.

NO CLAIM IS MADE TO THE EXCLUSIVE RIGHT TO USE "INVESTING", APART FROM THE MARK AS SHOWN.

FOR INVESTMENT MANAGEMENT; INVESTMENT CONSULTATION (U.S. CLS. 100, 101 AND 102).

SANJEEV VOHRA, EXAMINING ATTORNEY

SN 76-608,824. PRIORITY PARTNERS MANAGED CARE ORGANIZATION, INC., GLEN BURNIE, MD. FILED 8-26-2004.

PRIORITY PARTNERS

THE MARK CONSISTS OF STANDARD CHARACTERS WITHOUT CLAIM TO ANY PARTICULAR FONT, STYLE, SIZE, OR COLOR.

FOR INSURANCE ADMINISTRATION (U.S. CLS. 100, 101 AND 102).

FIRST USE 1-1-1997; IN COMMERCE 1-1-1997.
PAM WILLIS, EXAMINING ATTORNEY

CLASS 36—(Continued).

SN 76-609,388. FINANCIAL ADVANTAGE, INC., COLUMBIA, MD. FILED 8-30-2004.

FINANCIAL ADVANTAGE

THE MARK CONSISTS OF STANDARD CHARACTERS WITHOUT CLAIM TO ANY PARTICULAR FONT, STYLE, SIZE, OR COLOR.

NO CLAIM IS MADE TO THE EXCLUSIVE RIGHT TO USE "FINANCIAL", APART FROM THE MARK AS SHOWN.

FOR FINANCIAL PLANNING SERVICES AND MANAGEMENT OF PORTFOLIOS COMPRISED OF SECURITIES FOR INDIVIDUALS (U.S. CLS. 100, 101 AND 102).

FIRST USE 7-1-1987; IN COMMERCE 7-1-1987.
DAWN FELDMAN, EXAMINING ATTORNEY

SN 76-610,284. NOVUS CREDIT SERVICES INC., RIVERWOODS, IL. FILED 9-7-2004.

DISCOVER

THE MARK CONSISTS OF STANDARD CHARACTERS WITHOUT CLAIM TO ANY PARTICULAR FONT, STYLE, SIZE, OR COLOR.

OWNER OF U.S. REG. NOS. 1,479,946, 2,857,696 AND OTHERS.

FOR FINANCIAL SERVICES, NAMELY, CREDIT CARD SERVICES; PREPAID CARD SERVICES OFFERED THROUGH CARDS WITH STORED VALUE; DEBIT CARD SERVICES; ELECTRONIC CREDIT AND DEBIT TRANSACTION SERVICES; CASH DISBURSEMENT AND CASH REPLACEMENT SERVICES RENDERED BY CREDIT CARD; ELECTRONIC CASH TRANSACTIONS; CHECK VERIFICATION SERVICES; CHECK CASHING SERVICES; POINT OF SALE AND POINT OF TRANSACTION SERVICES; TRANSACTION AUTHORIZATION AND SETTLEMENT SERVICES; ELECTRONIC PAYMENT PROCESSING SERVICES; CREDIT CARD AND PAYMENT TRANSACTION AUTHENTICATION AND VERIFICATION SERVICES; BANKING SERVICES; BILL PAYMENT AND PRESENTMENT SERVICES; FACILITATING PAYMENT SERVICES THROUGH ELECTRONIC MEANS VIA A GLOBAL COMPUTER NETWORK; ELECTRONIC FUNDS TRANSFER; PROVIDING FINANCIAL INFORMATION, NAMELY CREDIT AND DEBIT CARD DATA AND REPORTS, FINANCIAL RECORDS MANAGEMENT; ELECTRONIC FUNDS TRANSFER SERVICES; CREDIT MANAGEMENT SERVICES; DISSEMINATION OF FINANCIAL INFORMATION VIA A GLOBAL COMPUTER NETWORK; AND ADVISORY SERVICES REGARDING ALL OF THE FOREGOING SERVICES (U.S. CLS. 100, 101 AND 102).

FIRST USE 2-20-1985; IN COMMERCE 2-20-1985.
JULIE WATSON, EXAMINING ATTORNEY

CLASS 36—(Continued).

SN 76-610,911. ALKI MORTGAGE, LLC, SEATTLE, WA. FILED 9-7-2004.



NO CLAIM IS MADE TO THE EXCLUSIVE RIGHT TO USE MORTGAGE, APART FROM THE MARK AS SHOWN. FOR MORTGAGE BROKERAGE SERVICES (U.S. CLS. 100, 101 AND 102).
FIRST USE 1-0-2003; IN COMMERCE 1-0-2003.
BARNEY CHARLON, EXAMINING ATTORNEY

SN 76-611,064. MIDDENDORF, SHARON, NEW YORK, NY. FILED 9-13-2004.

GO-COTTAGE

THE MARK CONSISTS OF STANDARD CHARACTERS WITHOUT CLAIM TO ANY PARTICULAR FONT, STYLE, SIZE, OR COLOR.
FOR RENTAL OF SEASONAL VACATION HOMES (U.S. CLS. 100, 101 AND 102).
FIRST USE 5-10-2003; IN COMMERCE 5-10-2003.
KEVIN DINALLO, EXAMINING ATTORNEY

SN 76-611,365. AEGIS VENTURE GROUP, LLC., ST. PETERSBURG, FL. FILED 9-7-2004.



NO CLAIM IS MADE TO THE EXCLUSIVE RIGHT TO USE THE IMAGE OF THE DOLLAR SIGN, APART FROM THE MARK AS SHOWN.
FOR FINANCIAL SERVICES FOR CONSUMERS, EMPLOYERS AND EMPLOYEES AND THEIR BENEFIT PROGRAMS, NAMELY ELECTRONIC INTERNATIONAL FUNDS TRANSFER, PROVIDING STORED VALUE ACCOUNTS IN ELECTRONIC ENVIRONMENT, AND PRE-AUTHORIZED STORED VALUE ACCOUNT OVERDRAFTS (U.S. CLS. 100, 101 AND 102).
FIRST USE 1-1-2004; IN COMMERCE 1-1-2004.
SKYE YOUNG, EXAMINING ATTORNEY

CLASS 36—(Continued).

SN 76-612,679. MICHEL, KIMBERLY, DBA MICHEL FINANCIAL GROUP, LOS ANGELES, CA. FILED 9-17-2004.

MICHEL FINANCIAL GROUP

THE MARK CONSISTS OF STANDARD CHARACTERS WITHOUT CLAIM TO ANY PARTICULAR FONT, STYLE, SIZE, OR COLOR.
NO CLAIM IS MADE TO THE EXCLUSIVE RIGHT TO USE "FINANCIAL GROUP", APART FROM THE MARK AS SHOWN.
FOR FINANCIAL SERVICES, NAMELY, UNDERWRITING, AGENCY AND BROKERAGE FEATURING LIFE INSURANCE, DISABILITY INCOME INSURANCE, LONG-TERM CARE INSURANCE AND CAPITAL INVESTMENTS (U.S. CLS. 100, 101 AND 102).
FIRST USE 4-0-2004; IN COMMERCE 4-0-2004.
H. M. FISHER, EXAMINING ATTORNEY

SN 76-612,762. MORTGAGE INVESTORS CORPORATION, ST. PETERSBURG, FL. FILED 9-24-2004.



NO CLAIM IS MADE TO THE EXCLUSIVE RIGHT TO USE "MORTGAGE INVESTORS CORPORATION" "MORTGAGE INVESTORS SINCE 1938", APART FROM THE MARK AS SHOWN.
FOR MORTGAGE FINANCING SERVICES, NAMELY REFINANCE AND ORIGINATION OF FIRST LIEN MORTGAGE LOANS (U.S. CLS. 100, 101 AND 102).
FIRST USE 7-23-1938; IN COMMERCE 9-2-1954.
KIMBERLY PERRY, EXAMINING ATTORNEY

SN 76-613,245. THE PRINCETON CORPORATION, KENTLAND, IN. FILED 9-22-2004.

THE INSURANCE YOU KEEP FOR LIFE

THE MARK CONSISTS OF STANDARD CHARACTERS WITHOUT CLAIM TO ANY PARTICULAR FONT, STYLE, SIZE, OR COLOR.
FOR ADMINISTERING INSURANCE PROGRAMS FOR OTHERS (U.S. CLS. 100, 101 AND 102).
KELLY BOULTON, EXAMINING ATTORNEY

CLASS 36—(Continued).

SN 76-614,364. MARSHALL WACE NORTH AMERICA L.P., GREENWICH, CT. FILED 10-1-2004.

TRADE OPTIMIZED PORTFOLIO SYSTEM - TOPS

THE MARK CONSISTS OF STANDARD CHARACTERS WITHOUT CLAIM TO ANY PARTICULAR FONT, STYLE, SIZE, OR COLOR.

FOR FINANCIAL INFORMATION SERVICES, NAMELY, SOLICITING TRADING IDEAS FROM INDUSTRY PROFESSIONALS, COMBINING AND APPLYING THESE IDEAS TO PORTFOLIO CONSTRUCTION, AND REPORTING THE EFFICACY OF THE IDEAS TO THE CONTRIBUTORS (U.S. CLS. 100, 101 AND 102).
PATRICIA EVANKO, EXAMINING ATTORNEY

SN 76-614,759. NAVY FEDERAL CREDIT UNION, MERRIFIELD, VA. FILED 10-7-2004.

ALL TO YOUR ADVANTAGE

THE MARK CONSISTS OF STANDARD CHARACTERS WITHOUT CLAIM TO ANY PARTICULAR FONT, STYLE, SIZE, OR COLOR.

FOR CREDIT UNION SERVICES (U.S. CLS. 100, 101 AND 102).
SAMUEL E. SHARPER JR., EXAMINING ATTORNEY

SN 76-614,981. RECTOR AND VISITORS OF THE UNIVERSITY OF VIRGINIA, CHARLOTTESVILLE, VA. FILED 10-7-2004.

ACCESS UVA

THE MARK CONSISTS OF STANDARD CHARACTERS WITHOUT CLAIM TO ANY PARTICULAR FONT, STYLE, SIZE, OR COLOR.

FOR FINANCIAL SERVICES; NAMELY, PROVIDING FINANCIAL-AID GRANT SERVICES AND COUNSELING IN CONNECTION WITH COLLEGE FINANCING AND DEBT MANAGEMENT (U.S. CLS. 100, 101 AND 102).

FIRST USE 2-6-2004; IN COMMERCE 2-6-2004.
CHARLES L. JENKINS, EXAMINING ATTORNEY

CLASS 36—(Continued).

SN 76-615,198. MY HOUSE REAL ESTATE, INC., BOYNTON BEACH, FL. FILED 10-12-2004.

AGENT 53

THE MARK CONSISTS OF STANDARD CHARACTERS WITHOUT CLAIM TO ANY PARTICULAR FONT, STYLE, SIZE, OR COLOR.

NO CLAIM IS MADE TO THE EXCLUSIVE RIGHT TO USE "AGENT", APART FROM THE MARK AS SHOWN.

FOR REAL ESTATE AGENCIES (U.S. CLS. 100, 101 AND 102).

FIRST USE 8-1-2004; IN COMMERCE 8-1-2004.
RON FAIRBANKS, EXAMINING ATTORNEY

SN 76-615,231. NORTH DALLAS BANK & TRUST CO., DALLAS, TX. FILED 10-12-2004.

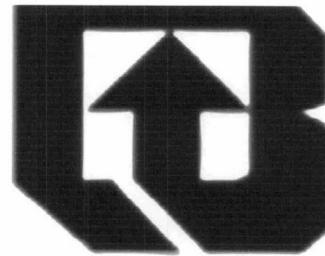

THE MARK CONSISTS OF A STYLIZED LETTER "B". FOR BANKING SERVICES (U.S. CLS. 100, 101 AND 102).

FIRST USE 12-31-1972; IN COMMERCE 12-31-1972.
DAYNA BROWNE, EXAMINING ATTORNEY

SN 76-615,232. THE RISCONSULTING GROUP LLC, BOSTON, MA. FILED 10-12-2004.

RISCONSULTING

THE MARK CONSISTS OF STANDARD CHARACTERS WITHOUT CLAIM TO ANY PARTICULAR FONT, STYLE, SIZE, OR COLOR.

OWNER OF U.S. REG. NO. 2,196,271.

NO CLAIM IS MADE TO THE EXCLUSIVE RIGHT TO USE "RISK CONSULTING", APART FROM THE MARK AS SHOWN.

SEC. 2(F).

FOR FINANCIAL ANALYSIS, ADVISORY, CONSULTING AND MODELING SERVICES IN THE FIELDS OF RISK MANAGEMENT AND MANAGEMENT OF ILLIQUID ASSETS AND LIABILITIES, PROVIDED TO FINANCIAL INSTITUTIONS, INSURANCE COMPANIES, AND LARGE BUSINESS ENTERPRISES (U.S. CLS. 100, 101 AND 102).

FIRST USE 8-0-1996; IN COMMERCE 8-0-1996.
DAYNA BROWNE, EXAMINING ATTORNEY

CLASS 36—(Continued).

SN 76-615,602. FLORIDA COMMUNITY MORTGAGE, INC., TALLAHASSEE, FL. FILED 10-13-2004.

FLORIDA COMMUNITY MORTGAGE

THE MARK CONSISTS OF STANDARD CHARACTERS WITHOUT CLAIM TO ANY PARTICULAR FONT, STYLE, SIZE, OR COLOR.

NO CLAIM IS MADE TO THE EXCLUSIVE RIGHT TO USE "FLORIDA" AND "MORTGAGE", APART FROM THE MARK AS SHOWN.

FOR FINANCIAL SERVICES, NAMELY MORTGAGE BANKING, MORTGAGE BROKERAGE, MORTGAGE LENDING, AND MORTGAGE PROCUREMENT FOR OTHERS (U.S. CLS. 100, 101 AND 102).

FIRST USE 9-1-2002; IN COMMERCE 9-1-2002.

H. M. FISHER, EXAMINING ATTORNEY

SN 76-615,766. NATIONAL WESTERN LIFE INSURANCE COMPANY, AUSTIN, TX. FILED 10-14-2004.

YOU CAME FOR ANNUITIES, NOW STAY FOR LIFE

THE MARK CONSISTS OF STANDARD CHARACTERS WITHOUT CLAIM TO ANY PARTICULAR FONT, STYLE, SIZE, OR COLOR.

OWNER OF U.S. REG. NOS. 2,111,038, 2,744,049 AND OTHERS.

FOR LIFE INSURANCE UNDERWRITING SERVICES AND ANNUITY UNDERWRITING SERVICES (U.S. CLS. 100, 101 AND 102).

DAWN FELDMAN, EXAMINING ATTORNEY

SN 76-616,085. ABEAM CONSULTING LTD., MINATO-KU, TOKYO, JAPAN, FILED 10-15-2004.

ABEAM

THE MARK CONSISTS OF STANDARD CHARACTERS WITHOUT CLAIM TO ANY PARTICULAR FONT, STYLE, SIZE, OR COLOR.

OWNER OF JAPAN REG. NO. 4788419, DATED 7-23-2004, EXPIRES 7-23-2014.

FOR PROVIDING CORPORATE FINANCIAL INFORMATION; INVESTIGATION AND ANALYSIS OF CORPORATE FINANCIAL MATTERS; GUIDANCE AND ADVICE ON CORPORATE FINANCIAL MATTERS (U.S. CLS. 100, 101 AND 102).

SUSAN STIGLITZ, EXAMINING ATTORNEY

CLASS 36—(Continued).

SN 76-616,183. FBL FINANCIAL GROUP, INC., WEST DES MOINES, IA. FILED 10-14-2004.

MARKETSEVEN INDEX

THE MARK CONSISTS OF STANDARD CHARACTERS WITHOUT CLAIM TO ANY PARTICULAR FONT, STYLE, SIZE, OR COLOR.

NO CLAIM IS MADE TO THE EXCLUSIVE RIGHT TO USE "INDEX", APART FROM THE MARK AS SHOWN.

FOR INVESTMENT MANAGEMENT OF AND DISTRIBUTION OF VARIABLE ANNUITIES (U.S. CLS. 100, 101 AND 102).

FIRST USE 9-30-2004; IN COMMERCE 9-30-2004.

DORITT L. CARROLL, EXAMINING ATTORNEY

SN 76-616,404. PARGAR, LLC, DBA PRUDENTIAL GEORGIA REALTY, ROSWELL, GA. FILED 10-19-2004.

The Right Choice

THE MARK CONSISTS OF STANDARD CHARACTERS WITHOUT CLAIM TO ANY PARTICULAR FONT, STYLE, SIZE, OR COLOR.

FOR REAL ESTATE BROKER SERVICES (U.S. CLS. 100, 101 AND 102).

FIRST USE 1-0-1997; IN COMMERCE 1-0-1997.

JULIE WATSON, EXAMINING ATTORNEY

SN 76-616,636. ARZU, INC., LAKE FOREST, IL. FILED 10-18-2004.

WEAVING HOPE FOR AFGHAN WOMEN

THE MARK CONSISTS OF STANDARD CHARACTERS WITHOUT CLAIM TO ANY PARTICULAR FONT, STYLE, SIZE, OR COLOR.

FOR CHARITABLE FUNDRAISING (U.S. CLS. 100, 101 AND 102).

FIRST USE 9-0-2003; IN COMMERCE 9-0-2003.

DOMINIC J. FERRAIUOLO, EXAMINING ATTORNEY

SN 76-616,767. EZFREEMOVE, L.L.C., CYPRESS, TX. FILED 10-18-2004.

EZFreeMove

THE MARK CONSISTS OF STANDARD CHARACTERS WITHOUT CLAIM TO ANY PARTICULAR FONT, STYLE, SIZE, OR COLOR.

FOR APARTMENT LOCATING SERVICES FOR OTHERS (U.S. CLS. 100, 101 AND 102).

FIRST USE 10-1-2004; IN COMMERCE 10-1-2004.

DANIEL CAPSHAW, EXAMINING ATTORNEY

CLASS 36—(Continued).

SN 76-616,944. MCCLELLAN, PETER A., DBA 401K LATTE COMPANY, BURNSVILLE, MN. FILED 10-20-2004.

CLASS 36—(Continued).

SN 76-620,546. DINEASSURED, LLC, WASHINGTON, DC. FILED 11-15-2004.

INVEST IN A CONVERSATION

THE MARK CONSISTS OF STANDARD CHARACTERS WITHOUT CLAIM TO ANY PARTICULAR FONT, STYLE, SIZE, OR COLOR.

FOR FINANCIAL SERVICES, NAMELY, PROVIDING TO INDIVIDUALS FINANCIAL ANALYSIS, CONSULTATION, PLANNING, MANAGEMENT, ADVISORY AND RESEARCH SERVICES WITH RESPECT TO FINANCIAL ISSUES (U.S. CLS. 100, 101 AND 102).

FIRST USE 9-15-2004; IN COMMERCE 9-15-2004.
INGA ERVIN, EXAMINING ATTORNEY

RESTASSURED

THE MARK CONSISTS OF STANDARD CHARACTERS WITHOUT CLAIM TO ANY PARTICULAR FONT, STYLE, SIZE, OR COLOR.

FOR PROVIDING EXTENDED WARRANTIES ON EQUIPMENT IN THE HOSPITALITY INDUSTRY; UNDERWRITING WARRANTY PROGRAMS FOR EQUIPMENT IN THE HOSPITALITY INDUSTRY (U.S. CLS. 100, 101 AND 102).

FIRST USE 7-0-2004; IN COMMERCE 7-0-2004.
JOHN E. MICHOS, EXAMINING ATTORNEY

SN 76-617,429. LIBERTY HOME MORTGAGE, LLC, WEST CALDWELL, NJ. FILED 10-25-2004.

LOOK NO FURTHER . . . YOU'RE HOME

THE MARK CONSISTS OF STANDARD CHARACTERS WITHOUT CLAIM TO ANY PARTICULAR FONT, STYLE, SIZE, OR COLOR.

FOR MORTGAGE BANKING SERVICES (U.S. CLS. 100, 101 AND 102).

FIRST USE 12-1-2000; IN COMMERCE 12-1-2000.
KATHLEEN M. VANSTON, EXAMINING ATTORNEY

SN 76-620,547. DINEASSURED, LLC, WASHINGTON, DC. FILED 11-15-2004.

DINEASSURED

OPERATIONSASSURED

THE MARK CONSISTS OF STANDARD CHARACTERS WITHOUT CLAIM TO ANY PARTICULAR FONT, STYLE, SIZE, OR COLOR.

FOR PROVIDING EXTENDED WARRANTIES ON EQUIPMENT IN THE FOOD SERVICE INDUSTRY AND HOSPITALITY INDUSTRY; UNDERWRITING WARRANTY PROGRAMS FOR EQUIPMENT IN THE FOOD SERVICE INDUSTRY AND HOSPITALITY INDUSTRY (U.S. CLS. 100, 101 AND 102).

FIRST USE 7-0-2004; IN COMMERCE 7-0-2004.
JOHN E. MICHOS, EXAMINING ATTORNEY

THE MARK CONSISTS OF STANDARD CHARACTERS WITHOUT CLAIM TO ANY PARTICULAR FONT, STYLE, SIZE, OR COLOR.

FOR PROVIDING EXTENDED WARRANTIES ON EQUIPMENT IN THE FOOD SERVICE INDUSTRY; UNDERWRITING WARRANTY PROGRAMS FOR EQUIPMENT IN THE FOOD SERVICE INDUSTRY (U.S. CLS. 100, 101 AND 102).

FIRST USE 7-0-2004; IN COMMERCE 7-0-2004.
JOHN E. MICHOS, EXAMINING ATTORNEY

CLASS 36—(Continued).

SN 76-620,870. PULSE EFT ASSOCIATION, INC., HOUSTON, TX. FILED 11-10-2004.



OWNER OF U.S. REG. NOS. 1,225,326, 2,461,084 AND OTHERS.

FOR ELECTRONIC FUND TRANSFERS; FINANCIAL SERVICES, NAMELY, THE ELECTRONIC SWITCHING AND/OR PROCESSING OF ELECTRONIC FUND TRANSFERS, INITIATED AT ANY AUTOMATED TELLER MACHINE, POINT-OF-SALE TERMINAL, OR OTHER HARDWARE DEVICE EMPLOYED BY FINANCIAL INSTITUTIONS, FINANCIAL INDUSTRY BUSINESSES OTHER THAN FINANCIAL INSTITUTIONS, OR MERCHANTS, TO FUND ACCOUNTS; ELECTRONIC BENEFIT TRANSFER SERVICES, NAMELY, THE ELECTRONIC SWITCHING AND/OR PROCESSING OF ELECTRONIC FUND TRANSFERS, INITIATED AT ANY AUTOMATED TELLER MACHINE, POINT-OF-SALE TERMINAL, OR OTHER HARDWARE DEVICE EMPLOYED BY FINANCIAL INSTITUTIONS, FINANCIAL INDUSTRY BUSINESSES OTHER THAN FINANCIAL INSTITUTIONS, OR MERCHANTS, TO FUND ACCOUNTS (U.S. CLS. 100, 101 AND 102).

FIRST USE 10-15-2003; IN COMMERCE 10-15-2003.
MARC LEIPZIG, EXAMINING ATTORNEY

SN 76-621,822. CARS 4 CAUSES, VENTURA, CA. FILED 11-22-2004.

C4C AIR PROGRAM

NO CLAIM IS MADE TO THE EXCLUSIVE RIGHT TO USE "PROGRAM", APART FROM THE MARK AS SHOWN.

FOR CHARITABLE FUND RAISING FOR DONOR DESIGNATED CHARITIES, NAMELY, SOLICITING, REPAIRING, AND SELLING DONATED VEHICLES FOR CHARITABLE FUND RAISING PURPOSES DIRECTED TO SAID DESIGNATED CHARITY (U.S. CLS. 100, 101 AND 102).

FIRST USE 11-10-2004; IN COMMERCE 11-10-2004.
INGA ERVIN, EXAMINING ATTORNEY

SN 76-622,135. THE PAYDAY LOAN STORE OF ILLINOIS, INC., CHICAGO, IL. FILED 11-26-2004.

THIS EASTER, PUT MORE EGGS IN YOUR BASKET

THE MARK CONSISTS OF STANDARD CHARACTERS WITHOUT CLAIM TO ANY PARTICULAR FONT, STYLE, SIZE, OR COLOR.

FOR FINANCIAL SERVICES, NAMELY, SHORT TERM LOAN SERVICES IN THE NATURE OF PAYDAY LOAN ADVANCES AND CHECK CASHING SERVICES (U.S. CLS. 100, 101 AND 102).

FIRST USE 4-16-2003; IN COMMERCE 4-16-2003.
LEIGH CAROLINE CASE, EXAMINING ATTORNEY

CLASS 36—(Continued).

SN 76-622,136. THE PAYDAY LOAN STORE OF ILLINOIS, INC., CHICAGO, IL. FILED 11-26-2004.

ANY DAY CAN BE A PAYDAY

THE MARK CONSISTS OF STANDARD CHARACTERS WITHOUT CLAIM TO ANY PARTICULAR FONT, STYLE, SIZE, OR COLOR.

FOR FINANCIAL SERVICES, NAMELY, SHORT TERM LOAN SERVICES IN THE NATURE OF PAYDAY LOAN ADVANCES AND CHECK CASHING SERVICES (U.S. CLS. 100, 101 AND 102).

FIRST USE 1-15-2003; IN COMMERCE 1-15-2003.
LEIGH CAROLINE CASE, EXAMINING ATTORNEY

SN 76-623,108. VENTAS, INC., LOUISVILLE, KY. FILED 12-3-2004.

CUSTOM CAPITAL. RAPIDLY DELIVERED.

THE MARK CONSISTS OF STANDARD CHARACTERS WITHOUT CLAIM TO ANY PARTICULAR FONT, STYLE, SIZE, OR COLOR.

NO CLAIM IS MADE TO THE EXCLUSIVE RIGHT TO USE "CAPITAL", APART FROM THE MARK AS SHOWN.

FOR REAL ESTATE SERVICES, NAMELY, REAL ESTATE INVESTMENT, ACQUISITION AND MANAGEMENT SERVICES, REAL ESTATE INVESTMENT TRUST SERVICES; REAL ESTATE ADMINISTRATION, NAMELY, REAL ESTATE FINANCING AND LEASING SERVICES; REAL ESTATE FUND MANAGEMENT SERVICES (U.S. CLS. 100, 101 AND 102).

FIRST USE 9-1-2003; IN COMMERCE 9-1-2003.
DAVID ELTON, EXAMINING ATTORNEY

SN 76-624,739. MONEY WAREHOUSE, INC., SOUTHAMPTON, PA. FILED 12-15-2004.



NO CLAIM IS MADE TO THE EXCLUSIVE RIGHT TO USE "MONEY", APART FROM THE MARK AS SHOWN.

FOR HOME MORTGAGE BROKERAGE AND MORTGAGE LENDING (U.S. CLS. 100, 101 AND 102).

FIRST USE 1-0-1999; IN COMMERCE 1-0-1999.
DOMINICK J. SALEMI, EXAMINING ATTORNEY

CLASS 36—(Continued).

SN 76-625,142. MULTIPLE LISTING SERVICE OF L.I., INC., WEST BABYLON, NY. FILED 12-20-2004.

MORE BUYERS OFFERS

FOR PROVIDING AN ONLINE DATA BASE WHICH FEATURES INFORMATION REGARDING REAL ESTATE LISTINGS WHICH ARE CARRIED BY THE APPLICANT'S MEMBERS (U.S. CLS. 100, 101 AND 102).
FIRST USE 3-31-2003; IN COMMERCE 3-31-2003.
KELLY BOULTON, EXAMINING ATTORNEY

SN 76-625,279. DEVINIX, INC., LA JOLLA, CA. FILED 12-20-2004.

LOCAL PAYMENTS, GLOBAL SERVICES

THE MARK CONSISTS OF STANDARD CHARACTERS WITHOUT CLAIM TO ANY PARTICULAR FONT, STYLE, SIZE, OR COLOR.
FOR CREDIT CARD TRANSACTION PROCESSING SERVICES, NAMELY, RECEIVING REQUESTS FOR AUTHORIZATIONS FOR CREDIT CARD TRANSACTIONS AND PROVIDING SUCH AUTHORIZATIONS TO MERCHANTS VIA A GLOBAL INFORMATION NETWORK (U.S. CLS. 100, 101 AND 102).
ESTHER A. BORSUK, EXAMINING ATTORNEY

SN 76-625,570. FEDERAL AGRICULTURAL MORTGAGE CORPORATION, WASHINGTON, DC. FILED 12-22-2004.



THE MARK CONSISTS, IN PART, OF THE LETTERS "FM" IN STYLIZED FORM.
FOR FINANCING SERVICES (U.S. CLS. 100, 101 AND 102).
FIRST USE 10-0-1994; IN COMMERCE 10-0-1994.
STEVEN PEREZ, EXAMINING ATTORNEY

CLASS 36—(Continued).

SN 76-625,679. CHILDREN'S HOSPITAL AND HEALTH CENTER, SAN DIEGO, CA. FILED 12-20-2004.

HEROES FOR CHILDREN'S

THE MARK CONSISTS OF STANDARD CHARACTERS WITHOUT CLAIM TO ANY PARTICULAR FONT, STYLE, SIZE, OR COLOR.
FOR CHARITABLE FUND RAISING (U.S. CLS. 100, 101 AND 102).
FIRST USE 4-1-2004; IN COMMERCE 4-1-2004.
KIMBERLY PERRY, EXAMINING ATTORNEY

SN 76-626,117. KSTP-FM, LLC, ST. PAUL, MN. FILED 12-29-2004.

CHANGE FOR KIDS

THE MARK CONSISTS OF STANDARD CHARACTERS WITHOUT CLAIM TO ANY PARTICULAR FONT, STYLE, SIZE, OR COLOR.
NO CLAIM IS MADE TO THE EXCLUSIVE RIGHT TO USE FOR KIDS, APART FROM THE MARK AS SHOWN.
FOR CHARITABLE FUNDRAISING ACTIVITIES FOR CHILDREN'S SPECIALTY HEALTHCARE, TREATMENT, RESEARCH AND AWARENESS; AND FOR RESEARCH AND TRAINING IN THE CURE, PREVENTION AND TREATMENT OF CHILDHOOD CANCER; AND FOR EDUCATIONAL RESOURCES TO HELP CHILDREN WITH DISABILITIES (U.S. CLS. 100, 101 AND 102).
FIRST USE 10-21-2004; IN COMMERCE 10-21-2004.
CAROLYN CATALDO, EXAMINING ATTORNEY

SN 76-642,284. NISSAN MOTOR ACCEPTANCE CORP., TORRANCE, CA. FILED 7-6-2005.

SIGNATUREGATEWAY

THE MARK CONSISTS OF STANDARD CHARACTERS WITHOUT CLAIM TO ANY PARTICULAR FONT, STYLE, SIZE, OR COLOR.
FOR AUTOMOBILE FINANCING SERVICES (U.S. CLS. 100, 101 AND 102).
FIRST USE 11-1-2004; IN COMMERCE 11-1-2004.
RON FAIRBANKS, EXAMINING ATTORNEY

CLASS 36—(Continued).

SN 76-977,360. T. ROWE PRICE GROUP, INC., BALTIMORE, MD. FILED 12-18-2003.

FuturePath

THE MARK CONSISTS OF STANDARD CHARACTERS WITHOUT CLAIM TO ANY PARTICULAR FONT, STYLE, SIZE, OR COLOR.

FOR ADMINISTRATION OF EMPLOYEE BENEFIT PLANS; AND MUTUAL FUND INVESTMENT (U.S. CLS. 100, 101 AND 102).

FIRST USE 2-0-2004; IN COMMERCE 2-0-2004.
DAVID MURRAY, EXAMINING ATTORNEY

SN 78-078,907. THE CANADA LIFE ASSURANCE COMPANY, TORONTO, ONTARIO, CANADA, FILED 8-13-2001.



Canada Life

PRIORITY CLAIMED UNDER SEC. 44(D) ON CANADA APPLICATION NO. 1,105,879, FILED 6-12-2001, REG. NO. TMA621,204, DATED 9-30-2004, EXPIRES 9-30-2019.

OWNER OF U.S. REG. NOS. 2,259,803 AND 2,439,622.

NO CLAIM IS MADE TO THE EXCLUSIVE RIGHT TO USE "CANADA LIFE", APART FROM THE MARK AS SHOWN.

THE MARK CONSISTS OF THE WORDS "CANADA LIFE" ALONG WITH THE DESIGN OF A BIRD WITH OUT-STRETCHED FEATHERS THAT FORM A CIRCLE.

FOR INSURANCE AGENCY SERVICES; FINANCIAL SERVICES, NAMELY, PROVIDING FINANCIAL INFORMATION TO CLIENTS AND POTENTIAL CLIENTS REGARDING INVESTMENTS, FINANCES, FINANCIAL PLANNING, INSURANCE, PORTFOLIOS, RETIREMENT ISSUES, RETIREMENT SAVINGS PLANS, REGISTERED RETIREMENT INCOME FUNDS AND INVESTOR RISK PROFILES; INSURANCE BROKERAGE; FINANCIAL INVESTMENT SERVICES IN THE FIELD OF RETIREMENT SAVINGS PLANS, REGISTERED RETIREMENT INCOME FUNDS, ANNUITIES, SEGREGATED FUNDS, INVESTMENT SECURITIES AND ASSET ALLOCATION FUNDS; FINANCIAL INVESTMENT COUNSELING SERVICES TO OTHERS; ANNUITIES SERVICES, NAMELY, ANNUITY UNDERWRITING; FINANCIAL INVESTMENT SERVICES IN THE FIELD OF SEGREGATED FUNDS; FINANCIAL INVESTMENT SERVICES IN THE FIELD OF INTEREST BEARING INVESTMENT FUNDS; FINANCIAL INVESTMENT SERVICES IN THE FIELD OF SECURITIES; FINANCIAL MANAGEMENT SERVICES FEATURING ASSET ALLOCATION FUNDS; INSURANCE UNDERWRITING SERVICES FOR ACCIDENT, SICKNESS, DISABILITY AND HOSPITALIZATION INSURANCE; INSURANCE SERVICES, NAMELY PROVIDING INSURANCE INFORMATION CONCERNING POLICIES AND OTHER INSURANCE PRODUCTS ON BEHALF OF INSURANCE COMPANIES TO THEIR PROSPECTIVE CUSTOMERS (U.S. CLS. 100, 101 AND 102).

MITCHELL FRONT, EXAMINING ATTORNEY

CLASS 36—(Continued).

SN 78-143,521. CNA FINANCIAL CORPORATION, CHICAGO, IL. FILED 7-12-2002.

JET ISSUE

NO CLAIM IS MADE TO THE EXCLUSIVE RIGHT TO USE "ISSUE", APART FROM THE MARK AS SHOWN.

FOR INSURANCE ADMINISTRATION, NAMELY, PROCESSING APPLICATIONS FOR INSURANCE (U.S. CLS. 100, 101 AND 102).

FIRST USE 5-14-1999; IN COMMERCE 5-14-1999.
JENNIFER MARTIN, EXAMINING ATTORNEY

SN 78-157,308. REALMARK GROUP, LLC, CAPE CORAL, FL. FILED 8-23-2002.

REALMARK

FOR REAL ESTATE MANAGEMENT; REAL ESTATE BROKERAGE; LAND ACQUISITION, NAMELY, REAL ESTATE BROKERAGE; LEASING OF REAL ESTATE; REAL ESTATE PROCUREMENT FOR OTHERS; REAL ESTATE AGENCIES; REAL ESTATE INVESTMENT; REAL ESTATE LISTING (U.S. CLS. 100, 101 AND 102).

FIRST USE 10-6-1997; IN COMMERCE 6-13-2000.
WANDA KAY PRICE, EXAMINING ATTORNEY

SN 78-162,844. NORTH FORK BANCORPORATION, INC., MELVILLE, NY. FILED 9-11-2002.

NORTH FORK BANK

NO CLAIM IS MADE TO THE EXCLUSIVE RIGHT TO USE "BANK", APART FROM THE MARK AS SHOWN.

FOR FULL LINE OF COMMERCIAL, PERSONAL AND MUNICIPAL BANKING SERVICES; COMMERCIAL, PERSONAL AND MUNICIPAL SAVINGS AND CHECKING ACCOUNT SERVICES; AUTOMATED TELLER MACHINE SERVICES; DIRECT DEPOSIT SERVICES; ELECTRONIC FUNDS TRANSFER SERVICES; TELEPHONE BANKING SERVICES FEATURING FUNDS TRANSFER SERVICES, CHECKING ACCOUNT STOP-PAYMENT SERVICES, TOUCH-TONE BALANCE REPORT SERVICES, PROVIDING INTEREST RATE, TAX, IRA, ACCOUNT BALANCE, TRANSACTION HISTORY, AND OTHER BANKING AND FINANCIAL INFORMATION, AND OTHER RELATED BANKING SERVICES; ONLINE BANKING SERVICES FEATURING BILL PAYMENT SERVICES, FUNDS TRANSFER SERVICES, ONLINE BANKING AND LOAN APPLICATION DOCUMENTS, CUSTOMER ACCOUNT BALANCES AND TRANSACTION INFORMATION, AND OTHER BANKING AND FINANCIAL INFORMATION, AND OTHER RELATED BANKING SERVICES; STUDENT CHECKING, SAVINGS AND LOAN FINANCING SERVICES; COMMERCIAL, CONSUMER, PERSONAL, OVERDRAFT CHECKING, AND AUTOMOBILE LENDING SERVICES; MORTGAGE BANKING, BROKERAGE AND LENDING SERVICES; HOME EQUITY LOAN SERVICES; RESIDENTIAL AND COMMERCIAL LAND AND CONSTRUCTION LOANS; SMALL BUSINESS LOAN FINANCING SERVICES; BUSINESS AND PERSONAL INSTALLMENT LOANS; LETTER OF CREDIT SERVICES; CASH MANAGEMENT SERVICES; CLEARING HOUSE SERVICES; WIRE AND INTERNAL TRANSFER SERVICES; LOCK BOX COLLECTION AND DEPOSIT SERVICES; ACCOUNT AND DEPOSIT RECONCILIATION SERVICES; REAL ESTATE ESCROW AND TENANT SECURITY ACCOUNT SERVICES; CREDIT CARD AND DEBIT CARD SERVICES; CREDIT CARD TRANSACTION PROCESSING SERVICES; TELEPHONE

CLASS 36—(Continued).

CALLING CARD SERVICES; INSURANCE BROKERAGE SERVICES IN THE FIELDS OF ANNUITIES, LIFE AND TERM INSURANCE AND LONG-TERM CARE INSURANCE; FINANCIAL, INVESTMENT, RETIREMENT AND BROKERAGE SERVICES, NAMELY, CERTIFICATES OF DEPOSIT, INDIVIDUAL RETIREMENT ACCOUNTS (IRAS), ROTH AND EDUCATION IRAS, EMPLOYEE PENSION PLANS, RETIREMENT PLANS, PROFIT-SHARING AND MONEY PURCHASE PLANS, PENSION TRUST SERVICES, 401K PLANS, DISTRIBUTION OF RETIREMENT FUNDS, BENEFICIARY DISTRIBUTION SERVICES, FUNDS INVESTMENT AND CONSULTATION, PORTFOLIO MANAGEMENT, STOCK BROKERAGE, MUTUAL FUNDS, BONDS, MONEY MARKET ACCOUNTS, TRUST AND ESTATE PLANNING, AND EXECUTOR, TRUSTEE AND CUSTODIAL SERVICES; FUNERAL TRUST MANAGEMENT SERVICES; PROVIDING LINKS TO THE WEB SITES OF THIRD PARTIES FEATURING FINANCIAL, BANKING, REAL ESTATE, INVESTMENT AND INSURANCE NEWS AND INFORMATION AND TO FINANCIAL AND BANKING DOCUMENT RETAILERS; AND PROVIDING INFORMATION AND CONSULTATION RELATED TO ALL OF THE ABOVE (U.S. CLS. 100, 101 AND 102).

JOHN HWANG, EXAMINING ATTORNEY

SN 78-224,321. MASTERCARD INTERNATIONAL INCORPORATED, PURCHASE, NY. FILED 3-11-2003.

MasterCard
SecureCode

THE MARK CONSISTS OF STANDARD CHARACTERS WITHOUT CLAIM TO ANY PARTICULAR FONT, STYLE, SIZE, OR COLOR.

OWNER OF U.S. REG. NOS. 1,292,519, 1,604,606 AND 2,212,783.

SEC. 2(F) SECURECODE.

FOR FINANCIAL SERVICES, NAMELY, BANKING, CREDIT CARD SERVICES, DEBIT CARD SERVICES; ELECTRONIC FUNDS TRANSFER SERVICES; AND FINANCIAL INFORMATION PROVIDED BY ELECTRONIC MEANS; FINANCIAL ADVISORY SERVICES PERTAINING TO SECURITY METHODOLOGY INVOLVING THE ENCRYPTION OF PAYMENT CARD NUMBERS AND RELATED DATA (U.S. CLS. 100, 101 AND 102).

FIRST USE 10-0-2002; IN COMMERCE 10-0-2002.

DAVID TAYLOR, EXAMINING ATTORNEY

SN 78-224,528. MJCM, LLC, HOUSTON, TX. FILED 3-12-2003.

LOAN INTELLIGENCE

NO CLAIM IS MADE TO THE EXCLUSIVE RIGHT TO USE "LOAN", APART FROM THE MARK AS SHOWN.

FOR CREDIT RISK MANAGEMENT PROVIDED TO FINANCIAL INSTITUTIONS (U.S. CLS. 100, 101 AND 102).

ESTHER A. BORSUK, EXAMINING ATTORNEY

CLASS 36—(Continued).

SN 78-243,080. HUDSON INSURANCE COMPANY, NEW YORK, NY. FILED 4-29-2003.



NO CLAIM IS MADE TO THE EXCLUSIVE RIGHT TO USE "INSURANCE GROUP", APART FROM THE MARK AS SHOWN.

THE COLOR(S) PANTONE REFLEX BLUE IS/ARE CLAIMED AS A FEATURE OF THE MARK.

THE COLOR PANTONE REFLEX BLUE IS CLAIMED AS A FEATURE OF THE MARK AND APPEARS AT FULL VALUE ON APPLICANT'S DESIGN ELEMENT AND ON THE TERM HUDSON AND AT A 50% VALUE ON THE TERMS INSURANCE GROUP.

FOR INSURANCE ADMINISTRATION SERVICES IN THE FORM OF THE PROVIDING OF COVERAGE AND PAYMENT OF CLAIMS FOR SPECIALTY PROPERTY AND CASUALTY INSURANCE RISKS (U.S. CLS. 100, 101 AND 102).

FIRST USE 4-1-2004; IN COMMERCE 4-1-2004.

LAURA KOVAISKY, EXAMINING ATTORNEY

SN 78-245,492. CONNOR, ROBERT W. JR., LA JOLLA, CA. FILED 5-5-2003.

PAYCODE

FOR ELECTRONIC PAYMENT, NAMELY ELECTRONIC PROCESSING AND TRANSMISSION OF POINT OF SALE TRANSACTION AND REDEMPTION DATA; ELECTRONIC COMMERCE PAYMENT SERVICES, NAMELY ESTABLISHING AND MAINTAINING ACCOUNTS USED TO PROMOTE AND PROVIDE COUPON AND TARGETED OFFERINGS TO CONSUMERS OVER THE INTERNET FOR CONSUMER USE IN THE PURCHASING OF GOODS AND SERVICES. (U.S. CLS. 100, 101 AND 102).

LAURA KOVAISKY, EXAMINING ATTORNEY

SN 78-248,157. LOANBRIGHT, EVERGREEN, CO. FILED 5-10-2003.

LOANBRIGHT

FOR FINANCIAL SERVICES NAMELY PROVISION OF INFORMATION CONCERNING MORTGAGES, HOME EQUITY, HOME LOANS AND DOWN PAYMENTS; FINDING FAVORABLE MORTGAGE RATES; PERFORMING LOAN CALCULATIONS (U.S. CLS. 100, 101 AND 102).

FIRST USE 11-18-1999; IN COMMERCE 11-18-1999.

DAWN FELDMAN, EXAMINING ATTORNEY

CLASS 36—(Continued).

SN 78-289,217. INTRA HOLDING CO. INC., WILMINGTON, DE. FILED 8-19-2003.



FOR FINANCIAL SERVICES, NAMELY, MONEY TRANSFER SERVICES, ELECTRONIC FUNDS TRANSFER SERVICES, BILL PAYMENT SERVICES, CHECK CASHING SERVICES, MONEY ORDER SERVICES, CREDIT CARD SERVICES, AUTOMATIC TELLER MACHINE SERVICES, DEBIT AND STORED VALUE CARD SERVICES AND DIRECT DEPOSIT SERVICES (U.S. CLS. 100, 101 AND 102).
DAWN FELDMAN, EXAMINING ATTORNEY

SN 78-301,865. CURANET LLC, LANSING, MI. FILED 9-17-2003.

CURANET

FOR ORGANIZING AND ADMINISTERING A PREFERRED PROVIDER PLAN IN THE FIELD OF HEALTH CARE SERVICES (U.S. CLS. 100, 101 AND 102).
BRIAN PINO, EXAMINING ATTORNEY

SN 78-302,853. MASTERCARD INTERNATIONAL INCORPORATED, PURCHASE, NY. FILED 9-19-2003.

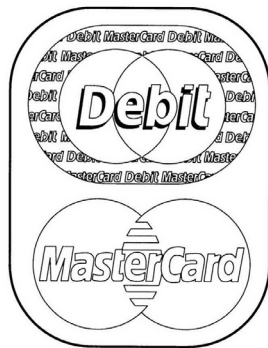

OWNER OF U.S. REG. NOS. 1,257,853, 1,814,279 AND OTHERS.
NO CLAIM IS MADE TO THE EXCLUSIVE RIGHT TO USE "DEBIT", APART FROM THE MARK AS SHOWN.
FOR FINANCIAL SERVICES, NAMELY, BANKING AND DEBIT CARD SERVICES (U.S. CLS. 100, 101 AND 102).
BERYL GARDNER, EXAMINING ATTORNEY

CLASS 36—(Continued).

SN 78-310,292. 38TH PARALLEL INVESTMENTS, INC., MINDEN, NV. FILED 10-7-2003.

38TH PARALLEL INVESTMENTS

NO CLAIM IS MADE TO THE EXCLUSIVE RIGHT TO USE INVESTMENT, APART FROM THE MARK AS SHOWN.
FOR REAL ESTATE INVESTMENT; REAL ESTATE MANAGEMENT; REAL ESTATE RENTALS, NAMELY, RENTAL OF BUILDINGS, HOUSES, APARTMENTS, OFFICE SPACE AND SHOPPING CENTER SPACE (U.S. CLS. 100, 101 AND 102).
CHRISTOPHER ADKINS, EXAMINING ATTORNEY

SN 78-318,303. LAZARUS, STUART, NEW ALBANY, OH. FILED 10-24-2003.

RUN TO REMEMBER

FOR CHARITABLE FUND RAISING THROUGH SPONSORED PARTICIPATION IN FOOT RACES (U.S. CLS. 100, 101 AND 102).
FIRST USE 10-1-2003; IN COMMERCE 10-19-2003.
ELLEN B. AWRICH, EXAMINING ATTORNEY

SN 78-318,957. CPA MUTUAL INSURANCE COMPANY OF AMERICA RISK RETENTION GROUP, GAINESVILLE, FL. FILED 10-27-2003.

CPA MUTUAL

OWNER OF U.S. REG. NO. 2,774,354.
NO CLAIM IS MADE TO THE EXCLUSIVE RIGHT TO USE "MUTUAL", APART FROM THE MARK AS SHOWN.
SEC. 2(F).
FOR CAPTIVE INSURANCE UNDERWRITING SERVICES IN THE FIELD OF RISK RETENTION, NAMELY, PROFESSIONAL AND EMPLOYMENT PRACTICES LIABILITY INSURANCE FOR CERTIFIED PUBLIC ACCOUNTANTS (U.S. CLS. 100, 101 AND 102).
FIRST USE 7-1-1987; IN COMMERCE 7-1-1987.
BARNEY CHARLON, EXAMINING ATTORNEY

SN 78-319,719. BEAMONE, LLC, BETHESDA, MD. FILED 10-28-2003.

BEAMONE

FOR ELECTRONIC COMMERCE PAYMENT SERVICES, NAMELY SECURE ELECTRONIC PROCESSING AND TRANSMISSION OF CREDIT CARD SERVICES VIA INFRARED TRANSMISSION (U.S. CLS. 100, 101 AND 102).
GINA FINK, EXAMINING ATTORNEY

CLASS 36—(Continued).

SN 78-335,740. BGI BENCHMARK GROUP INTERNATIONAL INC., MARKHAM, ONTARIO, CANADA, FILED 12-3-2003.

CLASS 36—(Continued).

SN 78-337,176. THE HUMAN DEVELOPMENT FOUNDATION OF NORTH AMERICA, SCHAUMBURG, IL. FILED 12-5-2003.

BGI BENCHMARK
GROUP INTERNATIONAL

HDFNA

THE MARK CONSISTS OF STANDARD CHARACTERS WITHOUT CLAIM TO ANY PARTICULAR FONT, STYLE, SIZE, OR COLOR.

PRIORITY CLAIMED UNDER SEC. 44(D) ON CANADA APPLICATION NO. 1194042, FILED 10-20-2003, REG. NO. TMA637976, DATED 4-21-2005, EXPIRES 4-21-2020.

NO CLAIM IS MADE TO THE EXCLUSIVE RIGHT TO USE "GROUP INTERNATIONAL", APART FROM THE MARK AS SHOWN.

FOR RECOVERY OF OVERPAYMENT OF TAXES, GOVERNMENT REMITTANCES AND OTHER AMOUNTS TO THIRD PARTIES (U.S. CLS. 100, 101 AND 102).

DAVID MURRAY, EXAMINING ATTORNEY

THE MARK CONSISTS OF STANDARD CHARACTERS WITHOUT CLAIM TO ANY PARTICULAR FONT, STYLE, SIZE, OR COLOR.

FOR COMMUNITY DEVELOPMENT SERVICES, NAMELY, CHARITABLE FUNDRAISING SERVICES TO SUPPORT COMMUNITY DEVELOPMENT PROJECTS IN THE NATURE OF LITERACY PROGRAMS, EDUCATIONAL PROGRAMS, HEALTH CARE PROGRAMS, ECONOMIC DEVELOPMENT PROGRAMS BASED ON MICRO-CREDITS AND PROJECTS FOR DEVELOPING COMMUNITY-BASED ORGANIZATIONS (U.S. CLS. 100, 101 AND 102).

FIRST USE 11-25-1997; IN COMMERCE 11-25-1997.
ELIZABETH J. WINTER, EXAMINING ATTORNEY

SN 78-337,139. WALLOS, ROBERT, KATONAH, NY. FILED 12-5-2003.

SN 78-339,100. AON RISK SERVICES, INC., LOS ANGELES, CA. FILED 12-10-2003.



The Construction Experts

NO CLAIM IS MADE TO THE EXCLUSIVE RIGHT TO USE "INDEX", APART FROM THE MARK AS SHOWN.

THE COLOR(S) GREY AND BLUE WITH BLACK BOUNDARY IS/ARE CLAIMED AS A FEATURE OF THE MARK.

THE MARK CONSISTS OF THE WORD MOB IN BLACK COLOR AGAINST A GREY BACKGROUND AND THE WORD INDEX IN WHITE AGAINST A BLUE BACKGROUND.

FOR FINANCIAL INFORMATION SERVICES, NAMELY, TRACKING EQUITY TRADING ACTIVITY BY AN ONLINE INDEX (U.S. CLS. 100, 101 AND 102).

DEZMONA MIZELLE, EXAMINING ATTORNEY

THE MARK CONSISTS OF STANDARD CHARACTERS WITHOUT CLAIM TO ANY PARTICULAR FONT, STYLE, SIZE, OR COLOR.

NO CLAIM IS MADE TO THE EXCLUSIVE RIGHT TO USE "CONSTRUCTION", APART FROM THE MARK AS SHOWN.

FOR CONSTRUCTION INSURANCE SERVICES, NAMELY, INSURANCE AND REINSURANCE BROKERAGE SERVICES, SURETY BONDING, INSURANCE CONSULTING AND RISK MANAGEMENT SERVICES, AND CONTROLLED INSURANCE PROGRAMS (U.S. CLS. 100, 101 AND 102).

FIRST USE 3-19-2003; IN COMMERCE 3-19-2003.
CHERYL CLAYTON, EXAMINING ATTORNEY

CLASS 36—(Continued).

SN 78-339,877. MILLENNIUM MARKETING GROUP, LLC,
HOUSTON, TX. FILED 12-12-2003.

MILLENNIUM
MULTIPLE EMPLOYER
WELFARE BENEFIT
PLAN

THE MARK CONSISTS OF STANDARD CHARACTERS WITHOUT CLAIM TO ANY PARTICULAR FONT, STYLE, SIZE, OR COLOR.

NO CLAIM IS MADE TO THE EXCLUSIVE RIGHT TO USE "MULTIPLE EMPLOYER WELFARE BENEFIT PLAN", APART FROM THE MARK AS SHOWN.

FOR FINANCIAL SERVICES, NAMELY CONSULTATION, ADVISING, PLANNING AND IMPLEMENTATION OF EMPLOYER AND EMPLOYEE BENEFITS (U.S. CLS. 100, 101 AND 102).

FIRST USE 11-0-2002; IN COMMERCE 11-0-2002.
PATRICIA EVANKO, EXAMINING ATTORNEY

CLASS 36—(Continued).

SN 78-342,348. VOYAGEUR ASSET MANAGEMENT INC.,
MINNEAPOLIS, MN. FILED 12-17-2003.

TAMARACK FUNDS

THE MARK CONSISTS OF STANDARD CHARACTERS WITHOUT CLAIM TO ANY PARTICULAR FONT, STYLE, SIZE, OR COLOR.

NO CLAIM IS MADE TO THE EXCLUSIVE RIGHT TO USE "FUNDS", APART FROM THE MARK AS SHOWN.

FOR FINANCIAL SERVICES, NAMELY MUTUAL FUND INVESTMENT SERVICES; MUTUAL FUND BROKERAGE, DISTRIBUTION, INVESTMENT, ADVISORY, AND MANAGEMENT SERVICES; FINANCIAL INVESTMENT IN THE FIELD OF SECURITIES; FINANCIAL PLANNING, ANALYSIS, RESEARCH, CONSULTATION, AND MANAGEMENT SERVICES; PROVIDING FINANCIAL INFORMATION; INVESTMENT ADVICE, BROKERAGE CONSULTATION, AND MANAGEMENT SERVICES; INVESTMENT OF FUNDS FOR OTHERS (U.S. CLS. 100, 101 AND 102).

REBECCA GILBERT, EXAMINING ATTORNEY

SN 78-342,340. VOYAGEUR ASSET MANAGEMENT INC.,
MINNEAPOLIS, MN. FILED 12-17-2003.

TAMARACK
DISTRIBUTORS

THE MARK CONSISTS OF STANDARD CHARACTERS WITHOUT CLAIM TO ANY PARTICULAR FONT, STYLE, SIZE, OR COLOR.

NO CLAIM IS MADE TO THE EXCLUSIVE RIGHT TO USE "DISTRIBUTORS", APART FROM THE MARK AS SHOWN.

FOR FINANCIAL SERVICES, NAMELY SECURITIES BROKERAGE SERVICES; FINANCIAL INVESTMENT IN THE FIELD OF SECURITIES; FINANCIAL PLANNING, ANALYSIS, RESEARCH, CONSULTATION, AND MANAGEMENT SERVICES; PROVIDING FINANCIAL INFORMATION; INVESTMENT ADVICE, BROKERAGE CONSULTATION, AND MANAGEMENT SERVICES; INVESTMENT OF FUNDS FOR OTHERS (U.S. CLS. 100, 101 AND 102).

REBECCA GILBERT, EXAMINING ATTORNEY

SN 78-342,360. VOYAGEUR ASSET MANAGEMENT, INC.,
MINNEAPOLIS, MN. FILED 12-17-2003.

TAMARACK TRUST

THE MARK CONSISTS OF STANDARD CHARACTERS WITHOUT CLAIM TO ANY PARTICULAR FONT, STYLE, SIZE, OR COLOR.

NO CLAIM IS MADE TO THE EXCLUSIVE RIGHT TO USE "TRUST", APART FROM THE MARK AS SHOWN.

FOR FINANCIAL SERVICES, NAMELY MUTUAL FUND INVESTMENT SERVICES; MUTUAL FUND BROKERAGE, DISTRIBUTION, INVESTMENT, ADVISORY, AND MANAGEMENT SERVICES; FINANCIAL INVESTMENT IN THE FIELD OF SECURITIES; FINANCIAL PLANNING, ANALYSIS, RESEARCH, CONSULTATION, AND MANAGEMENT SERVICES; PROVIDING FINANCIAL INFORMATION; INVESTMENT ADVICE, BROKERAGE CONSULTATION, AND MANAGEMENT SERVICES; INVESTMENT OF FUNDS FOR OTHERS; TRUST SERVICES, NAMELY, INVESTMENT AND TRUST COMPANY SERVICES (U.S. CLS. 100, 101 AND 102).

REBECCA GILBERT, EXAMINING ATTORNEY

CLASS 36—(Continued).

SN 78-346,834. HUBLEY, ROGER ALLEN, MARCO ISLAND, FL. FILED 12-31-2003.

NETWORTH WEALTH MANAGEMENT GROUP, INC.

THE MARK CONSISTS OF STANDARD CHARACTERS WITHOUT CLAIM TO ANY PARTICULAR FONT, STYLE, SIZE, OR COLOR.

NO CLAIM IS MADE TO THE EXCLUSIVE RIGHT TO USE "WEALTH MANAGEMENT GROUP, INC.", APART FROM THE MARK AS SHOWN.

FOR FINANCIAL PLANNING, NAMELY INVESTMENT BROKERAGE, BROKERING LIFE AND HEALTH INSURANCE PRODUCTS, AND INVESTMENT ADVISORY SERVICES (U.S. CLS. 100, 101 AND 102).
PRISCILLA MILTON, EXAMINING ATTORNEY

SN 78-351,880. GRUTKOWSKI, GARY V., SEBASTOPOL, CA. FILED 1-14-2004.

**SONOMA COUNTY
RELOCATION**

THE MARK CONSISTS OF STANDARD CHARACTERS WITHOUT CLAIM TO ANY PARTICULAR FONT, STYLE, SIZE, OR COLOR.

NO CLAIM IS MADE TO THE EXCLUSIVE RIGHT TO USE RELOCATION, APART FROM THE MARK AS SHOWN.

SEC. 2(F).
FOR REAL ESTATE AGENCY SERVICES PROVIDED ONLINE, NAMELY, PROVIDING RELOCATION AND REAL ESTATE SERVICES FOR INDIVIDUALS WHO ARE RELOCATING TO AND FROM DIFFERENT AREAS LOCALLY, NATIONALLY AND WORLDWIDE, CONSULTING ON THE SALE AND PURCHASE OF REAL ESTATE, ASSISTANCE WITH FINANCING SERVICES, AND DISTRIBUTION OF COMMUNITY INFORMATION TO ASSIST IN THE PURCHASE, SALE AND ASSESSMENT OF REAL ESTATE (U.S. CLS. 100, 101 AND 102).

FIRST USE 5-13-2000; IN COMMERCE 5-13-2000.
SEAN DWYER, EXAMINING ATTORNEY

CLASS 36—(Continued).

SN 78-361,497. PHYSICIANS CONSULTANTS, INC., OMAHA, NE. FILED 2-3-2004.



*Risk Management
Solutions*

NO CLAIM IS MADE TO THE EXCLUSIVE RIGHT TO USE "RISK MANAGEMENT SOLUTIONS", APART FROM THE MARK AS SHOWN.

THE COLORS LIGHT BLUE AND DARK BLUE ARE CLAIMED AS A FEATURE OF THE MARK.

THE MARK CONSISTS OF ONE BOX WITH LIGHT BLUE TINT OVERLAPPING ANOTHER BOX WITH DARKER BLUE TINT. THE COLORS LIGHT BLUE AND DARK BLUE ARE CLAIMED AS A FEATURE OF THE MARK.

FOR INSURANCE CONSULTATION (U.S. CLS. 100, 101 AND 102).

FIRST USE 12-23-1991; IN COMMERCE 12-23-1991.
RON FAIRBANKS, EXAMINING ATTORNEY

SN 78-365,393. A. G. EDWARDS & SONS, INC., ST. LOUIS, MO. FILED 2-10-2004.



FOR FINANCIAL SERVICES, NAMELY, FINANCIAL CONSULTATION, FINANCIAL INVESTMENT SERVICES IN THE FIELD OF SECURITIES, ANNUITIES, BONDS, CERTIFICATES OF DEPOSIT, DEFINED PORTFOLIOS, FUTURES, COMMODITIES, INSURANCE, MUTUAL FUNDS, STOCKS, OPTIONS, AND OTHER SECURITIES, AND FINANCIAL BROKERAGE SERVICES IN THE NATURE OF MUTUAL FUND, SECURITY, AND STOCK BROKERAGE SERVICES (U.S. CLS. 100, 101 AND 102).

STEPHANIE DAVIS, EXAMINING ATTORNEY

CLASS 36—(Continued).

SN 78-370,652. INTEGRAMED AMERICA, INC., PURCHASE, NY. FILED 2-19-2004.

SHARED RISK

THE MARK CONSISTS OF STANDARD CHARACTERS WITHOUT CLAIM TO ANY PARTICULAR FONT, STYLE, SIZE, OR COLOR.

FOR FINANCIAL SERVICES RELATED TO STRUCTURING PAYMENT FOR AND ADVISING REGARDING THE AFFORDABILITY OF MEDICAL SERVICES (U.S. CLS. 100, 101 AND 102).

FIRST USE 10-31-1991; IN COMMERCE 10-31-1991.
KEVON CHISOLM, EXAMINING ATTORNEY

CLASS 36—(Continued).

SN 78-378,849. GOLDMAN, SACHS & CO., NEW YORK, NY. FILED 3-4-2004.

AXIL

THE MARK CONSISTS OF STANDARD CHARACTERS WITHOUT CLAIM TO ANY PARTICULAR FONT, STYLE, SIZE, OR COLOR.

FOR STUDENT LOAN ORIGATION SERVICES; CREDIT SERVICES, NAMELY, ISSUANCE OF PRIVATE LABEL CREDIT CARDS TO STUDENTS; COLLEGE FINANCIAL AID FUNDING; MORTGAGE LOAN SERVICES (U.S. CLS. 100, 101 AND 102).

WARREN L. OLANDRIA, EXAMINING ATTORNEY

SN 78-378,979. GARDEN STATE MORTGAGE, WHYCKOFF, NJ. FILED 3-4-2004.

SN 78-375,068. OKOJIE, HENRY OSEZEFUA, DBA ALLSAFE DRIVING SCHOOLS AND INSURANCE COMPANY, LANDOVER HILLS, MD. FILED 2-27-2004.

ALLSAFE

THE MARK CONSISTS OF STANDARD CHARACTERS WITHOUT CLAIM TO ANY PARTICULAR FONT, STYLE, SIZE, OR COLOR.

FOR INSURANCE SERVICES, NAMELY, INSURANCE BROKERAGE IN THE FIELD OF AUTOMOBILE INSURANCE, HOME INSURANCE, ACCIDENT INSURANCE; INSURANCE PREMIUM RATE COMPUTING; INSURANCE SERVICES, NAMELY, UNDERWRITING IN THE FIELD OF AUTOMOBILES, HOME, LIFE, AND HEALTH (U.S. CLS. 100, 101 AND 102).

DARRYL SPRUILL, EXAMINING ATTORNEY

LOWRATES.COM

THE MARK CONSISTS OF STANDARD CHARACTERS WITHOUT CLAIM TO ANY PARTICULAR FONT, STYLE, SIZE, OR COLOR.

SEC. 2(F).
FOR MORTGAGE LENDING (U.S. CLS. 100, 101 AND 102).

FIRST USE 0-0-1995; IN COMMERCE 0-0-1995.
ANDREA SAUNDERS, EXAMINING ATTORNEY

SN 78-380,363. NACM CREDIT SERVICES, INC., OVERLAND PARK, KS. FILED 3-8-2004.



NO CLAIM IS MADE TO THE EXCLUSIVE RIGHT TO USE "CREDIT", APART FROM THE MARK AS SHOWN.
FOR BUSINESS CREDIT REPORTING (U.S. CLS. 100, 101 AND 102).

BRENDAN MCCAULEY, EXAMINING ATTORNEY

CLASS 36—(Continued).

SN 78-380,882. HARRIS TRUST AND SAVINGS BANK, CHICAGO, IL. FILED 3-9-2004.



OWNER OF U.S. REG. NOS. 1,008,229, 2,603,845 AND OTHERS.
 THE MARK CONSISTS OF, IN PART, A STYLIZED LION HEAD IN PROFILE.
 FOR BANKING SERVICES (U.S. CLS. 100, 101 AND 102).
 FIRST USE 3-15-2003; IN COMMERCE 3-15-2003.
 SHARI SHEFFIELD, EXAMINING ATTORNEY

CLASS 36—(Continued).

SN 78-385,143. GILBERT TOWN SQUARE, L.L.C., LAS VEGAS, NV. FILED 3-16-2004.



THE MARK CONSISTS OF STANDARD CHARACTERS WITHOUT CLAIM TO ANY PARTICULAR FONT, STYLE, SIZE, OR COLOR.
 NO CLAIM IS MADE TO THE EXCLUSIVE RIGHT TO USE "TOWN SQUARE", APART FROM THE MARK AS SHOWN.
 FOR LEASING OF SHOPPING CENTER SPACE; LEASING OF OFFICE SPACE; AND PROVIDING SHOPPING CENTER SERVICES (U.S. CLS. 100, 101 AND 102).
 SKYE YOUNG, EXAMINING ATTORNEY

SN 78-386,110. PETERS, DOW, RESTON, VA. FILED 3-17-2004.



THE MARK CONSISTS OF STANDARD CHARACTERS WITHOUT CLAIM TO ANY PARTICULAR FONT, STYLE, SIZE, OR COLOR.
 NO CLAIM IS MADE TO THE EXCLUSIVE RIGHT TO USE "ENDOWMENT PROGRAM", APART FROM THE MARK AS SHOWN.
 FOR ADMINISTRATION OF A CHARITABLE FUNDRAISING PROGRAM FUNDED THROUGH LIFE INSURANCE PROCEEDS (U.S. CLS. 100, 101 AND 102).
 FIRST USE 9-2-2002; IN COMMERCE 9-2-2002.
 MELISSA SHELLA, EXAMINING ATTORNEY

SN 78-381,874. RK CARVILL (INTERNATIONAL HOLDINGS) LIMITED, HAMILTON, BERMUDA, FILED 3-10-2004.



THE MARK CONSISTS OF STANDARD CHARACTERS WITHOUT CLAIM TO ANY PARTICULAR FONT, STYLE, SIZE, OR COLOR.
 SEC. 2(F).
 FOR REINSURANCE UNDERWRITING, NAMELY, REINSURANCE INTERMEDIARY SERVICES FOR ALL TYPES OF INSURANCE (U.S. CLS. 100, 101 AND 102).
 FIRST USE 2-2-1984; IN COMMERCE 2-2-1984.
 MARC LEIPZIG, EXAMINING ATTORNEY

SN 78-386,137. FIRST FRANKLIN FINANCIAL CORPORATION, SAN JOSE, CA. FILED 3-17-2004.



OWNER OF U.S. REG. NOS. 1,843,185 AND 1,929,915.
 NO CLAIM IS MADE TO THE EXCLUSIVE RIGHT TO USE "COMPANY", APART FROM THE MARK AS SHOWN.
 THE COLORS DARK CYAN AND LIGHT CYAN ARE CLAIMED AS FEATURES OF THE MARK".
 THE MARK CONSISTS OF A DESIGN OF A HOUSE WITH A DARK CYAN ROOF AND CHIMNEY AND A LIGHT CYAN WALL AND FOUNDATION.
 FOR FINANCIAL SERVICES, NAMELY MORTGAGE BANKING SERVICES AND MORTGAGE BROKERAGE SERVICES (U.S. CLS. 100, 101 AND 102).
 FIRST USE 6-0-2004; IN COMMERCE 6-0-2004.
 YONG KIM, EXAMINING ATTORNEY

CLASS 36—(Continued).

SN 78-388,955. ELITEAXIS, L.L.C., PHOENIX, AZ. FILED 3-23-2004.

CLASS 36—(Continued).

SN 78-393,522. THE KROGER CO., CINCINNATI, OH. FILED 3-30-2004.

ELITEAXIS

THE MARK CONSISTS OF STANDARD CHARACTERS WITHOUT CLAIM TO ANY PARTICULAR FONT, STYLE, SIZE, OR COLOR.

FOR BROKERAGE SERVICES IN THE FIELD OF TICKETS TO SPORTING EVENTS, MUSICAL CONCERTS AND RELATED MUSICAL EVENTS (U.S. CLS. 100, 101 AND 102).

FIRST USE 8-12-2003; IN COMMERCE 8-12-2003.
STEVEN JACKSON, EXAMINING ATTORNEY

THE MARK CONSISTS OF STANDARD CHARACTERS WITHOUT CLAIM TO ANY PARTICULAR FONT, STYLE, SIZE, OR COLOR.

FOR CREDIT CARD SERVICES (U.S. CLS. 100, 101 AND 102).

FIRST USE 6-28-2004; IN COMMERCE 6-28-2004.
ROBIN CHOSID, EXAMINING ATTORNEY

SN 78-394,442. TITLE PAC, INC., OKLAHOMA CITY, OK. FILED 3-31-2004.

SN 78-388,963. ELITEAXIS, L.L.C., PHOENIX, AZ. FILED 3-23-2004.



EscroPac

THE MARK CONSISTS OF A STYLIZED LETTER "E". FOR BROKERAGE SERVICES IN THE FIELD OF TICKETS TO SPORTING EVENTS, MUSIC CONCERTS AND RELATED MUSICAL EVENTS (U.S. CLS. 100, 101 AND 102).

FIRST USE 8-12-2003; IN COMMERCE 8-12-2003.
EDWARD NELSON, EXAMINING ATTORNEY

THE MARK CONSISTS OF STANDARD CHARACTERS WITHOUT CLAIM TO ANY PARTICULAR FONT, STYLE, SIZE, OR COLOR.

FOR INSURANCE AGENCIES IN THE FIELD OF ESCROW AGENTS ERRORS AND OMISSIONS LIABILITY INSURANCE (U.S. CLS. 100, 101 AND 102).

FIRST USE 10-1-1980; IN COMMERCE 10-1-1980.
STEVEN R. FINE, EXAMINING ATTORNEY

CLASS 36—(Continued).

SN 78-395,694. WALTON INTERNATIONAL GROUP INC., CALGARY, AB, CANADA, FILED 4-2-2004.

INVESTING ON SOLID GROUND

THE MARK CONSISTS OF STANDARD CHARACTERS WITHOUT CLAIM TO ANY PARTICULAR FONT, STYLE, SIZE, OR COLOR.

PRIORITY CLAIMED UNDER SEC. 44(D) ON CANADA APPLICATION NO. 1,193,582, FILED 10-3-2003.

FOR (1) REAL ESTATE INVESTMENT SERVICES; (2) BUILDING PROPERTY MANAGEMENT SERVICES; (3) CONSULTING SERVICES IN THE AREA OF REAL ESTATE (U.S. CLS. 100, 101 AND 102).

SEAN DWYER, EXAMINING ATTORNEY

CLASS 36—(Continued).

SN 78-398,314. THE BIONDO GROUP, LLC, MILFORD, PA. FILED 4-7-2004.



THE BIONDO GROUP

NO CLAIM IS MADE TO THE EXCLUSIVE RIGHT TO USE "GROUP", APART FROM THE MARK AS SHOWN.

THE FOREIGN WORDING IN THE MARK TRANSLATES INTO ENGLISH AS BLOND.

FOR FINANCIAL SERVICES, NAMELY, INVESTMENT MANAGEMENT AND SECURITIES BROKERAGE (U.S. CLS. 100, 101 AND 102).

WILLIAM BRECKENFELD, EXAMINING ATTORNEY

SN 78-396,202. LOVE 4 ONE ANOTHER CHARITIES, CHANHASSEN, MN. FILED 4-5-2004.

Love 4 One Another

THE MARK CONSISTS OF STANDARD CHARACTERS WITHOUT CLAIM TO ANY PARTICULAR FONT, STYLE, SIZE, OR COLOR.

FOR PROVIDING GRANTS TO CHARITIES (U.S. CLS. 100, 101 AND 102).

FIRST USE 1-1-1984; IN COMMERCE 1-1-1984.

G. MAYERSCHOFF, EXAMINING ATTORNEY

SN 78-398,439. DICKINSON FINANCIAL CORPORATION, KANSAS CITY, MO. FILED 4-8-2004.

ACADEMY BANK

SN 78-398,078. CHICAGO CLIMATE EXCHANGE, INC., CHICAGO, IL. FILED 4-7-2004.

GLOBAL CLIMATE EXCHANGE

THE MARK CONSISTS OF STANDARD CHARACTERS WITHOUT CLAIM TO ANY PARTICULAR FONT, STYLE, SIZE, OR COLOR.

OWNER OF U.S. REG. NO. 2,692,174.

NO CLAIM IS MADE TO THE EXCLUSIVE RIGHT TO USE GLOBAL AND EXCHANGE, APART FROM THE MARK AS SHOWN.

FOR COMMODITY EXCHANGE SERVICES, NAMELY, CARBON DIOXIDE AND OTHER GREENHOUSE GAS EMISSIONS EXCHANGE SERVICES THAT FACILITATE THE TRADING OR SALE OF CARBON DIOXIDE AND OTHER GREENHOUSE GAS EMISSIONS ALLOWANCES AND OFFSETS BETWEEN BUSINESS AND OTHER MARKET PARTICIPANTS (U.S. CLS. 100, 101 AND 102).

TERESA M. RUPP, EXAMINING ATTORNEY

THE MARK CONSISTS OF STANDARD CHARACTERS WITHOUT CLAIM TO ANY PARTICULAR FONT, STYLE, SIZE, OR COLOR.

NO CLAIM IS MADE TO THE EXCLUSIVE RIGHT TO USE "BANK", APART FROM THE MARK AS SHOWN.

FOR BANKING (U.S. CLS. 100, 101 AND 102).

FIRST USE 4-30-2000; IN COMMERCE 4-30-2000.

JACQUELINE A. LAVINE, EXAMINING ATTORNEY

CLASS 36—(Continued).

SN 78-398,887. ASSOCIATED VOLUME BUYERS, INC., LONG BEACH, CA. FILED 4-8-2004.

BRAND SOURCE EXPERT FINANCE

THE MARK CONSISTS OF STANDARD CHARACTERS WITHOUT CLAIM TO ANY PARTICULAR FONT, STYLE, SIZE, OR COLOR.

OWNER OF U.S. REG. NO. 2,482,876.

NO CLAIM IS MADE TO THE EXCLUSIVE RIGHT TO USE EXPERT FINANCE, APART FROM THE MARK AS SHOWN.

FOR FINANCIAL SERVICES NAMELY, INVENTORY FINANCING (U.S. CLS. 100, 101 AND 102).

FIRST USE 3-15-2004; IN COMMERCE 3-15-2004.

TRACY CROSS, EXAMINING ATTORNEY

SN 78-399,801. VALUEQUEST FINANCIAL GROUP LLC, MAHWAH, NJ. FILED 4-10-2004.



THE COLOR GOLD IS CLAIMED AS A FEATURE OF THE MARK.

THE COLOR GOLD APPEARS IN THE STAR TO THE LEFT OF THE WORDING VALUEQUEST.

FOR FINANCIAL AND INVESTMENT PLANNING, ANALYSIS, MANAGEMENT AND ADVISORY SERVICES FOR INDIVIDUALS, PARTNERSHIPS, TRUSTS, ESTATES, AND BUSINESSES (U.S. CLS. 100, 101 AND 102).

FIRST USE 4-9-2004; IN COMMERCE 4-9-2004.

MICHAEL ENGEL, EXAMINING ATTORNEY

SN 78-401,897. JANUS INTERNATIONAL HOLDING LLC, RENO, NV. FILED 4-14-2004.



JANUS CAPITAL
Group

OWNER OF U.S. REG. NOS. 1,828,568, 2,688,287 AND OTHERS.

NO CLAIM IS MADE TO THE EXCLUSIVE RIGHT TO USE "CAPITAL GROUP", APART FROM THE MARK AS SHOWN.

FOR INVESTING THE FUNDS OF OTHERS; MUTUAL FUND INVESTMENT SERVICES; INVESTMENT ADVISORY SERVICES (U.S. CLS. 100, 101 AND 102).

FIRST USE 2-1-2004; IN COMMERCE 2-1-2004.

G. MAYERSCHOFF, EXAMINING ATTORNEY

CLASS 36—(Continued).

SN 78-401,955. ADVANCE PLANNING SERVICES, APPLETON, WI. FILED 4-14-2004.



NO CLAIM IS MADE TO THE EXCLUSIVE RIGHT TO USE "ADVANCE PLANNING SERVICES", APART FROM THE MARK AS SHOWN.

THE COLOR(S) YELLOW LEAF LOGO AND "SERVICES" TEXT, WITH BLUE "ADVANCE PLANNING" TEXT IS/ARE CLAIMED AS A FEATURE OF THE MARK.

THE MARK CONSISTS OF THE LEAF LOGO IS TO THE LEFT OF TEXT AND IS COLORED YELLOW, THE SAME AS THE TEXT "SERVICES", WITH "ADVANCE PLANNING" TEXT IN BLUE.

THE MARK CONSISTS OF THE LEAF LOGO IS TO THE LEFT OF TEXT AND IS COLORED YELLOW, THE SAME AS THE TEXT "SERVICES", WITH "ADVANCE PLANNING" TEXT IN BLUE.

FOR INSURANCE BROKERAGE IN THE FIELD OF PRENEED (U.S. CLS. 100, 101 AND 102).

ARETHA SOMERVILLE, EXAMINING ATTORNEY

SN 78-402,446. AMERICAN COMMUNITY MUTUAL INSURANCE COMPANY, LIVONIA, MI. FILED 4-15-2004.

COMMUNITY MED HSA

THE MARK CONSISTS OF STANDARD CHARACTERS WITHOUT CLAIM TO ANY PARTICULAR FONT, STYLE, SIZE, OR COLOR.

OWNER OF U.S. REG. NO. 2,883,254.

NO CLAIM IS MADE TO THE EXCLUSIVE RIGHT TO USE "MED HSA", APART FROM THE MARK AS SHOWN.

FOR UNDERWRITING INSURANCE FOR AND ADMINISTRATION OF PRE-PAID HEALTH CARE PLANS (U.S. CLS. 100, 101 AND 102).

BRENDAN MCCAULEY, EXAMINING ATTORNEY

CLASS 36—(Continued).

SN 78-402,667. SIGNATURE BANK, NEW YORK, NY. FILED 4-15-2004.

CLASS 36—(Continued).

SN 78-403,883. AMERICAN INSURANCE ADMINISTRATORS, INC., COLUMBUS, OH. FILED 4-19-2004.

Signature Wealth Management

THE ALUMNI TRAVEL INSURANCE PROGRAM

THE MARK CONSISTS OF STANDARD CHARACTERS WITHOUT CLAIM TO ANY PARTICULAR FONT, STYLE, SIZE, OR COLOR.

NO CLAIM IS MADE TO THE EXCLUSIVE RIGHT TO USE "WEALTH MANAGEMENT", APART FROM THE MARK AS SHOWN.

FOR FINANCIAL MANAGEMENT SERVICE (U.S. CLS. 100, 101 AND 102).

FIRST USE 4-12-2004; IN COMMERCE 4-12-2004.
KELLY CHOE, EXAMINING ATTORNEY

THE MARK CONSISTS OF STANDARD CHARACTERS WITHOUT CLAIM TO ANY PARTICULAR FONT, STYLE, SIZE, OR COLOR.

OWNER OF U.S. REG. NOS. 2,363,611, 2,787,593 AND OTHERS.

NO CLAIM IS MADE TO THE EXCLUSIVE RIGHT TO USE "TRAVEL INSURANCE PROGRAM", APART FROM THE MARK AS SHOWN.

SEC. 2(F) IN PART, AS TO ALUMNI.
FOR INSURANCE BROKERAGE SERVICES, NAMELY, TRAVEL INSURANCE (U.S. CLS. 100, 101 AND 102).

FIRST USE 6-17-2003; IN COMMERCE 6-17-2003.
JENNIFER MARTIN, EXAMINING ATTORNEY

SN 78-403,214. FEDERATED MUTUAL INSURANCE COMPANY, OWATONNA, MN. FILED 4-16-2004.

SN 78-404,272. COHEN BROS. FINANCIAL MANAGEMENT, LLC, WILMINGTON, DE. FILED 4-19-2004.

BECAUSE YOU'RE THERE FOR US... WE'RE HERE FOR YOU

ALESCO PREFERRED FUNDING

THE MARK CONSISTS OF STANDARD CHARACTERS WITHOUT CLAIM TO ANY PARTICULAR FONT, STYLE, SIZE, OR COLOR.

FOR INSURANCE UNDERWRITING IN THE FIELD OF HEALTH, CASUALTY, PROPERTY, DISABILITY, RETIREMENT, BUSINESS AND LIFE (U.S. CLS. 100, 101 AND 102).

FIRST USE 4-1-2003; IN COMMERCE 8-0-2003.
KIM SAITO, EXAMINING ATTORNEY

THE MARK CONSISTS OF STANDARD CHARACTERS WITHOUT CLAIM TO ANY PARTICULAR FONT, STYLE, SIZE, OR COLOR.

NO CLAIM IS MADE TO THE EXCLUSIVE RIGHT TO USE "PREFERRED FUNDING", APART FROM THE MARK AS SHOWN.

FOR FINANCIAL SERVICES IN THE NATURE OF AN INVESTMENT SECURITY (U.S. CLS. 100, 101 AND 102).

FIRST USE 9-1-2003; IN COMMERCE 9-30-2003.
CURTIS FRENCH, EXAMINING ATTORNEY

CLASS 36—(Continued).

SN 78-405,018. PARADISE PROPERTIES USA, INC, ALDEN, MI. FILED 4-20-2004.

Paradise Properties USA

THE MARK CONSISTS OF STANDARD CHARACTERS WITHOUT CLAIM TO ANY PARTICULAR FONT, STYLE, SIZE, OR COLOR.

NO CLAIM IS MADE TO THE EXCLUSIVE RIGHT TO USE "PROPERTIES USA", APART FROM THE MARK AS SHOWN.

FOR REAL ESTATE AGENCY AND LISTING SERVICES FOR PREMIER WATERFRONT VACATION HOMES, COTTAGES, AND LAND (U.S. CLS. 100, 101 AND 102).

FIRST USE 1-31-2003; IN COMMERCE 1-31-2003.
SHARON MEIER, EXAMINING ATTORNEY

SN 78-405,546. INTERNATIONAL SECURITIES EXCHANGE, INC., NEW YORK, NY. FILED 4-21-2004.

Inside ISE

THE MARK CONSISTS OF STANDARD CHARACTERS WITHOUT CLAIM TO ANY PARTICULAR FONT, STYLE, SIZE, OR COLOR.

OWNER OF U.S. REG. NOS. 2,635,776, 2,686,458 AND 2,792,550.

FOR CONDUCTING A SECURITIES EXCHANGE (U.S. CLS. 100, 101 AND 102).

FIRST USE 12-22-2003; IN COMMERCE 12-22-2003.
PAULA MAHONEY, EXAMINING ATTORNEY

CLASS 36—(Continued).

SN 78-407,433. UNITED COMMUNITY BANKS, INC., BLAIRSVILLE, GA. FILED 4-23-2004.

UNITED COMMUNITY ADVISORY SERVICES

THE MARK CONSISTS OF STANDARD CHARACTERS WITHOUT CLAIM TO ANY PARTICULAR FONT, STYLE, SIZE, OR COLOR.

OWNER OF U.S. REG. NOS. 2,723,377, 2,784,016 AND 2,834,618.

NO CLAIM IS MADE TO THE EXCLUSIVE RIGHT TO USE "COMMUNITY ADVISORY SERVICES", APART FROM THE MARK AS SHOWN.

FOR BANKING AND FINANCIAL SERVICES, NAMELY, MONEY LENDING, SAVINGS ACCOUNTS AND PROGRAMS, CHECKING ACCOUNTS AND PROGRAMS, CERTIFICATES OF DEPOSIT ACCOUNTS AND PROGRAMS, IRA ACCOUNTS AND PROGRAMS, ISSUING CERTIFICATES OF DEPOSIT, CASH AND ASSET MANAGEMENT SERVICES, FINANCIAL AND INVESTMENT ADVISORY, CONSULTATION, PLANNING, MANAGEMENT, AND ADMINISTRATION SERVICES, INVESTMENT FUND TRANSFER AND TRANSACTION SERVICES, ESTATE PLANNING SERVICES, INVESTMENT AND SECURITIES BROKERAGE SERVICES, CREDIT CARD SERVICES, DEBIT CARD SERVICES, MONEY ORDER SERVICES, AUTOMATIC TELLER MACHINE SERVICES, DISTRIBUTION OF ANNUITIES, BILL PAYMENT SERVICES, FINANCIAL TRUST OPERATIONS, ISSUING PREPAID STORED VALUE CARDS, ELECTRONIC AND NON-ELECTRONIC PAYMENT AND CURRENCY TRANSFER SERVICES, MORTGAGE BANKING AND MORTGAGE LENDING SERVICES, AND PROVIDING ALL OF THE FOREGOING SERVICES BY TRADITIONAL METHODS, TELEPHONE, AND GLOBAL COMPUTER NETWORK (U.S. CLS. 100, 101 AND 102).

FIRST USE 7-7-2004; IN COMMERCE 7-7-2004.
MONIQUE MILLER, EXAMINING ATTORNEY

SN 78-409,219. U.S.A. MERIDIAN INTERNATIONAL, INC., NORTH JACKSON, OH. FILED 4-28-2004.

RAPID RESPONSE POSSE

THE MARK CONSISTS OF STANDARD CHARACTERS WITHOUT CLAIM TO ANY PARTICULAR FONT, STYLE, SIZE, OR COLOR.

NO CLAIM IS MADE TO THE EXCLUSIVE RIGHT TO USE "RAPID RESPONSE", APART FROM THE MARK AS SHOWN.

FOR DEBT MANAGEMENT AND COUNSELING SERVICES; VEHICLE REPOSSESSION SERVICES (U.S. CLS. 100, 101 AND 102).

FIRST USE 11-30-2004; IN COMMERCE 11-30-2004.
BRENDAN REGAN, EXAMINING ATTORNEY

CLASS 36—(Continued).

SN 78-410,831. NORTH BAY BANCORP, NAPA, CA. FILED 4-29-2004.

CLASS 36—(Continued).

SN 78-411,238. ONINK, TROY H, RUSSELL, PA. FILED 4-30-2004.

college planning
is retirement
planning



THE MARK CONSISTS OF STANDARD CHARACTERS WITHOUT CLAIM TO ANY PARTICULAR FONT, STYLE, SIZE, OR COLOR.

FOR FINANCIAL SERVICES, NAMELY, INVESTMENT FUND TRANSFER AND TRANSACTION SERVICES, ASSISTING OTHERS WITH THE COMPLETION OF FINANCIAL TRANSACTIONS FOR STOCKS, BONDS, SECURITIES AND EQUITIES, ISSUANCE AND MANAGEMENT OF CERTIFICATES BACKED BY LOAN PORTFOLIOS WHICH ARE SUBSEQUENTLY MANAGED TO INSURE THE INTEGRITY OF THE CERTIFICATES, FINANCIAL ANALYSIS AND CONSULTATION, FINANCIAL EVALUATION FOR INSURANCE PURPOSES, FINANCIAL FORECASTING, FINANCIAL INFORMATION PROVIDED BY ELECTRONIC MEANS, FINANCIAL INVESTMENT IN THE FIELD OF SECURITIES, FINANCIAL MANAGEMENT, FINANCIAL PLANNING, FINANCIAL PORTFOLIO MANAGEMENT, FINANCIAL RESEARCH, FINANCIAL TRUST OPERATIONS, FINANCIAL VALUATION OF PERSONAL PROPERTY AND REAL ESTATE, AND PROVIDING ON-LINE FINANCIAL CALCULATORS (U.S. CLS. 100, 101 AND 102).

FIRST USE 5-1-1998; IN COMMERCE 9-5-1998.
ERNEST SHOSHO, EXAMINING ATTORNEY

SN 78-411,707. 3 PHASES ENERGY SERVICES, RENO, NV.
FILED 4-30-2004.

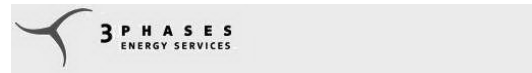

NO CLAIM IS MADE TO THE EXCLUSIVE RIGHT TO USE "BANK", APART FROM THE MARK AS SHOWN.

THE COLOR GRAY IS INTENDED TO INDICATE SHADING OR CONTRAST ONLY, AND THE MARK IS NOT IN COLOR. THE LINING IN THE DRAWING IS A CLAIMED AS A FEATURE OF THE MARK.

THE FOREIGN WORDING IN THE MARK TRANSLATES INTO ENGLISH AS EASTERLY WIND OR HOT WIND.

FOR BANKING SERVICES, MORTGAGE BANKING SERVICES, MORTGAGE LENDING SERVICES, MORTGAGE BROKERAGE SERVICES; PROVIDING ONLINE BANKING AND BANK CUSTOMER ACCOUNT INFORMATION VIA THE INTERNET AND COMPUTER NETWORKS (U.S. CLS. 100, 101 AND 102).

FIRST USE 5-17-2000; IN COMMERCE 5-17-2000.
STEVEN R. FINE, EXAMINING ATTORNEY

NO CLAIM IS MADE TO THE EXCLUSIVE RIGHT TO USE "ENERGY SERVICES", APART FROM THE MARK AS SHOWN.

FOR ENERGY BROKERAGE SERVICES, NAMELY BUYING, SELLING, AND TRADING ENERGY AND ENERGY CERTIFICATES (U.S. CLS. 100, 101 AND 102).

FIRST USE 11-30-1999; IN COMMERCE 7-30-2002.
AMY HELLA, EXAMINING ATTORNEY

CLASS 36—(Continued).

SN 78-412,254. IDT NETHERLANDS, B.V. (PUERTO RICO BRANCH), SAN JUAN, PUERTO RICO, FILED 5-3-2004.

CLASS 36—(Continued).

SN 78-417,456. CHILDREN'S CANCER RESEARCH FUND, MINNEAPOLIS, MN. FILED 5-12-2004.

REMEMBER

TIME TO FLY

THE MARK CONSISTS OF STANDARD CHARACTERS WITHOUT CLAIM TO ANY PARTICULAR FONT, STYLE, SIZE, OR COLOR.

FOR PREPAID TELEPHONE CALLING CARD AND TELEPHONE DEBIT CARD SERVICES (U.S. CLS. 100, 101 AND 102).

FIRST USE 3-31-2004; IN COMMERCE 3-31-2004.
LOURDES AYALA, EXAMINING ATTORNEY

THE MARK CONSISTS OF STANDARD CHARACTERS WITHOUT CLAIM TO ANY PARTICULAR FONT, STYLE, SIZE, OR COLOR.

FOR CHARITABLE FUND RAISING, NAMELY, ORGANIZING AND CONDUCTING FOOT RACES TO RAISE MONEY FOR THE CHILDREN'S CANCER RESEARCH (U.S. CLS. 100, 101 AND 102).

FIRST USE 3-8-2004; IN COMMERCE 3-8-2004.
FRED MANDIR, EXAMINING ATTORNEY

SN 78-416,220. ING NORTH AMERICA INSURANCE CORPORATION, ATLANTA, GA. FILED 5-10-2004.

SN 78-417,494. CHILDREN'S CANCER RESEARCH FUND, MINNEAPOLIS, MN. FILED 5-12-2004.

KNOWING MORE MEANS
RISKING LESS



THE MARK CONSISTS OF STANDARD CHARACTERS WITHOUT CLAIM TO ANY PARTICULAR FONT, STYLE, SIZE, OR COLOR.

FOR REINSURANCE SERVICES, NAMELY, REINSURANCE UNDERWRITING AND REINSURANCE ADMINISTRATION SERVICES (U.S. CLS. 100, 101 AND 102).

FIRST USE 10-7-2002; IN COMMERCE 10-7-2002.
JENNIFER MARTIN, EXAMINING ATTORNEY

FOR CHARITABLE FUND RAISING, NAMELY, ORGANIZING AND CONDUCTING FOOT RACES TO RAISE MONEY FOR CHILDREN'S CANCER RESEARCH (U.S. CLS. 100, 101 AND 102).

FIRST USE 3-8-2004; IN COMMERCE 3-8-2004.
FRED MANDIR, EXAMINING ATTORNEY

CLASS 36—(Continued).

SN 78-418,233. TREASURY BANK, N.A., CALABASAS, CA. FILED 5-13-2004.

Every Investor Counts

THE MARK CONSISTS OF STANDARD CHARACTERS WITHOUT CLAIM TO ANY PARTICULAR FONT, STYLE, SIZE, OR COLOR.

FOR BANKING SERVICES (U.S. CLS. 100, 101 AND 102).

CAROL SPILS, EXAMINING ATTORNEY



SN 78-421,373. TOMPKINS, BERNARD M, OMAHA, NE. FILED 5-19-2004.

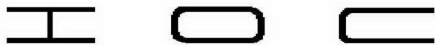

OWNER OF U.S. REG. NO. 1,321,210. FOR REAL ESTATE AGENCIES, REAL ESTATE BROKERAGE, REAL ESTATE MANAGEMENT AND ASSESSMENT (U.S. CLS. 100, 101 AND 102).

FIRST USE 1-1-1980; IN COMMERCE 1-1-1980.

ALEXANDER L. POWERS, EXAMINING ATTORNEY



SN 78-423,853. IDT NETHERLANDS, B.V. (PUERTO RICO BRANCH), SAN JUAN, PUERTO RICO, FILED 5-24-2004.

ALEGRIA DOMINICANA

THE MARK CONSISTS OF STANDARD CHARACTERS WITHOUT CLAIM TO ANY PARTICULAR FONT, STYLE, SIZE, OR COLOR.

OWNER OF U.S. REG. NO. 2,826,348.

NO CLAIM IS MADE TO THE EXCLUSIVE RIGHT TO USE "DOMINICANA", APART FROM THE MARK AS SHOWN.

THE FOREIGN WORDING IN THE MARK TRANSLATES INTO ENGLISH AS DOMINICAN HAPPINESS.

FOR PREPAID TELEPHONE CALLING CARD AND TELEPHONE DEBIT CARD SERVICES (U.S. CLS. 100, 101 AND 102).

FIRST USE 11-1-2001; IN COMMERCE 11-1-2001.

KIMBERLY FRYE, EXAMINING ATTORNEY

CLASS 36—(Continued).

SN 78-424,318. WELLS FARGO & COMPANY, MINNEAPOLIS, MN. FILED 5-25-2004.

STANDING STRONG IN CROP INSURANCE

THE MARK CONSISTS OF STANDARD CHARACTERS WITHOUT CLAIM TO ANY PARTICULAR FONT, STYLE, SIZE, OR COLOR.

FOR INSURANCE SERVICES, NAMELY RURAL INSURANCE SERVICES IN THE FIELD OF CROP, LIVESTOCK, PERSONAL AUTO, HOMEOWNERS, LIABILITY AND EXCESS LIABILITY, FLOOD, SMALL BUSINESS COMMERCIAL, FARM PROPERTY AND LIABILITY, FARM AUTOS, AND FARM EXCESS LIABILITY, COMMERCIAL AGRI-BUSINESS, LIFE, HEALTH, LONG TERM CARE, AND DISABILITY, PERSONAL UMBRELLA AND IN-HOME BUSINESS, AND AGENT'S ERRORS AND OMISSIONS COVERAGES (U.S. CLS. 100, 101 AND 102).

FIRST USE 5-26-2004; IN COMMERCE 5-26-2004.

SALLY SHIH, EXAMINING ATTORNEY



SN 78-425,076. US HOMELAND SECURITY INSURANCE CO., INC., NEW ROCHELLE, NY. FILED 5-26-2004.

HSIC

THE MARK CONSISTS OF STANDARD CHARACTERS WITHOUT CLAIM TO ANY PARTICULAR FONT, STYLE, SIZE, OR COLOR.

FOR INSURANCE UNDERWRITING SERVICES AGAINST DAMAGE AND LOSS FROM ACTS OF TERRORISM IN THE FIELDS OF LIFE INSURANCE, HEALTH INSURANCE, AUTOMOBILE INSURANCE, FIRE INSURANCE, ACCIDENT INSURANCE, MARINE INSURANCE, MEDICAL INSURANCE, REINSURANCE, PROPERTY INSURANCE (U.S. CLS. 100, 101 AND 102).

MAUREEN DALL, EXAMINING ATTORNEY

CLASS 36—(Continued).

SN 78-425,682. DOTSPAN VENTURES INC., BOSTON, MA. FILED 5-26-2004.



THE COLOR(S) RED IS/ARE CLAIMED AS A FEATURE OF THE MARK.

THE CIRCLE DESIGN APPEARS IN THE COLOR RED WITH A HIGHLIGHT IN THE UPPER LEFT QUADRANT. BLACK TEXT/WORD "DOT" RUNS OVER THE RED CIRCLE ABOVE THE CHECKMARK AT THE TOP OF THE CIRCLE. BLACK CHECKMARK RUNS OVER AND IS IN THE CENTER OF THE RED CIRCLE. BLACK TEXT/WORD ASSURE RUNS OVER THE RED CIRCLE BELOW THE CHECK AT THE BOTTOM OF THE CIRCLE.

FOR ELECTRONIC COMMERCE PAYMENT SERVICES, NAMELY, ESTABLISHING FUNDED ACCOUNTS USED TO PURCHASE GOODS AND SERVICES ON THE INTERNET (U.S. CLS. 100, 101 AND 102).

FIRST USE 1-15-1998; IN COMMERCE 4-15-2000. JAMES A. RAUEN, EXAMINING ATTORNEY

SN 78-426,910. NATIONAL COMMERCE FINANCIAL CORPORATION, MEMPHIS, TN. FILED 5-28-2004.

I LOVE THIS PLACE!

THE MARK CONSISTS OF STANDARD CHARACTERS WITHOUT CLAIM TO ANY PARTICULAR FONT, STYLE, SIZE, OR COLOR.

FOR BANKING SERVICES; FINANCIAL SERVICES, NAMELY, BILL PAYMENT SERVICES, CHECKING ACCOUNT SERVICES, MONEY LENDING SERVICES, PORTFOLIO MANAGEMENT SERVICES, AND CREDIT CARD SERVICES (U.S. CLS. 100, 101 AND 102).

FIRST USE 1-26-2004; IN COMMERCE 1-26-2004. RUSS HERMAN, EXAMINING ATTORNEY

CLASS 36—(Continued).

SN 78-427,156. FORRENTMLS.COM, MIDDLETOWN, OH. FILED 5-28-2004.

ForRentMLS.com

THE MARK CONSISTS OF STANDARD CHARACTERS WITHOUT CLAIM TO ANY PARTICULAR FONT, STYLE, SIZE, OR COLOR.

FOR PROVIDING A WEBSITE FEATURING LISTINGS OF APARTMENTS, CONDOMINIUMS, AND HOUSES FOR RENT IN THE GREATER CINCINNATI AREA, INCLUDING THE TRI-STATE AREA OF OHIO, KENTUCKY, AND INDIANA (U.S. CLS. 100, 101 AND 102).

AISHA CLARKE, EXAMINING ATTORNEY

SN 78-429,179. GLOBAL AEROSPACE, INC., SHORT HILLS, NJ. FILED 6-3-2004.



NO CLAIM IS MADE TO THE EXCLUSIVE RIGHT TO USE "GLOBAL AEROSPACE", APART FROM THE MARK AS SHOWN.

THE COLOR(S) RED AND GRAY IS/ARE CLAIMED AS A FEATURE OF THE MARK.

THE MARK CONSISTS OF THE WORDS "GLOBAL AEROSPACE" ABOVE THE DESIGN OF A GLOBE WITH A STRIPED RED PATTERN ON THE SIDES OF THE GLOBE. THE COLOR GRAY APPEARS IN THE GLOBE AND IN THE WORDING OF THE MARK.

FOR PROPERTY AND CASUALTY INSURANCE UNDERWRITING FOR AIRPLANES AND SPACE VEHICLES (U.S. CLS. 100, 101 AND 102).

FIRST USE 7-0-2001; IN COMMERCE 7-0-2001. ROBERT LORENZO, EXAMINING ATTORNEY

CLASS 36—(Continued).

SN 78-429,324. DECISIVE ENVIRONMENT, LLC, SALT LAKE CITY, UT. FILED 6-3-2004.

GLOBAL DECISIONS

THE MARK CONSISTS OF STANDARD CHARACTERS WITHOUT CLAIM TO ANY PARTICULAR FONT, STYLE, SIZE, OR COLOR.

FOR RISK MANAGEMENT IN THE FIELDS OF INTERNATIONAL ENVIRONMENTAL COMPLIANCE, ENVIRONMENTAL MANAGEMENT, OCCUPATIONAL AND COMMUNITY HEALTH AND SAFETY, AND CORPORATE SOCIAL RESPONSIBILITY; PROVIDING LINKS TO WEBSITES OF OTHERS FEATURING MULTILATERAL DEVELOPMENT BANK INFORMATION (U.S. CLS. 100, 101 AND 102).

ANGELA M. MICHELI, EXAMINING ATTORNEY

CLASS 36—(Continued).

SN 78-432,836. NORTHSIDE LENDING, INC., MARIETTA, GA. FILED 6-10-2004.



NO CLAIM IS MADE TO THE EXCLUSIVE RIGHT TO USE "LENDING, INC.", APART FROM THE MARK AS SHOWN.

FOR MORTGAGE LENDING AND BROKERAGE SERVICES (U.S. CLS. 100, 101 AND 102).
FIRST USE 1-22-2001; IN COMMERCE 7-30-2001.
INGRID C. EULIN, EXAMINING ATTORNEY

SN 78-431,069. ORGANIZAMERICA, INC., JOLIET, IL. FILED 6-7-2004.

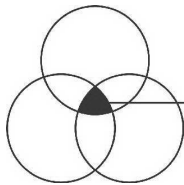

"Someone Who CARES"

FOR FINANCIAL PLANNING AND ANALYSIS SERVICES (U.S. CLS. 100, 101 AND 102).
RAMONA ORTIGA, EXAMINING ATTORNEY

SN 78-433,866. BAYVIEW FINANCIAL EXCHANGE SERVICES, LLC, CORAL GABLES, FL. FILED 6-11-2004.

I EXCHANGED.

THE MARK CONSISTS OF STANDARD CHARACTERS WITHOUT CLAIM TO ANY PARTICULAR FONT, STYLE, SIZE, OR COLOR.

FOR PROVIDING FINANCIAL INFORMATION ABOUT SECTION 1031 EXCHANGES AND PROVIDING QUALIFIED INTERMEDIARY SERVICES FOR TAX-DEFERRED PROPERTY EXCHANGE TRANSACTIONS (U.S. CLS. 100, 101 AND 102).
FIRST USE 5-24-2004; IN COMMERCE 5-24-2004.
MELVIN AXILBUND, EXAMINING ATTORNEY

SN 78-431,247. ZIONS BANCORPORATION, SALT LAKE CITY, UT. FILED 6-7-2004.

FAMILY A FAMILIA

THE MARK CONSISTS OF STANDARD CHARACTERS WITHOUT CLAIM TO ANY PARTICULAR FONT, STYLE, SIZE, OR COLOR.

THE FOREIGN WORDING IN THE MARK TRANSLATES INTO ENGLISH AS FAMILY TO FAMILY.

FOR FINANCIAL SERVICES, NAMELY, BANKING SERVICES; STORED VALUE-PREPAID BANK CARD SERVICES; DEBIT TRANSACTION SERVICES; ELECTRONIC CASH TRANSACTIONS; CASH DISBURSEMENTS; DEPOSIT ACCOUNT SERVICES, NAMELY DIRECT DEPOSIT ACCOUNT SERVICES AND CERTIFICATE OF DEPOSIT ACCOUNT SERVICES; POINT OF SALE AND POINT OF TRANSACTION SERVICES; DEPOSIT ACCESS AND AUTOMATED TELLER MACHINE SERVICES; MONEY TRANSFER SERVICES; CURRENCY EXCHANGE SERVICES; DEBIT CARD VERIFICATION SERVICES; TRANSACTION AUTHORIZATION AND SETTLEMENT SERVICES (U.S. CLS. 100, 101 AND 102).
ELLEN PERKINS, EXAMINING ATTORNEY

SN 78-434,983. PARKSIDE HOMES, LLC, FORT COLLINS, CO. FILED 6-14-2004.

DIAMOND CARE

THE MARK CONSISTS OF DIAMOND CARE WITH BOTH A'S SHAPED LIKE DIAMONDS.

FOR PROVIDING EXTENDED WARRANTIES FOR CONSTRUCTION-RELATED PROBLEMS, DEFECTS AND SPECIFIED AFTER-SALE CARE ON NEW RESIDENTIAL HOMES, BEYOND THOSE CUSTOMARILY PROVIDED IN THE TRADE (U.S. CLS. 100, 101 AND 102).
FIRST USE 1-5-2004; IN COMMERCE 1-7-2004.
JIM RINGLE, EXAMINING ATTORNEY

CLASS 36—(Continued).

SN 78-435,198. GFG LOAN COMPANY, OAK PARK, IL.
FILED 6-15-2004.

AMERICA'S FINANCIAL CHOICE

THE MARK CONSISTS OF STANDARD CHARACTERS
WITHOUT CLAIM TO ANY PARTICULAR FONT, STYLE,
SIZE, OR COLOR.
FOR FINANCIAL CONSUMER LENDING SERVICES
(U.S. CLS. 100, 101 AND 102).
KARANENDRA S. CHHINA, EXAMINING ATTORNEY

SN 78-435,498. HIGH POINT PLACE LP, BROADVIEW
HEIGHTS, OH. FILED 6-15-2004.

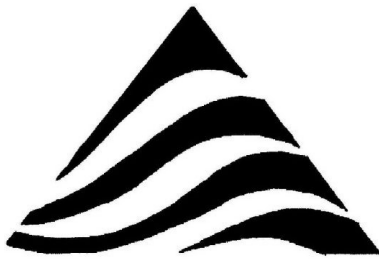

THE MARK CONSISTS OF A STYLIZED TRIANGLE.
FOR REAL ESTATE SERVICES, NAMELY, LISTING
AND LEASING COMMERCIAL AND RESIDENTIAL
PROPERTY (U.S. CLS. 100, 101 AND 102).
FIRST USE 11-1-2003; IN COMMERCE 11-1-2003.
SCOTT OSICK, EXAMINING ATTORNEY

SN 78-437,029. GE CAPITAL CONSUMER CARD CO.,
MASON, OH. FILED 6-17-2004.

SerenityCare
financing

NO CLAIM IS MADE TO THE EXCLUSIVE RIGHT TO
USE "FINANCING", APART FROM THE MARK AS
SHOWN.
FOR FINANCING SERVICES; NAMELY, LOANS FOR
FUNERAL EXPENSES; CREDIT CARD SERVICES FOR
FUNERAL EXPENSES (U.S. CLS. 100, 101 AND 102).
ANNE FARRELL, EXAMINING ATTORNEY

CLASS 36—(Continued).

SN 78-437,786. AMERITAS ACACIA MUTUAL INSURANCE
HOLDING COMPANY, LINCOLN, NE. FILED 6-18-2004.

THE MIGHTY TOOTH BRIGADE

THE MARK CONSISTS OF STANDARD CHARACTERS
WITHOUT CLAIM TO ANY PARTICULAR FONT, STYLE,
SIZE, OR COLOR.
FOR UNDERWRITING AND ADMINISTRATION OF
GROUP DENTAL INSURANCE PRODUCTS (U.S. CLS.
100, 101 AND 102).
FIRST USE 2-2-2004; IN COMMERCE 6-8-2004.
ALEXANDER L. POWERS, EXAMINING ATTORNEY

SN 78-438,653. PRIORITY ONE LENDING, INC., LOS AN-
GELES, CA. FILED 6-21-2004.

PRIORITYONE
LENDING

NO CLAIM IS MADE TO THE EXCLUSIVE RIGHT TO
USE LENDING, APART FROM THE MARK AS SHOWN.
THE COLOR(S) BLUE AND GRAY IS/ARE CLAIMED AS
A FEATURE OF THE MARK.
THE WORDS PRIORITY AND LENDING APPEAR IN
BLUE. THE HOUSE DESIGN AND LINE SEPARATING
PRIORITY ONE AND LENDING APPEAR IN GRAY. ONE
APPEARS IN GRAY.
FOR MORTGAGE BROKERAGE / MORTGAGE LEND-
ING (U.S. CLS. 100, 101 AND 102).
FIRST USE 7-14-2003; IN COMMERCE 10-1-2003.
ANDREW BENZMILLER, EXAMINING ATTORNEY

CLASS 36—(Continued).

SN 78-440,254. THURMAN, JOHN H., SAN ANTONIO, TX. FILED 6-23-2004.

**Heart Of Texas
Realty**

THE MARK CONSISTS OF STANDARD CHARACTERS WITHOUT CLAIM TO ANY PARTICULAR FONT, STYLE, SIZE, OR COLOR.

NO CLAIM IS MADE TO THE EXCLUSIVE RIGHT TO USE "REALTY", APART FROM THE MARK AS SHOWN. FOR REAL ESTATE BROKERAGE (U.S. CLS. 100, 101 AND 102).

FIRST USE 11-19-2002; IN COMMERCE 11-19-2002. ANNE FARRELL, EXAMINING ATTORNEY

SN 78-443,300. PAYMENT PROCESSING, INC., NEWARK, CA. FILED 6-29-2004.



Payment Processing
INCORPORATED

NO CLAIM IS MADE TO THE EXCLUSIVE RIGHT TO USE "PAYMENT PROCESSING INCORPORATED", APART FROM THE MARK AS SHOWN.

THE MARK CONSISTS OF THE STYLIZED LOGO DERIVED FROM THE LETTER "P" FORMED WITH ARROWS AND SQUARES AND SET WITHIN AN ELLIPSE, WITH THE WORDS "PAYMENT PROCESSING INCORPORATED".

FOR PROVIDING ELECTRONIC PROCESSING AND TRANSMISSION OF CREDIT CARD TRANSACTION DATA AND ELECTRONIC PAYMENT DATA VIA A GLOBAL COMPUTER NETWORK (U.S. CLS. 100, 101 AND 102).

FIRST USE 1-1-1996; IN COMMERCE 1-1-1996. MARLENE BELL, EXAMINING ATTORNEY

CLASS 36—(Continued).

SN 78-444,779. AMERICAN INTERNATIONAL GROUP, INC., NEW YORK, NY. FILED 7-1-2004.

**STARR EXCESS
LIABILITY
INSURANCE
INTERNATIONAL,
LTD.**

THE MARK CONSISTS OF STANDARD CHARACTERS WITHOUT CLAIM TO ANY PARTICULAR FONT, STYLE, SIZE, OR COLOR.

NO CLAIM IS MADE TO THE EXCLUSIVE RIGHT TO USE "EXCESS LIABILITY INSURANCE INTERNATIONAL LTD.", APART FROM THE MARK AS SHOWN.

FOR INSURANCE UNDERWRITING SERVICES, NAMELY, PROPERTY AND CASUALTY INSURANCE, DIRECTORS' AND OFFICERS' LIABILITY INSURANCE, ERRORS AND OMISSIONS LIABILITY, FIDUCIARY LIABILITY, EMPLOYEE PRACTICES LIABILITY, AND PROFESSIONAL LIABILITY INSURANCE (U.S. CLS. 100, 101 AND 102).

FIRST USE 1-28-1998; IN COMMERCE 1-28-1998. WENDY GOODMAN, EXAMINING ATTORNEY

SN 78-444,786. AMERICAN INTERNATIONAL GROUP, INC., NEW YORK, NY. FILED 7-1-2004.

**STARR EXCESS
INTERNATIONAL**

THE MARK CONSISTS OF STANDARD CHARACTERS WITHOUT CLAIM TO ANY PARTICULAR FONT, STYLE, SIZE, OR COLOR.

NO CLAIM IS MADE TO THE EXCLUSIVE RIGHT TO USE "EXCESS INTERNATIONAL", APART FROM THE MARK AS SHOWN.

FOR INSURANCE UNDERWRITING SERVICES, NAMELY, PROPERTY AND CASUALTY INSURANCE, DIRECTORS' AND OFFICERS' LIABILITY INSURANCE, ERRORS AND OMISSIONS LIABILITY, FIDUCIARY LIABILITY, EMPLOYEE PRACTICES LIABILITY, AND PROFESSIONAL LIABILITY INSURANCE (U.S. CLS. 100, 101 AND 102).

FIRST USE 1-28-1998; IN COMMERCE 1-28-1998. WENDY GOODMAN, EXAMINING ATTORNEY

CLASS 36—(Continued).

SN 78-445,026. COLLEGENET, INC., PORTLAND, OR. FILED 7-1-2004.

COLLEGENET

THE MARK CONSISTS OF STANDARD CHARACTERS WITHOUT CLAIM TO ANY PARTICULAR FONT, STYLE, SIZE, OR COLOR.

OWNER OF U.S. REG. NO. 2,045,384.
FOR ELECTRONIC PROCESSING OF CHARITABLE CONTRIBUTIONS VIA A GLOBAL COMPUTER NETWORK; CONSULTATION SERVICES RELATING TO ELECTRONIC PAYMENT SERVICES, NAMELY, ELECTRONIC PROCESSING AND TRANSMISSION OF BILL PAYMENT DATA FOR BUSINESSES, GOVERNMENT, EDUCATION INSTITUTIONS AND NON-PROFIT ENTITIES; CONSULTATION SERVICES RELATING TO ON-LINE CREDIT CARD TRANSACTION PROCESSING SERVICES, ELECTRONIC CASH TRANSACTIONS, ELECTRONIC CREDIT CARD TRANSACTIONS AND ELECTRONIC DEBIT TRANSACTIONS FOR BUSINESS, GOVERNMENT AND NON-PROFIT ENTITIES; PROVIDING FINANCIAL SERVICES, NAMELY, FACILITATING FINANCIAL TRANSACTIONS IN THE FIELD OF PAYMENT SERVICES, NAMELY, ELECTRONIC FUNDS TRANSFERS AND PAYMENT CARD TRANSACTIONS; PROVIDING FINANCIAL TRANSACTION INFORMATION AND REPORTS ON-LINE VIA AN INTERNET WEBSITE AND THROUGH OTHER ELECTRONIC MEANS; ELECTRONIC PAYMENT, NAMELY ELECTRONIC PAYMENT PROCESSING AND TRANSMISSION OF PAYMENT DATA VIA A GLOBAL COMPUTER NETWORK (U.S. CLS. 100, 101 AND 102).

FIRST USE 9-0-2001; IN COMMERCE 9-0-2001.
RON FAIRBANKS, EXAMINING ATTORNEY

CLASS 36—(Continued).

SN 78-445,278. GUIDANCE REAL ESTATE, INC., LAGUNA HILLS, CA. FILED 7-2-2004.



**GUIDANCE
REAL ESTATE**

"...guiding you safely home"

NO CLAIM IS MADE TO THE EXCLUSIVE RIGHT TO USE "PROV. 1:5" OR "REAL ESTATE", APART FROM THE MARK AS SHOWN.

THE COLORS ROYAL BLUE AND YELLOW ARE CLAIMED AS A FEATURE OF THE MARK.

THE MARK CONSISTS OF LIGHTHOUSE WITH ROYAL BLUE BASE AND YELLOW LAMP.

FOR RESIDENTIAL REAL ESTATE SERVICES, NAMELY, REAL ESTATE BROKERAGE AND INVESTMENT, RENTAL PROPERTY MANAGEMENT, AND RELOCATION SERVICES (U.S. CLS. 100, 101 AND 102).

FIRST USE 3-0-2004; IN COMMERCE 4-0-2004.
JOANNA DUKOVIC, EXAMINING ATTORNEY

SN 78-447,196. SECURE PAYMENT SYSTEMS, INC., SAN DIEGO, CA. FILED 7-7-2004.

enCash

THE MARK CONSISTS OF STANDARD CHARACTERS WITHOUT CLAIM TO ANY PARTICULAR FONT, STYLE, SIZE, OR COLOR.

FOR FINANCIAL SERVICES, NAMELY, BANKING, CREDIT CARD SERVICES, ELECTRONIC CREDIT CARD TRANSACTIONS, AND COMMERCIAL AND CONSUMER LENDING AND FINANCING; PROVIDING SECURE FINANCIAL TRANSACTIONS IN THE NATURE OF ELECTRONIC CASH TRANSACTIONS, ELECTRONIC CREDIT CARD TRANSACTIONS, ELECTRONIC DEBIT TRANSACTIONS, ELECTRONIC CHECK PROCESSING TRANSACTIONS AND ELECTRONIC TRANSMISSION OF BILL PAYMENT DATA, ALL VIA A GLOBAL COMPUTER NETWORK (U.S. CLS. 100, 101 AND 102).

ALEX KEAM, EXAMINING ATTORNEY

CLASS 36—(Continued).

SN 78-449,381. MEYER REAL ESTATE COMPANY, GULF SHORES, AL. FILED 7-12-2004.



THE MARK CONSISTS OF THE WORDS, STAR TREATMENT WITH A STARFISH CONSISTING OF THE LETTER "A" OF THE WORD STAR.
FOR REAL ESTATE BROKERAGE AND RENTAL (U.S. CLS. 100, 101 AND 102).
FIRST USE 6-1-2004; IN COMMERCE 6-1-2004.
REBECCA GILBERT, EXAMINING ATTORNEY

SN 78-451,696. STARBUCKS U.S. BRANDS, LLC, MINDEN, NV. FILED 7-16-2004.

STARBUCKS

THE MARK CONSISTS OF STANDARD CHARACTERS WITHOUT CLAIM TO ANY PARTICULAR FONT, STYLE, SIZE, OR COLOR.
OWNER OF U.S. REG. NOS. 2,035,005, 2,325,182 AND OTHERS.
FOR FINANCIAL SERVICES, NAMELY, DEBIT, CREDIT AND STORED VALUE CARD SERVICES (U.S. CLS. 100, 101 AND 102).
FIRST USE 6-28-2001; IN COMMERCE 7-23-2001.
BARBARA RUTLAND, EXAMINING ATTORNEY

CLASS 36—(Continued).

SN 78-452,121. THE MCGRAW-HILL COMPANIES, INC., NEW YORK, NY. FILED 7-16-2004.

ADVISOR INSIGHT

THE MARK CONSISTS OF STANDARD CHARACTERS WITHOUT CLAIM TO ANY PARTICULAR FONT, STYLE, SIZE, OR COLOR.
NO CLAIM IS MADE TO THE EXCLUSIVE RIGHT TO USE "ADVISOR", APART FROM THE MARK AS SHOWN.
FOR ONLINE FINANCIAL INFORMATION SERVICES OFFERING ACCESS TO FINANCIAL RESEARCH CONTENT AND ANALYTIC CAPABILITIES (U.S. CLS. 100, 101 AND 102).
FIRST USE 8-0-1998; IN COMMERCE 8-0-1998.
VERNA BETH RIRIE, EXAMINING ATTORNEY

SN 78-453,980. SHAREHOLDER INTELLIGENCE SERVICES LLC, ROWAYTON, CT. FILED 7-21-2004.



THE MARK CONSISTS OF A DESIGN OF A MAGNIFYING GLASS CONTAINING A LOWER CASE LETTER I.
FOR FINANCIAL ANALYSIS AND FINANCIAL RESEARCH SERVICES, NAMELY, PROVIDING COLLECTION AND ANALYSIS SERVICES FOR DATA RELATING TO THE HOLDERS OF SECURITIES (U.S. CLS. 100, 101 AND 102).
FIRST USE 4-1-2004; IN COMMERCE 4-1-2004.
ELLEN B. AWRICH, EXAMINING ATTORNEY

SN 78-454,122. GENERAL GROWTH MANAGEMENT, INC., CHICAGO, IL. FILED 7-21-2004.

FESTIVAL OF GIVING

THE MARK CONSISTS OF STANDARD CHARACTERS WITHOUT CLAIM TO ANY PARTICULAR FONT, STYLE, SIZE, OR COLOR.
FOR CHARITABLE FUNDRAISING SERVICES (U.S. CLS. 100, 101 AND 102).
CAROLYN CATALDO, EXAMINING ATTORNEY

CLASS 36—(Continued).

SN 78-454,191. FARR FINANCIAL INC., SAN JOSE, CA.
FILED 7-21-2004.

FAST Trading Platform

THE MARK CONSISTS OF STANDARD CHARACTERS
WITHOUT CLAIM TO ANY PARTICULAR FONT, STYLE,
SIZE, OR COLOR.

SEC. 2(F).

FOR ONLINE FINANCIAL TRADING SERVICES FEATURING
DOWNLOADABLE AND NON-DOWNLOADABLE SOFTWARE FOR FINANCIAL TRADING (U.S.
CLS. 100, 101 AND 102).

FIRST USE 5-10-2000; IN COMMERCE 5-10-2000.

MARGERY A. TIERNEY, EXAMINING ATTORNEY

CLASS 36—(Continued).

SN 78-456,571. MASTERMAN ROCHE INC., SOUTH PASADENA, CA. FILED 7-26-2004.

HUNTINGTON GROUP

THE MARK CONSISTS OF STANDARD CHARACTERS
WITHOUT CLAIM TO ANY PARTICULAR FONT, STYLE,
SIZE, OR COLOR.

NO CLAIM IS MADE TO THE EXCLUSIVE RIGHT TO
USE "GROUP", APART FROM THE MARK AS SHOWN.

FOR REAL ESTATE AGENCIES AND REAL ESTATE
ACQUISITION SERVICES (U.S. CLS. 100, 101 AND 102).

FIRST USE 10-1-1998; IN COMMERCE 10-1-1998.

LINDA MICKLEBURGH, EXAMINING ATTORNEY

SN 78-457,223. LEHMAN BROTHERS INC., NEW YORK, NY.
FILED 7-27-2004.

SN 78-454,200. NATIONAL CITY CORPORATION, CLEVELAND, OH. FILED 7-21-2004.

HABLAMOS EL IDIOMA DEL SERVICIO

THE MARK CONSISTS OF STANDARD CHARACTERS
WITHOUT CLAIM TO ANY PARTICULAR FONT, STYLE,
SIZE, OR COLOR.

THE FOREIGN WORDING IN THE MARK TRANSLATES
INTO ENGLISH AS WE SPEAK THE LANGUAGE OF
SERVICE.

FOR BANKING SERVICES (U.S. CLS. 100, 101 AND
102).

FIRST USE 3-26-2004; IN COMMERCE 3-26-2004.

MARGERY A. TIERNEY, EXAMINING ATTORNEY

LMX

THE MARK CONSISTS OF STANDARD CHARACTERS
WITHOUT CLAIM TO ANY PARTICULAR FONT, STYLE,
SIZE, OR COLOR.

FOR AUTOMATED BROKERAGE SERVICES IN THE
FIELDS OF OPTIONS, FUTURES AND EQUITY SECURITIES (U.S. CLS. 100, 101 AND 102).

FIRST USE 7-21-2004; IN COMMERCE 7-21-2004.

DAVID C. REIHNER, EXAMINING ATTORNEY

CLASS 36—(Continued).

SN 78-457,344. PROGRAM MANAGEMENT SERVICES, INC., TAMPA, FL. FILED 7-27-2004.

CLASS 36—(Continued).

SN 78-459,857. SAVINGSTREET, LLC, DENVER, CO. FILED 7-30-2004.

SAVINGSTREET

PRIA

THE MARK CONSISTS OF STANDARD CHARACTERS WITHOUT CLAIM TO ANY PARTICULAR FONT, STYLE, SIZE, OR COLOR.

FOR INSURANCE BROKERAGE AND ADMINISTRATION SERVICES IN THE FIELD OF WORKERS COMPENSATION, GENERAL LIABILITY, LEGAL LIABILITY AND PROPERTY AND CAUSALITY (U.S. CLS. 100, 101 AND 102).

FIRST USE 2-1-2004; IN COMMERCE 2-1-2004.
MIDGE BUTLER, EXAMINING ATTORNEY

THE MARK CONSISTS OF STANDARD CHARACTERS WITHOUT CLAIM TO ANY PARTICULAR FONT, STYLE, SIZE, OR COLOR.

FOR REAL ESTATE SERVICES, NAMELY, REAL ESTATE AGENCY SERVICES, REAL ESTATE BROKERAGE SERVICES, REAL ESTATE CONSULTATION SERVICES, REAL ESTATE ESCROW SERVICES, REAL ESTATE LISTING SERVICES, REAL ESTATE PROCUREMENT SERVICES, REAL ESTATE TRUSTEE SERVICES, REAL ESTATE VALUATION, APPRAISAL AND ASSESSMENT SERVICES, AND REAL ESTATE MANAGEMENT SERVICES; PROVIDING INFORMATION IN THE FIELD OF REAL ESTATE FEATURING INFORMATION RELATED TO BUYING, SELLING, OWNING, FINDING, FINANCING, INSURING, AND MAINTAINING REAL ESTATE; PROVIDING INFORMATION IN THE FIELD OF REAL ESTATE BY MEANS OF A WEB SITE AND LINKING TO OTHER WEB SITES FEATURING REAL ESTATE INFORMATION; OPERATING MARKETPLACES FOR REAL ESTATE AND REAL ESTATE SERVICES; MORTGAGE SERVICES, NAMELY, MORTGAGE BROKERAGE, MORTGAGE LENDING, MORTGAGE PROCUREMENT FOR OTHERS, BUYER PREQUALIFICATION OF MORTGAGES FOR MORTGAGE BROKERS AND BANKS, AND MAINTAINING MORTGAGE ESCROW ACCOUNTS; TITLE INSURANCE AGENCY, TITLE INSURANCE BROKERAGE (U.S. CLS. 100, 101 AND 102).

YSA DEJESUS, EXAMINING ATTORNEY

SN 78-457,396. AVIVA LIFE INSURANCE COMPANY, QUINCY, MA. FILED 7-27-2004.

SN 78-460,476. ELECTRONIC PAYMENT EXCHANGE, WILMINGTON, DE. FILED 8-2-2004.

TREASURE



THE MARK CONSISTS OF STANDARD CHARACTERS WITHOUT CLAIM TO ANY PARTICULAR FONT, STYLE, SIZE, OR COLOR.

FOR INSURANCE UNDERWRITING IN THE FIELD OF UNIVERSAL LIFE, WHOLE LIFE AND TERM LIFE (U.S. CLS. 100, 101 AND 102).

FIRST USE 10-18-2004; IN COMMERCE 10-18-2004.
JOHN WILKE, EXAMINING ATTORNEY

THE COLOR(S) BLUE AND YELLOW IS/ARE CLAIMED AS A FEATURE OF THE MARK.

THE MARK CONSISTS OF THE LETTERS "E" AND "P" AND A PORTION OF THE LETTER "X" IN THE COLOR BLUE. THE SWOOSH DESIGN WHICH FORMS A PART OF THE LETTER "X" IS IN THE COLOR YELLOW.

FOR THIRD PARTY CREDIT CARD TRANSACTION PROCESSING SERVICES (U.S. CLS. 100, 101 AND 102).
FIRST USE 5-1-1999; IN COMMERCE 5-1-1999.
DOUGLAS LEE, EXAMINING ATTORNEY

CLASS 36—(Continued).

SN 78-463,015. PAYMENTONE CORPORATION, SAN JOSE, CA. FILED 8-5-2004.

PayOne

THE MARK CONSISTS OF STANDARD CHARACTERS WITHOUT CLAIM TO ANY PARTICULAR FONT, STYLE, SIZE, OR COLOR.

OWNER OF U.S. REG. NO. 2,786,355.

FOR ELECTRONIC PAYMENT SERVICES, NAMELY, CLEARING AND RECONCILING FINANCIAL TRANSACTIONS VIA A GLOBAL COMPUTER NETWORK; DIRECT PAYMENT PROCESSING SERVICES; CREDIT CARD PROCESSING; AUTOMATED CLEARINGHOUSE (ACH) SERVICES; PROCESSING AND PAYMENT OF BILLS BY INCLUDING CHARGES ON CONSUMERS' TELEPHONE BILLS (U.S. CLS. 100, 101 AND 102).

ALICE SUE CARRUTHERS, EXAMINING ATTORNEY

CLASS 36—(Continued).

SN 78-465,169. NEELEY, RICHARD L., PALO ALTO, CA. FILED 8-10-2004.

CAROLINA HAIKU

THE MARK CONSISTS OF STANDARD CHARACTERS WITHOUT CLAIM TO ANY PARTICULAR FONT, STYLE, SIZE, OR COLOR.

THE NAME CAROLINA HAIKU DOES NOT IDENTIFY A LIVING INDIVIDUAL.

FOR REAL ESTATE MANAGEMENT (U.S. CLS. 100, 101 AND 102).

GEORGE LORENZO, EXAMINING ATTORNEY

SN 78-464,352. FRITZ, JEFF L., BLOOMINGTON, MN. FILED 8-9-2004.



NO CLAIM IS MADE TO THE EXCLUSIVE RIGHT TO USE BROKERAGE, APART FROM THE MARK AS SHOWN.

THE COLOR(S) BLUE, GREEN AND BLACK IS/ARE CLAIMED AS A FEATURE OF THE MARK.

THE COLOR GREEN APPEARS IN THE BACKGROUND WITH A BLUE WATERWAY AND THE COLOR BLACK IN TWO RECTANGLES ABOVE AND BELOW THE DESIGN OF THE WATERWAY.

THE MARK CONSISTS OF A STYLIZED WINDING RIVER IN A BLOCK.

FOR INSURANCE BROKERAGE IN THE FIELD OF AUTOMOBILE, BUSINESS INTERRUPTION, CRIME, GENERAL LIABILITY, PROPERTY, UMBRELLA LIABILITY, WORKERS COMPENSATION, ERRORS AND OMISSIONS, INTERNATIONAL INSURANCE, PROFESSIONAL LIABILITY, PRODUCT RECALL, POLLUTION LIABILITY, DIRECTORS AND OFFICERS, EMPLOYEE BENEFITS LIABILITY, EMPLOYMENT PRACTICES, FIDUCIARY LIABILITY, TRAVEL ACCIDENT, PERFORMANCE BONDS, SELF-INSURED RISK, SURETY BONDS (U.S. CLS. 100, 101 AND 102).

FIRST USE 12-0-2003; IN COMMERCE 12-0-2003.
ESTHER A. BORSUK, EXAMINING ATTORNEY

SN 78-469,024. BANK OF GENEVA, GENEVA, IN. FILED 8-17-2004.

Health Savings Advantage

NO CLAIM IS MADE TO THE EXCLUSIVE RIGHT TO USE "HEALTH SAVINGS", APART FROM THE MARK AS SHOWN.

FOR HEALTH SAVINGS ACCOUNTS (U.S. CLS. 100, 101 AND 102).

MICHAEL HALL, EXAMINING ATTORNEY

CLASS 36—(Continued).

SN 78-469,903. DIRIGO HEALTH, AUGUSTA, ME. FILED 8-19-2004.

DIRIGO CHOICE

THE MARK CONSISTS OF STANDARD CHARACTERS WITHOUT CLAIM TO ANY PARTICULAR FONT, STYLE, SIZE, OR COLOR.

NO CLAIM IS MADE TO THE EXCLUSIVE RIGHT TO USE "DIRIGO", APART FROM THE MARK AS SHOWN.

FOR ORGANIZING AND ADMINISTERING HEALTH INSURANCE AND ASSOCIATED PREVENTIVE CARE PLANS (U.S. CLS. 100, 101 AND 102).

FIRST USE 8-16-2004; IN COMMERCE 8-16-2004.
DANIEL CAPSHAW, EXAMINING ATTORNEY

SN 78-469,906. DIRIGO HEALTH, AUGUSTA, ME. FILED 8-19-2004.



NO CLAIM IS MADE TO THE EXCLUSIVE RIGHT TO USE "DIRIGO", APART FROM THE MARK AS SHOWN.

THE MARK CONSISTS OF SYLIZED HUMAN FIGURE WITH OUTSTRETCHED ARMS WITHIN A TRIANGLE SUPERIMPOSED OVER AN ARC, ALL ABOVE THE LITERAL ELEMENT.

FOR ORGANIZING AND ADMINISTERING HEALTH INSURANCE AND ASSOCIATED PREVENTIVE CARE PLANS (U.S. CLS. 100, 101 AND 102).

FIRST USE 8-16-2004; IN COMMERCE 8-16-2004.
DANIEL CAPSHAW, EXAMINING ATTORNEY

CLASS 36—(Continued).

SN 78-470,486. WOLF MOUNTAIN REALTY, INC., MARS HILL, NC. FILED 8-19-2004.

WOLF MOUNTAIN

THE MARK CONSISTS OF STANDARD CHARACTERS WITHOUT CLAIM TO ANY PARTICULAR FONT, STYLE, SIZE, OR COLOR.

NO CLAIM IS MADE TO THE EXCLUSIVE RIGHT TO USE "REALTY", APART FROM THE MARK AS SHOWN.

FOR REAL ESTATE AGENCY AND BROKERAGE SERVICES (U.S. CLS. 100, 101 AND 102).

FIRST USE 3-10-2004; IN COMMERCE 3-10-2004.
LINDA MICKLEBURGH, EXAMINING ATTORNEY

SN 78-470,891. DRASHER, PETER, WESTPORT, CT. FILED 8-20-2004.



First Charitable Brokerage

NO CLAIM IS MADE TO THE EXCLUSIVE RIGHT TO USE "BROKERAGE", APART FROM THE MARK AS SHOWN.

FOR FINANCIAL SERVICES, NAMELY, BROKERAGE SERVICES, FINANCIAL CONSULTING, INVESTMENT AND MONEY MANAGEMENT SERVICES (U.S. CLS. 100, 101 AND 102).

ANNE E. GUSTASON, EXAMINING ATTORNEY

SN 78-472,354. WESCOTT, ALAIN PATRICK, BROOKLYN, NY. AND WESCOTT, BRIAN ANTHONY, BROOKLYN, NY. FILED 8-24-2004.

Mint Dynasty

THE MARK CONSISTS OF STANDARD CHARACTERS WITHOUT CLAIM TO ANY PARTICULAR FONT, STYLE, SIZE, OR COLOR.

FOR PROVIDING EDUCATIONAL INFORMATION IN THE FIELD OF FINANCIAL INVESTMENTS (U.S. CLS. 100, 101 AND 102).

LEIGH LOWRY, EXAMINING ATTORNEY

CLASS 36—(Continued).

SN 78-473,082. BAIL BOND FRANCHISORS, INC., MOHNTON, PA. FILED 8-25-2004.



NO CLAIM IS MADE TO THE EXCLUSIVE RIGHT TO USE "BAIL", APART FROM THE MARK AS SHOWN, FOR BAIL BOND SERVICES (U.S. CLS. 100, 101 AND 102).

BRIAN NEVILLE, EXAMINING ATTORNEY

CLASS 36—(Continued).

SN 78-474,336. LOS GALLOS, INC., MINNEAPOLIS, MN. FILED 8-26-2004.

LOS GALLOS

THE MARK CONSISTS OF STANDARD CHARACTERS WITHOUT CLAIM TO ANY PARTICULAR FONT, STYLE, SIZE, OR COLOR.

THE FOREIGN WORDING IN THE MARK TRANSLATES INTO ENGLISH AS THE ROOSTERS.

FOR FINANCIAL SERVICES, NAMELY, MONEY TRANSFER SERVICES, ELECTRONIC FUNDS TRANSFER SERVICES, BILL PAYMENT SERVICES, MONEY EXCHANGE SERVICES, MONEY ORDER SERVICES, FOREIGN CURRENCY EXCHANGE SERVICES, TRAVELERS' CHECK ISSUANCE, AND TELEPHONE CALLING CARD SERVICES; ELECTRONIC PAYMENT SERVICES, NAMELY, ELECTRONIC PROCESSING AND TRANSMISSION OF BILL PAYMENT DATA (U.S. CLS. 100, 101 AND 102).

FIRST USE 8-26-1996; IN COMMERCE 8-26-1996.

ELIZABETH J. WINTER, EXAMINING ATTORNEY

SN 78-475,124. UNITED COMMUNITY BANKS, INC., BLAIRSVILLE, GA. FILED 8-27-2004.

UNITED COMMUNITY BANKS

THE MARK CONSISTS OF STANDARD CHARACTERS WITHOUT CLAIM TO ANY PARTICULAR FONT, STYLE, SIZE, OR COLOR.

OWNER OF U.S. REG. NOS. 2,723,377, 2,784,016 AND 2,834,618.

NO CLAIM IS MADE TO THE EXCLUSIVE RIGHT TO USE "COMMUNITY BANKS", APART FROM THE MARK AS SHOWN.

FOR BANKING AND FINANCIAL SERVICES, NAMELY, MONEY LENDING, SAVINGS ACCOUNTS, CHECKING ACCOUNTS, CERTIFICATES OF DEPOSIT ACCOUNTS, IRA ACCOUNT SERVICES, ISSUING CERTIFICATES OF DEPOSIT, CASH AND ASSET MANAGEMENT SERVICES, FINANCIAL AND INVESTMENT ADVISORY, CONSULTATION, PLANNING, MANAGEMENT, AND ADMINISTRATION SERVICES, INVESTMENT FUND TRANSFER AND TRANSACTION SERVICES, ESTATE PLANNING SERVICES, INVESTMENT, INSURANCE, AND SECURITIES BROKERAGE SERVICES, CREDIT CARD SERVICES, DEBIT CARD SERVICES, MONEY ORDER SERVICES, AUTOMATIC TELLER MACHINE SERVICES, DISTRIBUTION OF ANNUITIES, BILL PAYMENT SERVICES, AND CURRENCY TRANSFER SERVICES, MORTGAGE BANKING AND MORTGAGE LENDING SERVICES, AND PROVIDING ALL OF THE FOREGOING SERVICES BY TRADITIONAL METHODS, TELEPHONE, AND GLOBAL COMPUTER NETWORK (U.S. CLS. 100, 101 AND 102).

FIRST USE 12-31-1992; IN COMMERCE 12-31-1992.

ANN LINNEHAN, EXAMINING ATTORNEY

SN 78-473,357. NATIONAL CITY CORPORATION, CLEVELAND, OH. FILED 8-25-2004.

NATIONPOINT

THE MARK CONSISTS OF STANDARD CHARACTERS WITHOUT CLAIM TO ANY PARTICULAR FONT, STYLE, SIZE, OR COLOR.

FOR ON-LINE MORTGAGE LENDING; FINANCIAL PLANNING SERVICES; BANKING SERVICES (U.S. CLS. 100, 101 AND 102).

FIRST USE 12-9-2004; IN COMMERCE 12-9-2004.

TRACY WHITAKER-BOWN, EXAMINING ATTORNEY

CLASS 36—(Continued).

SN 78-475,205. DE YOUNG COMMUNITIES, INC., FRESNO, CA. FILED 8-27-2004.

CLASS 36—(Continued).

SN 78-476,659. THE ZOHOURI GROUP, LLC, ATLANTA, GA. FILED 8-31-2004.

DE YOUNG REALTY

INTEGRUS BANK

THE MARK CONSISTS OF STANDARD CHARACTERS WITHOUT CLAIM TO ANY PARTICULAR FONT, STYLE, SIZE, OR COLOR.

NO CLAIM IS MADE TO THE EXCLUSIVE RIGHT TO USE "REALTY", APART FROM THE MARK AS SHOWN. SEC. 2(F).

FOR REAL ESTATE MANAGEMENT; REAL ESTATE BROKERAGE; MORTGAGE LENDING AND REAL ESTATE ESCROW SERVICES IN CONNECTION WITH THE CONSTRUCTION AND SALE OF SINGLE FAMILY AND MULTIPLE FAMILY DWELLING UNITS (U.S. CLS. 100, 101 AND 102).

FIRST USE 2-2-1987; IN COMMERCE 2-2-1987. DAVID MURRAY, EXAMINING ATTORNEY

THE MARK CONSISTS OF STANDARD CHARACTERS WITHOUT CLAIM TO ANY PARTICULAR FONT, STYLE, SIZE, OR COLOR.

NO CLAIM IS MADE TO THE EXCLUSIVE RIGHT TO USE "BANK", APART FROM THE MARK AS SHOWN.

FOR BANKING SERVICES; CREDIT CARD AND DEBIT CARD SERVICES; CREDIT AND LENDING SERVICES, NAMELY, PROVIDING TEMPORARY LOANS AND MORTGAGES; ONLINE BANKING SERVICES, AND ONLINE BILL PAYMENT SERVICES (U.S. CLS. 100, 101 AND 102).

AMOS T. MATTHEWS, JR., EXAMINING ATTORNEY

SN 78-476,631. AMERICAN INTERNATIONAL GROUP, INC., NEW YORK, NY. FILED 8-31-2004.

SN 78-476,674. THE ZOHOURI GROUP, LLC, ATLANTA, GA. FILED 8-31-2004.



INTEGRUS BANC

NO CLAIM IS MADE TO THE EXCLUSIVE RIGHT TO USE "EXCESS INTERNATIONAL", APART FROM THE MARK AS SHOWN.

FOR INSURANCE UNDERWRITING SERVICES, NAMELY, PROPERTY AND CASUALTY INSURANCE, DIRECTORS' AND OFFICERS' LIABILITY, ERRORS AND OMISSIONS LIABILITY, FIDUCIARY LIABILITY, EMPLOYEE PRACTICES LIABILITY, AND PROFESSIONAL LIABILITY INSURANCE (U.S. CLS. 100, 101 AND 102).

FIRST USE 6-30-1993; IN COMMERCE 6-30-1993. WENDY GOODMAN, EXAMINING ATTORNEY

THE MARK CONSISTS OF STANDARD CHARACTERS WITHOUT CLAIM TO ANY PARTICULAR FONT, STYLE, SIZE, OR COLOR.

NO CLAIM IS MADE TO THE EXCLUSIVE RIGHT TO USE BANC, APART FROM THE MARK AS SHOWN.

FOR BANKING AND FINANCIAL SERVICES, NAMELY, FINANCIAL SERVICES IN THE FIELD OF MONEY LENDING; CREDIT CARD AND DEBIT CARD SERVICES; CREDIT AND LENDING SERVICES, NAMELY PROVIDING TEMPORARY LOANS AND MORTGAGE LENDING; ONLINE BANKING SERVICES, AND ONLINE BILL PAYMENT SERVICES (U.S. CLS. 100, 101 AND 102).

YSA DEJESUS, EXAMINING ATTORNEY

CLASS 36—(Continued).

SN 78-478,195. TOYOTA JIDOSHA KABUSHIKI KAISHA, TA TOYOTA MOTOR CORPORATION, TOYOTA-SHI, AICHIKEN, JAPAN, FILED 9-2-2004.

TOYOTA AND LEXUS
TELEPHONE PAYMENT
SYSTEM

THE MARK CONSISTS OF STANDARD CHARACTERS WITHOUT CLAIM TO ANY PARTICULAR FONT, STYLE, SIZE, OR COLOR.

OWNER OF U.S. REG. NOS. 843,138, 2,884,937 AND OTHERS.

NO CLAIM IS MADE TO THE EXCLUSIVE RIGHT TO USE "TELEPHONE PAYMENT SYSTEM", APART FROM THE MARK AS SHOWN.

FOR FINANCING THE PURCHASE AND LEASING OF MOTOR VEHICLES; PROVIDING MULTIPLE PAYMENT OPTIONS BY MEANS OF CUSTOMER-OPERATED ELECTRONIC TERMINALS AND TELEPHONES (U.S. CLS. 100, 101 AND 102).

JASON TURNER, EXAMINING ATTORNEY

CLASS 36—(Continued).

SN 78-482,102. JBSE, LLC, SAN FRANCISCO, CA. FILED 9-11-2004.

iPropertyPulse

THE MARK CONSISTS OF STANDARD CHARACTERS WITHOUT CLAIM TO ANY PARTICULAR FONT, STYLE, SIZE, OR COLOR.

FOR INVESTMENT MANAGEMENT (U.S. CLS. 100, 101 AND 102).

ANNE E. GUSTASON, EXAMINING ATTORNEY

SN 78-480,878. MONSOON CAPITAL, LLC, CAMBRIDGE, MA. FILED 9-9-2004.

MONSOON

THE MARK CONSISTS OF STANDARD CHARACTERS WITHOUT CLAIM TO ANY PARTICULAR FONT, STYLE, SIZE, OR COLOR.

FOR INVESTMENT MANAGEMENT SERVICES; INVESTMENT ADVISORY SERVICES; INVESTMENT FUND MANAGEMENT; HEDGE FUND MANAGEMENT; ASSET MANAGEMENT; INVESTMENT ANALYSIS AND ADVICE; FINANCIAL PORTFOLIO MANAGEMENT; BROKERAGE FOR TRADING OF SECURITIES, SHARE OPTIONS AND OTHER DERIVATIVE PRODUCTS IN THE NATURE OF CALL OPTIONS, PUT OPTIONS, CONVERTIBLE BONDS, FUTURES CONTRACTS, AND CONVERTIBLE PREFERRED STOCK (U.S. CLS. 100, 101 AND 102).

FIRST USE 6-1-2004; IN COMMERCE 6-1-2004.

NANCY CLARKE, EXAMINING ATTORNEY

SN 78-482,197. EMIDA TECHNOLOGIES INC, MIAMI, FL. FILED 9-12-2004.



NO CLAIM IS MADE TO THE EXCLUSIVE RIGHT TO USE "MEX", APART FROM THE MARK AS SHOWN.

THE COLOR(S) ORANGE, RED, BLACK, WHITE, BLUE, GREEN, YELLOW, BROWN IS/ARE CLAIMED AS A FEATURE OF THE MARK.

THE MARK CONSIST OF THE WORDS CLUB IN WHITE LETTERS WITH THE WORD MEX BELOW. THE LETTER M IS IN GREEN, THE E IN WHITE AND THE X IN RED. THE WORD PORTION OF THE MARK IS SUPERIMPOSED OVER MULTICOLORED STRIPES ON A RECTANGULAR BACKGROUND.

FOR PRE-PAID PURCHASE CARD, TELEPHONE CALLING CARD, DEBIT CARD SERVICES, NAMELY, MONEY TRANSFERS AND PROCESSING ELECTRONIC PAYMENTS THROUGH SUCH CARDS. (U.S. CLS. 100, 101 AND 102).

GISELLE AGOSTO, EXAMINING ATTORNEY

CLASS 36—(Continued).

SN 78-482,483. ICAP PLC, LONDON EC2M 7 UR, UNITED KINGDOM, FILED 9-13-2004.

ICAP-GARBAN

THE MARK CONSISTS OF STANDARD CHARACTERS WITHOUT CLAIM TO ANY PARTICULAR FONT, STYLE, SIZE, OR COLOR.

OWNER OF U.S. REG. NOS. 2,326,746, 2,821,905 AND 2,929,963.

FOR FINANCIAL SERVICES, NAMELY VOICE AND ELECTRONIC INTERDEALER BROKER, OF A WIDE RANGE OF SECURITIES PRODUCTS TO THE WHOLESALE MARKET, NAMELY, US TREASURY PRODUCTS, GSE AGENCIES, US MORTGAGES, MONEY MARKET INSTRUMENTS, EURO-GOVERNMENT BONDS, EURO-ZONE AND US REPURCHASE AGREEMENTS, CREDIT DERIVATIVES, INTEREST RATE DERIVATIVES AND OTHER OTC DERIVATIVE INSTRUMENTS, FOREIGN EXCHANGE SPOT, FOREIGN EXCHANGE FORWARDS, US CORPORATE SECURITIES, US MUNICIPAL SECURITIES, EQUITY INSTRUMENTS, EQUITY DERIVATIVES, AND ENERGY PRODUCTS INCLUSIVE OF OIL, POWER, NATURAL GAS AND COAL (U.S. CLS. 100, 101 AND 102).

JILL C. ALT, EXAMINING ATTORNEY

CLASS 36—(Continued).

SN 78-482,944. HARTFORD FIRE INSURANCE COMPANY, HARTFORD, CT. FILED 9-14-2004.

HARTFORD 401 SELECT LEGENDS

THE MARK CONSISTS OF STANDARD CHARACTERS WITHOUT CLAIM TO ANY PARTICULAR FONT, STYLE, SIZE, OR COLOR.

NO CLAIM IS MADE TO THE EXCLUSIVE RIGHT TO USE "401", APART FROM THE MARK AS SHOWN.

SEC. 2(F) AS TO HARTFORD.

FOR RETIREMENT FINANCIAL SERVICES; NAMELY, PROVIDING INVESTMENT ADVICE AND FUNDS INVESTMENT (U.S. CLS. 100, 101 AND 102).

SHARON MEIER, EXAMINING ATTORNEY

SN 78-482,945. HARTFORD FIRE INSURANCE COMPANY, HARTFORD, CT. FILED 9-14-2004.

SN 78-482,943. HARTFORD LIFE INSURANCE COMPANY, HARTFORD, CT. FILED 9-14-2004.

ASSOCIATE VIEW

THE MARK CONSISTS OF STANDARD CHARACTERS WITHOUT CLAIM TO ANY PARTICULAR FONT, STYLE, SIZE, OR COLOR.

NO CLAIM IS MADE TO THE EXCLUSIVE RIGHT TO USE "ASSOCIATE", APART FROM THE MARK AS SHOWN.

FOR PROVIDING INFORMATION TO EMPLOYEES, VIA AN ONLINE WEBSITE, REGARDING INSURANCE CLAIMS STATUS AND OTHER INFORMATION RELATED TO DISABILITY INSURANCE COVERAGE AND INSURANCE SERVICES (U.S. CLS. 100, 101 AND 102).

SHARON MEIER, EXAMINING ATTORNEY

THE MARK CONSISTS OF STANDARD CHARACTERS WITHOUT CLAIM TO ANY PARTICULAR FONT, STYLE, SIZE, OR COLOR.

NO CLAIM IS MADE TO THE EXCLUSIVE RIGHT TO USE "PROTECTION", APART FROM THE MARK AS SHOWN.

SEC. 2(F) AS TO HARTFORD.

FOR UNDERWRITING DIRECTORS AND OFFICERS LIABILITY INSURANCE; FINANCIAL SERVICES IN THE NATURE OF FINANCIAL ANALYSIS AND CONSULTATION (U.S. CLS. 100, 101 AND 102).

KIMBERLY PERRY, EXAMINING ATTORNEY

CLASS 36—(Continued).

SN 78-483,387. STATE STREET CORPORATION, BOSTON, MA. FILED 9-14-2004.



OWNER OF U.S. REG. NOS. 2,184,923, 2,234,893 AND OTHERS.

THE LINING AND STIPPLING IS A FEATURE OF THE MARK.

THE MARK CONSISTS OF THE DESIGN OF A SQUARE-RIGGED SHIP WITHIN A RECTANGLE.

FOR BANKING AND FINANCIAL SERVICES RELATING TO CASH, SECURITIES AND FOREIGN EXCHANGE, NAMELY, FINANCIAL MANAGEMENT SERVICES; FINANCIAL INVESTMENT SERVICES; FINANCIAL PRODUCT CUSTODY SERVICES; COMPUTERIZED FINANCIAL ACCOUNT TRACKING AND REPORTING SERVICES; FINANCIAL INFORMATION PROVIDED BY ELECTRONIC MEANS (U.S. CLS. 100, 101 AND 102).

FIRST USE 0-0-2002; IN COMMERCE 0-0-2002.
DAHLIA GEORGE, EXAMINING ATTORNEY

CLASS 36—(Continued).

SN 78-485,382. CITIZENS SOUTH BANKING CORPORATION, GASTONIA, NC. FILED 9-17-2004.

BODEGA BANK

SN 78-484,022. RINET COMPANY LLC, BOSTON, MA. FILED 9-15-2004.

RINET COMPANY

THE MARK CONSISTS OF STANDARD CHARACTERS WITHOUT CLAIM TO ANY PARTICULAR FONT, STYLE, SIZE, OR COLOR.

NO CLAIM IS MADE TO THE EXCLUSIVE RIGHT TO USE "COMPANY", APART FROM THE MARK AS SHOWN.

FOR FINANCIAL SERVICES, NAMELY ESTATE TRUST ADMINISTRATION SERVICES, INVESTMENT AND ASSET MANAGEMENT SERVICES, AND FINANCIAL PLANNING SERVICES (U.S. CLS. 100, 101 AND 102).

FIRST USE 0-0-1974; IN COMMERCE 0-0-1974.
JENNIFER MARTIN, EXAMINING ATTORNEY

THE MARK CONSISTS OF STANDARD CHARACTERS WITHOUT CLAIM TO ANY PARTICULAR FONT, STYLE, SIZE, OR COLOR.

NO CLAIM IS MADE TO THE EXCLUSIVE RIGHT TO USE "BANK", APART FROM THE MARK AS SHOWN.

THE FOREIGN WORDING IN THE MARK TRANSLATES INTO ENGLISH AS BANK WAREHOUSE.

FOR BANKING AND FINANCIAL SERVICES TARGETED TOWARD THE HISPANIC COMMUNITY, NAMELY BANKING AND CREDIT, DEBIT AND STORED VALUE CARD AND ELECTRONIC TRANSACTION SERVICES; FINANCIAL INFORMATION PROVIDED BY ELECTRONIC MEANS; BROKERAGE SERVICES IN THE FIELDS OF INSURANCE, INVESTMENTS, MORTGAGES, MUTUAL FUNDS, SECURITIES AND STOCKS; INSURANCE CONSULTATION; INVESTMENT ADVICE AND CONSULTATION; FUNDS INVESTMENT; MUTUAL FUNDS INVESTMENT; PERSONAL FINANCIAL MANAGEMENT AND PLANNING; LOAN FINANCING AND FINANCING SERVICES; CASH MANAGEMENT; CURRENCY EXCHANGE AND ADVICE, ELECTRONIC FUNDS TRANSFER SERVICES, AND INTERNATIONAL ELECTRONIC FUNDS TRANSFER SERVICES, ALL ACCOMPLISHED IN FACE-TO-FACE TRANSACTIONS AND VIA THE GLOBAL COMPUTER INFORMATION NETWORK (U.S. CLS. 100, 101 AND 102).

MONTIA G. PRESSEY, EXAMINING ATTORNEY

CLASS 36—(Continued).

SN 78-487,107. LIBERTY MUTUAL INSURANCE COMPANY, BOSTON, MA. FILED 9-21-2004.

THE COMPANY OF
CHOICE

THE MARK CONSISTS OF STANDARD CHARACTERS WITHOUT CLAIM TO ANY PARTICULAR FONT, STYLE, SIZE, OR COLOR.

FOR INSURANCE SERVICES, NAMELY, INSURANCE UNDERWRITING AND ADMINISTRATION OF INSURANCE DEALING WITH ACCIDENT, LIABILITY, AND PROPERTY INSURANCE AND REINSURANCE, INCLUDING THE FOLLOWING KINDS OF INSURANCE—FIRE AND OTHER PROPERTY, GENERAL LIABILITY, WORKMEN'S COMPENSATION, AUTOMOBILE, AIRCRAFT, DISABILITY, FIDELITY, SURETY, BURGLARY, FORGERY, WATER DAMAGE, MARINE AND OCEAN MARINE; INSURANCE BROKERAGE SERVICES; PROPERTY AND CASUALTY LOSS MANAGEMENT AND CLAIMS ADJUSTMENT SERVICES; INSURANCE CLAIMS ADMINISTRATION AND ADJUSTMENT SERVICES PROVIDED AS PART OF INSURED OR SELF-INSURANCE PROGRAMS; APPRAISAL, CONSULTING, AND ANALYTICAL SERVICE IN THE FIELDS OF MEDICAL, DISABILITY, PROPERTY AND CASUALTY INSURANCE CLAIMS; INSURANCE INFORMATION, MANAGEMENT, AND CONSULTANCY SERVICES; AND PROVISION OF THE ABOVE-LISTED INSURANCE SERVICES ON-LINE FROM A COMPUTER DATABASE OR VIA THE INTERNET (U.S. CLS. 100, 101 AND 102).

FIRST USE 0-0-1996; IN COMMERCE 0-0-1996.
CATHERINE CAIN, EXAMINING ATTORNEY

SN 78-487,877. COASTAL SOUTH BANCSHARES, INC., HILTON HEAD, SC. FILED 9-22-2004.

COASTALSTATES BANK

THE MARK CONSISTS OF STANDARD CHARACTERS WITHOUT CLAIM TO ANY PARTICULAR FONT, STYLE, SIZE, OR COLOR.

NO CLAIM IS MADE TO THE EXCLUSIVE RIGHT TO USE "BANK", APART FROM THE MARK AS SHOWN, FOR BANKING SERVICES (U.S. CLS. 100, 101 AND 102).

FIRST USE 9-5-2003; IN COMMERCE 2-2-2004.
MATTHEW PAPPAS, EXAMINING ATTORNEY

CLASS 36—(Continued).

SN 78-488,290. ICAP PLC, LONDON, UNITED KINGDOM, FILED 9-23-2004.

ICAP
GARBAN

OWNER OF U.S. REG. NOS. 2,326,746, 2,821,905 AND 2,929,963.

THE COLOR(S) NAVY BLUE AND RED IS/ARE CLAIMED AS A FEATURE OF THE MARK.

NAVY BLUE AND RED SQUARES DIAGONALLY OVERLAPPING WITH ICAP GARBAN IN NAVY BLUE.

THE MARK CONSISTS OF NAVY BLUE AND RED SQUARES DIAGONALLY OVERLAPPING WITH ICAP GARBAN IN NAVY BLUE.

FOR FINANCIAL SERVICES, NAMELY VOICE AND ELECTRONIC INTERDEALER BROKER, OF A WIDE RANGE OF SECURITIES PRODUCTS TO THE WHOLESALE MARKET, NAMELY, US TREASURY PRODUCTS, GSE AGENCIES, US MORTGAGES, MONEY MARKET INSTRUMENTS, EURO-GOVERNMENT BONDS, EUROZONE AND US REPURCHASE AGREEMENTS, CREDIT DERIVATIVES, INTEREST RATE DERIVATIVES AND OTHER OTC DERIVATIVE INSTRUMENTS, FOREIGN EXCHANGE SPOT, FOREIGN EXCHANGE FORWARDS, US CORPORATE SECURITIES, US MUNICIPAL SECURITIES, EQUITY INSTRUMENTS, EQUITY DERIVATIVES, AND ENERGY PRODUCTS INCLUSIVE OF OIL, POWER, NATURAL GAS AND COAL (U.S. CLS. 100, 101 AND 102).

JILL C. ALT, EXAMINING ATTORNEY

SN 78-488,955. BAOU TRUST, NEW YORK, NY. FILED 9-24-2004.

BAOU

THE MARK CONSISTS OF STANDARD CHARACTERS WITHOUT CLAIM TO ANY PARTICULAR FONT, STYLE, SIZE, OR COLOR.

FOR INVESTMENT TRUST MANAGEMENT AND TRUST SERVICES, NAMELY, INVESTMENT AND TRUST COMPANY SERVICES (U.S. CLS. 100, 101 AND 102).

FIRST USE 1-1-1980; IN COMMERCE 1-1-1980.
SANI KHOURI, EXAMINING ATTORNEY

CLASS 36—(Continued).

SN 78-490,242. 200 KELSEY ASSOCIATES, LLC, NEW ROCHELLE, NY. FILED 9-27-2004.

MIDLANTIC BANK

THE MARK CONSISTS OF STANDARD CHARACTERS WITHOUT CLAIM TO ANY PARTICULAR FONT, STYLE, SIZE, OR COLOR.

NO CLAIM IS MADE TO THE EXCLUSIVE RIGHT TO USE BANK, APART FROM THE MARK AS SHOWN.

FOR BANKING SERVICES; FINANCIAL SERVICES, NAMELY, FINANCIAL ANALYSIS AND CONSULTATION, FINANCIAL SERVICES IN THE FIELD OF MONEY LENDING, INVESTMENT FUND TRANSFER AND TRANSACTION SERVICES (U.S. CLS. 100, 101 AND 102).

ANNE FARRELL, EXAMINING ATTORNEY

SN 78-490,474. LOANSTAR FUNDING GROUP, INC., BRYAN, TX. FILED 9-28-2004.

COLLEDGE LOANS

THE MARK CONSISTS OF STANDARD CHARACTERS WITHOUT CLAIM TO ANY PARTICULAR FONT, STYLE, SIZE, OR COLOR.

OWNER OF U.S. REG. NOS. 2,327,408 AND 2,346,750.

NO CLAIM IS MADE TO THE EXCLUSIVE RIGHT TO USE "LOANS", APART FROM THE MARK AS SHOWN. SEC. 2(F).

FOR LOAN FINANCING SERVICES TO PROVIDE FINANCIAL AID FOR HIGHER EDUCATION (U.S. CLS. 100, 101 AND 102).

FIRST USE 12-31-1997; IN COMMERCE 12-31-1997.

REGINA DRUMMOND, EXAMINING ATTORNEY

CLASS 36—(Continued).

SN 78-490,728. PUNCH OUT BREAST CANCER, INC., ATLANTA, GA. FILED 9-28-2004.



THE COLOR(S) PINK, BLACK AND WHITE ARE CLAIMED AS A FEATURE OF THE MARK.

THE COLOR PINK APPEARS IN THE DESIGN OF A RIBBON AND A PAIR OF BOXING GLOVES. THE COLOR BLACK APPEARS IN THE WORDING "PUNCH OUT BREAST CANCER" AND IN THE OUTLINE OF THE BOXING GLOVE DESIGN. THE COLOR WHITE APPEARS WITHIN THE DESIGN OF THE BOXING GLOVES AS A THIN BAND.

FOR CHARITABLE FUNDRAISING SERVICES FOR BREAST CANCER RESEARCH AND TO SUPPORT BREAST HEALTH AWARENESS PROGRAMS (U.S. CLS. 100, 101 AND 102).

FIRST USE 9-1-2004; IN COMMERCE 9-1-2004.

KATRINA EDGE, EXAMINING ATTORNEY

SN 78-491,449. FIRST MARKET BANK, F.S.B., RICHMOND, VA. FILED 9-29-2004.

UKROP'S MORTGAGE

THE MARK CONSISTS OF STANDARD CHARACTERS WITHOUT CLAIM TO ANY PARTICULAR FONT, STYLE, SIZE, OR COLOR.

NO CLAIM IS MADE TO THE EXCLUSIVE RIGHT TO USE "MORTGAGE", APART FROM THE MARK AS SHOWN.

FOR LOAN FINANCING SERVICES, MORTGAGE BANKING SERVICES, NAMELY, ORIGINATION, ACQUISITION, SERVICING, SECURITIZATION AND BROKERAGE OF MORTGAGE LOANS (U.S. CLS. 100, 101 AND 102).

ANDREA K. NADELMAN, EXAMINING ATTORNEY

CLASS 36—(Continued).

SN 78-491,629. TUDOR INVESTMENT CORPORATION, GREENWICH, CT. FILED 9-29-2004.

**WITCHES ROCK FUND
L.P.**

THE MARK CONSISTS OF STANDARD CHARACTERS WITHOUT CLAIM TO ANY PARTICULAR FONT, STYLE, SIZE, OR COLOR.

NO CLAIM IS MADE TO THE EXCLUSIVE RIGHT TO USE "FUND L.P.", APART FROM THE MARK AS SHOWN. FOR FINANCIAL SERVICES, NAMELY, INVESTMENT SERVICES IN THE NATURE OF AN INVESTMENT FUND (U.S. CLS. 100, 101 AND 102).

ANDREA K. NADELMAN, EXAMINING ATTORNEY



SN 78-492,203. DEUTSCHE TELEKOM AG, BONN, FED REP GERMANY, FILED 9-30-2004.

t-maps

THE MARK CONSISTS OF STANDARD CHARACTERS WITHOUT CLAIM TO ANY PARTICULAR FONT, STYLE, SIZE, OR COLOR.

PRIORITY CLAIMED UNDER SEC. 44(D) ON FED REP GERMANY APPLICATION NO. 30418461638, FILED 4-2-2004, REG. NO. 30418461, DATED 5-7-2004, EXPIRES 4-30-2014.

FOR INSURANCE SERVICES, NAMELY, INSURANCE BROKERAGE, INSURANCE CLAIMS PROCESSING; FINANCIAL SERVICES, NAMELY, CLEARING OF SECURE FINANCIAL TRANSACTIONS THROUGH ONLINE SERVICES; FINANCIAL ANALYSIS AND CONSULTATION; FINANCIAL INFORMATION PROVIDED BY ELECTRONIC MEANS; FINANCIAL INFORMATION PROCESSING; FINANCIAL PORTFOLIO MANAGEMENT; FINANCIAL SERVICES, NAMELY, SECURITIES CONSULTING AND SAFE KEEPING; FINANCIAL SPONSORSHIP OF SPORTS, EDUCATIONAL AND ENTERTAINMENT PROGRAMS AND EVENTS; COMMERCIAL LENDING SERVICES; MONETARY EXCHANGE; CREDIT CARD SERVICES; TELEPHONE CALLING CARD SERVICES; ELECTRONIC COMMERCE SERVICES, NAMELY, ELECTRONIC DEBIT AND CREDIT CARD TRANSACTION PROCESSING SERVICES,

CLASS 36—(Continued).

FUNDS TRANSFER AND BILL PAYMENT-PROCESSING SERVICES; DISCOUNT BROKERAGE SERVICES; SECURITY BROKERAGE; BROKERAGE IN THE FIELD OF INSURANCE, STOCKS, COMMODITIES; CUSTOM BROKERAGE FOR THIRD PARTIES IN THE FIELD OF INSURANCE, STOCKS, COMMODITIES; BROKERAGE OF SHARES AND VENTURE CAPITAL FUNDING SERVICES TO START-UP COMPANIES; BROKERAGE OF FUND SHARES; BROKERAGE OF PRODUCTIVE INVESTMENT OF FUNDS; REAL ESTATE SERVICES, NAMELY, BROKERAGE, MANAGEMENT, LEASING, AND APPRAISAL OF REAL PROPERTY; CONSULTING SERVICES RELATING TO INSURANCE SERVICES, NAMELY, PROVIDING INFORMATION AND BROKERAGE OF INSURANCES IN THE FIELD OF HOME INSURANCE, ACCIDENT INSURANCE AND HEALTH INSURANCE; CONSULTING SERVICES RELATING TO BANK SERVICES; PROVIDING INFORMATION VIA THE TELEPHONE AND THE GLOBAL COMMUNICATION NETWORKS IN THE FIELD OF FINANCE (U.S. CLS. 100, 101 AND 102).

NELSON SNYDER, EXAMINING ATTORNEY



SN 78-492,313. GABLES & IVY REAL ESTATE INC., DULUTH, MN. FILED 9-30-2004.

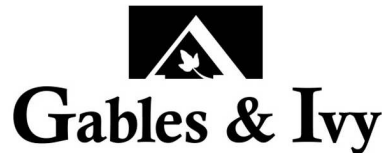

THE MARK CONSISTS OF AN IVY LEAF INSIDE OF A BUILDING GABLE REVERSED OUT OF A SOLID RECTANGLE.

FOR REAL ESTATE BROKERAGE SERVICES (U.S. CLS. 100, 101 AND 102).

FIRST USE 5-0-2000; IN COMMERCE 5-0-2000.
MICHAEL TANNER, EXAMINING ATTORNEY



SN 78-492,505. ASSURANT, INC., NEW YORK, NY. FILED 9-30-2004.

RENTERSECURITY

THE MARK CONSISTS OF STANDARD CHARACTERS WITHOUT CLAIM TO ANY PARTICULAR FONT, STYLE, SIZE, OR COLOR.

FOR INSURANCE SERVICES, NAMELY, UNDERWRITING INSURANCE FOR PERSONAL PROPERTY AND LIABILITY OF RESIDENTIAL TENANTS (U.S. CLS. 100, 101 AND 102).

ANNE FARRELL, EXAMINING ATTORNEY

CLASS 36—(Continued).

SN 78-492,560. NETELLER PLC, DOUGLAS, UNITED KINGDOM, FILED 9-30-2004.

INSTACASH

THE MARK CONSISTS OF STANDARD CHARACTERS WITHOUT CLAIM TO ANY PARTICULAR FONT, STYLE, SIZE, OR COLOR.

FOR ELECTRONIC MONEY ISSUANCE AND TRANSFER SERVICES FOR CONSUMERS AND MERCHANTS TO SEND AND RECEIVE PAYMENTS OVER THE INTERNET (U.S. CLS. 100, 101 AND 102).

FIRST USE 4-9-2001; IN COMMERCE 4-9-2001.

REBECCA GILBERT, EXAMINING ATTORNEY

SN 78-493,330. DEUTSCHE TELEKOM AG, BONN, FED REP GERMANY, FILED 10-1-2004.

T-Mobile multimedia experience

THE MARK CONSISTS OF STANDARD CHARACTERS WITHOUT CLAIM TO ANY PARTICULAR FONT, STYLE, SIZE, OR COLOR.

PRIORITY CLAIMED UNDER SEC. 44(D) ON FED REP GERMANY APPLICATION NO. 30418510838, FILED 4-2-2004, REG. NO. 30418510, DATED 4-22-2004, EXPIRES 4-30-2014.

OWNER OF U.S. REG. NO. 2,282,432.

NO CLAIM IS MADE TO THE EXCLUSIVE RIGHT TO USE "MULTIMEDIA", APART FROM THE MARK AS SHOWN.

FOR INSURANCE SERVICES, NAMELY, INSURANCE BROKERAGE, INSURANCE CLAIMS PROCESSING; FINANCIAL SERVICES, NAMELY, CLEARING OF SECURE FINANCIAL TRANSACTIONS THROUGH ONLINE SERVICES; FINANCIAL ANALYSIS AND CONSULTATION; FINANCIAL INFORMATION PROVIDED BY ELECTRONIC MEANS; FINANCIAL INFORMATION PROCESSING; FINANCIAL PORTFOLIO MANAGEMENT; FINANCIAL SERVICES, NAMELY, SECURITIES CONSULTING AND SAFE KEEPING; FINANCIAL SPONSORSHIP OF SPORTS, EDUCATIONAL AND ENTERTAINMENT PROGRAMS AND EVENTS; COMMERCIAL LENDING SERVICES; MONETARY EXCHANGE; CREDIT CARD SERVICES; TELEPHONE CALLING CARD SERVICES; ELECTRONIC COMMERCE SERVICES, NAMELY, ELECTRONIC DEBIT AND CREDIT

CLASS 36—(Continued).

CARD TRANSACTION PROCESSING SERVICES, FUNDS TRANSFER AND BILL PAYMENT-PROCESSING SERVICES; DISCOUNT BROKERAGE SERVICES; SECURITY BROKERAGE; BROKERAGE IN THE FIELD OF INSURANCE, STOCKS, COMMODITIES; CUSTOM BROKERAGE FOR THIRD PARTIES IN THE FIELD OF INSURANCE, STOCKS, COMMODITIES; BROKERAGE OF SHARES AND VENTURE CAPITAL FUNDING SERVICES TO START-UP COMPANIES; BROKERAGE OF FUND SHARES; BROKERAGE OF PRODUCTIVE INVESTMENT OF FUNDS; REAL ESTATE SERVICES, NAMELY, BROKERAGE, MANAGEMENT, LEASING, AND APPRAISAL OF REAL PROPERTY; CONSULTING SERVICES RELATING TO INSURANCE SERVICES, NAMELY, PROVIDING INFORMATION AND BROKERAGE OF INSURANCES IN THE FIELD OF HOME INSURANCE, ACCIDENT INSURANCE AND HEALTH INSURANCE; CONSULTING SERVICES RELATING TO BANK SERVICES; PROVIDING INFORMATION VIA THE TELEPHONE AND THE GLOBAL COMMUNICATION NETWORKS IN THE FIELD OF FINANCE (U.S. CLS. 100, 101 AND 102).

FLORENTINA BLANDU, EXAMINING ATTORNEY

SN 78-493,755. DELGUIDICE, FRANCESCA, LONGWOOD, FL. FILED 10-4-2004.

D. O. Thoughts

THE MARK CONSISTS OF STANDARD CHARACTERS WITHOUT CLAIM TO ANY PARTICULAR FONT, STYLE, SIZE, OR COLOR.

FOR NOT FOR PROFIT ORGANIZATION SERVICES, NAMELY, CHARITABLE FUND RAISING (U.S. CLS. 100, 101 AND 102).

EVELYN BRADLEY, EXAMINING ATTORNEY

CLASS 36—(Continued).

SN 78-493,818. ITI INTERNET SERVICES, INC., TACOMA, WA. FILED 10-4-2004.



NO CLAIM IS MADE TO THE EXCLUSIVE RIGHT TO USE MED CO PAY, APART FROM THE MARK AS SHOWN. THE COLOR(S) GREEN AND YELLOW ARE CLAIMED AS A FEATURE OF THE MARK.

THE COLOR GREEN APPEARS IN THE WORDS MED CO PAY AND THE COLOR YELLOW APPEARS IN THE PLUS DESIGN.

THE MARK CONSISTS OF MED IS ALIGNED VERTICALLY, WITH THE INSIDE LEG OF THE LETTER "M" EXTENDING HORIZONTALLY, AND "COPAY" ALIGNED HORIZONTALLY UNDER THE HORIZONTAL LEG, AND AN "+" LOCATED AT THE END OF THE HORIZONTAL LINE.

FOR ONLINE MEDICAL PAYMENT BILL PROCESSING AND VERIFICATION SERVICES (U.S. CLS. 100, 101 AND 102).

MARGERY A. TIERNEY, EXAMINING ATTORNEY

SN 78-493,882. MORGAN STANLEY, NEW YORK, NY. FILED 10-4-2004.

VESO

THE MARK CONSISTS OF STANDARD CHARACTERS WITHOUT CLAIM TO ANY PARTICULAR FONT, STYLE, SIZE, OR COLOR.

FOR FINANCIAL SERVICES, NAMELY, VALUATION OF STOCK OPTIONS (U.S. CLS. 100, 101 AND 102).

DAHLIA GEORGE, EXAMINING ATTORNEY

CLASS 36—(Continued).

SN 78-494,007. DEUTSCHE TELEKOM AG, BONN, FED REP GERMANY, FILED 10-4-2004.

**T-Mobile
mms&messaging**

THE MARK CONSISTS OF STANDARD CHARACTERS WITHOUT CLAIM TO ANY PARTICULAR FONT, STYLE, SIZE, OR COLOR.

PRIORITY CLAIMED UNDER SEC. 44(D) ON FED REP GERMANY APPLICATION NO. 30418512438, FILED 4-2-2004, REG. NO. 30418512, DATED 4-22-2004, EXPIRES 4-30-2014.

OWNER OF U.S. REG. NO. 2,282,432.

NO CLAIM IS MADE TO THE EXCLUSIVE RIGHT TO USE "MMS&MESSAGING", APART FROM THE MARK AS SHOWN.

FOR INSURANCE SERVICES, NAMELY, INSURANCE BROKERAGE, INSURANCE CLAIMS PROCESSING; FINANCIAL SERVICES, NAMELY, CLEARING OF SECURE FINANCIAL TRANSACTIONS THROUGH ONLINE SERVICES; FINANCIAL ANALYSIS AND CONSULTATION; FINANCIAL INFORMATION PROVIDED BY ELECTRONIC MEANS; FINANCIAL INFORMATION PROCESSING; FINANCIAL PORTFOLIO MANAGEMENT; FINANCIAL SERVICES, NAMELY, SECURITIES CONSULTING AND SAFE KEEPING; FINANCIAL SPONSORSHIP OF SPORTS, EDUCATIONAL AND ENTERTAINMENT PROGRAMS AND EVENTS; COMMERCIAL LENDING SERVICES; MONETARY EXCHANGE; CREDIT CARD SERVICES; TELEPHONE CALLING CARD SERVICES; ELECTRONIC COMMERCE SERVICES, NAMELY, ELECTRONIC DEBIT AND CREDIT CARD TRANSACTION PROCESSING SERVICES, FUNDS TRANSFER AND BILL PAYMENT-PROCESSING SERVICES; DISCOUNT BROKERAGE SERVICES; SECURITY BROKERAGE; BROKERAGE IN THE FIELD OF INSURANCE, STOCKS, COMMODITIES; CUSTOM BROKERAGE FOR THIRD PARTIES IN THE FIELD OF INSURANCE, STOCKS, COMMODITIES; BROKERAGE OF SHARES AND VENTURE CAPITAL FUNDING SERVICES TO START-UP COMPANIES; BROKERAGE OF FUND SHARES; BROKERAGE OF PRODUCTIVE INVESTMENT OF FUNDS; REAL ESTATE SERVICES, NAMELY, BROKERAGE, MANAGEMENT, LEASING, AND APPRAISAL OF REAL PROPERTY; CONSULTING SERVICES RELATING TO INSURANCE SERVICES, NAMELY, PROVIDING INFORMATION AND BROKERAGE OF INSURANCES IN THE FIELD OF HOME INSURANCE, ACCIDENT INSURANCE AND HEALTH INSURANCE; CONSULTING SERVICES RELATING TO BANK SERVICES; PROVIDING INFORMATION VIA THE TELEPHONE AND THE GLOBAL COMMUNICATION NETWORKS IN THE FIELD OF FINANCE (U.S. CLS. 100, 101 AND 102).

FLORENTINA BLANDU, EXAMINING ATTORNEY

CLASS 36—(Continued).

SN 78-494,159. DEUTSCHE TELEKOM AG, BONN, FED REP GERMANY, FILED 10-4-2004.

**T-Mobile instant
email**

THE MARK CONSISTS OF STANDARD CHARACTERS WITHOUT CLAIM TO ANY PARTICULAR FONT, STYLE, SIZE, OR COLOR.

PRIORITY CLAIMED UNDER SEC. 44(D) ON FED REP GERMANY APPLICATION NO. 30418511638, FILED 4-2-2004, REG. NO. 30418511, DATED 4-22-2004, EXPIRES 4-30-2014.

OWNER OF U.S. REG. NO. 2,282,432.

NO CLAIM IS MADE TO THE EXCLUSIVE RIGHT TO USE "INSTANT EMAIL", APART FROM THE MARK AS SHOWN.

FOR INSURANCE SERVICES, NAMELY, INSURANCE BROKERAGE, INSURANCE CLAIMS PROCESSING; FINANCIAL SERVICES, NAMELY, CLEARING OF SECURE FINANCIAL TRANSACTIONS THROUGH ONLINE SERVICES; FINANCIAL ANALYSIS AND CONSULTATION; FINANCIAL INFORMATION PROVIDED BY ELECTRONIC MEANS; FINANCIAL INFORMATION PROCESSING; FINANCIAL PORTFOLIO MANAGEMENT; FINANCIAL SERVICES, NAMELY, SECURITIES CONSULTING AND SAFE KEEPING; FINANCIAL SPONSORSHIP OF SPORTS, EDUCATIONAL AND ENTERTAINMENT PROGRAMS AND EVENTS; COMMERCIAL LENDING SERVICES; MONETARY EXCHANGE; CREDIT CARD SERVICES; TELEPHONE CALLING CARD SERVICES; ELECTRONIC COMMERCE SERVICES, NAMELY, ELECTRONIC DEBIT AND CREDIT CARD TRANSACTION PROCESSING SERVICES, FUNDS TRANSFER AND BILL PAYMENT-PROCESSING SERVICES; DISCOUNT BROKERAGE SERVICES; SECURITY BROKERAGE; BROKERAGE IN THE FIELD OF INSURANCE, STOCKS, COMMODITIES; CUSTOM BROKERAGE FOR THIRD PARTIES IN THE FIELD OF INSURANCE, STOCKS, COMMODITIES; BROKERAGE OF SHARES AND VENTURE CAPITAL FUNDING SERVICES TO START-UP COMPANIES; BROKERAGE OF FUND SHARES; BROKERAGE OF PRODUCTIVE INVESTMENT OF FUNDS; REAL ESTATE SERVICES, NAMELY, BROKERAGE, MANAGEMENT, LEASING, AND APPRAISAL OF REAL PROPERTY; CONSULTING SERVICES RELATING TO INSURANCE SERVICES, NAMELY, PROVIDING INFORMATION AND BROKERAGE OF INSURANCES IN THE FIELD OF HOME INSURANCE, ACCIDENT INSURANCE AND HEALTH INSURANCE; CONSULTING SERVICES RELATING TO BANK SERVICES; PROVIDING INFORMATION VIA THE TELEPHONE AND THE GLOBAL COMMUNICATION NETWORKS IN THE FIELD OF FINANCE (U.S. CLS. 100, 101 AND 102).

FLORENTINA BLANDU, EXAMINING ATTORNEY

CLASS 36—(Continued).

SN 78-495,288. PAYMENT PROCESSING, INC., NEWARK, CA. FILED 10-6-2004.



THE MARK CONSISTS OF THE LETTERS "P" AND "M" COMBINED TOGETHER, WITH THE LETTER "P" FORMED BY AN ARROW, WITH THE WORDS "PPI PAYMOVER" UNDERNEATH THE 2 LETTERS.

FOR PROVIDING ELECTRONIC PROCESSING AND TRANSMISSION OF CREDIT CARD TRANSACTION DATA AND ELECTRONIC PAYMENT DATA VIA A GLOBAL COMPUTER NETWORK (U.S. CLS. 100, 101 AND 102).

JOHN DWYER, EXAMINING ATTORNEY

SN 78-495,312. PAYMENT PROCESSING, INC., NEWARK, CA. FILED 10-6-2004.

PPI PAYMOVER

THE MARK CONSISTS OF STANDARD CHARACTERS WITHOUT CLAIM TO ANY PARTICULAR FONT, STYLE, SIZE, OR COLOR.

FOR PROVIDING ELECTRONIC PROCESSING AND TRANSMISSION OF CREDIT CARD TRANSACTION DATA AND ELECTRONIC PAYMENT DATA VIA A GLOBAL COMPUTER NETWORK (U.S. CLS. 100, 101 AND 102).

JOHN DWYER, EXAMINING ATTORNEY

CLASS 36—(Continued).

SN 78-495,608. THE CORPORATE EXECUTIVE BOARD COMPANY, WASHINGTON, DC. FILED 10-6-2004.

CLASS 36—(Continued).

SN 78-496,210. LEIGHT, GARY, DBA LEQUITY, LOS ALTOS, CA. FILED 10-7-2004.

**RETIREMENT
SERVICES
ROUNDTABLE**

LEQUITY

THE MARK CONSISTS OF STANDARD CHARACTERS WITHOUT CLAIM TO ANY PARTICULAR FONT, STYLE, SIZE, OR COLOR.

NO CLAIM IS MADE TO THE EXCLUSIVE RIGHT TO USE "RETIREMENT SERVICES", APART FROM THE MARK AS SHOWN.

FOR PROVIDING RESEARCH SERVICES AND INFORMATION FOR OTHERS, DELIVERED VIA A GLOBAL COMPUTER NETWORK, CONCERNING FINANCIAL PLANNING RETIREMENT ISSUES (U.S. CLS. 100, 101 AND 102).

FIRST USE 10-1-2001; IN COMMERCE 12-1-2001.
KARANENDRA S. CHHINA, EXAMINING ATTORNEY

THE MARK CONSISTS OF STANDARD CHARACTERS WITHOUT CLAIM TO ANY PARTICULAR FONT, STYLE, SIZE, OR COLOR.

FOR REAL ESTATE AGENCY SERVICES; REAL ESTATE BROKERAGE SERVICES; REAL ESTATE APPRAISAL, INVESTMENT AND CONSULTATION SERVICES; REAL ESTATE FINANCING SERVICES; MORTGAGE BROKERAGE SERVICES (U.S. CLS. 100, 101 AND 102).

FIRST USE 9-24-2004; IN COMMERCE 9-24-2004.
GENE MACIOL, EXAMINING ATTORNEY

SN 78-495,625. LOPITZ, MICHAEL J, BOULDER, CO. FILED 10-6-2004.

SN 78-496,245. AMERICAN INTERNATIONAL GROUP, INC., NEW YORK, NY. FILED 10-7-2004.

Conscious Capital

**AIG HEALTH
COMPANION**

THE MARK CONSISTS OF STANDARD CHARACTERS WITHOUT CLAIM TO ANY PARTICULAR FONT, STYLE, SIZE, OR COLOR.

NO CLAIM IS MADE TO THE EXCLUSIVE RIGHT TO USE "CAPITAL", APART FROM THE MARK AS SHOWN.

FOR EQUITY CAPITAL INVESTMENT (U.S. CLS. 100, 101 AND 102).

GINA FINK, EXAMINING ATTORNEY

THE MARK CONSISTS OF STANDARD CHARACTERS WITHOUT CLAIM TO ANY PARTICULAR FONT, STYLE, SIZE, OR COLOR.

NO CLAIM IS MADE TO THE EXCLUSIVE RIGHT TO USE "HEALTH", APART FROM THE MARK AS SHOWN.

FOR INSURANCE UNDERWRITING SERVICES, NAMELY, LIFE AND ACCIDENT INSURANCE (U.S. CLS. 100, 101 AND 102).

FIRST USE 11-1-2003; IN COMMERCE 11-1-2003.
JENNIFER CHICOSKI, EXAMINING ATTORNEY

CLASS 36—(Continued).

SN 78-496,253. DESERT GROWTH PARTNERS, L.L.C.,
TUCSON, AZ. FILED 10-7-2004.

**CLEAR BLUE
VENTURES**

THE MARK CONSISTS OF STANDARD CHARACTERS
WITHOUT CLAIM TO ANY PARTICULAR FONT, STYLE,
SIZE, OR COLOR.

NO CLAIM IS MADE TO THE EXCLUSIVE RIGHT TO
USE "VENTURES", APART FROM THE MARK AS SHOWN.
FOR VENTURE LENDING AND CAPITAL SERVICES,
NAMELY, PROVIDING FINANCIAL SOLUTIONS TO
EMERGING COMPANIES (U.S. CLS. 100, 101 AND 102).
FIRST USE 1-1-2004; IN COMMERCE 1-1-2004.
JUDITH HELFMAN, EXAMINING ATTORNEY

SN 78-496,480. CATHAY FINANCIAL HOLDING CO., LTD.,
TAIPEI, TAIWAN, FILED 10-7-2004.



OWNER OF U.S. REG. NO. 2,953,459.
THE MARK CONSISTS OF THE WORDS ENRICH YOUR
LIFE IN A STYLIZED FONT WITH A TREE DESIGN.
FOR BANKING SERVICES (U.S. CLS. 100, 101 AND
102).
FIRST USE 2-29-2004; IN COMMERCE 2-29-2004.
THEODORE MCBRIDE, EXAMINING ATTORNEY

CLASS 36—(Continued).

SN 78-496,566. UNITED FINANCIAL MORTGAGE CORP.,
OAK BROOK, IL. FILED 10-7-2004.

**Leading America
Home**

THE MARK CONSISTS OF STANDARD CHARACTERS
WITHOUT CLAIM TO ANY PARTICULAR FONT, STYLE,
SIZE, OR COLOR.

FOR MORTGAGE LENDING, HOME EQUITY LOANS,
AND COMMERCIAL LENDING SERVICES (U.S. CLS.
100, 101 AND 102).

FIRST USE 10-7-2004; IN COMMERCE 10-7-2004.
DEBRA LEE, EXAMINING ATTORNEY

SN 78-497,028. AMERICAN INTERNATIONAL GROUP,
INC., NEW YORK, NY. FILED 10-8-2004.

**AIG SMALL BUSINESS
SELECT**

THE MARK CONSISTS OF STANDARD CHARACTERS
WITHOUT CLAIM TO ANY PARTICULAR FONT, STYLE,
SIZE, OR COLOR.

OWNER OF U.S. REG. NOS. 1,151,229, 2,893,413 AND
OTHERS.

NO CLAIM IS MADE TO THE EXCLUSIVE RIGHT TO
USE "SMALL BUSINESS", APART FROM THE MARK AS
SHOWN.

FOR INSURANCE UNDERWRITING SERVICES,
NAMELY, PROFESSIONAL LIABILITY, ERRORS AND
OMISSIONS, EXCESS LIABILITY, DIRECTORS AND
OFFICERS, EMPLOYMENT LIABILITY, AND PRODUCT
LIABILITY INSURANCE, EMPLOYEE DEATH AND
DISMEMBERMENT INSURANCE UNDERWRITING,
EMPLOYEE VISION CARE INSURANCE UNDERWRITING,
BUSINESS TRAVEL ACCIDENT INSURANCE UN-
DERWRITING, ENERGY EXCESS CASUALTY
INSURANCE UNDERWRITING (U.S. CLS. 100, 101
AND 102).

BARNEY CHARLON, EXAMINING ATTORNEY

CLASS 36—(Continued).

SN 78-497,682. CENTRAL BANK & TRUST CO., LEXINGTON, KY. FILED 10-11-2004.

**Central Bank
People Who Know
You**

THE MARK CONSISTS OF STANDARD CHARACTERS WITHOUT CLAIM TO ANY PARTICULAR FONT, STYLE, SIZE, OR COLOR.
NO CLAIM IS MADE TO THE EXCLUSIVE RIGHT TO USE "BANK", APART FROM THE MARK AS SHOWN.
FOR BANKING SERVICES (U.S. CLS. 100, 101 AND 102).
FIRST USE 10-25-2002; IN COMMERCE 10-25-2002.
BRIAN PINO, EXAMINING ATTORNEY

SN 78-498,073. WILLIS NORTH AMERICA INC., NASHVILLE, TN. FILED 10-12-2004.

SHREDDERGUARD

THE MARK CONSISTS OF STANDARD CHARACTERS WITHOUT CLAIM TO ANY PARTICULAR FONT, STYLE, SIZE, OR COLOR.
FOR PROFESSIONAL LIABILITY INSURANCE FOR MEMBERS OF THE PAPER SHREDDING AND DOCUMENT DESTRUCTION INDUSTRY (U.S. CLS. 100, 101 AND 102).
FIRST USE 8-1-2004; IN COMMERCE 9-14-2004.
JOSETTE BEVERLY, EXAMINING ATTORNEY

CLASS 36—(Continued).

SN 78-498,195. THE LILLARD-COLLET COMPANY, ATLANTA, GA. FILED 10-12-2004.

LILLARD-COLLET

THE MARK CONSISTS OF STANDARD CHARACTERS WITHOUT CLAIM TO ANY PARTICULAR FONT, STYLE, SIZE, OR COLOR.
FOR FINANCIAL SERVICES, NAMELY, PROVIDING INVESTMENT ADVICE, BROKERAGE SERVICES, FINANCIAL AND RETIREMENT PLANNING AND COUNSELLING (U.S. CLS. 100, 101 AND 102).
FIRST USE 9-1-2004; IN COMMERCE 9-1-2004.
KEVON CHISOLM, EXAMINING ATTORNEY

SN 78-498,301. SOVEREIGN BANK, WYOMISSING, PA. FILED 10-12-2004.

SOValue Plus Loan

THE MARK CONSISTS OF STANDARD CHARACTERS WITHOUT CLAIM TO ANY PARTICULAR FONT, STYLE, SIZE, OR COLOR.
NO CLAIM IS MADE TO THE EXCLUSIVE RIGHT TO USE "LOAN", APART FROM THE MARK AS SHOWN.
FOR BANKING AND FINANCIAL SERVICES, NAMELY, STUDENT LOAN SERVICES (U.S. CLS. 100, 101 AND 102).
HOWARD B. LEVINE, EXAMINING ATTORNEY

SN 78-498,558. GREEN DRAKE PARTNERS, LLC, BERWYN, PA. FILED 10-12-2004.

**GREEN DRAKE
PARTNERS**

THE MARK CONSISTS OF STANDARD CHARACTERS WITHOUT CLAIM TO ANY PARTICULAR FONT, STYLE, SIZE, OR COLOR.
NO CLAIM IS MADE TO THE EXCLUSIVE RIGHT TO USE "PARTNERS", APART FROM THE MARK AS SHOWN.
FOR INVESTMENT MANAGEMENT SERVICES (U.S. CLS. 100, 101 AND 102).
FIRST USE 5-19-2004; IN COMMERCE 5-19-2004.
KIMBERLY FRYE, EXAMINING ATTORNEY

CLASS 36—(Continued).

SN 78-499,772. BUILDERS INSURANCE GROUP, INC., ATLANTA, GA. FILED 10-14-2004.



THE MARK CONSISTS OF THE STYLIZED LETTERS BI IN A CIRCLE LOGO.

FOR INSURANCE SERVICES, NAMELY PROVIDING COMMERCIAL INSURANCE AND PROPERTY AND CASUALTY INSURANCE (U.S. CLS. 100, 101 AND 102). FIRST USE 9-19-2001; IN COMMERCE 9-19-2001.

SUSAN LESLIE DUBOIS, EXAMINING ATTORNEY

SN 78-499,839. ASSAY DESIGNS, INC., ANN ARBOR, MI. FILED 10-14-2004.



NO CLAIM IS MADE TO THE EXCLUSIVE RIGHT TO USE "KITS FOR CHARITY", APART FROM THE MARK AS SHOWN.

THE MARK CONSISTS OF A COLORED SQUARE WITH SIXTEEN CIRCLES ARRANGED WITHIN THE SQUARE, AN OUTSTRETCHED HAND CENTERED WITHIN THE SQUARE OVERLAPPING SOME OF THE CIRCLES, AND THE LITERAL ELEMENT OF THE MARK DISPOSED ALONG TWO EDGES OF THE SQUARE.

FOR CHARITABLE FUNDRAISING IN THE NATURE OF A PROGRAM WHICH DONATES A PERCENTAGE OF PROCEEDS FROM THE SALE OF IMMUNOASSAY KITS AND RELATED PRODUCTS TO CHARITIES (U.S. CLS. 100, 101 AND 102).

FIRST USE 7-1-2000; IN COMMERCE 7-1-2000.

CHRISTOPHER ADKINS, EXAMINING ATTORNEY

CLASS 36—(Continued).

SN 78-500,009. DEUTSCHE TELEKOM AG, BONN, FED REP GERMANY, FILED 10-14-2004.

T-Systems

THE MARK CONSISTS OF STANDARD CHARACTERS WITHOUT CLAIM TO ANY PARTICULAR FONT, STYLE, SIZE, OR COLOR.

PRIORITY CLAIMED UNDER SEC. 44(D) ON FED REP GERMANY APPLICATION NO. 30421580535, FILED 4-15-2004, REG. NO. 30421580, DATED 9-9-2004, EXPIRES 4-30-2014.

OWNER OF U.S. REG. NOS. 2,448,571, 2,880,613 AND OTHERS.

FOR INSURANCE SERVICES, NAMELY, INSURANCE BROKERAGE, INSURANCE CLAIMS PROCESSING; FINANCIAL SERVICES, NAMELY, CLEARING OF SECURE FINANCIAL TRANSACTIONS THROUGH ONLINE SERVICES; FINANCIAL ANALYSIS AND CONSULTATION; FINANCIAL INFORMATION PROVIDED BY ELECTRONIC MEANS; FINANCIAL INFORMATION PROCESSING; FINANCIAL PORTFOLIO MANAGEMENT; FINANCIAL SERVICES, NAMELY, SECURITIES CONSULTING AND SAFE KEEPING; FINANCIAL SPONSORSHIP OF SPORTS, EDUCATIONAL AND ENTERTAINMENT PROGRAMS AND EVENTS; COMMERCIAL LENDING SERVICES; MONETARY EXCHANGE; CREDIT CARD SERVICES; TELEPHONE CALLING CARD SERVICES; ELECTRONIC COMMERCE SERVICES, NAMELY, ELECTRONIC DEBIT AND CREDIT CARD TRANSACTION PROCESSING SERVICES, FUNDS TRANSFER AND BILL PAYMENT-PROCESSING SERVICES; DISCOUNT BROKERAGE SERVICES; SECURITY BROKERAGE; BROKERAGE IN THE FIELD OF INSURANCE, STOCKS, COMMODITIES; CUSTOM BROKERAGE FOR THIRD PARTIES IN THE FIELD OF INSURANCE, STOCKS, COMMODITIES; BROKERAGE OF SHARES AND VENTURE CAPITAL FUNDING SERVICES TO START-UP COMPANIES; BROKERAGE OF FUND SHARES; BROKERAGE OF PRODUCTIVE INVESTMENT OF FUNDS; REAL ESTATE SERVICES, NAMELY, BROKERAGE, MANAGEMENT, LEASING, AND APPRAISAL OF REAL PROPERTY; CONSULTING SERVICES RELATING TO INSURANCE SERVICES, NAMELY, PROVIDING INFORMATION AND BROKERAGE OF INSURANCES IN THE FIELD OF HOME INSURANCE, ACCIDENT INSURANCE AND HEALTH INSURANCE; CONSULTING SERVICES RELATING TO BANK SERVICES; PROVIDING INFORMATION VIA THE TELEPHONE AND THE GLOBAL COMMUNICATION NETWORKS IN THE FIELD OF FINANCE (U.S. CLS. 100, 101 AND 102).

SKYE YOUNG, EXAMINING ATTORNEY

CLASS 36—(Continued).

SN 78-500,051. DEUTSCHE TELEKOM AG, BONN, FED REP GERMANY, FILED 10-14-2004.

T . . . Systems .

PRIORITY CLAIMED UNDER SEC. 44(D) ON FED REP GERMANY APPLICATION NO. 30421579135, FILED 4-15-2004, REG. NO. 30421579, DATED 9-9-2004, EXPIRES 4-30-2014.

OWNER OF U.S. REG. NOS. 2,448,571, 2,880,613 AND OTHERS.

THE COLOR(S) MAGENTA AND GREY IS/ARE CLAIMED AS A FEATURE OF THE MARK.

THE COLOR MAGENTA APPEARS IN THE LETTER "T" IN THE MARK; THE REMAINDER OF THE MARK APPEARS IN THE COLOR GREY.

FOR INSURANCE SERVICES, NAMELY, INSURANCE BROKERAGE, INSURANCE CLAIMS PROCESSING; FINANCIAL SERVICES, NAMELY, CLEARING OF SECURE FINANCIAL TRANSACTIONS THROUGH ONLINE SERVICES; FINANCIAL ANALYSIS AND CONSULTATION; FINANCIAL INFORMATION PROVIDED BY ELECTRONIC MEANS; FINANCIAL INFORMATION PROCESSING; FINANCIAL PORTFOLIO MANAGEMENT; FINANCIAL SERVICES, NAMELY, SECURITIES CONSULTING AND SAFE KEEPING; FINANCIAL SPONSORSHIP OF SPORTS, EDUCATIONAL AND ENTERTAINMENT PROGRAMS AND EVENTS; COMMERCIAL LENDING SERVICES; MONETARY EXCHANGE; CREDIT CARD SERVICES; TELEPHONE CALLING CARD SERVICES; ELECTRONIC COMMERCE SERVICES, NAMELY, ELECTRONIC DEBIT AND CREDIT CARD TRANSACTION PROCESSING SERVICES, FUNDS TRANSFER AND BILL PAYMENT-PROCESSING SERVICES; DISCOUNT BROKERAGE SERVICES; SECURITY BROKERAGE; BROKERAGE IN THE FIELD OF INSURANCE, STOCKS, COMMODITIES; CUSTOM BROKERAGE FOR THIRD PARTIES IN THE FIELD OF INSURANCE, STOCKS, COMMODITIES; BROKERAGE OF SHARES AND VENTURE CAPITAL FUNDING SERVICES TO START-UP COMPANIES; BROKERAGE OF FUND SHARES; BROKERAGE OF PRODUCTIVE INVESTMENT OF FUNDS; REAL ESTATE SERVICES, NAMELY, BROKERAGE, MANAGEMENT, LEASING, AND APPRAISAL OF REAL PROPERTY; CONSULTING SERVICES RELATING TO INSURANCE SERVICES, NAMELY, PROVIDING INFORMATION AND BROKERAGE OF INSURANCES IN THE FIELD OF HOME INSURANCE, ACCIDENT INSURANCE AND HEALTH INSURANCE; CONSULTING SERVICES RELATING TO BANK SERVICES; PROVIDING INFORMATION VIA THE TELEPHONE AND THE GLOBAL COMMUNICATION NETWORKS IN THE FIELD OF FINANCE (U.S. CLS. 100, 101 AND 102).

SKYE YOUNG, EXAMINING ATTORNEY

CLASS 36—(Continued).

SN 78-500,624. CORNERSTONE BUSINESS SERVICES, INC., GREEN BAY, WI. FILED 10-15-2004.

Because You Only
Sell Your Business
Once

THE MARK CONSISTS OF STANDARD CHARACTERS WITHOUT CLAIM TO ANY PARTICULAR FONT, STYLE, SIZE, OR COLOR.

FOR BUSINESS BROKER SERVICES (U.S. CLS. 100, 101 AND 102).

FIRST USE 7-1-2004; IN COMMERCE 7-1-2004.

SUNG IN, EXAMINING ATTORNEY

SN 78-500,877. DESERT GROWTH PARTNERS, L.L.C., TUCSON, AZ. FILED 10-15-2004.

CLEAR BLUE
VENTURES

NO CLAIM IS MADE TO THE EXCLUSIVE RIGHT TO USE "VENTURES", APART FROM THE MARK AS SHOWN.

FOR VENTURE LENDING AND CAPITAL SERVICES, NAMELY, PROVIDING FINANCIAL SOLUTIONS TO EMERGING COMPANIES (U.S. CLS. 100, 101 AND 102).

FIRST USE 3-12-2004; IN COMMERCE 3-12-2004.

JUDITH HELFMAN, EXAMINING ATTORNEY

SN 78-500,985. AMERICAN INTERNATIONAL GROUP, INC., NEW YORK, NY. FILED 10-16-2004.

PLATINUM INCOME
ANNUITY

THE MARK CONSISTS OF STANDARD CHARACTERS WITHOUT CLAIM TO ANY PARTICULAR FONT, STYLE, SIZE, OR COLOR.

NO CLAIM IS MADE TO THE EXCLUSIVE RIGHT TO USE INCOME ANNUITY, APART FROM THE MARK AS SHOWN.

FOR FINANCIAL INVESTMENT AND ADVISORY SERVICES IN THE FIELDS OF ANNUITIES AND RETIREMENT PLANS (U.S. CLS. 100, 101 AND 102).

FIRST USE 8-30-2000; IN COMMERCE 8-30-2000.

ANGELA M. MICHELI, EXAMINING ATTORNEY

CLASS 36—(Continued).

SN 78-501,498. IDT NETHERLANDS, B.V. (PUERTO RICO BRANCH), SAN JUAN, PUERTO RICO, FILED 10-18-2004.

CLASS 36—(Continued).

SN 78-501,692. FAST LANE FINANCIAL, INC., LOS ANGELES, CA. FILED 10-18-2004.

ZEE

**THE CHAMPION OF
AUTO FINANCE**

THE MARK CONSISTS OF STANDARD CHARACTERS WITHOUT CLAIM TO ANY PARTICULAR FONT, STYLE, SIZE, OR COLOR.

FOR PREPAID CALLING CARD AND TELEPHONE DEBIT CARD SERVICES (U.S. CLS. 100, 101 AND 102).
FIRST USE 10-1-2004; IN COMMERCE 10-1-2004.
JULIE GUTTADAURO, EXAMINING ATTORNEY

THE MARK CONSISTS OF STANDARD CHARACTERS WITHOUT CLAIM TO ANY PARTICULAR FONT, STYLE, SIZE, OR COLOR.

NO CLAIM IS MADE TO THE EXCLUSIVE RIGHT TO USE "AUTO FINANCE", APART FROM THE MARK AS SHOWN.

FOR TEMPORARY LOANS FOR ACQUIRING MOTOR VEHICLES (U.S. CLS. 100, 101 AND 102).
FIRST USE 6-15-2004; IN COMMERCE 6-15-2004.
IRA J. GOODSaid, EXAMINING ATTORNEY

SN 78-501,671. FAST LANE FINANCIAL, INC., LOS ANGELES, CA. FILED 10-18-2004.

SN 78-501,812. GROUP BENEFITS AGENCY, INC., COLUMBUS, OH. FILED 10-19-2004.

FastLane

**GBA
Group
Benefits
Agency,
Inc.**



THE MARK CONSISTS OF STANDARD CHARACTERS WITHOUT CLAIM TO ANY PARTICULAR FONT, STYLE, SIZE, OR COLOR.

FOR LOANS FOR ACQUIRING MOTOR VEHICLES (U.S. CLS. 100, 101 AND 102).
FIRST USE 6-15-2002; IN COMMERCE 6-15-2002.
TIMOTHY FINNEGAN, EXAMINING ATTORNEY

NO CLAIM IS MADE TO THE EXCLUSIVE RIGHT TO USE GROUP BENEFITS AGENCY, INC., APART FROM THE MARK AS SHOWN.

THE MARK CONSISTS OF THE WORDS ABOVE WITH A SHAPE CONSISTING OF A CRESCENT OR A PARTIAL OVAL.

FOR BROKERAGE SERVICES IN THE FIELDS OF EMPLOYEE BENEFITS AND INSURANCE; INSURANCE AND EMPLOYEE BENEFIT CONSULTATION; PROVIDING INFORMATION IN INSURANCE AND EMPLOYEE BENEFITS MATTERS (U.S. CLS. 100, 101 AND 102).
FIRST USE 7-1-2003; IN COMMERCE 7-1-2003.

TARAH HARDY, EXAMINING ATTORNEY

CLASS 36—(Continued).

SN 78-502,666. INTERNATIONAL INSURANCE GROUP, INC., FLAGSTAFF, AZ. FILED 10-20-2004.

CLASS 36—(Continued).

SN 78-503,138. FEDERAL HOME LOAN BANK OF CHICAGO, CHICAGO, IL. FILED 10-20-2004.

MEXPRO.COM

THE MARK CONSISTS OF STANDARD CHARACTERS WITHOUT CLAIM TO ANY PARTICULAR FONT, STYLE, SIZE, OR COLOR.
FOR BROKERAGE IN THE FIELD OF INSURANCE POLICIES; INSURANCE CONSULTATION (U.S. CLS. 100, 101 AND 102).
FIRST USE 11-10-1998; IN COMMERCE 11-15-1998.
CHRIS WELLS, EXAMINING ATTORNEY

DPP ADVANTAGE

THE MARK CONSISTS OF STANDARD CHARACTERS WITHOUT CLAIM TO ANY PARTICULAR FONT, STYLE, SIZE, OR COLOR.
FOR MORTGAGE ASSISTANCE SERVICES, NAMELY, MORTGAGE LENDING FOR HOUSING PURCHASES (U.S. CLS. 100, 101 AND 102).
FIRST USE 1-29-2004; IN COMMERCE 1-29-2004.
KATHY DE JONGE, EXAMINING ATTORNEY

SN 78-504,161. BOOKHEIMER, SCOTT, GALENA, OH. FILED 10-22-2004.

SN 78-503,128. FEDERAL HOME LOAN BANK OF CHICAGO, CHICAGO, IL. FILED 10-20-2004.

A-LIST REALTY

THE MARK CONSISTS OF STANDARD CHARACTERS WITHOUT CLAIM TO ANY PARTICULAR FONT, STYLE, SIZE, OR COLOR.
NO CLAIM IS MADE TO THE EXCLUSIVE RIGHT TO USE "REALTY", APART FROM THE MARK AS SHOWN.
FOR REAL ESTATE BROKERAGE (U.S. CLS. 100, 101 AND 102).
FIRST USE 11-30-2002; IN COMMERCE 11-30-2002.
VIVIAN MICZNIK FIRST, EXAMINING ATTORNEY

DPP

SN 78-504,329. TWIN OAKS FINANCIAL GROUP, INC., ESCONDIDO, CA. FILED 10-22-2004.

Financing Your Future, Today!

THE MARK CONSISTS OF STANDARD CHARACTERS WITHOUT CLAIM TO ANY PARTICULAR FONT, STYLE, SIZE, OR COLOR.
FOR MORTGAGE ASSISTANCE SERVICES, NAMELY, MORTGAGE LENDING FOR HOUSING PURCHASES (U.S. CLS. 100, 101 AND 102).
FIRST USE 5-1-2004; IN COMMERCE 5-1-2004.
KATHY DE JONGE, EXAMINING ATTORNEY

THE MARK CONSISTS OF STANDARD CHARACTERS WITHOUT CLAIM TO ANY PARTICULAR FONT, STYLE, SIZE, OR COLOR.
FOR MORTGAGE BROKERAGE (U.S. CLS. 100, 101 AND 102).
GEORGE LORENZO, EXAMINING ATTORNEY

CLASS 36—(Continued).

SN 78-505,369. WELLS FARGO & COMPANY, MINNEAPOLIS, MN. FILED 10-25-2004.

SMARTER BANKING FOR BUSINESS

THE MARK CONSISTS OF STANDARD CHARACTERS WITHOUT CLAIM TO ANY PARTICULAR FONT, STYLE, SIZE, OR COLOR.

NO CLAIM IS MADE TO THE EXCLUSIVE RIGHT TO USE "BANKING FOR BUSINESS", APART FROM THE MARK AS SHOWN.

FOR ONLINE BANKING SERVICES (U.S. CLS. 100, 101 AND 102).

MARC LEIPZIG, EXAMINING ATTORNEY

SN 78-505,411. HEALTH CARE SERVICE CORPORATION, A MUTUAL LEGAL RESERVE COMPANY, CHICAGO, IL. FILED 10-25-2004.

DIAMOND FORTIFIER

THE MARK CONSISTS OF STANDARD CHARACTERS WITHOUT CLAIM TO ANY PARTICULAR FONT, STYLE, SIZE, OR COLOR.

OWNER OF U.S. REG. NOS. 2,631,043, 2,792,456 AND OTHERS.

FOR ANNUITY AND LIFE INSURANCE UNDERWRITING (U.S. CLS. 100, 101 AND 102).

FIRST USE 9-15-2004; IN COMMERCE 9-15-2004.

KARLA PERKINS, EXAMINING ATTORNEY

SN 78-505,747. APEX ANALYTIX, INC., GREENSBORO, NC. FILED 10-26-2004.

FIRSTVENDOR

THE MARK CONSISTS OF STANDARD CHARACTERS WITHOUT CLAIM TO ANY PARTICULAR FONT, STYLE, SIZE, OR COLOR.

FOR PROVIDING ACCOUNTS PAYABLE INFORMATION VIA A GLOBAL NETWORK OF COMPUTERS (U.S. CLS. 100, 101 AND 102).

CHERYL CLAYTON, EXAMINING ATTORNEY

CLASS 36—(Continued).

SN 78-506,259. NOBEL LEARNING COMMUNITIES, INC., WEST CHESTER, PA. FILED 10-26-2004.

FREd

THE MARK CONSISTS OF STANDARD CHARACTERS WITHOUT CLAIM TO ANY PARTICULAR FONT, STYLE, SIZE, OR COLOR.

FOR FINANCIAL SERVICES, NAMELY, COLLEGE SAVINGS PROGRAMS (U.S. CLS. 100, 101 AND 102).

FIRST USE 10-5-2004; IN COMMERCE 10-5-2004.

RUSS HERMAN, EXAMINING ATTORNEY

SN 78-509,241. XE CAPITAL MANAGEMENT, LLC, NEW YORK, NY. FILED 11-1-2004.



THE MARK IS NOT IN COLOR

THE MARK CONSISTS OF SIX CIRCLES FORMING A PYRAMID, FIVE OF WHICH ARE THE SAME COLOR AND ONE OF WHICH IS A CONTRASTING COLOR WHERE THE TOP CIRCLE AND THE BOTTOM THREE CIRCLES EACH HAVE ONE FLATTENED SIDE.

FOR FINANCIAL SERVICES, NAMELY ASSET MANAGEMENT AND STRUCTURED FINANCE; TRANSACTIONS LINKED TO INSURANCE IN THE FIELD OF LIFE, HEALTH, ACCIDENT AND FIRE INSURANCE, NAMELY, FINANCING IN RELATION TO INSURANCE PREMIUMS; INSURANCE ADMINISTRATION; INSURANCE CONSULTATION (U.S. CLS. 100, 101 AND 102).

FIRST USE 4-1-2004; IN COMMERCE 4-1-2004.

SUNG IN, EXAMINING ATTORNEY

CLASS 36—(Continued).

SN 78-509,652. SHELL VACATIONS CLUB, L.P., NORTH-BROOK, IL. FILED 11-2-2004.

CLASS 36—(Continued).

SN 78-511,163. AMERICAN FAMILY LIFE ASSURANCE COMPANY OF COLUMBUS, COLUMBUS, GA. FILED 11-4-2004.

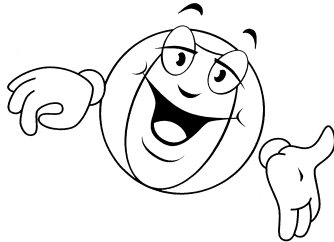

SCHOOLSONE

THE MARK CONSISTS OF A HUMAN SMILING FACE WITH HANDS.

FOR MANAGEMENT AND LEASING OF TIME SHARE APARTMENTS AND CONDOMINIUMS; REAL ESTATE BROKERAGE FEATURING TIMESHARE APARTMENTS AND CONDOMINIUMS (U.S. CLS. 100, 101 AND 102).

EUGENIA MARTIN, EXAMINING ATTORNEY

THE MARK CONSISTS OF STANDARD CHARACTERS WITHOUT CLAIM TO ANY PARTICULAR FONT, STYLE, SIZE, OR COLOR.

FOR INSURANCE UNDERWRITING SERVICES IN THE FIELDS OF DENTAL, VISION, ACCIDENT / DISABILITY, HOSPITAL INTENSIVE CARE, HOSPITAL INDEMNITY, CANCER, PERSONAL SHORT-TERM DISABILITY, HEALTH, LIFE, LONG-TERM HEALTH CARE, GROUP HEALTH MEDICARE SUPPLEMENTS AND GROUP SHORT-TERM DISABILITY (U.S. CLS. 100, 101 AND 102).

FIRST USE 7-14-2004; IN COMMERCE 7-14-2004.
GENE MACIOL, EXAMINING ATTORNEY

SN 78-510,854. ECON CORPORATE SERVICES, POINT ROBERTS, WA. FILED 11-3-2004.

SN 78-513,334. GIFTCO, INC., VERNON HILLS, IL. FILED 11-8-2004.



PRIZE GAZETTE

THE COLOR(S) BLUE AND YELLOW AND WHITE IS/ ARE CLAIMED AS A FEATURE OF THE MARK.

THE COLOR BLUE APPEARS ON THE BACKGROUND RECTANGLE, THE COLOR WHITE APPEARS ON THE WORDS INVESTOR AND BIG IDEAS FOR THE SMALL CAP INVESTOR. THE COLOR YELLOW APPEARS ON THE WORDS IDEAS.COM.

FOR PROVIDING A PORTAL WEBSITE FEATURING GLOBAL INVESTOR NEWS AND RESEARCH RESOURCES FOR STOCKS AND INDUSTRY; PROVIDING A PORTAL WEBSITE FEATURING GLOBAL FINANCIAL NEWS AND RESEARCH RESOURCES TO TRACK STOCKS LISTED ON SECURITIES EXCHANGES (U.S. CLS. 100, 101 AND 102).

FIRST USE 1-0-1999; IN COMMERCE 1-0-1999.
KATHRYN COWARD, EXAMINING ATTORNEY

THE MARK CONSISTS OF STANDARD CHARACTERS WITHOUT CLAIM TO ANY PARTICULAR FONT, STYLE, SIZE, OR COLOR.

NO CLAIM IS MADE TO THE EXCLUSIVE RIGHT TO USE "PRIZE", APART FROM THE MARK AS SHOWN.

FOR CHARITABLE FUND-RAISING FOR SCHOOLS THROUGH THE SALE OF MERCHANDISE FEATURING INCENTIVES GIVEN TO PARTICIPANTS WHO SELL MERCHANDISE THROUGH ISSUANCE OF AWARDS IN THE FORM OF TROPHIES, PLAQUES, PRIZES, SCHOLARSHIPS AND CONSUMER GOODS (U.S. CLS. 100, 101 AND 102).

FIRST USE 1-0-2003; IN COMMERCE 1-0-2003.
DAVID TAYLOR, EXAMINING ATTORNEY

CLASS 36—(Continued).

SN 78-513,400. ROSE-BRESLIN ASSOCIATES LLC, YONKERS, NY. FILED 11-8-2004.

BROOKHAVEN WALK

THE MARK CONSISTS OF STANDARD CHARACTERS WITHOUT CLAIM TO ANY PARTICULAR FONT, STYLE, SIZE, OR COLOR.

NO CLAIM IS MADE TO THE EXCLUSIVE RIGHT TO USE BROOKHAVEN, APART FROM THE MARK AS SHOWN.

FOR SHOPPING CENTER SERVICES, NAMELY, RENTAL OF SHOPPING CENTER SPACE; REAL ESTATE MANAGEMENT, NAMELY, MANAGEMENT OF SHOPPING CENTER SPACES PROVIDED FOR LEASE (U.S. CLS. 100, 101 AND 102).

TRACY FLETCHER, EXAMINING ATTORNEY

SN 78-514,330. MOHAWK BRANDS, INC., WILMINGTON, DE. FILED 11-10-2004.

**MOHAWK RECOVER
NETWORK**

THE MARK CONSISTS OF STANDARD CHARACTERS WITHOUT CLAIM TO ANY PARTICULAR FONT, STYLE, SIZE, OR COLOR.

OWNER OF U.S. REG. NOS. 1,099,660, 2,441,556 AND OTHERS.

NO CLAIM IS MADE TO THE EXCLUSIVE RIGHT TO USE "NETWORK", APART FROM THE MARK AS SHOWN.

FOR INSURANCE SERVICES, NAMELY, UNDERWRITING EXTENDED WARRANTY CONTRACTS IN THE FIELD OF CARPET REPLACEMENT (U.S. CLS. 100, 101 AND 102).

DOUGLAS LEE, EXAMINING ATTORNEY

CLASS 36—(Continued).

SN 78-514,761. BRIDGER COMMERCIAL FUNDING, MILL VALLEY, CA. FILED 11-10-2004.

B-MEZZ LOAN

THE MARK CONSISTS OF STANDARD CHARACTERS WITHOUT CLAIM TO ANY PARTICULAR FONT, STYLE, SIZE, OR COLOR.

NO CLAIM IS MADE TO THE EXCLUSIVE RIGHT TO USE "LOAN", APART FROM THE MARK AS SHOWN.

FOR FINANCIAL SERVICES IN THE FIELD OF TRADING AND ORIGINATING COMMERCIAL DEBTS, ASSETS, AND LOANS; MORTGAGE FINANCING; LOAN FINANCING AND FINANCIAL MANAGEMENT, NAMELY MANAGEMENT AND FINANCING OF LONG TERM, FIXED-RATE, COMMERCIAL REAL ESTATE LOANS (U.S. CLS. 100, 101 AND 102).

FIRST USE 11-8-2004; IN COMMERCE 11-8-2004.

MICHAEL SOUDERS, EXAMINING ATTORNEY

SN 78-514,790. ERC PROPERTIES, INC., BARLING, AR. FILED 11-10-2004.

**The Heights at
Delaware Ridge**

THE MARK CONSISTS OF STANDARD CHARACTERS WITHOUT CLAIM TO ANY PARTICULAR FONT, STYLE, SIZE, OR COLOR.

FOR REAL ESTATE MANAGEMENT AND LEASING OF REAL ESTATE (U.S. CLS. 100, 101 AND 102).

STEVEN R. FOSTER, EXAMINING ATTORNEY

CLASS 36—(Continued).

SN 78-515,557. MY PLANE, L.L.C., WATERLOO, IA. FILED 11-11-2004.

MyPlane

THE MARK CONSISTS OF STANDARD CHARACTERS WITHOUT CLAIM TO ANY PARTICULAR FONT, STYLE, SIZE, OR COLOR.

FOR AIRCRAFT FRACTIONAL OWNERSHIP PROGRAMS (U.S. CLS. 100, 101 AND 102).
ANNE E. GUSTASON, EXAMINING ATTORNEY

CLASS 36—(Continued).

SN 78-516,888. OPTEUM FINANCIAL SERVICES, LLC, PARAMUS, NJ. FILED 11-15-2004.



Opteum

THE COLOR(S) BLACK, BLUE, AND TEAL IS/ARE CLAIMED AS A FEATURE OF THE MARK.

THE MARK CONSISTS OF THE WORD OPTEUM IN BLACK, UNDER A STAR-SHAPED DESIGN IN BLUE AND TEAL.

FOR FINANCIAL SERVICES, NAMELY, MORTGAGE LENDING, AND MORTGAGE BANKING; AND MORTGAGE BROKERAGE SERVICES, NAMELY, THE PURCHASE AND SALE OF MORTGAGE BACKED SECURITIES, PRIVATE AND PUBLIC SALES OF MORTGAGE LOANS AND MORTGAGE LOAN PORTFOLIOS, SERVICING OF MORTGAGE LOAN PORTFOLIOS, AND BROKERING OF MORTGAGE LOAN SERVICING RIGHTS (U.S. CLS. 100, 101 AND 102).
ROBERT C. CLARK JR., EXAMINING ATTORNEY

SN 78-516,848. EDUCATION FINANCE PARTNERS, INC., SAN FRANCISCO, CA. FILED 11-15-2004.

BRIDGING THE GAP.
INCREASING
ACCESS.

THE MARK CONSISTS OF STANDARD CHARACTERS WITHOUT CLAIM TO ANY PARTICULAR FONT, STYLE, SIZE, OR COLOR.

FOR FINANCIAL SERVICES, NAMELY, STUDENT LOAN SERVICES, PRIVATE LENDING SERVICES, STUDENT LOAN ORIGATION SERVICES, AND STUDENT LOAN INFORMATION SERVICES (U.S. CLS. 100, 101 AND 102).
ROBERT LAVACHE, EXAMINING ATTORNEY

SN 78-517,352. MADZIN, JOHN P, CHATTANOOGA, TN. FILED 11-16-2004.

MADZIN

THE MARK CONSISTS OF STANDARD CHARACTERS WITHOUT CLAIM TO ANY PARTICULAR FONT, STYLE, SIZE, OR COLOR.

FOR FINANCIAL PLANNING INVESTMENT MANAGEMENT (U.S. CLS. 100, 101 AND 102).
KIMBERLY FRYE, EXAMINING ATTORNEY

CLASS 36—(Continued).

SN 78-517,747. MILLENNIUM FINANCIAL GROUP, INC.,
FREDERICK, MD. FILED 11-16-2004.

HOME LOANS MADE FAST & EASY

THE MARK CONSISTS OF STANDARD CHARACTERS
WITHOUT CLAIM TO ANY PARTICULAR FONT, STYLE,
SIZE, OR COLOR.

FOR COMMERCIAL LENDING SERVICES, HOME
EQUITY LOANS, MORTGAGE BANKING, MORTGAGE
BROKERAGE, MORTGAGE LENDING; MORTGAGES
SERVICES, NAMELY, BUYER PRE-QUALIFICATION
OF MORTGAGES FOR MORTGAGE BROKERS AND
BANKS (U.S. CLS. 100, 101 AND 102).

JULIE GUTTADAURO, EXAMINING ATTORNEY

SN 78-518,183. FINANCIAL INVESTMENT MANAGEMENT
GROUP, LTD., TRAVERSE CITY, MI. FILED 11-17-2004.

GOOD INTENTIONS HAVE POWER

THE MARK CONSISTS OF STANDARD CHARACTERS
WITHOUT CLAIM TO ANY PARTICULAR FONT, STYLE,
SIZE, OR COLOR.

FOR MUTUAL FUND INVESTMENT SERVICES (U.S.
CLS. 100, 101 AND 102).

SHARON MEIER, EXAMINING ATTORNEY

SN 78-519,016. FMR CORP., BOSTON, MA. FILED 11-18-2004.

SMART MOVE.

THE MARK CONSISTS OF STANDARD CHARACTERS
WITHOUT CLAIM TO ANY PARTICULAR FONT, STYLE,
SIZE, OR COLOR.

OWNER OF U.S. REG. NOS. 1,900,092 AND 2,207,908.

FOR MUTUAL FUND INVESTMENT SERVICES; RE-
TIREMENT FUND INVESTMENT SERVICES; INVEST-
MENT MANAGEMENT SERVICES; PROVIDING
FINANCIAL INFORMATION BY ELECTRONIC MEANS;
BROKERAGE AND DISTRIBUTION OF MUTUAL
FUNDS, SECURITIES AND ANNUITIES (U.S. CLS. 100,
101 AND 102).

FIRST USE 11-29-2004; IN COMMERCE 11-29-2004.

MARGERY A. TIERNEY, EXAMINING ATTORNEY

CLASS 36—(Continued).

SN 78-520,023. H & B, L.L.L.P., PHOENIX, AZ. FILED 11-19-
2004.



NO CLAIM IS MADE TO THE EXCLUSIVE RIGHT TO
USE "GROUP" AND "ESTATE & RETIREMENT SPECIAL-
LISTS", APART FROM THE MARK AS SHOWN.

THE COLOR(S) DARK GREEN FADED INTO LIGHT
GREEN; WHITE, LIGHT GREY, MEDIUM GREY, DARK
GREY, BLACK, IS/ARE CLAIMED AS A FEATURE OF THE
MARK.

THE MARK CONSISTS OF "THE HOUSEHOLDER
GROUP" IN GREEN WITH "ESTATE & RETIREMENT
SPECIALISTS" IN BLACK. TO THE LEFT OF THE WORD-
ING ARE TWO CONCENTRIC SEMI-CIRCLES, THE LAR-
GER OF THE TWO IN GREEN AND THE SMALL IN
WHITE. RESTING ON THE CIRCLES IS THE REPRESENT-
ATION OF A SEMI-COMPASS WITH NINE ALTERNAT-
ING BLACK AND GRAY POINTS. THE CENTER OF THE
SEMI-COMPASS IS BLACK.

FOR FINANCIAL SERVICES FOR RETIREMENT AND
ESTATE PLANNING PURPOSES (U.S. CLS. 100, 101 AND
102).

FIRST USE 6-19-1996; IN COMMERCE 6-19-1996.

JULIE GUTTADAURO, EXAMINING ATTORNEY

SN 78-524,676. BRIM REALTY, LLC, MUKILTEO, WA.
FILED 11-30-2004.

BRIM REALTY

THE MARK CONSISTS OF STANDARD CHARACTERS
WITHOUT CLAIM TO ANY PARTICULAR FONT, STYLE,
SIZE, OR COLOR.

NO CLAIM IS MADE TO THE EXCLUSIVE RIGHT TO
USE "REALTY", APART FROM THE MARK AS SHOWN.

FOR REAL ESTATE CONSULTING AND BROKER-
AGE SERVICES (U.S. CLS. 100, 101 AND 102).

FIRST USE 11-28-2004; IN COMMERCE 11-28-2004.

DEZMONA MIZELLE, EXAMINING ATTORNEY

CLASS 36—(Continued).

SN 78-525,098. BUREAU INTERNATIONAL DE MEDECINS SANS FRONTIERES, GENEVE 21, SWITZERLAND, FILED 12-1-2004.



OWNER OF U.S. REG. NO. 1,156,743.
THE COLOR(S) RED, BLACK AND WHITE ARE CLAIMED AS A FEATURE OF THE MARK.

THE WORDING "MEDECINS SANS FRONTIERES DOCTORS WITHOUT BORDERS" APPEARS IN BLACK. THE LINE SEPARATING THE WORDING AND THE HEAD, ARMS, AND BACKGROUND BEHIND THE MAN RUNNING APPEAR IN RED. THE LEGS OF THE MAN RUNNING APPEAR IN WHITE.

THE ENGLISH TRANSLATION OF MEDECINS SANS FRONTIERES IS DOCTORS WITHOUT BORDERS. FOR CHARITABLE FUNDRAISING SERVICES FOR INTERNATIONAL RELIEF PROJECTS (U.S. CLS. 100, 101 AND 102).

FIRST USE 12-0-1971; IN COMMERCE 10-0-2001.
APRIL L. RADEMACHER, EXAMINING ATTORNEY

SN 78-525,195. DEUTSCHE TELEKOM AG, BONN, FED REP GERMANY, FILED 12-1-2004.

**T-Mobile SMS
Manager**

THE MARK CONSISTS OF STANDARD CHARACTERS WITHOUT CLAIM TO ANY PARTICULAR FONT, STYLE, SIZE, OR COLOR.

PRIORITY CLAIMED UNDER SEC. 44(D) ON FED REP GERMANY APPLICATION NO. 30431982138, FILED 6-2-2004, REG. NO. 30431982, DATED 9-9-2004, EXPIRES 6-30-2014.

OWNER OF U.S. REG. NOS. 2,282,432 AND 2,889,632.
FOR INSURANCE SERVICES, NAMELY, INSURANCE BROKERAGE, INSURANCE CLAIMS PROCESSING; FINANCIAL SERVICES, NAMELY, CLEARING OF SECURE FINANCIAL TRANSACTIONS THROUGH ONLINE SERVICES; FINANCIAL ANALYSIS AND CONSULTATION; FINANCIAL INFORMATION PROVIDED BY ELECTRONIC MEANS; FINANCIAL INFORMATION PROCESSING; FINANCIAL PORTFOLIO MANAGEMENT; FINANCIAL SERVICES, NAMELY, SECURITIES CONSULTING AND SAFE KEEPING; FINANCIAL SPONSORSHIP OF SPORTS, EDUCATIONAL AND ENTERTAINMENT PROGRAMS AND EVENTS; COMMERCIAL LENDING SERVICES; MONETARY EXCHANGE; CREDIT CARD SERVICES; TELEPHONE CALLING CARD SERVICES; ELECTRONIC COMMERCE SERVICES, NAMELY, ELECTRONIC DEBIT AND CREDIT CARD TRANSACTION PROCESSING SERVICES,

CLASS 36—(Continued).

FUNDS TRANSFER AND BILL PAYMENT-PROCESSING SERVICES; DISCOUNT BROKERAGE SERVICES; SECURITY BROKERAGE; BROKERAGE IN THE FIELD OF INSURANCE, STOCKS, COMMODITIES; CUSTOM BROKERAGE FOR THIRD PARTIES IN THE FIELD OF INSURANCE, STOCKS, COMMODITIES; BROKERAGE OF SHARES AND VENTURE CAPITAL FUNDING SERVICES TO START-UP COMPANIES; BROKERAGE OF FUND SHARES; BROKERAGE OF PRODUCTIVE INVESTMENT OF FUNDS; REAL ESTATE SERVICES, NAMELY, BROKERAGE, MANAGEMENT, LEASING, AND APPRAISAL OF REAL PROPERTY; CONSULTING SERVICES RELATING TO INSURANCE SERVICES, NAMELY, PROVIDING INFORMATION AND BROKERAGE OF INSURANCES IN THE FIELD OF HOME INSURANCE, ACCIDENT INSURANCE AND HEALTH INSURANCE; CONSULTING SERVICES RELATING TO BANK SERVICES; PROVIDING INFORMATION VIA THE TELEPHONE AND THE GLOBAL COMMUNICATION NETWORKS IN THE FIELD OF FINANCE (U.S. CLS. 100, 101 AND 102).

Laurie Mayes, Examining Attorney

SN 78-525,235. EASTSIDE MANAGEMENT COMPANY, LLC, HUNTSVILLE, AL. FILED 12-1-2004.

EASTSIDE PARTNERS

THE MARK CONSISTS OF STANDARD CHARACTERS WITHOUT CLAIM TO ANY PARTICULAR FONT, STYLE, SIZE, OR COLOR.

NO CLAIM IS MADE TO THE EXCLUSIVE RIGHT TO USE "PARTNERS", APART FROM THE MARK AS SHOWN. FOR FINANCIAL SERVICES, NAMELY EQUITY CAPITAL INVESTMENT AND ADVISORY SERVICES (U.S. CLS. 100, 101 AND 102).

FIRST USE 2-4-2005; IN COMMERCE 2-4-2005.
Linda Mickleburgh, Examining Attorney

SN 78-525,507. GREY PANTHERS LIMITED, LONDON, UNITED KINGDOM, FILED 12-1-2004.

AVIVAEDGE

THE MARK CONSISTS OF STANDARD CHARACTERS WITHOUT CLAIM TO ANY PARTICULAR FONT, STYLE, SIZE, OR COLOR.

OWNER OF U.S. REG. NO. 2,773,101.
FOR PROVIDING INFORMATION IN THE FIELD OF UNIVERSAL LIFE, WHOLE LIFE INSURANCE, TERM LIFE INSURANCE AND ANNUITIES (U.S. CLS. 100, 101 AND 102).

FIRST USE 3-17-2003; IN COMMERCE 3-17-2003.
Scott Oslick, Examining Attorney

CLASS 36—(Continued).

SN 78-525,685. TIDWELL, KENNETH, NASHVILLE, TN.
FILED 12-2-2004.

WELDING
DISTRIBUTORS
PARTNERING GROUP

THE MARK CONSISTS OF STANDARD CHARACTERS
WITHOUT CLAIM TO ANY PARTICULAR FONT, STYLE,
SIZE, OR COLOR.

NO CLAIM IS MADE TO THE EXCLUSIVE RIGHT TO
USE "GROUP", APART FROM THE MARK AS SHOWN.
SEC. 2(F).

FOR INSURANCE CONSULTING AND INSURANCE
BROKERAGE SERVICES (U.S. CLS. 100, 101 AND 102).

FIRST USE 0-0-1987; IN COMMERCE 0-0-1987.
RAMONA ORTIGA, EXAMINING ATTORNEY

SN 78-525,976. GREY PANTHERS LIMITED, LONDON,
UNITED KINGDOM, FILED 12-2-2004.

AVIVAGO

THE MARK CONSISTS OF STANDARD CHARACTERS
WITHOUT CLAIM TO ANY PARTICULAR FONT, STYLE,
SIZE, OR COLOR.

OWNER OF U.S. REG. NO. 2,773,101.
FOR LIFE INSURANCE UNDERWRITING AND AD-
MINISTRATION (U.S. CLS. 100, 101 AND 102).

FIRST USE 4-19-2004; IN COMMERCE 4-19-2004.
ALEXANDER L. POWERS, EXAMINING ATTORNEY

CLASS 36—(Continued).

SN 78-526,929. DEUTSCHE TELEKOM AG, BONN, FED REP
GERMANY, FILED 12-3-2004.

T-Mobile M2M
Connect

THE MARK CONSISTS OF STANDARD CHARACTERS
WITHOUT CLAIM TO ANY PARTICULAR FONT, STYLE,
SIZE, OR COLOR.

PRIORITY CLAIMED UNDER SEC. 44(D) ON FED REP
GERMANY APPLICATION NO. 30433156238, FILED 6-7-
2004, REG. NO. 30433156, DATED 7-20-2004, EXPIRES 6-30-
2014.

OWNER OF U.S. REG. NOS. 2,282,432 AND 2,889,632.
FOR INSURANCE SERVICES, NAMELY, INSURANCE
BROKERAGE, INSURANCE CLAIMS PROCESSING; FI-
NANCIAL SERVICES, NAMELY, CLEARING OF SE-
CURE FINANCIAL TRANSACTIONS THROUGH
ONLINE SERVICES; FINANCIAL ANALYSIS AND CON-
SULTATION; FINANCIAL INFORMATION PROVIDED
BY ELECTRONIC MEANS; FINANCIAL INFORMATION
PROCESSING; FINANCIAL PORTFOLIO MANE-
GEMENT; FINANCIAL SERVICES, NAMELY, SECURITIES
CONSULTING AND SAFE KEEPING; FINANCIAL
SPONSORSHIP OF SPORTS, EDUCATIONAL AND EN-
TERTAINMENT PROGRAMS AND EVENTS; COMMER-
CIAL LENDING SERVICES; MONETARY EXCHANGE;
CREDIT CARD SERVICES; TELEPHONE CALLING
CARD SERVICES; ELECTRONIC COMMERCE SER-
VICES, NAMELY, ELECTRONIC DEBIT AND CREDIT
CARD TRANSACTION PROCESSING SERVICES,
FUNDS TRANSFER AND BILL PAYMENT-PROCES-
SING SERVICES; DISCOUNT BROKERAGE SERVICES;
SECURITY BROKERAGE; BROKERAGE IN THE FIELD
OF INSURANCE, STOCKS, COMMODITIES; CUSTOM
BROKERAGE FOR THIRD PARTIES IN THE FIELD OF
INSURANCE, STOCKS, COMMODITIES; BROKERAGE
OF SHARES AND VENTURE CAPITAL FUNDING
SERVICES TO START-UP COMPANIES; BROKERAGE
OF FUND SHARES; BROKERAGE OF PRODUCTIVE
INVESTMENT OF FUNDS; REAL ESTATE SERVICES,
NAMELY, BROKERAGE, MANAGEMENT, LEASING,
AND APPRAISAL OF REAL PROPERTY; CONSULTING
SERVICES RELATING TO INSURANCE SERVICES,
NAMELY, PROVIDING INFORMATION AND BROKER-
AGE OF INSURANCES IN THE FIELD OF HOME
INSURANCE, ACCIDENT INSURANCE AND HEALTH
INSURANCE; CONSULTING SERVICES RELATING TO
BANK SERVICES; PROVIDING INFORMATION VIA
THE TELEPHONE AND THE GLOBAL COMMUNICA-
TION NETWORKS IN THE FIELD OF FINANCE (U.S.
CLS. 100, 101 AND 102).

Laurie Mayes, Examining Attorney

CLASS 36—(Continued).

SN 78-530,689. REAL LIVING, INC., COLUMBUS, OH. FILED 12-10-2004.

CLASS 36—(Continued).

SN 78-532,132. SPIKERIDER, LLC, LAS VEGAS, NV. FILED 12-14-2004.

**IT'S GOT TO BE
REAL**

SpikeRider

THE MARK CONSISTS OF STANDARD CHARACTERS WITHOUT CLAIM TO ANY PARTICULAR FONT, STYLE, SIZE, OR COLOR.

FOR REAL ESTATE SERVICES, NAMELY REAL ESTATE BROKERAGE SERVICES (U.S. CLS. 100, 101 AND 102).

FIRST USE 11-1-2002; IN COMMERCE 11-1-2002.
WON TEAK OH, EXAMINING ATTORNEY

THE MARK CONSISTS OF STANDARD CHARACTERS WITHOUT CLAIM TO ANY PARTICULAR FONT, STYLE, SIZE, OR COLOR.

FOR FINANCIAL SERVICES, NAMELY PROVIDING STOCK MARK INFORMATION VIA THE INTERNET (U.S. CLS. 100, 101 AND 102).

FIRST USE 3-5-2004; IN COMMERCE 3-5-2004.
REBECCA GAN, EXAMINING ATTORNEY

SN 78-531,246. OPTEUM FINANCIAL SERVICES, LLC, PARAMUS, NJ. FILED 12-13-2004.

SN 78-532,310. KANTESARIA, DEVIANG, KING OF PRUSSIA, PA. FILED 12-14-2004.

OPTEMAC

**DEVON PARK
BIOVENTURES**

THE MARK CONSISTS OF STANDARD CHARACTERS WITHOUT CLAIM TO ANY PARTICULAR FONT, STYLE, SIZE, OR COLOR.

FOR MORTGAGE BANKING SERVICES, NAMELY, ORIGINATION, ACQUISITION, SERVICING, SECURITIZATION AND BROKERAGE OF MORTGAGE LOANS (U.S. CLS. 100, 101 AND 102).

MARGERY A. TIERNEY, EXAMINING ATTORNEY

THE MARK CONSISTS OF STANDARD CHARACTERS WITHOUT CLAIM TO ANY PARTICULAR FONT, STYLE, SIZE, OR COLOR.

NO CLAIM IS MADE TO THE EXCLUSIVE RIGHT TO USE "BIOVENTURES", APART FROM THE MARK AS SHOWN.

FOR INVESTMENT FUND MANAGEMENT SERVICES (U.S. CLS. 100, 101 AND 102).

FIRST USE 12-1-2004; IN COMMERCE 12-1-2004.
CATHERINE FAINT, EXAMINING ATTORNEY

CLASS 36—(Continued).

SN 78-533,265. WATROUS, LESLIE P., ORANGE, CA. FILED 12-15-2004.

LEAKFREE

THE MARK CONSISTS OF STANDARD CHARACTERS WITHOUT CLAIM TO ANY PARTICULAR FONT, STYLE, SIZE, OR COLOR.

OWNER OF U.S. REG. NO. 2,673,421.
SEC. 2(F).

FOR PROVIDING EXTENDED WARRANTY CONTRACTS REGARDING THE QUALITY AND CONDITION OR ROOF CONSTRUCTION ON HOMES AND OTHER RESIDENTIAL STRUCTURES (U.S. CLS. 100, 101 AND 102).

FIRST USE 9-1-1999; IN COMMERCE 9-1-1999.
INGRID C. EULIN, EXAMINING ATTORNEY

CLASS 36—(Continued).

SN 78-535,287. SCHULZE, JAMES MARTIN, PLYMOUTH, MA. FILED 12-20-2004.

BuyWell

THE MARK CONSISTS OF STANDARD CHARACTERS WITHOUT CLAIM TO ANY PARTICULAR FONT, STYLE, SIZE, OR COLOR.

FOR REAL ESTATE BROKERAGE SERVICES FEATURING A REBATE PROGRAM FOR HOMEBUYERS (U.S. CLS. 100, 101 AND 102).

RAUL CORDOVA, EXAMINING ATTORNEY

SN 78-535,289. U-HAUL INTERNATIONAL, INC., PHOENIX, AZ. FILED 12-20-2004.

U-HAUL

SN 78-533,664. MARSHALL BANKFIRST CORP., MINNEAPOLIS, MN. FILED 12-16-2004.



NO CLAIM IS MADE TO THE EXCLUSIVE RIGHT TO USE BANK, N.A., APART FROM THE MARK AS SHOWN.

THE COLOR(S) BLUE AND WHITE IS/ARE CLAIMED AS A FEATURE OF THE MARK.

THE MARKS CONSISTS OF A DISTINCTIVE LOGO COMPRISING THE DESIGN OF A WHITE COLORED MOUNTAIN WITH A STYLED LETTER "M" IN BLUE INSIDE THE MOUNTAIN AND THE MARSHALL BANK, N.A. MARK IN WHITE TO THE RIGHT OF THE MOUNTAIN, ALL ON A BLUE COLORED BACKGROUND.

FOR BANKING SERVICES (U.S. CLS. 100, 101 AND 102).

FIRST USE 5-0-2003; IN COMMERCE 5-0-2003.
LEIGH CAROLINE CASE, EXAMINING ATTORNEY

THE MARK CONSISTS OF STANDARD CHARACTERS WITHOUT CLAIM TO ANY PARTICULAR FONT, STYLE, SIZE, OR COLOR.

OWNER OF U.S. REG. NOS. 746,034, 893,891 AND OTHERS.

FOR ELECTRONIC CREDIT CARD AND CREDIT INFORMATION PROCESSING (U.S. CLS. 100, 101 AND 102).

FIRST USE 5-31-1993; IN COMMERCE 5-31-1993.
THEODORE MCBRIDE, EXAMINING ATTORNEY

CLASS 36—(Continued).

SN 78-535,386. BEST LISTING BID, LLC, ST. LOUIS, MO. FILED 12-20-2004.

HUNGRYAGENTS.COM

THE MARK CONSISTS OF STANDARD CHARACTERS WITHOUT CLAIM TO ANY PARTICULAR FONT, STYLE, SIZE, OR COLOR.

FOR COMPUTER SERVICES, NAMELY, MATCHING CONSUMERS WITH REAL ESTATE PROFESSIONALS IN THE FIELD OF REAL ESTATE SERVICES VIA A GLOBAL COMPUTER NETWORK (U.S. CLS. 100, 101 AND 102).

SUE LAWRENCE, EXAMINING ATTORNEY



SN 78-535,442. SANTA BARBARA ALPHA STRATEGIES, SANTA BARBARA, CA. FILED 12-20-2004.

SBAS

THE MARK CONSISTS OF STANDARD CHARACTERS WITHOUT CLAIM TO ANY PARTICULAR FONT, STYLE, SIZE, OR COLOR.

FOR FINANCIAL SERVICES, NAMELY, INVESTMENT ADVISORY AND ASSET MANAGEMENT SERVICES, MANAGEMENT OF HEDGE FUNDS AND ALTERNATIVE INVESTMENTS (U.S. CLS. 100, 101 AND 102).

FIRST USE 12-1-2004; IN COMMERCE 12-1-2004. MELISSA VALLILLO, EXAMINING ATTORNEY

CLASS 36—(Continued).

SN 78-536,124. APPLIANCE COMPUTING INC., DBA REDFIN, SEATTLE, WA. FILED 12-21-2004.

REDFIN

THE MARK CONSISTS OF STANDARD CHARACTERS WITHOUT CLAIM TO ANY PARTICULAR FONT, STYLE, SIZE, OR COLOR.

FOR PROVIDING INFORMATION ON REAL ESTATE AND REAL ESTATE LISTINGS FOR BUYERS, SELLERS AND AGENTS BY MEANS OF THE INTERNET (U.S. CLS. 100, 101 AND 102).

FIRST USE 4-1-2004; IN COMMERCE 9-1-2004. LAURA KOVAISKY, EXAMINING ATTORNEY



SN 78-536,572. TRIDENT INSURANCE SERVICES LLC, AUSTIN, TX. FILED 12-21-2004.



OWNER OF U.S. REG. NO. 2,479,808. NO CLAIM IS MADE TO THE EXCLUSIVE RIGHT TO USE INSURANCE SERVICES, APART FROM THE MARK AS SHOWN.

FOR INSURANCE SERVICES, NAMELY, INSURANCE AGENCY AND INSURANCE UNDERWRITING SERVICES IN THE FIELD OF PROPERTY, INLAND MARINE, CRIME GENERAL LIABILITY, PUBLIC OFFICIALS LIABILITY, LAW ENFORCEMENT LIABILITY, AUTOMOBILE LIABILITY, AUTOMOBILE PHYSICAL DAMAGE AND EXCESS LIABILITY INSURANCE COVERAGE FOR POLITICAL SUBDIVISIONS, NAMELY CITIES, COUNTIES AND TOWNS (U.S. CLS. 100, 101 AND 102).

FIRST USE 11-30-2001; IN COMMERCE 11-30-2001. LINDA E. BLOHM, EXAMINING ATTORNEY

CLASS 36—(Continued).

SN 78-536,974. F1 FINANCIAL, INC., LAGUNA NIGUEL, CA. FILED 12-22-2004.

CLASS 36—(Continued).

SN 78-537,108. CLEAR CAPITAL.COM, INC., TRUCKEE, CA. FILED 12-22-2004.



PI+AVM

NO CLAIM IS MADE TO THE EXCLUSIVE RIGHT TO USE "FINANCIAL", APART FROM THE MARK AS SHOWN.

FOR MORTGAGE BROKERAGE (U.S. CLS. 100, 101 AND 102).

FIRST USE 11-1-2004; IN COMMERCE 11-1-2004.
JUDITH HELFMAN, EXAMINING ATTORNEY

THE MARK CONSISTS OF STANDARD CHARACTERS WITHOUT CLAIM TO ANY PARTICULAR FONT, STYLE, SIZE, OR COLOR.

FOR FINANCIAL VALUATION OF REAL PROPERTY (U.S. CLS. 100, 101 AND 102).
WILLIAM P. SHANAHAN, EXAMINING ATTORNEY

SN 78-536,985. ITHECUS, SUTTON, MA. FILED 12-22-2004.

SN 78-537,168. KEYCORP, CLEVELAND, OH. FILED 12-22-2004.

ITHECUS

KEY4WOMEN

THE MARK CONSISTS OF STANDARD CHARACTERS WITHOUT CLAIM TO ANY PARTICULAR FONT, STYLE, SIZE, OR COLOR.

FOR REAL ESTATE MANAGEMENT SERVICES; REAL ESTATE INVESTMENT SERVICES; REAL ESTATE BROKERAGE SERVICES; LEASING OF REAL PROPERTY; INVESTMENT MANAGEMENT IN THE FIELD OF PRIVATE PLACEMENT OF SECURITIES (U.S. CLS. 100, 101 AND 102).
ANN LINNEHAN, EXAMINING ATTORNEY

THE MARK CONSISTS OF STANDARD CHARACTERS WITHOUT CLAIM TO ANY PARTICULAR FONT, STYLE, SIZE, OR COLOR.

OWNER OF U.S. REG. NOS. 1,722,378, 1,998,350 AND OTHERS.
FOR FINANCIAL SERVICES PROVIDED TO WOMEN-OWNED BUSINESSES, NAMELY, BANKING SERVICES (U.S. CLS. 100, 101 AND 102).
FIRST USE 1-12-2005; IN COMMERCE 1-12-2005.
PATRICIA EVANKO, EXAMINING ATTORNEY

CLASS 36—(Continued).

SN 78-538,169. BRANSON, FOWLKES & COMPANY, INC., HOUSTON, TX. FILED 12-23-2004.

CLASS 36—(Continued).

SN 78-538,935. BEDFORD INSURANCE SERVICES, INC., WOODLAND HILLS, CA. FILED 12-28-2004.

**D3 THE POWER OF
DIVERSIFICATION**

BEDFORD

THE MARK CONSISTS OF STANDARD CHARACTERS WITHOUT CLAIM TO ANY PARTICULAR FONT, STYLE, SIZE, OR COLOR.
FOR FINANCIAL PLANNING AND MONEY MANAGEMENT SERVICES (U.S. CLS. 100, 101 AND 102).
FIRST USE 6-0-1997; IN COMMERCE 6-0-1997.
JEFF DEFORD, EXAMINING ATTORNEY

THE MARK CONSISTS OF STANDARD CHARACTERS WITHOUT CLAIM TO ANY PARTICULAR FONT, STYLE, SIZE, OR COLOR.
FOR INSURANCE AGENCY SERVICES (U.S. CLS. 100, 101 AND 102).
FIRST USE 1-25-1972; IN COMMERCE 1-25-1972.
JANICE L. MCMORROW, EXAMINING ATTORNEY

SN 78-538,483. INSCAP MANAGEMENT, LLC, NASHVILLE, TN. FILED 12-27-2004.

SN 78-556,720. AMERICAN INTERNATIONAL GROUP, INC., NEW YORK, NY. FILED 1-31-2005.

LILIES

AGLA

THE MARK CONSISTS OF STANDARD CHARACTERS WITHOUT CLAIM TO ANY PARTICULAR FONT, STYLE, SIZE, OR COLOR.
FOR FINANCIAL SERVICES IN THE NATURE OF LIFE INSURANCE BACKED INVESTMENT SECURITIES (U.S. CLS. 100, 101 AND 102).
ELLEN BURNS, EXAMINING ATTORNEY

THE MARK CONSISTS OF STANDARD CHARACTERS WITHOUT CLAIM TO ANY PARTICULAR FONT, STYLE, SIZE, OR COLOR.
FOR INSURANCE UNDERWRITING SERVICES, NAMELY, LIFE AND ACCIDENT INSURANCE, HEALTH INSURANCE AND ANNUITIES (U.S. CLS. 100, 101 AND 102).
FIRST USE 1-1-1985; IN COMMERCE 1-1-1985.
SANJEEV VOHRA, EXAMINING ATTORNEY

CLASS 36—(Continued).

SN 78-566,599. AMERICAN INTERNATIONAL GROUP, INC., NEW YORK, NY. FILED 2-14-2005.

GOLD MEDALLION

THE MARK CONSISTS OF STANDARD CHARACTERS WITHOUT CLAIM TO ANY PARTICULAR FONT, STYLE, SIZE, OR COLOR.

FOR INSURANCE UNDERWRITING SERVICES, NAMELY, AVIATION INSURANCE (U.S. CLS. 100, 101 AND 102).

FIRST USE 1-1-1988; IN COMMERCE 1-1-1988.
SANJEEV VOHRA, EXAMINING ATTORNEY

SN 78-584,319. HEALTH CARE SERVICE CORPORATION, A MUTUAL LEGAL RESERVE COMPANY, CHICAGO, IL. FILED 3-10-2005.

CAPITAL FORTIFIER

THE MARK CONSISTS OF STANDARD CHARACTERS WITHOUT CLAIM TO ANY PARTICULAR FONT, STYLE, SIZE, OR COLOR.

OWNER OF U.S. REG. NOS. 1,840,873, 2,792,456 AND OTHERS.

NO CLAIM IS MADE TO THE EXCLUSIVE RIGHT TO USE CAPITAL, APART FROM THE MARK AS SHOWN.

FOR ANNUITY UNDERWRITING, ISSUANCE AND ADMINISTRATION (U.S. CLS. 100, 101 AND 102).

FIRST USE 1-1-1995; IN COMMERCE 1-1-1995.
APRIL L. RADEMACHER, EXAMINING ATTORNEY

SN 78-584,328. HEALTH CARE SERVICE CORPORATION, A MUTUAL LEGAL RESERVE COMPANY, CHICAGO, IL. FILED 3-10-2005.

FLEXIBLE FORTIFIER

THE MARK CONSISTS OF STANDARD CHARACTERS WITHOUT CLAIM TO ANY PARTICULAR FONT, STYLE, SIZE, OR COLOR.

OWNER OF U.S. REG. NOS. 1,840,873, 2,792,456 AND OTHERS.

NO CLAIM IS MADE TO THE EXCLUSIVE RIGHT TO USE FLEXIBLE, APART FROM THE MARK AS SHOWN.

FOR ANNUITY UNDERWRITING, ISSUANCE AND ADMINISTRATION (U.S. CLS. 100, 101 AND 102).

FIRST USE 5-1-1995; IN COMMERCE 5-1-1995.
APRIL L. RADEMACHER, EXAMINING ATTORNEY

CLASS 36—(Continued).

SN 78-604,068. AMERICAN INTERNATIONAL GROUP, INC., NEW YORK, NY. FILED 4-7-2005.

AG HORIZONCHOICE

THE MARK CONSISTS OF STANDARD CHARACTERS WITHOUT CLAIM TO ANY PARTICULAR FONT, STYLE, SIZE, OR COLOR.

FOR FINANCIAL INVESTMENT AND ADVISORY SERVICES IN THE FIELD OF ANNUITIES (U.S. CLS. 100, 101 AND 102).

FIRST USE 6-1-2004; IN COMMERCE 6-1-2004.
SANJEEV VOHRA, EXAMINING ATTORNEY

SN 78-604,080. AMERICAN INTERNATIONAL GROUP, INC., NEW YORK, NY. FILED 4-7-2005.

AG HORIZONFLEX

THE MARK CONSISTS OF STANDARD CHARACTERS WITHOUT CLAIM TO ANY PARTICULAR FONT, STYLE, SIZE, OR COLOR.

FOR FINANCIAL INVESTMENT AND ADVISORY SERVICES IN THE FIELD OF ANNUITIES (U.S. CLS. 100, 101 AND 102).

FIRST USE 6-1-2004; IN COMMERCE 6-1-2004.
SANJEEV VOHRA, EXAMINING ATTORNEY

SN 79-004,051. UBS AG, SWITZERLAND, FILED 4-20-2004.

ALPES

THE MARK CONSISTS OF STANDARD CHARACTERS WITHOUT CLAIM TO ANY PARTICULAR FONT, STYLE, SIZE, OR COLOR.

PRIORITY DATE OF 2-24-2004 IS CLAIMED.

OWNER OF INTERNATIONAL REGISTRATION 0829521 DATED 4-20-2004, EXPIRES 4-20-2014.

FOR BANKING; FINANCIAL SERVICES, NAMELY, INVESTMENT PLANNING RELATING TO PRIVATE EQUITY FUNDS; FINANCIAL MANAGEMENT AND FINANCIAL INVESTMENT RATING SERVICES (U.S. CLS. 100, 101 AND 102).

TINA L. SNAPP, EXAMINING ATTORNEY

CLASS 36—(Continued).

SN 79-005,249. THE BANK OF TOKYO-MITSUBISHI, LTD., JAPAN, FILED 8-10-2004.

B T M — G C M S

THE MARK CONSISTS OF STANDARD CHARACTERS WITHOUT CLAIM TO ANY PARTICULAR FONT, STYLE, SIZE, OR COLOR.

PRIORITY DATE OF 3-3-2004 IS CLAIMED.

OWNER OF INTERNATIONAL REGISTRATION 0833141 DATED 8-10-2004, EXPIRES 8-10-2014.

OWNER OF U.S. REG. NOS. 2,480,873 AND 2,926,919.

FOR BANKING SERVICES VIA A GLOBAL COMPUTER NETWORK; FINANCIAL INFORMATION PROVIDED BY ELECTRONIC MEANS; FINANCIAL INFORMATION PROCESSING (U.S. CLS. 100, 101 AND 102).

EDWARD NELSON, EXAMINING ATTORNEY

SN 79-005,529. DEUTSCHE BÖRSE AG, D-60487 FRANKFURT AM MAIN, FED REP GERMANY, FILED 4-20-2004.

STRATEGY WIZARD

THE MARK CONSISTS OF STANDARD CHARACTERS WITHOUT CLAIM TO ANY PARTICULAR FONT, STYLE, SIZE, OR COLOR.

PRIORITY DATE OF 12-5-2003 IS CLAIMED.

OWNER OF INTERNATIONAL REGISTRATION 0833782 DATED 4-20-2004, EXPIRES 4-20-2014.

NO CLAIM IS MADE TO THE EXCLUSIVE RIGHT TO USE "STRATEGY", APART FROM THE MARK AS SHOWN.

FOR FINANCIAL SERVICES; NAMELY DERIVATIVES EXCHANGE QUOTATION SERVICES; DERIVATIVES OTC TRADING PLATFORM QUOTATION SERVICES; DETERMINATION, CALCULATING AND PROVIDING INFORMATION ON DERIVATIVES; PROVIDING ON-LINE ELECTRONIC DATABASES IN THE FIELD OF FINANCIAL SERVICES, DERIVATIVES EXCHANGES AND A DERIVATIVES OTC TRADING PLATFORM (U.S. CLS. 100, 101 AND 102).

RICHARD WHITE, EXAMINING ATTORNEY

SN 79-006,254. SYNVESTOR VASTGOED B.V., NETHERLANDS, FILED 7-15-2004.

SYNVESTOR

THE MARK CONSISTS OF STANDARD CHARACTERS WITHOUT CLAIM TO ANY PARTICULAR FONT, STYLE, SIZE, OR COLOR.

OWNER OF INTERNATIONAL REGISTRATION 0773506 DATED 11-22-2001, EXPIRES 11-22-2011.

FOR FINANCIAL AFFAIRS, NAMELY, FINANCIAL FORECASTING, FINANCIAL RESEARCH, FINANCIAL CONSULTATION, FINANCIAL RISK MANAGEMENT, FINANCIAL GUARANTEE AND SURETY SERVICES, FINANCIAL TRUST OPERATIONS, FINANCIAL VALUATION OF PERSONAL PROPERTY AND REAL ESTATE, FINANCIAL PLANNING; MONETARY AFFAIRS, NAMELY, MONEY LENDING, ACQUISITION AND TRANSFER OF MONETARY CLAIMS; REAL ESTATE SERVICES, NAMELY, REAL ESTATE APPRAISAL, REAL ESTATE ASSESSMENT AND MANAGEMENT, REAL ESTATE BROKERAGE, REAL ESTATE AGENCIES, REAL ESTATE CONSULTATION, REAL ESTATE SYNDICATION, REAL ESTATE TRUSTEE SERVICES, REAL ESTATE VALUATION (U.S. CLS. 100, 101 AND 102).

ESTHER BELENKER, EXAMINING ATTORNEY

CLASS 37—CONSTRUCTION AND REPAIR

SN 76-430,586. THE HOME ZONE HANDYMAN SERVICES, INC., WESTFIELD, IN. FILED 7-10-2002.



NO CLAIM IS MADE TO THE EXCLUSIVE RIGHT TO USE "HOME PROJECTS" AND "HANDYMAN SERVICES", APART FROM THE MARK AS SHOWN.

FOR HOME MAINTENANCE AND REPAIR SERVICES (U.S. CLS. 100, 103 AND 106).

FIRST USE 6-30-2001; IN COMMERCE 6-30-2001.

BRIAN NEVILLE, EXAMINING ATTORNEY

SN 76-553,617. ADMIRAL ELEVATOR COMPANY, INC., BALTIMORE, MD. FILED 10-23-2003.



NO CLAIM IS MADE TO THE EXCLUSIVE RIGHT TO USE "ELEVATOR", APART FROM THE MARK AS SHOWN. FOR MAINTAIN, REPAIR AND MODERNIZE ELEVATORS (U.S. CLS. 100, 103 AND 106).

FIRST USE 11-1-2000; IN COMMERCE 11-1-2000.

KELLY BOULTON, EXAMINING ATTORNEY

CLASS 37—(Continued).

SN 76-569,639. SAFETY GUYS, INC., FT. LAUDERDALE, FL. FILED 1-5-2004.

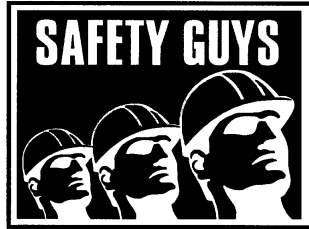

FOR CONSULTING SERVICES FOR THE CONSTRUCTION OF COMMERCIAL AND HIGH-RISE BUILDINGS, NAMELY, INSPECTING THE CONSTRUCTION SITES OF HIGH-RISE BUILDINGS AND PROVIDING RECOMMENDATIONS FOR THE SAFETY OF CONSTRUCTION WORKERS AS WELL IMPLEMENTING SAFETY RECOMMENDATIONS AT SUCH CONSTRUCTION SITES (U.S. CLS. 100, 103 AND 106).

FIRST USE 3-0-2002; IN COMMERCE 3-0-2002.
TINA L. SNAPP, EXAMINING ATTORNEY

SN 76-579,802. NATIONAL BUILDER SERVICES, INC., ORANGE, CA. FILED 3-8-2004.

NATIONAL BUILDER SERVICES

THE MARK CONSISTS OF STANDARD CHARACTERS WITHOUT CLAIM TO ANY PARTICULAR FONT, STYLE, SIZE, OR COLOR.

OWNER OF U.S. REG. NO. 2,447,659.
SEC. 2(F).
FOR SCHEDULING AND PERFORMANCE OF RESIDENTIAL WARRANTY AND REPAIR WORK (U.S. CLS. 100, 103 AND 106).
FIRST USE 9-0-1995; IN COMMERCE 9-0-1995.
BRIAN NEVILLE, EXAMINING ATTORNEY

SN 76-585,335. ZECH, DAVID W., JR., HERDON, VA. FILED 4-6-2004.

ZEBRA

THE MARK CONSISTS OF STANDARD CHARACTERS WITHOUT CLAIM TO ANY PARTICULAR FONT, STYLE, SIZE, OR COLOR.

OWNER OF U.S. REG. NOS. 2,379,150 AND 2,393,145.
FOR AUTOMOTIVE CUSTOMIZING, NAMELY PIN STRIPING, LETTERING, MOULDINGS, WINDOW TINTING AND AUTOMOTIVE CUSTOMIZED SIGN MAKING (U.S. CLS. 100, 103 AND 106).
FIRST USE 2-26-1992; IN COMMERCE 2-26-1992.
CAROLINE WEIMER, EXAMINING ATTORNEY

CLASS 37—(Continued).

SN 76-587,863. EAGLE REDEMPTION CORP., PRATTSVILLE, NY. FILED 4-21-2004.

**DEPOSIT BANDITS**

NO CLAIM IS MADE TO THE EXCLUSIVE RIGHT TO USE SODA AND DEPOSIT, APART FROM THE MARK AS SHOWN.

FOR BOTTLE AND CAN COLLECTIONS FOR RECYCLING, INCLUDING THE PAYMENT OF A DEPOSIT FOR CUSTOMERS (U.S. CLS. 100, 103 AND 106).
FIRST USE 2-24-2004; IN COMMERCE 2-24-2004.
MONTIA G. PRESSEY, EXAMINING ATTORNEY

SN 76-590,218. LEMÓN, ALBERTO JOSEPH, III, KENNER, LA. FILED 5-3-2004.

BERT'S COMPLETE AUTO REPAIR

THE MARK CONSISTS OF STANDARD CHARACTERS WITHOUT CLAIM TO ANY PARTICULAR FONT, STYLE, SIZE, OR COLOR.

NO CLAIM IS MADE TO THE EXCLUSIVE RIGHT TO USE COMPLETE AUTO REPAIR, APART FROM THE MARK AS SHOWN.

FOR VEHICLE MAINTENANCE AND REPAIR (U.S. CLS. 100, 103 AND 106).
FIRST USE 5-21-1988; IN COMMERCE 5-21-1988.
ALICE BENMAMAN, EXAMINING ATTORNEY

SN 76-592,704. HOME CLEANING CENTERS OF AMERICA, INC., OVERLAND PARK, KS. FILED 5-17-2004.

**COUNTRY CLUB
CLEANING**

OWNER OF U.S. REG. NO. 1,337,175.
NO CLAIM IS MADE TO THE EXCLUSIVE RIGHT TO USE "COUNTRY CLUB CLEANING", APART FROM THE MARK AS SHOWN.

FOR COMMERCIAL CLEANING SERVICES, NAMELY, CLEANING OF COUNTRY CLUB PREMISES (U.S. CLS. 100, 103 AND 106).
FIRST USE 0-0-1997; IN COMMERCE 0-0-1997.
MELISSA SHELLA, EXAMINING ATTORNEY

CLASS 37—(Continued).

SN 76-596,012. WATSON PACKER, LLC, MIDLAND, TX. FILED 6-7-2004.

WATSON PACKER

THE MARK CONSISTS OF STANDARD CHARACTERS WITHOUT CLAIM TO ANY PARTICULAR FONT, STYLE, SIZE, OR COLOR.

NO CLAIM IS MADE TO THE EXCLUSIVE RIGHT TO USE PACKER, APART FROM THE MARK AS SHOWN. SEC. 2(F).

FOR LEASING OF CONSTRUCTION EQUIPMENT NAMELY, DOWNHOLE OILWELL TOOLS AND ACCESSORIES FOR DRILLING AND COMPLETION (U.S. CLS. 100, 103 AND 106).

FIRST USE 10-12-1998; IN COMMERCE 10-12-1998. TRICIA SONNEBORN, EXAMINING ATTORNEY

CLASS 37—(Continued).

SN 76-612,435. OZBEK, ATTILA, LAFAYETTE, NJ. FILED 9-14-2004.

AMERIPAVE

THE MARK CONSISTS OF STANDARD CHARACTERS WITHOUT CLAIM TO ANY PARTICULAR FONT, STYLE, SIZE, OR COLOR.

FOR ASPHALT PAVING SERVICES FOR DRIVEWAYS, ROADS, AND PARKING LOTS; CONCRETE PAVING STONE SERVICES FOR SIDEWALKS AND DRIVEWAYS (U.S. CLS. 100, 103 AND 106).

MIDGE BUTLER, EXAMINING ATTORNEY

SN 76-613,864. RAINWATER CONTROL SYSTEMS, L.L.C., GRAWN, MI. FILED 9-23-2004.

SN 76-600,248. UNIT CORPORATION, TULSA, OK. FILED 7-1-2004.

UNIT CORPORATION

THE MARK CONSISTS OF STANDARD CHARACTERS WITHOUT CLAIM TO ANY PARTICULAR FONT, STYLE, SIZE, OR COLOR.

NO CLAIM IS MADE TO THE EXCLUSIVE RIGHT TO USE "CORPORATION", APART FROM THE MARK AS SHOWN.

FOR OIL AND NATURAL GAS WELL DRILLING (U.S. CLS. 100, 103 AND 106).

FIRST USE 7-28-1986; IN COMMERCE 7-28-1986. CHARLES JOYNER, EXAMINING ATTORNEY



RAIN WATER CONTROL SYSTEMS LLC

NO CLAIM IS MADE TO THE EXCLUSIVE RIGHT TO USE "RAINWATER CONTROL SYSTEMS LLC" AND "LLC", APART FROM THE MARK AS SHOWN.

FOR INSTALLATION OF SEAMLESS RAIN GUTTERS, SIDING AND WINDOWS (U.S. CLS. 100, 103 AND 106).

FIRST USE 1-1-2003; IN COMMERCE 1-1-2003. RONALD MCMORROW, EXAMINING ATTORNEY

SN 76-615,676. KMP ENTERPRISES, DBA POWELL ELECTRIC, LOS ANGELES, CA. FILED 10-13-2004.

SN 76-605,223. RUSSELL ELECTRIC, INC. OF ROCKY MOUNT, ROCKY MOUNT, NC. FILED 8-2-2004.

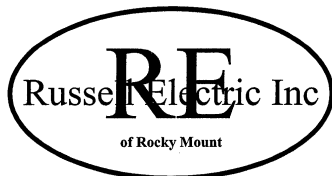

NO CLAIM IS MADE TO THE EXCLUSIVE RIGHT TO USE ELECTRIC INC AND ROCKY MOUNT, APART FROM THE MARK AS SHOWN.

FOR ELECTRICAL CONTRACTING (U.S. CLS. 100, 103 AND 106).

FIRST USE 3-0-2001; IN COMMERCE 3-0-2001. GENE MACIOL, EXAMINING ATTORNEY

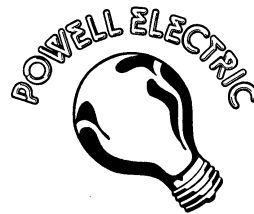

NO CLAIM IS MADE TO THE EXCLUSIVE RIGHT TO USE "ELECTRIC", APART FROM THE MARK AS SHOWN.

FOR ELECTRICAL CONTRACTING; REPAIR, MAINTENANCE, AND INSTALLATION OF ELECTRICAL WIRING, ELECTRICAL OUTLETS, LIGHT FIXTURES AND ELECTRICAL PANELS (U.S. CLS. 100, 103 AND 106).

FIRST USE 1-1-1981; IN COMMERCE 1-1-1981. DAVID ELTON, EXAMINING ATTORNEY

CLASS 37—(Continued).

SN 76-616,902. ONE-STOP BUSINESS, INC., MCKINNEY, TX. FILED 10-20-2004.



OWNER OF U.S. REG. NO. 2,881,090.
NO CLAIM IS MADE TO THE EXCLUSIVE RIGHT TO USE BUSINESS, APART FROM THE MARK AS SHOWN.
FOR MOVIE AND OFFICE FACILITIES CLEANING SERVICES (U.S. CLS. 100, 103 AND 106).
FIRST USE 10-0-1999; IN COMMERCE 10-0-1999.
TARAH HARDY, EXAMINING ATTORNEY

SN 76-616,904. ONE-STOP BUSINESS, INC., MCKINNEY, TX. FILED 10-20-2004.



OWNER OF U.S. REG. NO. 2,881,090.
NO CLAIM IS MADE TO THE EXCLUSIVE RIGHT TO USE CARPET CLEANING, APART FROM THE MARK AS SHOWN.
FOR COMMERCIAL CARPET AND FLOOR CARE CLEANING SERVICES (U.S. CLS. 100, 103 AND 106).
FIRST USE 10-0-1999; IN COMMERCE 10-0-1999.
TARAH HARDY, EXAMINING ATTORNEY

SN 76-619,808. MEDCO EQUIPMENT, INC., NEW BRIGHTON, MN. FILED 11-8-2004.

MEDCO EQUIPMENT

THE MARK CONSISTS OF STANDARD CHARACTERS WITHOUT CLAIM TO ANY PARTICULAR FONT, STYLE, SIZE, OR COLOR.

OWNER OF U.S. REG. NO. 2,937,424.
NO CLAIM IS MADE TO THE EXCLUSIVE RIGHT TO USE EQUIPMENT, APART FROM THE MARK AS SHOWN.
FOR RENTAL AND LEASING OF INDUSTRIAL WASHING MACHINES; RENTAL AND LEASING OF PORTABLE, HEAVY-DUTY INDUSTRIAL WASHING MACHINES FOR CLEANING AND SANITIZING SURFACES; RENTAL AND LEASING OF INDUSTRIAL WASHING MACHINES FOR SHOPPING CARTS, WHEEL CHAIRS, AND SIMILAR DURABLE GOODS; RENTAL AND LEASING OF WASHING MACHINES USED FOR CLEANING AND BATHING DOGS; RENTAL AND LEASING OF INDUSTRIAL WASHING MACHINES VIA DIRECT MAILING AND THE INTERNET (U.S. CLS. 100, 103 AND 106).
FIRST USE 1-31-1994; IN COMMERCE 1-31-1994.
KARLA PERKINS, EXAMINING ATTORNEY

CLASS 37—(Continued).

SN 76-623,488. MIRABELLA CONSTRUCTION INC., ESCONCIDO, CA. FILED 12-6-2004.



NO CLAIM IS MADE TO THE EXCLUSIVE RIGHT TO USE "DESIGN/BUILD", APART FROM THE MARK AS SHOWN.
FOR CONSTRUCTION AND REPAIR OF RESIDENTIAL AND COMMERCIAL BUILDINGS (U.S. CLS. 100, 103 AND 106).
FIRST USE 7-15-2002; IN COMMERCE 7-15-2002.
ANDREW RHIM, EXAMINING ATTORNEY

SN 76-624,792. BENJAMIN FRANKLIN FRANCHISING, LLC, ST. LOUIS, MO. FILED 12-17-2004.



OWNER OF U.S. REG. NOS. 2,673,705 AND 2,762,541.
FOR PLUMBING SERVICES (U.S. CLS. 100, 103 AND 106).
FIRST USE 3-0-2002; IN COMMERCE 3-0-2002.
JASON TURNER, EXAMINING ATTORNEY

SN 76-625,231. ACORDIA HOMES, INC., MONUMENT, CO. FILED 12-21-2004.

ACORDIA HOMES

THE MARK CONSISTS OF STANDARD CHARACTERS WITHOUT CLAIM TO ANY PARTICULAR FONT, STYLE, SIZE, OR COLOR.

NO CLAIM IS MADE TO THE EXCLUSIVE RIGHT TO USE "HOMES", APART FROM THE MARK AS SHOWN.
FOR RESIDENTIAL BUILDING CONSTRUCTION (U.S. CLS. 100, 103 AND 106).
FIRST USE 11-1-2004; IN COMMERCE 11-1-2004.
ATTIYA MALIK, EXAMINING ATTORNEY

CLASS 37—(Continued).

SN 76-625,629. MCO PROPERTIES INC., FOUNTAIN HILLS, AZ. FILED 12-27-2004.



OWNER OF U.S. REG. NO. 1,735,279.
THE ENGLISH TRANSLATION OF "MIRADA" IN THE MARK IS "VIEW".
FOR REAL ESTATE DEVELOPMENT SERVICES (U.S. CLS. 100, 103 AND 106).
FIRST USE 8-3-2002; IN COMMERCE 8-3-2002.
RONALD MCMORROW, EXAMINING ATTORNEY

SN 78-344,079. GMD ENGINEERING PTY LTD, REGENTS PARK, AUSTRALIA, FILED 12-22-2003.

GMD COMPUTRACK

THE MARK CONSISTS OF STANDARD CHARACTERS WITHOUT CLAIM TO ANY PARTICULAR FONT, STYLE, SIZE, OR COLOR.

PRIORITY CLAIMED UNDER SEC. 44(D) ON AUSTRALIA APPLICATION NO. 960126, FILED 7-2-2003, REG. NO. 960126, DATED 7-2-2003, EXPIRES 7-2-2013.

OWNER OF U.S. REG. NOS. 2,158,191 AND 2,713,544.
FOR INSPECTION, REPAIR, AND ADJUSTMENT OF GEOMETRY AND ALIGNMENT OF MOTORCYCLES (U.S. CLS. 100, 103 AND 106).

MICHELLE S. WISEMAN, EXAMINING ATTORNEY

SN 78-356,030. MOSQUITO INFORMATION CORPORATION, HOUSTON, TX. FILED 1-22-2004.

Mosquitopedia

THE MARK CONSISTS OF STANDARD CHARACTERS WITHOUT CLAIM TO ANY PARTICULAR FONT, STYLE, SIZE, OR COLOR.

FOR PROVIDING ON-LINE INFORMATION AND NEWS IN THE FIELD OF PREVENTION AND CONTROL OF NUISANCE MOSQUITOES (U.S. CLS. 100, 103 AND 106).

FIRST USE 6-30-2003; IN COMMERCE 6-30-2003.
STACY WAHLBERG, EXAMINING ATTORNEY

CLASS 37—(Continued).

SN 78-359,001. ON THE SPOT JEWELRY REPAIR, INC., MARY ESTHER, FL. FILED 1-28-2004.



NO CLAIM IS MADE TO THE EXCLUSIVE RIGHT TO USE "JEWELRY & WATCH EXPRESS", APART FROM THE MARK AS SHOWN.

FOR WATCH AND JEWELRY REPAIR SERVICES (U.S. CLS. 100, 103 AND 106).

FIRST USE 1-26-2004; IN COMMERCE 1-26-2004.
SUE LAWRENCE, EXAMINING ATTORNEY

SN 78-374,656. THYSSEN ELEVATOR CAPITAL CORPORATION, TROY, MI. FILED 2-26-2004.

TEAMSERVICE

THE MARK CONSISTS OF STANDARD CHARACTERS WITHOUT CLAIM TO ANY PARTICULAR FONT, STYLE, SIZE, OR COLOR.

FOR CONSTRUCTION, INSTALLATION, MAINTENANCE, REPAIR AND MODERNIZATION SERVICES OF ELEVATORS, ESCALATORS, MOVING WALKWAYS AND RELATED CARRIERS (U.S. CLS. 100, 103 AND 106).

BARBARA RUTLAND, EXAMINING ATTORNEY

SN 78-392,295. CHEROKEE SKY, LLC, TELLICO PLAINS, TN. FILED 3-29-2004.



FOR REAL ESTATE DEVELOPMENT SERVICES (U.S. CLS. 100, 103 AND 106).

FIRST USE 10-0-2003; IN COMMERCE 10-0-2003.
KATHY DE JONGE, EXAMINING ATTORNEY

CLASS 37—(Continued).

SN 78-399,238. WHITE POST SUPPLY CO., INC., DBA WHITE POST RESTORATIONS, WHITE POST, VA. FILED 4-9-2004.



NO CLAIM IS MADE TO THE EXCLUSIVE RIGHT TO USE RESTORATIONS, APART FROM THE MARK AS SHOWN.

FOR RESTORATION AND REPAIR OF VEHICLES AND VEHICLE PARTS (U.S. CLS. 100, 103 AND 106).

FIRST USE 10-15-1976; IN COMMERCE 10-15-1976.
HOWARD B. LEVINE, EXAMINING ATTORNEY

CLASS 37—(Continued).

SN 78-411,691. PAINTING PLUS, CAPE ELIZABETH, ME. FILED 4-30-2004.



NO CLAIM IS MADE TO THE EXCLUSIVE RIGHT TO USE "PAINTING", APART FROM THE MARK AS SHOWN. THE MARK CONSISTS OF A CARTOON PAINTER IN COVERALLS AND WEARING A HAT. HE IS HOLDING A PAINTBRUSH IN HIS LEFT HAND AND A PAINT CAN IN HIS RIGHT. HE IS STANDING NEXT TO THE WORDS PAINTING PLUS.

FOR HOME IMPROVEMENT SERVICES, NAMELY, REMODELING HOMES, RENOVATION IN THE FIELD OF HOMES AND COMMERCIAL BUILDINGS, PAINTING, WALLPAPERING, PRESSURE WASHING; GENERAL CONTRACTING HOME REPAIR AND REMODELING; HOME AND OFFICE CLEANING SERVICES (U.S. CLS. 100, 103 AND 106).

FIRST USE 8-1-1987; IN COMMERCE 9-1-1987.

ROBIN CHOSID, EXAMINING ATTORNEY

SN 78-415,524. KOOWI, INC., BROOKLYN, NY. FILED 5-8-2004.

KooWi

OPTI-PRO

THE MARK CONSISTS OF STANDARD CHARACTERS WITHOUT CLAIM TO ANY PARTICULAR FONT, STYLE, SIZE, OR COLOR.

FOR PERFORMANCE OPTIMIZATION SERVICES, NAMELY, EQUIPMENT BEING UPGRADED, NAMELY FILTER BELT DEWATERING PRESSES, IN THE WATER AND WASTEWATER AFTERMARKET (U.S. CLS. 100, 103 AND 106).

FIRST USE 10-15-1999; IN COMMERCE 10-15-1999.
ASMAT KHAN, EXAMINING ATTORNEY

THE MARK CONSISTS OF STANDARD CHARACTERS WITHOUT CLAIM TO ANY PARTICULAR FONT, STYLE, SIZE, OR COLOR.

FOR RESIDENTIAL BUILDING MAINTENANCE AND REPAIR NAMELY, CLEANING OF FURNACES, CHIMNEYS, REPAIR AND CLEANING OF CONCRETE, BRICKWORK, SIDING, AND STONE; WINDOW REPAIR SERVICES FOR RESIDENTIAL HOMES, NAMELY CLEANING AND/OR REPLACEMENT OF WINDOW CAULKING AND SURROUNDING WINDOW INSULATION AND REPAIRS OR MAINTENANCE RELATING TO THE ELIMINATION AND/OR REDUCTION OF DRAFTS AND REPAIR AND CLEANING OF WINDOW SCREENING AND MOUNTING APPARATUS, WINTER STORM WINDOW MAINTENANCE, REMOVAL AND STORAGE DURING SUMMER MONTHS; PLUMBING SERVICES, NAMELY PLUMBING MAINTENANCE SERVICES, CLEARING OF BLOCKED WASTE PIPES AND REPAIR OF LEAKY PIPES, REPAIR OF LEAKY FAUCETS, REPLACEMENT OF WATER CLOSET GASKETS, HOT WATER HEATER FLUSHING AND, ADJUSTMENTS, HUMIDIFIER, DEHUMIDIFIER AND VENTILATION SYSTEM MAINTENANCE AND REPAIR; ELECTRICAL REPAIRS AND INSTALLATION OF HEATING APPARATUS, HEATING CONTRACTOR SERVICES; ROOFING REPAIR (U.S. CLS. 100, 103 AND 106).

FIRST USE 8-15-2001; IN COMMERCE 8-15-2001.

CHRIS WELLS, EXAMINING ATTORNEY

CLASS 37—(Continued).

SN 78-421,684. CARSMETICS, INC., CLEARWATER, FL.
FILED 5-19-2004.



THE MARK CONSISTS OF STANDARD CHARACTERS WITHOUT CLAIM TO ANY PARTICULAR FONT, STYLE, SIZE, OR COLOR.

OWNER OF U.S. REG. NOS. 1,777,415, 2,711,320 AND 2,763,846.

NO CLAIM IS MADE TO THE EXCLUSIVE RIGHT TO USE EXPRESS ACCIDENT REPAIR, APART FROM THE MARK AS SHOWN.

FOR AUTOMOTIVE REPAIR SERVICES (U.S. CLS. 100, 103 AND 106).

FIRST USE 1-15-2004; IN COMMERCE 1-15-2004.
CHERYL CLAYTON, EXAMINING ATTORNEY

CLASS 37—(Continued).

SN 78-434,074. UNIT LINER COMPANY, SHAWNEE, OK.
FILED 6-11-2004.

POND PRO SHOP

THE MARK CONSISTS OF STANDARD CHARACTERS WITHOUT CLAIM TO ANY PARTICULAR FONT, STYLE, SIZE, OR COLOR.

NO CLAIM IS MADE TO THE EXCLUSIVE RIGHT TO USE "POND AND SHOP", APART FROM THE MARK AS SHOWN.

FOR INSTALLATION AND MAINTENANCE OF WATER GARDENS, PONDS AND WATERFALLS (U.S. CLS. 100, 103 AND 106).

FIRST USE 1-16-2004; IN COMMERCE 1-16-2004.
CHRISIE B. KING, EXAMINING ATTORNEY

SN 78-424,562. MCGUCKIN DRILLING INCORPORATED,
PHOENIX, AZ. FILED 5-25-2004.

SN 78-437,073. RARITY COMMUNITIES, INC., VONORE,
TN. FILED 6-17-2004.

TORRENT

THE MARK CONSISTS OF STANDARD CHARACTERS WITHOUT CLAIM TO ANY PARTICULAR FONT, STYLE, SIZE, OR COLOR.

FOR INSTALLATION OF DRYWELL DRAINAGE SYSTEMS, SEWAGE DISPOSAL SYSTEMS, AND RECHARGING WELLS FOR ENVIRONMENTAL REMEDIATION AND MUNICIPAL RECHARGE (U.S. CLS. 100, 103 AND 106).

ANN E. SAPPENFIELD, EXAMINING ATTORNEY

RARITY MEADOWS

THE MARK CONSISTS OF STANDARD CHARACTERS WITHOUT CLAIM TO ANY PARTICULAR FONT, STYLE, SIZE, OR COLOR.

NO CLAIM IS MADE TO THE EXCLUSIVE RIGHT TO USE "MEADOWS", APART FROM THE MARK AS SHOWN. FOR RESIDENTIAL COMMUNITY AND COMMERCIAL REAL ESTATE DEVELOPMENT (U.S. CLS. 100, 103 AND 106).

FIRST USE 9-0-2001; IN COMMERCE 9-0-2001.
TRACY WHITAKER-BOWN, EXAMINING ATTORNEY

CLASS 37—(Continued).

SN 78-460,242. CENTEX CORPORATION, DALLAS, TX.
FILED 8-2-2004.

THE HOLLOWES

THE MARK CONSISTS OF STANDARD CHARACTERS WITHOUT CLAIM TO ANY PARTICULAR FONT, STYLE, SIZE, OR COLOR.

FOR DEVELOPMENT AND CONSTRUCTION OF RESIDENTIAL, SECOND-HOME AND RESORT COMMUNITIES, AND RELATED AMENITIES AND FACILITIES FOR THE AFORESAID COMMUNITIES (U.S. CLS. 100, 103 AND 106).

FIRST USE 7-2-2004; IN COMMERCE 7-2-2004.
LINDA MICKLEBURGH, EXAMINING ATTORNEY

SN 78-460,246. CENTEX CORPORATION, DALLAS, TX.
FILED 8-2-2004.

**THE HOLLOWES**

THE MARK CONSISTS OF A STYLIZED LETTER H WITH THE WORDS THE HOLLOWES UNDERNEATH.

FOR DEVELOPMENT AND CONSTRUCTION OF RESIDENTIAL, SECOND-HOME AND RESORT COMMUNITIES, AND RELATED AMENITIES AND FACILITIES FOR THE AFORESAID COMMUNITIES (U.S. CLS. 100, 103 AND 106).

FIRST USE 7-2-2004; IN COMMERCE 7-2-2004.
LINDA MICKLEBURGH, EXAMINING ATTORNEY

SN 78-463,893. MIDBAR CONDO DEVELOPMENT, L.P., LAS VEGAS, NV. FILED 8-8-2004.

ONE LAS VEGAS

THE MARK CONSISTS OF STANDARD CHARACTERS WITHOUT CLAIM TO ANY PARTICULAR FONT, STYLE, SIZE, OR COLOR.

NO CLAIM IS MADE TO THE EXCLUSIVE RIGHT TO USE "LAS VEGAS", APART FROM THE MARK AS SHOWN.

FOR REAL ESTATE DEVELOPMENT AND CONSTRUCTION OF COMMERCIAL AND RESIDENTIAL PROPERTY, INCLUDING CONDOMINIUMS (U.S. CLS. 100, 103 AND 106).

AMOS T. MATTHEWS, JR., EXAMINING ATTORNEY

CLASS 37—(Continued).

SN 78-470,951. DE YOUNG COMMUNITIES, INC., FRESNO, CA. FILED 8-20-2004.

TEAM 5

THE MARK CONSISTS OF STANDARD CHARACTERS WITHOUT CLAIM TO ANY PARTICULAR FONT, STYLE, SIZE, OR COLOR.

FOR CONSTRUCTION SERVICES, NAMELY, PLANNING, LAYING OUT AND CUSTOM CONSTRUCTION OF RESIDENTIAL AND COMMERCIAL COMMUNITIES (U.S. CLS. 100, 103 AND 106).

FIRST USE 1-28-2003; IN COMMERCE 1-28-2003.
DAVID MURRAY, EXAMINING ATTORNEY

SN 78-470,985. DE YOUNG COMMUNITIES, INC., FRESNO, CA. FILED 8-20-2004.

**DE YOUNG
COMMUNITIES**

THE MARK CONSISTS OF STANDARD CHARACTERS WITHOUT CLAIM TO ANY PARTICULAR FONT, STYLE, SIZE, OR COLOR.

NO CLAIM IS MADE TO THE EXCLUSIVE RIGHT TO USE "COMMUNITIES", APART FROM THE MARK AS SHOWN.

FOR CONSTRUCTION SERVICES, NAMELY, PLANNING, LAYING OUT AND CUSTOM CONSTRUCTION OF RESIDENTIAL AND COMMERCIAL COMMUNITIES, REAL ESTATE DEVELOPMENT AND CONSTRUCTION MANAGEMENT (U.S. CLS. 100, 103 AND 106).

FIRST USE 6-24-1998; IN COMMERCE 6-24-1998.
DAVID MURRAY, EXAMINING ATTORNEY

CLASS 37—(Continued).

SN 78-473,648. DIVISION 7, INC., SILVERTHORNE, CO. FILED 8-25-2004.



NO CLAIM IS MADE TO THE EXCLUSIVE RIGHT TO USE "QUALITY INSULATION SYSTEMS", APART FROM THE MARK AS SHOWN.
FOR INSTALLATION OF BUILDING INSULATION; INSTALLATION OF BATT INSULATION, BLOWN INSULATION, SOUND ATTENUATION AND FOAM INSULATION (U.S. CLS. 100, 103 AND 106).
FIRST USE 12-31-2000; IN COMMERCE 12-31-2000.
SUSAN STIGLITZ, EXAMINING ATTORNEY

SN 78-475,849. MALLO ENTERPRISE, LLC, MESA, AZ. FILED 8-30-2004.



OWNER OF U.S. REG. NOS. 2,900,159 AND 2,929,191.
THE MARK CONSISTS OF THE WORD 'BUYDIRECT.' A SWIRL-LIKE DESIGN IS LOCATED ABOVE THE LETTER 'T'.
FOR AUTOMOBILE REPAIR AND MAINTENANCE SERVICES (U.S. CLS. 100, 103 AND 106).
FIRST USE 7-11-2004; IN COMMERCE 7-11-2004.
PATRICIA EVANKO, EXAMINING ATTORNEY

CLASS 37—(Continued).

SN 78-477,191. HYDRADRY, INC., ORLANDO, FL. FILED 9-1-2004.

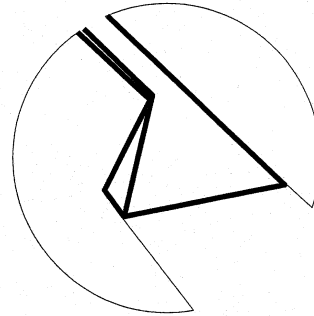

THE MARK CONSISTS OF DESIGN OF A CARPET NOZZLE.
FOR CARPET AND UPHOLSTERY CLEANING, REPAIR, MAINTENANCE AND WATER DAMAGE RESTORATION SERVICES; INSTALLATION OF CARPETS, CARPET PADDING AND WOOD AND VINYL FLOORING; AND MATTRESS CLEANING (U.S. CLS. 100, 103 AND 106).
FIRST USE 1-0-1983; IN COMMERCE 1-0-1983.
ALICIA COLLINS, EXAMINING ATTORNEY

SN 78-479,682. UNITED RADIO, INC., DBA UNITED RADIO SERVICE, SYRACUSE, NY. FILED 9-7-2004.



THE MARK CONSISTS OF STYLIZED U AND R CONNECTED.
FOR INSTALLATION, MAINTENANCE AND REPAIR OF CONSUMER ELECTRONIC EQUIPMENT NAMELY, TELEVISIONS, DVD PLAYERS, COMPACT DISC PLAYERS, RADIOS, CAMCORDERS, AMPLIFIERS, STEREO EQUIPMENT, SATELLITE RADIO EQUIPMENT, GLOBAL NAVIGATIONAL HARDWARE, MICROWAVE OVENS, DIGITAL SIGNAL PROCESSORS, SOUNDBOARDS, PAGERS, SPEAKERS, PORTABLE AUDIO AND COMMUNICATION EQUIPMENT, NAMELY, RADIOS, REPEATERS, MOBILE DATA TERMINALS, VIDEO SURVEILLANCE EQUIPMENT, MICROWAVE TRANSMITTERS, PAGING TERMINALS, AMPLIFIERS, AND AUDIO SIRENS IN LAW ENFORCEMENT AND EMERGENCY VEHICLES AND FACILITIES (U.S. CLS. 100, 103 AND 106).
FIRST USE 6-0-1970; IN COMMERCE 6-0-1970.
NELSON SNYDER, EXAMINING ATTORNEY

CLASS 37—(Continued).

SN 78-483,177. MARSH, PETER R., BEAVERTON, OR. FILED 9-14-2004.

**Practical Homes
for Practical People**

THE MARK CONSISTS OF STANDARD CHARACTERS WITHOUT CLAIM TO ANY PARTICULAR FONT, STYLE, SIZE, OR COLOR.

FOR RESIDENTIAL AND COMMERCIAL BUILDING LAYOUT AND CONSTRUCTION; RESIDENTIAL AND COMMERCIAL BUILDING CONSTRUCTION AND CONSTRUCTION PLANNING; GENERAL CONTRACTOR SERVICES IN THE FIELD OF BUILDING CONSTRUCTION AND DEVELOPMENT, AND REPAIR, NAMELY CARPENTRY, REMODELING/RENOVATION, CARPETING/FLOORING, CAULKING/GLAZING, GRAFFITI REMOVAL, PAINTING, PARKING LOT STRIPING, SANDBLASTING, WATER-BLASTING/PRESSURE WASHING, AND WALL-COVERING (U.S. CLS. 100, 103 AND 106).

FIRST USE 1-1-1994; IN COMMERCE 1-1-1994.
MIDGE BUTLER, EXAMINING ATTORNEY

SN 78-487,932. LONG FENCE COMPANY, INC., CAPITOL HEIGHTS, MD. FILED 9-22-2004.

LONG CONSERVATORIES

OWNER OF U.S. REG. NOS. 2,638,445, 2,638,446 AND 2,638,447.

NO CLAIM IS MADE TO THE EXCLUSIVE RIGHT TO USE "CONSERVATORIES", APART FROM THE MARK AS SHOWN.

FOR CONSTRUCTION AND INSTALLATION OF CONSERVATORIES (U.S. CLS. 100, 103 AND 106).

FIRST USE 6-1-2004; IN COMMERCE 9-16-2004.
RENEE MCCRAY, EXAMINING ATTORNEY

CLASS 37—(Continued).

SN 78-488,123. SOUTHERN ELECTRICAL SERVICES INCORPORATED, SUGAR LAND, TX. FILED 9-22-2004.

**"How can we
brighten your day?"**

THE MARK CONSISTS OF STANDARD CHARACTERS WITHOUT CLAIM TO ANY PARTICULAR FONT, STYLE, SIZE, OR COLOR.

SEC. 2(F).

FOR ELECTRICAL CONTRACTOR SERVICES FOR RESIDENTIAL AND COMMERCIAL CUSTOMERS (U.S. CLS. 100, 103 AND 106).

FIRST USE 8-31-2004; IN COMMERCE 8-31-2004.

WON TEAK OH, EXAMINING ATTORNEY

SN 78-490,459. PRINTELLIGENT, SALT LAKE CITY, UT. FILED 9-28-2004.

Printelligent

THE MARK CONSISTS OF STANDARD CHARACTERS WITHOUT CLAIM TO ANY PARTICULAR FONT, STYLE, SIZE, OR COLOR.

FOR SUPPORT OF ELECTRONIC IMAGING EQUIPMENT, NAMELY, REPAIR AND MAINTENANCE OF COMPUTER PRINTERS AND FAX MACHINES (U.S. CLS. 100, 103 AND 106).

FIRST USE 4-1-1996; IN COMMERCE 4-1-1996.

JENNIFER WILLISTON, EXAMINING ATTORNEY

CLASS 37—(Continued).

SN 78-491,501. JOHN H SCHILLING, MAGNOLIA, TX.
FILED S.R. 9-29-2004; AM. P.R. 5-18-2005.

**Take the sting out
of building costs**

THE MARK CONSISTS OF STANDARD CHARACTERS WITHOUT CLAIM TO ANY PARTICULAR FONT, STYLE, SIZE, OR COLOR.

FOR CONSULTING SERVICES IN THE FIELD OF RESIDENTIAL AND COMMERCIAL BUILDING (U.S. CLS. 100, 103 AND 106).

FIRST USE 5-1-2004; IN COMMERCE 5-3-2004.
SKYE YOUNG, EXAMINING ATTORNEY

SN 78-492,132. LIFESTYLE CUSTOM CYCLES, LLC, VILLA PARK, CA. FILED 9-30-2004.

**LIFESTYLE CUSTOM
CYCLES**

THE MARK CONSISTS OF STANDARD CHARACTERS WITHOUT CLAIM TO ANY PARTICULAR FONT, STYLE, SIZE, OR COLOR.

NO CLAIM IS MADE TO THE EXCLUSIVE RIGHT TO USE "CUSTOM CYCLES", APART FROM THE MARK AS SHOWN.

FOR MOTORCYCLE SERVICE, REPAIR, MAINTENANCE, AND CUSTOMIZATION (U.S. CLS. 100, 103 AND 106).

FIRST USE 3-0-2000; IN COMMERCE 3-0-2000.
ANGELA M. MICHELI, EXAMINING ATTORNEY

CLASS 37—(Continued).

SN 78-492,788. QUACKT GLASS, LLC, LANCASTER, SC.
FILED 10-1-2004.



THE COLOR(S) ORANGE, YELLOW, AND BLUE. IS/ARE CLAIMED AS A FEATURE OF THE MARK.

THE MARK CONSISTS OF A DUCK WITH A YELLOW BODY AND A ORANGE BILL AND ORANGE FEET AND LEGS. THE DUCK IS STANDING BESIDE THE STYLIZED WORDS QUACKT GLASS WHICH ARE WRITTEN IN ORANGE WITH A BLUE BORDER SURROUNDING THE LETTERS.

FOR WINDSHIELD GLASS REPLACEMENT AND REPAIR SERVICE FOR ALL TYPES OF MOTOR VEHICLES (U.S. CLS. 100, 103 AND 106).

FIRST USE 2-1-2004; IN COMMERCE 2-1-2004.
JULIE GUTTADAURO, EXAMINING ATTORNEY

SN 78-494,304. BERKELY SUTTON CLEANERS CORP., NEW YORK, NY. FILED 10-4-2004.



Berkely Sutton Cleaners

NO CLAIM IS MADE TO THE EXCLUSIVE RIGHT TO USE "CLEANERS", APART FROM THE MARK AS SHOWN. THE NAME BERKELY SUTTON DOES NOT IDENTIFY A LIVING INDIVIDUAL.

THE COLOR(S) YELLOW AND BLACK IS/ARE CLAIMED AS A FEATURE OF THE MARK.

THE COLOR YELLOW APPEARS IN THE MARK WITHIN THE HANGER PERSON DESIGN WITH A BLACK BORDER OUTLINE AND WITH ALL WORDING IN BLACK LETTERING.

THE MARK CONSISTS OF HANGER WITH WINK FACE AND A THUMB UP.

FOR DRY CLEANING, LAUNDERING OF SHIRTS, AND WASH AND FOLD LAUNDERING SERVICES FOR OTHERS (U.S. CLS. 100, 103 AND 106).

FIRST USE 1-1-2000; IN COMMERCE 1-1-2000.
DOMINIC J. FERRAIUOLO, EXAMINING ATTORNEY

SN 78-496,572. MESA, MILTON, MIAMI, FL. FILED 10-7-2004.



THE COLOR(S) RED, BLUE, YELLOW IS/ARE CLAIMED AS A FEATURE OF THE MARK.

THE MARK CONSISTS OF THERE IS A LOGO AND TWO WORDS. THE LOGO IS A RHOMBUS FIGURE DIVIDED BY

CLASS 37—(Continued).

A CENTRAL VERTICAL YELLOW LINE THAT CREATES TWO TRIANGLES. THE LEFT-SIDE TRIANGLE IS RED WITH A STYLIZED YELLOW "M" EMBEDDED. THE RIGHT-SIDE TRIANGLE IS BLUE WITH A STYLIZED YELLOW "M" EMBEDDED. THE BORDERS OF THE RHOMBUS CONNECT WITH THE CENTRAL LINE AND THEY ARE ALSO YELLOW. THE FIRST WORD IS "MEGA" IN UPPERCASE. ITS MAIN-CORE COLOR IS BLUE AND IT'S SURROUNDED BY A YELLOW GLOWING EFFECT. THE SECOND WORD IS "MASTER" IN UPPERCASE. IT'S MAIN-CORE COLOR IS RED AND IT'S SURROUNDED BY A YELLOW GLOWING EFFECT ALSO.

FOR REPAIRS, UPGRADES, AND MAINTENANCE FOR COMPUTERS AND COMPUTER PERIPHERALS, COMPUTER NETWORK INSTALLATION (U.S. CLS. 100, 103 AND 106).

FIRST USE 9-18-2004; IN COMMERCE 9-18-2004.
DEBRA LEE, EXAMINING ATTORNEY

CLASS 37—(Continued).

SN 78-497,185. CALKINS, DANIEL J., CLARKSBURG, MD.
FILED 10-8-2004.

repairmax

SN 78-496,946. GREASE MONKEY INTERNATIONAL, INC.,
DENVER, CO. FILED 10-8-2004.

MONKEY SHINE

THE MARK CONSISTS OF STANDARD CHARACTERS WITHOUT CLAIM TO ANY PARTICULAR FONT, STYLE, SIZE, OR COLOR.

OWNER OF U.S. REG. NO. 1,857,928.
FOR AUTOMOBILE WASHING AND WAXING SERVICES (U.S. CLS. 100, 103 AND 106).
FIRST USE 7-0-1993; IN COMMERCE 7-0-1993.
PAULA MAYS, EXAMINING ATTORNEY

THE MARK CONSISTS OF STANDARD CHARACTERS WITHOUT CLAIM TO ANY PARTICULAR FONT, STYLE, SIZE, OR COLOR.

FOR REPAIR AND MAINTENANCE FOR HOUSEHOLD AIR CONDITIONING, HEATING AND PLUMBING (U.S. CLS. 100, 103 AND 106).

KEVIN DINALLO, EXAMINING ATTORNEY

SN 78-497,109. ANYTHING ELECTRIC, INC., AMERICAN
FORK, UT. FILED 10-8-2004.

Captain Electric

THE MARK CONSISTS OF STANDARD CHARACTERS WITHOUT CLAIM TO ANY PARTICULAR FONT, STYLE, SIZE, OR COLOR.

NO CLAIM IS MADE TO THE EXCLUSIVE RIGHT TO USE "ELECTRIC", APART FROM THE MARK AS SHOWN.

FOR ELECTRICAL REPAIRS, INSTALLATION AND CONTRACTING SERVICES FOR RESIDENTIAL AND COMMERCIAL WIRING OF ELECTRICAL APPARATUSSES, APPLIANCES, STEREO COMPONENTS, AND TELEVISION COMPONENTS, ELECTRICAL PANELS, ELECTRICAL OUTLETS, SWITCHES AND LIGHT FIXTURES (U.S. CLS. 100, 103 AND 106).

DAVID H. STINE, EXAMINING ATTORNEY

SN 78-500,950. WEISSMAN, DWIGHT B., GREAT NECK, NY.
FILED 10-15-2004.

STATUS FAUX

THE MARK CONSISTS OF STANDARD CHARACTERS WITHOUT CLAIM TO ANY PARTICULAR FONT, STYLE, SIZE, OR COLOR.

NO CLAIM IS MADE TO THE EXCLUSIVE RIGHT TO USE FAUX, APART FROM THE MARK AS SHOWN.

FOR CUSTOM DECORATIVE PAINTING SERVICES IN THE NATURE OF FAUX FINISHES, STENCILING, TEXTURES, AIRBRUSHING, ANTIQUING, AND GILDING (U.S. CLS. 100, 103 AND 106).

FIRST USE 7-1-2002; IN COMMERCE 7-1-2002.

AMY HELLA, EXAMINING ATTORNEY

CLASS 37—(Continued).

SN 78-501,539. CENTEX CORPORATION, DALLAS, TX. FILED 10-18-2004.

YOUR LOT. YOUR HOME. YOUR WAY.

THE MARK CONSISTS OF STANDARD CHARACTERS WITHOUT CLAIM TO ANY PARTICULAR FONT, STYLE, SIZE, OR COLOR.

FOR CONSTRUCTION SERVICES, NAMELY, PLANNING, LAYING OUT AND CONSTRUCTION OF RESIDENTIAL AND COMMERCIAL COMMUNITIES, AND CUSTOM CONSTRUCTION SERVICES ON CUSTOMER-OWNED LOTS (U.S. CLS. 100, 103 AND 106).

FIRST USE 8-21-2004; IN COMMERCE 8-21-2004.
ANNE E. GUSTASON, EXAMINING ATTORNEY

CLASS 37—(Continued).

SN 78-502,251. KLEEN SEAL FRANCHISE SYSTEMS, LLC, METUCHEN, NJ. FILED 10-19-2004.

KLEEN SEAL

THE MARK CONSISTS OF STANDARD CHARACTERS WITHOUT CLAIM TO ANY PARTICULAR FONT, STYLE, SIZE, OR COLOR.

NO CLAIM IS MADE TO THE EXCLUSIVE RIGHT TO USE "SEAL", APART FROM THE MARK AS SHOWN. FOR ASPHALT DRIVEWAY SEALING SERVICES (U.S. CLS. 100, 103 AND 106).

FIRST USE 8-31-1994; IN COMMERCE 8-31-1994.
ELLEN BURNS, EXAMINING ATTORNEY

SN 78-501,581. FRONT ROW HOME THEATER AND AUDIO, LLC, RIVERVALE, NJ. FILED 10-18-2004.

FRONT ROW

THE MARK CONSISTS OF STANDARD CHARACTERS WITHOUT CLAIM TO ANY PARTICULAR FONT, STYLE, SIZE, OR COLOR.

FOR MECHANICAL INSTALLATION OF EQUIPMENT, NAMELY, ELECTRONIC CONTROL SYSTEMS, ALARMS, AUDIO, VIDEO, WHOLE-HOUSE AUTOMATION, WHOLE-HOUSE AUDIO, WHOLE-HOUSE VIDEO, AND WIRING IN RESIDENTIAL PROPERTIES; CUSTOM INSTALLATION OF AUDIO, VIDEO, WHOLE-HOUSE AUTOMATION, WHOLE-HOUSE AUDIO, WHOLE-HOUSE VIDEO, AND WIRING IN RESIDENTIAL PROPERTIES (U.S. CLS. 100, 103 AND 106).

FIRST USE 11-15-2004; IN COMMERCE 1-5-2005.
CHRISTOPHER BUONGIORNO, EXAMINING ATTORNEY

SN 78-502,351. ELECTRO MECHANICAL TECHNOLOGIES, INC., HILLSIDE, NJ. FILED 10-19-2004.

NitroClean

THE MARK CONSISTS OF STANDARD CHARACTERS WITHOUT CLAIM TO ANY PARTICULAR FONT, STYLE, SIZE, OR COLOR.

FOR CLEANING SERVICES FOR INTERNAL COMPONENTS OF ELECTRONIC EQUIPMENT SUCH AS ELEVATORS AND INDUSTRIAL MOTORS (U.S. CLS. 100, 103 AND 106).

FIRST USE 8-7-1991; IN COMMERCE 8-7-1991.
BRIAN PINO, EXAMINING ATTORNEY

CLASS 37—(Continued).

SN 78-502,982. SHADDOCK BUILDERS & DEVELOPERS, INC., DBA SOTHERBY HOMES, PLANO, TX. FILED 10-20-2004.

SOTHERBY HOMES

THE MARK CONSISTS OF STANDARD CHARACTERS WITHOUT CLAIM TO ANY PARTICULAR FONT, STYLE, SIZE, OR COLOR.

NO CLAIM IS MADE TO THE EXCLUSIVE RIGHT TO USE "HOMES", APART FROM THE MARK AS SHOWN.

FOR CUSTOM CONSTRUCTION OF HOMES (U.S. CLS. 100, 103 AND 106).

FIRST USE 4-0-1995; IN COMMERCE 4-0-1995.

ELISSA GARBER KON, EXAMINING ATTORNEY

SN 78-503,399. CENTEX CORPORATION, DALLAS, TX. FILED 10-21-2004.

**WE BUILD AMERICA'S
DREAMS. AND THEN
WE BACK THEM.**

THE MARK CONSISTS OF STANDARD CHARACTERS WITHOUT CLAIM TO ANY PARTICULAR FONT, STYLE, SIZE, OR COLOR.

FOR CONSTRUCTION SERVICES, NAMELY, PLANNING, LAYING OUT AND CONSTRUCTION OF RESIDENTIAL AND COMMERCIAL COMMUNITIES (U.S. CLS. 100, 103 AND 106).

FIRST USE 2-8-2004; IN COMMERCE 2-8-2004.

LINDA ESTRADA, EXAMINING ATTORNEY

SN 78-504,173. CENTEX CORPORATION, DALLAS, TX. FILED 10-22-2004.

**WE BUILD AMERICA'S
DREAMS.**

THE MARK CONSISTS OF STANDARD CHARACTERS WITHOUT CLAIM TO ANY PARTICULAR FONT, STYLE, SIZE, OR COLOR.

FOR CONSTRUCTION SERVICES, NAMELY, PLANNING, LAYING OUT AND CONSTRUCTION OF RESIDENTIAL AND COMMERCIAL COMMUNITIES (U.S. CLS. 100, 103 AND 106).

FIRST USE 2-9-2003; IN COMMERCE 2-9-2003.

LINDA ESTRADA, EXAMINING ATTORNEY

CLASS 37—(Continued).

SN 78-505,144. F & R HOLDINGS, INC., TIMEWELL, IL. FILED 10-25-2004.

YIELD BASED DESIGN

THE MARK CONSISTS OF STANDARD CHARACTERS WITHOUT CLAIM TO ANY PARTICULAR FONT, STYLE, SIZE, OR COLOR.

FOR WATER MANAGEMENT SERVICES, NAMELY, THE INSTALLATION OF WATER DRAINAGE SYSTEMS (U.S. CLS. 100, 103 AND 106).

FIRST USE 9-0-2004; IN COMMERCE 9-0-2004.

RICHARD A. STRASER, EXAMINING ATTORNEY

SN 78-505,378. THRIFTY OIL CO., SANTA FE SPRINGS, CA. FILED 10-25-2004.

THRIFTY

THE MARK CONSISTS OF STANDARD CHARACTERS WITHOUT CLAIM TO ANY PARTICULAR FONT, STYLE, SIZE, OR COLOR.

OWNER OF U.S. REG. NOS. 1,304,137 AND 1,306,383. FOR GASOLINE SERVICE STATION SERVICES AND CAR WASHING SERVICES (U.S. CLS. 100, 103 AND 106).

FIRST USE 1-1-1969; IN COMMERCE 1-1-1969.

DOMINICK J. SALEMI, EXAMINING ATTORNEY

SN 78-506,870. CROZIER, PAUL, SAN JOSE, CA. FILED 10-27-2004.



NO CLAIM IS MADE TO THE EXCLUSIVE RIGHT TO USE "CLEAN TRASH CANS", APART FROM THE MARK AS SHOWN.

FOR CLEANING RESIDENTIAL OUTDOOR TRASH CANS FOR OTHERS (U.S. CLS. 100, 103 AND 106).

H. M. FISHER, EXAMINING ATTORNEY

CLASS 37—(Continued).

SN 78-511,979. UNITED GOLF, LLC, TULSA, OK. FILED 11-5-2004.

UNITED GOLF

THE MARK CONSISTS OF STANDARD CHARACTERS WITHOUT CLAIM TO ANY PARTICULAR FONT, STYLE, SIZE, OR COLOR.
NO CLAIM IS MADE TO THE EXCLUSIVE RIGHT TO USE "GOLF", APART FROM THE MARK AS SHOWN.
FOR CONSTRUCTION OF GOLF COURSES (U.S. CLS. 100, 103 AND 106).
FIRST USE 5-0-1997; IN COMMERCE 5-0-1997.
APRIL L. RADEMACHER, EXAMINING ATTORNEY

SN 78-513,827. PRECHEL, OLIVER, FORT MYERS, FL. FILED 11-9-2004.



NO CLAIM IS MADE TO THE EXCLUSIVE RIGHT TO USE "BUILDERS", APART FROM THE MARK AS SHOWN. THE COLOR(S) BLACK, RED, AND GRAY IS/ARE CLAIMED AS A FEATURE OF THE MARK.
THE MARK CONSISTS OF A STYLIZED HURRICANE SYMBOL WITH THE TOP CURVE IN RED, THE BOTTOM CURVE IN BLACK, AND A GRAY CENTER. THE WORDS STORM READY BUILDERS "WHO SAYS YOU CAN'T BEAT MOTHER NATURE" ARE IN BLACK.
FOR NEW HOME BUILDING (U.S. CLS. 100, 103 AND 106).
MICHELLE DUBOIS, EXAMINING ATTORNEY

CLASS 37—(Continued).

SN 78-515,807. NEW FAR EAST SIDE DEVELOPMENT CO., LLC, DETROIT, MI. FILED 11-12-2004.

Fox Creek

THE MARK CONSISTS OF STANDARD CHARACTERS WITHOUT CLAIM TO ANY PARTICULAR FONT, STYLE, SIZE, OR COLOR.
FOR REAL ESTATE CONSTRUCTION, NAMELY RESIDENTIAL AND APARTMENT BUILDING CONSTRUCTION; REAL ESTATE DEVELOPMENT AND REAL ESTATE SITE-SELECTION SERVICES; LAND DEVELOPMENT SERVICES, NAMELY PLANNING AND LAYING OUT OF RESIDENTIAL AND / OR COMMERCIAL COMMUNITIES (U.S. CLS. 100, 103 AND 106).
KRISTINA KLOIBER, EXAMINING ATTORNEY

SN 78-524,549. DAVID LEE GARCIA, DBA AFFORDABLE OVERHEAD DOOR COMPANY, ADKINS, TX. FILED 11-30-2004.

**AFFORDABLE
OVERHEAD DOOR
COMPANY**

THE MARK CONSISTS OF STANDARD CHARACTERS WITHOUT CLAIM TO ANY PARTICULAR FONT, STYLE, SIZE, OR COLOR.
NO CLAIM IS MADE TO THE EXCLUSIVE RIGHT TO USE "OVERHEAD DOOR COMPANY", APART FROM THE MARK AS SHOWN.
SEC. 2(F).
FOR REPAIR AND INSTALLATION OF GARAGE DOORS AND GARAGE DOOR OPENERS (U.S. CLS. 100, 103 AND 106).
FIRST USE 1-1-1990; IN COMMERCE 1-1-1990.
STEVEN PEREZ, EXAMINING ATTORNEY

CLASS 37—(Continued).

SN 78-525,487. COMPLETE HOME SERVICES, INC., CASTLE ROCK, CO. FILED 12-1-2004.



NO CLAIM IS MADE TO THE EXCLUSIVE RIGHT TO USE HANDYMAN, APART FROM THE MARK AS SHOWN. THE COLOR(S) BLACK, RED & WHITE IS/ARE CLAIMED AS A FEATURE OF THE MARK.

THE MARK CONSISTS OF A STYLIZED WORKMAN IN BLACK AND WHITE WEARING A RED, WHITE AND BLACK HARD HAT. HE IS SET ON AN INCOMPLETE DIAMOND BEHIND THE STYLIZED WORDS WHICH ARE RED AND BLACK AND UNDERLINED.

FOR BUILDING MAINTENANCE, CONSTRUCTION, REMODELING AND REPAIR (U.S. CLS. 100, 103 AND 106).

FIRST USE 6-1-2001; IN COMMERCE 6-1-2001.
GISELLE AGOSTO, EXAMINING ATTORNEY

CLASS 37—(Continued).

SN 78-526,618. MAXONS RESTORATION, INC., NEW YORK, NY. FILED 12-3-2004.

**MAXONS 3-2-1 RAPID
RESPONSE
GUARANTEE**

THE MARK CONSISTS OF STANDARD CHARACTERS WITHOUT CLAIM TO ANY PARTICULAR FONT, STYLE, SIZE, OR COLOR.

OWNER OF U.S. REG. NOS. 2,342,554 AND 2,342,556. NO CLAIM IS MADE TO THE EXCLUSIVE RIGHT TO USE "RAPID RESPONSE GUARANTEE", APART FROM THE MARK AS SHOWN.

FOR BUILDING RESTORATION NAMELY REPAIR OF BUILDING INTERIORS, DRAPERY, ELECTRICAL SYSTEMS, ELEVATORS, HOUSEHOLD APPLIANCES, LINOLEUM, PAINTINGS, PLUMBING, TILES, WALL PANELING, WOOD FLOORING; RESTORATION IN THE FIELDS OF DRAPERY, ANTIQUES, APPAREL, BOOKS, BUILDING INTERIORS, CHINA, STAINED GLASS, PORCELAIN AND MARBLE, BOOKS AND DOCUMENTS, APPAREL, BUILDING INTERIORS, DRAPERY, FURNITURE, ORIENTAL RUGS, WINDOWS FOR OTHERS (U.S. CLS. 100, 103 AND 106).

TRACY FLETCHER, EXAMINING ATTORNEY

SN 78-526,482. LIGHTHOUSE LANDSCAPE LIGHTING FRANCHISOR, INC., BISHOPVILLE, MD. FILED 12-3-2004.

**Lighthouse Outdoor
Living**

THE MARK CONSISTS OF STANDARD CHARACTERS WITHOUT CLAIM TO ANY PARTICULAR FONT, STYLE, SIZE, OR COLOR.

NO CLAIM IS MADE TO THE EXCLUSIVE RIGHT TO USE "OUTDOOR", APART FROM THE MARK AS SHOWN. FOR INSTALLATION OF LANDSCAPE LIGHTING AND ILLUMINATION LIGHTING ON THE OUTSIDE OF HOUSES (U.S. CLS. 100, 103 AND 106).

DOMINIC J. FERRAIUOLO, EXAMINING ATTORNEY

SN 78-530,430. PAK INVESTMENT HOLDINGS, INC., BROOKLYN CENTER, MN. FILED 12-10-2004.



NO CLAIM IS MADE TO THE EXCLUSIVE RIGHT TO USE "TRUE LOFT" OR "GENUINE PROPERTY", APART FROM THE MARK AS SHOWN.

FOR REAL ESTATE DEVELOPMENT, AND CONSTRUCTION AND RENOVATION OF BUILDINGS (U.S. CLS. 100, 103 AND 106).

FIRST USE 8-31-2003; IN COMMERCE 8-31-2003.
RONALD MCMORROW, EXAMINING ATTORNEY

CLASS 37—(Continued).

SN 78-532,176. VISTA WINDOW COMPANY, WARREN, OH. AND JERVIS, JOHN H., PALM BEACH GARDENS, FL. FILED 12-14-2004.



NO CLAIM IS MADE TO THE EXCLUSIVE RIGHT TO USE NATIONAL WINDOW AND SERVICE, APART FROM THE MARK AS SHOWN.

THE COLOR(S) WHITE, YELLOW, BLUE AND PURPLE IS/ARE CLAIMED AS A FEATURE OF THE MARK.

THE CIRCLE OF STARS IS WHITE. THE LEAVES AND THE REPRESENTATION OF THE WINDOW GLASS ARE YELLOW. THE OUTER CIRCLE IS YELLOW, THE INNER CIRCLE IS PURPLE. THE FRAMES OF THE WINDOWS, THE WORDING IN THE MARK, THE STARS SEPARATING THE WORDING AND THE STARS ON THE SHIELD ARE BLUE. THE SHIELD IS STRIPED WITH YELLOW AND BLUE.

FOR INSTALLATION OF RESIDENTIAL WINDOWS AND DOORS (U.S. CLS. 100, 103 AND 106).

FIRST USE 12-30-2002; IN COMMERCE 9-12-2003.

JOHN HWANG, EXAMINING ATTORNEY

CLASS 37—(Continued).

SN 78-532,855. ASURION CORPORATION, SAN MATEO, CA. FILED 12-15-2004.



OWNER OF U.S. REG. NOS. 2,287,169 AND 2,301,365. THE MARK CONSISTS OF THE STYLIZED WORDS RESCUE LINK INSIDE THE OUTLINE OF AN ARROW; A HOOK HANGS FROM THE LETTER K.

FOR EMERGENCY ROADSIDE SERVICES (U.S. CLS. 100, 103 AND 106).

FIRST USE 12-5-2000; IN COMMERCE 12-5-2000.

STEVEN PEREZ, EXAMINING ATTORNEY

SN 78-532,687. AQUAZONA POOLS & SPAS, INC., MESA, AZ. FILED 12-15-2004.



NO CLAIM IS MADE TO THE EXCLUSIVE RIGHT TO USE "POOLS AND SPAS", APART FROM THE MARK AS SHOWN.

THE COLORS DARK BLUE, LIGHT BLUE AND WHITE ARE CLAIMED AS A FEATURE OF THE MARK.

THE COLOR DARK BLUE APPEARS IN THE BOTTOM HALF OF THE WORDING AQUAZONA AS WELL AS IN THE WORDING POOLS AND SPAS. THE COLOR LIGHT BLUE APPEARS IN THE TOP HALF OF THE WORDING AQUAZONA AND THE COLOR WHITE APPEARS IN THE WAVY STRIPE ACROSS THE WORDING AQUAZONA AS WELL AS IN THE OUTLINE OF THE AIR BUBBLE DESIGNS.

FOR NEW CONSTRUCTION AND REMODELING OF IN- GROUND SWIMMING POOLS AND SPAS (U.S. CLS. 100, 103 AND 106).

JOHN GARTNER, EXAMINING ATTORNEY

SN 78-533,742. MYERS AND CHAPMAN, INC., CHARLOTTE, NC. FILED 12-16-2004.

**YOUR BUILDING
PARTNER**

THE MARK CONSISTS OF STANDARD CHARACTERS WITHOUT CLAIM TO ANY PARTICULAR FONT, STYLE, SIZE, OR COLOR.

FOR CUSTOM CONSTRUCTION OF BUILDINGS (U.S. CLS. 100, 103 AND 106).

FIRST USE 12-16-2004; IN COMMERCE 12-16-2004.

JILL PRATER, EXAMINING ATTORNEY

CLASS 37—(Continued).

SN 78-535,033. GREENER CLEANER, INC., CHICAGO, IL. FILED 12-18-2004.

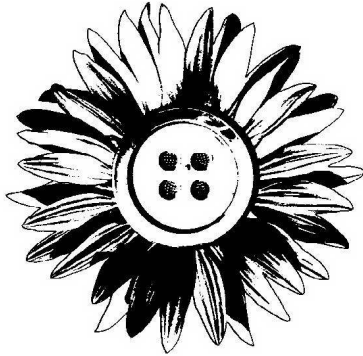

THE MARK CONSISTS OF A FLOWER WITH A BUTTON IN THE CENTER OF THE FLOWER IN PLACE OF THE STIGMA.

FOR GARMENT AND FABRIC CLEANING SERVICES (U.S. CLS. 100, 103 AND 106).

FIRST USE 9-1-2004; IN COMMERCE 10-6-2004. MELVIN AXILBUND, EXAMINING ATTORNEY

CLASS 37—(Continued).

SN 78-536,977. MAID YOUR DAY, INC., ROSWELL, GA. FILED 12-22-2004.



FOR RESIDENTIAL AND COMMERCIAL CLEANING SERVICES/MAID SERVICES, CARPET CLEANING, WINDOW CLEANING, GUTTER CLEANING, AND PRESSURE WASHING (U.S. CLS. 100, 103 AND 106).

FIRST USE 12-17-2004; IN COMMERCE 12-17-2004. SUSAN HAYASH, EXAMINING ATTORNEY

SN 78-535,298. U-HAUL INTERNATIONAL, INC., PHOENIX, AZ. FILED 12-20-2004.

U-HAUL

THE MARK CONSISTS OF STANDARD CHARACTERS WITHOUT CLAIM TO ANY PARTICULAR FONT, STYLE, SIZE, OR COLOR.

OWNER OF U.S. REG. NOS. 746,034, 893,891 AND OTHERS.

FOR INSTALLATION OF TRUCK HITCHES, TRAILER HITCHES, AUTOMOBILE HITCHES, AND TRUCK AND AUTOMOBILE TOWING SYSTEMS, INCLUDING LIGHTS, SHOCK ABSORBERS, AND TRANSMISSIONS COOLERS (U.S. CLS. 100, 103 AND 106).

FIRST USE 5-12-1980; IN COMMERCE 5-12-1980. THEODORE MCBRIDE, EXAMINING ATTORNEY

SN 78-537,222. DYNAMIC SEAWALL MAINTENANCE SYSTEM, INC., MARCO ISLAND, FL. FILED 12-22-2004.

DSMS

THE MARK CONSISTS OF STANDARD CHARACTERS WITHOUT CLAIM TO ANY PARTICULAR FONT, STYLE, SIZE, OR COLOR.

FOR INSTALLATION OF APPARATUS FOR MAINTAINING SEAWALLS (U.S. CLS. 100, 103 AND 106).

FIRST USE 11-1-2004; IN COMMERCE 11-1-2004. JENNIFER KRISP, EXAMINING ATTORNEY

CLASS 37—(Continued).

SN 78-538,151. TILLMAN, MICHAEL, DBA AMDECON, IRVING, TX. FILED 12-23-2004.

AMDECON

THE MARK CONSISTS OF STANDARD CHARACTERS WITHOUT CLAIM TO ANY PARTICULAR FONT, STYLE, SIZE, OR COLOR.

FOR CLEANING SERVICES, NAMELY, THE COLLECTION AND DISPOSAL OF BIOHAZARDOUS WASTE, HUMAN OR ANIMAL REMAINS OR BODY FLUIDS, AND DISINFECTING OF SITES WHERE SUCH WASTE AND REMAINS ARE LOCATED; AND SANITATION CONSULTATION RELATING THERETO (U.S. CLS. 100, 103 AND 106).

FIRST USE 12-17-2004; IN COMMERCE 12-17-2004.
JEFF DEFORD, EXAMINING ATTORNEY

SN 78-538,890. TILLMAN, MICHAEL, DBA AMDECON, IRVING, TX. FILED 12-28-2004.

**Call 911. Then call
us.**

THE MARK CONSISTS OF STANDARD CHARACTERS WITHOUT CLAIM TO ANY PARTICULAR FONT, STYLE, SIZE, OR COLOR.

FOR CLEANING SERVICES, NAMELY, THE COLLECTION AND DISPOSAL OF BIOHAZARDOUS WASTE, HUMAN OR ANIMAL REMAINS OR BODY FLUIDS, AND DISINFECTING OF SITES WHERE SUCH WASTE AND REMAINS ARE LOCATED; AND SANITATION CONSULTATION RELATING THERETO (U.S. CLS. 100, 103 AND 106).

FIRST USE 11-16-2002; IN COMMERCE 11-16-2002.
JENNIFER MARTIN, EXAMINING ATTORNEY

CLASS 37—(Continued).

SN 78-540,350. GARDNER DENVER, INC., QUINCY, IL. FILED 12-30-2004.



NO CLAIM IS MADE TO THE EXCLUSIVE RIGHT TO USE "AIR", APART FROM THE MARK AS SHOWN.

THE MARK CONSISTS OF THE WORDS AIR AND RELIEF WITH AN IMPELLER DESIGN.

FOR MAINTENANCE, REPAIR, INSTALLATION, AND SERVICING OF INDUSTRIAL AIR COMPRESSORS AND OF COMPONENTS FOR INDUSTRIAL AIR COMPRESSORS (U.S. CLS. 100, 103 AND 106).

FIRST USE 10-0-2003; IN COMMERCE 10-0-2003.
CYNTHIA SLOAN, EXAMINING ATTORNEY

SN 78-543,180. T-3 PROPERTY HOLDINGS, INC., HOUSTON, TX. FILED 1-6-2005.

T3

THE MARK CONSISTS OF STANDARD CHARACTERS WITHOUT CLAIM TO ANY PARTICULAR FONT, STYLE, SIZE, OR COLOR.

FOR REPAIR AND MAINTENANCE OF PIPELINE AND DRILLING EQUIPMENT (U.S. CLS. 100, 103 AND 106).

FIRST USE 1-27-2001; IN COMMERCE 1-27-2001.
TEJBIR SINGH, EXAMINING ATTORNEY

CLASS 37—(Continued).

SN 78-543,185. T-3 PROPERTY HOLDINGS, INC., HOUSTON, TX. FILED 1-6-2005.



FOR REPAIR AND MAINTENANCE OF PIPELINE AND DRILLING EQUIPMENT (U.S. CLS. 100, 103 AND 106).

FIRST USE 1-27-2001; IN COMMERCE 1-27-2001.
TEJBIR SINGH, EXAMINING ATTORNEY

CLASS 38—COMMUNICATION

SN 75-922,145. MILLENNIUM DIGITAL MEDIA, LLC, ST. LOUIS, MO. FILED 2-17-2000.

US.NET

SEC. 2(F).
FOR TELECOMMUNICATIONS SERVICES, NAMELY, PROVIDING MULTIPLE USER ACCESS TO A GLOBAL COMPUTER INFORMATION NETWORK AND PROVIDING ACCESS FROM PRIVATE COMPUTER NETWORKS TO A GLOBAL COMPUTER INFORMATION NETWORK (U.S. CLS. 100, 101 AND 104).

DOMINIC J. FERRAIUOLO, EXAMINING ATTORNEY

SN 76-291,573. GOAMERICA, INC., HACKENSACK, NJ. FILED 7-27-2001.

GO.MESSENGER

FOR PROVIDING WIRELESS TELECOMMUNICATIONS CONNECTIONS TO A GLOBAL COMPUTER NETWORK; PROVIDING WIRELESS ELECTRONIC DIGITAL MESSAGING AND VOICE MAIL SERVICES VIA A GLOBAL INFORMATION NETWORK FEATURING MANAGEMENT, FILTERING, STORING, FORWARDING, ROUTING AND PREVIEW CAPABILITIES; ELECTRONIC MESSAGING SERVICES ENABLING USERS TO RECEIVE VOICE, FACSIMILE, ELECTRONIC MAIL AND OTHER FORMS OF MESSAGES VIA WIRELESS DEVICE; PROVIDING MULTIPLE-USER ACCESS TO A GLOBAL COMPUTER NETWORK (U.S. CLS. 100, 101 AND 104).

FIRST USE 5-30-2001; IN COMMERCE 5-30-2001.
VIVIAN MICZNIK FIRST, EXAMINING ATTORNEY

CLASS 38—(Continued).

SN 76-301,706. SWIFTCOMM, INC., RIVERSIDE, CA. FILED 8-20-2001.

SWIFTBROADBAND

NO CLAIM IS MADE TO THE EXCLUSIVE RIGHT TO USE "BROADBAND", APART FROM THE MARK AS SHOWN.

FOR FIXED WIRELESS SERVICES, NAMELY THE WIRELESS TRANSMISSION OF VOICE AND DATA SERVICES (U.S. CLS. 100, 101 AND 104).

FIRST USE 6-28-2001; IN COMMERCE 6-28-2001.
CHRIS WELLS, EXAMINING ATTORNEY

SN 76-384,853. TELEFONICA, S.A., 28013 MADRID, SPAIN, FILED 3-18-2002.

TELEFONICA MOVISTAR

OWNER OF SPAIN REG. NO. 2,291,410, DATED 9-5-2000, EXPIRES 2-16-2010.

OWNER OF U.S. REG. NOS. 2,692,008, 2,790,106 AND 2,806,932.

THE ENGLISH TRANSLATION OF "TELEFONICA" IS "TELEPHONIC."

SEC. 2(F) AS TO THE TERM "TELEFONICA".
FOR PROVIDING TELECOMMUNICATIONS CONNECTIONS TO A GLOBAL COMPUTER NETWORK; TELECOMMUNICATIONS CONSULTATION; COMMUNICATIONS SERVICES, NAMELY, TRANSMITTING STREAMED SOUND AND AUDIO-VISUAL RECORDINGS VIA THE INTERNET; ELECTRONIC TRANSMISSION OF FACSIMILE COMMUNICATIONS AND DATA FEATURING ENCRYPTION AND DECRYPTION; PROVIDING COLLOCATION SERVICES FOR VOICE, VIDEO AND DATA COMMUNICATIONS APPLICATIONS; TELECOMMUNICATION SERVICES, NAMELY, LOCAL AND LONG DISTANCE TRANSMISSION OF VOICE, DATA, GRAPHICS BY MEANS OF TELEPHONE, TELEGRAPHIC, CABLE AND SATELLITE TRANSMISSIONS; TELECOMMUNICATION SERVICES IN THE FIELD OF PROVIDING LONG DISTANCE SERVICE WITH AUDIO ADVERTISING FOR OTHERS AS A COMPONENT OF THE LONG DISTANCE SERVICE; ELECTRONIC DELIVERY OF IMAGES AND PHOTOGRAPHS VIA A GLOBAL COMPUTER NETWORK; ONLINE DOCUMENT DELIVERY VIA A GLOBAL COMPUTER INFORMATION NETWORK ; DELIVERY OF MESSAGES BY ELECTRONIC TRANSMISSION; WEBSITE FORWARDING SERVICES; ELECTRONIC TRANSMISSION OF MESSAGES AND DATA; PROVIDING ON-LINE FORUMS FOR TRANSMISSION OF MESSAGES AMONG COMPUTER USERS CONCERNING E-COMMERCE (U.S. CLS. 100, 101 AND 104).

STEPHANIE DAVIS, EXAMINING ATTORNEY

CLASS 38—(Continued).

SN 76-503,389. BROADBAND MARITIME, INC., NEW YORK, NY. FILED 4-2-2003.



NO CLAIM IS MADE TO THE EXCLUSIVE RIGHT TO USE "BROADBAND MARITIME", APART FROM THE MARK AS SHOWN.

THE STIPPLING IS FOR SHADING PURPOSES ONLY. THE COLORS BLACK AND GRAY ARE CLAIMED AS A FEATURE OF THE MARK.

THE COLOR BLACK APPEARS IN THE LETTERING OF THE MARK, AND THE COLOR GRAY APPEARS AS SHADING AROUND THE LETTERS AND ON THE STYLIZED "O" IN BROADBAND.

FOR COMMUNICATION SERVICES, NAMELY TRANSMISSION OF VOICE, DATA, VIDEO AND AUDIO SIGNALS AND IMAGES BETWEEN REMOTE PARTIES AND SERVICES FOR FILTERING THE CONTENT AND VIRUSES OF THESE VOICE, DATA, IMAGES, VIDEO, AND AUDIO SIGNALS (U.S. CLS. 100, 101 AND 104).

FIRST USE 6-3-2002; IN COMMERCE 6-3-2002.

THEODORE MCBRIDE, EXAMINING ATTORNEY

SN 76-568,161. DEUTSCHE TELEKOM AG, BONN, 53113, FED REP GERMANY, FILED 12-22-2003.

T-SPIRIT

THE MARK CONSISTS OF STANDARD CHARACTERS WITHOUT CLAIM TO ANY PARTICULAR FONT, STYLE, SIZE, OR COLOR.

PRIORITY CLAIMED UNDER SEC. 44(D) ON FED REP GERMANY APPLICATION NO. 30331487738, FILED 6-26-2003, REG. NO. 30331487, DATED 1-26-2004, EXPIRES 6-30-2013.

OWNER OF U.S. REG. NOS. 2,156,145, 2,596,825 AND OTHERS.

FOR TELECOMMUNICATIONS AND INFORMATION TECHNOLOGY SERVICES, NAMELY, ELECTRIC, DIGITAL, CELLULAR AND WIRELESS TRANSMISSION OF VOICE, DATA, INFORMATION, IMAGES, SIGNALS AND MESSAGES AND TRANSMISSION OF VOICE, DATA, IMAGES, AUDIO, AND VIDEO MATERIALS VIA TELEPHONE, TELEVISION AND GLOBAL COMMUNICATION NETWORKS; PROVIDING TELECOMMUNICATIONS CONNECTIONS OVER A GLOBAL TELECOMMUNICATIONS INFORMATION NETWORK, ELECTRONIC MAIL, VOICE MAIL AND MESSAGING SERVICES, NAMELY, THE RECORDING AND STORAGE AND SUBSEQUENT TRANSMISSION OF VOICE MESSAGES BY TELEPHONE; RENTAL OF TELECOMMUNICATIONS EQUIPMENT, NAMELY, EQUIPMENT FOR ELECTRONIC ACCESS TO GLOBAL TELECOMMUNICATIONS NETWORK, EQUIPMENT FOR TRANSMITTING, RECEIVING, RECORDING AND MONITORING VOICE, DATA, INFORMATION, IMAGES, SIGNALS, MESSAGES, COMPRISED OF DATA AND WORD PROCESSORS, AND TELECOMMUNICA-

CLASS 38—(Continued).

TIONS HARDWARE AND SOFTWARE AND COMPONENTS AND PERIPHERALS THEREOF FOR USE IN THE TELECOMMUNICATIONS INDUSTRY, AND RENTAL OF EQUIPMENT FOR TRANSMITTING, RECEIVING, RECORDING AND MONITORING COMPUTER PROGRAMS FOR USE IN OPERATING AND ACCESSING TELECOMMUNICATIONS SYSTEMS; AUDIO AND VIDEO BROADCASTING FEATURING ENTERTAINMENT IN THE NATURE OF LIVE VISUAL AND AUDIO PERFORMANCES, AND MUSICAL, VARIETY, NEWS AND COMEDY SHOWS; PROVIDING MULTIPLE-USER DIAL-UP AND DEDICATED ACCESS TO THE INTERNET; TELECOMMUNICATIONS SERVICES, NAMELY, PERSONAL COMMUNICATIONS SERVICES; PAGER SERVICES; ELECTRONIC MAIL SERVICES; TRANSMISSION AND BROADCAST OF AUDIO AND VIDEO PROGRAMS; PROVIDING MULTIPLE-USER ACCESS TO A GLOBAL COMMUNICATION INFORMATION NETWORK; LEASING TELECOMMUNICATIONS EQUIPMENT, COMPONENTS, SYSTEMS AND SUPPLIES (U.S. CLS. 100, 101 AND 104).

CHRIS WELLS, EXAMINING ATTORNEY

SN 76-580,753. LEARFIELD COMMUNICATIONS, INC., JEFFERSON CITY, MO. FILED 3-12-2004.

WISCONSIN RADIO NETWORK

THE MARK CONSISTS OF STANDARD CHARACTERS WITHOUT CLAIM TO ANY PARTICULAR FONT, STYLE, SIZE, OR COLOR.

NO CLAIM IS MADE TO THE EXCLUSIVE RIGHT TO USE "RADIO NETWORK", APART FROM THE MARK AS SHOWN.

SEC. 2(F).

FOR RADIO BROADCASTING SERVICES (U.S. CLS. 100, 101 AND 104).

FIRST USE 2-0-1991; IN COMMERCE 2-0-1991.

TINA L. SNAPP, EXAMINING ATTORNEY

SN 76-580,754. LEARFIELD COMMUNICATIONS, INC., JEFFERSON CITY, MO. FILED 3-12-2004.

RADIO IOWA

THE MARK CONSISTS OF STANDARD CHARACTERS WITHOUT CLAIM TO ANY PARTICULAR FONT, STYLE, SIZE, OR COLOR.

NO CLAIM IS MADE TO THE EXCLUSIVE RIGHT TO USE "RADIO", APART FROM THE MARK AS SHOWN.

SEC. 2(F).

FOR RADIO BROADCASTING SERVICES (U.S. CLS. 100, 101 AND 104).

FIRST USE 7-0-1987; IN COMMERCE 7-0-1987.

TINA L. SNAPP, EXAMINING ATTORNEY

CLASS 38—(Continued).

SN 76-590,020. CHUNGHWA TELECOM GLOBAL, INC., SANTA CLARA, CA. FILED 5-3-2004.



FOR TELECOMMUNICATIONS SERVICES, NAMELY, PROVIDING LOCAL AND LONG DISTANCE TRANSMISSION OF VOICE, DATA AND GRAPHICS BY MEANS OF TELEPHONE, TELEGRAPHIC, CABLE AND SATELLITE TRANSMISSIONS; TELECOMMUNICATIONS BY E-MAIL; PROVIDING FACILITIES AND EQUIPMENT FOR VIDEO CONFERENCING; PROVIDING MULTIPLE USER DIAL-UP AND DEDICATED ACCESS TO THE INTERNET; VIDEO-ON-DEMAND TRANSMISSION SERVICES; STREAMING OF AUDIO AND VIDEO MATERIAL ON THE INTERNET; RADIO, TELEVISION AND VIDEO BROADCASTING AND TRANSMISSION SERVICES (U.S. CLS. 100, 101 AND 104).
FIRST USE 1-17-2004; IN COMMERCE 1-17-2004.
IRA J. GOODSaid, EXAMINING ATTORNEY

SN 76-596,768. SIRIUS SATELLITE RADIO INC., NEW YORK, NY. FILED 6-14-2004.

FACTION

THE MARK CONSISTS OF STANDARD CHARACTERS WITHOUT CLAIM TO ANY PARTICULAR FONT, STYLE, SIZE, OR COLOR.
FOR SATELLITE RADIO BROADCASTING SERVICES BROADCAST VIA RADIO, TELEVISION, INTERNET AND TELEPHONE (U.S. CLS. 100, 101 AND 104).
FIRST USE 2-0-2004; IN COMMERCE 2-0-2004.
CURTIS FRENCH, EXAMINING ATTORNEY

SN 76-598,413. PERFUME OF LIFE, INC., JACKSONVILLE, FL. FILED 6-21-2004.

PERFUME OF LIFE

THE MARK CONSISTS OF STANDARD CHARACTERS WITHOUT CLAIM TO ANY PARTICULAR FONT, STYLE, SIZE, OR COLOR.
NO CLAIM IS MADE TO THE EXCLUSIVE RIGHT TO USE "PERFUME", APART FROM THE MARK AS SHOWN.
FOR PROVIDING ELECTRONIC TRANSMISSION OF MESSAGES, DATA AND DOCUMENTS; ONLINE ELECTRONIC BULLETIN BOARDS AND CHAT ROOMS FOR TRANSMISSION OF MESSAGES AMONG COMPUTER USERS CONCERNING FRAGRANCE PRODUCTS (U.S. CLS. 100, 101 AND 104).
FIRST USE 3-1-2002; IN COMMERCE 3-1-2002.
JOANNA DUKOVIC, EXAMINING ATTORNEY

CLASS 38—(Continued).

SN 76-613,915. ENTRAVISION COMMUNICATIONS CORPORATION, SANTA MONICA, CA. FILED 9-30-2004.

VIVA

THE MARK CONSISTS OF STANDARD CHARACTERS WITHOUT CLAIM TO ANY PARTICULAR FONT, STYLE, SIZE, OR COLOR.
OWNER OF U.S. REG. NO. 2,872,029.
THE ENGLISH TRANSLATION OF THE WORD VIVA IS "LIVING, ALIVE".
FOR RADIO BROADCASTING SERVICES (U.S. CLS. 100, 101 AND 104).
FIRST USE 8-0-2000; IN COMMERCE 8-0-2000.
LOURDES AYALA, EXAMINING ATTORNEY

SN 76-617,142. DIAMOND RADIO, INC., SACRAMENTO, CA. FILED 10-18-2004.

THE BOMB

THE MARK CONSISTS OF STANDARD CHARACTERS WITHOUT CLAIM TO ANY PARTICULAR FONT, STYLE, SIZE, OR COLOR.
FOR RADIO BROADCASTING SERVICES (U.S. CLS. 100, 101 AND 104).
FIRST USE 11-1-1997; IN COMMERCE 11-1-1997.
MARK T. MULLEN, EXAMINING ATTORNEY

CLASS 38—(Continued).

SN 76-621,423. DEUTSCHE TELEKOM AG, BONN, FED REP GERMANY, FILED 10-4-2004.

**T-Mobile
email&chat**

THE MARK CONSISTS OF STANDARD CHARACTERS WITHOUT CLAIM TO ANY PARTICULAR FONT, STYLE, SIZE, OR COLOR.

PRIORITY CLAIMED UNDER SEC. 44(D) ON FED REP GERMANY APPLICATION NO. 30418465.938, FILED 4-2-2004, REG. NO. 30418465, DATED 5-7-2004, EXPIRES 4-30-2014.

OWNER OF U.S. REG. NO. 2,282,432.

NO CLAIM IS MADE TO THE EXCLUSIVE RIGHT TO USE "EMAIL & CHAT", APART FROM THE MARK AS SHOWN.

FOR TELECOMMUNICATIONS SERVICES, NAMELY, ELECTRIC, DIGITAL, CELLULAR AND WIRELESS TRANSMISSION OF VOICE, DATA, INFORMATION IMAGES, SIGNALS AND MESSAGES AND TRANSMISSION OF VOICE, DATA, IMAGES, AUDIO, VIDEO AND INFORMATION VIA TELEPHONE, TELEVISION AND GLOBAL COMMUNICATION NETWORKS; PROVIDING TELECOMMUNICATIONS CONNECTIONS OVER A GLOBAL COMMUNICATIONS NETWORK, ELECTRONIC MAIL, VOICE MAIL AND MESSAGING SERVICES, NAMELY, THE RECORDING AND SUBSEQUENT TRANSMISSION OF VOICE MESSAGES BY TELEPHONE; RENTAL OF TELECOMMUNICATIONS EQUIPMENT, NAMELY, EQUIPMENT FOR ELECTRONIC ACCESS TO GLOBAL TELECOMMUNICATIONS NETWORK, EQUIPMENT FOR TRANSMITTING, RECEIVING, RECORDING AND MONITORING VOICE, DATA, INFORMATION IMAGES, SIGNALS, MESSAGES COMPRISED OF DATA AND WORD PROCESSORS, AND TELECOMMUNICATIONS HARDWARE COMPONENTS AND PERIPHERALS THEREOF FOR USE IN THE TELECOMMUNICATIONS INDUSTRY, AND RENTAL OF EQUIPMENT FOR TRANSMITTING, RECEIVING, RECORDING AND MONITORING COMPUTER PROGRAMS FOR USE IN OPERATING AND ACCESSING TELECOMMUNICATIONS SYSTEMS; AUDIO AND VIDEO BROADCASTING; PROVIDING MULTIPLE-USER DIAL-UP AND DEDICATED ACCESS TO THE INTERNET; PERSONAL COMMUNICATIONS SERVICES; PAGER SERVICES; TRANSMISSION AND BROADCAST OF AUDIO AND VIDEO PROGRAMMING; LEASING OF TELECOMMUNICATIONS EQUIPMENT, COMPONENTS AND SYSTEMS; PROVIDING INFORMATION VIA THE TELEPHONE AND THE GLOBAL COMMUNICATION NETWORKS IN THE FIELD OF TELECOMMUNICATIONS; CONSULTING IN THE FIELD OF TELECOMMUNICATIONS (U.S. CLS. 100, 101 AND 104).

LINDA M. KING, EXAMINING ATTORNEY

CLASS 38—(Continued).

SN 76-621,430. RAYMOND, DON N., NASHVILLE, TN. FILED 11-22-2004.

EGI EXTRAORDINARY GIVING INITIATIVE

THE MARK CONSISTS OF STANDARD CHARACTERS WITHOUT CLAIM TO ANY PARTICULAR FONT, STYLE, SIZE, OR COLOR.

FOR TELECOMMUNICATION CONSULTATION SERVICES WHEREBY FOR-PROFIT CORPORATIONS ARE SHOWN HOW TO SAVE MONEY ON TELECOMMUNICATION SERVICES AND AGREE TO REDIRECT A PERCENTAGE OF THOSE SAVINGS TO NOT-FOR-PROFIT CORPORATIONS (U.S. CLS. 100, 101 AND 104).

FIRST USE 3-31-2003; IN COMMERCE 3-31-2003.
JEFFERY COWARD, EXAMINING ATTORNEY

SN 78-292,829. BOSWELL, JOHN DAVIDE, BEVERLY HILLS, CA. FILED 8-27-2003.



THE COLOR(S) RED, BLUE, GREEN AND PURPLE IS/ARE CLAIMED AS A FEATURE OF THE MARK.

THE DESIGN INCLUDES A GREEN "N", A CIRCULAR RUSTY RED COLORED "E" AROUND A GLOBE WHICH IS BLUE AND GREEN, A BLUE "T", A MAGENTA/PURPLE "V" WITH A BLUE ARC BENEATH IT.

SEC. 2(F) AS TO "NETV!"

FOR TELEVISION BROADCASTING SERVICES AND ELECTRONIC TRANSMISSION OF DATA AND DOCUMENT VIA COMPUTER TERMINALS (U.S. CLS. 100, 101 AND 104).

FIRST USE 4-1-1994; IN COMMERCE 4-1-1995.

KEVON CHISOLM, EXAMINING ATTORNEY

SN 78-357,250. HAGEN, WILLIAM A, MONTARA, CA. FILED 1-26-2004.

ETHERIC NETWORKS

THE MARK CONSISTS OF STANDARD CHARACTERS WITHOUT CLAIM TO ANY PARTICULAR FONT, STYLE, SIZE, OR COLOR.

NO CLAIM IS MADE TO THE EXCLUSIVE RIGHT TO USE "NETWORKS", APART FROM THE MARK AS SHOWN.

FOR WIRELESS INTERNET SERVICE PROVIDER, NAMELY, PROVIDING FIXED AND MOBILE INTERNET ACCESS (U.S. CLS. 100, 101 AND 104).

FIRST USE 10-1-1999; IN COMMERCE 1-20-2003.

JOHN DWYER, EXAMINING ATTORNEY

CLASS 38—(Continued).

SN 78-361,368. HOMBRE MEDIA, INC., SHERMAN OAKS, CA. FILED 2-2-2004.

HOMBRETV

THE MARK CONSISTS OF STANDARD CHARACTERS WITHOUT CLAIM TO ANY PARTICULAR FONT, STYLE, SIZE, OR COLOR.

THE FOREIGN WORDING IN THE MARK TRANSLATES INTO ENGLISH AS MAN.

FOR TELEVISION BROADCASTING, NAMELY, SPANISH CABLE TELEVISION NETWORK FOR HISPANIC MEN (U.S. CLS. 100, 101 AND 104).

FIRST USE 6-1-2004; IN COMMERCE 6-1-2004.
JAMES A. RAUEN, EXAMINING ATTORNEY

CLASS 38—(Continued).

SN 78-378,867. OJALÁ, INC., WALTHAM, MA. FILED 3-4-2004.



THE COLOR ORANGE IS CLAIMED AS A FEATURE OF THE MARK.

THE MARK CONSISTS OF THE WORD "OJALA" PRECEDED BY A SUN. BOTH ARE COLORED ORANGE.

THE FOREIGN WORDING IN THE MARK TRANSLATES INTO ENGLISH AS I HOPE, HOPEFULLY.

FOR CELLULAR TELEPHONE SERVICES; LONG DISTANCE TELEPHONE COMMUNICATION SERVICES; TELECOMMUNICATION SERVICES, NAMELY, LOCAL AND LONG DISTANCE TRANSMISSION OF VOICE, DATA, AND GRAPHICS BY MEANS OF TELEPHONE, TELEGRAPHIC, CABLE AND SATELLITE TRANSMISSIONS; INTERNATIONAL TELEPHONE COMMUNICATION SERVICES; TELEPHONE VOICE MESSAGING SERVICES; VOICE MAIL SERVICES; ELECTRONIC VOICE MESSAGING, NAMELY, RECORDING AND SUBSEQUENT TRANSMISSION OF VOICE MESSAGES BY TELEPHONE; PREPAID AND POST-PAID INTERNET SERVICE PROVIDER SERVICES, NAMELY, PROVIDING HIGH SPEED ACCESS TO AREA COMPUTER NETWORKS AND A GLOBAL COMPUTER INFORMATION NETWORK; PROVIDING EMAIL AND ONLINE CHAT ROOMS FOR THE TRANSMISSION OF MESSAGES (U.S. CLS. 100, 101 AND 104).

FIRST USE 5-28-2002; IN COMMERCE 5-28-2002.
RICHARD WHITE, EXAMINING ATTORNEY

SN 78-376,593. V-SPAN, INC., KING OF PRUSSIA, PA. FILED 3-1-2004.

INNOVATIVE COLLABORATION SOLUTIONS

THE MARK CONSISTS OF STANDARD CHARACTERS WITHOUT CLAIM TO ANY PARTICULAR FONT, STYLE, SIZE, OR COLOR.

FOR VIDEO TELECONFERENCING, AUDIO TELECONFERENCING AND WEB CONFERRING SERVICES (U.S. CLS. 100, 101 AND 104).

FIRST USE 12-17-2003; IN COMMERCE 12-17-2003.
HENRY S. ZAK, EXAMINING ATTORNEY

SN 78-390,592. HONER, JODI, NY, NY. FILED 3-25-2004.

I'M OFF THE HOOK

THE MARK CONSISTS OF STANDARD CHARACTERS WITHOUT CLAIM TO ANY PARTICULAR FONT, STYLE, SIZE, OR COLOR.

FOR CELLULAR TELEPHONE SERVICES; PERSONAL COMMUNICATIONS SERVICES; TELECOMMUNICATIONS SERVICES, NAMELY, THE TRANSMISSION OF VOICE, DATA, TEXT, IMAGES, AUDIO, VIDEO AND INFORMATION VIA TELEPHONE, SATELLITE, GLOBAL COMPUTER NETWORKS AND WIRELESS HANDHELD DEVICES; COMMUNICATION SERVICES, NAMELY, PROVIDING INDIVIDUAL OR MULTI-USER WIRELESS INTERNET ACCESS VIA WIRELESS DIGITAL DEVICES, IN A PUBLIC OR PRIVATE VENUE; PROVIDING INTRANET COMMUNICATIONS SERVICES; TELEVISION TRANSMISSION TO WIRELESS DIGITAL DEVICES; PROVIDING TELECOMMUNICATIONS CONNECTIONS TO INTERACTIVE TELEVISION; PROVIDING MULTI-USER ACCESS TO ELECTRONIC COMMUNICATIONS NETWORKS; TV AND RADIO BROADCASTING; SATELLITE TELEVISION BROADCASTING; VIDEO BROADCASTING AND NARROWCASTING SERVICES; PAY-PER-VIEW TELEVISION TRANSMISSION SERVICES; VIDEO-ON-DEMAND TRANSMISSION SERVICES; AUDIO AND VIDEO TELECONFERENCING; TELETXT SERVICES; ELECTRONIC MAIL SERVICES; VOICE MAIL SERVICES; PAGING SERVICES; ONLINE BULLETIN BOARD SERVICES,

CLASS 38—(Continued).

NAMELY, PROVIDING ONLINE ELECTRONIC BULLETIN BOARDS FOR TRANSMISSION OF MESSAGES AMONG USERS IN THE FIELD OF GENERAL INTEREST INFORMATION; WIRELESS DIGITAL TEXT MESSAGING SERVICES; FACSIMILE TRANSMISSION AND RETRIEVAL SERVICES; PROVIDING ELECTRONIC FORWARDING OF VOICE, IMAGES, AUDIO, VIDEO, SIGNALS AND DATA; VOICE-ACTIVATED AND VOICE-RECOGNITION COMMUNICATIONS SERVICES, NAMELY, VOICE-ACTIVATED DIALING SERVICES, AND PERSONAL COMMUNICATION SERVICES USING VOICE-RECOGNITION APPLICATIONS FOR SECURE ELECTRONIC EXCHANGE OF DATA VIA TELECOMMUNICATION NETWORKS; PERSONAL COMMUNICATIONS SERVICES UTILIZING IMAGE-RECOGNITION APPLICATIONS FOR THE PURPOSE OF PRIVATE AND SECURE ELECTRONIC TRANSACTIONS VIA TELECOMMUNICATION SYSTEMS AND INTERACTIVE TELEVISION; WEBCASTING SERVICES; WIRELESS PBX SERVICES; WIRELESS DIGITAL MESSAGING AND COMMAND SERVICES, NAMELY, REMOTE ACTIVATION SERVICES VIA CELLULAR PHONES AND HANDHELD DIGITAL DEVICES; LOCAL AND LONG DISTANCE TELEPHONE SERVICES; INTERNATIONAL TELEPHONE SERVICES; LEASING OF TELECOMMUNICATION SYSTEMS EQUIPMENT (U.S. CLS. 100, 101 AND 104).

CATHERINE CAIN, EXAMINING ATTORNEY

CLASS 38—(Continued).

SN 78-395,770. LIBERATION MANAGEMENT LLC, CARDIFF, CA. FILED 4-2-2004.



THE MARK CONSISTS OF A STYLIZED EYE. FOR TELECOMMUNICATION SERVICES, NAMELY PROVIDING WIRELESS TRANSMISSION OF IMAGES TO THE INTERNET, TRANSMITTING SOUND, AUDIO AND VISUAL RECORDINGS FROM A WIRELESS DEVICE TO THE INTERNET, AND PROVIDING AN INTERNET PLATFORM FOR BUSINESS TO BUSINESS AND PERSON TO PERSON COMMUNICATIONS. (U.S. CLS. 100, 101 AND 104).

FIRST USE 7-8-2003; IN COMMERCE 7-8-2003.
JOHN HWANG, EXAMINING ATTORNEY

SN 78-391,116. TELLNET COMMUNICATIONS INC., TAMPA, FL. FILED 3-25-2004.

SN 78-396,198. HUTH, DIANE CLAUSS, SAN ANTONIO, TX. FILED 4-5-2004.

Phonetnet.com

TeleFamilia

THE MARK CONSISTS OF STANDARD CHARACTERS WITHOUT CLAIM TO ANY PARTICULAR FONT, STYLE, SIZE, OR COLOR.

SEC. 2(F).

FOR TELECOMMUNICATIONS SERVICES NAMELY, TELEPHONE TO TELEPHONE WORLDWIDE CALLING AND ROUTING OF TELEPHONE VOICE AND DATA OVER THE INTERNET NETWORK ALSO KNOWN AS VOICE OVER IP (VOIP) SERVICES (U.S. CLS. 100, 101 AND 104).

FIRST USE 12-3-1998; IN COMMERCE 12-3-1998.
YSA DEJESUS, EXAMINING ATTORNEY

THE MARK CONSISTS OF STANDARD CHARACTERS WITHOUT CLAIM TO ANY PARTICULAR FONT, STYLE, SIZE, OR COLOR.

THE ENGLISH TRANSLATION OF "TELEFAMILIA" IN THE MARK IS "FAMILY PHONE".

FOR TELEPHONE COMMUNICATION SERVICES DIRECTED TO THE HISPANIC MARKET (U.S. CLS. 100, 101 AND 104).

G. MAYERSCHOFF, EXAMINING ATTORNEY

CLASS 38—(Continued).

SN 78-398,400. ACCUTEL CONFERENCING SYSTEMS, INC., TORONTO, ONTARIO, CANADA, FILED 4-8-2004.

SCREENPLAY PREMIER

THE MARK CONSISTS OF STANDARD CHARACTERS WITHOUT CLAIM TO ANY PARTICULAR FONT, STYLE, SIZE, OR COLOR.

OWNER OF U.S. REG. NO. 2,807,247.

NO CLAIM IS MADE TO THE EXCLUSIVE RIGHT TO USE PREMIER, APART FROM THE MARK AS SHOWN.

FOR INTERACTIVE WEB BROADCASTING AND CONFERENCING SERVICES SPECIFICALLY DESIGNED FOR SMALL TO MEDIUM GROUPS; COMMUNICATIONS SERVICES, NAMELY TRANSMITTING ENHANCED STREAMED SOUND AND AUDIO-VISUAL RECORDINGS VIA THE INTERNET FOR CONFERENCE PRESENTERS WHICH INCLUDES APPLICATION SHARING, PRINTING AND HANDOUT CAPABILITIES (U.S. CLS. 100, 101 AND 104).

FIRST USE 7-7-2002; IN COMMERCE 8-29-2002.

PAULA MAYS, EXAMINING ATTORNEY

SN 78-400,026. PIXIUS COMMUNICATIONS, LLC, WICHITA, KS. FILED 4-12-2004.

PIXIUS

THE MARK CONSISTS OF STANDARD CHARACTERS WITHOUT CLAIM TO ANY PARTICULAR FONT, STYLE, SIZE, OR COLOR.

FOR TELECOMMUNICATIONS SERVICES, NAMELY, MULTIPLE USER ACCESS TO A GLOBAL COMPUTER INFORMATION NETWORK (U.S. CLS. 100, 101 AND 104).

FIRST USE 8-14-2001; IN COMMERCE 9-13-2001.

WILLIAM VERHOSEK, EXAMINING ATTORNEY

CLASS 38—(Continued).

SN 78-400,339. STAR TELEVISION PRODUCTIONS LIMITED, TORTOLA, BR. VIRGIN ISLANDS, FILED 4-12-2004.



OWNER OF U.S. REG. NO. 2,387,482.

NO CLAIM IS MADE TO THE EXCLUSIVE RIGHT TO USE "NEWS", APART FROM THE MARK AS SHOWN.

FOR TELEVISION BROADCASTING SERVICES; DIGITAL TELEVISION TRANSMISSION SERVICES; TRANSMISSION OF TELEVISION PROGRAMS; SATELLITE TRANSMISSION SERVICES, NAMELY, OPERATION OF EARTH-TO-SATELLITE TRANSMITTERS FOR TRANSMISSION OF SIGNALS TO SATELLITE, OPERATION OF SATELLITE-TO-EARTH RECEIVING AERIALS AND FREQUENCY CONVERSION OF MICROWAVE SIGNALS RELAYED BY SATELLITE; BROADCASTING TELEVISION PROGRAMS BY SATELLITE; CABLE TELEVISION BROADCASTING SERVICES; TRANSMISSION OF DATA AND OF INFORMATION FOR OTHERS VIA COMPUTER, CABLE, TELEVISION, MICROWAVE, AND COMMUNICATIONS SATELLITE (U.S. CLS. 100, 101 AND 104).

LEIGH LOWRY, EXAMINING ATTORNEY

SN 78-400,824. PIXIUS COMMUNICATIONS, LLC, WICHITA, KS. FILED 4-13-2004.

THE COLOR(S) GRAY IS/ARE CLAIMED AS A FEATURE OF THE MARK.

THE COLOR GRAY APPEARS IN THE UPPER CURVED LINES ABOVE THE STYLIZED LETTER X.

FOR TELECOMMUNICATIONS SERVICES, NAMELY, MULTIPLE USER ACCESS TO A GLOBAL COMPUTER INFORMATION NETWORK (U.S. CLS. 100, 101 AND 104).

FIRST USE 8-14-2001; IN COMMERCE 9-13-2001.

WILLIAM VERHOSEK, EXAMINING ATTORNEY

CLASS 38—(Continued).

SN 78-401,818. VIACOM INTERNATIONAL INC., NEW YORK, NY. FILED 4-14-2004.

CLASS 38—(Continued).

SN 78-403,839. DANIEL, COLONNESE, FAYETTEVILLE, NC. FILED 4-19-2004.

NICKTOONS

PEAK OIL

THE MARK CONSISTS OF STANDARD CHARACTERS WITHOUT CLAIM TO ANY PARTICULAR FONT, STYLE, SIZE, OR COLOR.

OWNER OF U.S. REG. NOS. 1,390,284 AND 1,578,189. FOR TELEVISION BROADCASTING SERVICES VIA CABLE, SATELLITE AND OTHER MEANS (U.S. CLS. 100, 101 AND 104).

FIRST USE 5-1-2002; IN COMMERCE 5-1-2002. RON FAIRBANKS, EXAMINING ATTORNEY

THE MARK CONSISTS OF STANDARD CHARACTERS WITHOUT CLAIM TO ANY PARTICULAR FONT, STYLE, SIZE, OR COLOR.

FOR PROVIDING ON-LINE ELECTRONIC BULLETIN BOARDS FOR TRANSMISSION OF MESSAGES AMONG COMPUTER USERS CONCERNING NEWS ABOUT OIL (U.S. CLS. 100, 101 AND 104).

CAROL SPILS, EXAMINING ATTORNEY

SN 78-407,781. PDNS, LLC, HAROLD, KY. FILED 4-26-2004.

SN 78-403,375. GRAND CENTRAL COMMUNICATIONS, INC., SAN FRANCISCO, CA. FILED 4-16-2004.

INTEGRATION ON DEMAND



THE MARK CONSISTS OF STANDARD CHARACTERS WITHOUT CLAIM TO ANY PARTICULAR FONT, STYLE, SIZE, OR COLOR.

FOR ELECTRONIC TRANSMISSION OF AUTOMATED MESSAGES AMONG BUSINESS PROVIDED IN CONNECTION WITH A WEB SERVICES NETWORK (U.S. CLS. 100, 101 AND 104).

LINDA M. KING, EXAMINING ATTORNEY

OWNER OF U.S. REG. NOS. 2,393,431 AND 2,393,432. THE MARK CONSISTS OF THE WORD MIKROTEC WITH A WAVY LINE ABOVE IT.

FOR PROVIDING MULTIPLE-USER ACCESS TO A GLOBAL COMPUTER INFORMATION NETWORK; TELEPHONE COMMUNICATION SERVICES, NAMELY, PROVIDING LOCAL AND LONG DISTANCE TELECOMMUNICATION SERVICES (U.S. CLS. 100, 101 AND 104).

FIRST USE 6-12-2000; IN COMMERCE 6-12-2000. ALLISON HOLTZ, EXAMINING ATTORNEY

CLASS 38—(Continued).

SN 78-407,911. EQUATOR HD COMPANY LLC, BETHPAGE, NY. FILED 4-26-2004.

EQUATOR HD

THE MARK CONSISTS OF STANDARD CHARACTERS WITHOUT CLAIM TO ANY PARTICULAR FONT, STYLE, SIZE, OR COLOR.

NO CLAIM IS MADE TO THE EXCLUSIVE RIGHT TO USE "HD", APART FROM THE MARK AS SHOWN.

FOR SATELLITE TELEVISION BROADCASTING SERVICES; ELECTRONIC TRANSMISSION OF DATA, SIGNALS, IMAGES, AUDIO, VOICE, AND MESSAGES VIA SATELLITE, TELEVISION, AND COMMUNICATION NETWORKS; PAY-PER-VIEW TRANSMISSION SERVICES; VIDEO BROADCASTING AND MESSAGING SERVICES; VIDEO-ON-DEMAND TRANSMISSION SERVICES (U.S. CLS. 100, 101 AND 104).

MATTHEW KLINE, EXAMINING ATTORNEY

SN 78-413,746. AMERICAN BROADCASTING COMPANIES, INC., BURBANK, CA. FILED 5-5-2004.

ABC FAMILY

THE MARK CONSISTS OF STANDARD CHARACTERS WITHOUT CLAIM TO ANY PARTICULAR FONT, STYLE, SIZE, OR COLOR.

NO CLAIM IS MADE TO THE EXCLUSIVE RIGHT TO USE "FAMILY", APART FROM THE MARK AS SHOWN.

FOR TELEVISION TRANSMISSION AND BROADCASTING SERVICES (U.S. CLS. 100, 101 AND 104).

FIRST USE 12-19-2001; IN COMMERCE 12-19-2001.

JOHN DALIER, EXAMINING ATTORNEY

CLASS 38—(Continued).

SN 78-424,799. NETWORK ENHANCED TELECOM LLP, LONGVIEW, TX. FILED 5-25-2004.

The Phonecard That Calls You

THE MARK CONSISTS OF STANDARD CHARACTERS WITHOUT CLAIM TO ANY PARTICULAR FONT, STYLE, SIZE, OR COLOR.

FOR TELECOMMUNICATIONS SERVICES, NAMELY, THE ELECTRONIC TRANSMISSION OF VOICE, FACSIMILE, DATA AND INFORMATION; INTERNET TELEPHONY SERVICES; PROVIDING INTERNET VOICE COMMUNICATION SERVICES THAT ALLOW FOR TOLL FREE AND LOCAL CALLING FROM DIFFERENT GEOGRAPHIC LOCATIONS TO A SINGLE SUBSCRIBER; TELEPHONE COMMUNICATIONS SERVICES PROVIDED VIA PREPAID CALLING CARDS; TELECOMMUNICATIONS RESELLER SERVICES, NAMELY, PROVIDING LONG DISTANCE TELECOMMUNICATIONS SERVICES (U.S. CLS. 100, 101 AND 104).

BARBARA GAYNOR, EXAMINING ATTORNEY

SN 78-428,891. CINCINNATI BELL INC., CINCINNATI, OH. FILED 6-2-2004.



FOR TELECOMMUNICATION SERVICES, NAMELY, LOCAL AND LONG DISTANCE TELEPHONE TRANSMISSION SERVICES; TELEPHONE COMMUNICATION SERVICES, AND ASSOCIATED VOICE MAIL AND CUSTOM CALLING FEATURES, NAMELY, THREE WAY CALLING, SPEED DIALING, CALL FORWARDING, CALL RETURN, CALL WAITING, CALLER ID; WIRELESS TELECOMMUNICATION SERVICES, NAMELY, ELECTRONIC TRANSMISSION OF MESSAGES, DATA, SOUND, TEXT, IMAGE MESSAGES, VIDEO AND DOCUMENTS VIA A GLOBAL COMPUTER COMMUNICATIONS NETWORK, TELEVISION AND TELECOMMUNICATIONS NETWORKS; TELECOMMUNICATIONS GATEWAY SERVICES; PROVIDING TELECOMMUNICATIONS CONNECTIONS TO A GLOBAL COMPUTER NETWORK; PROVIDING MULTIPLE-USER ACCESS TO A GLOBAL COMPUTER INFORMATION NETWORK; AND HIGH-SPEED INTERNET TRANSMISSION SERVICES, PROVIDING ELECTRONIC MAIL SERVICES; AND ELECTRONIC MESSAGING STORE AND FORWARD SERVICES (U.S. CLS. 100, 101 AND 104).

FIRST USE 2-1-2004; IN COMMERCE 2-1-2004.

KIMBERLY PERRY, EXAMINING ATTORNEY

CLASS 38—(Continued).

SN 78-431,211. VERIZON COMMUNICATIONS INC., NEW YORK, NY. FILED 6-7-2004.

CLASS 38—(Continued).

SN 78-437,703. FEDERAL HOME LOAN BANK OF DALLAS, IRVING, TX. FILED 6-18-2004.

PREMIUM MESSAGE BOARD

ASSETCONNECTION

THE MARK CONSISTS OF STANDARD CHARACTERS WITHOUT CLAIM TO ANY PARTICULAR FONT, STYLE, SIZE, OR COLOR.
OWNER OF U.S. REG. NOS. 1,785,052, 2,928,708 AND OTHERS.
SEC. 2(F).
FOR TELEPHONE VOICE MESSAGING SERVICES (U.S. CLS. 100, 101 AND 104).
FIRST USE 12-0-1991; IN COMMERCE 12-0-1991.
TRACY CROSS, EXAMINING ATTORNEY

THE MARK CONSISTS OF STANDARD CHARACTERS WITHOUT CLAIM TO ANY PARTICULAR FONT, STYLE, SIZE, OR COLOR.
OWNER OF U.S. REG. NO. 2,166,269.
FOR PROVIDING MULTI-USER ACCESS TO AN ON-LINE ELECTRONIC BULLETIN BOARD FOR TRANSMISSION OF ASSET INFORMATION TO FACILITATE TRADING IN ASSETS AMONG USERS (U.S. CLS. 100, 101 AND 104).
FIRST USE 8-31-2003; IN COMMERCE 10-1-2003.
MICHAEL WEBSTER, EXAMINING ATTORNEY

SN 78-436,494. HIGHWINDS MEDIA GROUP, INC., WINTER PARK, FL. FILED 6-16-2004.

SN 78-440,351. VOICEMAX COMMUNICATIONS, FORT LAUDERDALE, FL. FILED 6-23-2004.

WIND TUNNEL

VOICEMAX

THE MARK CONSISTS OF STANDARD CHARACTERS WITHOUT CLAIM TO ANY PARTICULAR FONT, STYLE, SIZE, OR COLOR.
FOR COMPUTER SERVICES, NAMELY TRANSMISSION OF NEWS FEEDS VIA A GLOBAL COMPUTER NETWORK FOR NEWS AND DISCUSSION GROUPS; USENET NEWS INFORMATION TRANSMISSION SERVICES VIA DIGITAL NETWORKS (U.S. CLS. 100, 101 AND 104).
FIRST USE 3-15-2004; IN COMMERCE 3-15-2004.
NELSON SNYDER, EXAMINING ATTORNEY

THE MARK CONSISTS OF STANDARD CHARACTERS WITHOUT CLAIM TO ANY PARTICULAR FONT, STYLE, SIZE, OR COLOR.
FOR INTERNET TELEPHONY SERVICES (U.S. CLS. 100, 101 AND 104).
DANIEL CAPSHAW, EXAMINING ATTORNEY

CLASS 38—(Continued).

SN 78-441,595. TRINSIC, INC., TAMPA, FL. FILED 6-25-2004.

TRINSIC

THE MARK CONSISTS OF STANDARD CHARACTERS WITHOUT CLAIM TO ANY PARTICULAR FONT, STYLE, SIZE, OR COLOR.

FOR LOCAL AND LONG DISTANCE TELEPHONE SERVICES; VOICE CALLING FEATURES FOR TELEPHONE SUBSCRIBERS, NAMELY, VOICE MESSAGING SERVICES AND VOICE ACTIVATED DIALING; VOICE MAIL SERVICES; PROVIDING A HIGH SPEED ACCESS TO AREA NETWORKS AND A GLOBAL COMPUTER INFORMATION NETWORK; ELECTRONIC MAIL SERVICES (U.S. CLS. 100, 101 AND 104).

FIRST USE 5-31-2004; IN COMMERCE 5-31-2004.
CAROL SPILS, EXAMINING ATTORNEY

CLASS 38—(Continued).

SN 78-457,653. FISHER, MICHELLE, OAKLAND, CA. FILED 7-27-2004.

MOBILE CANDY DISH

THE MARK CONSISTS OF STANDARD CHARACTERS WITHOUT CLAIM TO ANY PARTICULAR FONT, STYLE, SIZE, OR COLOR.

NO CLAIM IS MADE TO THE EXCLUSIVE RIGHT TO USE "MOBILE", APART FROM THE MARK AS SHOWN, FOR WIRELESS COMMUNICATIONS SERVICES, NAMELY, TRANSMISSION OF MULTIPLAYER GAMES, GRAPHICS, COUPONS, RING TONES, AND ALERTS, TO MOBILE TELEPHONES (U.S. CLS. 100, 101 AND 104).
RICHARD WHITE, EXAMINING ATTORNEY

SN 78-445,013. COLLEGENET, INC., PORTLAND, OR. FILED 7-1-2004.

COLLEGENET

THE MARK CONSISTS OF STANDARD CHARACTERS WITHOUT CLAIM TO ANY PARTICULAR FONT, STYLE, SIZE, OR COLOR.

OWNER OF U.S. REG. NO. 2,045,384.
FOR COMMUNICATION SERVICES, NAMELY, TRANSMISSION OF INFORMATION RELATING TO PROSPECTIVE STUDENTS, FOR USE BY COLLEGES, UNIVERSITIES AND OTHER EDUCATIONAL INSTITUTIONS VIA A GLOBAL COMPUTER NETWORK; COMMUNICATION SERVICES, NAMELY TRANSMISSION OF RESPONSES TO AND FORWARDING ELECTRONIC COMMUNICATIONS SUBMITTED VIA A GLOBAL COMPUTER NETWORK (U.S. CLS. 100, 101 AND 104).

FIRST USE 9-0-2001; IN COMMERCE 9-0-2001.
RON FAIRBANKS, EXAMINING ATTORNEY

SN 78-467,244. ALPHEUS COMMUNICATIONS, L.P., FORMERLY EL PASO NETWORKS, L.P., HOUSTON, TX. FILED 8-13-2004.

**ALPHEUS**

FOR TELECOMMUNICATION SERVICES, NAMELY BROADBAND TRANSMISSION OF VOICE, VIDEO AND/OR DATA FOR WHOLESALE AND ENTERPRISE CUSTOMERS (U.S. CLS. 100, 101 AND 104).

FIRST USE 8-1-2004; IN COMMERCE 8-1-2004.
CARRIE ACHEN, EXAMINING ATTORNEY

CLASS 38—(Continued).

SN 78-467,674. CENCOURSE, INC., MIAMI, FL. FILED 8-15-2004.

CENCOURSE

THE MARK CONSISTS OF STANDARD CHARACTERS WITHOUT CLAIM TO ANY PARTICULAR FONT, STYLE, SIZE, OR COLOR.

FOR TELECOMMUNICATIONS SERVICES, NAMELY THE TRANSMISSION OF INFORMATION, VOICE, DATA, IMAGES, VIDEO AND AUDIO VIA MOBILE PHONES AND THE GLOBAL COMPUTER NETWORKS; MOBILE WIRELESS ELECTRONIC MESSAGING SERVICES, NAMELY THE RECORDING AND SUBSEQUENT TRANSMISSION OF MESSAGES FROM AND TO MOBILE WIRELESS PHONES; PROVIDING ON-LINE ELECTRONIC BULLETIN BOARDS FOR TRANSMISSION OF MESSAGES AMONG COMPUTER USERS IN THE FIELD OF GENERAL INTEREST (U.S. CLS. 100, 101 AND 104).

DOMINIC J. FERRAIUOLO, EXAMINING ATTORNEY

CLASS 38—(Continued).

SN 78-471,265. DEUTSCHE TELEKOM AG, BONN, FED REP GERMANY, FILED 8-20-2004.



OWNER OF FED REP GERMANY REG. NO. 30360238, DATED 1-9-2004, EXPIRES 11-30-2013.

OWNER OF U.S. REG. NOS. 2,712,615, 2,833,572 AND OTHERS.

NO CLAIM IS MADE TO THE EXCLUSIVE RIGHT TO USE "SYSTEMS", APART FROM THE MARK AS SHOWN.

THE COLORS MAGENTA AND GRAY ARE CLAIMED AS A FEATURE OF THE MARK.

THE COLOR MAGENTA APPEARS IN THE BACKGROUND CARRIER RECTANGLE OF THE MARK AND THE LETTER "T"; AND THE COLOR GRAY APPEARS IN THE WORD "SYSTEMS" AND A SERIES OF SQUARES IN THE CENTER OF THE MARK.

FOR TELECOMMUNICATION SERVICES, NAMELY, ELECTRIC, DIGITAL, CELLULAR AND WIRELESS TRANSMISSION OF VOICE, DATA, INFORMATION IMAGES, SIGNALS AND MESSAGES AND TRANSMISSION OF VOICE, DATA, IMAGES, AUDIO, VIDEO AND INFORMATION VIA TELEPHONE, TELEVISION AND GLOBAL COMMUNICATION NETWORKS; PROVIDING TELECOMMUNICATIONS CONNECTIONS TO A GLOBAL COMMUNICATIONS NETWORK, ELECTRONIC MAIL, VOICE MAIL AND MESSAGING SERVICES, NAMELY, THE RECORDING AND SUBSEQUENT TRANSMISSION OF VOICE MESSAGES BY TELEPHONE; RENTAL OF TELECOMMUNICATIONS EQUIPMENT, NAMELY, EQUIPMENT FOR ELECTRONIC ACCESS TO GLOBAL TELECOMMUNICATIONS NETWORK, RENTAL OF TELECOMMUNICATIONS HARDWARE COMPONENTS AND PERIPHERALS THEREOF FOR USE IN THE TELECOMMUNICATIONS INDUSTRY, AND RENTAL OF EQUIPMENT FOR TRANSMITTING, RECEIVING, RECORDING AND MONITORING COMPUTER PROGRAMS FOR USE IN OPERATING AND ACCESSING TELECOMMUNICATIONS SYSTEMS; AUDIO AND VIDEO BROADCASTING; PROVIDING MULTIPLE-USER DIAL-UP AND DEDICATED ACCESS TO THE INTERNET; PERSONAL COMMUNICATIONS SERVICES; PAGER SERVICES; BROADCAST OF AUDIO AND VIDEO PROGRAMMING; LEASING OF TELECOMMUNICATIONS EQUIPMENT; CONSULTING IN THE FIELD OF TELECOMMUNICATIONS (U.S. CLS. 100, 101 AND 104).

RUSS HERMAN, EXAMINING ATTORNEY

SN 78-484,972. AUTOMOTIVE NETWORKS LLC, ACTON, MA. FILED 9-16-2004.



FOR SATELLITE, CABLE, VIDEO ON DEMAND AND BROADBAND NETWORK TRANSMISSION OF SOUNDS, IMAGES, SIGNALS AND DATA OF WHEELED VEHICLES (U.S. CLS. 100, 101 AND 104).

FIRST USE 0-0-1993; IN COMMERCE 8-1-1995.

ALEXANDER L. POWERS, EXAMINING ATTORNEY

CLASS 38—(Continued).

SN 78-485,097. KLAUS ENTERTAINMENT, INC., ATLANTA, GA. FILED 9-16-2004.

KANEVA

THE MARK CONSISTS OF STANDARD CHARACTERS WITHOUT CLAIM TO ANY PARTICULAR FONT, STYLE, SIZE, OR COLOR.

FOR TELECOMMUNICATION SERVICES, NAMELY, ELECTRONIC TRANSMISSION OF STREAMED AND DOWNLOADABLE AUDIO, VIDEO AND GAME FILES VIA COMPUTER AND ELECTRONIC COMMUNICATIONS NETWORKS; PROVIDING ON-LINE CHAT ROOMS, BULLETIN BOARDS AND COMMUNITY FORUMS FOR THE TRANSMISSION OF MESSAGES AMONG COMPUTER USERS CONCERNING ENTERTAINMENT, MUSIC, CONCERTS, VIDEOS, RADIO, TELEVISION, FILM, NEWS, SPORTS, GAMES AND CULTURAL EVENTS; WEBCASTING SERVICES; DELIVERY OF MESSAGES BY ELECTRONIC TRANSMISSION; PROVIDING CONNECTIVITY SERVICES AND ACCESS TO ELECTRONIC TELECOMMUNICATIONS NETWORKS FOR TRANSMISSION OR RECEPTION OF AUDIO, VIDEO, GAME OR MULTIMEDIA CONTENT (U.S. CLS. 100, 101 AND 104).

DAVID ELTON, EXAMINING ATTORNEY

SN 78-487,239. OGURA CORPORATION, GARDEN CITY, NY. FILED 9-21-2004.



Ogura Corporation

NO CLAIM IS MADE TO THE EXCLUSIVE RIGHT TO USE "CORPORATION", APART FROM THE MARK AS SHOWN.

FOR PROVIDING ON-LINE FORUMS FOR TRANSMISSION OF MESSAGES AMONG COMPUTER USERS CONCERNING THE FIELD OF GENERAL INTEREST; PROVIDING ON-LINE ELECTRONIC BULLETIN BOARDS FOR TRANSMISSION OF MESSAGES AMONG USERS IN THE FIELD OF GENERAL INTEREST (U.S. CLS. 100, 101 AND 104).

FIRST USE 8-0-2004; IN COMMERCE 8-0-2004.
JOHN DWYER, EXAMINING ATTORNEY

CLASS 38—(Continued).

SN 78-488,804. STRAITSHOT COMMUNICATIONS, INC., BELLEVUE, WA. FILED 9-23-2004.

STRAITSHOT

THE MARK CONSISTS OF STANDARD CHARACTERS WITHOUT CLAIM TO ANY PARTICULAR FONT, STYLE, SIZE, OR COLOR.

FOR NETWORK SERVICES, NAMELY THE DELIVERY OF WIRED AND WIRELESS CONNECTIVITY TO APPLICATIONS BETWEEN MULTIPLE LOCATIONS AND WITH REMOTE USERS IN THE FIELD OF WIDE-AREA COMMUNICATION OF DATA AND VOICE (U.S. CLS. 100, 101 AND 104).

FIRST USE 1-16-2004; IN COMMERCE 2-15-2004.
ODESSA BIBBINS, EXAMINING ATTORNEY

SN 78-489,421. WEST CORPORATION, OMAHA, NE. FILED 9-24-2004.

INTERACTIVE AGENT

THE MARK CONSISTS OF STANDARD CHARACTERS WITHOUT CLAIM TO ANY PARTICULAR FONT, STYLE, SIZE, OR COLOR.

NO CLAIM IS MADE TO THE EXCLUSIVE RIGHT TO USE "INTERACTIVE", APART FROM THE MARK AS SHOWN.

FOR TELECOMMUNICATION SERVICES, NAMELY, LOCAL AND LONG DISTANCE TRANSMISSION OF VOICE, DATA, GRAPHICS BY MEANS OF TELEPHONE, TELEGRAPHIC, CABLE, AND SATELLITE TRANSMISSION; VOICE-ACTIVATED DIALING SERVICES; AND SPEECH RECOGNITION DIALING AND INTERACTIVE VOICE RESPONSE TELECOMMUNICATION SERVICES (U.S. CLS. 100, 101 AND 104).

EVELYN BRADLEY, EXAMINING ATTORNEY

CLASS 38—(Continued).

SN 78-493,302. DEUTSCHE TELEKOM AG, BONN, FED REP GERMANY, FILED 10-1-2004.

T-Mobile Sound Alarm

THE MARK CONSISTS OF STANDARD CHARACTERS WITHOUT CLAIM TO ANY PARTICULAR FONT, STYLE, SIZE, OR COLOR.

PRIORITY CLAIMED UNDER SEC. 44(D) ON FED REP GERMANY APPLICATION NO. 30418517538, FILED 4-2-2004, REG. NO. 30418517, DATED 4-22-2004, EXPIRES 4-30-2014.

OWNER OF U.S. REG. NO. 2,282,432.

FOR TELECOMMUNICATION AND INFORMATION TECHNOLOGY SERVICES, NAMELY, ELECTRIC, DIGITAL, CELLULAR AND WIRELESS TRANSMISSION OF VOICE, DATA, INFORMATION, IMAGES, SIGNALS AND MESSAGES AND TRANSMISSION OF VOICE, DATA, IMAGES, AUDIO, VIDEO AND INFORMATION VIA TELEPHONE, TELEVISION AND GLOBAL COMMUNICATION NETWORKS; PROVIDING TELECOMMUNICATIONS CONNECTIONS OVER A GLOBAL COMMUNICATIONS NETWORK, ELECTRONIC MAIL, VOICE MAIL AND MESSAGING SERVICES, NAMELY, THE RECORDING AND SUBSEQUENT TRANSMISSION OF VOICE MESSAGES BY TELEPHONE; RENTAL OF TELECOMMUNICATIONS EQUIPMENT, NAMELY, EQUIPMENT FOR ELECTRONIC ACCESS TO GLOBAL TELECOMMUNICATIONS NETWORK, EQUIPMENT FOR TRANSMITTING, RECEIVING, RECORDING AND MONITORING VOICE, DATA, INFORMATION, IMAGES, SIGNALS, MESSAGES, COMPRISED OF DATA AND WORD PROCESSORS, AND TELECOMMUNICATIONS HARDWARE COMPONENTS AND PERIPHERALS THEREOF FOR USE IN THE TELECOMMUNICATIONS INDUSTRY, AND RENTAL OF EQUIPMENT FOR TRANSMITTING, RECEIVING, RECORDING AND MONITORING COMPUTER PROGRAMS FOR USE IN OPERATING AND ACCESSING TELECOMMUNICATIONS SYSTEMS; AUDIO AND VIDEO BROADCASTING; PROVIDING MULTIPLE-USER DIAL-UP AND DEDICATED ACCESS TO THE INTERNET; PERSONAL COMMUNICATIONS SERVICES; PAGER SERVICES; TRANSMISSION AND BROADCAST OF AUDIO AND VIDEO PROGRAMMING; LEASING OF TELECOMMUNICATIONS EQUIPMENT, COMPONENTS AND SYSTEMS; PROVIDING INFORMATION VIA THE TELEPHONE AND THE GLOBAL COMMUNICATION NETWORKS IN THE FIELD OF TELECOMMUNICATIONS; CONSULTING IN THE FIELD OF TELECOMMUNICATIONS (U.S. CLS. 100, 101 AND 104).

FLORENTINA BLANDU, EXAMINING ATTORNEY

CLASS 38—(Continued).

SN 78-493,338. DEUTSCHE TELEKOM AG, BONN, FED REP GERMANY, FILED 10-1-2004.

T-Mobile multimedia experience

THE MARK CONSISTS OF STANDARD CHARACTERS WITHOUT CLAIM TO ANY PARTICULAR FONT, STYLE, SIZE, OR COLOR.

PRIORITY CLAIMED UNDER SEC. 44(D) ON FED REP GERMANY APPLICATION NO. 30418510838, FILED 4-2-2004, REG. NO. 30418510, DATED 4-22-2004, EXPIRES 4-30-2014.

OWNER OF U.S. REG. NO. 2,282,432.

NO CLAIM IS MADE TO THE EXCLUSIVE RIGHT TO USE "MULTIMEDIA", APART FROM THE MARK AS SHOWN.

FOR TELECOMMUNICATION AND INFORMATION TECHNOLOGY SERVICES, NAMELY, ELECTRIC, DIGITAL, CELLULAR AND WIRELESS TRANSMISSION OF VOICE, DATA, INFORMATION, IMAGES, SIGNALS AND MESSAGES AND TRANSMISSION OF VOICE, DATA, IMAGES, AUDIO, VIDEO AND INFORMATION VIA TELEPHONE, TELEVISION AND GLOBAL COMMUNICATION NETWORKS; PROVIDING TELECOMMUNICATIONS CONNECTIONS OVER A GLOBAL COMMUNICATIONS NETWORK, ELECTRONIC MAIL, VOICE MAIL AND MESSAGING SERVICES, NAMELY, THE RECORDING AND SUBSEQUENT TRANSMISSION OF VOICE MESSAGES BY TELEPHONE; RENTAL OF TELECOMMUNICATIONS EQUIPMENT, NAMELY, EQUIPMENT FOR ELECTRONIC ACCESS TO GLOBAL TELECOMMUNICATIONS NETWORK, EQUIPMENT FOR TRANSMITTING, RECEIVING, RECORDING AND MONITORING VOICE, DATA, INFORMATION, IMAGES, SIGNALS, MESSAGES, COMPRISED OF DATA AND WORD PROCESSORS, AND TELECOMMUNICATIONS HARDWARE COMPONENTS AND PERIPHERALS THEREOF FOR USE IN THE TELECOMMUNICATIONS INDUSTRY, AND RENTAL OF EQUIPMENT FOR TRANSMITTING, RECEIVING, RECORDING AND MONITORING COMPUTER PROGRAMS FOR USE IN OPERATING AND ACCESSING TELECOMMUNICATIONS SYSTEMS; AUDIO AND VIDEO BROADCASTING; PROVIDING MULTIPLE-USER DIAL-UP AND DEDICATED ACCESS TO THE INTERNET; PERSONAL COMMUNICATIONS SERVICES; PAGER SERVICES; TRANSMISSION AND BROADCAST OF AUDIO AND VIDEO PROGRAMMING; LEASING OF TELECOMMUNICATIONS EQUIPMENT, COMPONENTS AND SYSTEMS; PROVIDING INFORMATION VIA THE TELEPHONE AND THE GLOBAL COMMUNICATION NETWORKS IN THE FIELD OF TELECOMMUNICATIONS; CONSULTING IN THE FIELD OF TELECOMMUNICATIONS (U.S. CLS. 100, 101 AND 104).

FLORENTINA BLANDU, EXAMINING ATTORNEY

CLASS 38—(Continued).

SN 78-494,015. DEUTSCHE TELEKOM AG, BONN, FED REP GERMANY, FILED 10-4-2004.

T-Mobile mms&messaging

THE MARK CONSISTS OF STANDARD CHARACTERS WITHOUT CLAIM TO ANY PARTICULAR FONT, STYLE, SIZE, OR COLOR.

PRIORITY CLAIMED UNDER SEC. 44(D) ON FED REP GERMANY APPLICATION NO. 30418512438, FILED 4-2-2004, REG. NO. 30418512, DATED 4-22-2004, EXPIRES 4-30-2014.

OWNER OF U.S. REG. NO. 2,282,432.

NO CLAIM IS MADE TO THE EXCLUSIVE RIGHT TO USE "MMS&MESSAGING", APART FROM THE MARK AS SHOWN.

FOR TELECOMMUNICATION AND INFORMATION TECHNOLOGY SERVICES, NAMELY, ELECTRIC, DIGITAL, CELLULAR AND WIRELESS TRANSMISSION OF VOICE, DATA, INFORMATION, IMAGES, SIGNALS AND MESSAGES AND TRANSMISSION OF VOICE, DATA, IMAGES, AUDIO, VIDEO AND INFORMATION VIA TELEPHONE, TELEVISION AND GLOBAL COMMUNICATION NETWORKS; PROVIDING TELECOMMUNICATIONS CONNECTIONS OVER A GLOBAL COMMUNICATIONS NETWORK, ELECTRONIC MAIL, VOICE MAIL AND MESSAGING SERVICES, NAMELY, THE RECORDING AND SUBSEQUENT TRANSMISSION OF VOICE MESSAGES BY TELEPHONE; RENTAL OF TELECOMMUNICATIONS EQUIPMENT, NAMELY, EQUIPMENT FOR ELECTRONIC ACCESS TO GLOBAL TELECOMMUNICATIONS NETWORK, EQUIPMENT FOR TRANSMITTING, RECEIVING, RECORDING AND MONITORING VOICE, DATA, INFORMATION, IMAGES, SIGNALS, MESSAGES, COMPRISED OF DATA AND WORD PROCESSORS, AND TELECOMMUNICATIONS HARDWARE COMPONENTS AND PERIPHERALS THEREOF FOR USE IN THE TELECOMMUNICATIONS INDUSTRY, AND RENTAL OF EQUIPMENT FOR TRANSMITTING, RECEIVING, RECORDING AND MONITORING COMPUTER PROGRAMS FOR USE IN OPERATING AND ACCESSING TELECOMMUNICATIONS SYSTEMS; AUDIO AND VIDEO BROADCASTING; PROVIDING MULTIPLE-USER DIAL-UP AND DEDICATED ACCESS TO THE INTERNET; PERSONAL COMMUNICATIONS SERVICES; PAGER SERVICES; TRANSMISSION AND BROADCAST OF AUDIO AND VIDEO PROGRAMMING; LEASING OF TELECOMMUNICATIONS EQUIPMENT, COMPONENTS AND SYSTEMS; PROVIDING INFORMATION VIA THE TELEPHONE AND THE GLOBAL COMMUNICATION NETWORKS IN THE FIELD OF TELECOMMUNICATIONS; CONSULTING IN THE FIELD OF TELECOMMUNICATIONS (U.S. CLS. 100, 101 AND 104).

FLORENTINA BLANDU, EXAMINING ATTORNEY

CLASS 38—(Continued).

SN 78-494,123. DEUTSCHE TELEKOM AG, BONN, FED REP GERMANY, FILED 10-4-2004.

T-Mobile multimedia netcard

THE MARK CONSISTS OF STANDARD CHARACTERS WITHOUT CLAIM TO ANY PARTICULAR FONT, STYLE, SIZE, OR COLOR.

PRIORITY CLAIMED UNDER SEC. 44(D) ON FED REP GERMANY APPLICATION NO. 30418509438, FILED 4-2-2004, REG. NO. 30418509, DATED 4-22-2004, EXPIRES 4-30-2014.

OWNER OF U.S. REG. NO. 2,282,432.

NO CLAIM IS MADE TO THE EXCLUSIVE RIGHT TO USE "MULTIMEDIA NETCARD", APART FROM THE MARK AS SHOWN.

FOR TELECOMMUNICATION AND INFORMATION TECHNOLOGY SERVICES, NAMELY, ELECTRIC, DIGITAL, CELLULAR AND WIRELESS TRANSMISSION OF VOICE, DATA, INFORMATION, IMAGES, SIGNALS AND MESSAGES AND TRANSMISSION OF VOICE, DATA, IMAGES, AUDIO, VIDEO AND INFORMATION VIA TELEPHONE, TELEVISION AND GLOBAL COMMUNICATION NETWORKS; PROVIDING TELECOMMUNICATIONS CONNECTIONS OVER A GLOBAL COMMUNICATIONS NETWORK, ELECTRONIC MAIL, VOICE MAIL AND MESSAGING SERVICES, NAMELY, THE RECORDING AND SUBSEQUENT TRANSMISSION OF VOICE MESSAGES BY TELEPHONE; RENTAL OF TELECOMMUNICATIONS EQUIPMENT, NAMELY, EQUIPMENT FOR ELECTRONIC ACCESS TO GLOBAL TELECOMMUNICATIONS NETWORK, EQUIPMENT FOR TRANSMITTING, RECEIVING, RECORDING AND MONITORING VOICE, DATA, INFORMATION, IMAGES, SIGNALS, MESSAGES, COMPRISED OF DATA AND WORD PROCESSORS, AND TELECOMMUNICATIONS HARDWARE COMPONENTS AND PERIPHERALS THEREOF FOR USE IN THE TELECOMMUNICATIONS INDUSTRY, AND RENTAL OF EQUIPMENT FOR TRANSMITTING, RECEIVING, RECORDING AND MONITORING COMPUTER PROGRAMS FOR USE IN OPERATING AND ACCESSING TELECOMMUNICATIONS SYSTEMS; AUDIO AND VIDEO BROADCASTING; PROVIDING MULTIPLE-USER DIAL-UP AND DEDICATED ACCESS TO THE INTERNET; PERSONAL COMMUNICATIONS SERVICES; PAGER SERVICES; TRANSMISSION AND BROADCAST OF AUDIO AND VIDEO PROGRAMMING; LEASING OF TELECOMMUNICATIONS EQUIPMENT, COMPONENTS AND SYSTEMS; PROVIDING INFORMATION VIA THE TELEPHONE AND THE GLOBAL COMMUNICATION NETWORKS IN THE FIELD OF TELECOMMUNICATIONS; CONSULTING IN THE FIELD OF TELECOMMUNICATIONS (U.S. CLS. 100, 101 AND 104).

FLORENTINA BLANDU, EXAMINING ATTORNEY

CLASS 38—(Continued).

SN 78-494,160. DEUTSCHE TELEKOM AG, BONN, FED REP GERMANY, FILED 10-4-2004.

T-Mobile instant email

THE MARK CONSISTS OF STANDARD CHARACTERS WITHOUT CLAIM TO ANY PARTICULAR FONT, STYLE, SIZE, OR COLOR.

PRIORITY CLAIMED UNDER SEC. 44(D) ON FED REP GERMANY APPLICATION NO. 30418511638, FILED 4-2-2004, REG. NO. 30418511, DATED 4-22-2004, EXPIRES 4-30-2014.

OWNER OF U.S. REG. NO. 2,282,432.

NO CLAIM IS MADE TO THE EXCLUSIVE RIGHT TO USE "INSTANT EMAIL", APART FROM THE MARK AS SHOWN.

FOR TELECOMMUNICATION AND INFORMATION TECHNOLOGY SERVICES, NAMELY, ELECTRIC, DIGITAL, CELLULAR AND WIRELESS TRANSMISSION OF VOICE, DATA, INFORMATION, IMAGES, SIGNALS AND MESSAGES AND TRANSMISSION OF VOICE, DATA, IMAGES, AUDIO, VIDEO AND INFORMATION VIA TELEPHONE, TELEVISION AND GLOBAL COMMUNICATION NETWORKS; PROVIDING TELECOMMUNICATIONS CONNECTIONS OVER A GLOBAL COMMUNICATIONS NETWORK, ELECTRONIC MAIL, VOICE MAIL AND MESSAGING SERVICES, NAMELY, THE RECORDING AND SUBSEQUENT TRANSMISSION OF VOICE MESSAGES BY TELEPHONE; RENTAL OF TELECOMMUNICATIONS EQUIPMENT, NAMELY, EQUIPMENT FOR ELECTRONIC ACCESS TO GLOBAL TELECOMMUNICATIONS NETWORK, EQUIPMENT FOR TRANSMITTING, RECEIVING, RECORDING AND MONITORING VOICE, DATA, INFORMATION, IMAGES, SIGNALS, MESSAGES, COMPRISED OF DATA AND WORD PROCESSORS, AND TELECOMMUNICATIONS HARDWARE COMPONENTS AND PERIPHERALS THEREOF FOR USE IN THE TELECOMMUNICATIONS INDUSTRY, AND RENTAL OF EQUIPMENT FOR TRANSMITTING, RECEIVING, RECORDING AND MONITORING COMPUTER PROGRAMS FOR USE IN OPERATING AND ACCESSING TELECOMMUNICATIONS SYSTEMS; AUDIO AND VIDEO BROADCASTING; PROVIDING MULTIPLE-USER DIAL-UP AND DEDICATED ACCESS TO THE INTERNET; PERSONAL COMMUNICATIONS SERVICES; PAGER SERVICES; TRANSMISSION AND BROADCAST OF AUDIO AND VIDEO PROGRAMMING; LEASING OF TELECOMMUNICATIONS EQUIPMENT, COMPONENTS AND SYSTEMS; PROVIDING INFORMATION VIA THE TELEPHONE AND THE GLOBAL COMMUNICATION NETWORKS IN THE FIELD OF TELECOMMUNICATIONS; CONSULTING IN THE FIELD OF TELECOMMUNICATIONS (U.S. CLS. 100, 101 AND 104).

FLORENTINA BLANDU, EXAMINING ATTORNEY

CLASS 38—(Continued).

SN 78-494,185. DEUTSCHE TELEKOM AG, BONN, FED REP GERMANY, FILED 10-4-2004.

T-Mobile screen styles

THE MARK CONSISTS OF STANDARD CHARACTERS WITHOUT CLAIM TO ANY PARTICULAR FONT, STYLE, SIZE, OR COLOR.

PRIORITY CLAIMED UNDER SEC. 44(D) ON FED REP GERMANY APPLICATION NO. 30418515938, FILED 4-2-2004, REG. NO. 30418515, DATED 4-22-2004, EXPIRES 4-30-2014.

OWNER OF U.S. REG. NO. 2,282,432.

NO CLAIM IS MADE TO THE EXCLUSIVE RIGHT TO USE "SCREEN STYLES", APART FROM THE MARK AS SHOWN.

FOR TELECOMMUNICATION AND INFORMATION TECHNOLOGY SERVICES, NAMELY, ELECTRIC, DIGITAL, CELLULAR AND WIRELESS TRANSMISSION OF VOICE, DATA, INFORMATION, IMAGES, SIGNALS AND MESSAGES AND TRANSMISSION OF VOICE, DATA, IMAGES, AUDIO, VIDEO AND INFORMATION VIA TELEPHONE, TELEVISION AND GLOBAL COMMUNICATION NETWORKS; PROVIDING TELECOMMUNICATIONS CONNECTIONS OVER A GLOBAL COMMUNICATIONS NETWORK, ELECTRONIC MAIL, VOICE MAIL AND MESSAGING SERVICES, NAMELY, THE RECORDING AND SUBSEQUENT TRANSMISSION OF VOICE MESSAGES BY TELEPHONE; RENTAL OF TELECOMMUNICATIONS EQUIPMENT, NAMELY, EQUIPMENT FOR ELECTRONIC ACCESS TO GLOBAL TELECOMMUNICATIONS NETWORK, EQUIPMENT FOR TRANSMITTING, RECEIVING, RECORDING AND MONITORING VOICE, DATA, INFORMATION, IMAGES, SIGNALS, MESSAGES, COMPRISED OF DATA AND WORD PROCESSORS, AND TELECOMMUNICATIONS HARDWARE COMPONENTS AND PERIPHERALS THEREOF FOR USE IN THE TELECOMMUNICATIONS INDUSTRY, AND RENTAL OF EQUIPMENT FOR TRANSMITTING, RECEIVING, RECORDING AND MONITORING COMPUTER PROGRAMS FOR USE IN OPERATING AND ACCESSING TELECOMMUNICATIONS SYSTEMS; AUDIO AND VIDEO BROADCASTING; PROVIDING MULTIPLE-USER DIAL-UP AND DEDICATED ACCESS TO THE INTERNET; PERSONAL COMMUNICATIONS SERVICES; PAGER SERVICES; TRANSMISSION AND BROADCAST OF AUDIO AND VIDEO PROGRAMMING; LEASING OF TELECOMMUNICATIONS EQUIPMENT, COMPONENTS AND SYSTEMS; PROVIDING INFORMATION VIA THE TELEPHONE AND THE GLOBAL COMMUNICATION NETWORKS IN THE FIELD OF TELECOMMUNICATIONS; CONSULTING IN THE FIELD OF TELECOMMUNICATIONS (U.S. CLS. 100, 101 AND 104).

FLORENTINA BLANDU, EXAMINING ATTORNEY

CLASS 38—(Continued).

SN 78-495,700. TIME WARNER TELECOM HOLDINGS INC.,
LITTLETON, CO. FILED 10-6-2004.

SANFRANCISCOCONNECT
T

THE MARK CONSISTS OF STANDARD CHARACTERS
WITHOUT CLAIM TO ANY PARTICULAR FONT, STYLE,
SIZE, OR COLOR.

FOR TELECOMMUNICATIONS SERVICES, NAMELY,
INTEGRATED VOICE AND DATA NETWORKING SER-
VICES (U.S. CLS. 100, 101 AND 104).
JILL C. ALT, EXAMINING ATTORNEY

SN 78-495,741. TIME WARNER TELECOM HOLDINGS INC.,
LITTLETON, CO. FILED 10-6-2004.

AUSTINCONNECT

THE MARK CONSISTS OF STANDARD CHARACTERS
WITHOUT CLAIM TO ANY PARTICULAR FONT, STYLE,
SIZE, OR COLOR.

FOR TELECOMMUNICATIONS SERVICES, NAMELY,
INTEGRATED VOICE AND DATA NETWORKING SER-
VICES (U.S. CLS. 100, 101 AND 104).
LINDA MICKLEBURGH, EXAMINING ATTORNEY

SN 78-495,742. TIME WARNER TELECOM HOLDINGS INC.,
LITTLETON, CO. FILED 10-6-2004.

PORTLANDCONNECT

THE MARK CONSISTS OF STANDARD CHARACTERS
WITHOUT CLAIM TO ANY PARTICULAR FONT, STYLE,
SIZE, OR COLOR.

FOR TELECOMMUNICATIONS SERVICES, NAMELY,
INTEGRATED VOICE AND DATA NETWORKING SER-
VICES (U.S. CLS. 100, 101 AND 104).
LINDA MICKLEBURGH, EXAMINING ATTORNEY

CLASS 38—(Continued).

SN 78-496,620. RTT ENTERPRISES, INC., SAN ANTONIO,
TX. FILED 10-7-2004.

Wi-Fi SA!

THE MARK CONSISTS OF STANDARD CHARACTERS
WITHOUT CLAIM TO ANY PARTICULAR FONT, STYLE,
SIZE, OR COLOR.

NO CLAIM IS MADE TO THE EXCLUSIVE RIGHT TO
USE "WI-FI", APART FROM THE MARK AS SHOWN.

FOR WIRELESS TELECOMMUNICATIONS SERVICES,
NAMELY, PROVIDING USERS WIRELESS ACCESS TO
THE INTERNET THROUGH A DISTRIBUTED COMMU-
NICATIONS NETWORK VIA PERSONAL COMPUTERS,
LAPTOPS, PDAS, AND OTHER WIRELESS DEVICES
(U.S. CLS. 100, 101 AND 104).

CAROLYN CATALDO, EXAMINING ATTORNEY

SN 78-498,765. MOVIDA COMMUNICATIONS, INC., CORAL
GABLES, FL. FILED 10-13-2004.

movida

THE MARK CONSISTS OF STANDARD CHARACTERS
WITHOUT CLAIM TO ANY PARTICULAR FONT, STYLE,
SIZE, OR COLOR.

THE ENGLISH TRANSLATION OF THE WORD MOVIDA
IN THE MARK IS MOVE OR MOVEMENT.

FOR MOBILE TELEPHONE COMMUNICATION (U.S.
CLS. 100, 101 AND 104).

FIRST USE 4-11-2005; IN COMMERCE 4-11-2005.

LOURDES AYALA, EXAMINING ATTORNEY

CLASS 38—(Continued).

SN 78-499,754. PINNATECH, INC., GIBSONIA, PA. FILED 10-14-2004.



OWNER OF U.S. REG. NOS. 2,942,216 AND 2,942,217.
NO CLAIM IS MADE TO THE EXCLUSIVE RIGHT TO USE "INTERNET SERVICES", APART FROM THE MARK AS SHOWN.

THE MARK CONSISTS OF THREE OVERLAPPING SAIL FIGURES WITH THE LITERAL ELEMENT.

FOR ELECTRONIC MAIL SERVICES; PROVIDING SUBSCRIBERS WITH MULTIPLE-USER ACCESS TO A GLOBAL COMPUTER INFORMATION NETWORK BY MEANS OF COMPUTER MODEMS OR OTHER ELECTRONIC LINK UPS (U.S. CLS. 100, 101 AND 104).

FIRST USE 2-1-1995; IN COMMERCE 2-1-1995.
BRENDAN REGAN, EXAMINING ATTORNEY

CLASS 38—(Continued).

SN 78-503,651. FERRERA, SALVATORE J., CHICAGO, IL. FILED 10-21-2004.



THE MARK CONSISTS OF THE WORD "MIND" IN LOWER-CASE, BOLD BLACK LETTERING, AND THE WORD "JOURNEY" IN LOWERCASE, STANDARD, BLACK LETTERING. THE WORDS "THE ULTIMATE TRIP" APPEAR BELOW "MIND JOURNEY" IN SLIGHTLY SMALLER, LOWERCASE LETTERS.

FOR CHATROOM SERVICES, NAMELY, PROVIDING ON-LINE INTERACTIVE DISCUSSION CONCERNING RELATIONSHIPS AND LIFE ISSUES (U.S. CLS. 100, 101 AND 104).

FIRST USE 4-0-2004; IN COMMERCE 4-0-2004.
CYNTHIA SLOAN, EXAMINING ATTORNEY

SN 78-502,752. VIDEOPORT INTERNATIONAL, GAITHERSBURG, MD. FILED 10-20-2004.

ZoomCall

THE MARK CONSISTS OF STANDARD CHARACTERS WITHOUT CLAIM TO ANY PARTICULAR FONT, STYLE, SIZE, OR COLOR.

FOR VIDEOCONFERENCING, VIDEO STREAMING, AND WEB CONFERENCING SERVICES (U.S. CLS. 100, 101 AND 104).

FIRST USE 1-1-2003; IN COMMERCE 4-1-2003.
KAREN BRACEY, EXAMINING ATTORNEY

SN 78-504,752. IMFORWARDS, INC., HERNDON, VA. FILED 10-22-2004.

MESSAGE_ME NOW

THE MARK CONSISTS OF STANDARD CHARACTERS WITHOUT CLAIM TO ANY PARTICULAR FONT, STYLE, SIZE, OR COLOR.

FOR COMMUNICATIONS SERVICES NAMELY, ROUTING INSTANT MESSAGE COMMUNICATIONS, SHORT MESSAGE SERVICES, EMAIL, AUDIO, VIDEO, GRAPHICS, TEXT, AND DATA BETWEEN A FIRST USER ON ONE NETWORK TO A SECOND USER ON A DIFFERENT NETWORK (U.S. CLS. 100, 101 AND 104).

FIRST USE 10-22-2004; IN COMMERCE 10-22-2004.
SEAN DWYER, EXAMINING ATTORNEY

CLASS 38—(Continued).

SN 78-510,336. CINCINNATI BELL INC., CINCINNATI, OH.
FILED 11-3-2004.

**YOU ADD, WE
SUBTRACT.**

THE MARK CONSISTS OF STANDARD CHARACTERS WITHOUT CLAIM TO ANY PARTICULAR FONT, STYLE, SIZE, OR COLOR.

FOR TELECOMMUNICATION SERVICES, NAMELY, LOCAL AND LONG DISTANCE TELEPHONE TRANSMISSION SERVICES; TELEPHONE COMMUNICATION SERVICES, AND ASSOCIATED VOICE MAIL AND CUSTOM CALLING FEATURES, NAMELY, THREE WAY CALLING, SPEED DIALING, CALL FORWARDING, CALL RETURN, CALL WAITING, CALLER ID; WIRELESS TELECOMMUNICATION SERVICES, NAMELY, ELECTRONIC TRANSMISSION OF MESSAGES, DATA, SOUND, TEXT, IMAGE MESSAGES, VIDEO AND DOCUMENTS VIA A GLOBAL COMPUTER COMMUNICATIONS NETWORK, TELEVISION AND TELECOMMUNICATIONS NETWORKS; TELECOMMUNICATIONS GATEWAY SERVICES; PROVIDING TELECOMMUNICATIONS CONNECTIONS TO A GLOBAL COMPUTER NETWORK; PROVIDING MULTIPLE-USER ACCESS TO A GLOBAL COMPUTER INFORMATION NETWORK; AND HIGH-SPEED INTERNET TRANSMISSION SERVICES, PROVIDING ELECTRONIC MAIL SERVICES; AND ELECTRONIC MESSAGING STORE AND FORWARD SERVICES (U.S. CLS. 100, 101 AND 104).

FIRST USE 2-1-2004; IN COMMERCE 2-1-2004.
GRETTA YAO, EXAMINING ATTORNEY

SN 78-513,205. STANAPHONE COMMUNICATIONS, LLC,
NEW YORK, NY. FILED 11-8-2004.

STANACARD

THE MARK CONSISTS OF STANDARD CHARACTERS WITHOUT CLAIM TO ANY PARTICULAR FONT, STYLE, SIZE, OR COLOR.

FOR PROVIDING VOICE COMMUNICATION SERVICES VIA THE INTERNET; VOICEMAIL SERVICES; CALL FORWARDING SERVICES (U.S. CLS. 100, 101 AND 104).

FIRST USE 2-1-2004; IN COMMERCE 2-1-2004.
DANIEL BRODY, EXAMINING ATTORNEY

CLASS 38—(Continued).

SN 78-514,428. ONE WORLD TELECOM, MIAMI, FL. FILED
11-10-2004.



NO CLAIM IS MADE TO THE EXCLUSIVE RIGHT TO USE "NOPIN.US A PREPAID LONG DISTANCE SERVICE", APART FROM THE MARK AS SHOWN.

THE MARK CONSISTS OF THE WORD MARK "NOPIN.US A PREPAID LONG DISTANCE SERVICE" WITH A TELEPHONE WITHIN A CIRCLE WITH FOUR OUTWARD-POINTING ARROWS.

FOR PRE-PAID LONG DISTANCE TELEPHONE SERVICES (U.S. CLS. 100, 101 AND 104).

FIRST USE 11-1-2003; IN COMMERCE 11-1-2003.
JAMES GRIFFIN, EXAMINING ATTORNEY

SN 78-515,328. GHB RADIO, INC., ATLANTA, GA. FILED 11-
11-2004.

The Ball

THE MARK CONSISTS OF STANDARD CHARACTERS WITHOUT CLAIM TO ANY PARTICULAR FONT, STYLE, SIZE, OR COLOR.

FOR RADIO BROADCASTING (U.S. CLS. 100, 101 AND 104).

FIRST USE 12-27-2004; IN COMMERCE 12-27-2004.
JACQUELINE A. LAVINE, EXAMINING ATTORNEY

CLASS 38—(Continued).

SN 78-515,548. EMPRESA DE TELECOMUNICACIONES DE BOGOTA, BOGOTA, COLOMBIA, FILED 11-11-2004.

CLASS 38—(Continued).

SN 78-525,200. DEUTSCHE TELEKOM AG, BONN, FED REP GERMANY, FILED 12-1-2004.



**T-Mobile SMS
Manager**

FOR TELEPHONE TELECOMMUNICATIONS SERVICES PROVIDED PRIMARILY TO COLOMBIA VIA PREPAID TELEPHONE CALLING CARDS (U.S. CLS. 100, 101 AND 104).
FIRST USE 8-28-1884; IN COMMERCE 9-1-2004.
KATHRYN COWARD, EXAMINING ATTORNEY

SN 78-518,335. AT&T CORP., NEW YORK, NY. FILED 11-17-2004.

THE MARK CONSISTS OF STANDARD CHARACTERS WITHOUT CLAIM TO ANY PARTICULAR FONT, STYLE, SIZE, OR COLOR.

PRIORITY CLAIMED UNDER SEC. 44(D) ON FED REP GERMANY APPLICATION NO. 30431982138, FILED 6-2-2004, REG. NO. 30431982, DATED 9-9-2004, EXPIRES 6-30-2014.

OWNER OF U.S. REG. NOS. 2,282,432 AND 2,889,632.
NO CLAIM IS MADE TO THE EXCLUSIVE RIGHT TO USE "SMS", APART FROM THE MARK AS SHOWN.

FOR TELECOMMUNICATION SERVICES, NAMELY, ELECTRIC, DIGITAL, CELLULAR AND WIRELESS TRANSMISSION OF VOICE, DATA, INFORMATION IMAGES, SIGNALS AND MESSAGES AND TRANSMISSION OF VOICE, DATA, IMAGES, AUDIO, VIDEO AND INFORMATION VIA TELEPHONE, TELEVISION AND GLOBAL COMMUNICATION NETWORKS; PROVIDING TELECOMMUNICATIONS CONNECTIONS TO A GLOBAL COMMUNICATIONS NETWORK, ELECTRONIC MAIL, VOICE MAIL AND MESSAGING SERVICES, NAMELY, THE RECORDING AND SUBSEQUENT TRANSMISSION OF VOICE MESSAGES BY TELEPHONE; RENTAL OF TELECOMMUNICATIONS EQUIPMENT, NAMELY, EQUIPMENT FOR ELECTRONIC ACCESS TO GLOBAL TELECOMMUNICATIONS NETWORK; RENTAL OF TELECOMMUNICATIONS HARDWARE COMPONENTS AND PERIPHERALS THEREOF FOR USE IN THE TELECOMMUNICATIONS INDUSTRY, AND RENTAL OF EQUIPMENT FOR TRANSMITTING, RECEIVING, RECORDING AND MONITORING COMPUTER PROGRAMS FOR USE IN OPERATING AND ACCESSING TELECOMMUNICATIONS SYSTEMS; AUDIO AND VIDEO BROADCASTING; PROVIDING MULTIPLE-USER DIAL-UP AND DEDICATED ACCESS TO THE INTERNET; PERSONAL COMMUNICATIONS SERVICES; PAGER SERVICES; BROADCAST OF AUDIO AND VIDEO PROGRAMMING; LEASING OF TELECOMMUNICATIONS EQUIPMENT; CONSULTING IN THE FIELD OF TELECOMMUNICATIONS (U.S. CLS. 100, 101 AND 104).

Laurie Mayes, Examining Attorney

ZOIP

THE MARK CONSISTS OF STANDARD CHARACTERS WITHOUT CLAIM TO ANY PARTICULAR FONT, STYLE, SIZE, OR COLOR.

FOR TELECOMMUNICATIONS SERVICES, NAMELY, THE ELECTRONIC TRANSMISSION OF VOICE, DATA, FACSIMILE, VIDEO AND INFORMATION; INTERNET ACCESS SERVICES (U.S. CLS. 100, 101 AND 104).

Rebecca Gilbert, Examining Attorney

CLASS 38—(Continued).

SN 78-527,419. SPRINT COMMUNICATIONS COMPANY L.P., OVERLAND PARK, KS. FILED 12-6-2004.

Sprint PCS Ready Link

THE MARK CONSISTS OF STANDARD CHARACTERS WITHOUT CLAIM TO ANY PARTICULAR FONT, STYLE, SIZE, OR COLOR.

OWNER OF U.S. REG. NOS. 1,104,943, 2,907,208 AND OTHERS.

NO CLAIM IS MADE TO THE EXCLUSIVE RIGHT TO USE "PCS AND LINK", APART FROM THE MARK AS SHOWN.

FOR TELECOMMUNICATIONS SERVICES, NAMELY, WIRELESS PERSONAL COMMUNICATION SERVICES FEATURING A DEVICE THAT ALLOWS THE USER TO ACCESS VOICE TRANSMISSION SERVICES BY PUSHING A BUTTON (U.S. CLS. 100, 101 AND 104).

FIRST USE 2-1-2004; IN COMMERCE 2-1-2004.
EDWARD NELSON, EXAMINING ATTORNEY

SN 78-528,046. VIETNAM TELEVISION, HANOI, VIETNAM, FILED 12-7-2004.



OWNER OF VIETNAM REG. NO. 52464, DATED 2-4-2004, EXPIRES 2-4-2014.

THE COLOR(S) RED, COBALT BLUE, GREEN IS/ARE CLAIMED AS A FEATURE OF THE MARK.

THE MARK CONSISTS OF THE LETTERS VTV AND THE NUMBER 4. THE FIRST LETTER V AND THE NUMBER 4 ARE IN RED COLOR. THE LETTER T IS STYLIZED AND IN GREEN COLOR. THE SECOND LETTER V IS STYLIZED AND IN COBALT BLUE COLOR.

FOR TELEVISION BROADCASTING SERVICES; TELEVISION TRANSMISSION SERVICES (U.S. CLS. 100, 101 AND 104).

CHARLES L. JENKINS, EXAMINING ATTORNEY

CLASS 38—(Continued).

SN 78-528,374. WAZEE MULTIMEDIA, LLC, DENVER, CO. FILED 12-7-2004.

RADIO WAZEE

THE MARK CONSISTS OF STANDARD CHARACTERS WITHOUT CLAIM TO ANY PARTICULAR FONT, STYLE, SIZE, OR COLOR.

NO CLAIM IS MADE TO THE EXCLUSIVE RIGHT TO USE "RADIO", APART FROM THE MARK AS SHOWN.

FOR STREAMING OF AUDIO MATERIAL ON THE INTERNET (U.S. CLS. 100, 101 AND 104).

FIRST USE 5-1-2000; IN COMMERCE 5-1-2000.
MARK T. MULLEN, EXAMINING ATTORNEY

SN 78-530,092. CALLWAVE, INC., SANTA BARBARA, CA. FILED 12-9-2004.

IT'S WHAT'S NEXT FOR YOUR CELL PHONE

THE MARK CONSISTS OF STANDARD CHARACTERS WITHOUT CLAIM TO ANY PARTICULAR FONT, STYLE, SIZE, OR COLOR.

FOR LOCAL AND LONG DISTANCE TELEPHONE SERVICES TO INDIVIDUALS, HOMES AND OFFICES VIA GLOBAL COMPUTER NETWORKS, FEATURING ENHANCED INFORMATION ABOUT REAL-TIME VOICE COMMUNICATIONS, FAXES AND OTHER ELECTRONIC MESSAGES; ELECTRONIC TRANSMISSION OF MESSAGES AND DATA; TELECOMMUNICATIONS SERVICES, NAMELY, PROVIDING CALLER IDENTIFICATION INFORMATION ABOUT AN INCOMING TELEPHONE CALL; ELECTRONIC VOICE MESSAGING, NAMELY, THE FORWARDING, SCREENING, RECORDING AND SUBSEQUENT TRANSMISSION OF VOICE AND TEXT MESSAGES BY TELEPHONE, CELLULAR PHONE, WIRELESS COMMUNICATIONS DEVICES, AND THE INTERNET; ELECTRONIC, ELECTRIC, AND DIGITAL TRANSMISSION OF VOICE, DATA, SIGNALS, AND MESSAGES (U.S. CLS. 100, 101 AND 104).

FIRST USE 12-7-2004; IN COMMERCE 12-7-2004.
ATTIYA MALIK, EXAMINING ATTORNEY

CLASS 38—(Continued).

SN 78-530,178. ELECTRIC CALIFORNIA WESTERN, INC., SAN DIEGO, CA. FILED 12-9-2004.

CLASS 38—(Continued).

SN 78-532,462. DBS COMMUNICATIONS, INC., SCHAM-BURG, IL. FILED 12-14-2004.

HDLA

**BUILDING
RELATATIONSHIPS
THROUGH
TECHNOLOGY**

THE MARK CONSISTS OF STANDARD CHARACTERS WITHOUT CLAIM TO ANY PARTICULAR FONT, STYLE, SIZE, OR COLOR.

FOR HIGH DEFINITION TELECOMMUNICATIONS SERVICES, NAMELY, TELEVISION AND INTERNET BROADCASTING AND SATELLITE UP LINKING (U.S. CLS. 100, 101 AND 104).

MONTIA G. PRESSEY, EXAMINING ATTORNEY

THE MARK CONSISTS OF STANDARD CHARACTERS WITHOUT CLAIM TO ANY PARTICULAR FONT, STYLE, SIZE, OR COLOR.

FOR TELEPHONE TELECOMMUNICATION SERVICES PROVIDED VIA PREPAID TELEPHONE CALLING CARDS (U.S. CLS. 100, 101 AND 104).

FIRST USE 12-1-2004; IN COMMERCE 12-1-2004.
SEAN DWYER, EXAMINING ATTORNEY

SN 78-530,677. COMCAST PROGRAMMING VENTURES II, INC., PHILADELPHIA, PA. FILED 12-10-2004.

SN 78-532,549. MOBILE ACCESS COMMUNICATIONS SERVICES, INC., JACKSONVILLE, NC. FILED 12-14-2004.

ACE Network

MAGS

THE MARK CONSISTS OF STANDARD CHARACTERS WITHOUT CLAIM TO ANY PARTICULAR FONT, STYLE, SIZE, OR COLOR.

NO CLAIM IS MADE TO THE EXCLUSIVE RIGHT TO USE "NETWORK", APART FROM THE MARK AS SHOWN. FOR TELEVISION BROADCASTING; CABLE TELEVISION BROADCASTING; SATELLITE TELEVISION BROADCASTING (U.S. CLS. 100, 101 AND 104).

YONG KIM, EXAMINING ATTORNEY

FOR WIRELESS TELECOMMUNICATIONS CONSULTING SERVICE (U.S. CLS. 100, 101 AND 104).

FIRST USE 9-10-2002; IN COMMERCE 9-10-2002.

KATHLEEN M. VANSTON, EXAMINING ATTORNEY

CLASS 38—(Continued).

SN 78-534,684. ALL EIGHTS, L.L.C., DALLAS, TX. FILED 12-17-2004.

INFOEIGHTS

THE MARK CONSISTS OF STANDARD CHARACTERS WITHOUT CLAIM TO ANY PARTICULAR FONT, STYLE, SIZE, OR COLOR.

FOR GLOBAL COMPUTER NETWORK SERVICES, NAMELY, PROVIDING TELECOMMUNICATIONS GATEWAY SERVICES; TELECOMMUNICATIONS SERVICES, NAMELY, PROVIDING TELEPHONIC ROUTING SERVICES, NAMELY, ACTIVATING CALL FORWARDING FROM TELEPHONE TO TELEPHONE (U.S. CLS. 100, 101 AND 104).

CAROLINE WEIMER, EXAMINING ATTORNEY

CLASS 38—(Continued).

SN 78-537,186. BITWISE COMMUNICATIONS, INC., PEORIA, IL. FILED 12-22-2004.

OmniNumber

THE MARK CONSISTS OF STANDARD CHARACTERS WITHOUT CLAIM TO ANY PARTICULAR FONT, STYLE, SIZE, OR COLOR.

FOR INTERNET TELEPHONY SERVICES (U.S. CLS. 100, 101 AND 104).

MICHELLE DUBOIS, EXAMINING ATTORNEY

SN 78-537,692. LAYER-Z, INC, WICHITA, KS. FILED 12-23-2004.

SN 78-535,282. GRANDE RIVER COMMUNICATIONS, L.P., RAYMONDVILLE, TX. FILED 12-20-2004.

ProntoNet

THE COLOR(S) GREEN IS/ARE CLAIMED AS A FEATURE OF THE MARK.

THE MARK CONSISTS OF A STYLIZED VERSION OF THE WORD "PRONTONET" IN GREEN AND DARK SHADING AROUND SUCH.

FOR WIRELESS TELECOMMUNICATIONS SERVICES, NAMELY PROVIDING WIRELESS ACCESS TO A GLOBAL COMPUTER NETWORK TO OTHERS (U.S. CLS. 100, 101 AND 104).

FIRST USE 10-1-2004; IN COMMERCE 12-8-2004.
RAUL CORDOVA, EXAMINING ATTORNEY

SendThisFile

THE MARK CONSISTS OF STANDARD CHARACTERS WITHOUT CLAIM TO ANY PARTICULAR FONT, STYLE, SIZE, OR COLOR.

OWNER OF U.S. REG. NO. 2,917,528.

FOR ELECTRONIC TRANSMISSION OF COMPUTER FILES CONTAINING DATA, TEXT, IMAGES, SOUND, AND VIDEO (U.S. CLS. 100, 101 AND 104).

FIRST USE 11-6-2003; IN COMMERCE 11-6-2003.
EVELYN BRADLEY, EXAMINING ATTORNEY

CLASS 38—(Continued).

SN 78-975,913. NEXTEL COMMUNICATIONS, INC., RESTON, VA. FILED 1-17-2003.

EMERGENCY GROUP CONNECT

NO CLAIM IS MADE TO THE EXCLUSIVE RIGHT TO USE "EMERGENCY", APART FROM THE MARK AS SHOWN.

SEC. 2(F) AS TO "GROUP CONNECT".

FOR TELECOMMUNICATION SERVICES, NAMELY, ELECTRONIC, ELECTRIC, AND DIGITAL TRANSMISSION OF VOICE, DATA, PICTURES, MUSIC, AND VIDEO VIA WIRELESS NETWORKS; TWO-WAY RADIO DISPATCHING SERVICES, ELECTRONIC TRANSMISSION OF VOICE, TEXT, IMAGES, DATA, AND INFORMATION BY MEANS OF TWO-WAY RADIOS, MOBILE RADIOS, CELLULAR TELEPHONES, DIGITAL CELLULAR TELEPHONES, MOBILE TELEPHONES, DISPATCH RADIOS, PAGERS, MOBILE DISPATCH RADIOS, MOBILE DATA RECEIVERS, NAMELY, HANDHELD PERSONAL COMPUTERS AND DIGITAL ASSISTANTS (PDAS), ELECTRONIC HANDHELD UNITS; PAGING SERVICES; MOBILE TELEPHONE COMMUNICATION SERVICES; WIRELESS INTERNET ACCESS SERVICES; AND WIRELESS DATA SERVICES FOR MOBILE DEVICES VIA A WIRELESS NETWORK FOR THE PURPOSE OF SENDING AND RECEIVING ELECTRONIC MAIL, FACSIMILES, DATA, IMAGES, INFORMATION, TEXT, NUMERIC MESSAGING AND TEXT MESSAGING AND FOR ACCESSING A GLOBAL COMMUNICATIONS NETWORK (U.S. CLS. 100, 101 AND 104).

FIRST USE 1-0-2003; IN COMMERCE 1-0-2003.
KELLY BOULTON, EXAMINING ATTORNEY

CLASS 39—TRANSPORTATION AND STORAGE

SN 76-490,002. AIR CANADA, ST. LAURENT, QUEBEC, H4Y 1H4, CANADA, FILED 2-19-2003.

AIR CANADA ELITE

PRIORITY CLAIMED UNDER SEC. 44(D) ON CANADA APPLICATION NO. 1,154,646, FILED 10-3-2002, REG. NO. TMA618841, DATED 9-8-2004, EXPIRES 9-8-2019.

OWNER OF U.S. REG. NOS. 1,041,958 AND 1,714,223.

SEC. 2(F) "AIR CANADA".

FOR TRANSPORTATION OF PASSENGERS, BAGGAGE, AND FREIGHT BY AIR (U.S. CLS. 100 AND 105).
THEODORE MCBRIDE, EXAMINING ATTORNEY

SN 76-490,003. AIR CANADA, ST. LAURENT, QUEBEC, H4Y 1H4, CANADA, FILED 2-19-2003.

AIR CANADA SUPER ELITE

PRIORITY CLAIMED UNDER SEC. 44(D) ON CANADA APPLICATION NO. 1,154,645, FILED 10-3-2002, REG. NO. TMA619019, DATED 9-9-2004, EXPIRES 9-9-2019.

OWNER OF U.S. REG. NOS. 1,041,958 AND 1,714,223.

SEC. 2(F) "AIR CANADA".

FOR TRANSPORTATION OF PASSENGERS, BAGGAGE, AND FREIGHT BY AIR (U.S. CLS. 100 AND 105).
THEODORE MCBRIDE, EXAMINING ATTORNEY

CLASS 39—(Continued).

SN 76-504,034. ANALYTICAL SOFTWARE PACKAGES, INC., DELRAY BEACH, FL. FILED 4-7-2003.



AllAroundTheGlobe.com

THE LINING IS A FEATURE OF THE MARK AND DOES NOT INDICATE COLOR.

THE MARK CONSISTS OF A DUAL SHADED COLOR OF BLUE WORLD GLOBE, RED LETTERING OF THE WORD ALL, BLUE COLORED LETTERING OF THE WORD AROUND, RED COLORED WORD, THE BLUE COLORED WORD GLOBE, RED COLORED.COM, SHADED RAINBOW COLOR ABOVE LETTERING.

FOR TRAVEL BOOKING AGENCIES (U.S. CLS. 100 AND 105).

FIRST USE 6-26-2002; IN COMMERCE 6-26-2002.
PAULA MAYS, EXAMINING ATTORNEY

SN 76-568,040. S & L TRAVEL PARTNERS, INC., ASPEN, CO. FILED 1-2-2004.

SPORTOURS

THE MARK CONSISTS OF STANDARD CHARACTERS WITHOUT CLAIM TO ANY PARTICULAR FONT, STYLE, SIZE, OR COLOR.

SEC. 2(F).

FOR TRAVEL SERVICES, NAMELY ORGANIZING AND CONDUCTING TRAVEL TOURS (U.S. CLS. 100 AND 105).

FIRST USE 5-8-1974; IN COMMERCE 5-8-1974.

MITCHELL FRONT, EXAMINING ATTORNEY

SN 76-574,694. ANGELS NEST SUSTAINABLE RETREATS LLC., LONG BEACH, CA. FILED 2-9-2004.

ANGEL'S NEST

THE MARK CONSISTS OF STANDARD CHARACTERS WITHOUT CLAIM TO ANY PARTICULAR FONT, STYLE, SIZE, OR COLOR.

FOR TRANSPORTATION SERVICES, NAMELY PROVIDING SUSTAINABLE ENERGY TRANSPORTATION IN THE NATURE OF LAND VEHICLES FOR PASSENGERS TO AND FROM A RESORT HOTEL (U.S. CLS. 100 AND 105).

FIRST USE 11-1-2003; IN COMMERCE 11-1-2003.

DOMINIC J. FERRAIUOLO, EXAMINING ATTORNEY

CLASS 39—(Continued).

SN 76-584,906. ZAHNCOR, CARY, NC. FILED 4-2-2004.

TRIP LOGICS

THE MARK CONSISTS OF STANDARD CHARACTERS WITHOUT CLAIM TO ANY PARTICULAR FONT, STYLE, SIZE, OR COLOR.

NO CLAIM IS MADE TO THE EXCLUSIVE RIGHT TO USE "TRIP", APART FROM THE MARK AS SHOWN.

FOR TRAVEL AGENCY SERVICES, NAMELY, MAKING RESERVATIONS AND BOOKINGS FOR TRANSPORTATION, NAMELY, AIRLINE TICKETS, CARS, CRUISES AND TOURS (U.S. CLS. 100 AND 105).

FIRST USE 9-1-2004; IN COMMERCE 9-1-2004.

DOUGLAS LEE, EXAMINING ATTORNEY

CLASS 39—(Continued).

SN 76-598,969. ADVANCED PARKING CONCEPTS, INC., UPPER SADDLE RIVER, NJ. FILED 6-22-2004.

APC

THE MARK CONSISTS OF STANDARD CHARACTERS WITHOUT CLAIM TO ANY PARTICULAR FONT, STYLE, SIZE, OR COLOR.

FOR CAR PARKING SERVICES, NAMELY, PROVISION OF VALET PARKING AND VEHICLE ATTENDANT SERVICES, MANAGEMENT OF TRAFFIC FLOW, PARKING ARRANGEMENTS AND GREETER SERVICES AT SPECIAL EVENTS; CONSULTATION REGARDING THE USE OF VALET PARKING, SELF-PARKING AND OTHER PARKING MECHANISMS IN EXISTING PARKING FACILITIES (U.S. CLS. 100 AND 105).

FIRST USE 6-1-1985; IN COMMERCE 6-1-1985.

DAVID MURRAY, EXAMINING ATTORNEY

SN 76-587,573. OVERALL PARTS SOLUTIONS, INC., GRAPEVINE, TX. FILED 4-20-2004.

OVERALL PARTS SOLUTIONS

THE MARK CONSISTS OF STANDARD CHARACTERS WITHOUT CLAIM TO ANY PARTICULAR FONT, STYLE, SIZE, OR COLOR.

NO CLAIM IS MADE TO THE EXCLUSIVE RIGHT TO USE "PARTS", APART FROM THE MARK AS SHOWN.

FOR DELIVERY OF AUTOMOBILE PARTS BY TRUCK FROM AUTOMOTIVE DEALERSHIPS TO AUTOMOTIVE COLLISION REPAIR SHOPS (U.S. CLS. 100 AND 105).

FIRST USE 1-0-2002; IN COMMERCE 1-0-2002.

ALEXANDER L. POWERS, EXAMINING ATTORNEY

SN 76-598,970. ADVANCED PARKING CONCEPTS, INC., UPPER SADDLE RIVER, NJ. FILED 6-22-2004.

SN 76-594,388. CIF CHINA INTERNATIONAL FREIGHT LLC, ATLANTA, GA. FILED 5-27-2004.

**CIF CHINA
INTERNATIONAL
FREIGHT****Creating the Perfect First and Last Impression**

THE MARK CONSISTS OF STANDARD CHARACTERS WITHOUT CLAIM TO ANY PARTICULAR FONT, STYLE, SIZE, OR COLOR.

FOR CAR PARKING SERVICES, NAMELY, PROVISION OF VALET PARKING AND VEHICLE ATTENDANT SERVICES, MANAGEMENT OF TRAFFIC FLOW, PARKING ARRANGEMENTS AND GREETER SERVICES AT SPECIAL EVENTS; CONSULTATION REGARDING THE USE OF VALET PARKING, SELF-PARKING AND OTHER PARKING MECHANISMS IN EXISTING PARKING FACILITIES (U.S. CLS. 100 AND 105).

FIRST USE 6-1-1985; IN COMMERCE 6-1-1985.

KATHLEEN M. VANSTON, EXAMINING ATTORNEY

THE MARK CONSISTS OF STANDARD CHARACTERS WITHOUT CLAIM TO ANY PARTICULAR FONT, STYLE, SIZE, OR COLOR.

NO CLAIM IS MADE TO THE EXCLUSIVE RIGHT TO USE "CHINA INTERNATIONAL FREIGHT", APART FROM THE MARK AS SHOWN.

FOR SUPPLY CHAIN, LOGISTICS AND REVERSE LOGISTICS SERVICES, NAMELY, STORAGE, TRANSPORTATION AND DELIVERY OF DOCUMENTS, PACKAGES, RAW MATERIALS, AND OTHER FREIGHT FOR OTHERS BY AIR, RAIL, SHIP OR TRUCK. (U.S. CLS. 100 AND 105).

JOHN SCHUYLER YARD, EXAMINING ATTORNEY

CLASS 39—(Continued).

SN 76-598,971. ADVANCED PARKING CONCEPTS, INC., UPPER SADDLE RIVER, NJ. FILED 6-22-2004.



FOR CAR PARKING SERVICES, NAMELY PROVISION OF VALET PARKING AND VEHICLE ATTENDANT SERVICES, MANAGEMENT OF TRAFFIC FLOW, PARKING ARRANGEMENTS AND GREETER SERVICES AT SPECIAL EVENTS; CONSULTATION REGARDING THE USE OF VALET PARKING, SELF-PARKING AND OTHER PARKING MECHANISMS IN EXISTING PARKING FACILITIES (U.S. CLS. 100 AND 105).

FIRST USE 2-1-2004; IN COMMERCE 2-1-2004.
DAVID MURRAY, EXAMINING ATTORNEY

CLASS 39—(Continued).

SN 76-602,716. IMPERIAL WINE STORAGE, INC., WEST PALM BEACH, FL. FILED 7-19-2004.



IMPERIAL
Wine Storage

NO CLAIM IS MADE TO THE EXCLUSIVE RIGHT TO USE WINE STORAGE, APART FROM THE MARK AS SHOWN.

FOR STORAGE OF BOTTLED WINE AND WINE COLLECTIONS IN A WAREHOUSE OR OTHER BUILDINGS (U.S. CLS. 100 AND 105).

FIRST USE 1-16-2004; IN COMMERCE 1-16-2004.
TRACY CROSS, EXAMINING ATTORNEY

SN 76-602,717. IMPERIAL WINE STORAGE, INC., WEST PALM BEACH, FL. FILED 7-19-2004.

AN EXTENSION OF YOUR HOME CELLAR

THE MARK CONSISTS OF STANDARD CHARACTERS WITHOUT CLAIM TO ANY PARTICULAR FONT, STYLE, SIZE, OR COLOR.

FOR STORAGE OF BOTTLED WINE AND WINE COLLECTIONS IN A WAREHOUSE OR OTHER BUILDINGS (U.S. CLS. 100 AND 105).

FIRST USE 1-16-2004; IN COMMERCE 1-16-2004.
TRACY CROSS, EXAMINING ATTORNEY

SN 76-602,715. IMPERIAL WINE STORAGE, INC., WEST PALM BEACH, FL. FILED 7-19-2004.

IMPERIAL WINE STORAGE

THE MARK CONSISTS OF STANDARD CHARACTERS WITHOUT CLAIM TO ANY PARTICULAR FONT, STYLE, SIZE, OR COLOR.

NO CLAIM IS MADE TO THE EXCLUSIVE RIGHT TO USE WINE STORAGE, APART FROM THE MARK AS SHOWN.

FOR STORAGE OF BOTTLED WINE AND WINE COLLECTIONS IN A WAREHOUSE OR OTHER BUILDINGS (U.S. CLS. 100 AND 105).

FIRST USE 1-16-2004; IN COMMERCE 1-16-2004.
TRACY CROSS, EXAMINING ATTORNEY

SN 76-604,078. VELA INTERNATIONAL MARINE, LIMITED, DHAHRAN 31311, SAUDI ARABIA, FILED 7-26-2004.



THE TRANSLATION OF THE WORD "VELA" MEANS "SAIL" IN LATIN.

FOR TRANSPORTATION OF GOODS BY SEA (U.S. CLS. 100 AND 105).

FIRST USE 9-0-1984; IN COMMERCE 9-0-1984.
DARRYL SPRUILL, EXAMINING ATTORNEY

CLASS 39—(Continued).

SN 76-612,126. DD4HIRE, INCORPORATED, BOARDMAN, OH. FILED 9-13-2004.



NO CLAIM IS MADE TO THE EXCLUSIVE RIGHT TO USE "DESIGNATED DRIVER FOR HIRE", APART FROM THE MARK AS SHOWN.

FOR TRANSPORTATION SERVICES FOR PASSENGERS BY MOTOR VEHICLE (U.S. CLS. 100 AND 105). ANNE FARRELL, EXAMINING ATTORNEY

CLASS 39—(Continued).

SN 76-614,485. THE OLIVIA COMPANIES, LLC, SAN FRANCISCO, CA. FILED 10-1-2004.

OLIVIA

THE MARK CONSISTS OF STANDARD CHARACTERS WITHOUT CLAIM TO ANY PARTICULAR FONT, STYLE, SIZE, OR COLOR.

FOR TRAVEL AND TOURING, NAMELY, MAKING RESERVATIONS AND BOOKINGS FOR TRANSPORTATION; ARRANGING TRAVEL TOURS AND TRAVEL GUIDE SERVICES (U.S. CLS. 100 AND 105).

FIRST USE 10-31-1989; IN COMMERCE 10-31-1989. LAURIE MAYES, EXAMINING ATTORNEY

SN 76-614,410. THE OLIVIA COMPANIES, LLC, SAN FRANCISCO, CA. FILED 10-1-2004.



FOR TRAVEL AND TOURING, NAMELY, MAKING RESERVATIONS AND BOOKINGS FOR TRANSPORTATION; ARRANGING TRAVEL TOURS AND TRAVEL GUIDE SERVICES (U.S. CLS. 100 AND 105).

FIRST USE 4-1-2003; IN COMMERCE 4-1-2003. LAURIE MAYES, EXAMINING ATTORNEY

SN 76-615,321. HAWAIIAN AIRLINES, INC., HONOLULU, HI. FILED 10-12-2004.

FOLLOW ME HOME

THE MARK CONSISTS OF STANDARD CHARACTERS WITHOUT CLAIM TO ANY PARTICULAR FONT, STYLE, SIZE, OR COLOR.

FOR AIR TRANSPORTATION SERVICES (U.S. CLS. 100 AND 105).

FIRST USE 4-0-2004; IN COMMERCE 4-0-2004. ROBERT LORENZO, EXAMINING ATTORNEY

SN 76-614,440. THE OLIVIA COMPANIES, LLC, SAN FRANCISCO, CA. FILED 10-1-2004.

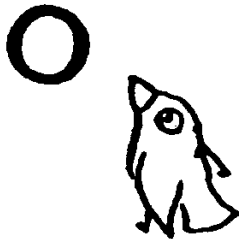

THE MARK CONSISTS OF A BIRD LOOKING UP AT THE LETTER O.

FOR TRAVEL AND TOURING, NAMELY, MAKING RESERVATIONS AND BOOKINGS FOR TRANSPORTATION; ARRANGING TRAVEL TOURS AND TRAVEL GUIDE SERVICES (U.S. CLS. 100 AND 105).

FIRST USE 4-1-2003; IN COMMERCE 4-1-2003. LAURIE MAYES, EXAMINING ATTORNEY

SN 76-615,819. FOREMOST TRAVEL & TOURS, CHICAGO, IL. FILED 10-12-2004.

TRAVELONI

THE MARK CONSISTS OF STANDARD CHARACTERS WITHOUT CLAIM TO ANY PARTICULAR FONT, STYLE, SIZE, OR COLOR.

FOR TRAVEL AGENCY AND BOOKING SERVICES, NAMELY MAKING AIRLINE, CRUISE, CAR RENTAL AND TOUR PACKAGE RESERVATIONS AND BOOKINGS FOR TRANSPORTATION TO THE TRADE AND TO THE PUBLIC; ARRANGING FOR TRAVEL VISAS, PASSPORTS AND TRAVEL DOCUMENTS FOR PERSONS TRAVELING ABROAD; TRAVEL CLUBS; TRAVEL GUIDE SERVICES; TRAVEL INFORMATION SERVICES; AND ARRANGING TRAVEL TOURS (U.S. CLS. 100 AND 105).

FIRST USE 5-20-2004; IN COMMERCE 8-23-2004. MARY ROSSMAN, EXAMINING ATTORNEY

CLASS 39—(Continued).

SN 76-615,927. AMERICAN CRUISE LINES, INC., GUILFORD, CT. FILED 10-14-2004.



OWNER OF U.S. REG. NOS. 2,437,726 AND 2,437,727.
NO CLAIM IS MADE TO THE EXCLUSIVE RIGHT TO USE CRUISE LINES, APART FROM THE MARK AS SHOWN.
SEC. 2(F) AS TO "AMERICAN".
FOR CRUISE SHIP SERVICES; TRANSPORTATION OF PASSENGERS BY SHIP (U.S. CLS. 100 AND 105).
FIRST USE 7-30-1999; IN COMMERCE 10-1-1999.
MATTHEW KLINE, EXAMINING ATTORNEY

CLASS 39—(Continued).

SN 76-619,231. JACKSON & PERKINS COMPANY, MEDFORD, OR. FILED 11-4-2004.

JP FRESH EXPRESS SERVICE

THE MARK CONSISTS OF STANDARD CHARACTERS WITHOUT CLAIM TO ANY PARTICULAR FONT, STYLE, SIZE, OR COLOR.
OWNER OF U.S. REG. NO. 2,693,050.
NO CLAIM IS MADE TO THE EXCLUSIVE RIGHT TO USE EXPRESS SERVICE, APART FROM THE MARK AS SHOWN.
FOR EXPEDITED DELIVERY SERVICE OF CATALOG ITEMS BY LAND, AIR AND/OR SEA (U.S. CLS. 100 AND 105).
FIRST USE 3-8-2004; IN COMMERCE 3-0-2004.
NICHOLAS ALTREE, EXAMINING ATTORNEY

SN 76-615,969. DETROIT & CANADA TUNNEL CORP., DETROIT, MI. FILED 10-14-2004.

NEXPRESSWAY

THE MARK CONSISTS OF STANDARD CHARACTERS WITHOUT CLAIM TO ANY PARTICULAR FONT, STYLE, SIZE, OR COLOR.
OWNER OF U.S. REG. NO. 2,806,416.
FOR TRANSPORTATION SERVICES, NAMELY PROVIDING A PUBLICLY OWNED AND PRIVATELY OPERATED TUNNEL FOR OTHERS (U.S. CLS. 100 AND 105).
FIRST USE 5-24-2004; IN COMMERCE 5-24-2004.
LEIGH CAROLINE CASE, EXAMINING ATTORNEY

SN 76-625,573. NATIONAL RAILROAD PASSENGER CORPORATION, WASHINGTON, DC. FILED 12-22-2004.

SUNSET LTD

THE MARK CONSISTS OF STANDARD CHARACTERS WITHOUT CLAIM TO ANY PARTICULAR FONT, STYLE, SIZE, OR COLOR.
NO CLAIM IS MADE TO THE EXCLUSIVE RIGHT TO USE "LTD", APART FROM THE MARK AS SHOWN.
FOR RAILROAD TRANSPORTATION SERVICES (U.S. CLS. 100 AND 105).
FIRST USE 6-11-1972; IN COMMERCE 6-11-1972.
SUSAN HAYASH, EXAMINING ATTORNEY

SN 76-616,314. EUROAMERICAN PROPAGATORS, LLC, BONSALL, CA. FILED 10-7-2004.

FREIGHT OPTIONS PLUS

THE MARK CONSISTS OF STANDARD CHARACTERS WITHOUT CLAIM TO ANY PARTICULAR FONT, STYLE, SIZE, OR COLOR.
NO CLAIM IS MADE TO THE EXCLUSIVE RIGHT TO USE "FREIGHT", APART FROM THE MARK AS SHOWN.
FOR PACKAGING, TRANSPORTATION AND DELIVERY OF GOODS (U.S. CLS. 100 AND 105).
FIRST USE 12-0-2003; IN COMMERCE 12-0-2003.
JENNIFER KRISP, EXAMINING ATTORNEY

SN 78-257,072. YX PROPERTIES, LLC, OMAHA, NE. FILED 6-2-2003.

MIDWEST AIRLINES SAVER SERVICE

OWNER OF U.S. REG. NOS. 1,522,113, 2,812,929 AND OTHERS.
NO CLAIM IS MADE TO THE EXCLUSIVE RIGHT TO USE "AIRLINES SAVER SERVICE", APART FROM THE MARK AS SHOWN.
SEC. 2(F) AS TO "MIDWEST".
FOR TRANSPORTATION OF PASSENGERS AND FREIGHT BY AIR; AIR TRANSPORTATION SERVICES FEATURING A FREQUENT FLYER BONUS PROGRAM (U.S. CLS. 100 AND 105).
FIRST USE 6-3-2003; IN COMMERCE 6-3-2003.
STEVEN JACKSON, EXAMINING ATTORNEY

CLASS 39—(Continued).

SN 78-307,834. GULLIVER'S TRAVEL SERVICE, INC., FORT WORTH, TX. FILED 10-1-2003.



OWNER OF U.S. REG. NO. 2,351,778.
 NO CLAIM IS MADE TO THE EXCLUSIVE RIGHT TO USE TRAVEL SERVICE INC., APART FROM THE MARK AS SHOWN.
 THE MARK CONSISTS OF THE WORDING GULLIVER'S TRAVEL SERVICE, INC. AND A DESIGN OF THE WORDS IN A SPECIAL FONT, WITH THE WORD "GULLIVER'S" ON THE FIRST LINE; THE WORD "TRAVEL" ON THE SECOND LINE AND THE WORDS "SERVICE, INC." ON THE THIRD LINE.
 FOR TRAVEL AGENCY SERVICES; NAMELY, MAKING RESERVATIONS AND BOOKINGS FOR TRANSPORTATION AND ARRANGING FOR TRAVEL TOURS (U.S. CLS. 100 AND 105).
 FIRST USE 3-0-1994; IN COMMERCE 3-0-1994.
 MARY ROSSMAN, EXAMINING ATTORNEY

CLASS 39—(Continued).

SN 78-396,620. SUPERIOR AIR-GROUND AMBULANCE SERVICE, INC., ELMHURST, IL. FILED 4-5-2004.

ILLINOIS MEDI-CAR

THE MARK CONSISTS OF STANDARD CHARACTERS WITHOUT CLAIM TO ANY PARTICULAR FONT, STYLE, SIZE, OR COLOR.
 SEC. 2(F).
 FOR AMBULANCE TRANSPORT (U.S. CLS. 100 AND 105).
 FIRST USE 6-17-1974; IN COMMERCE 6-17-1974.
 CAROLINE WOOD, EXAMINING ATTORNEY

SN 78-408,759. TEXAS DEPARTMENT OF TRANSPORTATION, AUSTIN, TX. FILED 4-27-2004.

SN 78-313,671. PETER G. HART, SYDNEY, NEW SOUTH WALES, AUSTRALIA, FILED 10-15-2003.



NO CLAIM IS MADE TO THE EXCLUSIVE RIGHT TO USE "VIETNAMESE VACATIONS", APART FROM THE MARK AS SHOWN.
 THE MARK CONSISTS OF IN PART OF A SILHOUETTE OF A MAN ON A BICYCLE IN FRONT OF A SQUARE WITH A STAR IN IT.
 FOR TRAVEL AGENCY SERVICES, NAMELY, MAKING RESERVATIONS AND BOOKINGS FOR TRANSPORTATION, TRAVEL BOOKING AGENCIES, ARRANGING TRAVEL TOURS, TRAVEL GUIDE SERVICES (U.S. CLS. 100 AND 105).
 FIRST USE 0-0-1998; IN COMMERCE 0-0-1998.
 PRISCILLA MILTON, EXAMINING ATTORNEY



NO CLAIM IS MADE TO THE EXCLUSIVE RIGHT TO USE TEXAS DEPARTMENT OF TRANSPORTATION, APART FROM THE MARK AS SHOWN.
 THE COLOR(S) RED, WHITE, BLUE AND BLACK IS/ARE CLAIMED AS A FEATURE OF THE MARK.
 THE MARK CONSISTS OF THE WORD "DALTRANS" WITH THE "DAL" IN BLACK AND THE RED "TRANS" LEANING SLIGHTLY TO THE RIGHT. A BLUE LINE SEPARATES "DALTRANS" FROM THE WORDS "TEXAS DEPARTMENT OF TRANSPORTATION" WHICH ARE WRITTEN IN BLACK UNDERNEATH. A DEPICTION OF A BLUE HIGHWAY IS TO THE LEFT AND ABOVE THE "DALTRANS" WITH THE BLUE OUTLINE OF THE DALLAS SKYLINE TO THE RIGHT OF THE HIGHWAY.
 FOR TRAFFIC CONTROL AND TRAFFIC INFORMATION SERVICES FOR MOTORISTS (U.S. CLS. 100 AND 105).
 FIRST USE 2-1-2001; IN COMMERCE 10-1-2001.
 ANDREW BENZMILLER, EXAMINING ATTORNEY

CLASS 39—(Continued).

SN 78-416,078. BAZUCA.COM CHILE S.A., SANTIAGO, CHILE, FILED 5-10-2004.

BAZUCA

THE MARK CONSISTS OF STANDARD CHARACTERS WITHOUT CLAIM TO ANY PARTICULAR FONT, STYLE, SIZE, OR COLOR.

OWNER OF CHILE REG. NO. 575137, DATED 8-25-2000, EXPIRES 8-25-2010.

OWNER OF U.S. REG. NO. 2,541,395.

FOR GENERAL STORAGE SERVICES; DISTRIBUTION SERVICES, NAMELY, PICK-UP AND PACKAGING FOR SHIPMENT OF PACKAGES AND GENERAL MERCHANDISE FOR OTHERS; TRANSPORTATION AND DELIVERY SERVICES, NAMELY, SAME DAY AND TWO-DAY SHIPMENT SERVICES (U.S. CLS. 100 AND 105).

HENRY S. ZAK, EXAMINING ATTORNEY

CLASS 39—(Continued).

SN 78-445,112. SUPERIOR AIR-GROUND AMBULANCE SERVICE, INC., ELMHURST, IL. FILED 7-2-2004.

**SUPERIOR AIR-
GROUND AMBULANCE
SERVICE**

THE MARK CONSISTS OF STANDARD CHARACTERS WITHOUT CLAIM TO ANY PARTICULAR FONT, STYLE, SIZE, OR COLOR.

NO CLAIM IS MADE TO THE EXCLUSIVE RIGHT TO USE "AIR-GROUND AMBULANCE SERVICE", APART FROM THE MARK AS SHOWN.

SEC. 2(F).

FOR AMBULANCE TRANSPORT (U.S. CLS. 100 AND 105).

FIRST USE 6-17-1974; IN COMMERCE 6-17-1974.

SKYE YOUNG, EXAMINING ATTORNEY

SN 78-432,413. ISRAM WHOLESALE TOURS & TRAVEL LTD., NEW YORK, NY. FILED 6-9-2004.

PRIDEWORLD

THE MARK CONSISTS OF STANDARD CHARACTERS WITHOUT CLAIM TO ANY PARTICULAR FONT, STYLE, SIZE, OR COLOR.

FOR WHOLESALE AND RETAIL TRAVEL SERVICES, NAMELY ARRANGING TRAVEL TOURS (U.S. CLS. 100 AND 105).

FIRST USE 10-31-2002; IN COMMERCE 10-31-2002.

MARK SPARACINO, EXAMINING ATTORNEY

SN 78-447,228. SANTILLI, JOE, MIAMI, FL. FILED 7-7-2004.

PLANET RINGTONE

THE MARK CONSISTS OF STANDARD CHARACTERS WITHOUT CLAIM TO ANY PARTICULAR FONT, STYLE, SIZE, OR COLOR.

NO CLAIM IS MADE TO THE EXCLUSIVE RIGHT TO USE "RING TONE", APART FROM THE MARK AS SHOWN.

FOR STORAGE SERVICES FOR ARCHIVING OF ELECTRONIC MEDIA, NAMELY, IMAGES, TEXT AND AUDIO DATA (U.S. CLS. 100 AND 105).

FIRST USE 2-1-2004; IN COMMERCE 2-1-2004.

FRED MANDIR, EXAMINING ATTORNEY

CLASS 39—(Continued).

SN 78-458,045. ZUBOX, LLC, BELCAMP, MD. FILED 7-28-2004.

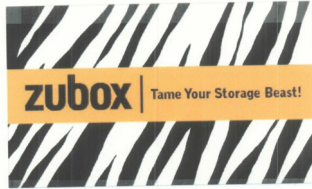

THE COLOR(S) YELLOW AND BLACK AND WHITE IS/ ARE CLAIMED AS A FEATURE OF THE MARK.

THE MARK CONSISTS OF RECTANGLE OF WHITE AND BLACK ZEBRA STRIPES WITH SMALL NARROW YELLOW RECTANGLE IN THE MIDDLE OF THE ZEBRA STRIPES. THE WORD "ZUBOX" IN BOLD BLACK LETTERS WITH A BLACK LINE SEPARATING "ZUBOX" AND "TAME YOUR STORAGE BEAST!"

FOR WAREHOUSE STORAGE (U.S. CLS. 100 AND 105).

FIRST USE 9-1-2004; IN COMMERCE 9-1-2004.
MARGERY A. TIERNEY, EXAMINING ATTORNEY

CLASS 39—(Continued).

SN 78-475,704. SOUTHWEST AIRLINES CO., DALLAS, TX. FILED 8-30-2004.

WANNA GET AWAY?

THE MARK CONSISTS OF STANDARD CHARACTERS WITHOUT CLAIM TO ANY PARTICULAR FONT, STYLE, SIZE, OR COLOR.

FOR TRANSPORTATION SERVICES BY AIR (U.S. CLS. 100 AND 105).

FIRST USE 3-1-1998; IN COMMERCE 3-1-1998.
TRACY WHITAKER-BOWN, EXAMINING ATTORNEY

SN 78-476,504. OHIO RIVER PIPE LINE LLC, FINDLAY, OH. FILED 8-31-2004.



OWNER OF U.S. REG. NO. 2,833,180.
NO CLAIM IS MADE TO THE EXCLUSIVE RIGHT TO USE "PRODUCTS PIPELINE", APART FROM THE MARK AS SHOWN.

FOR TRANSMITTING PETROLEUM BY PIPELINE (U.S. CLS. 100 AND 105).

FIRST USE 12-22-2003; IN COMMERCE 12-22-2003.
WINSTON FOLMAR, EXAMINING ATTORNEY

SN 78-470,505. DALEY TRANSPORT., LLC, LOS ANGELES, CA. FILED 8-19-2004.



NO CLAIM IS MADE TO THE EXCLUSIVE RIGHT TO USE "TRANSPORT", APART FROM THE MARK AS SHOWN.

THE MARK CONSISTS, IN PART, OF A TRUCK AND TWO HANDS IN A CIRCLE.

FOR GLOBAL TRANSPORTATION OF FREIGHT FOR OTHERS BY ALL AVAILABLE MEANS (U.S. CLS. 100 AND 105).

FIRST USE 12-1-2001; IN COMMERCE 12-1-2001.
SALLY SHIH, EXAMINING ATTORNEY

SN 78-476,566. MONTGOMERY COUNTY, MARYLAND, ROCKVILLE, MD. FILED 8-31-2004.



NO CLAIM IS MADE TO THE EXCLUSIVE RIGHT TO USE "MONTGOMERY COUNTY TRANSIT", APART FROM THE MARK AS SHOWN.

FOR TRANSPORT OF PASSENGERS BY BUS (U.S. CLS. 100 AND 105).

FIRST USE 6-1-1988; IN COMMERCE 6-1-1988.
ERNEST SHOSHO, EXAMINING ATTORNEY

CLASS 39—(Continued).

SN 78-489,633. BUCKET O' BREW, LLC, MIDDLETON, ID. FILED 9-25-2004.



THE COLOR(S) RED, GREEN, BLUE, TAN, BROWN, GRAY, MAROON, YELLOW, PURPLE, RED IS/ARE CLAIMED AS A FEATURE OF THE MARK.

THE COLOR BLUE APPEARS IN THE BANNER FEATURING THE WORD BUCKET O' BREW AND IN A BOTTLE, THE COLOR MAROON APPEARS IN THE OVAL RING, THE COLOR YELLOW APPEARS IN THE WHEAT AND THE ICE IN THE BUCKET, THE COLOR PURPLE APPEARS IN THE GRAPES, THE COLOR GREEN APPEARS IN THE LEAVES AND A BOTTLE, THE COLOR BROWN APPEARS IN THE BOTTLES, THE COLOR GRAY APPEARS IN THE BUCKET.

FOR DELIVERY OF THEMED GIFT BUCKETS OF PREMIUM BOTTLES OF BEER AND WINE (U.S. CLS. 100 AND 105).

FIRST USE 7-21-2004; IN COMMERCE 9-23-2004.
ANGELA M. MICHELI, EXAMINING ATTORNEY

SN 78-490,541. EZ DRIVE, DAVIS, CA. FILED 9-28-2004.

EZ Drive

THE MARK CONSISTS OF STANDARD CHARACTERS WITHOUT CLAIM TO ANY PARTICULAR FONT, STYLE, SIZE, OR COLOR.

NO CLAIM IS MADE TO THE EXCLUSIVE RIGHT TO USE "DRIVE", APART FROM THE MARK AS SHOWN.

FOR ELECTRONIC STORAGE OF DATA, TEXT, IMAGES, VIDEO, AUDIO WHICH MAY BE ACCESSED IN A SEAMLESS MANNER OVER A GLOBAL COMPUTER NETWORK VIA A USER'S PERSONAL COMPUTER (U.S. CLS. 100 AND 105).

MICHAEL KAZAZIAN, EXAMINING ATTORNEY

CLASS 39—(Continued).

SN 78-492,859. SMARTE CARTE, INC., ST. PAUL, MN. FILED 10-1-2004.

SMARTEWHEELS

THE MARK CONSISTS OF STANDARD CHARACTERS WITHOUT CLAIM TO ANY PARTICULAR FONT, STYLE, SIZE, OR COLOR.

FOR RENTING OF STROLLERS (U.S. CLS. 100 AND 105).

FIRST USE 6-15-2004; IN COMMERCE 6-15-2004.
MICHAEL TANNER, EXAMINING ATTORNEY

SN 78-495,061. CAESAR JAMES AUGUSTUS, LAKE CITY, GA. FILED 10-5-2004.

UNIVERSAL TRANSPORT FORCES

NO CLAIM IS MADE TO THE EXCLUSIVE RIGHT TO USE "TRANSPORT FORCES", APART FROM THE MARK AS SHOWN.

FOR FREIGHT TRANSPORTATION BY ROADWAY, RAIL, AIR, OR SEA (U.S. CLS. 100 AND 105).

FIRST USE 1-29-2005; IN COMMERCE 1-29-2005.
ELLEN B. AWRICH, EXAMINING ATTORNEY

SN 78-496,033. CENTRAL MASS COURIERS, INC., WORCESTER, MA. FILED 10-7-2004.

Leading the way to your door

THE MARK CONSISTS OF STANDARD CHARACTERS WITHOUT CLAIM TO ANY PARTICULAR FONT, STYLE, SIZE, OR COLOR.

FOR COURIER SERVICES OF PARCELS, MESSAGES, AND TIME SENSITIVE DATA IN THE UNITED STATES AND ABROAD, PRIMARILY BY AUTOMOBILE AND GROUND TRANSPORTATION AND OCCASIONALLY BY AIR (U.S. CLS. 100 AND 105).

FIRST USE 10-4-2004; IN COMMERCE 10-4-2004.
MARIAM MAHMOUDI, EXAMINING ATTORNEY

CLASS 39—(Continued).

SN 78-496,185. JASEN RIDES, LLC, WASHINGTON, DC.
FILED 10-7-2004.

CLASS 39—(Continued).

SN 78-497,641. U-HAUL INTERNATIONAL, INC., PHOENIX,
AZ. FILED 10-11-2004.

Bike the Sites

THE MARK CONSISTS OF STANDARD CHARACTERS
WITHOUT CLAIM TO ANY PARTICULAR FONT, STYLE,
SIZE, OR COLOR.

FOR GUIDED BICYCLE TOURS AND BICYCLE REN-
TALS (U.S. CLS. 100 AND 105).

FIRST USE 4-1-1995; IN COMMERCE 4-1-1995.

TIMOTHY FINNEGAN, EXAMINING ATTORNEY



SN 78-496,278. THE TENNERGY CORPORATION, JACK-
SON, TN. FILED 10-7-2004.

TENNERGY

THE MARK CONSISTS OF STANDARD CHARACTERS
WITHOUT CLAIM TO ANY PARTICULAR FONT, STYLE,
SIZE, OR COLOR.

FOR UTILITY SERVICES, NAMELY, TRANSMISSION
OF ELECTRICITY, NATURAL GAS AND PROPANE GAS
(U.S. CLS. 100 AND 105).

FIRST USE 12-11-1997; IN COMMERCE 12-11-1997.

SANJEEV VOHRA, EXAMINING ATTORNEY

OWNER OF U.S. REG. NOS. 2,354,804 AND 2,359,559.

NO CLAIM IS MADE TO THE EXCLUSIVE RIGHT TO
USE "TOW DOLLY EASY LOADING & UNLOADING",
APART FROM THE MARK AS SHOWN.

THE MARK CONSISTS OF A HALF CIRCLE DESIGN
CONTAINING THE WORDS U-HAUL TOW DOLLY OVER
THREE HORIZONTAL LINES WITH THE WORDS EASY
LOADING & UNLOADING UNDER THE THREE HORI-
ZONTAL LINES.

FOR RENTAL SERVICES, NAMELY, RENTAL OF
TRUCKS, TRAILERS, VANS, AUTOMOBILE FREIGHT
TRAILERS, HITCHES, PADS, TOW BARS, DOLLIES,
CARRIERS, HAND TRUCKS, MOVING EQUIPMENT,
VEHICLES, MOVING VANS; GENERAL STORAGE SER-
VICES; RENTAL OF WAREHOUSE SPACE; WARE-
HOUSE STORAGE SERVICES; RENTAL OF GARAGE
SPACE; PARKING LOT SERVICES; RENTAL OF PARK-
ING SPACES; CARGO HANDLING, CARGO UNLOAD-
ING; MOVING VAN SERVICES, MOVING VAN
SERVICES, MOVING VAN TRANSPORT; RENTAL OF
MOVING VANS; FURNITURE MOVING; DELIVERY OF
GOODS BY TRUCK, CAR OR VAN; TRUCK HAULING,
TRUCK TOWING (U.S. CLS. 100 AND 105).

FIRST USE 1-1-1999; IN COMMERCE 1-1-1999.

MONTIA G. PRESSEY, EXAMINING ATTORNEY

CLASS 39—(Continued).

SN 78-497,657. U-HAUL INTERNATIONAL, INC., PHOENIX, AZ. FILED 10-11-2004.



OWNER OF U.S. REG. NOS. 746,034, 893,891 AND OTHERS.

NO CLAIM IS MADE TO THE EXCLUSIVE RIGHT TO USE "AUTO TRANSPORT BEST RATES", APART FROM THE MARK AS SHOWN.

FOR RENTAL SERVICES, NAMELY, RENTAL OF TRUCKS, TRAILERS, VANS, AUTOMOBILE FREIGHT TRAILERS, HITCHES, PADS, TOW BARS, DOLLIES, CARRIERS, HAND TRUCKS, MOVING EQUIPMENT, VEHICLES, MOVING VANS; GENERAL STORAGE SERVICES; RENTAL OF WAREHOUSE SPACE; WAREHOUSE STORAGE SERVICES, RENTAL OF GARAGE SPACE; PARKING LOT SERVICES; RENTAL OF PARKING SPACES; CARGO HANDLING, CARGO UNLOADING; MOVING VAN SERVICES, MOVING VAN SERVICES, MOVING VAN TRANSPORT; RENTAL OF MOVING VANS; FURNITURE MOVING; DELIVERY OF GOODS BY TRUCK, CAR OR VAN; TRUCK HAULING, TRUCK TOWING (U.S. CLS. 100 AND 105).

FIRST USE 1-1-1999; IN COMMERCE 1-1-1999,
CATHERINE CAIN, EXAMINING ATTORNEY

CLASS 39—(Continued).

SN 78-502,502. ONETIME.COM, INC., LAS VEGAS, NV. FILED 10-19-2004.

ONETIME

THE MARK CONSISTS OF STANDARD CHARACTERS WITHOUT CLAIM TO ANY PARTICULAR FONT, STYLE, SIZE, OR COLOR.

FOR TRAVEL INFORMATION SERVICES, NAMELY, PROVIDING ONLINE COMPUTERIZED TRAVEL INFORMATION FOR USE BY OTHERS; PROVIDING AN ON-LINE COMPUTER DATABASE IN THE NATURE OF TRAVEL RATE COMPARISONS; PROVIDING AN ON-LINE COMPUTER DATABASE FOR COMPARING PRICES AND RATES FOR TRAVELERS, NAMELY, HOTELS, LODGING, RESTAURANTS, AIR FARE, GROUND TRANSPORTATION, CAR RENTALS, CRUISES, AND VACATIONS; TRAVEL AGENCY SERVICES, NAMELY MAKING RESERVATIONS AND BOOKINGS FOR TRANSPORTATION; ONLINE TRAVEL AGENCY SERVICES (U.S. CLS. 100 AND 105).

FIRST USE 9-26-2000; IN COMMERCE 4-7-2004.
LOURDES AYALA, EXAMINING ATTORNEY

SN 78-498,828. PPC MARKETING, LTD., PITTSBURGH, TX. FILED 10-13-2004.



NO CLAIM IS MADE TO THE EXCLUSIVE RIGHT TO USE "TRANSPORTATION COMPANY" AND THE OUTLINE OF THE MAP OF THE UNITED STATES, APART FROM THE MARK AS SHOWN.

FOR TRANSPORTATION SERVICES, NAMELY, TRANSPORTATION OF PASSENGERS AND GOODS BY RAIL, AIR, TRUCKS, BOATS AND BUSES (U.S. CLS. 100 AND 105).

INGRID C. EULIN, EXAMINING ATTORNEY

SN 78-504,377. EMPIRE AIRLINES, INC., HAYDEN, ID. FILED 10-22-2004.

WE CAN DO THAT

THE MARK CONSISTS OF STANDARD CHARACTERS WITHOUT CLAIM TO ANY PARTICULAR FONT, STYLE, SIZE, OR COLOR.

FOR AIR TRANSPORTATION SERVICES (U.S. CLS. 100 AND 105).

FIRST USE 9-30-2001; IN COMMERCE 9-30-2001.
ANDREA K. NADELMAN, EXAMINING ATTORNEY

CLASS 39—(Continued).

SN 78-504,427. DELTA CORPORATE IDENTITY, INC.,
ATLANTA, GA. FILED 10-22-2004.

GOOD GOES AROUND

THE MARK CONSISTS OF STANDARD CHARACTERS
WITHOUT CLAIM TO ANY PARTICULAR FONT, STYLE,
SIZE, OR COLOR.

FOR AIR TRANSPORTATION SERVICES (U.S. CLS.
100 AND 105).

FIRST USE 1-5-2005; IN COMMERCE 1-5-2005.

RUSS HERMAN, EXAMINING ATTORNEY

SN 78-506,054. GOCAR RENTALS, INC., SAN FRANCISCO,
CA. FILED 10-26-2004.



NO CLAIM IS MADE TO THE EXCLUSIVE RIGHT TO
USE "RENTALS", APART FROM THE MARK AS SHOWN.

FOR RENTAL OF GPS GUIDED TOUR VEHICLES;
ARRANGING EXCURSIONS FOR TOURISTS (U.S. CLS.
100 AND 105).

FIRST USE 4-10-2004; IN COMMERCE 4-10-2004.

INGRID C. EULIN, EXAMINING ATTORNEY

SN 78-529,606. ENTERPRISE RENT-A-CAR COMPANY, ST.
LOUIS, MO. FILED 12-9-2004.



OWNER OF U.S. REG. NOS. 2,064,660, 2,532,725 AND
OTHERS.

NO CLAIM IS MADE TO THE EXCLUSIVE RIGHT TO
USE "1 800 RENT-A-CAR" AND "VAN", APART FROM THE
MARK AS SHOWN.

FOR VEHICLE RENTAL AND LEASING SERVICES,
AND RESERVATION SERVICES FOR THE RENTAL
AND LEASING OF VEHICLES (U.S. CLS. 100 AND 105).

FIRST USE 5-31-2001; IN COMMERCE 5-31-2001.

MARY CRAWFORD, EXAMINING ATTORNEY

CLASS 39—(Continued).

SN 78-535,406. LIGHTNING JOE'S, INC., NEW FREEDOM,
PA. FILED 12-20-2004.

Lightning Joe's

THE MARK CONSISTS OF STANDARD CHARACTERS
WITHOUT CLAIM TO ANY PARTICULAR FONT, STYLE,
SIZE, OR COLOR.

FOR FREIGHT FORWARDING AND GLOBAL
TRANSPORTATION OF FREIGHT FOR OTHERS BY
ALL AVAILABLE MEANS (U.S. CLS. 100 AND 105).

FIRST USE 2-24-2004; IN COMMERCE 9-22-2004.

CHERYL STEPLIGHT, EXAMINING ATTORNEY

SN 78-535,434. LIGHTNING JOE'S, INC., NEW FREEDOM,
PA. FILED 12-20-2004.

**Putting your
freight delivery on
the fast track**

THE MARK CONSISTS OF STANDARD CHARACTERS
WITHOUT CLAIM TO ANY PARTICULAR FONT, STYLE,
SIZE, OR COLOR.

FOR FREIGHT FORWARDING AND GLOBAL
TRANSPORTATION OF FREIGHT FOR OTHERS BY
ALL AVAILABLE MEANS (U.S. CLS. 100 AND 105).

FIRST USE 9-22-2004; IN COMMERCE 9-22-2004.

ESTHER BELENKER, EXAMINING ATTORNEY

CLASS 39—(Continued).

SN 78-535,483. ORBITAL STORAGE & TRANSPORT, INC., TOLEDO, OH. FILED 12-20-2004.



NO CLAIM IS MADE TO THE EXCLUSIVE RIGHT TO USE "STORAGE, TRANSPORT AND INC"., APART FROM THE MARK AS SHOWN.

FOR STORAGE AND TRANSPORTATION SERVICES, NAMELY, PROVIDING PORTABLE MODULAR CONTAINERS FOR ON-SITE STORAGE USE BY CUSTOMERS, TRANSPORTATION SERVICES USING PORTABLE MODULAR CONTAINERS LOADED BY CUSTOMERS, OFF-SITE STORAGE SERVICES USING PORTABLE MODULAR CONTAINERS FILLED BY CUSTOMERS, AND LEVEL LIFTING AND TRANSPORT OF BOTH EMPTY AND FILLED PORTABLE MODULAR CONTAINERS (U.S. CLS. 100 AND 105).

FIRST USE 2-29-2004; IN COMMERCE 2-29-2004.
LESLEY LAMOTHE, EXAMINING ATTORNEY

SN 78-536,759. HEARTPASS, INC., PORT WASHINGTON, NY. FILED 12-22-2004.

HEARTPASS

THE MARK CONSISTS OF STANDARD CHARACTERS WITHOUT CLAIM TO ANY PARTICULAR FONT, STYLE, SIZE, OR COLOR.

FOR PROVIDING SECURE ELECTRONIC STORAGE OF A PATIENT'S BASELINE ELECTROCARDIOGRAM (ECG) AND OTHER CRITICAL CARDIAC INFORMATION THAT CAN BE RETRIEVED OVER THE INTERNET (U.S. CLS. 100 AND 105).

FIRST USE 9-0-2004; IN COMMERCE 9-0-2004.
DAVID YONTEF, EXAMINING ATTORNEY

CLASS 39—(Continued).

SN 78-539,870. MOOLAH PLACE, L.P., ST. LOUIS, MO. FILED 12-29-2004.

MOOLAH PARKING

THE MARK CONSISTS OF STANDARD CHARACTERS WITHOUT CLAIM TO ANY PARTICULAR FONT, STYLE, SIZE, OR COLOR.

NO CLAIM IS MADE TO THE EXCLUSIVE RIGHT TO USE "PARKING", APART FROM THE MARK AS SHOWN.

FOR OPERATION OF VEHICLE PARKING LOTS (U.S. CLS. 100 AND 105).

FIRST USE 2-13-2003; IN COMMERCE 2-13-2003.
DAYNA BROWNE, EXAMINING ATTORNEY

SN 79-005,880. NORBERT DENTRESSANGLE, FRANCE. FILED 7-30-2004.



OWNER OF INTERNATIONAL REGISTRATION 0535944 DATED 3-6-1989, EXPIRES 3-6-2009.

FOR TRANSPORTATION OF GOODS VIA AIR, BOAT, RAIL, BUS, AND TRUCKS; RENTAL OF INDUSTRIAL VEHICLES, NAMELY, CRANES, TRACTORS, TRUCKS, TRAILERS, ROAD TANKERS, REFRIGERATED VEHICLES, TIPPERS AND SWAP BODIES; BAGGING, NAMELY, PACKING ARTICLES FOR SHIPPING AND TRANSPORTATION; WAREHOUSING SERVICES (U.S. CLS. 100 AND 105).

MICHAEL TANNER, EXAMINING ATTORNEY

CLASS 40—MATERIAL TREATMENT

SN 76-454,314. BEST SIGNS, INC., PALM SPRINGS, CA. FILED 9-26-2002.

BESTSIGNS

SEC. 2(F).

FOR CUSTOM MANUFACTURE OF TWO AND THREE DIMENSIONAL SIGNS, SIGN CABINETS, ILLUMINATED LETTERS, FLEET MARKINGS, SIGN LETTERING AND VINYL LETTERING; PRINTING, NAMELY DIGITAL PRINTING AND SILK SCREEN PRINTING (U.S. CLS. 100, 103 AND 106).

FIRST USE 0-0-1960; IN COMMERCE 0-0-1960.
BILL DAWE, EXAMINING ATTORNEY

CLASS 40—(Continued).

SN 76-584,588. INNOVANCE, INC., ALBERT LEA, MN.
FILED 4-2-2004.

INNOVANCE

THE MARK CONSISTS OF STANDARD CHARACTERS WITHOUT CLAIM TO ANY PARTICULAR FONT, STYLE, SIZE, OR COLOR.

FOR CUSTOM MANUFACTURE OF GENERAL PRODUCT LINES IN THE FIELDS OF AUTOMOTIVE SERVICE EQUIPMENT, INDUSTRIAL EQUIPMENT, PAINT GUN CLEANING EQUIPMENT AND SOLVENT RECLAIMING EQUIPMENT AND CUSTOM MANUFACTURE OF PARTS, ASSEMBLIES AND STRUCTURAL PARTS RELATED TO AUTOMOTIVE SERVICE EQUIPMENT, INDUSTRIAL EQUIPMENT, PAINT GUN CLEANING EQUIPMENT AND SOLVENT RECLAIMING EQUIPMENT (U.S. CLS. 100, 103 AND 106).

SKYE YOUNG, EXAMINING ATTORNEY

SN 76-587,459. OUR SUNDAY VISITOR, INC., HUNTINGTON, IN. FILED 4-19-2004.



SEC. 2(F) AS TO "AMERICANCHURCH".
FOR PRINTING SERVICES PRIMARILY FOR CHURCHES AND OTHER PLACES OF WORSHIP, NAMELY, PRINTING OFFERING ENVELOPES, BUSINESS ENVELOPES, BUSINESS CARDS, STATIONERY, BULLETINS, PASTORAL LETTERS, CORRESPONDENCE NOTES AND RECORD KEEPING FORMS (U.S. CLS. 100, 103 AND 106).

FIRST USE 12-31-1995; IN COMMERCE 12-31-1995.
MONTIA G. PRESSEY, EXAMINING ATTORNEY

SN 76-587,460. OUR SUNDAY VISITOR, INC., HUNTINGTON, IN. FILED 4-19-2004.

AMERICANCHURCH

THE MARK CONSISTS OF STANDARD CHARACTERS WITHOUT CLAIM TO ANY PARTICULAR FONT, STYLE, SIZE, OR COLOR.

SEC. 2(F).
FOR PRINTING SERVICES PRIMARILY FOR CHURCHES AND OTHER PLACES OF WORSHIP, NAMELY, PRINTING OFFERING ENVELOPES, BUSINESS ENVELOPES, BUSINESS CARDS, STATIONERY, BULLETINS, PASTORAL LETTERS, CORRESPONDENCE NOTES AND RECORD KEEPING FORMS (U.S. CLS. 100, 103 AND 106).

FIRST USE 12-31-1995; IN COMMERCE 12-31-1995.
MONTIA G. PRESSEY, EXAMINING ATTORNEY

CLASS 40—(Continued).

SN 76-588,299. PLIANT CORPORATION, SCHAUMBURG, IL. FILED 4-21-2004.

CRYSTAL TUBULAR

THE MARK CONSISTS OF STANDARD CHARACTERS WITHOUT CLAIM TO ANY PARTICULAR FONT, STYLE, SIZE, OR COLOR.

NO CLAIM IS MADE TO THE EXCLUSIVE RIGHT TO USE "TUBULAR", APART FROM THE MARK AS SHOWN.

FOR CUSTOM MANUFACTURING IN THE FIELD OF PLASTIC FILMS FOR INDUSTRIAL AND COMMERCIAL USE (U.S. CLS. 100, 103 AND 106).

ANNE FARRELL, EXAMINING ATTORNEY

SN 76-589,675. IMAGINEERING ENTERPRISES, INC., SOUTH BEND, IN. FILED 4-26-2004.

KNOWLEDGESOURCE

THE MARK CONSISTS OF STANDARD CHARACTERS WITHOUT CLAIM TO ANY PARTICULAR FONT, STYLE, SIZE, OR COLOR.

FOR METAL FINISHING AND APPLYING PROTECTIVE COATINGS TO METAL SUBSTRATES (U.S. CLS. 100, 103 AND 106).

FIRST USE 11-30-2003; IN COMMERCE 11-30-2003.
BRIDGETT SMITH, EXAMINING ATTORNEY

SN 76-590,894. LION BROTHERS COMPANY, INC., OWINGS MILLS, MD. FILED 5-6-2004.



FOR TEXTILE TREATMENT IN THE NATURE OF REMOVING THE TOP LAYER OF THE MATERIAL TO FASHION A DESIGN IN THE FABRIC (U.S. CLS. 100, 103 AND 106).

FIRST USE 12-18-2003; IN COMMERCE 12-18-2003.
KELLEY WELLS, EXAMINING ATTORNEY

CLASS 40—(Continued).

SN 76-590,978. NI AUTOWINDOW SYSTEMS INC., LEXINGTON, KY. FILED 5-7-2004.



NO CLAIM IS MADE TO THE EXCLUSIVE RIGHT TO USE "AUTO WINDOW" & "INC.", APART FROM THE MARK AS SHOWN.
FOR VEHICLE COMPONENT ASSEMBLY SERVICES FOR OTHERS (U.S. CLS. 100, 103 AND 106).
FIRST USE 11-0-2003; IN COMMERCE 11-0-2003.
KARANENDRA S. CHHINA, EXAMINING ATTORNEY

CLASS 40—(Continued).

SN 76-605,316. BC INTERNATIONAL GROUP, INC., TOTOWA, NJ. FILED 8-3-2004.

SILK GLOSS

THE MARK CONSISTS OF STANDARD CHARACTERS WITHOUT CLAIM TO ANY PARTICULAR FONT, STYLE, SIZE, OR COLOR.
NO CLAIM IS MADE TO THE EXCLUSIVE RIGHT TO USE "GLOSS", APART FROM THE MARK AS SHOWN.
FOR PROVIDING REPELLANT PROCESSES FOR PROTECTION OF FUR COATS AND FUR PRODUCTS FROM WINTER ELEMENTS (U.S. CLS. 100, 103 AND 106).
FIRST USE 11-0-1999; IN COMMERCE 11-0-1999.
BRIAN NEVILLE, EXAMINING ATTORNEY

SN 76-590,980. NI AUTOWINDOW SYSTEMS INC., LEXINGTON, KY. FILED 5-7-2004.

NI AUTOWINDOW SYSTEMS, INC.

THE MARK CONSISTS OF STANDARD CHARACTERS WITHOUT CLAIM TO ANY PARTICULAR FONT, STYLE, SIZE, OR COLOR.
NO CLAIM IS MADE TO THE EXCLUSIVE RIGHT TO USE "AUTO WINDOW" & "INC.", APART FROM THE MARK AS SHOWN.
FOR VEHICLE COMPONENT ASSEMBLY SERVICES FOR OTHERS (U.S. CLS. 100, 103 AND 106).
FIRST USE 11-0-2003; IN COMMERCE 11-0-2003.
KARANENDRA S. CHHINA, EXAMINING ATTORNEY

SN 76-609,424. INGRETEC, LTD, LEBANON, PA. FILED 8-30-2004.

INGRETEC

THE MARK CONSISTS OF STANDARD CHARACTERS WITHOUT CLAIM TO ANY PARTICULAR FONT, STYLE, SIZE, OR COLOR.
FOR CUSTOM MANUFACTURING OF CHEESE FLAVORINGS FOR THE FOOD PROCESSING INDUSTRY (U.S. CLS. 100, 103 AND 106).
FIRST USE 1-1-1993; IN COMMERCE 1-1-1993.
TINA L. SNAPP, EXAMINING ATTORNEY

SN 76-604,973. NEMSCHOFF CHAIRS, INC., SHEBOYGAN, WI. FILED 8-2-2004.

REAL WORLD R&D

THE MARK CONSISTS OF STANDARD CHARACTERS WITHOUT CLAIM TO ANY PARTICULAR FONT, STYLE, SIZE, OR COLOR.
FOR FURNITURE MANUFACTURING SERVICES, NAMELY, DEVELOPING FURNITURE TO THE SPECIFICATION OF OTHERS (U.S. CLS. 100, 103 AND 106).
FIRST USE 3-0-2004; IN COMMERCE 3-0-2004.
SUSAN HAYASH, EXAMINING ATTORNEY

SN 76-611,293. MOTOR COMPONENTS, LLC, ELMIRA, NY. FILED 9-14-2004.

WE MOVE FUEL

THE MARK CONSISTS OF STANDARD CHARACTERS WITHOUT CLAIM TO ANY PARTICULAR FONT, STYLE, SIZE, OR COLOR.
FOR MANUFACTURE OF FUEL PUMPS FOR ENGINES AND FUEL HANDLING SYSTEMS FOR AND TO THE ORDER AND SPECIFICATION OF OTHERS (U.S. CLS. 100, 103 AND 106).
FIRST USE 3-15-2004; IN COMMERCE 3-15-2004.
MARTHA FROMM, EXAMINING ATTORNEY

CLASS 40—(Continued).

SN 76-616,391. TXDC, L.P., IRVING, TX. FILED 10-18-2004.

GORDON'S LASERGUARD PROTECTION

THE MARK CONSISTS OF STANDARD CHARACTERS WITHOUT CLAIM TO ANY PARTICULAR FONT, STYLE, SIZE, OR COLOR.

OWNER OF U.S. REG. NOS. 1,637,241, 2,835,139 AND OTHERS.

NO CLAIM IS MADE TO THE EXCLUSIVE RIGHT TO USE PROTECTION, APART FROM THE MARK AS SHOWN.

FOR IDENTIFICATION INSCRIPTION AND MARKING SERVICES FOR JEWELRY (U.S. CLS. 100, 103 AND 106).

FIRST USE 10-4-2004; IN COMMERCE 10-4-2004.
KELLEY WELLS, EXAMINING ATTORNEY

SN 76-617,828. AARON BROTHERS, INC., IRVING, TX.
FILED 10-27-2004.

WE FRAME THE THINGS YOU LOVE

THE MARK CONSISTS OF STANDARD CHARACTERS WITHOUT CLAIM TO ANY PARTICULAR FONT, STYLE, SIZE, OR COLOR.

NO CLAIM IS MADE TO THE EXCLUSIVE RIGHT TO USE FRAME, APART FROM THE MARK AS SHOWN.

FOR FRAMING WORKS OF ART FOR OTHERS (U.S. CLS. 100, 103 AND 106).

FIRST USE 3-0-2004; IN COMMERCE 3-0-2004.
EVELYN BRADLEY, EXAMINING ATTORNEY

SN 76-618,481. FCX PERFORMANCE, INC., COLUMBUS, OH. FILED 10-29-2004.

QUICK-I.D.

THE MARK CONSISTS OF STANDARD CHARACTERS WITHOUT CLAIM TO ANY PARTICULAR FONT, STYLE, SIZE, OR COLOR.

FOR CUSTOM SILICONE LABELING OF HIGH-PURITY AND INDUSTRIAL HOSES (U.S. CLS. 100, 103 AND 106).

FIRST USE 10-27-2004; IN COMMERCE 10-27-2004.
TEJBIR SINGH, EXAMINING ATTORNEY

CLASS 40—(Continued).

SN 76-626,589. IBIS CONSULTING, INC., PROVIDENCE, RI. FILED 12-30-2004.

CONTROL YOUR DATA

THE MARK CONSISTS OF STANDARD CHARACTERS WITHOUT CLAIM TO ANY PARTICULAR FONT, STYLE, SIZE, OR COLOR.

FOR DOCUMENT DATA TRANSFER AND PHYSICAL CONVERSION FROM ONE MEDIA TO ANOTHER (U.S. CLS. 100, 103 AND 106).

FIRST USE 5-18-2001; IN COMMERCE 5-18-2001.
SUSAN HAYASH, EXAMINING ATTORNEY

SN 76-626,592. IBIS CONSULTING, INC., PROVIDENCE, RI.
FILED 12-30-2004.

IBIS

THE MARK CONSISTS OF STANDARD CHARACTERS WITHOUT CLAIM TO ANY PARTICULAR FONT, STYLE, SIZE, OR COLOR.

FOR DOCUMENT DATA TRANSFER AND PHYSICAL CONVERSION FROM ONE MEDIA TO ANOTHER (U.S. CLS. 100, 103 AND 106).

FIRST USE 8-3-1992; IN COMMERCE 8-3-1992.
SUSAN HAYASH, EXAMINING ATTORNEY

SN 78-234,958. GEIGER, STEPHEN, JOSEPH, BURBANK, CA.
FILED 4-8-2003.

SIMPLE CD

NO CLAIM IS MADE TO THE EXCLUSIVE RIGHT TO USE "CD", APART FROM THE MARK AS SHOWN.

FOR DATA TRANSFER AND PHYSICAL CONVERSION OF DIGITAL INFORMATION, NAMELY, AUDIO DATA, VIDEO DATA, IMAGE DATA, AND TEXT DATA FROM ONE MEDIA TO CD-ROM AND/OR DVD-ROM (U.S. CLS. 100, 103 AND 106).

FIRST USE 5-13-2002; IN COMMERCE 4-5-2003.
RUSS HERMAN, EXAMINING ATTORNEY

CLASS 40—(Continued).

SN 78-321,995. ALL THAT GLITTERS, INC., FRANKFORT, IL. FILED 11-2-2003.



All that Glitters

NO CLAIM IS MADE TO THE EXCLUSIVE RIGHT TO USE "THE DESIGN OF A DIAMOND", APART FROM THE MARK AS SHOWN.

THE MARK CONSISTS OF STYLIZED WORDING WITH A THREE-DIMENSIONAL DIAMOND ABOVE THE LETTER "I" IN THE WORD "GLITTER".

FOR CUSTOM MANUFACTURE OF JEWELRY. (U.S. CLS. 100, 103 AND 106).

FIRST USE 3-1-2002; IN COMMERCE 3-1-2002.

CHERYL CLAYTON, EXAMINING ATTORNEY

SN 78-365,750. PORT-O-SHRED, LLC, PASADENA, CA. FILED 2-10-2004.

PORT-O-SHRED
Secure On-Site
Document Destruction

THE MARK CONSISTS OF STANDARD CHARACTERS WITHOUT CLAIM TO ANY PARTICULAR FONT, STYLE, SIZE, OR COLOR.

NO CLAIM IS MADE TO THE EXCLUSIVE RIGHT TO USE "SECURE ON-SITE DOCUMENT DESTRUCTION", APART FROM THE MARK AS SHOWN.

FOR SECURE ON-SITE DOCUMENT DESTRUCTION, NAMELY FOR DOCUMENTS, DATA STORAGE MEDIA, PLASTIC CREDIT AND IDENTIFICATION CARDS, AND DOCUMENT-BASED MATERIALS, DOCUMENT-BASED ARTICLES, DOCUMENT-BASED GOODS AND DOCUMENT-BASED PRODUCTS, WHETHER CONTAINING PERSONAL, BUSINESS, LEGAL, TECHNICAL, MEDICAL, FINANCIAL OR CONFIDENTIAL OR SECURITY INFORMATION; DOCUMENT SHREDDING SERVICES FOR DOCUMENTS, DATA STORAGE MEDIA, AND DOCUMENT-BASED MATERIALS, DOCUMENT-BASED ARTICLES, DOCUMENT-BASED GOODS AND DOCUMENT-BASED PRODUCTS; RECYCLING OF WASTE PAPER FOR PULPING (U.S. CLS. 100, 103 AND 106).

FIRST USE 3-15-2003; IN COMMERCE 3-15-2003.

CHRISTOPHER ADKINS, EXAMINING ATTORNEY

CLASS 40—(Continued).

SN 78-368,829. FLOWERS FOREVER, BROMSGROVE, UNITED KINGDOM, FILED 2-17-2004.



Flowers
Forever

NO CLAIM IS MADE TO THE EXCLUSIVE RIGHT TO USE FLOWERS, APART FROM THE MARK AS SHOWN.

THE COLOR(S) GREEN IS/ARE CLAIMED AS A FEATURE OF THE MARK.

THE MARK CONSISTS OF GREEN STYLIZED F WITH A LOOP TO THE BASE OF THE MARK ENCAPSULATING THE WHOLE MARK AND A STYLIZED FLOWER AT THE END. ALL MARK WITH A DROP SHADOW.

FOR FLORAL PRESERVATION (U.S. CLS. 100, 103 AND 106).

FIRST USE 0-0-1990; IN COMMERCE 0-0-1992.

ROBIN CHOSID, EXAMINING ATTORNEY

SN 78-370,946. SCIENTIFIC DRILLING INTERNATIONAL, INC., HOUSTON, TX. FILED 2-19-2004.

**SCIENTIFIC
DRILLING**

THE MARK CONSISTS OF STANDARD CHARACTERS WITHOUT CLAIM TO ANY PARTICULAR FONT, STYLE, SIZE, OR COLOR.

NO CLAIM IS MADE TO THE EXCLUSIVE RIGHT TO USE "DRILLING", APART FROM THE MARK AS SHOWN. SEC. 2(F).

FOR OIL AND GAS PRODUCTION SERVICES (U.S. CLS. 100, 103 AND 106).

FIRST USE 12-31-1990; IN COMMERCE 1-10-1991.

KARLA PERKINS, EXAMINING ATTORNEY

CLASS 40—(Continued).

SN 78-376,431. GROUPE ELECTROPOLI, SAINT JAMES, FRANCE, FILED 3-1-2004.

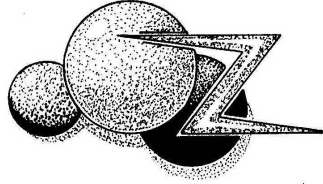

OWNER OF FRANCE REG. NO. 033253308, DATED 10-24-2003, EXPIRES 10-24-2013.

THE STIPPLING SHOWN IN THE DRAWING IS FOR SHADING PURPOSES ONLY SHOWING THE THREE DIMENSIONAL NATURE OF THE MARK.

THE MARK CONSISTS OF THREE SPHERES AND A LIGHTENING BOLT.

FOR CHROMIUM PLATING; NICKEL PLATING; METAL PLATING BY ELECTROLYZE; BURNISHING BY ABRASION; MATERIAL TREATMENT, NAMELY, CONVERSION, CHEMICAL AND PHYSICAL TREATMENT OF STEEL, INOX STEEL, CAST IRON, ALUMINUM AND ALLOYS THEREOF AND ABS BY PLATING OR COATING THESE MATERIALS WITH COPPER, NICKEL, CHROME, GOLD, SILVER, ZINC, IRON, TIN, LEAD, CADMIUM OR ALUMINUM, ANODIC OXIDATION, CHROMATING, PASSIVATION, RINSING, PICKLING, DEGREASING AND/OR GALVANIZING TO IMPROVE APPEARANCE, TEXTURE, DURABILITY, DEGREASE AND/OR DEODOXIDIZE THE SURFACE (U.S. CLS. 100, 103 AND 106).

CHERYL CLAYTON, EXAMINING ATTORNEY

CLASS 40—(Continued).

SN 78-445,341. CUSTOM SPINE, INC., PARSIPPANY, NJ, FILED 7-2-2004.

Your Ideas
Engineered to Life

THE MARK CONSISTS OF STANDARD CHARACTERS WITHOUT CLAIM TO ANY PARTICULAR FONT, STYLE, SIZE, OR COLOR.

FOR CUSTOM MANUFACTURING OF MEDICAL INSTRUMENTS FOR SPINAL SURGICAL OPERATIONS (U.S. CLS. 100, 103 AND 106).

FIRST USE 1-1-2004; IN COMMERCE 2-1-2004.

SHARI SHEFFIELD, EXAMINING ATTORNEY

SN 78-453,140. ENGINETICS CORPORATION, HUBER HEIGHTS, OH. FILED 7-20-2004.

ENGINETICS

SN 78-440,591. FEDERAL BUSINESS PRODUCTS, INC., CLIFTON, NJ. FILED 6-24-2004.

Next Generation
Forms

THE MARK CONSISTS OF STANDARD CHARACTERS WITHOUT CLAIM TO ANY PARTICULAR FONT, STYLE, SIZE, OR COLOR.

NO CLAIM IS MADE TO THE EXCLUSIVE RIGHT TO USE "FORMS", APART FROM THE MARK AS SHOWN.

FOR PRINTING OF BUSINESS FORMS (U.S. CLS. 100, 103 AND 106).

FIRST USE 6-9-2004; IN COMMERCE 6-9-2004.

ANDREA SAUNDERS, EXAMINING ATTORNEY

THE MARK CONSISTS OF STANDARD CHARACTERS WITHOUT CLAIM TO ANY PARTICULAR FONT, STYLE, SIZE, OR COLOR.

OWNER OF U.S. REG. NO. 1,307,931.

FOR CUSTOM MANUFACTURE OF PARTS FOR THE AEROSPACE INDUSTRY, NAMELY EXHAUST LINERS, DIVERGENT FLAPS, BRACKETS, BLADE RETAINERS, TURBINE SUPPORTS, LINER SUPPORTS, FLAME-HOLDERS, AIR BAFFLES, SUMP SEALS, WIRE SEALS, COMPRESSOR SHROUDS, TURBINE NOZZLES, AIR SEALS, HEAT SHIELDS, RING SEALS, INNER AND OUTER COWLS, EXHAUST NOZZLES, AUGMENTOR DAMPERS, LINER STRUTS, LINERS, TURBINE CASES, TURBINE FRAMES, AUGMENTOR DUCTS, RETAINING STRAPS, WINDAGE SHIELDS, NOZZLE PARTITIONS, DIFFUSER CASES, BEARING CAGES, SHROUD SEALS, COMBUSTION LINERS, DEFLECTORS, CENTERBODY BAFFLES, COUNTERBALANCE WEIGHTS, LINER SEGMENTS, INNER/OUTER SEALS, RETAINER SEALS, FAN DUCTS, OIL SEAL RETAINERS, FLAME-HOLDERS SWIRLERS, AND AUGMENTOR RINGS (U.S. CLS. 100, 103 AND 106).

FIRST USE 5-3-2004; IN COMMERCE 5-3-2004.

ZACHARY BELLO, EXAMINING ATTORNEY

CLASS 40—(Continued).

SN 78-453,732. GENERAL ATOMICS ELECTRONIC SYSTEMS, INC., SAN DIEGO, CA. FILED 7-20-2004.

**GENERAL ATOMICS
ELECTRONIC
SYSTEMS, INC.**

THE MARK CONSISTS OF STANDARD CHARACTERS WITHOUT CLAIM TO ANY PARTICULAR FONT, STYLE, SIZE, OR COLOR.

OWNER OF U.S. REG. NOS. 709,041, 1,549,501 AND 1,555,093.

NO CLAIM IS MADE TO THE EXCLUSIVE RIGHT TO USE "ELECTRONIC SYSTEMS, INC.", APART FROM THE MARK AS SHOWN.

FOR CUSTOM MANUFACTURING AND ASSEMBLY OF ELECTRICAL COMPONENTS AND SUBSYSTEMS; NAMELY- TERMINAL AUTOMATION SYSTEMS FOR INTEGRATED BULK DISTRIBUTION OF PETROLEUM, FERTILIZER AND CHEMICAL PRODUCTS; RADIATION MONITORING AND MEASURING INSTRUMENTS; AND HIGH VOLTAGE CAPACITORS, POWER SUPPLIES, RESISTORS, AND FUSES (U.S. CLS. 100, 103 AND 106).

FIRST USE 12-1-2003; IN COMMERCE 12-1-2003.
G. MAYERSCHOFF, EXAMINING ATTORNEY

CLASS 40—(Continued).

SN 78-487,023. CAUTTRELL ENTERPRISES, INC., ST. LOUIS, MO. FILED 9-21-2004.



OWNER OF U.S. REG. NO. 1,858,061.
NO CLAIM IS MADE TO THE EXCLUSIVE RIGHT TO USE "SPECIALTY PRODUCTS", APART FROM THE MARK AS SHOWN.

THE COLOR(S) GRAY AND GREEN IS/ARE CLAIMED AS A FEATURE OF THE MARK.

THE MARK CONSISTS OF THE LETTERS CEI IN STYLIZED FORM ALONG WITH THE WORDS CEI SPECIALTY PRODUCTS. THE STYLIZED C IS IN GRAY; THE TWO LINES THAT DEFINE THE E AND THE LINE FOR THE I ARE IN GREEN.

FOR CUSTOM STEEL ROLLING AND FABRICATION TO THE ORDER AND SPECIFICATION OF OTHERS (U.S. CLS. 100, 103 AND 106).

FIRST USE 9-8-2004; IN COMMERCE 9-9-2004.
RICHARD WHITE, EXAMINING ATTORNEY

SN 78-490,876. GUSTAFSON, FREDERICK RICHARD, SHELTON, WA. FILED 9-28-2004.

SN 78-468,869. DOCENTRUST SYSTEMS, NEWPORT BEACH, CA. FILED 8-17-2004.



THE COLOR(S) BLACK AND YELLOW IS/ARE CLAIMED AS A FEATURE OF THE MARK.

THE MARK CONSISTS OF A CAPITAL D, LOWERCASE OC, CAPITAL E, LOWERCASE N, CAPITAL T IN A YELLOW CIRCLE WITH BLACK LINES AND A PADLOCK, LOWERCASE RUST.

FOR DOCUMENT IMAGING SERVICES IN THE NATURE OF CONVERTING DOCUMENTS FROM PAPER AND DIGITAL FORMATS INTO ELECTRONIC FORMAT THAT ARE SEARCHABLE AND RETRIEVABLE AND DIGITALLY STORED IN ELECTRONIC VAULTS ACCESSIBLE BY AUTHORIZED USERS VIA A GLOBAL COMPUTER NETWORK (U.S. CLS. 100, 103 AND 106).

FIRST USE 1-1-2005; IN COMMERCE 1-1-2005.
MARGERY A. TIERNEY, EXAMINING ATTORNEY

KwiKolor

THE MARK CONSISTS OF STANDARD CHARACTERS WITHOUT CLAIM TO ANY PARTICULAR FONT, STYLE, SIZE, OR COLOR.

FOR SCREEN PRINTING AND EMBROIDERY SERVICES FOR GARMENTS AND SIGNS (U.S. CLS. 100, 103 AND 106).

FIRST USE 10-1-1989; IN COMMERCE 10-1-1989.
ALINA MORRIS, EXAMINING ATTORNEY

CLASS 40—(Continued).

SN 78-500,858. SUN VALLEY RICE COMPANY, LLC, ARBUCKLE, CA. FILED 10-15-2004.

SUN VALLEY RICE

THE MARK CONSISTS OF STANDARD CHARACTERS WITHOUT CLAIM TO ANY PARTICULAR FONT, STYLE, SIZE, OR COLOR.

NO CLAIM IS MADE TO THE EXCLUSIVE RIGHT TO USE "RICE", APART FROM THE MARK AS SHOWN, FOR RICE MILLING (U.S. CLS. 100, 103 AND 106). FIRST USE 3-31-1999; IN COMMERCE 12-31-1999. KIMBERLY PERRY, EXAMINING ATTORNEY

CLASS 40—(Continued).

SN 78-516,249. STUDSVIK DEVELOPMENT, INC., ERWIN, TN. FILED 11-12-2004.

MINROC

THE MARK CONSISTS OF STANDARD CHARACTERS WITHOUT CLAIM TO ANY PARTICULAR FONT, STYLE, SIZE, OR COLOR.

FOR WASTE TREATMENT SERVICES, NAMELY, CONVERTING WASTES TO STABILIZED MINERAL MONOLITHS FOR STORAGE AND DISPOSAL (U.S. CLS. 100, 103 AND 106). ROBERT LAVACHE, EXAMINING ATTORNEY

SN 78-505,728. LATEX FOAM INTERNATIONAL HOLDINGS, INC., SHELTON, CT. FILED 10-26-2004.

YOUR BEST BEDSIDE
MANNER

THE MARK CONSISTS OF STANDARD CHARACTERS WITHOUT CLAIM TO ANY PARTICULAR FONT, STYLE, SIZE, OR COLOR.

FOR MANUFACTURE OF LATEX FOAM MATTRESSES, CUSHIONS, AND MATTRESS TOPPERS TO THE ORDER AND SPECIFICATION OF OTHERS (U.S. CLS. 100, 103 AND 106). FIRST USE 10-15-2004; IN COMMERCE 10-15-2004. THEODORE MCBRIDE, EXAMINING ATTORNEY

SN 78-518,697. SAFETY AND ECOLOGY HOLDINGS CORPORATION, KNOXVILLE, TN. FILED 11-17-2004.



NO CLAIM IS MADE TO THE EXCLUSIVE RIGHT TO USE "FEDERAL SERVICES CORPORATION", APART FROM THE MARK AS SHOWN.

FOR NUCLEAR REACTOR DEACTIVATION AND CLOSURE SERVICES (U.S. CLS. 100, 103 AND 106). LINDA M. KING, EXAMINING ATTORNEY

CLASS 40—(Continued).

SN 78-519,276. BECKER AUTOMOTIVE DESIGN, INC., OXNARD, CA. FILED 11-18-2004.

CLASS 40—(Continued).

SN 78-524,160. HALLIBURTON ENERGY SERVICES, INC., CARROLLTON, TX. FILED 11-30-2004.



BARASORB

FOR CUSTOM MANUFACTURE OF AUTOMOTIVE INTERIORS, SYSTEMS AND COMPONENTS, NAMELY, INSTRUMENT PANELS, HEADLINERS, DOOR PANELS, DOOR TRIM, FLOOR CONSOLES, SUN VISORS, GRAB HANDLES, PILLAR TRIM, GLOVE BOXES, QUARTER PANELS, FLOOR SCUFFS, SEAT STRUCTURES, LIGHTING, TABLES, SEATING AND ELECTRONICS (U.S. CLS. 100, 103 AND 106).

DOUGLAS LEE, EXAMINING ATTORNEY

THE MARK CONSISTS OF STANDARD CHARACTERS WITHOUT CLAIM TO ANY PARTICULAR FONT, STYLE, SIZE, OR COLOR.

OWNER OF U.S. REG. NOS. 1,184,304 AND 2,803,365.

FOR WASTE TREATMENT AND TREATMENT OF CONTAMINATION IN OIL AND GAS WELLS. (U.S. CLS. 100, 103 AND 106).

MELISSA SHELLA, EXAMINING ATTORNEY

SN 78-520,885. TXU CORP., DALLAS, TX. FILED 11-22-2004.

SN 78-533,165. AMERICAN TRIM, L.L.C., LIMA, OH. FILED 12-15-2004.



MONOFORM

NO CLAIM IS MADE TO THE EXCLUSIVE RIGHT TO USE POWER, APART FROM THE MARK AS SHOWN.

THE MARK CONSISTS OF EMBOSSED STAR TO THE LEFT OF THE LITERAL ELEMENT.

FOR POWER GENERATION, NAMELY THE GENERATION OF ELECTRIC POWER (U.S. CLS. 100, 103 AND 106).

FIRST USE 6-21-2004; IN COMMERCE 6-21-2004.
HOWARD SMIGA, EXAMINING ATTORNEY

THE MARK CONSISTS OF STANDARD CHARACTERS WITHOUT CLAIM TO ANY PARTICULAR FONT, STYLE, SIZE, OR COLOR.

FOR STAMPING, DRAWING AND EXTRUDING METAL PARTS FOR OTHERS IN THE AUTOMOTIVE, APPLIANCE AND CONSTRUCTION INDUSTRIES (U.S. CLS. 100, 103 AND 106).

LANA PHAM, EXAMINING ATTORNEY

CLASS 40—(Continued).

SN 78-536,046. R.R. FLOODY COMPANY, INC., ROCK-FORD, IL. FILED 12-21-2004.

KMV

THE MARK CONSISTS OF STANDARD CHARACTERS WITHOUT CLAIM TO ANY PARTICULAR FONT, STYLE, SIZE, OR COLOR.

FOR CUSTOM MANUFACTURE OF X-RAY EQUIPMENT TO THE ORDER AND SPECIFICATION OF OTHERS (U.S. CLS. 100, 103 AND 106).

FIRST USE 1-0-2003; IN COMMERCE 1-0-2003.
KEVIN DINALLO, EXAMINING ATTORNEY

SN 78-536,204. K.T.'S KITCHENS, INC., CARSON, CA. FILED 12-21-2004.

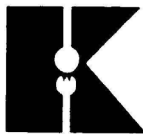

K.T.'S KITCHENS, INC.

OWNER OF U.S. REG. NOS. 1,770,278 AND 2,281,256.
NO CLAIM IS MADE TO THE EXCLUSIVE RIGHT TO USE "KITCHENS, INC.", APART FROM THE MARK AS SHOWN.

THE MARK CONSISTS OF A STYLIZED LETTER K WITH A STYLIZED REPRESENTATION OF A SPOON AND FORK SUPERIMPOSED OVER THE LETTER.

FOR MANUFACTURE OF PROCESSED FOOD PRODUCTS TO THE ORDER AND SPECIFICATION OF OTHERS (U.S. CLS. 100, 103 AND 106).

FIRST USE 6-1-1987; IN COMMERCE 6-1-1987.
ESTHER BELENKER, EXAMINING ATTORNEY

CLASS 40—(Continued).

SN 78-537,068. BELLSOUTH INTELLECTUAL PROPERTY CORPORATION, WILMINGTON, DE. FILED 12-22-2004.

VALUE OPTION

THE MARK CONSISTS OF STANDARD CHARACTERS WITHOUT CLAIM TO ANY PARTICULAR FONT, STYLE, SIZE, OR COLOR.

FOR PRODUCT RECYCLING PROGRAM IN THE FIELD OF TELECOMMUNICATIONS EQUIPMENT (U.S. CLS. 100, 103 AND 106).

CIMMERIAN COLEMAN, EXAMINING ATTORNEY

SN 78-538,558. SUN VALLEY RICE COMPANY, LLC, ARBUCKLE, CA. FILED 12-27-2004.

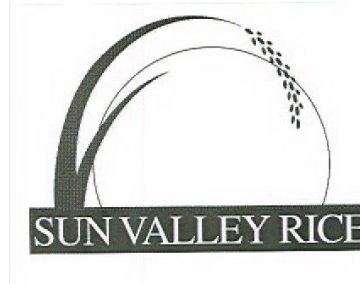

NO CLAIM IS MADE TO THE EXCLUSIVE RIGHT TO USE "RICE", APART FROM THE MARK AS SHOWN.
FOR RICE MILLING (U.S. CLS. 100, 103 AND 106).
FIRST USE 12-31-1999; IN COMMERCE 12-31-1999.
KIMBERLY PERRY, EXAMINING ATTORNEY

CLASS 41—EDUCATION AND ENTERTAINMENT

SN 75-763,185. ROBERT HALL TRADING SEMINARS INC., SIDNEY, BRITISH COLUMBIA, CANADA, FILED 7-29-1999.

THE PIRANHA

PRIORITY CLAIMED UNDER SEC. 44(D) ON CANADA APPLICATION NO. 1,003,858, FILED 2-1-1999.

FOR ON-LINE PUBLICATIONS, NAMELY, A DAILY NEWSLETTER DEALING WITH STOCK MARKET ISSUES ACCESSIBLE BY MEANS OF A GLOBAL COMPUTER NETWORK (U.S. CLS. 100, 101 AND 107).

PAULA MAYS, EXAMINING ATTORNEY

CLASS 41—(Continued).

SN 75-806,054. PETER MATTHEW PRODUCTIONS, INC., RIDGEFIELD, CT. FILED 9-22-1999.



FOR ENTERTAINMENT SERVICES, NAMELY, A SERIES OF TELEVISION PROGRAMS IN A NEWS MAGAZINE-FORMAT FEATURING HEALTH CARE NEWS AND INFORMATION RELATING TO HEALTH AND WELLNESS (U.S. CLS. 100, 101 AND 107).
 JULIA HARDY COFIELD, EXAMINING ATTORNEY

SN 75-921,976. HONDA GIKEN KOGYO KABUSHIKI KAISHA (HONDA MOTOR CO., LTD.), MINATO-KU, TOKYO 107, JAPAN, FILED 2-17-2000.



OWNER OF U.S. REG. NOS. 826,779 AND 2,341,038.
 NO CLAIM IS MADE TO THE EXCLUSIVE RIGHT TO USE "QUALITY TECHNICAL CENTER", APART FROM THE MARK AS SHOWN.
 FOR EDUCATIONAL SERVICES, NAMELY, PROVIDING TRAINING IN MANAGEMENT (U.S. CLS. 100, 101 AND 107).
 JULIE WATSON, EXAMINING ATTORNEY

CLASS 41—(Continued).

SN 76-315,461. NEXTMOVE INC., TORONTO, ONTARIO M5C 2W3, CANADA, FILED 9-20-2001.



PRIORITY CLAIMED UNDER SEC. 44(D) ON CANADA APPLICATION NO. 1101607, FILED 4-30-2001, REG. NO. TMA629,189, DATED 12-31-2004, EXPIRES 12-31-2019.
 THE MARK CONSISTS IN PART OF A LEAF DESIGN.
 FOR PROVIDING COURSES OF INSTRUCTION AT THE POST-SECONDARY AND COLLEGE LEVEL IN THE FIELDS OF BUSINESS, COMPUTER SOFTWARE, MANAGEMENT, PERSONNEL, HUMAN RESOURCES EDUCATION AND EMPLOYEE DEVELOPMENT TRAINING SERVICES IN THE USE OF COMPUTERS AND SOFTWARE EDUCATIONAL SERVICES, NAMELY, CONDUCTING WORKSHOPS, SEMINARS, AND CLASSES VIA A GLOBAL COMMUNICATION NETWORK AND VIA APPLICATIONS HOSTED ON A COMPUTER IN THE FIELDS OF BUSINESS, COMPUTER SOFTWARE, MANAGEMENT, PERSONNEL, HUMAN RESOURCES EDUCATION AND EMPLOYEE DEVELOPMENT PROVIDING INSTRUCTION BY ELECTRONIC MEANS IN THE FIELDS OF BUSINESS, COMPUTER SOFTWARE, MANAGEMENT, PERSONNEL, HUMAN RESOURCES EDUCATION AND EMPLOYEE DEVELOPMENT (U.S. CLS. 100, 101 AND 107).
 G. MAYERSCHOFF, EXAMINING ATTORNEY

SN 76-365,723. AMERICAN FOUNDRY SOCIETY, DES PLAINES, IL. FILED 2-1-2002.

AMERICAN FOUNDRY SOCIETY

NO CLAIM IS MADE TO THE EXCLUSIVE RIGHT TO USE "SOCIETY", APART FROM THE MARK AS SHOWN.
 SEC. 2(F).
 FOR EDUCATIONAL SERVICES, NAMELY CONDUCTING SEMINARS AND PUBLISHING BOOKS, MAGAZINES, NEWS LETTERS, AND RESEARCH REPORTS ALL IN THE FIELD OF FOUNDRY RELATED TECHNOLOGY AND OPERATION; PRODUCTION OF VIDEO CASSETTES AND VIDEO DISCS FOR OTHERS IN THE FIELD OF FOUNDRY RELATED TECHNOLOGY AND OPERATION (U.S. CLS. 100, 101 AND 107).
 FIRST USE 4-0-2000; IN COMMERCE 4-0-2000.
 STACY WAHLBERG, EXAMINING ATTORNEY

CLASS 41—(Continued).

SN 76-366,058. RANDOM ACTS OF KINDNESS FOUNDATION, THE, DENVER, CO. FILED 2-1-2002.

RAK

FOR EDUCATION AND ENTERTAINMENT SERVICES, NAMELY ORGANIZING EVENTS AND ASSISTING OTHERS WITH ORGANIZING EVENTS INSTRUCTING AND ENCOURAGING THE DOING OF KIND ACTS FOR OTHERS (U.S. CLS. 100, 101 AND 107).
FIRST USE 1-1-1993; IN COMMERCE 1-1-1993.
KAREN K. BUSH, EXAMINING ATTORNEY

SN 76-366,062. RANDOM ACTS OF KINDNESS FOUNDATION, THE, DENVER, CO. FILED 2-1-2002.

RAK WEEK

NO CLAIM IS MADE TO THE EXCLUSIVE RIGHT TO USE "WEEK", APART FROM THE MARK AS SHOWN.
FOR EDUCATION AND ENTERTAINMENT SERVICES, NAMELY ORGANIZING EVENTS AND ASSISTING OTHERS WITH ORGANIZING EVENTS INSTRUCTING AND ENCOURAGING THE DOING OF KIND ACTS FOR OTHERS (U.S. CLS. 100, 101 AND 107).
FIRST USE 6-1-1996; IN COMMERCE 6-1-1996.
KAREN K. BUSH, EXAMINING ATTORNEY

SN 76-405,864. BRUCE MAST & ASSOCIATES, INC., EXETER, NH. FILED 5-3-2002.

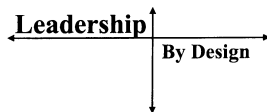

NO CLAIM IS MADE TO THE EXCLUSIVE RIGHT TO USE "LEADERSHIP" AND "ASSOCIATES, INC." AND "PROFESSIONALS IN LEADERSHIP AND ORGANIZATIONAL DEVELOPMENT", APART FROM THE MARK AS SHOWN.
FOR EDUCATIONAL SERVICES, NAMELY, PROVIDING SEMINARS AND COURSES OF INSTRUCTION TO BUSINESSES AND OTHER ORGANIZATIONS ON LEADERSHIP SKILLS AND ORGANIZATIONAL DEVELOPMENT (U.S. CLS. 100, 101 AND 107).
FIRST USE 11-1-2001; IN COMMERCE 11-1-2001.
DAWN FELDMAN, EXAMINING ATTORNEY

CLASS 41—(Continued).

SN 76-406,261. FREEFALL ADVENTURES, INC., WILLIAMSTOWN, NJ. FILED 5-10-2002.

YOU HAVEN'T LIVED UNTIL YOU'VE HAD A FREEFALL ADVENTURE

NO CLAIM IS MADE TO THE EXCLUSIVE RIGHT TO USE "FREEFALL", APART FROM THE MARK AS SHOWN.
FOR EDUCATIONAL SERVICES, NAMELY, PROVIDING INSTRUCTIONS AND TRAINING IN PARACHUTING AND SKYDIVING AND ENTERTAINMENT SERVICES IN THE NATURE OF PARACHUTING AND SKYDIVING EXHIBITIONS (U.S. CLS. 100, 101 AND 107).
FIRST USE 4-0-1989; IN COMMERCE 4-0-1989.
DAWN FELDMAN, EXAMINING ATTORNEY

SN 76-406,262. FREEFALL ADVENTURES, INC., WILLIAMSTOWN, NJ. FILED 5-10-2002.

FREEFALL ADVENTURES

NO CLAIM IS MADE TO THE EXCLUSIVE RIGHT TO USE "FREEFALL", APART FROM THE MARK AS SHOWN.
FOR EDUCATIONAL SERVICES, NAMELY, PROVIDING INSTRUCTIONS AND TRAINING IN PARACHUTING AND SKYDIVING AND ENTERTAINMENT SERVICES IN THE NATURE OF PARACHUTING AND SKYDIVING EXHIBITIONS (U.S. CLS. 100, 101 AND 107).
FIRST USE 4-0-1986; IN COMMERCE 4-0-1988.
DAWN FELDMAN, EXAMINING ATTORNEY

SN 76-409,013. THE EXECUTIVE CONVERSATION, INC., SEATTLE, WA. FILED 5-16-2002.

CIA

FOR EDUCATIONAL SERVICES, NAMELY CONDUCTING COMPUTER-AIDED CLASSES AND SEMINARS IN THE FIELDS OF BUSINESS MANAGEMENT, SALES AND MARKETING, CUSTOMER RELATIONSHIPS, CUSTOMER AND ACCOUNT DEVELOPMENT AND CONCERNS, FINANCIAL ANALYSIS TECHNIQUES AND BUSINESS ACUMEN; AND DISTRIBUTING COURSE MATERIALS IN THE NATURE OF PROPRIETARY COMPUTER SOFTWARE FOR DATA ANALYSIS AND ACCOMPANYING TEXT BOOKS, WORK BOOKS, LESSON PLANS, EXAMPLE PROBLEMS AND CASE STUDIES IN CONNECTION THEREWITH (U.S. CLS. 100, 101 AND 107).
FIRST USE 1-0-1998; IN COMMERCE 1-0-1998.
WON TEAK OH, EXAMINING ATTORNEY

CLASS 41—(Continued).

SN 76-436,596. SOUP2NUTS INC., WATERTOWN, MA.
FILED 8-1-2002.



FOR ENTERTAINMENT SERVICES, NAMELY PRODUCTION AND DISTRIBUTION OF TELEVISION PROGRAMMING FOR OTHERS; PRODUCTION AND DISTRIBUTION OF ANIMATED AND LIVE ACTION SHORT FILMS VIA THE INTERNET (U.S. CLS. 100, 101 AND 107).

FIRST USE 0-0-1994; IN COMMERCE 0-0-1995.
MICHAEL KAZAZIAN, EXAMINING ATTORNEY

SN 76-476,966. CELESTIAL PICTURES LIMITED, KOWLOON, HONG KONG, FILED 12-18-2002.

天映娛樂

OWNER OF U.S. REG. NO. 2,649,601.

THE NON-LATIN CHARACTERS IN THE MARK TRANSLITERATION TO TIAN YING DAO AND THIS ROUGHLY MEANS SKY, SHINE, REFLECT, AND FREQUENCY IN ENGLISH.

FOR PRODUCTION AND DISTRIBUTION OF MOTION PICTURES AND DOCUMENTARIES; SCRIPT WRITING SERVICES; AUDIO RECORDING AND PRODUCTION OF MUSIC; CONDUCTING ENTERTAINMENT EXHIBITIONS IN THE NATURE OF FILM FESTIVALS AND ORGANIZING AND CONDUCTING ENTERTAINING EXHIBITIONS IN THE FIELDS OF FILM TECHNOLOGY; CONDUCTING AWARD CEREMONIES TO PROMOTE EXCELLENCE IN THE ENTERTAINMENT INDUSTRY; ENTERTAINMENT IN THE NATURE OF TELEVISION SHOWS AND DOCUMENTARIES IN THE FIELDS OF ACTION/ADVENTURE, COMEDY, CRIME, DRAMA, HORROR, MUSICALS, SCIENCE FICTION, WAR, WESTERNS, SOAP OPERAS, MARTIAL ARTS, SPORTS, NEWS, AND GAME SHOWS; ENTERTAINMENT IN THE NATURE OF LIVE AND ON-LINE MUSICAL PERFORMANCES, FILM FESTIVALS, AND FASHION SHOWS; PROVIDING ON-LINE COMPUTER GAMES; ENTERTAINMENT IN THE NATURE OF VISUAL AND AUDIO PERFORMANCES, DANCE PERFORMANCES, AMUSEMENT PARK SHOWS, AND THEATRE PRODUCTIONS; ENTERTAINMENT SERVICES, NAMELY PROVIDING A WEB SITE FEATURING MUSICAL PERFORMANCES, MUSICAL VIDEOS, PHOTOGRAPHS, MOVIES, LIVE-ACTIONS, COMEDIES, DRAMAS, RELATED FILM CLIPS, AND OTHER MULTIMEDIA MATERIALS, AND RELATED REVIEWS; ENTERTAINMENT SERVICES, NAMELY LIVE, TELEvised AND MOVIE APPEARANCES BY PROFESSIONAL ENTERTAINERS, MOVIE STARS, SINGERS, AND SPORTS CELEBRITIES; ENTERTAINMENT SERVICES, NAMELY PROVIDING TELEVISION PRO-

CLASS 41—(Continued).

GRAMS IN THE FIELDS OF MOVIES, LIVE-ACTIONS, COMEDIES, AND DRAMAS VIA A GLOBAL COMPUTER NETWORK; ENTERTAINMENT SERVICES, NAMELY PROVIDING ON-LINE REVIEWS OF MOVIES, LIVE-ACTIONS, COMEDIES, DRAMAS, BOOKS, MUSIC AND COMPUTER GAMES; ARRANGING TICKET RESERVATIONS FOR SHOWS AND OTHER ENTERTAINMENT EVENTS; EDUCATIONAL AND ENTERTAINMENT SERVICES, NAMELY PROVIDING MOTIVATIONAL AND EDUCATIONAL SPEAKERS; ENTERTAINMENT IN THE NATURE OF COMPETITIONS IN THE FIELDS OF FILMS, TELEVISION SHOWS, TELEVISION SERIES, MUSIC, FASHION, SPORTS, ANIMATION SHOWS, DANCE, THEATRE PRODUCTIONS, AND ON-LINE COMPUTER GAMES; ENTERTAINMENT SERVICES, NAMELY PROVIDING PRERECORDED MUSIC, INFORMATION IN THE FIELD OF MUSIC, AND COMMENTARY AND ARTICLES ABOUT MUSIC, ALL ON-LINE VIA A GLOBAL COMPUTER NETWORK AND ELECTRONIC GLOBAL COMMUNICATIONS NETWORK; ENTERTAINMENT, NAMELY LIVE PERFORMANCES BY MUSICAL BANDS; ENTERTAINMENT, NAMELY LIVE MUSIC CONCERTS; RADIO ENTERTAINMENT PRODUCTION; ENTERTAINMENT SERVICES, NAMELY PROVIDING RADIO PROGRAMS, TELEVISION PROGRAMS, AND CONDUCTING CONTESTS AND FESTIVALS IN THE FIELDS OF MUSIC, FILM, SPORTS, ANIMATION, AND AUDIO AND VISUAL SHOWS VIA A GLOBAL COMPUTER NETWORK; ENTERTAINMENT SERVICES, NAMELY CONDUCTING CONTESTS ON BOARD CRUISE SHIPS FOR PASSENGERS OF ALL AGES, IN FUNCTION ROOMS, STADIUMS, EXHIBITION CENTERS, CONCERT HALLS, PARKS, OR SHOPPING MALLS; RADIO ENTERTAINMENT SERVICES, NAMELY RADIO PROGRAMS FEATURING PERFORMANCES BY FICTIONAL CHARACTERS, RADIO OR SPORTS OR MOVIE OR GAMES PERSONALITIES, PROFESSIONAL ENTERTAINERS, MOVIE STARS, SINGERS OR SPORTS CELEBRITIES; MOVIE STUDIOS; MOVIE THEATRES; AND PRODUCTION OF RADIO AND TELEVISION PROGRAMS; ANIMATION PRODUCTION SERVICES (U.S. CLS. 100, 101 AND 107).

TONI HICKEY, EXAMINING ATTORNEY

SN 76-476,968. CELESTIAL PICTURES LIMITED, KOWLOON, HONG KONG, FILED 12-18-2002.

天映

OWNER OF U.S. REG. NO. 2,649,601.

THE NON-LATIN CHARACTERS IN THE MARK TRANSLITERATE TO TIAN YING AND THIS ROUGHLY MEANS SKY, SHINE, AND REFLECT.

FOR PRODUCTION AND DISTRIBUTION OF MOTION PICTURES AND DOCUMENTARIES; SCRIPT WRITING SERVICES; AUDIO RECORDING AND PRODUCTION OF MUSIC; CONDUCTING ENTERTAINMENT EXHIBITIONS IN THE NATURE OF FILM FESTIVALS AND ORGANIZING AND CONDUCTING ENTERTAINMENT EXHIBITIONS IN THE FIELD OF FILM TECHNOLOGY; CONDUCTING AWARD CEREMONIES TO PROMOTE EXCELLENCE IN THE ENTERTAINMENT INDUSTRY; ENTERTAINMENT IN THE NATURE OF TELEVISION SHOWS AND DOCUMENTARIES IN THE FIELDS OF ACTION/ADVENTURE, COMEDY, CRIME, DRAMA, HORROR, MUSICALS, SCIENCE FICTION, WAR, WESTERNS, SOAP OPERAS, MARTIAL ARTS, SPORTS, NEWS, AND GAME SHOWS; ENTERTAINMENT IN THE NATURE OF LIVE AND ON-LINE MUSICAL PERFORMANCES, FILM FESTIVALS, AND FASHION SHOWS; PROVIDING ON-LINE COMPUTER GAMES; ENTERTAINMENT IN THE NATURE OF VISUAL AND AUDIO PERFORMANCES, DANCE PERFORMANCES, AMUSEMENT PARK SHOWS, AND

CLASS 41—(Continued).

THEATRE PRODUCTIONS; ENTERTAINMENT SERVICES, NAMELY PROVIDING A WEB SITE FEATURING MUSICAL PERFORMANCES, MUSICAL VIDEOS, PHOTOGRAPHS, MOVIES, LIVE-ACTIONS, COMEDIES, DRAMAS, RELATED FILM CLIPS, AND OTHER MULTIMEDIA MATERIALS, AND RELATED REVIEWS; ENTERTAINMENT SERVICES, NAMELY LIVE, TELEVISED AND MOVIE APPEARANCES BY PROFESSIONAL ENTERTAINERS, MOVIE STARS, SINGERS, AND SPORTS CELEBRITIES; ENTERTAINMENT SERVICES, NAMELY PROVIDING TELEVISION PROGRAMS IN THE FIELDS OF MOVIES, LIVE-ACTIONS, COMEDIES, AND DRAMAS VIA A GLOBAL COMPUTER NETWORK; ENTERTAINMENT SERVICES, NAMELY PROVIDING ON-LINE REVIEWS OF MOVIES, LIVE-ACTIONS, COMEDIES, DRAMAS, BOOKS, MUSIC AND COMPUTER GAMES; ARRANGING TICKET RESERVATIONS FOR SHOWS AND OTHER ENTERTAINMENT EVENTS; EDUCATIONAL AND ENTERTAINMENT SERVICES, NAMELY PROVIDING MOTIVATIONAL AND EDUCATIONAL SPEAKERS; ENTERTAINMENT IN THE NATURE OF COMPETITIONS IN THE FIELDS OF FILMS, TELEVISION SHOWS, TELEVISION SERIES, MUSIC, FASHION, SPORTS, ANIMATION SHOWS, DANCE, THEATRE PRODUCTIONS, AND ON-LINE COMPUTER GAMES; ENTERTAINMENT SERVICES, NAMELY PROVIDING PRERECORDED MUSIC, INFORMATION IN THE FIELD OF MUSIC, AND COMMENTARY AND ARTICLES ABOUT MUSIC, ALL ON-LINE VIA A GLOBAL COMPUTER NETWORK AND ELECTRONIC GLOBAL COMMUNICATIONS NETWORK; ENTERTAINMENT, NAMELY LIVE PERFORMANCES BY MUSICAL BANDS; ENTERTAINMENT, NAMELY LIVE MUSIC CONCERTS; RADIO ENTERTAINMENT PRODUCTION; ENTERTAINMENT SERVICES, NAMELY PROVIDING RADIO PROGRAMS, TELEVISION PROGRAMS, AND CONDUCTING CONTESTS AND FESTIVALS IN THE FIELDS OF MUSIC, FILM, SPORTS, ANIMATION, AND AUDIO AND VISUAL SHOWS VIA A GLOBAL COMPUTER NETWORK; ENTERTAINMENT SERVICES, NAMELY CONDUCTING CONTESTS ON BOARD CRUISE SHIPS FOR PASSENGERS OF ALL AGES, IN FUNCTION ROOMS, STADIUMS, EXHIBITION CENTERS, CONCERT HALLS, PARKS, OR SHOPPING MALLS; RADIO ENTERTAINMENT SERVICES, NAMELY RADIO PROGRAMS FEATURING PERFORMANCES BY FICTIONAL CHARACTERS, RADIO OR SPORTS OR MOVIE OR GAMES PERSONALITIES, PROFESSIONAL ENTERTAINERS, MOVIE STARS, SINGERS OR SPORTS CELEBRITIES; MOVIE STUDIOS; MOVIE THEATRES; AND PRODUCTION OF RADIO AND TELEVISION PROGRAMS; ANIMATION PRODUCTION SERVICES (U.S. CLS. 100, 101 AND 107).

TONI HICKEY, EXAMINING ATTORNEY

SN 76-484,338. BIGGS, HENRY, DBA FUNKY TICKLE PRODUCTIONS, ST. LOUIS, MO. FILED 1-21-2003.

HEADMESS

FOR ENTERTAINMENT SERVICES, NAMELY, LIVE MUSICAL PERFORMANCES (U.S. CLS. 100, 101 AND 107).

FIRST USE 7-30-2002; IN COMMERCE 7-30-2002.
KAREN M. STRYZ, EXAMINING ATTORNEY

CLASS 41—(Continued).

SN 76-501,137. UNIVERSITY OF PORTLAND, PORTLAND, OR. FILED 3-26-2003.

OREGON'S CATHOLIC UNIVERSITY

NO CLAIM IS MADE TO THE EXCLUSIVE RIGHT TO USE "CATHOLIC UNIVERSITY", APART FROM THE MARK AS SHOWN.

SEC. 2(F).

FOR HIGHER EDUCATION SERVICES IN THE NATURE OF COURSES AT THE UNIVERSITY LEVEL (U.S. CLS. 100, 101 AND 107).

FIRST USE 1-2-1992; IN COMMERCE 1-2-1992.

MARY BOAGNI, EXAMINING ATTORNEY

SN 76-502,927. FORDHAM UNIVERSITY, BRONX, NY. FILED 3-17-2003.

CITYSCAPE

FOR ENTERTAINMENT SERVICES, NAMELY, PROVIDING A RADIO PROGRAM IN THE FIELD OF LOCAL PUBLIC AFFAIRS AND CULTURAL FEATURES VIA RADIO AND INTERNET (U.S. CLS. 100, 101 AND 107).

FIRST USE 1-1-1988; IN COMMERCE 1-1-1988.

DAVID ELTON, EXAMINING ATTORNEY

SN 76-510,512. CORINTHIAN COLLEGES, INC., SANTA ANA, CA. FILED 4-30-2003.

BRYMAN COLLEGE

NO CLAIM IS MADE TO THE EXCLUSIVE RIGHT TO USE "COLLEGE", APART FROM THE MARK AS SHOWN.

SEC. 2(F).

FOR EDUCATIONAL SERVICES, NAMELY PROVIDING CAREER ORIENTED COURSES OF INSTRUCTION AT THE POST SECONDARY SCHOOL LEVEL IN THE BUSINESS, TECHNOLOGY AND HEALTHCARE FIELDS (U.S. CLS. 100, 101 AND 107).

FIRST USE 7-0-1966; IN COMMERCE 7-0-1966.

MATTHEW PAPPAS, EXAMINING ATTORNEY

SN 76-511,353. TRANS-HIGH CORPORATION, INC., NEW YORK, NY. FILED 5-2-2003.

HIGH TIMES

OWNER OF U.S. REG. NOS. 1,883,561, 2,780,476 AND OTHERS.

FOR ENTERTAINMENT SERVICES IN THE NATURE OF PRODUCTION AND DISTRIBUTION OF MOTION PICTURE FILMS AND TELEVISION PROGRAMS (U.S. CLS. 100, 101 AND 107).

FIRST USE 5-20-2003; IN COMMERCE 5-20-2003.

JULIE WATSON, EXAMINING ATTORNEY

CLASS 41—(Continued).

SN 76-514,691. LOVE INC, LOVE IN THE NAME OF CHRIST, MINNEAPOLIS, MN. FILED 5-15-2003.



FOR CHARITABLE SERVICES, NAMELY, PROVIDING TRAINING IN THE FIELD OF MOBILIZING LOCAL CHURCHES TO SERVE PEOPLE IN NEED (U.S. CLS. 100, 101 AND 107).

FIRST USE 4-25-2003; IN COMMERCE 5-12-2003.
ROBERT LAVACHE, EXAMINING ATTORNEY

SN 76-518,227. MEDIA WEST - APP, INC., RENO, NV. FILED 5-29-2003.

INJERSEY.COM

OWNER OF U.S. REG. NOS. 2,020,009 AND 2,022,665.
FOR PROVIDING AN INTERNET WEBSITE CONTAINING NEWS AND INFORMATION IN THE FIELD OF GENERAL AND LOCAL, NATIONAL AND INTERNATIONAL NEWS, INFORMATION ON MOVIES, THEATER, TELEVISION AND RADIO PROGRAMS, SPORTING EVENTS, CONCERTS, BOOKS, MUSEUMS, EXHIBITIONS AND FESTIVALS, IN NEW JERSEY AND INFORMATION ON SIGHTS AND ATTRACTIONS OF INTEREST FOR RESIDENTS OF AND VISITORS TO NEW JERSEY (U.S. CLS. 100, 101 AND 107).

FIRST USE 11-4-2000; IN COMMERCE 11-4-2000.
STEVEN JACKSON, EXAMINING ATTORNEY

SN 76-519,812. YOUTH OF MEMPHIS COMPETITORS ASSOCIATION, INC., MEMPHIS, TN. FILED 6-5-2003.

YOMCA

THE MARK CONSISTS OF STANDARD CHARACTERS WITHOUT CLAIM TO ANY PARTICULAR FONT, STYLE, SIZE, OR COLOR.

FOR ORGANIZING AND CONDUCTING AMATEUR ATHLETIC PROGRAMS AND ACTIVITIES (U.S. CLS. 100, 101 AND 107).

FIRST USE 1-10-2003; IN COMMERCE 1-10-2003.
ESTHER A. BORSUK, EXAMINING ATTORNEY

CLASS 41—(Continued).

SN 76-522,052. DREZ, JANET, CHANDLER, AZ. FILED 6-9-2003.

OCTOPUS FAITH

FOR EDUCATIONAL SERVICES, NAMELY, CONDUCTING WORKSHOPS, CLASSES, AND SEMINARS IN THE FIELDS OF BIBLE STUDY, SPIRITUAL GROWTH, AND OTHER CHRISTIAN FAITH-BASED ISSUES (U.S. CLS. 100, 101 AND 107).

FIRST USE 5-21-2003; IN COMMERCE 5-21-2003.
BARBARA A. GOLD, EXAMINING ATTORNEY

SN 76-539,032. SOUTHLAND ENTERTAINMENT, LLC, BESSEMER, AL. FILED 8-21-2003.

CELEBRATION CITY

FOR ENTERTAINMENT SERVICES, NAMELY, OPERATION OF AMUSEMENT AND THEME PARKS; CONDUCTING ENTERTAINMENT EXHIBITIONS IN THE NATURE OF HOLIDAY AND FESTIVAL SHOWS; AND ENTERTAINMENT IN THE NATURE OF VISUAL AND AUDIO PERFORMANCES, NAMELY, MUSICAL SHOWS (U.S. CLS. 100, 101 AND 107).

FIRST USE 5-18-1996; IN COMMERCE 5-18-1996.
TINA L. SNAPP, EXAMINING ATTORNEY

SN 76-552,096. WORLD CORPORATE IMAGE RESEARCH, INC., MONTREAL, QUEBEC, CANADA, FILED 10-15-2003.

PERSUASIONIST

PRIORITY CLAIMED UNDER SEC. 44(D) ON CANADA APPLICATION NO. 1193561, FILED 10-14-2003, REG. NO. TMA622870, DATED 10-19-2004, EXPIRES 10-19-2019.

FOR CORPORATE TRAINING SERVICES, NAMELY, PUBLIC SPEAKING AND LEADERSHIP SKILLS, PERSONAL AND GROUP MOTIVATION, BUSINESS ETIQUETTE, INTERPERSONAL COMMUNICATION SKILLS, AND BUSINESS WRITING; CONDUCTING SEMINARS, GROUP DISCUSSIONS, PERSONAL AND GROUP CONSULTATIONS, WEB SEMINARS AND CONFERENCING PERTAINING TO PUBLIC SPEAKING AND LEADERSHIP SKILLS, PERSONAL AND GROUP MOTIVATION, BUSINESS ETIQUETTE, INTERPERSONAL COMMUNICATION SKILLS, AND BUSINESS WRITING, USING OR UTILIZING ORGANIZATIONAL DEVELOPMENT AND CONSULTING BOOKS, MANUALS, PAMPHLETS, AND NEWSLETTERS IN BOTH HARD COPY AND ELECTRONIC FORM; AND TEACHING MATERIALS SUCH AS PRERECORDED AUDIO AND VIDEO CDS AND DVDS; AND POSTERS AND LAMINATED CHARTS DITRIBUTED IN CONNECTION THEREWITH. (U.S. CLS. 100, 101 AND 107).

HENRY S. ZAK, EXAMINING ATTORNEY

CLASS 41—(Continued).

SN 76-554,077. INTERNATIONAL BOARD OF LACTATION CONSULTANT EXAMINERS, FALLS CHURCH, VA. FILED 10-2-2003.



IBLCE

OWNER OF U.S. REG. NOS. 1,972,416, 2,749,041 AND OTHERS.

NO CLAIM IS MADE TO THE EXCLUSIVE RIGHT TO USE PROTECTING, PROMOTING AND SUPPORTING BREASTFEEDING WORLDWIDE, APART FROM THE MARK AS SHOWN.

THE STIPPLING IN THE DRAWING IS FOR SHADING PURPOSES ONLY.

FOR EDUCATIONAL SERVICES IN THE FIELD OF LACTATION AND BREASTFEEDING; EDUCATIONAL CONSULTING IN THE FIELD OF LACTATION AND BREASTFEEDING (U.S. CLS. 100, 101 AND 107).

FIRST USE 5-31-2002; IN COMMERCE 5-31-2002.
INGA ERVIN, EXAMINING ATTORNEY

CLASS 41—(Continued).

SN 76-559,990. EXCELSIOR RADIO NETWORKS, INC., NEW YORK, NY. FILED 10-28-2003.

GOSPEL TRAXX

NO CLAIM IS MADE TO THE EXCLUSIVE RIGHT TO USE GOSPEL, APART FROM THE MARK AS SHOWN.

FOR ENTERTAINMENT SERVICES IN THE NATURE OF AN ONGOING RADIO PROGRAM FEATURING MUSIC AND RELATED INTERVIEWS (U.S. CLS. 100, 101 AND 107).

FIRST USE 1-1-1995; IN COMMERCE 1-1-1995.
CHRIS WELLS, EXAMINING ATTORNEY

SN 76-558,443. MORTON, ALAN, NORTH KINGSTOWN, RI. FILED 11-12-2003.

SALSADANCERCISE

THE MARK CONSISTS OF STANDARD CHARACTERS WITHOUT CLAIM TO ANY PARTICULAR FONT, STYLE, SIZE, OR COLOR.

SEC. 2(F).
FOR PHYSICAL FITNESS INSTRUCTION (U.S. CLS. 100, 101 AND 107).

FIRST USE 6-0-1999; IN COMMERCE 6-0-1999.
DARRYL SPRUILL, EXAMINING ATTORNEY

SN 76-564,778. WYNN RESORTS HOLDINGS, LLC, LAS VEGAS, NV. FILED 11-28-2003.

WYNN

SN 76-558,966. SCHOLASTIC INC., NEW YORK, NY. FILED 11-10-2003.

ESCHOLASTIC

THE MARK CONSISTS OF STANDARD CHARACTERS WITHOUT CLAIM TO ANY PARTICULAR FONT, STYLE, SIZE, OR COLOR.

OWNER OF U.S. REG. NOS. 2,392,914, 2,707,701 AND OTHERS.

SEC. 2(F) SCHOLASTIC.
FOR PROVIDING INFORMATION VIA GLOBAL COMPUTER NETWORK ABOUT CHILDREN'S BOOKS, BOOK CLUBS, BOOK FAIRS, EDUCATIONAL CURRICULUM PROGRAMS AND MATERIALS, CHILDREN'S MAGAZINES, TELEVISION PROGRAMS, FILMS, HOME VIDEOS AND GAMES; PROVIDING INFORMATION VIA A GLOBAL COMPUTER NETWORK ABOUT INSTRUCTIONAL ACTIVITIES AND EDUCATIONAL GAMES FOR ELEMENTARY SCHOOL AGED CHILDREN FOR USE IN TEACHING, READING, MATH, SCIENCE, LANGUAGE ARTS, SOCIAL STUDIES, GEOGRAPHY AND HISTORY (U.S. CLS. 100, 101 AND 107).
JENNIFER MARTIN, EXAMINING ATTORNEY

THE MARK CONSISTS OF STANDARD CHARACTERS WITHOUT CLAIM TO ANY PARTICULAR FONT, STYLE, SIZE, OR COLOR.

OWNER OF U.S. REG. NO. 2,585,021.
SEC. 2(F).

FOR CASINO SERVICES AND ENTERTAINMENT SERVICES, NAMELY LIVE PERFORMANCES FEATURING SINGERS, DANCERS, MAGICIANS, ACTORS, ACROBATS, AND COMEDIANS, INTEGRATED WITH PRERECORDED MUSIC AND VIDEO (U.S. CLS. 100, 101 AND 107).
ANGELA M. MICHELI, EXAMINING ATTORNEY

CLASS 41—(Continued).

SN 76-564,981. GLOBAL LEARNING SEMESTERS, INC., RESTON, VA. FILED 12-1-2003.

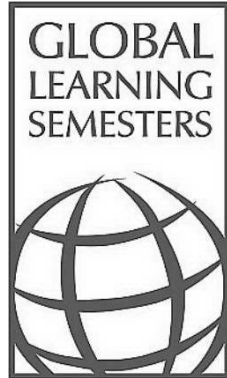

FOR EDUCATIONAL SERVICES IN THE NATURE OF CONDUCTING ACCREDITED OVERSEAS STUDY PROGRAMS, INCLUDING SUMMER STUDY PROGRAMS, FOR UNDERGRADUATE UNIVERSITY STUDENTS, COMBINING CLASSROOM LEARNING WITH FIELD-BASED STUDY INVOLVING SUPERVISED TRAVEL TO MULTIPLE COUNTRIES; GUIDED STUDY TOURS OF INTERNATIONAL DESTINATIONS AND SITES FOR SENIOR CITIZENS (U.S. CLS. 100, 101 AND 107).

FIRST USE 3-1-2004; IN COMMERCE 3-1-2004.
NICHOLAS ALTREE, EXAMINING ATTORNEY

SN 76-565,803. POPPY TOM ENDEAVORS, INC., MANALAPAN, NJ. FILED 11-28-2003.

REAL FANTASY WRESTLING

THE MARK CONSISTS OF STANDARD CHARACTERS WITHOUT CLAIM TO ANY PARTICULAR FONT, STYLE, SIZE, OR COLOR.

NO CLAIM IS MADE TO THE EXCLUSIVE RIGHT TO USE FANTASY WRESTLING, APART FROM THE MARK AS SHOWN.

FOR ENTERTAINMENT SERVICES, NAMELY, CONDUCTING ON-LINE, MULTIPLE-USER, INTERACTIVE CONTESTS FEATURING FANTASY PROFESSIONAL WRESTLING COMPETITIONS (U.S. CLS. 100, 101 AND 107).

FIRST USE 8-19-2003; IN COMMERCE 8-19-2003.
BARBARA GAYNOR, EXAMINING ATTORNEY

CLASS 41—(Continued).

SN 76-566,537. DIVORCETALK, INC., MIAMI, FL. FILED 12-15-2003.

DIVORCE TALK

NO CLAIM IS MADE TO THE EXCLUSIVE RIGHT TO USE "DIVORCE", APART FROM THE MARK AS SHOWN. FOR ENTERTAINMENT SERVICES IN THE NATURE OF AN ON-GOING TALK RADIO PROGRAM FEATURING DISCUSSIONS ABOUT DIVORCE; EDUCATIONAL SERVICES, NAMELY, ARRANGING AND CONDUCTING SEMINARS IN THE FIELD OF DIVORCE (U.S. CLS. 100, 101 AND 107).

INGA ERVIN, EXAMINING ATTORNEY

SN 76-566,856. ACKERMAN, PAUL, MIAMI, FL. FILED 12-4-2003.

The Access Training

THE MARK CONSISTS OF STANDARD CHARACTERS WITHOUT CLAIM TO ANY PARTICULAR FONT, STYLE, SIZE, OR COLOR.

NO CLAIM IS MADE TO THE EXCLUSIVE RIGHT TO USE "TRAINING", APART FROM THE MARK AS SHOWN. FOR CONDUCTING SEMINARS IN SELF-AWARENESS (U.S. CLS. 100, 101 AND 107).

FIRST USE 6-17-2002; IN COMMERCE 6-17-2002.
MICHAEL WEBSTER, EXAMINING ATTORNEY

SN 76-569,248. CHANNEL 23 LIMITED PARTNERSHIP, CHICAGO, IL. FILED 1-12-2004.

THE HOMEWORK SHOW

THE MARK CONSISTS OF STANDARD CHARACTERS WITHOUT CLAIM TO ANY PARTICULAR FONT, STYLE, SIZE, OR COLOR.

OWNER OF U.S. REG. NO. 2,078,195.

NO CLAIM IS MADE TO THE EXCLUSIVE RIGHT TO USE "SHOW", APART FROM THE MARK AS SHOWN.

FOR ENTERTAINMENT SERVICES IN THE NATURE OF ON-GOING TELEVISION PROGRAMS IN THE FIELD OF CHILDREN'S EDUCATIONAL PROGRAMMING AND ENTERTAINMENT (U.S. CLS. 100, 101 AND 107).

FIRST USE 9-0-1996; IN COMMERCE 9-0-1996.
MICHAEL HALL, EXAMINING ATTORNEY

CLASS 41—(Continued).

SN 76-572,654. NATIONAL CHARITY LEAGUE CORONET DEBUTANTE BALL, LOS ANGELES, CA. FILED S.R. 1-20-2004; AM. P.R. 5-19-2005.

CORONET

THE MARK CONSISTS OF STANDARD CHARACTERS WITHOUT CLAIM TO ANY PARTICULAR FONT, STYLE, SIZE, OR COLOR.

FOR ENTERTAINMENT SERVICES; NAMELY, CONDUCTING A DEBUTANTE BALL (U.S. CLS. 100, 101 AND 107).

FIRST USE 11-26-1949; IN COMMERCE 11-26-1949.
TERESA M. RUPP, EXAMINING ATTORNEY

CLASS 41—(Continued).

SN 76-575,385. CORPORACION MUSICAL HERMANOS PABON SA DE CV, C.P. 04230 DELEGACION COYOACAN, MEXICO, FILED 2-13-2004.

GRUPO CAÑAREAL

THE MARK CONSISTS OF STANDARD CHARACTERS WITHOUT CLAIM TO ANY PARTICULAR FONT, STYLE, SIZE, OR COLOR.

NO CLAIM IS MADE TO THE EXCLUSIVE RIGHT TO USE "GRUPO", APART FROM THE MARK AS SHOWN.

THE WORD "GRUPO" MEANS "GROUP" IN SPANISH; THE MARK TRANSLATES TO MEAN "REAL SUGARCANE GROUP."

FOR ENTERTAINMENT, NAMELY, LIVE PERFORMANCES BY A MUSICAL BAND (U.S. CLS. 100, 101 AND 107).

FIRST USE 11-10-2003; IN COMMERCE 11-10-2003.
FRED MANDIR, EXAMINING ATTORNEY

SN 76-575,386. CAMARILLO, PEDRO M., III, SAN ANTONIO, TX. FILED 2-13-2004.

DIRTY WERK

THE MARK CONSISTS OF STANDARD CHARACTERS WITHOUT CLAIM TO ANY PARTICULAR FONT, STYLE, SIZE, OR COLOR.

NO CLAIM IS MADE TO THE EXCLUSIVE RIGHT TO USE "DIRTY", APART FROM THE MARK AS SHOWN.

THE ENGLISH TRANSLATION OF THE WORD "WERK" IN THE MARK IS "WORK"

FOR ENTERTAINMENT, NAMELY, LIVE PERFORMANCES BY A MUSICAL BAND (U.S. CLS. 100, 101 AND 107).

FIRST USE 2-1-2001; IN COMMERCE 11-15-2003.
FRED MANDIR, EXAMINING ATTORNEY

SN 76-573,088. AZTECA INTERNATIONAL CORPORATION, EL SEGUNDO, CA. FILED 1-29-2004.

NOTICIERO AZTECA AMERICA

SN 76-575,519. SOCIETY OF WINE EDUCATORS, INC., WASHINGTON, DC. FILED 2-13-2004.

SOCIETY OF WINE EDUCATORS

OWNER OF U.S. REG. NO. 2,289,909.
NO CLAIM IS MADE TO THE EXCLUSIVE RIGHT TO USE NOTICIERO AND AMERICA, APART FROM THE MARK AS SHOWN.

THE FOREIGN WORDING IN THE MARK TRANSLATES INTO ENGLISH AS "AZTECA AMERICA NEWSCAST".

FOR ENTERTAINMENT SERVICES IN THE NATURE OF AN ONGOING NEWS TELEVISION PROGRAM (U.S. CLS. 100, 101 AND 107).

FIRST USE 12-1-2003; IN COMMERCE 12-1-2003.
MARIA-VICTORIA SUAREZ, EXAMINING ATTORNEY

THE MARK CONSISTS OF STANDARD CHARACTERS WITHOUT CLAIM TO ANY PARTICULAR FONT, STYLE, SIZE, OR COLOR.

SEC. 2(F).

FOR EDUCATIONAL SERVICES, NAMELY, CONDUCTING PROGRAMS IN THE FIELD OF WINE EDUCATION THAT PROMOTE KNOWLEDGE OF WINES AND THE WINE INDUSTRY (U.S. CLS. 100, 101 AND 107).

FIRST USE 6-0-1978; IN COMMERCE 6-0-1978.
SONYA STEPHENS, EXAMINING ATTORNEY

CLASS 41—(Continued).

SN 76-576,489. COMCAST SPORTSNET PHILADELPHIA, L.P., PHILADELPHIA, PA. FILED 2-20-2004.

PRE-GAME LIVE

THE MARK CONSISTS OF STANDARD CHARACTERS WITHOUT CLAIM TO ANY PARTICULAR FONT, STYLE, SIZE, OR COLOR.

OWNER OF U.S. REG. NO. 2,927,546. SEC. 2(F).
 FOR ENTERTAINMENT SERVICES, NAMELY, A SERIES OF TELEVISION PROGRAMS FEATURING SPORTS COMMENTARY, DISCUSSIONS, AND INTERVIEWS (U.S. CLS. 100, 101 AND 107).
 FIRST USE 5-0-2001; IN COMMERCE 5-0-2001.
 ALICE SUE CARRUTHERS, EXAMINING ATTORNEY

SN 76-576,490. COMCAST SPORTSNET PHILADELPHIA, L.P., PHILADELPHIA, PA. FILED 2-20-2004.

PRO FOOTBALL THURSDAY

THE MARK CONSISTS OF STANDARD CHARACTERS WITHOUT CLAIM TO ANY PARTICULAR FONT, STYLE, SIZE, OR COLOR.

NO CLAIM IS MADE TO THE EXCLUSIVE RIGHT TO USE "PRO FOOTBALL", APART FROM THE MARK AS SHOWN.
 SEC. 2(F).
 FOR ENTERTAINMENT SERVICES, NAMELY, A SERIES OF TELEVISION PROGRAMS FEATURING SPORTS COMMENTARY, DISCUSSIONS AND INTERVIEWS ON THE TOPIC OF PROFESSIONAL FOOTBALL (U.S. CLS. 100, 101 AND 107).
 FIRST USE 9-0-2002; IN COMMERCE 9-0-2002.
 ALICE SUE CARRUTHERS, EXAMINING ATTORNEY

SN 76-576,900. CORE CONNECTIONS INCORPORATED, CHERRY HILL, NJ. FILED 2-17-2004.

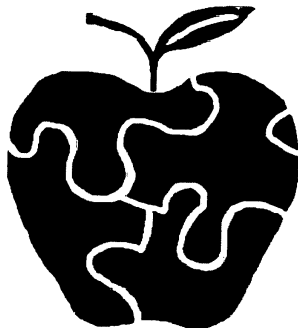

FOR EDUCATIONAL CONSULTING SERVICES IN THE FIELD OF SPECIAL EDUCATION, COMMUNICATION AND BEHAVIOR DISORDERS (U.S. CLS. 100, 101 AND 107).
 FIRST USE 9-20-2003; IN COMMERCE 9-20-2003.
 RUSS HERMAN, EXAMINING ATTORNEY

CLASS 41—(Continued).

SN 76-577,356. PARK, MOON SOON, POLAND, OH. FILED 2-17-2004.

MR. TAEKWONDO

THE MARK CONSISTS OF STANDARD CHARACTERS WITHOUT CLAIM TO ANY PARTICULAR FONT, STYLE, SIZE, OR COLOR.

NO CLAIM IS MADE TO THE EXCLUSIVE RIGHT TO USE "TAE KWON DO", APART FROM THE MARK AS SHOWN.
 FOR ARRANGING AND CONDUCTING DEMONSTRATIONS OF MARTIAL ARTS AND MARTIAL ARTS COMPETITIONS; INSTRUCTION AND TEACHING OF ALL TYPES OF MARTIAL ARTS; ARRANGING AND CONDUCTING PROGRAMS, EXHIBITIONS, DEMONSTRATIONS, AND CONFERENCES IN THE FIELD OF MARTIAL ARTS FOR ALL TYPES OF MARTIAL ARTS COMPETITIONS (U.S. CLS. 100, 101 AND 107).
 FIRST USE 11-1-2003; IN COMMERCE 11-1-2003.
 JASON TURNER, EXAMINING ATTORNEY

SN 76-577,357. PARK, MOON SOON, POLAND, OH. FILED 2-17-2004.

MISS TAEKWONDO

THE MARK CONSISTS OF STANDARD CHARACTERS WITHOUT CLAIM TO ANY PARTICULAR FONT, STYLE, SIZE, OR COLOR.

NO CLAIM IS MADE TO THE EXCLUSIVE RIGHT TO USE "TAE KWON DO", APART FROM THE MARK AS SHOWN.
 FOR ARRANGING AND CONDUCTING DEMONSTRATIONS OF MARTIAL ARTS AND MARTIAL ARTS COMPETITIONS; INSTRUCTION AND TEACHING OF ALL TYPES OF MARTIAL ARTS; ARRANGING AND CONDUCTING PROGRAMS, EXHIBITIONS, DEMONSTRATIONS, AND CONFERENCES IN THE FIELD OF MARTIAL ARTS FOR ALL TYPES OF MARTIAL ARTS COMPETITIONS (U.S. CLS. 100, 101 AND 107).
 FIRST USE 11-1-2003; IN COMMERCE 11-1-2003.
 JASON TURNER, EXAMINING ATTORNEY

SN 76-577,358. PARK, MOON SOON, POLAND, OH. FILED 2-17-2004.

MS. TAEKWONDO

THE MARK CONSISTS OF STANDARD CHARACTERS WITHOUT CLAIM TO ANY PARTICULAR FONT, STYLE, SIZE, OR COLOR.

NO CLAIM IS MADE TO THE EXCLUSIVE RIGHT TO USE "TAE KWON DO", APART FROM THE MARK AS SHOWN.
 FOR ARRANGING AND CONDUCTING DEMONSTRATIONS OF MARTIAL ARTS AND MARTIAL ARTS COMPETITIONS; INSTRUCTION AND TEACHING OF ALL TYPES OF MARTIAL ARTS; ARRANGING AND CONDUCTING PROGRAMS, EXHIBITIONS, DEMONSTRATIONS, AND CONFERENCES IN THE FIELD OF MARTIAL ARTS FOR ALL TYPES OF MARTIAL ARTS COMPETITIONS (U.S. CLS. 100, 101 AND 107).
 FIRST USE 11-1-2003; IN COMMERCE 11-1-2003.
 JASON TURNER, EXAMINING ATTORNEY

CLASS 41—(Continued).

SN 76-577,359. PARK, MOON SOON, POLAND, OH. FILED 2-17-2004.

MR. KUNGFU

THE MARK CONSISTS OF STANDARD CHARACTERS WITHOUT CLAIM TO ANY PARTICULAR FONT, STYLE, SIZE, OR COLOR.

NO CLAIM IS MADE TO THE EXCLUSIVE RIGHT TO USE "KUNG FU", APART FROM THE MARK AS SHOWN.

FOR ARRANGING AND CONDUCTING DEMONSTRATIONS OF MARTIAL ARTS AND MARTIAL ARTS COMPETITIONS; INSTRUCTION AND TEACHING OF ALL TYPES OF MARTIAL ARTS; ARRANGING AND CONDUCTING PROGRAMS, EXHIBITIONS, DEMONSTRATIONS, AND CONFERENCES IN THE FIELD OF MARTIAL ARTS FOR ALL TYPES OF MARTIAL ARTS COMPETITIONS (U.S. CLS. 100, 101 AND 107).

FIRST USE 11-1-2003; IN COMMERCE 11-1-2003.
JASON TURNER, EXAMINING ATTORNEY

SN 76-577,360. PARK, MOON SOON, POLAND, OH. FILED 2-17-2004.

MISS KUNGFU

THE MARK CONSISTS OF STANDARD CHARACTERS WITHOUT CLAIM TO ANY PARTICULAR FONT, STYLE, SIZE, OR COLOR.

NO CLAIM IS MADE TO THE EXCLUSIVE RIGHT TO USE "KUNG FU", APART FROM THE MARK AS SHOWN.

FOR ARRANGING AND CONDUCTING DEMONSTRATIONS OF MARTIAL ARTS AND MARTIAL ARTS COMPETITIONS; INSTRUCTION AND TEACHING OF ALL TYPES OF MARTIAL ARTS; ARRANGING AND CONDUCTING PROGRAMS, EXHIBITIONS, DEMONSTRATIONS, AND CONFERENCES IN THE FIELD OF MARTIAL ARTS FOR ALL TYPES OF MARTIAL ARTS COMPETITIONS (U.S. CLS. 100, 101 AND 107).

FIRST USE 11-1-2003; IN COMMERCE 11-1-2003.
JASON TURNER, EXAMINING ATTORNEY

SN 76-577,361. PARK, MOON SOON, POLAND, OH. FILED 2-17-2004.

MS. KUNGFU

THE MARK CONSISTS OF STANDARD CHARACTERS WITHOUT CLAIM TO ANY PARTICULAR FONT, STYLE, SIZE, OR COLOR.

NO CLAIM IS MADE TO THE EXCLUSIVE RIGHT TO USE "KUNG FU", APART FROM THE MARK AS SHOWN.

FOR ARRANGING AND CONDUCTING DEMONSTRATIONS OF MARTIAL ARTS AND MARTIAL ARTS COMPETITIONS; INSTRUCTION AND TEACHING OF ALL TYPES OF MARTIAL ARTS; ARRANGING AND CONDUCTING PROGRAMS, EXHIBITIONS, DEMONSTRATIONS, AND CONFERENCES IN THE FIELD OF MARTIAL ARTS FOR ALL TYPES OF MARTIAL ARTS COMPETITIONS (U.S. CLS. 100, 101 AND 107).

FIRST USE 11-1-2003; IN COMMERCE 11-1-2003.
JASON TURNER, EXAMINING ATTORNEY

CLASS 41—(Continued).

SN 76-577,397. ZHI GANG SHA, LLC, PETALUMA, CA. FILED 2-13-2004.

SOUL MIND BODY MEDICINE

THE MARK CONSISTS OF STANDARD CHARACTERS WITHOUT CLAIM TO ANY PARTICULAR FONT, STYLE, SIZE, OR COLOR.

NO CLAIM IS MADE TO THE EXCLUSIVE RIGHT TO USE "MIND BODY MEDICINE", APART FROM THE MARK AS SHOWN.

FOR EDUCATIONAL SERVICES, NAMELY CONDUCTING CLASSES, COURSES, SEMINARS, CONFERENCES AND WORKSHOPS IN THE FIELD OF ENERGY AND SPIRITUAL HEALING AND PROVIDING COURSE MATERIALS AND SOFTWARE IN CONNECTION THEREWITH (U.S. CLS. 100, 101 AND 107).

FIRST USE 10-25-2003; IN COMMERCE 10-25-2003.
CATHERINE FAINT, EXAMINING ATTORNEY

SN 76-578,480. BURROUGHS & CHAPIN COMPANY, INC., MYRTLE BEACH, SC. FILED 3-1-2004.

THRILL ZONE

THE MARK CONSISTS OF STANDARD CHARACTERS WITHOUT CLAIM TO ANY PARTICULAR FONT, STYLE, SIZE, OR COLOR.

FOR AMUSEMENT PARK SERVICES, NAMELY AMUSEMENT RIDE SERVICES (U.S. CLS. 100, 101 AND 107).
DOUGLAS LEE, EXAMINING ATTORNEY

SN 76-578,918. LEWIS, ROBERT A., PHOENIX, AZ. FILED 3-3-2004.

BRAND YOUR LIFE, LIVE YOUR BRAND

THE MARK CONSISTS OF STANDARD CHARACTERS WITHOUT CLAIM TO ANY PARTICULAR FONT, STYLE, SIZE, OR COLOR.

FOR TRAINING PROGRAMS DIRECTED TO PERSONAL GROWTH AND CAREER AND BUSINESS DEVELOPMENT (U.S. CLS. 100, 101 AND 107).

FIRST USE 2-13-2004; IN COMMERCE 2-13-2004.
ALICIA COLLINS, EXAMINING ATTORNEY

CLASS 41—(Continued).

SN 76-580,965. COREVISION STRATEGIES L.L.C., BOCA RATON, FL. FILED 3-15-2004.

COREVISION UNIVERSITY

THE MARK CONSISTS OF STANDARD CHARACTERS WITHOUT CLAIM TO ANY PARTICULAR FONT, STYLE, SIZE, OR COLOR.

OWNER OF U.S. REG. NO. 2,852,675.

NO CLAIM IS MADE TO THE EXCLUSIVE RIGHT TO USE UNIVERSITY, APART FROM THE MARK AS SHOWN.

FOR EDUCATIONAL SERVICES, NAMELY, PROVIDING EDUCATION INFORMATION AND TRAINING IN THE FIELDS OF BUSINESS, COMMUNICATION, DIVERSITY TRAINING AND MANAGEMENT, EMPLOYMENT, FINANCE, HEALTH CARE, HEALTH CARE AND BENEFITS COMPLIANCE, MANAGEMENT, NEGOTIATING SKILLS, PERSONAL SKILLS, PROFESSIONAL GROWTH AND INTEREST, PROJECT MANAGEMENT AND LEADERSHIP, REGULATORY AND COMPLIANCE, SALES AND CUSTOMER SERVICES, TEAM SKILLS, TECHNOLOGY AND INFORMATION TECHNOLOGY (U.S. CLS. 100, 101 AND 107).
RON FAIRBANKS, EXAMINING ATTORNEY

CLASS 41—(Continued).

SN 76-581,517. ZIJIU INSTITUTE, INC., LILBURN, GA. FILED 3-15-2004.

ZIJIU INSTITUTE

THE MARK CONSISTS OF STANDARD CHARACTERS WITHOUT CLAIM TO ANY PARTICULAR FONT, STYLE, SIZE, OR COLOR.

NO CLAIM IS MADE TO THE EXCLUSIVE RIGHT TO USE "INSTITUTE", APART FROM THE MARK AS SHOWN. THE TERM "ZIJIU" IS THE PHONETIC SPELLING OF TWO CHINESE CHARACTERS WHICH COMBINED MEAN "SAVE ONE'S HEALTH BY ONE'S SELF."

FOR EDUCATIONAL SERVICES, NAMELY, CONDUCTING CLASSES, SEMINARS AND PRACTICE INSTRUCTION IN THE FIELD OF MEDITATION (U.S. CLS. 100, 101 AND 107).

FIRST USE 7-0-2000; IN COMMERCE 7-0-2000.
SONYA STEPHENS, EXAMINING ATTORNEY

SN 76-583,816. SYLVAN LEARNING, INC., BALTIMORE, MD. FILED 3-29-2004.

ACADEMIC INROADS

THE MARK CONSISTS OF STANDARD CHARACTERS WITHOUT CLAIM TO ANY PARTICULAR FONT, STYLE, SIZE, OR COLOR.

NO CLAIM IS MADE TO THE EXCLUSIVE RIGHT TO USE ACADEMIC, APART FROM THE MARK AS SHOWN.

FOR EDUCATIONAL SERVICES AND PROGRAMS ON THE K-12 LEVEL, NAMELY, COURSES OF INSTRUCTION AT THE PRIMARY AND SECONDARY LEVEL FOR GRADES K- 12 SUCH AS MATH AND READING, WHICH ARE OFFERED TO PARENTS, SCHOOLS, SCHOOL DISTRICTS, AND COMMUNITY BASED ORGANIZATIONS (U.S. CLS. 100, 101 AND 107).
SCOTT OSLICK, EXAMINING ATTORNEY

SN 76-580,970. MUSKEGON TOWNSHIP FAMILY & FRIENDS REUNION, MUSKEGON, MI. FILED 3-15-2004.



NO CLAIM IS MADE TO THE EXCLUSIVE RIGHT TO USE "REUNION", APART FROM THE MARK AS SHOWN. THE MARK CONSISTS OF A TREE WITH CHILDREN AND ADULTS AROUND AND UNDER IT WITH STREET NAMES LISTED ON BRANCHES.

SEC. 2(F) "MUSKEGON TOWNSHIP FAMILY & FRIENDS REUNION".

FOR ORGANIZING COMMUNITY REUNION FESTIVALS FEATURING A VARIETY OF ACTIVITIES, NAMELY SPORTING EVENTS, LIVE MUSICAL PERFORMANCES, AND THE LIKE (U.S. CLS. 100, 101 AND 107).

FIRST USE 8-1-1993; IN COMMERCE 8-1-1993.
BRENDAN REGAN, EXAMINING ATTORNEY

SN 76-584,093. ROZELLA & OZELLA UNIV. ED. CORPORATION, MPLS., MN. FILED 3-29-2004.

PROFESSOR DOGG

THE MARK CONSISTS OF STANDARD CHARACTERS WITHOUT CLAIM TO ANY PARTICULAR FONT, STYLE, SIZE, OR COLOR.

FOR EDUCATIONAL AND ENTERTAINMENT SERVICES, NAMELY, PROVIDING MOTIVATIONAL AND EDUCATIONAL SPEAKERS REGARDING THE HARMS OF SMOKING (U.S. CLS. 100, 101 AND 107).

FIRST USE 5-7-2003; IN COMMERCE 5-7-2003.
IRA J. GOODSaid, EXAMINING ATTORNEY

CLASS 41—(Continued).

SN 76-584,101. SCHOLASTIC INC., NEW YORK, NY. FILED 3-29-2004.

DOWNLOADS2GO

THE MARK CONSISTS OF STANDARD CHARACTERS WITHOUT CLAIM TO ANY PARTICULAR FONT, STYLE, SIZE, OR COLOR.

FOR PROVIDING ONLINE COMPUTER GAMES AND COMPUTER GAME SOFTWARE VIA THE INTERNET (U.S. CLS. 100, 101 AND 107).

FIRST USE 2-7-2004; IN COMMERCE 2-7-2004.

ANDREW BENZMILLER, EXAMINING ATTORNEY

SN 76-584,750. ADVOCATES INTERNATIONAL, INC., FAIRFAX, VA. FILED 4-5-2004.

ADVOCATES INTERNATIONAL

THE MARK CONSISTS OF STANDARD CHARACTERS WITHOUT CLAIM TO ANY PARTICULAR FONT, STYLE, SIZE, OR COLOR.

SEC. 2(F).

FOR CHARITABLE SERVICES, NAMELY, DONATING BOOKS AND OTHER EDUCATIONAL OR RELIGIOUS PRINTED MATTER TO RESISTERS, TARGETS OR VICTIMS OF RELIGIOUS PERSECUTION; EDUCATIONAL SERVICES, NAMELY, CONDUCTING CLASSES, SEMINARS, CONFERENCES, WORKSHOPS AND TRAINING IN THE FIELDS OF— RESISTING AND ELIMINATING RELIGIOUS PERSECUTION; PROVIDING ASSISTANCE TO RESISTERS, TARGETS OR VICTIMS OF RELIGIOUS PERSECUTION; PROMOTING RELIGIOUS FREEDOM AND TOLERANCE, THE RULE OF LAW, CIVIL SOCIETY, HUMAN RIGHTS, JUSTICE, RECONCILIATION, PEACEFUL CONFLICT RESOLUTION, AN INDEPENDENT JUDICIARY, PROFESSIONAL ETHICS, AND THE INTEGRATION OF FAITH AND LEGAL PRACTICE (U.S. CLS. 100, 101 AND 107).

FIRST USE 7-0-1993; IN COMMERCE 7-0-1993.

IRA J. GOODSaid, EXAMINING ATTORNEY

CLASS 41—(Continued).

SN 76-586,194. CURTAIN CALL PRODUCTIONS, LLC, MCLEAN, VA. FILED 4-12-2004.

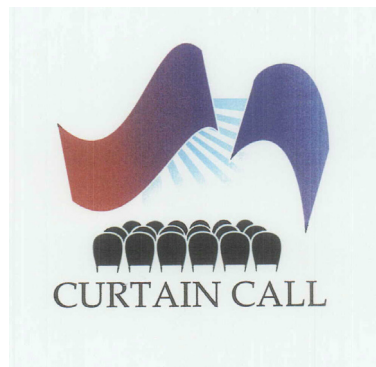

THE COLOR(S) ROSE AND BLUE IS/ARE CLAIMED AS A FEATURE OF THE MARK.

THE COLOR ROSE APPEARS IN THE BANNER DESIGN COMPRISING THE UPPER LEFT QUADRANT OF THE MARK AND THE COLOR BLUE APPEARS IN BOTH THE BANNER COMPRISING THE UPPER RIGHT QUADRANT OF THE MARK AND THE BARS SEPARATING THE TWO BANNERS.

FOR PRODUCTION OF VIDEO AND AUDIO CASSETTES AND DISCS FOR RELIGIOUS AND SECULAR ORGANIZATIONS (U.S. CLS. 100, 101 AND 107).

FIRST USE 7-1-2002; IN COMMERCE 7-1-2002.

KARLA PERKINS, EXAMINING ATTORNEY

SN 76-586,454. SMITHSONIAN INSTITUTION, WASHINGTON, DC. FILED 4-9-2004.

**THE PAUL PECK PRESIDENTIAL INITIATIVE
PRESERVING DEMOCRACY ONE AMERICAN AT A TIME**

THE APPLICANT HEREBY STATES THAT PAUL PECK IDENTIFIES A LIVING INDIVIDUAL WHOSE CONSENT IS OF RECORD.

FOR EDUCATIONAL SERVICES, NAMELY, EXHIBITIONS, WORKSHOPS, LECTURES, AND OTHER PUBLIC PROGRAMS ABOUT THE PRESIDENCY AND DEMOCRACY (U.S. CLS. 100, 101 AND 107).

FIRST USE 8-12-2003; IN COMMERCE 1-26-2004.

GINA HAYES, EXAMINING ATTORNEY

SN 76-586,456. RHEE, GUNN WOO, EDISON, NJ. FILED 4-8-2004.



NO CLAIM IS MADE TO THE EXCLUSIVE RIGHT TO USE "REVIEW", APART FROM THE MARK AS SHOWN.

FOR EDUCATIONAL SERVICES, NAMELY, PROVIDING COURSES OF INSTRUCTION AT THE PRIMARY AND SECONDARY LEVEL AND DISTRIBUTING COURSE MATERIAL IN CONNECTION THEREWITH (U.S. CLS. 100, 101 AND 107).

FIRST USE 0-0-1993; IN COMMERCE 0-0-1993.

SEAN DWYER, EXAMINING ATTORNEY

CLASS 41—(Continued).

SN 76-586,746. DRIVING GOSPEL MEDIA PRODUCTIONS, LLC, SILVER SPRING, MD. FILED 4-14-2004.

DRIVING GOSPEL

THE MARK CONSISTS OF STANDARD CHARACTERS WITHOUT CLAIM TO ANY PARTICULAR FONT, STYLE, SIZE, OR COLOR.

NO CLAIM IS MADE TO THE EXCLUSIVE RIGHT TO USE GOSPEL, APART FROM THE MARK AS SHOWN.

FOR ENTERTAINMENT SERVICES IN THE NATURE OF RECORD AND RECORD MASTER PRODUCTION; RECORDING STUDIOS; MUSIC PUBLISHING SERVICES (U.S. CLS. 100, 101 AND 107).

FIRST USE 1-12-2004; IN COMMERCE 1-12-2004.
ZHALEH DELANEY, EXAMINING ATTORNEY

CLASS 41—(Continued).

SN 76-592,974. MILLIGAN, DAVID P., IRVINE, CA. AND MAGNUSSEN, DEBORAH-ANN, IRVINE, CA. FILED 5-19-2004.

SOUL AT HOME

THE MARK CONSISTS OF STANDARD CHARACTERS WITHOUT CLAIM TO ANY PARTICULAR FONT, STYLE, SIZE, OR COLOR.

FOR SEMINAR SERVICES, NAMELY IN PERSONAL GROWTH AND HOME DESIGN (U.S. CLS. 100, 101 AND 107).

FIRST USE 1-0-2003; IN COMMERCE 1-0-2003.
KATHY DE JONGE, EXAMINING ATTORNEY

SN 76-588,967. GYM TECH INC., SMITH, AL. FILED 4-27-2004.

GYM TECH OUTLAWS

THE MARK CONSISTS OF STANDARD CHARACTERS WITHOUT CLAIM TO ANY PARTICULAR FONT, STYLE, SIZE, OR COLOR.

FOR EDUCATIONAL SERVICES, NAMELY, CONDUCTING CLASSES AND COMPETITIONS FOR STUDENTS AND COMPETITORS IN THE FIELD OF CHEERLEADING (U.S. CLS. 100, 101 AND 107).

FIRST USE 4-4-2000; IN COMMERCE 4-4-2000.
KEVON CHISOLM, EXAMINING ATTORNEY

SN 76-593,026. NATIONAL COUNCIL OF YOUNG MEN'S CHRISTIAN ASSOCIATIONS OF THE UNITED STATES OF AMERICA, CHICAGO, IL. FILED 5-17-2004.

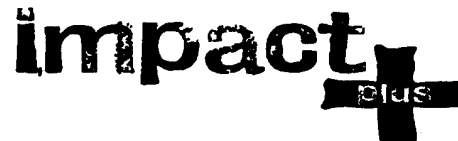

FOR EDUCATIONAL SERVICES, NAMELY, CONDUCTING CLASSES, SEMINARS, AND WORKSHOPS IN THE FIELD OF CIVICS (U.S. CLS. 100, 101 AND 107).

FIRST USE 2-1-2004; IN COMMERCE 2-1-2004.
GRETTA YAO, EXAMINING ATTORNEY

SN 76-592,098. SONCPOOL, INC., HOLLYWOOD, CA. FILED 5-13-2004.



THE MARK CONSISTS OF THE WORD "SONICPOOL" INSCRIBED INSIDE AN OVAL WITH THREE CONCENTRIC OVALS EMANATING FROM THE FIRST "O" IN "SONICPOOL".

FOR AUDIO AND VIDEO STUDIO SERVICES, NAMELY, COMPOSING, RECORDING AND MIXING MUSIC AND SOUNDS FOR OTHERS; SOUNDTRACK RECORDING AND MIXING; VOICE OVER RECORDING AND MIXING; FOLEY RECORDING, EDITING AND MIXING; AUDIO SWEETENING; VIDEO AND FILM EDITING; PHOTO EDITING, AND VIDEO AND FILM SPECIAL EFFECTS CREATION, RENDERING, EDITING AND FINISHING (U.S. CLS. 100, 101 AND 107).

FIRST USE 7-0-2001; IN COMMERCE 7-0-2001.
ROBIN CHOSID, EXAMINING ATTORNEY

SN 76-594,003. CONSERVATION RESOURCE ALLIANCE, TRAVERSE CITY, MI. FILED 5-21-2004.

WILD LINK

FOR EDUCATIONAL SERVICES, NAMELY, CONDUCTING PROGRAMS IN THE FIELD OF LAND USE AND CONSERVATION TO PROTECT AND RESTORE NATURAL AND ECOLOGICAL CORRIDORS (U.S. CLS. 100, 101 AND 107).

FIRST USE 12-16-1996; IN COMMERCE 12-16-1996.
CAROLYN GRAY, EXAMINING ATTORNEY

CLASS 41—(Continued).

SN 76-595,025. MARTIN, ROBERT, AKA JEFF WALKER, WILKES-BARRE, PA. FILED 6-2-2004.

EVERY SONG HAS A STORY

THE MARK CONSISTS OF STANDARD CHARACTERS WITHOUT CLAIM TO ANY PARTICULAR FONT, STYLE, SIZE, OR COLOR.

FOR ENTERTAINMENT SERVICES IN THE NATURE OF A RADIO PROGRAM FEATURING A SEGMENT FOCUSING ON VARIOUS SONGS AND INTERESTING FACTS OR HISTORY PERTAINING TO THE SONGS (U.S. CLS. 100, 101 AND 107).

FIRST USE 10-13-2003; IN COMMERCE 10-13-2003.
LOURDES AYALA, EXAMINING ATTORNEY

SN 76-595,334. WILLIS, LAURETTE E., TAHLEQUAH, OK. FILED 6-5-2003.

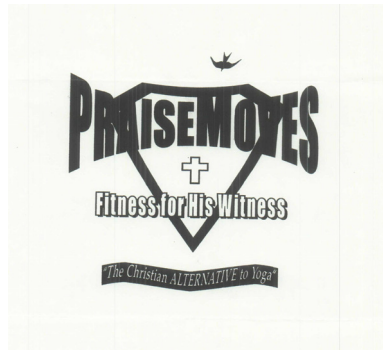

NO CLAIM IS MADE TO THE EXCLUSIVE RIGHT TO USE "THE CHRISTIAN ALTERNATIVE TO YOGA", APART FROM THE MARK AS SHOWN.

THE STIPPLING IN THE DRAWING IS NOT INTENDED TO INDICATE COLOR.

THE MARK CONSISTS OF CAPITALIZED LETTER P AND CAPITALIZED LETTER M IN ONE WORD PRAISEMOVES.

FOR EDUCATIONAL SERVICES, NAMELY, CLASSES, SEMINARS, CONFERENCES, AND WORKSHOPS IN THE FIELDS OF EXERCISE, ALTERNATIVES TO YOGA, AND STRETCHING POSTURES; PROVIDING TRAINING IN THE FIELDS OF EXERCISE, ALTERNATIVES TO YOGA, STRETCHING POSTURES AND EXERCISE; PROVIDING MOTIVATIONAL AND EDUCATIONAL SPEAKERS IN THE FIELD OF THE BIBLE (U.S. CLS. 100, 101 AND 107).

FIRST USE 12-10-2002; IN COMMERCE 1-1-2003.
INGA ERVIN, EXAMINING ATTORNEY

CLASS 41—(Continued).

SN 76-595,603. CREATRAC, ELLISVILLE, MO. FILED 6-2-2004.



FOR EDUCATION SERVICES, NAMELY, CONDUCTING CLASSES, SEMINARS, CONFERENCES, AND WORKSHOPS IN THE FIELD OF BUSINESS MARKETING AND SALES TECHNIQUES, AND THE DISTRIBUTION OF COURSE MATERIALS IN CONNECTION THEREWITH (U.S. CLS. 100, 101 AND 107).

FIRST USE 7-1-2002; IN COMMERCE 7-1-2002.
RONALD AIKENS, EXAMINING ATTORNEY

SN 76-596,532. SPIRIT, LLC, MILWAUKEE, WI. FILED 6-10-2004.



FOR ENTERTAINMENT SERVICES IN THE NATURE OF LIVE THEATRICAL, MUSICAL, LIGHT AND DANCE PERFORMANCES; ORGANIZING COMMUNITY CULTURAL EVENTS; PROVIDING INFORMATION VIA AN INTERNET WEBSITE IN THE FIELDS OF LIVE THEATRICAL PERFORMANCES, MUSICAL PERFORMANCES, LIGHT PERFORMANCES, DANCE PERFORMANCES, MUSIC, ARTS AND CRAFTS, NATIVE AMERICAN HISTORY, AMERICAN HISTORY, MUSICAL SOUND RECORDINGS, AUDIO AND VISUAL RECORDINGS FEATURING THEATRICAL, LIGHT AND DANCE RECORDINGS, BOOKS, POSTERS, AND STATIONERY ITEMS (U.S. CLS. 100, 101 AND 107).

FIRST USE 1-9-2003; IN COMMERCE 1-23-2003.
DAWN HAN, EXAMINING ATTORNEY

CLASS 41—(Continued).

SN 76-596,978. EAST COAST TOURNAMENT BASEBALL, INC., GILBERTSVILLE, PA. FILED 6-14-2004.

SAM

FOR ARRANGING AND CONDUCTING ATHLETIC COMPETITIONS, NAMELY, BASEBALL LEAGUES (U.S. CLS. 100, 101 AND 107).
ANNE E. GUSTASON, EXAMINING ATTORNEY

SN 76-597,834. WYNN RESORTS HOLDINGS, LLC, LAS VEGAS, NV. FILED 6-15-2004.

CABANA BAR & CASINO

THE MARK CONSISTS OF STANDARD CHARACTERS WITHOUT CLAIM TO ANY PARTICULAR FONT, STYLE, SIZE, OR COLOR.
NO CLAIM IS MADE TO THE EXCLUSIVE RIGHT TO USE BAR & CASINO, APART FROM THE MARK AS SHOWN.
FOR CASINO SERVICES (U.S. CLS. 100, 101 AND 107).
SOPHIA S. KIM, EXAMINING ATTORNEY

SN 76-598,337. AZTECA INTERNATIONAL CORPORATION, EL SEGUNDO, CA. FILED 6-17-2004.

HISTORIAS DE LA VIDA REAL

THE MARK CONSISTS OF STANDARD CHARACTERS WITHOUT CLAIM TO ANY PARTICULAR FONT, STYLE, SIZE, OR COLOR.
NO CLAIM IS MADE TO THE EXCLUSIVE RIGHT TO USE "HISTORIAS", APART FROM THE MARK AS SHOWN.
THE ENGLISH TRANSLATION OF THE MARK IS "STORIES OF REAL LIFE."
FOR ENTERTAINMENT SERVICES IN THE NATURE OF AN ONGOING TELEVISION SERVICES IN THE FIELDS OF RELATIONSHIPS AND FAMILY (U.S. CLS. 100, 101 AND 107).
FIRST USE 1-12-2003; IN COMMERCE 1-12-2003.
AMOS T. MATTHEWS, JR., EXAMINING ATTORNEY

CLASS 41—(Continued).

SN 76-598,579. SOCIETY FOR RESEARCH AND INITIATIVES FOR SUSTAINABLE TECHNOLOGIES AND INSTITUTIONS, AHMEDABAD: 380009, GUJARAT, INDIA. FILED 6-21-2004.

SRISTI

FOR EDUCATIONAL SERVICES IN THE NATURE OF ORGANIZATION OF SEMINARS, WORKING GROUPS, RESEARCH GROUPS AND CONVENTIONS PROVIDED TO GRASS ROOTS INNOVATORS IN THE FIELDS OF BIOTECHNOLOGY, AGRICULTURE, ECOLOGY, ECONOMICS, CONSERVATION AND EDUCATION; ORGANIZATION OF EDUCATIONAL PROGRAMS INVOLVING TRAVEL; EDUCATIONAL RESEARCH; PROVIDING INFORMATION REGARDING ALL OF THE FOREGOING (U.S. CLS. 100, 101 AND 107).
FIRST USE 6-0-1993; IN COMMERCE 12-0-1999.
MICHAEL KAZAZIAN, EXAMINING ATTORNEY

SN 76-598,593. SPEEDSHAPE INCORPORATED, TROY, MI. FILED 6-21-2004.

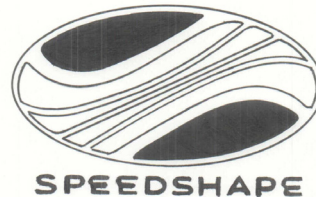

COLOR IS NOT CLAIMED AS A FEATURE OF THE MARK.
FOR DIGITAL IMAGING SERVICES, NAMELY THE VISUALIZATION, IMAGING, AND REDESIGN OF THE DIGITAL DATA OF OTHERS (U.S. CLS. 100, 101 AND 107).
FIRST USE 7-1-2003; IN COMMERCE 7-1-2003.
MICHAEL TANNER, EXAMINING ATTORNEY

SN 76-599,714. NATIONAL ASSOCIATION OF MUSIC MERCHANTS, INC., CARLSBAD, CA. FILED 6-28-2004.



THIS MARK CONSISTS OF THE TEXT MIEB2B IN WHITE RELIEF, INSIDE A DARK RECTANGULAR SHAPED BOX

CLASS 41—(Continued).

WITH ROUNDED CORNERS. THE LETTERS M AND I ARE CAPITALIZED. THE LETTERS E AND B ARE ALL IN SMALL TEXT. THE NUMERAL 2 IS LARGER THAN THE OTHER TEXT AND THE UNDERSCORE PORTION OF THE NUMERAL DROPS BELOW THE LINE OF THE OTHER TEXT, EXTENDING BELOW AND UNDERNEATH THE LETTER B TO ITS RIGHT, WITH A SILHOUETTE OF THE END OF AN ELECTRIC GUITAR CABLE IN THE CENTER OF THE UNDERSCORE, AND TERMINATING IN AN ARROW. COLOR IS NOT PART OF THIS MARK.

FOR INSTRUCTIONAL SERVICES PROVIDED TO THE MUSIC PRODUCTS INDUSTRY RELATING TO CONDUCTING BUSINESS OVER THE INTERNET (U.S. CLS. 100, 101 AND 107).

FIRST USE 1-15-2004; IN COMMERCE 1-15-2004.
BRENDAN REGAN, EXAMINING ATTORNEY

CLASS 41—(Continued).

SN 76-600,584. PENDRAGON PUBLISHING, INC., PARK RIDGE, IL. FILED 7-2-2004.



SN 76-600,357. MALONEY, ALLISON, WEST HOLLYWOOD, CA. FILED 6-30-2004.

Alyson

FOR PUBLISHING OF BOOKS (U.S. CLS. 100, 101 AND 107).

FIRST USE 11-0-2002; IN COMMERCE 11-0-2002.
MARGERY A. TIERNEY, EXAMINING ATTORNEY

THE MARK CONSISTS OF STANDARD CHARACTERS WITHOUT CLAIM TO ANY PARTICULAR FONT, STYLE, SIZE, OR COLOR.

FOR ENTERTAINMENT SERVICES IN THE NATURE OF LIVE MUSICAL PERFORMANCES BY AN INDIVIDUAL; PROVIDING INFORMATION RELATING TO MUSICAL PERFORMANCES BY AN INDIVIDUAL, PROVIDING MUSIC VIA A GLOBAL COMPUTER NETWORK (U.S. CLS. 100, 101 AND 107).

FIRST USE 9-1-2002; IN COMMERCE 9-1-2002.
GEORGIA CARTY, EXAMINING ATTORNEY

SN 76-600,670. RIC INVESTMENTS, LLC, WILMINGTON, DE. FILED 7-2-2004.

BREATHING IN BALANCE

SN 76-600,578. PENDRAGON PUBLISHING, INC., PARK RIDGE, IL. FILED 7-2-2004.



FOR PUBLISHING OF BOOKS (U.S. CLS. 100, 101 AND 107).

FIRST USE 11-0-2002; IN COMMERCE 11-0-2002.
MARGERY A. TIERNEY, EXAMINING ATTORNEY

THE MARK CONSISTS OF STANDARD CHARACTERS WITHOUT CLAIM TO ANY PARTICULAR FONT, STYLE, SIZE, OR COLOR.

NO CLAIM IS MADE TO THE EXCLUSIVE RIGHT TO USE "BREATHING", APART FROM THE MARK AS SHOWN.

FOR EDUCATIONAL PROGRAMS, NAMELY, INSTRUCTIONAL PRESENTATIONS, COURSES AND SEMINARS AND SERVICES FOR OTHERS IN THE FIELD OF CARDIOPULMONARY DISEASES AND DISORDERS AND MEDICAL PRODUCTS AND INSTRUMENTS FOR USE IN THE TREATMENT OF SUCH DISEASES AND DISORDERS (U.S. CLS. 100, 101 AND 107).

FIRST USE 8-14-2003; IN COMMERCE 8-14-2003.
GEORGIA CARTY, EXAMINING ATTORNEY

CLASS 41—(Continued).

SN 76-601,696. MARK L. LAYTON PRODUCTIONS, DBA LAYTON PRODUCTIONS, OREM, UT. FILED 7-12-2004.



NO CLAIM IS MADE TO THE EXCLUSIVE RIGHT TO USE "BEST", APART FROM THE MARK AS SHOWN.

THE MARK CONSISTS OF A REPRESENTATION OF THE TOP PART OF A TROPHY AND THE WORDS "BEST OF STATE" IN LARGE LETTERS TO THE SIDE OF THE TROPHY, ALL WITHIN A CIRCLE DESIGN.

FOR PROVIDING RECOGNITION AND INCENTIVES BY WAY OF AWARDS TO INDIVIDUALS WHO DEMONSTRATE EXCELLENCE IN THE FIELDS OF ARTS, TECHNOLOGIES, ACADEMIA, TRADE AND INDUSTRY (U.S. CLS. 100, 101 AND 107).

FIRST USE 8-6-2002; IN COMMERCE 8-6-2002.

ANNE E. GUSTASON, EXAMINING ATTORNEY

SN 76-601,748. UNIVERSAL CITY STUDIOS LLLP, UNIVERSAL CITY, CA. FILED 7-12-2004.

UNSEEN UNTOLD

THE MARK CONSISTS OF STANDARD CHARACTERS WITHOUT CLAIM TO ANY PARTICULAR FONT, STYLE, SIZE, OR COLOR.

FOR ENTERTAINMENT SERVICES IN THE NATURE OF AN ONGOING TELEVISION PROGRAM FEATURING BEHIND THE SCENES LOOKS AT MOTION PICTURES (U.S. CLS. 100, 101 AND 107).

FIRST USE 8-24-2003; IN COMMERCE 8-24-2003.

MARC LEIPZIG, EXAMINING ATTORNEY

SN 76-601,908. TUERFF-DAVIS ENVIROMEDIA, INC., AUSTIN, TX. FILED 7-12-2004.

ZEROBESITY

THE MARK CONSISTS OF STANDARD CHARACTERS WITHOUT CLAIM TO ANY PARTICULAR FONT, STYLE, SIZE, OR COLOR.

FOR EDUCATIONAL SERVICES, NAMELY, CONDUCTING CLASSES, SEMINARS, CONFERENCES, AND WORKSHOPS IN THE FIELD OF THE PREVENTION OF CHILDHOOD OBESITY (U.S. CLS. 100, 101 AND 107).

FIRST USE 6-30-2004; IN COMMERCE 6-30-2004.

ROBIN CHOSID, EXAMINING ATTORNEY

CLASS 41—(Continued).

SN 76-602,249. WCI COMMUNITIES, INC., BONITA SPRINGS, FL. FILED 7-13-2004.

WCI LIFESTYLES BEYOND EXPECTATIONS

THE MARK CONSISTS OF STANDARD CHARACTERS WITHOUT CLAIM TO ANY PARTICULAR FONT, STYLE, SIZE, OR COLOR.

OWNER OF U.S. REG. NOS. 2,561,231, 2,701,343 AND OTHERS.

FOR COUNTRY CLUB SERVICES AND GOLF CLUB SERVICES, NAMELY, OPERATION OF COUNTRY CLUBS AND GOLF COURSES, PROVIDING RECREATIONAL AND ENTERTAINMENT SERVICES AND FACILITIES THEREFOR, NAMELY, GOLF COURSES, TENNIS COURT FACILITIES, FITNESS FACILITIES, AND SWIMMING POOLS, AND PROVIDING INSTRUCTION IN GOLF (U.S. CLS. 100, 101 AND 107).

FIRST USE 1-0-2004; IN COMMERCE 1-0-2004.

ROBERT C. CLARK JR., EXAMINING ATTORNEY

SN 76-602,300. CABLE IN THE CLASSROOM, WASHINGTON, DC. FILED 7-14-2004.

CABLE'S LEADERS IN LEARNING AWARDS

THE MARK CONSISTS OF STANDARD CHARACTERS WITHOUT CLAIM TO ANY PARTICULAR FONT, STYLE, SIZE, OR COLOR.

NO CLAIM IS MADE TO THE EXCLUSIVE RIGHT TO USE "CABLE'S" AND AWARDS, APART FROM THE MARK AS SHOWN.

FOR ENTERTAINMENT SERVICES, NAMELY, SOLICITING NOMINATIONS AND ORGANIZING, ARRANGING, AND CONDUCTING AWARD CEREMONIES TO RECOGNIZE, PROMOTE AND HONOR EXCELLENCE IN THE FIELD OF K-12 EDUCATION (U.S. CLS. 100, 101 AND 107).

ANN E. SAPPENFIELD, EXAMINING ATTORNEY

SN 76-602,522. HOWARD COMMUNITY COLLEGE, COLUMBIA, MD. AND PRINCE GEORGE'S COMMUNITY COLLEGE, LARGO, MD. FILED 7-16-2004.

GET AHEAD IN LIFE

THE MARK CONSISTS OF STANDARD CHARACTERS WITHOUT CLAIM TO ANY PARTICULAR FONT, STYLE, SIZE, OR COLOR.

FOR PROVIDING COMMUNITY COLLEGE AND OTHER POST SECONDARY EDUCATIONAL COURSES AND PROGRAMS, NAMELY CREDIT COURSES AND DEGREE PROGRAMS, NON-CREDIT COURSES, CERTIFICATION PROGRAMS, INFORMATION SESSIONS RELATING TO ALL OF THE FOREGOING, COMMUNITY MEETINGS FOR PROVIDING INFORMATION RELATING TO ALL OF THE FOREGOING, AND SEMINARS AND WORKSHOPS FOR PROVIDING INFORMATION RELATING TO ALL OF THE FOREGOING (U.S. CLS. 100, 101 AND 107).

FIRST USE 8-15-2003; IN COMMERCE 7-18-2003.

DOMINIC J. FERRAIUOLO, EXAMINING ATTORNEY

CLASS 41—(Continued).

SN 76-602,845. THE LOTTE BERK METHOD LIMITED, NEW YORK, NY. FILED 7-19-2004.

LOTTE BERK METHOD

THE MARK CONSISTS OF STANDARD CHARACTERS WITHOUT CLAIM TO ANY PARTICULAR FONT, STYLE, SIZE, OR COLOR.

NO CLAIM IS MADE TO THE EXCLUSIVE RIGHT TO USE "METHOD", APART FROM THE MARK AS SHOWN.

THE NAME(S), PORTRAIT(S), AND/OR SIGNATURE(S) SHOWN IN THE MARK DOES NOT IDENTIFY A PARTICULAR LIVING INDIVIDUAL.

FOR PROVIDING CONSULTATION AND INSTRUCTION IN THE FIELD OF PHYSICAL EXERCISE; PROVIDING FITNESS AND EXERCISE FACILITIES (U.S. CLS. 100, 101 AND 107).

FIRST USE 0-0-1971; IN COMMERCE 0-0-1971.
ASMAT KHAN, EXAMINING ATTORNEY

SN 76-603,102. THE JEWISH THEOLOGICAL SEMINARY OF AMERICA, NEW YORK, NY. FILED S.R. 7-19-2004; AM. P.R. 6-17-2005.

CAMP RAMAH

THE MARK CONSISTS OF STANDARD CHARACTERS WITHOUT CLAIM TO ANY PARTICULAR FONT, STYLE, SIZE, OR COLOR.

NO CLAIM IS MADE TO THE EXCLUSIVE RIGHT TO USE "CAMP", APART FROM THE MARK AS SHOWN.

THE ENGLISH TRANSLATION OF THE WORD "RAMAH" IN THE MARK IS "LEVEL."

FOR RESIDENT SUMMER CAMP PROGRAMS; EDUCATIONAL SERVICES NAMELY, PROVIDING COURSES OF INSTRUCTION IN THE FIELDS OF JUDAICA, JEWISH STUDIES, MUSIC, HISTORY, RELIGION, PHILOSOPHY, LANGUAGE, LITERATURE; EDUCATIONAL SERVICES, NAMELY, CONDUCTING PROGRAMS IN THE FIELDS OF TEACHING AND COMMUNITY EDUCATION PROGRAMS; EDUCATION PROGRAMS; CONDUCTING SEMINARS, WORKSHOPS AND ARRANGING AND CONDUCTING EDUCATIONAL CONFERENCES IN THE FIELDS OF JUDAICA AND JEWISH STUDIES (U.S. CLS. 100, 101 AND 107).

FIRST USE 9-0-1947; IN COMMERCE 9-0-1947.
CHARLES JOYNER, EXAMINING ATTORNEY

CLASS 41—(Continued).

SN 76-603,288. HEUMANNLY CAPABLE, INC., ANN ARBOR, MI. FILED 7-21-2004.



FOR EDUCATIONAL SERVICES NAMELY CONDUCTING CLASSES AND SEMINARS IN THE FIELD OF PERSONAL AND PROFESSIONAL IMPROVEMENT (U.S. CLS. 100, 101 AND 107).

FIRST USE 1-15-2003; IN COMMERCE 1-15-2003.
LINDA E. BLOHM, EXAMINING ATTORNEY

SN 76-603,845. MISSIONS FEST NORTHWEST, PORTLAND, OR. FILED 7-26-2004.

MISSIONS FEST

THE MARK CONSISTS OF STANDARD CHARACTERS WITHOUT CLAIM TO ANY PARTICULAR FONT, STYLE, SIZE, OR COLOR.

NO CLAIM IS MADE TO THE EXCLUSIVE RIGHT TO USE "MISSIONS", APART FROM THE MARK AS SHOWN.

FOR EDUCATIONAL SERVICES, NAMELY CONDUCTING CLASSES AND SEMINARS IN THE FIELD OF THE NEEDS AND OPPORTUNITIES FOR EVANGELISM (U.S. CLS. 100, 101 AND 107).

FIRST USE 11-15-2001; IN COMMERCE 11-15-2001.
AISHA CLARKE, EXAMINING ATTORNEY

SN 76-603,859. ISAACSON, CATHERINE A., RICHBORO, PA. FILED 7-23-2004.

CENTRE PILATES

THE MARK CONSISTS OF STANDARD CHARACTERS WITHOUT CLAIM TO ANY PARTICULAR FONT, STYLE, SIZE, OR COLOR.

NO CLAIM IS MADE TO THE EXCLUSIVE RIGHT TO USE "PILATES", APART FROM THE MARK AS SHOWN.

FOR EDUCATIONAL SERVICES, NAMELY PROVIDING INSTRUCTION IN BODY CONDITIONING TECHNIQUES AND FITNESS TRAINING BY MEANS OF INDIVIDUAL LESSONS, GROUP CLASSES, INSTRUCTOR TRAINING, SEMINARS, WORKSHOPS (U.S. CLS. 100, 101 AND 107).

FIRST USE 4-30-2001; IN COMMERCE 4-30-2001.
SKYE YOUNG, EXAMINING ATTORNEY

CLASS 41—(Continued).

SN 76-605,238. MOCK DRAFT CENTRAL, LLC, GRAND RAPIDS, MI. FILED 8-2-2004.



NO CLAIM IS MADE TO THE EXCLUSIVE RIGHT TO USE MOCK DRAFT, APART FROM THE MARK AS SHOWN.

FOR INTERNET-BASED SERVICES PROVIDING SPORTS FANS WITH A FORMAT, LISTS AND INFORMATION IN WHICH TO DRAFT PLAYERS OF SPORTS LEAGUES IN SPORTS COMPETITIONS (U.S. CLS. 100, 101 AND 107).

FIRST USE 3-22-2002; IN COMMERCE 3-22-2002.
CAROL SPILS, EXAMINING ATTORNEY

SN 76-605,239. MOCK DRAFT CENTRAL, LLC, GRAND RAPIDS, MI. FILED 8-2-2004.

MOCK DRAFT CENTRAL

THE MARK CONSISTS OF STANDARD CHARACTERS WITHOUT CLAIM TO ANY PARTICULAR FONT, STYLE, SIZE, OR COLOR.

NO CLAIM IS MADE TO THE EXCLUSIVE RIGHT TO USE MOCK DRAFT, APART FROM THE MARK AS SHOWN.

FOR INTERNET-BASED SERVICES PROVIDING SPORTS FANS WITH A FORMAT, LISTS AND INFORMATION IN WHICH TO DRAFT PLAYERS OF SPORTS LEAGUES IN SPORTS COMPETITIONS (U.S. CLS. 100, 101 AND 107).

FIRST USE 7-9-2001; IN COMMERCE 8-29-2001.
CAROL SPILS, EXAMINING ATTORNEY

SN 76-607,128. DEJA VU CONSULTING, INC., LANSING, MI. FILED 8-16-2004.

DEJA VU SHOWGIRLS

THE MARK CONSISTS OF STANDARD CHARACTERS WITHOUT CLAIM TO ANY PARTICULAR FONT, STYLE, SIZE, OR COLOR.

OWNER OF U.S. REG. NOS. 1,726,389, 2,404,571 AND OTHERS.

NO CLAIM IS MADE TO THE EXCLUSIVE RIGHT TO USE "SHOWGIRLS", APART FROM THE MARK AS SHOWN.

FOR PUBLICATION OF AN ELECTRONIC MAGAZINE FEATURING ADULT ENTERTAINMENT (U.S. CLS. 100, 101 AND 107).

FIRST USE 12-12-1998; IN COMMERCE 12-12-1998.
DAWN FELDMAN, EXAMINING ATTORNEY

CLASS 41—(Continued).

SN 76-607,254. AMERICAN LANGUAGE COMMUNICATION CENTERS, INC., NEW YORK, NY. FILED 8-11-2004.

AMERICAN LANGUAGE COMMUNICATION CENTERS

THE MARK CONSISTS OF STANDARD CHARACTERS WITHOUT CLAIM TO ANY PARTICULAR FONT, STYLE, SIZE, OR COLOR.

NO CLAIM IS MADE TO THE EXCLUSIVE RIGHT TO USE "CENTERS", APART FROM THE MARK AS SHOWN. SEC. 2(F).

FOR EDUCATIONAL SERVICES IN THE NATURE OF A LANGUAGE SCHOOL, NAMELY TEACHING ENGLISH, TEACHING ENGLISH AS A SECOND LANGUAGE, TEACHING FOREIGN LANGUAGES, PUBLICATION OF BOOKS FOR LEARNING ENGLISH AND OTHER FOREIGN LANGUAGES (U.S. CLS. 100, 101 AND 107).

FIRST USE 4-20-1980; IN COMMERCE 4-20-1980.
EVELYN BRADLEY, EXAMINING ATTORNEY

SN 76-607,424. HENDERSON, JERRY, EDMOND, OK. FILED S.R. 8-13-2004; AM. P.R. 6-16-2005.

THE MEN OF LAS VEGAS

THE MARK CONSISTS OF STANDARD CHARACTERS WITHOUT CLAIM TO ANY PARTICULAR FONT, STYLE, SIZE, OR COLOR.

SEC. 2(F).
FOR ENTERTAINMENT IN THE NATURE OF DANCE PERFORMANCES (U.S. CLS. 100, 101 AND 107).

FIRST USE 4-0-1997; IN COMMERCE 4-0-1997.
MARIAM MAHMOUDI, EXAMINING ATTORNEY

SN 76-607,515. GRAPE VENTURES, LLC, BALTIMORE, MD. FILED 8-18-2004.

WOMEN'S WINE & DINE

THE MARK CONSISTS OF STANDARD CHARACTERS WITHOUT CLAIM TO ANY PARTICULAR FONT, STYLE, SIZE, OR COLOR.

NO CLAIM IS MADE TO THE EXCLUSIVE RIGHT TO USE "WOMEN'S", APART FROM THE MARK AS SHOWN. FOR SPECIAL EVENTS, NAMELY WINE APPRECIATION SEMINARS (U.S. CLS. 100, 101 AND 107).

FIRST USE 4-30-2004; IN COMMERCE 4-30-2004.
JOHN LINCOSKI, EXAMINING ATTORNEY

CLASS 41—(Continued).

SN 76-607,605. INSTITUTE FOR PROFESSIONALS IN TAXATION, ATLANTA, GA. FILED 8-19-2004.

INSTITUTE FOR PROFESSIONALS IN TAXATION

THE MARK CONSISTS OF STANDARD CHARACTERS WITHOUT CLAIM TO ANY PARTICULAR FONT, STYLE, SIZE, OR COLOR.

OWNER OF U.S. REG. NO. 2,252,080.

NO CLAIM IS MADE TO THE EXCLUSIVE RIGHT TO USE "INSTITUTE," APART FROM THE MARK AS SHOWN. SEC. 2(F).

FOR ORGANIZING AND CONDUCTING SEMINARS AND COURSES DEALING WITH SALES, USE, AND OTHER STATE AND LOCAL TAXES RELATING TO BUSINESS PROPERTY (U.S. CLS. 100, 101 AND 107).

FIRST USE 7-2-1997; IN COMMERCE 7-2-1997.

ANDREW BENZMILLER, EXAMINING ATTORNEY

SN 76-608,625. JACKLICH, DIANA M., EVANSTON, IL. FILED 8-23-2004.

WINE GODDESS

THE MARK CONSISTS OF STANDARD CHARACTERS WITHOUT CLAIM TO ANY PARTICULAR FONT, STYLE, SIZE, OR COLOR.

NO CLAIM IS MADE TO THE EXCLUSIVE RIGHT TO USE "WINE", APART FROM THE MARK AS SHOWN.

FOR ENTERTAINMENT SERVICES, NAMELY, WINE TASTINGS; EDUCATIONAL SERVICES, NAMELY, CONDUCTING SEMINARS AND CLASSES IN THE FIELD OF WINE AND SPIRITS, AND DISTRIBUTING COURSE MATERIALS IN CONNECTION THEREWITH (U.S. CLS. 100, 101 AND 107).

FIRST USE 12-2-2002; IN COMMERCE 12-2-2002.

STEVEN R. FOSTER, EXAMINING ATTORNEY

CLASS 41—(Continued).

SN 76-608,669. SCHUMACKER & COMPANY, INC., SUNRISE, FL. FILED 8-23-2004.



OWNER OF U.S. REG. NO. 2,914,269.

NO CLAIM IS MADE TO THE EXCLUSIVE RIGHT TO USE "BOWLING", APART FROM THE MARK AS SHOWN.

FOR ENTERTAINMENT SERVICES PROVIDED IN CONNECTION WITH BOWLING AND RECREATIONAL CENTERS, NAMELY, PROVIDING BOWLING ALLEYS, CONDUCTING BOWLING GAMES AND TOURNAMENTS, PROVIDING AMUSEMENT ARCADE ROOMS, PROVIDING BILLIARDS ROOMS, AND CONDUCTING PRIVATE PARTIES AT BOWLING ALLEYS (U.S. CLS. 100, 101 AND 107).

FIRST USE 4-0-2000; IN COMMERCE 4-0-2000.

WINSTON FOLMAR, EXAMINING ATTORNEY

SN 76-608,670. SCHUMACKER & COMPANY, INC., SUNRISE, FL. FILED 8-23-2004.



THE NEXT GENERATION OF BOWLING

OWNER OF U.S. REG. NO. 2,896,833.

FOR ENTERTAINMENT SERVICES PROVIDED IN CONNECTION WITH BOWLING AND RECREATIONAL CENTERS, NAMELY, PROVIDING BOWLING ALLEYS, CONDUCTING BOWLING GAMES AND TOURNAMENTS, PROVIDING AMUSEMENT ARCADE ROOMS, PROVIDING BILLIARDS ROOMS, AND CONDUCTING PRIVATE PARTIES AT BOWLING ALLEYS (U.S. CLS. 100, 101 AND 107).

FIRST USE 6-0-2002; IN COMMERCE 6-0-2002.

WINSTON FOLMAR, EXAMINING ATTORNEY

CLASS 41—(Continued).

SN 76-610,067. NATIONAL FALLEN FIREFIGHTERS FOUNDATION, EMMITSBURG, MD. FILED 9-3-2004.



NO CLAIM IS MADE TO THE EXCLUSIVE RIGHT TO USE LINE-OF-DUTY DEATH, FIRE, FIGHTER, AND LIFE SAFETY INITIATIVES, APART FROM THE MARK AS SHOWN.

FOR EDUCATIONAL SERVICES, NAMELY, CONDUCTING PROGRAMS IN THE FIELD OF SAFETY FOR FIREFIGHTERS TO PREVENT FIREFIGHTER LINE-OF-DUTY DEATHS AND INJURIES (U.S. CLS. 100, 101 AND 107).

FIRST USE 5-14-2004; IN COMMERCE 7-15-2004.
APRIL L. RADEMACHER, EXAMINING ATTORNEY

SN 76-610,276. THARA NATALIE LLC, RIVERVALE, NJ. FILED 9-7-2004.

THARA

FOR ENTERTAINMENT IN THE NATURE OF VISUAL AND AUDIO PERFORMANCES, NAMELY, MUSICAL PERFORMANCES, DANCE PERFORMANCES, TELEVISION PERFORMANCES, RADIO PERFORMANCES, NIGHTCLUB PERFORMANCES, THEATRE PERFORMANCES AND MOVIE PERFORMANCES (U.S. CLS. 100, 101 AND 107).

FIRST USE 10-1-2003; IN COMMERCE 10-1-2003.
ROBERT C. CLARK JR., EXAMINING ATTORNEY

CLASS 41—(Continued).

SN 76-610,653. ASHER BARTOS ENTERPRISES, INC., SYKESVILLE, MD. FILED 9-7-2004.



NO CLAIM IS MADE TO THE EXCLUSIVE RIGHT TO USE "HOME AND DESIGN TV", APART FROM THE MARK AS SHOWN.

FOR ENTERTAINMENT IN THE NATURE OF ONGOING TELEVISION PROGRAMS FEATURING NEW HOME BUILDERS AND COMMUNITIES AND HOME INTERIOR DESIGN TIPS (U.S. CLS. 100, 101 AND 107).

FIRST USE 1-1-2004; IN COMMERCE 1-4-2004.
DANIEL BRODY, EXAMINING ATTORNEY

SN 76-610,833. CAPITALMAX CORPORATION, LOS ANGELES, CA. FILED 9-7-2004.

BROKER POWER SYSTEM

THE MARK CONSISTS OF STANDARD CHARACTERS WITHOUT CLAIM TO ANY PARTICULAR FONT, STYLE, SIZE, OR COLOR.

NO CLAIM IS MADE TO THE EXCLUSIVE RIGHT TO USE "BROKER" OR "SYSTEM", APART FROM THE MARK AS SHOWN.

FOR EDUCATIONAL AND TRAINING SERVICES FOR THE MORTGAGE INDUSTRY, NAMELY, SEMINARS AND WORKSHOPS (U.S. CLS. 100, 101 AND 107).

FIRST USE 6-0-2004; IN COMMERCE 6-0-2004.
BRENDAN REGAN, EXAMINING ATTORNEY

SN 76-612,189. DUNLAP, CODDING & ROGERS, P.C., OKLAHOMA CITY, OK. FILED 9-15-2004.

PHOSITA

THE MARK CONSISTS OF STANDARD CHARACTERS WITHOUT CLAIM TO ANY PARTICULAR FONT, STYLE, SIZE, OR COLOR.

PHOSITA IDENTIFIES A MYTHICAL PERSON OF ORDINARY SKILL IN A PARTICULAR PATENT ART.

FOR PROVIDING ON-LINE NEWS AND INFORMATION IN THE FIELD OF INTELLECTUAL PROPERTIES (U.S. CLS. 100, 101 AND 107).

FIRST USE 1-0-2004; IN COMMERCE 1-0-2004.
EDWARD NELSON, EXAMINING ATTORNEY

CLASS 41—(Continued).

SN 76-612,439. LAC DU FLAMBEAU BAND OF LAKE SUPERIOR CHIPPEWA INDIANS, LAC DU FLAMBEAU, WI. FILED 9-14-2004.

THE CASINO WITH AN OUTSIDE

THE MARK CONSISTS OF STANDARD CHARACTERS WITHOUT CLAIM TO ANY PARTICULAR FONT, STYLE, SIZE, OR COLOR.

NO CLAIM IS MADE TO THE EXCLUSIVE RIGHT TO USE CASINO, APART FROM THE MARK AS SHOWN.

FOR CASINO SERVICES (U.S. CLS. 100, 101 AND 107).

FIRST USE 1-0-1998; IN COMMERCE 1-0-1998.

SUSAN LESLIE DUBOIS, EXAMINING ATTORNEY

SN 76-612,624. PERFORMANCE DIRECTIONS INTERNATIONAL, LLC, PITTSSTOWN, NJ. FILED 9-17-2004.

PERFORMANCE DIRECTIONS

THE MARK CONSISTS OF STANDARD CHARACTERS WITHOUT CLAIM TO ANY PARTICULAR FONT, STYLE, SIZE, OR COLOR.

FOR EDUCATIONAL SERVICES, NAMELY, ARRANGING AND CONDUCTING CLASSES, SEMINARS AND WORKSHOPS IN THE FIELDS OF SALES TRAINING AND MANAGEMENT DEVELOPMENT TRAINING, AND DISTRIBUTING INSTRUCTIONAL MATERIALS FOR AND IN CONNECTION WITH SUCH TRAINING (U.S. CLS. 100, 101 AND 107).

FIRST USE 4-19-2004; IN COMMERCE 5-7-2004.

PAULA MAHONEY, EXAMINING ATTORNEY

SN 76-613,126. PHILADELPHIA LIBERTY MEDAL, INC., PHILADELPHIA, PA. FILED 9-21-2004.

PHILADELPHIA LIBERTY MEDAL

THE MARK CONSISTS OF STANDARD CHARACTERS WITHOUT CLAIM TO ANY PARTICULAR FONT, STYLE, SIZE, OR COLOR.

NO CLAIM IS MADE TO THE EXCLUSIVE RIGHT TO USE "LIBERTY MEDAL", APART FROM THE MARK AS SHOWN.

SEC. 2(F).

FOR CONDUCTING AN AWARDS PROGRAM RECOGNIZING INDIVIDUALS AND ORGANIZATIONS WHO HAVE DEMONSTRATED LEADERSHIP AND VISION IN PURSUIT OF LIBERTY OF CONSCIENCE OR FREEDOM FROM OPPRESSION, IGNORANCE OR DEPRIVATION (U.S. CLS. 100, 101 AND 107).

FIRST USE 7-4-1989; IN COMMERCE 7-4-1989.

EDWARD NELSON, EXAMINING ATTORNEY

CLASS 41—(Continued).

SN 76-613,928. GOLD KEY CREDIT EDUCATION, LLC, FAIRFIELD, CT. FILED 9-24-2004.

GOLD KEY CREDIT EDUCATION

THE MARK CONSISTS OF STANDARD CHARACTERS WITHOUT CLAIM TO ANY PARTICULAR FONT, STYLE, SIZE, OR COLOR.

NO CLAIM IS MADE TO THE EXCLUSIVE RIGHT TO USE "CREDIT EDUCATION", APART FROM THE MARK AS SHOWN.

FOR EDUCATIONAL SERVICES, NAMELY, CONDUCTING SEMINARS AND WORKSHOPS TO EDUCATE CONSUMERS ABOUT FINANCES AND MANAGING CREDIT; PROVIDING ON-LINE COURSES IN THE FIELD OF CONSUMER CREDIT (U.S. CLS. 100, 101 AND 107).

FIRST USE 5-1-2004; IN COMMERCE 5-1-2004.

PAM WILLIS, EXAMINING ATTORNEY

SN 76-614,157. HUNTER, DEON, ROANOKE, TX. FILED 9-29-2004.

HOOP HUNTER BASKETBALL

THE MARK CONSISTS OF STANDARD CHARACTERS WITHOUT CLAIM TO ANY PARTICULAR FONT, STYLE, SIZE, OR COLOR.

NO CLAIM IS MADE TO THE EXCLUSIVE RIGHT TO USE "HOOP" AND "BASKETBALL", APART FROM THE MARK AS SHOWN.

FOR PHYSICAL EDUCATION SERVICES, NAMELY, TRAINING IN BASKETBALL SKILLS (U.S. CLS. 100, 101 AND 107).

FIRST USE 9-5-1995; IN COMMERCE 9-5-1995.

KAREN BRACEY, EXAMINING ATTORNEY

SN 76-614,282. ALAN-MCAFEE, INC., NASHVILLE, TN. FILED 9-29-2004.



NO CLAIM IS MADE TO THE EXCLUSIVE RIGHT TO USE "WORLD'S FASTEST DRUMMER EXTREME SPORT DRUMMING WWW.EXTREMESPORTDRUMMING.COM", APART FROM THE MARK AS SHOWN.

FOR ENTERTAINMENT IN THE NATURE OF FASTEST DRUMMER COMPETITIONS (U.S. CLS. 100, 101 AND 107).

FIRST USE 1-23-2001; IN COMMERCE 1-23-2001.

RONALD AIKENS, EXAMINING ATTORNEY

CLASS 41—(Continued).

SN 76-614,628. SKY MEDIA, CENTENNIAL, CO. FILED 10-6-2004.

ZANY KIDS

THE MARK CONSISTS OF STANDARD CHARACTERS WITHOUT CLAIM TO ANY PARTICULAR FONT, STYLE, SIZE, OR COLOR.

NO CLAIM IS MADE TO THE EXCLUSIVE RIGHT TO USE "KIDS", APART FROM THE MARK AS SHOWN.

FOR ENTERTAINMENT SERVICES, NAMELY, PROVIDING ON-LINE COMPUTER GAMES WITH A RELIGIOUS THEME (U.S. CLS. 100, 101 AND 107).

FIRST USE 3-15-2004; IN COMMERCE 3-15-2004.
ROBERT LAVACHE, EXAMINING ATTORNEY

SN 76-614,961. NTSI CORPORATION, TUCSON, AZ. FILED 10-4-2004.

NTSI.US

FOR EDUCATIONAL SERVICES; NAMELY, CONDUCTING CLASSES, SEMINARS, AND WORKSHOPS, BOTH IN THE TRADITIONAL CLASSROOM SETTING AND THROUGH INTERNET DELIVERY SYSTEMS, IN THE FIELD OF DRIVER SAFETY EDUCATION PROGRAMS AND TRAFFIC OFFENDER TRAINING AND REHABILITATION PROGRAMS; DEVELOPMENT AND PUBLICATION OF TRAINING MANUALS, WORKBOOKS, FILMS, VIDEOS, CD'S, CLASSROOM INSTRUCTION, ONLINE TRAINING PROGRAMS IN THE FIELD OF DRIVER SAFETY EDUCATION PROGRAMS AND TRAFFIC OFFENDER TRAINING AND REHABILITATION PROGRAMS (U.S. CLS. 100, 101 AND 107).

FIRST USE 9-1-2004; IN COMMERCE 9-1-2004.
ANGELA M. MICHEL, EXAMINING ATTORNEY

SN 76-615,042. HALLELUJAH ACRES, INC., SHELBY, NC. FILED 10-6-2004.

THE RAW TRUTH ABOUT HEALTH

THE MARK CONSISTS OF STANDARD CHARACTERS WITHOUT CLAIM TO ANY PARTICULAR FONT, STYLE, SIZE, OR COLOR.

FOR PROGRAM BROADCAST PERIODICALLY OVER RADIO AND INTERNET ABOUT FOLLOWING REGIMENS OF DIET, HEALTH AND NUTRITION (U.S. CLS. 100, 101 AND 107).

FIRST USE 10-22-2003; IN COMMERCE 10-22-2003.
JAQUELINE A. LAVINE, EXAMINING ATTORNEY

CLASS 41—(Continued).

SN 76-615,228. INSTITUTE FOR PROFESSIONAL DEVELOPMENT, LTD., DBA CLINE/FAY INSTITUTE, INC., GOLDEN, CO. FILED 10-12-2004.

LOVE AND LOGIC

THE MARK CONSISTS OF STANDARD CHARACTERS WITHOUT CLAIM TO ANY PARTICULAR FONT, STYLE, SIZE, OR COLOR.

OWNER OF U.S. REG. NOS. 1,813,708, 2,484,299 AND OTHERS.

FOR SEMINARS, CONFERENCES AND WORKSHOPS, ALL ON HOW PARENTS AND TEACHERS CAN INTERACT WITH CHILDREN, AND ACCOMPANYING EDUCATIONAL MATERIALS; PROVIDING EDUCATIONAL CONTENT VIA A GLOBAL COMPUTER NETWORK ON HOW PARENTS AND TEACHERS CAN INTERACT WITH CHILDREN; AND PROVIDING INFORMATION VIA A GLOBAL COMPUTER NETWORK ABOUT BOOKS, INSTRUCTIONAL MANUALS, NEWSLETTERS, PRE-RECORDED AUDIO AND VIDEO CASSETTE TAPES, PRE-RECORDED AUDIO AND VIDEO DIGITAL PROGRAMMING, INTERACTIVE MULTIMEDIA CD-ROM AND DOWNLOADABLE SOFTWARE, ALL ON HOW PARENTS AND TEACHERS CAN INTERACT WITH CHILDREN (U.S. CLS. 100, 101 AND 107).

FIRST USE 1-31-1999; IN COMMERCE 1-31-1999.
SHARON MEIER, EXAMINING ATTORNEY

SN 76-615,250. BLUELINE ENTERPRISES, LLC, INDIANAPOLIS, IN. FILED 10-12-2004.

THE FUTURE OF HOCKEY

FOR ENTERTAINMENT SERVICES IN THE NATURE OF AMATEUR HOCKEY COMPETITIONS (U.S. CLS. 100, 101 AND 107).

FIRST USE 5-31-2004; IN COMMERCE 5-31-2004.
JASON TURNER, EXAMINING ATTORNEY

SN 76-615,665. ANIMAL PAINTBALL, LLC, LAREDO, TX. FILED 10-7-2004.

BUNKERFEST

THE MARK CONSISTS OF STANDARD CHARACTERS WITHOUT CLAIM TO ANY PARTICULAR FONT, STYLE, SIZE, OR COLOR.

FOR ORGANIZING, HOSTING AND CONDUCTING PAINTBALL TOURNAMENTS (U.S. CLS. 100, 101 AND 107).

FIRST USE 6-26-2003; IN COMMERCE 6-26-2003.
NANCY CLARKE, EXAMINING ATTORNEY

CLASS 41—(Continued).

SN 76-615,731. BAT OUT OF HELL, INC., NEW YORK, NY. FILED 10-14-2004.

BAT OUT OF HELL

THE MARK CONSISTS OF STANDARD CHARACTERS WITHOUT CLAIM TO ANY PARTICULAR FONT, STYLE, SIZE, OR COLOR.

OWNER OF U.S. REG. NOS. 1,971,464 AND 2,588,724.

FOR ENTERTAINMENT IN THE NATURE OF THEATER PRODUCTIONS AND MUSICAL EVENTS; ENTERTAINMENT, NAMELY, PRODUCTION OF PLAYS; ENTERTAINMENT PRODUCTIONS, NAMELY, LIVE POETRY READINGS, COMEDY, MUSICAL AND DRAMATIC PERFORMANCES; ENTERTAINMENT SERVICES, NAMELY, PERSONAL APPEARANCES BY A COMEDIAN, MUSICIAN, POET, LITERARY FIGURE, SPORTS CELEBRITY, TELEVISION AND MOVIE STAR; ENTERTAINMENT SERVICES, NAMELY, LIVE, TELEVISED AND MOVIE APPEARANCES BY A PROFESSIONAL ENTERTAINER; ENTERTAINMENT SERVICES, NAMELY, PROVIDING A WEB SITE FEATURING MUSICAL PERFORMANCES, MUSICAL VIDEOS, RELATED FILM CLIPS, PHOTOGRAPHS, AND OTHER MULTIMEDIA MATERIALS; ENTERTAINMENT SERVICES, NAMELY, PROVIDING PRERECORDED MUSIC, INFORMATION IN THE FIELD OF MUSIC, AND COMMENTARY AND ARTICLES ABOUT MUSIC, ALL ONLINE VIA A GLOBAL COMPUTER NETWORK; ENTERTAINMENT SERVICES, NAMELY, PROVIDING ONLINE REVIEWS OF LIVE COMEDIC, MUSICAL, DRAMATIC AND LITERARY PERFORMANCES; ARRANGING FOR TICKET RESERVATIONS FOR SHOWS AND OTHER ENTERTAINMENT EVENTS; RECORD AND MUSIC PRODUCTION; AUDIO RECORDING AND PRODUCTION; MUSIC COMPOSITION AND TRANSCRIPTION FOR OTHERS; SONG WRITING SERVICES AND MUSIC PUBLISHING SERVICES (U.S. CLS. 100, 101 AND 107).

JUDITH HELFMAN, EXAMINING ATTORNEY

SN 76-616,059. CARLETON PUBLIC RELATIONS, INCORPORATED, HUNTSVILLE, AL. FILED 10-14-2004.

LAWCALL

THE MARK CONSISTS OF STANDARD CHARACTERS WITHOUT CLAIM TO ANY PARTICULAR FONT, STYLE, SIZE, OR COLOR.

FOR ENTERTAINMENT, NAMELY A TALK SHOW BROADCAST OVER TELEVISION, SATELLITE, AUDIO AND VIDEO MEDIA (U.S. CLS. 100, 101 AND 107).

FIRST USE 1-5-2003; IN COMMERCE 1-5-2003.

PAM WILLIS, EXAMINING ATTORNEY

CLASS 41—(Continued).

SN 76-616,086. MAGNA ENTERTAINMENT CORP., AURORA, ONTARIO L4G 7K1, CANADA, FILED 10-15-2004.

MAGNA 5

THE MARK CONSISTS OF STANDARD CHARACTERS WITHOUT CLAIM TO ANY PARTICULAR FONT, STYLE, SIZE, OR COLOR.

OWNER OF U.S. REG. NO. 2,640,283.

NO CLAIM IS MADE TO THE EXCLUSIVE RIGHT TO USE THE NUMBER "5", APART FROM THE MARK AS SHOWN.

FOR ENTERTAINMENT SERVICES, NAMELY, ORGANIZING AND CONDUCTING HORSE RACES; BETTING, PARIMUTUEL AND SPORTS WAGERING SERVICES, NAMELY, ON-LINE, INTERNET AND ELECTRONIC WAGERING SERVICES, TELEPHONE AND TELEVISION ACCOUNT WAGERING SERVICES, INTERTRACK, OFF-TRACK, AND ON-TRACK WAGERING SERVICES; AND PROVIDING HORSE RACE EXHIBITIONS (U.S. CLS. 100, 101 AND 107).

FIRST USE 1-10-2004; IN COMMERCE 1-10-2004.

SUSAN STIGLITZ, EXAMINING ATTORNEY

SN 76-616,274. FIRST NATIONWIDE LENDING OF AMERICA, INC., VALENCIA, CA. FILED 10-18-2004.

MORTGAGE MAKEOVERS

THE MARK CONSISTS OF STANDARD CHARACTERS WITHOUT CLAIM TO ANY PARTICULAR FONT, STYLE, SIZE, OR COLOR.

NO CLAIM IS MADE TO THE EXCLUSIVE RIGHT TO USE "MORTGAGE", APART FROM THE MARK AS SHOWN.

FOR ENTERTAINMENT SERVICES, NAMELY, PROVIDING A RADIO PROGRAM IN THE FIELD OF INFORMATION ON HOW TO OBTAIN MORTGAGES IN SPITE OF CREDIT ISSUES (U.S. CLS. 100, 101 AND 107).

FIRST USE 6-5-2004; IN COMMERCE 6-5-2004.

WARREN L. OLANDRIA, EXAMINING ATTORNEY

SN 76-616,429. ARGOSY GAMING COMPANY, ALTON, IL. FILED 10-18-2004.

YOUR LUCKY PLACE

THE MARK CONSISTS OF STANDARD CHARACTERS WITHOUT CLAIM TO ANY PARTICULAR FONT, STYLE, SIZE, OR COLOR.

FOR CASINO ENTERTAINMENT SERVICES (U.S. CLS. 100, 101 AND 107).

FIRST USE 4-1-2004; IN COMMERCE 4-1-2004.

BARBARA GAYNOR, EXAMINING ATTORNEY

CLASS 41—(Continued).

SN 76-616,536. CUJÉ, BETH B., ARLINGTON, VA. FILED 10-18-2004.

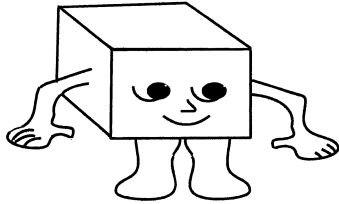

FOR EDUCATIONAL SERVICES, NAMELY, CONDUCTING WORKSHOPS AND LECTURES IN THE FIELD OF PSYCHOLOGY, THERAPY AND HUMAN POTENTIAL, AND DISTRIBUTING COURSE MATERIALS IN CONNECTION THEREWITH (U.S. CLS. 100, 101 AND 107).

FIRST USE 1-0-1994; IN COMMERCE 6-0-1994.
ANDREA K. NADELMAN, EXAMINING ATTORNEY

SN 76-616,656. GRAZZI EXHIBITIONS LLC, PARAMUS, NJ. FILED 10-15-2004.

YES YOU CAN!

THE MARK CONSISTS OF STANDARD CHARACTERS WITHOUT CLAIM TO ANY PARTICULAR FONT, STYLE, SIZE, OR COLOR.

FOR PROVIDING RECOGNITION AND INCENTIVES BY WAY OF AWARDS TO DEMONSTRATE EXCELLENCE IN THE ACHIEVEMENTS OF CELEBRATED WOMEN (U.S. CLS. 100, 101 AND 107).

FIRST USE 9-1-2004; IN COMMERCE 9-1-2004.
TARAH HARDY, EXAMINING ATTORNEY

SN 76-616,687. MY SCRAPBOOK STORE CORPORATION, FAIRFAX, VA. FILED 10-18-2004.

SCRAPTOGETHER

THE MARK CONSISTS OF STANDARD CHARACTERS WITHOUT CLAIM TO ANY PARTICULAR FONT, STYLE, SIZE, OR COLOR.

FOR EDUCATIONAL SERVICES, NAMELY, CONDUCTING CLASSES IN THE FIELDS OF PAPER CRAFTING AND ARCHIVAL QUALITY SCRAPBOOKING; EDUCATIONAL SERVICES, NAMELY, CONDUCTING PROGRAMS IN THE FIELD OF SCRAPBOOKING; PROVIDING FACILITIES FOR RECREATION ACTIVITIES, NAMELY, SCRAPBOOKING (U.S. CLS. 100, 101 AND 107).

FIRST USE 1-0-1997; IN COMMERCE 1-0-1997.
GRETTA YAO, EXAMINING ATTORNEY

CLASS 41—(Continued).

SN 76-617,022. WURZBURG, ROBERT J., ST. JOHNSBURY, VT. FILED 10-18-2004.

dogsharks

THE MARK CONSISTS OF STANDARD CHARACTERS WITHOUT CLAIM TO ANY PARTICULAR FONT, STYLE, SIZE, OR COLOR.

FOR ENTERTAINMENT SERVICES, SPECIFICALLY CHILDREN'S THEATER PRODUCTIONS (U.S. CLS. 100, 101 AND 107).

FIRST USE 6-19-2004; IN COMMERCE 8-1-2004.
KAREN BRACEY, EXAMINING ATTORNEY

SN 76-617,030. RUPERT'S KIDS, INC., INDIANAPOLIS, IN. FILED 10-18-2004.

RUPERT'S KIDS

THE MARK CONSISTS OF STANDARD CHARACTERS WITHOUT CLAIM TO ANY PARTICULAR FONT, STYLE, SIZE, OR COLOR.

NO CLAIM IS MADE TO THE EXCLUSIVE RIGHT TO USE "KIDS", APART FROM THE MARK AS SHOWN.

FOR CHARITABLE SERVICES, NAMELY PROVIDING VOCATIONAL TRAINING IN THE FIELDS OF MASONRY, CARPENTRY, PAINTING, LANDSCAPING, ROOFING, PLUMBING AND ELECTRICAL INSTALLATION AND REPAIRS, AND LIFE SKILLS TRAINING (U.S. CLS. 100, 101 AND 107).

FIRST USE 9-0-2004; IN COMMERCE 9-0-2004.
SUSAN STIGLITZ, EXAMINING ATTORNEY

SN 76-617,041. COLUMBIA CITY BALLET, COLUMBIA, SC. FILED 10-18-2004.

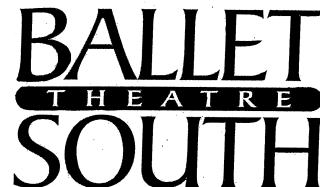

NO CLAIM IS MADE TO THE EXCLUSIVE RIGHT TO USE "BALLET THEATRE", APART FROM THE MARK AS SHOWN.

FOR BALLET PERFORMANCES (U.S. CLS. 100, 101 AND 107).

FIRST USE 9-29-2004; IN COMMERCE 9-29-2004.
CURTIS FRENCH, EXAMINING ATTORNEY

CLASS 41—(Continued).

SN 76-617,067. OPPORTUNITY KNOCKS OF WISCONSIN LLC, MEQUON, WI. FILED 10-18-2004.

CLASS 41—(Continued).

SN 76-617,194. WEIR, BOB, NEW YORK, NY. FILED 10-19-2004.

**ARE YOU READY FOR
YOUR NEXT BIG GIG?**

RATDOG

THE MARK CONSISTS OF STANDARD CHARACTERS WITHOUT CLAIM TO ANY PARTICULAR FONT, STYLE, SIZE, OR COLOR.

FOR COACHING SERVICES IN THE FIELD OF CAREER AND PROFESSIONAL DEVELOPMENT; PERSONAL AND PROFESSIONAL CAREER DEVELOPMENT SERVICES (U.S. CLS. 100, 101 AND 107).

FIRST USE 10-1-2004; IN COMMERCE 10-1-2004.
JULIE GUTTADAURO, EXAMINING ATTORNEY

THE MARK CONSISTS OF STANDARD CHARACTERS WITHOUT CLAIM TO ANY PARTICULAR FONT, STYLE, SIZE, OR COLOR.

FOR ENTERTAINMENT SERVICES IN THE NATURE OF A LIVE MUSICAL GROUP (U.S. CLS. 100, 101 AND 107).

FIRST USE 1-31-1995; IN COMMERCE 1-31-1995.
STEVEN R. FOSTER, EXAMINING ATTORNEY

SN 76-617,125. ITT EDUCATIONAL SERVICES, INC., CARMEL, IN. FILED 10-22-2004.

SN 76-617,299. ITT EDUCATIONAL SERVICES, INC., CARMEL, IN. FILED 10-22-2004.

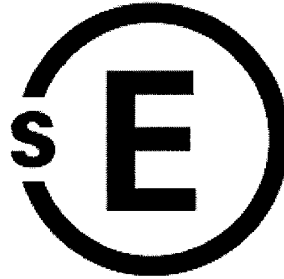
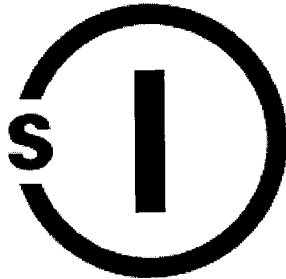

THE MARK INCLUDES THE LETTER "I" POSITIONED WITHIN A BROKEN CIRCLE WITH THE LETTER "S" INTERSECTING THE CIRCLE AT THE BREAK.

FOR EDUCATIONAL SERVICES, NAMELY, PROVIDING COURSES FOR INSTRUCTION IN INFORMATION SYSTEMS, INFORMATION TECHNOLOGY, SOFTWARE ENGINEERING, AND DATA COMMUNICATION AT THE COLLEGE LEVEL AND DISTRIBUTION OF COURSE MATERIAL IN CONNECTION THEREWITH (U.S. CLS. 100, 101 AND 107).

FIRST USE 9-27-2004; IN COMMERCE 9-27-2004.
DEBRA LEE, EXAMINING ATTORNEY

THE MARK INCLUDES THE LETTER "E" POSITIONED WITHIN A BROKEN CIRCLE WITH THE LETTER "S" INTERSECTING THE CIRCLE AT THE BREAK.

FOR EDUCATIONAL SERVICES, NAMELY, PROVIDING COURSES FOR INSTRUCTION IN COMPUTER AND ELECTRONICS ENGINEERING, INDUSTRIAL AUTOMATION ENGINEERING, AND ELECTRONICS AND COMMUNICATION ENGINEERING AT THE COLLEGE LEVEL AND DISTRIBUTION OF COURSE MATERIAL IN CONNECTION THEREWITH (U.S. CLS. 100, 101 AND 107).

FIRST USE 9-27-2004; IN COMMERCE 9-27-2004.
KELLEY WELLS, EXAMINING ATTORNEY

CLASS 41—(Continued).

SN 76-617,923. REED SMITH LLP, PITTSBURGH, PA. FILED 10-26-2004.



FOR LIBRARY SERVICES (U.S. CLS. 100, 101 AND 107).
FIRST USE 3-31-2003; IN COMMERCE 3-31-2003.
MARK RADEMACHER, EXAMINING ATTORNEY

SN 76-618,149. MONTOYA, MATTHEW, EL MONTE, CA. AND AHERN, JOHN, SUMMERLAND, CA. AND LISCA-NO, JOSE, CHINO, CA. AND SALDIVAR, HECTOR, ONTARIO, CA. AND GARCIA, ADRIAN, CHINO HILLS, CA. FILED 10-28-2004.

CRY HAVOC

THE MARK CONSISTS OF STANDARD CHARACTERS WITHOUT CLAIM TO ANY PARTICULAR FONT, STYLE, SIZE, OR COLOR.
FOR ENTERTAINMENT, NAMELY, LIVE PERFORMANCES BY A MUSICAL GROUP (U.S. CLS. 100, 101 AND 107).
FIRST USE 2-0-2002; IN COMMERCE 7-0-2002.
JULIE GUTTADAURO, EXAMINING ATTORNEY

SN 76-618,642. SILICON VALLEY SEMINARS, INC., LAFAYETTE, CO. FILED 11-1-2004.

TELEPATENT

THE MARK CONSISTS OF STANDARD CHARACTERS WITHOUT CLAIM TO ANY PARTICULAR FONT, STYLE, SIZE, OR COLOR.
FOR EDUCATIONAL SERVICES, NAMELY CONDUCTING TRAINING COURSES, WORKSHOPS, AND SEMINARS, IN THE INTELLECTUAL PROPERTY FIELD (U.S. CLS. 100, 101 AND 107).
FIRST USE 8-27-2004; IN COMMERCE 8-27-2004.
STEVEN JACKSON, EXAMINING ATTORNEY

CLASS 41—(Continued).

SN 76-618,975. SPARK THE WAVE, INC., WESTCHESTER, PA. FILED 11-1-2004.

SPARK THE WAVE

THE MARK CONSISTS OF STANDARD CHARACTERS WITHOUT CLAIM TO ANY PARTICULAR FONT, STYLE, SIZE, OR COLOR.
FOR EDUCATIONAL SERVICES, NAMELY, CONDUCTING TRAINING SEMINARS, WORKSHOPS AND SUMMER CAMPS IN THE FIELD OF YOUTH DEVELOPMENT, GOOD CITIZENSHIP, VOLUNTEERISM, PHILANTHROPY, LEADERSHIP AND COMMUNITY SERVICE (U.S. CLS. 100, 101 AND 107).
FIRST USE 9-5-2004; IN COMMERCE 10-14-2004.
JOHN GARTNER, EXAMINING ATTORNEY

SN 76-619,649. COLLEGE OF SAINT BENEDICT, ST. JOSEPH, MN. FILED 11-8-2004.

Inspired Learning. Inspiring Lives.

THE MARK CONSISTS OF STANDARD CHARACTERS WITHOUT CLAIM TO ANY PARTICULAR FONT, STYLE, SIZE, OR COLOR.
NO CLAIM IS MADE TO THE EXCLUSIVE RIGHT TO USE LEARNING, APART FROM THE MARK AS SHOWN.
FOR EDUCATIONAL SERVICES, NAMELY, PROVIDING COURSES OF INSTRUCTION AT THE UNDERGRADUATE AND GRADUATE LEVELS (U.S. CLS. 100, 101 AND 107).
FIRST USE 9-1-2002; IN COMMERCE 9-1-2002.
AMY GEARIN, EXAMINING ATTORNEY

CLASS 41—(Continued).

SN 76-621,501. SMITH, SHELDON BRUCE, ARLINGTON, VA. FILED 11-19-2004.

SHELDON SMITH

THE MARK CONSISTS OF STANDARD CHARACTERS WITHOUT CLAIM TO ANY PARTICULAR FONT, STYLE, SIZE, OR COLOR.

THE NAME SHELDON SMITH IDENTIFIES A LIVING INDIVIDUAL WHOSE CONSENT IS OF RECORD.

FOR ENTERTAINMENT SERVICES, NAMELY, PROVIDING VOICEOVER AND VOICEOVER NARRATION FOR TAPES, CDS, AND OTHER RECORDED MEDIA FOR USE ON RADIO, TELEVISION, AND INTERNET COMMERCIALS AND COMMERCIAL ANNOUNCEMENTS, AND FOR USE IN PROMOS, DOCUMENTARY FILMS, BUSINESS PRESENTATIONS, AND TRAINING PROGRAM PRESENTATIONS; ENTERTAINMENT IN THE NATURE OF LIVE PERFORMANCES BY AN ANNOUNCER FOR LIVE RADIO COMMERCIAL ANNOUNCEMENTS (U.S. CLS. 100, 101 AND 107).

FIRST USE 1-0-1965; IN COMMERCE 1-0-1965.
MELISSA SHELLA, EXAMINING ATTORNEY

SN 76-622,730. ABSOLUTE ENTERTAINMENT SA, COROZAL TOWN, BELIZE, FILED 12-1-2004.

ABSOLUTE POKER.COM

THE MARK CONSISTS OF STANDARD CHARACTERS WITHOUT CLAIM TO ANY PARTICULAR FONT, STYLE, SIZE, OR COLOR.

NO CLAIM IS MADE TO THE EXCLUSIVE RIGHT TO USE "POKER.COM", APART FROM THE MARK AS SHOWN.

FOR ENTERTAINMENT SERVICES, NAMELY CONDUCTING ON-LINE POKER GAMES AND TOURNAMENTS (U.S. CLS. 100, 101 AND 107).

FIRST USE 10-0-2003; IN COMMERCE 10-0-2003.
ANDREW RHIM, EXAMINING ATTORNEY

SN 76-622,731. ABSOLUTE ENTERTAINMENT SA, COROZAL TOWN, BELIZE, FILED 12-1-2004.

NO CLAIM IS MADE TO THE EXCLUSIVE RIGHT TO USE "POKER.COM", APART FROM THE MARK AS SHOWN.

FOR ENTERTAINMENT SERVICES, NAMELY CONDUCTING ON-LINE POKER GAMES AND TOURNAMENTS (U.S. CLS. 100, 101 AND 107).

FIRST USE 10-0-2003; IN COMMERCE 10-0-2003.
ANDREW RHIM, EXAMINING ATTORNEY

CLASS 41—(Continued).

SN 76-622,732. ABSOLUTE ENTERTAINMENT SA, COROZAL TOWN, BELIZE, FILED 12-1-2004.

ABSOLUTE POKER

THE MARK CONSISTS OF STANDARD CHARACTERS WITHOUT CLAIM TO ANY PARTICULAR FONT, STYLE, SIZE, OR COLOR.

NO CLAIM IS MADE TO THE EXCLUSIVE RIGHT TO USE "POKER", APART FROM THE MARK AS SHOWN.

FOR ENTERTAINMENT SERVICES, NAMELY CONDUCTING ON-LINE POKER GAMES AND TOURNAMENTS (U.S. CLS. 100, 101 AND 107).

FIRST USE 10-0-2003; IN COMMERCE 10-0-2003.
ANDREW RHIM, EXAMINING ATTORNEY

SN 76-624,749. ELITE RACING, INC., SAN DIEGO, CA. FILED 12-15-2004.

ELITE RACING MUSICAL MARATHON TOUR

THE MARK CONSISTS OF STANDARD CHARACTERS WITHOUT CLAIM TO ANY PARTICULAR FONT, STYLE, SIZE, OR COLOR.

NO CLAIM IS MADE TO THE EXCLUSIVE RIGHT TO USE "RACING MUSICAL MARATHON TOUR", APART FROM THE MARK AS SHOWN.

FOR ENTERTAINMENT IN THE NATURE OF FOOT RACES; ORGANIZING COMMUNITY FAIRS FEATURING VENDOR BOOTHS OF FOOD AND FOOT RACE RELATED SPORTING GOODS, AND PLANNING PARTIES (U.S. CLS. 100, 101 AND 107).

FIRST USE 11-11-2004; IN COMMERCE 11-11-2004.
LA TONIA FISHER, EXAMINING ATTORNEY

SN 76-625,094. INTELLIM RESEARCH, INC., BOCA RATON, FL. FILED 12-16-2004.

THE MARK CONSISTS OF STANDARD CHARACTERS WITHOUT CLAIM TO ANY PARTICULAR FONT, STYLE, SIZE, OR COLOR.

FOR ENTERTAINMENT SERVICES, NAMELY, PROVIDING AN ON-LINE COMPUTER GAME (U.S. CLS. 100, 101 AND 107).

FIRST USE 1-0-2004; IN COMMERCE 1-0-2004.
CARRIE ACHEN, EXAMINING ATTORNEY

CLASS 41—(Continued).

SN 76-625,384. MASTERYWORKS, INC., MCLEAN, VA.
FILED 12-22-2004.



OWNER OF U.S. REG. NOS. 2,265,357 AND 2,265,358.
THE COLORS PURPLE, AQUAMARINE AND WHITE
ARE CLAIMED AS A FEATURE OF THE MARK.

THE FIGURE'S HEAD AND RIGHT LEG ARE BLUE, ITS
LEFT ARM IS PURPLE AND ITS RIGHT ARM AND LEFT
LEG ARE WHITE. THE WORD "MASTERY" APPEARS AS
UPPERCASE BLUE STYLIZED TEXT AND THE WORD
"WORKS" APPEARS AS UPPERCASE PURPLE STYLIZED
TEXT.

THE MARK CONSISTS OF A STYLIZED HUMAN STICK-
FIGURE WITH TWO ARMS, TWO LEGS AND A ROUND
HEAD ABOVE THE WORDS "MASTERY WORKS" IN
UPPERCASE STYLIZED TEXT. THE FIGURE'S ARMS
ARE RAISED IN AN UPWARD POSITION ON EITHER
SIDE OF THE FIGURE'S HEAD.

FOR EDUCATIONAL AND TRAINING SERVICES IN
THE NATURE OF CLASSES, SEMINARS, CONFER-
ENCES AND WORKSHOPS IN THE AREA OF CAREER
AND PERSONAL DEVELOPMENT FOR INDIVIDUALS
AND ORGANIZATIONS (U.S. CLS. 100, 101 AND 107).

FIRST USE 1-1-2001; IN COMMERCE 1-1-2001.
MARGERY A. TIERNEY, EXAMINING ATTORNEY

SN 76-625,607. SIERRA KIDS FOUNDATION, RENO, NV.
FILED 12-27-2004.

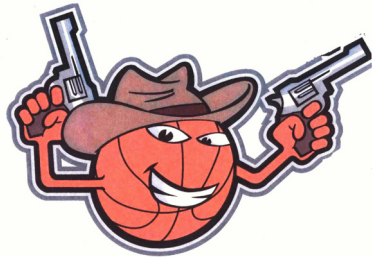

THE COLOR(S) BLACK, WHITE, GRAY, BROWN, AND
ORANGE IS/ARE CLAIMED AS A FEATURE OF THE
MARK.

THE OUTLINES IN THE MARK ARE GRAY AND
BLACK. THE PISTOLS ARE WHITE, BLACK, BROWN,
AND GRAY. THE HAT IS BROWN AND BLACK. THE
BASKETBALL, HANDS, AND ARMS ARE ORANGE. THE
SEGMENTS IN THE BASKETBALL FACE CONTAIN
BLACK LINES. THE EYES, SMILE, AND TEETH IN THE
FACE CONTAIN BLACK AND WHITE.

FOR ENTERTAINMENT IN THE NATURE OF BAS-
KETBALL GAMES (U.S. CLS. 100, 101 AND 107).
FIRST USE 3-1-2004; IN COMMERCE 3-1-2004.
PAUL F. GAST, EXAMINING ATTORNEY

CLASS 41—(Continued).

SN 76-625,710. CHRISTIAN HOSPITAL, ST. LOUIS, MO.
FILED 12-17-2004.

No Loafers.

THE MARK CONSISTS OF STANDARD CHARACTERS
WITHOUT CLAIM TO ANY PARTICULAR FONT, STYLE,
SIZE, OR COLOR.

FOR HEALTH AND EXERCISE EDUCATION PRO-
GRAM WHICH ENCOURAGES DAILY ACTIVITY AND
EXERCISE (U.S. CLS. 100, 101 AND 107).

FIRST USE 12-30-2003; IN COMMERCE 12-30-2003.
NORA BUCHANAN WILL, EXAMINING ATTORNEY

SN 76-625,906. SMITHSONIAN INSTITUTION, WASHING-
TON, DC. FILED 12-29-2004.

ARAGO

FOR EDUCATIONAL SERVICES, NAMELY, PROVID-
ING AN ONLINE RESEARCH DATABASE OF THE
NATIONAL COLLECTION AND ASSOCIATED RE-
SOURCE WHOSE PRIMARY FOCUS IS UNITED
STATES PHILATELIC AND POSTAL HISTORY (U.S.
CLS. 100, 101 AND 107).

FIRST USE 9-9-2003; IN COMMERCE 9-9-2003.
MICHAEL WEBSTER, EXAMINING ATTORNEY

SN 76-626,144. AVI RENTAL SERVICES DIVISION, L.L.C.,
TAMPA, FL. FILED 12-27-2004.

GIG-A-BOX

THE MARK CONSISTS OF STANDARD CHARACTERS
WITHOUT CLAIM TO ANY PARTICULAR FONT, STYLE,
SIZE, OR COLOR.

FOR AUDIO VISUAL EQUIPMENT LEASING SER-
VICES (U.S. CLS. 100, 101 AND 107).

FIRST USE 7-15-2004; IN COMMERCE 7-15-2004.
CAROLINE WEIMER, EXAMINING ATTORNEY

CLASS 41—(Continued).

SN 76-626,212. WILLIAMS, PETER-JOHN, NEW YORK, NY.
FILED 12-23-2004.

PETER-JOHN

THE MARK IS NOT THE NAME OF A LIVING INDIVIDUAL OTHER THAN APPLICANT.
FOR ENTERTAINMENT SERVICES IN THE NATURE OF MUSICAL PERFORMANCES BY AN INDIVIDUAL OR GROUP (U.S. CLS. 100, 101 AND 107).
FIRST USE 1-0-2001; IN COMMERCE 2-0-2003.
TARAH HARDY, EXAMINING ATTORNEY

SN 76-626,414. KENTUCKY LOTTERY CORPORATION,
LOUISVILLE, KY. FILED 12-28-2004.

**BREAK
FORT KNOX**

FOR LOTTERY SERVICES (U.S. CLS. 100, 101 AND 107).
FIRST USE 7-5-1990; IN COMMERCE 7-5-1990.
SANI KHOURI, EXAMINING ATTORNEY

SN 76-626,746. MONKEY BIZNESS, LLC, CENTENNIAL, CO.
FILED 1-3-2005.

MONKEY BIZNESS

THE MARK CONSISTS OF STANDARD CHARACTERS WITHOUT CLAIM TO ANY PARTICULAR FONT, STYLE, SIZE, OR COLOR.
FOR RECREATION CENTER FOR CHILDREN (U.S. CLS. 100, 101 AND 107).
FIRST USE 1-0-2003; IN COMMERCE 1-0-2003.
JILL PRATER, EXAMINING ATTORNEY

CLASS 41—(Continued).

SN 76-626,785. OFFSHORE SUPER SERIES POWER BOAT ASSOCIATION, CORPUS CHRISTI, TX. FILED 1-3-2005.

OSS

THE MARK CONSISTS OF STANDARD CHARACTERS WITHOUT CLAIM TO ANY PARTICULAR FONT, STYLE, SIZE, OR COLOR.
FOR ENTERTAINMENT SERVICES, NAMELY SANCTIONING POWER BOAT SPORTING EVENTS (U.S. CLS. 100, 101 AND 107).
FIRST USE 12-0-2003; IN COMMERCE 12-0-2003.
GRETTA YAO, EXAMINING ATTORNEY

SN 76-626,786. OFFSHORE SUPER SERIES POWER BOAT ASSOCIATION, CORPUS CHRISTI, TX. FILED 1-3-2005.

:OSS:

FOR ENTERTAINMENT SERVICES, NAMELY SANCTIONING POWER BOAT SPORTING EVENTS (U.S. CLS. 100, 101 AND 107).
FIRST USE 2-0-2004; IN COMMERCE 2-0-2004.
GRETTA YAO, EXAMINING ATTORNEY

SN 76-634,853. TIME WISE SOLUTIONS, LLC., MORRILL, ME. FILED 4-1-2005.

TIME WISE INSTITUTE

THE MARK CONSISTS OF STANDARD CHARACTERS WITHOUT CLAIM TO ANY PARTICULAR FONT, STYLE, SIZE, OR COLOR.
OWNER OF U.S. REG. NOS. 2,848,213 AND 2,923,973.
NO CLAIM IS MADE TO THE EXCLUSIVE RIGHT TO USE "INSTITUTE", APART FROM THE MARK AS SHOWN.
FOR EDUCATIONAL SERVICES, NAMELY, PROVIDING COURSES OF INSTRUCTION AND CONDUCTING TRAINING AND WORKSHOPS IN THE FIELD OF BUSINESS MANAGEMENT AND PRODUCTIVITY, AND DISTRIBUTING INSTRUCTIONAL MATERIALS IN CONNECTION THEREWITH (U.S. CLS. 100, 101 AND 107).
FIRST USE 9-1-2004; IN COMMERCE 10-1-2004.
MICHELLE DUBOIS, EXAMINING ATTORNEY

CLASS 41—(Continued).

SN 78-068,063. VIACOM INTERNATIONAL INC., NEW YORK, NY. FILED 6-8-2001.

NICKELODEON SMASHED

OWNER OF U.S. REG. NOS. 1,217,864, 2,103,137 AND OTHERS.

FOR ENTERTAINMENT SERVICES IN THE NATURE OF AN ON-GOING TELEVISION PROGRAM FEATURING A GAME SHOW; PROVIDING ENTERTAINMENT INFORMATION RENDERED VIA COMPUTER BY MEANS OF A GLOBAL COMPUTER NETWORK, NAMELY, PROVIDING INFORMATION REGARDING TELEVISION PROGRAMS; PROVIDING ENTERTAINMENT RENDERED VIA COMPUTER BY MEANS OF A GLOBAL COMPUTER NETWORK, NAMELY PROVIDING AN ON-LINE COMPUTER GAME (U.S. CLS. 100, 101 AND 107).

MARY BOAGNI, EXAMINING ATTORNEY

SN 78-133,455. DARGI, STEVEN B., HOPKINS, MN. FILED 6-5-2002.

BLACK ON BLACK

FOR COMPOSITION OF MUSIC FOR OTHERS, LIVE PERFORMANCES BY A MUSICAL BAND, MOTION PICTURE FILM PRODUCTION, MUSIC PUBLISHING SERVICES, ORGANIZING EXHIBITIONS FOR MUSICAL ENTERTAINMENT, PRODUCTION OF RECORDED MEDIA IN THE NATURE OF AUDIO CASSETTES, COMPACT DISCS, DIGITAL ON-LINE MEDIA, DVDS, PHONOGRAPH RECORDS, AND VIDEO CASSETTES AND LASER DISCS (U.S. CLS. 100, 101 AND 107).

FIRST USE 10-1-1975; IN COMMERCE 10-1-1975.

MARTHA SANTOMARTINO, EXAMINING ATTORNEY

SN 78-228,842. GLOBAL PARTNERSHIP, LLC, NORTH LITTLE ROCK, AR. FILED 3-23-2003.

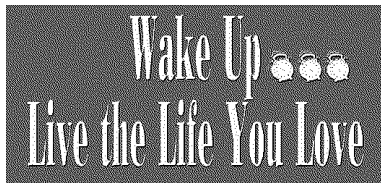

FOR EDUCATIONAL AND ENTERTAINMENT SERVICES, NAMELY, PROVIDING MOTIVATIONAL AND EDUCATIONAL SPEAKERS; CONDUCTING CLASSES, WORKSHOPS AND SEMINARS IN THE FIELDS OF WELLNESS, FITNESS, HEALTH AND SELF DEVELOPMENT TECHNIQUES; AND PROVIDING ON-GOING TELEVISION PROGRAMS IN THE FIELD OF WELLNESS, FITNESS, HEALTH AND SELF DEVELOPMENT (U.S. CLS. 100, 101 AND 107).

FIRST USE 9-1-2001; IN COMMERCE 11-1-2001.

SAMUEL E. SHARPER JR., EXAMINING ATTORNEY

CLASS 41—(Continued).

SN 78-243,169. JEFFRIE STORY & ASSOCIATES, INC., SCOTTSDALE, AZ. FILED 4-29-2003.

UNLEASH YOUR SALES DNA

FOR TRAINING SERVICES IN THE FIELD OF SALES (U.S. CLS. 100, 101 AND 107).

FIRST USE 0-0-2000; IN COMMERCE 0-0-2000.

ALICIA COLLINS, EXAMINING ATTORNEY

SN 78-251,440. JDH GROUP, INC., POWELL, OH. FILED 5-19-2003.



NO CLAIM IS MADE TO THE EXCLUSIVE RIGHT TO USE "SALES SYSTEM", APART FROM THE MARK AS SHOWN.

FOR TRAINING SERVICES IN THE FIELD OF SALES (U.S. CLS. 100, 101 AND 107).

TRACY FLETCHER, EXAMINING ATTORNEY

SN 78-254,391. LIFESPING HEALTH NETWORK LLC, LOS GATOS, CA. FILED 5-27-2003.

LIFESPING

FOR EDUCATION SERVICES, NAMELY, CONDUCTING CLASSES IN THE FIELDS OF FITNESS, HEALTH AND WELLNESS; WELLNESS TRAINING, NAMELY, HEALTH CLUB SERVICES; PROVIDING FACILITIES AND SERVICES FOR EXERCISE, PHYSICAL FITNESS, HEALTH (U.S. CLS. 100, 101 AND 107).

GEORGIA CARTY, EXAMINING ATTORNEY

CLASS 41—(Continued).

SN 78-266,264. TAMBAR PRODUCTIONS LTD., LONDON, UNITED KINGDOM, FILED 6-24-2003.

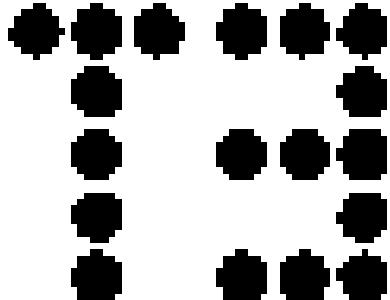

FOR ENTERTAINMENT SERVICES, NAMELY, PRODUCTION OF THEATRICAL EVENTS, THEATRICAL SHOWS, TELEVISION PROGRAMS, LIVE PERFORMANCES, CONCERTS AND FEATURE FILMS AND VIDEO FILMS; ENTERTAINMENT IN THE NATURE OF ON-GOING TELEVISION PROGRAMS IN THE FIELD OF COMEDY, VARIETY, DRAMA, MUSICALS, NEWS, DOCUMENTARIES AND ANIMATION; ENTERTAINMENT IN THE NATURE OF THEATER PRODUCTIONS; ARRANGING FOR TICKET RESERVATIONS FOR SHOWS AND OTHER ENTERTAINMENT EVENTS (U.S. CLS. 100, 101 AND 107).

MICHAEL KAZAZIAN, EXAMINING ATTORNEY

SN 78-291,762. SUSAN R. GOTTSCHALK, CANTON, MI. FILED 8-25-2003.

DISCOVERY ENRICHMENT

FOR EDUCATIONAL ENRICHMENT SERVICES IN THE FIELD OF CRAFTS, DRAMA, MUSIC, COOKING, SOCCER, FOOTBALL, BASKETBALL, GYMNASTICS AND SKIING FOR ADULTS AND SCHOOL AGE YOUTH; ENTERTAINMENT IN THE NATURE OF MAGIC FOR ADULTS AND SCHOOL AGE YOUTH (U.S. CLS. 100, 101 AND 107).

SKYE YOUNG, EXAMINING ATTORNEY

SN 78-294,005. THE KENNEDY CENTER FOR REAL ESTATE EDUCATION, INC., MARIETTA, GA. FILED 8-29-2003.



FOR EDUCATIONAL SERVICES, NAMELY CONDUCTING COURSES, TESTING, AND SEMINARS CONCERNING THE PROFESSIONAL ROLE OF THE REAL ESTATE LISTING AGENT IN SERVING AS A SELLER'S REPRESENTATIVE (U.S. CLS. 100, 101 AND 107).

CATHERINE CAIN, EXAMINING ATTORNEY

CLASS 41—(Continued).

SN 78-295,614. AMERICAN INNS OF COURT FOUNDATION, ALEXANDRIA, VA. FILED 9-3-2003.

INNSIGHT

FOR PROVIDING ELECTRONIC NEWSLETTERS FOR MEMBERS OF A LEGAL ORGANIZATION OF ATTORNEYS, JUDGES, LAW PROFESSORS AND LAW STUDENTS, ON THE TOPIC OF IMPROVING THE SKILLS, PROFESSIONALISM, ETHICS, AND CIVILITY OF THE BENCH AND BAR IN THE STUDY AND PRACTICE OF LAW; PUBLICATION OF ON-LINE NEWSLETTERS FOR MEMBERS OF A LEGAL ORGANIZATION OF ATTORNEYS, JUDGES, LAW PROFESSORS AND LAW STUDENTS, ON THE TOPIC OF IMPROVING THE SKILLS, PROFESSIONALISM, ETHICS AND CIVILITY OF THE BENCH AND BAR IN THE STUDY AND PRACTICE OF LAW (U.S. CLS. 100, 101 AND 107).

FIRST USE 7-1-2002; IN COMMERCE 7-1-2002.
GWEN STOKOLS, EXAMINING ATTORNEY

SN 78-303,103. MAINZ, PAUL H., ROCHESTER, MN. FILED 9-19-2003.

SEATADAPANTS

THE MARK CONSISTS OF STANDARD CHARACTERS WITHOUT CLAIM TO ANY PARTICULAR FONT, STYLE, SIZE, OR COLOR.

FOR ENTERTAINMENT IN THE NATURE OF VISUAL AND AUDIO PERFORMANCES, AND MUSICAL, VARIETY, NEWS AND COMEDY SHOWS (U.S. CLS. 100, 101 AND 107).

BERYL GARDNER, EXAMINING ATTORNEY

SN 78-313,378. ABWE MINISTRIES, INC., NEW CUMBERLAND, PA. FILED 10-14-2003.

CEIM

FOR EDUCATIONAL SERVICES, NAMELY, CONDUCTING CLASSES, SEMINARS, CONFERENCES, WORKSHOPS AND TRAINING IN THE FIELD OF INTERNATIONAL AND CROSS-CULTURAL RELIGIOUS ACTIVITIES AND DISTRIBUTING COURSE MATERIALS IN CONNECTION THEREWITH (U.S. CLS. 100, 101 AND 107).

FIRST USE 11-19-2003; IN COMMERCE 5-1-2004.
HOWARD SMIGA, EXAMINING ATTORNEY

CLASS 41—(Continued).

SN 78-317,180. KINGDOM WORLDWIDE WEB OPERATIONS, INC., GAINESVILLE, FL. FILED 10-22-2003.

ATK GALLERIA

FOR PROVIDING AN INTERACTIVE WEBSITE IN THE FIELD OF ADULT ENTERTAINMENT FEATURING PHOTOGRAPHIC, VIDEO GRAPHIC, AUDIO AND PRINT FORMATS OF MALE AND FEMALE MODELS AVAILABLE VIA CABLE, SATELLITE, PHONE, OR OPTICAL COMPUTER NETWORK (U.S. CLS. 100, 101 AND 107).

FIRST USE 11-1-1996; IN COMMERCE 11-1-1966.
KEVON CHISOLM, EXAMINING ATTORNEY

CLASS 41—(Continued).

SN 78-332,130. HOUSTON MEDIASOURCE, HOUSTON, TX. FILED 11-24-2003.

PSA DUDE

THE MARK CONSISTS OF STANDARD CHARACTERS WITHOUT CLAIM TO ANY PARTICULAR FONT, STYLE, SIZE, OR COLOR.

NO CLAIM IS MADE TO THE EXCLUSIVE RIGHT TO USE PSA, APART FROM THE MARK AS SHOWN.

FOR ENTERTAINMENT IN THE NATURE OF ONGOING TELEVISION PROGRAMS IN THE FIELD OF PUBLIC SERVICE ANNOUNCEMENTS (U.S. CLS. 100, 101 AND 107).

FIRST USE 1-1-1995; IN COMMERCE 10-1-2002.
KATHERINE STOIDES, EXAMINING ATTORNEY

SN 78-330,848. THE SISTERS OF PROVIDENCE OF SAINT MARY'S OF THE WOODS, SAINT MARY-OF-THE-WOODS, IN. FILED 11-20-2003.



NO CLAIM IS MADE TO THE EXCLUSIVE RIGHT TO USE "GOLF SCRAMBLE", APART FROM THE MARK AS SHOWN.

THE COLORS GREEN, WHITE, GRAY, DARK GRAY AND LAVENDER ARE CLAIMED AS A FEATURE OF THE MARK.

THE COLOR GREEN APPEARS IN THE GOLF FLAG, WORDING, AND THE WINGS OF THE STYLIZED GOLF BALL DESIGN. THE GROUND IS GRAY AND THE MOUNTAINS ARE DARK GRAY. THE SUN IS LAVENDER. THE GOLF BALL DESIGN IS GRAY. THE BACKGROUND OF THE MARK IS WHITE.

FOR CONDUCTING ANNUAL GOLF TOURNAMENTS (U.S. CLS. 100, 101 AND 107).

FIRST USE 8-8-2003; IN COMMERCE 8-8-2003.
KIMBERLY FRYE, EXAMINING ATTORNEY

SN 78-336,272. KAID, LYNDA LEE, GAINESVILLE, FL. FILED 12-4-2003.



NO CLAIM IS MADE TO THE EXCLUSIVE RIGHT TO USE "VOTE", APART FROM THE MARK AS SHOWN.

THE COLOR(S) RED AND WHITE AND BLUE AND BLACK IS/ARE CLAIMED AS A FEATURE OF THE MARK.

THE MARK CONSISTS OF A CAPITAL U WITH ALTERNATE COLOR BANDS ON A DIAGONAL, UPPER RIGHT TO LOWER LEFT, THE TOP OF THE BANDS BEING RED, THE MIDDLE OF THE BANDS BEING WHITE, THE BOTTOM OF THE BANDS BEING BLUE, WITH THREE WHITE STARS OVERLAID ON THE BOTTOM BLUE BAND OF THE U, WITH THE WORD VOTE IN BLACK LOWER-CASE LETTERS OVERLAID ON THE U IN THE LOWER HALF OF THE U.

FOR EDUCATIONAL RESEARCH IN THE FIELD OF POLITICAL COMMUNICATION AND VOTING BEHAVIOR (U.S. CLS. 100, 101 AND 107).

FIRST USE 10-1-2003; IN COMMERCE 11-10-2003.
ALEX KEAM, EXAMINING ATTORNEY

CLASS 41—(Continued).

SN 78-338,058. GENEVA MEDIA, LLC, REDWOOD CITY, CA. FILED 12-8-2003.

LIQUID DIGITAL MEDIA

THE MARK CONSISTS OF STANDARD CHARACTERS WITHOUT CLAIM TO ANY PARTICULAR FONT, STYLE, SIZE, OR COLOR.

NO CLAIM IS MADE TO THE EXCLUSIVE RIGHT TO USE "DIGITAL MEDIA", APART FROM THE MARK AS SHOWN.

FOR PROVIDING INFORMATION IN THE FIELD OF MUSIC AND ENTERTAINMENT VIA ELECTRONIC COMMUNICATION NETWORKS; MUSIC PUBLISHING SERVICES (U.S. CLS. 100, 101 AND 107).

FIRST USE 12-1-2003; IN COMMERCE 12-1-2003.
NICHOLAS ALTREE, EXAMINING ATTORNEY

CLASS 41—(Continued).

SN 78-349,504. NATIONAL BROADCASTING COMPANY, INC., NEW YORK, NY. FILED 1-8-2004.

National Broadband Company

THE MARK CONSISTS OF STANDARD CHARACTERS WITHOUT CLAIM TO ANY PARTICULAR FONT, STYLE, SIZE, OR COLOR.

NO CLAIM IS MADE TO THE EXCLUSIVE RIGHT TO USE COMPANY, APART FROM THE MARK AS SHOWN.

FOR ENTERTAINMENT SERVICES, NAMELY, PRODUCTION AND DISTRIBUTION OF TELEVISION PROGRAMS (U.S. CLS. 100, 101 AND 107).

ANN LINNEHAN, EXAMINING ATTORNEY

SN 78-348,390. AID TO ADOPTION OF SPECIAL KIDS/ ARIZONA, PHOENIX, AZ. FILED 1-6-2004.



NO CLAIM IS MADE TO THE EXCLUSIVE RIGHT TO USE FAMILY AND CENTER, APART FROM THE MARK AS SHOWN.

THE MARK CONSISTS OF AN IMAGE OF THREE PUZZLE PIECES ON TOP OF THE WORDS "FAMILY CONNECTIONS CENTER".

FOR CHARITABLE SERVICES, NAMELY, PROVIDING RESOURCE LIBRARY SERVICES TO THOSE IN NEED NAMELY, FOSTER AND ADOPTIVE FAMILIES; EDUCATIONAL SERVICES NAMELY, OFFERING TRAINING COURSES AND ONE-ON-ONE MENTORING AND EXPERT COUNSELING IN THE FIELD OF FOSTER AND ADOPTIVE FAMILY AND PARENTING SKILLS (U.S. CLS. 100, 101 AND 107).

FIRST USE 1-4-2004; IN COMMERCE 1-4-2004.
HENRY S. ZAK, EXAMINING ATTORNEY

SN 78-355,099. LYNDA.COM INC., OJAI, CA. FILED 1-21-2004.

ONLINE LEARNING LIBRARY

THE MARK CONSISTS OF STANDARD CHARACTERS WITHOUT CLAIM TO ANY PARTICULAR FONT, STYLE, SIZE, OR COLOR.

NO CLAIM IS MADE TO THE EXCLUSIVE RIGHT TO USE LIBRARY, APART FROM THE MARK AS SHOWN.

FOR PROVIDING ONLINE EDUCATIONAL TRAINING INFORMATION IN THE FIELD OF COMPUTERS (U.S. CLS. 100, 101 AND 107).

FIRST USE 2-28-2002; IN COMMERCE 2-28-2002.
BRIDGETT SMITH, EXAMINING ATTORNEY

CLASS 41—(Continued).

SN 78-355,810. BRIDGEWATER ICE ARENA, LLC, BRIDGEWATER, MA. FILED 1-22-2004.



THE MARK CONSISTS OF THE STYLIZED LETTER H PARTIALLY ENCIRCLED BY TWO CRESCENTS.

FOR ENTERTAINMENT AND EDUCATION SERVICES, NAMELY THE OPERATION OF ICE HOCKEY LEAGUES, TOURNAMENTS, CLINICS, AND CAMPS, AND CONDUCTING ICE HOCKEY LEAGUE GAMES (U.S. CLS. 100, 101 AND 107).

FIRST USE 2-15-2002; IN COMMERCE 2-15-2004.
SUSAN LESLIE DUBOIS, EXAMINING ATTORNEY

SN 78-357,569. THE MARCUS CORPORATION, MILWAUKEE, WI. FILED 1-26-2004.



THE MARK CONSISTS OF A STYLIZED M.

FOR RECREATIONAL SERVICES IN THE NATURE OF MOVIE THEATERS, AQUATIC FACILITIES, NIGHT-CLUBS, SKI RESORTS; PROVIDING FACILITIES FOR EDUCATIONAL CONVENTIONS; LIVE ENTERTAINMENT IN THE NATURE OF LIVE MUSICAL CONCERTS, MAGIC SHOWS, COMEDY AND FIREWORKS SHOWS; GOLF COURSES; TENNIS FACILITIES; SPORTS ACTIVITIES IN THE NATURE OF BICYCLING, WEIGHT TRAINING, AEROBICS, BOATING, HIKING, JOGGING, HORSEBACK RIDING, ICE SKATING, SLEDGING, SLEIGH RIDING, SNOWMOBILING, SNOWBOARDING, SKIING, FISHING; POOLS, HEALTH CLUB SERVICES NAMELY FITNESS SALONS; PARTY PLANNING (U.S. CLS. 100, 101 AND 107).

FIRST USE 5-31-1973; IN COMMERCE 5-31-1973.
BRIDGETT SMITH, EXAMINING ATTORNEY

CLASS 41—(Continued).

SN 78-357,828. ANDRADE, VICTOR J., ANN ARBOR, MI. FILED 1-26-2004.

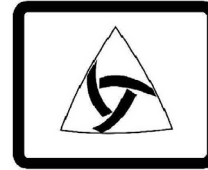

Global Linguistics
A World Without Limits

THE MARK CONSISTS OF A SQUARE WITH ROUNDED CORNERS, DISPOSED THEREIN IS A TRIANGLE WITH SLIGHTLY BULGING SIDES, THE TRIANGLE FURTHER COMPRISING THREE BARS ARRANGED IN A CONCENTRIC FASION TO FORM AN INNER TRIANGLE.

FOR TRANSLATION SERVICES (U.S. CLS. 100, 101 AND 107).

FIRST USE 10-1-2003; IN COMMERCE 10-1-2003.
KIMBERLY FRYE, EXAMINING ATTORNEY

SN 78-362,134. FICAROTTA, CATHLENE B., PINE BUSH, NY. FILED 2-4-2004.

Name: "Issues of Faith"

THE MARK CONSISTS OF STANDARD CHARACTERS WITHOUT CLAIM TO ANY PARTICULAR FONT, STYLE, SIZE, OR COLOR.

FOR ENTERTAINMENT, NAMELY, LIVE PERFORMANCES BY A MUSICAL BAND (U.S. CLS. 100, 101 AND 107).

DAVID MURRAY, EXAMINING ATTORNEY

CLASS 41—(Continued).

SN 78-363,551. ENGEL, AUSTIN R, CORONA, CA. AND PLEIS, FREDERICK W, CORONA, CA. FILED 2-6-2004.

Who Ya Hatin'

THE MARK CONSISTS OF STANDARD CHARACTERS WITHOUT CLAIM TO ANY PARTICULAR FONT, STYLE, SIZE, OR COLOR.

FOR ENTERTAINMENT IN THE NATURE OF ONGOING RADIO PROGRAMS IN THE FIELD OF VARIETY (U.S. CLS. 100, 101 AND 107).

STEVEN JACKSON, EXAMINING ATTORNEY

SN 78-370,850. M SQUARED PRODUCTIONS LLC, SAN FRANCISCO, CA. FILED 2-19-2004.

You've Heard Us

THE MARK CONSISTS OF STANDARD CHARACTERS WITHOUT CLAIM TO ANY PARTICULAR FONT, STYLE, SIZE, OR COLOR.

FOR AUDIO PRODUCTION, AUDIO POST PRODUCTION, AND SOUND DESIGN SERVICES (U.S. CLS. 100, 101 AND 107).

STACY WAHLBERG, EXAMINING ATTORNEY

SN 78-373,207. MEDTRONIC, INC., MINNEAPOLIS, MN. FILED 2-24-2004.

VIRTUAL CATH LAB

THE MARK CONSISTS OF STANDARD CHARACTERS WITHOUT CLAIM TO ANY PARTICULAR FONT, STYLE, SIZE, OR COLOR.

NO CLAIM IS MADE TO THE EXCLUSIVE RIGHT TO USE "VIRTUAL AND LAB", APART FROM THE MARK AS SHOWN.

FOR TRAINING SERVICES IN THE FIELD OF PLACEMENT OF CARDIAC LEADS (U.S. CLS. 100, 101 AND 107).

RON FAIRBANKS, EXAMINING ATTORNEY

CLASS 41—(Continued).

SN 78-373,391. THE UNIVERSITY OF SOUTH DAKOTA, VERMILLION, SD. FILED 2-24-2004.



THE MARK CONSISTS OF A CUPOLA AND THE LETTER U FOLLOWED BY A PERIOD.

FOR EDUCATIONAL SERVICES IN A VARIETY OF FIELDS, NAMELY, PROVIDING CLASSES, COURSES, SEMINARS, WORKSHOPS, CONFERENCES AND LECTURES AT THE UNDERGRADUATE, GRADUATE AND DOCTORAL LEVELS; ENTERTAINMENT SERVICES, NAMELY PROVIDING MOTIVATIONAL AND EDUCATIONAL SPEAKERS; PROVIDING INFORMATION IN THE FIELD OF UNIVERSITY ALUMNI ACTIVITIES AND THE UNIVERSITY IN GENERAL VIA WEBSITES ON GLOBAL COMPUTER NETWORKS; PROVIDING ON-LINE NEWSLETTERS IN THE FIELD OF UNIVERSITY ALUMNI ACTIVITIES AND THE UNIVERSITY IN GENERAL (U.S. CLS. 100, 101 AND 107).

FIRST USE 6-1-2003; IN COMMERCE 6-1-2003.

MICHAEL SOUDERS, EXAMINING ATTORNEY

SN 78-377,904. HEART FOR HUMANITY, INC., COCONUT GROVE, FL. FILED 3-3-2004.

HEART FOR HUMANITY

THE MARK CONSISTS OF STANDARD CHARACTERS WITHOUT CLAIM TO ANY PARTICULAR FONT, STYLE, SIZE, OR COLOR.

FOR WELLNESS PROGRAMS FOR SENIOR CITIZENS IN THE NATURE OF PROVIDING CLASSES IN THE FIELD OF PHYSICAL FITNESS EXERCISES, PROVIDING LECTURES ON EASTERN PHILOSOPHY, INDIVIDUAL EXPRESSION, INDIVIDUAL COMMUNICATION SKILLS, AND PROVIDING MEDITATION CLASSES TO MAINTAIN PHYSICAL AND MENTAL HEALTH; PARENTING SERVICES, NAMELY PROVIDING WORKSHOPS ON FAMILY REUNIFICATION, PREVENTING DOMESTIC VIOLENCE AND PROMOTING HARMONY AMONG FAMILY MEMBERS; WORKSHOPS ON ALCOHOL AND DRUG ABUSE PREVENTION AND TRAINING PARENTS ON DEALING WITH PROBLEM AND GIFTED CHILDREN AND ON HOW TO DEAL WITH SEPARATION OR DIVORCE; RENDERING ASSISTANCE TO ORPHANAGES IN THE NATURE OF CHARITABLE SERVICES, NAMELY PROVIDING TOYS TO NEEDY CHILDREN (U.S. CLS. 100, 101 AND 107).

REBECCA GILBERT, EXAMINING ATTORNEY

CLASS 41—(Continued).

SN 78-378,197. AQUATICS GALORE, INC., CHICAGO, IL. FILED 3-3-2004.



NO CLAIM IS MADE TO THE EXCLUSIVE RIGHT TO USE AQUATICS AND INC., APART FROM THE MARK AS SHOWN.

THE COLOR(S) RED AND BLUE IS/ARE CLAIMED AS A FEATURE OF THE MARK.

THE MARK CONSISTS OF RING BUOY IN BLUE OUTLINE AND A FISH WITH A RED BODY WITH BUBBLES IN RED OUTLINE.

FOR EDUCATIONAL SERVICES, NAMELY, PROVIDING INSTRUCTION IN WATER SAFETY, SWIMMING, LIFEGUARDING (U.S. CLS. 100, 101 AND 107).

FIRST USE 1-27-2003; IN COMMERCE 2-28-2003.

RUDY R. SINGLETON, EXAMINING ATTORNEY

CLASS 41—(Continued).

SN 78-383,366. EDUCATIONAL SERVICES INTERNATIONAL, ARCADIA, CA. FILED 3-12-2004.



Serve with Purpose and Passion

NO CLAIM IS MADE TO THE EXCLUSIVE RIGHT TO USE "TEACH OVERSEAS .ORG", APART FROM THE MARK AS SHOWN.

THE MARK CONSISTS OF LETTERS IN LOWER CASE EXCEPT FOR THE "O" IN OVERSEAS. THE "O" IS CAPITALIZED AND DEPICTS A GLOBE WITH A HEART IN THE CENTER OF IT. WITHIN THE HEART IS THE SILHOUETTE OF A HAND.

FOR CHARITABLE SERVICES, NAMELY, ORGANIZING AND CONDUCTING PROGRAMS FOR CHRISTIANS TO TEACH ENGLISH AND BUSINESS OVERSEAS (U.S. CLS. 100, 101 AND 107).

FIRST USE 11-12-2003; IN COMMERCE 12-9-2003.

SHARON MEIER, EXAMINING ATTORNEY

SN 78-381,117. GLOBAL EXPLORER, INC., DELTONA, FL. FILED 3-9-2004.

Global Explorer

THE MARK CONSISTS OF STANDARD CHARACTERS WITHOUT CLAIM TO ANY PARTICULAR FONT, STYLE, SIZE, OR COLOR.

FOR PRODUCTION OF FILMS AND FILM DOCUMENTARIES EXCLUDING THOSE ABOUT TRAVEL OR EXPLORATION (U.S. CLS. 100, 101 AND 107).

FIRST USE 2-2-2004; IN COMMERCE 2-2-2004.

MARY BOAGNI, EXAMINING ATTORNEY

SN 78-394,699. TRIVERITY CORPORATION, CHANTILLY, VA. FILED 4-1-2004.

**ALL ABOUT RACING
SCHOOLS FROM A TO
Z**

THE MARK CONSISTS OF STANDARD CHARACTERS WITHOUT CLAIM TO ANY PARTICULAR FONT, STYLE, SIZE, OR COLOR.

FOR PROVIDING INFORMATION REGARDING RACING SCHOOLS AND DRIVING SCHOOLS, INCLUDING, ENROLLMENT INFORMATION (U.S. CLS. 100, 101 AND 107).

KARANENDRA S. CHHINA, EXAMINING ATTORNEY

CLASS 41—(Continued).

SN 78-395,602. SEASECURE LLC, FT. LAUDERDALE, FL.
FILED 4-2-2004.

SeaWatch

THE MARK CONSISTS OF STANDARD CHARACTERS WITHOUT CLAIM TO ANY PARTICULAR FONT, STYLE, SIZE, OR COLOR.

FOR ELECTRONIC AND PRINT NEWS REPORTING AND ANALYSIS IN THE FIELD OF MARITIME SECURITY (U.S. CLS. 100, 101 AND 107).

FIRST USE 3-1-2003; IN COMMERCE 3-1-2003.
MATTHEW PAPPAS, EXAMINING ATTORNEY

CLASS 41—(Continued).

SN 78-395,941. DEES ENTERTAINMENT, INC., WOODLAND HILLS, CA. FILED 4-3-2004.

DR. BILLY FRANK BIRMINGHAM

THE MARK CONSISTS OF STANDARD CHARACTERS WITHOUT CLAIM TO ANY PARTICULAR FONT, STYLE, SIZE, OR COLOR.

THE NAME "DR. BILLY FRANK BIRMINGHAM" DOES NOT IDENTIFY A PARTICULAR LIVING INDIVIDUAL.

FOR ENTERTAINMENT SERVICES, NAMELY, A CONTINUING SERIES OF RADIO PROGRAMS FEATURING PERFORMANCES BY A FICTIONAL CHARACTER (U.S. CLS. 100, 101 AND 107).

EDWARD NELSON, EXAMINING ATTORNEY

SN 78-395,817. THOMPSON, E. JEAN, MITCHELLVILLE, MD. FILED 4-2-2004.

CHOSEN CHAMPIONS

THE MARK CONSISTS OF STANDARD CHARACTERS WITHOUT CLAIM TO ANY PARTICULAR FONT, STYLE, SIZE, OR COLOR.

FOR EDUCATIONAL SERVICES, NAMELY, CONDUCTING CLASSES, SEMINARS AND WORKSHOPS IN THE AREAS OF FINANCIAL SUCCESS, SELF-AWARENESS AND SELF-IMPROVEMENT, AND DISTRIBUTING COURSE MATERIALS IN CONNECTION THEREWITH; PUBLICATION OF BOOKS, PAMPHLETS, AND MAGAZINES; ELECTRONIC PUBLISHING SERVICES, NAMELY, PUBLICATION OF TEXT AND GRAPHIC WORKS OF OTHERS ON VIDEO CASSETTE, DVD, AUDIO CASSETTE AND COMPACT DISC, FEATURING ADVICE ON FINANCIAL SUCCESS, SELF-AWARENESS AND SELF-IMPROVEMENT; PRODUCTION OF MOTION PICTURE FILMS; PRODUCTION OF VIDEO CASSETTES, DVD, AND COMPACT DISC (U.S. CLS. 100, 101 AND 107).

ANDREW RHIM, EXAMINING ATTORNEY

SN 78-395,942. DEES ENTERTAINMENT, INC., WOODLAND HILLS, CA. FILED 4-3-2004.

CANDY PLASTIQUE

THE MARK CONSISTS OF STANDARD CHARACTERS WITHOUT CLAIM TO ANY PARTICULAR FONT, STYLE, SIZE, OR COLOR.

THE NAME CANDY PLASTIQUE DOES NOT IDENTIFY A PARTICULAR LIVING INDIVIDUAL.

FOR ENTERTAINMENT SERVICES, NAMELY, A CONTINUING SERIES OF RADIO PROGRAMS FEATURING PERFORMANCES BY A FICTIONAL CHARACTER (U.S. CLS. 100, 101 AND 107).

EDWARD NELSON, EXAMINING ATTORNEY

CLASS 41—(Continued).

SN 78-396,229. STRATIVITY GROUP, INC., LIVINGSTON, NJ. FILED 4-5-2004.



THE MARK CONSISTS OF A CIRCULAR DESIGN BEARING THE STYLIZED TEXT "INSPIRE INFORM IMPACT" REPETITIOUSLY IN VARYING SIZE.

FOR EDUCATIONAL SERVICES, NAMELY, CONDUCTING PROGRAMS IN THE FIELD OF BUSINESS WITH A FOCUS ON EXPERIENCE MANAGEMENT, ORGANIZATION BUILDING, CUSTOMER RELATIONSHIP DEVELOPMENT, AND BUSINESS STRATEGY DEVELOPMENT AND IMPLEMENTATION (U.S. CLS. 100, 101 AND 107).

FIRST USE 10-1-2003; IN COMMERCE 10-1-2003.
CHRIS WELLS, EXAMINING ATTORNEY

SN 78-396,318. STRATIVITY GROUP, INC., LIVINGSTON, NJ. FILED 4-5-2004.

Strativity Group

THE MARK CONSISTS OF STANDARD CHARACTERS WITHOUT CLAIM TO ANY PARTICULAR FONT, STYLE, SIZE, OR COLOR.

NO CLAIM IS MADE TO THE EXCLUSIVE RIGHT TO USE "GROUP", APART FROM THE MARK AS SHOWN.

FOR BUSINESS EDUCATION SERVICES, NAMELY PROVIDING TRAINING AND CLASSES IN EXPERIENCE MANAGEMENT, ORGANIZATION BUILDING, CUSTOMER RELATIONSHIP DEVELOPMENT, AND BUSINESS STRATEGY DEVELOPMENT AND IMPLEMENTATION (U.S. CLS. 100, 101 AND 107).

FIRST USE 5-1-2002; IN COMMERCE 5-1-2002.
KATHY DE JONGE, EXAMINING ATTORNEY

CLASS 41—(Continued).

SN 78-397,099. ROUND ROCK BASEBALL, INC, ROUND ROCK, TX. FILED 4-6-2004.

**CORPUS CHRISTI
HOOKS**

THE MARK CONSISTS OF STANDARD CHARACTERS WITHOUT CLAIM TO ANY PARTICULAR FONT, STYLE, SIZE, OR COLOR.

NO CLAIM IS MADE TO THE EXCLUSIVE RIGHT TO USE "CORPUS CHRISTI", APART FROM THE MARK AS SHOWN.

FOR ENTERTAINMENT SERVICES IN THE NATURE OF BASEBALL GAMES, ORGANIZING BASEBALL EXHIBITIONS AND PERSONAL APPEARANCES BY MASCOT (U.S. CLS. 100, 101 AND 107).

FIRST USE 2-0-2004; IN COMMERCE 3-11-2004.
TONJA GASKINS, EXAMINING ATTORNEY

SN 78-397,805. GREGG, JASON, CHEPACHET, RI. FILED 4-7-2004.



THE COLORS RED, WHITE, AND ARE FEATURES OF THE MARK.

THE MARK CONSISTS OF THE WORD "PSYCLE" WITH A DISTINCTIVE IMAGE OF A SUN SET IN RED IN THE BACKGROUND AND VARIOUS COMBINATIONS THEREOF. THE COLOR RED APPEAR IN THE SUN DESIGN.

FOR ENTERTAINMENT, NAMELY LIVE PERFORMANCES BY MUSICAL BAND (U.S. CLS. 100, 101 AND 107).

FIRST USE 1-1-2000; IN COMMERCE 1-1-2001.
AMOS T. MATTHEWS, JR., EXAMINING ATTORNEY

SN 78-399,043. PARNES, MICHAEL, PALO ALTO, CA. FILED 4-8-2004.

**WORLD SERIES OF
TRADING**

THE MARK CONSISTS OF STANDARD CHARACTERS WITHOUT CLAIM TO ANY PARTICULAR FONT, STYLE, SIZE, OR COLOR.

NO CLAIM IS MADE TO THE EXCLUSIVE RIGHT TO USE TRADING, APART FROM THE MARK AS SHOWN.

FOR ENTERTAINMENT SERVICES, NAMELY, AN ONLINE FANTASY STOCK TRADING GAME (U.S. CLS. 100, 101 AND 107).

WILLIAM BRECKENFELD, EXAMINING ATTORNEY

CLASS 41—(Continued).

SN 78-400,494. GATT, MICHAEL D., SANTA MONICA, CA. AND HAZELTON, ROBERT, LOS ANGELES, CA. FILED 4-12-2004.



THE MARK CONSISTS OF TITLE/CHARACTERS/STORY FOR CHILDREN'S ANIMATED TELEVISION SHOW. SHIP, TANK, DRAGSTER, BUS, SUBMARINE, OCTOPUS LIKE ALIEN, BOTTLED WATER ALIEN, ASTRONAUT LIKE ALIEN, 4 "BUSTS" OF MILITARY LIKE GROUP, 4 SUPER-HEROES, 4 HEADS OF THE HEROES AS REGULAR PEOPLE.

FOR ENTERTAINMENT SERVICES IN THE NATURE OF ON-GOING TELEVISION PROGRAMS IN THE FIELD OF CHILDREN'S ANIMATED ENTERTAINMENT (U.S. CLS. 100, 101 AND 107).

REBECCA GILBERT, EXAMINING ATTORNEY

SN 78-401,366. SWINK, SCOTT W., DBA IN RECKLESS PURSUIT, LA CANADA, CA. FILED 4-14-2004.

Leap of Faith

THE MARK CONSISTS OF STANDARD CHARACTERS WITHOUT CLAIM TO ANY PARTICULAR FONT, STYLE, SIZE, OR COLOR.

FOR ENTERTAINMENT, NAMELY, LIVE PERFORMANCES BY A MUSICAL BAND FOR WORSHIP SERVICES, CONVENTIONS, CONCERTS, FUNDRAISERS AND THE LIKE (U.S. CLS. 100, 101 AND 107).

FIRST USE 2-1-1996; IN COMMERCE 2-1-1996.

MICHAEL SOUDERS, EXAMINING ATTORNEY

CLASS 41—(Continued).

SN 78-401,744. CHELLIS, JAMES D., SANTA CRUZ, CA. FILED 4-14-2004.

Comcourse

THE MARK CONSISTS OF STANDARD CHARACTERS WITHOUT CLAIM TO ANY PARTICULAR FONT, STYLE, SIZE, OR COLOR.

FOR EDUCATIONAL SERVICES, NAMELY, PROVIDING ONLINE COURSES, TUTORIALS, DEGREE AND CERTIFICATE-RELATED MATERIALS IN THE FIELDS OF BUSINESS, ALLIED HEALTH, MEDICAL, INFORMATION TECHNOLOGY, LAW, DESIGN VIA AN INTERACTIVE WEBSITE ON THE INTERNET, AND PROVIDING AN ONLINE INTERACTIVE WEBSITE LEARNING ENVIRONMENT (LEARNING MANAGEMENT SYSTEM) TO HOST COURSES (U.S. CLS. 100, 101 AND 107).

FIRST USE 0-0-2003; IN COMMERCE 0-0-2003.

JILL C. ALT, EXAMINING ATTORNEY

SN 78-402,483. VIACOM INTERNATIONAL INC., NEW YORK, NY. FILED 4-15-2004.

NICKELODEON

OWNER OF U.S. REG. NOS. 1,217,864, 2,385,829 AND OTHERS.

FOR ENTERTAINMENT SERVICES, NAMELY, ON-GOING TELEVISION PROGRAMS FEATURING LIVE ACTION, DRAMA, COMEDY, SCI-FI, ANIMATION, MUSIC, NEWS, AND GENERAL ENTERTAINMENT; PROVIDING INFORMATION IN THE FIELD OF ENTERTAINMENT AND EDUCATION RENDERED VIA COMPUTER BY MEANS OF A GLOBAL COMPUTER NETWORK; ENTERTAINMENT SERVICES IN THE NATURE OF ON-GOING RADIO PROGRAMS IN THE FIELDS OF MUSIC AND NEWS; PRODUCTION OF RADIO PROGRAMS; AND DISTRIBUTION OF RADIO PROGRAMS FOR OTHERS; AMUSEMENT PARKS; PUBLICATION OF MAGAZINES (U.S. CLS. 100, 101 AND 107).

FIRST USE 12-1-1991; IN COMMERCE 12-1-1991.

NANCY CLARKE, EXAMINING ATTORNEY

CLASS 41—(Continued).

SN 78-403,653. REZNIK, RONALD A., LOS ANGELES, CA. FILED 4-17-2004.



FOR PRODUCTION AND DISTRIBUTION OF MOTION PICTURES; ANIMATION AND RECORD PRODUCTION SERVICES; ENTERTAINMENT, NAMELY, PRODUCTION OF PLAYS (U.S. CLS. 100, 101 AND 107). FIRST USE 2-0-1994; IN COMMERCE 10-0-2000. IRA J. GOODSAD, EXAMINING ATTORNEY

CLASS 41—(Continued).

SN 78-404,881. BATT, CARL A., GROTON, NY. FILED 4-20-2004.

Main Street Science

THE MARK CONSISTS OF STANDARD CHARACTERS WITHOUT CLAIM TO ANY PARTICULAR FONT, STYLE, SIZE, OR COLOR.

NO CLAIM IS MADE TO THE EXCLUSIVE RIGHT TO USE "SCIENCE", APART FROM THE MARK AS SHOWN. FOR EDUCATIONAL SERVICES, NAMELY, PROVIDING COURSES OF INSTRUCTION AT THE KINDERGARTEN THROUGH GRADE 12 LEVEL, IN ALL FIELDS OF SCIENCE INCLUDING BIOLOGY, PHYSICS, CHEMISTRY, EARTH SCIENCE, NANOTECHNOLOGY, MATH, ENGINEERING AND TECHNOLOGY (U.S. CLS. 100, 101 AND 107).

FIRST USE 6-1-2003; IN COMMERCE 6-1-2003. RON FAIRBANKS, EXAMINING ATTORNEY

SN 78-405,284. KOZER, SARAH, LOS ANGELES, CA. FILED 4-20-2004.

SN 78-403,733. CARLEBACH, NEILA, NEW YORK, NY. AND CARLEBACH, NEDARA, NEW YORK, NY. AND CARLEBACH, NESHAMA, NEW YORK, NY. FILED 4-18-2004.

SHLOMO CARLEBACH

THE MARK CONSISTS OF STANDARD CHARACTERS WITHOUT CLAIM TO ANY PARTICULAR FONT, STYLE, SIZE, OR COLOR.

THE NAME(S), PORTRAIT(S), AND/OR SIGNATURE(S) SHOWN IN THE MARK DOES NOT IDENTIFY A PARTICULAR LIVING INDIVIDUAL.

FOR ENTERTAINMENT IN THE NATURE OF LIVE MUSICAL CONCERTS (U.S. CLS. 100, 101 AND 107). FIRST USE 12-16-1959; IN COMMERCE 12-16-1959. MICHAEL WEBSTER, EXAMINING ATTORNEY

SARAH KOZER

THE MARK CONSISTS OF STANDARD CHARACTERS WITHOUT CLAIM TO ANY PARTICULAR FONT, STYLE, SIZE, OR COLOR.

THE NAME SARAH KOZER IDENTIFIES A LIVING INDIVIDUAL WHOSE CONSENT IS OF RECORD.

FOR ENTERTAINMENT SERVICES NAMELY LIVE, TELEVISED, MOVIE AND MODELING APPEARANCES BY A PROFESSIONAL ENTERTAINER; ENTERTAINMENT SERVICES, NAMELY, PERSONAL APPEARANCES BY A TELEVISION PERSONALITY/ACTRESS AND MODEL; ENTERTAINMENT SERVICES, NAMELY, PROVIDING TELEVISION PROGRAMING IN THE FIELDS OF TELEVISION NEWS AND TALK SHOWS VIA A GLOBAL COMPUTER NETWORK; ENTERTAINMENT IN THE NATURE OF REALITY TELEVISION SERIES AND ENTERTAINMENT NEWS; AND ENTERTAINMENT SERVICES, NAMELY, PROVIDING A WEB SITE FEATURING RELATED TELEVISION CLIPS, RELATED FILM CLIPS, PHOTOGRAPHS, AND OTHER MULTIMEDIA MATERIALS (U.S. CLS. 100, 101 AND 107).

FIRST USE 12-15-2000; IN COMMERCE 12-15-2000. CHRIS WELLS, EXAMINING ATTORNEY

CLASS 41—(Continued).

SN 78-405,748. WORLD WRESTLING ENTERTAINMENT, INC., STAMFORD, CT. FILED 4-21-2004.

BUBBA RAY DUDLEY

THE MARK CONSISTS OF STANDARD CHARACTERS WITHOUT CLAIM TO ANY PARTICULAR FONT, STYLE, SIZE, OR COLOR.

THE NAME(S), PORTRAIT(S), AND/OR SIGNATURE(S) SHOWN IN THE MARK DOES NOT IDENTIFY A PARTICULAR LIVING INDIVIDUAL.

FOR ENTERTAINMENT SERVICES, NAMELY WRESTLING EXHIBITIONS AND PERFORMANCES BY A PROFESSIONAL WRESTLER AND ENTERTAINER; PROVIDING WRESTLING NEWS AND INFORMATION VIA A GLOBAL COMPUTER NETWORK (U.S. CLS. 100, 101 AND 107).

ZACHARY BELLO, EXAMINING ATTORNEY

CLASS 41—(Continued).

SN 78-410,078. NATIONAL FIELD TRIAL CHAMPIONSHIP ASSOCIATION, INC., GRAND JUNCTION, TN. FILED 4-29-2004.

AMES PLANTATION

THE MARK CONSISTS OF STANDARD CHARACTERS WITHOUT CLAIM TO ANY PARTICULAR FONT, STYLE, SIZE, OR COLOR.

FOR ENTERTAINMENT SERVICES, NAMELY, DOG FIELD TRIAL CHAMPIONSHIPS (U.S. CLS. 100, 101 AND 107).

FIRST USE 12-31-1901; IN COMMERCE 12-31-1901.

RONALD AIKENS, EXAMINING ATTORNEY

SN 78-405,913. GRAND MASTER FIDDLER CHAMPIONSHIP INC., FRANKLIN, TN. FILED 4-21-2004.



**Grand Master Fiddler
Championship Inc.**

NO CLAIM IS MADE TO THE EXCLUSIVE RIGHT TO USE "GRAND MASTER FIDDLER CHAMPIONSHIP INC", APART FROM THE MARK AS SHOWN.

THE COLOR(S) RED, BLUE, AND WHITE IS/ARE CLAIMED AS A FEATURE OF THE MARK.

THE COLOR RED APPEARS IN THE FIDDLE AND LINING THE CIRCLE SURROUNDING THE VIOLIN, THE COLOR BLUE APPEARS IN THE WORDING AND THE SQUARE DESIGN, AND THE COLOR WHITE APPEARS IN THE BACKGROUND.

FOR EDUCATIONAL SERVICES, NAMELY ORGANIZING AND CONDUCTING A FIDDLING COMPETITION FOR THE PURPOSE OF PROMOTING FIDDLING AS A CULTURAL ART FORM (U.S. CLS. 100, 101 AND 107).

FIRST USE 12-1-2003; IN COMMERCE 3-5-2004.
MONTIA G. PRESSEY, EXAMINING ATTORNEY

SN 78-410,309. WILSON, JESSE REUBEN, WEST SUSSEX, UNITED KINGDOM, FILED 4-29-2004.

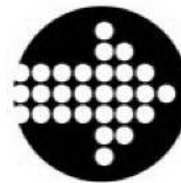

POSITIVEFLOW

THE MARK CONSISTS OF DOTTED RIGHT FACING ARROW INSIDE CIRCLE.

FOR ENTERTAINMENT SERVICES, NAMELY, LIVE MUSICAL CONCERTS AND PERFORMANCES BY AN ARTIST AND BY A MUSICAL GROUP (U.S. CLS. 100, 101 AND 107).

FIRST USE 1-1-2004; IN COMMERCE 3-29-2004.
FLORENTINA BLANDU, EXAMINING ATTORNEY

CLASS 41—(Continued).

SN 78-410,585. PERFECT 10, INC., BEVERLY HILLS, CA. FILED 4-29-2004.

CLASS 41—(Continued).

SN 78-410,965. COUNTRY MUSIC TELEVISION, INC, NEW YORK, NY. FILED 4-30-2004.

NATURAL 10

THE MARK CONSISTS OF STANDARD CHARACTERS WITHOUT CLAIM TO ANY PARTICULAR FONT, STYLE, SIZE, OR COLOR.

FOR ENTERTAINMENT IN THE NATURE OF TELEVISION PROGRAMS IN THE FIELDS OF COMEDY, MODELING, VARIETY, ADULT ENTERTAINMENT, FITNESS, SPORTS, AND LIFESTYLES; PRODUCTION OF TELEVISION PROGRAMS; TELEVISION PROGRAM SYNDICATION; DISTRIBUTION OF TELEVISION PROGRAMS FOR OTHERS. (U.S. CLS. 100, 101 AND 107).
DAWN HAN, EXAMINING ATTORNEY

SN 78-410,764. TOUPS, SHARON S., COLLEGE STATION, TX. FILED 4-29-2004.

Center Stage Productions

THE MARK CONSISTS OF STANDARD CHARACTERS WITHOUT CLAIM TO ANY PARTICULAR FONT, STYLE, SIZE, OR COLOR.

NO CLAIM IS MADE TO THE EXCLUSIVE RIGHT TO USE PRODUCTIONS, APART FROM THE MARK AS SHOWN.

FOR ENTERTAINMENT IN THE NATURE OF BALLET PERFORMANCES, BEAUTY PAGEANTS, DANCE AND GYMNASTIC EXHIBITIONS AND THEATER PERFORMANCES (U.S. CLS. 100, 101 AND 107).

FIRST USE 9-1-2004; IN COMMERCE 9-1-2004.
LESLEY LAMOTHE, EXAMINING ATTORNEY

TREAT ME LIKE A COUNTRY STAR SWEEPSTAKES

THE MARK CONSISTS OF STANDARD CHARACTERS WITHOUT CLAIM TO ANY PARTICULAR FONT, STYLE, SIZE, OR COLOR.

NO CLAIM IS MADE TO THE EXCLUSIVE RIGHT TO USE "SWEEPSTAKES", APART FROM THE MARK AS SHOWN.

FOR ENTERTAINMENT SERVICES, NAMELY, ONGOING SWEEPSTAKES IN CONNECTION WITH TELEVISION PROGRAMMING SERVICES (U.S. CLS. 100, 101 AND 107).

FIRST USE 6-30-2004; IN COMMERCE 6-30-2004.
GRETTA YAO, EXAMINING ATTORNEY

SN 78-411,616. KING WORLD PRODUCTIONS, INC., SANTA MONICA, CA. FILED 4-30-2004.

H² HOLLYWOOD SQUARES

OWNER OF U.S. REG. NOS. 1,448,954 AND 2,582,520.
FOR ENTERTAINMENT SERVICES IN THE NATURE OF A TELEVISION GAME SHOW; PROVIDING INFORMATION IN THE FIELD OF ENTERTAINMENT VIA A GLOBAL COMPUTER NETWORK; PROVIDING INFORMATION ABOUT CELEBRITIES VIA A GLOBAL COMPUTER NETWORK (U.S. CLS. 100, 101 AND 107).

FIRST USE 9-16-2002; IN COMMERCE 9-16-2002.
JACQUELINE A. LAVINE, EXAMINING ATTORNEY

CLASS 41—(Continued).

SN 78-412,972. REEL MAGIC PRODUCTIONS, CORONA, CA. FILED 5-4-2004.

Reel Magic Productions

THE MARK CONSISTS OF STANDARD CHARACTERS WITHOUT CLAIM TO ANY PARTICULAR FONT, STYLE, SIZE, OR COLOR.

NO CLAIM IS MADE TO THE EXCLUSIVE RIGHT TO USE PRODUCTIONS, APART FROM THE MARK AS SHOWN.

FOR MOTION PICTURE FILM PRODUCTION AND DISTRIBUTION; TELEVISION PRODUCTION; DISTRIBUTION OF TELEVISION PROGRAMS FOR OTHERS (U.S. CLS. 100, 101 AND 107).

FIRST USE 3-1-1986; IN COMMERCE 3-1-1986.
KHANH LE, EXAMINING ATTORNEY

CLASS 41—(Continued).

SN 78-414,040. THE CARTOON NETWORK LP, LLLP, ATLANTA, GA. FILED 5-6-2004.



OWNER OF U.S. REG. NO. 2,687,130.

FOR ENTERTAINMENT AND EDUCATION SERVICES IN THE NATURE OF A CONTINUING COMEDY, DRAMA, ACTION, ADVENTURE AND ANIMATION PROGRAM SERIES AND MOTION PICTURE FILM PRODUCTION, PROVIDED THROUGH CABLE TELEVISION, BROADCAST TELEVISION, BROADCAST RADIO AND THE GLOBAL COMPUTER INFORMATION NETWORK (U.S. CLS. 100, 101 AND 107).

FIRST USE 8-24-2001; IN COMMERCE 8-24-2001.
JILL C. ALT, EXAMINING ATTORNEY

SN 78-413,341. MILLION DOLLAR SKINS, INC., BRIDGEVILLE, PA. FILED 5-5-2004.



NO CLAIM IS MADE TO THE EXCLUSIVE RIGHT TO USE "MILLION DOLLAR SKINS", APART FROM THE MARK AS SHOWN.

THE COLOR(S) BRICK RED, GOLD, GREEN AND BLACK IS/ARE CLAIMED AS A FEATURE OF THE MARK.

THE MARK CONSISTS OF THE WORD SKINS IN BRICK RED WITH GOLD TRIM AND BLACK SHADOW IN FRONT OF AN UPSIDE DOWN GREEN PYRAMID. GOLD BANNER CONNECTED TO THE PYRAMID WITH GREEN TRIM CONTAINING THE WORDS MILLION DOLLAR IN BLACK LETTERING. DOLLAR SYMBOL IN BRICK RED WITH GOLD TRIM AND BLACK SHADOW ABOVE TWO SMALLER GOLD BANNERS. GOLD RAYS OF LIGHT EMANATE FROM BEHIND THE PYRAMID.

FOR ARRANGING AND CONDUCTING ATHLETIC COMPETITIONS, NAMELY GOLF TOURNAMENTS (U.S. CLS. 100, 101 AND 107).

PRISCILLA MILTON, EXAMINING ATTORNEY

SN 78-414,401. MATCH.COM, L.P., RICHARDSON, TX. FILED 5-6-2004.

TOTAL ATTRACTION MATCHING

THE MARK CONSISTS OF STANDARD CHARACTERS WITHOUT CLAIM TO ANY PARTICULAR FONT, STYLE, SIZE, OR COLOR.

NO CLAIM IS MADE TO THE EXCLUSIVE RIGHT TO USE "MATCHING", APART FROM THE MARK AS SHOWN.

FOR ENTERTAINMENT SERVICES, NAMELY, CONDUCTING PARTIES FOR THE PURPOSE OF DATING AND SOCIAL INTRODUCTION FOR ADULTS (U.S. CLS. 100, 101 AND 107).

CAROLINE WOOD, EXAMINING ATTORNEY

CLASS 41—(Continued).

SN 78-415,416. JOHNSEN, APOLLO RAY, SANTA CLARA, CA. FILED 5-7-2004.



FOR ENTERTAINMENT SERVICES IN THE NATURE OF AN ON-GOING REALITY-BASED DATING GAME TELEVISION PROGRAM VIA TELEVISION, CABLE, INTERNET, AND LIVE SHOWS DIRECTED PRIMARILY TO BLACK AMERICANS; PRODUCTION AND DISTRIBUTION OF LIVE-ACTION, COMEDY, DRAMA, AND ANIMATED TELEVISION PROGRAMS FOR OTHERS, DIRECTED PRIMARILY TO BLACK AMERICANS (U.S. CLS. 100, 101 AND 107).

PRISCILLA MILTON, EXAMINING ATTORNEY

SN 78-415,418. JOHNSEN, APOLLO RAY, SANTA CLARA, CA. FILED 5-7-2004.

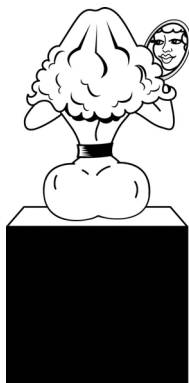

FOR ENTERTAINMENT SERVICES IN THE NATURE OF AN ON-GOING REALITY-BASED DATING GAME TELEVISION PROGRAM VIA TELEVISION, CABLE, INTERNET, AND LIVE SHOWS DIRECTED PRIMARILY TO BLACK AMERICANS; PRODUCTION AND DISTRIBUTION OF LIVE-ACTION, COMEDY, DRAMA, AND ANIMATED TELEVISION PROGRAMS FOR OTHERS, DIRECTED PRIMARILY TO BLACK AMERICANS (U.S. CLS. 100, 101 AND 107).

PRISCILLA MILTON, EXAMINING ATTORNEY

CLASS 41—(Continued).

SN 78-415,470. AEI, INC., EAST LANSING, MI. FILED 5-8-2004.

Advantage Education

THE MARK CONSISTS OF STANDARD CHARACTERS WITHOUT CLAIM TO ANY PARTICULAR FONT, STYLE, SIZE, OR COLOR.

NO CLAIM IS MADE TO THE EXCLUSIVE RIGHT TO USE "EDUCATION", APART FROM THE MARK AS SHOWN.

SEC. 2(F).

FOR EDUCATIONAL SERVICES, NAMELY TUTORING AND TEST PREPARATION SERVICES IN THE FIELD OF GENERAL EDUCATION, AND HIGH SCHOOL, COLLEGE, AND LAW SCHOOL ADMISSIONS COUNSELING; CONDUCTING PROFESSIONAL WORKSHOPS AND TRAINING COURSES IN THE FIELD OF STANDARDIZED TEST PREPARATION; HIGH SCHOOL, COLLEGE, AND LAW SCHOOL ADMISSIONS COUNSELING, AND GENERAL EDUCATION; EDUCATIONAL PRODUCT DEVELOPMENT, NAMELY CREATION, DEVELOPMENT, AND DISSEMINATION OF EDUCATIONAL MATERIALS FOR OTHERS IN THE FIELD OF STANDARDIZED TEST PREPARATION, HIGH SCHOOL, COLLEGE, AND LAW SCHOOL ADMISSIONS COUNSELING, AND GENERAL EDUCATION (U.S. CLS. 100, 101 AND 107).

FIRST USE 9-1-1997; IN COMMERCE 9-1-1997.

THEODORE MCBRIDE, EXAMINING ATTORNEY

SN 78-417,371. A. CIPHER RECORDINGS, REYNOLDSBURG, OH. FILED 5-12-2004.



NO CLAIM IS MADE TO THE EXCLUSIVE RIGHT TO USE "RECORDINGS", APART FROM THE MARK AS SHOWN.

FOR AUDIO RECORDING AND PRODUCTION. (U.S. CLS. 100, 101 AND 107).

FIRST USE 2-1-1999; IN COMMERCE 4-1-1999.

PAULA MAYS, EXAMINING ATTORNEY

CLASS 41—(Continued).

SN 78-419,218. WORLD WIDE LEARN INC., CALGARY, ALBERTA, CANADA, FILED 5-14-2004.

THE MORE YOU LEARN,
THE MORE YOU ARE

THE MARK CONSISTS OF STANDARD CHARACTERS WITHOUT CLAIM TO ANY PARTICULAR FONT, STYLE, SIZE, OR COLOR.

PRIORITY CLAIMED UNDER SEC. 44(D) ON CANADA APPLICATION NO. 1207653, FILED 2-26-2004, REG. NO. TMA637206, DATED 4-13-2005, EXPIRES 4-13-2020.

FOR ONLINE NEWSLETTERS AND BROCHURES RELATING TO THE PROVISION OF A DIRECTORY OF ONLINE COURSES, DEGREE TRAINING, TUTORIALS, WORKSHOPS AND EDUCATIONS RESOURCES; THE PROVISION OF ONLINE EDUCATION DIRECTORY SERVICES, NAMELY THE PROVISION OF A DIRECTORY OF ONLINE COURSES, DEGREES, TRAINING, TUTORIALS, WORKSHOPS AND OTHER EDUCATIONS RESOURCES (U.S. CLS. 100, 101 AND 107).

FIRST USE 10-13-1999; IN COMMERCE 10-13-1999.
KIM SAITO, EXAMINING ATTORNEY

SN 78-419,806. CGTV MEDIA GROUP, INC., LAS VEGAS, NV. FILED 5-17-2004.

Poker Showcase

THE MARK CONSISTS OF STANDARD CHARACTERS WITHOUT CLAIM TO ANY PARTICULAR FONT, STYLE, SIZE, OR COLOR.

NO CLAIM IS MADE TO THE EXCLUSIVE RIGHT TO USE POKER, APART FROM THE MARK AS SHOWN.

FOR TELEVISION SHOW PRODUCTION (U.S. CLS. 100, 101 AND 107).

CHRIS WELLS, EXAMINING ATTORNEY

CLASS 41—(Continued).

SN 78-419,877. VOMVOLAKIS, SCOTT, SOUTH PASADENA, CA. FILED 5-17-2004.

Weapons of Mass
Percussion

THE MARK CONSISTS OF STANDARD CHARACTERS WITHOUT CLAIM TO ANY PARTICULAR FONT, STYLE, SIZE, OR COLOR.

FOR PRESENTATION OF MUSICAL PERFORMANCE; MUSIC PRODUCTION SERVICES (U.S. CLS. 100, 101 AND 107).

FIRST USE 12-4-2004; IN COMMERCE 12-4-2004.
JAMES A. RAUEN, EXAMINING ATTORNEY

SN 78-419,942. MINNESOTA STATE AGRICULTURAL SOCIETY, ST. PAUL, MN. FILED 5-17-2004.



NO CLAIM IS MADE TO THE EXCLUSIVE RIGHT TO USE "MINNESOTA STATE FAIR", APART FROM THE MARK AS SHOWN.

THE MARK CONSISTS OF THE WORDS, "MINNESOTA STATE FAIR" IN BLOCK LETTERING, WITH THE WORDS "MINNESOTA" AND "STATE" APPEARING IN A SMALLER TYPE SIZE AND IMMEDIATELY ABOVE THE WORD "FAIR" WHICH IS IN A LARGER TYPE SIZE; A STAR-SHAPED CUT-OUT APPEARS IN THE LETTERS "O" AND "A" IN "MINNESOTA," IN THE LETTER "A" IN "STATE," AND IN THE LETTERS "A" AND "R" IN "FAIR". THE TAIL OF THE "R" IN "FAIR" EXTENDS TO THE RIGHT IN A FORM SUGGESTIVE OF TWO PARALLEL FLOWING STREAMERS; THE WORD "FAIR" IS ALSO OUTLINED; AND APPEARING AROUND AND IN CLOSE PROXIMITY TO THE WORD ELEMENTS ARE SCATTERED SYMBOLS IN THE FORM OF STYLIZED MUSICAL NOTES, STARS, BALLOONS, EXPLODING FIREWORKS, AND CHEVRONS.

FOR ENTERTAINMENT, NAMELY, CONDUCTING AN ANNUAL STATE FAIR, INCLUDING EXHIBITIONS OF ART, CRAFTS, CONCERTS, CONCESSIONS, AMUSEMENTS, RIDES, CONTESTS, SHOWS, EDUCATIONAL DISPLAYS AND AMATEUR AND PROFESSIONAL ENTERTAINMENTS (U.S. CLS. 100, 101 AND 107).

FIRST USE 1-1-1981; IN COMMERCE 1-1-1981.
SOPHIA S. KIM, EXAMINING ATTORNEY

CLASS 41—(Continued).

SN 78-421,295. JOURNAL COMMUNICATIONS, INC., MILWAUKEE, WI. FILED 5-19-2004.

**STANDING UP FOR
WHAT'S RIGHT**

THE MARK CONSISTS OF STANDARD CHARACTERS WITHOUT CLAIM TO ANY PARTICULAR FONT, STYLE, SIZE, OR COLOR.

FOR ENTERTAINMENT SERVICES, NAMELY, PROVIDING A TALK SHOW RADIO PROGRAM IN THE FIELD OF NEWS AND GENERAL INTEREST TOPICS VIA A GLOBAL COMPUTER NETWORK; PUBLICATION OF THE EDITORIAL CONTENT RELATING TO A RADIO TALK SHOW PROGRAM ACCESSIBLE VIA A GLOBAL COMPUTER NETWORK (U.S. CLS. 100, 101 AND 107).

FIRST USE 10-9-2002; IN COMMERCE 10-9-2002.
SKYE YOUNG, EXAMINING ATTORNEY

CLASS 41—(Continued).

SN 78-421,766. DIKE, JUSTIN, CHAMBLEE, GA. FILED 5-19-2004.



NO CLAIM IS MADE TO THE EXCLUSIVE RIGHT TO USE "CARTOON" AND ".COM", APART FROM THE MARK AS SHOWN.

FOR EDUCATION SERVICES, NAMELY, PROVIDING ONLINE VIDEO TUTORIALS IN THE FIELD OF COMPUTER SOFTWARE AND ART DESIGN (U.S. CLS. 100, 101 AND 107).

FIRST USE 1-31-2004; IN COMMERCE 1-31-2004.
GENE MACIOL, EXAMINING ATTORNEY

SN 78-421,523. WB, INC., WINNEMUCCA, NV. FILED 5-19-2004.



THE MARK CONSISTS OF SKULL WEARING A DERBY. FOR ENTERTAINMENT SERVICES, NAMELY IN THE NATURE OF A MOTORCYCLE CLUB (U.S. CLS. 100, 101 AND 107).

FIRST USE 9-19-1999; IN COMMERCE 9-19-1999.
CAROLYN GRAY, EXAMINING ATTORNEY

SN 78-423,783. CITY CENTER 55TH STREET THEATER FOUNDATION, INC., NEW YORK, NY. FILED 5-24-2004.

CITYTIX

THE MARK CONSISTS OF STANDARD CHARACTERS WITHOUT CLAIM TO ANY PARTICULAR FONT, STYLE, SIZE, OR COLOR.

OWNER OF U.S. REG. NO. 2,147,289.
FOR ARRANGING FOR TICKET RESERVATIONS VIA TELEPHONE, FACSIMILE, INTERNET AND MAIL FOR LIVE PERFORMANCES AND OTHER ENTERTAINMENT EVENTS (U.S. CLS. 100, 101 AND 107).

FIRST USE 10-31-1992; IN COMMERCE 2-28-1994.
CHARLES L. JENKINS, EXAMINING ATTORNEY

CLASS 41—(Continued).

SN 78-424,841. FISHMAN, MICHAEL D., BLOOMFIELD HILLS, MI. FILED 5-25-2004.

MITZVAHMAN

THE MARK CONSISTS OF STANDARD CHARACTERS WITHOUT CLAIM TO ANY PARTICULAR FONT, STYLE, SIZE, OR COLOR.

FOR PROVIDING ON-LINE MAGAZINES, COMIC STRIPS, BOOKS, AND SHORT STORIES, ALL FEATURING JEWISH CULTURE, EDUCATION, FOLKLORE, HUMOR, AND POETRY; ENTERTAINMENT AND EDUCATIONAL SERVICES, NAMELY, PROVIDING INFORMATION VIA A WEBSITE ON THE INTERNET, FEATURING JEWISH CULTURE, EDUCATION, FOLKLORE, HUMOR, AND POETRY (U.S. CLS. 100, 101 AND 107).

BARBARA A. GOLD, EXAMINING ATTORNEY

SN 78-426,613. FUEL TV, INC., LOS ANGELES, CA. FILED 5-27-2004.

FUEL TV

THE MARK CONSISTS OF STANDARD CHARACTERS WITHOUT CLAIM TO ANY PARTICULAR FONT, STYLE, SIZE, OR COLOR.

NO CLAIM IS MADE TO THE EXCLUSIVE RIGHT TO USE TV, APART FROM THE MARK AS SHOWN.

FOR PRODUCTION AND DISTRIBUTION OF TELEVISION PROGRAMS (U.S. CLS. 100, 101 AND 107).

FIRST USE 4-11-2004; IN COMMERCE 4-11-2004.

GWEN STOKOLS, EXAMINING ATTORNEY

CLASS 41—(Continued).

SN 78-426,831. GEMS PUBLISHING, USA, INC., FRAMINGHAM, MA. FILED 5-28-2004.

GEMS GOLD DOZEN

THE MARK CONSISTS OF STANDARD CHARACTERS WITHOUT CLAIM TO ANY PARTICULAR FONT, STYLE, SIZE, OR COLOR.

FOR PERSONAL COACHING IN THE FIELD OF DENTISTRY AND DENTAL PRACTICE MANAGEMENT AND PROMOTION (U.S. CLS. 100, 101 AND 107).

FIRST USE 9-1-2001; IN COMMERCE 9-1-2001.

SALLY SHIH, EXAMINING ATTORNEY

SN 78-426,836. NEUHAUS, MAX, NEW YORK, NY. FILED 5-28-2004.

Auracle

THE MARK CONSISTS OF STANDARD CHARACTERS WITHOUT CLAIM TO ANY PARTICULAR FONT, STYLE, SIZE, OR COLOR.

FOR ENTERTAINMENT, NAMELY, PROVIDING A WEB SITE FEATURING AN INTERACTIVE COLLABORATIVE MUSICAL INSTRUMENT (U.S. CLS. 100, 101 AND 107).

FIRST USE 9-2-2001; IN COMMERCE 9-2-2001.

MARK T. MULLEN, EXAMINING ATTORNEY

CLASS 41—(Continued).

SN 78-427,719. DISCIPLESHIP NETWORK OF AMERICA, SIGNAL MOUNTAIN, TN. FILED 6-1-2004.

CLASS 41—(Continued).

SN 78-428,894. BARCLIFT, MICHAEL, SUFFOLK, VA. FILED 6-2-2004.

DNA Ministries

DA HAVKNOTZ

THE MARK CONSISTS OF STANDARD CHARACTERS WITHOUT CLAIM TO ANY PARTICULAR FONT, STYLE, SIZE, OR COLOR.

NO CLAIM IS MADE TO THE EXCLUSIVE RIGHT TO USE "MINISTRIES", APART FROM THE MARK AS SHOWN.

FOR RELIGIOUS INSTRUCTION SERVICES (U.S. CLS. 100, 101 AND 107).

FIRST USE 0-0-2001; IN COMMERCE 7-15-2001.

DOMINIC J. FERRAIUOLO, EXAMINING ATTORNEY

THE MARK CONSISTS OF STANDARD CHARACTERS WITHOUT CLAIM TO ANY PARTICULAR FONT, STYLE, SIZE, OR COLOR.

FOR ENTERTAINMENT SERVICES, NAMELY, PROVIDING LIVE PERFORMANCES OF A MUSICAL GROUP; PROVIDING A WEB SITE FEATURING MUSICAL PERFORMANCES, MUSICAL VIDEOS, RELATED FILM CLIPS, PHOTOGRAPHS AND OTHER MULTIMEDIA MATERIALS; AND SONG WRITING SERVICES (U.S. CLS. 100, 101 AND 107).

FIRST USE 10-0-1998; IN COMMERCE 3-0-1999.

KIMBERLY PERRY, EXAMINING ATTORNEY

SN 78-428,290. MYSTICAL STONE ENTERTAINMENT, LLC, SHERMAN OAKS, CA. FILED 6-1-2004.

SN 78-429,328. DECISIVE ENVIRONMENT, LLC, SALT LAKE CITY, UT. FILED 6-3-2004.

VIDEO GAMES LIVE

GLOBAL DECISIONS

THE MARK CONSISTS OF STANDARD CHARACTERS WITHOUT CLAIM TO ANY PARTICULAR FONT, STYLE, SIZE, OR COLOR.

NO CLAIM IS MADE TO THE EXCLUSIVE RIGHT TO USE LIVE, APART FROM THE MARK AS SHOWN.

FOR ENTERTAINMENT SERVICES, NAMELY CONCERT PRESENTATIONS FEATURING MUSIC, VIDEO, AND LIVE PERFORMANCES (U.S. CLS. 100, 101 AND 107).

FIRST USE 11-20-2002; IN COMMERCE 11-20-2002.

C. DIONNE CLYBURN, EXAMINING ATTORNEY

THE MARK CONSISTS OF STANDARD CHARACTERS WITHOUT CLAIM TO ANY PARTICULAR FONT, STYLE, SIZE, OR COLOR.

FOR TRANSLATION SERVICES; EDUCATIONAL SERVICES, NAMELY, CONDUCTING PRESENTATIONS ON INTERNATIONAL ENVIRONMENTAL, HEALTH AND SAFETY MATTERS; LANGUAGE TRANSLATION OF INTERNATIONAL ENVIRONMENTAL, HEALTH AND SAFETY LAWS, REGULATIONS AND RELATED DOCUMENTS, NAMELY, ENVIRONMENTAL IMPACT ASSESSMENTS, GOVERNMENT AGENCY NOTICES AND TRAINING PROGRAMS (U.S. CLS. 100, 101 AND 107).

ANGELA M. MICHELI, EXAMINING ATTORNEY

CLASS 41—(Continued).

SN 78-429,419. GINA COMMUNICATIONS CORPORATION, LOS ANGELES, CA. FILED 6-3-2004.

AMERICA'S FUNNIEST PEOPLE

THE MARK CONSISTS OF STANDARD CHARACTERS WITHOUT CLAIM TO ANY PARTICULAR FONT, STYLE, SIZE, OR COLOR.

OWNER OF U.S. REG. NOS. 1,793,909, 2,948,440 AND OTHERS.

SEC. 2(F).

FOR ENTERTAINMENT SERVICES IN THE NATURE OF A TELEVISION COMEDY PROGRAM SERIES; PROVIDING TELEVISION PROGRAM SCHEDULING INFORMATION AND SUBJECT MATTER RELATED TO TELEVISION PROGRAM OF SAME NAME VIA THE INTERNET (U.S. CLS. 100, 101 AND 107).

FIRST USE 9-16-1990; IN COMMERCE 9-16-1990.
LAURA KOVAISKY, EXAMINING ATTORNEY

CLASS 41—(Continued).

SN 78-430,086. GIRLS EMPOWERED, LLC, BIRMINGHAM, MI. FILED 6-4-2004.

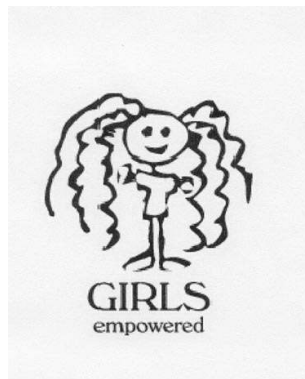

NO CLAIM IS MADE TO THE EXCLUSIVE RIGHT TO USE "GIRLS", APART FROM THE MARK AS SHOWN.

FOR EDUCATIONAL SERVICES, NAMELY, CONDUCTING PROGRAMS, WORKSHOPS, CLASSES, SEMINARS AND CONFERENCES FOR GIRLS AND YOUNG WOMEN FOR PROMOTING GOOD HEALTH, PHYSICAL FITNESS, SELF ESTEEM, CONFIDENCE AND INTELLECTUAL GROWTH AND DEVELOPMENT (U.S. CLS. 100, 101 AND 107).

FIRST USE 8-1-1999; IN COMMERCE 8-1-1999.

MARGERY A. TIERNEY, EXAMINING ATTORNEY

SN 78-429,970. TERRAZAS, JOSE LUIS, STONE PARK, IL. FILED 6-4-2004.

PATRULLA 81

THE MARK CONSISTS OF STANDARD CHARACTERS WITHOUT CLAIM TO ANY PARTICULAR FONT, STYLE, SIZE, OR COLOR.

THE FOREIGN WORDING IN THE MARK TRANSLATES INTO ENGLISH AS PATROL 81.

FOR ENTERTAINMENT IN THE NATURE OF A LIVE MUSICAL GROUP AND VISUAL AND AUDIO PERFORMANCES BY A MUSICAL GROUP (U.S. CLS. 100, 101 AND 107).

FIRST USE 5-5-1997; IN COMMERCE 5-5-1997.

KARANENDRA S. CHHINA, EXAMINING ATTORNEY

SN 78-430,721. MARKERNET, INC., CANTON, OH. FILED 6-7-2004.

MARKERMAN

THE MARK CONSISTS OF STANDARD CHARACTERS WITHOUT CLAIM TO ANY PARTICULAR FONT, STYLE, SIZE, OR COLOR.

FOR TRAINING SERVICES AND TEACHING OF OTHERS IN THE FIELD OF APPLYING BUSINESS PRINCIPLES FOR INDEPENDENT BUSINESS OWNERS; EDUCATIONAL SERVICES, NAMELY, PROVIDING MOTIVATIONAL AND EDUCATIONAL SPEAKERS IN THE FIELD OF APPLYING BUSINESS PRINCIPLES FOR INDEPENDENT BUSINESS OWNERS (U.S. CLS. 100, 101 AND 107).

FIRST USE 10-31-1997; IN COMMERCE 10-31-1997.

ANDREW RHIM, EXAMINING ATTORNEY

CLASS 41—(Continued).

SN 78-430,734. MARKERNET, INC., CANTON, OH. FILED 6-7-2004.

MARKERNET

THE MARK CONSISTS OF STANDARD CHARACTERS WITHOUT CLAIM TO ANY PARTICULAR FONT, STYLE, SIZE, OR COLOR.

FOR EDUCATIONAL SEMINARS, CONFERENCES AND TRAINING IN APPLYING BUSINESS PRINCIPLES (U.S. CLS. 100, 101 AND 107).

FIRST USE 1-31-1998; IN COMMERCE 1-31-1998.
IRENE D. WILLIAMS, EXAMINING ATTORNEY

CLASS 41—(Continued).

SN 78-433,022. LYNCHBURG SALOON, INC., HUNTSVILLE, AL. FILED 6-10-2004.

LYNCHBURG MOTORCYCLE RALLY

THE MARK CONSISTS OF STANDARD CHARACTERS WITHOUT CLAIM TO ANY PARTICULAR FONT, STYLE, SIZE, OR COLOR.

NO CLAIM IS MADE TO THE EXCLUSIVE RIGHT TO USE MOTORCYCLE RALLY, APART FROM THE MARK AS SHOWN.

SEC. 2(F).
FOR ENTERTAINMENT SERVICES, NAMELY, ORGANIZING, ARRANGING, PROMOTING, AND CONDUCTING MOTORCYCLE RALLIES (U.S. CLS. 100, 101 AND 107).

FIRST USE 6-1-2002; IN COMMERCE 6-1-2002.
JENNIFER MARTIN, EXAMINING ATTORNEY

SN 78-433,071. UNITED STATES SURFING FEDERATION, INC., NEPTUNE BEACH, FL. FILED 6-10-2004.

United States Surfing Federation

SN 78-431,950. DOLAN MEDIA COMPANY, MINNEAPOLIS, MN. FILED 6-8-2004.

IDAHO BUSINESS REVIEW

THE MARK CONSISTS OF STANDARD CHARACTERS WITHOUT CLAIM TO ANY PARTICULAR FONT, STYLE, SIZE, OR COLOR.

NO CLAIM IS MADE TO THE EXCLUSIVE RIGHT TO USE "BUSINESS REVIEW", APART FROM THE MARK AS SHOWN.

SEC. 2(F).
FOR PROVIDING ONLINE PUBLICATIONS IN THE NATURE OF NEWSLETTERS FEATURING INFORMATION IN THE FIELD OF BUSINESS IN THE STATE OF IDAHO (U.S. CLS. 100, 101 AND 107).

FIRST USE 12-31-1999; IN COMMERCE 12-31-1999.
MARY CRAWFORD, EXAMINING ATTORNEY

THE MARK CONSISTS OF STANDARD CHARACTERS WITHOUT CLAIM TO ANY PARTICULAR FONT, STYLE, SIZE, OR COLOR.

NO CLAIM IS MADE TO THE EXCLUSIVE RIGHT TO USE "SURFING", APART FROM THE MARK AS SHOWN.

SEC. 2(F).
FOR ENTERTAINMENT IN THE NATURE OF COMPETITIONS IN THE FIELD OF SURFING (U.S. CLS. 100, 101 AND 107).

FIRST USE 12-31-1982; IN COMMERCE 12-31-1982.
EUGENIA MARTIN, EXAMINING ATTORNEY

CLASS 41—(Continued).

SN 78-433,297. HOLCOMB, JULIE D., EMERYVILLE, CA. FILED 6-10-2004.

Il Merlo Press

THE MARK CONSISTS OF STANDARD CHARACTERS WITHOUT CLAIM TO ANY PARTICULAR FONT, STYLE, SIZE, OR COLOR.

NO CLAIM IS MADE TO THE EXCLUSIVE RIGHT TO USE "PRESS", APART FROM THE MARK AS SHOWN.

THE FOREIGN WORDING IN THE MARK TRANSLATES INTO ENGLISH AS THE BLACKBIRD.

FOR PUBLICATION OF BOOKS (U.S. CLS. 100, 101 AND 107).

KATHLEEN M. VANSTON, EXAMINING ATTORNEY

SN 78-433,423. POLK, JOHN M., ORLANDO, FL. FILED 6-10-2004.

The MADD Hatter

THE MARK CONSISTS OF STANDARD CHARACTERS WITHOUT CLAIM TO ANY PARTICULAR FONT, STYLE, SIZE, OR COLOR.

FOR PROVIDING DISC JOCKEYS FOR PARTIES AND SPECIAL EVENTS; PROVIDING FACILITIES FOR ENTERTAINMENT AND RECREATIONAL ACTIVITIES FEATURING KARAOKE SHOWS AND COMPETITIONS (U.S. CLS. 100, 101 AND 107).

FIRST USE 8-15-2002; IN COMMERCE 8-15-2002.

RUSS HERMAN, EXAMINING ATTORNEY

CLASS 41—(Continued).

SN 78-433,658. MCCOY, CATHERINE, LUTZ, FL. FILED S.R. 6-11-2004; AM. P.R. 7-18-2005.



NO CLAIM IS MADE TO THE EXCLUSIVE RIGHT TO USE "COMMUNICATE", APART FROM THE MARK AS SHOWN.

THE COLORS RED, ORANGE, YELLOW, GREEN, DARK BLUE, LIGHT BLUE, PURPLE, GREY, BLACK AND WHITE ARE CLAIMED AS A FEATURE OF THE MARK.

THE MARK CONSISTS OF A RAINBOW BACKGROUND IN THE COLORS RED, ORANGE, YELLOW, GREEN, LIGHT BLUE, DARK BLUE, AND PURPLE WITH A GREEN AND GREY LAPTOP COMPUTER LOOKING THROUGH TO THE RAINBOW WITH THE SCREEN OF THE COMPUTER OUTLINED IN WHITE PLUS THE PHRASE COMMUNI-CATE WITH BLUE LETTERS, UNDER THE RIGHT MIDDLE AND RIGHT SIDE OF THE RAINBOW. THE RAINBOW IS OUTLINED IN BLACK.

THE MARK CONSISTS OF A RAINBOW BACKGROUND IN THE COLORS RED, ORANGE, YELLOW, GREEN, LIGHT BLUE, DARK BLUE, AND PURPLE WITH A GREEN AND GREY LAPTOP COMPUTER LOOKING THROUGH TO THE RAINBOW WITH THE SCREEN OF THE COMPUTER OUTLINED IN WHITE PLUS THE PHRASE COMMUNI-CATE WITH BLUE LETTERS, UNDER THE RIGHT MIDDLE AND RIGHT SIDE OF THE RAINBOW. THE RAINBOW IS OUTLINED IN BLACK.

FOR EDUCATIONAL SERVICES, NAMELY, CONDUCTING LECTURES AND CLASSES IN THE FIELD OF COMPUTERS AND COMMUNICATIONS TECHNOLOGY AND DISTRIBUTING COURSE MATERIALS TOGETHER THEREWITH (U.S. CLS. 100, 101 AND 107).

FIRST USE 6-1-2004; IN COMMERCE 6-1-2004.

CATHERINE FAINT, EXAMINING ATTORNEY

SN 78-434,043. ASC UTAH, PARK CITY, UT. FILED 6-11-2004.

THE CANYONS

THE MARK CONSISTS OF STANDARD CHARACTERS WITHOUT CLAIM TO ANY PARTICULAR FONT, STYLE, SIZE, OR COLOR.

OWNER OF U.S. REG. NOS. 2,327,938 AND 2,472,921.

FOR YEAR-ROUND RECREATIONAL SERVICES, NAMELY, PROVIDING SERVICES AND FACILITIES FOR SKIING, SNOWBOARDING, HIKING, MOUNTAIN BIKING, GOLF, HORSEBACK RIDING, SIGHT-SEEING, TENNIS, SWIMMING, AND ORGANIZING AND CONDUCTING SOCIAL EVENTS AND COMMUNITY FESTIVALS IN THE NATURE OF PARTIES, FAIRS, SPORTING EVENTS, ART EXHIBITS, AND FLEA AND FARMERS' MARKETS AND THE LIKE; AND PROVIDING INSTRUCTION IN THE FIELD OF SKIING AND SNOWBOARDING (U.S. CLS. 100, 101 AND 107).

FIRST USE 7-3-1997; IN COMMERCE 7-3-1997.

AMY HELLA, EXAMINING ATTORNEY

CLASS 41—(Continued).

SN 78-434,060. ELVIS PRESLEY ENTERPRISES, INC., MEMPHIS, TN. FILED 6-11-2004.

CLASS 41—(Continued).

SN 78-434,425. TOTALLY COACHED, INC., SCOTTSDALE, AZ. FILED 6-13-2004.



INTRINSIC COACH

OWNER OF U.S. REG. NOS. 1,360,668 AND 1,653,283. FOR MUSEUM SERVICES, NAMELY, OPERATING A MUSEUM IN ELVIS PRESLEY'S FORMER HOME AND PROVIDING TOURS THEREOF (U.S. CLS. 100, 101 AND 107).
FIRST USE 6-8-1982; IN COMMERCE 6-8-1982.
MARIA-VICTORIA SUAREZ, EXAMINING ATTORNEY

THE MARK CONSISTS OF STANDARD CHARACTERS WITHOUT CLAIM TO ANY PARTICULAR FONT, STYLE, SIZE, OR COLOR.
NO CLAIM IS MADE TO THE EXCLUSIVE RIGHT TO USE "COACH", APART FROM THE MARK AS SHOWN.
FOR COACHING AND COACH TRAINING SERVICES IN THE FIELD OF THINKING, ANALYSIS, LOGIC, AND STRATEGY-MAKING (U.S. CLS. 100, 101 AND 107).
FIRST USE 10-28-2003; IN COMMERCE 10-28-2003.
CHRIS WELLS, EXAMINING ATTORNEY

SN 78-434,364. MINNESOTA STATE LOTTERY AGENCY, ROSEVILLE, MN. FILED 6-13-2004.

SN 78-435,821. LEWIS, YVETTE W., LAUREL, MD. FILED 6-15-2004.



So This Is Opera

NO CLAIM IS MADE TO THE EXCLUSIVE RIGHT TO USE "GAMES", APART FROM THE MARK AS SHOWN. FOR LOTTERY SERVICES (U.S. CLS. 100, 101 AND 107).
FIRST USE 2-29-2004; IN COMMERCE 2-29-2004.
LOURDES AYALA, EXAMINING ATTORNEY

THE MARK CONSISTS OF STANDARD CHARACTERS WITHOUT CLAIM TO ANY PARTICULAR FONT, STYLE, SIZE, OR COLOR.
NO CLAIM IS MADE TO THE EXCLUSIVE RIGHT TO USE OPERA, APART FROM THE MARK AS SHOWN. FOR OPERA PERFORMANCES FOR STUDENTS IN GRADES K-12 AND FOR FAMILIES (U.S. CLS. 100, 101 AND 107).
FIRST USE 0-0-1991; IN COMMERCE 0-0-1991.
BRIAN NEVILLE, EXAMINING ATTORNEY

CLASS 41—(Continued).

SN 78-436,364. LAMAS QI GONG OF AMERICA INC., FORT LAUDERDALE, FL. FILED 6-16-2004.

LAMAS QI GONG

THE MARK CONSISTS OF STANDARD CHARACTERS WITHOUT CLAIM TO ANY PARTICULAR FONT, STYLE, SIZE, OR COLOR.

NO CLAIM IS MADE TO THE EXCLUSIVE RIGHT TO USE "QI GONG", APART FROM THE MARK AS SHOWN.

THE FOREIGN WORDING IN THE MARK TRANSLATES INTO ENGLISH AS "QI GONG" IS AS FOLLOWS: THE DISCIPLINE OF DEVELOPING ENERGY, THROUGH THE USE OF AIR OR BREATH, FOR HEALTH OR VITALITY.

FOR QI GONG INSTRUCTION; EDUCATIONAL SERVICES, NAMELY, CLASSES, SEMINARS, CONFERENCES, WORKSHOPS AND MEETINGS IN THE FIELD OF QI GONG (U.S. CLS. 100, 101 AND 107).

FIRST USE 1-29-1990; IN COMMERCE 3-16-2003.
GEOFFREY FOSDICK, EXAMINING ATTORNEY

SN 78-436,543. FORT PRODUCTIONS, INC., WALDWICK, NJ. FILED 6-16-2004.

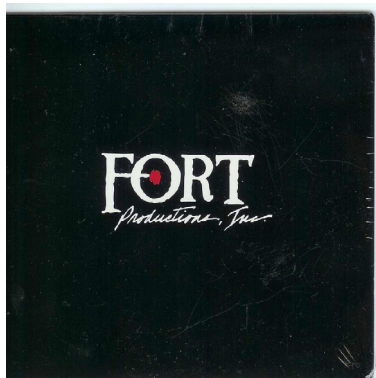

NO CLAIM IS MADE TO THE EXCLUSIVE RIGHT TO USE "PRODUCTIONS, INC.", APART FROM THE MARK AS SHOWN.

THE COLOR(S) WHITE LETTERS, RED DOT IN THE MIDDLE OF THE "O", IS/ARE CLAIMED AS A FEATURE OF THE MARK.

THE COLOR WHITE APPEARS IN THE LETTERS; THE COLOR RED APPEARS IN THE DOT IN THE MIDDLE OF THE LETTER "O".

FOR ENTERTAINMENT SERVICES, NAMELY, ANIMATION PRODUCTION SERVICES; AUDIO VOICE-OVERS; MUSIC PRODUCTION SERVICES; PROVIDING PRE-RECORDED MUSIC TO OTHERS; VISUAL PRODUCTION SERVICES, NAMELY TELEVISION COMMERCIALS, TELEVISION SHOWS, VIDEOS AND DVDS; MULTIMEDIA SOFTWARE PRODUCTION SERVICES (U.S. CLS. 100, 101 AND 107).

FIRST USE 8-1-1989; IN COMMERCE 8-1-1989.
SUSAN STIGLITZ, EXAMINING ATTORNEY

CLASS 41—(Continued).

SN 78-438,097. MILLER, LEE ANN, CHARM, OH. FILED 6-19-2004.

Homestead COOKING

THE MARK CONSISTS OF STANDARD CHARACTERS WITHOUT CLAIM TO ANY PARTICULAR FONT, STYLE, SIZE, OR COLOR.

NO CLAIM IS MADE TO THE EXCLUSIVE RIGHT TO USE "COOKING", APART FROM THE MARK AS SHOWN.

FOR ENTERTAINMENT SERVICES RENDERED THROUGH THE MEDIUM OF TELEVISION OR LIVE ENTERTAINMENT EXHIBITIONS IN THE NATURE OF CELEBRITY CHEF PRESENTATIONS AND CULINARY DEMONSTRATIONS (U.S. CLS. 100, 101 AND 107).

FIRST USE 5-20-2004; IN COMMERCE 5-20-2004.
DOMINICK J. SALEMI, EXAMINING ATTORNEY

SN 78-438,609. UNIVERSAL TECHNICAL INSTITUTE, INC., PHOENIX, AZ. FILED 6-21-2004.

MARINE MECHANICS INSTITUTE

THE MARK CONSISTS OF STANDARD CHARACTERS WITHOUT CLAIM TO ANY PARTICULAR FONT, STYLE, SIZE, OR COLOR.

NO CLAIM IS MADE TO THE EXCLUSIVE RIGHT TO USE "INSTITUTE", APART FROM THE MARK AS SHOWN. SEC. 2(F).

FOR EDUCATIONAL SERVICES, NAMELY, CONDUCTING PROGRAMS IN THE FIELD OF MARINE AND WATERCRAFT TECHNOLOGY (U.S. CLS. 100, 101 AND 107).

FIRST USE 0-0-1991; IN COMMERCE 0-0-1991.
ANN LINNEHAN, EXAMINING ATTORNEY

CLASS 41—(Continued).

SN 78-439,277. RESIDENTIAL PROPERTIES LTD., SMITH-FIELD, RI. FILED 6-22-2004.

CLASS 41—(Continued).

SN 78-439,738. LINGOTEACH, INC., SUNNYVALE, CA. FILED 6-22-2004.

**REAL ESTATE
INSIGHT**

teach2go

THE MARK CONSISTS OF STANDARD CHARACTERS WITHOUT CLAIM TO ANY PARTICULAR FONT, STYLE, SIZE, OR COLOR.

NO CLAIM IS MADE TO THE EXCLUSIVE RIGHT TO USE "REAL ESTATE", APART FROM THE MARK AS SHOWN.

FOR ENTERTAINMENT AND EDUCATIONAL SERVICES, NAMELY PROVIDING A RADIO PROGRAM IN THE FIELD OF REAL ESTATE (U.S. CLS. 100, 101 AND 107).

FIRST USE 1-11-2004; IN COMMERCE 1-11-2004.
JOHN GARTNER, EXAMINING ATTORNEY

THE MARK CONSISTS OF STANDARD CHARACTERS WITHOUT CLAIM TO ANY PARTICULAR FONT, STYLE, SIZE, OR COLOR.

FOR COMPUTER EDUCATION TRAINING FEATURING LANGUAGE INSTRUCTIONS (U.S. CLS. 100, 101 AND 107).

WILLIAM VERHOSEK, EXAMINING ATTORNEY

SN 78-439,374. SMITH, TIMOTHY J., CAMBRIDGE, MA. AND BARNICK, JENNIFER J., CAMBRIDGE, MA. FILED 6-22-2004.

SN 78-439,888. PH. D IN RESULTS, OAK PARK, IL. FILED 6-23-2004.

**The Better Drink A
Sparkling Wine and
Living Magazine**

DNA for Results

THE MARK CONSISTS OF STANDARD CHARACTERS WITHOUT CLAIM TO ANY PARTICULAR FONT, STYLE, SIZE, OR COLOR.

NO CLAIM IS MADE TO THE EXCLUSIVE RIGHT TO USE "MAGAZINE", APART FROM THE MARK AS SHOWN.

FOR PUBLICATION OF MAGAZINES (U.S. CLS. 100, 101 AND 107).

YSA DEJESUS, EXAMINING ATTORNEY

THE MARK CONSISTS OF STANDARD CHARACTERS WITHOUT CLAIM TO ANY PARTICULAR FONT, STYLE, SIZE, OR COLOR.

NO CLAIM IS MADE TO THE EXCLUSIVE RIGHT TO USE DNA, APART FROM THE MARK AS SHOWN.

FOR TRAINING IN THE FIELD OF SALES AND MARKETING TO IMPROVE A PERSON'S BEHAVIOR STYLE, THINKING STYLE AND VALUE (U.S. CLS. 100, 101 AND 107).

FIRST USE 6-1-2002; IN COMMERCE 6-1-2003.
RUSS HERMAN, EXAMINING ATTORNEY

CLASS 41—(Continued).

SN 78-441,247. STEPHANIE A. DAVID AND JUSTIN B. THOMAS PARTNERSHIP, THE, BALTIMORE, MD. FILED 6-25-2004.



NO CLAIM IS MADE TO THE EXCLUSIVE RIGHT TO USE PRODUCTIONS, APART FROM THE MARK AS SHOWN.

THE COLOR(S) RED AND BLACK IS/ARE CLAIMED AS A FEATURE OF THE MARK.

THE MARK CONSISTS OF JUSTEPHAN PRODUCTIONS - INSTEAD OF THE "S" USE THE RED TREBLE CLEF INCLOSED IN A BLACK OVAL.

FOR MUSIC PRODUCTION SERVICES (U.S. CLS. 100, 101 AND 107).

FIRST USE 6-24-2004; IN COMMERCE 6-24-2004.
CHRIS WELLS, EXAMINING ATTORNEY

CLASS 41—(Continued).

SN 78-441,642. STROLLERFIT, INC., CINCINNATI, OH. FILED 6-25-2004.

PowerMom

THE MARK CONSISTS OF STANDARD CHARACTERS WITHOUT CLAIM TO ANY PARTICULAR FONT, STYLE, SIZE, OR COLOR.

FOR PROVIDER OF PHYSICAL FITNESS TRAINING AND INSTRUCTION (U.S. CLS. 100, 101 AND 107).

FIRST USE 9-1-2000; IN COMMERCE 9-1-2000.
JEAN IM, EXAMINING ATTORNEY

SN 78-441,624. STROLLERFIT, INC., CINCINNATI, OH. FILED 6-25-2004.

StrollerFriends

SN 78-441,750. MACFADDEN-PROTECH, LLC, NEW ALBANY, IN. FILED 6-25-2004.



NO CLAIM IS MADE TO THE EXCLUSIVE RIGHT TO USE "IDEA EXCHANGE", APART FROM THE MARK AS SHOWN.

FOR ARRANGING AND CONDUCTING EDUCATIONAL EVENTS, NAMELY, WORKSHOPS, SEMINARS, ROUNDTABLE DISCUSSIONS, PRESENTATIONS, AND LECTURES FOR THE PIZZA SERVICE INDUSTRY IN THE FIELDS OF FOOD PREPARATION, COOKING, FOOD AND COOKING TECHNOLOGY, MARKETING, ADVERTISING, MANAGEMENT SKILLS, INTERIOR DESIGN AND GRAPHIC DESIGN (U.S. CLS. 100, 101 AND 107).

FIRST USE 2-1-2002; IN COMMERCE 2-1-2002.

KATHLEEN M. VANSTON, EXAMINING ATTORNEY

THE MARK CONSISTS OF STANDARD CHARACTERS WITHOUT CLAIM TO ANY PARTICULAR FONT, STYLE, SIZE, OR COLOR.

OWNER OF U.S. REG. NO. 2,279,881.

FOR PROVIDER OF PHYSICAL FITNESS TRAINING, INSTRUCTION AND COORDINATION PROGRAMS (U.S. CLS. 100, 101 AND 107).

FIRST USE 10-1-2002; IN COMMERCE 10-1-2002.

KIMBERLY FRYE, EXAMINING ATTORNEY

CLASS 41—(Continued).

SN 78-442,278. NATIONAL ASSOCIATION FOR STOCK CAR AUTO RACING, INC., DAYTONA BEACH, FL. FILED 6-28-2004.

CHASE FOR THE CUP

THE MARK CONSISTS OF STANDARD CHARACTERS WITHOUT CLAIM TO ANY PARTICULAR FONT, STYLE, SIZE, OR COLOR.

NO CLAIM IS MADE TO THE EXCLUSIVE RIGHT TO USE "CUP", APART FROM THE MARK AS SHOWN.

FOR ENTERTAINMENT SERVICES, NAMELY CONDUCTING MOTORSPORTS RACING EVENTS (U.S. CLS. 100, 101 AND 107).

JOHN E. MICHOS, EXAMINING ATTORNEY

CLASS 41—(Continued).

SN 78-443,378. ORTMAN, RONALD A., OJAI, CA. FILED 6-29-2004.



novus
publishing

NO CLAIM IS MADE TO THE EXCLUSIVE RIGHT TO USE "PUBLISHING", APART FROM THE MARK AS SHOWN.

THE COLOR(S) BLACK AND WHITE IS/ARE CLAIMED AS A FEATURE OF THE MARK.

THE MARK IS INTENDED TO BE HIGH-CONTRAST BLACK AND WHITE ONLY, WITHOUT ANY INTERMEDIATE TONES. THE GREY TONES IN THE DRAWING ARE NOT INTENDED TO INDICATE THE COLOR GREY.

FOR PUBLICATION OF TEXT BOOKS (U.S. CLS. 100, 101 AND 107).

FIRST USE 6-29-2004; IN COMMERCE 6-29-2004.
ANNE E. GUSTASON, EXAMINING ATTORNEY

SN 78-442,830. HOLLENBAUGH, NONA, PLYMOUTH, IN. FILED 6-29-2004.



THE COLOR(S) PURPLE AND BLUE-VIOLET IS/ARE CLAIMED AS A FEATURE OF THE MARK.

THE COLOR PURPLE APPEARS IN THE WORDING "SMILE" AND THE WORDING "SOMETHING MAGICAL IGNITES LOVE EVERYWHERE" IN THE MARK. THE COLOR BLUE-VIOLET APPEARS IN THE WORDING "SMILE".

FOR EDUCATIONAL SERVICES, NAMELY, CONDUCTING EDUCATIONAL PROGRAMS, SEMINARS AND WORKSHOPS IN THE FIELDS OF RELIGIOUS INSTRUCTION AND FELLOWSHIP FOR YOUNG PEOPLE AND DISTRIBUTING COURSE MATERIALS IN CONNECTION THEREWITH. (U.S. CLS. 100, 101 AND 107).

RON FAIRBANKS, EXAMINING ATTORNEY

SN 78-443,471. HOLCOMB, JULIE, EMERYVILLE, CA. FILED 6-29-2004.



THE MARK CONSISTS OF STANDARD CHARACTERS WITHOUT CLAIM TO ANY PARTICULAR FONT, STYLE, SIZE, OR COLOR.

FOR PUBLICATION OF BOOKS (U.S. CLS. 100, 101 AND 107).

DANIEL CAPSHAW, EXAMINING ATTORNEY

CLASS 41—(Continued).

SN 78-445,597. PICTURE THIS HOME PERFECT, INC.,
ROMEOVILLE, IL. FILED 7-2-2004.

**PICTURE THIS HOME
PERFECT**

THE MARK CONSISTS OF STANDARD CHARACTERS
WITHOUT CLAIM TO ANY PARTICULAR FONT, STYLE,
SIZE, OR COLOR.
FOR PHOTOGRAPHY SERVICES TO PROVIDE VIDEO
PICTURES AND TOURS OF HOMES AND BUILDINGS
(U.S. CLS. 100, 101 AND 107).
FIRST USE 3-20-2004; IN COMMERCE 4-25-2004.
C. DIONNE CLYBURN, EXAMINING ATTORNEY

SN 78-447,806. INTERNATIONAL HEALTH SYSTEMS, LLC,
MEQUON, WI. FILED 7-8-2004.

**"The Person, Not
The Pose"**

THE MARK CONSISTS OF STANDARD CHARACTERS
WITHOUT CLAIM TO ANY PARTICULAR FONT, STYLE,
SIZE, OR COLOR.
FOR EDUCATION, TRAINING, AND INSTRUC-
TIONAL SERVICES, NAMELY, CLASSES, SEMINARS,
WORKSHOPS, AND CONFERENCES IN THE FIELDS OF
FITNESS, YOGA, PILATES, RELAXATION TECHNI-
QUES, MEDIATION, BREATHWORK, AND MIND-
BODY EXERCISE (U.S. CLS. 100, 101 AND 107).
FIRST USE 1-25-2001; IN COMMERCE 1-25-2001.
STEVEN JACKSON, EXAMINING ATTORNEY

CLASS 41—(Continued).

SN 78-449,243. STROLLERFIT, INC., CINCINNATI, OH.
FILED 7-12-2004.

**StrollerFit
Exercise With
Your Baby**

THE MARK CONSISTS OF STANDARD CHARACTERS
WITHOUT CLAIM TO ANY PARTICULAR FONT, STYLE,
SIZE, OR COLOR.
OWNER OF U.S. REG. NO. 2,279,881.
NO CLAIM IS MADE TO THE EXCLUSIVE RIGHT TO
USE "EXERCISE WITH YOUR BABY", APART FROM THE
MARK AS SHOWN.
FOR PROVIDER OF PHYSICAL FITNESS TRAINING,
INSTRUCTION AND COORDINATION PROGRAMS
(U.S. CLS. 100, 101 AND 107).
FIRST USE 9-1-1997; IN COMMERCE 9-1-1997.
KIMBERLY FRYE, EXAMINING ATTORNEY

SN 78-449,246. REIN, DIANA, CHICAGO, IL. FILED 7-12-
2004.

Diana Rein

THE MARK CONSISTS OF STANDARD CHARACTERS
WITHOUT CLAIM TO ANY PARTICULAR FONT, STYLE,
SIZE, OR COLOR.
FOR ENTERTAINMENT SERVICES NAMELY, LIVE
MUSICAL, DANCE AND DRAMATIC PERFORMANCES;
AUDIO RECORDING AND PRODUCTION; MUSIC PUB-
LISHING SERVICES; MUSIC COMPOSITION AND
SONGWRITING (U.S. CLS. 100, 101 AND 107).
FIRST USE 12-31-1990; IN COMMERCE 12-31-1990.
MARIA-VICTORIA SUAREZ, EXAMINING ATTORNEY

CLASS 41—(Continued).

SN 78-449,295. CROWN GOLF PROPERTIES, L.P., WILMETTE, IL. FILED 7-12-2004.



THE STIPPLING IS FOR SHADING PURPOSES ONLY. THE COLOR(S) GREEN, GRAY AND BLACK IS/ARE CLAIMED AS A FEATURE OF THE MARK.

THE MARK CONSISTS OF A STYLIZED TROPHY CUP IN BLACK AND GRAY, ACCOMPANIED BY THE TEXT "CROWNCLUB" IN GREEN

FOR ADMINISTRATION OF A DISCOUNT PROGRAM FOR ENABLING PARTICIPANTS TO OBTAIN DISCOUNTS AT GOLF COURSES THROUGH THE USE OF MEMBERSHIP CERTIFICATES (U.S. CLS. 100, 101 AND 107).

FIRST USE 1-2-2004; IN COMMERCE 1-2-2004.
THEODORE MCBRIDE, EXAMINING ATTORNEY

CLASS 41—(Continued).

SN 78-450,480. GIBILISCO, KIMBERLY J., NEW YORK, NY. FILED 7-14-2004.



NO CLAIM IS MADE TO THE EXCLUSIVE RIGHT TO USE PILATES, APART FROM THE MARK AS SHOWN, FOR UNIQUE PILATES TRAINING AND LIVE INSTRUCTION (U.S. CLS. 100, 101 AND 107).

FIRST USE 1-1-2002; IN COMMERCE 1-1-2002.
SHARI SHEFFIELD, EXAMINING ATTORNEY

SN 78-450,022. EDUCATIONAL RESEARCH CENTER OF AMERICA, INC., MORRISTOWN, NJ. FILED 7-13-2004.

**Educational
Research Center of
America**

THE MARK CONSISTS OF STANDARD CHARACTERS WITHOUT CLAIM TO ANY PARTICULAR FONT, STYLE, SIZE, OR COLOR.

SEC. 2(F).
FOR EDUCATIONAL SERVICES, NAMELY CONDUCTING SURVEYS IN THE FIELD OF SECONDARY AND POST-SECONDARY EDUCATION; PROVIDING SURVEY RESULTS IN CONNECTION THEREWITH (U.S. CLS. 100, 101 AND 107).

FIRST USE 9-15-1999; IN COMMERCE 9-15-1999.
KAREN K. BUSH, EXAMINING ATTORNEY

SN 78-451,442. GREENBERG, PATRICIA, LOS ANGELES, CA. FILED 7-15-2004.

**THE FITNESS
GOURMET**

THE MARK CONSISTS OF STANDARD CHARACTERS WITHOUT CLAIM TO ANY PARTICULAR FONT, STYLE, SIZE, OR COLOR.

NO CLAIM IS MADE TO THE EXCLUSIVE RIGHT TO USE GOURMET, APART FROM THE MARK AS SHOWN. FOR EDUCATIONAL SERVICES, NAMELY, CLASSES AND SEMINARS IN THE FIELD OF COOKING AND FOOD PREPARATION (U.S. CLS. 100, 101 AND 107).

FIRST USE 1-31-1990; IN COMMERCE 1-31-1990.
KATHERINE STOIDES, EXAMINING ATTORNEY

CLASS 41—(Continued).

SN 78-451,612. THE ART OF BEING, LLC, PAIA, HI. FILED 7-15-2004.



FOR EDUCATIONAL SERVICES, NAMELY, CONDUCTING CLASSES IN THE FIELD OF SELF-AWARENESS (U.S. CLS. 100, 101 AND 107).
FIRST USE 2-28-1996; IN COMMERCE 2-28-1996.
GIANCARLO CASTRO, EXAMINING ATTORNEY

CLASS 41—(Continued).

SN 78-454,385. BABIGIAN, ARTHUR, DOWNEY, CA. FILED 7-21-2004.

Identity Theft

THE MARK CONSISTS OF STANDARD CHARACTERS WITHOUT CLAIM TO ANY PARTICULAR FONT, STYLE, SIZE, OR COLOR.

FOR ENTERTAINMENT SERVICES IN THE NATURE OF LIVE PERFORMANCES BY A MUSICAL GROUP (U.S. CLS. 100, 101 AND 107).

ALICE SUE CARRUTHERS, EXAMINING ATTORNEY

SN 78-455,312. REYES, GILDA, SPRING VALLEY, CA. FILED 7-22-2004.

CAMP SO KID

SN 78-451,940. STALZER, SEAN T, FREDERICKSBURG, VA. FILED 7-16-2004.



FOR ENTERTAINMENT SERVICES, NAMELY, AN ONLINE GAMING GUILD PROVIDING IN GAME OPPORTUNITIES FOR PROLIFERATING GAME EXPERTISE AND CAMARADERIE AMONG GAMERS SUPPORTED BY A WEB SITE FEATURING MULTIMEDIA MATERIALS (U.S. CLS. 100, 101 AND 107).
FIRST USE 2-15-1996; IN COMMERCE 5-15-1996.
CHARLES JOYNER, EXAMINING ATTORNEY

THE MARK CONSISTS OF STANDARD CHARACTERS WITHOUT CLAIM TO ANY PARTICULAR FONT, STYLE, SIZE, OR COLOR.

NO CLAIM IS MADE TO THE EXCLUSIVE RIGHT TO USE CAMP, APART FROM THE MARK AS SHOWN.

FOR SUMMER CAMP (U.S. CLS. 100, 101 AND 107).

FIRST USE 1-1-2004; IN COMMERCE 1-1-2004.

APRIL L. RADEMACHER, EXAMINING ATTORNEY

SN 78-456,230. ACADEMICS ETC., INC., CROFTON, MD. FILED 7-25-2004.

Academics Etc., Inc.

NO CLAIM IS MADE TO THE EXCLUSIVE RIGHT TO USE ACADEMICS AND INC., APART FROM THE MARK AS SHOWN.

THE MARK CONSISTS OF 3 HORIZONTAL BLUE LINES WITH CENTER LINE DASHED.

FOR EDUCATIONAL SERVICES, NAMELY PROVIDING AFTER SCHOOL ENRICHMENT PROGRAMS AT THE ELEMENTARY SCHOOL LEVEL (U.S. CLS. 100, 101 AND 107).

FIRST USE 8-1-2003; IN COMMERCE 8-1-2003.

CHERYL STEPLIGHT, EXAMINING ATTORNEY

CLASS 41—(Continued).

SN 78-457,291. TORAND PRODUCTIONS, LOS ANGELES, CA. FILED 7-27-2004.



OWNER OF U.S. REG. NO. 2,510,281.
 THE STIPLING IS A FEATURE OF THE MARK.
 THE MARK CONSISTS OF A CIRCLE WITH THE MARK BEVERLY HILLS 90210.
 FOR ENTERTAINMENT SERVICES IN THE NATURE OF A DRAMATIC TELEVISION SERIES (U.S. CLS. 100, 101 AND 107).
 FIRST USE 10-4-1990; IN COMMERCE 10-4-1990.
 SAMUEL E. SHARPER JR., EXAMINING ATTORNEY

SN 78-458,487. BROWN, LAURA, NEW YORK, NY. FILED 7-28-2004.



THE COLOR(S) BLACK AND RED IS/ARE CLAIMED AS A FEATURE OF THE MARK.
 THE COLOR RED APPEARS IN THE SMALL STAR PORTION OF THE MARK. THE REST OF THE MARK IS SHOWN IN BLACK.
 THE MARK CONSISTS OF THE WORD DRAMAZINE WITH THE LETTER "O" FORMED BY A STAR DESIGN WITH TWO STARS WITH FACE DESIGNS AND SEVERAL SMALLER STARS.
 FOR THEATRICAL TRAINING SERVICES IN THE FIELDS OF DRAMA, MUSIC, ART AND DANCE (U.S. CLS. 100, 101 AND 107).
 FIRST USE 11-1-2003; IN COMMERCE 11-1-2003.
 SCOTT OSLICK, EXAMINING ATTORNEY

CLASS 41—(Continued).

SN 78-459,189. RUSSO, MICHAEL A., SARATOGA SPRINGS, NY. FILED 7-29-2004.



NO CLAIM IS MADE TO THE EXCLUSIVE RIGHT TO USE "COOKING FOR KIDS", APART FROM THE MARK AS SHOWN.
 THE COLOR(S) ORANGE, YELLOW, GREY AND BLACK IS/ARE CLAIMED AS A FEATURE OF THE MARK.
 THE MARK CONSISTS OF AN ORANGE OVAL WITH A GRAY FORK ON THE TOP LEFT SIDE AND THE WORDS "COOKING FOR KIDS" WITH THE WORD "COOKING" IN BLACK AND THE WORDING "FOR KIDS" IN WHITE. ON A GRAY BANNER BELOW THE ORANGE OVAL, ARE THE WORDS "WITH MIKE RUSSO" IN YELLOW.
 FOR ENTERTAINMENT, IN THE NATURE OF ONGOING TELEVISION PROGRAMS IN THE FIELD OF CHILDHOOD NUTRITION; LIVE SHOW PERFORMANCES FEATURING A COOKING PRESENTATION IN THE FIELD OF CHILDHOOD NUTRITION (U.S. CLS. 100, 101 AND 107).
 FIRST USE 6-1-2003; IN COMMERCE 6-1-2003.
 GINNY ISAACSON, EXAMINING ATTORNEY

SN 78-460,225. THINK DETROIT, DETROIT, MI. FILED 8-2-2004.

THINK ATLANTA

THE MARK CONSISTS OF STANDARD CHARACTERS WITHOUT CLAIM TO ANY PARTICULAR FONT, STYLE, SIZE, OR COLOR.
 FOR EDUCATIONAL SERVICES PROVIDED BY A NONPROFIT YOUTH PROGRAM, NAMELY, FEATURING INSTRUCTION IN SPORTS AND TRAINING IN COMPUTER LITERACY AND INTERNET USE (U.S. CLS. 100, 101 AND 107).
 LINDA E. BLOHM, EXAMINING ATTORNEY

CLASS 41—(Continued).

SN 78-460,648. TRI4HIM, INC., KELLER, TX. FILED 8-2-2004.



THE COLOR(S) RED IS/ARE CLAIMED AS A FEATURE OF THE MARK.

THE COLOR RED APPEARS IN THE MARK IN THE FORM OF THE NUMERAL 4 IN THE MIDDLE OF THE MARK.

FOR TRAINING SERVICES IN THE SPORT OF TRIATHLON TO HELP INDIVIDUALS IMPLEMENT PRINCIPLES OF CHRISTIAN FAITH AND VALUES IN THEIR DAILY LIVES (U.S. CLS. 100, 101 AND 107).

FIRST USE 1-1-2004; IN COMMERCE 1-1-2004.
CHERYL CLAYTON, EXAMINING ATTORNEY

CLASS 41—(Continued).

SN 78-461,677. WALLACE, DAN, CHICAGO, IL. FILED 8-4-2004.

the pindrops

THE MARK CONSISTS OF STANDARD CHARACTERS WITHOUT CLAIM TO ANY PARTICULAR FONT, STYLE, SIZE, OR COLOR.

FOR ENTERTAINMENT, NAMELY, LIVE PERFORMANCES BY A MUSICAL BAND (U.S. CLS. 100, 101 AND 107).

ROBERT LAVACHE, EXAMINING ATTORNEY

SN 78-460,693. CHICAGO REGION SPORTS CAR CLUB OF AMERICA, INCORPORATED, GLENVIEW, IL. FILED 8-2-2004.

TRIPLE CROWN

THE MARK CONSISTS OF STANDARD CHARACTERS WITHOUT CLAIM TO ANY PARTICULAR FONT, STYLE, SIZE, OR COLOR.

FOR PROMOTING, ARRANGING AND CONDUCTING SPORTS CAR AND AUTOMOBILE RACES AND RACE ACTIVITIES, NAMELY, A SERIES OF SPORTS CAR AND AUTOMOBILE RACE EVENTS TO DETERMINE AN OVERALL WINNER OF THE SERIES OF SPORTS CAR AND AUTOMOBILE RACE EVENTS (U.S. CLS. 100, 101 AND 107).

ERNEST SHOSHO, EXAMINING ATTORNEY

SN 78-461,846. MEHL, MICHAEL JOSEPH, SAN ANTONIO, TX. FILED 8-4-2004.

FOTOSEPTIEMBRE USA SAFOTO

THE MARK CONSISTS OF STANDARD CHARACTERS WITHOUT CLAIM TO ANY PARTICULAR FONT, STYLE, SIZE, OR COLOR.

NO CLAIM IS MADE TO THE EXCLUSIVE RIGHT TO USE USA, APART FROM THE MARK AS SHOWN.

THE ENGLISH TRANSLATION OF "FOTOSEPTIEMBRE" IS "PHOTOSEPTEMBER".

FOR ORGANIZING AND PROVIDING CURATOR SERVICES FOR PHOTOGRAPHY FESTIVALS AND EXHIBITIONS AT VENUES INCLUDING PRIVATE AND PUBLIC GALLERIES, MUSEUMS, CULTURAL ORGANIZATIONS, ALTERNATIVE SPACES, OPEN SPACES, AND ANY OTHER AD-HOC AND CULTURAL SPACES, THE INTERNET AND INTRANET, AND WEB GALLERIES (U.S. CLS. 100, 101 AND 107).

FIRST USE 9-1-1995; IN COMMERCE 9-1-1995.
TRICIA THOMPSON, EXAMINING ATTORNEY

CLASS 41—(Continued).

SN 78-462,162. BEAUTYSALON, LLC, THOUSAND OAKS, CA. FILED 8-4-2004.

HAIR SHOW

THE MARK CONSISTS OF STANDARD CHARACTERS WITHOUT CLAIM TO ANY PARTICULAR FONT, STYLE, SIZE, OR COLOR.

NO CLAIM IS MADE TO THE EXCLUSIVE RIGHT TO USE SHOW, APART FROM THE MARK AS SHOWN.

FOR PRODUCTION AND DISTRIBUTION OF LIVE ACTION, COMEDY, DRAMA AND ANIMATED MOTION PICTURE THEATRICAL FILMS; PROVIDING ENTERTAINMENT, NAMELY, ONGOING TELEVISION PROGRAMS AND LIVE STAGE SHOWS FEATURING LIVE ACTION, COMEDY, DRAMA AND ANIMATION; PROVIDING INFORMATION ABOUT MOTION PICTURE FILMS, TELEVISION PROGRAMS AND STAGE SHOWS VIA A GLOBAL COMPUTER NETWORK (U.S. CLS. 100, 101 AND 107).

PATRICIA EVANKO, EXAMINING ATTORNEY



SN 78-462,394. TALARIS RESEARCH INSTITUTE, SEATTLE, WA. FILED 8-5-2004.

Parenting Counts

THE MARK CONSISTS OF STANDARD CHARACTERS WITHOUT CLAIM TO ANY PARTICULAR FONT, STYLE, SIZE, OR COLOR.

NO CLAIM IS MADE TO THE EXCLUSIVE RIGHT TO USE "PARENTING", APART FROM THE MARK AS SHOWN.

FOR EDUCATIONAL SERVICES, NAMELY, PROVIDING SEMINARS THROUGH LOCAL CAMPAIGN COORDINATORS, WORKSHOPS AND CONFERENCES, AND PROVIDING DAYCARE TRAINING, LANGUAGE TRAINING AND TEACHER TRAINING, ALL IN THE FIELD OF EARLY LEARNING AND PARENTING (U.S. CLS. 100, 101 AND 107).

STACY WAHLBERG, EXAMINING ATTORNEY

CLASS 41—(Continued).

SN 78-462,616. MANUFACTURING TECHNOLOGY INSTITUTE, INC., JAMESTOWN, NY. FILED 8-5-2004.

MANUFACTURING MAYHEM

THE MARK CONSISTS OF STANDARD CHARACTERS WITHOUT CLAIM TO ANY PARTICULAR FONT, STYLE, SIZE, OR COLOR.

NO CLAIM IS MADE TO THE EXCLUSIVE RIGHT TO USE "MANUFACTURING", APART FROM THE MARK AS SHOWN.

FOR ENTERTAINMENT SERVICES IN THE NATURE OF A NON-FICTION TELEVISION SERIES (U.S. CLS. 100, 101 AND 107).

FIRST USE 5-11-2004; IN COMMERCE 5-11-2004.
ALICE BENMAMAN, EXAMINING ATTORNEY



SN 78-462,847. CITY OF SAN ANTONIO, SAN ANTONIO, TX. FILED 8-5-2004.

HEMISFAIR PARK

THE MARK CONSISTS OF STANDARD CHARACTERS WITHOUT CLAIM TO ANY PARTICULAR FONT, STYLE, SIZE, OR COLOR.

NO CLAIM IS MADE TO THE EXCLUSIVE RIGHT TO USE "PARK", APART FROM THE MARK AS SHOWN.

FOR RECREATIONAL PARK SERVICES, IN THE NATURE OF AMUSEMENT PARK RIDES; ENTERTAINMENT SERVICES IN THE NATURE OF THEATER PRODUCTIONS, FIREWORKS DISPLAYS, PRESENTATIONS OF LIVE MUSICAL PERFORMANCES, AND ORGANIZING COMMUNITY CULTURAL EVENTS; EDUCATIONAL SERVICES, NAMELY, CONDUCTING CLASSES, SEMINARS, CONFERENCES AND WORKSHOPS IN THE FIELD OF HISTORY, HORTICULTURE, LANGUAGE, DANCE, ART, AND DRAMA (U.S. CLS. 100, 101 AND 107).

FIRST USE 0-0-1988; IN COMMERCE 0-0-1988.
MELISSA SHELLA, EXAMINING ATTORNEY

CLASS 41—(Continued).

SN 78-462,857. CITY OF SAN ANTONIO, SAN ANTONIO, TX.
FILED 8-5-2004.

CLASS 41—(Continued).

SN 78-463,850. HEJAZI, SAMMY, SUPERIOR, CO. FILED 8-7-2004.

HEMISFAIR

THE MARK CONSISTS OF STANDARD CHARACTERS WITHOUT CLAIM TO ANY PARTICULAR FONT, STYLE, SIZE, OR COLOR.

FOR RECREATIONAL PARK SERVICES, IN THE NATURE OF AMUSEMENT PARK RIDES; ENTERTAINMENT SERVICES IN THE NATURE OF THEATER PRODUCTIONS, FIREWORKS DISPLAYS, PRESENTATIONS OF LIVE MUSICAL PERFORMANCES, AND ORGANIZING COMMUNITY CULTURAL EVENTS; EDUCATIONAL SERVICES, NAMELY, CONDUCTING CLASSES, SEMINARS, CONFERENCES AND WORKSHOPS IN THE FIELD OF HISTORY, HORTICULTURE, LANGUAGE, DANCE, ART, AND DRAMA (U.S. CLS. 100, 101 AND 107).

FIRST USE 3-0-2004; IN COMMERCE 3-0-2004.
MELISSA SHELLA, EXAMINING ATTORNEY

Watch The Birdie

SN 78-463,558. CYBREL ENTERTAINMENT D/B/A DIGITAL SOUTH GROUP CORPORATION, MIAMI BEACH, FL.
FILED 8-6-2004.

MOLE

THE MARK CONSISTS OF STANDARD CHARACTERS WITHOUT CLAIM TO ANY PARTICULAR FONT, STYLE, SIZE, OR COLOR.

FOR ENTERTAINMENT IN THE NATURE OF LIVE VISUAL AND AUDIO PERFORMANCES BY A ROCK MUSIC GROUP (U.S. CLS. 100, 101 AND 107).

ROBERT LAVACHE, EXAMINING ATTORNEY

THE MARK CONSISTS OF STANDARD CHARACTERS WITHOUT CLAIM TO ANY PARTICULAR FONT, STYLE, SIZE, OR COLOR.

FOR EDUCATIONAL SERVICES, NAMELY PROVIDING GOLF SWING ANALYSIS UTILIZING COMPUTER HARDWARE AND CUSTOM SOFTWARE FOR RECORDING, DISPLAYING AND REPRODUCING GOLF SWING IMAGES AND VIDEO CLIPS TO BE VIEWED ON MONITOR SCREENS, TO BE PRINTED OR TO BE RECORDED ON COMPUTER MEDIA; ENTERTAINMENT SERVICES, NAMELY, PRODUCTION OF VIDEO DISCS AND CASSETTES FOR OTHERS FEATURING GOLF SWINGS IMAGES AND VIDEO CLIPS WHICH CAN BE DISPLAYED ON MONITORS FOR VIEWING AND PRINTING (U.S. CLS. 100, 101 AND 107).

FIRST USE 10-12-2001; IN COMMERCE 6-28-2003.

KELLEY WELLS, EXAMINING ATTORNEY

CLASS 41—(Continued).

SN 78-464,360. LOS ANGELES COMMUNITY CHURCH OF RELIGIOUS SCIENCE, INC., JAMUL, CA. FILED 8-9-2004.

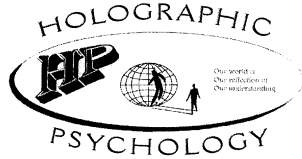

NO CLAIM IS MADE TO THE EXCLUSIVE RIGHT TO USE "HP HOLOGRAPHIC PSYCHOLOGY", APART FROM THE MARK AS SHOWN.

THE WORDS "HOLOGRAPHIC PSYCHOLOGY" AROUND AN OVAL WHICH CONTAINS THE LETTERS "HP" A FIGURE OF A PERSON WITH HIS IMAGE REFLECTED ON A REPRESENTATION OF THE GLOBE AND THE WORDS "OUR WORLD IS OUR REFLECTION OF OUR UNDERSTANDING".

FOR EDUCATIONAL SERVICES, NAMELY, CONDUCTING CLASSES, COURSES, LECTURES, PRESENTATIONS, TUTORIALS, WORKSHOPS, CONFERENCES, SEMINARS, CORRESPONDENCE COURSE SERVICES AND INTERACTIVE ONLINE EDUCATIONAL SERVICES, IN THE FIELDS OF PERSONAL, SPIRITUAL AND INDIVIDUAL GROWTH, SPIRITUAL COUNSELING, THE DEVELOPMENT OF HUMAN POTENTIAL, SELF ACTUALIZATION, PERSONAL DECISION-MAKING, PERSONAL AWARENESS, SELF-IMPROVEMENT, PSYCHOLOGICAL DEVELOPMENT AND HEALTH, COMPARATIVE RELIGIOUS AND PSYCHOLOGICAL STUDIES AND THE STUDY OF CONSCIOUSNESS, METAPHYSICS, SELF-AWARENESS PSYCHO SPIRITUAL PROCESSES THAT FACILITATE A SHIFT IN HUMAN CONSCIOUSNESS, ENLIGHTENMENT AND PERSONAL TRANSFORMATION, OVERCOMING OBSTACLES, ACHIEVING PHYSICAL AND PSYCHOLOGICAL HEALTH, WELL-BEING, PEACE, HAPPINESS, WISDOM AND UNDERSTANDING, AND DISTRIBUTING COURSE MATERIALS IN CONNECTION THEREWITH (U.S. CLS. 100, 101 AND 107).

FIRST USE 2-9-1999; IN COMMERCE 4-17-2004.
HOWARD SMIGA, EXAMINING ATTORNEY

SN 78-465,107. OTSEGO SKI CLUB - HIDDEN VALLEY, INC., GAYLORD, MI. FILED 8-10-2004.

OTSEGO CLUB

THE MARK CONSISTS OF STANDARD CHARACTERS WITHOUT CLAIM TO ANY PARTICULAR FONT, STYLE, SIZE, OR COLOR.

NO CLAIM IS MADE TO THE EXCLUSIVE RIGHT TO USE "CLUB", APART FROM THE MARK AS SHOWN.

SEC. 2(F).
FOR GOLF AND SKI RESORT (U.S. CLS. 100, 101 AND 107).

FIRST USE 0-0-1941; IN COMMERCE 0-0-1941.
MELVIN AXILBUND, EXAMINING ATTORNEY

CLASS 41—(Continued).

SN 78-467,784. FREELANCE PLAYERS, INC., JAMAICA PLAIN, MA. FILED 8-16-2004.



NO CLAIM IS MADE TO THE EXCLUSIVE RIGHT TO USE "IMPROV", APART FROM THE MARK AS SHOWN.

THE MARK CONSISTS OF A LOGO.
FOR EDUCATIONAL SERVICES FOR CHILDREN, IN THE NATURE OF STRUCTURED THEATER IMPROVISATION TO TEACH DECISION MAKING, IMPULSE CONTROL, VIOLENCE PREVENTION, AND VALUES CLARIFICATION (U.S. CLS. 100, 101 AND 107).

FIRST USE 12-31-1993; IN COMMERCE 12-31-1993.
FLORENTINA BLANDU, EXAMINING ATTORNEY

SN 78-468,066. BAY HARBOR COMPANY, L.L.C., BAY HARBOR, MI. FILED 8-16-2004.



NO CLAIM IS MADE TO THE EXCLUSIVE RIGHT TO USE "SWIM & FITNESS CLUB", APART FROM THE MARK AS SHOWN.

THE MARK CONSISTS OF THE LITERAL ELEMENTS OF THE MARK ABOVE A WAVE DESIGN.

SEC. 2(F) BAY HARBOR.
FOR PROVIDING FITNESS AND EXERCISE FACILITIES: PHYSICAL FITNESS INSTRUCTION; PHYSICAL FITNESS CONSULTATION; SWIMMING INSTRUCTION; PROVIDING SWIMMING FACILITIES; PROVIDING RECREATIONAL FACILITIES (U.S. CLS. 100, 101 AND 107).

FIRST USE 6-5-2003; IN COMMERCE 6-5-2003.
REBECCA GAN, EXAMINING ATTORNEY

CLASS 41—(Continued).

SN 78-470,495. ALLIED WASTE NORTH AMERICA, INC., SCOTTSDALE, AZ. FILED 8-19-2004.

GARBAGE GUS

THE MARK CONSISTS OF STANDARD CHARACTERS WITHOUT CLAIM TO ANY PARTICULAR FONT, STYLE, SIZE, OR COLOR.

FOR EDUCATIONAL SERVICES, NAMELY, CONDUCTING EDUCATIONAL SAFETY PROGRAMS FOR SCHOOL-AGE CHILDREN (U.S. CLS. 100, 101 AND 107).

FIRST USE 4-0-2004; IN COMMERCE 4-0-2004.
STEVEN JACKSON, EXAMINING ATTORNEY

CLASS 41—(Continued).

SN 78-473,075. WELCH ALLYN, INC., SKANEATELES FALLS, NY. FILED 8-25-2004.



NO CLAIM IS MADE TO THE EXCLUSIVE RIGHT TO USE "THE LODGE", APART FROM THE MARK AS SHOWN.

FOR INTERNATIONAL CENTER FOR TRAINING IN THE FIELD OF MEDICAL PRODUCTION INFORMATION AND SELLING TECHNIQUES (U.S. CLS. 100, 101 AND 107).

FIRST USE 7-29-1999; IN COMMERCE 7-29-1999.
TONI HICKEY, EXAMINING ATTORNEY

SN 78-471,681. EDNA DOANE, WEST ENFIELD, ME. FILED 8-23-2004.

Violette Raye Vibrations

THE MARK CONSISTS OF STANDARD CHARACTERS WITHOUT CLAIM TO ANY PARTICULAR FONT, STYLE, SIZE, OR COLOR.

NO CLAIM IS MADE TO THE EXCLUSIVE RIGHT TO USE "VIBRATIONS", APART FROM THE MARK AS SHOWN.

FOR EDUCATIONAL SERVICES, NAMELY, CONDUCTING CLASSES, WORKSHOPS, AND COURSES OF INSTRUCTION IN THE FIELD OF VIBRATIONAL THERAPY INVOLVING THE USE OF TUNING FORKS TO APPLY THERAPEUTIC VIBRATIONS TO PATIENTS' BODIES (U.S. CLS. 100, 101 AND 107).

FIRST USE 7-19-2003; IN COMMERCE 5-21-2004.
STEVEN JACKSON, EXAMINING ATTORNEY

SN 78-473,582. HOLYFIELD, EVANDER, FAIRBURN, GA. FILED 8-25-2004.

4Shades

THE MARK CONSISTS OF STANDARD CHARACTERS WITHOUT CLAIM TO ANY PARTICULAR FONT, STYLE, SIZE, OR COLOR.

FOR ENTERTAINMENT, NAMELY LIVE PERFORMANCES BY A MUSICAL BAND (U.S. CLS. 100, 101 AND 107).

FIRST USE 0-0-2001; IN COMMERCE 0-0-2001.
MICHAEL TANNER, EXAMINING ATTORNEY

CLASS 41—(Continued).

SN 78-474,932. UNIVERSAL AUTOGRAPH COLLECTORS CLUB, MOUNT DORA, FL. FILED 8-27-2004.



NO CLAIM IS MADE TO THE EXCLUSIVE RIGHT TO USE AUTOGRAPH COLLECTORS CLUB, APART FROM THE MARK AS SHOWN.

THE MARK CONSISTS OF STYLIZED LETTERS "UACC" ON TOP AND WORDS "UNIVERSAL AUTOGRAPH COLLECTORS CLUB" ON BOTTOM.

FOR CONDUCTING LECTURES, SEMINARS AND CONFERENCES IN THE AREA OF AUTOGRAPHS, MANUSCRIPTS, DOCUMENTS AND LETTERS; PUBLISHING SERVICES, NAMELY, PUBLICATION OF BOOKS AND JOURNALS IN THE AREA OF AUTOGRAPHS, MANUSCRIPTS, DOCUMENTS AND LETTERS (U.S. CLS. 100, 101 AND 107).

FIRST USE 0-0-1965; IN COMMERCE 0-0-1965.

ESTHER BELENKER, EXAMINING ATTORNEY

SN 78-476,696. DIRECTECH, INC., PHOENIX, AZ. FILED 8-31-2004.

SPRINGTHOMAS

THE MARK CONSISTS OF STANDARD CHARACTERS WITHOUT CLAIM TO ANY PARTICULAR FONT, STYLE, SIZE, OR COLOR.

THE NAME(S), PORTRAIT(S), AND/OR SIGNATURE(S) SHOWN IN THE MARK DOES NOT IDENTIFY A PARTICULAR LIVING INDIVIDUAL.

FOR PROVIDING INFORMATION IN THE FIELD OF ADULT ENTERTAINMENT VIA A GLOBAL COMPUTER NETWORK (U.S. CLS. 100, 101 AND 107).

FIRST USE 1-31-2003; IN COMMERCE 1-31-2003.

JOHN DWYER, EXAMINING ATTORNEY

SN 78-477,151. DIXIE STAMPEDE, LLC, PIGEON FORGE, TN. FILED 9-1-2004.

ORLANDO'S #1 CHOICE FOR THE HOLIDAYS!

THE MARK CONSISTS OF STANDARD CHARACTERS WITHOUT CLAIM TO ANY PARTICULAR FONT, STYLE, SIZE, OR COLOR.

FOR ENTERTAINMENT SERVICES IN THE NATURE OF PLAYS, SHOWS, AND PAGEANTS, PROMINENTLY FEATURING HORSE RIDING AND PERIOD COSTUMES RELATING TO HISTORICAL EVENTS (U.S. CLS. 100, 101 AND 107).

FIRST USE 10-15-2004; IN COMMERCE 10-15-2004.

STACY WAHLBERG, EXAMINING ATTORNEY

CLASS 41—(Continued).

SN 78-477,193. LESNICK, STEVEN, FORT LAUDERDALE, FL. FILED 9-1-2004.

Seductions Miami's Gentlemen's Club

THE MARK CONSISTS OF STANDARD CHARACTERS WITHOUT CLAIM TO ANY PARTICULAR FONT, STYLE, SIZE, OR COLOR.

NO CLAIM IS MADE TO THE EXCLUSIVE RIGHT TO USE "MIAMI'S GENTLEMEN'S CLUB", APART FROM THE MARK AS SHOWN.

FOR NIGHTCLUB SERVICES (U.S. CLS. 100, 101 AND 107).

WILLIAM BRECKENFELD, EXAMINING ATTORNEY

SN 78-478,187. KB NETWORKS, INC., PLANO, TX. FILED 9-2-2004.

[H]

THE MARK CONSISTS OF STANDARD CHARACTERS WITHOUT CLAIM TO ANY PARTICULAR FONT, STYLE, SIZE, OR COLOR.

FOR PROVIDING AN ON-LINE MAGAZINE IN THE FIELD OF HARDWARE FOR THE COMPUTER GAMING INDUSTRY (U.S. CLS. 100, 101 AND 107).

FIRST USE 4-0-1998; IN COMMERCE 4-0-1998.

TRACY CROSS, EXAMINING ATTORNEY

CLASS 41—(Continued).

SN 78-480,706. NEW BEGINNINGS PROJECT, ALEXANDRIA, VA. FILED 9-9-2004.

New Beginnings
Wilson Smith Life
Profile

THE MARK CONSISTS OF STANDARD CHARACTERS WITHOUT CLAIM TO ANY PARTICULAR FONT, STYLE, SIZE, OR COLOR.

NO CLAIM IS MADE TO THE EXCLUSIVE RIGHT TO USE "LIFE PROFILE", APART FROM THE MARK AS SHOWN.

FOR CAREER COUNSELING, NAMELY, USE OF AN ASSESSMENT INSTRUMENT TO BE USED BY INDIVIDUALS TO ASSIST IN THEIR PLANNING FOR POST RETIREMENT OR OTHER LATE CAREER TRANSITIONS (U.S. CLS. 100, 101 AND 107).

ANNE E. GUSTASON, EXAMINING ATTORNEY

SN 78-481,432. STALZER, SEAN, FREDERICKSBURG, VA. FILED 9-10-2004.

The Syndicate

THE MARK CONSISTS OF STANDARD CHARACTERS WITHOUT CLAIM TO ANY PARTICULAR FONT, STYLE, SIZE, OR COLOR.

FOR ENTERTAINMENT SERVICES, NAMELY, AN ONLINE GAMING GUILD PROVIDING IN GAME OPPORTUNITIES FOR PROLIFERATING GAME EXPERTISE AND CAMARADERIE AMONG GAMERS SUPPORTED BY A WEB SITE FEATURING MULTIMEDIA MATERIALS (U.S. CLS. 100, 101 AND 107).

FIRST USE 2-15-1996; IN COMMERCE 5-15-1996.
CHARLES JOYNER, EXAMINING ATTORNEY

CLASS 41—(Continued).

SN 78-481,877. AMERICA'S DRIVE-IN CORP., WICHITA, KS. FILED 9-10-2004.



OWNER OF U.S. REG. NOS. 776,766, 2,777,963 AND OTHERS.

THE MARK CONSISTS OF TWO SMALL ROUNDED STYLIZED TRIANGLES, A BIG ROUNDED STYLIZED TRIANGLE CONTAINING THE WORD SONIC WITH A DROP SHADOW, ABOVE A STYLIZED CAR AND THE WORD CRUISERS OUTLINED AND IN STYLIZED LETTERS.

FOR FAN CLUB (U.S. CLS. 100, 101 AND 107).
FIRST USE 6-1-2004; IN COMMERCE 6-1-2004.
JIM RINGLE, EXAMINING ATTORNEY

SN 78-482,825. CAREER RESEARCH ASSOCIATES, INC., HOUSTON, TX. FILED 9-13-2004.

"THE PARALEGAL PEOPLE"

THE MARK CONSISTS OF STANDARD CHARACTERS WITHOUT CLAIM TO ANY PARTICULAR FONT, STYLE, SIZE, OR COLOR.

FOR EDUCATIONAL SERVICES, NAMELY CONDUCTING CLASSES, SEMINARS, CONFERENCES, WORKSHOPS AND CONTINUING EDUCATION CLASSES IN THE FIELD OF PARALEGAL EDUCATION (U.S. CLS. 100, 101 AND 107).

FIRST USE 1-0-1987; IN COMMERCE 1-0-1987.
DAWN HAN, EXAMINING ATTORNEY

CLASS 41—(Continued).

SN 78-483,048. KIM, IN MOOK, SAN ANTONIO, TX. FILED 9-14-2004.

**KIM'S ACADEMY OF
TAE KWON DO**

THE MARK CONSISTS OF STANDARD CHARACTERS WITHOUT CLAIM TO ANY PARTICULAR FONT, STYLE, SIZE, OR COLOR.

NO CLAIM IS MADE TO THE EXCLUSIVE RIGHT TO USE "ACADEMY OF TAE KWON DO", APART FROM THE MARK AS SHOWN.

FOR INSTRUCTION AND TRAINING IN THE MARTIAL ARTS INCLUDING THE INSTRUCTION OF TAE KWON-DO AND INSTRUCTION IN THE TOURNAMENT RULES AND PROCEDURES FOR, AND CONDUCT OF, THE SPORT OF TAE KWON-DO (U.S. CLS. 100, 101 AND 107).

FIRST USE 9-15-1970; IN COMMERCE 5-12-1971.
CHRISTOPHER ADKINS, EXAMINING ATTORNEY



SN 78-483,272. 20 MINUTES TO FITNESS, L.L.C., CLAYTON, MO. FILED 9-14-2004.

**20 MINUTES TO
FITNESS**

THE MARK CONSISTS OF STANDARD CHARACTERS WITHOUT CLAIM TO ANY PARTICULAR FONT, STYLE, SIZE, OR COLOR.

OWNER OF U.S. REG. NO. 2,879,735.

FOR HEALTH CLUB SERVICES, NAMELY PROVIDING INSTRUCTION AND EQUIPMENT IN THE FIELD OF PHYSICAL EXERCISE FOR THE PURPOSE OF WEIGHT REDUCTION (U.S. CLS. 100, 101 AND 107).

FIRST USE 8-31-2002; IN COMMERCE 2-3-2003.
ELLEN BURNS, EXAMINING ATTORNEY

CLASS 41—(Continued).

SN 78-483,614. GREEN WISDOM, INC., TUJUNGA, CA. FILED 9-14-2004.

Green Wisdom

THE MARK CONSISTS OF STANDARD CHARACTERS WITHOUT CLAIM TO ANY PARTICULAR FONT, STYLE, SIZE, OR COLOR.

FOR EDUCATION SERVICES, NAMELY, PROVIDING COURSES OF INSTRUCTION IN THE FIELDS OF PUBLIC RELATIONS AND ENVIRONMENTAL AWARENESS (U.S. CLS. 100, 101 AND 107).

TEJBIR SINGH, EXAMINING ATTORNEY



SN 78-484,574. THE CHURCH NEXT DOOR, COLUMBUS, OH. FILED 9-16-2004.

**The Church
Next Door** 
Moving People Closer to God

NO CLAIM IS MADE TO THE EXCLUSIVE RIGHT TO USE "CHURCH", APART FROM THE MARK AS SHOWN. FOR RELIGIOUS INSTRUCTION SERVICES (U.S. CLS. 100, 101 AND 107).

FIRST USE 8-1-2004; IN COMMERCE 8-12-2004.
CHARLES L. JENKINS, EXAMINING ATTORNEY



SN 78-484,717. SKEZAS, AMY, PETALUMA, CA. FILED 9-16-2004.

**Flow Alignment and
Connection**

THE MARK CONSISTS OF STANDARD CHARACTERS WITHOUT CLAIM TO ANY PARTICULAR FONT, STYLE, SIZE, OR COLOR.

FOR EDUCATIONAL SERVICES, NAMELY, CONDUCTING SEMINARS IN THE FIELDS OF SELF-IMPROVEMENT, METAPHYSICS, AND HOW TO BE OF SERVICE TO OTHERS (U.S. CLS. 100, 101 AND 107).

FIRST USE 2-2-1991; IN COMMERCE 2-2-1991.
EDWARD NELSON, EXAMINING ATTORNEY

CLASS 41—(Continued).

SN 78-484,762. MOSELEY, INC., MANASSAS, VA. FILED 9-16-2004.



THE COLOR(S) GREEN AND BLACK IS/ARE CLAIMED AS A FEATURE OF THE MARK.

THE MARK CONSISTS OF A GREEN OAK TREE ASSOCIATED WITH AND NEXT TO THE WORDS "MOSELEY SUCCESS THROUGH LEARNING". A GREEN LINE SEPARATES "MOSELEY" AND "SUCCESS THROUGH LEARNING".

FOR PROFESSIONAL EDUCATION SERVICES, NAMELY CONDUCTING COURSES IN THE FIELDS OF REAL ESTATE, REAL ESTATE APPRAISAL, AND LAW (U.S. CLS. 100, 101 AND 107).

FIRST USE 4-1-1998; IN COMMERCE 4-1-1998.
JOHN E. MICHOŠ, EXAMINING ATTORNEY

CLASS 41—(Continued).

SN 78-485,782. SHADOW SCREEN PRODUCTIONS, LLC, NOVATO, CA. FILED 9-17-2004.

SHADOW SCREEN
PRODUCTIONS

THE MARK CONSISTS OF STANDARD CHARACTERS WITHOUT CLAIM TO ANY PARTICULAR FONT, STYLE, SIZE, OR COLOR.

NO CLAIM IS MADE TO THE EXCLUSIVE RIGHT TO USE "PRODUCTIONS", APART FROM THE MARK AS SHOWN.

FOR ENTERTAINMENT SERVICES, NAMELY FILM, MOTION PICTURE, TELEVISION, VIDEO, AND AUDIO-TAPE PRODUCTION SERVICES (U.S. CLS. 100, 101 AND 107).

FIRST USE 8-24-2004; IN COMMERCE 8-24-2004.
KIMBERLY FRYE, EXAMINING ATTORNEY

SN 78-485,044. BECOMEX, PORTLAND, OR. FILED 9-16-2004.

BECOME X

THE MARK CONSISTS OF STANDARD CHARACTERS WITHOUT CLAIM TO ANY PARTICULAR FONT, STYLE, SIZE, OR COLOR.

FOR EDUCATIONAL SERVICES, NAMELY, CONDUCTING CLASSES, SEMINARS, CONFERENCES AND WORKSHOPS IN THE FIELD OF LIFE SKILLS, PERSONAL DEVELOPMENT, SELF-AWARENESS, SELF-ESTEEM, LEADERSHIP SKILLS AND CAREER DEVELOPMENT FOR GIRLS AND YOUNG WOMEN (U.S. CLS. 100, 101 AND 107).

FIRST USE 1-0-2004; IN COMMERCE 3-0-2004.
WON TEAK OH, EXAMINING ATTORNEY

SN 78-486,015. MOVE YOUR MIND, LTD., UPPER ARLINGTON, OH. FILED 9-20-2004.

Move Your Mind

THE MARK CONSISTS OF STANDARD CHARACTERS WITHOUT CLAIM TO ANY PARTICULAR FONT, STYLE, SIZE, OR COLOR.

FOR PROVIDING FITNESS AND EXERCISE FACILITIES, NAMELY A HEALTH AND FITNESS STUDIO PROVIDING USE OF EXERCISE AND WORKOUT EQUIPMENT AND PROVIDING EDUCATIONAL SERVICES, NAMELY, CONDUCTING INDIVIDUAL AND GROUP CLASSES, SEMINARS AND WORKSHOPS IN THE FIELD OF PHYSICAL FITNESS AND TRAINING IN THE USE OF PHYSICAL FITNESS MACHINES (U.S. CLS. 100, 101 AND 107).

FIRST USE 9-6-2002; IN COMMERCE 9-30-2002.
DANIEL BRODY, EXAMINING ATTORNEY

CLASS 41—(Continued).

SN 78-486,438. ZUMAYA, ROBERTO RAUL, GUADALAJARA, MEXICO, FILED 9-20-2004.

banda astilleros

THE MARK CONSISTS OF STANDARD CHARACTERS WITHOUT CLAIM TO ANY PARTICULAR FONT, STYLE, SIZE, OR COLOR.

NO CLAIM IS MADE TO THE EXCLUSIVE RIGHT TO USE "BANDA", APART FROM THE MARK AS SHOWN.

THE FOREIGN WORDING IN THE MARK TRANSLATES INTO ENGLISH AS SHIPYARD BAND.

FOR ENTERTAINMENT SERVICES, NAMELY LIVE PERFORMANCES BY A MUSICAL BAND (U.S. CLS. 100, 101 AND 107).

BILL DAWE, EXAMINING ATTORNEY

CLASS 41—(Continued).

SN 78-487,547. MAZUR, BRANDON W, PARLIN, NJ. FILED 9-22-2004.

paris gun

THE MARK CONSISTS OF STANDARD CHARACTERS WITHOUT CLAIM TO ANY PARTICULAR FONT, STYLE, SIZE, OR COLOR.

FOR ENTERTAINMENT SERVICES, NAMELY, LIVE PERFORMANCES BY A MUSICAL BAND (U.S. CLS. 100, 101 AND 107).

FIRST USE 7-4-2003; IN COMMERCE 7-4-2003.

RAMONA ORTIGA, EXAMINING ATTORNEY

SN 78-488,054. YWCA OF GREATER PORTLAND, PORTLAND, OR. FILED 9-22-2004.

CAMP WESTWIND

SN 78-486,680. PARK, CHAN KYUNG, SILVER SPRING, MD. FILED 9-20-2004.



NO CLAIM IS MADE TO THE EXCLUSIVE RIGHT TO USE TANGO ZEN, APART FROM THE MARK AS SHOWN.

FOR EDUCATIONAL SERVICES, NAMELY, CONDUCTING CLASSES, WORKSHOPS, AND SEMINARS PROVIDING TRAINING IN A SYSTEM OF BODY, MIND AND SPIRIT EXERCISES INVOLVING TANGO MUSIC, TANGO DANCE MOVEMENTS, ZEN, WALKING AND MEDITATION (U.S. CLS. 100, 101 AND 107).

FIRST USE 7-1-2004; IN COMMERCE 8-1-2004.
SHAUNIA WALLACE, EXAMINING ATTORNEY

THE MARK CONSISTS OF STANDARD CHARACTERS WITHOUT CLAIM TO ANY PARTICULAR FONT, STYLE, SIZE, OR COLOR.

NO CLAIM IS MADE TO THE EXCLUSIVE RIGHT TO USE "CAMP", APART FROM THE MARK AS SHOWN.

FOR EDUCATIONAL SERVICES, NAMELY ORGANIZING AND PROVIDING CAMP PROGRAMS AND ACTIVITIES IN THE NATURE OF SCIENCE CAMP, MOTHER-CHILD CAMP, MARINE DISCOVERY CAMP, RANCH CAMP, AND YOUTH CAMP, ON A DAY AND RESIDENT BASIS; RECREATIONAL SERVICES, NAMELY, ORGANIZING AND PROVIDING CAMP PROGRAMS AND ACTIVITIES IN THE NATURE OF HORSEBACK RIDING, KAYAKING, ART, MUSIC PERFORMANCE, HIKING, AND BEACHCOMBING; TRAINING SERVICES, NAMELY, CONDUCTING PROGRAMS, CLASSES, WORKSHOPS, RETREATS, MEETINGS AND SEMINARS IN THE FIELD OF CHARACTER AND SOCIAL DEVELOPMENT, SPORTS AND OUTDOOR ACTIVITY SKILLS IN THE FIELDS OF ECOLOGICAL SCIENCE AND NATURE CONSERVATION, AND LEADERSHIP SKILLS, NAMELY, YOUTH LEADERSHIP DEVELOPMENT IN THE VALUE OF DIVERSITY AND THE ELIMINATION OF RACISM (U.S. CLS. 100, 101 AND 107).

FIRST USE 6-28-1948; IN COMMERCE 6-28-1948.
SUSAN STIGLITZ, EXAMINING ATTORNEY

CLASS 41—(Continued).

SN 78-488,456. CAPE COD SEA CAMPS, INC., BREWSTER, MA. FILED 9-23-2004.

CAPE COD SEA CAMPS

THE MARK CONSISTS OF STANDARD CHARACTERS WITHOUT CLAIM TO ANY PARTICULAR FONT, STYLE, SIZE, OR COLOR.

NO CLAIM IS MADE TO THE EXCLUSIVE RIGHT TO USE "CAMP", APART FROM THE MARK AS SHOWN.

SEC. 2(F).
FOR RECREATIONAL RESIDENT AND DAY CAMPS (U.S. CLS. 100, 101 AND 107).

FIRST USE 12-0-1922; IN COMMERCE 12-0-1922.
JOANNA DUKOVIC, EXAMINING ATTORNEY

CLASS 41—(Continued).

SN 78-489,156. GREATER TEXAS COMMUNITY PARTNERS, DALLAS, TX. FILED 9-24-2004.



THE MARK CONSISTS OF A HAT WITH CUT-OUTS ON THE BRIM.

FOR CHARITABLE SERVICES, NAMELY, PROVIDING TRAINING IN THE FIELD OF NON-PROFIT AND VOLUNTEER ORGANIZATIONS AND IN THE FIELD OF BENEFITTING ABUSED AND NEGLECTED CHILDREN; EDUCATIONAL SERVICES, NAMELY, ARRANGING AND CONDUCTING CONFERENCES, WORKSHOPS AND SEMINARS IN THE FIELD OF NON-PROFIT AND VOLUNTEER ORGANIZATIONS, AND IN THE FIELDS OF BENEFITTING ABUSED AND NEGLECTED CHILDREN AND RAISING AWARENESS OF THE PLIGHT OF ABUSED AND NEGLECTED CHILDREN (U.S. CLS. 100, 101 AND 107).

FIRST USE 10-8-2003; IN COMMERCE 10-8-2003.
MICHAEL ENGEL, EXAMINING ATTORNEY

SN 78-488,566. PARAMOUNT PICTURES CORPORATION, HOLLYWOOD, CA. FILED 9-23-2004.

THE PAT DOWN

THE MARK CONSISTS OF STANDARD CHARACTERS WITHOUT CLAIM TO ANY PARTICULAR FONT, STYLE, SIZE, OR COLOR.

FOR ENTERTAINMENT, NAMELY, A CONTINUING NEWS SHOW BROADCAST OVER TELEVISION (U.S. CLS. 100, 101 AND 107).

NAAKWAMA ANKRAH, EXAMINING ATTORNEY

SN 78-489,334. DNC PARKS & RESORTS AT KSC, INC., BUFFALO, NY. FILED 9-24-2004.



NO CLAIM IS MADE TO THE EXCLUSIVE RIGHT TO USE "CAMP", APART FROM THE MARK AS SHOWN.

THE MARK CONSISTS OF THE LITERAL ELEMENT CAMP KSC IN STYLIZED FORM WHEREIN THE LETTER K IS REPRESENTS A HUMAN FIGURE REACHING FOR A STAR AND THE FINAL LETTER C REPRESENTS THE PLUME OF A SPACE VEHICLE.

FOR ASTRONAUT AND SPACE-THEMED CAMPS; GUIDED TOURS OF A SPACE CENTER (U.S. CLS. 100, 101 AND 107).

FIRST USE 6-20-2001; IN COMMERCE 6-20-2001.
NELSON SNYDER, EXAMINING ATTORNEY

CLASS 41—(Continued).

SN 78-489,453. STEINFELD, ADAM, PLANTATION, FL. FILED 9-24-2004.



OWNER OF U.S. REG. NO. 2,603,159.
NO CLAIM IS MADE TO THE EXCLUSIVE RIGHT TO USE "MAGIC", APART FROM THE MARK AS SHOWN.
SEC. 2(F).

FOR ENTERTAINMENT EXHIBITIONS IN THE NATURE OF MAGIC SHOWS, GRAND ILLUSION, STREET PERFORMANCES, AND CLOSE UP MAGIC DEMONSTRATIONS; ENTERTAINMENT SERVICES, NAMELY, PROVIDING PERSONAL APPEARANCES OF MAGICIANS, BOTH LIVE AND PRERECORDED MAGIC SHOWS AND MAGIC SHOWS DISTRIBUTED OVER TELEVISION, SATELLITE, AUDIO AND VIDEO MEDIAS (U.S. CLS. 100, 101 AND 107).

FIRST USE 9-23-1999; IN COMMERCE 9-23-1999.
ROBERT C. CLARK JR., EXAMINING ATTORNEY

CLASS 41—(Continued).

SN 78-489,791. FINGER, ALAN, NEW YORK, NY. FILED 9-27-2004.

ISHTA YOGA

THE MARK CONSISTS OF STANDARD CHARACTERS WITHOUT CLAIM TO ANY PARTICULAR FONT, STYLE, SIZE, OR COLOR.

NO CLAIM IS MADE TO THE EXCLUSIVE RIGHT TO USE "YOGA", APART FROM THE MARK AS SHOWN.

FOR YOGA INSTRUCTION (U.S. CLS. 100, 101 AND 107).

FIRST USE 12-30-1985; IN COMMERCE 12-30-1985.
KIMBERLY FRYE, EXAMINING ATTORNEY

SN 78-489,655. RACE MAN TELL-A-PICTURES, WASHINGTON, DC. FILED 9-26-2004.



THE MARK CONSISTS OF AN AFRICAN MASK ON A FRAME OF MOTION PICTURE FILM.

FOR MOTION PICTURE FILM PRODUCTION; TELEVISION SHOW PRODUCTION; ENTERTAINMENT NAMELY, PRODUCTION OF MOVIES AND TELEVISION SHOWS; ENTERTAINMENT SERVICES, NAMELY, PROVIDING A WEB SITE FEATURING MUSICAL PERFORMANCES, MUSICAL VIDEOS, RELATED FILM CLIPS, PHOTOGRAPHS AND OTHER MULTIMEDIA MATERIALS (U.S. CLS. 100, 101 AND 107).

FIRST USE 10-1-2000; IN COMMERCE 3-15-2004.
KIMBERLY FRYE, EXAMINING ATTORNEY

SN 78-490,237. MOTHER USA, INC., BOSTON, MA. FILED 9-27-2004.

TUNEFLY

THE MARK CONSISTS OF STANDARD CHARACTERS WITHOUT CLAIM TO ANY PARTICULAR FONT, STYLE, SIZE, OR COLOR.

FOR ENTERTAINMENT SERVICES, NAMELY, PROVIDING USER NOTIFICATIONS AND ACCESS TO INFORMATION UPON REQUEST OF A USER REGARDING SONGS, SONG TITLES, ARTISTS, VIDEOS, VIDEO IMAGES AND PURCHASE OPTIONS RELATED TO THE FORGOING (U.S. CLS. 100, 101 AND 107).

ANNE FARRELL, EXAMINING ATTORNEY

CLASS 41—(Continued).

SN 78-490,365. MILLER, SHARON L., SWANSEA, IL. FILED 9-27-2004.



THE COLOR(S) GREEN, LIGHT GREEN, BROWN, LIGHT BROWN, RED, BLACK AND GRAY IS/ARE CLAIMED AS A FEATURE OF THE MARK.

THE LEAVES OF THE TREE AND GREEN AND LIGHT GREEN, THE TRUNK AND BRANCHES OF THE TREE ARE BROWN AND LIGHT BROWN, THE SIX HEARTS ARE RED OUTLINED IN BLACK, THE LETTERS BWC ARE BLACK, AND THE SHADING ABOVE THE LETTERS BWC AROUND THE TRUNK OF THE TREE IS GRAY.

FOR TRAINING SERVICES IN THE FIELD OF NURSING AND EDUCATIONAL SERVICES, NAMELY, CONDUCTING CLASSES, SEMINARS, CONFERENCES, AND WORKSHOPS IN THE FIELD OF NURSING (U.S. CLS. 100, 101 AND 107).

FIRST USE 9-15-1997; IN COMMERCE 9-15-1997.
MICHELLE DUBOIS, EXAMINING ATTORNEY

SN 78-490,448. INTEGRITY ENTERPRISES, INC., HICKORY, NC. FILED 9-28-2004.

**CONNECTED
COMMUNITY**

THE MARK CONSISTS OF STANDARD CHARACTERS WITHOUT CLAIM TO ANY PARTICULAR FONT, STYLE, SIZE, OR COLOR.

FOR EDUCATIONAL SERVICES, NAMELY, CONDUCTING SEMINARS AND CLASSES IN THE FIELD OF BUSINESS AND THE DISTRIBUTION OF WRITTEN MATERIALS THEREWITH (U.S. CLS. 100, 101 AND 107).

FIRST USE 0-0-1997; IN COMMERCE 0-0-1997.
SKYE YOUNG, EXAMINING ATTORNEY

CLASS 41—(Continued).

SN 78-490,635. GRANT, MELISSA ANTOINETTE, NEW YORK, NY. FILED 9-28-2004.

MELSOULTREE

THE MARK CONSISTS OF STANDARD CHARACTERS WITHOUT CLAIM TO ANY PARTICULAR FONT, STYLE, SIZE, OR COLOR.

THE MARK, MELSOULTREE, IDENTIFIES THE PROFESSIONAL AND STAGE NAME OF A LIVING INDIVIDUAL, MELISSA ANTOINETTE GRANT, WHOSE CONSENT IS OF RECORD.

FOR ENTERTAINMENT SERVICES IN THE NATURE OF LIVE PERFORMANCES BY A MUSICAL ENTERTAINER (U.S. CLS. 100, 101 AND 107).

FIRST USE 6-5-2003; IN COMMERCE 6-5-2003.
ATTIYA MALIK, EXAMINING ATTORNEY

SN 78-490,826. FRINGE PRODUCERS, LLC, BEVERLY HILLS, CA. FILED 9-28-2004.

FRINGE PRODUCERS

THE MARK CONSISTS OF STANDARD CHARACTERS WITHOUT CLAIM TO ANY PARTICULAR FONT, STYLE, SIZE, OR COLOR.

NO CLAIM IS MADE TO THE EXCLUSIVE RIGHT TO USE "PRODUCERS", APART FROM THE MARK AS SHOWN.

FOR ENTERTAINMENT SERVICES, NAMELY, PRODUCTION AND DISTRIBUTION OF MOTION PICTURES, FILMS, TELEVISION PROGRAMS, AND MUSIC PRODUCTION SERVICES (U.S. CLS. 100, 101 AND 107).

MARK SPARACINO, EXAMINING ATTORNEY

CLASS 41—(Continued).

SN 78-491,172. MID-ATLANTIC FLY-IN & SPORT AVIATION CONVENTION, THE, LUMBERTON, NC. FILED 9-29-2004.



NO CLAIM IS MADE TO THE EXCLUSIVE RIGHT TO USE "MID-ATLANTIC FLY-IN & SPORT AVIATION CONVENTION", APART FROM THE MARK AS SHOWN.

THE MARK CONSISTS OF THE WORDS OF THE MARK APPEAR ABOVE AND BELOW A ROUNDED RECTANGLE INCLUDING A FANCIFUL REPRESENTATION OF THREE AIRPLANES, THE SUN, A MONUMENT, AND A BEACH LANDSCAPE.

FOR EDUCATIONAL AND ENTERTAINMENT SERVICES, NAMELY, CONDUCTING AN AIR SHOW AND CONDUCTING SEMINARS AND WORKSHOPS IN THE FIELDS OF AIR SAFETY AND EDUCATION (U.S. CLS. 100, 101 AND 107).

FIRST USE 3-15-2004; IN COMMERCE 3-23-2004.
ERNEST SHOSHO, EXAMINING ATTORNEY

CLASS 41—(Continued).

SN 78-492,347. SAVE THE RIVER, INC., CLAYTON, NY. FILED 9-30-2004.



Save The River

SEC. 2(F) AS TO "SAVE THE RIVER".
FOR EDUCATIONAL SERVICES, NAMELY, CONDUCTING WORKSHOPS, SEMINARS, AND CLASSES IN THE FIELD OF WATER AND OTHER ENVIRONMENTAL QUALITY OF THE ST; LAWRENCE RIVER AND DISTRIBUTING LITERATURE IN CONJUNCTION THEREWITH; PUBLISHING AND DISTRIBUTION OF PAMPHLETS AND OTHER PRINTED MATTER IN THE FIELD OF WATER AND OTHER ENVIRONMENTAL QUALITY OF THE ST; LAWRENCE RIVER (U.S. CLS. 100, 101 AND 107).

FIRST USE 12-31-1978; IN COMMERCE 12-31-1978.
RONALD MCMORROW, EXAMINING ATTORNEY

SN 78-491,612. PENSACOLA CHRISTIAN COLLEGE, PENSACOLA, FL. FILED 9-29-2004.

CAMP O' THE PINES

THE MARK CONSISTS OF STANDARD CHARACTERS WITHOUT CLAIM TO ANY PARTICULAR FONT, STYLE, SIZE, OR COLOR.

NO CLAIM IS MADE TO THE EXCLUSIVE RIGHT TO USE "CAMP", APART FROM THE MARK AS SHOWN.

FOR YEAR-ROUND RECREATIONAL CAMPS; EDUCATIONAL SERVICES, NAMELY CONDUCTING PROGRAMS IN THE FIELD OF YEAR-ROUND CAMPING (U.S. CLS. 100, 101 AND 107).

FIRST USE 6-2-1958; IN COMMERCE 6-2-1958.
ALLISON HOLTZ, EXAMINING ATTORNEY

SN 78-492,973. OS GOLF CLUB LLC, PLYMOUTH, MA. FILED 10-1-2004.

OLD SANDWICH GOLF CLUB

THE MARK CONSISTS OF STANDARD CHARACTERS WITHOUT CLAIM TO ANY PARTICULAR FONT, STYLE, SIZE, OR COLOR.

NO CLAIM IS MADE TO THE EXCLUSIVE RIGHT TO USE "GOLF CLUB", APART FROM THE MARK AS SHOWN.

FOR GOLF CLUB SERVICES AND GOLF MEMBERSHIP SERVICES (U.S. CLS. 100, 101 AND 107).

FIRST USE 8-1-2003; IN COMMERCE 8-25-2004.
PAULA MAHONEY, EXAMINING ATTORNEY

CLASS 41—(Continued).

SN 78-493,046. COLBY, LOUISE B., BRISTOL, IN. FILED 10-1-2004.

YOUR DRIVING
HISTORY IS YOUR
FUTURE!

THE MARK CONSISTS OF STANDARD CHARACTERS WITHOUT CLAIM TO ANY PARTICULAR FONT, STYLE, SIZE, OR COLOR.

FOR EDUCATIONAL SERVICES, NAMELY, CONDUCTING SEMINARS, WORKSHOPS, TALKS AND MEETINGS FOR INDIVIDUALS IN THE TRUCKING INDUSTRY REGARDING DRIVING SAFELY, DRIVER ACCOUNTABILITY AND PRACTICES THAT PROMOTE RETENTION OF CDL LICENSES (U.S. CLS. 100, 101 AND 107).

FIRST USE 2-28-2004; IN COMMERCE 2-28-2004.
MELVIN AXILBUND, EXAMINING ATTORNEY

SN 78-493,133. KIRBY, SHAWN, PHILADELPHIA, PA. FILED 10-1-2004.

ΩKΨ
Omega Kappa Psi
RECORDING

NO CLAIM IS MADE TO THE EXCLUSIVE RIGHT TO USE RECORDING, APART FROM THE MARK AS SHOWN.

THE COLOR(S) RED AND BLACK IS/ARE CLAIMED AS A FEATURE OF THE MARK.

THE MARK CONSISTS OF GREEK LETTERS—"OMEGA" "KAPPA" AND "PSI" WITH ENGLISH SPELLINGS AND THE WORD "RECORDING". ALL LETTER AND CHARACTERS FILLED IN RED WITH BLACK SHADOWING.

FOR MUSICAL PRODUCTION AND RECORDING SERVICES (U.S. CLS. 100, 101 AND 107).

TRICIA SONNEBORN, EXAMINING ATTORNEY

CLASS 41—(Continued).

SN 78-493,204. CHRISTOPHER B. PICKETT, WEYMOUTH, MA. FILED 10-1-2004.



NO CLAIM IS MADE TO THE EXCLUSIVE RIGHT TO USE "DISC JOCKEY SERVICE", APART FROM THE MARK AS SHOWN.

THE COLOR(S) DARK BLUE AND WHITE IS/ARE CLAIMED AS A FEATURE OF THE MARK.

THE COLOR DARK BLUE APPEARS IN THE BACKGROUND OF THE UPPER RECTANGLE, IN THE OUTLINE OF THE G CLEF, AND IN THE WORDS DISC JOCKEY SERVICE. THE COLOR WHITE APPEARS IN THE BACKGROUND OF THE G CLEF, IN THE WORDS CHRIS PICKETT, AND IN THE BACKGROUND OF THE SMALL, LOWER RECTANGLE.

THE MARK CONSISTS, IN PART, OF A STYLIZED G CLEF

FOR DISC-JOCKEY SERVICES FOR ENTERTAINMENT PURPOSES (U.S. CLS. 100, 101 AND 107).

ESTHER BELENKER, EXAMINING ATTORNEY

SN 78-493,288. OUTDOOR LIFE NETWORK, L.L.C., STAMFORD, CT. FILED 10-1-2004.

EFORCE

THE MARK CONSISTS OF STANDARD CHARACTERS WITHOUT CLAIM TO ANY PARTICULAR FONT, STYLE, SIZE, OR COLOR.

FOR ENTERTAINMENT SERVICES IN THE NATURE OF TELEVISION PRODUCTION; DISTRIBUTION OF TELEVISION PROGRAMMING TO CABLE TELEVISION SYSTEMS; ENTERTAINMENT IN THE NATURE OF ONGOING TELEVISION PROGRAMS IN THE FIELD OF OUTDOOR ADVENTURES; PROVIDING INFORMATION AND ENTERTAINMENT VIA A GLOBAL COMPUTER NETWORK, NAMELY, SCHEDULES, SYNOPSIS, PHOTOS, VIDEO CLIPS AND INTERVIEWS, ALL RELATING TO APPLICANT'S TELEVISION PROGRAMMING. (U.S. CLS. 100, 101 AND 107).

KAREN BRACEY, EXAMINING ATTORNEY

CLASS 41—(Continued).

SN 78-493,362. TWENTIETH CENTURY FOX FILM CORPORATION, LOS ANGELES, CA. FILED 10-1-2004.

CLASS 41—(Continued).

SN 78-493,682. ANOGIANAKIS, ANTONIOS E./EMMANUEL, SAN FRANCISCO, CA. FILED 10-3-2004.

THE SIMPLE LIFE

OK COACH!

THE MARK CONSISTS OF STANDARD CHARACTERS WITHOUT CLAIM TO ANY PARTICULAR FONT, STYLE, SIZE, OR COLOR.

FOR ENTERTAINMENT SERVICES IN THE NATURE OF A TELEVISION SERIES IN THE REALITY GENRE (U.S. CLS. 100, 101 AND 107).

FIRST USE 12-2-2003; IN COMMERCE 12-2-2003.
MICHAEL TANNER, EXAMINING ATTORNEY

THE MARK CONSISTS OF STANDARD CHARACTERS WITHOUT CLAIM TO ANY PARTICULAR FONT, STYLE, SIZE, OR COLOR.

NO CLAIM IS MADE TO THE EXCLUSIVE RIGHT TO USE "COACH", APART FROM THE MARK AS SHOWN.

FOR EDUCATIONAL SERVICES, NAMELY, PROVIDING INSTRUCTIONS VIA PERSONAL TRAINING, ATHLETIC PREPARATION, SEMINARS, AND WORKSHOPS IN THE FIELD OF WEIGHT TRAINING AND PHYSICAL FITNESS (U.S. CLS. 100, 101 AND 107).

FIRST USE 5-1-1998; IN COMMERCE 1-1-2000.
INGA ERVIN, EXAMINING ATTORNEY

SN 78-493,494. A&E TELEVISION NETWORKS, NEW YORK, NY. FILED 10-1-2004.

SN 78-493,723. COUNTRY MUSIC TELEVISION, NEW YORK, NY. FILED 10-4-2004.

A&E INDIEFILMS

**BEAUTY SHOP
SECRETS**

THE MARK CONSISTS OF STANDARD CHARACTERS WITHOUT CLAIM TO ANY PARTICULAR FONT, STYLE, SIZE, OR COLOR.

OWNER OF U.S. REG. NOS. 1,311,477 AND 1,845,909.
NO CLAIM IS MADE TO THE EXCLUSIVE RIGHT TO USE "INDIEFILMS", APART FROM THE MARK AS SHOWN.

FOR CABLE TELEVISION PROGRAMMING (U.S. CLS. 100, 101 AND 107).
REBECCA SMITH, EXAMINING ATTORNEY

THE MARK CONSISTS OF STANDARD CHARACTERS WITHOUT CLAIM TO ANY PARTICULAR FONT, STYLE, SIZE, OR COLOR.

FOR ENTERTAINMENT SERVICES IN THE NATURE OF AN ON-GOING REALITY-BASED TELEVISION SHOW FEATURING LIVE ACTION, COMEDY AND DRAMA; PROVIDING ONLINE INFORMATION IN THE FIELD OF ENTERTAINMENT CONCERNING TELEVISION PROGRAMS (U.S. CLS. 100, 101 AND 107).

FIRST USE 10-29-2003; IN COMMERCE 10-29-2003.
GRETTA YAO, EXAMINING ATTORNEY

CLASS 41—(Continued).

SN 78-493,887. MCKENNA, BARBARA F., CENTENNIAL, CO. FILED 10-4-2004.

STORY PARTY

THE MARK CONSISTS OF STANDARD CHARACTERS WITHOUT CLAIM TO ANY PARTICULAR FONT, STYLE, SIZE, OR COLOR.

NO CLAIM IS MADE TO THE EXCLUSIVE RIGHT TO USE "STORY", APART FROM THE MARK AS SHOWN.

FOR EDUCATIONAL SERVICES, NAMELY, CONSULTING CLASSES IN THE FIELD OF AUTHORSHIP AND WRITING AND PROVIDING PRINTED MATERIALS, PUBLICATIONS, SOFTWARE, CDS, DVDS, AND VIDEOS DISTRIBUTED IN CONNECTION THEREWITH (U.S. CLS. 100, 101 AND 107).

DAHLIA GEORGE, EXAMINING ATTORNEY

SN 78-494,435. BKN INTERNATIONAL AG, COLOGNE, FED REP GERMANY, FILED 10-5-2004.

Shanghai Tiger

THE MARK CONSISTS OF STANDARD CHARACTERS WITHOUT CLAIM TO ANY PARTICULAR FONT, STYLE, SIZE, OR COLOR.

FOR ENTERTAINMENT IN THE NATURE OF ONGOING TELEVISION PROGRAMS IN THE FIELD OF ANIMATION (U.S. CLS. 100, 101 AND 107).

STACY WAHLBERG, EXAMINING ATTORNEY

CLASS 41—(Continued).

SN 78-494,632. 2H-ENTERTAINMENT INC., LOS ANGELES, CA. FILED 10-5-2004.

PANODOME

THE MARK CONSISTS OF STANDARD CHARACTERS WITHOUT CLAIM TO ANY PARTICULAR FONT, STYLE, SIZE, OR COLOR.

FOR ENTERTAINMENT SERVICES, NAMELY, PRODUCING, OPERATING, AND CONDUCTING ENTERTAINMENT EXHIBITIONS IN THE NATURE OF PANORAMIC MOTION PICTURES AND/OR PANORAMIC PICTURE DISPLAYS (U.S. CLS. 100, 101 AND 107).

KEVIN DINALLO, EXAMINING ATTORNEY

SN 78-494,958. GRANATA, MICHAEL, STONEHAM, MA. FILED 10-5-2004.

RIPT

THE MARK CONSISTS OF STANDARD CHARACTERS WITHOUT CLAIM TO ANY PARTICULAR FONT, STYLE, SIZE, OR COLOR.

FOR ENTERTAINMENT SERVICES, NAMELY, LIVE PERFORMANCES BY A VOCAL AND INSTRUMENTAL GROUP (U.S. CLS. 100, 101 AND 107).

ROBERT LAVACHE, EXAMINING ATTORNEY

CLASS 41—(Continued).

SN 78-495,652. INTERNATIONAL EXHIBITIONS, INC., HOUSTON, TX. FILED 10-6-2004.

**PETS FRIENDS &
MORE EXPO**

THE MARK CONSISTS OF STANDARD CHARACTERS WITHOUT CLAIM TO ANY PARTICULAR FONT, STYLE, SIZE, OR COLOR.

FOR CONDUCTING EDUCATIONAL AND ENTERTAINMENT EXHIBITIONS IN THE NATURE OF PET OWNERSHIP, PET ADOPTION, AND PET PRODUCT DISPLAYS (U.S. CLS. 100, 101 AND 107).

FIRST USE 9-8-2004; IN COMMERCE 9-8-2004.
TEJBIR SINGH, EXAMINING ATTORNEY

CLASS 41—(Continued).

SN 78-496,014. PSYCHOLOGICAL ASSOCIATES, INC., ST. LOUIS, MO. FILED 10-7-2004.

DPM

THE MARK CONSISTS OF STANDARD CHARACTERS WITHOUT CLAIM TO ANY PARTICULAR FONT, STYLE, SIZE, OR COLOR.

FOR EDUCATIONAL SERVICES, NAMELY, SEMINARS AND TRAINING PROGRAMS IN THE FIELDS OF BUSINESS MANAGEMENT, LEADERSHIP, SALES AND INTERPERSONAL COMMUNICATION (U.S. CLS. 100, 101 AND 107).

FIRST USE 6-1-1992; IN COMMERCE 6-1-1992.
NORA BUCHANAN WILL, EXAMINING ATTORNEY

SN 78-495,718. MINTY FRESH, INC., CHICAGO, IL. FILED 10-6-2004.

**ROADKILL
COMMANDOES**

THE MARK CONSISTS OF STANDARD CHARACTERS WITHOUT CLAIM TO ANY PARTICULAR FONT, STYLE, SIZE, OR COLOR.

FOR ENTERTAINMENT IN THE NATURE OF ONGOING TELEVISION PROGRAMS IN THE FIELD OF COMEDY (U.S. CLS. 100, 101 AND 107).

JAMES A. RAUEN, EXAMINING ATTORNEY

SN 78-496,226. THE IMAGE FACTORY INC., NEW YORK, NY. FILED 10-7-2004.

SN 78-495,733. INTERNATIONAL EXHIBITIONS, INC., HOUSTON, TX. FILED 10-6-2004.

**GOURMET FOODS AND HOT
AND SPICY FOOD PAVILION**

NO CLAIM IS MADE TO THE EXCLUSIVE RIGHT TO USE "GOURMET FOODS AND HOT & SPICY FOOD", APART FROM THE MARK AS SHOWN.

FOR CONDUCTING EDUCATIONAL AND ENTERTAINMENT EXHIBITIONS IN THE NATURE OF COOKING DEMONSTRATIONS AND COOKING PRODUCT DISPLAYS (U.S. CLS. 100, 101 AND 107).

FIRST USE 9-8-2004; IN COMMERCE 9-8-2004.
SAMUEL E. SHARPER JR., EXAMINING ATTORNEY

OPPORTUNITY ROCKS

THE MARK CONSISTS OF STANDARD CHARACTERS WITHOUT CLAIM TO ANY PARTICULAR FONT, STYLE, SIZE, OR COLOR.

FOR ENTERTAINMENT SERVICES IN THE NATURE OF A CONTINUING TELEVISION SHOW FEATURING MUSICAL PERFORMANCES (U.S. CLS. 100, 101 AND 107).

GENE MACIOL, EXAMINING ATTORNEY

CLASS 41—(Continued).

SN 78-496,327. THE 1% CLUB, INC., ATLANTA, GA. FILED 10-7-2004.

CLASS 41—(Continued).

SN 78-496,392. STAR FARM PRODUCTIONS LLC, CHICAGO, IL. FILED 10-7-2004.

SUCCESS IS NOT AN
ACCIDENT



THE MARK CONSISTS OF STANDARD CHARACTERS WITHOUT CLAIM TO ANY PARTICULAR FONT, STYLE, SIZE, OR COLOR.

FOR CONDUCTING MOTIVATIONAL SEMINARS, WORKSHOPS, ONE-ON-ONE TRAINING, AND PERSONAL EFFECTIVENESS TRAINING IN THE FIELD OF BUSINESS MANAGEMENT (U.S. CLS. 100, 101 AND 107).

FIRST USE 12-31-1977; IN COMMERCE 12-31-1977.

MARLENE BELL, EXAMINING ATTORNEY

FOR ENTERTAINMENT SERVICES, NAMELY, MOTION PICTURE, TELEVISION, INTERNET, LASER DISC, VIDEOTAPE AND AUDIO TAPE PRODUCTION SERVICES; MUSIC PRODUCTION; MULTIMEDIA ENTERTAINMENT SOFTWARE PRODUCTION SERVICES; PRODUCTION OF MULTIMEDIA EFFECTS AND ANIMATION FOR COMPUTER GAME TAPES, COMPUTER GAME CASSETTES, COMPUTER GAME CARTRIDGES, COMPUTER GAME SOFTWARE, MULTIMEDIA GAME SOFTWARE AND VIDEOTAPE GAME CARTRIDGES AND CASSETTES (U.S. CLS. 100, 101 AND 107).

FIRST USE 5-1-2003; IN COMMERCE 6-1-2003.

ARETHA SOMERVILLE, EXAMINING ATTORNEY

SN 78-496,335. MARASHI, CAROL A, AUSTIN, TX. FILED 10-7-2004.

SN 78-496,734. INCUBATION MUSIC LLC, NEW YORK CITY, NY. FILED 10-8-2004.

bodychoir

Incubation Music

THE MARK CONSISTS OF STANDARD CHARACTERS WITHOUT CLAIM TO ANY PARTICULAR FONT, STYLE, SIZE, OR COLOR.

FOR ECSTATIC DANCE CLASS (U.S. CLS. 100, 101 AND 107).

MARLENE BELL, EXAMINING ATTORNEY

THE MARK CONSISTS OF STANDARD CHARACTERS WITHOUT CLAIM TO ANY PARTICULAR FONT, STYLE, SIZE, OR COLOR.

NO CLAIM IS MADE TO THE EXCLUSIVE RIGHT TO USE "MUSIC", APART FROM THE MARK AS SHOWN.

FOR MUSIC COMPOSITION FOR OTHERS; AND MUSIC PUBLISHING SERVICES (U.S. CLS. 100, 101 AND 107).

BARBARA A. LOUGHRAN, EXAMINING ATTORNEY

CLASS 41—(Continued).

SN 78-496,931. PROVISIO, INC., CHICAGO, IL. FILED 10-8-2004.

**APPRENTICESHIP
ACCELERATOR**

THE MARK CONSISTS OF STANDARD CHARACTERS WITHOUT CLAIM TO ANY PARTICULAR FONT, STYLE, SIZE, OR COLOR.

NO CLAIM IS MADE TO THE EXCLUSIVE RIGHT TO USE "APPRENTICESHIP", APART FROM THE MARK AS SHOWN.

FOR EDUCATIONAL SERVICES, NAMELY, PROVIDING SEMINARS AND WORKSHOPS IN THE FIELD OF MANAGEMENT AND WORKFORCE TRAINING (U.S. CLS. 100, 101 AND 107).

FIRST USE 11-30-2003; IN COMMERCE 11-30-2004.
ADA HAN, EXAMINING ATTORNEY

CLASS 41—(Continued).

SN 78-497,578. YOUNGHANS, DAVID, BOULDER, CO. FILED 10-11-2004.

Gorilla Test Prep

THE MARK CONSISTS OF STANDARD CHARACTERS WITHOUT CLAIM TO ANY PARTICULAR FONT, STYLE, SIZE, OR COLOR.

NO CLAIM IS MADE TO THE EXCLUSIVE RIGHT TO USE "TEST PREP", APART FROM THE MARK AS SHOWN. FOR TEST PREPARATION INSTRUCTION SERVICES FOR COLLEGE AND ADVANCED EDUCATION ADMISSIONS EXAMS (U.S. CLS. 100, 101 AND 107).

FIRST USE 2-16-2003; IN COMMERCE 2-16-2003.
JILL C. ALT, EXAMINING ATTORNEY

SN 78-497,203. NASHVILLE KATS, L.L.C., NASHVILLE, TN. FILED 10-8-2004.

TENNESSEE STUDS

THE MARK CONSISTS OF STANDARD CHARACTERS WITHOUT CLAIM TO ANY PARTICULAR FONT, STYLE, SIZE, OR COLOR.

NO CLAIM IS MADE TO THE EXCLUSIVE RIGHT TO USE TENNESSEE, APART FROM THE MARK AS SHOWN.

FOR ENTERTAINMENT SERVICES IN THE NATURE OF PROFESSIONAL FOOTBALL GAMES AND EXHIBITIONS; PROVIDING SPORTS AND ENTERTAINMENT INFORMATION VIA A GLOBAL COMPUTER NETWORK OR A COMMERCIAL ON-LINE SERVICE; ARRANGING AND CONDUCTING ATHLETIC COMPETITIONS; ENTERTAINMENT SERVICES, NAMELY, MUSICAL AND DANCE PERFORMANCES PROVIDED DURING INTERVALS AT SPORTS EVENTS; FAN CLUB SERVICES; EDUCATIONAL SERVICES, NAMELY, PHYSICAL EDUCATION PROGRAMS; PRODUCTION OF RADIO AND TELEVISION PROGRAMS AND LIVE SHOWS FEATURING FOOTBALL GAMES, EXHIBITIONS, COMPETITIONS AND MUSICAL, COMEDY AND DANCE PERFORMANCES (U.S. CLS. 100, 101 AND 107).

LEIGH CAROLINE CASE, EXAMINING ATTORNEY

SN 78-497,694. TURNER, TIM, HARRIS, NC. FILED 10-11-2004.

LINK TO EXCEL

THE MARK CONSISTS OF STANDARD CHARACTERS WITHOUT CLAIM TO ANY PARTICULAR FONT, STYLE, SIZE, OR COLOR.

FOR CHARITABLE SERVICES TO ASSIST YOUNG MEN ACHIEVE THEIR FULL POTENTIAL, NAMELY, ACADEMIC MENTORING OF SCHOOL AGE CHILDREN, AND EDUCATIONAL RESEARCH; CHARITABLE SERVICES TO ASSIST YOUNG MEN ACHIEVE THEIR FULL POTENTIAL, NAMELY, SEMINARS IN THE FIELD OF SELF-AWARENESS AND PERSONAL DEVELOPMENT (U.S. CLS. 100, 101 AND 107).

FIRST USE 6-30-2002; IN COMMERCE 6-30-2002.
BRIAN PINO, EXAMINING ATTORNEY

CLASS 41—(Continued).

SN 78-497,784. DEMON MEDIA LIMITED, GREAT DUNMOW, ESSEX, UNITED KINGDOM, FILED 10-11-2004.

GAYDEMON

THE MARK CONSISTS OF STANDARD CHARACTERS WITHOUT CLAIM TO ANY PARTICULAR FONT, STYLE, SIZE, OR COLOR.

FOR ENTERTAINMENT SERVICES, NAMELY, PROVIDING ADULT-ORIENTED ENTERTAINMENT VIA THE INTERNET FEATURING ADULT-ORIENTED STORIES, PHOTOGRAPHS, VIDEOS AND STREAMING VIDEOS AND INFORMATION ABOUT ADULT-ORIENTED ENTERTAINMENT AND WEB SITES (U.S. CLS. 100, 101 AND 107).

FIRST USE 1-1-1999; IN COMMERCE 1-1-1999.
SHARON MEIER, EXAMINING ATTORNEY

CLASS 41—(Continued).

SN 78-498,147. FAIRFAX BAND, LLC, NASHVILLE, TN. FILED 10-12-2004.

FAIRFAX

THE MARK CONSISTS OF STANDARD CHARACTERS WITHOUT CLAIM TO ANY PARTICULAR FONT, STYLE, SIZE, OR COLOR.

FOR ENTERTAINMENT SERVICES, NAMELY, LIVE PERFORMANCES BY A MUSICAL GROUP (U.S. CLS. 100, 101 AND 107).

FIRST USE 9-1-2002; IN COMMERCE 9-1-2002.
TARAH HARDY, EXAMINING ATTORNEY

SN 78-497,785. ADDIE'S STUDIO 1 ON 1, INC., SAN DIEGO, CA. FILED 10-11-2004.

REMODEL YOUR BODY

THE MARK CONSISTS OF STANDARD CHARACTERS WITHOUT CLAIM TO ANY PARTICULAR FONT, STYLE, SIZE, OR COLOR.

FOR PERSONAL TRAINING SERVICES, NAMELY, STRENGTH AND CONDITIONING TRAINING (U.S. CLS. 100, 101 AND 107).

SHARON MEIER, EXAMINING ATTORNEY

SN 78-498,189. CREW TRAINING INTERNATIONAL, INC., MEMPHIS, TN. FILED 10-12-2004.

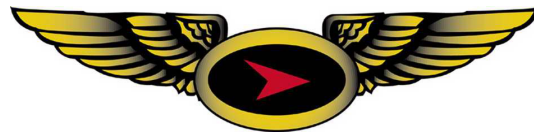

THE COLOR(S) GOLD, RED AND BLACK, IS/ARE CLAIMED AS A FEATURE OF THE MARK.

THE MARK CONSISTS OF WINGS ARE GOLD BEHIND A GOLD CENTER CIRCLE WITH BLACK INSIDE THE CIRCLE AND A RED ARROW IN THE CENTER OF THE CIRCLE.

FOR EDUCATIONAL SERVICES, NAMELY, CONDUCTING CREW RESOURCE MANAGEMENT AND HUMAN FACTOR CLASSES IN THE FIELDS OF AVIATION AND MEDICINE (U.S. CLS. 100, 101 AND 107).

FIRST USE 6-4-2003; IN COMMERCE 8-7-2003.
KEVON CHISOLM, EXAMINING ATTORNEY

CLASS 41—(Continued).

SN 78-498,879. CREW TRAINING INTERNATIONAL, INC., MEMPHIS, TN. FILED 10-13-2004.

CLASS 41—(Continued).

SN 78-498,945. PERSISTENCE MEDIA LLC, PORTLAND, ME. FILED 10-13-2004.

CTI

INSIDE LINE

THE MARK CONSISTS OF STANDARD CHARACTERS WITHOUT CLAIM TO ANY PARTICULAR FONT, STYLE, SIZE, OR COLOR.

FOR EDUCATIONAL SERVICES, NAMELY, CONDUCTING CREW RESOURCE MANAGEMENT AND HUMAN FACTOR CLASSES IN THE FIELDS OF AVIATION AND MEDICINE (U.S. CLS. 100, 101 AND 107).

FIRST USE 8-4-1992; IN COMMERCE 10-5-1993.
PAM WILLIS, EXAMINING ATTORNEY

THE MARK CONSISTS OF STANDARD CHARACTERS WITHOUT CLAIM TO ANY PARTICULAR FONT, STYLE, SIZE, OR COLOR.

FOR ENTERTAINMENT, NAMELY ONGOING TELEVISION PROGRAMS IN THE FIELD OF MOTOR SPORTS (U.S. CLS. 100, 101 AND 107).

FIRST USE 6-23-2004; IN COMMERCE 6-23-2004.
BARBARA A. GOLD, EXAMINING ATTORNEY

SN 78-498,928. BUSCH ENTERTAINMENT CORPORATION, ST. LOUIS, MO. FILED 10-13-2004.

SN 78-498,970. METZGER, MARSHA T., WENHAM, MA. FILED 10-13-2004.

SHEEKRA

EASHOA YOGA

THE MARK CONSISTS OF STANDARD CHARACTERS WITHOUT CLAIM TO ANY PARTICULAR FONT, STYLE, SIZE, OR COLOR.

FOR ENTERTAINMENT SERVICES IN THE NATURE OF AN AMUSEMENT PARK ATTRACTION (U.S. CLS. 100, 101 AND 107).

REBECCA SMITH, EXAMINING ATTORNEY

THE MARK CONSISTS OF STANDARD CHARACTERS WITHOUT CLAIM TO ANY PARTICULAR FONT, STYLE, SIZE, OR COLOR.

NO CLAIM IS MADE TO THE EXCLUSIVE RIGHT TO USE YOGA, APART FROM THE MARK AS SHOWN. FOR YOGA INSTRUCTION (U.S. CLS. 100, 101 AND 107).

FIRST USE 7-26-2004; IN COMMERCE 10-1-2004.
JOHN HWANG, EXAMINING ATTORNEY

CLASS 41—(Continued).

SN 78-499,793. INTERNATIONAL DAIRY FOODS ASSOCIATION, WASHINGTON, DC. FILED 10-14-2004.

D-BRIEF

THE MARK CONSISTS OF STANDARD CHARACTERS WITHOUT CLAIM TO ANY PARTICULAR FONT, STYLE, SIZE, OR COLOR.

FOR PROVIDING ONLINE NEWSLETTERS ON TOPICS RELATING TO THE DAIRY INDUSTRY (U.S. CLS. 100, 101 AND 107).

FIRST USE 1-9-2003; IN COMMERCE 1-9-2003.
KELLY BOULTON, EXAMINING ATTORNEY

SN 78-499,795. SEARCY ENTERTAINMENT, INC., LAS VEGAS, NV. FILED 10-14-2004.

SING OUT LOUD

THE MARK CONSISTS OF STANDARD CHARACTERS WITHOUT CLAIM TO ANY PARTICULAR FONT, STYLE, SIZE, OR COLOR.

FOR ENTERTAINMENT SERVICES, NAMELY, LIVE PERFORMANCES FEATURING MUSICIANS, SINGERS, DANCERS, MAGICIANS, ACTORS, ACROBATS, COMEDIANS WITH PRERECORDED MUSIC AND VIDEO (U.S. CLS. 100, 101 AND 107).

KELLY BOULTON, EXAMINING ATTORNEY

CLASS 41—(Continued).

SN 78-499,856. SAINT JOSEPH'S UNIVERSITY, PHILADELPHIA, PA. FILED 10-14-2004.

**SPIRIT, INTELLECT,
PURPOSE.**

THE MARK CONSISTS OF STANDARD CHARACTERS WITHOUT CLAIM TO ANY PARTICULAR FONT, STYLE, SIZE, OR COLOR.

FOR EDUCATIONAL SERVICES, NAMELY, PROVIDING COURSES OF INSTRUCTION AT THE UNIVERSITY LEVEL (U.S. CLS. 100, 101 AND 107).

CURTIS FRENCH, EXAMINING ATTORNEY

SN 78-500,000. EXCEL INSTITUTE, WASHINGTON, DC. FILED 10-14-2004.

Excel
I N S T I T U T E

NO CLAIM IS MADE TO THE EXCLUSIVE RIGHT TO USE "INSTITUTE", APART FROM THE MARK AS SHOWN.

FOR EDUCATION SERVICES NAMELY AUTOMOTIVE TECHNOLOGY TRAINING (U.S. CLS. 100, 101 AND 107).

FIRST USE 1-1-2003; IN COMMERCE 1-1-2003.
MICHAEL HALL, EXAMINING ATTORNEY

SN 78-500,278. DIVERSIFIED SERVICE OPTIONS, INC., JACKSONVILLE, FL. FILED 10-15-2004.

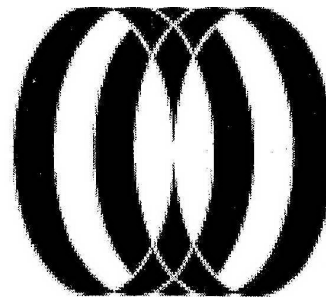

OWNER OF U.S. REG. NOS. 2,872,122, 2,872,123 AND 2,886,463.

THE MARK CONSISTS OF INTERSECTING RING DESIGN.

FOR TRAINING SERVICES IN THE FIELD OF INFORMATION TECHNOLOGY (U.S. CLS. 100, 101 AND 107).

FIRST USE 4-15-2004; IN COMMERCE 4-15-2004.
INGA ERVIN, EXAMINING ATTORNEY

CLASS 41—(Continued).

SN 78-500,282. DIVERSIFIED SERVICE OPTIONS, INC., JACKSONVILLE, FL. FILED 10-15-2004.

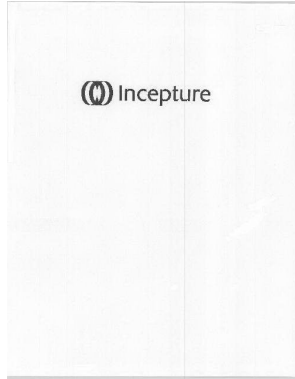

OWNER OF U.S. REG. NOS. 2,872,109, 2,872,123 AND OTHERS.

THE MARK CONSISTS OF INTERSECTING RING DESIGN WITH THE WORD INCEPTION.

FOR TRAINING SERVICES IN THE FIELD OF INFORMATION TECHNOLOGY (U.S. CLS. 100, 101 AND 107).

FIRST USE 4-15-2004; IN COMMERCE 4-15-2004.
RUSS HERMAN, EXAMINING ATTORNEY

CLASS 41—(Continued).

SN 78-500,582. BUKOW, TIFFANY BASS, SAN FRANCISCO, CA. FILED 10-15-2004.

Thrive Media

THE MARK CONSISTS OF STANDARD CHARACTERS WITHOUT CLAIM TO ANY PARTICULAR FONT, STYLE, SIZE, OR COLOR.

NO CLAIM IS MADE TO THE EXCLUSIVE RIGHT TO USE "MEDIA", APART FROM THE MARK AS SHOWN.

FOR PRODUCTION OF RADIO AND TELEVISION PROGRAMS (U.S. CLS. 100, 101 AND 107).

FIRST USE 1-1-2004; IN COMMERCE 1-1-2004.
IRA J. GOODSaid, EXAMINING ATTORNEY

SN 78-500,286. DIVERSIFIED SERVICE OPTIONS, INC., JACKSONVILLE, FL. FILED 10-15-2004.

Inception

THE MARK CONSISTS OF STANDARD CHARACTERS WITHOUT CLAIM TO ANY PARTICULAR FONT, STYLE, SIZE, OR COLOR.

OWNER OF U.S. REG. NOS. 2,836,630, 2,872,109 AND 2,872,122.

FOR TRAINING SERVICES IN THE FIELD OF INFORMATION TECHNOLOGY (U.S. CLS. 100, 101 AND 107).

FIRST USE 4-15-2004; IN COMMERCE 4-15-2004.
MARK RADEMACHER, EXAMINING ATTORNEY

SN 78-500,761. ADLER, BARBARA, ROSLYN HARBOR, NY, AND ESHEL, SUSAN, ROSLYN, NY, AND ESTEP, SUSAN, BROOKVILLE, NY, AND FEINER, AUDREY, ROSLYN HARBOR, NY, AND FRIEDMAN, BARRIE, OLD BROOKVILLE, NY. FILED 10-15-2004.

MOMZ-N-DA HOOD

THE MARK CONSISTS OF STANDARD CHARACTERS WITHOUT CLAIM TO ANY PARTICULAR FONT, STYLE, SIZE, OR COLOR.

FOR ENTERTAINMENT IN THE NATURE OF DANCE AND LIVE THEATRICAL PERFORMANCES; DANCE AND THEATRICAL DRAMA PRODUCTIONS; DANCE AND THEATRICAL DRAMA STUDIOS AND SCHOOLS (U.S. CLS. 100, 101 AND 107).

FIRST USE 6-2-2003; IN COMMERCE 6-2-2003.
SUSAN STIGLITZ, EXAMINING ATTORNEY

CLASS 41—(Continued).

SN 78-500,793. GLIDE PUBLISHING LLC, BOSTON, MA.
FILED 10-15-2004.

Glide Magazine

THE MARK CONSISTS OF STANDARD CHARACTERS
WITHOUT CLAIM TO ANY PARTICULAR FONT, STYLE,
SIZE, OR COLOR.

NO CLAIM IS MADE TO THE EXCLUSIVE RIGHT TO
USE "MAGAZINE", APART FROM THE MARK AS SHOWN.
FOR ONLINE AND PRINT MAGAZINE PUBLISHING
(U.S. CLS. 100, 101 AND 107).

FIRST USE 7-5-2002; IN COMMERCE 2-4-2003.
JILL C. ALT, EXAMINING ATTORNEY

SN 78-500,885. SUNSHINE FILMS, INC., VAN NUYS, CA.
FILED 10-15-2004.

CHERRY POPPERS

THE MARK CONSISTS OF STANDARD CHARACTERS
WITHOUT CLAIM TO ANY PARTICULAR FONT, STYLE,
SIZE, OR COLOR.

OWNER OF U.S. REG. NO. 2,906,394.
FOR ENTERTAINMENT SERVICES, NAMELY, PRO-
VIDING A SUBSCRIPTION WEB SITE FEATURING
ADULT VIDEOS, RELATED FILM CLIPS AND PHOTO-
GRAPHS (U.S. CLS. 100, 101 AND 107).

FIRST USE 0-0-1993; IN COMMERCE 0-0-1993.
CHRISTOPHER BUONGIORNO, EXAMINING ATTOR-
NEY

SN 78-500,922. RBB DESIGN & PRODUCTION, ROSLYN
HTS, NY. FILED 10-15-2004.

LLEGAMOS!

THE ENGLISH TRANSLATION OF THE WORD LLEGA-
MOS IN THE MARK IS "WE HAVE ARRIVED".

FOR ENTERTAINMENT IN THE NATURE OF ON-
GOING TELEVISION PROGRAMS IN THE FIELD OF
COMEDY (U.S. CLS. 100, 101 AND 107).

FIRST USE 7-1-2004; IN COMMERCE 8-24-2004.
JOANNA DUKOVIC, EXAMINING ATTORNEY

CLASS 41—(Continued).

SN 78-501,205. ADVANCED ACADEMICS, INC., OKLAHO-
MA CITY, OK. FILED 10-18-2004.

PASSING LANE

THE MARK CONSISTS OF STANDARD CHARACTERS
WITHOUT CLAIM TO ANY PARTICULAR FONT, STYLE,
SIZE, OR COLOR.

FOR EDUCATIONAL SERVICES, NAMELY PROVID-
ING ONLINE INSTRUCTION AND COURSES, AND
CURRICULUM GUIDANCE AND CONSULTATION AT
THE PRIMARY AND SECONDARY LEVELS, INCLUD-
ING PROVIDING COURSE MATERIALS IN CONNEC-
TION THEREWITH (U.S. CLS. 100, 101 AND 107).

FIRST USE 8-25-2003; IN COMMERCE 8-25-2003.
LINDA MICKLEBURGH, EXAMINING ATTORNEY

SN 78-501,317. RESCUE 3 INTERNATIONAL, INC., ELK
GROVE, CA. FILED 10-18-2004.

RESCUE 3

THE MARK CONSISTS OF STANDARD CHARACTERS
WITHOUT CLAIM TO ANY PARTICULAR FONT, STYLE,
SIZE, OR COLOR.

NO CLAIM IS MADE TO THE EXCLUSIVE RIGHT TO
USE RESCUE, APART FROM THE MARK AS SHOWN.

FOR PROVIDING COURSES OF INSTRUCTION AND
TRAINING PROGRAMS IN THE FIELD OF TOWER,
WATER, ROPE, ICE AND HELO RESCUE TECHNIQUES
(U.S. CLS. 100, 101 AND 107).

FIRST USE 8-1-1979; IN COMMERCE 6-1-1983.
CAROLYN GRAY, EXAMINING ATTORNEY

CLASS 41—(Continued).

SN 78-501,608. CENTER FOR OCCUPATIONAL RESEARCH AND DEVELOPMENT, INC., WACO, TX. FILED 10-18-2004.

CORD

THE MARK CONSISTS OF STANDARD CHARACTERS WITHOUT CLAIM TO ANY PARTICULAR FONT, STYLE, SIZE, OR COLOR.

FOR RESEARCH REGARDING TECHNICAL AND VOCATIONAL EDUCATIONAL REFORM AND CURRICULUM DESIGN AND DEVELOPMENT; EDUCATIONAL SERVICES; NAMELY, OFFERING CLASSES AND SEMINARS OF A TECHNICAL OR VOCATIONAL NATURE IN THE FIELDS OF APPLIED MATHEMATICS, SCIENCE AND TECHNOLOGY, DEVELOPMENT AND DISSEMINATION OF TECHNICAL AND VOCATIONAL EDUCATIONAL MATERIALS IN THE FIELDS OF APPLIED MATHEMATICS, SCIENCE AND TECHNOLOGY (U.S. CLS. 100, 101 AND 107).

FIRST USE 7-1-1980; IN COMMERCE 7-1-1980.
CAROLINE WOOD, EXAMINING ATTORNEY

SN 78-501,647. B.A.S.S. (IP), LLC, BRISTOL, CT. FILED 10-18-2004.

BASSMASTER UNIVERSITY

THE MARK CONSISTS OF STANDARD CHARACTERS WITHOUT CLAIM TO ANY PARTICULAR FONT, STYLE, SIZE, OR COLOR.

OWNER OF U.S. REG. NOS. 921,984, 2,611,712 AND OTHERS.

FOR ENTERTAINMENT SERVICES, NAMELY, AN ONGOING TELEVISION PROGRAM IN THE FIELD OF FISHING; ENTERTAINMENT SERVICES VIA A GLOBAL COMPUTER NETWORK IN THE FIELD OF FISHING, NAMELY, PROVIDING FISHING INFORMATION AND INSTRUCTION, PROVIDING INFORMATION ABOUT AN ONGOING TELEVISION PROGRAM IN THE FIELD OF FISHING; PROVIDING FISHING INFORMATION VIA WIRELESS AND MOBILE DEVICES (U.S. CLS. 100, 101 AND 107).

FIRST USE 1-0-1999; IN COMMERCE 1-0-1999.
KIMBERLY FRYE, EXAMINING ATTORNEY

CLASS 41—(Continued).

SN 78-501,813. FLORIDA STRAWBERRY FESTIVAL, INC., PLANT CITY, FL. FILED 10-19-2004.



OWNER OF U.S. REG. NO. 1,289,389.
NO CLAIM IS MADE TO THE EXCLUSIVE RIGHT TO USE "FLORIDA INDUSTRIAL & TECHNOLOGY EDUCATION COMPETITION", APART FROM THE MARK AS SHOWN.

THE MARK CONSISTS OF THE WORDS "FLORIDA STRAWBERRY FESTIVAL" AND "FLORIDA INDUSTRIAL & TECHNOLOGY EDUCATION COMPETITION" APPEAR ABOVE AND BELOW A STYLIZED PRESENTATION OF THE COINED WORD "FITEC." A FANCIFUL REPRESENTATION OF THREE GEARS APPEARS AT THE LOWER RIGHT OF THE LETTER "F", A FANCIFUL REPRESENTATION OF AN ATOM APPEARS AT THE END OF THE CROSSBAR OF THE LETTER "T", AND A FANCIFUL REPRESENTATION OF A STRAWBERRY APPEARS WITHIN THE CURVE OF THE LETTER "C".

FOR ORGANIZING AND CONDUCTING COMPETITIONS IN THE FIELD OF INDUSTRIAL AND TECHNOLOGY EDUCATION (U.S. CLS. 100, 101 AND 107).

FIRST USE 10-28-2004; IN COMMERCE 10-28-2004.

TARAH HARDY, EXAMINING ATTORNEY

SN 78-502,066. WML, INC., OAK PARK, CA. FILED 10-19-2004.

BetterMen

THE MARK CONSISTS OF STANDARD CHARACTERS WITHOUT CLAIM TO ANY PARTICULAR FONT, STYLE, SIZE, OR COLOR.

FOR CONDUCTING WORKSHOPS AND SEMINARS IN PERSONAL AWARENESS (U.S. CLS. 100, 101 AND 107).

FIRST USE 4-1-2004; IN COMMERCE 4-1-2004.
EDWARD NELSON, EXAMINING ATTORNEY

CLASS 41—(Continued).

SN 78-502,117. MEAIRS, SHANNON, CANOGA PARK, CA.
FILED 10-19-2004.

Full Ride

THE MARK CONSISTS OF STANDARD CHARACTERS WITHOUT CLAIM TO ANY PARTICULAR FONT, STYLE, SIZE, OR COLOR.

FOR COLLEGE ADMISSION COUNSELING SERVICES TO HIGH SCHOOL STUDENTS; CAREER COUNSELING (U.S. CLS. 100, 101 AND 107).

FIRST USE 10-1-2004; IN COMMERCE 10-1-2004.
LAURA KOVAISKY, EXAMINING ATTORNEY

SN 78-502,118. BOY SCOUTS OF AMERICA, IRVING, TX.
FILED 10-19-2004.



NO CLAIM IS MADE TO THE EXCLUSIVE RIGHT TO USE "FUTBOL SOCCER", APART FROM THE MARK AS SHOWN.

THE MARK CONSISTS OF THE WORDS FUTBOL AND SOCCER WITH A FLEUR-DI-LIS LOGO BETWEEN THE TWO WORDS AND THE WORD SCOUTING ABOVE A SOCCER BALL.

FOR OUTREACH PROGRAM TO RECRUIT HISPANIC YOUTH AND FAMILIES BY COMBINING SOCCER COACHING AND PLAY WITH A YOUTH SERVING ORGANIZATION AND THE DISTRIBUTION OF PAMPHLETS, POSTERS, LESSON PLANS AND CD-ROMS IN CONNECTION THEREWITH (U.S. CLS. 100, 101 AND 107).

FIRST USE 8-25-2004; IN COMMERCE 8-25-2004.
LAURA KOVAISKY, EXAMINING ATTORNEY

CLASS 41—(Continued).

SN 78-502,242. ADVENTURES WILDE, L.L.C., MESQUITE, TX. FILED 10-19-2004.

ADVENTURES WILD

THE MARK CONSISTS OF STANDARD CHARACTERS WITHOUT CLAIM TO ANY PARTICULAR FONT, STYLE, SIZE, OR COLOR.

FOR HUNTING GUIDE SERVICES (U.S. CLS. 100, 101 AND 107).

FIRST USE 1-31-2001; IN COMMERCE 2-28-2001.
ELLEN BURNS, EXAMINING ATTORNEY

SN 78-502,323. WORLDSTAR FITNESS, LLC, NORTH BRUNSWICK, NJ. FILED 10-19-2004.

MISS TEEN FITNESS

THE MARK CONSISTS OF STANDARD CHARACTERS WITHOUT CLAIM TO ANY PARTICULAR FONT, STYLE, SIZE, OR COLOR.

SEC. 2(F).

FOR ENTERTAINMENT SERVICES, NAMELY PRESENTATION OF PAGEANTS AND CONTESTS (U.S. CLS. 100, 101 AND 107).

FIRST USE 9-1-1999; IN COMMERCE 9-1-1999.

KATHRYN COWARD, EXAMINING ATTORNEY

SN 78-502,687. CBI DISTRIBUTING CORP., WILMINGTON, DE. FILED 10-20-2004.

WHERE THROWING A PARTY IS ALL THE FUN

THE MARK CONSISTS OF STANDARD CHARACTERS WITHOUT CLAIM TO ANY PARTICULAR FONT, STYLE, SIZE, OR COLOR.

FOR ENTERTAINMENT SERVICES, NAMELY, ARRANGING AND CONDUCTING PARTIES FOR YOUNG CHILDREN (U.S. CLS. 100, 101 AND 107).

BILL DAWE, EXAMINING ATTORNEY

CLASS 41—(Continued).

SN 78-502,688. HORTON, VAIL, B., PORTLAND, OR. FILED 10-20-2004.

HANDICRAP

THE MARK CONSISTS OF STANDARD CHARACTERS WITHOUT CLAIM TO ANY PARTICULAR FONT, STYLE, SIZE, OR COLOR.

FOR EDUCATIONAL, ENTERTAINMENT, AND CHARITABLE SERVICES, NAMELY MENTORING, COACHING AND COUNSELING, AND PROVIDING MOTIVATIONAL AND EDUCATIONAL SPEAKERS AND RESOURCES PROVIDED IN CONNECTION THEREWITH, ALL IN THE FIELD OF HELPING INDIVIDUALS WITH DISABILITIES (U.S. CLS. 100, 101 AND 107).

FIRST USE 8-22-2001; IN COMMERCE 3-8-2002.
RICHARD WHITE, EXAMINING ATTORNEY

CLASS 41—(Continued).

SN 78-503,208. SPOTNITZ, FRANK, BEVERLY HILLS, CA. FILED 10-20-2004.

BIG LIGHT PRODUCTIONS

THE MARK CONSISTS OF STANDARD CHARACTERS WITHOUT CLAIM TO ANY PARTICULAR FONT, STYLE, SIZE, OR COLOR.

NO CLAIM IS MADE TO THE EXCLUSIVE RIGHT TO USE "PRODUCTIONS", APART FROM THE MARK AS SHOWN.

FOR PRODUCTION OF MOTION PICTURES AND TELEVISION PROGRAMS. (U.S. CLS. 100, 101 AND 107).
ANDREA SAUNDERS, EXAMINING ATTORNEY

SN 78-503,024. BUSCH ENTERTAINMENT CORPORATION, ST. LOUIS, MO. FILED 10-20-2004.

SN 78-503,024. BUSCH ENTERTAINMENT CORPORATION, ST. LOUIS, MO. FILED 10-20-2004.

Pro Master Class

SHEIKRA

THE MARK CONSISTS OF STANDARD CHARACTERS WITHOUT CLAIM TO ANY PARTICULAR FONT, STYLE, SIZE, OR COLOR.

FOR ENTERTAINMENT SERVICES IN THE NATURE OF AN AMUSEMENT PARK ATTRACTION (U.S. CLS. 100, 101 AND 107).

REBECCA SMITH, EXAMINING ATTORNEY

THE MARK CONSISTS OF STANDARD CHARACTERS WITHOUT CLAIM TO ANY PARTICULAR FONT, STYLE, SIZE, OR COLOR.

NO CLAIM IS MADE TO THE EXCLUSIVE RIGHT TO USE "MASTER CLASS", APART FROM THE MARK AS SHOWN.

FOR EDUCATIONAL SERVICES, NAMELY, CONDUCTING ARTISTIC INSTRUCTION CLASSES IN THE FIELD OF PERFORMING ARTS, NAMELY, DANCE, SINGING AND ACTING INSTRUCTION (U.S. CLS. 100, 101 AND 107).

FIRST USE 7-1-2004; IN COMMERCE 9-1-2004.
ESTHER BELENKER, EXAMINING ATTORNEY

CLASS 41—(Continued).

SN 78-503,508. PEORIA CIVIC CENTER AUTHORITY,
PEORIA, IL. FILED 10-21-2004.

Women's Lifestyle Show

THE MARK CONSISTS OF STANDARD CHARACTERS
WITHOUT CLAIM TO ANY PARTICULAR FONT, STYLE,
SIZE, OR COLOR.

SEC. 2(F).

FOR ENTERTAINMENT SERVICES IN THE NATURE
OF A LIFESTYLE TELEVISION SHOW (U.S. CLS. 100, 101
AND 107).

FIRST USE 1-1-1995; IN COMMERCE 1-1-1995.

MARGERY A. TIERNEY, EXAMINING ATTORNEY

SN 78-503,850. ARJEE ENTERPRISES INC., GARFIELD, NJ.
FILED 10-21-2004.

BAKBAKAN INTERNATIONAL

THE MARK CONSISTS OF STANDARD CHARACTERS
WITHOUT CLAIM TO ANY PARTICULAR FONT, STYLE,
SIZE, OR COLOR.

NO CLAIM IS MADE TO THE EXCLUSIVE RIGHT TO
USE "INTERNATIONAL", APART FROM THE MARK AS
SHOWN.

THE ENGLISH TRANSLATION OF THE WORD BAKBA-
KAN IN THE MARK IS "FREE FOR ALL".

FOR MARTIAL ARTS INSTRUCTION SERVICES (U.S.
CLS. 100, 101 AND 107).

FIRST USE 3-13-1975; IN COMMERCE 3-13-1975.

KATHLEEN M. VANSTON, EXAMINING ATTORNEY

SN 78-503,873. ARJEE ENTERPRISES INC., GARFIELD, NJ.
FILED 10-21-2004.



THE MARK CONSISTS OF STYLIZED LOGO CONTAIN-
ING A MIRROR IMAGE OF TWO BIRDS.

FOR MARTIAL ARTS INSTRUCTION SERVICES (U.S.
CLS. 100, 101 AND 107).

FIRST USE 3-13-1975; IN COMMERCE 3-13-1975.

KELLY CHOE, EXAMINING ATTORNEY

CLASS 41—(Continued).

SN 78-504,048. FOX NEWS NETWORK, LLC, NEW YORK,
NY. FILED 10-21-2004.

THE BELTWAY BOYS

THE MARK CONSISTS OF STANDARD CHARACTERS
WITHOUT CLAIM TO ANY PARTICULAR FONT, STYLE,
SIZE, OR COLOR.

FOR ENTERTAINMENT SERVICES IN THE NATURE
OF A TELEVISION SERIES FEATURING POLITICS (U.S.
CLS. 100, 101 AND 107).

FIRST USE 7-25-1998; IN COMMERCE 7-25-1998.

JULIE WATSON, EXAMINING ATTORNEY

SN 78-504,982. SEAN CONWAY, INC., TIVERTON, RI. FILED
10-25-2004.

CULTIVATING LIFE

THE MARK CONSISTS OF STANDARD CHARACTERS
WITHOUT CLAIM TO ANY PARTICULAR FONT, STYLE,
SIZE, OR COLOR.

FOR DISTRIBUTION OF TELEVISION PROGRAM-
MING FOR OTHERS; ENTERTAINMENT IN THE NATURE
OF ON-GOING TELEVISION PROGRAMS IN THE
FIELDS OF HORTICULTURE AND GARDENING; IN-
STRUCTION IN THE FIELDS OF HORTICULTURE AND
GARDENING; PRODUCTION OF GARDENING TELE-
VISION PROGRAMS; PROVIDING ON-LINE NEWSLET-
TERS IN THE FIELDS OF GARDENING AND
HORTICULTURE; AND PROVIDING ON-LINE INFOR-
MATION IN THE FIELDS OF GARDENING EDUCA-
TION AND HORTICULTURAL EDUCATION (U.S. CLS.
100, 101 AND 107).

JULIE WATSON, EXAMINING ATTORNEY

CLASS 41—(Continued).

SN 78-505,581. KOFFLER, HENRY, TUCSON, AZ. FILED 10-25-2004.

FESTIVAL IN THE
SUN

THE MARK CONSISTS OF STANDARD CHARACTERS WITHOUT CLAIM TO ANY PARTICULAR FONT, STYLE, SIZE, OR COLOR.

NO CLAIM IS MADE TO THE EXCLUSIVE RIGHT TO USE "FESTIVAL", APART FROM THE MARK AS SHOWN.

FOR ORGANIZING AND CONDUCTING FESTIVALS FEATURING CULTURAL EVENTS AND ENTERTAINMENT, INCLUDING MUSIC, THEATER, BALLET, DANCES, ARTISTIC EXHIBITS, POETRY READINGS, LECTURES, EDUCATIONAL COURSES, FORUMS, SYMPOSIA, WORKSHOPS, AND THE LIKE (U.S. CLS. 100, 101 AND 107).

DARRYL SPRUILL, EXAMINING ATTORNEY

CLASS 41—(Continued).

SN 78-505,946. KIWANIS INTERNATIONAL, INC., INDIANAPOLIS, IN. FILED 10-26-2004.



THE MARK CONSISTS OF A GLOBE WITH HANDS ON EITHER SIDE WITH THE WORDS "KEY LEADER" WRITTEN UNDERNEATH.

FOR EDUCATIONAL SERVICES, NAMELY CONDUCTING A LEADERSHIP TRAINING PROGRAM FOR YOUNG MEN AND WOMEN WITH THE GOAL OF DEVELOPING MORAL CHARACTER, LEADERSHIP SKILLS, AND LOYALTY TO SCHOOL, COMMUNITY AND NATION (U.S. CLS. 100, 101 AND 107).

FIRST USE 9-30-2004; IN COMMERCE 9-30-2004.

JOHN E. MICHOS, EXAMINING ATTORNEY

SN 78-505,638. MAHAN, EG, VENICE, CA. FILED 10-25-2004.

ATOM WWW.
ATHEATREOFMIME.COM

THE MARK CONSISTS OF STANDARD CHARACTERS WITHOUT CLAIM TO ANY PARTICULAR FONT, STYLE, SIZE, OR COLOR.

NO CLAIM IS MADE TO THE EXCLUSIVE RIGHT TO USE "WWW.ATHEATREOFMIME.COM", APART FROM THE MARK AS SHOWN.

FOR ENTERTAINMENT SERVICES IN THE NATURE OF MIME THEATER PERFORMANCES AND PRODUCTIONS (U.S. CLS. 100, 101 AND 107).

FIRST USE 11-1-1998; IN COMMERCE 11-1-1998.

MARGERÝ A. TIERNEY, EXAMINING ATTORNEY

SN 78-506,435. SPEED CHANNEL, INC., LOS ANGELES, CA. FILED 10-26-2004.

FUEL THEIR PASSION

THE MARK CONSISTS OF STANDARD CHARACTERS WITHOUT CLAIM TO ANY PARTICULAR FONT, STYLE, SIZE, OR COLOR.

OWNER OF U.S. REG. NO. 2,879,656.

FOR ENTERTAINMENT SERVICES IN THE NATURE OF TELEVISION PROGRAMMING (U.S. CLS. 100, 101 AND 107).

FIRST USE 5-31-2003; IN COMMERCE 5-31-2003.

MONTIA G. PRESSEY, EXAMINING ATTORNEY

CLASS 41—(Continued).

SN 78-508,076. SAVOR DALLAS 2005, INC, DALLAS, TX.
FILED 10-29-2004.

Savor Dallas

THE MARK CONSISTS OF STANDARD CHARACTERS WITHOUT CLAIM TO ANY PARTICULAR FONT, STYLE, SIZE, OR COLOR.

NO CLAIM IS MADE TO THE EXCLUSIVE RIGHT TO USE "DALLAS", APART FROM THE MARK AS SHOWN.

FOR ANNUAL INTERNATIONAL WINE, FOOD AND SPIRITS FESTIVAL, CONSISTING OF EDUCATIONAL SEMINARS AND FOOD, WINE AND SPIRITS AND ORGANIZED TASTINGS OF FOOD, WINE AND SPIRITS (U.S. CLS. 100, 101 AND 107).

FIRST USE 9-15-2004; IN COMMERCE 9-15-2004.
JULIE WATSON, EXAMINING ATTORNEY

CLASS 41—(Continued).

SN 78-510,222. WELLSOURCE, INC., CLACKAMAS, OR.
FILED 11-2-2004.

WellNotes

THE MARK CONSISTS OF STANDARD CHARACTERS WITHOUT CLAIM TO ANY PARTICULAR FONT, STYLE, SIZE, OR COLOR.

FOR NEWSLETTER IN THE FIELD OF HEALTH AND WELLNESS VIA EMAIL (U.S. CLS. 100, 101 AND 107).

FIRST USE 11-1-2004; IN COMMERCE 11-1-2004.
CHERYL STEPLIGHT, EXAMINING ATTORNEY

SN 78-509,183. LANGUAGE CORPS, INC., SUDBURY, MA.
FILED 11-1-2004.

Language Corps

THE MARK CONSISTS OF STANDARD CHARACTERS WITHOUT CLAIM TO ANY PARTICULAR FONT, STYLE, SIZE, OR COLOR.

NO CLAIM IS MADE TO THE EXCLUSIVE RIGHT TO USE "LANGUAGE", APART FROM THE MARK AS SHOWN.

FOR EDUCATIONAL SERVICES, NAMELY, TRAINING NATIVE ENGLISH SPEAKERS AS TEACHERS OF ENGLISH AS A FOREIGN LANGUAGE, AND CERTIFYING THOSE TEACHERS IN NON-ENGLISH SPEAKING COUNTRIES; PROVIDING INFORMATION IN THE FIELD OF EDUCATIONAL SERVICES VIA A GLOBAL COMPUTER NETWORK (U.S. CLS. 100, 101 AND 107).

FIRST USE 5-1-2004; IN COMMERCE 5-1-2004.
TEJBIR SINGH, EXAMINING ATTORNEY

SN 78-510,250. RUSSELL, MICHELLE RENEE, APACHE JUNCTION, AZ. FILED 11-2-2004.

RELUCTANT CHRISTIAN

THE MARK CONSISTS OF STANDARD CHARACTERS WITHOUT CLAIM TO ANY PARTICULAR FONT, STYLE, SIZE, OR COLOR.

NO CLAIM IS MADE TO THE EXCLUSIVE RIGHT TO USE "CHRISTIAN", APART FROM THE MARK AS SHOWN.

FOR WORKSHOPS AND CAMPS FOR ADULTS AND YOUTHS PROVIDING MOTIVATIONAL LEADERSHIP TRAINING BASED ON CHRISTIAN BELIEFS (U.S. CLS. 100, 101 AND 107).

MELVIN AXILBUND, EXAMINING ATTORNEY

CLASS 41—(Continued).

SN 78-510,653. OUTDOOR LIFE NETWORK, L.L.C., STAMFORD, CT. FILED 11-3-2004.

**OUTDOOR
INVESTIGATIONS**

THE MARK CONSISTS OF STANDARD CHARACTERS WITHOUT CLAIM TO ANY PARTICULAR FONT, STYLE, SIZE, OR COLOR.

NO CLAIM IS MADE TO THE EXCLUSIVE RIGHT TO USE "INVESTIGATIONS", APART FROM THE MARK AS SHOWN.

FOR ENTERTAINMENT IN THE NATURE OF ONGOING TELEVISION PROGRAMS FEATURING MYSTERIOUS EVENTS AND PHENOMENA; PRODUCTION AND DISTRIBUTION OF TELEVISION PROGRAMS; PROVIDING INFORMATION AND ENTERTAINMENT VIA A GLOBAL COMPUTER NETWORK RELATED TO AN ONGOING TELEVISION PROGRAM FEATURING MYSTERIOUS EVENTS AND PHENOMENA (U.S. CLS. 100, 101 AND 107).

KIMBERLY FRYE, EXAMINING ATTORNEY

CLASS 41—(Continued).

SN 78-511,254. RAGO, NICHOLAS W., STRATHAM, NH. FILED 11-4-2004.

got homework?

NO CLAIM IS MADE TO THE EXCLUSIVE RIGHT TO USE "HOMEWORK", APART FROM THE MARK AS SHOWN.

FOR PROVIDING AN ONLINE EDUCATIONAL COMPUTER DATABASE TO FACILITATE SCHOOL-TO-HOME COMMUNICATION REGARDING MATTERS SUCH AS HOMEWORK, CLASSROOM ACTIVITIES, SCHOOL ANNOUNCEMENTS AND OTHER RELATED SCHOOL MATTERS (U.S. CLS. 100, 101 AND 107).

FIRST USE 8-1-1998; IN COMMERCE 8-1-1998.
ALICIA COLLINS, EXAMINING ATTORNEY

SN 78-511,404. GIRMUS, RONALD, L., SEDONA, AZ. FILED 11-4-2004.

MathActive

SN 78-510,814. TASTE OF HEAVEN, LLC, BURR RIDGE, IL. FILED 11-3-2004.

TASTE OF HEAVEN

THE MARK CONSISTS OF STANDARD CHARACTERS WITHOUT CLAIM TO ANY PARTICULAR FONT, STYLE, SIZE, OR COLOR.

FOR ENTERTAINMENT SERVICES, NAMELY LIVE PERFORMANCES BY AN ENTERTAINER (U.S. CLS. 100, 101 AND 107).

FIRST USE 9-1-1994; IN COMMERCE 9-1-1994.
BARBARA RUTLAND, EXAMINING ATTORNEY

THE MARK CONSISTS OF STANDARD CHARACTERS WITHOUT CLAIM TO ANY PARTICULAR FONT, STYLE, SIZE, OR COLOR.

FOR EDUCATIONAL SERVICES, NAMELY, CONDUCTING WORKSHOPS AND TRAINING SEMINARS FOR TEACHERS IN THE FIELD OF MATH (U.S. CLS. 100, 101 AND 107).

FIRST USE 1-15-2001; IN COMMERCE 4-15-2001.
MICHAEL TANNER, EXAMINING ATTORNEY

CLASS 41—(Continued).

SN 78-511,634. SKEZAS, AMY, PETALUMA, CA. FILED 11-4-2004.

Building the Golden Body

THE MARK CONSISTS OF STANDARD CHARACTERS WITHOUT CLAIM TO ANY PARTICULAR FONT, STYLE, SIZE, OR COLOR.

FOR EDUCATIONAL SERVICES, NAMELY, CONDUCTING SEMINARS IN THE FIELDS OF SELF IMPROVEMENT, METAPHYSICS, AND HOW TO BE OF SERVICE TO OTHERS (U.S. CLS. 100, 101 AND 107).

JOHN LINCOSKI, EXAMINING ATTORNEY

SN 78-512,681. JUMP ON IN, INC., WESTFORD, MA. FILED 11-7-2004.



NO CLAIM IS MADE TO THE EXCLUSIVE RIGHT TO USE "PARTIES & MORE", APART FROM THE MARK AS SHOWN.

THE COLOR(S) RED, YELLOW, TEAL, PURPLE IS/ARE CLAIMED AS A FEATURE OF THE MARK.

THE MARK CONSISTS OF A PURPLE STYLIZED FIGURINE WITH RED, YELLOW, TEAL AND PURPLE CONFETTI IN BACKGROUND JUMPING INTO STYLIZED LETTERS FEATURING THE WORD "JUMP" IN RED, THE WORD "ON" IN YELLOW, AND THE WORD "IN" IN TEAL.

FOR PROVIDING RECREATION FACILITIES FEATURING INFLATABLE EQUIPMENT AND OTHER PLAY EQUIPMENT, NAMELY, INFLATABLE SLIDES, JUMPERS, OBSTACLE COURSES, AND TRAMPOLINES (U.S. CLS. 100, 101 AND 107).

FIRST USE 2-23-2004; IN COMMERCE 8-23-2004.
WANDA KAY PRICE, EXAMINING ATTORNEY

CLASS 41—(Continued).

SN 78-513,209. CIRCLE R MEDIA, L.L.C., SHREVEPORT, LA. FILED 11-8-2004.



Circle **R** Media

NO CLAIM IS MADE TO THE EXCLUSIVE RIGHT TO USE MEDIA, APART FROM THE MARK AS SHOWN.

THE COLORS BLACK, GRAY, AND RED ARE CLAIMED AS A FEATURE OF THE MARK.

THE COLOR BLACK FADING TO GRAY APPEARS IN THE DESIGN ELEMENT, THE COLOR BLACK APPEARS IN THE WORDS CIRCLE AND MEDIA, AND THE COLOR RED APPEARS IN THE LETTER R THAT IS BETWEEN THE WORDS CIRCLE AND MEDIA.

THE MARK CONSISTS OF A STYLIZED CIRCLE WITH THE LETTER R INSIDE.

FOR VIDEO AND DIGITAL MEDIA PRODUCTION SERVICES, NAMELY PRODUCTION OF COMMERCIALS, SHORT FILMS, AND TRAINING FILMS FOR COMMERCIAL AND INDUSTRIAL USE (U.S. CLS. 100, 101 AND 107).

FIRST USE 1-1-2004; IN COMMERCE 1-1-2004.
LINDA POWELL, EXAMINING ATTORNEY

SN 78-513,466. LASKOW, LEONARD, SANTA ROSA, CA. FILED 11-8-2004.

Awakening Through Love

THE MARK CONSISTS OF STANDARD CHARACTERS WITHOUT CLAIM TO ANY PARTICULAR FONT, STYLE, SIZE, OR COLOR.

FOR EDUCATIONAL SERVICES, NAMELY, CONDUCTING SEMINARS IN THE FIELD OF SPIRITUALITY AND WHOLISTIC HEALING; COURSE MATERIALS MAY BE DISTRIBUTED IN CONNECTION WITH SEMINARS (U.S. CLS. 100, 101 AND 107).

FIRST USE 2-15-2003; IN COMMERCE 9-19-2004.
GINA FINK, EXAMINING ATTORNEY

CLASS 41—(Continued).

SN 78-513,882. DORIO, JULIAN G., ANNAPOLIS, MD. AND GISPERT, PARKER A., ROSWELL, GA. AND SULLIVANT, HENRY P. III, MEMPHIS, TN. FILED 11-9-2004.

CLASS 41—(Continued).

SN 78-516,503. BECKLEY, EDWARD, TAMPA, FL. FILED 11-13-2004.

THE WHIGS

THE POWER OF PRESENCE

THE MARK CONSISTS OF STANDARD CHARACTERS WITHOUT CLAIM TO ANY PARTICULAR FONT, STYLE, SIZE, OR COLOR.

FOR ENTERTAINMENT SERVICES, NAMELY PERFORMANCES BY A LIVE MUSICAL ARTIST AND PROVIDING PRE-RECORDED MUSIC ONLINE AND INFORMATION REGARDING A MUSICAL ARTIST ONLINE VIA A GLOBAL COMPUTER NETWORK (U.S. CLS. 100, 101 AND 107).

FIRST USE 4-23-2001; IN COMMERCE 9-1-2003.
MICHAEL HALL, EXAMINING ATTORNEY

THE MARK CONSISTS OF STANDARD CHARACTERS WITHOUT CLAIM TO ANY PARTICULAR FONT, STYLE, SIZE, OR COLOR.

FOR CONDUCTING WORKSHOPS AND SEMINARS IN THE FIELD OF SPIRITUALITY AND SELF-HELP (U.S. CLS. 100, 101 AND 107).

H. M. FISHER, EXAMINING ATTORNEY

SN 78-516,984. EDUVISOR, INC., DALLAS, TX. FILED 11-15-2004.

SN 78-516,482. RYAN, ANDREW J., WASHINGTON, DC. FILED 11-13-2004.

Edupedia

Hip-Hop Matters!

THE MARK CONSISTS OF STANDARD CHARACTERS WITHOUT CLAIM TO ANY PARTICULAR FONT, STYLE, SIZE, OR COLOR.

NO CLAIM IS MADE TO THE EXCLUSIVE RIGHT TO USE "HIP-HOP", APART FROM THE MARK AS SHOWN.

FOR EDUCATIONAL CONSULTING (U.S. CLS. 100, 101 AND 107).

BRENDAN REGAN, EXAMINING ATTORNEY

THE MARK CONSISTS OF STANDARD CHARACTERS WITHOUT CLAIM TO ANY PARTICULAR FONT, STYLE, SIZE, OR COLOR.

FOR EDUCATIONAL SERVICES, NAMELY, PROVIDING A WEBSITE FOR AUTHORIZED COUNTRIES, STATES, SCHOOL DISTRICTS, COLLEGES AND OTHER EDUCATIONAL INSTITUTIONS THAT ENABLES AUTHORIZED EDUCATORS IN VIRTUAL TEAMS, WITHOUT TRAVEL, TO CREATE AND DELIVER CURRICULUM FOR COURSES FOR GRADES 3-16 IN PUBLIC AND PRIVATE PRIMARY, SECONDARY, AND POST-SECONDARY SCHOOLS, WHICH COURSES INCLUDE GENERAL EDUCATION MATERIALS FOR ACADEMIC OR CAREER AND TECHNOLOGY COURSES AND ARE MADE AVAILABLE TO NATIONS, STATES, SCHOOLS, COLLEGES AND FOR STUDENTS OF ANY AGE (U.S. CLS. 100, 101 AND 107).

KIMBERLY FRYE, EXAMINING ATTORNEY

CLASS 41—(Continued).

SN 78-517,233. FRASHER, KELI, LAS VEGAS, NV. FILED 11-15-2004.

WEB GODDESS

THE MARK CONSISTS OF STANDARD CHARACTERS WITHOUT CLAIM TO ANY PARTICULAR FONT, STYLE, SIZE, OR COLOR.

NO CLAIM IS MADE TO THE EXCLUSIVE RIGHT TO USE WEB, APART FROM THE MARK AS SHOWN.

FOR ENTERTAINMENT SERVICES, NAMELY, PROVIDING VISUAL IMAGES AND ARTICLES IN THE FIELD OF ADULT ENTERTAINMENT VIA A GLOBAL COMPUTER NETWORK, THE INTERNET OR THE WORLD WIDE WEB (U.S. CLS. 100, 101 AND 107).

FIRST USE 4-17-1999; IN COMMERCE 4-17-1999.
CHRIS WELLS, EXAMINING ATTORNEY

CLASS 41—(Continued).

SN 78-518,551. MARTIN, VIRGINIA W., ATLANTA, GA. FILED 11-17-2004.

**Timeline
Productions**

THE MARK CONSISTS OF STANDARD CHARACTERS WITHOUT CLAIM TO ANY PARTICULAR FONT, STYLE, SIZE, OR COLOR.

NO CLAIM IS MADE TO THE EXCLUSIVE RIGHT TO USE "PRODUCTIONS", APART FROM THE MARK AS SHOWN.

FOR PRODUCTION OF VIDEO DISCS FOR OTHERS, NAMELY VIDEO BIOGRAPHIES FOR PERSONAL USE (U.S. CLS. 100, 101 AND 107).

ALINA MORRIS, EXAMINING ATTORNEY

SN 78-517,406. BOY SCOUTS OF AMERICA, IRVING, TX. FILED 11-16-2004.



NO CLAIM IS MADE TO THE EXCLUSIVE RIGHT TO USE "FUTBOL SOCCER", APART FROM THE MARK AS SHOWN.

THE MARK CONSISTS OF AN EAGLE INSIDE A FLEUR-DE-LIS SURROUNDED BY THE WORDS FUTBOL SOCCER SCOUTING ALL ABOVE A SOCCER BALL.

FOR OUTREACH PROGRAM TO RECRUIT HISPANIC YOUTH AND FAMILIES BY COMBINING SOCCER COACHING AND PLAY WITH A YOUTH SERVING ORGANIZATION AND THE DISTRIBUTION OF PAMPHLETS, POSTERS, LESSON PLANS AND CD-ROMS IN CONNECTION THEREWITH (U.S. CLS. 100, 101 AND 107).

FIRST USE 8-25-2004; IN COMMERCE 8-25-2004.
LAURA KOVAISKY, EXAMINING ATTORNEY

SN 78-518,612. RAVINIA FESTIVAL ASSOCIATION, HIGHLAND PARK, IL. FILED 11-17-2004.

ONE SCORE

THE MARK CONSISTS OF STANDARD CHARACTERS WITHOUT CLAIM TO ANY PARTICULAR FONT, STYLE, SIZE, OR COLOR.

OWNER OF U.S. REG. NO. 2,947,948.

NO CLAIM IS MADE TO THE EXCLUSIVE RIGHT TO USE "SCORE", APART FROM THE MARK AS SHOWN.

FOR EDUCATIONAL SERVICES, NAMELY, SEMINARS, LECTURES, PERFORMANCES AND WORKSHOPS TO PROMOTE THE ENJOYMENT OF CLASSICAL MUSIC (U.S. CLS. 100, 101 AND 107).

RAMONA ORTIGA, EXAMINING ATTORNEY

CLASS 41—(Continued).

SN 78-518,738. DVA SPORTS, LLC, SARASOTA, FL. FILED 11-17-2004.



FOR ENTERTAINMENT SERVICES, NAMELY, PROVIDING PROFESSIONAL HOCKEY EXHIBITIONS (U.S. CLS. 100, 101 AND 107).
GRETTA YAO, EXAMINING ATTORNEY

SN 78-518,837. ALEXANDER, MALÉ B., BRIDGEWATER, NJ. FILED 11-17-2004.

**MALÉ ALEXANDER'S
WHAT ARE YOU
THINKING SHOW**

THE MARK CONSISTS OF STANDARD CHARACTERS WITHOUT CLAIM TO ANY PARTICULAR FONT, STYLE, SIZE, OR COLOR.
NO CLAIM IS MADE TO THE EXCLUSIVE RIGHT TO USE "SHOW", APART FROM THE MARK AS SHOWN.
FOR ENTERTAINMENT IN THE NATURE OF A TELEVISION COMEDY SERIES; ENTERTAINMENT IN THE NATURE OF A TELEVISION REALTY SHOW SERIES; ON-GOING TELEVISION PROGRAMS IN THE FIELDS OF COMEDY AND REALITY SHOWS; PRODUCTION OF TELEVISION SHOWS AND PROGRAMS (U.S. CLS. 100, 101 AND 107).
BARBARA BROWN, EXAMINING ATTORNEY

CLASS 41—(Continued).

SN 78-518,955. BOISVERT, MICHAEL E., DELAVAN, WI. FILED 11-17-2004.



FOR ENTERTAINMENT SERVICES IN THE NATURE OF AUTOMOBILE RACING BY A RACING TEAM (U.S. CLS. 100, 101 AND 107).
DOUGLAS LEE, EXAMINING ATTORNEY

SN 78-519,748. INAMED CORPORATION, SANTA BARBARA, CA. FILED 11-18-2004.



OWNER OF U.S. REG. NOS. 2,545,046, 2,944,362 AND OTHERS.
THE COLOR(S) GRAY AND BLACK IS/ARE CLAIMED AS A FEATURE OF THE MARK.
THE COLOR BLACK APPEARS IN THE WORDING AND GRAY APPEARS IN THE BACKGROUND DESIGN.
FOR EDUCATIONAL SERVICES, NAMELY, CONDUCTING CLASSES, WORKSHOPS, TRAINING SEMINARS, AND DISCUSSION FORUMS IN THE FIELDS OF BREAST AUGMENTATION, FACIAL AESTHETICS AND IMPLANTS, MEDICAL DEVICES AND GENERAL COSMETIC SURGERY (U.S. CLS. 100, 101 AND 107).
FIRST USE 11-6-2003; IN COMMERCE 11-6-2003.
IRENE D. WILLIAMS, EXAMINING ATTORNEY

CLASS 41—(Continued).

SN 78-522,070. VINTAGE ADVENTURE, L.L.C., CENTENNIAL, CO. FILED 11-23-2004.

Vintage Adventure

THE MARK CONSISTS OF STANDARD CHARACTERS WITHOUT CLAIM TO ANY PARTICULAR FONT, STYLE, SIZE, OR COLOR.

NO CLAIM IS MADE TO THE EXCLUSIVE RIGHT TO USE "ADVENTURE", APART FROM THE MARK AS SHOWN.

FOR ENTERTAINMENT SERVICES IN THE NATURE OF AN ON-GOING TELEVISION PROGRAM IN THE FIELD OF ARCHAEOLOGY, HISTORY AND EXPLORATION DOCUMENTARIES (U.S. CLS. 100, 101 AND 107).
LAURIE MAYES, EXAMINING ATTORNEY

SN 78-523,882. B.STING FILM LLC, ST MICHAEL, MN. FILED 11-29-2004.

The People's Movie

THE MARK CONSISTS OF STANDARD CHARACTERS WITHOUT CLAIM TO ANY PARTICULAR FONT, STYLE, SIZE, OR COLOR.

NO CLAIM IS MADE TO THE EXCLUSIVE RIGHT TO USE "MOVIE", APART AS SHOWN.

FOR G AND S—ENTERTAINMENT SERVICES IN THE NATURE OF LIVE-ACTION, COMEDY, DRAMA AND ANIMATED TELEVISION SERIES; PRODUCTION OF LIVE-ACTION, COMEDY, DRAMA AND ANIMATED TELEVISION SERIES; PRODUCTION OF LIVE-ACTION, COMEDY, DRAMA AND ANIMATED MOTION PICTURE THEATRICAL FILM SERIES; DISTRIBUTION OF LIVE ACTION, COMEDY, DRAMA AND ANIMATED MOTION PICTURE THEATRICAL FILM SERIES; ENTERTAINMENT IN THE NATURE OF LIVE THEATRICAL PERFORMANCES; PROVIDING ON-LINE INFORMATION VIA AN ELECTRONIC GLOBAL COMPUTER NETWORK IN THE FIELD OF ENTERTAINMENT RELATING SPECIFICALLY TO MUSIC, MOVIES, AND TELEVISION; PROVIDING GENERAL INTEREST NEWS, ENTERTAINMENT, AND EDUCATIONAL INFORMATION VIA A GLOBAL COMPUTER NETWORK; AND PROVIDING INFORMATION FOR AND ACTUAL ENTERTAINMENT VIA ELECTRONIC GLOBAL COMMUNICATIONS NETWORK IN THE NATURE OF LIVE-ACTION, COMEDY, AND DRAMA ON-LINE INTERACTIVE MOVIE CLIPS AND PRODUCTION OF LIVE-ACTION COMEDY, ACTION AND ANIMATED MOTION FILMS FOR DISTRIBUTION VIA A GLOBAL COMPUTER NETWORK (U.S. CLS. 100, 101 AND 107).
ELLEN B. AWRICH, EXAMINING ATTORNEY

CLASS 41—(Continued).

SN 78-523,949. OPERATION BASS, INC, BENTON, KY. FILED 11-29-2004.

WORLD SERIES OF KINGFISH FISHING

THE MARK CONSISTS OF STANDARD CHARACTERS WITHOUT CLAIM TO ANY PARTICULAR FONT, STYLE, SIZE, OR COLOR.

NO CLAIM IS MADE TO THE EXCLUSIVE RIGHT TO USE "KINGFISH FISHING", APART FROM THE MARK AS SHOWN.

FOR ENTERTAINMENT SERVICES, NAMELY, ORGANIZING AND CONDUCTING FISHING TOURNAMENTS AND TELEVISION PROGRAMMING RELATING TO FISHING TOURNAMENTS; ORGANIZING AND CONDUCTING EDUCATIONAL PROGRAMS AND SEMINARS IN THE FIELD OF BOATING AND FISHING (U.S. CLS. 100, 101 AND 107).
WILLIAM P. SHANAHAN, EXAMINING ATTORNEY

SN 78-524,850. FOUNDATION FOR GLOBAL COMMUNITY, PALO ALTO, CA. FILED 11-30-2004.

Global MindShift

THE MARK CONSISTS OF STANDARD CHARACTERS WITHOUT CLAIM TO ANY PARTICULAR FONT, STYLE, SIZE, OR COLOR.

NO CLAIM IS MADE TO THE EXCLUSIVE RIGHT TO USE "GLOBAL", APART FROM THE MARK AS SHOWN.

FOR EDUCATIONAL SERVICES, NAMELY CONDUCTING CLASSES, SEMINARS, CONFERENCES AND WORKSHOPS, AND CLASSES, SEMINARS, CONFERENCES AND WORKSHOPS BROADCAST ON THE INTERNET, IN THE FIELD OF CURRENT EVENTS, THE GLOBAL COMMUNITY AND ENVIRONMENTAL ISSUES, AND DISTRIBUTING COURSE MATERIALS IN CONNECTION THEREWITH (U.S. CLS. 100, 101 AND 107).

FIRST USE 10-1-2003; IN COMMERCE 12-1-2003.
INGRID C. EULIN, EXAMINING ATTORNEY

CLASS 41—(Continued).

SN 78-524,923. SMITH, FERDINAND J., ROCHESTER, NY. FILED 12-1-2004.

SERPENTS IN THE SANCTUARY

THE MARK CONSISTS OF STANDARD CHARACTERS WITHOUT CLAIM TO ANY PARTICULAR FONT, STYLE, SIZE, OR COLOR.
FOR ENTERTAINMENT SERVICES IN THE NATURE OF LIVE PERFORMANCES BY A MUSICAL GROUP (U.S. CLS. 100, 101 AND 107).
ALICIA COLLINS, EXAMINING ATTORNEY

SN 78-524,945. THE INSPIRATIONAL NETWORK, INC., CHARLOTTE, NC. FILED 12-1-2004.

EVERYDAY WOMAN

THE MARK CONSISTS OF STANDARD CHARACTERS WITHOUT CLAIM TO ANY PARTICULAR FONT, STYLE, SIZE, OR COLOR.
NO CLAIM IS MADE TO THE EXCLUSIVE RIGHT TO USE "WOMAN", APART FROM THE MARK AS SHOWN.
FOR ENTERTAINMENT SERVICES, NAMELY, A RELIGIOUS TELEVISION PROGRAM SERIES FEATURING TOPICS OF INTEREST TO WOMEN (U.S. CLS. 100, 101 AND 107).
MIDGE BUTLER, EXAMINING ATTORNEY

SN 78-525,477. LMNO PRODUCTIONS, INC., ENCINO, CA. FILED 12-1-2004.

Wickedly Perfect

THE MARK CONSISTS OF STANDARD CHARACTERS WITHOUT CLAIM TO ANY PARTICULAR FONT, STYLE, SIZE, OR COLOR.
FOR ENTERTAINMENT IN THE NATURE OF ONGOING TELEVISION PROGRAMS IN THE FIELD OF REALITY TELEVISION FEATURING CONTESTANTS COMPETING TO WIN A PRIZE (U.S. CLS. 100, 101 AND 107).
CAROLINE WOOD, EXAMINING ATTORNEY

CLASS 41—(Continued).

SN 78-525,920. WACHHOLZ, JILL, K., CHICAGO, IL. FILED S.R. 12-2-2004; AM. P.R. 7-29-2005.

GroupStir

THE MARK CONSISTS OF STANDARD CHARACTERS WITHOUT CLAIM TO ANY PARTICULAR FONT, STYLE, SIZE, OR COLOR.
FOR TRAINING SERVICES IN THE FIELD OF ORGANIZATIONAL AND INDIVIDUAL DEVELOPMENT; EDUCATIONAL AND ENTERTAINMENT SERVICES, NAMELY, PROVIDING MOTIVATIONAL AND EDUCATIONAL SPEAKERS; PERSONAL COACHING SERVICES IN THE FIELD OF ORGANIZATIONAL AND INDIVIDUAL DEVELOPMENT (U.S. CLS. 100, 101 AND 107).
FIRST USE 2-12-2002; IN COMMERCE 6-1-2002.
ANNE E. GUSTASON, EXAMINING ATTORNEY

SN 78-527,182. YUHAS, STEVE, SAN DIEGO, CA. FILED 12-4-2004.

uniquely conservative talk radio

THE MARK CONSISTS OF STANDARD CHARACTERS WITHOUT CLAIM TO ANY PARTICULAR FONT, STYLE, SIZE, OR COLOR.
NO CLAIM IS MADE TO THE EXCLUSIVE RIGHT TO USE "CONSERVATIVE TALK RADIO", APART FROM THE MARK AS SHOWN.
FOR ENTERTAINMENT SERVICES, NAMELY, PROVIDING A RADIO PROGRAM IN THE FIELD OF CONSERVATIVE TALK RADIO (U.S. CLS. 100, 101 AND 107).
FIRST USE 8-15-2004; IN COMMERCE 8-15-2004.
ANN LINNEHAN, EXAMINING ATTORNEY

CLASS 41—(Continued).

SN 78-528,337. MUNYER, ARTHUR E., CARMEL, CA. FILED 12-7-2004.

The Munyer Method

THE MARK CONSISTS OF STANDARD CHARACTERS WITHOUT CLAIM TO ANY PARTICULAR FONT, STYLE, SIZE, OR COLOR.

NO CLAIM IS MADE TO THE EXCLUSIVE RIGHT TO USE METHOD, APART FROM THE MARK AS SHOWN.

THE NAME IN THE MARK IDENTIFIES A LIVING INDIVIDUAL WHOSE CONSENT IS OF RECORD.

FOR EDUCATIONAL SERVICES, NAMELY, TRAINING PROGRAMS TO DEVELOP SELF-AWARENESS AND WELL BEING (U.S. CLS. 100, 101 AND 107).

KAREN K. BUSH, EXAMINING ATTORNEY

SN 78-529,888. WPC PRODUCTIONS LIMITED, 1/5 IRISH TOWN, GIBRALTAR, FILED 12-9-2004.

PARTYSLOTS

THE MARK CONSISTS OF STANDARD CHARACTERS WITHOUT CLAIM TO ANY PARTICULAR FONT, STYLE, SIZE, OR COLOR.

FOR ENTERTAINMENT SERVICES, NAMELY, PROVIDING ONLINE ENTERTAINMENT IN THE NATURE OF COMPUTER GAMING CONTESTS AND GAMES OF CHANCE (U.S. CLS. 100, 101 AND 107).

FIRST USE 12-14-2004; IN COMMERCE 12-14-2004.

MICHAEL TANNER, EXAMINING ATTORNEY

CLASS 41—(Continued).

SN 78-530,669. COMCAST PROGRAMMING VENTURES II, INC., PHILADELPHIA, PA. FILED 12-10-2004.

A.C.E.: Adventure Competition Entertainment

THE MARK CONSISTS OF STANDARD CHARACTERS WITHOUT CLAIM TO ANY PARTICULAR FONT, STYLE, SIZE, OR COLOR.

NO CLAIM IS MADE TO THE EXCLUSIVE RIGHT TO USE "ENTERTAINMENT", APART FROM THE MARK AS SHOWN.

FOR ENTERTAINMENT SERVICES IN THE NATURE OF TELEVISION PROGRAMMING; PRODUCTION AND DISTRIBUTION OF TELEVISION PROGRAMS; PROVIDING INFORMATION CONCERNING TELEVISION PROGRAMMING VIA A GLOBAL COMPUTER NETWORK (U.S. CLS. 100, 101 AND 107).

YONG KIM, EXAMINING ATTORNEY

SN 78-530,684. COMCAST PROGRAMMING VENTURES II, INC., PHILADELPHIA, PA. FILED 12-10-2004.

ACE Network

THE MARK CONSISTS OF STANDARD CHARACTERS WITHOUT CLAIM TO ANY PARTICULAR FONT, STYLE, SIZE, OR COLOR.

NO CLAIM IS MADE TO THE EXCLUSIVE RIGHT TO USE "NETWORK", APART FROM THE MARK AS SHOWN.

FOR ENTERTAINMENT SERVICES IN THE NATURE OF TELEVISION PROGRAMMING; PRODUCTION AND DISTRIBUTION OF TELEVISION PROGRAMS; PROVIDING INFORMATION CONCERNING TELEVISION PROGRAMMING VIA A GLOBAL COMPUTER NETWORK (U.S. CLS. 100, 101 AND 107).

YONG KIM, EXAMINING ATTORNEY

CLASS 41—(Continued).

SN 78-532,082. CELEBRITY KIDS STUDIOS, LLC, FISHERS, IN. FILED 12-14-2004.



OWNER OF U.S. REG. NO. 2,347,315.
 NO CLAIM IS MADE TO THE EXCLUSIVE RIGHT TO USE "KIDS PORTRAIT STUDIOS", APART FROM THE MARK AS SHOWN.
 THE MARK CONSISTS OF A STYLIZED VERSION OF THE PHRASE "CELEBRITY KIDS PORTRAIT STUDIOS" SURROUNDED BY CONFETTI.
 FOR PORTRAIT PHOTOGRAPHY SERVICES (U.S. CLS. 100, 101 AND 107).
 FIRST USE 3-15-2002; IN COMMERCE 3-15-2002.
 ANDREA K. NADELMAN, EXAMINING ATTORNEY

CLASS 41—(Continued).

SN 78-533,799. HERKIMER COUNTY COMMUNITY COLLEGE, HERKIMER, NY. FILED 12-16-2004.

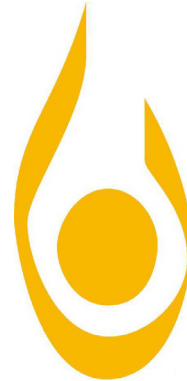

THE COLOR YELLOW IS CLAIMED AS A FEATURE OF THE MARK.
 THE COLOR YELLOW APPEARS IN THE FLAME DESIGN.
 THE MARK CONSISTS OF A YELLOW FLAME FOR EDUCATIONAL SERVICES, NAMELY, PROVIDING COURSES OF INSTRUCTION AT THE COLLEGE LEVEL (U.S. CLS. 100, 101 AND 107).
 FIRST USE 9-0-2004; IN COMMERCE 9-0-2004.
 SUNG IN, EXAMINING ATTORNEY

SN 78-533,761. HERKIMER COUNTY COMMUNITY COLLEGE, HERKIMER, NY. FILED 12-16-2004.

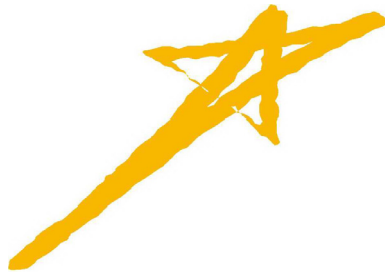

THE COLOR YELLOW IS CLAIMED AS A FEATURE OF THE MARK.
 THE COLOR YELLOW APPEARS IN THE STAR DESIGN. THE MARK CONSISTS OF A YELLOW STAR.
 FOR EDUCATIONAL AND ENTERTAINMENT SERVICES, NAMELY ORGANIZING AND CONDUCTING COLLEGE ATHLETIC PROGRAMS AND EXHIBITIONS (U.S. CLS. 100, 101 AND 107).
 FIRST USE 9-0-2004; IN COMMERCE 9-0-2004.
 SUNG IN, EXAMINING ATTORNEY

SN 78-533,848. HERKIMER COUNTY COMMUNITY COLLEGE, HERKIMER, NY. FILED 12-16-2004.



OWNER OF U.S. REG. NOS. 1,822,631 AND 2,731,411.
 NO CLAIM IS MADE TO THE EXCLUSIVE RIGHT TO USE "COMMUNITY COLLEGE", APART FROM THE MARK AS SHOWN.
 THE COLORS YELLOW AND GREEN ARE CLAIMED AS A FEATURE OF THE MARK.
 THE COLOR YELLOW APPEARS IN THE TOP FLAME DESIGN AND THE VERTICAL LINES AFTER COUNTY AND BEFORE COLLEGE; AND THE COLOR GREEN APPEARS IN THE MIDDLE FLAME DESIGN AND THE LETTERING.
 THE MARK CONSISTS OF THE NAME HERKIMER COUNTY COMMUNITY COLLEGE AND A FLAME DESIGN.
 SEC. 2(F) AS TO HERKIMER COUNTY.
 FOR EDUCATIONAL SERVICES, NAMELY, PROVIDING COURSES OF INSTRUCTION AT THE COLLEGE LEVEL (U.S. CLS. 100, 101 AND 107).
 FIRST USE 9-0-2004; IN COMMERCE 9-0-2004.
 SUNG IN, EXAMINING ATTORNEY

CLASS 41—(Continued).

SN 78-533,895. HERKIMER COUNTY COMMUNITY COLLEGE, HERKIMER, NY. FILED 12-16-2004.



OWNER OF U.S. REG. NOS. 1,822,631 AND 2,731,411. THE COLORS YELLOW AND GREEN ARE CLAIMED AS A FEATURE OF THE MARK.

THE COLOR YELLOW APPEARS IN THE STAR DESIGN, AND THE COLOR GREEN APPEARS IN THE LETTERING. THE MARK CONSISTS OF THE NAME HERKIMER GENERALS AND A STAR DESIGN.

SEC. 2(F) AS TO HERKIMER. FOR EDUCATIONAL AND ENTERTAINMENT SERVICES, NAMELY, ORGANIZING AND CONDUCTING ATHLETIC PROGRAMS AND EXHIBITIONS (U.S. CLS. 100, 101 AND 107).

FIRST USE 9-0-2004; IN COMMERCE 9-0-2004. SUNG IN, EXAMINING ATTORNEY

CLASS 41—(Continued).

SN 78-534,973. KATHRYN P. BALCH, SAN FRANCISCO, CA. FILED 12-17-2004.



NO CLAIM IS MADE TO THE EXCLUSIVE RIGHT TO USE BOOK, APART FROM THE MARK AS SHOWN. FOR BOOK-LENDING SERVICE FOR CHILDREN (U.S. CLS. 100, 101 AND 107).

FIRST USE 12-17-2004; IN COMMERCE 12-17-2004. AMY HELLA, EXAMINING ATTORNEY

SN 78-534,613. TEXAS ROLLERGIRLS, LLC, AUSTIN, TX. FILED 12-17-2004.



NO CLAIM IS MADE TO THE EXCLUSIVE RIGHT TO USE TEXAS, APART FROM THE MARK AS SHOWN. THE STIPPLING IS A FEATURE OF THE MARK.

THE COLORS RED, WHITE AND BLACK ARE CLAIMED AS A FEATURE OF THE MARK.

THE COLOR RED APPEARS IN THE STAR DESIGN AND WORDING "ROCK N' ROLLERDERBY"; THE COLOR BLACK APPEARS IN THE BACKGROUND AND STIPPLING; AND THE COLOR WHITE APPEARS IN THE WORDING TEXAS ROLLERGIRLS.

FOR ENTERTAINMENT EXHIBITION INVOLVING CONTEST BETWEEN TEAMS OF ROLLER SKATERS (U.S. CLS. 100, 101 AND 107).

FIRST USE 4-9-2003; IN COMMERCE 4-9-2003. STEVEN R. FINE, EXAMINING ATTORNEY

SN 78-535,639. Z&F CONSULTING, INC., WAYNE, PA. FILED 12-20-2004.



THE MARK CONSISTS OF STANDARD CHARACTERS WITHOUT CLAIM TO ANY PARTICULAR FONT, STYLE, SIZE, OR COLOR.

FOR PROVIDING NEWSLETTERS IN THE FIELD OF ENGINEERING CONSULTING AND SERVICES VIA EMAIL OR THE INTERNET (U.S. CLS. 100, 101 AND 107).

FIRST USE 10-20-2004; IN COMMERCE 10-28-2004. JASON ROTH, EXAMINING ATTORNEY

CLASS 41—(Continued).

SN 78-535,677. HDNET LLC, DALLAS, TX. FILED 12-20-2004.

CLASS 41—(Continued).

SN 78-536,048. GERICO MARKETING SERVICES, INC., OMAHA, NE. FILED 12-21-2004.

**LIKE YOU'VE NEVER
SEEN BEFORE**

**CUISINE ON THE
GREEN**

THE MARK CONSISTS OF STANDARD CHARACTERS WITHOUT CLAIM TO ANY PARTICULAR FONT, STYLE, SIZE, OR COLOR.

FOR ENTERTAINMENT IN THE NATURE OF ONGOING TELEVISION PROGRAMS IN THE FIELDS OF SPORTS, NEWS, CONCERTS, MUSIC VIDEOS, DOCUMENTARIES, AND MOVIES (U.S. CLS. 100, 101 AND 107).

FIRST USE 11-3-2003; IN COMMERCE 11-3-2003.
GINA FINK, EXAMINING ATTORNEY

THE MARK CONSISTS OF STANDARD CHARACTERS WITHOUT CLAIM TO ANY PARTICULAR FONT, STYLE, SIZE, OR COLOR.

FOR ORGANIZING AND CONDUCTING AN EXHIBITION ON THE SUBJECT OF, AND FEATURING, FOOD, DINING, BEVERAGES, RECIPES, KITCHEN ACCESSORIES AND COOKING ACCESSORIES (U.S. CLS. 100, 101 AND 107).

FIRST USE 6-0-2003; IN COMMERCE 6-0-2003.
KEVIN DINALLO, EXAMINING ATTORNEY

SN 78-535,948. CAPE EDUCATION, INC., BUCKINGHAM, VA. FILED 12-21-2004.

SN 78-536,255. MIRAGE RESORTS, INCORPORATED, LAS VEGAS, NV. FILED 12-21-2004.

CAPE EDUCATION

FALLEN OAK

THE MARK CONSISTS OF STANDARD CHARACTERS WITHOUT CLAIM TO ANY PARTICULAR FONT, STYLE, SIZE, OR COLOR.

OWNER OF U.S. REG. NO. 2,910,554.
NO CLAIM IS MADE TO THE EXCLUSIVE RIGHT TO USE "EDUCATION", APART FROM THE MARK AS SHOWN.

FOR PROFESSIONAL EDUCATIONAL SERVICES, NAMELY, CONDUCTING LIVE CLASSES, SEMINARS, CONFERENCES AND WORKSHOPS, PRESENTING ONLINE TEXT, AUDIO AND VIDEO COURSES, AND PROVIDING HOME STUDY COURSES IN THE FIELDS OF INSURANCE, LAW, REAL ESTATE AND ACCOUNTING (U.S. CLS. 100, 101 AND 107).

FIRST USE 5-31-1992; IN COMMERCE 5-31-1992.
GIANCARLO CASTRO, EXAMINING ATTORNEY

THE MARK CONSISTS OF STANDARD CHARACTERS WITHOUT CLAIM TO ANY PARTICULAR FONT, STYLE, SIZE, OR COLOR.

FOR GOLF CLUB SERVICES; GOLF TOURNAMENTS; GOLF CADDIE SERVICES; RENTAL OF GOLF EQUIPMENT (U.S. CLS. 100, 101 AND 107).

AMY HELLA, EXAMINING ATTORNEY

CLASS 41—(Continued).

SN 78-536,287. GAME SHOW NETWORK, LLC, SANTA MONICA, CA. FILED 12-21-2004.

CLASS 41—(Continued).

SN 78-536,506. GOLDEN AGE FITNESS, INC., WOODSTOCK, GA. FILED 12-21-2004.

**TRIPLE CROWN OF
CRAPS**

GOLDEN AGE FITNESS

THE MARK CONSISTS OF STANDARD CHARACTERS WITHOUT CLAIM TO ANY PARTICULAR FONT, STYLE, SIZE, OR COLOR.

NO CLAIM IS MADE TO THE EXCLUSIVE RIGHT TO USE CRAPS, APART FROM THE MARK AS SHOWN.

FOR ENTERTAINMENT SERVICES, NAMELY, PROVIDING A TELEVISION PROGRAM AND CONDUCTING CONTESTS AND EVENTS IN THE FIELD OF CRAPS (U.S. CLS. 100, 101 AND 107).

ALEXANDER L. POWERS, EXAMINING ATTORNEY

THE MARK CONSISTS OF STANDARD CHARACTERS WITHOUT CLAIM TO ANY PARTICULAR FONT, STYLE, SIZE, OR COLOR.

NO CLAIM IS MADE TO THE EXCLUSIVE RIGHT TO USE "FITNESS", APART FROM THE MARK AS SHOWN.

FOR HEALTH CLUB SERVICES, NAMELY PROVIDING INSTRUCTION AND EQUIPMENT IN THE FIELD OF PHYSICAL EXERCISE (U.S. CLS. 100, 101 AND 107).

JENNIFER WILLISTON, EXAMINING ATTORNEY

SN 78-536,489. FANNY, PAUL, HOOKSETT, NH. FILED 12-21-2004.

SN 78-536,517. FANNY, PAUL, HOOKSETT, NH. FILED 12-21-2004.

**IMPAIRING A GOOD
PHYSICAL
CONSCIENCE IS
ANATOMICALLY
INCORRECT, FOR
NATURAL HEALTH IS
OUR BIRTHRIGHT**

**THE H.D.A.,
ACCREDITING THE
WORLD'S ONLY
HYGIOPHYSICIANED
DOCTORS IN
ORTHOPHYSIOBIOTI
CS,
VITABIOHYGIENICS,
HYGIOPHYSICS,
PSYCHOHYGIENICS,
PATHOGNOMY,
HYGIOBIOLOGY,
ORTHOPATHOLOGY,
HYGIOPHYSIOLOGY,
AND FASTOLOGY.**

THE MARK CONSISTS OF STANDARD CHARACTERS WITHOUT CLAIM TO ANY PARTICULAR FONT, STYLE, SIZE, OR COLOR.

FOR EDUCATION SERVICES IN THE HEALTH FIELD, NAMELY, PLANNING AND CONDUCTING CLASSES AND COURSES IN NATURAL HYGIENE, NATURAL HEALTH, NUTRITION, AND RELIGION AND RELIGIOUS INSTRUCTIONAL SERVICES (U.S. CLS. 100, 101 AND 107).

FIRST USE 11-15-2004; IN COMMERCE 11-15-2004.
G. MAYERSCHOFF, EXAMINING ATTORNEY

THE MARK CONSISTS OF STANDARD CHARACTERS WITHOUT CLAIM TO ANY PARTICULAR FONT, STYLE, SIZE, OR COLOR.

FOR EDUCATION SERVICES IN THE HEALTH FIELD, NAMELY, PLANNING AND CONDUCTING CLASSES AND COURSES IN NATURAL HYGIENE, NATURAL HEALTH, NUTRITION, AND RELIGION AND RELIGIOUS INSTRUCTIONAL SERVICES (U.S. CLS. 100, 101 AND 107).

FIRST USE 11-15-2004; IN COMMERCE 11-15-2004.
ANGELA M. MICHELI, EXAMINING ATTORNEY

CLASS 41—(Continued).

SN 78-536,884. MASON, ROBERT J., CAMBY, IN. AND CRIDER, TRAVIS B., BLOOMINGTON, IN. FILED 12-22-2004.

CLASS 41—(Continued).

SN 78-537,296. MARTINEZ, DEBRA, JACKSON, MO. AND MARTINEZ, GABRIEL, JACKSON, MO. AND MARTINEZ, TIMOTHY, JACKSON, MO. FILED 12-22-2004.

**Betrayed With A
Kiss**

CIRCLESLIDE

THE MARK CONSISTS OF STANDARD CHARACTERS WITHOUT CLAIM TO ANY PARTICULAR FONT, STYLE, SIZE, OR COLOR.

FOR ENTERTAINMENT, NAMELY, LIVE MUSICAL PERFORMANCES BY A MUSICAL BAND (U.S. CLS. 100, 101 AND 107).

GIANCARLO CASTRO, EXAMINING ATTORNEY

THE MARK CONSISTS OF STANDARD CHARACTERS WITHOUT CLAIM TO ANY PARTICULAR FONT, STYLE, SIZE, OR COLOR.

FOR ENTERTAINMENT SERVICES IN THE NATURE OF LIVE PERFORMANCES BY A MUSICAL GROUP (U.S. CLS. 100, 101 AND 107).

FIRST USE 9-0-2003; IN COMMERCE 9-0-2003.
LOURDES AYALA, EXAMINING ATTORNEY

SN 78-536,959. MEADWESTVACO CORPORATION, STAMFORD, CT. FILED 12-22-2004.

SN 78-537,331. FOX, TERRY, BELVIDERE, IL. FILED 12-22-2004.



**UNDERGROUND ARTS
CONNECTION**

OWNER OF U.S. REG. NOS. 1,204,022 AND 1,213,923.
NO CLAIM IS MADE TO THE EXCLUSIVE RIGHT TO USE "COOPERATIVE FOREST MANAGEMENT", APART FROM THE MARK AS SHOWN.

FOR EDUCATIONAL SERVICES, NAMELY PROVIDING A PROGRAM IN FOREST MANAGEMENT (U.S. CLS. 100, 101 AND 107).

FIRST USE 5-22-2004; IN COMMERCE 5-22-2004.
JUDITH HELFMAN, EXAMINING ATTORNEY

THE MARK CONSISTS OF STANDARD CHARACTERS WITHOUT CLAIM TO ANY PARTICULAR FONT, STYLE, SIZE, OR COLOR.

NO CLAIM IS MADE TO THE EXCLUSIVE RIGHT TO USE "ARTS", APART FROM THE MARK AS SHOWN.

FOR ENTERTAINMENT IN THE NATURE OF VISUAL AND AUDIO PERFORMANCES, NAMELY, LIVE MUSICAL PERFORMANCES, GYMNASTIC, DANCE, THEATER, AND POETRY PERFORMANCES; THEATER PRODUCTIONS; PRODUCTION OF THEATRICAL PRODUCTIONS AND STAGE PLAYS (U.S. CLS. 100, 101 AND 107).

FIRST USE 3-15-2004; IN COMMERCE 3-15-2004.
DOUGLAS LEE, EXAMINING ATTORNEY

CLASS 41—(Continued).

SN 78-537,335. FOX, TERRY, BELVIDERE, IL. FILED 12-22-2004.

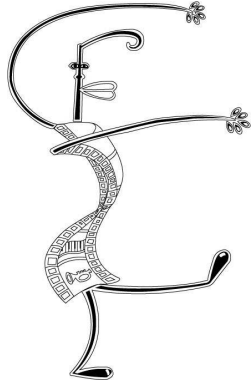

THE MARK CONSISTS OF A MISCELLANEOUS CHARACTER.

FOR ENTERTAINMENT IN THE NATURE OF VISUAL AND AUDIO PERFORMANCES, NAMELY, LIVE MUSICAL PERFORMANCES, GYMNASTIC, DANCE, THEATER, AND POETRY PERFORMANCES; THEATER PRODUCTIONS; PRODUCTION OF THEATRICAL PRODUCTIONS AND STAGE PLAYS (U.S. CLS. 100, 101 AND 107).

FIRST USE 3-15-2004; IN COMMERCE 3-15-2004.
DOUGLAS LEE, EXAMINING ATTORNEY

CLASS 41—(Continued).

SN 78-537,527. CORDAIRE & PARTNERS COMPANY INC., ZONA 3, PANAMA CITY, PANAMA, FILED 12-23-2004.

POPULAR POKER

THE MARK CONSISTS OF STANDARD CHARACTERS WITHOUT CLAIM TO ANY PARTICULAR FONT, STYLE, SIZE, OR COLOR.

NO CLAIM IS MADE TO THE EXCLUSIVE RIGHT TO USE "POKER", APART FROM THE MARK AS SHOWN.

FOR BETTING SERVICES (U.S. CLS. 100, 101 AND 107).

FIRST USE 1-0-2002; IN COMMERCE 1-0-2002.
ELLEN B. AWRICH, EXAMINING ATTORNEY

SN 78-537,697. PUBLIC RADIO INTERNATIONAL, INC., MINNEAPOLIS, MN. FILED 12-23-2004.

SN 78-537,494. BEYER, BROOKE A. JR., NEW YORK, NY. FILED 12-22-2004.

PRIMARY SOURCES**THE WEDDING CRASHER**

THE MARK CONSISTS OF STANDARD CHARACTERS WITHOUT CLAIM TO ANY PARTICULAR FONT, STYLE, SIZE, OR COLOR.

FOR ENTERTAINMENT SERVICES IN THE NATURE OF AN ON-GOING REALITY BASED TELEVISION PROGRAM (U.S. CLS. 100, 101 AND 107).

ROBERT LORENZO, EXAMINING ATTORNEY

THE MARK CONSISTS OF STANDARD CHARACTERS WITHOUT CLAIM TO ANY PARTICULAR FONT, STYLE, SIZE, OR COLOR.

FOR RADIO PROGRAMMING AND DISTRIBUTION OF RADIO PROGRAMMING FOR OTHERS; RADIO ENTERTAINMENT PRODUCTION; RADIO ENTERTAINMENT SERVICES, NAMELY RADIO PROGRAMS FEATURING OPINIONS AND EDITORIALS ON SUBJECT OF GENERAL INTEREST (U.S. CLS. 100, 101 AND 107).

FIRST USE 6-23-2004; IN COMMERCE 6-23-2004.
PAUL F. GAST, EXAMINING ATTORNEY

CLASS 41—(Continued).

SN 78-537,754. TILLMAN, MICHAEL, DBA AMDECON, IRVING, TX. FILED 12-23-2004.

CLASS 41—(Continued).

SN 78-537,929. LAWRENCE, COWARD, ENGLEWOOD, NJ. FILED 12-23-2004.

ASK THE KING

AMDECON

THE MARK CONSISTS OF STANDARD CHARACTERS WITHOUT CLAIM TO ANY PARTICULAR FONT, STYLE, SIZE, OR COLOR.

FOR EDUCATIONAL SERVICES, NAMELY, PROVIDING COURSES OF INSTRUCTION ON CLEANING SERVICES RELATING TO THE COLLECTION AND DISPOSAL OF BIOHAZARDOUS WASTE, HUMAN OR ANIMAL REMAINS OR BODY FLUIDS, AND THE DECONTAMINATION, DEODORIZING AND DISINFECTING OF SITES WHERE SUCH WASTE AND REMAINS ARE LOCATED (U.S. CLS. 100, 101 AND 107).

FIRST USE 3-23-2004; IN COMMERCE 3-23-2004.
JEFF DEFORD, EXAMINING ATTORNEY

THE MARK CONSISTS OF STANDARD CHARACTERS WITHOUT CLAIM TO ANY PARTICULAR FONT, STYLE, SIZE, OR COLOR.

FOR ENTERTAINMENT SERVICES IN THE NATURE OF ON GOING RADIO, TELEVISION AND INTERNET PROGRAMS FEATURING A DISCUSSION OF PERSONAL RELATIONSHIPS, NEWS, SPORTS, FASHION, MUSIC, COMEDY, POLITICS, ENTERTAINMENT, CELEBRITIES, CURRENT EVENTS AND TOPICS OF GENERAL INTEREST RELATED THERETO (U.S. CLS. 100, 101 AND 107).

MICHELE SWAIN, EXAMINING ATTORNEY

SN 78-538,003. ADOBE SYSTEMS INCORPORATED, SAN JOSE, CA. FILED 12-23-2004.

SN 78-537,857. GALLOWAY/TOUCHBERRY PRODUCTIONS, LLC, NORTHBROOK, IL. FILED 12-23-2004.

ADOBE



NO CLAIM IS MADE TO THE EXCLUSIVE RIGHT TO USE "PRODUCTIONS", APART FROM THE MARK AS SHOWN.

THE COLOR(S) BLACK, YELLOW, AND GRAY IS/ARE CLAIMED AS A FEATURE OF THE MARK.

THE MARK CONSISTS OF A DIRECTOR'S CHAIR WITH A CAT TAIL (IN BLACK) WITH THE LETTERS BG (IN YELLOW), A SLASH MARK (IN GRAY), THE WORD CAT (IN GRAY) AND THE WORD PRODUCTIONS (IN GRAY).

FOR PRODUCTION AND DISTRIBUTION OF MOTION PICTURES (U.S. CLS. 100, 101 AND 107).

FIRST USE 11-0-2004; IN COMMERCE 11-0-2004.
SEAN DWYER, EXAMINING ATTORNEY

THE MARK CONSISTS OF STANDARD CHARACTERS WITHOUT CLAIM TO ANY PARTICULAR FONT, STYLE, SIZE, OR COLOR.

OWNER OF U.S. REG. NOS. 1,475,793, 1,482,233 AND OTHERS.

FOR EDUCATIONAL AND TRAINING SERVICES, NAMELY CLASSROOM TRAINING, ONLINE TRAINING, WEB-BASED TRAINING, AND VIDEO TRAINING IN THE FIELDS OF COMPUTER SOFTWARE, DESKTOP PUBLISHING, DIGITAL PUBLISHING, ELECTRONIC PUBLISHING, GRAPHIC DESIGN, BUSINESS DOCUMENT AND FORMS CREATION, AND AUTOMATION OF BUSINESS DOCUMENT AND FORMS PROCESSING AND WORKFLOW; EDUCATIONAL SERVICES, NAMELY, ARRANGING PROFESSIONAL WORKSHOPS AND TRAINING COURSES, CONDUCTING CLASSES, SEMINARS, CONFERENCES, AND WORKSHOPS IN THE FIELDS OF COMPUTER SOFTWARE, DESKTOP PUBLISHING, DIGITAL PUBLISHING, ELECTRONIC PUBLISHING, GRAPHIC DESIGN, BUSINESS DOCUMENT AND FORMS CREATION, AND AUTOMATION OF BUSINESS DOCUMENT AND FORMS PROCESSING AND WORKFLOW (U.S. CLS. 100, 101 AND 107).

FIRST USE 0-0-1995; IN COMMERCE 0-0-1995.
ALLISON SCHRODY, EXAMINING ATTORNEY

CLASS 41—(Continued).

SN 78-538,459. ASK ASSOCIATES SHARING KNOWLEDGE, INC., DBA ASK ASSOCIATES, BOYNTON BEACH, FL. FILED 12-27-2004.

CLASS 41—(Continued).

SN 78-539,101. LOGGHE, KYLE, SEATTLE, WA. AND FRANZ, TIM, SEATTLE, WA. FILED 12-28-2004.

COLAB PLANNING SERIES

THE MARK CONSISTS OF STANDARD CHARACTERS WITHOUT CLAIM TO ANY PARTICULAR FONT, STYLE, SIZE, OR COLOR.

NO CLAIM IS MADE TO THE EXCLUSIVE RIGHT TO USE "PLANNING SERIES", APART FROM THE MARK AS SHOWN.

FOR PROVIDING TRAINING TO DEVELOP INNOVATIVE SOLUTIONS FOR SATISFYING ORGANIZATIONAL OR COMMUNITY NEEDS WITHIN THE NONPROFIT SUB-SECTOR (U.S. CLS. 100, 101 AND 107).

FIRST USE 0-0-2002; IN COMMERCE 0-0-2002.
CHARLES JOYNER, EXAMINING ATTORNEY

VERONA

THE MARK CONSISTS OF STANDARD CHARACTERS WITHOUT CLAIM TO ANY PARTICULAR FONT, STYLE, SIZE, OR COLOR.

FOR ENTERTAINMENT SERVICES, NAMELY, LIVE PERFORMANCES BY A MUSICAL GROUP (U.S. CLS. 100, 101 AND 107).

FIRST USE 6-14-1999; IN COMMERCE 6-14-1999.
ELIZABETH PIGNATELLO, EXAMINING ATTORNEY

SN 78-538,819. MINNESOTA PUBLIC RADIO, ST. PAUL, MN. FILED 12-28-2004.

SN 78-539,138. J.R. MCDADE COMPANY, INC., SCOTTSDALE, AZ. FILED 12-28-2004.

REMINDING YOU THAT ALL MUSIC WAS ONCE NEW

THE MARK CONSISTS OF STANDARD CHARACTERS WITHOUT CLAIM TO ANY PARTICULAR FONT, STYLE, SIZE, OR COLOR.

FOR ENTERTAINMENT SERVICES IN THE NATURE OF ON-GOING RADIO PROGRAMS FEATURING INFORMATION ABOUT COMPOSERS, MUSIC, AND LIVE MUSICAL EVENTS; AND ENTERTAINMENT SERVICES, NAMELY PROVIDING RADIO PROGRAMMING AND INFORMATION FEATURING INFORMATION ABOUT COMPOSERS, MUSIC AND LIVE MUSICAL EVENTS VIA A GLOBAL COMPUTER NETWORK (U.S. CLS. 100, 101 AND 107).

FIRST USE 7-3-2000; IN COMMERCE 7-3-2000.
KAREN BRACEY, EXAMINING ATTORNEY

DINE & DESIGN

THE MARK CONSISTS OF STANDARD CHARACTERS WITHOUT CLAIM TO ANY PARTICULAR FONT, STYLE, SIZE, OR COLOR.

FOR EDUCATION SERVICES, NAMELY, CONDUCTING CLASSES, SEMINARS, CONFERENCES AND WORKSHOPS IN THE FIELD OF CULINARY ARTS, INTERIOR DESIGN AND HOME REMODELING AND CONSTRUCTION AND DISTRIBUTING COURSE MATERIALS IN CONNECTION THEREWITH; ENTERTAINMENT SERVICES IN THE NATURE OF HOME REMODELING AND CONSTRUCTION AND CULINARY ARTS EXHIBITIONS (U.S. CLS. 100, 101 AND 107).

FIRST USE 11-0-2004; IN COMMERCE 11-0-2004.
ANDREW BENZMILLER, EXAMINING ATTORNEY

CLASS 41—(Continued).

SN 78-539,836. RELIASOFT CORPORATION, TUCSON, AZ.
FILED 12-29-2004.

CLASS 41—(Continued).

SN 78-539,868. MOOLAH PLACE, L.P., ST. LOUIS, MO.
FILED 12-29-2004.

**Master the Subject,
Master the Tools**

MOOLAH LANES

THE MARK CONSISTS OF STANDARD CHARACTERS WITHOUT CLAIM TO ANY PARTICULAR FONT, STYLE, SIZE, OR COLOR.

FOR EDUCATIONAL SERVICES, NAMELY, CONDUCTING SEMINARS IN THE FIELD OF RELIABILITY ENGINEERING AND THE USE OF ASSOCIATED SOFTWARE TOOLS, AND DISTRIBUTING COURSE MATERIALS IN CONNECTION THEREWITH (U.S. CLS. 100, 101 AND 107).

FIRST USE 9-0-1997; IN COMMERCE 11-0-1997.
JOHN SCHUYLER YARD, EXAMINING ATTORNEY

THE MARK CONSISTS OF STANDARD CHARACTERS WITHOUT CLAIM TO ANY PARTICULAR FONT, STYLE, SIZE, OR COLOR.

NO CLAIM IS MADE TO THE EXCLUSIVE RIGHT TO USE "LANES", APART FROM THE MARK AS SHOWN. FOR ENTERTAINMENT SERVICES IN THE NATURE OF PROVIDING FACILITIES FOR BOWLING (U.S. CLS. 100, 101 AND 107).

FIRST USE 6-27-2004; IN COMMERCE 6-27-2004.
DAYNA BROWNE, EXAMINING ATTORNEY

SN 78-541,301. FREES, WILLIAM, A., LIVINGSTON, NJ.
FILED 1-3-2005.

SN 78-539,859. MOOLAH PLACE, L.P., ST. LOUIS, MO.
FILED 12-29-2004.

MOOLAH THEATRE

tizbit

THE MARK CONSISTS OF STANDARD CHARACTERS WITHOUT CLAIM TO ANY PARTICULAR FONT, STYLE, SIZE, OR COLOR.

NO CLAIM IS MADE TO THE EXCLUSIVE RIGHT TO USE "THEATRE", APART FROM THE MARK AS SHOWN. FOR MOVIE THEATRE SERVICES (U.S. CLS. 100, 101 AND 107).

FIRST USE 10-6-2004; IN COMMERCE 10-6-2004.
DAYNA BROWNE, EXAMINING ATTORNEY

THE MARK CONSISTS OF STANDARD CHARACTERS WITHOUT CLAIM TO ANY PARTICULAR FONT, STYLE, SIZE, OR COLOR.

FOR PUBLISHING BOOKS FOR CHILDREN (U.S. CLS. 100, 101 AND 107).

FIRST USE 11-1-2004; IN COMMERCE 11-1-2004.
WILLIAM BRECKENFELD, EXAMINING ATTORNEY

CLASS 41—(Continued).

SN 78-541,481. COX, RYAN MICHAEL, BOTHELL, WA. AND COX, MICHAEL WILLIAM, BOTHELL, WA. FILED 1-3-2005.

Gift of Prophecy

THE MARK CONSISTS OF STANDARD CHARACTERS WITHOUT CLAIM TO ANY PARTICULAR FONT, STYLE, SIZE, OR COLOR.

FOR ENTERTAINMENT NAMELY, LIVE PERFORMANCES BY A MUSICAL BAND (U.S. CLS. 100, 101 AND 107).

FIRST USE 9-1-2003; IN COMMERCE 7-27-2004.
INGA ERVIN, EXAMINING ATTORNEY

SN 78-581,885. JACKSON HOLE FILM FESTIVAL, INC., WILSON, WY. FILED 3-7-2005.

jacksonholefilmfestival 

OWNER OF U.S. REG. NO. 2,872,951.

NO CLAIM IS MADE TO THE EXCLUSIVE RIGHT TO USE JACKSON HOLE FILM FESTIVAL, APART FROM THE MARK AS SHOWN.

THE MARK CONSISTS IN PART OF FOUR-LEAF DESIGN FORMING A SQUARE.

FOR ENTERTAINMENT SERVICES, NAMELY, ORGANIZING A FILM FESTIVAL IN INTERNATIONAL CLASS 41 (U.S. CLS. 100, 101 AND 107).

FIRST USE 7-8-2004; IN COMMERCE 7-8-2004.
GENE MACIOL, EXAMINING ATTORNEY

SN 78-582,853. ATARI INTERACTIVE, INC., BEVERLY, MA. FILED 3-8-2005.

ACCESS ATARI

THE MARK CONSISTS OF STANDARD CHARACTERS WITHOUT CLAIM TO ANY PARTICULAR FONT, STYLE, SIZE, OR COLOR.

THE ENGLISH TRANSLATION OF THE JAPANESE WORDING "ATARI" IS "SUCCESS" OR "LUCK".

FOR PROVIDING NEWSLETTERS IN THE FIELD OF INTERACTIVE GAMING VIA EMAIL (U.S. CLS. 100, 101 AND 107).

FIRST USE 11-17-2004; IN COMMERCE 11-17-2004.
ANDREA K. NADELMAN, EXAMINING ATTORNEY

CLASS 41—(Continued).

SN 78-583,510. 20 MINUTES TO FITNESS, L.L.C., CLAYTON, MO. FILED 3-9-2005.



OWNER OF U.S. REG. NO. 2,879,735.

THE COLOR(S) BLUE AND ORANGE/YELLOW IS/ARE CLAIMED AS A FEATURE OF THE MARK.

THE MARK CONSISTS OF THE NUMERAL 20 IS THE COLOR ORANGE/YELLOW SURROUNDED BY A BLUE OVAL BACKGROUND AND AN ORANGE/YELLOW OVAL BORDER THAT CULMINATES IN A SWIRLING SWOOSH. THE WORDS MINUTES TO FITNESS ARE BELOW IN BLUE AND IN ALL CAPITAL LETTERS.

FOR HEALTH CLUB SERVICES, NAMELY PROVIDING INSTRUCTION AND EQUIPMENT IN THE FIELD OF PHYSICAL EXERCISE FOR THE PURPOSE OF WEIGHT REDUCTION (U.S. CLS. 100, 101 AND 107).

FIRST USE 2-3-2003; IN COMMERCE 2-3-2003.
ELLEN BURNS, EXAMINING ATTORNEY

SN 78-604,739. PURCELL ENTERPRISES, INC., HILTON HEAD ISLAND, SC. FILED 4-8-2005.

LINKS

THE MARK CONSISTS OF STANDARD CHARACTERS WITHOUT CLAIM TO ANY PARTICULAR FONT, STYLE, SIZE, OR COLOR.

OWNER OF U.S. REG. NOS. 1,656,785 AND 1,993,681.
SEC. 2(F).

FOR ONLINE PUBLICATIONS, NAMELY, ELECTRONIC PUBLICATIONS PERTAINING TO GOLF AND LIFESTYLES (U.S. CLS. 100, 101 AND 107).

FIRST USE 8-2-1995; IN COMMERCE 8-2-1995.
ANGELA M. MICHELI, EXAMINING ATTORNEY

CLASS 41—(Continued).

SN 78-621,589. BELCASTRO, ELAINE D., ALLENTOWN, PA. AND BELCASTRO-ALBANESE, VERONIKA (NIKA), ALLENTOWN, PA. FILED 5-2-2005.



THE LINING SHOWN IN THE DRAWING IS A FEATURE OF THE MARK AND THE STIPPLING SHOWN IN THE DRAWING IS A FEATURE OF THE MARK.

THE NAMES TERRA COTTA POTS AND TWIG DO NOT IDENTIFY LIVING INDIVIDUALS.

THE MARK CONSISTS OF THE MARK CONSISTS, IN PART, OF A CRACKED TERRA COTTA POT WITH A SUNFLOWER GROWING OUT OF IT AND STAWBERRIES REPLACING THE LETTER "O" IN THE TEXT "MRS. TERRA COTTA POTS & TWIG".

FOR ENTERTAINMENT IN THE NATURE OF LIVE PROFESSIONAL STORYTELLING AND PERFORMANCES OF STORIES USING PROPS, MUSIC, PUPPETS, CHARACTERIZATIONS, SINGING, COMPOSING, DIRECTING AND DANCING; CONDUCTING EDUCATIONAL WORKSHOPS IN THE FIELD OF STORYTELLING, WRITING STORIES AND CRAFTING AND PERFORMING (U.S. CLS. 100, 101 AND 107).

FIRST USE 9-1-1995; IN COMMERCE 10-18-1996.
BILL DAWE, EXAMINING ATTORNEY

SN 78-650,169. SUNSHINE PUBLICATIONS, INC., BONITA SPRINGS, FL. FILED 6-14-2005.

LET'S DO LUNCH

THE MARK CONSISTS OF STANDARD CHARACTERS WITHOUT CLAIM TO ANY PARTICULAR FONT, STYLE, SIZE, OR COLOR.

OWNER OF U.S. REG. NO. 2,820,513.
FOR PRODUCTION OF TELEVISION AND RADIO PROGRAMS (U.S. CLS. 100, 101 AND 107).

RONALD MCMORROW, EXAMINING ATTORNEY

CLASS 41—(Continued).

SN 79-004,510. DR. JOHANNES GASSER, BERNE, SWITZERLAND, FILED 8-5-2004.

Ressourciv

THE MARK CONSISTS OF STANDARD CHARACTERS WITHOUT CLAIM TO ANY PARTICULAR FONT, STYLE, SIZE, OR COLOR.

PRIORITY DATE OF 2-5-2004 IS CLAIMED.

OWNER OF INTERNATIONAL REGISTRATION 0830937 DATED 8-5-2004, EXPIRES 8-5-2014.

FOR EDUCATION SERVICES, NAMELY, ADMINISTERING AND CONDUCTING A TRAINING INSTITUTE IN DEVELOPING SPECIAL NEEDS CURRICULA AND GUIDANCE; EDUCATION SERVICES, NAMELY, DEVELOPING SPECIAL NEEDS CURRICULA AND GUIDANCE PROGRAMS, AND PROVIDING TRAINING AND CONTINUING TRAINING FEATURING A SPECIAL NEEDS CURRICULA (U.S. CLS. 100, 101 AND 107).
TEJBIR SINGH, EXAMINING ATTORNEY

SN 79-006,207. CAMILLA SUNDE, NORWAY, FILED 5-28-2004.

The Green Children

PRIORITY DATE OF 5-26-2004 IS CLAIMED.

OWNER OF INTERNATIONAL REGISTRATION 0835710 DATED 5-28-2004, EXPIRES 5-28-2014.

FOR ENTERTAINMENT SERVICES, NAMELY, LIVE, TELEVISED AND MOVIE APPEARANCES BY ONE OR MORE PROFESSIONAL ENTERTAINERS; MOTION PICTURE FILM PRODUCTION (U.S. CLS. 100, 101 AND 107).
STEVEN R. FINE, EXAMINING ATTORNEY

CLASS 42—SCIENTIFIC, COMPUTER AND LEGAL SERVICES

SN 75-701,880. CLOAKWARE CORPORATION, KANATA, ONTARIO M5H 3Z7, CANADA, FILED 5-10-1999.

CLOAKWARE

OWNER OF CANADA REG. NO. TMA535592, DATED 10-24-2000, EXPIRES 10-24-2015.

FOR COMPUTER SOFTWARE DEVELOPMENT FOR OTHERS (U.S. CLS. 100 AND 101).

MICHAEL WEBSTER, EXAMINING ATTORNEY

SN 75-864,509. COOL THINGS WITH COMPUTERS, INC., ENGLEWOOD, CO. FILED 12-6-1999.

EDISC

FOR PRINTING AND GRAPHIC ART DESIGN SERVICES (U.S. CLS. 100 AND 101).

FIRST USE 5-6-1999; IN COMMERCE 7-1-1999.

JENNIFER KRISP, EXAMINING ATTORNEY

CLASS 42—(Continued).

SN 75-922,147. MILLENNIUM DIGITAL MEDIA, LLC, ST. LOUIS, MO. FILED 2-17-2000.

US.NET

SEC. 2(F).

FOR COMPUTER SERVICES, NAMELY, CREATING AND MAINTAINING WEB SITES FOR OTHERS ON A COMPUTER SERVER FOR A GLOBAL COMPUTER INFORMATION NETWORK; CONSULTING SERVICES FACILITATING ACCESS TO A GLOBAL COMPUTER INFORMATION NETWORK, NAMELY, TECHNICAL ASSISTANCE IN MATTERS RANGING FROM EQUIPMENT TO SOFTWARE AND NETWORK CONFIGURATION TO WEB SITE DEVELOPMENT (U.S. CLS. 100 AND 101).

DOMINIC J. FERRAIUOLO, EXAMINING ATTORNEY

SN 76-020,611. OPERATION KIDS FOUNDATION, BLUFFDALE, UT. FILED 4-6-2000.



OWNER OF U.S. REG. NOS. 2,528,339, 2,769,497 AND 2,901,898.

NO CLAIM IS MADE TO THE EXCLUSIVE RIGHT TO USE "KIDS", APART FROM THE MARK AS SHOWN.

FOR CHARITABLE FUNDRAISING SERVICES DEDICATED TO HELPING THE LIVES OF CHILDREN BY FUNDING ACTIVITIES AND PROGRAMS THAT TEACH THE DANGERS OF PORNOGRAPHY ON THE INTERNET (U.S. CLS. 100 AND 101).

FIRST USE 1-20-2000; IN COMMERCE 1-20-2000.
SUSAN HAYASH, EXAMINING ATTORNEY

SN 76-020,878. OPERATION KIDS FOUNDATION, BLUFFDALE, UT. FILED 4-6-2000.

OK OPERATION KIDS

OWNER OF U.S. REG. NOS. 2,528,339, 2,769,497 AND 2,901,898.

NO CLAIM IS MADE TO THE EXCLUSIVE RIGHT TO USE "KIDS", APART FROM THE MARK AS SHOWN.

FOR PROMOTING PUBLIC AWARENESS OF THE NEED FOR ACTIVITIES, PROGRAMS AND CHARITIES THAT ARE DESIGNED TO BENEFIT CHILDREN (U.S. CLS. 100 AND 101).

FIRST USE 1-20-2000; IN COMMERCE 1-20-2000.
SUSAN HAYASH, EXAMINING ATTORNEY

CLASS 42—(Continued).

SN 76-038,094. RECTOR, EDWIN, ALEXANDRIA, VA. FILED 5-1-2000.

?.COM

FOR COMPUTER SERVICES, NAMELY PROVIDING SEARCH ENGINES FOR OBTAINING DATA ON A GLOBAL COMPUTER NETWORK; PROVIDING INFORMATION ON A WIDE VARIETY OF TOPICS VIA GLOBAL COMPUTER NETWORK (U.S. CLS. 100 AND 101).

FIRST USE 4-18-2000; IN COMMERCE 4-21-2000.
KATHLEEN M. VANSTON, EXAMINING ATTORNEY

SN 76-145,632. FIRSTEGG, LLC, LOUISVILLE, KY. FILED 10-13-2000.

FIRSTEGG

FOR COMPUTER SERVICES, NAMELY, DESIGNING, MAINTAINING, AND HOSTING WEB SITES FOR OTHERS (U.S. CLS. 100 AND 101).

FIRST USE 2-0-2000; IN COMMERCE 2-0-2000.
ELLEN B. AWRICH, EXAMINING ATTORNEY

SN 76-240,483. NETWORK STAFFING SERVICES, INC., DALLAS, TX. FILED 4-12-2001.

TECHNIKI INFORMATICA

THE WORDING "TECHNIKI" IS TRANSLATED IN TO ENGLISH AS "TECHNIQUES." THE WORDING "INFORMATICA" HAS NO ENGLISH TRANSLATION.

FOR COMPUTER SERVICES, NAMELY, PROVIDING NETWORK, SOFTWARE AND HARDWARE CONSULTING, COMPUTER PROGRAMMING AND WEB PAGE DESIGN FOR OTHERS (U.S. CLS. 100 AND 101).

FIRST USE 5-23-1996; IN COMMERCE 5-23-1996.
SAMUEL E. SHARPER JR., EXAMINING ATTORNEY

CLASS 42—(Continued).

SN 76-270,939. PEGASUS SOLUTIONS, INC., DALLAS, TX. FILED 6-13-2001.

PEGASUSCENTRAL

FOR APPLICATION SERVICE PROVIDER FOR THE HOTEL INDUSTRY FEATURING DATABASE MANAGEMENT SOFTWARE USED FOR MAKING MULTI-PROPERTY RESERVATIONS, DATABASE MANAGEMENT SOFTWARE FOR MANAGING HOTEL RESERVATIONS, CHECK-IN, CHECK-OUT, HOUSEKEEPING, NIGHT AUDIO AND FOLIO MANAGEMENT, SOFTWARE FOR PROVIDING AN INTERFACE BETWEEN A HOTEL AND A CENTRAL RESERVATION SYSTEM, DATABASE SOFTWARE FOR MANAGING GUEST LEDGER CHARGES FOR ROOMS AND IN-ROOM SERVICES SUCH AS TELEPHONES, DRY CLEANING, IN-ROOM MOVIES, COMPUTER E-COMMERCE SOFTWARE TO ALLOW USERS TO PERFORM ELECTRONIC HOTEL RESERVATIONS VIA A GLOBAL COMPUTER NETWORK, DATABASE MANAGEMENT SOFTWARE USED IN SALES AND CATERING FOR MANAGING BANQUETS AND OTHER EVENTS, POINT-OF-SALE TRANSACTION SOFTWARE FOR IN-PROPERTY RESTAURANTS AND BARS, FITNESS CENTERS, AND SHOPS, AND BACK-OFFICE OPERATING SOFTWARE FOR PREPARING PROFIT AND LOSS STATEMENTS, BALANCE SHEETS, INVENTORY CONTROL RECORDS, ACCOUNTS PAYABLE AND RECEIVABLE RECORDS AND OTHER ACCOUNTING FUNCTIONS (U.S. CLS. 100 AND 101).

FIRST USE 5-0-2001; IN COMMERCE 5-0-2001.
KATHERINE STOIDES, EXAMINING ATTORNEY

CLASS 42—(Continued).

SN 76-362,455. ZERONE, INC., WASHINGTON, DC. FILED 1-24-2002.



FOR INFORMATION TECHNOLOGY SERVICES FOR OTHERS, NAMELY, DESIGN, DEVELOPMENT AND INTEGRATION OF COMPUTER SYSTEMS AND NETWORKS FOR OTHERS; COMPUTER SYSTEMS ANALYSIS; DEVELOPMENT OF NEW TECHNOLOGY FOR OTHERS IN THE FIELD OF COMPUTER SOFTWARE AND HARDWARE; TESTING, ANALYSIS AND EVALUATION OF COMPUTER SOFTWARE PRODUCTS OF OTHERS; COMPUTER PROJECT MANAGEMENT SERVICES; DATA AUTOMATION AND COLLECTION SERVICE USING PROPRIETARY SOFTWARE TO EVALUATE, ANALYZE AND COLLECT DATA; COMPUTER DATABASE DESIGN FOR OTHERS; COMPUTER SERVICES, NAMELY, DESIGNING WEB SITES FOR OTHERS; COMPUTER SYSTEMS ANALYSIS TO SECURITY PURPOSES; AND COMPUTER PROGRAMMING FOR OTHERS (U.S. CLS. 100 AND 101).

FIRST USE 6-6-1994; IN COMMERCE 6-6-1994.
MONIQUE MILLER, EXAMINING ATTORNEY

SN 76-362,454. ZERONE, INC., WASHINGTON, DC. FILED 1-24-2002.

ZERONE

FOR INFORMATION TECHNOLOGY SERVICES FOR OTHERS, NAMELY, DESIGN, DEVELOPMENT AND INTEGRATION OF COMPUTER SYSTEMS AND NETWORKS FOR OTHERS; COMPUTER SYSTEMS ANALYSIS; DEVELOPMENT OF NEW TECHNOLOGY FOR OTHERS IN THE FIELD OF COMPUTER SOFTWARE AND HARDWARE; TESTING, ANALYSIS AND EVALUATION OF COMPUTER SOFTWARE PRODUCTS OF OTHERS; COMPUTER PROJECT MANAGEMENT SERVICES; DATA AUTOMATION AND COLLECTION SERVICE USING PROPRIETARY SOFTWARE TO EVALUATE, ANALYZE AND COLLECT DATA; COMPUTER DATABASE DESIGN FOR OTHERS; COMPUTER SERVICES, NAMELY, DESIGNING WEB SITES FOR OTHERS; COMPUTER SYSTEMS ANALYSIS TO SECURITY PURPOSES; AND COMPUTER PROGRAMMING FOR OTHERS (U.S. CLS. 100 AND 101).

FIRST USE 10-5-1983; IN COMMERCE 10-11-1983.
MONIQUE MILLER, EXAMINING ATTORNEY

SN 76-405,752. FLORIDA PUBLIC RELATIONS ASSOCIATION, SARASOTA, FL. FILED 5-6-2002.



NO CLAIM IS MADE TO THE EXCLUSIVE RIGHT TO USE "CERTIFIED" AND "PR COUNSELOR", APART FROM THE MARK AS SHOWN.

FOR ACCREDITATION SERVICES, NAMELY, DEVELOPING, EVALUATING, AND TESTING STANDARDS FOR SENIOR MEMBERS ENGAGED IN PUBLIC RELATIONS COUNSELING AND OTHER PUBLIC RELATIONS SERVICES AND ACTIVITIES FOR THE PURPOSE OF ACCREDITATION (U.S. CLS. 100 AND 101).

FIRST USE 1-0-1999; IN COMMERCE 7-0-1999.
CHRISTOPHER ADKINS, EXAMINING ATTORNEY

CLASS 42—(Continued).

SN 76-497,267. STEGANOS GMBH, FRANKFURT, FED REP GERMANY, FILED 3-14-2003.

STEGANOS

OWNER OF ERPN CMNTY TM OFC REG. NO. 002322196, DATED 1-14-2003, EXPIRES 9-18-2011.

IN ANCIENT GREEK, THE TERM "STEGANOS" MEANS "COVERED."

FOR CREATION, DESIGN, MAINTENANCE AND UPDATE OF COMPUTER SOFTWARE IN THE FIELDS OF DATA ENCRYPTION AND DATA DECRYPTION, INTERNET ANONYMITY AND PREVENTION AND DESTRUCTION OF DIGITAL TRACES AND SECURING AND PROTECTING COMPUTER SYSTEMS, NETWORKS, DATA AND APPLICATIONS; CREATION, DESIGN, MAINTENANCE AND UPDATE OF TUNING SOFTWARE, CREATION, DESIGN, MAINTENANCE AND UPDATE OF BACK-UP SOFTWARE, DESIGN, MAINTENANCE AND IMPLEMENTATION OF NETWORK MANAGEMENT, MONITORING AND SECURITY SYSTEMS, TECHNICAL CONSULTANCY FOR THE AFOREMENTIONED SERVICES; TECHNICAL SUPPORT FOR THE AFOREMENTIONED SERVICES; PROVIDING ONLINE NEWS AND INFORMATION IN THE FIELDS OF TUNING SOFTWARE, BACK-UP SOFTWARE, DATA ENCRYPTION AND DATA DECRYPTION, INTERNET ANONYMITY AND PREVENTION AND DESTRUCTION OF DIGITAL TRACES, SECURING AND PROTECTING COMPUTER SYSTEMS, NETWORKS, DATA AND APPLICATIONS (U.S. CLS. 100 AND 101).

CYNTHIA SLOAN, EXAMINING ATTORNEY

SN 76-499,174. VAAGE, LAUREN, DAVIS, CA. FILED 3-20-2003.

INTERIOR PERFORMANCE

NO CLAIM IS MADE TO THE EXCLUSIVE RIGHT TO USE "INTERIOR", APART FROM THE MARK AS SHOWN. FOR DESIGN SERVICES, NAMELY, ARCHITECTURAL AND INTERIOR DESIGN (U.S. CLS. 100 AND 101).

FIRST USE 3-31-2002; IN COMMERCE 3-31-2002.

CATHERINE CAIN, EXAMINING ATTORNEY

SN 76-501,425. AVANTICA, MENLO PARK, CA. FILED 3-26-2003.

AVANTICA

FOR COMPUTER SERVICES, NAMELY, DESIGNING AND IMPLEMENTING NETWORK WEBSITES; TECHNICAL SUPPORT SERVICES, NAMELY, TROUBLESHOOTING OF COMPUTER HARDWARE AND SOFTWARE PROBLEMS; CONSULTING SERVICES IN THE FIELD OF DESIGN, SELECTION, IMPLEMENTATION AND USE OF COMPUTER HARDWARE AND SOFTWARE SYSTEMS FOR OTHERS; CONSULTING SERVICES IN THE FIELD OF DESIGN, SELECTION, IMPLEMENTATION AND USE OF BUSINESS SOFTWARE SYSTEMS FOR OTHERS; PROVIDING QUALITY ASSURANCE SERVICES IN THE FIELD OF BUSINESS SOFTWARE; INTEGRATION OF COMPUTER SYSTEMS AND NETWORKS; CONSULTING SERVICES IN THE FIELD OF COMPUTER DATABASE DESIGN, NETWORK ARCHITECTURE AND WEB DESIGN (U.S. CLS. 100 AND 101).

FIRST USE 7-1-2000; IN COMMERCE 7-1-2000.

KELLY BOULTON, EXAMINING ATTORNEY

CLASS 42—(Continued).

SN 76-529,352. TESTMARCX ASSOCIATES, INC., LAS VEGAS, NV. FILED 7-14-2003.

TESTMARCX

FOR ENGINEERING SERVICES; ENGINEERING CONSULTATION SERVICES, NAMELY, PROVIDING CONSULTATION IN THE DESIGN OF MECHANICAL, PLUMBING, ELECTRICAL CLIMATE CONTROL, BUILDING MANAGEMENT, SMOKE CONTROL, FIRE ALARM, FIRE PROTECTION, LIFE SAFETY, ENERGY, INDOOR ENVIRONMENTAL AIR QUALITY, BUILDING AND ARCHITECTURAL SYSTEMS AND PROCESSES; BUILDING INSPECTIONS SERVICES NOT IN THE COURSE OF CONSTRUCTION, NAMELY INSPECTIONS OF MECHANICAL, PLUMBING, INFRASTRUCTURAL, STRUCTURAL, ELECTRICAL, CLIMATE CONTROL, BUILDING MANAGEMENT, SMOKE CONTROL, FIRE ALARM, FIRE PROTECTION, ENERGY, POWER, COMMUNICATION NETWORKS, SECURITY/CARD ACCESS, LIFE SAFETY, INDOOR ENVIRONMENTAL AIR QUALITY, BUILDING AND ARCHITECTURAL SYSTEMS AND PROCESSES (U.S. CLS. 100 AND 101).

FIRST USE 6-23-2003; IN COMMERCE 6-23-2003.

CHRISTOPHER BUONGIORNO, EXAMINING ATTORNEY

SN 76-541,203. BOLT SYSTEMS, INC., BETHESDA, MD. FILED 8-20-2003.



NO CLAIM IS MADE TO THE EXCLUSIVE RIGHT TO USE NETWORK SERVICES, APART FROM THE MARK AS SHOWN.

THE COLORS WHITE, BLUE, GREEN, BROWN, BLACK, OFF-WHITE AND GRAY ARE CLAIMED AS A FEATURE OF THE MARK.

DESIGN OF A LIGHTHOUSE, OFF-WHITE TOWER WITH BLACK WINDOW AND LANTERN, AND ADJACENT LIGHT KEEPER'S DWELLING, OFF-WHITE WITH BLACK AND GRAY SHADED ROOF, ON A ROCKY POINT, WITH BROWN AND GREEN BASE SPOTTED WITH BLACK, AND A BLACK AND GRAY SHADED ROCKY CRAG ON THE TIP, WITH THE WORDS SAFEPORT NETWORK SERVICES BESIDE THE DESIGN, ALL ON A BLUE RECTANGULAR BACKGROUND.

FOR HOSTING THE WEB SITES OF OTHERS ON A COMPUTER SERVER FOR A GLOBAL COMPUTER NETWORK; CREATING AND MAINTAINING WEB SITES FOR OTHERS; DESIGNING AND IMPLEMENTING NETWORK WEB PAGES AND WEB SITES FOR OTHERS (U.S. CLS. 100 AND 101).

FIRST USE 6-0-1995; IN COMMERCE 6-0-1995.

TRACY CROSS, EXAMINING ATTORNEY

CLASS 42—(Continued).

SN 76-542,884. CASEKNOWLEDGE, L.L.C., CHICAGO, IL.
FILED 9-5-2003.

CASEKNOWLEDGE

FOR LITIGATION MANAGEMENT SERVICES (U.S.
CLS. 100 AND 101).
FIRST USE 6-2-2003; IN COMMERCE 6-2-2003.
ADA HAN, EXAMINING ATTORNEY

SN 76-545,745. METAVANTE CORPORATION, BROWN
DEER, WI. FILED 9-22-2003.

ADVISORWEB

FOR PROVIDING TEMPORARY USE OF NON-DOWN-
LOADABLE WEB-BASED DATA ACCESS AND DELIV-
ERY SOFTWARE THAT PROVIDES REAL-TIME
ACCESS TO PORTFOLIO AND DATA ACTIVITY FOR
INVESTMENT ADVISORS (U.S. CLS. 100 AND 101).
FIRST USE 1-0-1998; IN COMMERCE 1-0-1998.
JOSETTE BEVERLY, EXAMINING ATTORNEY

SN 76-552,209. UBISTOR, INC., SCHAUMBURG, IL. FILED 9-
29-2003.

UBISTOR

FOR PROVIDING ONLINE BACKUP AND RETRIEVAL
OF DATA IN PARTICULAR CONFIGURING CUSTOMERS'
SERVERS FOR ONLINE BACKUP AND RETRIEVAL OF
THEIR DATA; COMPUTER CONSULTING SERVICES,
NAMELY, COMPUTER DISASTER RECOVERY PLAN-
NING, TESTING AND CUSTOM PROGRAMMING OF
COMPUTER SOFTWARE FOR OTHERS; CONSULTING
SERVICES IN THE FIELD OF DESIGN, SELECTION,
IMPLEMENTATION AND USE OF COMPUTER HARD-
WARE AND SOFTWARE SYSTEMS FOR OTHERS (U.S.
CLS. 100 AND 101).
FIRST USE 4-0-2002; IN COMMERCE 4-0-2002.
TRICIA THOMPSON, EXAMINING ATTORNEY

SN 76-555,312. EPCGLOBAL, INC., LAWRENCEVILLE, NJ.
FILED 10-10-2003.

EPCGLOBAL

FOR DEVELOPING, PROMULGATING AND REGULATING
STANDARDS FOR AUTOMATED IDENTIFICATION AND
ELECTRONIC COMMERCE INVOLVING GOODS AND
SERVICES (U.S. CLS. 100 AND 101).
FIRST USE 9-17-2003; IN COMMERCE 9-17-2003.
G. MAYERSCHOFF, EXAMINING ATTORNEY

CLASS 42—(Continued).

SN 76-555,847. EPCGLOBAL, INC., LAWRENCEVILLE, NJ.
FILED 10-10-2003.



NO CLAIM IS MADE TO THE EXCLUSIVE RIGHT TO
USE "EPC", APART FROM THE MARK AS SHOWN.

FOR DEVELOPING, PROMULGATING AND REGULATING
STANDARDS FOR AUTOMATED IDENTIFICATION AND
ELECTRONIC COMMERCE INVOLVING GOODS AND
SERVICES (U.S. CLS. 100 AND 101).
FIRST USE 9-17-2003; IN COMMERCE 9-17-2003.
G. MAYERSCHOFF, EXAMINING ATTORNEY

SN 76-568,160. DEUTSCHE TELEKOM AG, BONN, 53113,
FED REP GERMANY, FILED 12-22-2003.

T-SPIRIT

THE MARK CONSISTS OF STANDARD CHARACTERS
WITHOUT CLAIM TO ANY PARTICULAR FONT, STYLE,
SIZE, OR COLOR.

PRIORITY CLAIMED UNDER SEC. 44(D) ON FED REP
GERMANY APPLICATION NO. 30331487738, FILED 6-26-
2003, REG. NO. 30331487, DATED 1-26-2004, EXPIRES 6-30-
2013.

OWNER OF U.S. REG. NOS. 2,156,145, 2,596,825 AND
OTHERS.

FOR COMPUTER PROGRAMMING SERVICES FOR
OTHERS; RENTAL OF SOFTWARE AND HARDWARE
FOR ONLINE ACCESS; SERVICES OF AN INTERNET
TRUST CENTER, NAMELY, ASSURANCE AND ADMIN-
ISTRATION OF DIGITAL KEYS AND/OR DIGITAL
CERTIFICATES; WEB PAGE HOSTING SERVICES;
COMPUTER SERVICES, NAMELY, CREATING IN-
DEXES OF INFORMATION AVAILABLE ON COM-
PUTER NETWORKS; CONSULTING SERVICES IN THE
FIELD OF DESIGN, SELECTION, IMPLEMENTATION
AND USE OF COMPUTER HARDWARE AND SOFT-
WARE SYSTEMS FOR OTHERS; INSTALLATION,
MAINTENANCE AND REPAIR OF COMPUTER SOFT-
WARE (U.S. CLS. 100 AND 101).
CHRIS WELLS, EXAMINING ATTORNEY

CLASS 42—(Continued).

SN 76-581,900. WEST PUBLISHING CORPORATION, EAGAN, MN. FILED 3-19-2004.

CLASS 42—(Continued).

SN 76-585,661. STORM COMMERCE, INC., NEW YORK, NY. FILED 4-5-2004.

WESTCHECK.COM

THE MARK CONSISTS OF STANDARD CHARACTERS WITHOUT CLAIM TO ANY PARTICULAR FONT, STYLE, SIZE, OR COLOR.

OWNER OF U.S. REG. NO. 2,233,890.
FOR PROVIDING AN ONLINE AUTOMATED LEGAL CITATION SERVICE VIA THE INTERNET THAT VERIFIES THE STATUS OF CITATIONS EXTRACTED FROM A LEGAL DOCUMENT OR IN A CITATIONS LIST CREATED MANUALLY (U.S. CLS. 100 AND 101).

FIRST USE 4-24-2004; IN COMMERCE 4-24-2004.
MICHAEL ENGEL, EXAMINING ATTORNEY

Storm Portal

THE MARK CONSISTS OF STANDARD CHARACTERS WITHOUT CLAIM TO ANY PARTICULAR FONT, STYLE, SIZE, OR COLOR.

NO CLAIM IS MADE TO THE EXCLUSIVE RIGHT TO USE "PORTAL", APART FROM THE MARK AS SHOWN.

FOR COMPUTER SERVICES, NAMELY, PROVIDING TEMPORARY USE OF NON-DOWNLOADABLE COMPUTER SOFTWARE FOR PROGRAMMING AND SOFTWARE DEVELOPMENT; FOR CREATING, MANAGING AND INTEGRATING ONLINE COMMERCIAL EXCHANGES AND FOR SUPPLY CHAIN MANAGEMENT; FOR INTEGRATION AND SHARED USE OF INFORMATION FROM DIFFERENT SOFTWARE APPLICATIONS, PLATFORMS, OPERATING SYSTEMS OR DATABASES; FOR DEVELOPING, DEPLOYING, MANAGING, PUBLISHING, AND INTEGRATING ONLINE BUSINESS TRANSACTIONS, AND FOR ONLINE TRANSACTION PROCESSING (U.S. CLS. 100 AND 101).

KELLEY WELLS, EXAMINING ATTORNEY

SN 76-585,667. STORM COMMERCE, INC., NEW YORK, NY. FILED 4-5-2004.

SN 76-585,475. COSWORTH TECHNOLOGY, INC., NOVI, MI. FILED 4-5-2004.

DESIGNWORKS

THE MARK CONSISTS OF STANDARD CHARACTERS WITHOUT CLAIM TO ANY PARTICULAR FONT, STYLE, SIZE, OR COLOR.

FOR ENGINEERING SERVICES, NAMELY CALIBRATION, MODELING, DEVELOPMENT, VALIDATION AND TESTING IN THE AUTOMOTIVE FIELD (U.S. CLS. 100 AND 101).

FIRST USE 10-29-2003; IN COMMERCE 10-29-2003.
JENNIFER CHICOSKI, EXAMINING ATTORNEY

Storm Server

THE MARK CONSISTS OF STANDARD CHARACTERS WITHOUT CLAIM TO ANY PARTICULAR FONT, STYLE, SIZE, OR COLOR.

NO CLAIM IS MADE TO THE EXCLUSIVE RIGHT TO USE "SERVER", APART FROM THE MARK AS SHOWN.

FOR COMPUTER SERVICES, NAMELY, PROVIDING TEMPORARY USE OF NON-DOWNLOADABLE COMPUTER SOFTWARE FOR PROGRAMMING AND SOFTWARE DEVELOPMENT; FOR CREATING, MANAGING AND INTEGRATING ONLINE COMMERCIAL EXCHANGES AND FOR SUPPLY CHAIN MANAGEMENT; FOR INTEGRATION AND SHARED USE OF INFORMATION FROM DIFFERENT SOFTWARE APPLICATIONS, PLATFORMS, OPERATING SYSTEMS OR DATABASES; FOR DEVELOPING, DEPLOYING, MANAGING, PUBLISHING, AND INTEGRATING ONLINE BUSINESS TRANSACTIONS, AND FOR ONLINE TRANSACTION PROCESSING (U.S. CLS. 100 AND 101).

KELLEY WELLS, EXAMINING ATTORNEY

CLASS 42—(Continued).

SN 76-585,669. STORM COMMERCE, INC., NEW YORK, NY. FILED 4-5-2004.

Storm Technology

THE MARK CONSISTS OF STANDARD CHARACTERS WITHOUT CLAIM TO ANY PARTICULAR FONT, STYLE, SIZE, OR COLOR.

NO CLAIM IS MADE TO THE EXCLUSIVE RIGHT TO USE "TECHNOLOGY", APART FROM THE MARK AS SHOWN.

FOR COMPUTER SERVICES, NAMELY, PROVIDING TEMPORARY USE OF NON-DOWNLOADABLE COMPUTER SOFTWARE FOR PROGRAMMING AND SOFTWARE DEVELOPMENT; FOR CREATING, MANAGING AND INTEGRATING ONLINE COMMERCIAL EXCHANGES AND FOR SUPPLY CHAIN MANAGEMENT; FOR INTEGRATION AND SHARED USE OF INFORMATION FROM DIFFERENT SOFTWARE APPLICATIONS, PLATFORMS, OPERATING SYSTEMS OR DATABASES; FOR DEVELOPING, DEPLOYING, MANAGING, PUBLISHING, AND INTEGRATING ONLINE BUSINESS TRANSACTIONS, AND FOR ONLINE TRANSACTION PROCESSING (U.S. CLS. 100 AND 101).

KELLEY WELLS, EXAMINING ATTORNEY



SN 76-586,002. FOX ROTHSCHILD LLP, PHILADELPHIA, PA. FILED 4-9-2004.

SMALL FIRM FEEL...BIG FIRM RESULTS

THE MARK CONSISTS OF STANDARD CHARACTERS WITHOUT CLAIM TO ANY PARTICULAR FONT, STYLE, SIZE, OR COLOR.

FOR LEGAL SERVICES (U.S. CLS. 100 AND 101).

FIRST USE 6-30-2002; IN COMMERCE 6-30-2002.

CHARLES L. JENKINS, EXAMINING ATTORNEY



SN 76-586,003. FOX ROTHSCHILD LLP, PHILADELPHIA, PA. FILED 4-9-2004.

FOX ROTHSCHILD

THE MARK CONSISTS OF STANDARD CHARACTERS WITHOUT CLAIM TO ANY PARTICULAR FONT, STYLE, SIZE, OR COLOR.

FOR LEGAL SERVICES (U.S. CLS. 100 AND 101).

FIRST USE 4-1-2003; IN COMMERCE 4-1-2003.

CHARLES L. JENKINS, EXAMINING ATTORNEY

CLASS 42—(Continued).

SN 76-586,546. INDYMAC BANK, F.S.B., PASADENA, CA. FILED 4-13-2004.

C-MITS

THE MARK CONSISTS OF STANDARD CHARACTERS WITHOUT CLAIM TO ANY PARTICULAR FONT, STYLE, SIZE, OR COLOR.

OWNER OF U.S. REG. NOS. 2,190,744, 2,196,613 AND 2,460,794.

FOR PROVIDING TEMPORARY USE OF NON-DOWNLOADABLE SOFTWARE VIA THE INTERNET FOR THE PURCHASE AND SALE OF MORTGAGE LOANS, TRANSFER OF DATA FOR PROCESSING MORTGAGE LOANS, UNDERWRITING AND PRICING OF MORTGAGE LOANS, AND DELIVERY OF RESULTS OF MORTGAGE LOANS PROCESSING AND RELATED ELECTRONIC INSTRUCTION MANUALS; AND PROVIDING TEMPORARY USE OF NON-DOWNLOADABLE COMPUTER SOFTWARE WHICH ENABLES A USER TO ELECTRONICALLY ACCESS AN AUTOMATED SELLER INFORMATION AND PROCESSING SYSTEM FOR THE SALE OF MORTGAGE LOANS, AND ACCOMPANYING ELECTRONIC INSTRUCTIONAL DOCUMENTATION (U.S. CLS. 100 AND 101).

FIRST USE 4-1-2005; IN COMMERCE 4-1-2005.

DAVID C. REIHNER, EXAMINING ATTORNEY



SN 76-586,928. ANIMATED DESIGNS LLC, WESTLAKE VILLAGE, CA. FILED 4-13-2004.

ANIMATED DESIGNS

THE MARK CONSISTS OF STANDARD CHARACTERS WITHOUT CLAIM TO ANY PARTICULAR FONT, STYLE, SIZE, OR COLOR.

NO CLAIM IS MADE TO THE EXCLUSIVE RIGHT TO USE "DESIGNS", APART FROM THE MARK AS SHOWN. SEC. 2(F).

FOR COMPUTER-GENERATED GRAPHIC DESIGN SERVICES, NAMELY, DESIGN OF WEB SITES AND WEB PAGES (U.S. CLS. 100 AND 101).

FIRST USE 9-1-1995; IN COMMERCE 9-1-1995.

DAVID H. STINE, EXAMINING ATTORNEY

CLASS 42—(Continued).

SN 76-587,025. WEST PUBLISHING CORPORATION, EAGAN, MN. FILED 4-19-2004.

WESTLAW PROFILER

THE MARK CONSISTS OF STANDARD CHARACTERS WITHOUT CLAIM TO ANY PARTICULAR FONT, STYLE, SIZE, OR COLOR.

NO CLAIM IS MADE TO THE EXCLUSIVE RIGHT TO USE "PROFILER", APART FROM THE MARK AS SHOWN.

FOR PROVIDING DATABASES FEATURING BACKGROUND INFORMATION ON ATTORNEYS, JUDGES AND EXPERT WITNESSES VIA A GLOBAL COMPUTER NETWORK (U.S. CLS. 100 AND 101).

FIRST USE 2-15-2003; IN COMMERCE 2-15-2003.
MIDGE BUTLER, EXAMINING ATTORNEY

SN 76-587,561. SELECTIVE INSURANCE GROUP, INC., BRANCHVILLE, NJ. FILED 4-20-2004.

ESELECT

THE MARK CONSISTS OF STANDARD CHARACTERS WITHOUT CLAIM TO ANY PARTICULAR FONT, STYLE, SIZE, OR COLOR.

FOR PROVIDING TEMPORARY USE OF NON-DOWNLOADABLE SOFTWARE FOR USE BY INSURANCE AGENTS FOR THE PURPOSE OF REVIEWING POLICY INFORMATION, MAKING AND RESOLVING BILLING AND CLAIMS INQUIRIES, AND ACCESSING AND DOWNLOADING FORMS AND REPORTS, IN THE FIELD OF PROPERTY AND CASUALTY INSURANCE (U.S. CLS. 100 AND 101).

FIRST USE 12-0-1999; IN COMMERCE 12-0-1999.
DARRYL SPRULL, EXAMINING ATTORNEY

SN 76-588,230. AT LAST SPORTSWEAR INC, SECAUCUS, NJ. FILED 4-22-2004.

SPEED INNOVATIONS

THE MARK CONSISTS OF STANDARD CHARACTERS WITHOUT CLAIM TO ANY PARTICULAR FONT, STYLE, SIZE, OR COLOR.

NO CLAIM IS MADE TO THE EXCLUSIVE RIGHT TO USE "INNOVATIONS", APART FROM THE MARK AS SHOWN.

FOR COMPUTER SOFTWARE DEVELOPMENT; PRODUCT RESEARCH AND DEVELOPMENT; COMPUTER SOFTWARE CONSULTATION; TECHNICAL SUPPORT SERVICES, NAMELY TROUBLESHOOTING OF COMPUTER HARDWARE AND SOFTWARE PROBLEMS; COMPUTER PROGRAMMING FOR OTHERS (U.S. CLS. 100 AND 101).

FIRST USE 2-9-1999; IN COMMERCE 2-9-1999.
TIMOTHY FINNEGAN, EXAMINING ATTORNEY

CLASS 42—(Continued).

SN 76-588,350. CHAMBERLAIN D'AMANDA OPPENHEIMER & GREENFIELD, LLP, ROCHESTER, NY. FILED 4-22-2004.

ChamberlainD'Amanda

FOR LEGAL SERVICES IN THE FIELDS OF LABOR LAW, PERSONAL INJURY LAW AND OTHER CIVIL LITIGATION, ESTATES AND TRUST LAW, CORPORATE LAW, TAX LAW, SECURITIES LAW, FINANCE AND VENTURE CAPITAL LAW AND GENERAL BUSINESS LAW (U.S. CLS. 100 AND 101).

FIRST USE 12-10-2003; IN COMMERCE 12-10-2003.
JIM RINGLE, EXAMINING ATTORNEY

SN 76-588,351. CHAMBERLAIN D'AMANDA OPPENHEIMER & GREENFIELD, LLP, ROCHESTER, NY. FILED 4-22-2004.

Doing what's right for you.

FOR LEGAL SERVICES IN THE FIELDS OF LABOR LAW, PERSONAL INJURY LAW AND OTHER CIVIL LITIGATION, ESTATES AND TRUST LAW, CORPORATE LAW, TAX LAW, SECURITIES LAW, FINANCE AND VENTURE CAPITAL LAW AND GENERAL BUSINESS LAW (U.S. CLS. 100 AND 101).

FIRST USE 12-10-2003; IN COMMERCE 12-10-2003.
JIM RINGLE, EXAMINING ATTORNEY

SN 76-588,472. REES ASSOCIATES, INC., DALLAS, TX. FILED 4-23-2004.

REES

THE MARK CONSISTS OF STANDARD CHARACTERS WITHOUT CLAIM TO ANY PARTICULAR FONT, STYLE, SIZE, OR COLOR.

SEC. 2(F).

FOR ARCHITECTURAL PLANNING SERVICES (U.S. CLS. 100 AND 101).

FIRST USE 11-3-1975; IN COMMERCE 11-3-1975.

ELIZABETH PIGNATELLO, EXAMINING ATTORNEY

CLASS 42—(Continued).

SN 76-588,473. REES ASSOCIATES, INC., DALLAS, TX.
FILED 4-23-2004.

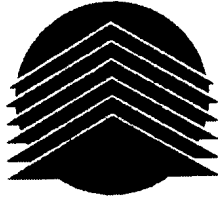

FOR ARCHITECTURAL PLANNING SERVICES (U.S. CLS. 100 AND 101).
FIRST USE 3-0-1995; IN COMMERCE 3-0-1995.
ELIZABETH PIGNATELLO, EXAMINING ATTORNEY

SN 76-588,474. REES ASSOCIATES, INC., DALLAS, TX.
FILED 4-23-2004.



NO CLAIM IS MADE TO THE EXCLUSIVE RIGHT TO USE "ARCHITECTURE PLANNING INTERIORS", APART FROM THE MARK AS SHOWN.
FOR ARCHITECTURAL PLANNING SERVICES (U.S. CLS. 100 AND 101).
FIRST USE 3-0-1995; IN COMMERCE 3-0-1995.
ELIZABETH PIGNATELLO, EXAMINING ATTORNEY

SN 76-590,748. GRAVITYWORKS, INC., SCOTTSDALE, AZ.
FILED 5-6-2004.

GRAVITYWORKS

THE MARK CONSISTS OF STANDARD CHARACTERS WITHOUT CLAIM TO ANY PARTICULAR FONT, STYLE, SIZE, OR COLOR.
FOR ARCHITECTURAL DESIGN CONSULTING SERVICES, NAMELY STRUCTURAL ASSESSMENT FOR ARCHITECTS, BUILDERS, CONSTRUCTION CONTRACTORS, DEVELOPERS AND BUILDING OWNERS (U.S. CLS. 100 AND 101).
FIRST USE 9-25-2002; IN COMMERCE 6-19-2003.
RONALD MCMORROW, EXAMINING ATTORNEY

CLASS 42—(Continued).

SN 76-592,332. STARR MAP COMPANY, LLC, ANACORTES, WA. FILED 5-17-2004.



CONCURRENT USE PROCEEDING SUPERIOR COURT OF WASHINGTON, CASE NO. 00-21495-0 SEA, STARR MAP COMPANY, LLC V LARRY MORRIS AND MARIA MORRIS DAB TOWN GRAPHIC (FINDING IN FAVOR OF CONCURRENT USE REGISTRATIONS). PURSUANT TO SECTION 2.42, APPLICANT STATES THAT THE GEOGRAPHIC AREA OF APPLICANT USE SHALL BE AS FOLLOWS: APPLICANT IS GRANTED RIGHTS OF CONCURRENT USE IN ALL STATES EXCEPT WASHINGTON.
OWNER OF U.S. REG. NO. 2,308,880.
NO CLAIM IS MADE TO THE EXCLUSIVE RIGHT TO USE "MAPS" AND "GUIDES", APART FROM THE MARK AS SHOWN.
THE STIPPLING IS A FEATURE OF THE MARK.
FOR CARTOGRAPHIC SERVICES (U.S. CLS. 100 AND 101).
FIRST USE 3-1-2004; IN COMMERCE 3-1-2004.
SAMUEL E. SHARPER JR., EXAMINING ATTORNEY

SN 76-595,267. SLEEP SERVICES OF AMERICA, INC., GLEN BURNIE, MD. FILED 6-3-2004.

SLEEP SERVICES OF AMERICA

THE MARK CONSISTS OF STANDARD CHARACTERS WITHOUT CLAIM TO ANY PARTICULAR FONT, STYLE, SIZE, OR COLOR.
OWNER OF U.S. REG. NO. 2,239,900.
NO CLAIM IS MADE TO THE EXCLUSIVE RIGHT TO USE "SLEEP SERVICES", APART FROM THE MARK AS SHOWN.
SEC. 2(F).
FOR DIAGNOSTIC SERVICES IN THE FIELD OF SLEEP DISORDERS (U.S. CLS. 100 AND 101).
FIRST USE 3-0-1997; IN COMMERCE 6-0-1997.
ALICE SUE CARRUTHERS, EXAMINING ATTORNEY

CLASS 42—(Continued).

SN 76-598,441. QTOPIA, INC., DBA DATA ARMOR AND AMERICAN DATA ARMOR, CHICAGO, IL. FILED 6-21-2004.

DATA ARMOR

THE MARK CONSISTS OF STANDARD CHARACTERS WITHOUT CLAIM TO ANY PARTICULAR FONT, STYLE, SIZE, OR COLOR.

FOR APPLICATION HOSTING SERVICES FOR OTHERS; COMPUTER INFRASTRUCTURE ANALYSIS, DESIGN, MAINTENANCE AND SUPPORT SERVICES FOR OTHERS, NAMELY, MONITORING OF COMPUTER SOFTWARE, HARDWARE, NETWORKS AND SYSTEMS FOR BACK-UP, DISASTER RECOVERY, PERFORMANCE AND SECURITY PURPOSES; COMPUTER DIAGNOSTIC ADVICE AND TECHNICAL SUPPORT, NAMELY, TROUBLESHOOTING OF COMPUTER SOFTWARE, HARDWARE, NETWORK AND SYSTEM PROBLEMS; COMPUTER SOFTWARE PROGRAMMING FOR OTHERS; CONSULTING SERVICES IN THE FIELD OF ANALYSIS, DESIGN, SELECTION, IMPLEMENTATION AND USE OF COMPUTER HARDWARE, SOFTWARE, NETWORKS AND SYSTEMS (U.S. CLS. 100 AND 101).

FIRST USE 11-0-2001; IN COMMERCE 11-0-2001.

ALICE SUE CARRUTHERS, EXAMINING ATTORNEY

CLASS 42—(Continued).

SN 76-602,266. FIRESTOP CONTRACTORS INTERNATIONAL ASSOCIATION, WHEATON, IL. FILED 7-13-2004.



NO CLAIM IS MADE TO THE EXCLUSIVE RIGHT TO USE "FIRESTOP CONTRACTORS INTERNATIONAL ASSOCIATION", APART FROM THE MARK AS SHOWN.

THE STIPLING IN THE DRAWING IS FOR SHADING PURPOSES ONLY.

FOR ASSOCIATION SERVICES, NAMELY, PROMOTING THE INTERESTS OF BUILDERS AND CONSTRUCTION CONTRACTORS WHO SUPPLY, INSTALL, MAINTAIN AND REPAIR FIRE AND SMOKE RESISTANT PRODUCTS AND MATERIALS (U.S. CLS. 100 AND 101).

FIRST USE 6-1-1999; IN COMMERCE 6-1-1999.

RUSS HERMAN, EXAMINING ATTORNEY

SN 76-598,654. GRAVITEX INTERNATIONAL, LLC, LOS ANGELES, CA. FILED 6-18-2004.

GRAVITEX INTERNATIONAL

THE MARK CONSISTS OF STANDARD CHARACTERS WITHOUT CLAIM TO ANY PARTICULAR FONT, STYLE, SIZE, OR COLOR.

NO CLAIM IS MADE TO THE EXCLUSIVE RIGHT TO USE "INTERNATIONAL", APART FROM THE MARK AS SHOWN.

FOR PRODUCT RELATED DEVELOPMENT IN THE FIELD OF LIFESTYLE RELATED CONSUMER PRODUCTS (U.S. CLS. 100 AND 101).

FIRST USE 9-1-2002; IN COMMERCE 11-1-2002.

RENEE MCCRAY, EXAMINING ATTORNEY

SN 76-609,094. ALLIANCE FOR TELECOMMUNICATIONS INDUSTRY SOLUTIONS, INC., WASHINGTON, DC. FILED 8-27-2004.

T1M1

THE MARK CONSISTS OF STANDARD CHARACTERS WITHOUT CLAIM TO ANY PARTICULAR FONT, STYLE, SIZE, OR COLOR.

FOR TECHNICAL RESEARCH IN THE FIELD OF TELECOMMUNICATIONS, NAMELY DEVELOPMENT AND DISSEMINATION OF TECHNICAL AND OPERATIONAL STANDARDS AND REQUIREMENTS APPLICABLE TO TELECOMMUNICATIONS AND INFORMATION TECHNOLOGY (U.S. CLS. 100 AND 101).

FIRST USE 5-0-1984; IN COMMERCE 5-0-1984.

CHERYL CLAYTON, EXAMINING ATTORNEY

CLASS 42—(Continued).

SN 76-609,095. ALLIANCE FOR TELECOMMUNICATIONS INDUSTRY SOLUTIONS, INC., WASHINGTON, DC. FILED 8-27-2004.

T1E1

THE MARK CONSISTS OF STANDARD CHARACTERS WITHOUT CLAIM TO ANY PARTICULAR FONT, STYLE, SIZE, OR COLOR.

FOR TECHNICAL RESEARCH IN THE FIELD OF TELECOMMUNICATIONS, NAMELY DEVELOPMENT AND DISSEMINATION OF TECHNICAL AND OPERATIONAL STANDARDS AND REQUIREMENTS APPLICABLE TO TELECOMMUNICATIONS AND INFORMATION TECHNOLOGY (U.S. CLS. 100 AND 101).

FIRST USE 2-0-1988; IN COMMERCE 2-0-1988.
CHERYL CLAYTON, EXAMINING ATTORNEY

CLASS 42—(Continued).

SN 76-615,084. CMS PRODUCTS, INC., DBA DRIVEMEDIC, COSTA MESA, CA. FILED 10-8-2004.

DRIVEMEDIC

THE MARK CONSISTS OF STANDARD CHARACTERS WITHOUT CLAIM TO ANY PARTICULAR FONT, STYLE, SIZE, OR COLOR.

FOR COMPUTER SERVICES, NAMELY DATA RECOVERY SERVICES (U.S. CLS. 100 AND 101).

FIRST USE 6-1-2004; IN COMMERCE 6-1-2004.
KIMBERLY PERRY, EXAMINING ATTORNEY

SN 76-609,096. ALLIANCE FOR TELECOMMUNICATIONS INDUSTRY SOLUTIONS, INC., WASHINGTON, DC. FILED 8-27-2004.

T1X1

THE MARK CONSISTS OF STANDARD CHARACTERS WITHOUT CLAIM TO ANY PARTICULAR FONT, STYLE, SIZE, OR COLOR.

FOR TECHNICAL RESEARCH IN THE FIELD OF TELECOMMUNICATIONS, NAMELY DEVELOPMENT AND DISSEMINATION OF TECHNICAL AND OPERATIONAL STANDARDS AND REQUIREMENTS APPLICABLE TO TELECOMMUNICATIONS AND INFORMATION TECHNOLOGY (U.S. CLS. 100 AND 101).

FIRST USE 5-0-1984; IN COMMERCE 5-0-1984.
CHERYL CLAYTON, EXAMINING ATTORNEY

SN 76-615,469. RATHBURN, BRIAN, FITCHBURG, MA. FILED 10-7-2004.

BRYEZEN

THE MARK CONSISTS OF STANDARD CHARACTERS WITHOUT CLAIM TO ANY PARTICULAR FONT, STYLE, SIZE, OR COLOR.

FOR COMPUTER SERVICES, NAMELY, ASSISTING USERS IN NAVIGATING INTERNET WEB SITES (U.S. CLS. 100 AND 101).

MELISSA VALLILLO, EXAMINING ATTORNEY

SN 76-614,280. R. L. POLK & CO., SOUTHFIELD, MI. FILED 9-27-2004.

ECOVERS

THE MARK CONSISTS OF STANDARD CHARACTERS WITHOUT CLAIM TO ANY PARTICULAR FONT, STYLE, SIZE, OR COLOR.

OWNER OF U.S. REG. NO. 1,923,491.
FOR APPLICATION SERVICE PROVIDER (ASP) FEATURING WEB-BASED SOFTWARE AND USER MANUAL DESIGNED TO ASSIST IN THE REGISTRATION AND TRACKING OF COMMERCIAL VEHICLES TRAVELING THROUGH MULTIPLE JURISDICTIONS (U.S. CLS. 100 AND 101).

DAYNA BROWNE, EXAMINING ATTORNEY

SN 76-616,852. MEDICAL INFORMATICS ENGINEERING, INCORPORATED, FORT WAYNE, IN. FILED 10-21-2004.

NOMORECLIPBOARD

THE MARK CONSISTS OF STANDARD CHARACTERS WITHOUT CLAIM TO ANY PARTICULAR FONT, STYLE, SIZE, OR COLOR.

FOR APPLICATION SERVICE PROVIDER (ASP) FEATURING SOFTWARE FOR USE IN STORING, UPDATING, TRACKING, AND SHARING MEDICAL INFORMATION AND PATIENT RECORDS (U.S. CLS. 100 AND 101).

FIRST USE 10-24-2002; IN COMMERCE 10-24-2002.
ELIZABETH HUGHITT, EXAMINING ATTORNEY

CLASS 42—(Continued).

SN 76-617,006. SUNRISE SENIOR LIVING, INC., MCLEAN, VA. FILED 10-21-2004.

BASIS

THE MARK CONSISTS OF STANDARD CHARACTERS WITHOUT CLAIM TO ANY PARTICULAR FONT, STYLE, SIZE, OR COLOR.

FOR PROVIDING TEMPORARY USE OF NON-DOWNLOADABLE COMPUTER SOFTWARE OVER COMPUTER NETWORKS, INTRANETS, AND THE INTERNET FOR BILLING AND SERVICES MANAGEMENT IN THE SENIOR AND ASSISTED LIVING INDUSTRIES (U.S. CLS. 100 AND 101).

FIRST USE 8-18-2003; IN COMMERCE 8-18-2003.
DOMINIC J. FERRAIUOLO, EXAMINING ATTORNEY

SN 76-618,539. SUNRISE SENIOR LIVING, INC., MCLEAN, VA. FILED 10-28-2004.

SOLAR SYSTEM

THE MARK CONSISTS OF STANDARD CHARACTERS WITHOUT CLAIM TO ANY PARTICULAR FONT, STYLE, SIZE, OR COLOR.

FOR PROVIDING TEMPORARY USE OF NON-DOWNLOADABLE COMPUTER SOFTWARE OVER COMPUTER NETWORKS, INTRANETS, AND THE INTERNET FOR PROCUREMENT, NAMELY PURCHASING FOOD, MEDICAL SUPPLIES, JANITORIAL PRODUCTS, OFFICE SUPPLIES, FACILITY MAINTENANCE SERVICES, HEALTH CARE EQUIPMENT, MAINTENANCE EQUIPMENT, AND PHARMACEUTICALS FOR OTHERS (U.S. CLS. 100 AND 101).

FIRST USE 12-13-2001; IN COMMERCE 12-13-2001.
MICHAEL HALL, EXAMINING ATTORNEY

CLASS 42—(Continued).

SN 76-618,575. WEST PHARMACEUTICAL SERVICES, INC., LIONVILLE, PA. FILED 10-29-2004.

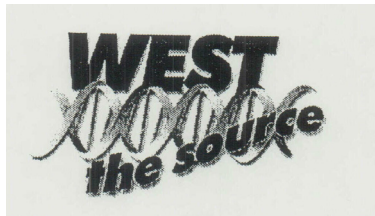

OWNER OF U.S. REG. NOS. 1,321,775, 1,910,756 AND OTHERS.

FOR TESTING OF PACKAGING FOR PHARMACEUTICALS; CONSULTING SERVICES IN THE FIELD OF PACKAGING FOR PHARMACEUTICALS, NAMELY, CONSULTATION REGARDING PACKAGING SELECTION AND REGULATORY COMPLIANCE— LABORATORY RESEARCH AND DEVELOPMENT IN THE FIELD OF PACKAGING FOR PHARMACEUTICALS (U.S. CLS. 100 AND 101).

FIRST USE 10-4-2004; IN COMMERCE 10-4-2004.
MICHAEL HALL, EXAMINING ATTORNEY

SN 76-619,192. NOMADICS, INC., STILLWATER, OK. FILED 11-3-2004.

SCIENCE IN MOTION

THE MARK CONSISTS OF STANDARD CHARACTERS WITHOUT CLAIM TO ANY PARTICULAR FONT, STYLE, SIZE, OR COLOR.

FOR SCIENTIFIC AND PRODUCT RESEARCH AND PRODUCT DEVELOPMENT (U.S. CLS. 100 AND 101).

FIRST USE 3-4-1996; IN COMMERCE 3-4-1996.
ROBERT LORENZO, EXAMINING ATTORNEY

SN 76-622,437. GLADU, CHRISTIAN, BEND, OR. FILED 11-26-2004.

The **BUNGALOW**  **COMPANY**

NO CLAIM IS MADE TO THE EXCLUSIVE RIGHT TO USE "COMPANY", APART FROM THE MARK AS SHOWN. FOR ARCHITECTURAL DESIGN SERVICES (U.S. CLS. 100 AND 101).

FIRST USE 9-26-2000; IN COMMERCE 9-26-2000.
JOHN WILKE, EXAMINING ATTORNEY

CLASS 42—(Continued).

SN 76-623,487. MIRABELLA CONSTRUCTION INC., ESCON-
DIDO, CA. FILED 12-6-2004.



NO CLAIM IS MADE TO THE EXCLUSIVE RIGHT TO
USE "DESIGN/BUILD", APART FROM THE MARK AS
SHOWN.

FOR ARCHITECTURAL DESIGN OF RESIDENTIAL
AND COMMERCIAL BUILDINGS AND INTERIORS OF
BUILDINGS (U.S. CLS. 100 AND 101).

FIRST USE 7-15-2002; IN COMMERCE 7-15-2002.
ANDREW RHIM, EXAMINING ATTORNEY

CLASS 42—(Continued).

SN 76-624,719. J.E. EVANS-JACKSON & CO., LONDON EC1V
0JP, UNITED KINGDOM, FILED 12-14-2004.

EASYIP

OWNER OF UNITED KINGDOM REG. NO. 2318178,
DATED 10-10-2003, EXPIRES 12-11-2012.

FOR LEGAL SERVICES, NAMELY PROFESSIONAL,
ADVISORY AND CONSULTANCY SERVICES RELAT-
ING TO INTELLECTUAL PROPERTY MATTERS (U.S.
CLS. 100 AND 101).

ODESSA BIBBINS, EXAMINING ATTORNEY

SN 76-624,365. ATERRA LIGHTING AND CONTROLS, LLC,
SCOTTSDALE, AZ. FILED 12-9-2004.

ATERRA

THE MARK CONSISTS OF STANDARD CHARACTERS
WITHOUT CLAIM TO ANY PARTICULAR FONT, STYLE,
SIZE, OR COLOR.

FOR ARCHITECTURAL LIGHTING DESIGN SER-
VICES (U.S. CLS. 100 AND 101).

FIRST USE 10-26-2000; IN COMMERCE 10-1-2004.
MARK SPARACINO, EXAMINING ATTORNEY

SN 76-626,230. SE & ASSOCIATES, INC., JANESVILLE, WI.
FILED 12-27-2004.

DIGITAL HOUSEKEEPER

FOR PROVIDING TEMPORARY USE OF NON-DOWN-
LOADABLE WEB-BASED COMPUTER SOFTWARE PRO-
GRAMS FOR USE IN ENVIRONMENTAL AND
CLEANING SERVICES MANAGEMENT (U.S. CLS. 100
AND 101).

FIRST USE 10-15-2004; IN COMMERCE 10-15-2004.
JOHN WILKE, EXAMINING ATTORNEY

SN 76-624,486. IDL SOLUTIONS, INC., BROOKFIELD, WI.
FILED 12-14-2004.

IDL SOLUTIONS

THE MARK CONSISTS OF STANDARD CHARACTERS
WITHOUT CLAIM TO ANY PARTICULAR FONT, STYLE,
SIZE, OR COLOR.

NO CLAIM IS MADE TO THE EXCLUSIVE RIGHT TO
USE "SOLUTIONS", APART FROM THE MARK AS
SHOWN.

FOR PROVIDING STRATEGIC ENTERPRISE SOLU-
TIONS, NAMELY, DESIGN AND DEVELOPMENT OF
INFORMATION AND DATA BASES, DESIGN AND
DEVELOPMENT OF NETWORKS, AND DESIGN AND
DEVELOPMENT OF ONLINE COMPUTER SOFTWARE
SYSTEMS (U.S. CLS. 100 AND 101).

FIRST USE 1-1-1993; IN COMMERCE 1-1-1993.
DAVID ELTON, EXAMINING ATTORNEY

SN 76-626,242. TEKNIT LIMITED, ATLANTA, GA. FILED 12-
22-2004.

TEKNIT

THE MARK CONSISTS OF STANDARD CHARACTERS
WITHOUT CLAIM TO ANY PARTICULAR FONT, STYLE,
SIZE, OR COLOR.

FOR DESIGN SERVICES FOR OTHERS IN THE FIELD
OF SEAT COVERS FOR VEHICLES AND FURNITURE
(U.S. CLS. 100 AND 101).

FIRST USE 3-19-1992; IN COMMERCE 3-19-1992.
CHRISTOPHER BUONGIORNO, EXAMINING ATTOR-
NEY

CLASS 42—(Continued).

SN 76-626,588. IBIS CONSULTING, INC., PROVIDENCE, RI.
FILED 12-30-2004.

CONTROL YOUR DATA

THE MARK CONSISTS OF STANDARD CHARACTERS
WITHOUT CLAIM TO ANY PARTICULAR FONT, STYLE,
SIZE, OR COLOR.

FOR LITIGATION SUPPORT SERVICES (U.S. CLS. 100
AND 101).

FIRST USE 5-18-2001; IN COMMERCE 5-18-2001.
LINDA M. KING, EXAMINING ATTORNEY

SN 76-626,591. IBIS CONSULTING, INC., PROVIDENCE, RI.
FILED 12-30-2004.

IBIS

THE MARK CONSISTS OF STANDARD CHARACTERS
WITHOUT CLAIM TO ANY PARTICULAR FONT, STYLE,
SIZE, OR COLOR.

FOR LITIGATION SUPPORT SERVICES (U.S. CLS. 100
AND 101).

FIRST USE 8-3-1992; IN COMMERCE 8-3-1992.
SUSAN HAYASH, EXAMINING ATTORNEY

SN 78-027,146. SUNGOLD INTERNATIONAL HOLDINGS
CORP., VANCOUVER, BC, CANADA, FILED 9-21-2000.

HORSEPOWER

PRIORITY CLAIMED UNDER SEC. 44(D) ON CANADA
APPLICATION NO. 1051757, FILED 3-21-2000, REG. NO.
TMA590484, DATED 9-23-2003, EXPIRES 9-23-2018.

FOR ENTERTAINMENT SERVICES IN THE NATURE
OF PUBLIC AND PRIVATE GAMING, NAMELY, CON-
DUCTING GAMBLING SERVICES AS IT RELATES TO A
FANTASY GAME (U.S. CLS. 100 AND 101).

FIRST USE 8-0-2000; IN COMMERCE 8-0-2000.
KELLY BOULTON, EXAMINING ATTORNEY

CLASS 42—(Continued).

SN 78-081,180. MOCHA MEDIA, INC., CANOGA PARK, CA.
FILED 8-26-2001.

MOCHA MEDIA

NO CLAIM IS MADE TO THE EXCLUSIVE RIGHT TO
USE "MEDIA", APART FROM THE MARK AS SHOWN.

FOR GRAPHIC ART DESIGN SERVICES; COMPUTER
GRAPHICS SERVICES, INCLUDING INTERACTIVE
MULTIMEDIA COMPUTER GRAPHICS DESIGN SER-
VICES; TECHNICAL COMPUTER MEDIA CONSULTA-
TION SERVICES; CONSULTATION SERVICES IN THE
FIELD OF DEVELOPMENT OF NEW COMPUTER GRA-
PHICS TECHNOLOGY FOR OTHERS; COMPUTER CON-
SULTATION SERVICES IN RELATION TO KIOSK AND
CD-ROM DEVELOPMENT; COMPUTER SERVICES;
NAMELY, DESIGNING AND IMPLEMENTING WEB
SITES FOR OTHERS (U.S. CLS. 100 AND 101).

FIRST USE 4-15-1998; IN COMMERCE 4-15-1998.
ZHALEH DELANEY, EXAMINING ATTORNEY

SN 78-190,247. GILDAN ACTIVEWEAR INC., MONTREAL,
QUEBEC, CANADA, FILED 12-2-2002.

GILDAN FINDER.COM

PRIORITY CLAIMED UNDER SEC. 44(D) ON CANADA
APPLICATION NO. 1160226, FILED 11-26-2002, REG. NO.
TMA609,134, DATED 5-3-2004, EXPIRES 5-3-2020.

FOR COMPUTER SERVICES, NAMELY, PROVIDING
A SEARCH ENGINE FOR LOCATING PRODUCTS AT
VARIOUS DISTRIBUTORS VIA A GLOBAL COMMUNI-
CATIONS NETWORK (U.S. CLS. 100 AND 101).

FIRST USE 1-0-2000; IN COMMERCE 1-0-2000.
ROBIN CHOSID, EXAMINING ATTORNEY

SN 78-194,510. ICLAIM SYSTEMS CORP., GARDEN CITY,
NY, FILED 12-13-2002.

ICASEMANAGE

FOR PROVIDING TEMPORARY USE OF NON-DOWN-
LOADABLE SOFTWARE FOR USE IN CASE MANAGE-
MENT, BILLING, TRACKING DOCUMENT STORAGE,
REPORTING, GENERATING FORMS AND ANALYZ-
ING STORED DATA IN THE FIELD OF MEDICAL
BILLING (U.S. CLS. 100 AND 101).

FIRST USE 1-0-2002; IN COMMERCE 6-0-2002.
CHARLES L. JENKINS, EXAMINING ATTORNEY

CLASS 42—(Continued).

SN 78-197,282. ARIADNE GENOMICS INC., ROCKVILLE, MD. FILED 12-23-2002.



**ARIADNE
GENOMICS**
Tools for Systems Biology

NO CLAIM IS MADE TO THE EXCLUSIVE RIGHT TO USE "GENOMICS" AND "TOOLS FOR SYSTEMS BIOLOGY", APART FROM THE MARK AS SHOWN.

FOR CUSTOM COMPUTER SOFTWARE DEVELOPMENT FOR OTHERS AND CUSTOM COMPUTER PROGRAMMING FOR OTHERS IN THE FIELDS OF BIOTECHNOLOGY, MEDICINE, NATURAL LANGUAGE PROCESSING, MEDICAL INFORMATICS, DRUG DISCOVERY, GENETICS, MOLECULAR BIOLOGY, ARTIFICIAL INTELLIGENCE, COMMUNICATIONS, GLOBAL COMPUTER INFORMATION NETWORK, FINANCIAL FORECASTING, PREDICTIVE ANALYSIS AND BANKING, AND DATA BASE MANAGEMENT SYSTEMS DEVELOPMENT, NAMELY, KNOWLEDGE BASE SOFTWARE ENGINEERING (U.S. CLS. 100 AND 101).

FIRST USE 5-0-2002; IN COMMERCE 10-0-2002.
JEFFERY COWARD, EXAMINING ATTORNEY

CLASS 42—(Continued).

SN 78-317,399. AGENTMASTER LLC, WOLFEBORO, NH. FILED 10-23-2003.

AGENTMASTER

FOR SERVICES PROVIDING WEBSITES FOR OTHERS, NAMELY, CREATING AND MAINTAINING WEB SITES FOR REAL ESTATE PROFESSIONALS; WEB SITE CONSULTATION IN THE FIELD OF CREATING IMPLEMENTING AND MAINTAINING WEBSITES; WEB SITE HOSTING; COMPUTER SOFTWARE DESIGN FOR OTHERS IN THE FIELD OF REAL ESTATE WEB SITE SOFTWARE (U.S. CLS. 100 AND 101).

FIRST USE 1-1-2000; IN COMMERCE 1-1-2000.
KELLY BOULTON, EXAMINING ATTORNEY

SN 78-227,983. CTI GROUP (HOLDINGS), INC., INDIANAPOLIS, IN. FILED 3-20-2003.

TRANSACT

FOR LICENSING OF INTELLECTUAL PROPERTY (U.S. CLS. 100 AND 101).

BARBARA RUTLAND, EXAMINING ATTORNEY

SN 78-337,105. PLANET3 WIRELESS, INC., BREMEN, GA. FILED 12-5-2003.

CWSE

SN 78-229,798. JAVELIN TECHNOLOGIES, INC., NEW YORK, NY. FILED 3-25-2003.



NO CLAIM IS MADE TO THE EXCLUSIVE RIGHT TO USE "INTEGRATOR", APART FROM THE MARK AS SHOWN.

FOR PROVIDING TEMPORARY USE OF NON-DOWNLOADABLE SOFTWARE FOR ROUTING ORDERS AND EXECUTION MESSAGES BETWEEN AND AMONG FINANCIAL INSTITUTIONS TRADING VARIOUS ASSET CLASSES (U.S. CLS. 100 AND 101).

FIRST USE 6-19-2002; IN COMMERCE 6-19-2002.
TRACY FLETCHER, EXAMINING ATTORNEY

THE MARK CONSISTS OF STANDARD CHARACTERS WITHOUT CLAIM TO ANY PARTICULAR FONT, STYLE, SIZE, OR COLOR.

FOR COMPUTER SECURITY MANAGEMENT SERVICES IN THE FIELD OF WIRELESS COMPUTER HARDWARE AND SOFTWARE NETWORKING SYSTEMS; COMPUTER CONSULTING SERVICES IN THE DESIGN OF NETWORK SECURITY FOR COMPUTER HARDWARE AND SOFTWARE WIRELESS NETWORKING EQUIPMENT AND SYSTEMS; COMPUTER CONSULTATION SERVICES IN THE INSTALLATION OF COMPUTER SOFTWARE WIRELESS NETWORKING SYSTEMS (U.S. CLS. 100 AND 101).

BRIDGETT SMITH, EXAMINING ATTORNEY

CLASS 42—(Continued).

SN 78-339,532. KRIVENYSHEV, ALEXANDER, WEST NEW YORK, NJ. FILED 12-11-2003.

WTZ

THE MARK CONSISTS OF STANDARD CHARACTERS WITHOUT CLAIM TO ANY PARTICULAR FONT, STYLE, SIZE, OR COLOR.

FOR ASTRONOMY, MAPPING, METEOROLOGICAL FORECASTING, SCIENTIFIC RESEARCH, WEATHER FORECASTING (U.S. CLS. 100 AND 101).

CAROLYN CATALDO, EXAMINING ATTORNEY

SN 78-345,779. STOYLES, CHRIS, M, MONTGOMERY, AL. FILED 12-27-2003.

ARCHISCAPES

THE MARK CONSISTS OF STANDARD CHARACTERS WITHOUT CLAIM TO ANY PARTICULAR FONT, STYLE, SIZE, OR COLOR.

FOR ARCHITECTURAL DESIGN SERVICES, ARCHITECTURAL SPECIFICATION WRITING, ARCHITECTURAL ENGINEERING SERVICES, ARCHITECTURAL CONSULTING, DRAFTING SERVICES, GRAPHIC DESIGN SERVICES, ARCHITECTURAL SITE AND MASTER PLANNING SERVICES (U.S. CLS. 100 AND 101).

FIRST USE 10-1-2003; IN COMMERCE 12-11-2003.

MICHELE SWAIN, EXAMINING ATTORNEY

CLASS 42—(Continued).

SN 78-357,460. UNITY VILLAGE SOFTWARE, INC., TULSA, OK. FILED 1-26-2004.



FOR PROVIDING ONLINE NON-DOWNLOADABLE WEB-BASED COMPUTER DATABASE MANAGEMENT SOFTWARE FOR USE BY VOLUNTEER AND NON-PROFIT ORGANIZATIONS; CONSULTING SERVICES FOR OTHERS IN THE FIELD OF DESIGN, SELECTION, IMPLEMENTATION AND USE OF COMPUTER SOFTWARE SYSTEMS (U.S. CLS. 100 AND 101).

FIRST USE 11-1-2003; IN COMMERCE 11-1-2003.

KHANH LE, EXAMINING ATTORNEY

SN 78-360,662. TRADEMARKPLACE, LLC, CARLSBAD, CA. FILED 2-1-2004.

**TradeMarketPlace,
LLC**

THE MARK CONSISTS OF STANDARD CHARACTERS WITHOUT CLAIM TO ANY PARTICULAR FONT, STYLE, SIZE, OR COLOR.

NO CLAIM IS MADE TO THE EXCLUSIVE RIGHT TO USE "LLC", APART FROM THE MARK AS SHOWN.

FOR INTELLECTUAL PROPERTY LICENSING (U.S. CLS. 100 AND 101).

FIRST USE 12-1-2003; IN COMMERCE 12-1-2003.

SUSAN HAYASH, EXAMINING ATTORNEY

SN 78-361,570. DREAMSPAN PRODUCT INNOVATION, PHOENIX, AZ. FILED 2-3-2004.

**DREAMSPAN PRODUCT
INNOVATION**

THE MARK CONSISTS OF STANDARD CHARACTERS WITHOUT CLAIM TO ANY PARTICULAR FONT, STYLE, SIZE, OR COLOR.

NO CLAIM IS MADE TO THE EXCLUSIVE RIGHT TO USE PRODUCT INNOVATION, APART FROM THE MARK AS SHOWN.

FOR PROFESSIONAL CONSULTATION SERVICES IN THE FIELDS OF GRAPHIC ART DESIGN, ENGINEERING, AND PRODUCT DEVELOPMENT FOR NEW AND EXISTING PRODUCTS (U.S. CLS. 100 AND 101).

FIRST USE 6-0-2003; IN COMMERCE 6-0-2003.

MELVIN AXILBUND, EXAMINING ATTORNEY

CLASS 42—(Continued).

SN 78-363,805. WORK & WELL, INC., SOMERVILLE, NJ. FILED 2-6-2004.

WORQUEST

THE MARK CONSISTS OF STANDARD CHARACTERS WITHOUT CLAIM TO ANY PARTICULAR FONT, STYLE, SIZE, OR COLOR.

FOR APPLICATION SERVICE PROVIDER SERVICES, NAMELY, WEB-BASED APPLICATION USED FOR HEALTHCARE AND BENEFIT MANAGEMENT, DATA MANAGEMENT AND DATA REPORTING (U.S. CLS. 100 AND 101).

FIRST USE 8-31-2003; IN COMMERCE 8-31-2003.
CHERYL CLAYTON, EXAMINING ATTORNEY

CLASS 42—(Continued).

SN 78-373,360. TIER3SME, LLC, RALEIGH, NC. FILED 2-24-2004.



NO CLAIM IS MADE TO THE EXCLUSIVE RIGHT TO USE "ACCURACY," "INTEGRITY," AND "EFFICIENCY", APART FROM THE MARK AS SHOWN.

THE STIPPLING IS FOR SHADING PURPOSES ONLY AND IS NOT ACTUALLY PART OF THE MARK

FOR COMPUTER SOFTWARE CONSULTATION AND DEVELOPMENT SERVICES; INSTALLATION AND MAINTENANCE OF COMPUTER SOFTWARE; TECHNICAL SUPPORT SERVICES FOR COMPUTER SOFTWARE, NAMELY, TROUBLESHOOTING OF COMPUTER SOFTWARE PROBLEMS; COMPUTER SOFTWARE AUTHORIZING (U.S. CLS. 100 AND 101).

FIRST USE 9-1-2003; IN COMMERCE 9-1-2003.
AMOS T. MATTHEWS, JR., EXAMINING ATTORNEY

SN 78-367,377. DAY, DENNIS G, II, DUBLIN, OH. FILED 2-12-2004.



NO CLAIM IS MADE TO THE EXCLUSIVE RIGHT TO USE ".COM", APART FROM THE MARK AS SHOWN.

THE COLORS DARK BLUE, LIGHT BLUE, BLACK, YELLOW AND WHITE ARE CLAIMED AS A FEATURE OF THE MARK.

THE DARK BLUE COLOR APPEARS IN THE WORD "WORK". THE WHITE COLOR APPEARS IN THE "TICKET" PORTION OF THE MARK. THE BLACK COLOR APPEARS IN THE ".COM" PORTION OF THE MARK. LIGHT BLUE IS USED TO MAKE UP A BACKGROUND FOR THE MARK, AND YELLOW IS USED TO INTEGRATE A SMALL CIRCULAR GRAPHIC.

FOR PROVIDING TEMPORARY USE OF ONLINE NON-DOWNLOADABLE COMPUTER SOFTWARE, NAMELY, WEB BASED COMPUTER SOFTWARE SERVICE FOR DESIGNING WORKFLOW PROCESSES, SHARING WORK IN TEAMS, MEASURING CYCLE TIMES, AND MANAGING ELECTRONIC DOCUMENTS (U.S. CLS. 100 AND 101).

FIRST USE 7-9-2003; IN COMMERCE 1-16-2004.
PATRICIA EVANKO, EXAMINING ATTORNEY

SN 78-376,603. APPLERA CORPORATION, ROCKVILLE, MD. FILED 3-1-2004.



OWNER OF U.S. REG. NOS. 2,767,274, 2,851,273 AND 2,854,187.

NO CLAIM IS MADE TO THE EXCLUSIVE RIGHT TO USE "SYSTEM", APART FROM THE MARK AS SHOWN.

THE MARK CONSISTS OF A PORTION OF A DNA STRAND.

THE WORD CELERA IS DERIVED FROM THE LATIN TERM CELER MEANING "SWIFT, SPEEDY".

FOR PROVIDING AN ON-LINE COMPUTER DATABASE FEATURING INFORMATION IN THE FIELD OF SCIENTIFIC AND MEDICAL RESEARCH; PROVIDING TEMPORARY USE OF ON-LINE NON-DOWNLOADABLE SOFTWARE FOR USE IN DATABASE MANAGEMENT AND VIEWING OF INFORMATION IN THE FIELD OF SCIENTIFIC AND MEDICAL RESEARCH (U.S. CLS. 100 AND 101).

HENRY S. ZAK, EXAMINING ATTORNEY

CLASS 42—(Continued).

SN 78-378,259. GENOMATIX CORPORATION, CINCINNATI, OH. FILED 3-4-2004.



THE COLOR(S) LIGHT AND DARK PURPLE, BLUE, RED, GREEN AND ORANGE IS/ARE CLAIMED AS A FEATURE OF THE MARK.

THE COLORS DARK AND LIGHT PURPLE APPEAR IN THE LETTER G THAT IS IN THE CENTER OF A CIRCLE. THE EDGE OF THE CIRCLE APPEARS IN DARK PURPLE WITH BLUE, RED AND GREEN ARROWS FOLLOWED BY AN ORANGE RECTANGULAR SHAPE ROUNDING OUT THE CIRCLE.

FOR RESEARCH AND DEVELOPMENT SERVICES FOR OTHERS IN THE FIELDS OF GENETIC AND BIOTECHNOLOGY, NAMELY, GENETICALLY ENGINEERING DNA, BIOLOGICAL ORGANISMS, CELLS, VIRUSES, PATHOGENS, AND SPECIAL PURPOSE CELLS FOR SCIENTIFIC, MEDICAL RESEARCH, AND LABORATORY USE (U.S. CLS. 100 AND 101).

FIRST USE 1-17-2004; IN COMMERCE 1-17-2004.
TRICIA SONNEBORN, EXAMINING ATTORNEY

CLASS 42—(Continued).

SN 78-382,546. PALADIN LAW GROUP, WALNUT CREEK, CA. FILED 3-11-2004.

Paladin Law Group

THE MARK CONSISTS OF STANDARD CHARACTERS WITHOUT CLAIM TO ANY PARTICULAR FONT, STYLE, SIZE, OR COLOR.

NO CLAIM IS MADE TO THE EXCLUSIVE RIGHT TO USE LAW GROUP, APART FROM THE MARK AS SHOWN. FOR LEGAL SERVICES (U.S. CLS. 100 AND 101).
FIRST USE 7-23-2003; IN COMMERCE 7-23-2003.
ALICIA COLLINS, EXAMINING ATTORNEY

SN 78-382,930. COATES, THEODATE, NEW YORK, NY. FILED 3-12-2004.

SN 78-381,755. THE CHUBB CORPORATION, WARREN, NJ. FILED 3-10-2004.

AGENCY CLAIMVIEW

theoc

THE MARK CONSISTS OF STANDARD CHARACTERS WITHOUT CLAIM TO ANY PARTICULAR FONT, STYLE, SIZE, OR COLOR.

NO CLAIM IS MADE TO THE EXCLUSIVE RIGHT TO USE "AGENCY", APART FROM THE MARK AS SHOWN.

FOR PROVIDING TEMPORARY USE OF ON-LINE NON-DOWNLOADABLE COMPUTER SOFTWARE, NAMELY, APPLICATION THAT ALLOWS ACCESS TO INSURANCE CLAIMS INFORMATION BY INSURANCE AGENTS AND INSURANCE BROKERS OVER A GLOBAL COMPUTER NETWORK (U.S. CLS. 100 AND 101).

FIRST USE 10-0-2003; IN COMMERCE 10-0-2003.
JOSETTE BEVERLY, EXAMINING ATTORNEY

THE MARK CONSISTS OF STANDARD CHARACTERS WITHOUT CLAIM TO ANY PARTICULAR FONT, STYLE, SIZE, OR COLOR.

THE NAME(S), PORTRAIT(S), AND/OR SIGNATURE(S) SHOWN IN THE MARK IDENTIFIES, WHOSE CONSENT(S) TO REGISTER IS SUBMITTED.

FOR COMPUTER SERVICES, NAMELY, CREATING AND MAINTAINING WEBSITES FOR OTHERS (U.S. CLS. 100 AND 101).

TRACY FLETCHER, EXAMINING ATTORNEY

CLASS 42—(Continued).

SN 78-384,691. DIGITAL COURIER LLC, FARGO, ND.
FILED 3-15-2004.

DIGITAL COURIER

THE MARK CONSISTS OF STANDARD CHARACTERS WITHOUT CLAIM TO ANY PARTICULAR FONT, STYLE, SIZE, OR COLOR.

NO CLAIM IS MADE TO THE EXCLUSIVE RIGHT TO USE "DIGITAL", APART FROM THE MARK AS SHOWN.

FOR PROVIDING TEMPORARY USE OF NON-DOWNLOADABLE SOFTWARE FOR USE IN TRANSFERRING AND ACCESSING MEDICAL DATA VIA GLOBAL COMPUTER NETWORKS (U.S. CLS. 100 AND 101).

FIRST USE 5-31-2002; IN COMMERCE 5-31-2002.
ANDREA SAUNDERS, EXAMINING ATTORNEY

SN 78-385,932. GORDON, GEOFFREY, LOUISVILLE, CO.
FILED 3-17-2004.

IT MEDIC

THE MARK CONSISTS OF STANDARD CHARACTERS WITHOUT CLAIM TO ANY PARTICULAR FONT, STYLE, SIZE, OR COLOR.

NO CLAIM IS MADE TO THE EXCLUSIVE RIGHT TO USE "IT", APART FROM THE MARK AS SHOWN.

FOR COMPUTER SOFTWARE MAINTENANCE SERVICES FOR OTHERS; TECHNICAL SUPPORT SERVICES, NAMELY, TROUBLESHOOTING OF SOFTWARE AND HARDWARE PROBLEMS AND DIAGNOSTIC SERVICES; CONSULTING SERVICES IN THE FIELD OF INFORMATION TECHNOLOGY, NAMELY THE SELECTION, ACQUISITION, UPGRADE AND RECONFIGURATION OF INFORMATION TECHNOLOGY SYSTEMS, AND COMPUTER HARDWARE, PERIPHERALS, NETWORKS, AND SOFTWARE; INSTALLATION OF COMPUTER SOFTWARE; COMPUTER PROGRAMMING FOR OTHERS, COMPUTER DISASTER RECOVERY PLANNING SERVICES; COMPUTER SYSTEM ANALYSIS; AND COMPUTER PROJECT MANAGEMENT SERVICES FOR OTHERS. (U.S. CLS. 100 AND 101).

ANDREA SAUNDERS, EXAMINING ATTORNEY

CLASS 42—(Continued).

SN 78-388,299. THE TRIZETTO GROUP, INC., NEWPORT BEACH, CA. FILED 3-22-2004.

ONE POWERFUL SOURCE

THE MARK CONSISTS OF STANDARD CHARACTERS WITHOUT CLAIM TO ANY PARTICULAR FONT, STYLE, SIZE, OR COLOR.

FOR APPLICATION SERVICE PROVIDER (ASP), NAMELY, HOSTING COMPUTER SOFTWARE APPLICATIONS OF OTHERS FOR THE HEALTHCARE INSURANCE INDUSTRY; CROSS-PLATFORM CONVERSION OF DIGITAL CONTENT INTO OTHER FORMS OF DIGITAL CONTENT THAT ALLOW INSURANCE HEALTH PLANS TO EXCHANGE INFORMATION AND CONDUCT BUSINESS WITH PROVIDERS, MEMBERS, EMPLOYERS AND BROKERS OVER A COMPUTER NETWORK; AND THAT ALLOW INSURANCE HEALTHCARE CUSTOMERS TO ACCESS SOFTWARE APPLICATIONS WITHOUT OWNING, UPGRADING AND MAINTAINING THEIR OWN COMPUTER SYSTEMS; DEVELOPMENT, UPDATING AND MAINTENANCE OF SOFTWARE AND DATA BASES, NAMELY, INPUT OF INSURANCE HEALTHCARE INDUSTRY CLIENT DATA, MAINTENANCE AND UPDATING OF CLIENT DATA, AND MAINTAINING CLIENT DATA AVAILABLE TO THE CLIENT; APPLICATION SERVICE PROVIDER (ASP) FEATURING SOFTWARE IN THE FIELD FOR USE IN DATABASE MANAGEMENT, FOR USE AS A SPREADSHEET, FOR WORD PROCESSING; CONSULTING SERVICES IN THE FIELD OF DESIGN, SELECTION, IMPLEMENTATION AND USE OF COMPUTER HARDWARE AND SOFTWARE SYSTEMS FOR OTHERS; PROVIDING INTEGRATION OF COMPUTER SYSTEMS AND NETWORKS FOR THE INSURANCE HEALTHCARE INDUSTRY; MAINTENANCE OF COMPUTER SOFTWARE FOR THE HEALTHCARE RELATED INDUSTRY; AND PROVIDING TECHNICAL SUPPORT SERVICES TO THE INSURANCE HEALTHCARE RELATED INDUSTRY, NAMELY, TROUBLESHOOTING OF COMPUTER HARDWARE AND SOFTWARE PROBLEMS BY TELEPHONE, VIA EMAIL, VIA A COMPUTER NETWORK AND IN PERSON; PROVIDING COMPUTER DIAGNOSTIC SERVICES AND INSPECTIONS OF COMPUTER NETWORKS; PROVIDING COMPUTER DATA AND DISASTER RECOVERY SERVICES, NAMELY, PLANNING, TESTING, AND RECOVERY OF COMPUTER DATA; PROVIDING COMPUTER TIME-SHARING SERVICES THROUGH A BUREAU; PROVIDING ON-LINE BATCH COMPUTER SERVICES; PROVIDING A COMPUTER DATA BASE IN THE FIELD OF HEALTHCARE INFORMATION; DESIGNING, IMPLEMENTING, CREATING AND MAINTAINING COMPUTER WEB SITES FOR OTHERS; PROVIDING COMPUTER SOFTWARE DESIGN, TESTING AND CUSTOM PROGRAMMING AND SOFTWARE FOR OTHERS IN THE INSURANCE HEALTHCARE INDUSTRY; PROVIDING COMPUTER SYSTEMS ANALYSIS; PROVIDING COMPUTER DESIGN FOR OTHERS, NAMELY, COMPUTER SYSTEMS DESIGN; DESIGN AND TESTING FOR NEW PRODUCT DEVELOPMENT PROVIDING COMPUTER CONSULTING RELATING TO COMPUTER ARCHITECTURE; PROVIDING INTEGRATION OF COMPUTER SYSTEMS AND COMPUTER NETWORKS; PROVIDING COMPUTER SOFTWARE PRODUCT RESEARCH AND DEVELOPMENT SERVICES; CUSTOM COMPUTER PROGRAMMING SERVICES FOR OTHERS, NAMELY, DATABASE DEVELOPMENT, INFORMATION ARCHIVAL AND RETRIEVAL SERVICES; PROVIDING DATA CONVERSION OF COMPUTER PROGRAM DATA OR INFORMATION SERVICES; HOSTING THE WEB SITES OF OTHERS ON A COMPUTER SERVER FOR A COMPUTER NETWORK; MONITORING THE COMPUTER SYSTEMS OF OTHERS, AND PROVIDING BACK-UP COMPUTER PROGRAMS

CLASS 42—(Continued).

AND FACILITIES SERVICES; PROVIDING COMPUTER INFORMATION SERVICES, NAMELY, COMPUTER DATA ARCHIVAL SERVICES; COMPUTER SERVICES, NAMELY, PROVIDING INFORMATION RELATING TO HEALTHCARE AND MEDICAL INFORMATION VIA A COMPUTER NETWORK; PROVIDING SERVICES FOR THE REMOTE OR ON-SITE MONITORING OF COMPUTER SYSTEMS; PROVIDING INSURANCE HEALTHCARE PAYER AND PROVIDER CUSTOMERS WITH TECHNOLOGY SUPPORT IN THE NATURE OF TROUBLESHOOTING AND MONITORING NETWORK SYSTEMS FOR BUSINESS TRANSACTIONS, INCLUDING INSURANCE HEALTH PLAN ENROLLMENT, RECEIVABLES MANAGEMENT, CREDENTIALING, BILLING AND CUSTOMER SERVICE; CONSULTATION SERVICES IN THE FIELD OF INFORMATION TECHNOLOGY, DEVELOPING AND PROVIDING COMPUTER SOFTWARE; INTERNET PLATFORMS FOR THE HEALTHCARE INDUSTRY; REVIEWING STANDARDS AND PRACTICES TO ASSURE COMPLIANCE WITH HEALTHCARE INFORMATION TECHNOLOGY AND SOFTWARE LAWS AND REGULATIONS, AND REVIEWING STANDARDS AND PRACTICES OF HEALTHCARE ORGANIZATIONS, PROVIDERS AND PAYERS TO ASSURE COMPLIANCE WITH THE HEALTH INSURANCE PORTABILITY AND ACCOUNTABILITY ACT OF 1996 (HIPAA) LEGISLATION, THE SERVICES INCORPORATING THE COMPONENTS AND FUNCTIONALITY NECESSARY FOR HEALTHCARE ORGANIZATIONS, PROVIDERS, AND PAYERS TO RECEIVE, ANALYZE, ASSESS, ROUTE, STORE AND QUERY HIPAA ELECTRONIC STANDARD TRANSACTIONS, AND SERVICES TO FACILITATE, MONITOR AND ASSIST HEALTHCARE ORGANIZATIONS, PROVIDERS, AND PAYERS IN THEIR COMPLIANCE EFFORT WITH HIPAA, AND MANAGING DATA GATHERED IN THAT EFFORT; ALSO CONSULTING SERVICES IN THE FIELD OF ELECTRONIC HEALTHCARE DATABASE AND SYSTEM INTERFACE DESIGN; TESTING, ANALYSIS, AND EVALUATION OF THE GOODS AND SERVICES OF OTHERS FOR THE PURPOSE OF CERTIFICATION; AND COMPUTER SERVICES, NAMELY, PROVIDING COMPUTERIZED DATA BASES IN THE FIELD OF HEALTHCARE; CONSULTING SERVICES IN THE FIELD OF SELECTION, IMPLEMENTATION AND USE OF COMPUTER HARDWARE AND SOFTWARE FOR OTHERS; APPLICATION SERVICE PROVIDER (ASP) SERVICES FEATURING SOFTWARE IN THE FIELD OF HEALTHCARE DATABASE MANAGEMENT AND DATA EXCHANGE; TECHNICAL SUPPORT SERVICES, NAMELY, MONITORING OF NETWORKS, TROUBLESHOOTING OF COMPUTER HARDWARE AND SOFTWARE PROBLEMS, AND PROVIDING COMPUTER PROGRAM AND DATABASE BACK-UP APPLICATION SERVICE PROVIDER (ASP) SERVICES FEATURING SOFTWARE FOR THE HEALTHCARE INDUSTRY HOSTING SOFTWARE APPLICATIONS FROM VENDORS, AND CONFIGURING THE SAME FOR USE OVER COMPUTER NETWORKS; BUT EXCLUDING ANY AND ALL OF THE ABOVE SERVICES FOR THE ADMINISTRATION OF EMPLOYEE VOLUNTARY BENEFIT INSURANCE PLANS; TECHNICAL SUPPORT, NAMELY, PROVIDING BACK-UP COMPUTER PROGRAMS, COMPUTER HARDWARE AND FACILITIES FOR HEALTHCARE INDUSTRY RELATED CLIENTS; BUT EXCLUDING THE PROVISION OF VOLUNTARY BENEFIT NEEDS FOR ADMINISTRATION OF EMPLOYEE BENEFIT INSURANCE PLANS (U.S. CLS. 100 AND 101).

FIRST USE 1-31-2001; IN COMMERCE 1-31-2001.

GINA HAYES, EXAMINING ATTORNEY

CLASS 42—(Continued).

SN 78-395,071. EDOC SYSTEMS, INC., CONCORD, NC.
FILED 4-1-2004.



NO CLAIM IS MADE TO THE EXCLUSIVE RIGHT TO USE "EDOC SYSTEMS", APART FROM THE MARK AS SHOWN.

THE COLOR(S) RED, GRAY AND BLACK IS/ARE CLAIMED AS A FEATURE OF THE MARK.

THE MARK CONSISTS OF A STYLIZED LOWER-CASE LETTER "E" IN RED SURROUNDED BY TWO GRAY SWOOSHES AND TWO RED DOTS; THE WORD "DOC" (ALL LETTERS CAPITALIZED) IN BLACK; THE WORD "SYSTEMS" UNDERNEATH THE WORD "DOC" IN RED WITH THE FIRST LETTER (S) CAPITALIZED.

FOR COMPUTER SOFTWARE DEVELOPMENT (U.S. CLS. 100 AND 101).

FIRST USE 1-1-2003; IN COMMERCE 1-1-2004.

KELLY CHOE, EXAMINING ATTORNEY

SN 78-395,461. VERIFY BRAND, INC., MINNEAPOLIS, MN.
FILED 4-2-2004.

VeriTrack!

THE MARK CONSISTS OF STANDARD CHARACTERS WITHOUT CLAIM TO ANY PARTICULAR FONT, STYLE, SIZE, OR COLOR.

FOR DEVELOPMENT, UPDATING AND MAINTENANCE OF SOFTWARE; PROVIDING TEMPORARY USE OF ON-LINE NON-DOWNLOADABLE SOFTWARE FOR CAPTURING DATA FROM PRODUCT CODES, ANALYZING DATA AND GENERATING REPORTS REGARDING SUPPLY CHAIN ACTIVITY (U.S. CLS. 100 AND 101).

FIRST USE 3-29-2004; IN COMMERCE 3-29-2004.

MICHAEL HALL, EXAMINING ATTORNEY

CLASS 42—(Continued).

SN 78-395,927. PICTOGRAM STUDIO, GARRETT PARK, MD. FILED 4-3-2004.

CLASS 42—(Continued).

SN 78-406,157. DYAX CORP., CAMBRIDGE, MA. FILED 4-22-2004.

Pictogram Press

EDEMA2

THE MARK CONSISTS OF STANDARD CHARACTERS WITHOUT CLAIM TO ANY PARTICULAR FONT, STYLE, SIZE, OR COLOR.

OWNER OF U.S. REG. NO. 2,229,837.

NO CLAIM IS MADE TO THE EXCLUSIVE RIGHT TO USE "PRESS", APART FROM THE MARK AS SHOWN.

FOR ART SERVICES, NAMELY GRAPHIC DESIGN, GRAPHIC ART DESIGN, AND COMMERCIAL ART DESIGN; DESIGN SERVICES, NAMELY INDUSTRIAL DESIGN, ORGANIZATIONAL DESIGN, AND PRODUCT AND/OR SERVICES IDENTITY DESIGN; AND COMPUTER SOFTWARE DESIGN (U.S. CLS. 100 AND 101).

FIRST USE 1-1-1989; IN COMMERCE 4-3-2004.

SOPHIA S. KIM, EXAMINING ATTORNEY

THE MARK CONSISTS OF STANDARD CHARACTERS WITHOUT CLAIM TO ANY PARTICULAR FONT, STYLE, SIZE, OR COLOR.

FOR PROVIDING MEDICAL AND SCIENTIFIC RESEARCH INFORMATION ABOUT PHARMACEUTICALS AND CLINICAL TRIALS BY MEANS OF AN INTERNET WEB SITE; AND MEDICAL AND SCIENTIFIC RESEARCH, NAMELY CONDUCTING CLINICAL TRIALS (U.S. CLS. 100 AND 101).

LOURDES AYALA, EXAMINING ATTORNEY

SN 78-401,690. HOSTWAY CORPORATION, CHICAGO, IL. FILED 4-14-2004.

SN 78-406,852. VACCARO, HENRY S., BRADENTON, FL. FILED 4-23-2004.

WhoisProtector

Standard Analytics

THE MARK CONSISTS OF STANDARD CHARACTERS WITHOUT CLAIM TO ANY PARTICULAR FONT, STYLE, SIZE, OR COLOR.

FOR REGISTRATION OF DOMAIN NAMES ON BEHALF OF OTHERS FOR IDENTIFICATION OF USERS ON A GLOBAL COMPUTER NETWORK (U.S. CLS. 100 AND 101).

FIRST USE 4-6-2004; IN COMMERCE 4-6-2004.

TIMOTHY FINNEGAN, EXAMINING ATTORNEY

THE MARK CONSISTS OF STANDARD CHARACTERS WITHOUT CLAIM TO ANY PARTICULAR FONT, STYLE, SIZE, OR COLOR.

FOR COMPUTER SOFTWARE DEVELOPMENT (U.S. CLS. 100 AND 101).

FIRST USE 6-1-2002; IN COMMERCE 8-20-2002.

C. DIONNE CLYBURN, EXAMINING ATTORNEY

CLASS 42—(Continued).

SN 78-407,755. CONTINENTAL TRAFFIC SERVICE, INC., MEMPHIS, TN. FILED 4-26-2004.

e-CTMS

THE MARK CONSISTS OF STANDARD CHARACTERS WITHOUT CLAIM TO ANY PARTICULAR FONT, STYLE, SIZE, OR COLOR.

FOR PROVIDING TEMPORARY USE OF NON-DOWNLOADABLE WEB-BASED COMPUTER SOFTWARE FOR DATA PROCESSING AND CALCULATIONS IN THE FIELD OF TRANSPORTATION MANAGEMENT (U.S. CLS. 100 AND 101).

FIRST USE 5-6-2004; IN COMMERCE 5-6-2004.
LEIGH LOWRY, EXAMINING ATTORNEY

SN 78-409,468. MARKET INTELLIGENCE GROUP, LLC, CINCINNATI, OH. FILED 4-28-2004.

DataWell

THE MARK CONSISTS OF STANDARD CHARACTERS WITHOUT CLAIM TO ANY PARTICULAR FONT, STYLE, SIZE, OR COLOR.

NO CLAIM IS MADE TO THE EXCLUSIVE RIGHT TO USE "DATA", APART FROM THE MARK AS SHOWN.

FOR COMPUTER SERVICE, NAMELY, ACTING AS AN APPLICATION SERVICE PROVIDER IN THE FIELD OF KNOWLEDGE MANAGEMENT TO HOST COMPUTER APPLICATION SOFTWARE FOR CREATING SEARCHABLE DATABASES OF INFORMATION AND DATA; COMPUTER SERVICE, NAMELY, ACTING AS AN APPLICATION SERVICE PROVIDER IN THE FIELD OF KNOWLEDGE MANAGEMENT TO HOST COMPUTER APPLICATION SOFTWARE FOR THE COLLECTION, EDITING, ORGANIZING, MODIFYING, BOOK MARKING, TRANSMISSION, STORAGE AND SHARING OF DATA AND INFORMATION (U.S. CLS. 100 AND 101).

FIRST USE 11-19-2001; IN COMMERCE 11-19-2001.
JEFF DEFORD, EXAMINING ATTORNEY

CLASS 42—(Continued).

SN 78-410,606. SPEEDY LIEN INC., MERRICK, NY. FILED 4-29-2004.

THE LIEN KING

THE MARK CONSISTS OF STANDARD CHARACTERS WITHOUT CLAIM TO ANY PARTICULAR FONT, STYLE, SIZE, OR COLOR.

OWNER OF U.S. REG. NO. 2,185,765.

NO CLAIM IS MADE TO THE EXCLUSIVE RIGHT TO USE "LIEN", APART FROM THE MARK AS SHOWN.

FOR MECHANIC'S LIEN SEARCH AND FILING SERVICES (U.S. CLS. 100 AND 101).

FIRST USE 1-1-2001; IN COMMERCE 1-1-2001.

KATHY DE JONGE, EXAMINING ATTORNEY

SN 78-417,166. PAUL, SCOTT, KATY, TX. FILED 5-12-2004.

IOWNIE

THE MARK CONSISTS OF STANDARD CHARACTERS WITHOUT CLAIM TO ANY PARTICULAR FONT, STYLE, SIZE, OR COLOR.

FOR REGISTRATION OF DOMAIN NAMES FOR IDENTIFICATION OF USERS ON A GLOBAL COMPUTER NETWORK (U.S. CLS. 100 AND 101).

NANCY CLARKE, EXAMINING ATTORNEY

SN 78-417,457. ACTION GAMING, INC., LAS VEGAS, NV. FILED 5-12-2004.

ACTION GAMING

THE MARK CONSISTS OF STANDARD CHARACTERS WITHOUT CLAIM TO ANY PARTICULAR FONT, STYLE, SIZE, OR COLOR.

NO CLAIM IS MADE TO THE EXCLUSIVE RIGHT TO USE "GAMING", APART FROM THE MARK AS SHOWN.

FOR DESIGN AND DEVELOPMENT OF GAMING EQUIPMENT AND GAMING SOFTWARE (U.S. CLS. 100 AND 101).

FIRST USE 12-31-1998; IN COMMERCE 12-31-1998.

ROBIN CHOSID, EXAMINING ATTORNEY

CLASS 42—(Continued).

SN 78-417,774. DIGITAL 21, INCORPORATED, ATLANTA, GA. FILED 5-12-2004.

CLASS 42—(Continued).

SN 78-421,000. INSCAPE PUBLISHING, INC., MINNEAPOLIS, MN. FILED 5-18-2004.

INSCAPE PUBLISHING

DIGITAL 21

THE MARK CONSISTS OF STANDARD CHARACTERS WITHOUT CLAIM TO ANY PARTICULAR FONT, STYLE, SIZE, OR COLOR.

NO CLAIM IS MADE TO THE EXCLUSIVE RIGHT TO USE DIGITAL, APART FROM THE MARK AS SHOWN.

FOR COMPUTER GRAPHICS SERVICES COMPUTER PROGRAMMING FOR OTHERS COMPUTER PROJECT MANAGEMENT SERVICES COMPUTER SERVICES, NAMELY, CREATING AND MAINTAINING WEB SITES FOR OTHERS COMPUTER SERVICES, NAMELY, DESIGNING AND IMPLEMENTING WEB SITES FOR OTHERS COMPUTER SERVICES, NAMELY, MANAGING WEB SITES FOR OTHERS (U.S. CLS. 100 AND 101).

FIRST USE 5-21-2002; IN COMMERCE 5-21-2002.
MARIA-VICTORIA SUAREZ, EXAMINING ATTORNEY

THE MARK CONSISTS OF STANDARD CHARACTERS WITHOUT CLAIM TO ANY PARTICULAR FONT, STYLE, SIZE, OR COLOR.

OWNER OF U.S. REG. NOS. 2,622,088, 2,672,880 AND OTHERS.

NO CLAIM IS MADE TO THE EXCLUSIVE RIGHT TO USE "PUBLISHING", APART FROM THE MARK AS SHOWN.

FOR PROVIDING TEMPORARY USE OF ONLINE NON-DOWNLOADABLE SOFTWARE CONTAINING INSTRUCTIONAL AND EXPLANATORY TEXTS, QUESTIONS, RESPONSES AND INTERPRETIVE DATA FOR USE IN BEHAVIOR EVALUATION, COUNSELING, PERSONAL DEVELOPMENT, YOUTH DEVELOPMENT, PARENTAL TRAINING, BUSINESS MANAGEMENT AND EMPLOYEE TRAINING (U.S. CLS. 100 AND 101).

FIRST USE 10-19-2001; IN COMMERCE 10-19-2001.
HENRY S. ZAK, EXAMINING ATTORNEY

SN 78-421,077. SPECTRAL MANAGEMENT, CASSELBERRY, FL. FILED 5-18-2004.

SN 78-420,957. MENGES, MCLAUGHLIN, CUNNINGHAM AND KALASNIK, P.C., YORK, PA. FILED 5-18-2004.



NO CLAIM IS MADE TO THE EXCLUSIVE RIGHT TO USE "LLP" AND "ATTORNEYS AT LAW", APART FROM THE MARK AS SHOWN.

THE MARK CONSISTS OF A PARTIAL OVAL EXTENDING TO THE RIGHT OF THE LITERAL ELEMENT AND INTERSECTED BY THREE CURVED LINES.

FOR LEGAL SERVICES (U.S. CLS. 100 AND 101).
FIRST USE 1-0-2004; IN COMMERCE 1-0-2004.
PAM WILLIS, EXAMINING ATTORNEY



NO CLAIM IS MADE TO THE EXCLUSIVE RIGHT TO USE "MANAGEMENT INCORPORATED", APART FROM THE MARK AS SHOWN.

THE COLOR(S) BLUE, GREEN, YELLOW, AND RED IS/ARE CLAIMED AS A FEATURE OF THE MARK.

THE MARK CONSISTS OF THE WORDING "SPECTRAL MANAGEMENT INCORPORATED" AND A DESIGN OF A BLACK ISOSCELES TRIANGLE WITH A CIRCLE OF WHITE IN ITS CENTER FROM WHICH THE COLORS BLUE, GREEN, YELLOW, AND RED FLARE UPWARD.

FOR ELECTRICAL ENGINEERING SERVICES RELATED TO THE TELECOMMUNICATIONS INDUSTRY (U.S. CLS. 100 AND 101).

FIRST USE 3-10-2001; IN COMMERCE 4-12-2002.
DAVID C. REIHNER, EXAMINING ATTORNEY

CLASS 42—(Continued).

SN 78-421,419. CIREXSYSTEMS, TUSTIN, CA. FILED 5-19-2004.

CirexSystems

THE MARK CONSISTS OF STANDARD CHARACTERS WITHOUT CLAIM TO ANY PARTICULAR FONT, STYLE, SIZE, OR COLOR.

FOR INFORMATION TECHNOLOGY (IT) CONSULTING SERVICES, NAMELY, COMPUTER HARDWARE AND SOFTWARE CONSULTATION; COMPUTER NETWORK DESIGN FOR OTHERS; INSTALLATION AND MAINTENANCE OF COMPUTER SERVER OPERATING SOFTWARE (U.S. CLS. 100 AND 101).

FIRST USE 1-21-2004; IN COMMERCE 1-24-2004.
NELSON SNYDER, EXAMINING ATTORNEY

CLASS 42—(Continued).

SN 78-423,239. ENVENTYS, LLC, CHARLOTTE, NC. FILED 5-21-2004.

ENVENTYS

THE MARK CONSISTS OF STANDARD CHARACTERS WITHOUT CLAIM TO ANY PARTICULAR FONT, STYLE, SIZE, OR COLOR.

FOR PRODUCT DEVELOPMENT AND INDUSTRIAL DESIGN SERVICES (U.S. CLS. 100 AND 101).

FIRST USE 8-10-2001; IN COMMERCE 1-7-2002.
MICHAEL ENGEL, EXAMINING ATTORNEY

SN 78-423,391. OMNILALA, INC., NEWTON CENTER, MA. FILED 5-22-2004.

OMNILALA

THE MARK CONSISTS OF STANDARD CHARACTERS WITHOUT CLAIM TO ANY PARTICULAR FONT, STYLE, SIZE, OR COLOR.

FOR TECHNICAL CONSULTANCY, RESEARCH, INDUSTRIAL ANALYSIS RELATING TO AND DESIGN, ENGINEERING AND DEVELOPMENT OF— COMPUTER HARDWARE, SOFTWARE AND CONSUMER ELECTRONIC TECHNOLOGIES USED IN HOME AND BUSINESS APPLICATIONS, INCLUDING— AUDIOVISUAL AND COMPUTER SYSTEM INTEGRATION AND DEVICE CONNECTIVITY, SERVERS FOR AUDIO, VIDEO, TEXT AND INFORMATION CONTENT, MUSIC AND VIDEO SYSTEMS, HOME AUTOMATION, MANUFACTURING AUTOMATION, DIGITAL AUDIO NETWORKS, ENTERTAINMENT SYSTEMS, AND COMMUNICATION DEVICES (U.S. CLS. 100 AND 101).

FIRST USE 7-3-2003; IN COMMERCE 7-3-2003.

THEODORE MCBRIDE, EXAMINING ATTORNEY

SN 78-421,474. PRESENCE IT, PARADISE VALLEY, AZ. FILED 5-19-2004.



NO CLAIM IS MADE TO THE EXCLUSIVE RIGHT TO USE SMARTPHONE, APART FROM THE MARK AS SHOWN.

THE COLOR(S) GREEN, BLACK AND WHITE IS/ARE CLAIMED AS A FEATURE OF THE MARK.

THE MARK CONSISTS OF STYLIZED BLACK LETTERING AND A STYLIZED WHITE NUMBER 4 ENCLOSED WITHIN A GREEN SQUARE.

FOR COMPUTER SERVICES, NAMELY, PROVIDING NON-DOWNLOADABLE COMPUTER PROGRAMS FOR USE IN WIRELESSLY ACCESSING DATA, FACSIMILES, IMAGES, AND BUSINESS INFORMATION VIA GLOBAL AND LOCAL COMPUTER NETWORKS (U.S. CLS. 100 AND 101).

FIRST USE 10-1-2001; IN COMMERCE 1-3-2002.

ZACHARY BELLO, EXAMINING ATTORNEY

CLASS 42—(Continued).

SN 78-425,575. CEMINES, INC., EVERGREEN, CO. FILED 5-26-2004.

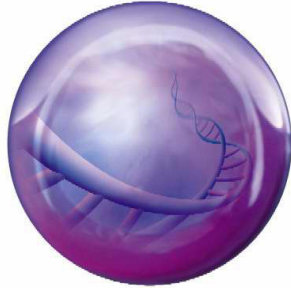

THE COLOR PURPLE IS CLAIMED AS A FEATURE OF THE MARK.

THE COLOR PURPLE APPEARS IN A DARKER SHADE AT THE BOTTOM OF THE ROUND DESIGN MARK AND TRANSITIONS INTO LIGHTER SHADES OF PURPLE IN THE MIDDLE AND THEN AT THE TOP OF THE ROUND DESIGN MARK. A HELIX ELEMENT WITHIN THE ROUND DESIGN APPEARS IN A DARKER PURPLE COLOR.

THE MARK CONSISTS OF DESIGN OF BALL CONTAINING STYLIZED DNA HELIX.

FOR MEDICAL RESEARCH AND PRODUCT DEVELOPMENT SERVICES IN THE FIELDS OF MOLECULAR SCREENING, AND DEVELOPMENT OF DIAGNOSTIC TEST METHODS AND THERAPEUTICS FOR HUMAN AND ANIMAL DISEASES (U.S. CLS. 100 AND 101).

FIRST USE 10-0-2002; IN COMMERCE 10-0-2002.
REBECCA GILBERT, EXAMINING ATTORNEY

SN 78-425,939. HNTB HOLDINGS LTD, KANSAS CITY, MO. FILED 5-27-2004.

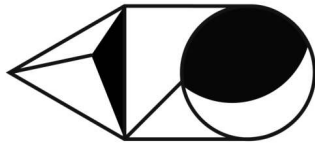

FOR ARCHITECTURAL DESIGN, PLANNING AND ENGINEERING SERVICES; CONVERTING ARCHITECTURAL AND ENGINEERING DESIGN DATA TO 3-D MODELING DATA FOR OTHERS USING COMPUTER SOFTWARE (U.S. CLS. 100 AND 101).

FIRST USE 5-10-2004; IN COMMERCE 5-10-2004.
KIMBERLY FRYE, EXAMINING ATTORNEY

CLASS 42—(Continued).

SN 78-428,789. TRAFFICWERKS SYSTEMS, INC., NEWPORT BEACH, CA. FILED 6-2-2004.

TRAFFICWERKS

THE MARK CONSISTS OF STANDARD CHARACTERS WITHOUT CLAIM TO ANY PARTICULAR FONT, STYLE, SIZE, OR COLOR.

FOR COMPUTER INFORMATION SYSTEMS INTEGRATION SERVICES, ENGINEERING AND ENGINEERING CONSULTING SERVICES, DATA AUTOMATION AND COLLECTION SERVICES USING PROPRIETARY SOFTWARE TO EVALUATE, ANALYZE AND COLLECT SERVICE DATA, DATA MINING, DATABASE DEVELOPMENT SERVICES, AND DEVELOPMENT, UPDATING AND MAINTENANCE OF DATA BASES, ALL IN THE FIELD OF INTELLIGENT TRANSPORTATION SYSTEMS (U.S. CLS. 100 AND 101).

FIRST USE 12-31-2000; IN COMMERCE 12-31-2000.
MELISSA SHELLA, EXAMINING ATTORNEY

SN 78-429,153. DECISIVE ENVIRONMENT, LLC, SALT LAKE CITY, UT. FILED 6-3-2004.

GLOBAL DECISIONS

THE MARK CONSISTS OF STANDARD CHARACTERS WITHOUT CLAIM TO ANY PARTICULAR FONT, STYLE, SIZE, OR COLOR.

FOR ONLINE COMPUTER DATABASES FEATURING GOVERNMENT LEGISLATION AND REGULATIONS, LEGISLATION AND REGULATION MONITORING REPORTS, REGULATION SUMMARIES, REGULATORY STANDARDS, NOMENCLATURE AND ACRONYM GUIDES, TERMINOLOGY GUIDANCE MANUALS, LITIGATION MONITORING REPORTS, REGULATORY AGENCY ORGANIZATIONAL CHARTS AND CONTACT INFORMATION, AND COUNTRY GOVERNMENTAL JURISDICTION INFORMATION (U.S. CLS. 100 AND 101).

ANGELA M. MICHELI, EXAMINING ATTORNEY

CLASS 42—(Continued).

SN 78-429,334. DECISIVE ENVIRONMENT, LLC, SALT LAKE CITY, UT. FILED 6-3-2004.

CLASS 42—(Continued).

SN 78-429,507. LAND AND AERIAL LLC, SANTA FE, NM. FILED 6-3-2004.

GLOBAL DECISIONS

THE MARK CONSISTS OF STANDARD CHARACTERS WITHOUT CLAIM TO ANY PARTICULAR FONT, STYLE, SIZE, OR COLOR.

FOR CONSULTING SERVICES IN THE FIELDS OF INTERNATIONAL ENVIRONMENTAL COMPLIANCE, ENVIRONMENTAL MANAGEMENT, OCCUPATIONAL AND COMMUNITY HEALTH AND SAFETY, AND CORPORATE SOCIAL RESPONSIBILITY; ENVIRONMENTAL AUDITING AND ENVIRONMENTAL DUE DILIGENCE, NAMELY, REVIEWING STANDARDS AND PRACTICES TO ASSESS CORPORATE COMPLIANCE WITH ENVIRONMENTAL LAWS, REGULATIONS AND VOLUNTARY STANDARDS; ANALYZING AND ASSESSING OCCUPATIONAL AND COMMUNITY HEALTH AND SAFETY SYSTEMS AND COMPLIANCE WITH OCCUPATIONAL, COMMUNITY AND CORPORATE SOCIAL RESPONSIBILITY HEALTH AND SAFETY LAWS; TECHNICAL CONSULTATION AND RESEARCH, NAMELY, ANALYZING AND DEVELOPING ENVIRONMENTAL AND OCCUPATIONAL AND COMMUNITY HEALTH AND SAFETY COMPLIANCE PROGRAMS AND BENCHMARKS; PROVIDING TEMPORARY USE OF WEB-BASED NON-DOWNLOADABLE SOFTWARE FOR MEASURING, MONITORING, MANAGING, AND ANALYZING ENVIRONMENTAL, HEALTH AND SAFETY PROGRAMS TO FACILITATE CORPORATE COMPLIANCE WITH INTERNATIONAL ENVIRONMENTAL, HEALTH AND SAFETY LAWS, REGULATIONS AND STANDARDS; PROVIDING AN ON-LINE COMPUTER DATABASE IN THE FIELDS OF INTERNATIONAL ENVIRONMENTAL COMPLIANCE; ENVIRONMENTAL MANAGEMENT, OCCUPATIONAL AND COMMUNITY HEALTH AND SAFETY, AND CORPORATE SOCIAL RESPONSIBILITY; ONLINE CONSULTING SERVICES RELATING TO INTERNATIONAL ENVIRONMENTAL COMPLIANCE, ENVIRONMENTAL MANAGEMENT, OCCUPATIONAL AND COMMUNITY HEALTH AND SAFETY, AND CORPORATE SOCIAL RESPONSIBILITY; RESEARCH AND ANALYSIS OF GOVERNMENT LEGISLATION AND REGULATIONS; PROVIDING LINKS TO WEBSITES OF OTHERS FEATURING GOVERNMENT ORGANIZATION INFORMATION AND UNILATERAL DEVELOPMENT AGENCY INFORMATION; ONLINE COMPUTER DATABASES FEATURING GOVERNMENT LEGISLATION AND REGULATIONS, LEGISLATION AND REGULATION MONITORING REPORTS, REGULATION SUMMARIES, REGULATORY STANDARDS, NOMENCLATURE AND ACRONYM GUIDES, TERMINOLOGY GUIDANCE MANUALS, LITIGATION MONITORING REPORTS, REGULATORY AGENCY ORGANIZATIONAL CHARTS AND CONTACT INFORMATION, AND COUNTRY GOVERNMENTAL JURISDICTION INFORMATION (U.S. CLS. 100 AND 101).

ANGELA M. MICHELI, EXAMINING ATTORNEY

Land & Aerial

THE MARK CONSISTS OF STANDARD CHARACTERS WITHOUT CLAIM TO ANY PARTICULAR FONT, STYLE, SIZE, OR COLOR.

FOR SURVEYING AND ENGINEERING (U.S. CLS. 100 AND 101).

FIRST USE 5-4-2004; IN COMMERCE 5-24-2004.

ANNE E. GUSTASON, EXAMINING ATTORNEY

SN 78-429,571. LEET PRODUCTIONS, LLC, TOWSON, MD. FILED 6-3-2004.

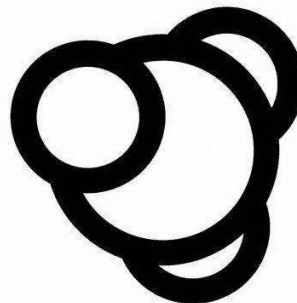

THE MARK CONSISTS OF MOLECULE DESIGN, FOR GRAPHIC DESIGN SERVICES; DESIGNING AND CREATING COMPUTER GRAPHICS; AND CONSULTATION REGARDING DESIGN OF AND IMPLEMENTATION OF GRAPHIC DESIGN PROJECTS FOR OTHERS (U.S. CLS. 100 AND 101).

FIRST USE 5-1-2003; IN COMMERCE 8-5-2003.

SAMUEL E. SHARPER JR., EXAMINING ATTORNEY

CLASS 42—(Continued).

SN 78-430,018. INNOVATIVE AFTERMARKET SYSTEMS, LP, LEANDER, TX. FILED 6-4-2004.

CLASS 42—(Continued).

SN 78-432,035. COWAN, BAIRD W, MATHER, CA. FILED 6-8-2004.

SMART DEALER PRODUCTS

Webalist

THE MARK CONSISTS OF STANDARD CHARACTERS WITHOUT CLAIM TO ANY PARTICULAR FONT, STYLE, SIZE, OR COLOR.

NO CLAIM IS MADE TO THE EXCLUSIVE RIGHT TO USE "DEALER PRODUCTS", APART FROM THE MARK AS SHOWN.

FOR PROVIDING TEMPORARY USE OF NON-DOWNLOADABLE COMPUTER SOFTWARE USED BY DEALERS TO MANAGE VEHICLE DEALER OPERATIONS, NAMELY, DEALER WARRANTIES, DEALER RECORD-KEEPING, DEALER TRANSACTIONS, AND SOTRE PROMOTIONAL PRESENTATIONS, CONSUMER INFORMED CONSENT AGREEMENTS AND EMPLOYEE TRAINING PROGRAMS. (U.S. CLS. 100 AND 101).

FIRST USE 5-24-2004; IN COMMERCE 5-24-2004.
STEPHANIE DAVIS, EXAMINING ATTORNEY

THE MARK CONSISTS OF STANDARD CHARACTERS WITHOUT CLAIM TO ANY PARTICULAR FONT, STYLE, SIZE, OR COLOR.

FOR MAINTENANCE OF WEB SITES FOR THIRD PARTIES; HOSTING OF WEB SITES FOR OTHERS; AND REGISTRATION OF DOMAIN NAMES FOR IDENTIFICATION OF USERS ON A GLOBAL COMPUTER NETWORK, ALL PERFORMED BY MEANS OF COMPUTER GLOBAL NETWORKS (U.S. CLS. 100 AND 101).

FIRST USE 6-19-2004; IN COMMERCE 6-19-2004.
DAVID MURRAY, EXAMINING ATTORNEY

SN 78-430,881. POINT ROLL, INC., FORT WASHINGTON, PA. FILED 6-7-2004.

SN 78-432,967. HONEYWELL INTERNATIONAL INC., MORRISTOWN, NJ. FILED 6-10-2004.



GET FOCUSED

THE COLOR(S) GREEN IS/ARE CLAIMED AS A FEATURE OF THE MARK.

THE MARK CONSISTS OF THE WORD MARK TOMBOY IN GREEN.

FOR PROVIDING TEMPORARY USE OF NON-DOWNLOADABLE COMPUTER SOFTWARE FOR USE IN CREATING WEB-BASED ADVERTISEMENTS (U.S. CLS. 100 AND 101).

FIRST USE 5-1-2004; IN COMMERCE 5-8-2004.
JEFFERY COWARD, EXAMINING ATTORNEY

THE MARK CONSISTS OF STANDARD CHARACTERS WITHOUT CLAIM TO ANY PARTICULAR FONT, STYLE, SIZE, OR COLOR.

FOR PATIENT HEALTH CARE MONITORING SERVICES, NAMELY, REMOTE MONITORING OF DATA INDICATIVE OF THE HEALTH OR CONDITION OF AN INDIVIDUAL OR GROUP OF INDIVIDUALS (U.S. CLS. 100 AND 101).

THEODORE MCBRIDE, EXAMINING ATTORNEY

CLASS 42—(Continued).

SN 78-433,982. JOHNSTON MCLAMB, CHANTILLY, VA.
FILED 6-11-2004.

LBDM

THE MARK CONSISTS OF STANDARD CHARACTERS WITHOUT CLAIM TO ANY PARTICULAR FONT, STYLE, SIZE, OR COLOR.

FOR COMPUTER SOFTWARE DEVELOPMENT (U.S. CLS. 100 AND 101).

FIRST USE 3-26-2004; IN COMMERCE 3-26-2004.
STEVEN R. FOSTER, EXAMINING ATTORNEY

SN 78-438,661. XTENSIBLE SOLUTIONS, INC., SATELLITE BEACH, FL. FILED 6-21-2004.



The logo for Xtensible Solutions features the words "Xtensible Solutions" in a blue serif font. The word "Xtensible" is underlined with a red dashed line. A light blue wave-like graphic is positioned behind the text.

OWNER OF U.S. REG. NO. 7,559,359.
NO CLAIM IS MADE TO THE EXCLUSIVE RIGHT TO USE "EXTENSIBLE SOLUTIONS", APART FROM THE MARK AS SHOWN.

THE COLOR(S) DARK BLUE, RED AND GRAY IS/ARE CLAIMED AS A FEATURE OF THE MARK.

THE WORDS XTENSIBLE SOLUTIONS IN DARK BLUE WITH A DASHED UNDERLINE IN RED FADING FROM LEFT TO RIGHT; A GRAY DOUBLE ARCH DESIGN FLOWS BEHIND THE WORDS XTENSIBLE SOLUTIONS

FOR G & S: INTEGRATION SERVICES, NAMELY, DESIGNING, IMPROVING AND IMPLEMENTING SOLUTIONS FOR THE INTEGRATION OF COMPUTING SYSTEMS TO PROVIDE INFORMATION PERTAINING TO BUSINESS AND ENGINEERING SYSTEMS TO USERS IN UTILITIES AND OTHER COMPANIES; CONSULTING SERVICES RELATING TO THE INTEGRATION SERVICES; FIRST USE IN COMMERCE: 19980301 (U.S. CLS. 100 AND 101).

FIRST USE 11-23-1998; IN COMMERCE 11-23-1998.
ANN LINNEHAN, EXAMINING ATTORNEY

CLASS 42—(Continued).

SN 78-439,207. EFISHANTSEA, INC., KANSAS CITY, MO.
FILED 6-22-2004.

EFISHANTSEA

THE MARK CONSISTS OF STANDARD CHARACTERS WITHOUT CLAIM TO ANY PARTICULAR FONT, STYLE, SIZE, OR COLOR.

FOR COMPUTER SERVICES, NAMELY MAINTENANCE, CONSULTING, TECHNICAL SUPPORT SERVICES IN THE NATURE OF TROUBLESHOOTING COMPUTER SOFTWARE PROBLEMS AND MONITORING NETWORK SYSTEMS, AND COMPUTER SYSTEM ADMINISTRATION VIA TELEPHONE, ON-LINE, AND IN PERSON AND ALL FOR COMPUTER SOFTWARE, COMPUTER DATABASES, COMPUTER NETWORKS, AND COMPUTER OPERATING SYSTEMS (U.S. CLS. 100 AND 101).

FIRST USE 8-1-2002; IN COMMERCE 8-1-2002.
BRIDGETT SMITH, EXAMINING ATTORNEY

SN 78-442,083. KODIAK GROUP, GRAYLING, MI. FILED 6-28-2004.



The logo for Kodiak Group features the words "Kodiak Group" in a blue sans-serif font. The word "Kodiak" is underlined with a blue solid line.

NO CLAIM IS MADE TO THE EXCLUSIVE RIGHT TO USE "GROUP", APART FROM THE MARK AS SHOWN.

FOR PROFESSIONAL ENGINEERING DESIGN IN THE FIELDS OF MATERIAL HANDLING EQUIPMENT, OF AUTOMATION EQUIPMENT, NAMELY, AUTOMATED FACTORY ASSEMBLY EQUIPMENT, OF STRUCTURAL STEEL, OF CONCRETE, OF DUST COLLECTION EQUIPMENT AND OF INDUSTRIAL PROCESSES, NAMELY, FACTORY DESIGN LAYOUT (U.S. CLS. 100 AND 101).

FIRST USE 7-26-2002; IN COMMERCE 7-26-2002.
PAUL F. GAST, EXAMINING ATTORNEY

CLASS 42—(Continued).

SN 78-443,290. BRIGHTON ASSOCIATES, L.L.C., BARRINGTON, IL. FILED 6-29-2004.



NO CLAIM IS MADE TO THE EXCLUSIVE RIGHT TO USE "PROCESS KNOWLEDGE EXPERIENCE TECHNOLOGY COMPLIANCE", APART FROM THE MARK AS SHOWN.

THE COLOR(S) BLUE, BROWN, GREEN, ORANGE AND PURPLE ARE CLAIMED AS A FEATURE OF THE MARK.

THE COLORS BLUE, BROWN, GREEN, ORANGE AND PURPLE ARE CLAIMED AS A FEATURE OF THE MARK. THE COLOR BLUE APPEARS IN THE BACKGROUND; THE COLOR BROWN APPEARS IN THE TOP LEFT CIRCLE; THE COLOR GREEN APPEARS IN THE TOP RIGHT CIRCLE; THE COLOR ORANGE APPEARS IN THE BOTTOM LEFT CIRCLE; THE COLOR PURPLE APPEARS IN THE BOTTOM RIGHT CIRCLE.

FOR CONSULTING SERVICES, NAMELY, PROVIDING COMPUTER SOFTWARE CONSULTING SERVICES IN THE NATURE OF COMPUTER SOFTWARE DEVELOPMENT IN THE FIELDS OF LIFE SCIENCES, PHARMACEUTICALS, BIOTECHNOLOGY AND MEDICAL DEVICES (U.S. CLS. 100 AND 101).

FIRST USE 8-0-2003; IN COMMERCE 12-2-2003.
MARLENE BELL, EXAMINING ATTORNEY

CLASS 42—(Continued).

SN 78-450,868. MICROSOFT CORPORATION, REDMOND, WA. FILED 7-14-2004.

WINDOWS UPDATE

THE MARK CONSISTS OF STANDARD CHARACTERS WITHOUT CLAIM TO ANY PARTICULAR FONT, STYLE, SIZE, OR COLOR.

OWNER OF U.S. REG. NOS. 1,872,264, 2,513,051 AND OTHERS.

NO CLAIM IS MADE TO THE EXCLUSIVE RIGHT TO USE UPDATE, APART FROM THE MARK AS SHOWN.

SEC. 2(F).

FOR COMPUTER SERVICES, NAMELY, UPDATING COMPUTER SOFTWARE FOR OTHERS VIA THE INTERNET; PROVIDING ONLINE INFORMATION CONCERNING COMPUTERS, COMPUTER PERIPHERALS AND COMPUTER SOFTWARE; AND ONLINE TECHNICAL SUPPORT IN THE FIELD OF COMPUTERS AND COMPUTER SOFTWARE (U.S. CLS. 100 AND 101).

FIRST USE 6-25-1998; IN COMMERCE 6-25-1998.
ESTHER BELENKER, EXAMINING ATTORNEY

SN 78-452,696. AGERE SYSTEMS INC., ALLENTOWN, PA. FILED 7-19-2004.

SN 78-446,242. REGULATORY COMPLIANCE ASSOCIATES INC., PLEASANT PRAIRIE, WI. FILED 7-6-2004.

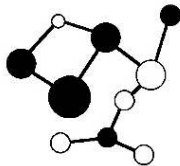

**Regulatory
Compliance
Associates Inc.**

NO CLAIM IS MADE TO THE EXCLUSIVE RIGHT TO USE REGULATORY COMPLIANCE ASSOCIATES INC., APART FROM THE MARK AS SHOWN.

FOR REVIEWING STANDARDS AND PRACTICES TO ENSURE COMPLIANCE WITH GOOD MANUFACTURING PRACTICES FOR THE PHARMACEUTICAL, BIOTECHNOLOGY, AND MEDICAL DEVICE INDUSTRIES (U.S. CLS. 100 AND 101).

FIRST USE 5-1-2001; IN COMMERCE 5-1-2001.
JOHN E. MICHOS, EXAMINING ATTORNEY

AGERE

THE MARK CONSISTS OF STANDARD CHARACTERS WITHOUT CLAIM TO ANY PARTICULAR FONT, STYLE, SIZE, OR COLOR.

OWNER OF U.S. REG. NOS. 2,448,190, 2,900,539 AND OTHERS.

FOR TECHNICAL CONSULTATION IN THE FIELDS OF SEMICONDUCTOR TECHNOLOGY, REFERENCE DESIGNS FOR SEMICONDUCTORS, AND COMPUTER SOFTWARE, FOR USE IN CONSUMER ELECTRONICS, COMPUTER SYSTEMS, DATA STORAGE SYSTEMS, AND TELECOMMUNICATION NETWORK APPLICATIONS (U.S. CLS. 100 AND 101).

FIRST USE 7-26-1999; IN COMMERCE 7-26-1999.
BARBARA A. GOLD, EXAMINING ATTORNEY

CLASS 42—(Continued).

SN 78-456,390. ANH REFRACTORIES COMPANY, MOON TOWNSHIP, PA. FILED 7-26-2004.



OWNER OF U.S. REG. NOS. 265,489 AND 2,809,505.
NO CLAIM IS MADE TO THE EXCLUSIVE RIGHT TO USE "REFRACTORIES", APART FROM THE MARK AS SHOWN.

THE MARK CONSISTS OF THE TERM "ANH REFRACTORIES" ENCIRCLED BY THE WORDS "AP GREEN, NARCO" AND "HARBISON-WALKER".

FOR ENGINEERING AND TECHNICAL CONSULTATION SERVICES IN THE FIELD OF REFRACTORY MATERIALS AND REFRACTORY PRODUCTS (U.S. CLS. 100 AND 101).

FIRST USE 7-19-2004; IN COMMERCE 7-19-2004.
RONALD AIKENS, EXAMINING ATTORNEY

CLASS 42—(Continued).

SN 78-461,179. MEDTURN, WESTFIELD, IN. FILED 8-3-2004.

Med reTurn

THE MARK CONSISTS OF STANDARD CHARACTERS WITHOUT CLAIM TO ANY PARTICULAR FONT, STYLE, SIZE, OR COLOR.

NO CLAIM IS MADE TO THE EXCLUSIVE RIGHT TO USE "MED", APART FROM THE MARK AS SHOWN.

FOR PROVIDING TEMPORARY USE OF ONLINE NON-DOWNLOADABLE SOFTWARE FOR INVENTORY MANAGEMENT RELATED TO THE PROCESSING AND RETURNING OF PHARMACEUTICALS THAT ARE EXPIRED OR RECALLED, FOR PHARMACIES, HEALTH CARE FACILITIES, PHYSICIAN OFFICES, AND CLINICS (U.S. CLS. 100 AND 101).

FIRST USE 6-1-2004; IN COMMERCE 6-1-2004.
SANJEEV VOHRA, EXAMINING ATTORNEY

SN 78-457,437. TESTAMERICA ENVIRONMENTAL MICROBIOLOGY LABORATORY, INC., SAN BRUNO, CA. FILED 7-27-2004.

EMLab

THE MARK CONSISTS OF STANDARD CHARACTERS WITHOUT CLAIM TO ANY PARTICULAR FONT, STYLE, SIZE, OR COLOR.

FOR ANALYSIS OF AIR AND SURFACE SAMPLES FOR FUNGI AND BACTERIA, NAMELY, CULTURABLE AIR SAMPLES, SPORE TRAP SAMPLES, TAPE, BULK, SWAB AND WATER SAMPLES; E COLI AND LEGIONELLA ANALYSIS; ALLERGEN ANALYSIS AND TESTING FOR DUST MITE, COCKROACH, CAT, DOG, RAT, AND MOUSE ALLERGENS (U.S. CLS. 100 AND 101).

FIRST USE 2-1-2002; IN COMMERCE 2-1-2002.
KEVON CHISOLM, EXAMINING ATTORNEY

SN 78-465,958. E.I. PARTNERS, INC., HOUSTON, TX. FILED 8-11-2004.

FIRESLAYER

THE MARK CONSISTS OF STANDARD CHARACTERS WITHOUT CLAIM TO ANY PARTICULAR FONT, STYLE, SIZE, OR COLOR.

FOR APPLICATION SERVICE PROVIDER FEATURING SECURITY SOFTWARE FOR DETECTION, SCANNING, FILTERING AND BLOCKING SERVER TRAFFIC ON A GLOBAL COMPUTER NETWORK (U.S. CLS. 100 AND 101).

FIRST USE 6-1-2004; IN COMMERCE 6-1-2004.
IRA J. GOODSID, EXAMINING ATTORNEY

CLASS 42—(Continued).

SN 78-466,114. AIR ROAMER INC., TORONTO M5H 4E7, CANADA, FILED 8-11-2004.

CLASS 42—(Continued).

SN 78-470,065. CORPORATE CONSULTING LTD., WILMINGTON, DE. FILED 8-19-2004.

AirRoamer

THE MARK CONSISTS OF STANDARD CHARACTERS WITHOUT CLAIM TO ANY PARTICULAR FONT, STYLE, SIZE, OR COLOR.

FOR COMPUTER SECURITY SERVICE, NAMELY, RESTRICTING ACCESS TO AND BY COMPUTER NETWORKS TO AND OF UNDESIRED WEBSITES, MEDIA AND INDIVIDUALS AND FACILITIES (U.S. CLS. 100 AND 101).

FIRST USE 4-1-2004; IN COMMERCE 6-23-2004.
KATRINA EDGE, EXAMINING ATTORNEY

ez2Inc.

SN 78-467,670. JOHN BRUCKNER PC, AUSTIN, TX. FILED 8-15-2004.

JOHN BRUCKNER PC

THE MARK CONSISTS OF STANDARD CHARACTERS WITHOUT CLAIM TO ANY PARTICULAR FONT, STYLE, SIZE, OR COLOR.

NO CLAIM IS MADE TO THE EXCLUSIVE RIGHT TO USE "PC", APART FROM THE MARK AS SHOWN.

FOR LEGAL SERVICES (U.S. CLS. 100 AND 101).

FIRST USE 7-31-2003; IN COMMERCE 7-31-2003.

DOMINIC J. FERRAIUOLO, EXAMINING ATTORNEY

THE MARK CONSISTS OF STANDARD CHARACTERS WITHOUT CLAIM TO ANY PARTICULAR FONT, STYLE, SIZE, OR COLOR.

FOR PREPARING AND FILING INCORPORATION PAPERS (U.S. CLS. 100 AND 101).

FIRST USE 8-19-2004; IN COMMERCE 8-19-2004.

ANGELA M. MICHELI, EXAMINING ATTORNEY

CLASS 42—(Continued).

SN 78-471,268. DEUTSCHE TELEKOM AG, BONN, FED REP GERMANY, FILED 8-20-2004.

CLASS 42—(Continued).

SN 78-472,577. TRIAD HOSPITALS, INC., PLANO, TX. FILED 8-24-2004.

Preferred Labs



THE MARK CONSISTS OF STANDARD CHARACTERS WITHOUT CLAIM TO ANY PARTICULAR FONT, STYLE, SIZE, OR COLOR.

NO CLAIM IS MADE TO THE EXCLUSIVE RIGHT TO USE "LABS", APART FROM THE MARK AS SHOWN.

FOR MEDICAL LABORATORY SERVICES, NAMELY, LABORATORY TESTING, EVALUATION, AND RESEARCH SERVICES; MEDICAL LABORATORY SERVICES, NAMELY, DISEASE MANAGEMENT AND PATHOLOGY SERVICES; AND MEDICAL LABORATORY SERVICES, NAMELY, PROVIDING MEDICAL LABORATORY INFORMATION TO HEALTH CARE PROVIDERS, MANAGED CARE PROVIDERS AND PATIENTS VIA GLOBAL COMPUTER NETWORKS, FACSIMILE, AND SIMILAR MEANS (U.S. CLS. 100 AND 101).

FIRST USE 12-1-2004; IN COMMERCE 12-1-2004.

JEFF DEFORD, EXAMINING ATTORNEY

OWNER OF FED REP GERMANY REG. NO. 30360238, DATED 1-9-2004, EXPIRES 11-30-2013.

OWNER OF U.S. REG. NOS. 2,712,615, 2,833,572 AND OTHERS.

NO CLAIM IS MADE TO THE EXCLUSIVE RIGHT TO USE "SYSTEMS", APART FROM THE MARK AS SHOWN.

THE COLORS MAGENTA AND GRAY ARE CLAIMED AS A FEATURE OF THE MARK.

THE COLOR MAGENTA APPEARS IN THE BACKGROUND CARRIER RECTANGLE OF THE MARK AND THE LETTER "T"; AND THE COLOR GRAY APPEARS IN THE WORD "SYSTEMS" AND A SERIES OF SQUARES IN THE CENTER OF THE MARK.

FOR COMPUTER PROGRAMMING SERVICES FOR OTHERS; RENTAL OF COMPUTER SOFTWARE AND HARDWARE; DATA ENCRYPTION SERVICES; APPLICATION SERVICE PROVIDER, NAMELY, HOSTING COMPUTER SOFTWARE APPLICATIONS FOR OTHERS, HOSTING OF DIGITAL CONTENT ON THE INTERNET; HOSTING THE WEBSITES OF OTHERS ON A COMPUTER SERVER FOR A GLOBAL COMPUTER NETWORK; COMPUTER SERVICES, NAMELY, CREATING INDEXES OF INFORMATION AVAILABLE ON COMPUTER NETWORKS; CONSULTING SERVICES IN THE FIELD OF DESIGN, SELECTION, IMPLEMENTATION AND USE OF COMPUTER HARDWARE AND SOFTWARE SYSTEMS FOR OTHERS; INSTALLATION, MAINTENANCE AND REPAIR OF COMPUTER SOFTWARE; TECHNICAL CONSULTATION IN THE FIELD OF NETWORK EQUIPMENT FOR USE IN WIDE BAND OR SATELLITE TELECOMMUNICATIONS; PROVIDING INFORMATION AT THE SPECIFIC REQUEST OF END-USERS BY MEANS OF TELEPHONE OR GLOBAL COMMUNICATIONS NETWORKS (U.S. CLS. 100 AND 101).

RUSS HERMAN, EXAMINING ATTORNEY

SN 78-474,137. JUNIKO, INC, BURLINGTON, VT. FILED 8-26-2004.

ZooFoo

THE MARK CONSISTS OF STANDARD CHARACTERS WITHOUT CLAIM TO ANY PARTICULAR FONT, STYLE, SIZE, OR COLOR.

FOR APPLICATION SERVICE PROVIDER (ASP) FEATURING SOFTWARE IN THE FIELD OF DIRECT SALES AND MARKETING (U.S. CLS. 100 AND 101).

FIRST USE 7-23-2004; IN COMMERCE 7-23-2004.

ASMAT KHAN, EXAMINING ATTORNEY

CLASS 42—(Continued).

SN 78-475,158. SHINGAYA INC, LAS VEGAS, NV. FILED 8-27-2004.

Shingaya

THE MARK CONSISTS OF STANDARD CHARACTERS WITHOUT CLAIM TO ANY PARTICULAR FONT, STYLE, SIZE, OR COLOR.

FOR ONLINE RETAIL STORE AND WHOLESALE ORDERING SERVICES FEATURING A COMPREHENSIVE LINE OF HERBAL PRODUCTS (U.S. CLS. 100 AND 101).

FIRST USE 11-4-2001; IN COMMERCE 11-4-2001.
KHANH LE, EXAMINING ATTORNEY

CLASS 42—(Continued).

SN 78-480,744. COUNCIL FOR ACCREDITATION OF COUNSELING AND RELATED EDUCATIONAL PROGRAMS, ALEXANDRIA, VA. FILED 9-9-2004.



FOR ACCREDITATION SERVICES, NAMELY, DEVELOPING, EVALUATING, AND TESTING STANDARDS FOR HIGHER EDUCATION FOR THE PURPOSE OF ACCREDITATION (U.S. CLS. 100 AND 101).

FIRST USE 7-1-1987; IN COMMERCE 7-1-1987.
BARBARA BROWN, EXAMINING ATTORNEY

SN 78-478,848. ACCUPATH DIAGNOSTIC LABORATORIES, INC., IRVINE, CA. FILED 9-3-2004.

US LABS

THE MARK CONSISTS OF STANDARD CHARACTERS WITHOUT CLAIM TO ANY PARTICULAR FONT, STYLE, SIZE, OR COLOR.

NO CLAIM IS MADE TO THE EXCLUSIVE RIGHT TO USE "LABS", APART FROM THE MARK AS SHOWN. SEC. 2(F).

FOR MEDICAL LABORATORY TESTING, DIAGNOSTIC AND PATHOLOGY SERVICES (U.S. CLS. 100 AND 101).

FIRST USE 8-18-1997; IN COMMERCE 8-18-1997.
SCOTT OSLICK, EXAMINING ATTORNEY

SN 78-484,900. HISTORX, INC., NEW HAVEN, CT. FILED 9-16-2004.

HISTORX

THE MARK CONSISTS OF STANDARD CHARACTERS WITHOUT CLAIM TO ANY PARTICULAR FONT, STYLE, SIZE, OR COLOR.

FOR PHARMACEUTICAL RESEARCH AND DEVELOPMENT; MEDICAL AND MEDICAL DIAGNOSTIC RESEARCH (U.S. CLS. 100 AND 101).

FIRST USE 9-13-2004; IN COMMERCE 9-13-2004.
GENE MACIOL, EXAMINING ATTORNEY

CLASS 42—(Continued).

SN 78-486,767. KUMAR, CHANDINI S., FOREST HILLS, NY.
FILED 9-21-2004.

CLASS 42—(Continued).

SN 78-489,952. METAMETRIX, INC., NORCROSS, GA.
FILED 9-27-2004.

The Research Solution

THE MARK CONSISTS OF STANDARD CHARACTERS WITHOUT CLAIM TO ANY PARTICULAR FONT, STYLE, SIZE, OR COLOR.

NO CLAIM IS MADE TO THE EXCLUSIVE RIGHT TO USE "RESEARCH", APART FROM THE MARK AS SHOWN. FOR LEGAL RESEARCH (U.S. CLS. 100 AND 101).
BILL DAWE, EXAMINING ATTORNEY

SN 78-488,013. KEYNOMICS, INC., SAN FRANCISCO, CA.
FILED 9-22-2004.

TALK, TYPE, LISTEN

THE MARK CONSISTS OF STANDARD CHARACTERS WITHOUT CLAIM TO ANY PARTICULAR FONT, STYLE, SIZE, OR COLOR.

FOR PROVIDING TEMPORARY USE OF ONLINE NON-DOWNLOADABLE SOFTWARE FOR USE AS AN ASSESSMENT AND TRAINING TOOL FOR INCREASING WORKER PRODUCTIVITY, FOCUSING ON KEYBOARDING SKILLS AND ERGONOMICS (U.S. CLS. 100 AND 101).

FIRST USE 7-13-2005; IN COMMERCE 7-13-2005.
DAVID MURRAY, EXAMINING ATTORNEY

SN 78-489,175. TM ACQUISITION CORP., LAS VEGAS, NV.
FILED 9-24-2004.

AGENTWORKS

THE MARK CONSISTS OF STANDARD CHARACTERS WITHOUT CLAIM TO ANY PARTICULAR FONT, STYLE, SIZE, OR COLOR.

FOR PROVIDING TEMPORARY USE OF ON-LINE NON-DOWNLOADABLE SOFTWARE FOR SEARCHING AND BOOKING VACATION RENTAL PROPERTY (U.S. CLS. 100 AND 101).

FIRST USE 9-2-2002; IN COMMERCE 9-2-2002.
DAWN HAN, EXAMINING ATTORNEY

ORGANIX

THE MARK CONSISTS OF STANDARD CHARACTERS WITHOUT CLAIM TO ANY PARTICULAR FONT, STYLE, SIZE, OR COLOR.

FOR CLINICAL LABORATORY TESTING SERVICES, NAMELY, TESTING FOR NUTRITION AND METABOLISM-RELATED STATUS AND CONDITIONS (U.S. CLS. 100 AND 101).

FIRST USE 3-1-1998; IN COMMERCE 3-1-1998.
TEJBIR SINGH, EXAMINING ATTORNEY

CLASS 42—(Continued).

SN 78-493,082. DEUTSCHE TELEKOM AG, BONN, FED REP GERMANY, FILED 10-1-2004.

CLASS 42—(Continued).

SN 78-493,346. DEUTSCHE TELEKOM AG, BONN, FED REP GERMANY, FILED 10-1-2004.

T-Mobile Sound
Alert

T-Mobile
multimedia
experience

THE MARK CONSISTS OF STANDARD CHARACTERS WITHOUT CLAIM TO ANY PARTICULAR FONT, STYLE, SIZE, OR COLOR.

OWNER OF FED REP GERMANY REG. NO. 30418516, DATED 4-2-2004, EXPIRES 4-30-2014.

OWNER OF U.S. REG. NOS. 2,282,432, 2,959,646 AND OTHERS.

FOR COMPUTER PROGRAMMING SERVICES FOR OTHERS; RENTAL OF COMPUTER SOFTWARE AND HARDWARE FOR ONLINE ACCESS; APPLICATION SERVICE PROVIDER, NAMELY, HOSTING COMPUTER SOFTWARE APPLICATIONS FOR OTHERS, HOSTING OF DIGITAL CONTENT ON THE INTERNET; HOSTING THE WEBSITES OF OTHERS ON A COMPUTER SERVER FOR A GLOBAL COMPUTER NETWORK; COMPUTER SERVICES, NAMELY, CREATING INDEXES OF INFORMATION AVAILABLE ON COMPUTER NETWORKS; PROVIDING INFORMATION VIA THE TELEPHONE AND THE GLOBAL COMMUNICATION NETWORKS IN THE FIELD OF INFORMATION TECHNOLOGY; CONSULTING SERVICES IN THE FIELD OF DESIGN, SELECTION, IMPLEMENTATION AND USE OF COMPUTER HARDWARE AND SOFTWARE SYSTEMS FOR OTHERS; INSTALLATION, MAINTENANCE AND REPAIR OF COMPUTER SOFTWARE; TECHNICAL CONSULTATION REGARDING THE PROJECT PLANNING FOR THE PRODUCTION OF TELECOMMUNICATIONS EQUIPMENT; PROVIDING GENERAL INFORMATION AT THE SPECIFIC REQUEST OF END-USERS BY MEANS OF TELEPHONE OR GLOBAL COMMUNICATIONS NETWORKS; PROVIDING TEMPORARY USE OF ONLINE NON-DOWNLOADABLE TELECOMMUNICATIONS SOFTWARE FOR PROVIDING MULTIPLE USER ACCESS TO THE GLOBAL COMPUTER NETWORK (U.S. CLS. 100 AND 101).

NANCY CLARKE, EXAMINING ATTORNEY

THE MARK CONSISTS OF STANDARD CHARACTERS WITHOUT CLAIM TO ANY PARTICULAR FONT, STYLE, SIZE, OR COLOR.

PRIORITY CLAIMED UNDER SEC. 44(D) ON FED REP GERMANY APPLICATION NO. 30418510838, FILED 4-2-2004, REG. NO. 30418510, DATED 4-22-2004, EXPIRES 4-30-2014.

OWNER OF U.S. REG. NO. 2,282,432.

NO CLAIM IS MADE TO THE EXCLUSIVE RIGHT TO USE "MULTIMEDIA", APART FROM THE MARK AS SHOWN.

FOR COMPUTER PROGRAMMING SERVICES FOR OTHERS; RENTAL OF COMPUTER SOFTWARE AND HARDWARE FOR ONLINE ACCESS; DATA ENCRYPTION SERVICES, NAMELY, ADMINISTRATION OF DIGITAL KEYS AND DIGITAL CERTIFICATES; APPLICATION SERVICE PROVIDER, NAMELY, HOSTING COMPUTER SOFTWARE APPLICATIONS FOR OTHERS, HOSTING OF DIGITAL CONTENT ON THE INTERNET; HOSTING THE WEBSITES OF OTHERS ON A COMPUTER SERVER FOR A GLOBAL COMPUTER NETWORK; COMPUTER SERVICES, NAMELY, CREATING INDEXES OF INFORMATION AVAILABLE ON COMPUTER NETWORKS; PROVIDING INFORMATION VIA THE TELEPHONE AND THE GLOBAL COMMUNICATION NETWORKS IN THE FIELD OF INFORMATION TECHNOLOGY; CONSULTING SERVICES IN THE FIELD OF DESIGN, SELECTION, IMPLEMENTATION AND USE OF COMPUTER HARDWARE AND SOFTWARE SYSTEMS FOR OTHERS; INSTALLATION, MAINTENANCE AND REPAIR OF COMPUTER SOFTWARE; TECHNICAL PROJECT PLANNING SERVICES RELATED TO TELECOMMUNICATIONS EQUIPMENT; PROVIDING GENERAL INFORMATION AT THE SPECIFIC REQUEST OF END-USERS BY MEANS OF TELEPHONE OR GLOBAL COMMUNICATIONS NETWORKS; TELECOMMUNICATIONS SOFTWARE FOR USE IN THE TELECOMMUNICATIONS INDUSTRY (U.S. CLS. 100 AND 101).

FLORENTINA BLANDU, EXAMINING ATTORNEY

CLASS 42—(Continued).

SN 78-494,349. MATTHEWS, DEAN W, FAIRBURY, NE.
FILED 10-4-2004.

CLASS 42—(Continued).

SN 78-494,451. CLARK, ANISA DAWN, LA MIRADA, CA.
FILED 10-5-2004.

Matrim Industries

THE MARK CONSISTS OF STANDARD CHARACTERS WITHOUT CLAIM TO ANY PARTICULAR FONT, STYLE, SIZE, OR COLOR.

NO CLAIM IS MADE TO THE EXCLUSIVE RIGHT TO USE "INDUSTRIES", APART FROM THE MARK AS SHOWN.

FOR DESIGN, CREATION, HOSTING, MAINTENANCE OF WEBSITES FOR OTHERS; COMPUTER SOFTWARE DESIGN, COMPUTER PROGRAMMING, OR MAINTENANCE OF COMPUTER SOFTWARE (U.S. CLS. 100 AND 101).

FIRST USE 8-20-1997; IN COMMERCE 8-20-1997.
RAUL CORDOVA, EXAMINING ATTORNEY

Making motherhood even more beautiful

THE MARK CONSISTS OF STANDARD CHARACTERS WITHOUT CLAIM TO ANY PARTICULAR FONT, STYLE, SIZE, OR COLOR.

FOR DESIGNER SERVICES, NAMELY, DESIGN FOR OTHERS IN THE FIELD OF MATERNITY CLOTHING (U.S. CLS. 100 AND 101).

FIRST USE 1-1-2004; IN COMMERCE 1-1-2004.
MICHAEL TANNER, EXAMINING ATTORNEY

SN 78-494,357. TOOMEY, PHILIP A., TORRANCE, CA. AND ARTIANO, A. JAMES, TORRANCE, CA. AND GUZMAN, DENISE M., TORRANCE, CA. FILED 10-4-2004.

SN 78-494,550. VALOR MEDICAL, LLC, SAN DIEGO, CA.
FILED 10-5-2004.

EXTRAORDINARY RESULTS, ONE CLIENT AT A TIME

THE MARK CONSISTS OF STANDARD CHARACTERS WITHOUT CLAIM TO ANY PARTICULAR FONT, STYLE, SIZE, OR COLOR.

FOR LEGAL SERVICES (U.S. CLS. 100 AND 101).
RAUL CORDOVA, EXAMINING ATTORNEY

VALOR MEDICAL

THE MARK CONSISTS OF STANDARD CHARACTERS WITHOUT CLAIM TO ANY PARTICULAR FONT, STYLE, SIZE, OR COLOR.

NO CLAIM IS MADE TO THE EXCLUSIVE RIGHT TO USE "MEDICAL", APART FROM THE MARK AS SHOWN, FOR RESEARCH, DEVELOPMENT AND TESTING OF MEDICAL PREPARATIONS, COMPOSITIONS AND DEVICES (U.S. CLS. 100 AND 101).

KIMBERLY FRYE, EXAMINING ATTORNEY

CLASS 42—(Continued).

SN 78-494,900. GLOBAL MARKET INSITE, INC., MERCER ISLAND, WA. FILED 10-5-2004.

GMI

THE MARK CONSISTS OF STANDARD CHARACTERS WITHOUT CLAIM TO ANY PARTICULAR FONT, STYLE, SIZE, OR COLOR.

FOR APPLICATION SERVICE PROVIDER (ASP) FEATURING SOFTWARE IN THE FIELD OF COMPANY, BUSINESS SECTOR AND INDUSTRY DATA AND RESEARCH FOR USE IN DATABASE MANAGEMENT; TECHNICAL SUPPORT SERVICES, NAMELY, TROUBLESHOOTING OF COMPUTER HARDWARE AND SOFTWARE PROBLEMS (U.S. CLS. 100 AND 101).

FIRST USE 6-30-2000; IN COMMERCE 6-30-2000.
TEJBIR SINGH, EXAMINING ATTORNEY

SN 78-494,909. GLOBAL MARKET INSITE, INC., MERCER ISLAND, WA. FILED 10-5-2004.

NET-MR

THE MARK CONSISTS OF STANDARD CHARACTERS WITHOUT CLAIM TO ANY PARTICULAR FONT, STYLE, SIZE, OR COLOR.

FOR APPLICATION SERVICE PROVIDER (ASP) FEATURING SOFTWARE IN THE FIELD OF COMPANY, BUSINESS SECTOR AND INDUSTRY DATA AND RESEARCH FOR USE IN DATABASE MANAGEMENT; TECHNICAL SUPPORT SERVICES, NAMELY, TROUBLESHOOTING OF COMPUTER HARDWARE AND SOFTWARE PROBLEMS (U.S. CLS. 100 AND 101).

FIRST USE 6-30-2000; IN COMMERCE 6-30-2000.
TEJBIR SINGH, EXAMINING ATTORNEY

CLASS 42—(Continued).

SN 78-494,917. GLOBAL MARKET INSITE, INC., MERCER ISLAND, WA. FILED 10-5-2004.



FOR APPLICATION SERVICE PROVIDER (ASP) FEATURING SOFTWARE IN THE FIELD OF COMPANY, BUSINESS SECTOR AND INDUSTRY DATA AND RESEARCH FOR USE IN DATABASE MANAGEMENT; TECHNICAL SUPPORT SERVICES, NAMELY, TROUBLESHOOTING OF COMPUTER HARDWARE AND SOFTWARE PROBLEMS (U.S. CLS. 100 AND 101).

FIRST USE 6-30-2000; IN COMMERCE 6-30-2000.
TEJBIR SINGH, EXAMINING ATTORNEY

SN 78-495,752. ALBO & OBLON, L.L.P., ARLINGTON, VA. FILED 10-6-2004.



NO CLAIM IS MADE TO THE EXCLUSIVE RIGHT TO USE L.L.P. ATTORNEYS AND COUNSELORS AT LAW, APART FROM THE MARK AS SHOWN.

THE COLOR(S) GOLD AND NAVY BLUE IS/ARE CLAIMED AS A FEATURE OF THE MARK.

THE MARK CONSISTS OF STYLIZED LETTERS "A & O", IN GOLD, AS THE FIRST LETTERS OF THE WORDS "ALBO AND OBLON" IN STYLIZED FORMAT IN NAVY BLUE, UNDERSCORED BY A GOLD HORIZONTAL LINE, COMBINED WITH THE FOLLOWING WORDS IN NAVY BLUE AND STYLIZED FORMAT- "ATTORNEYS AND COUNSELORS AT LAW".

FOR LEGAL SERVICES (U.S. CLS. 100 AND 101).
FIRST USE 10-31-2001; IN COMMERCE 10-31-2001.
ANN E. SAPPENFIELD, EXAMINING ATTORNEY

CLASS 42—(Continued).

SN 78-495,758. NATIONAL RURAL ELECTRIC COOPERATIVE ASSOCIATION, ARLINGTON, VA. FILED 10-6-2004.

CLASS 42—(Continued).

SN 78-496,924. GUESTCLICK, INC., BONITA SPRINGS, FL. FILED 10-8-2004.

**LAWYERS WITH THE
CO-OP EDGE**

THE MARK CONSISTS OF STANDARD CHARACTERS WITHOUT CLAIM TO ANY PARTICULAR FONT, STYLE, SIZE, OR COLOR.

FOR PROVIDING A WEBSITE FEATURING INFORMATION, REFERENCE MATERIAL, NEWS AND COMMENTARY CONCERNING TOPICS OF INTEREST TO LAWYERS IN THE FIELD OF ELECTRIC COOPERATIVES; PROVIDING INFORMATION IN THE FORM OF E-MAIL NOTIFICATIONS CONCERNING TOPICS OF INTEREST TO LAWYERS IN THE FIELD OF ELECTRIC COOPERATIVES (U.S. CLS. 100 AND 101).

FIRST USE 10-30-2000; IN COMMERCE 10-30-2000.
KRISTINA KLOIBER, EXAMINING ATTORNEY

VacationClick

THE MARK CONSISTS OF STANDARD CHARACTERS WITHOUT CLAIM TO ANY PARTICULAR FONT, STYLE, SIZE, OR COLOR.

FOR APPLICATION SERVICE PROVIDER (ASP) FEATURING SOFTWARE IN THE FIELD OF HOSPITALITY AND APPLICATION SERVICE PROVIDER (ASP) FEATURING SOFTWARE FOR USE BY HOSPITALITY AND TRAVEL BASED COMPANIES TO ADVERTISE SPECIALS, MAKE RESERVATIONS, OFFER COUPONS, SPECIALS, DISCOUNTS, MENUS AND DIRECTIONS AND FOR USE IN ACCESSING INTERACTIVE CUSTOMER SERVICES OF OTHERS; PROVIDING INFORMATION SERVICES IN THE FIELD OF APPLICATION SERVICE PROVIDER (ASP) FEATURING SOFTWARE IN THE FIELD OF HOSPITALITY AND APPLICATION SERVICE PROVIDER (ASP) FEATURING SOFTWARE FOR USE BY HOSPITALITY BASED COMPANIES TO ADVERTISE SPECIALS, MAKE RESERVATIONS, OFFER COUPONS, SPECIALS, DISCOUNTS, MENUS AND DIRECTIONS AND FOR USE IN ACCESSING INTERACTIVE CUSTOMER SERVICES OF OTHERS (U.S. CLS. 100 AND 101).

FIRST USE 7-12-2004; IN COMMERCE 8-20-2004.
TINA L. SNAPP, EXAMINING ATTORNEY

SN 78-496,798. PNEUMADYNE, INC., PLYMOUTH, MN. FILED 10-8-2004.

SN 78-497,122. CONWELL, LLC, ANNAPOLIS, MD. FILED 10-8-2004.

BUILD-A-VALVE

THE MARK CONSISTS OF STANDARD CHARACTERS WITHOUT CLAIM TO ANY PARTICULAR FONT, STYLE, SIZE, OR COLOR.

FOR PROVIDING AN INTERACTIVE COMPUTER DATABASE CONCERNING ENGINEERING AND DESIGN IN THE FIELD OF PNEUMATICS (U.S. CLS. 100 AND 101).

JOHN LINCOSKI, EXAMINING ATTORNEY

**Technology is the
new world
language. Do you
speak it?**

THE MARK CONSISTS OF STANDARD CHARACTERS WITHOUT CLAIM TO ANY PARTICULAR FONT, STYLE, SIZE, OR COLOR.

FOR PROVIDING LEGAL SERVICES TO BUSINESS, TECHNOLOGY AND INTERNATIONAL COMPANIES (U.S. CLS. 100 AND 101).

FIRST USE 7-1-2004; IN COMMERCE 7-1-2004.
CYNTHIA SLOAN, EXAMINING ATTORNEY

CLASS 42—(Continued).

SN 78-498,224. BEN NEUMANN, STUDIO CITY, CA. FILED 10-12-2004.

CLASS 42—(Continued).

SN 78-498,722. GRAHAM & DUNN PC, SEATTLE, WA. FILED 10-12-2004.

SUPERSIZE

**BEDS, BOTTLES &
BRANDS**

THE MARK CONSISTS OF STANDARD CHARACTERS WITHOUT CLAIM TO ANY PARTICULAR FONT, STYLE, SIZE, OR COLOR.
FOR LEGAL SERVICES (U.S. CLS. 100 AND 101).
FIRST USE 9-6-2002; IN COMMERCE 9-6-2002.
MARIA-VICTORIA SUAREZ, EXAMINING ATTORNEY

THE MARK CONSISTS OF STANDARD CHARACTERS WITHOUT CLAIM TO ANY PARTICULAR FONT, STYLE, SIZE, OR COLOR.
FOR HOSTING THE WEB SITES OF OTHERS ON A COMPUTER SERVER FOR A GLOBAL COMPUTER NETWORK (U.S. CLS. 100 AND 101).
FIRST USE 5-0-2004; IN COMMERCE 10-6-2004.
PAULA MAHONEY, EXAMINING ATTORNEY

SN 78-498,750. I/PRO CORPORATION, SAN FRANCISCO, CA. FILED 10-12-2004.

SN 78-498,611. IMAGEVISIBLE, INC., DALLAS, TX. FILED 10-12-2004.

IMAGEVISIBLE

I/PRO

THE MARK CONSISTS OF STANDARD CHARACTERS WITHOUT CLAIM TO ANY PARTICULAR FONT, STYLE, SIZE, OR COLOR.
FOR DESIGN, CREATION, HOSTING AND MAINTENANCE OF WEBSITES FOR ADVERTISING FOR OTHERS (U.S. CLS. 100 AND 101).
FIRST USE 3-21-2002; IN COMMERCE 3-21-2002.
KEVON CHISOLM, EXAMINING ATTORNEY

THE MARK CONSISTS OF STANDARD CHARACTERS WITHOUT CLAIM TO ANY PARTICULAR FONT, STYLE, SIZE, OR COLOR.
FOR REMOTE MONITORING OF COMPUTER NETWORKS TO COLLECT, MONITOR, ANALYZE, AUDIT, CERTIFY AND REPORT GLOBAL COMPUTER NETWORK USE DATA (U.S. CLS. 100 AND 101).
FIRST USE 7-1-1995; IN COMMERCE 7-1-1995.
APRIL L. RADEMACHER, EXAMINING ATTORNEY

CLASS 42—(Continued).

SN 78-499,624. SENEARTHCO, INC., MINNEAPOLIS, MN. FILED 10-14-2004.

SENEARTHCO

THE MARK CONSISTS OF STANDARD CHARACTERS WITHOUT CLAIM TO ANY PARTICULAR FONT, STYLE, SIZE, OR COLOR.

OWNER OF U.S. REG. NO. 2,735,204.
FOR APPLICATION SERVICE PROVIDER (ASP) FEATURING SOFTWARE IN THE FIELD OF PROPERTY MANAGEMENT AND ACCOUNTING SERVICES AND DISTRIBUTING MATERIALS IN CONNECTION THEREWITH (U.S. CLS. 100 AND 101).

FIRST USE 6-0-2004; IN COMMERCE 6-0-2004.
FLORENTINA BLANDU, EXAMINING ATTORNEY

SN 78-499,693. BLACKWELL IGBANUGO P.A., MINNEAPOLIS, MN. FILED 10-14-2004.

BLACKWELL IGBANUGO

THE MARK CONSISTS OF STANDARD CHARACTERS WITHOUT CLAIM TO ANY PARTICULAR FONT, STYLE, SIZE, OR COLOR.

FOR LEGAL SERVICES (U.S. CLS. 100 AND 101).
FIRST USE 1-1-2003; IN COMMERCE 1-1-2003.
MICHAEL WEBSTER, EXAMINING ATTORNEY

SN 78-499,788. BLACKWELL IGBANUGO, MINNEAPOLIS, MN. FILED 10-14-2004.



NO CLAIM IS MADE TO THE EXCLUSIVE RIGHT TO USE "P.A.", APART FROM THE MARK AS SHOWN.

THE COLOR(S) RED, ORANGE AND YELLOW IS/ARE CLAIMED AS A FEATURE OF THE MARK.

THE MARK CONSISTS OF THE LETTERS "BLACKWELL IGBANUGO" IN YELLOW OVER A RED AND ORANGE BACKGROUND.

FOR LEGAL SERVICES (U.S. CLS. 100 AND 101).
FIRST USE 1-1-2003; IN COMMERCE 1-1-2003.
KELLY BOULTON, EXAMINING ATTORNEY

CLASS 42—(Continued).

SN 78-499,828. VIDACARE CORPORATION, SAN ANTONIO, TX. FILED 10-14-2004.

THE POWER TO SAVE LIVES

THE MARK CONSISTS OF STANDARD CHARACTERS WITHOUT CLAIM TO ANY PARTICULAR FONT, STYLE, SIZE, OR COLOR.

FOR DESIGN AND DEVELOPMENT OF EMERGENCY MEDICAL INSTRUMENTS AND DEVICES (U.S. CLS. 100 AND 101).

FIRST USE 7-9-2003; IN COMMERCE 7-9-2004.
DOMINIC J. FERRAIUOLO, EXAMINING ATTORNEY

SN 78-500,590. WONG, CABELLO, LUTSCH, RUTHERFORD & BRUCCULERI, L.L.P., HOUSTON, TX. FILED 10-15-2004.

WONG CABELLO

THE MARK CONSISTS OF STANDARD CHARACTERS WITHOUT CLAIM TO ANY PARTICULAR FONT, STYLE, SIZE, OR COLOR.

FOR LEGAL SERVICES (U.S. CLS. 100 AND 101).
FIRST USE 5-31-2001; IN COMMERCE 5-31-2001.
WILLIAM VERHOSEK, EXAMINING ATTORNEY

SN 78-500,927. I/PRO CORPORATION, SAN FRANCISCO, CA. FILED 10-15-2004.



FOR REMOTE MONITORING OF COMPUTER NETWORKS TO COLLECT, MONITOR, ANALYZE, AUDIT, CERTIFY AND REPORT GLOBAL COMPUTER NETWORK USE DATA (U.S. CLS. 100 AND 101).

FIRST USE 6-3-1996; IN COMMERCE 6-3-1996.
JOANNA DUKOVIC, EXAMINING ATTORNEY

CLASS 42—(Continued).

SN 78-500,967. HEIRLINES FAMILY HISTORY & GENEALOGY, SANDY, UT. FILED 10-16-2004.

CLASS 42—(Continued).

SN 78-501,591. BRIGHT BYTE CONSULTING INC., ATLANTA, GA. FILED 10-18-2004.



HEIRLINES

THE MARK CONSISTS OF STANDARD CHARACTERS WITHOUT CLAIM TO ANY PARTICULAR FONT, STYLE, SIZE, OR COLOR.

FOR GENEALOGICAL RESEARCH SERVICES (U.S. CLS. 100 AND 101).

FIRST USE 4-10-1980; IN COMMERCE 10-21-1980.

KIMBERLY PERRY, EXAMINING ATTORNEY

NO CLAIM IS MADE TO THE EXCLUSIVE RIGHT TO USE "CONSULTING INC.", APART FROM THE MARK AS SHOWN.

FOR TECHNOLOGY CONSULTATION IN THE FIELD OF INFORMATION TECHNOLOGY AND COMPUTER SOFTWARE DEVELOPMENT (U.S. CLS. 100 AND 101).

FIRST USE 7-28-2004; IN COMMERCE 7-28-2004.

DEBRA LEE, EXAMINING ATTORNEY

SN 78-501,114. SENIOR LEGAL CARE, P.C., ARVADA, CO. FILED 10-17-2004.

SN 78-502,813. SLEP-TONE ENTERTAINMENT CORPORATION, CHARLOTTE, NC. FILED 10-20-2004.



HOOK FINDER

NO CLAIM IS MADE TO THE EXCLUSIVE RIGHT TO USE SENIOR LEGAL CARE, APART FROM THE MARK AS SHOWN.

THE COLOR(S) GREEN IS/ARE CLAIMED AS A FEATURE OF THE MARK.

THE LEAF TO THE LEFT OF THE NAME "SENIOR LEGAL CARE" IS COLORED WITH VARIOUS SHADES OF MEDIUM GREEN SIMILAR TO A LEAF FOUND ON AN ACTUAL PLANT.

FOR LEGAL SERVICES (U.S. CLS. 100 AND 101).

FIRST USE 9-5-2004; IN COMMERCE 9-11-2004.

PATRICIA EVANKO, EXAMINING ATTORNEY

THE MARK CONSISTS OF STANDARD CHARACTERS WITHOUT CLAIM TO ANY PARTICULAR FONT, STYLE, SIZE, OR COLOR.

NO CLAIM IS MADE TO THE EXCLUSIVE RIGHT TO USE "FINDER", APART FROM THE MARK AS SHOWN.

FOR ONLINE SEARCH ENGINE THAT ALLOWS USERS TO SEARCH SONGS AND RELATED INFORMATION BY KEYWORDS OR PHRASES AS DEFINED BY THE USER (U.S. CLS. 100 AND 101).

FIRST USE 9-1-2004; IN COMMERCE 9-1-2004.

DAVID MURRAY, EXAMINING ATTORNEY

CLASS 42—(Continued).

SN 78-502,824. PAULSSON GEOPHYSICAL SERVICES, INC.,
BREA, CA. FILED 10-20-2004.

CLASS 42—(Continued).

SN 78-502,847. VEDDER PRICE KAUFMAN & KAMMHOLZ
PC, CHICAGO, IL. FILED 10-20-2004.

Well1D

VEDDER PRICE

THE MARK CONSISTS OF STANDARD CHARACTERS
WITHOUT CLAIM TO ANY PARTICULAR FONT, STYLE,
SIZE, OR COLOR.

FOR GEOPHYSICAL SURVEYS AND RELATED SER-
VICES, NAMELY TIME-LAPSED THREE-DIMEN-
SIONAL VERTICAL SEISMIC PROFILING (U.S. CLS.
100 AND 101).

FIRST USE 10-11-2004; IN COMMERCE 10-11-2004.
CAROLINE WOOD, EXAMINING ATTORNEY

THE MARK CONSISTS OF STANDARD CHARACTERS
WITHOUT CLAIM TO ANY PARTICULAR FONT, STYLE,
SIZE, OR COLOR.

FOR LEGAL SERVICES (U.S. CLS. 100 AND 101).
FIRST USE 5-1-1992; IN COMMERCE 5-1-1992.
CAROLINE WOOD, EXAMINING ATTORNEY

SN 78-502,846. PAULSSON GEOPHYSICAL SERVICES, INC.,
BREA, CA. FILED 10-20-2004.

SN 78-502,856. PAULSSON GEOPHYSICAL SERVICES, INC.,
BREA, CA. FILED 10-20-2004.

Well2D

Well3D

THE MARK CONSISTS OF STANDARD CHARACTERS
WITHOUT CLAIM TO ANY PARTICULAR FONT, STYLE,
SIZE, OR COLOR.

FOR GEOPHYSICAL SURVEYS AND RELATED SER-
VICES, NAMELY TIME-LAPSED THREE-DIMEN-
SIONAL VERTICAL SEISMIC PROFILING (U.S. CLS.
100 AND 101).

FIRST USE 10-11-2004; IN COMMERCE 10-11-2004.
CAROLINE WOOD, EXAMINING ATTORNEY

THE MARK CONSISTS OF STANDARD CHARACTERS
WITHOUT CLAIM TO ANY PARTICULAR FONT, STYLE,
SIZE, OR COLOR.

FOR GEOPHYSICAL SURVEYS AND RELATED SER-
VICES, NAMELY TIME-LAPSED THREE-DIMEN-
SIONAL VERTICAL SEISMIC PROFILING (U.S. CLS.
100 AND 101).

FIRST USE 10-11-2004; IN COMMERCE 10-11-2004.
CAROLINE WOOD, EXAMINING ATTORNEY

CLASS 42—(Continued).

SN 78-502,865. PAULSSON GEOPHYSICAL SERVICES, INC., BREA, CA. FILED 10-20-2004.

Well4D

THE MARK CONSISTS OF STANDARD CHARACTERS WITHOUT CLAIM TO ANY PARTICULAR FONT, STYLE, SIZE, OR COLOR.

FOR GEOPHYSICAL SURVEYS AND RELATED SERVICES, NAMELY TIME-LAPSED THREE-DIMENSIONAL VERTICAL SEISMIC PROFILING (U.S. CLS. 100 AND 101).

FIRST USE 10-11-2004; IN COMMERCE 10-11-2004.
CAROLINE WOOD, EXAMINING ATTORNEY

SN 78-503,821. CELTSOFT, INC., ATLANTA, GA. FILED 10-21-2004.

CELSOFT

THE MARK CONSISTS OF STANDARD CHARACTERS WITHOUT CLAIM TO ANY PARTICULAR FONT, STYLE, SIZE, OR COLOR.

FOR CONSULTING SERVICES IN THE FIELD OF COMPUTER SYSTEMS DESIGN, INTEGRATION AND IMPLEMENTATION; INTEGRATION OF COMPUTER HARDWARE AND SOFTWARE SYSTEMS FOR OTHERS; COMPUTER PROGRAMMING FOR OTHERS (U.S. CLS. 100 AND 101).

FIRST USE 2-0-2003; IN COMMERCE 2-0-2003.
KELLEY WELLS, EXAMINING ATTORNEY

CLASS 42—(Continued).

SN 78-504,018. CROWNPEAK TECHNOLOGY, LOS ANGELES, CA. FILED 10-21-2004.

CROWNPEAK

THE MARK CONSISTS OF STANDARD CHARACTERS WITHOUT CLAIM TO ANY PARTICULAR FONT, STYLE, SIZE, OR COLOR.

FOR PROVIDING USE OF ONLINE NON-DOWNLOADABLE SOFTWARE, NAMELY, COMPUTER CODE FOR USE IN CONNECTION WITH DEVELOPING, MANAGING, UPDATING, AND MAINTAINING WEB SITES, INTRANETS, EXTRANETS AND OTHER WEB-BASED CONTENT REPOSITORIES; COMPUTER SERVICES, NAMELY, MAINTAINING WEB SITES FOR OTHERS; COMPUTER SERVICES, NAMELY, CUSTOMIZATION, CONFIGURATION, AND INTEGRATION OF NON-DOWNLOADABLE SOFTWARE; COMPUTER SERVICES, NAMELY, ONLINE NON-DOWNLOADABLE SOFTWARE DEVELOPMENT KITS TO ENABLE OTHERS TO DEVELOP, MANAGE, UPDATE, AND MAINTAIN WEB SITES, INTRANETS, EXTRANETS, AND OTHER WEB-BASED CONTENT REPOSITORIES (U.S. CLS. 100 AND 101).

FIRST USE 12-12-2000; IN COMMERCE 4-9-2001.
MARK RADEMACHER, EXAMINING ATTORNEY

SN 78-504,471. ASCENTIUM CORPORATION, BELLEVUE, WA. FILED 10-22-2004.

ASCENTIUM

THE MARK CONSISTS OF STANDARD CHARACTERS WITHOUT CLAIM TO ANY PARTICULAR FONT, STYLE, SIZE, OR COLOR.

FOR CONSULTING SERVICES IN THE FIELD OF DESIGN, SELECTION, IMPLEMENTATION AND USE OF COMPUTER HARDWARE AND SOFTWARE SYSTEMS FOR OTHERS; DESIGN OF HOME PAGES, COMPUTER SOFTWARE AND WEB SITES (U.S. CLS. 100 AND 101).

FIRST USE 2-20-2001; IN COMMERCE 2-20-2001.
RONALD AIKENS, EXAMINING ATTORNEY

CLASS 42—(Continued).

SN 78-505,015. CORDINGLEY, ROBERT J, HOUSTON, TX.
FILED 10-25-2004.

CLASS 42—(Continued).

SN 78-506,386. ASK JEEVES, INC., OAKLAND, CA. FILED
10-26-2004.

cirrillian

THE MARK CONSISTS OF STANDARD CHARACTERS
WITHOUT CLAIM TO ANY PARTICULAR FONT, STYLE,
SIZE, OR COLOR.
FOR COMPUTER CONSULTING SERVICE (U.S. CLS.
100 AND 101).
FIRST USE 0-0-2003; IN COMMERCE 0-0-2004.
ROBERT LORENZO, EXAMINING ATTORNEY

THE MARK CONSISTS OF STANDARD CHARACTERS
WITHOUT CLAIM TO ANY PARTICULAR FONT, STYLE,
SIZE, OR COLOR.
FOR COMPUTER SERVICES, NAMELY, PROVIDING
A SEARCH ENGINE THAT ALLOWS USERS TO
SEARCH FOR INFORMATION ON THE INTERNET,
AND TO SAVE, ORGANIZE, AND SEARCH PAST
QUERIES (U.S. CLS. 100 AND 101).
FIRST USE 9-21-2004; IN COMMERCE 9-21-2004.
JAMES A. RAUEN, EXAMINING ATTORNEY

SN 78-505,827. NOBLE, ROBIN, FALLS CHURCH, VA. FILED
10-26-2004.

SN 78-506,428. ASK JEEVES, INC., OAKLAND, CA. FILED
10-26-2004.



Designer for a Day

THE MARK CONSISTS OF STANDARD CHARACTERS
WITHOUT CLAIM TO ANY PARTICULAR FONT, STYLE,
SIZE, OR COLOR.
FOR INTERIOR DESIGN AND DECORATING CON-
SULTATION, NAMELY PREPARATION OF FLOOR
PLANS WITH FURNITURE LAYOUT; SPECIFICATION
OF DESIGN MATERIALS FOR USE ON WALLS, WIN-
DOWS, FLOORS, CEILINGS; SPECIFICATION AND DE-
SIGN OF HOUSEHOLD FURNITURE, FURNISHINGS
AND ACCESSORIES INCLUDING ARTWORK, LIGHT-
ING AND REARRANGEMENT AND REUSE OF CUS-
TOMER'S OWN GOODS (U.S. CLS. 100 AND 101).
FIRST USE 10-21-1992; IN COMMERCE 9-0-1995.
ANNE E. GUSTASON, EXAMINING ATTORNEY

THE MARK CONSISTS OF THE WORDS MY JEEVES IN A
STYLIZED FONT WITH WORD MY IN A FILLED IN OVAL
DESIGN.
FOR COMPUTER SERVICES, NAMELY, PROVIDING
A SEARCH ENGINE THAT ALLOWS USERS TO
SEARCH FOR INFORMATION ON THE INTERNET,
AND TO SAVE, ORGANIZE, AND SEARCH PAST
QUERIES (U.S. CLS. 100 AND 101).
FIRST USE 9-21-2004; IN COMMERCE 9-21-2004.
ZHALEH DELANEY, EXAMINING ATTORNEY

CLASS 42—(Continued).

SN 78-508,132. GH2 GRALLA ARCHITECTS, LLC, TULSA, OK. FILED 10-29-2004.



THE COLORS RED, GRAY AND BLACK ARE CLAIMED AS A FEATURE OF THE MARK.
THE LETTER "G" IS RED; THE LETTER "H" IS GRAY; AND THE NUMBER "2" IS BLACK.
THE MARK CONSISTS OF THE STYLIZED LETTERS "G" AND "H" AND THE NUMBER "2".
FOR ARCHITECTURAL DESIGN SERVICES (U.S. CLS. 100 AND 101).
FIRST USE 1-1-2000; IN COMMERCE 1-1-2000.
YONG KIM, EXAMINING ATTORNEY

CLASS 42—(Continued).

SN 78-508,628. ASPEN EXPLORATION CORPORATION, DENVER, CO. FILED 10-29-2004.

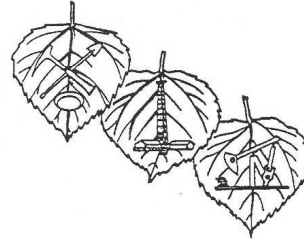

THE MARK CONSISTS OF THREE STAGGERED ASPEN LEAVES WITH PETROLEUM AND MINERAL EXPLORATION SYMBOLS OVERLAYED ON EACH LEAF: FIRST LEAF BEARING PROSPECTOR'S PICK, SHOVEL AND GOLD PAN; SECOND LEAF BEARING AN OIL DERRICK; THIRD LEAF BEARING AN OIL PUMP.
FOR MINING, MINERAL AND PETROLEUM EXPLORATION SERVICES (U.S. CLS. 100 AND 101).
FIRST USE 6-1-1980; IN COMMERCE 6-1-1980.
PRISCILLA MILTON, EXAMINING ATTORNEY

SN 78-510,355. STAFFMETRIC, LLC, TULSA, OK. FILED 11-3-2004.

SN 78-508,375. ELECTRICAL AND CONTROL SYSTEM ENGINEERING, INC., DBA ARCSINE ENGINEERING, REDDING, CA. FILED 10-29-2004.



StaffMetric

NO CLAIM IS MADE TO THE EXCLUSIVE RIGHT TO USE "ENGINEERING" AND "A FULL SPECTRUM ENGINEERING COMPANY", APART FROM THE MARK AS SHOWN.
THE COLORS RED AND BLACK ARE CLAIMED AS A FEATURE OF THE MARK.
THE COLOR RED APPEARS IN THE UPPER LEFT CORNER OF THE MARK AS AN "ARCH" AND IN THE WORDING ARC; THE REMAINDER OF THE MARK IS BLACK.
FOR ELECTRICAL ENGINEERING, MECHANICAL ENGINEERING, CONTROL SYSTEM ENGINEERING, LIGHTING DESIGN (U.S. CLS. 100 AND 101).
FIRST USE 12-5-2003; IN COMMERCE 12-5-2003.
LA TONIA FISHER, EXAMINING ATTORNEY

THE MARK CONSISTS OF STANDARD CHARACTERS WITHOUT CLAIM TO ANY PARTICULAR FONT, STYLE, SIZE, OR COLOR.
FOR APPLICATION SERVICE PROVIDER FEATURING SOFTWARE IN THE FIELD OF EMPLOYEE MANAGEMENT AND REPORTING, NAMELY, RECORDING, TRACKING, AND REPORTING EMPLOYEE TIME AND ATTENDANCE AND CREATING BUDGET REPORTS (U.S. CLS. 100 AND 101).
FIRST USE 10-3-2001; IN COMMERCE 10-3-2001.
HEATHER THOMPSON, EXAMINING ATTORNEY

CLASS 42—(Continued).

SN 78-511,119. SMG TRUST, COMPRISING MICHAEL F. SOLOMON, A U.S. CITIZEN, WASHINGTON, DC. FILED 11-4-2004.

SONIC SIGNATURE

THE MARK CONSISTS OF STANDARD CHARACTERS WITHOUT CLAIM TO ANY PARTICULAR FONT, STYLE, SIZE, OR COLOR.

FOR PACKAGING DESIGN FOR OTHERS IN THE FIELD OF CONSUMER ENTERTAINMENT PRODUCTS, WHICH INCORPORATE THE PREFERENCES OF CELEBRITIES (U.S. CLS. 100 AND 101).

STEVEN R. FINE, EXAMINING ATTORNEY

SN 78-514,099. CBeyond COMMUNICATIONS, LLC, ATLANTA, GA. FILED 11-9-2004.

BEYONDVOIP

THE MARK CONSISTS OF STANDARD CHARACTERS WITHOUT CLAIM TO ANY PARTICULAR FONT, STYLE, SIZE, OR COLOR.

OWNER OF U.S. REG. NOS. 2,761,638, 2,816,962 AND OTHERS.

FOR APPLICATION SERVICE PROVIDER, NAMELY, HOSTING COMPUTER SOFTWARE APPLICATIONS OF OTHERS (U.S. CLS. 100 AND 101).

ADA HAN, EXAMINING ATTORNEY

CLASS 42—(Continued).

SN 78-515,272. SLEP-TONE ENTERTAINMENT CORPORATION, CHARLOTTE, NC. FILED 11-11-2004.

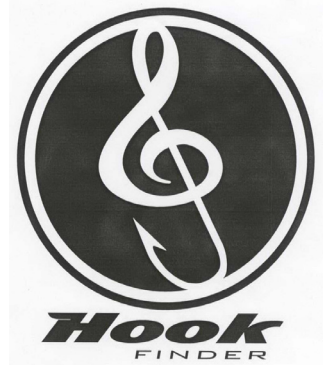

NO CLAIM IS MADE TO THE EXCLUSIVE RIGHT TO USE "FINDER", APART FROM THE MARK AS SHOWN.

FOR ONLINE SEARCH ENGINE THAT ALLOWS USERS TO SEARCH SONGS AND RELATED INFORMATION BY KEYWORDS OR PHRASES AS DEFINED BY THE USER (U.S. CLS. 100 AND 101).

FIRST USE 10-1-2004; IN COMMERCE 10-1-2004.

DAVID MURRAY, EXAMINING ATTORNEY

SN 78-515,657. LANIT CONSULTING, INC., COLUMBIA, MO. FILED 11-11-2004.



FOR PROVIDING TEMPORARY USE OF ON-LINE NON-DOWNLOADABLE SOFTWARE USED FOR PERSONAL AND ORGANIZATIONAL PROFESSIONAL DEVELOPMENT CENTERED ON THE USE OF ELECTRONIC PORTFOLIO SYSTEMS AND COMPLIMENTARY ASSESSMENT INSTRUMENTS (U.S. CLS. 100 AND 101).

FIRST USE 6-29-2003; IN COMMERCE 6-29-2003.

GEORGIA CARTY, EXAMINING ATTORNEY

CLASS 42—(Continued).

SN 78-517,804. SETTLEMATRIX CORPORATION, ORLANDO, FL. FILED 11-16-2004.

SettleMatrix

THE MARK CONSISTS OF STANDARD CHARACTERS WITHOUT CLAIM TO ANY PARTICULAR FONT, STYLE, SIZE, OR COLOR.

FOR ALTERNATIVE DISPUTE RESOLUTION (U.S. CLS. 100 AND 101).
MICHELE SWAIN, EXAMINING ATTORNEY

SN 78-519,015. MILLENNIUM INFORMATION TECHNOLOGIES PVT LTD, MALABE, SRI LANKA, FILED 11-18-2004.

Millennium IT

THE MARK CONSISTS OF STANDARD CHARACTERS WITHOUT CLAIM TO ANY PARTICULAR FONT, STYLE, SIZE, OR COLOR.

NO CLAIM IS MADE TO THE EXCLUSIVE RIGHT TO USE "IT", APART FROM THE MARK AS SHOWN.

FOR DESIGN, DEVELOPMENT, INSTALLATION, IMPLEMENTATION AND MAINTENANCE OF COMPUTER SOFTWARE FOR CAPITAL MARKET TRADING SYSTEMS; CONSULTING SERVICES IN THE FIELD OF DESIGN, DEVELOPMENT, INSTALLATION, IMPLEMENTATION AND MAINTENANCE OF COMPUTER SOFTWARE FOR CAPITAL MARKET TRADING SYSTEMS (U.S. CLS. 100 AND 101).

FIRST USE 1-0-1996; IN COMMERCE 0-0-2000.
MARGERY A. TIERNEY, EXAMINING ATTORNEY

CLASS 42—(Continued).

SN 78-520,955. ROSE INTERNATIONAL INC, CHESTERFIELD, MO. FILED 11-22-2004.



THE COLOR(S) BLUE, GREEN AND GRAY IS/ARE CLAIMED AS A FEATURE OF THE MARK.

THE COLOR BLUE APPEARS IN THE WORD MAESTRO, EXCEPT FOR THE LETTER T, THE COLOR GREEN APPEARS IN THE LETTER T, WHICH IS COMPRISED OF A DESIGN OF A CONDUCTOR DESIGN, AND THE COLOR GRAY APPEARS IN THE LETTERS VMS AND THE RECTANGULAR OUTLINE.

FOR PROVIDING ONLINE NON-DOWNLOADABLE SOFTWARE FOR MANAGING CONTINGENT COMPANY HUMAN RESOURCE NEEDS, WORKFORCE CONTRACTS, PERMANENT PLACEMENTS AND LABOR FORCE (U.S. CLS. 100 AND 101).

FIRST USE 10-1-2004; IN COMMERCE 10-1-2004.
SUNG IN, EXAMINING ATTORNEY

SN 78-521,068. BIT ANALYTICAL INSTRUMENTS GMBH, SCHWALBACH, FED REP GERMANY, FILED 11-22-2004.



NO CLAIM IS MADE TO THE EXCLUSIVE RIGHT TO USE "ANALYTICAL INSTRUMENTS, INC.", APART FROM THE MARK AS SHOWN.

FOR DESIGNING MEDICAL, LABORATORY AND INDUSTRIAL EQUIPMENT, PARTS AND COMPONENTS FOR OTHERS (U.S. CLS. 100 AND 101).

FIRST USE 11-21-2004; IN COMMERCE 11-21-2004.
JOHN DWYER, EXAMINING ATTORNEY

SN 78-523,272. TOBITS, LLC, COLUMBUS, OH. FILED 11-27-2004.



THE COLORS LIGHT BLUE AND GRAY ARE CLAIMED AS A FEATURE OF THE MARK.

THE WORD TOBITS IS LIGHT BLUE, THE CURVED LINE AND DOTS ARE GRAY.

FOR CROSS PLATFORM CONVERSION OF DIGITAL, ANALOG AND OTHER ELECTRONIC AUDIO AND VIDEO CONTENT INTO PURELY DIGITAL FORM (U.S. CLS. 100 AND 101).

FIRST USE 11-15-2004; IN COMMERCE 11-15-2004.
JOHN WILKE, EXAMINING ATTORNEY

CLASS 42—(Continued).

SN 78-524,382. APSRFID, LLC, DBA AMERICAN PROJECT SERVICES, MEMPHIS, TN. FILED 11-30-2004.

CLASS 42—(Continued).

SN 78-525,204. DEUTSCHE TELEKOM AG, BONN, FED REP GERMANY, FILED 12-1-2004.

T-Mobile SMS Manager

THE MARK CONSISTS OF STANDARD CHARACTERS WITHOUT CLAIM TO ANY PARTICULAR FONT, STYLE, SIZE, OR COLOR.

PRIORITY CLAIMED UNDER SEC. 44(D) ON FED REP GERMANY APPLICATION NO. 30431982138, FILED 6-2-2004, REG. NO. 30431982, DATED 9-9-2004, EXPIRES 6-30-2014.

OWNER OF U.S. REG. NOS. 2,282,432, 2,959,646 AND OTHERS.

FOR COMPUTER PROGRAMMING SERVICES FOR OTHERS; RENTAL OF COMPUTER SOFTWARE AND HARDWARE FOR ONLINE ACCESS; DATA ENCRYPTION SERVICES; APPLICATION SERVICE PROVIDER, NAMELY, HOSTING COMPUTER SOFTWARE APPLICATIONS FOR OTHERS, HOSTING OF DIGITAL CONTENT ON THE INTERNET; HOSTING THE WEBSITES OF OTHERS ON A COMPUTER SERVER FOR A GLOBAL COMPUTER NETWORK; COMPUTER SERVICES, NAMELY, CREATING INDEXES OF INFORMATION AVAILABLE ON COMPUTER NETWORKS; PROVIDING INFORMATION VIA THE TELEPHONE AND THE GLOBAL COMMUNICATION NETWORKS IN THE FIELD OF INFORMATION TECHNOLOGY; CONSULTING SERVICES IN THE FIELD OF DESIGN, SELECTION, IMPLEMENTATION AND USE OF COMPUTER HARDWARE AND SOFTWARE SYSTEMS FOR OTHERS; INSTALLATION, MAINTENANCE AND REPAIR OF COMPUTER SOFTWARE; TECHNICAL PROJECT PLANNING SERVICES RELATED TO TELECOMMUNICATIONS EQUIPMENT; PROVIDING INFORMATION AT THE SPECIFIC REQUEST OF END-USERS BY MEANS OF TELEPHONE OR GLOBAL COMMUNICATIONS NETWORKS; PROVIDING TEMPORARY USE OF ONLINE NON-DOWNLOADABLE TELECOMMUNICATIONS SOFTWARE FOR PROVIDING MULTIPLE USER ACCESS TO THE GLOBAL COMPUTER NETWORK (U.S. CLS. 100 AND 101).

LAURIE MAYES, EXAMINING ATTORNEY

TOWERWATCH

SN 78-525,877. AIM SYSTEMS, INC., ATASCADERO, CA. FILED 12-2-2004.



THE MARK CONSISTS OF STANDARD CHARACTERS WITHOUT CLAIM TO ANY PARTICULAR FONT, STYLE, SIZE, OR COLOR.

FOR MONITORING THE PERFORMANCE OF WIRELESS TELEPHONE TOWER LIGHTS (U.S. CLS. 100 AND 101).

KIMBERLY FRYE, EXAMINING ATTORNEY

NO CLAIM IS MADE TO THE EXCLUSIVE RIGHT TO USE "TOOLS", APART FROM THE MARK AS SHOWN.

FOR COMPUTER SERVICES, NAMELY, CUSTOM SOFTWARE DEVELOPMENT (U.S. CLS. 100 AND 101).

FIRST USE 6-1-2004; IN COMMERCE 6-1-2004.

TEJBIR SINGH, EXAMINING ATTORNEY

CLASS 42—(Continued).

SN 78-526,035. DEUTSCHE TELEKOM AG, BONN, FED REP GERMANY, FILED 12-2-2004.

CLASS 42—(Continued).

SN 78-526,938. DEUTSCHE TELEKOM AG, BONN, FED REP GERMANY, FILED 12-3-2004.

T-Mobile Data Connect

T-Mobile M2M Connect

THE MARK CONSISTS OF STANDARD CHARACTERS WITHOUT CLAIM TO ANY PARTICULAR FONT, STYLE, SIZE, OR COLOR.

OWNER OF FED REP GERMANY REG. NO. 30433157, DATED 7-20-2004, EXPIRES 6-30-2014.

OWNER OF U.S. REG. NOS. 2,282,432 AND 2,889,632.

NO CLAIM IS MADE TO THE EXCLUSIVE RIGHT TO USE DATA CONNECT, APART FROM THE MARK AS SHOWN.

FOR COMPUTER PROGRAMMING SERVICES FOR OTHERS; RENTAL OF COMPUTER SOFTWARE AND HARDWARE FOR ONLINE ACCESS; DATA ENCRYPTION SERVICES; APPLICATION SERVICE PROVIDER, NAMELY, HOSTING COMPUTER SOFTWARE APPLICATIONS FOR OTHERS, HOSTING OF DIGITAL CONTENT ON THE INTERNET; HOSTING THE WEBSITES OF OTHERS ON A COMPUTER SERVER FOR A GLOBAL COMPUTER NETWORK; COMPUTER SERVICES, NAMELY, CREATING INDEXES OF INFORMATION AVAILABLE ON COMPUTER NETWORKS; PROVIDING INFORMATION VIA THE TELEPHONE AND THE GLOBAL COMMUNICATION NETWORKS IN THE FIELD OF INFORMATION TECHNOLOGY; CONSULTING SERVICES IN THE FIELD OF DESIGN, SELECTION, IMPLEMENTATION AND USE OF COMPUTER HARDWARE AND SOFTWARE SYSTEMS FOR OTHERS; INSTALLATION, MAINTENANCE AND REPAIR OF COMPUTER SOFTWARE; TECHNICAL PROJECT PLANNING SERVICES RELATED TO TELECOMMUNICATIONS EQUIPMENT; PROVIDING TEMPORARY USE OF ONLINE NON-DOWNLOADABLE TELECOMMUNICATIONS SOFTWARE FOR PROVIDING MULTIPLE USER ACCESS TO THE GLOBAL COMPUTER NETWORK; PROVIDING INFORMATION AT THE SPECIFIC REQUEST OF END-USERS BY MEANS OF TELEPHONE OR GLOBAL COMMUNICATIONS NETWORKS (U.S. CLS. 100 AND 101).

LAURIE MAYES, EXAMINING ATTORNEY

THE MARK CONSISTS OF STANDARD CHARACTERS WITHOUT CLAIM TO ANY PARTICULAR FONT, STYLE, SIZE, OR COLOR.

PRIORITY CLAIMED UNDER SEC. 44(D) ON FED REP GERMANY APPLICATION NO. 30433156238, FILED 6-7-2004, REG. NO. 30433156, DATED 7-20-2004, EXPIRES 6-30-2014.

OWNER OF U.S. REG. NOS. 2,282,432 AND 2,889,632.

NO CLAIM IS MADE TO THE EXCLUSIVE RIGHT TO USE CONNECT, APART FROM THE MARK AS SHOWN.

FOR COMPUTER PROGRAMMING SERVICES FOR OTHERS; RENTAL OF COMPUTER SOFTWARE AND HARDWARE FOR ONLINE ACCESS; DATA ENCRYPTION SERVICES; APPLICATION SERVICE PROVIDER, NAMELY, HOSTING COMPUTER SOFTWARE APPLICATIONS FOR OTHERS, HOSTING OF DIGITAL CONTENT ON THE INTERNET; HOSTING THE WEBSITES OF OTHERS ON A COMPUTER SERVER FOR A GLOBAL COMPUTER NETWORK; COMPUTER SERVICES, NAMELY, CREATING INDEXES OF INFORMATION AVAILABLE ON COMPUTER NETWORKS; PROVIDING INFORMATION VIA THE TELEPHONE AND THE GLOBAL COMMUNICATION NETWORKS IN THE FIELD OF INFORMATION TECHNOLOGY; CONSULTING SERVICES IN THE FIELD OF DESIGN, SELECTION, IMPLEMENTATION AND USE OF COMPUTER HARDWARE AND SOFTWARE SYSTEMS FOR OTHERS; INSTALLATION, MAINTENANCE AND REPAIR OF COMPUTER SOFTWARE; TECHNICAL PROJECT PLANNING SERVICES RELATED TO TELECOMMUNICATIONS EQUIPMENT; PROVIDING TEMPORARY USE OF ONLINE NON-DOWNLOADABLE TELECOMMUNICATIONS SOFTWARE FOR PROVIDING MULTIPLE USER ACCESS TO THE GLOBAL COMPUTER NETWORK; PROVIDING INFORMATION AT THE SPECIFIC REQUEST OF END-USERS BY MEANS OF TELEPHONE OR GLOBAL COMMUNICATIONS NETWORKS (U.S. CLS. 100 AND 101).

LAURIE MAYES, EXAMINING ATTORNEY

CLASS 42—(Continued).

SN 78-529,857. SURFCONTROL PLC, CONGLETON, UNITED KINGDOM, FILED 12-9-2004.

SURFCONTROL

THE MARK CONSISTS OF STANDARD CHARACTERS WITHOUT CLAIM TO ANY PARTICULAR FONT, STYLE, SIZE, OR COLOR.

OWNER OF U.S. REG. NOS. 2,128,321 AND 2,630,224.

FOR COMPUTER CONSULTANCY SERVICES; CONSULTANCY IN THE FIELD OF ELECTRONIC CONTENT FILTERING; CONSULTANCY IN THE FIELD OF FILTERING OF ELECTRONIC COMMUNICATIONS; PROVIDING DATABASES FEATURING INFORMATION TO ASSIST USERS IN FILTERING ELECTRONIC CONTENT; COMPUTER SERVICES, NAMELY FILTERING TELECOMMUNICATION MESSAGES; FILTERING THE TRANSMISSION OF ELECTRONIC COMMUNICATIONS IN COMPUTER NETWORKS; FILTERING EMAIL, TEXT MESSAGES, PICTURE MESSAGES AND INSTANT MESSAGES; FILTERING ACCESS TO WIDE AREA NETWORKS SUCH AS THE INTERNET, NAMELY, RESTRICTING ACCESS TO AND BY COMPUTER NETWORKS TO AND OF UNDESIRE WEB SITES, MEDIA AND INDIVIDUALS AND FACILITIES; ADVICE RELATING TO FILTERING ELECTRONIC CONTENT AND PROVIDING INFORMATION IN THE FIELD OF FILTERING ELECTRONIC CONTENT (U.S. CLS. 100 AND 101).

FIRST USE 10-30-1999; IN COMMERCE 10-30-1999.
MICHELLE DUBOIS, EXAMINING ATTORNEY

SN 78-530,742. HSE SYSTEMS, INC., MASSILLON, OH. FILED 12-10-2004.

CIMgen

THE MARK CONSISTS OF STANDARD CHARACTERS WITHOUT CLAIM TO ANY PARTICULAR FONT, STYLE, SIZE, OR COLOR.

FOR WEB-BASED NON-DOWNLOADABLE COMPUTER SOFTWARE FOR CHEMICAL INVENTORY MANAGEMENT, TRACKING AND REPORTING (U.S. CLS. 100 AND 101).

FIRST USE 9-26-2004; IN COMMERCE 10-12-2004.
JENNIFER WILLISTON, EXAMINING ATTORNEY

CLASS 42—(Continued).

SN 78-531,395. DOTMAN GRAPHIC DESIGN INC., NORMAN, OK. FILED 12-13-2004.



NO CLAIM IS MADE TO THE EXCLUSIVE RIGHT TO USE "GRAPHIC DESIGN INC", APART FROM THE MARK AS SHOWN.

FOR GRAPHIC DESIGN FOR PRINT, AND WEB SITES (U.S. CLS. 100 AND 101).

FIRST USE 9-1-1999; IN COMMERCE 9-1-1999.
FRED MANDIR, EXAMINING ATTORNEY

SN 78-532,273. REMEDYTEMP, INC., ALISO VIEJO, CA. FILED 12-14-2004.

REMX VERIFY

THE MARK CONSISTS OF STANDARD CHARACTERS WITHOUT CLAIM TO ANY PARTICULAR FONT, STYLE, SIZE, OR COLOR.

OWNER OF U.S. REG. NOS. 2,443,159 AND 2,520,583.
FOR PROVIDING USE OF TEMPORARY ONLINE NON-DOWNLOADABLE SOFTWARE FOR A SKILLS ASSESSMENT SYSTEM AND TUTORIALS FOR SKILLS DEVELOPMENT FOR USE IN CONNECTION WITH TEMPORARY AND PERMANENT EMPLOYMENT PLACEMENT SERVICES (U.S. CLS. 100 AND 101).

RENEE MCCRAY, EXAMINING ATTORNEY

CLASS 42—(Continued).

SN 78-533,078. NOVOCELL SEMICONDUCTOR, INC., W. MIDDLESEX, PA. FILED 12-15-2004.

CLASS 42—(Continued).

SN 78-535,389. HUNTON & WILLIAMS LLP, RICHMOND, VA. FILED 12-20-2004.

**NOVOCELL
SEMICONDUCTOR**

EHUNT

THE MARK CONSISTS OF STANDARD CHARACTERS WITHOUT CLAIM TO ANY PARTICULAR FONT, STYLE, SIZE, OR COLOR.

NO CLAIM IS MADE TO THE EXCLUSIVE RIGHT TO USE SEMICONDUCTOR, APART FROM THE MARK AS SHOWN.

FOR ENGINEERING SERVICES (U.S. CLS. 100 AND 101).

FIRST USE 12-31-2002; IN COMMERCE 12-31-2002.
PATRICIA EVANKO, EXAMINING ATTORNEY

THE MARK CONSISTS OF STANDARD CHARACTERS WITHOUT CLAIM TO ANY PARTICULAR FONT, STYLE, SIZE, OR COLOR.

FOR PROVIDING CUSTOMIZED ONLINE WEB PAGES FEATURING USER-DEFINED INFORMATION, WHICH INCLUDES SEARCH ENGINES AND ONLINE WEB LINKS TO OTHER WEB SITES RELATING TO THE PRACTICE OF LAW (U.S. CLS. 100 AND 101).

CARRIE ACHEN, EXAMINING ATTORNEY

SN 78-535,027. DAKOTA GOLD RESEARCH ASSOCIATION, SIOUX FALLS, SD. FILED 12-18-2004.

SN 78-535,830. ELEMENTOOL INC., NEW YORK, NY. FILED 12-20-2004.

DGRA



THE MARK CONSISTS OF STANDARD CHARACTERS WITHOUT CLAIM TO ANY PARTICULAR FONT, STYLE, SIZE, OR COLOR.

FOR AGRICULTURAL RESEARCH AND TECHNICAL CONSULTING IN THE FIELD OF GRAINS AND FEED (U.S. CLS. 100 AND 101).

FIRST USE 0-0-2002; IN COMMERCE 0-0-2002.
JENNIFER KRISP, EXAMINING ATTORNEY

FOR PROVIDING TEMPORARY USE OF NON-DOWNLOADABLE WEB-BASED MANAGEMENT SOFTWARE TOOLS FOR MANAGING CUSTOMER SERVICE OPERATIONS, TRACKING BUGS AND DEFECTS, FILE SHARING, AND TIME TRACKING FOR PROJECTS AND ASSIGNMENTS (U.S. CLS. 100 AND 101).

FIRST USE 6-19-2000; IN COMMERCE 6-19-2000.
JEAN IM, EXAMINING ATTORNEY

CLASS 42—(Continued).

SN 78-536,031. JASON R WALKOWICZ, HUDSON, MI.
FILED 12-21-2004.

Neutronis

THE MARK CONSISTS OF STANDARD CHARACTERS WITHOUT CLAIM TO ANY PARTICULAR FONT, STYLE, SIZE, OR COLOR.

FOR TECHNICAL SUPPORT SERVICES, NAMELY, TROUBLESHOOTING OF COMPUTER HARDWARE AND SOFTWARE PROBLEMS; DESIGN, CREATION, HOSTING, MAINTENANCE OF WEBSITES FOR OTHERS (U.S. CLS. 100 AND 101).

ALICE BENMAMAN, EXAMINING ATTORNEY

SN 78-537,237. THUNDERBIRD TECHNOLOGIES, INC.,
MORRISVILLE, NC. FILED 12-22-2004.

FERMI-FET

THE MARK CONSISTS OF STANDARD CHARACTERS WITHOUT CLAIM TO ANY PARTICULAR FONT, STYLE, SIZE, OR COLOR.

FOR DESIGN FOR OTHERS OF MICROELECTRONIC DEVICES AND COMPUTER SOFTWARE FOR USE IN DESIGNING MICROELECTRONIC DEVICES (U.S. CLS. 100 AND 101).

FIRST USE 3-20-1994; IN COMMERCE 3-20-1994.
NAAKWAMA ANKRAH, EXAMINING ATTORNEY

CLASS 42—(Continued).

SN 78-538,123. MARKETINGGENIUS.COM, INC., SAN FRANCISCO, CA. FILED 12-23-2004.

MARKETINGGENIUS. COM

THE MARK CONSISTS OF STANDARD CHARACTERS WITHOUT CLAIM TO ANY PARTICULAR FONT, STYLE, SIZE, OR COLOR.

OWNER OF U.S. REG. NO. 2,182,071.

FOR TEMPORARY USE OF ON-LINE NON-DOWNLOADABLE SOFTWARE THAT ALLOWS A USER TO TRACK, ANALYZE AND COMMUNICATE WITH CUSTOMERS (U.S. CLS. 100 AND 101).

DEBRA LEE, EXAMINING ATTORNEY

SN 78-539,321. ACCELOVATION, INC., MOUNTAIN VIEW,
CA. FILED 12-28-2004.

Accelovation

THE MARK CONSISTS OF STANDARD CHARACTERS WITHOUT CLAIM TO ANY PARTICULAR FONT, STYLE, SIZE, OR COLOR.

FOR COMPUTER SERVICES, NAMELY, PROVIDING SEARCH ENGINES FOR OBTAINING DATA ON A GLOBAL COMPUTER NETWORK IN THE FIELDS OF INTELLECTUAL ASSET MANAGEMENT, INTELLECTUAL ASSETS AND CAPITAL MANAGEMENT, INTELLECTUAL CAPITAL MANAGEMENT, INTELLECTUAL PROPERTY LICENSING, INTELLECTUAL PROPERTY MANAGEMENT LICENSING, OUT-LICENSING, PATENT LICENSING, TECHNOLOGY COMMERCIALIZATION, TECHNOLOGY LICENSING, TECHNOLOGY TRANSFER, AND CARROT LICENSING OF INTELLECTUAL PROPERTY (U.S. CLS. 100 AND 101).

FIRST USE 6-0-2004; IN COMMERCE 6-0-2004.
ALINA MORRIS, EXAMINING ATTORNEY

CLASS 42—(Continued).

SN 78-573,126. REPROMEDIX CORPORATION, WOBURN, MA. FILED 2-23-2005.



THE MARK CONSISTS OF THE WORD REPROMEDIX WITH A CIRCLE SURROUNDED BY TWO CONJOINED OVALS APPEARING TO THE UPPER RIGHT OF THE WORD.

FOR LABORATORY TESTING AND RESEARCH IN THE FIELD OF REPRODUCTIVE HEALTH AND MEDICINE AND PROVIDING INFORMATION ON THE SUBJECT OF SCIENTIFIC RESEARCH IN THE FIELD OF REPRODUCTIVE HEALTH (U.S. CLS. 100 AND 101).
FIRST USE 10-16-2004; IN COMMERCE 10-16-2004.
CARRIE ACHEN, EXAMINING ATTORNEY

CLASS 43—HOTEL AND RESTAURANT SERVICES

SN 76-561,648. CHACARERO INC., BOSTON, MA. FILED 11-12-2003.

CHACARERO

THE MARK CONSISTS OF STANDARD CHARACTERS WITHOUT CLAIM TO ANY PARTICULAR FONT, STYLE, SIZE, OR COLOR.

THE ENGLISH TRANSLATION OF THE MARK IS FARMER.

FOR CARRY-OUT RESTAURANT AND CATERING SERVICES (U.S. CLS. 100 AND 101).
FIRST USE 7-23-1998; IN COMMERCE 7-23-1998.
REBECCA SMITH, EXAMINING ATTORNEY

SN 79-008,099. SANKYO COMPANY, LIMITED, JAPAN, FILED 10-1-2004.



PRIORITY DATE OF 9-1-2004 IS CLAIMED.
OWNER OF INTERNATIONAL REGISTRATION 0840936 DATED 10-1-2004, EXPIRES 10-1-2014.

THE COLOR(S) BLUE, BLACK, RED AND WHITE IS/ARE CLAIMED AS A FEATURE OF THE MARK.

THE COLOR BLUE APPEARS IN THE WORD PORTION OF THE MARK, CAPTIVATE, AND THE COLORS BLUE, BLACK, RED AND WHITE APPEAR IN THE DESIGN PORTION OF THE MARK. THE LINES SURROUNDING THE ARTERY AND THE SOUND WAVES APPEAR IN BLUE. THE ARTERY IN RED AND THE SOUND WAVES IN BLACK. THE BACKGROUND APPEARS IN WHITE.

FOR PHARMACEUTICAL RESEARCH, NAMELY, CONDUCTING CLINICAL STUDIES, TRIALS AND INVESTIGATIONS (U.S. CLS. 100 AND 101).

APRIL L. RADEMACHER, EXAMINING ATTORNEY

SN 76-574,049. 2 MANATEES, L.L.C., TULSA, OK. FILED 1-26-2004.

IN THE RAW

THE MARK CONSISTS OF STANDARD CHARACTERS WITHOUT CLAIM TO ANY PARTICULAR FONT, STYLE, SIZE, OR COLOR.

NO CLAIM IS MADE TO THE EXCLUSIVE RIGHT TO USE "SUSHI", APART FROM THE MARK AS SHOWN.

FOR RESTAURANTS FEATURING SUSHI AND OTHER JAPANESE CUISINE (U.S. CLS. 100 AND 101).
FIRST USE 2-1-1998; IN COMMERCE 9-1-1998.

SHARON MEIER, EXAMINING ATTORNEY

CLASS 43—(Continued).

SN 76-577,335. EL JARIPEO MEXICAN RESTURANT, INC., MCCORDSVILLE, IN. FILED 1-12-2004.

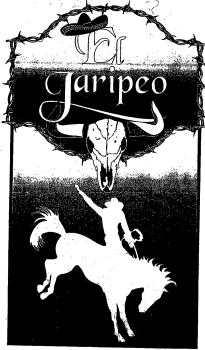

DESIGN OF A COWBOY RIDING A BUCKING BRONCO WITH A STEER'S SKULL LOCATED ABOVE AND THE WORDS EL JARIPEO.

THE ENGLISH TRANSLATION FOR THE MARK, EL JARIPEO, IS THE "RODEO".

FOR MEXICAN RESTURANT PREPARING AND SERVING MEXICAN FOOD (U.S. CLS. 100 AND 101).

FIRST USE 2-1-2002; IN COMMERCE 2-1-2002.

HOWARD B. LEVINE, EXAMINING ATTORNEY

SN 76-578,809. LEWIS, KENNETH, SR., FLOSSMOOR, IL. FILED 3-2-2004.



NO CLAIM IS MADE TO THE EXCLUSIVE RIGHT TO USE "CHICKEN", APART FROM THE MARK AS SHOWN.

FOR RESTAURANT SERVICES, AND BAR AND GRILL SERVICES (U.S. CLS. 100 AND 101).

FIRST USE 2-1-2004; IN COMMERCE 2-1-2004.

TINA L. SNAPP, EXAMINING ATTORNEY

CLASS 43—(Continued).

SN 76-582,285. HELEN BRETT ENTERPRISES, INC., DBA MOMENTUM EVENT NETWORK, LISLE, IL. FILED 3-18-2004.



NO CLAIM IS MADE TO THE EXCLUSIVE RIGHT TO USE "EVENT NETWORK", APART FROM THE MARK AS SHOWN.

FOR PROVIDING FOR OTHERS RESERVATION SERVICES, ROOM LISTS, ONLINE INTERACTIVE MAPPING OF ROOMS, AND REAL-TIME E-BROCHURES AND INFORMATION FOR TEMPORARY HOUSING SERVICES IN CONNECTION WITH TRADE SHOWS, MEETINGS, AND EXHIBITIONS (U.S. CLS. 100 AND 101).

FIRST USE 1-0-2002; IN COMMERCE 1-0-2002.

ELIZABETH PIGNATELLO, EXAMINING ATTORNEY

SN 76-584,421. BARRETT, MICHAEL, NEW YORK, NY. AND FRIED, DANIEL, NEW YORK, NY. FILED 4-1-2004.



NO CLAIM IS MADE TO THE EXCLUSIVE RIGHT TO USE "SANDWICHES", APART FROM THE MARK AS SHOWN.

THE COLOR BLUE VARYING SHADES OF THE COLOR BLUE ARE CLAIMED AS A FEATURE OF THE MARK.

THE MARK CONSISTS OF THE WORDS CARVE UNIQUE SANDWICHES WITH A BACKGROUND DESIGN CONSISTING OF RECTANGLES AND SQUARES OF VARYING SHADES OF BLUE.

FOR RESTAURANT AND CATERING SERVICES; TAKE-OUT RESTAURANT SERVICES; CAFE AND DELICATESSEN RESTAURANT SERVICES; AND PREPARATION OF FOOD ITEMS (U.S. CLS. 100 AND 101).

FIRST USE 6-25-2004; IN COMMERCE 6-25-2004.

TRICIA SONNEBORN, EXAMINING ATTORNEY

SN 76-585,977. JIPC MANAGEMENT, INC., SAN LUIS OBISPO, CA. FILED 4-9-2004.

JOHN'S INCREDIBLE PIZZA CO.

THE MARK CONSISTS OF STANDARD CHARACTERS WITHOUT CLAIM TO ANY PARTICULAR FONT, STYLE, SIZE, OR COLOR.

NO CLAIM IS MADE TO THE EXCLUSIVE RIGHT TO USE "PIZZA CO", APART FROM THE MARK AS SHOWN. FOR RESTAURANT SERVICES (U.S. CLS. 100 AND 101).

FIRST USE 9-0-1997; IN COMMERCE 9-0-1997.

RAMONA ORTIGA, EXAMINING ATTORNEY

CLASS 43—(Continued).

SN 76-587,368. FORNARELLI, DANIELLE J., CHICAGO, IL. FILED 4-15-2004.

GOT PIZZA

THE MARK CONSISTS OF STANDARD CHARACTERS WITHOUT CLAIM TO ANY PARTICULAR FONT, STYLE, SIZE, OR COLOR.

NO CLAIM IS MADE TO THE EXCLUSIVE RIGHT TO USE "PIZZA", APART FROM THE MARK AS SHOWN, FOR RESTAURANTS FEATURING HOME DELIVERY (U.S. CLS. 100 AND 101).

FIRST USE 10-9-2003; IN COMMERCE 10-9-2003.
RONALD MCMORROW, EXAMINING ATTORNEY

SN 76-587,482. SANDELLA'S, LLC, WEST REDDING, CT. FILED 4-19-2004.

EAT RIGHT, RIGHT AWAY!

THE MARK CONSISTS OF STANDARD CHARACTERS WITHOUT CLAIM TO ANY PARTICULAR FONT, STYLE, SIZE, OR COLOR.

FOR RESTAURANT SERVICES FEATURING SANDWICH WRAPS, PIZZAS, QUASADILLAS, PANINIS, RICE BOWLS, NOODLE BOWLS AND SALADS (U.S. CLS. 100 AND 101).

FIRST USE 11-1-2003; IN COMMERCE 11-1-2003.
SCOTT OSCLICK, EXAMINING ATTORNEY

SN 76-587,862. L.A. FOOD SERVICES, INC., PISCATAWAY, NJ. FILED 4-21-2004.

L.A. CAFÉ

THE MARK CONSISTS OF STANDARD CHARACTERS WITHOUT CLAIM TO ANY PARTICULAR FONT, STYLE, SIZE, OR COLOR.

NO CLAIM IS MADE TO THE EXCLUSIVE RIGHT TO USE CAFÉ, APART FROM THE MARK AS SHOWN.

FOR RESTAURANT SERVICES OFFERED TO THE GENERAL PUBLIC IN DINING FACILITIES OPEN MOST DAYS TO THE GENERAL PUBLIC AND CATERING SERVICES PROVIDED PRIVATELY AT RESIDENCES AND COMMERCIAL BUILDINGS (U.S. CLS. 100 AND 101).

FIRST USE 11-0-1990; IN COMMERCE 11-0-2003.
JOHN GARTNER, EXAMINING ATTORNEY

CLASS 43—(Continued).

SN 76-591,427. CHEEBURGER CHEEBURGER RESTAURANTS, INC., FORT MYERS, FL. FILED 5-10-2004.



OWNER OF U.S. REG. NOS. 1,590,234 AND 1,917,040. SEC. 2(F) AS TO "CHEEBURGER". FOR RESTAURANTS, TAKE-OUT RESTAURANTS, AND RESTAURANTS FEATURING HOME DELIVERY (U.S. CLS. 100 AND 101). FIRST USE 12-17-2003; IN COMMERCE 12-17-2003.
DORITT L. CARROLL, EXAMINING ATTORNEY

SN 76-594,039. WYNDHAM IP CORPORATION, WILMINGTON, DE. FILED 5-26-2004.

WYNDHAM HISTORIC HOTEL

OWNER OF U.S. REG. NOS. 2,096,650, 2,859,133 AND OTHERS.

NO CLAIM IS MADE TO THE EXCLUSIVE RIGHT TO USE "HISTORIC HOTEL", APART FROM THE MARK AS SHOWN.

FOR HOTEL SERVICES; NAMELY, PROVIDING LODGINGS, ROOMS AND MEALS (U.S. CLS. 100 AND 101). FIRST USE 1-0-1999; IN COMMERCE 1-0-1999.
RON FAIRBANKS, EXAMINING ATTORNEY

CLASS 43—(Continued).

SN 76-597,575. CRAZY WOK CHINESE TAKEOUT, INC., CORAL SPRINGS, FL. FILED 6-16-2004.



think fresh, eat fresh

NO CLAIM IS MADE TO THE EXCLUSIVE RIGHT TO USE "WOK" OR "CHINESE EXPRESS CUISINE", APART FROM THE MARK AS SHOWN.

THE COLOR(S) ORANGE IS/ARE CLAIMED AS A FEATURE OF THE MARK.

THE ORANGE COLOR APPEARS IN THE BACKGROUND CIRCLE OF THE MARK AS WELL AS PART OF THE COLORS OF THE CHINESE TAKEOUT CONTAINER AND THE FORTUNE COOKIE.

THE NON-LATIN CHARACTERS IN THE MARK TRANSLITERATE TO "QUALITY TASTE HOUSE" AND THIS MEANS "HOUSE OF QUALITY AND TASTE" IN ENGLISH.

FOR CHINESE CUISINE EXPRESS TAKEOUT RESTAURANT SERVICE WITH FRESH INGREDIENTS (U.S. CLS. 100 AND 101).

FIRST USE 6-1-2004; IN COMMERCE 6-1-2004.
DOMINIC J. FERRAIUOLO, EXAMINING ATTORNEY

SN 76-597,628. STAGGERING OX, INC., HELENA, MT. FILED 6-16-2004.

STAGGERING OX

THE MARK CONSISTS OF STANDARD CHARACTERS WITHOUT CLAIM TO ANY PARTICULAR FONT, STYLE, SIZE, OR COLOR.

FOR RESTAURANT SERVICES (U.S. CLS. 100 AND 101).

FIRST USE 10-1-1983; IN COMMERCE 10-1-1983.
DOMINIC J. FERRAIUOLO, EXAMINING ATTORNEY

CLASS 43—(Continued).

SN 76-597,835. WYNN RESORTS HOLDINGS, LLC, LAS VEGAS, NV. FILED 6-15-2004.

CABANA BAR

THE MARK CONSISTS OF STANDARD CHARACTERS WITHOUT CLAIM TO ANY PARTICULAR FONT, STYLE, SIZE, OR COLOR.

NO CLAIM IS MADE TO THE EXCLUSIVE RIGHT TO USE "BAR", APART FROM THE MARK AS SHOWN.

FOR RESTAURANT, BAR AND COCKTAIL LOUNGE SERVICES (U.S. CLS. 100 AND 101).

SOPHIA S. KIM, EXAMINING ATTORNEY

SN 76-598,767. WILLIS, ROBERT, RICHMOND, TX. FILED 6-21-2004.



NO CLAIM IS MADE TO THE EXCLUSIVE RIGHT TO USE "TEX-CAJUN RESTAURANT CHICKEN SEAFOOD MEXICAN BARBEQUE", APART FROM THE MARK AS SHOWN.

FOR RESTAURANT SERVICES (U.S. CLS. 100 AND 101).

FIRST USE 11-1-2003; IN COMMERCE 11-1-2003.
ANN LINNEHAN, EXAMINING ATTORNEY

SN 76-599,462. LODGEWORKS, L.P., WICHITA, KS. FILED 6-28-2004.

 **SIERRA SUITES
HOTEL**

NO CLAIM IS MADE TO THE EXCLUSIVE RIGHT TO USE "SUITES HOTEL", APART FROM THE MARK AS SHOWN.

THE MARK CONSISTS OF THE WORDS SIERRA SUITES HOTEL IN COMBINATION WITH A STYLIZED REPRESENTATION OF INTERSECTING MOUNTAINS.

FOR HOTEL SERVICES; PROVIDING ONLINE INFORMATION REGARDING HOTEL ACCOMMODATION RATES; HOTEL SERVICES FEATURING INCENTIVE PROGRAMS PROVIDING SPECIAL GUEST SERVICES, AMENITIES AND AWARDS TO MEMBERS (U.S. CLS. 100 AND 101).

TARAH HARDY, EXAMINING ATTORNEY

CLASS 43—(Continued).

SN 76-599,463. LODGEWORKS, LP, WICHITA, KS. FILED 6-28-2004.



NO CLAIM IS MADE TO THE EXCLUSIVE RIGHT TO USE "SUITES HOTEL", APART FROM THE MARK AS SHOWN.

THE MARK CONSISTS OF THE WORDS SIERRA SUITES HOTEL IN COMBINATION WITH A STYLIZED REPRESENTATION OF INTERSECTING MOUNTAINS.

FOR HOTEL SERVICES; PROVIDING ONLINE INFORMATION REGARDING HOTEL ACCOMMODATION RATES; HOTEL SERVICES FEATURING INCENTIVE PROGRAMS PROVIDING SPECIAL GUEST SERVICES, AMENITIES AND AWARDS TO MEMBERS (U.S. CLS. 100 AND 101).

TARAH HARDY, EXAMINING ATTORNEY

SN 76-602,466. SÁEZ, MARIO RODRIGUEZ, MEXICO CITY, MEXICO, FILED 7-12-2004.



THE ENGLISH TRANSLATION OF THE WORD SALSACAFE EL NUEVO RITMO TROPICAL IN THE MARK IS SALSACAFE THE NEW TROPICAL RHYTHM.

FOR RESTAURANT AND BAR SERVICES (U.S. CLS. 100 AND 101).

SHARI SHEFFIELD, EXAMINING ATTORNEY

SN 76-602,974. SOFA KING, INC., VINCENNES, IN. FILED 7-16-2004.



NO CLAIM IS MADE TO THE EXCLUSIVE RIGHT TO USE "SUBS & SALADS", APART FROM THE MARK AS SHOWN.

FOR RESTAURANT SERVICES; CATERING SERVICES; TAKE-OUT RESTAURANT SERVICES (U.S. CLS. 100 AND 101).

FIRST USE 7-28-2003; IN COMMERCE 9-11-2003.
NELSON SNYDER, EXAMINING ATTORNEY

CLASS 43—(Continued).

SN 76-604,769. SELECT GRILLE, LLC, WEST LAWN, PA. FILED 7-29-2004.

J.B. Dawson's Restaurant & Bar

THE MARK CONSISTS OF STANDARD CHARACTERS WITHOUT CLAIM TO ANY PARTICULAR FONT, STYLE, SIZE, OR COLOR.

NO CLAIM IS MADE TO THE EXCLUSIVE RIGHT TO USE RESTAURANT AND BAR, APART FROM THE MARK AS SHOWN.

THE NAME J.B. DAWSON DOES NOT IDENTIFY A LIVING INDIVIDUAL.

FOR RESTAURANT AND BAR (U.S. CLS. 100 AND 101).

FIRST USE 1-25-1999; IN COMMERCE 1-25-1999.
BILL DAWE, EXAMINING ATTORNEY

SN 76-607,116. THE GREAT PACIFIC COFFEE COMPANY, INC., PACIFIC, MO. FILED 8-16-2004.

GREAT PACIFIC COFFEE COMPANY

THE MARK CONSISTS OF STANDARD CHARACTERS WITHOUT CLAIM TO ANY PARTICULAR FONT, STYLE, SIZE, OR COLOR.

NO CLAIM IS MADE TO THE EXCLUSIVE RIGHT TO USE "COFFEE COMPANY", APART FROM THE MARK AS SHOWN.

FOR PREPARATION OF DRINK AND FOOD FOR CONSUMPTION, NAMELY THE OPERATION OF ONE OR MORE COFFEE BARS AND RESTAURANTS (U.S. CLS. 100 AND 101).

FIRST USE 1-1-2004; IN COMMERCE 1-1-2004.
KELLY CHOE, EXAMINING ATTORNEY

SN 76-607,303. ESCAPEES, INC., LIVINGSTON, TX. FILED 8-14-2004.

THE MARK CONSISTS OF STANDARD CHARACTERS WITHOUT CLAIM TO ANY PARTICULAR FONT, STYLE, SIZE, OR COLOR.

OWNER OF U.S. REG. NOS. 1,364,429 AND 1,802,086.
NO CLAIM IS MADE TO THE EXCLUSIVE RIGHT TO USE CO-OP, APART FROM THE MARK AS SHOWN.

FOR PARKS FOR RVS (U.S. CLS. 100 AND 101).
FIRST USE 12-31-1985; IN COMMERCE 12-31-1985.
TIMOTHY FINNEGAN, EXAMINING ATTORNEY

CLASS 43—(Continued).

SN 76-607,588. THOMPSON, GLENN, LAKE WORTH, FL.
FILED 8-16-2004.

TREE'S, WINGS AND RIBS

THE MARK CONSISTS OF STANDARD CHARACTERS WITHOUT CLAIM TO ANY PARTICULAR FONT, STYLE, SIZE, OR COLOR.

OWNER OF U.S. REG. NO. 1,913,998.
NO CLAIM IS MADE TO THE EXCLUSIVE RIGHT TO USE "WINGS AND RIBS", APART FROM THE MARK AS SHOWN.

FOR RESTAURANT SERVICES (U.S. CLS. 100 AND 101).

FIRST USE 7-15-1991; IN COMMERCE 7-15-1991.
RONALD MCMORROW, EXAMINING ATTORNEY

SN 76-609,298. SERRA CANYON COMPANY LTD, MALIBU, CA. FILED 8-30-2004.

MALIBU BEACH R.V. PARK

THE MARK CONSISTS OF STANDARD CHARACTERS WITHOUT CLAIM TO ANY PARTICULAR FONT, STYLE, SIZE, OR COLOR.

NO CLAIM IS MADE TO THE EXCLUSIVE RIGHT TO USE "R.V. PARK", APART FROM THE MARK AS SHOWN. SEC. 2(F).

FOR PROVIDING FAMILY-ORIENTED CAMP-GROUND AND RECREATIONAL VEHICLE FACILITIES (U.S. CLS. 100 AND 101).

FIRST USE 6-30-1976; IN COMMERCE 12-30-1976.
IRA J. GOODSAD, EXAMINING ATTORNEY

SN 76-611,400. TERRY'S TAP ROOM, INC., SPARTANBURG, SC. FILED 9-7-2004.

TERRY'S TAP ROOM

THE MARK CONSISTS OF STANDARD CHARACTERS WITHOUT CLAIM TO ANY PARTICULAR FONT, STYLE, SIZE, OR COLOR.

NO CLAIM IS MADE TO THE EXCLUSIVE RIGHT TO USE "TAPROOM", APART FROM THE MARK AS SHOWN. FOR BAR AND TAPROOM SERVICES (U.S. CLS. 100 AND 101).

FIRST USE 7-1-2004; IN COMMERCE 7-1-2004.
LEIGH LOWRY, EXAMINING ATTORNEY

CLASS 43—(Continued).

SN 76-612,019. IMPACT RESTAURANTS L.L.C., TAMPA, FL.
FILED 9-13-2004.

M.J. BARLEYHOPPERS

THE MARK CONSISTS OF STANDARD CHARACTERS WITHOUT CLAIM TO ANY PARTICULAR FONT, STYLE, SIZE, OR COLOR.

APPLICANT SEEKS REGISTRATION TO USE THE SUBJECT MARK IN THE UNITED STATES WITH THE EXCEPTION OF A CIRCLE WITH A RADIUS OF TWO HUNDRED (200) MILES, HAVING AS ITS CENTER LOCATED AT 621 21ST STREET, LEWISTON, IDAHO.

"M.J. BARLEYHOPPERS" DOES NOT IDENTIFY A LIVING INDIVIDUAL.

FOR RESTAURANT AND LOUNGE SERVICES (U.S. CLS. 100 AND 101).

FIRST USE 1-30-2004; IN COMMERCE 1-30-2004.
ROBERT LAVACHE, EXAMINING ATTORNEY

SN 76-615,801. M & J RISTORANTE, INC., INDIANAPOLIS, IN. FILED 10-12-2004.

**A TASTE OF ITALY THAT'S AROUND THE CORNER,
NOT AROUND THE WORLD**

THE MARK CONSISTS OF STANDARD CHARACTERS WITHOUT CLAIM TO ANY PARTICULAR FONT, STYLE, SIZE, OR COLOR.

FOR RESTAURANT SERVICES (U.S. CLS. 100 AND 101).

FIRST USE 7-5-2004; IN COMMERCE 7-5-2004.
REGINA DRUMMOND, EXAMINING ATTORNEY

SN 76-615,890. QUEENS OF THE GUMBO DIRT, ROHWER, AR. FILED 10-12-2004.

QUEENS OF THE GUMBO DIRT

THE MARK CONSISTS OF STANDARD CHARACTERS WITHOUT CLAIM TO ANY PARTICULAR FONT, STYLE, SIZE, OR COLOR.

FOR HOTEL SERVICES, NAMELY, PROVIDING BED AND BREAKFAST LODGING (U.S. CLS. 100 AND 101).

FIRST USE 9-1-2004; IN COMMERCE 9-1-2004.
KENNETH D. BATTLE, EXAMINING ATTORNEY

SN 76-616,435. DOGS BY DAY, LLC, WASHINGTON, DC. FILED 10-18-2004.

DOGS BY DAY

THE MARK CONSISTS OF STANDARD CHARACTERS WITHOUT CLAIM TO ANY PARTICULAR FONT, STYLE, SIZE, OR COLOR.

FOR PETCARE SERVICES, NAMELY CAGELESS DOG DAYCARE AND BOARDING (U.S. CLS. 100 AND 101).

FIRST USE 4-0-1999; IN COMMERCE 4-0-1999.
KELLEY WELLS, EXAMINING ATTORNEY

CLASS 43—(Continued).

SN 76-616,548. FAMIGLIA-DEBARTOLO, LLC, WHITE PLAINS, NY. FILED 10-18-2004.



OWNER OF U.S. REG. NOS. 1,515,970, 2,729,930 AND OTHERS.

NO CLAIM IS MADE TO THE EXCLUSIVE RIGHT TO USE "PIZZERIA", APART FROM THE MARK AS SHOWN. THE ENGLISH TRANSLATION OF THE WORD FAMIGLIA IN THE MARK IS FAMILY.

FOR RESTAURANT SERVICES (U.S. CLS. 100 AND 101).

FIRST USE 8-1-2004; IN COMMERCE 8-1-2004.
KRISTINA KLOIBER, EXAMINING ATTORNEY

SN 76-616,657. MEYER JABARA HOTELS, LLC, WEST PALM BEACH, FL. FILED 10-15-2004.

HARBOR MAGIC

THE MARK CONSISTS OF STANDARD CHARACTERS WITHOUT CLAIM TO ANY PARTICULAR FONT, STYLE, SIZE, OR COLOR.

FOR HOTEL SERVICES AND MAKING HOTEL RESERVATIONS FOR TRAVELERS (U.S. CLS. 100 AND 101).

FIRST USE 0-0-1999; IN COMMERCE 0-0-1999.
TARAH HARDY, EXAMINING ATTORNEY

SN 76-616,730. DI FARA PIZZERIA, INC., BROOKLYN, NY. FILED 10-19-2004.

DIFARA

THE MARK CONSISTS OF STANDARD CHARACTERS WITHOUT CLAIM TO ANY PARTICULAR FONT, STYLE, SIZE, OR COLOR.

FOR RESTAURANT SERVICES; CARRY-OUT RESTAURANT SERVICES (U.S. CLS. 100 AND 101).

FIRST USE 0-0-1964; IN COMMERCE 0-0-1964.
KEVIN DINALLO, EXAMINING ATTORNEY

CLASS 43—(Continued).

SN 76-616,924. CAMP, CHARLES A., ALPHARETTA, GA. FILED 10-20-2004.

SPONDIVITS

THE MARK CONSISTS OF STANDARD CHARACTERS WITHOUT CLAIM TO ANY PARTICULAR FONT, STYLE, SIZE, OR COLOR.

FOR BAR AND RESTAURANT SERVICES (U.S. CLS. 100 AND 101).

FIRST USE 6-0-1979; IN COMMERCE 6-0-1979.
STEVEN R. FOSTER, EXAMINING ATTORNEY

SN 76-617,606. FLIGHT LLC, GLENVIEW, IL. FILED 10-26-2004.



THE MARK CONSISTS OF THE WORD "FLIGHT" AND A STYLIZED IMAGE OF A PROPELLER.

FOR RESTAURANTS, RESTAURANT SERVICES, WINE BARS, BAR SERVICES (U.S. CLS. 100 AND 101).

FIRST USE 4-0-2003; IN COMMERCE 12-0-2003.
TRACY WHITAKER-BOWN, EXAMINING ATTORNEY

SN 76-617,900. KEN KAWAI MA AND APRIL YUET WAN, DBA HUI LAU SAN, INC., NEW YORK, NY. FILED 10-26-2004.



WHEREIN THE MARK IS COMPRISED OF THREE CHINESE CHARACTERS.

THERE ARE MANY DIFFERENT DIALECTS IN THE CHINESE LANGUAGE. THE MANDARIN TRANSLITERATION OF THE MARK FROM RIGHT TO LEFT ARE SHAN, LIU, XU. THE TRANSLATION FOR THE CHINESE CHARACTERS ARE AS FOLLOWS— THE CHARACTER HAS A MEANING OF "PERMIT", HAS A MEANING OF "DETAIN", AND HAS A MEANING OF "MOUNTAIN". THE ENTIRE MARK HAS NO SPECIFIC MEANING OTHER THAN ITS FUNCTION AS A TRADEMARK.

FOR RESTAURANT SERVICES (U.S. CLS. 100 AND 101).

FIRST USE 7-1-2002; IN COMMERCE 7-1-2002.
ANGELA M. MICHELI, EXAMINING ATTORNEY

CLASS 43—(Continued).

SN 76-618,873. JEWEL BAKO, INC., NEW YORK, NY. FILED 11-1-2004.



THE COLOR(S) BLACK, RED AND WHITE IS/ARE CLAIMED AS A FEATURE OF THE MARK.

THE MARK CONSISTS OF A BLACK SQUARE WITH FADED SIDES AND EDGES AND WITH FOUR RED AND SEVEN WHITE GEOMETRIC SHAPES WITHIN THE SQUARE. THERE ARE FOUR RED GEOMETRIC SHAPES: ONE RED VERTICAL RECTANGLE IN THE UPPER LEFT SECTION OF THE BLACK SQUARE, ONE RED HORIZONTAL OVAL IN THE LOWER LEFT SECTION, ONE RED VERTICAL OVAL IN THE UPPER RIGHT SECTION AND ONE LARGER RED VERTICAL OVAL IN THE BOTTOM LEFT SECTION. THERE ARE ALSO SEVEN WHITE GEOMETRIC SHAPES: ONE WHITE HORIZONTAL RECTANGLE AND ONE SMALL WHITE CIRCLE IN THE UPPER LEFT SECTION OF THE BLACK SQUARE, ONE WHITE VERTICAL OVAL AND ONE WHITE HORIZONTAL OVAL IN THE LOWER LEFT SECTION, ONE LARGER WHITE CIRCLE AND ONE THIN WHITE VERTICAL RECTANGLE IN THE UPPER RIGHT SECTION, AND ONE WHITE VERTICAL RECTANGLE IN THE MIDDLE RIGHT SECTION.

THE ENGLISH TRANSLATION OF THE JAPANESE WORD "BAKO" IN THE MARK IS "BOX".

FOR RESTAURANT SERVICES (U.S. CLS. 100 AND 101).

FIRST USE 10-11-2000; IN COMMERCE 10-11-2000.
JOHN DALIER, EXAMINING ATTORNEY

SN 76-620,354. AP'S KANI, INC., WOODSTOCK, GA. FILED 11-12-2004.



NO CLAIM IS MADE TO THE EXCLUSIVE RIGHT TO USE "KANI HOUSE" AND THE NON-LATIN CHARACTERS THAT MEAN "CRAB", APART FROM THE MARK AS SHOWN.

"KANI HOUSE" WITH THE JAPANESE CHARACTERS "KANI" WHICH TRANSLATES INTO THE ENGLISH WORD "CRAB", ENCLOSED BY A BLACK CIRCLE/SPHERE WITH CHOPSTICKS COMING OUT OF THE SAID CIRCLE/SPHERE.

THE FOREIGN WORDING IN THE MARK TRANSLATES INTO ENGLISH AS "CRAB".

FOR RESTAURANT SERVICES (U.S. CLS. 100 AND 101).

FIRST USE 3-0-1999; IN COMMERCE 3-0-1999.
LA TONIA FISHER, EXAMINING ATTORNEY

CLASS 43—(Continued).

SN 76-622,435. LAWRENCE T. TYLER INCORPORATED, CAMDEN, NJ. FILED 11-26-2004.

TYLER FRIED CHICKEN

THE MARK CONSISTS OF STANDARD CHARACTERS WITHOUT CLAIM TO ANY PARTICULAR FONT, STYLE, SIZE, OR COLOR.

NO CLAIM IS MADE TO THE EXCLUSIVE RIGHT TO USE "FRIED CHICKEN", APART FROM THE MARK AS SHOWN.

FOR RESTAURANT SERVICES; TAKE-OUT RESTAURANT SERVICES; FAST FOOD RESTAURANT SERVICES (U.S. CLS. 100 AND 101).

FIRST USE 1-31-2004; IN COMMERCE 1-31-2004.
JOHN WILKE, EXAMINING ATTORNEY

SN 76-625,659. LAGRANJA FRANCHISING CORPORATION, MARGATE, FL. FILED 12-20-2004.

LA GRANJA PARRILLA

THE MARK CONSISTS OF STANDARD CHARACTERS WITHOUT CLAIM TO ANY PARTICULAR FONT, STYLE, SIZE, OR COLOR.

OWNER OF U.S. REG. NO. 2,830,592.

NO CLAIM IS MADE TO THE EXCLUSIVE RIGHT TO USE "PARRILLA", APART FROM THE MARK AS SHOWN. THE ENGLISH TRANSLATION OF "LA GRANJA PARRILLA" IS "THE FARM GRILL".

FOR RESTAURANT SERVICES (U.S. CLS. 100 AND 101).

FIRST USE 6-15-2000; IN COMMERCE 6-15-2000.
ATTIYA MALIK, EXAMINING ATTORNEY

SN 76-626,430. ANDREWS, CHRISTOPHER, NEW YORK, NY. FILED 12-28-2004.

BAO NOODLE

THE MARK CONSISTS OF STANDARD CHARACTERS WITHOUT CLAIM TO ANY PARTICULAR FONT, STYLE, SIZE, OR COLOR.

NO CLAIM IS MADE TO THE EXCLUSIVE RIGHT TO USE NOODLE, APART FROM THE MARK AS SHOWN.

THE ENGLISH TRANSLATION OF BAO IS "TREASURE". FOR RESTAURANT, CARRY-OUT RESTAURANT AND BAR SERVICES (U.S. CLS. 100 AND 101).

FIRST USE 9-18-2003; IN COMMERCE 9-18-2003.
NICHOLAS ALTREE, EXAMINING ATTORNEY

CLASS 43—(Continued).

SN 78-191,925. SINCLAIR OIL CORPORATION, SALT LAKE CITY, UT. FILED 12-6-2002.

RIVER RUN

FOR RESTAURANT SERVICES (U.S. CLS. 100 AND 101).
FIRST USE 0-0-1939; IN COMMERCE 0-0-1939.
ANGELA M. MICHELI, EXAMINING ATTORNEY

SN 78-276,847. EVERYTHING YOGURT BRANDS, INC., STATEN ISLAND, NY. FILED 7-21-2003.



FOR RESTAURANT SERVICES AND TAKE-OUT RESTAURANT SERVICES, FEATURING FRESH FRUIT DRINKS AND SMOOTHIES (U.S. CLS. 100 AND 101).
FIRST USE 8-28-1991; IN COMMERCE 8-28-1991.
BARBARA A. GOLD, EXAMINING ATTORNEY

SN 78-305,622. MCDONALD, JOHN F., NEW YORK, NY. FILED 9-25-2003.

LURE FISHBAR

NO CLAIM IS MADE TO THE EXCLUSIVE RIGHT TO USE "FISHBAR", APART FROM THE MARK AS SHOWN.
FOR RESTAURANT SERVICES (U.S. CLS. 100 AND 101).
SHARON MEIER, EXAMINING ATTORNEY

SN 78-313,541. RESTAURANT MANAGEMENT GROUP, LLC, SPRINGDALE, AR. FILED 10-14-2003.



NO CLAIM IS MADE TO THE EXCLUSIVE RIGHT TO USE SNACK PLACE AND FRESH & FAST, APART FROM THE MARK AS SHOWN.
THE MARK CONSISTS OF SNACK PLACE FRESH & FAST.
FOR TAKE OUT RESTAURANT SERVICES (U.S. CLS. 100 AND 101).
FIRST USE 4-28-2003; IN COMMERCE 4-28-2003.
CAROLINE WOOD, EXAMINING ATTORNEY

CLASS 43—(Continued).

SN 78-315,812. ISLAND HARBOR BEACH CLUB, LTD., CAPE HAZE, FL. FILED 10-20-2003.



OWNER OF U.S. REG. NO. 1,516,844.
NO CLAIM IS MADE TO THE EXCLUSIVE RIGHT TO USE "RESORT", APART FROM THE MARK AS SHOWN. THE STIPPLING IS FOR SHADING PURPOSES ONLY.
SEC. 2(F).
FOR RESORT HOTEL SERVICES (U.S. CLS. 100 AND 101).
FIRST USE 10-1-1987; IN COMMERCE 10-1-1987.
INGA ERVIN, EXAMINING ATTORNEY

SN 78-317,150. MCCARNEY, KEVIN T., DBA POQUITO MAS, NO. HOLLYWOOD, CA. FILED 10-22-2003.

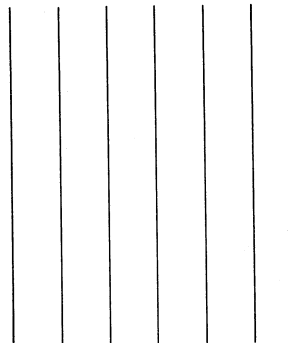

THE MARK CONSISTS OF GREEN VERTICAL STRIPES.
SEC. 2(F).
FOR RESTAURANT SERVICES (U.S. CLS. 100 AND 101).
FIRST USE 5-1-1993; IN COMMERCE 5-1-1993.
GINA FINK, EXAMINING ATTORNEY

CLASS 43—(Continued).

SN 78-325,320. SIX CONTINENTS HOTELS, INC., ATLANTA, GA. FILED 11-10-2003.

CLASS 43—(Continued).

SN 78-333,357. ADAMS, MICHAEL A., CYPRESS, TX. FILED 11-25-2003.



Java on the Run

OWNER OF U.S. REG. NOS. 1,281,951, 2,361,552 AND OTHERS.

NO CLAIM IS MADE TO THE EXCLUSIVE RIGHT TO USE BOUTIQUE BAKERY, APART FROM THE MARK AS SHOWN.

FOR RESTAURANT SERVICES OFFERED WITHIN A HOTEL (U.S. CLS. 100 AND 101).

STEVEN JACKSON, EXAMINING ATTORNEY

THE MARK CONSISTS OF STANDARD CHARACTERS WITHOUT CLAIM TO ANY PARTICULAR FONT, STYLE, SIZE, OR COLOR.

NO CLAIM IS MADE TO THE EXCLUSIVE RIGHT TO USE JAVA, APART FROM THE MARK AS SHOWN.

FOR RESTAURANT SERVICES FEATURING BREWED COFFEE, DRINKS AND FOOD (U.S. CLS. 100 AND 101).

KIM SAITO, EXAMINING ATTORNEY

SN 78-338,221. NEW CONNECTICUT EXPRESSO, LLC, NEWINGTON, CT. FILED 12-9-2003.

SN 78-329,113. AVERILL, DOUGLAS, D, BIGFORK, MT. FILED S.R. 11-17-2003; AM. P.R. 11-3-2004.



Zu Zu Cafe

NO CLAIM IS MADE TO THE EXCLUSIVE RIGHT TO USE "LODGE", APART FROM THE MARK AS SHOWN.

THE MARK CONSISTS OF STEER HEAD WITH STYLIZED AVERILL'S FLATHEAD LAKE LODGE.

SEC. 2(F).

FOR DUDE RANCHING-RESORT SERVICES (U.S. CLS. 100 AND 101).

FIRST USE 6-1-1945; IN COMMERCE 6-1-1945.

CHERYL CLAYTON, EXAMINING ATTORNEY

THE MARK CONSISTS OF STANDARD CHARACTERS WITHOUT CLAIM TO ANY PARTICULAR FONT, STYLE, SIZE, OR COLOR.

NO CLAIM IS MADE TO THE EXCLUSIVE RIGHT TO USE "CAFE", APART FROM THE MARK AS SHOWN.

FOR RESTAURANT SERVICES, NAMELY THE OPERATION OF A ESTABLISHMENT(S) SERVING FOOD AND BEVERAGES SPECIFICALLY INCLUDING COFFEE AND BAKED GOODS (U.S. CLS. 100 AND 101).

YSA DEJESUS, EXAMINING ATTORNEY

CLASS 43—(Continued).

SN 78-374,935. JACK IN THE BOX INC., SAN DIEGO, CA.
FILED 2-26-2004.

CLASS 43—(Continued).

SN 78-385,763. LARCOMB, THOMAS, NAPLES, FL. FILED 3-17-2004.

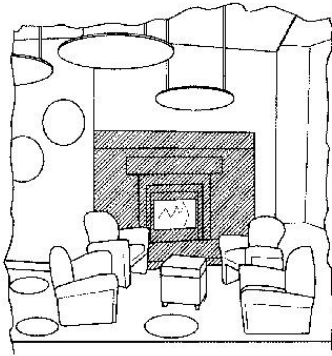

THE MARK CONSISTS OF THE DÉCOR OF PART OF THE INTERIOR SPACE IN WHICH THE SERVICES ARE RENDERED, NAMELY THE DISTINCTIVE GALVANIZED STEEL-SURFACE FIREPLACE, CIRCULAR PANELS SUSPENDED FROM THE CEILING, CIRCULAR PANELS AFFIXED TO THE WALLS AND FLOORS, ALONG WITH ARM-CHAIR SEATING AND AN OTTOMAN. THE STIPPLING INDICATES A GALVANIZED STEEL SURFACE. THE ACTUAL SHAPE OF THE ARM-CHAIRS AND OTTOMAN ARE NOT CLAIMED AS PART OF THE MARK.
FOR RESTAURANT SERVICES (U.S. CLS. 100 AND 101).

JERI J. FICKES, EXAMINING ATTORNEY

HAROLD'S PLACE

THE MARK CONSISTS OF STANDARD CHARACTERS WITHOUT CLAIM TO ANY PARTICULAR FONT, STYLE, SIZE, OR COLOR.

NO CLAIM IS MADE TO THE EXCLUSIVE RIGHT TO USE PLACE, APART FROM THE MARK AS SHOWN.

FOR RESTAURANTS; RESTAURANT SERVICES; BAR SERVICES; COCKTAIL LOUNGE SERVICES (U.S. CLS. 100 AND 101).

FIRST USE 8-0-1981; IN COMMERCE 8-0-1981.

MICHELE SWAIN, EXAMINING ATTORNEY

SN 78-388,566. DRAGON BUFFET, LAKE FOREST, CA.
FILED 3-22-2004.

SN 78-378,884. KING BISCUIT ENTERTAINMENT GROUP,
NEW YORK, NY. FILED 3-4-2004.

KING BISCUIT

THE MARK CONSISTS OF STANDARD CHARACTERS WITHOUT CLAIM TO ANY PARTICULAR FONT, STYLE, SIZE, OR COLOR.

OWNER OF U.S. REG. NO. 2,613,629.
FOR RESTAURANT SERVICES (U.S. CLS. 100 AND 101).

SCOTT OSLICK, EXAMINING ATTORNEY

DRAGON BUFFET

THE MARK CONSISTS OF STANDARD CHARACTERS WITHOUT CLAIM TO ANY PARTICULAR FONT, STYLE, SIZE, OR COLOR.

NO CLAIM IS MADE TO THE EXCLUSIVE RIGHT TO USE "BUFFET", APART FROM THE MARK AS SHOWN.

FOR RESTAURANT SERVICES (U.S. CLS. 100 AND 101).

FIRST USE 4-25-2003; IN COMMERCE 4-25-2003.

DANIEL CAPSHAW, EXAMINING ATTORNEY

CLASS 43—(Continued).

SN 78-390,752. TOULABI, REZA, CHICAGO, IL. FILED 3-25-2004.

REZA'S

THE MARK CONSISTS OF STANDARD CHARACTERS WITHOUT CLAIM TO ANY PARTICULAR FONT, STYLE, SIZE, OR COLOR.

THE NAME "REZA" IDENTIFIES A LIVING INDIVIDUAL WHOSE CONSENT IS OF RECORD.

FOR RESTAURANT SERVICES (U.S. CLS. 100 AND 101).

FIRST USE 12-15-1984; IN COMMERCE 12-15-1984.
JENNIFER KRISP, EXAMINING ATTORNEY

SN 78-392,183. HOWE, KAREN ANNE, GREENWICH, CT. FILED 3-29-2004.



NO CLAIM IS MADE TO THE EXCLUSIVE RIGHT TO USE DONUT, APART FROM THE MARK AS SHOWN.

THE MARK CONSISTS OF A STYLIZED FRAME WITH THE WORDS DECADENT DONUT THEREIN WITH A STYLIZED DONUT SEPARATING THE WORDS IN THE FRAME.

FOR RESTAURANT AND CARRY OUT SERVICES (U.S. CLS. 100 AND 101).

GINA HAYES, EXAMINING ATTORNEY

CLASS 43—(Continued).

SN 78-397,496. TANEJA, INC., MOUNTAIN VIEW, CA. FILED 4-6-2004.



FOR RESTAURANT AND BAR SERVICES; CARRY-OUT RESTAURANT SERVICES; CATERING (U.S. CLS. 100 AND 101).

FIRST USE 1-1-1989; IN COMMERCE 1-1-1989.
MELISSA SHELLA, EXAMINING ATTORNEY

SN 78-398,188. ALI, SHAUKAT, QUEENS VILLAGE, NY. AND KHAMISSA, WAZIR A., QUEENS VILLAGE, NY. AND USMAN, SAEED, QUEENS VILLAGE, NY. FILED 4-7-2004.

KABAB KING MAHAL

THE MARK CONSISTS OF STANDARD CHARACTERS WITHOUT CLAIM TO ANY PARTICULAR FONT, STYLE, SIZE, OR COLOR.

NO CLAIM IS MADE TO THE EXCLUSIVE RIGHT TO USE KABAB, APART FROM THE MARK AS SHOWN.

THE TERM "MAHAL" MEANS "PALACE" OR "GRAND HOUSE" IN URDU, ONE OF THE PRIMARY LANGUAGES FOUND IN PAKISTAN. WHEN TAKEN TOGETHER, THE MARK KABAB KING MAHAL ROUGHLY TRANSLATES INTO "KABAB KING PALACE".

FOR RESTAURANT SERVICES (U.S. CLS. 100 AND 101).

FIRST USE 7-0-2000; IN COMMERCE 7-0-2000.

JACQUELINE A. LAVINE, EXAMINING ATTORNEY

CLASS 43—(Continued).

SN 78-400,037. SYBARIS CLUBS INTERNATIONAL, ARLINGTON HEIGHTS, IL. FILED 4-12-2004.



OWNER OF U.S. REG. NOS. 1,321,354, 1,507,578 AND 2,231,349.

NO CLAIM IS MADE TO THE EXCLUSIVE RIGHT TO USE "POOL SUITES" OR "VOTED BEST ROMANTIC GETAWAY", APART FROM THE MARK AS SHOWN. FOR MOTEL SERVICES (U.S. CLS. 100 AND 101). FIRST USE 11-1-2003; IN COMMERCE 12-1-2003. MARK RADEMACHER, EXAMINING ATTORNEY

SN 78-403,368. B.R. GUEST TRADEMARK COMPANY INC., NEW YORK, NY. FILED 4-16-2004.

LEVEL SKY

THE MARK CONSISTS OF STANDARD CHARACTERS WITHOUT CLAIM TO ANY PARTICULAR FONT, STYLE, SIZE, OR COLOR.

FOR BAR AND COCKTAIL LOUNGE SERVICES (U.S. CLS. 100 AND 101). SAMUEL E. SHARPER JR., EXAMINING ATTORNEY

SN 78-408,831. KFC CORPORATION, LOUISVILLE, KY. FILED 4-27-2004.

CHICKEN CAPITAL USA

THE MARK CONSISTS OF STANDARD CHARACTERS WITHOUT CLAIM TO ANY PARTICULAR FONT, STYLE, SIZE, OR COLOR.

NO CLAIM IS MADE TO THE EXCLUSIVE RIGHT TO USE "CHICKEN" OR "USA", APART FROM THE MARK AS SHOWN.

FOR RESTAURANT SERVICES (U.S. CLS. 100 AND 101). MARK SPARACINO, EXAMINING ATTORNEY

CLASS 43—(Continued).

SN 78-409,964. VIRTUAL NET, S.L., MALAGA, SPAIN, FILED 4-29-2004.

Click & Eat

THE MARK CONSISTS OF STANDARD CHARACTERS WITHOUT CLAIM TO ANY PARTICULAR FONT, STYLE, SIZE, OR COLOR.

PRIORITY CLAIMED UNDER SEC. 44(D) ON ERPNTY TM OFC APPLICATION NO. 003430485, FILED 10-30-2003.

FOR RESTAURANT SERVICES (U.S. CLS. 100 AND 101). CHERYL STEPLIGHT, EXAMINING ATTORNEY

SN 78-411,709. VINEYARD CITY CHURCH, REDDING, CA. FILED 4-30-2004.



NO CLAIM IS MADE TO THE EXCLUSIVE RIGHT TO USE "COFFEE" AND "SHOP", APART FROM THE MARK AS SHOWN.

THE COLOR(S) GREEN AND BROWN AND WHITE IS/ARE CLAIMED AS A FEATURE OF THE MARK.

THE COLOR GREEN IS USED AS A BACKGROUND COLOR. THE SWIRL IS WHITE AND THE EYES ARE WHITE AND BROWN.

THE MARK CONSISTS OF THE IMAGE OF THE YAK HEAD WITH THE EYES IS PART OF THE TRADEMARK IT ALSO DENOTES THE "Y" IN YAKS. THE MARK IS ALSO ACRONYM FOR "YES ANOTHER KOFFEE SHOP".

FOR COFFEE SHOPS (U.S. CLS. 100 AND 101). ROBIN CHOSID, EXAMINING ATTORNEY

CLASS 43—(Continued).

SN 78-413,416. HAMBURDOG, INC., RANCHO SANTA FE, CA. FILED 5-5-2004.



NO CLAIM IS MADE TO THE EXCLUSIVE RIGHT TO USE "WORLD FAMOUS", APART FROM THE MARK AS SHOWN.
 FOR RESTAURANT SERVICES (U.S. CLS. 100 AND 101).
 NAAKWAMA ANKRAH, EXAMINING ATTORNEY

SN 78-417,882. HAHM JI BACH, INC., BAYSIDE, NY. FILED 5-13-2004.

HAHM JI BACH

THE MARK CONSISTS OF STANDARD CHARACTERS WITHOUT CLAIM TO ANY PARTICULAR FONT, STYLE, SIZE, OR COLOR.
 THE NAME "HAHM JI BACH" SHOWN IN THE MARK DOES NOT IDENTIFY A PARTICULAR LIVING INDIVIDUAL.
 THE FOREIGN WORDING IN THE MARK TRANSLATES INTO ENGLISH AS A LARGE WOODEN ROUND BOWL USED FOR STORAGE OR PREPARATION OF FOOD.
 FOR RESTAURANT SERVICES (U.S. CLS. 100 AND 101).
 PAULA MAHONEY, EXAMINING ATTORNEY

CLASS 43—(Continued).

SN 78-421,205. ZHANG, MENG, SAN GABRIEL, CA. FILED 5-19-2004.



NO CLAIM IS MADE TO THE EXCLUSIVE RIGHT TO USE "COFFEE", APART FROM THE MARK AS SHOWN.
 THE NON-LATIN CHARACTERS IN THE MARK TRANSLITERATE TO U.B.C. AND THIS MEANS "ABOVE THE ISLAND" IN ENGLISH.
 FOR RESTAURANT SERVICES (U.S. CLS. 100 AND 101).
 KATHRYN COWARD, EXAMINING ATTORNEY

SN 78-421,219. PASCUA YAQUI TRIBE, TUCSON, AZ. FILED 5-19-2004.

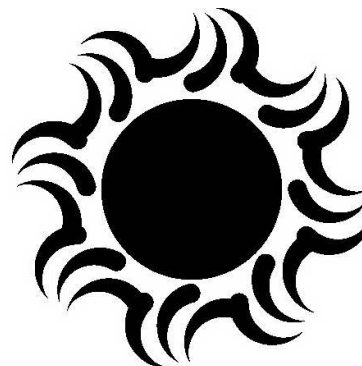

OWNER OF U.S. REG. NOS. 2,744,706 AND 2,774,046.
 FOR RESTAURANT SERVICES (U.S. CLS. 100 AND 101).
 FIRST USE 10-11-2001; IN COMMERCE 10-11-2001.
 STEVEN JACKSON, EXAMINING ATTORNEY

CLASS 43—(Continued).

SN 78-421,220. PASCUA YAQUI TRIBE, TUCSON, AZ. FILED 5-19-2004.

CASINO DEL SOL

THE MARK CONSISTS OF STANDARD CHARACTERS WITHOUT CLAIM TO ANY PARTICULAR FONT, STYLE, SIZE, OR COLOR.

OWNER OF U.S. REG. NO. 2,211,188.

THE FOREIGN WORDING IN THE MARK TRANSLATES INTO ENGLISH AS CASINO OF THE SUN.

FOR RESTAURANT SERVICES (U.S. CLS. 100 AND 101).

FIRST USE 10-11-2001; IN COMMERCE 10-11-2001.

STEVEN JACKSON, EXAMINING ATTORNEY

CLASS 43—(Continued).

SN 78-434,451. NH HOTELES, S.A., MADRID, SPAIN, FILED 6-14-2004.



NO CLAIM IS MADE TO THE EXCLUSIVE RIGHT TO USE "FAST GOOD", APART FROM THE MARK AS SHOWN.

FOR RESTAURANT SERVICES; TAKE-OUT RESTAURANT SERVICES (U.S. CLS. 100 AND 101).

CHARLES JOYNER, EXAMINING ATTORNEY

SN 78-431,636. MR. EMS SYSTEM, INC., ST. PAUL, MN. FILED 6-8-2004.

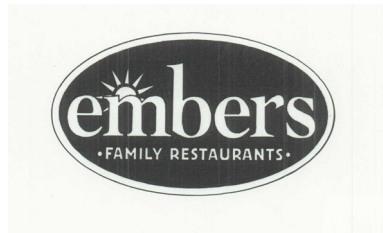

OWNER OF U.S. REG. NOS. 1,770,658, 2,235,948 AND 2,302,799.

NO CLAIM IS MADE TO THE EXCLUSIVE RIGHT TO USE "FAMILY RESTAURANTS", APART FROM THE MARK AS SHOWN.

FOR RESTAURANT SERVICES (U.S. CLS. 100 AND 101).

FIRST USE 10-31-2003; IN COMMERCE 10-31-2003.

TANYA AMOS, EXAMINING ATTORNEY

SN 78-436,402. GALACCO, INC., EL PASO, TX. FILED 6-16-2004.



OWNER OF U.S. REG. NO. 2,075,075.

NO CLAIM IS MADE TO THE EXCLUSIVE RIGHT TO USE "AMERICAN" AND "CO.", APART FROM THE MARK AS SHOWN.

THE MARK CONSISTS OF AN OVAL-SHAPED MEDALION SURROUNDED BY AN OVAL ROPED BORDER WITH AN IMAGE OF A LONGHORN STEER IN THE CENTER, PLUS THE LITERAL MARK PRESENTED IN A WESTERN-STYLE FONT.

FOR RESTAURANT SERVICES (U.S. CLS. 100 AND 101).

FIRST USE 11-20-1977; IN COMMERCE 6-1-1986.

RUSS HERMAN, EXAMINING ATTORNEY

SN 78-433,713. THE COOP DEVILLE FRANCHISING, INC., HATTIESBURG, MS. FILED 6-11-2004.

COOP DEVILLE

THE MARK CONSISTS OF STANDARD CHARACTERS WITHOUT CLAIM TO ANY PARTICULAR FONT, STYLE, SIZE, OR COLOR.

FOR RESTAURANT SERVICES (U.S. CLS. 100 AND 101).

FIRST USE 4-28-1993; IN COMMERCE 4-28-1993.

PATRICIA EVANKO, EXAMINING ATTORNEY

CLASS 43—(Continued).

SN 78-436,800. OTG MANAGEMENT, INC., PHILADELPHIA, PA. FILED 6-17-2004.



NO CLAIM IS MADE TO THE EXCLUSIVE RIGHT TO USE NEW YORK SPORTS GRILL, APART FROM THE MARK AS SHOWN.

THE COLORS BLUE, ORANGE, AND GRAY ARE CLAIMED AS A FEATURE OF THE MARK.

THE COLOR BLUE APPEARS IN THE WORDING "NYSG" AND IN THE RECTANGULAR BACKGROUND BEHIND THE WORDING "NEW YORK SPORTS GRILL." THE COLOR ORANGE APPEARS IN THE WORDING "NEW YORK SPORTS GRILL." THE COLOR GRAY APPEARS IN A THIN FRAME AROUND THE BLUE RECTANGLE, WHICH BLUE RECTANGLE CONTAINS THE WORDING "NEW YORK SPORTS GRILL."

FOR RESTAURANT AND BAR SERVICES (U.S. CLS. 100 AND 101).

FIRST USE 11-7-2003; IN COMMERCE 11-7-2003.
MICHAEL HALL, EXAMINING ATTORNEY

CLASS 43—(Continued).

SN 78-450,382. GELIN ENTERPRISES LLC, ALBUQUERQUE, NM. FILED 7-14-2004.



NO CLAIM IS MADE TO THE EXCLUSIVE RIGHT TO USE "TEA", APART FROM THE MARK AS SHOWN.

THE COLOR(S) RED AND GREEN IS/ARE CLAIMED AS A FEATURE OF THE MARK.

THE COLOR RED COLORS THE WORD, HADLEY'S AND THE COLOR GREEN COLORS THE WORD TEA

FOR RESTAURANT SERVICES FEATURING BEVERAGES, BAKED GOODS, SANDWICHES, CONFECTIONARY ITEMS; TEA ROOM SERVICES FEATURING FLAVORED AND BREWED DRINKS, LOOSE TEA, TEA CAKES, TEA SANDWICHES AND CANDIES (U.S. CLS. 100 AND 101).

FIRST USE 11-1-2003; IN COMMERCE 11-1-2003.
PAM WILLIS, EXAMINING ATTORNEY

SN 78-444,702. FANDINO, DIEGO, LONGWOOD, FL. AND FRANCO, OSCAR WILLIAM, MANHASSET, NY. FILED 7-1-2004.

POLLOS MARIO

THE MARK CONSISTS OF STANDARD CHARACTERS WITHOUT CLAIM TO ANY PARTICULAR FONT, STYLE, SIZE, OR COLOR.

NO CLAIM IS MADE TO THE EXCLUSIVE RIGHT TO USE "POLLOS", APART FROM THE MARK AS SHOWN.

THE ENGLISH TRANSLATION OF THE WORD POLLOS IN THE MARK IS CHICKEN.

THE NON-LATIN CHARACTER(S) IN THE MARK TRANSLITERATES INTO POLLOS, AND THIS MEANS CHICKEN IN ENGLISH.

SEC. 2(F).
FOR RESTAURANT SERVICES (U.S. CLS. 100 AND 101).

FIRST USE 1-31-1994; IN COMMERCE 1-31-1994.
H. M. FISHER, EXAMINING ATTORNEY

SN 78-454,710. CALYPSO CAFE, INC., NASHVILLE, TN. FILED 7-22-2004.

COUVA CALYPSO CAFE

THE MARK CONSISTS OF STANDARD CHARACTERS WITHOUT CLAIM TO ANY PARTICULAR FONT, STYLE, SIZE, OR COLOR.

NO CLAIM IS MADE TO THE EXCLUSIVE RIGHT TO USE "CALYPSO CAFE", APART FROM THE MARK AS SHOWN.

FOR RESTAURANT SERVICES (U.S. CLS. 100 AND 101).

JILL C. ALT, EXAMINING ATTORNEY

CLASS 43—(Continued).

SN 78-456,374. AMERICAN DAIRY QUEEN CORPORATION,
EDINA, MN. FILED 7-26-2004.

BURGERS WITH
SOMETHING TO PROVE

THE MARK CONSISTS OF STANDARD CHARACTERS
WITHOUT CLAIM TO ANY PARTICULAR FONT, STYLE,
SIZE, OR COLOR.
FOR RESTAURANT SERVICES; CARRY OUT FOOD
SERVICES (U.S. CLS. 100 AND 101).
FIRST USE 9-30-2004; IN COMMERCE 9-30-2004.
ODESSA BIBBINS, EXAMINING ATTORNEY

SN 78-458,106. NUBE S.L., 07800 IBIZA, SPAIN, FILED 7-28-
2004.



PRIORITY CLAIMED UNDER SEC. 44(D) ON SPAIN
APPLICATION NO. 2.604.110/3, FILED 6-29-2004, REG. NO.
2604110-3, DATED 10-18-2004, EXPIRES 6-29-2014.
NO CLAIM IS MADE TO THE EXCLUSIVE RIGHT TO
USE "EL HOTEL", APART FROM THE MARK AS SHOWN.
THE COLOR(S) GREEN AND RED IS/ARE CLAIMED AS
A FEATURE OF THE MARK.
THE MARK CONSISTS OF THE TOP PORTION OF A RED
CHERRY WITH A GREEN STEM AND LEAF.
FOR RESTAURANT SERVICES; PROVIDING TEM-
PORARY ACCOMMODATIONS (U.S. CLS. 100 AND 101).
GEOFFREY FOSDICK, EXAMINING ATTORNEY

CLASS 43—(Continued).

SN 78-471,717. FIRST IMPRESSIONS CATERING, LLC,
COLORADO SPRINGS, CO. FILED 8-23-2004.

First Impressions
Catering

THE MARK CONSISTS OF STANDARD CHARACTERS
WITHOUT CLAIM TO ANY PARTICULAR FONT, STYLE,
SIZE, OR COLOR.
NO CLAIM IS MADE TO THE EXCLUSIVE RIGHT TO
USE "CATERING", APART FROM THE MARK AS SHOWN.
FOR CATERING SERVICES (U.S. CLS. 100 AND 101).
FIRST USE 1-7-2004; IN COMMERCE 1-7-2004.
FLORENTINA BLANDU, EXAMINING ATTORNEY

SN 78-473,000. PURPLE ENTERTAINMENT, INC., DENVER,
CO. FILED 8-25-2004.



NO CLAIM IS MADE TO THE EXCLUSIVE RIGHT TO
USE "PURPLE MARTINI", APART FROM THE MARK AS
SHOWN.
THE COLOR(S) PURPLE WRITING ON WHITE BACK-
GROUND IS/ARE CLAIMED AS A FEATURE OF THE
MARK.
THE MARK CONSISTS OF PURPLE MARTINI GLASS
WITH OLIVE AND TOOTHPICK FLANKED BY WORDS
"PURPLE MARTINI".
FOR RESTAURANT SERVICES, NAMELY, PROVID-
ING MEALS AND BEVERAGES (U.S. CLS. 100 AND 101).
FIRST USE 3-16-1994; IN COMMERCE 9-19-2001.
DARRYL SPRUILL, EXAMINING ATTORNEY

CLASS 43—(Continued).

SN 78-473,329. DWD ENTERPRISES, INC., COCONUT CREEK, FL. FILED 8-25-2004.

Sazio

THE MARK CONSISTS OF STYLIZED SAZIO. THE ENGLISH TRANSLATION OF THE ITALIAN WORD SAZIO IN THE MARK IS SATIATED. FOR RESTAURANTS FEATURING HOME DELIVERY; CATERING; AND BAR SERVICES (U.S. CLS. 100 AND 101).

FIRST USE 9-5-2002; IN COMMERCE 9-5-2002.
TRACY CROSS, EXAMINING ATTORNEY

SN 78-475,879. FOLLIA, INC., CHICAGO, IL. FILED 8-30-2004.

FOLLIA

THE MARK CONSISTS OF STANDARD CHARACTERS WITHOUT CLAIM TO ANY PARTICULAR FONT, STYLE, SIZE, OR COLOR.

THE ENGLISH TRANSLATION OF FOLLIA IS "FOOLISHNESS" OR "MADNESS". FOR RESTAURANT SERVICES (U.S. CLS. 100 AND 101).

FIRST USE 9-27-2002; IN COMMERCE 9-27-2002.
JIM RINGLE, EXAMINING ATTORNEY

CLASS 43—(Continued).

SN 78-478,484. BLASHEK, CAROLYN, ENCINO, CA. FILED 9-3-2004.

OPERATION
GRATITUDE

THE MARK CONSISTS OF STANDARD CHARACTERS WITHOUT CLAIM TO ANY PARTICULAR FONT, STYLE, SIZE, OR COLOR.

FOR CHARITABLE SERVICES, NAMELY COORDINATION OF PROCUREMENT AND PREPARATION OF PACKAGES PRIMARILY CONTAINING FOOD AS WELL AS TOILETRIES AND ENTERTAINMENT ITEMS SUCH AS CDS AND DVDS AND DISTRIBUTION OF SAME TO DEPLOYED MILITARY PERSONNEL (U.S. CLS. 100 AND 101).

FIRST USE 3-0-2003; IN COMMERCE 3-0-2003.
JOHN WILKE, EXAMINING ATTORNEY

SN 78-478,594. RC ENTERTAINMENT, INC., MADISON, AL. FILED 9-3-2004.

THE
STATION
PUB & GRILL

NO CLAIM IS MADE TO THE EXCLUSIVE RIGHT TO USE "PUB & GRILL", APART FROM THE MARK AS SHOWN.

FOR BAR, COCKTAIL LOUNGE AND RESTAURANT SERVICES (U.S. CLS. 100 AND 101).

FIRST USE 2-1-2003; IN COMMERCE 2-1-2003.
DAWN HAN, EXAMINING ATTORNEY

CLASS 43—(Continued).

SN 78-483,644. MORRIS INTERNATIONAL FOOD SERVICE LLC, DAVIDSON, NC. FILED 9-14-2004.



NO CLAIM IS MADE TO THE EXCLUSIVE RIGHT TO USE "CARIBBEAN BARBECUE", APART FROM THE MARK AS SHOWN.

THE MARK CONSISTS OF THE WORDS "BIMINI BOB CARIBBEAN BARBEQUE" WITH A PALM TREE GRAPHIC. FOR MOBILE RESTAURANT SERVICES, NAMELY, RESTAURANT SERVICES PROVIDED VIA A MOBILE A LUNCH TRUCK; RESTAURANT SERVICES; TAKE-OUT RESTAURANT SERVICES (U.S. CLS. 100 AND 101). SCOTT OSCLICK, EXAMINING ATTORNEY

SN 78-488,091. CLUB B.E.D. MANAGEMENT LLC, SANTA BARBARA, CA. FILED 9-22-2004.

COUCHEZ

THE MARK CONSISTS OF STANDARD CHARACTERS WITHOUT CLAIM TO ANY PARTICULAR FONT, STYLE, SIZE, OR COLOR.

THE ENGLISH TRANSLATION OF THE FRENCH WORD "COUCHEZ" IN THE MARK IS "SLEEP." FOR RESTAURANT (U.S. CLS. 100 AND 101). WON TEAK OH, EXAMINING ATTORNEY

CLASS 43—(Continued).

SN 78-488,376. OFF THE MENU, LLC, GREENWICH, CT. FILED 9-23-2004.

'CESCA

FOR RESTAURANT (U.S. CLS. 100 AND 101). FIRST USE 9-8-2003; IN COMMERCE 9-8-2003. DOMINIC J. FERRAIUOLO, EXAMINING ATTORNEY

SN 78-489,209. SYRACUSES' PIZZA PLANT INC., WILLIAMSVILLE, NY. FILED 9-24-2004.

PIZZA PLANT

THE MARK CONSISTS OF STANDARD CHARACTERS WITHOUT CLAIM TO ANY PARTICULAR FONT, STYLE, SIZE, OR COLOR.

NO CLAIM IS MADE TO THE EXCLUSIVE RIGHT TO USE "PIZZA", APART FROM THE MARK AS SHOWN. FOR RESTAURANT SERVICE (U.S. CLS. 100 AND 101). FIRST USE 10-20-1980; IN COMMERCE 10-20-1980. ADA HAN, EXAMINING ATTORNEY

SN 78-489,733. JOBSON, OWEN R., SAN JOSE, CA. FILED 9-27-2004.

Blue Rock Barbecue

THE MARK CONSISTS OF STANDARD CHARACTERS WITHOUT CLAIM TO ANY PARTICULAR FONT, STYLE, SIZE, OR COLOR.

NO CLAIM IS MADE TO THE EXCLUSIVE RIGHT TO USE BARBECUE, APART FROM THE MARK AS SHOWN. FOR RESTAURANTS (U.S. CLS. 100 AND 101). THEODORE MCBRIDE, EXAMINING ATTORNEY

CLASS 43—(Continued).

SN 78-491,267. THE HEARTY BOYS CATERERS, INC., CHICAGO, IL. FILED 9-29-2004.



OWNER OF U.S. REG. NO. 2,893,605.
 NO CLAIM IS MADE TO THE EXCLUSIVE RIGHT TO USE "CATERERS, INC.", APART FROM THE MARK AS SHOWN.
 THE MARK CONSISTS, IN PART, OF HEAD PROFILES OF TWO YOUNG MEN WEARING CHEF'S HATS.
 FOR CAFES, CARRY-OUT RESTAURANTS, CATERING, AND FOOD PREPARATION (U.S. CLS. 100 AND 101).
 FIRST USE 3-29-1999; IN COMMERCE 3-29-1999.
 DOMINICK J. SALEMI, EXAMINING ATTORNEY

SN 78-493,855. MAGGIORE, JOSEPH P, CARLSBAD, CA. FILED 10-4-2004.

JOEY'S SMOKIN' B-B-Q (OUR RIBS ARE SMOKIN'!)

THE MARK CONSISTS OF STANDARD CHARACTERS WITHOUT CLAIM TO ANY PARTICULAR FONT, STYLE, SIZE, OR COLOR.
 NO CLAIM IS MADE TO THE EXCLUSIVE RIGHT TO USE "B-B-Q", APART FROM THE MARK AS SHOWN.
 FOR RESTAURANT SERVICES (U.S. CLS. 100 AND 101).
 WON TEAK OH, EXAMINING ATTORNEY

CLASS 43—(Continued).

SN 78-495,139. SINGH, PARMINDER, BELLEVUE, WA. FILED 10-6-2004.



NO CLAIM IS MADE TO THE EXCLUSIVE RIGHT TO USE "MAGAZINE CAFE", APART FROM THE MARK AS SHOWN.
 THE COLOR REDDISH BROWN IS CLAIMED AS A FEATURE OF THE MARK.
 THE MARK CONSISTS OF THE WORDING "HUNGRY-MIND MAGAZINE CAFE FUEL FOR THE MIND & BODY", AND THE DESIGN COMPRISED OF A COFFEE CUP, EYEGLASSES AND A BOOK ALL SURROUNDED BY A CIRCLE. THE WORD "MIND," THE COFFEE CUP, THE SHADING ON THE LENSES OF THE EYEGLASSES AND THE SHADING ON THE PAGE OF THE BOOK ALL APPEAR IN THE COLOR REDDISH BROWN.
 FOR CAFE-RESTAURANTS (U.S. CLS. 100 AND 101).
 FIRST USE 3-1-2004; IN COMMERCE 3-1-2004.
 JEFFERY COWARD, EXAMINING ATTORNEY

SN 78-495,525. WINECONNECT, INC., MINNEAPOLIS, MN. FILED 10-6-2004.

WINECONNECT

THE MARK CONSISTS OF STANDARD CHARACTERS WITHOUT CLAIM TO ANY PARTICULAR FONT, STYLE, SIZE, OR COLOR.
 FOR WINE INFORMATION SERVICES, NAMELY, PROVIDING INFORMATION ABOUT WINE CHARACTERISTICS, VINTNER AND VARIETAL INFORMATION, FOOD PAIRINGS AND WINE REVIEWS TO PATRONS VISITING RETAIL WINE AND LIQUOR STORES VIA AN ELECTRONIC MEDIUM AND PROVIDING SAID INFORMATION TO CONSUMERS VIA THE INTERNET (U.S. CLS. 100 AND 101).
 HEATHER THOMPSON, EXAMINING ATTORNEY

CLASS 43—(Continued).

SN 78-497,051. STOKELY HOSPITALITY ENTERPRISES, G.P., KNOXVILLE, TN. FILED 10-8-2004.

CLASS 43—(Continued).

SN 78-498,211. NIBUR, LAURENCE, PROSPECT, KY. FILED 10-12-2004.

BRASS LANTERN

FAIRDINKUMS

THE MARK CONSISTS OF STANDARD CHARACTERS WITHOUT CLAIM TO ANY PARTICULAR FONT, STYLE, SIZE, OR COLOR.
FOR RESTAURANT SERVICES (U.S. CLS. 100 AND 101).
FIRST USE 6-15-1968; IN COMMERCE 6-15-1968.
LINDA MICKLEBURGH, EXAMINING ATTORNEY

THE MARK CONSISTS OF STANDARD CHARACTERS WITHOUT CLAIM TO ANY PARTICULAR FONT, STYLE, SIZE, OR COLOR.
FOR RESTAURANT SERVICES (U.S. CLS. 100 AND 101).
HEATHER THOMPSON, EXAMINING ATTORNEY

SN 78-497,674. ROMERO-NUNEZ, SUSANA, MORELIA, MICHOACAN, MEXICO, FILED 10-11-2004.

SN 78-498,618. THE MAY DEPARTMENT STORES COMPANY, ST. LOUIS, MO. FILED 10-12-2004.

EL MAGO

FRANGO CAFÉ

THE MARK CONSISTS OF STANDARD CHARACTERS WITHOUT CLAIM TO ANY PARTICULAR FONT, STYLE, SIZE, OR COLOR.
THE ENGLISH TRANSLATION OF EL MAGO IS THE MAGICIAN.
FOR RESTAURANT SERVICES (U.S. CLS. 100 AND 101).
KELLEY WELLS, EXAMINING ATTORNEY

OWNER OF U.S. REG. NOS. 1,064,058, 1,297,227 AND OTHERS.
NO CLAIM IS MADE TO THE EXCLUSIVE RIGHT TO USE "CAFE", APART FROM THE MARK AS SHOWN.
FOR RESTAURANT SERVICES (U.S. CLS. 100 AND 101).
FIRST USE 10-1-1998; IN COMMERCE 10-1-1998.
KEVON CHISOLM, EXAMINING ATTORNEY

CLASS 43—(Continued).

SN 78-498,907. CHATEAU AVALON INC., LENEXA, KS. FILED 10-13-2004.



Chateau Avalon

NO CLAIM IS MADE TO THE EXCLUSIVE RIGHT TO USE "CHATEAU", APART FROM THE MARK AS SHOWN.

THE MARK CONSISTS OF APPLICANT'S COAT OF ARMS. THE CREST IS COMPRISED OF A FLEUR-DE-LIS AND LEAF DESIGN; THE SHIELD FEATURES A CIRCULAR PLATE WITH THE STYLIZED LETTERS CA; THE LEFT AND RIGHT SUPPORTERS ARE LIONS ABOVE A FURLED RIBBON, CONTAINING THE LATIN PHRASE VIDERE HOSPITIUM GLORIA; THE WORDS CHATEAU AVALON APPEAR BELOW THE COAT OF ARMS IN A HIGHLY STYLIZED FONT.

THE FOREIGN WORDING IN THE MARK TRANSLATES INTO ENGLISH AS VISION, HOSPITALITY, GLORY TO GOD.

FOR HOTEL SERVICES; RESORT LODGING SERVICES; PROVISION OF GENERAL-PURPOSE FACILITIES FOR MEETINGS, CONFERENCES AND EXHIBITIONS; PROVISION OF BANQUET AND SOCIAL FUNCTION FACILITIES FOR SPECIAL OCCASION; AND RESERVATION SERVICES FOR HOTEL ACCOMMODATIONS (U.S. CLS. 100 AND 101).

FIRST USE 1-0-2004; IN COMMERCE 1-0-2004.
CAROLINE WOOD, EXAMINING ATTORNEY

SN 78-499,524. SEPTEMBER, INC., JOHNSTON, IA. FILED 10-14-2004.

drink. the original
fun bar

THE MARK CONSISTS OF STANDARD CHARACTERS WITHOUT CLAIM TO ANY PARTICULAR FONT, STYLE, SIZE, OR COLOR.

NO CLAIM IS MADE TO THE EXCLUSIVE RIGHT TO USE "DRINK," "THE ORIGINAL," AND "BAR", APART FROM THE MARK AS SHOWN.

FOR PROVISION OF DRINK AND FOOD IN CONNECTION WITH OPERATION OF BARS (U.S. CLS. 100 AND 101).

FIRST USE 5-4-2001; IN COMMERCE 5-4-2001.
JEAN IM, EXAMINING ATTORNEY

CLASS 43—(Continued).

SN 78-499,798. BRE/HOMESTEAD VILLAGE, L.L.C., NEW YORK, NY. FILED 10-14-2004.

You go the
distance. We do
the same.

THE MARK CONSISTS OF STANDARD CHARACTERS WITHOUT CLAIM TO ANY PARTICULAR FONT, STYLE, SIZE, OR COLOR.

FOR PROVIDING TEMPORARY HOUSING ACCOMMODATION SERVICES AND HOTEL SERVICES (U.S. CLS. 100 AND 101).

FIRST USE 1-1-1998; IN COMMERCE 1-1-1998.
KELLY BOULTON, EXAMINING ATTORNEY

SN 78-500,221. BAMBERY, JOSEPH P., NORFOLK, VA. FILED 10-14-2004.

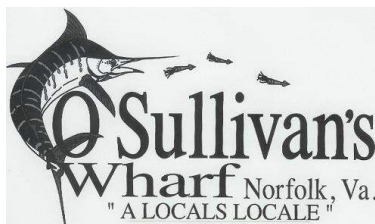

NO CLAIM IS MADE TO THE EXCLUSIVE RIGHT TO USE "NORFOLK, VA", APART FROM THE MARK AS SHOWN.

FOR RESTAURANTS (U.S. CLS. 100 AND 101).
FIRST USE 5-1-1990; IN COMMERCE 5-1-1990.
HOWARD B. LEVINE, EXAMINING ATTORNEY

SN 78-501,541. GOTEKGS, INC., LAS VEGAS, NV. FILED 10-18-2004.

THE CRACKED EGG

THE MARK CONSISTS OF STANDARD CHARACTERS WITHOUT CLAIM TO ANY PARTICULAR FONT, STYLE, SIZE, OR COLOR.

FOR RESTAURANT SERVICES (U.S. CLS. 100 AND 101).

FIRST USE 10-8-2001; IN COMMERCE 10-8-2001.
CIMMERIAN COLEMAN, EXAMINING ATTORNEY

CLASS 43—(Continued).

SN 78-502,426. SAMUEL F. PONESS II, STRABANE, PA.
FILED 10-19-2004.



BAR PROS

NO CLAIM IS MADE TO THE EXCLUSIVE RIGHT TO USE "BAR PROS", APART FROM THE MARK AS SHOWN. THE COLOR(S) RED, WHITE, BLUE, AND BLACK IS/ARE CLAIMED AS A FEATURE OF THE MARK.

THE MARK CONSISTS OF WHITE SILHOUETTE OF PERSON POURING WITH RED BACKGROUND TO THE LEFT, BLUE BACKGROUND TO THE RIGHT, AND BLACK STYLIZED LETTERS BAR PROS.

FOR BAR SERVICES; BAR SERVICES, NAMELY, PROVIDING COMMERCIAL AND RESIDENTIAL BANQUET AND BAR SERVICES (U.S. CLS. 100 AND 101).

FIRST USE 11-18-2003; IN COMMERCE 11-18-2003.
ELISSA GARBER KON, EXAMINING ATTORNEY

CLASS 43—(Continued).

SN 78-504,872. GOTHE, AXEL, NEW YORK, NY. FILED 10-24-2004.

HARLEM'S IN

NO CLAIM IS MADE TO THE EXCLUSIVE RIGHT TO USE "HARLEM'S", APART FROM THE MARK AS SHOWN. FOR PROVIDING TEMPORARY LODGING ACCOMMODATIONS; RESTAURANT SERVICES (U.S. CLS. 100 AND 101).

DOUGLAS LEE, EXAMINING ATTORNEY

SN 78-504,451. ATMAN HOSPITALITY GROUP, INC.,
SOUTH SAN FRANCISCO, CA. FILED 10-22-2004.

ATMAN

THE MARK CONSISTS OF STANDARD CHARACTERS WITHOUT CLAIM TO ANY PARTICULAR FONT, STYLE, SIZE, OR COLOR.

FOR HOTEL, HOTEL AFFILIATE SYSTEM, MOTEL AND HOTEL SERVICES, MAKING HOTEL RESERVATIONS FOR OTHERS (U.S. CLS. 100 AND 101).

PRISCILLA MILTON, EXAMINING ATTORNEY

SN 78-504,951. KONISAN, INC., CHICAGO, IL. FILED 10-25-2004.

KAMEHACHI

THE MARK CONSISTS OF STANDARD CHARACTERS WITHOUT CLAIM TO ANY PARTICULAR FONT, STYLE, SIZE, OR COLOR.

OWNER OF U.S. REG. NOS. 1,858,261 AND 2,791,490.

THE FOREIGN WORDING IN THE MARK TRANSLATES INTO ENGLISH AS 8 TURTLES.

FOR RESTAURANT SERVICES; TAKE-OUT RESTAURANT SERVICES; CATERING (U.S. CLS. 100 AND 101).

FIRST USE 2-22-1994; IN COMMERCE 2-22-1994.
JOANNA DUKOVIC, EXAMINING ATTORNEY

CLASS 43—(Continued).

SN 78-505,012. OUTBACK/FLEMING'S, LLC, TAMPA, FL. FILED 10-25-2004.



OWNER OF U.S. REG. NOS. 2,329,744, 2,354,237 AND 2,379,146.
 FOR RESTAURANT AND BAR SERVICES (U.S. CLS. 100 AND 101).
 FIRST USE 10-1-1998; IN COMMERCE 10-1-1998.
 ROBERT LORENZO, EXAMINING ATTORNEY

SN 78-509,417. DMA HOUSING, INC., SOLANA BEACH, CA. FILED 11-1-2004.

TEMPORARY HOUSING
 FOR THE UNIQUE
 NEEDS OF THE
 INSURANCE INDUSTRY

THE MARK CONSISTS OF STANDARD CHARACTERS WITHOUT CLAIM TO ANY PARTICULAR FONT, STYLE, SIZE, OR COLOR.
 NO CLAIM IS MADE TO THE EXCLUSIVE RIGHT TO USE "TEMPORARY HOUSING" AND "INSURANCE INDUSTRY", APART FROM THE MARK AS SHOWN.
 FOR ARRANGING TEMPORARY HOUSING ACCOMMODATIONS (U.S. CLS. 100 AND 101).
 FIRST USE 8-0-1999; IN COMMERCE 8-0-1999.
 CIMMERIAN COLEMAN, EXAMINING ATTORNEY

CLASS 43—(Continued).

SN 78-509,923. NH HOTELES, S.A., MADRID, SPAIN, FILED 11-2-2004.



NO CLAIM IS MADE TO THE EXCLUSIVE RIGHT TO USE "FAST GOOD", APART FROM THE MARK AS SHOWN.
 FOR RESTAURANT SERVICES; TAKE-OUT RESTAURANT SERVICES (U.S. CLS. 100 AND 101).
 CHARLES JOYNER, EXAMINING ATTORNEY

SN 78-509,986. GREAT WRAPS, INCORPORATED, ATLANTA, GA. FILED 11-2-2004.

HEY, JUST GO WITH
 IT!

THE MARK CONSISTS OF STANDARD CHARACTERS WITHOUT CLAIM TO ANY PARTICULAR FONT, STYLE, SIZE, OR COLOR.
 FOR RESTAURANT AND FAST FOOD SERVICES (U.S. CLS. 100 AND 101).
 FIRST USE 10-1-2004; IN COMMERCE 10-1-2004.
 SHARI SHEFFIELD, EXAMINING ATTORNEY

CLASS 43—(Continued).

SN 78-514,156. CETINA, GILBERTO, LOS ANGELES, CA. FILED 11-9-2004.



NO CLAIM IS MADE TO THE EXCLUSIVE RIGHT TO USE "MEXICAN SOUTHEAST", APART FROM THE MARK AS SHOWN.

THE COLOR(S) YELLOW, BLACK AND RED IS/ARE CLAIMED AS A FEATURE OF THE MARK.

THE MARK CONSISTS OF THE STYLIZED WORDING "CHICHEN ITZA" IN YELLOW, APPEARING TO THE LEFT OF A BLACK OUTLINE OF A STYLIZED PYRAMID, BEHIND WHICH APPEARS A RED SUN. A YELLOW LINE FORMS THE RIGHT SIDE OF THE PYRAMID AND ANOTHER YELLOW LINE APPEARS BELOW THESE ELEMENTS AND ABOVE THE WORDING "A TASTE OF THE MEXICAN SOUTHEAST", WHICH APPEARS IN BLACK.

THE FOREIGN WORDING IN THE MARK TRANSLATES INTO ENGLISH AS MOUTH OF THE WELL OF THE ITZA. FOR RESTAURANT SERVICES AND CATERING SERVICES (U.S. CLS. 100 AND 101).

FIRST USE 2-0-2001; IN COMMERCE 2-0-2001. ROBERT LAVACHE, EXAMINING ATTORNEY

CLASS 43—(Continued).

SN 78-515,354. SUSAN KRUL, GEORGETOWN, PA. FILED 11-11-2004.



NO CLAIM IS MADE TO THE EXCLUSIVE RIGHT TO USE PET RESORT INC., APART FROM THE MARK AS SHOWN.

THE COLORS MAROON, MAUVE AND WHITE ARE IS/ARE CLAIMED AS A FEATURE OF THE MARK.

THE COLOR MAROON APPEARS IN THE SILHOUETTE OF A STANDING CAT LICKING THE FACE OF A SITTING PUPPY, AS WELL AS IN ARCH DRAWN AROUND THE SILHOUETTE. THE RECTANGULAR BASE BELOW THE SILHOUETTE APPEARS IN MAUVE AND CONTAINS WHITE TEXT. THE WORDING PET RESORT INC. APPEARS IN MAROON.

FOR PET BOARDING SERVICES (U.S. CLS. 100 AND 101).

FIRST USE 1-2-2000; IN COMMERCE 6-1-2002. STEVEN PEREZ, EXAMINING ATTORNEY

SN 78-516,122. DIXIE STAMPEDE, LLC, PIGEON FORGE, TN. FILED 11-12-2004.

SN 78-514,593. EAT'N PARK HOSPITALITY GROUP, INC., PITTSBURGH, PA. FILED 11-10-2004.

SIX PENN KITCHEN

THE MARK CONSISTS OF STANDARD CHARACTERS WITHOUT CLAIM TO ANY PARTICULAR FONT, STYLE, SIZE, OR COLOR.

NO CLAIM IS MADE TO THE EXCLUSIVE RIGHT TO USE "KITCHEN", APART FROM THE MARK AS SHOWN.

FOR RESTAURANT SERVICES (U.S. CLS. 100 AND 101).

RAUL CORDOVA, EXAMINING ATTORNEY

**MYRTLE BEACH'S #1
CHOICE FOR THE
HOLIDAYS**

THE MARK CONSISTS OF STANDARD CHARACTERS WITHOUT CLAIM TO ANY PARTICULAR FONT, STYLE, SIZE, OR COLOR.

FOR RESTAURANT SERVICES (U.S. CLS. 100 AND 101).

KHANH LE, EXAMINING ATTORNEY

CLASS 43—(Continued).

SN 78-516,152. DOG-EASE DAYCARE, INC., SHREWSBURY, NJ. FILED 11-12-2004.



NO CLAIM IS MADE TO THE EXCLUSIVE RIGHT TO USE DOG AND DAYCARE INC. & KENNELS, APART FROM THE MARK AS SHOWN.

THE COLOR(S) RED, ORANGE, YELLOW, BROWN, GRAY, TAN, BLUE AND GREEN IS/ARE CLAIMED AS A FEATURE OF THE MARK.

THE COLOR ORANGE APPEARS IN THE WORDS DOG EASE DAYCARE, INC., RED APPEARS IN THE OUTLINE OF DOG EASE AND AS & KENNELS, AND IN THE RED CIRCLE. THE COLORS OF YELLOW, BROWN, GRAY, TAN, BLUE AND GREEN APPEAR IN THE DOGS IN THE CENTER OF THE CIRCLE.

FOR DOG DAYCARE AND KENNEL SERVICES (U.S. CLS. 100 AND 101).

FIRST USE 11-13-2000; IN COMMERCE 11-13-2000.
YSA DEJESUS, EXAMINING ATTORNEY

CLASS 43—(Continued).

SN 78-519,865. FERNANDES, ARLENE J., SARATOGA SPRINGS, NY. FILED 11-19-2004.



NO CLAIM IS MADE TO THE EXCLUSIVE RIGHT TO USE "GOURMET COFFEE SANDWICHES", APART FROM THE MARK AS SHOWN.

FOR RESTAURANT SERVICES, NAMELY, GOURMET COFFEE AND SANDWICH SHOP (U.S. CLS. 100 AND 101).

FLORENTINA BLANDU, EXAMINING ATTORNEY

SN 78-518,781. JACK IN THE BOX INC., SAN DIEGO, CA. FILED 11-17-2004.

JBX GRILL

THE MARK CONSISTS OF STANDARD CHARACTERS WITHOUT CLAIM TO ANY PARTICULAR FONT, STYLE, SIZE, OR COLOR.

NO CLAIM IS MADE TO THE EXCLUSIVE RIGHT TO USE "GRILL", APART FROM THE MARK AS SHOWN.

FOR RESTAURANT SERVICES (U.S. CLS. 100 AND 101).

KEVIN DINALLO, EXAMINING ATTORNEY

SN 78-524,529. KIMPTON HOTEL & RESTAURANT GROUP, LLC, SAN FRANCISCO, CA. FILED 11-30-2004.

JSIX

THE MARK CONSISTS OF STANDARD CHARACTERS WITHOUT CLAIM TO ANY PARTICULAR FONT, STYLE, SIZE, OR COLOR.

FOR RESTAURANT, BAR AND LOUNGE SERVICES (U.S. CLS. 100 AND 101).

ELLEN BURNS, EXAMINING ATTORNEY

CLASS 43—(Continued).

SN 78-524,667. HDOS ENTERPRISES, CARLSBAD, CA. FILED 11-30-2004.



OWNER OF U.S. REG. NOS. 2,428,681, 2,651,663 AND 2,957,648.

THE COLOR(S) YELLOW, BLUE AND GREEN IS/ARE CLAIMED AS A FEATURE OF THE MARK.

THE WORDS MUSCLE BEACH LEMONADE ARE YELLOW WITH BLUE OUTLINES; THE LEMON SLICES ARE YELLOW, THE BAR STRIPES ARE GREEN, THE HAT IS GREEN AND BLUE, THE SHIRT IS GREEN, YELLOW AND BLUE.

SEC. 2(F).
FOR RESTAURANT SERVICES (U.S. CLS. 100 AND 101).

JOHN WILKE, EXAMINING ATTORNEY

CLASS 43—(Continued).

SN 78-527,085. FUSION PIZZA INC., WICHITA, KS. FILED 12-3-2004.



NO CLAIM IS MADE TO THE EXCLUSIVE RIGHT TO USE "FUSION PIZZA INC.", APART FROM THE MARK AS SHOWN.

THE COLOR(S) ORANGE, BLACK AND WHITE IS/ARE CLAIMED AS A FEATURE OF THE MARK.

THE MARK CONSISTS OF STYLIZED WORD "FUSION" IN WHITE WITH ORANGE SWISH/STROKE SITTING RIGHT ABOVE THE WORD. NEXT LINE IS THE WORD "PIZZA" IN A THINK FONT AND IN WHITE. THE WORD "INC" IS NEXT TO "PIZZA" BUT ALIGNED VERTICALLY AND IS ALSO IN WHITE. NEXT LINE IS THE SLOGAN "WHAT'S YOUR FUSION" IN WHITE. ALL THESE ARE ON A BLACK BOX WITH BRUSH STROKED EDGES.

FOR RESTAURANT SERVICES FEATURING WOOD OVEN PIZZAS, SALADS, PASTA, SANDWICHES, APPETIZERS, DESSERTS, BEVERAGES; AND RESTAURANT TAKE-OUT SERVICES (U.S. CLS. 100 AND 101).

FIRST USE 12-3-2003; IN COMMERCE 12-18-2003.
DAVID C. REIHNER, EXAMINING ATTORNEY

SN 78-525,353. EL CHUBBY'S, INC, AURORA, CO. FILED 12-1-2004.

EL CHUBBY'S

THE MARK CONSISTS OF STANDARD CHARACTERS WITHOUT CLAIM TO ANY PARTICULAR FONT, STYLE, SIZE, OR COLOR.

FOR RESTAURANT SERVICES FEATURING MEXICAN FOOD (U.S. CLS. 100 AND 101).

FIRST USE 10-4-1990; IN COMMERCE 11-1-1990.
JUDITH HELFMAN, EXAMINING ATTORNEY

SN 78-528,126. WING KING, INC., COLLEGE PARK, GA. FILED 12-7-2004.

W.K.CAFE

THE MARK CONSISTS OF STANDARD CHARACTERS WITHOUT CLAIM TO ANY PARTICULAR FONT, STYLE, SIZE, OR COLOR.

OWNER OF U.S. REG. NO. 2,238,404.
NO CLAIM IS MADE TO THE EXCLUSIVE RIGHT TO USE "CAFE", APART FROM THE MARK AS SHOWN.

FOR RESTAURANT SERVICES (U.S. CLS. 100 AND 101).

FIRST USE 6-22-2004; IN COMMERCE 6-22-2004.
JAMES A. RAUEN, EXAMINING ATTORNEY

CLASS 43—(Continued).

SN 78-528,521. WALEWSKI, JEFFREY J., CARNEGIE, PA. AND WALEWSKI, SHERRI ANN, CARNEGIE, PA. FILED 12-7-2004.



THE STIPPLING IS FOR SHADING PURPOSES ONLY. FOR RESTAURANT AND BAR SERVICES (U.S. CLS. 100 AND 101). FIRST USE 12-24-1990; IN COMMERCE 12-24-1990. REBECCA GAN, EXAMINING ATTORNEY

CLASS 43—(Continued).

SN 78-532,031. RUTH'S CHRIS STEAK HOUSE, INC., METAIRIE, LA. FILED 12-14-2004.

Just Follow the Sizzle

THE MARK CONSISTS OF STANDARD CHARACTERS WITHOUT CLAIM TO ANY PARTICULAR FONT, STYLE, SIZE, OR COLOR. FOR RESTAURANT AND LOUNGE SERVICES (U.S. CLS. 100 AND 101). FIRST USE 12-2-2004; IN COMMERCE 12-2-2004. ANNE MADDEN, EXAMINING ATTORNEY

SN 78-533,950. MATT & RACHEL, LLC, CARMEL, IN. FILED 12-16-2004.

SN 78-529,593. THE DAILY BAGEL, INC., BEVERLY, MA. FILED 12-9-2004.



NO CLAIM IS MADE TO THE EXCLUSIVE RIGHT TO USE "CAFÉ OR ESTABLISHED 1996", APART FROM THE MARK AS SHOWN.

THE MARK CONSISTS OF THE DAILY HARVEST IN GOUDY OLD STYLE (SMALL CAPS) FONT; CAFÉ IN PAPYRUS FONT; ESTABLISHED IN 1996 IN EDWARDIAN SCRIPT FONT; A PICTURE WITH A BAGEL, TWO CUPS OF COFFEE, COFFEE BEANS, COFFEE BEAN GRINDER, CHEESE AND A SANDWICH INTERTWINED WITH IVY; ALL SURROUNDED BY A THICK AND THIN LINE BORDER.

FOR CAFE-RESTAURANTS (U.S. CLS. 100 AND 101). JOHN LINCOSKI, EXAMINING ATTORNEY

BUB'S

THE MARK CONSISTS OF STANDARD CHARACTERS WITHOUT CLAIM TO ANY PARTICULAR FONT, STYLE, SIZE, OR COLOR.

OWNER OF U.S. REG. NO. 2,932,601. FOR RESTAURANT SERVICES (U.S. CLS. 100 AND 101).

FIRST USE 2-5-2003; IN COMMERCE 2-5-2003. TARAH HARDY, EXAMINING ATTORNEY

CLASS 43—(Continued).

SN 78-534,434. CONDOMINIOS VENTANA DEL SOL, S.A. DE C.V., PUERTO VALLARTA, MEXICO, FILED 12-17-2004.

CLASS 43—(Continued).

SN 78-534,849. PRIMROSE, INC., ABERDEEN, SD. FILED 12-17-2004.

Playa del Sol

THE MARK CONSISTS OF STANDARD CHARACTERS WITHOUT CLAIM TO ANY PARTICULAR FONT, STYLE, SIZE, OR COLOR.

THE FOREIGN WORDING IN THE MARK TRANSLATES INTO ENGLISH AS BEACH OF THE SUN.

FOR HOSTELS, HOTEL SERVICES FOR PREFERRED CUSTOMERS, HOTELS, MAKING HOTEL RESERVATIONS FOR OTHERS, MOTELS, RENTAL OF ROOMS, RESORT HOTELS, RESORT LODGING SERVICES, TOURIST HOSTELS, TRAVEL AGENCY SERVICES, NAMELY, MAKING RESERVATIONS AND BOOKING FOR TEMPORARY LODGING (U.S. CLS. 100 AND 101).

FIRST USE 1-1-1999; IN COMMERCE 1-1-1999.
SUNG IN, EXAMINING ATTORNEY

SN 78-534,601. LONGO, NICOLA, HUNTSVILLE, AL. FILED 12-17-2004.

WHY HAVE ICE CREAM
WHEN YOU CAN HAVE
GELATO?

THE MARK CONSISTS OF STANDARD CHARACTERS WITHOUT CLAIM TO ANY PARTICULAR FONT, STYLE, SIZE, OR COLOR.

FOR ITALIAN THEMED CAFE SERVING FOOD AND BEVERAGES (U.S. CLS. 100 AND 101).

CAROLINE WEIMER, EXAMINING ATTORNEY

THIS IS LIVING

THE MARK CONSISTS OF STANDARD CHARACTERS WITHOUT CLAIM TO ANY PARTICULAR FONT, STYLE, SIZE, OR COLOR.

FOR PROVIDING CONGREGATE, INDEPENDENT, AND ASSISTED LIVING FACILITIES (U.S. CLS. 100 AND 101).

FIRST USE 9-28-2003; IN COMMERCE 9-28-2003.
ANDREA SAUNDERS, EXAMINING ATTORNEY

SN 78-535,413. CREMALITA MANAGEMENT, LLC, NEW YORK, NY. FILED 12-20-2004.



NO CLAIM IS MADE TO THE EXCLUSIVE RIGHT TO USE "CUPCAKE COMPANY", APART FROM THE MARK AS SHOWN.

THE LINING IS A FEATURE OF THE MARK AND DOES NOT INDICATE COLOR.

THE MARK CONSISTS OF A GRAPHIC DESIGN OF A CUPCAKE IN BETWEEN THE WORDS SOHO CUPCAKE AND COMPANY WITH A FANCIFUL "S" ON TOP OF THE CUPCAKE.

FOR RESTAURANT SERVICES (U.S. CLS. 100 AND 101).

FIRST USE 12-2-2004; IN COMMERCE 12-2-2004.
IRA J. GOODSaid, EXAMINING ATTORNEY

CLASS 43—(Continued).

SN 78-536,571. COPLEY PLAZA 2001 LLC, TORONTO, ONTARIO, CANADA, FILED 12-21-2004.

COPLEY PLAZA

THE MARK CONSISTS OF STANDARD CHARACTERS WITHOUT CLAIM TO ANY PARTICULAR FONT, STYLE, SIZE, OR COLOR.
FOR HOTEL AND RESTAURANT SERVICES (U.S. CLS. 100 AND 101).
FIRST USE 8-0-1912; IN COMMERCE 8-0-1912.
DOUGLAS LEE, EXAMINING ATTORNEY

CLASS 43—(Continued).

SN 78-537,424. BARRETT, MARK, OSAGE BEACH, MO. FILED 12-22-2004.



NO CLAIM IS MADE TO THE EXCLUSIVE RIGHT TO USE "BAR & GRILL", APART FROM THE MARK AS SHOWN.

THE MARK CONSISTS OF AN IMAGE OF A DOG HOLDING A BEVERAGE AND A FISHING POLE WHILE FLOATING IN A TUB
FOR RESTAURANT SERVICES (U.S. CLS. 100 AND 101).
FIRST USE 12-17-2004; IN COMMERCE 12-17-2004.
LINDA POWELL, EXAMINING ATTORNEY

SN 78-538,502. RED, WHITE & BREW BISTROS, INC., MESA, AZ. FILED 12-27-2004.

RED WHITE & BREW

THE MARK CONSISTS OF STANDARD CHARACTERS WITHOUT CLAIM TO ANY PARTICULAR FONT, STYLE, SIZE, OR COLOR.
FOR RESTAURANT SERVICES FEATURING A WINE BAR (U.S. CLS. 100 AND 101).
FIRST USE 6-30-2001; IN COMMERCE 6-30-2001.
GENE MACIOL, EXAMINING ATTORNEY

SN 78-537,139. JARAL EAST END HOTEL CORP., GARDEN CITY, NY. FILED 12-22-2004.

**THE BEST OF BOTH
FORKS**

THE MARK CONSISTS OF STANDARD CHARACTERS WITHOUT CLAIM TO ANY PARTICULAR FONT, STYLE, SIZE, OR COLOR.
FOR HOTEL AND INN SERVICES; RESTAURANT SERVICES; TAKE-OUT RESTAURANT SERVICES; CATERING SERVICES; COCKTAIL LOUNGE AND BAR SERVICES (U.S. CLS. 100 AND 101).
RAUL CORDOVA, EXAMINING ATTORNEY

SN 78-976,325. DORFCO, INC., DAVIE, FL. FILED 11-30-2004.

SOFA KING'S R-RATED BAR

THE MARK CONSISTS OF STANDARD CHARACTERS WITHOUT CLAIM TO ANY PARTICULAR FONT, STYLE, SIZE, OR COLOR.
NO CLAIM IS MADE TO THE EXCLUSIVE RIGHT TO USE "BAR", APART FROM THE MARK AS SHOWN.
FOR BAR AND RESTAURANT SERVICES (U.S. CLS. 100 AND 101).
FIRST USE 10-31-2004; IN COMMERCE 11-10-2004.
IRA J. GOODSARD, EXAMINING ATTORNEY

CLASS 44—MEDICAL, BEAUTY AND AGRICULTURAL SERVICES

CLASS 44—(Continued).

SN 76-467,522. STEAM, LOS ANGELES, CA. FILED 11-18-2002.

SN 76-575,505. UHS OF DELAWARE, INC., KING OF PRUSSIA, PA. FILED 2-13-2004.

STEAM

**Centennial Hills Hospital
Medical Center**

FOR SALON SERVICES NAMELY HAIR CUTTING, HAIR COLORING, MANICURES AND PEDICURES (U.S. CLS. 100 AND 101).
FIRST USE 11-3-1999; IN COMMERCE 1-14-2000.
TERESA M. RUPP, EXAMINING ATTORNEY

NO CLAIM IS MADE TO THE EXCLUSIVE RIGHT TO USE HOSPITAL MEDICAL CENTER, APART FROM THE MARK AS SHOWN.
FOR MEDICAL AND HEALTHCARE SERVICES (U.S. CLS. 100 AND 101).
KENNETH D. BATTLE, EXAMINING ATTORNEY

SN 76-567,541. CHILDREN'S MEMORIAL MEDICAL CENTER, INC., CHICAGO, IL. FILED 12-17-2003.

SN 76-578,555. INJURED WORKERS PHARMACY, LLC, METHUEN, MA. FILED 3-2-2004.

1.800.KIDS DOC

IWP INJURED WORKERS PHARMACY

THE MARK CONSISTS OF STANDARD CHARACTERS WITHOUT CLAIM TO ANY PARTICULAR FONT, STYLE, SIZE, OR COLOR.
NO CLAIM IS MADE TO THE EXCLUSIVE RIGHT TO USE "DOC", APART FROM THE MARK AS SHOWN.
SEC. 2(F).
FOR MEDICAL CARE SERVICES; PROVIDING MEDICAL AND HEALTHCARE INFORMATION BY TELEPHONE (U.S. CLS. 100 AND 101).
FIRST USE 12-6-1987; IN COMMERCE 12-6-1987.
MARLENE BELL, EXAMINING ATTORNEY

THE MARK CONSISTS OF STANDARD CHARACTERS WITHOUT CLAIM TO ANY PARTICULAR FONT, STYLE, SIZE, OR COLOR.
NO CLAIM IS MADE TO THE EXCLUSIVE RIGHT TO USE "INJURED WORKERS PHARMACY", APART FROM THE MARK AS SHOWN.
FOR DISPENSING OF PHARMACEUTICALS; AND DISPENSING OF PHARMACEUTICALS THROUGH THE MAIL (U.S. CLS. 100 AND 101).
FIRST USE 10-23-2001; IN COMMERCE 10-23-2001.
KARLA PERKINS, EXAMINING ATTORNEY

SN 76-570,619. CIGNA INTELLECTUAL PROPERTY, INC., CLAYMONT, DE. FILED 1-16-2004.

SN 76-583,239. EUROAMERICAN PROPAGATORS, LLC, BONSALL, CA. FILED 3-25-2004.

CIGNA WELL AWARE FOR BETTER HEALTH

EUROAMERICAN

THE MARK CONSISTS OF STANDARD CHARACTERS WITHOUT CLAIM TO ANY PARTICULAR FONT, STYLE, SIZE, OR COLOR.
OWNER OF U.S. REG. NOS. 1,270,224, 1,926,164 AND 2,226,666.
FOR PROVIDING HEALTH CARE INFORMATION, NAMELY, PROVIDING INFORMATION TO INDIVIDUALS REGARDING DISEASE MANAGEMENT AND TREATMENT VIA TELEPHONE AND PROVIDING HEALTH CARE INFORMATION TO INDIVIDUALS BY NURSES VIA TELEPHONE (U.S. CLS. 100 AND 101).
FIRST USE 1-1-2004; IN COMMERCE 1-1-2004.
SHARI SHEFFIELD, EXAMINING ATTORNEY

THE MARK CONSISTS OF STANDARD CHARACTERS WITHOUT CLAIM TO ANY PARTICULAR FONT, STYLE, SIZE, OR COLOR.
FOR PLANT AND SHRUB NURSERIES (U.S. CLS. 100 AND 101).
FIRST USE 10-1-1992; IN COMMERCE 10-1-1992.
ROBERT C. CLARK JR., EXAMINING ATTORNEY

CLASS 44—(Continued).

SN 76-586,755. ADSIT LANDSCAPE & DESIGN FIRM, LLC, MEMPHIS, TN. FILED 4-14-2004.

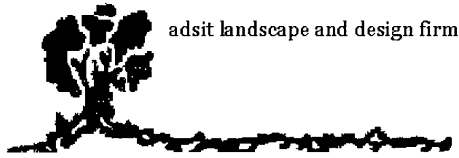

adsit landscape and design firm

NO CLAIM IS MADE TO THE EXCLUSIVE RIGHT TO USE "LANDSCAPE AND DESIGN FIRM", APART FROM THE MARK AS SHOWN.

FOR LANDSCAPE DESIGN, CONSTRUCTION AND MAINTENANCE SERVICES (U.S. CLS. 100 AND 101).

FIRST USE 9-15-1976; IN COMMERCE 9-15-1976.
AISHA CLARKE, EXAMINING ATTORNEY

CLASS 44—(Continued).

SN 76-591,522. PROPATH SERVICES, LLP, DALLAS, TX. FILED 5-10-2004.

PROPATH KNOWNOW HOTLINE

THE MARK CONSISTS OF STANDARD CHARACTERS WITHOUT CLAIM TO ANY PARTICULAR FONT, STYLE, SIZE, OR COLOR.

NO CLAIM IS MADE TO THE EXCLUSIVE RIGHT TO USE "HOTLINE", APART FROM THE MARK AS SHOWN.

FOR PROVIDING MEDICAL INFORMATION SERVICES, NAMELY, PROVIDING MEDICAL TEST RESULTS VIA AN INTERACTIVE VOICE RESPONSE SYSTEM (U.S. CLS. 100 AND 101).

FIRST USE 4-5-2004; IN COMMERCE 4-5-2004.
MELISSA SHELLA, EXAMINING ATTORNEY

SN 76-586,790. COMPLETE LAWN CARE, INC., LAYTONSVILLE, MD. FILED 4-12-2004.



OWNER OF U.S. REG. NO. 2,000,801.

NO CLAIM IS MADE TO THE EXCLUSIVE RIGHT TO USE "COMPLETE LAWN CARE", APART FROM THE MARK AS SHOWN.

THE STIPPLING SHOWN IN THE DRAWING IS A FEATURE OF THE MARK AND IS NOT INTENDED TO INDICATE ANY PARTICULAR COLOR.

FOR LANDSCAPING SERVICES, NAMELY, LANDSCAPE GARDENING AND DESIGN SERVICES (U.S. CLS. 100 AND 101).

FIRST USE 1-22-2004; IN COMMERCE 1-22-2004.
CHRISTOPHER BUONGIORNO, EXAMINING ATTORNEY

SN 76-592,099. ORLAND PARK DENTISTRY FOR CHILDREN, P.C., ORLAND PARK, IL. FILED 5-13-2004.



Orland Park
Dentistry For Children

NO CLAIM IS MADE TO THE EXCLUSIVE RIGHT TO USE "ORLAND PARK" AND "DENTISTRY FOR CHILDREN", APART FROM THE MARK AS SHOWN.

THE MARK CONSISTS OF A GROUP OF CHILDREN IN A LINE HOLDING ON TO A PIECE OF STRING, AND THE WORDING, "ORLAND PARK DENTISTRY FOR CHILDREN," APPEARS BELOW THE DESIGN.

FOR DENTIST SERVICES (U.S. CLS. 100 AND 101).
FIRST USE 5-1-2003; IN COMMERCE 5-1-2003.
ROBIN CHOSID, EXAMINING ATTORNEY

SN 76-591,001. CARGILE, WILLIAM ALLEN, JR., BLACK MOUNTAIN, NC. FILED 5-7-2004.

FamilyCare_{IMS}

FOR PHYSICIAN SERVICES (U.S. CLS. 100 AND 101).
FIRST USE 11-5-2003; IN COMMERCE 11-5-2003.
MARLENE BELL, EXAMINING ATTORNEY

SN 76-592,377. JOHNSON, ROBERT, UNIONVILLE, MO. AND JOHNSON, SUSAN, UNIONVILLE, MO. FILED 5-14-2004.

COZY KITTEN CATTERY

THE MARK CONSISTS OF STANDARD CHARACTERS WITHOUT CLAIM TO ANY PARTICULAR FONT, STYLE, SIZE, OR COLOR.

NO CLAIM IS MADE TO THE EXCLUSIVE RIGHT TO USE "CATTERY", APART FROM THE MARK AS SHOWN. FOR CAT BREEDING SERVICES (U.S. CLS. 100 AND 101).

FIRST USE 3-2-1995; IN COMMERCE 4-15-1995.
ELIZABETH J. WINTER, EXAMINING ATTORNEY

CLASS 44—(Continued).

SN 76-595,930. UHS OF DELAWARE, INC., KING OF PRUSSIA, PA. FILED 6-4-2004.



NO CLAIM IS MADE TO THE EXCLUSIVE RIGHT TO USE "WOMEN'S HOSPITAL", APART FROM THE MARK AS SHOWN.

FOR PROVIDING OBSTETRIC AND GYNECOLOGICAL SERVICES FOR WOMEN IN A CENTER-TYPE ENVIRONMENT FEATURING DIAGNOSTIC LABORATORIES, COUNSELING FACILITIES, DELIVERY AND OPERATING ROOMS AND ASSOCIATED HOSPITAL BEDS (U.S. CLS. 100 AND 101).

FIRST USE 1-1-1999; IN COMMERCE 1-1-1999.
INGRID C. EULIN, EXAMINING ATTORNEY

SN 76-596,465. MCNUTT, CHARLES DANIEL, SR., GREENVILLE, SC. FILED 6-9-2004.



THE MARK CONSISTS IN PART OF A FANCIFUL DESIGN OF A FAIRY HOLDING A BOW AND ARROW, AND THE ARROW IS IN THE FORM OF A TOOTHBRUSH. FOR PEDIATRIC DENTISTRY (U.S. CLS. 100 AND 101).

FIRST USE 1-15-2004; IN COMMERCE 1-15-2004.
MARY ROSSMAN, EXAMINING ATTORNEY

SN 76-597,750. BATLLE, FRANCISCO DR., DALLAS, TX. FILED 6-17-2004.

WELLNESS MANAGEMENT ORGANIZATION (WMO)

THE MARK CONSISTS OF STANDARD CHARACTERS WITHOUT CLAIM TO ANY PARTICULAR FONT, STYLE, SIZE, OR COLOR.

NO CLAIM IS MADE TO THE EXCLUSIVE RIGHT TO USE "WELLNESS MANAGEMENT ORGANIZATION", APART FROM THE MARK AS SHOWN.

FOR MEDICAL SERVICES, IN PARTICULAR PREVENTATIVE HEALTHCARE AND HEALTH SPA (U.S. CLS. 100 AND 101).

DOUGLAS LEE, EXAMINING ATTORNEY

CLASS 44—(Continued).

SN 76-604,259. MARTIN'S LANDSCAPING INC., WATERBURY, CT. FILED 7-26-2004.



NO CLAIM IS MADE TO THE EXCLUSIVE RIGHT TO USE LANDSCAPING INC., APART FROM THE MARK AS SHOWN.

THE COLOR(S) GREEN AND BLACK IS/ARE CLAIMED AS A FEATURE OF THE MARK.

THE COLOR BLACK IS CLAIMED TO APPEAR IN THE LETTERING OF MARTIN'S LANDSCAPING INC. THE COLOR GREEN IS CLAIMED TO APPEAR AS THE TOP OF THE TREE ON THE T.

FOR LANDSCAPING/GARDENING SERVICE (U.S. CLS. 100 AND 101).

FIRST USE 6-0-1970; IN COMMERCE 6-0-1970.
ANDREA SAUNDERS, EXAMINING ATTORNEY

SN 76-604,472. NAPERVILLE PSYCHIATRIC VENTURES, DBA LINDEN OAKS HOSPITAL, NAPERVILLE, IL. FILED 7-27-2004.

LINDEN OAKS HOSPITAL

THE MARK CONSISTS OF STANDARD CHARACTERS WITHOUT CLAIM TO ANY PARTICULAR FONT, STYLE, SIZE, OR COLOR.

NO CLAIM IS MADE TO THE EXCLUSIVE RIGHT TO USE "HOSPITAL", APART FROM THE MARK AS SHOWN.

FOR HEALTH CARE, NAMELY, PROVIDING TREATMENT AND SUPPORT SERVICES FOR ADULTS AND ADOLESCENTS WHO ARE COPING WITH EATING DISORDERS, ALCOHOLISM, DEPRESSION, ANXIETY, SELF-INJURY, AND OTHER BEHAVIORAL HEALTH ISSUES (U.S. CLS. 100 AND 101).

FIRST USE 0-0-1989; IN COMMERCE 0-0-1989.
DANIEL BRODY, EXAMINING ATTORNEY

SN 76-604,874. UHS OF DELAWARE, INC., KING OF PRUSSIA, PA. FILED 7-30-2004.



NO CLAIM IS MADE TO THE EXCLUSIVE RIGHT TO USE "THE BARIATRIC CENTER AT SOUTHWEST HEALTHCARE SYSTEM", APART FROM THE MARK AS SHOWN.

FOR MEDICAL, HEALTHCARE AND HOSPITAL SERVICES (U.S. CLS. 100 AND 101).

FIRST USE 6-4-2004; IN COMMERCE 6-4-2004.
GINA HAYES, EXAMINING ATTORNEY

CLASS 44—(Continued).

SN 76-605,469. IMALUX CORPORATION, CLEVELAND, OH.
FILED 8-4-2004.



NO CLAIM IS MADE TO THE EXCLUSIVE RIGHT TO USE "MEDICAL IMAGING", APART FROM THE MARK AS SHOWN.

FOR OPTICAL COHERENCE TOMOGRAPHY IMAGING SERVICES FOR MEDICAL PURPOSES (U.S. CLS. 100 AND 101).

FIRST USE 4-16-2004; IN COMMERCE 4-16-2004.
MITCHELL FRONT, EXAMINING ATTORNEY

SN 76-607,489. WEISE, JOANI MARIE, PHILADELPHIA, PA.
FILED 8-18-2004.

LI'JOANA SKIN & BODY CLINIC

THE MARK CONSISTS OF STANDARD CHARACTERS WITHOUT CLAIM TO ANY PARTICULAR FONT, STYLE, SIZE, OR COLOR.

NO CLAIM IS MADE TO THE EXCLUSIVE RIGHT TO USE "SKIN & BODY CLINIC", APART FROM THE MARK AS SHOWN.

THE NAME "LI'JOANA" DOES NOT IDENTIFY A LIVING INDIVIDUAL.

FOR MEDICALLY SUPERVISED SKIN AND BODY TREATMENTS, NAMELY, BOTULINUM TOXIN INJECTIONS, MICRODERMABRASION AND CHEMICAL SKIN PEELS, AND DEEP MASSAGE THERAPY (U.S. CLS. 100 AND 101).

FIRST USE 6-1-2004; IN COMMERCE 6-1-2004.
JOHN KELLY, EXAMINING ATTORNEY

CLASS 44—(Continued).

SN 76-611,848. BETTER BEDREST, INC., COLUMBIA, MD.
FILED 9-17-2004.

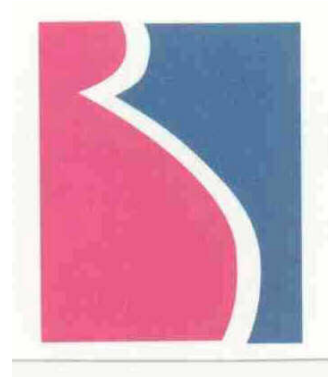

THE COLORS RED, BLUE AND WHITE ARE CLAIMED AS A FEATURE OF THE MARK.

THE MARK CONSISTS OF THE DESIGN OF A SILHOUETTE OF PREGNANT WOMAN'S BELLY IN THE COLOR PURPLE WITH A BLUE BACKGROUND.

FOR PROVIDING HEALTH RESOURCE INFORMATION FOR PREGNANT WOMEN (U.S. CLS. 100 AND 101).

FIRST USE 12-0-1993; IN COMMERCE 12-0-1993.
TRACY CROSS, EXAMINING ATTORNEY

SN 76-611,849. BETTER BEDREST, INC., COLUMBIA, MD.
FILED 9-17-2004.

BETTER BEDREST

THE MARK CONSISTS OF STANDARD CHARACTERS WITHOUT CLAIM TO ANY PARTICULAR FONT, STYLE, SIZE, OR COLOR.

SEC. 2(F) AS TO "BEDREST".

FOR PROVIDING HEALTH RESOURCE INFORMATION FOR PREGNANT WOMEN (U.S. CLS. 100 AND 101).

FIRST USE 12-0-1993; IN COMMERCE 12-0-1993.
TRACY CROSS, EXAMINING ATTORNEY

SN 76-612,580. SIMONIDES, VERONICA M., SANTEE, CA.
FILED 9-23-2004.

ON THE GO SPA

THE MARK CONSISTS OF STANDARD CHARACTERS WITHOUT CLAIM TO ANY PARTICULAR FONT, STYLE, SIZE, OR COLOR.

NO CLAIM IS MADE TO THE EXCLUSIVE RIGHT TO USE "SPA", APART FROM THE MARK AS SHOWN.

FOR HEALTH SPA SERVICES, NAMELY, COSMETIC BODY CARE SERVICES (U.S. CLS. 100 AND 101).

FIRST USE 12-2-2002; IN COMMERCE 12-2-2002.
SUE LAWRENCE, EXAMINING ATTORNEY

CLASS 44—(Continued).

SN 76-613,956. CITY PARKWAY V, INC., LAS VEGAS, NV. FILED 9-27-2002.



FOR MEDICAL SERVICES; HOSPITAL SERVICES; HEALTH CARE SERVICES; DENTAL SERVICES; OPTOMETRY SERVICES; HEALTH SPA SERVICES, NAMELY, COSMETIC BODY CARE SERVICES AND PROVIDING SAUNA AND STEAM ROOM FACILITIES, CHIROPRACTIC SERVICES, NUTRITIONAL COUNSELING, PHYSICAL REHABILITATION, MASSAGE THERAPY, AROMATHERAPY, HYDROTHERAPY, PSYCHOTHERAPY AND HYPNOTHERAPY; BEAUTY SALON SERVICES; VETERINARY SERVICES; TANNING SALON SERVICES; PROVIDING MEDICAL, HOSPITAL, HEALTH, DENTAL, OPTOMETRY, HEALTH SPA, BEAUTY AND VETERINARY INFORMATION (U.S. CLS. 100 AND 101).

SALLY SHIH, EXAMINING ATTORNEY

CLASS 44—(Continued).

SN 76-614,921. GREG J. PERENTIS, DDS, PLLC, DURHAM, NC. FILED 10-6-2004.

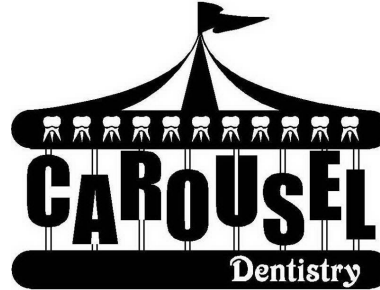

NO CLAIM IS MADE TO THE EXCLUSIVE RIGHT TO USE "DENTISTRY", APART FROM THE MARK AS SHOWN.

THE DESIGN CONSISTS OF AN IMAGE OF A CAROUSEL.

FOR DENTISTRY AND DENTIST SERVICES (U.S. CLS. 100 AND 101).

FIRST USE 9-17-2001; IN COMMERCE 9-17-2001.
JAMES A. RAUEN, EXAMINING ATTORNEY

SN 76-615,085. NORTHAM CORPORATION, DBA TRUEFIT & HILL, N.A., CHICAGO, IL. FILED 10-8-2004.

GROOMING MEN FOR GREATNESS

THE MARK CONSISTS OF STANDARD CHARACTERS WITHOUT CLAIM TO ANY PARTICULAR FONT, STYLE, SIZE, OR COLOR.

FOR GROOMING SERVICES, NAMELY SHAVES, HAIR CUTTING, STYLING, COLORING AND REPLACING, MANICURES, PEDICURES, EXPERT GROOMING TIPS AND ADVICE, MASSAGES, AND PERSONAL SKIN CARE SERVICES (U.S. CLS. 100 AND 101).

FIRST USE 10-6-2004; IN COMMERCE 10-6-2004.
KIMBERLY PERRY, EXAMINING ATTORNEY

SN 76-613,970. CITY PARKWAY V, INC., LAS VEGAS, NV. FILED 9-27-2004.



THE MARK CONSISTS OF STANDARD CHARACTERS WITHOUT CLAIM TO ANY PARTICULAR FONT, STYLE, SIZE, OR COLOR.

FOR MEDICAL SERVICES; HOSPITAL SERVICES; HEALTH CARE SERVICES; DENTAL SERVICES; OPTOMETRY SERVICES; HEALTH SPA SERVICES, NAMELY, COSMETIC BODY CARE SERVICES AND PROVIDING SAUNA AND STEAM ROOM FACILITIES, CHIROPRACTIC SERVICES, NUTRITIONAL COUNSELING, PHYSICAL REHABILITATION, MASSAGE THERAPY, AROMATHERAPY, HYDROTHERAPY, PSYCHOTHERAPY AND HYPNOTHERAPY; BEAUTY SALON SERVICES; VETERINARY SERVICES; TANNING SALON SERVICES; PROVIDING MEDICAL, HOSPITAL, HEALTH, DENTAL, OPTOMETRY, HEALTH SPA, BEAUTY AND VETERINARY INFORMATION (U.S. CLS. 100 AND 101).

SALLY SHIH, EXAMINING ATTORNEY

SN 76-615,584. EBERLE, SUZANNE GIRARD, PORTLAND, OR. FILED 10-13-2004.

EAT, DRINK, WIN!

THE MARK CONSISTS OF STANDARD CHARACTERS WITHOUT CLAIM TO ANY PARTICULAR FONT, STYLE, SIZE, OR COLOR.

FOR NUTRITION COUNSELING (U.S. CLS. 100 AND 101).

FIRST USE 8-13-2003; IN COMMERCE 8-13-2003.
MICHELLE S. WISEMAN, EXAMINING ATTORNEY

CLASS 44—(Continued).

SN 76-615,667. UHS OF DELAWARE, INC., KING OF PRUSSIA, PA. FILED 10-7-2004.



South Texas Health
Care Network PHO

OWNER OF U.S. REG. NO. 2,554,879.
NO CLAIM IS MADE TO THE EXCLUSIVE RIGHT TO USE "SOUTH TEXAS HEALTH CARE NETWORK PHO", APART FROM THE MARK AS SHOWN.
FOR HEALTH CARE SERVICES AND MEDICAL SERVICES (U.S. CLS. 100 AND 101).
FIRST USE 4-27-2004; IN COMMERCE 4-27-2004.
KELLY CHOE, EXAMINING ATTORNEY

SN 76-616,158. PERRY, FRANK C., MEDFORD, NY. FILED 10-12-2004.

SCARDY CATS

THE MARK CONSISTS OF STANDARD CHARACTERS WITHOUT CLAIM TO ANY PARTICULAR FONT, STYLE, SIZE, OR COLOR.
FOR DENTAL SERVICES (U.S. CLS. 100 AND 101).
EUGENIA MARTIN, EXAMINING ATTORNEY

SN 76-616,231. ALLAN, BRENT R., PARADISE VALLEY, AZ. FILED 10-15-2004.

DESIGNED TO LAST A LIFETIME

THE MARK CONSISTS OF STANDARD CHARACTERS WITHOUT CLAIM TO ANY PARTICULAR FONT, STYLE, SIZE, OR COLOR.
FOR WEIGHT REDUCTION DIET PLANNING AND SUPERVISION, NAMELY, A MULTI-MONTH DIET PROGRAM SPECIFIC FOR DISEASE MANAGEMENT, ADULT OBESITY, MIGRAINE, HA, HPT, HYPERLIPIDEMIA, DM, ARTHRITIS, LONGEVITY, HEALTHY WOMEN, PEDIATRICS, ADOLESCENT OBESITY, HEART DISEASE, FOOD ALLERGIES, AND POST OBESITY SURGERY (U.S. CLS. 100 AND 101).
FIRST USE 8-15-2004; IN COMMERCE 8-15-2004.
ANNE FARRELL, EXAMINING ATTORNEY

CLASS 44—(Continued).

SN 76-616,257. PROFESSIONAL BEEF SERVICES, LLC, CANTON, MO. FILED 10-18-2004.



FOR AGRICULTURAL SERVICES, NAMELY, AGRICULTURAL MANAGEMENT, CONSULTATION AND ADVICE IN THE CATTLE INDUSTRY (U.S. CLS. 100 AND 101).
FIRST USE 8-1-2003; IN COMMERCE 8-1-2003.
JUDITH HELFMAN, EXAMINING ATTORNEY

SN 76-616,409. KRYO KINETICS, INC., PULLMAN, WA. FILED 10-19-2004.

KRYO KINETICS

THE MARK CONSISTS OF STANDARD CHARACTERS WITHOUT CLAIM TO ANY PARTICULAR FONT, STYLE, SIZE, OR COLOR.
FOR ANIMAL MARKING SERVICES, SPECIFICALLY, FREEZE MARKING OF ANIMAL FOR INDIVIDUAL IDENTIFICATION (U.S. CLS. 100 AND 101).
FIRST USE 2-20-1975; IN COMMERCE 2-3-1976.
MICHAEL KAZAZIAN, EXAMINING ATTORNEY

SN 76-616,735. YAN, YONG SHAN, FORT LEE, NJ. FILED 10-21-2004.

PINKY NAILS

THE MARK CONSISTS OF STANDARD CHARACTERS WITHOUT CLAIM TO ANY PARTICULAR FONT, STYLE, SIZE, OR COLOR.
NO CLAIM IS MADE TO THE EXCLUSIVE RIGHT TO USE "NAILS", APART FROM THE MARK AS SHOWN.
FOR MANICURE SALON (U.S. CLS. 100 AND 101).
FIRST USE 4-6-2004; IN COMMERCE 4-6-2004.
SUSAN STIGLITZ, EXAMINING ATTORNEY

CLASS 44—(Continued).

SN 76-616,990. HEALTH CARE AND RETIREMENT CORPORATION OF AMERICA, TOLEDO, OH. FILED 10-21-2004.

Heartland 

OWNER OF U.S. REG. NO. 1,300,002.
FOR PROVIDING HEALTH CARE AND RETIREMENT FACILITY SERVICES, NAMELY, HEALTH CARE, PHYSICAL AND OCCUPATIONAL REHABILITATION, TRANSITIONAL HEALTH CARE, NURSING HOME CARE, HOME HEALTH AND HOSPICE (U.S. CLS. 100 AND 101).

FIRST USE 12-11-1975; IN COMMERCE 2-1-1976.
MICHAEL WEBSTER, EXAMINING ATTORNEY

SN 76-616,993. HEALTH CARE AND RETIREMENT CORPORATION OF AMERICA, TOLEDO, OH. FILED 10-21-2004.

BUILDING ON A TRADITION OF EXCELLENCE

THE MARK CONSISTS OF STANDARD CHARACTERS WITHOUT CLAIM TO ANY PARTICULAR FONT, STYLE, SIZE, OR COLOR.

FOR PROVIDING HEALTH CARE AND RETIREMENT FACILITY SERVICES, NAMELY, HEALTH CARE, PHYSICAL AND OCCUPATIONAL REHABILITATION, TRANSITIONAL HEALTH CARE, NURSING HOME CARE, HOME HEALTH AND HOSPICE CARE (U.S. CLS. 100 AND 101).

FIRST USE 7-12-2004; IN COMMERCE 7-12-2004.
MICHAEL WEBSTER, EXAMINING ATTORNEY

SN 76-617,357. SLIMMER IMAGE, INC., TOPEKA, KS. FILED 10-21-2004.

SLIMMER IMAGE

THE MARK CONSISTS OF STANDARD CHARACTERS WITHOUT CLAIM TO ANY PARTICULAR FONT, STYLE, SIZE, OR COLOR.

NO CLAIM IS MADE TO THE EXCLUSIVE RIGHT TO USE "SLIMMER", APART FROM THE MARK AS SHOWN.

FOR WEIGHT LOSS SERVICES, NAMELY WEIGHT REDUCTION DIET PLANNING AND SUPERVISION (U.S. CLS. 100 AND 101).

FIRST USE 1-30-1996; IN COMMERCE 1-30-1996.
REBECCA SMITH, EXAMINING ATTORNEY

CLASS 44—(Continued).

SN 76-618,032. UNITED MEDICAL SYSTEMS (DE), INC., WESTBOROUGH, MA. FILED 10-27-2004.

UMS

THE MARK CONSISTS OF STANDARD CHARACTERS WITHOUT CLAIM TO ANY PARTICULAR FONT, STYLE, SIZE, OR COLOR.

OWNER OF U.S. REG. NO. 2,195,189.
FOR MEDICAL SERVICES, NAMELY, PROVIDING ORTHOPEDIC SHOCK WAVE THERAPY, LITHOTRIPSY, MOLECULAR IMAGING, MRI IMAGING, STEREOTACTIC BREAST BIOPSY TESTING, DIAGNOSTIC AND TREATMENT SERVICES TO HEALTHCARE AND MEDICAL FACILITIES AND PRACTICES; MEDICAL CONSULTATION SERVICES RELATED TO THE USE OF SHOCKWAVE TREATMENT BY MEDICAL TECHNICIANS; MEDICAL SURGICAL CENTERS (U.S. CLS. 100 AND 101).

FIRST USE 4-17-2002; IN COMMERCE 4-17-2002.
ELISSA GARBER KON, EXAMINING ATTORNEY

SN 76-618,112. ACCELERATED GENETICS, BARABOO, WI. FILED 10-25-2004.

ASAP

THE MARK CONSISTS OF STANDARD CHARACTERS WITHOUT CLAIM TO ANY PARTICULAR FONT, STYLE, SIZE, OR COLOR.

FOR CATTLE BREEDING SERVICES, NAMELY, IMPLEMENTING, MANAGING, AND MONITORING CATTLE ESTRUS SYNCHRONIZATION PROGRAMS (U.S. CLS. 100 AND 101).

FIRST USE 9-28-2004; IN COMMERCE 9-28-2004.
KEVIN DINALLO, EXAMINING ATTORNEY

SN 76-618,131. UNITED MEDICAL SYSTEMS (DE), INC., WESTBOROUGH, MA. FILED 10-27-2004.

Delivering Hope Through Imaging

FOR MEDICAL SERVICES, NAMELY, MOLECULAR IMAGING SERVICES (U.S. CLS. 100 AND 101).

FIRST USE 6-0-2004; IN COMMERCE 6-0-2004.
FRED MANDIR, EXAMINING ATTORNEY

CLASS 44—(Continued).

SN 76-618,369. THE CARE GROUP, LLC, INDIANAPOLIS, IN. FILED 10-25-2004.

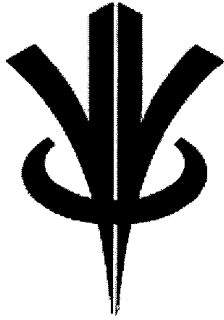

FOR MEDICAL SERVICES, NAMELY, THE COMPREHENSIVE DIAGNOSIS AND TREATMENT OF PERIPHERAL VASCULAR DISEASE (U.S. CLS. 100 AND 101).
FIRST USE 9-30-2002; IN COMMERCE 9-30-2002.
ANNE E. GUSTASON, EXAMINING ATTORNEY

SN 76-618,605. PAMELA I. WU O.D. & ASSOCIATES, INC., IRVINE, CA. FILED 11-1-2004.

時代眼鏡

NO CLAIM IS MADE TO THE EXCLUSIVE RIGHT TO USE "YAN JING", APART FROM THE MARK AS SHOWN. THE NON-LATIN CHARACTERS IN THE MARK TRANSLITERATE TO "SHI DAI YAN JING," AND THIS MEANS "TIME OPTICAL".
FOR OPTOMETRY SERVICES (U.S. CLS. 100 AND 101).
FIRST USE 8-13-2004; IN COMMERCE 8-13-2004.
MICHAEL SOUDERS, EXAMINING ATTORNEY

SN 76-619,095. THE NEW YORK ASSOCIATION OF HOMES AND SERVICES FOR THE AGING, INC., ALBANY, NY. FILED 11-3-2004.

NYAHSA PROCARE CONSULTANTS

THE MARK CONSISTS OF STANDARD CHARACTERS WITHOUT CLAIM TO ANY PARTICULAR FONT, STYLE, SIZE, OR COLOR.
NO CLAIM IS MADE TO THE EXCLUSIVE RIGHT TO USE "CONSULTANTS", APART FROM THE MARK AS SHOWN.
FOR HEALTH CARE CONSULTING SERVICES FOR LONG TERM CARE FACILITIES (U.S. CLS. 100 AND 101).
FIRST USE 1-1-2003; IN COMMERCE 1-1-2003.
IRENE D. WILLIAMS, EXAMINING ATTORNEY

CLASS 44—(Continued).

SN 76-619,676. LEONARD A. ROUDNER M.D., F.A.C.S., P.A., MIAMI, FL. FILED 11-8-2004.

DR. LENNY

THE MARK CONSISTS OF STANDARD CHARACTERS WITHOUT CLAIM TO ANY PARTICULAR FONT, STYLE, SIZE, OR COLOR.

THE NAME "DR. LENNY" IDENTIFIES A LIVING INDIVIDUAL WHOSE CONSENT IS OF RECORD. FOR MEDICAL AND AESTHETIC SURGERY SERVICES (U.S. CLS. 100 AND 101).
FIRST USE 12-31-1985; IN COMMERCE 12-31-1985.
CHARLES L. JENKINS, EXAMINING ATTORNEY

SN 78-166,036. OSDE ORGANIZACION DE SERVICIOS DIRECTOS EMPRESARIOS, BUENOS AIRES, ARGENTINA, FILED 9-19-2002.



OWNER OF ARGENTINA REG. NO. 1,493,401, DATED 12-30-1993, RENEWED AS REG. NO. 1917851, DATED 2-26-2004, EXPIRES 2-26-2014.
OWNER OF U.S. REG. NOS. 2,280,218 AND 2,529,009.
FOR MEDICAL ASSISTANCE SERVICES, NAMELY, MEDICAL CLINICAL SERVICES, MEDICAL SERVICES AND PARAMEDICAL SERVICES RENDERED BY PROFESSIONALS IN MEDICAL CLINICS, HOSPITALS AND MEDICAL LABORATORIES (U.S. CLS. 100 AND 101).
MARY CRAWFORD, EXAMINING ATTORNEY

SN 78-175,235. MAYNARD, MICHAEL J., POUGHKEEPSIE, NY. FILED 10-16-2002.

ORTHO PLASTIC

FOR MEDICAL SERVICES (U.S. CLS. 100 AND 101).
RONALD AIKENS, EXAMINING ATTORNEY

CLASS 44—(Continued).

SN 78-286,469. CASTLE DENTAL CENTERS, INC., HOUSTON, TX. FILED 8-12-2003.



OWNER OF U.S. REG. NO. 2,095,162.
 THE MARK CONSISTS OF STYLIZED CASTLE WITH STYLIZED FAMILY FIGURES WITHIN THE CASTLE.
 FOR DENTAL CARE SERVICES, NAMELY, ORTHODONTIC SERVICES, DENTAL HYGIENIST SERVICES, AND ORAL SURGERY (U.S. CLS. 100 AND 101).
 FIRST USE 3-1-1983; IN COMMERCE 1-0-1985.
 CAROL SPILS, EXAMINING ATTORNEY

CLASS 44—(Continued).

SN 78-336,817. THE CENTER FOR THE VICTIMS OF TORTURE, MINNEAPOLIS, MN. FILED 12-5-2003.



NO CLAIM IS MADE TO THE EXCLUSIVE RIGHT TO USE "CENTER", APART FROM THE MARK AS SHOWN.
 THE LINING IS A FEATURE OF THE MARK AND DOES NOT INDICATE COLOR.

THE MARK CONSISTS IN PART OF A DEPICTION OF A PARTIAL ECLIPSE. THE MOON IS REPRESENTED BY A SOLID CIRCLE. THE SUN IS REPRESENTED BY A CIRCLE WITH RAYS EXTENDING OUTWARD.

SEC. 2(F) AS TO "THE CENTER FOR VICTIMS OF TORTURE".

FOR PROVIDING MENTAL AND PHYSICAL REHABILITATIVE CARE TO SURVIVORS OF TORTURE AND MEMBER OF THEIR FAMILIES (U.S. CLS. 100 AND 101).
 FIRST USE 5-5-1985; IN COMMERCE 5-5-1985.
 ELIZABETH J. WINTER, EXAMINING ATTORNEY

SN 78-322,596. THE OHIO STATE UNIVERSITY, COLUMBUS, OH. FILED 11-4-2003.

INTENSIVE CARING

THE MARK CONSISTS OF STANDARD CHARACTERS WITHOUT CLAIM TO ANY PARTICULAR FONT, STYLE, SIZE, OR COLOR.
 OWNER OF U.S. REG. NO. 1,768,951.
 FOR MEDICAL FACILITY BASED HEALTH CARE SERVICES (U.S. CLS. 100 AND 101).
 FIRST USE 1-18-1990; IN COMMERCE 1-22-1990.
 KIMBERLY FRYE, EXAMINING ATTORNEY

SN 78-382,488. CENTRE FOR NEURO SKILLS, BAKERSFIELD, CA. FILED 3-11-2004.

CENTRE FOR NEURO SKILLS

THE MARK CONSISTS OF STANDARD CHARACTERS WITHOUT CLAIM TO ANY PARTICULAR FONT, STYLE, SIZE, OR COLOR.

NO CLAIM IS MADE TO THE EXCLUSIVE RIGHT TO USE CENTRE, APART FROM THE MARK AS SHOWN.

SEC. 2(F).
 FOR MEDICAL TREATMENT FACILITIES PROVIDING OUTPATIENT REHABILITATION SERVICES AND PROGRAMS AND RESIDENTIAL REHABILITATION SERVICES AND PROGRAMS FOR BRAIN INJURY PATIENTS (U.S. CLS. 100 AND 101).
 FIRST USE 6-23-1980; IN COMMERCE 6-23-1980.

ANGELA M. MICHELI, EXAMINING ATTORNEY

CLASS 44—(Continued).

SN 78-385,629. SANDRALYNN DISTEFANO, NEWARK, DE.
FILED 3-17-2004.

CLASS 44—(Continued).

SN 78-390,566. THAD S. VUAGNIAUX AND NIKKI R.
VUAGNIAUX PARTNERSHIP, THE, GLEN CARBON, IL.
FILED 3-25-2004.

Serenity Now

VUAGNIAUX

THE MARK CONSISTS OF STANDARD CHARACTERS
WITHOUT CLAIM TO ANY PARTICULAR FONT, STYLE,
SIZE, OR COLOR.
FOR MASSAGE THERAPY AND BODYWORK MAS-
SAGE SERVICES (U.S. CLS. 100 AND 101).
VERNA BETH RIRIE, EXAMINING ATTORNEY

THE MARK CONSISTS OF STANDARD CHARACTERS
WITHOUT CLAIM TO ANY PARTICULAR FONT, STYLE,
SIZE, OR COLOR.
SEC. 2(F).
FOR CHIROPRACTIC SERVICES (U.S. CLS. 100 AND
101).
FIRST USE 5-31-1994; IN COMMERCE 5-31-1994.
JOHN KELLY, EXAMINING ATTORNEY

SN 78-387,003. WELLPOINT HEALTH NETWORKS INC.,
THOUSAND OAKS, CA. FILED 3-18-2004.

SN 78-391,692. OUTCOME MEDICAL, LLC, FAYETTEVILLE,
GA. FILED 3-26-2004.

LIFECONNEX

OUTCOME MEDICAL

THE MARK CONSISTS OF STANDARD CHARACTERS
WITHOUT CLAIM TO ANY PARTICULAR FONT, STYLE,
SIZE, OR COLOR.
FOR HEALTH SERVICES, NAMELY MEDICAL TEST-
ING, MEDICAL ANALYSIS, IN-HOME NURSING AID
SERVICES TO MONITOR MEDICAL CONDITIONS, DNA
TESTING AND ANALYSIS, AND COUNSELING SER-
VICES RELATED TO PHYSICAL WELL-BEING AND
NUTRITION (U.S. CLS. 100 AND 101).
CATHERINE CAIN, EXAMINING ATTORNEY

THE MARK CONSISTS OF STANDARD CHARACTERS
WITHOUT CLAIM TO ANY PARTICULAR FONT, STYLE,
SIZE, OR COLOR.
NO CLAIM IS MADE TO THE EXCLUSIVE RIGHT TO
USE "MEDICAL", APART FROM THE MARK AS SHOWN.
FOR MEDICAL SERVICES, NAMELY, PERFORMING
DIAGNOSIS OF DISEASE, MEDICAL CLINICS, CON-
SULTATION, AND PROVIDING MEDICAL INFORMA-
TION IN THE FIELD OF PAIN MANAGEMENT (U.S.
CLS. 100 AND 101).
DAWN HAN, EXAMINING ATTORNEY

CLASS 44—(Continued).

SN 78-393,899. SPIVACK VISION CLINIC, P.C., CENTENNIAL, CO. FILED 3-31-2004.

**SPIVACK VISION
CENTER**

THE MARK CONSISTS OF STANDARD CHARACTERS WITHOUT CLAIM TO ANY PARTICULAR FONT, STYLE, SIZE, OR COLOR.

OWNER OF U.S. REG. NO. 2,293,786.

NO CLAIM IS MADE TO THE EXCLUSIVE RIGHT TO USE "VISION CENTER", APART FROM THE MARK AS SHOWN.

SEC. 2(F).

FOR EYE CARE MEDICAL SERVICES, NAMELY, EYE SURGERY, VISION CORRECTION PROCEDURES, RADIAL KERATOMY (RK), GLAUCOMA AND CATARACT CARE, CONTACT LENS AND OPTICAL SERVICES, NAMELY, CONTACT AND OPTICAL LENS FITTING, OPTICIAN SERVICES, REFRACTIVE EYE CARE, LASER VISION CORRECTION, PHOTOREFRACTIVE KERATECTOMY (PRK), LASER ASSISTED IN-SITU KERATOMILEUSIS (LASIK), AND COSMETIC EYE SURGERY (U.S. CLS. 100 AND 101).

FIRST USE 12-31-1999; IN COMMERCE 12-31-1999.
STEVEN R. FOSTER, EXAMINING ATTORNEY

CLASS 44—(Continued).

SN 78-407,482. WESTERN EXTERMINATOR COMPANY, ANAHEIM, CA. FILED 4-23-2004.



NO CLAIM IS MADE TO THE EXCLUSIVE RIGHT TO USE SOIL, APART FROM THE MARK AS SHOWN.

THE MARK CONSISTS OF THE WORD SOIL APPEARING ABOVE THE WORD WORKS. THE WORD WORKS IS INSIDE A SHADED RECTANGLE. THERE IS A TRIANGLE FOLLOWING THE WORD SOIL.

FOR NON-FOOD AGRICULTURAL ADVICE (U.S. CLS. 100 AND 101).

FIRST USE 10-0-1991; IN COMMERCE 5-0-1992.
ANNE FARRELL, EXAMINING ATTORNEY

SN 78-411,408. CURRIE HAIR SKIN NAILS, INC., GLEN MILLS, PA. FILED 4-30-2004.

**CURRIE
HAIR | SKIN | NAILS**



NO CLAIM IS MADE TO THE EXCLUSIVE RIGHT TO USE "HAIR", "SKIN" AND "NAILS", APART FROM THE MARK AS SHOWN.

FOR BEAUTY SALONS, HAIRDRESSING SALONS, HAIRDRESSING SERVICES, HAIR STYLING, HAIR CUTTING, PROVIDING MANICURE AND PEDICURE SERVICES, MASSAGE SERVICES, SKIN CARE SALON SERVICES FEATURING FACIALS, AND HEALTH SPA SERVICES, NAMELY, COSMETIC BODY CARE SERVICES (U.S. CLS. 100 AND 101).

FIRST USE 10-0-1990; IN COMMERCE 10-0-1990.
ELIZABETH J. WINTER, EXAMINING ATTORNEY

SN 78-396,544. WESTERN PROSCAPES, INC, ENGLEWOOD, CO. FILED 4-5-2004.

**WE PUT THE COLOR
IN COLORADO**

THE MARK CONSISTS OF STANDARD CHARACTERS WITHOUT CLAIM TO ANY PARTICULAR FONT, STYLE, SIZE, OR COLOR.

FOR LANDSCAPING SERVICES FOR RESIDENTIAL AND COMMERCIAL CUSTOMERS (U.S. CLS. 100 AND 101).

FIRST USE 7-1-2003; IN COMMERCE 7-1-2003.
MICHELE SWAIN, EXAMINING ATTORNEY

CLASS 44—(Continued).

SN 78-414,273. LOVING, INC., LOUISVILLE, KY. FILED 5-6-2004.

LOVING LASER CENTER

THE MARK CONSISTS OF STANDARD CHARACTERS WITHOUT CLAIM TO ANY PARTICULAR FONT, STYLE, SIZE, OR COLOR.

NO CLAIM IS MADE TO THE EXCLUSIVE RIGHT TO USE "LASER CENTER", APART FROM THE MARK AS SHOWN.

FOR MEDICAL SERVICES, NAMELY LASER HAIR REMOVAL SERVICES (U.S. CLS. 100 AND 101).

FIRST USE 9-1-2002; IN COMMERCE 9-1-2002.
MICHELE SWAIN, EXAMINING ATTORNEY

SN 78-416,330. MOBILESPA.COM, STONEHAM, MA. FILED 5-11-2004.

We bring the day
spa experience to
you!

THE MARK CONSISTS OF STANDARD CHARACTERS WITHOUT CLAIM TO ANY PARTICULAR FONT, STYLE, SIZE, OR COLOR.

FOR HEALTH SPA SERVICES TO BE PROVIDED IN HOMES, OFFICES, AND HOTELS, NAMELY, COSMETIC BODY CARE SERVICES (U.S. CLS. 100 AND 101).

FIRST USE 1-1-2003; IN COMMERCE 1-1-2003.
EVELYN BRADLEY, EXAMINING ATTORNEY

CLASS 44—(Continued).

SN 78-418,144. MILES & LYLE, INC., AVENTURA, FL. FILED 5-13-2004.

MILES & LYLE

THE MARK CONSISTS OF STANDARD CHARACTERS WITHOUT CLAIM TO ANY PARTICULAR FONT, STYLE, SIZE, OR COLOR.

FOR SALON AND BARBER SHOP SERVICES, NAMELY HAIR CUTTING, HAIR STYLING, SHAMPOOING AND COLORING; AESTHETICIAN SERVICES, NAMELY FACIALS, HAIR REMOVAL, SHAVING SERVICES, HAIR COLORING SERVICES AND TANNING SERVICES; NAIL SERVICES, NAMELY PROVIDING MANICURES AND PEDICURES; AND MASSAGE SERVICES. (U.S. CLS. 100 AND 101).

BARBARA A. LOUGHRAN, EXAMINING ATTORNEY

SN 78-419,163. STONER, TAMMY, DOUGLASVILLE, GA. FILED 5-14-2004.

THE BEAR TECHNIQUE

THE MARK CONSISTS OF STANDARD CHARACTERS WITHOUT CLAIM TO ANY PARTICULAR FONT, STYLE, SIZE, OR COLOR.

FOR PSYCHOLOGICAL COUNSELING (U.S. CLS. 100 AND 101).

FIRST USE 2-0-2002; IN COMMERCE 2-0-2002.
ERNEST SHOSHO, EXAMINING ATTORNEY

SN 78-419,537. PETERSON, MARY KATHY, BIRMINGHAM, AL. FILED 5-16-2004.

COLLECTIBLE LLAMAS

THE MARK CONSISTS OF STANDARD CHARACTERS WITHOUT CLAIM TO ANY PARTICULAR FONT, STYLE, SIZE, OR COLOR.

NO CLAIM IS MADE TO THE EXCLUSIVE RIGHT TO USE "LLAMAS", APART FROM THE MARK AS SHOWN.

FOR SERVICES PROVIDED IN CONNECTION WITH FURTHERING THE VIABILITY OF A NEW BREED OF LLAMAS, NAMELY, PROVIDING A WEBSITE FEATURING BREEDING, STUD, AND GROOMING INFORMATION AS WELL AS INFORMATION CONCERNING THE PROPER CARE AND FEEDING OF SPECIFIC TYPES OF LLAMAS (U.S. CLS. 100 AND 101).

MICHAEL TANNER, EXAMINING ATTORNEY

CLASS 44—(Continued).

SN 78-422,360. HAVE-U-HEARD, LLC, DENVER, CO. FILED 5-20-2004.

CLASS 44—(Continued).

SN 78-427,187. BLISS WORLD LLC, NEW YORK, NY. FILED 5-28-2004.

HAVE-U-HEARD

THE MARK CONSISTS OF STANDARD CHARACTERS WITHOUT CLAIM TO ANY PARTICULAR FONT, STYLE, SIZE, OR COLOR.
FOR AUDIOLOGY AND HEARING AID SERVICES (U.S. CLS. 100 AND 101).
FIRST USE 9-16-1997; IN COMMERCE 9-16-1997.
TIMOTHY FINNEGAN, EXAMINING ATTORNEY

SN 78-427,093. INNOVATIVE PATHOLOGY SERVICES, PLLC, KNOXVILLE, TN. FILED 5-28-2004.

REMEDE

THE MARK CONSISTS OF STANDARD CHARACTERS WITHOUT CLAIM TO ANY PARTICULAR FONT, STYLE, SIZE, OR COLOR.
OWNER OF U.S. REG. NOS. 2,489,360, 2,618,674 AND 2,635,744.
THE ENGLISH TRANSLATION OF THE WORD "REMEDE" IN THE MARK IS "REMEDY" OR "CURE".
FOR HEALTH AND SPA SERVICES, NAMELY, COSMETIC BODY CARE, SKIN CARE, FACIAL CARE AND MASSAGE SERVICES (U.S. CLS. 100 AND 101).
FIRST USE 12-6-2004; IN COMMERCE 12-6-2004.
ROBERT LORENZO, EXAMINING ATTORNEY

SN 78-428,721. CENTENE CORPORATION, ST. LOUIS, MO. FILED 6-2-2004.

IPAP5

THE MARK CONSISTS OF STANDARD CHARACTERS WITHOUT CLAIM TO ANY PARTICULAR FONT, STYLE, SIZE, OR COLOR.
FOR MEDICAL TESTING, FOR IDENTIFICATION OF PATHOLOGICAL CHANGES TO HUMAN CELLS, AND THE DETECTION OF SEXUALLY-TRANSMITTED VIRUSES AND BACTERIA (U.S. CLS. 100 AND 101).
FIRST USE 4-1-2004; IN COMMERCE 4-1-2004.
JANICE L. MCMORROW, EXAMINING ATTORNEY

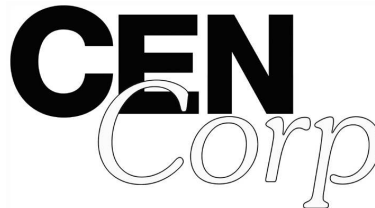

THE MARK CONSISTS OF THE LETTERS CENCORP IN A STYLIZED FONT.
FOR MANAGED HEALTHCARE SERVICES (U.S. CLS. 100 AND 101).
JOHN LINCOSKI, EXAMINING ATTORNEY

CLASS 44—(Continued).

SN 78-429,258. KWON, RON, WAILUKU, MAUI, HI. FILED 6-3-2004.



NO CLAIM IS MADE TO THE EXCLUSIVE RIGHT TO USE "HEALTH AND MEDICAL CENTER", APART FROM THE MARK AS SHOWN.

THE COLOR(S) CYAN BLUE IS/ARE CLAIMED AS A FEATURE OF THE MARK.

THE COLOR BLUE APPEARS IN THE UPPER ARC AND PORTION OF THE WHITE SEMI-CIRCLE ABOVE THE WORDING "MALULANI HEALTH AND MEDICAL CENTER".

THE FOREIGN WORDING IN THE MARK TRANSLATES INTO ENGLISH AS "UNDER THE SHELTER OR PROTECTION OF HEAVEN".

FOR HOSPITAL (U.S. CLS. 100 AND 101).

ANNE E. GUSTASON, EXAMINING ATTORNEY

CLASS 44—(Continued).

LETTERS APPEAR IN LOWER CASE LETTERS. ALIGNED UNDER THE LETTERS "TERS" IS ANOTHER STYLIZED HORIZONTAL WAVE. THREE MORE HORIZONTAL WAVE MARKS, THAT ARE VERTICALLY STACKED AND APPEAR BELOW AND TO THE LEFT OF THE SECOND HORIZONTAL WAVE, ARE CENTERED BELOW THE LETTERS "ATE." BELOW AND TO THE RIGHT OF THE FIFTH HORIZONTAL WAVE, IN A STYLIZED FONT, ARE THE WORDS "MEDICAL DAY SPA" IN LOWER CASE LETTERS.

FOR HEALTH SPA SERVICES, NAMELY, COSMETIC BODY CARE SERVICES; MASSAGE SERVICES; LASER HAIR REMOVAL; LASER SKIN RESURFACING; LASER VEIN THERAPY; FACIAL REJUVENATION THERAPY, NAMELY MICRODERMABRASION, SCLEROTHERAPY, LASER WRINKLE REDUCTION, CHEMICAL PEELS FOR SKIN, SKIN PHOTOREJUVENATION, AND HYPODERMIC INJECTIONS OF COLLAGEN, DERMALOGEN, OR HYALURONIC ACID; COSMETIC AND RECONSTRUCTIVE FACIAL SURGERY; HOLISTIC AND ALTERNATIVE HEALING THROUGH HANDS-ON MASSAGE THERAPIES; BODY WAXING; COSMETIC ELECTROLYSIS; AND CELLULITE REDUCTION TREATMENTS USING LIGHT AND RADIO WAVE FREQUENCIES (U.S. CLS. 100 AND 101).

FIRST USE 5-9-2002; IN COMMERCE 5-9-2002.

JACQUELINE A. LAVINE, EXAMINING ATTORNEY

SN 78-435,672. WASHOE HEALTH SYSTEM, RENO, NV. FILED 6-15-2004.

WASHOE MEDICAL CENTER

SN 78-430,898. HEALING WATERS MEDICAL DAY SPA, LC, WICHITA, KS. FILED 6-7-2004.



NO CLAIM IS MADE TO THE EXCLUSIVE RIGHT TO USE "MEDICAL DAY SPA", APART FROM THE MARK AS SHOWN.

THE MARK CONSISTS OF THE WORD HEALING IN A STYLIZED SCRIPT FONT ABOVE A STYLIZED HORIZONTAL WAVE. THE H OF HEALING IS CAPITALIZED AND THE REST OF THE LETTERS APPEAR IN LOWER CASE LETTERS. THE WORD WATERS IN A STYLIZED SCRIPT FONT APPEARS BELOW THE WAVE AND IS ALIGNED ON THE LEFT WITH THE WORD HEALING. THE W OF WATERS IS CAPITALIZED AND THE REST OF THE

THE MARK CONSISTS OF STANDARD CHARACTERS WITHOUT CLAIM TO ANY PARTICULAR FONT, STYLE, SIZE, OR COLOR.

NO CLAIM IS MADE TO THE EXCLUSIVE RIGHT TO USE "MEDICAL CENTER", APART FROM THE MARK AS SHOWN.

SEC. 2(F).

FOR ADDICTION TREATMENT SERVICES; EMERGENCY MEDICAL ASSISTANCE; HEALTHCARE; HOME HEALTH CARE SERVICES; HOME NURSING AID SERVICES; HOSPITALS; MANAGED HEALTH CARE SERVICES; MEDICAL CLINICS; MEDICAL COUNSELING; MEDICAL EVALUATION SERVICES, NAMELY, FUNCTIONAL ASSESSMENT PROGRAM FOR PATIENTS RECEIVING MEDICAL REHABILITATION SERVICES FOR PURPOSES OF GUIDING TREATMENT AND ASSESSING PROGRAM EFFECTIVENESS; MEDICAL IMAGING SERVICES; MEDICAL SERVICES; MEDICAL TESTING; MENTAL HEALTH SERVICES; NURSING CARE; NUTRITION COUNSELING; OBSTETRIC AND GYNECOLOGY SERVICES; PHYSICAL THERAPY; PHYSICIAN SERVICES; PROVIDING HEALTH INFORMATION; PROVIDING MEDICAL INFORMATION; PSYCHIATRIC CONSULTATION; PSYCHIATRIC SERVICES; PSYCHIATRIC TESTING; PSYCHOLOGICAL CONSULTATION; PSYCHOLOGICAL COUNSELING; PSYCHOLOGICAL TESTING SERVICES; REHABILITATION OF ALCOHOL ADDICTED PATIENTS; REHABILITATION OF DRUG ADDICTED PATIENTS; REHABILITATION OF NARCOTIC ADDICTED PATIENTS; X-RAY TECHNICIAN SERVICES (U.S. CLS. 100 AND 101).

FIRST USE 1-31-1986; IN COMMERCE 1-31-1986.

SAMUEL E. SHARPER JR., EXAMINING ATTORNEY

CLASS 44—(Continued).

SN 78-439,205. INGENIX, INC., EDEN PRAIRIE, MN. FILED 6-22-2004.

INGENIX TOUCHSTONE

THE MARK CONSISTS OF STANDARD CHARACTERS WITHOUT CLAIM TO ANY PARTICULAR FONT, STYLE, SIZE, OR COLOR.

OWNER OF U.S. REG. NOS. 2,390,360, 2,676,239 AND OTHERS.

FOR PROVIDING AN ON-LINE COMPUTER DATABASE IN THE FIELD OF HEALTH CARE USED IN CONNECTION WITH HEALTH AND PRODUCTIVITY RESEARCH AND ANALYSIS (U.S. CLS. 100 AND 101).

FIRST USE 4-14-2004; IN COMMERCE 4-14-2004.
BRIDGETT SMITH, EXAMINING ATTORNEY

SN 78-446,267. AETNA INC., BLUE BELL, PA. FILED 7-6-2004.

**AETNA HEALTHY BODY,
HEALTHY WEIGHT
PROGRAM**

THE MARK CONSISTS OF STANDARD CHARACTERS WITHOUT CLAIM TO ANY PARTICULAR FONT, STYLE, SIZE, OR COLOR.

NO CLAIM IS MADE TO THE EXCLUSIVE RIGHT TO USE "HEALTHY BODY, HEALTHY WEIGHT PROGRAM", APART FROM THE MARK AS SHOWN.

FOR PROVIDING HEALTH CARE INFORMATION IN THE FIELD OF WEIGHT MANAGEMENT, DISEASE PREVENTION AND WELLNESS (U.S. CLS. 100 AND 101).
FRED MANDIR, EXAMINING ATTORNEY

SN 78-446,305. MENTAL HEALTH RESOURCE FOUNDATION, OGDEN, UT. FILED 7-6-2004.



NO CLAIM IS MADE TO THE EXCLUSIVE RIGHT TO USE "MENTAL HEALTH," "RESOURCE FOUNDATION," AND "FOR MENTAL, SOCIAL, & EMOTIONAL SUPPORT", APART FROM THE MARK AS SHOWN.

THE COLOR(S) BLUE, BLACK, WHITE ON A BLUE BACKGROUND IS/ARE CLAIMED AS A FEATURE OF THE MARK.

THE MARK CONSISTS OF THE WORD "MENTAL" IN

CLASS 44—(Continued).

BLUE, ALL CAPITAL LETTERS SITS ABOVE A GLOBE OF THE EARTH SHOWING THE NORTH AND SOUTH AMERICAN CONTINENTS. A BLACK LINE EXTENDS HORIZONTALLY FROM EITHER SIDE OF THE GLOBE. THE WORD "HEALTH" IN BLUE, ALL CAPITAL LETTERS IS PLACED UNDER THE GLOBE AND CURVES SO THE OUTSIDE LETTERS ARE TALLER THAN THE INSIDE LETTERS. DIRECTLY BELOW "HEALTH", "RESOURCE FOUNDATION" IS IN BLACK, ALL CAPITAL LETTERS. BELOW "RESOURCE FOUNDATION", ON A RECTANGULAR BLOCK OF BLUE, ARE THE WORDS "FOR MENTAL, SOCIAL, & EMOTIONAL SUPPORT" WITH THE INITIAL LETTER OF EACH WORD CAPITALIZED. THE ENTIRE MARK IS SURROUNDED BY A BLACK LINE

FOR MENTAL HEALTH SERVICES PROVIDING, NAMELY, RESOURCES AND INFORMATION IN THE FIELD OF MENTAL HEALTH TO RELIGIOUS AND COMMUNITY ORGANIZATIONS (U.S. CLS. 100 AND 101).

FIRST USE 4-15-2004; IN COMMERCE 4-15-2004.
ROBIN CHOSID, EXAMINING ATTORNEY

SN 78-447,200. MEDICOR LABS CORP., CARROLLTON, TX. FILED 7-7-2004.

123 FEEL BETTER

THE MARK CONSISTS OF STANDARD CHARACTERS WITHOUT CLAIM TO ANY PARTICULAR FONT, STYLE, SIZE, OR COLOR.

FOR COMPREHENSIVE WELLNESS PROGRAM CONSISTING OF A TREATMENT THAT COMBINES NUTRITIONAL HERBAL FORMULATIONS AND AN INDIVIDUAL'S ACTIVE PARTICIPATION IN A BEHAVIOR MODIFICATION REGIMEN BASED ON THE THEORY OF COGNITIVE BEHAVIORAL THERAPY (CBT), DESIGNED TO CREATE, ENHANCE AND MAINTAIN EMOTIONAL, MENTAL, SPIRITUAL AND PHYSICAL WELLNESS, FOR USE IN TREATING ANXIETY, SOCIAL ANXIETY, GENERALIZED ANXIETY DISORDER, OBSESSIVE COMPULSIVE DISORDER, PANIC ATTACKS, MOOD SWINGS, DEPRESSION, BIPOLAR DEPRESSION I AND II, ANGER MANAGEMENT, PERFECTIONISM, AND RELATED EMOTIONAL DISTURBANCES (U.S. CLS. 100 AND 101).

FIRST USE 5-1-2004; IN COMMERCE 5-15-2004.
MELVIN AXILBUND, EXAMINING ATTORNEY

CLASS 44—(Continued).

SN 78-448,096. ROANOKE HEART INSTITUTE, P.L.C., ROANOKE, VA. FILED 7-8-2004.

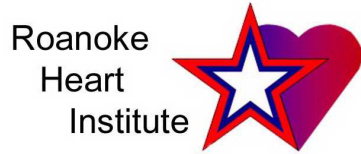

NO CLAIM IS MADE TO THE EXCLUSIVE RIGHT TO USE "ROANOKE HEART INSTITUTE", APART FROM THE MARK AS SHOWN.

THE COLOR(S) RED, WHITE AND BLUE IS/ARE CLAIMED AS A FEATURE OF THE MARK.

THE COLOR RED APPEARS IN THE OUTER BORDER OF THE STAR AND THE COLOR BLUE APPEARS IN THE INNER OUTLINE OF THE STAR. THE HEART CONTAINS A GRADIENT OF THE COLOR RED AND BLUE.

FOR CARDIOVASCULAR MEDICINE SERVICES, NAMELY, TREATMENT OF HEART DISEASE (U.S. CLS. 100 AND 101).

FIRST USE 6-15-2003; IN COMMERCE 6-15-2003. NAAKWAMA ANKRAH, EXAMINING ATTORNEY

CLASS 44—(Continued).

SN 78-453,226. NATIONAL ASSOCIATION FOR HEALTH-CARE COMMUNICATIONS, INC., THE, SULLIVAN, IL. FILED 7-20-2004.

**Family Access
Anywhere**

THE MARK CONSISTS OF STANDARD CHARACTERS WITHOUT CLAIM TO ANY PARTICULAR FONT, STYLE, SIZE, OR COLOR.

FOR PROVIDING MEDICAL INFORMATION VIA THE INTERNET (U.S. CLS. 100 AND 101).

FIRST USE 7-19-2004; IN COMMERCE 7-19-2004. LOURDES AYALA, EXAMINING ATTORNEY

SN 78-451,052. ADVANCED BODY SOLUTIONS, INC., ENCINITAS, CA. FILED 7-15-2004.



NO CLAIM IS MADE TO THE EXCLUSIVE RIGHT TO USE "BODY" AND "INC", APART FROM THE MARK AS SHOWN.

FOR HEALTH SPA SERVICES, NAMELY, SPA OFFERING SKIN AND BODY TREATMENTS (U.S. CLS. 100 AND 101).

FIRST USE 6-10-2003; IN COMMERCE 6-10-2003. GEORGIA CARTY, EXAMINING ATTORNEY

SN 78-456,931. LVRC HOLDINGS, LLC, LAS VEGAS, NV. FILED 7-26-2004.



NO CLAIM IS MADE TO THE EXCLUSIVE RIGHT TO USE "LAS VEGAS RECOVERY CENTER", APART FROM THE MARK AS SHOWN.

THE COLOR RED AND GREEN ARE CLAIMED AS A FEATURE OF THE MARK.

THE MARK CONSISTS OF WORDS LAS VEGAS AND BELOW THAT THE WORDS RECOVERY CENTER ALL IN RED COLOR UNDER A STYLIZED AGAVE PLANT IN DIFFERENT SHADES OF GREEN COLOR.

FOR ADDICTION TREATMENT SERVICES, NAMELY, MEDICALLY-MANAGED WITHDRAWAL AND CHEMICAL DEPENDENCY TREATMENT SERVICES; MEDICAL EVALUATION SERVICES, NAMELY, FUNCTIONAL ASSESSMENT PROGRAM FOR PATIENTS RECEIVING MEDICAL REHABILITATION SERVICES FOR PURPOSE OF GUIDING TREATMENT AND ASSESSING PROGRAM EFFECTIVENESS (U.S. CLS. 100 AND 101).

FIRST USE 2-15-2004; IN COMMERCE 2-15-2004. ELISSA GARBER KON, EXAMINING ATTORNEY

CLASS 44—(Continued).

SN 78-456,953. LVRC HOLDINGS, LLC, LAS VEGAS, NV. FILED 7-26-2004.

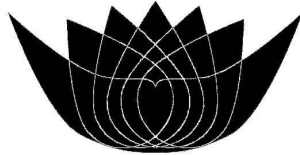

LAS VEGAS
RECOVERY CENTER

Renewal Recovery Results...
One Client at a Time

NO CLAIM IS MADE TO THE EXCLUSIVE RIGHT TO USE "LAS VEGAS RECOVERY CENTER", APART FROM THE MARK AS SHOWN.

THE MARK CONSISTS OF THE WORDS LAS VEGAS AND BELOW THAT THE WORDS RECOVERY CENTER, AND BELOW THAT THE WORDS RENEWAL RECOVERY RESULTS... AND BELOW THAT THE WORDS ONE CLIENT AT A TIME UNDER A STYLIZED AGAVE PLANT.

FOR ADDICTION TREATMENT SERVICES, NAMELY, MEDICALLY-MANAGED WITHDRAWAL AND CHEMICAL DEPENDENCY TREATMENT SERVICES; MEDICAL EVALUATION SERVICES, NAMELY, FUNCTIONAL ASSESSMENT PROGRAM FOR PATIENTS RECEIVING MEDICAL REHABILITATION SERVICES FOR PURPOSE OF GUIDING TREATMENT AND ASSESSING PROGRAM EFFECTIVENESS (U.S. CLS. 100 AND 101).

FIRST USE 2-15-2004; IN COMMERCE 2-15-2004.
ELISSA GARBER KON, EXAMINING ATTORNEY

SN 78-458,118. TLC VISION CORPORATION, ST. LOUIS, MO. FILED 7-28-2004.

**TLC LIFETIME
COMMITMENT**

THE MARK CONSISTS OF STANDARD CHARACTERS WITHOUT CLAIM TO ANY PARTICULAR FONT, STYLE, SIZE, OR COLOR.

OWNER OF U.S. REG. NOS. 2,464,092, 2,809,088 AND 2,862,627.

FOR MEDICAL SERVICES IN THE FIELD OF OPHTHALMOLOGY (U.S. CLS. 100 AND 101).

FIRST USE 11-1-2002; IN COMMERCE 11-1-2002.
CHRISTOPHER BUONGIORNO, EXAMINING ATTORNEY

CLASS 44—(Continued).

SN 78-461,730. OMS INVESTMENTS, INC., LOS ANGELES, CA. FILED 8-4-2004.

NATURE SCAPES

THE MARK CONSISTS OF STANDARD CHARACTERS WITHOUT CLAIM TO ANY PARTICULAR FONT, STYLE, SIZE, OR COLOR.

OWNER OF U.S. REG. NO. 1,850,111.
FOR LANDSCAPE GARDENING SERVICES (U.S. CLS. 100 AND 101).
ZACHARY BELLO, EXAMINING ATTORNEY

SN 78-463,437. INSPEECH, INC., TUCSON, AZ. FILED 8-6-2004.



Associates in Speech Therapy
Where opportunity speaks its own language.

NO CLAIM IS MADE TO THE EXCLUSIVE RIGHT TO USE ASSOCIATES IN SPEECH THERAPY, APART FROM THE MARK AS SHOWN.

THE COLOR(S) BLUE, BLACK AND GREY IS/ARE CLAIMED AS A FEATURE OF THE MARK.

THE COLOR BLUE APPEARS AS THE OUTLINE OF THE LADY'S FACE AND HAIR, AS WELL AS FOR THE LETTERING FOR THE WORDS "ASSOCIATES IN SPEECH THERAPY." THE COLOR GREY APPEARS AS THE BREATH COMING FROM THE LADY'S FACE AS WELL AS FOR THE LETTERING FOR THE WORDS "WHERE OPPORTUNITY SPEAKS ITS OWN LANGUAGE." THE COLOR BLACK APPEARS IN THE LETTERING FOR THE WORDS "INSPEECH."

FOR SPEECH AND HEARING THERAPY AND REHABILITATION (U.S. CLS. 100 AND 101).

FIRST USE 1-1-2004; IN COMMERCE 1-1-2004.
ERNEST SHOSHO, EXAMINING ATTORNEY

CLASS 44—(Continued).

SN 78-465,050. INGRIDIENTS, INC., TAMPA, FL. FILED 8-10-2004.

CLASS 44—(Continued).

SN 78-471,549. ELYSIAN VISION, OROVILLE, WA. FILED 8-22-2004.

INGRIDIENTS

Mommy-Muse.com

THE MARK CONSISTS OF STANDARD CHARACTERS WITHOUT CLAIM TO ANY PARTICULAR FONT, STYLE, SIZE, OR COLOR.
FOR PROVIDING ON-LINE INFORMATION IN THE FIELD OF NUTRITION (U.S. CLS. 100 AND 101).
FIRST USE 9-1-1982; IN COMMERCE 10-1-2002.
DOMINIC J. FERRAIUOLO, EXAMINING ATTORNEY

THE MARK CONSISTS OF STANDARD CHARACTERS WITHOUT CLAIM TO ANY PARTICULAR FONT, STYLE, SIZE, OR COLOR.
FOR ONLINE MEDICAL, HEALTHCARE, AND PSYCHOLOGICAL COUNSELING SERVICES FOR NEW MOTHERS; PROVIDING ONLINE RESOURCES NAMELY, PROVIDING ONLINE MEDICAL, HEALTHCARE, AND PSYCHOLOGICAL INFORMATION FOR NEW MOTHERS (U.S. CLS. 100 AND 101).
FIRST USE 7-0-2004; IN COMMERCE 7-0-2004.
RUDY R. SINGLETON, EXAMINING ATTORNEY

SN 78-466,296. SWANSON, ROBERT J., BERKELEY, CA. FILED 8-12-2004.

SN 78-477,224. TIGHT CUTS, INC., MERIDIAN, ID. FILED 9-1-2004.

New Skin Clinic

TIGHT CUTS

THE MARK CONSISTS OF STANDARD CHARACTERS WITHOUT CLAIM TO ANY PARTICULAR FONT, STYLE, SIZE, OR COLOR.
NO CLAIM IS MADE TO THE EXCLUSIVE RIGHT TO USE "SKIN CLINIC", APART FROM THE MARK AS SHOWN.
FOR SKIN TREATMENT SERVICES, NAMELY, HAIR REMOVAL AND REPAIR OF LESIONS CAUSED BY AGE AND SUN DAMAGE (U.S. CLS. 100 AND 101).
KEVIN DINALLO, EXAMINING ATTORNEY

THE MARK CONSISTS OF STANDARD CHARACTERS WITHOUT CLAIM TO ANY PARTICULAR FONT, STYLE, SIZE, OR COLOR.
NO CLAIM IS MADE TO THE EXCLUSIVE RIGHT TO USE "CUTS", APART FROM THE MARK AS SHOWN.
FOR HAIR SALON SERVICES PROVIDING PROFESSIONAL HAIR CARE SERVICES FOR MEN AND WOMEN WITH AN EMPHASIS ON HAIR CUTS AND COLORING SERVICES (U.S. CLS. 100 AND 101).
FIRST USE 11-1-2003; IN COMMERCE 11-1-2003.
JANICE L. MCMORROW, EXAMINING ATTORNEY

CLASS 44—(Continued).

SN 78-477,301. ST. MARY'S DULUTH CLINIC HEALTH SYSTEM, DULUTH, MN. FILED 9-1-2004.



THE MARK CONSISTS OF AN ASYMMETRICAL DIAMOND INSIDE OF A DIAMOND.
FOR HEALTH CARE SERVICES, MEDICAL SERVICES AND HOSPITAL SERVICES (U.S. CLS. 100 AND 101).
FIRST USE 1-15-2004; IN COMMERCE 1-15-2004.
CAROLINE WOOD, EXAMINING ATTORNEY

CLASS 44—(Continued).

SN 78-482,930. PERLAZA, HAROLD, SHERMAN OAKS, CA. FILED 9-14-2004.

**Where Smiles
Change Everyday!**

THE MARK CONSISTS OF STANDARD CHARACTERS WITHOUT CLAIM TO ANY PARTICULAR FONT, STYLE, SIZE, OR COLOR.
NO CLAIM IS MADE TO THE EXCLUSIVE RIGHT TO USE "SMILES", APART FROM THE MARK AS SHOWN.
FOR DENTIST SERVICES, NAMELY GENERAL DENTAL SERVICES AND COSMETIC DENTAL SERVICES (U.S. CLS. 100 AND 101).
FIRST USE 8-2-2002; IN COMMERCE 8-2-2002.
WON TEAK OH, EXAMINING ATTORNEY

SN 78-477,420. OREGON RESEARCH INSTITUTE, EUGENE, OR. FILED 9-1-2004.

ChewFree

THE MARK CONSISTS OF STANDARD CHARACTERS WITHOUT CLAIM TO ANY PARTICULAR FONT, STYLE, SIZE, OR COLOR.
FOR ADDICTION TREATMENT SERVICES FEATURING SMOKELESS TOBACCO CESSATION PROGRAMS (U.S. CLS. 100 AND 101).
FIRST USE 9-1-1996; IN COMMERCE 9-1-1996.
FLORENTINA BLANDU, EXAMINING ATTORNEY

SN 78-484,266. DEAN, TERCITA L., ALAMEDA, CA. FILED 9-15-2004.



THE STIPPLING IS FOR SHADING PURPOSES ONLY. THE MARK CONSISTS OF A DRAWING OF A WOMAN WEARING A SUIT.
FOR MEDICAL, DENTAL, OSTEOPATHIC AND NATUROPATHIC MEDICINE SERVICES (U.S. CLS. 100 AND 101).
FIRST USE 4-11-2004; IN COMMERCE 4-11-2004.
ALEXANDER L. POWERS, EXAMINING ATTORNEY

CLASS 44—(Continued).

SN 78-487,858. AMERICAN RETIREMENT CORPORATION, BRENTWOOD, TN. FILED 9-22-2004.



NO CLAIM IS MADE TO THE EXCLUSIVE RIGHT TO USE "INNOVATIVE SENIOR CARE", APART FROM THE MARK AS SHOWN.

FOR PHYSICAL THERAPY, OCCUPATIONAL THERAPY, SPEECH THERAPY, MEDICAL FITNESS EVALUATION AND MASSAGE THERAPY (U.S. CLS. 100 AND 101).

FIRST USE 9-9-2004; IN COMMERCE 9-9-2004.
JAMES A. RAUEN, EXAMINING ATTORNEY

CLASS 44—(Continued).

SN 78-489,919. NOVARTIS AG, BASEL, SWITZERLAND, FILED 9-27-2004.

I.S.E.

THE MARK CONSISTS OF STANDARD CHARACTERS WITHOUT CLAIM TO ANY PARTICULAR FONT, STYLE, SIZE, OR COLOR.

FOR HEALTH INFORMATION SERVICES, NAMELY, PROVIDING INFORMATION ON HUMAN DISEASES AND DISORDERS AND ON AVAILABLE TREATMENTS FOR PATIENTS THROUGH GLOBAL COMPUTER NETWORKS, RADIO AND TELEVISION PUBLIC SERVICE ANNOUNCEMENTS (U.S. CLS. 100 AND 101).

ZACHARY BELLO, EXAMINING ATTORNEY

SN 78-488,302. SCHWARTZ, DAVID, BRICK, NJ. FILED 9-23-2004.

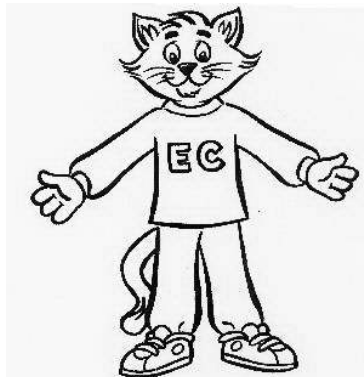

FOR HEALTH CARE, NAMELY, FALL PREVENTION ASSESSMENT AND TREATMENT SERVICES (U.S. CLS. 100 AND 101).

FIRST USE 1-1-2000; IN COMMERCE 1-1-2000.
CAROLINE WOOD, EXAMINING ATTORNEY

SN 78-489,921. NOVARTIS AG, BASEL, SWITZERLAND, FILED 9-27-2004.

I.A.P.

THE MARK CONSISTS OF STANDARD CHARACTERS WITHOUT CLAIM TO ANY PARTICULAR FONT, STYLE, SIZE, OR COLOR.

FOR HEALTH INFORMATION SERVICES, NAMELY, PROVIDING INFORMATION ON HUMAN DISEASES AND DISORDERS AND ON AVAILABLE TREATMENTS FOR PATIENTS THROUGH GLOBAL COMPUTER NETWORKS, RADIO AND TELEVISION PUBLIC SERVICE ANNOUNCEMENTS (U.S. CLS. 100 AND 101).

ZACHARY BELLO, EXAMINING ATTORNEY

CLASS 44—(Continued).

SN 78-489,922. NOVARTIS AG, BASEL, SWITZERLAND,
FILED 9-27-2004.

I.A.E.

THE MARK CONSISTS OF STANDARD CHARACTERS WITHOUT CLAIM TO ANY PARTICULAR FONT, STYLE, SIZE, OR COLOR.

FOR HEALTH INFORMATION SERVICES, NAMELY, PROVIDING INFORMATION ON HUMAN DISEASES AND DISORDERS AND ON AVAILABLE TREATMENTS FOR PATIENTS THROUGH GLOBAL COMPUTER NETWORKS, RADIO AND TELEVISION PUBLIC SERVICE ANNOUNCEMENTS (U.S. CLS. 100 AND 101).
ZACHARY BELLO, EXAMINING ATTORNEY



SN 78-489,934. NOVARTIS AG, BASEL, SWITZERLAND,
FILED 9-27-2004.

IAP

THE MARK CONSISTS OF STANDARD CHARACTERS WITHOUT CLAIM TO ANY PARTICULAR FONT, STYLE, SIZE, OR COLOR.

FOR HEALTH INFORMATION SERVICES, NAMELY, PROVIDING INFORMATION ON HUMAN DISEASES AND DISORDERS AND ON AVAILABLE TREATMENTS FOR PATIENTS THROUGH GLOBAL COMPUTER NETWORKS, RADIO AND TELEVISION PUBLIC SERVICE ANNOUNCEMENTS (U.S. CLS. 100 AND 101).
ZACHARY BELLO, EXAMINING ATTORNEY

CLASS 44—(Continued).

SN 78-489,935. NOVARTIS AG, BASEL, SWITZERLAND,
FILED 9-27-2004.

ISE

THE MARK CONSISTS OF STANDARD CHARACTERS WITHOUT CLAIM TO ANY PARTICULAR FONT, STYLE, SIZE, OR COLOR.

FOR HEALTH INFORMATION SERVICES, NAMELY, PROVIDING INFORMATION ON HUMAN DISEASES AND DISORDERS AND ON AVAILABLE TREATMENTS FOR PATIENTS THROUGH GLOBAL COMPUTER NETWORKS, RADIO AND TELEVISION PUBLIC SERVICE ANNOUNCEMENTS (U.S. CLS. 100 AND 101).
ZACHARY BELLO, EXAMINING ATTORNEY



SN 78-491,117. TEAL NW, LLC, SALEM, OR. FILED 9-28-2004.



NO CLAIM IS MADE TO THE EXCLUSIVE RIGHT TO USE "BRONZE" OR "TANNING STUDIO", APART FROM THE MARK AS SHOWN.

FOR TANNING SALON SERVICES (U.S. CLS. 100 AND 101).
EVELYN BRADLEY, EXAMINING ATTORNEY

CLASS 44—(Continued).

SN 78-492,752. SURGICENTER OF GREATER MILWAUKEE LIMITED PARTNERSHIP, MILWAUKEE, WI. FILED 9-30-2004.



NO CLAIM IS MADE TO THE EXCLUSIVE RIGHT TO USE "SURGICENTER OF GREATER MILWAUKEE", APART FROM THE MARK AS SHOWN.

THE COLOR(S) BLUE IS/ARE CLAIMED AS A FEATURE OF THE MARK.

THE MARK CONSISTS OF THE WORD SURGICENTER IN STYLIZED BLUE LETTERING, BENEATH WHICH ARE THE WORDS OF GREATER MILWAUKEE IN SMALLER BLACK STYLIZED LETTERING AND TO THE LEFT OF WHICH IS A STYLIZED BLUE LETTER S SUPERIMPOSED OVER A STYLIZED BLACK CADUCEUS SYMBOL.

FOR HEALTH CARE AND SURGICAL SERVICES (U.S. CLS. 100 AND 101).

FIRST USE 0-0-1991; IN COMMERCE 0-0-1991.
ZACHARY BELLO, EXAMINING ATTORNEY

CLASS 44—(Continued).

SN 78-496,219. CHOICE HEARING CENTER, INC., NEW PHILADELPHIA, OH. FILED 10-7-2004.

Choice Hearing Center

THE MARK CONSISTS OF STANDARD CHARACTERS WITHOUT CLAIM TO ANY PARTICULAR FONT, STYLE, SIZE, OR COLOR.

NO CLAIM IS MADE TO THE EXCLUSIVE RIGHT TO USE HEARING CENTER, APART FROM THE MARK AS SHOWN.

FOR HEARING AID SERVICES (U.S. CLS. 100 AND 101).

FIRST USE 2-15-1994; IN COMMERCE 2-15-1994.
GENE MACIOL, EXAMINING ATTORNEY

SN 78-493,447. KNOCKOUTS LP, DALLAS, TX. FILED 10-1-2004.

KNOCKOUTS GIRLS

THE MARK CONSISTS OF STANDARD CHARACTERS WITHOUT CLAIM TO ANY PARTICULAR FONT, STYLE, SIZE, OR COLOR.

OWNER OF U.S. REG. NOS. 2,843,021 AND 2,889,142.

NO CLAIM IS MADE TO THE EXCLUSIVE RIGHT TO USE "GIRLS", APART FROM THE MARK AS SHOWN.

FOR MASSAGE SERVICES, MANICURING AND PEDICURING SERVICES AND HAIR REMOVAL SERVICES (U.S. CLS. 100 AND 101).

FIRST USE 5-1-2004; IN COMMERCE 5-1-2004.
MONTIA G. PRESSEY, EXAMINING ATTORNEY

SN 78-496,347. CHOICE HEARING CENTER, INC., NEW PHILADELPHIA, OH. FILED 10-7-2004.

To Hear Well is To Live Well

THE MARK CONSISTS OF STANDARD CHARACTERS WITHOUT CLAIM TO ANY PARTICULAR FONT, STYLE, SIZE, OR COLOR.

FOR HEARING AID SERVICES (U.S. CLS. 100 AND 101).

FIRST USE 10-4-2004; IN COMMERCE 10-4-2004.
MARLENE BELL, EXAMINING ATTORNEY

CLASS 44—(Continued).

SN 78-496,699. PAJOLO ALPACAS, AUSTIN, MN. FILED 10-8-2004.

CLASS 44—(Continued).

SN 78-500,415. DEDICATED DENTAL SYSTEMS, INC., BAKERSFIELD, CA. FILED 10-15-2004.

**PRESCRIPTION FOR
QUALITY...PURE &
SIMPLE**



THE MARK CONSISTS OF STANDARD CHARACTERS WITHOUT CLAIM TO ANY PARTICULAR FONT, STYLE, SIZE, OR COLOR.

FOR ALPACA FARMING SERVICES (U.S. CLS. 100 AND 101).

FIRST USE 12-31-1997; IN COMMERCE 12-31-1997.
ANNE MADDEN, EXAMINING ATTORNEY

OWNER OF U.S. REG. NOS. 2,150,980 AND 2,172,814. NO CLAIM IS MADE TO THE EXCLUSIVE RIGHT TO USE DENTAL, APART FROM THE MARK AS SHOWN.

THE MARK CONSISTS OF A DESIGN ELEMENT, NAMELY, A CIRCLE FEATURING A SPARKLING SMILE DESIGN, FLANKED BY THE WORDS DEDICATED AND DENTAL; UNDERNEATH THIS FEATURE ARE THE WORDS THE DEDICATED DIFFERENCE!

FOR DENTISTRY SERVICES AND HEALTH CARE SERVICES IN THE NATURE OF DENTAL HEALTH MAINTENANCE ORGANIZATIONS (U.S. CLS. 100 AND 101).

FIRST USE 6-9-2004; IN COMMERCE 6-9-2004.
YSA DEJESUS, EXAMINING ATTORNEY

SN 78-500,267. WEISEN, LORRI, ROSEVILLE, MN. FILED 10-15-2004.

SN 78-500,550. HCA HEALTH SERVICES OF FLORIDA, INC., NASHVILLE, TN. FILED 10-15-2004.

FAIR-DO'S

**CARE THAT REVOLVES
AROUND YOU**

THE MARK CONSISTS OF STANDARD CHARACTERS WITHOUT CLAIM TO ANY PARTICULAR FONT, STYLE, SIZE, OR COLOR.

FOR HAIR STYLING SERVICES (U.S. CLS. 100 AND 101).

FIRST USE 8-1-2002; IN COMMERCE 8-1-2002.
BRENDAN MCCAULEY, EXAMINING ATTORNEY

THE MARK CONSISTS OF STANDARD CHARACTERS WITHOUT CLAIM TO ANY PARTICULAR FONT, STYLE, SIZE, OR COLOR.

FOR HOSPITALS (U.S. CLS. 100 AND 101).
FIRST USE 10-10-2004; IN COMMERCE 10-10-2004.
ELLEN BURNS, EXAMINING ATTORNEY

CLASS 44—(Continued).

SN 78-501,081. GUERTLER, LINDA M, BLYTHEWOOD, SC. FILED 10-17-2004.

Spiritual
Balancing

THE MARK CONSISTS OF STANDARD CHARACTERS WITHOUT CLAIM TO ANY PARTICULAR FONT, STYLE, SIZE, OR COLOR.

FOR HEALTH SERVICE FOR HEALTH AND WELLNESS OF THE BODY AND SPIRIT (U.S. CLS. 100 AND 101).

FIRST USE 10-4-2004; IN COMMERCE 10-4-2004.
MARK RADEMACHER, EXAMINING ATTORNEY

CLASS 44—(Continued).

SN 78-501,920. THE GOOD SAMARITAN HEALTH CENTER, INC., ATLANTA, GA. FILED 10-19-2004.



THE MARK CONSISTS OF TWO PERSONS IN FRONT OF A CROSS.

FOR HOSPITAL AND HEALTH CARE SERVICES (U.S. CLS. 100 AND 101).

FIRST USE 3-1-2004; IN COMMERCE 3-1-2004.
PRISCILLA MILTON, EXAMINING ATTORNEY

SN 78-501,133. WAG MY TAIL AMERICA, INC., TUJUNGA, CA. FILED 10-18-2004.

Wagmytail.com

THE MARK CONSISTS OF STANDARD CHARACTERS WITHOUT CLAIM TO ANY PARTICULAR FONT, STYLE, SIZE, OR COLOR.

FOR PET GROOMING BUSINESS (U.S. CLS. 100 AND 101).

FIRST USE 8-1-2004; IN COMMERCE 9-1-2004.
CHRIS WELLS, EXAMINING ATTORNEY

SN 78-506,293. AUSTIN COMPUTER DIAGNOSTIC, LTD., AUSTIN, TX. FILED 10-26-2004.



RIVER RANCH RADIOLOGY

NO CLAIM IS MADE TO THE EXCLUSIVE RIGHT TO USE "RADIOLOGY", APART FROM THE MARK AS SHOWN.

THE COLORS LIGHT BLUE, AND DARK BLUE ARE CLAIMED AS FEATURES OF THE MARK.

THE MARK CONSISTS OF A THREE CREST WAVE DESIGN WHICH FADES FROM DARK BLUE TO LIGHT BLUE AND BACK FOR EACH CREST.

FOR RADIOLOGY SERVICES (U.S. CLS. 100 AND 101).
FIRST USE 8-16-2002; IN COMMERCE 8-16-2002.
GEOFFREY FOSDICK, EXAMINING ATTORNEY

CLASS 44—(Continued).

SN 78-509,234. ALPHA BEAUTY CLINIC, INC., JACKSONVILLE, FL. FILED 11-1-2004.



THE COLOR(S) GREEN AND WHITE IS/ARE CLAIMED AS A FEATURE OF THE MARK.

THE COLOR GREEN APPEARS IN A BLOCK, CAPITAL N AND LINE DRAWING OF MALE AND FEMALE FIGURES WITHIN THE N.

THE MARK CONSISTS OF ONE FEMALE LINE DRAWN CHARACTER AND ONE MALE LINE DRAWN CHARACTER OVER-LYING A GREEN CAPITAL N.

FOR PERFORMING DIAGNOSIS OF DISEASES, NAMELY, THE DIAGNOSIS OF HAIR THINNING AND HAIR LOSS, NAMELY, HEREDITY, MALE PATTERN BALDNESS, DIET, ILLNESS OR DISEASE, MEDICATIONS, HORMONAL CHANGES, OVER-PROCESSING, AND STRESS; PERFORMING DIAGNOSIS OF DISEASES, NAMELY, THE DIAGNOSIS OF SCALP CONDITIONS, NAMELY, DRYNESS, OILINESS, AND SCALING; AND THE TREATMENT OF HAIR THINNING AND HAIR LOSS AND SCALP CONDITIONS, NAMELY, THROUGH THE USE OF DIETARY SUPPLEMENTS, TOPICAL APPLICATIONS, APPLICATION OF MULTI-CHROMAL LIGHT, SHAMPOOS AND CONDITIONERS, AND MASSAGE (U.S. CLS. 100 AND 101).

FIRST USE 6-8-2004; IN COMMERCE 10-1-2004.
BILL DAWE, EXAMINING ATTORNEY

SN 78-514,534. NELSON, CHARLIE, ROMOLAND, CA. FILED 11-10-2004.

**Bear Mountain
Terriers**

THE MARK CONSISTS OF STANDARD CHARACTERS WITHOUT CLAIM TO ANY PARTICULAR FONT, STYLE, SIZE, OR COLOR.

NO CLAIM IS MADE TO THE EXCLUSIVE RIGHT TO USE "TERRIERS", APART FROM THE MARK AS SHOWN. FOR BREEDING AMERICAN STAFFORDSHIRE TERRIERS (U.S. CLS. 100 AND 101).

FIRST USE 8-1-1989; IN COMMERCE 8-1-1989.
MICHAEL KEATING, EXAMINING ATTORNEY

CLASS 44—(Continued).

SN 78-518,244. EQUINE MRI OF NJ, LLC, OLDWICK, NJ. FILED 11-17-2004.

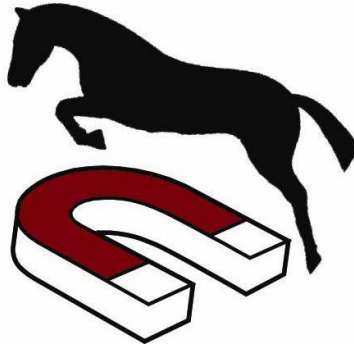

THE COLORS BLACK, BURGUNDY AND WHITE ARE CLAIMED AS A FEATURE OF THE MARK.

THE DEPICTED HORSE IS COLORED BLACK. THE UPPER PORTION OF THE DEPICTED MAGNET IS BURGUNDY AND THE LOWER PORTION OF THE MAGNET APPEARS IN WHITE.

THE MARK CONSISTS OF A BLACK HORSE JUMPING OVER A WHITE AND BURGUNDY MAGNET. FOR VETERINARY MRI SERVICES (U.S. CLS. 100 AND 101).

FIRST USE 7-22-2004; IN COMMERCE 7-22-2004.
APRIL L. RADEMACHER, EXAMINING ATTORNEY

SN 78-521,584. FAULKNER HOSPITAL, INC., BOSTON, MA. FILED 11-23-2004.

FAULKNER HOSPITAL

THE MARK CONSISTS OF STANDARD CHARACTERS WITHOUT CLAIM TO ANY PARTICULAR FONT, STYLE, SIZE, OR COLOR.

NO CLAIM IS MADE TO THE EXCLUSIVE RIGHT TO USE "HOSPITAL", APART FROM THE MARK AS SHOWN. SEC. 2(F).

FOR HOSPITAL AND HEALTH CARE SERVICES (U.S. CLS. 100 AND 101).

FIRST USE 0-0-1900; IN COMMERCE 0-0-1900.
ALINA MORRIS, EXAMINING ATTORNEY

CLASS 44—(Continued).

SN 78-523,970. BUREAU INTERNATIONAL DE MEDECINS SANS FRONTIERES, GENEVE 21, SWITZERLAND, FILED 11-29-2004.

MEDECINS SANS FRONTIERES

THE MARK CONSISTS OF STANDARD CHARACTERS WITHOUT CLAIM TO ANY PARTICULAR FONT, STYLE, SIZE, OR COLOR.

OWNER OF U.S. REG. NO. 1,156,743.

THE ENGLISH TRANSLATION OF MEDECINS SANS FRONTIERES IS DOCTORS WITHOUT BORDERS.

FOR CHARITABLE SERVICES, NAMELY, PROVIDING MEDICAL SERVICES TO UNDERDEVELOPED COUNTRIES (U.S. CLS. 100 AND 101).

FIRST USE 12-0-1971; IN COMMERCE 4-0-1991.

APRIL L. RADEMACHER, EXAMINING ATTORNEY

CLASS 44—(Continued).

SN 78-525,540. NIKOLAIDIS, GREGORY, AUSTIN, TX. FILED 12-1-2004.

LIPOSMOOTH

THE MARK CONSISTS OF STANDARD CHARACTERS WITHOUT CLAIM TO ANY PARTICULAR FONT, STYLE, SIZE, OR COLOR.

FOR PROVIDING AESTHETICS SERVICES, NAMELY A COMBINATION OF CELLULITE TREATMENT WHICH REMOVES CELLULITE THROUGH THE USE OF A RADIO-FREQUENCY DEVICE AND MESOTHERAPY, NAMELY INJECTIONS THAT MELT FAT (U.S. CLS. 100 AND 101).

CHRISTOPHER ADKINS, EXAMINING ATTORNEY

SN 78-525,106. BUREAU INTERNATIONAL DE MEDECINS SANS FRONTIERES, GENEVE 21, SWITZERLAND, FILED 12-1-2004.



OWNER OF U.S. REG. NO. 1,156,743.

THE COLOR(S) RED, BLACK AND WHITE ARE CLAIMED AS A FEATURE OF THE MARK

THE WORDING "MEDECINS SANS FRONTIERES DOCTORS WITHOUT BORDERS" APPEARS IN BLACK. THE LINE SEPARATING THE WORDING AND THE HEAD, ARMS, AND BACKGROUND BEHIND THE MAN RUNNING APPEAR IN RED. THE LEGS OF THE MAN RUNNING APPEAR IN WHITE.

THE ENGLISH TRANSLATION OF MEDECINS SANS FRONTIERES IS DOCTORS WITHOUT BORDERS.

FOR CHARITABLE SERVICES, NAMELY, PROVIDING MEDICAL SERVICES TO UNDERDEVELOPED COUNTRIES (U.S. CLS. 100 AND 101).

FIRST USE 12-0-1971; IN COMMERCE 10-0-2001.

APRIL L. RADEMACHER, EXAMINING ATTORNEY

SN 78-529,918. JACK J. KLAUSNER, D.D.S., P.C., DBA BACK BAY DENTAL CARE, BOSTON, MA. FILED 12-9-2004.

BACK BAY DENTAL CARE

THE MARK CONSISTS OF STANDARD CHARACTERS WITHOUT CLAIM TO ANY PARTICULAR FONT, STYLE, SIZE, OR COLOR.

NO CLAIM IS MADE TO THE EXCLUSIVE RIGHT TO USE "DENTAL CARE", APART FROM THE MARK AS SHOWN.

SEC. 2(F).

FOR DENTIST SERVICES (U.S. CLS. 100 AND 101).

FIRST USE 10-30-1998; IN COMMERCE 10-30-1998.

ANDREA K. NADELMAN, EXAMINING ATTORNEY

CLASS 44—(Continued).

SN 78-539,864. PIERRE MICHEL INC., NEW YORK, NY.
FILED 12-29-2004.

Pierre Michel

THE MARK CONSISTS OF STANDARD CHARACTERS WITHOUT CLAIM TO ANY PARTICULAR FONT, STYLE, SIZE, OR COLOR.

THE NAME(S), PORTRAIT(S), AND/OR SIGNATURE(S) SHOWN IN THE MARK DOES NOT IDENTIFY A PARTICULAR LIVING INDIVIDUAL.

FOR BEAUTY AND SALON SERVICES NAMELY HAIR AND SKIN CARE, HAIR CUTTING AND HAIR STYLING (U.S. CLS. 100 AND 101).

FIRST USE 3-1-1967; IN COMMERCE 3-1-1967.
FRED MANDIR, EXAMINING ATTORNEY

CLASS 44—(Continued).

SN 78-542,069. AFFINITY SALON INC., DAYTON, OH.
FILED 1-4-2005.



NO CLAIM IS MADE TO THE EXCLUSIVE RIGHT TO USE "SALON", APART FROM THE MARK AS SHOWN.

FOR SALON SERVICES THAT PROVIDE BEAUTY ENHANCEMENTS UTILIZING- HAIR STYLING, HAIR CUTTING, CHEMICAL RETEXTURIZING (STRAIGHTENING AND CURLING), HAIR COLORING, MANICURES, PEDICURES AND MAKEUP APPLICATION (U.S. CLS. 100 AND 101).

FIRST USE 2-15-1995; IN COMMERCE 3-15-1995.
REBECCA GAN, EXAMINING ATTORNEY

CLASS 45—PERSONAL SERVICES

SN 76-572,841. SECURICOM INC., HILLSIDE, IL. FILED 1-30-2004.

CHILDPAGE

THE MARK CONSISTS OF STANDARD CHARACTERS WITHOUT CLAIM TO ANY PARTICULAR FONT, STYLE, SIZE, OR COLOR.

FOR MONITORING OF CHILDREN FOR SECURITY PURPOSES (U.S. CLS. 100 AND 101).

FIRST USE 2-1-2002; IN COMMERCE 2-1-2002.
SOPHIA S. KIM, EXAMINING ATTORNEY

SN 78-540,358. DUTCHMAN TATTOOS, INC., NEW WESTMINSTER, BRITISH COLUMBIA, CANADA, FILED 12-30-2004.



NO CLAIM IS MADE TO THE EXCLUSIVE RIGHT TO USE "TATTOOS", APART FROM THE MARK AS SHOWN.

FOR TATTOOING SERVICES (U.S. CLS. 100 AND 101).
FIRST USE 8-30-1988; IN COMMERCE 1-21-1998.

VIVIAN MICZNIK FIRST, EXAMINING ATTORNEY

SN 76-575,256. ALLEN, YVONNE M., DBA FUNCHASERS.-COM, FAIRFAX, VA. FILED 2-12-2004.

Funchasers

THE MARK CONSISTS OF STANDARD CHARACTERS WITHOUT CLAIM TO ANY PARTICULAR FONT, STYLE, SIZE, OR COLOR.

FOR ONLINE SUBSCRIPTION-BASED DATING SERVICES (U.S. CLS. 100 AND 101).

FIRST USE 11-25-2003; IN COMMERCE 11-25-2003.
GENE MACIOL, EXAMINING ATTORNEY

CLASS 45—(Continued).

SN 76-581,081. SECURITY INSIGHT, OXON HILL, MD.
FILED 3-11-2004.



NO CLAIM IS MADE TO THE EXCLUSIVE RIGHT TO USE SECURITY, APART FROM THE MARK AS SHOWN. THE COLOR GRAY IS A FEATURE OF THE MARK. THE COLOR GRAY APPEARS AROUND THE OUTSIDE EDGES OF THE LARGE "S" AND THE LARGE "I". FOR CONSULTATION IN THE FIELD OF BUSINESS AND RESIDENTIAL SECURITY, FINANCIAL IDENTITY MONITORING SERVICES, AND SECURITY GUARD SERVICES (U.S. CLS. 100 AND 101). FIRST USE 10-1-2003; IN COMMERCE 10-1-2003. GINA HAYES, EXAMINING ATTORNEY

SN 76-592,725. BERNSTEIN, BRADLEY, EMERYVILLE, CA.
FILED 5-17-2004.

SPARK AVENUE

THE MARK CONSISTS OF STANDARD CHARACTERS WITHOUT CLAIM TO ANY PARTICULAR FONT, STYLE, SIZE, OR COLOR. FOR CONSULTATION SERVICES IN THE FIELD OF PERSONAL GROWTH (U.S. CLS. 100 AND 101). FIRST USE 0-0-2001; IN COMMERCE 0-0-2001. KIMBERLY PERRY, EXAMINING ATTORNEY

SN 76-597,831. WYNN RESORTS HOLDINGS, LLC, LAS VEGAS, NV. FILED 6-15-2004.

LAVENDER CHAPEL

THE MARK CONSISTS OF STANDARD CHARACTERS WITHOUT CLAIM TO ANY PARTICULAR FONT, STYLE, SIZE, OR COLOR. NO CLAIM IS MADE TO THE EXCLUSIVE RIGHT TO USE "CHAPEL", APART FROM THE MARK AS SHOWN. FOR WEDDING CHAPEL SERVICES (U.S. CLS. 100 AND 101). SOPHIA S. KIM, EXAMINING ATTORNEY

CLASS 45—(Continued).

SN 76-597,833. WYNN RESORTS HOLDINGS, LLC, LAS VEGAS, NV. FILED 6-15-2004.

LILAC CHAPEL

THE MARK CONSISTS OF STANDARD CHARACTERS WITHOUT CLAIM TO ANY PARTICULAR FONT, STYLE, SIZE, OR COLOR. NO CLAIM IS MADE TO THE EXCLUSIVE RIGHT TO USE "CHAPEL", APART FROM THE MARK AS SHOWN. FOR WEDDING CHAPEL SERVICES (U.S. CLS. 100 AND 101). SOPHIA S. KIM, EXAMINING ATTORNEY

SN 76-602,267. PINPOINT TRACKING SOLUTIONS, LLC, PACOIMA, CA. FILED 7-13-2004.



THE WORDING "PINPOINT" APPEARS IN DISTINCT FONT LETTERING IN ALL CAPITALS WITH THE LETTER "O" IN PINPOINT HAVING A FILLED IN CIRCLE AT ITS UPPER OPEN PORTION. EXTENDING OUT FROM THE LETTER "O" AND ONTO THE SURROUNDING TEXT ARE LARGER CIRCLES MIRRORING THE SHAPE OF THE LETTER "O". FOR STOLEN VEHICLE TRACKING SERVICES (U.S. CLS. 100 AND 101). FIRST USE 7-8-2004; IN COMMERCE 7-8-2004. RUSS HERMAN, EXAMINING ATTORNEY

SN 76-602,268. PINPOINT TRACKING SOLUTIONS, LLC, PACOIMA, CA. FILED 7-13-2004.

PINPOINT

THE MARK CONSISTS OF STANDARD CHARACTERS WITHOUT CLAIM TO ANY PARTICULAR FONT, STYLE, SIZE, OR COLOR. FOR STOLEN VEHICLE TRACKING SERVICES (U.S. CLS. 100 AND 101). FIRST USE 7-8-2004; IN COMMERCE 7-8-2004. RUSS HERMAN, EXAMINING ATTORNEY

CLASS 45—(Continued).

SN 76-605,117. MADININA DATA SYSTEMS, LLC, LOS ANGELES, CA. FILED 7-26-2004.

CLASS 45—(Continued).

SN 76-613,420. WCI COMMUNITIES, INC., BONITA SPRINGS, FL. FILED 9-29-2004.

PEOPLEFIND



THE MARK CONSISTS OF STANDARD CHARACTERS WITHOUT CLAIM TO ANY PARTICULAR FONT, STYLE, SIZE, OR COLOR.

FOR PROVIDING AN ON-LINE COMPUTER DATABASE IN THE FIELD OF LOCATING AND INVESTIGATING INDIVIDUALS, PLACES, ORGANIZATIONS, PHONE NUMBERS AND ELECTRONIC MAIL ADDRESSES (U.S. CLS. 100 AND 101).

FIRST USE 12-10-1997; IN COMMERCE 12-10-1997.
ANGELA M. MICHELI, EXAMINING ATTORNEY

NO CLAIM IS MADE TO THE EXCLUSIVE RIGHT TO USE SERVICES CONCIERGE, APART FROM THE MARK AS SHOWN.

FOR PERSONALIZED CONCIERGE SERVICES FOR OTHERS, NAMELY, MAKING REQUESTED PERSONAL ARRANGEMENTS AND RESERVATIONS, INCLUDING LAUNDRY, DRY CLEANING, IN-HOME SPA AND FITNESS, SCHEDULING DINNER AND THEATER RESERVATIONS, HOME REPAIR SERVICES, TRANSPORTATION SERVICES TO AND FROM THE AIRPORT HOME WATCH SERVICES, HOME OPENING AND CLOSING SERVICES, HOME CLEANING SERVICES, TRAVEL VENDOR SERVICES AND PROVIDING CUSTOMER-SPECIFIC INFORMATION TO MEET INDIVIDUAL NEEDS RENDERED TOGETHER IN LEISURE-ORIENTED RESIDENTIAL COMMUNITIES (U.S. CLS. 100 AND 101).

FIRST USE 3-25-2004; IN COMMERCE 3-25-2004.
PRISCILLA MILTON, EXAMINING ATTORNEY

SN 76-613,011. HICKMAN, JULIE D., SHAWNEE MISSION, KS. FILED 9-20-2004.

B.O.S.S. FORCE

THE MARK CONSISTS OF STANDARD CHARACTERS WITHOUT CLAIM TO ANY PARTICULAR FONT, STYLE, SIZE, OR COLOR.

FOR CONSULTING SERVICES IN THE FIELD OF SCHOOL SAFETY, SCHOOL SECURITY, PUBLIC SAFETY, AND SURVEILLANCE; SECURITY GUARD SERVICES, NAMELY, PROVIDING SECURITY PERSONNEL; PROVIDING CONSULTATION AND INFORMATION IN THE FIELD OF EMERGENCY RESPONSE FOR SCHOOLS AND BUSINESSES; EMERGENCY OPERATIONS PLANNING FOR SCHOOLS AND BUSINESSES, NAMELY, ASSISTING LOCALITIES AND LOCAL ENTITIES IN ORGANIZING AND ESTABLISHING GROUPS OF PRACTICING AND RETIRED PHYSICIANS, NURSES, AND OTHER HEALTH PROFESSIONALS TO ACT IN A COORDINATED MANNER IN TIMES OF LOCAL EMERGENCIES; CONSULTATION SERVICES IN THE FIELD OF SCHOOL SECURITY AND CRISIS PREPAREDNESS; PROVIDING SECURITY RISK MANAGEMENT, SECURITY RISK ANALYSIS, THREAT ASSESSMENT, AND VULNERABILITY ASSESSMENT ANALYSIS INCLUDING SIMULATIONS, MODELING, AND ALGORITHMS, IN THE FIELD OF SCHOOL SECURITY, FACILITIES SECURITY, AND PERSONNEL SECURITY. (U.S. CLS. 100 AND 101).

FIRST USE 5-19-2004; IN COMMERCE 5-19-2004.
JENNIFER MARTIN, EXAMINING ATTORNEY

SN 76-616,150. WORLD LITERATURE CRUSADE, COLORADO SPRINGS, CO. FILED 10-12-2004.

EVERY HOME FOR CHRIST

THE MARK CONSISTS OF STANDARD CHARACTERS WITHOUT CLAIM TO ANY PARTICULAR FONT, STYLE, SIZE, OR COLOR.

FOR MINISTERIAL SERVICES, NAMELY, TAKING GOSPEL LITERATURE TO HOMES (U.S. CLS. 100 AND 101).

FIRST USE 12-0-1985; IN COMMERCE 12-0-1985.
EUGENIA MARTIN, EXAMINING ATTORNEY

CLASS 45—(Continued).

SN 78-258,797. SPORTS OUTREACH AMERICA, GRAND RAPIDS, MI. FILED 6-5-2003.



OWNER OF U.S. REG. NO. 2,615,457.
FOR EVANGELISTIC MINISTRY SERVICES THAT INCLUDE SPORTS ACTIVITIES (U.S. CLS. 100 AND 101).
FIRST USE 3-12-2002; IN COMMERCE 3-12-2002.
KAREN BRACEY, EXAMINING ATTORNEY

CLASS 45—(Continued).

SN 78-354,527. COBURN, TAYLOR, PROVIDENCE, RI. FILED 1-20-2004.

ClariCare

THE MARK CONSISTS OF STANDARD CHARACTERS WITHOUT CLAIM TO ANY PARTICULAR FONT, STYLE, SIZE, OR COLOR.

FOR PERSONAL CARE ASSISTANCE OF ACTIVITIES OF DAILY LIVING, NAMELY BATHING, GROOMING AND PERSONAL MOBILITY FOR MENTALLY OR PHYSICALLY CHALLENGED PEOPLE; PERSONAL CHEF SERVICES (U.S. CLS. 100 AND 101).
FIRST USE 11-12-2003; IN COMMERCE 11-12-2003.
CHERYL CLAYTON, EXAMINING ATTORNEY

SN 78-294,497. U. S. SECURITY ASSOCIATES, INC., ROSWELL, GA. FILED 8-31-2003.



NO CLAIM IS MADE TO THE EXCLUSIVE RIGHT TO USE SECURITY ASSOCIATES, APART FROM THE MARK AS SHOWN.

SEC. 2(F) U.S. SECURITY ASSOCIATES.
FOR PROVIDING ONLINE INTERACTIVE INFORMATION SERVICES RELATING TO DETECTIVE AND INVESTIGATIVE SERVICES, SECURITY SERVICES, SECURITY GUARD SERVICES, SECURITY PATROL SERVICES, SECURITY EQUIPMENT LEASING AND SECURITY ALARM MONITORING (U.S. CLS. 100 AND 101).
FIRST USE 7-3-2003; IN COMMERCE 7-3-2003.
ANN LINNEHAN, EXAMINING ATTORNEY

SN 78-361,864. OZZ TV, INC., LOS ANGELES, CA. FILED 2-3-2004.

PRECOGNITO

THE MARK CONSISTS OF STANDARD CHARACTERS WITHOUT CLAIM TO ANY PARTICULAR FONT, STYLE, SIZE, OR COLOR.

FOR PROVIDING ONLINE INFORMATION VIA THE INTERNET IN THE FIELD OF SELF-IMPROVEMENT (U.S. CLS. 100 AND 101).
FIRST USE 9-20-2003; IN COMMERCE 9-20-2003.
HEATHER THOMPSON, EXAMINING ATTORNEY

CLASS 45—(Continued).

SN 78-371,529. WAINRIGHT, PHILIP H., KUALA LUMPUR, MALAYSIA, FILED 2-20-2004.

SPARTA

THE MARK CONSISTS OF STANDARD CHARACTERS WITHOUT CLAIM TO ANY PARTICULAR FONT, STYLE, SIZE, OR COLOR.

FOR MONITORING SECURITY SYSTEMS, NAMELY SYSTEMS WITH DATA REGARDING THE LOCATION, CHARACTERISTICS, AND MOVEMENTS OF GOODS IN TRANSPORT; MONITORING OF COMPUTER SYSTEMS FOR SECURITY PURPOSES; PROVIDING INFORMATION REGARDING UNDERSTANDING AND PREVENTING TERRORISM; AND SECURITY INSPECTION SERVICES FOR OTHERS (U.S. CLS. 100 AND 101).

FIRST USE 10-0-2003; IN COMMERCE 11-0-2003.
SUSAN STIGLITZ, EXAMINING ATTORNEY

CLASS 45—(Continued).

SN 78-375,828. JOHN RODRIGUEZ, WASHINGTON, DC, FILED 2-28-2004.

CITA CON EL TAROT "CRISTOBAL" EL HOMBRE DE LA SUERTE

THE MARK CONSISTS OF STANDARD CHARACTERS WITHOUT CLAIM TO ANY PARTICULAR FONT, STYLE, SIZE, OR COLOR.

THE ENGLISH TRANSLATION OF CITA CON EL TAROT CRISTOBAL EL HOMBRE DE LA SUERTE IN THE MARK IS APPOINTMENT WITH THE TAROT CRISTOBAL THE MAN OF LUCK.

FOR SPIRITUAL CONSULTATION SERVICES, NAMELY, PROVIDING ASTROLOGICAL FORECASTING AND CONSULTATION, ZODIAC CONSULTATION, HOROSCOPE FORECASTING, CLAIRVOYANT READINGS, TAROT READINGS, PALMISTRY, HANDWRITING ANALYSIS, DREAM ANALYSIS AND PAST LIVES ANALYSIS (U.S. CLS. 100 AND 101).

FIRST USE 5-0-1999; IN COMMERCE 5-0-1999.
RON FAIRBANKS, EXAMINING ATTORNEY

SN 78-374,559. PATRICK KEN SHINSATO, HONOLULU, HI, FILED S.R. 2-26-2004; AM. P.R. 5-16-2005.

TACTICAL EDGE SERVICES

THE MARK CONSISTS OF STANDARD CHARACTERS WITHOUT CLAIM TO ANY PARTICULAR FONT, STYLE, SIZE, OR COLOR.

NO CLAIM IS MADE TO THE EXCLUSIVE RIGHT TO USE "SERVICES", APART FROM THE MARK AS SHOWN.

FOR PROVIDING THE PROFESSIONAL SERVICE OF CONDUCTING BACKGROUND PROFILES AND INVESTIGATION AND SURVEILLANCE ON WORKER'S COMPENSATION, DOMESTIC, ABUSE, THEFT, PERSONAL INJURY, AND ACCIDENT CASES FOR PRIVATE INDUSTRY AND GOVERNMENT (U.S. CLS. 100 AND 101).

FIRST USE 1-1-1998; IN COMMERCE 1-1-1998.
ALICIA COLLINS, EXAMINING ATTORNEY

SN 78-388,002. CHRIST CHURCH OF THE HEARTLAND, CAPE GIRARDEAU, MO. FILED 3-20-2004.



NO CLAIM IS MADE TO THE EXCLUSIVE RIGHT TO USE "CHRIST CHURCH", APART FROM THE MARK AS SHOWN.

THE COLOR(S) BLUE, GOLD LIGHT PERIWINKLE BLUE IS/ARE CLAIMED AS A FEATURE OF THE MARK.

THE COLOR(S) LETTERS ARE IN NAVY BLUE WITH WHITE LETTERING ON THE LOWER BANNER. GOLD CROSS IN THE CENTER WITH A LIGHT PERIWINKLE BLUE "SWISH" AT THE LEFT SIDE.

THE MARK CONSISTS OF CROSS IS GOLD COLOR AND THE "SWISH" ON THE LEFT SIDE IS LIGHT PERIWINKLE BLUE.

FOR CONDUCTING MINISTERIAL AND CHURCH SERVICES (U.S. CLS. 100 AND 101).

ERNEST SHOSHO, EXAMINING ATTORNEY

CLASS 45—(Continued).

SN 78-392,863. BLACK SINGLES CONNECTION, L.L.C., PROVO, UT. FILED 3-29-2004.

BLACKSINGLES CONNECTION

THE MARK CONSISTS OF STANDARD CHARACTERS WITHOUT CLAIM TO ANY PARTICULAR FONT, STYLE, SIZE, OR COLOR.

NO CLAIM IS MADE TO THE EXCLUSIVE RIGHT TO USE "BLACKSINGLES", APART FROM THE MARK AS SHOWN.

FOR COMPUTER DATING SERVICES, NAMELY, PROVIDING ONLINE INFORMATION IN THE FIELD OF COMPUTER DATING SERVICES, AND PROVIDING AN ONLINE FORUM TO ENABLE OTHERS TO EXCHANGE MESSAGES AND INFORMATION IN THE FIELD OF COMPUTER DATING SERVICES, AND PROVIDING AN ONLINE GALLERY TO ENABLE OTHERS TO DISPLAY PHOTOGRAPHS AND DETAILED PERSONAL INFORMATION IN THE FIELD OF COMPUTER DATING SERVICES (U.S. CLS. 100 AND 101).

FIRST USE 10-7-2002; IN COMMERCE 11-30-2002.

SUSAN LESLIE DUBOIS, EXAMINING ATTORNEY

SN 78-392,993. BROOKES, BERNARD, L. GERMANTOWN, MD. FILED 3-30-2004.

JOYFUL PSALMIST

THE MARK CONSISTS OF STANDARD CHARACTERS WITHOUT CLAIM TO ANY PARTICULAR FONT, STYLE, SIZE, OR COLOR.

NO CLAIM IS MADE TO THE EXCLUSIVE RIGHT TO USE PSALMIST, APART FROM THE MARK AS SHOWN.

FOR MINISTERIAL SERVICES (U.S. CLS. 100 AND 101).

FIRST USE 3-31-2004; IN COMMERCE 3-31-2004.

KAREN K. BUSH, EXAMINING ATTORNEY

SN 78-407,366. SHIRLEY THOMPSON INC., INDIANAPOLIS, IN. FILED 4-23-2004.

CHURCH AND COMMUNITY. FUNERALS IN FAMILIAR PLACES

THE MARK CONSISTS OF STANDARD CHARACTERS WITHOUT CLAIM TO ANY PARTICULAR FONT, STYLE, SIZE, OR COLOR.

NO CLAIM IS MADE TO THE EXCLUSIVE RIGHT TO USE "FUNERALS", APART FROM THE MARK AS SHOWN. FOR PERSONALIZED FUNERAL AND MEMORIAL SERVICES (U.S. CLS. 100 AND 101).

FIRST USE 9-17-2001; IN COMMERCE 9-17-2001.

MICHAEL KEATING, EXAMINING ATTORNEY

CLASS 45—(Continued).

SN 78-414,993. NATIONAL LONGHOUSE, LTD., WESTLAKE, OH. FILED 5-7-2004.

NATIVE SONS AND DAUGHTERS PROGRAMS

THE MARK CONSISTS OF STANDARD CHARACTERS WITHOUT CLAIM TO ANY PARTICULAR FONT, STYLE, SIZE, OR COLOR.

NO CLAIM IS MADE TO THE EXCLUSIVE RIGHT TO USE "SONS AND DAUGHTERS PROGRAMS", APART FROM THE MARK AS SHOWN.

FOR COUNSELING IN THE FIELD OF PARENT-CHILD RELATIONSHIPS TO ESTABLISH AND STRENGTHEN PARENT-CHILD RELATIONSHIPS IN A MANNER THAT IS BASED UPON CHRISTIAN IDEOLOGY AND THE THEME THAT YOU HELP YOURSELF BY HELPING OTHERS (U.S. CLS. 100 AND 101).

FIRST USE 3-22-2003; IN COMMERCE 3-22-2003.

DOUGLAS LEE, EXAMINING ATTORNEY

SN 78-415,052. NATIONAL LONGHOUSE, LTD., WESTLAKE, OH. FILED 5-7-2004.

NATIVE MOMS AND SONS

THE MARK CONSISTS OF STANDARD CHARACTERS WITHOUT CLAIM TO ANY PARTICULAR FONT, STYLE, SIZE, OR COLOR.

NO CLAIM IS MADE TO THE EXCLUSIVE RIGHT TO USE "MOMS AND SONS", APART FROM THE MARK AS SHOWN.

FOR COUNSELING IN THE FIELD OF PARENT-CHILD RELATIONSHIPS TO ESTABLISH AND STRENGTHEN PARENT-CHILD RELATIONSHIPS IN A MANNER THAT IS BASED UPON CHRISTIAN IDEOLOGY AND THE THEME THAT YOU HELP YOURSELF BY HELPING OTHERS (U.S. CLS. 100 AND 101).

FIRST USE 3-22-2003; IN COMMERCE 3-22-2003.

DOUGLAS LEE, EXAMINING ATTORNEY

CLASS 45—(Continued).

SN 78-415,071. NATIONAL LONGHOUSE, LTD., WESTLAKE, OH. FILED 5-7-2004.

NATIVE MOMS AND DAUGHTERS

THE MARK CONSISTS OF STANDARD CHARACTERS WITHOUT CLAIM TO ANY PARTICULAR FONT, STYLE, SIZE, OR COLOR.

NO CLAIM IS MADE TO THE EXCLUSIVE RIGHT TO USE "MOMS AND DAUGHTERS", APART FROM THE MARK AS SHOWN.

FOR COUNSELING IN THE FIELD OF PARENT-CHILD RELATIONSHIPS TO ESTABLISH AND STRENGTHEN PARENT-CHILD RELATIONSHIPS IN A MANNER THAT IS BASED UPON CHRISTIAN IDEOLOGY AND THE THEME THAT YOU HELP YOURSELF BY HELPING OTHERS (U.S. CLS. 100 AND 101).

FIRST USE 3-22-2003; IN COMMERCE 3-22-2003.
DOUGLAS LEE, EXAMINING ATTORNEY

SN 78-417,826. IDENTITY THEFT ASSISTANCE CORPORATION, WASHINGTON, DC. FILED 5-13-2004.

ITAC

THE MARK CONSISTS OF STANDARD CHARACTERS WITHOUT CLAIM TO ANY PARTICULAR FONT, STYLE, SIZE, OR COLOR.

FOR PERSONAL ASSISTANCE SERVICES TO VICTIMS OF IDENTITY THEFT, NAMELY, PROVIDING ADVICE, COUNSEL AND ASSISTANCE TO IDENTITY THEFT VICTIMS TO REPAIR DAMAGE CAUSED BY IDENTITY THEFT AND DAMAGE TO CREDIT HISTORY, AND PROVIDING INFORMATION ABOUT INCIDENTS OF IDENTITY THEFT TO CREDIT REPORTING AGENCIES, CREDITORS, AND GOVERNMENT AND REGULATORY AGENCIES (U.S. CLS. 100 AND 101).

FIRST USE 3-23-2004; IN COMMERCE 4-21-2004.
GINA HAYES, EXAMINING ATTORNEY

CLASS 45—(Continued).

SN 78-423,593. CELESTIAL CHURCH OF CHRIST AMERICAN DIOCESE, MOUNT RAINIER, MD. FILED 5-24-2004.

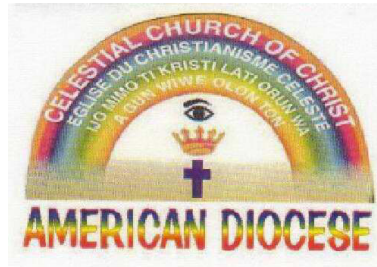

NO CLAIM IS MADE TO THE EXCLUSIVE RIGHT TO USE "CHURCH OF CHRIST" AND "EGLISE DU CHRISTIANISME" AND "IJO MIMO TI KRISTI" AND "A GUN WIWE" AND "AMERICAN DIOCESE" AND THE "REPRESENTATION OF THE CROSS", APART FROM THE MARK AS SHOWN.

THE COLORS RED, ORANGE, YELLOW, GREEN, BLUE, INDIGO, VIOLET, TAN AND WHITE ARE CLAIMED AS A FEATURE OF THE MARK.

THE MARK CONSISTS OF A RAINBOW CONTAINING THE COLORS RED, ORANGE, YELLOW, GREEN, BLUE, INDIGO AND VIOLET FROM BOTTOM TO TOP AND WITH A TAN BAND CONNECTING THE BASE OF THE RAINBOW AND THE WORDING CELESTIAL CHURCH OF CHRIST, EGLISE DU CHRISTIANISME CELESTE, IJO MIMO TI KRISTI LATI ORUN WA, AND A GUN WIWE OLON TON APPEARING IN THE COLOR WHITE, ARCHED OVER AN EYE IN THE COLOR BLUE, A CROWN IN THE COLORS RED AND ORANGE, AND A CROSS IN THE COLOR VIOLET OVER THE WORDING AMERICAN DIOCESE APPEARING IN THE COLORS RED, ORANGE, YELLOW, GREEN, BLUE AND VIOLET FROM BOTTOM TO TOP.

FOR RELIGIOUS SERVICES, NAMELY, CONDUCTING CHURCH AND MINISTERIAL SERVICES; RELIGIOUS SERVICES, NAMELY, OPERATING PLACES OF ASSEMBLY FOR PRAYER AND WORSHIP; MINISTERIAL SERVICES, NAMELY PROVIDING RELIGIOUS WORSHIP SERVICES AND CONDUCTING CHURCH SPONSORED RELIGIOUS PROGRAMS (U.S. CLS. 100 AND 101).

FIRST USE 8-0-1975; IN COMMERCE 7-0-1987.
JEFFERY COWARD, EXAMINING ATTORNEY

SN 78-423,996. LOVERS LANE UNITED METHODIST CHURCH, DALLAS, TX. FILED 5-24-2004.

WANNAKNOWWHY

THE MARK CONSISTS OF STANDARD CHARACTERS WITHOUT CLAIM TO ANY PARTICULAR FONT, STYLE, SIZE, OR COLOR.

FOR CHURCH RELATED SERVICES, NAMELY, MINISTERIAL SERVICES; SPIRITUAL GUIDANCE SERVICES, NAMELY, PROVIDING ONLINE INFORMATION IN THE FIELD OF SPIRITUALITY (U.S. CLS. 100 AND 101).

FIRST USE 3-18-2004; IN COMMERCE 3-18-2004.
DAVID MURRAY, EXAMINING ATTORNEY

CLASS 45—(Continued).

SN 78-445,178. TECHMED-IT, INC., UPPER ARLINGTON, OH. FILED 7-2-2004.

WEBVEILLANCE

THE MARK CONSISTS OF STANDARD CHARACTERS WITHOUT CLAIM TO ANY PARTICULAR FONT, STYLE, SIZE, OR COLOR.

FOR PROVIDING VIDEO SURVEILLANCE SERVICES, VIDEO SURVEILLANCE CONSULTATION SERVICES, AND VIDEO SURVEILLANCE SUPPORT SERVICES (U.S. CLS. 100 AND 101).

FIRST USE 9-29-2003; IN COMMERCE 9-29-2003.
KIMBERLY FRYE, EXAMINING ATTORNEY

CLASS 45—(Continued).

SN 78-452,353. NASSIRI, NICK, EL SEGUNDO, CA. FILED 7-17-2004.

VERIFX

THE MARK CONSISTS OF STANDARD CHARACTERS WITHOUT CLAIM TO ANY PARTICULAR FONT, STYLE, SIZE, OR COLOR.

FOR COMPUTER VERIFICATION SERVICES, NAMELY, VERIFICATION OF A PERSON'S SIGNATURE AND VERIFICATION OF NOTARIZATION ON A DOCUMENT, VERIFICATION OF FINGERPRINTS, VERIFICATION OF PROFESSIONAL LICENSES AND THE VERIFICATION OF HAVING OBTAINED GOVERNMENTAL PERMITS (U.S. CLS. 100 AND 101).

DAVID MURRAY, EXAMINING ATTORNEY

SN 78-446,077. RLH INDUSTRIES, INC., GAYLORD, MI. FILED 7-6-2004.



FOR REMINDER SERVICES IN THE AREA OF UPCOMING ANNUAL CHIMNEY MAINTENANCE INSPECTION (U.S. CLS. 100 AND 101).

FIRST USE 2-1-2004; IN COMMERCE 2-1-2004.
CAROLINE WOOD, EXAMINING ATTORNEY

SN 78-460,896. PAPER PAYMENT SERVICES, LLC, SHOREVIEW, MN. FILED 8-3-2004.

I.D. THEFT GUARD

THE MARK CONSISTS OF STANDARD CHARACTERS WITHOUT CLAIM TO ANY PARTICULAR FONT, STYLE, SIZE, OR COLOR.

NO CLAIM IS MADE TO THE EXCLUSIVE RIGHT TO USE "I.D. THEFT", APART FROM THE MARK AS SHOWN. FOR IDENTITY THEFT PROTECTION SERVICES, NAMELY, PERSONAL INFORMATION AND FINANCIAL IDENTITY MONITORING (U.S. CLS. 100 AND 101).

FIRST USE 2-28-2004; IN COMMERCE 2-28-2004.
REBECCA SMITH, EXAMINING ATTORNEY

CLASS 45—(Continued).

SN 78-464,295. LACEY, JOAN, NEW YORK, NY. FILED 8-9-2004.

ASK JOAN

THE MARK CONSISTS OF STANDARD CHARACTERS WITHOUT CLAIM TO ANY PARTICULAR FONT, STYLE, SIZE, OR COLOR.

FOR PERSONAL SHOPPING SERVICES FOR OTHERS; PERSONAL GIFT SELECTION SERVICES FOR OTHERS (U.S. CLS. 100 AND 101).

WILLIAM VERHOSEK, EXAMINING ATTORNEY

CLASS 45—(Continued).

SN 78-475,012. BLOCK, DEBORAH J., ALEXANDRIA, VA. FILED 8-27-2004.



THE COLOR(S) MAUVE IS/ARE CLAIMED AS A FEATURE OF THE MARK.

THE COLOR MAUVE APPEARS AS SHADING FOR THE GROOM'S TUXEDO, BOW TIE AND HAIR AND BRIDE'S HAIR. THE COLOR MAUVE APPEARS AS SILHOUETTE HIGHLIGHTS FOR THE GROOMS HAND AND FACE AND FOR THE BRIDE'S DRESS, BODY AND VEIL.

FOR WEDDING AND SOCIAL DANCE INSTRUCTION (U.S. CLS. 100 AND 101).

FIRST USE 8-1-2004; IN COMMERCE 8-1-2004.

KAREN K. BUSH, EXAMINING ATTORNEY

SN 78-479,773. EMMIS PUBLISHING, L.P., INDIANAPOLIS, IN. FILED 9-7-2004.

SN 78-468,561. HAPPY SOFTWARE, INC., SARATOGA SPRINGS, NY. FILED 8-17-2004.

TENANTCHECK



THE MARK CONSISTS OF STANDARD CHARACTERS WITHOUT CLAIM TO ANY PARTICULAR FONT, STYLE, SIZE, OR COLOR.

FOR PROVIDING AN ELECTRONIC DATABASE FOR USE IN BACKGROUND SCREENING AND INVESTIGATION OF PROSPECTIVE TENANTS, FEATURING FINANCIAL RECORDS AND CRIMINAL ACTIVITY (U.S. CLS. 100 AND 101).

FIRST USE 6-1-1997; IN COMMERCE 1-29-1999.

STEVEN R. FINE, EXAMINING ATTORNEY

THE COLORS RED, BLUE AND WHITE ARE CLAIMED AS A FEATURE OF THE MARK.

THE MARK CONSISTS OF THE WORD "TWOSTEP" SUPERIMPOSED OVER A RED RECTANGLE AND A BLUE RECTANGLE. THE LETTERS "TW" OF THE WORD "TWOSTEP" APPEAR UNDER A CUTOUT OF A WHITE HEART. FOR COMPUTER DATING SERVICES (U.S. CLS. 100 AND 101).

FIRST USE 7-19-2004; IN COMMERCE 7-19-2004.

PAULA MAHONEY, EXAMINING ATTORNEY

CLASS 45—(Continued).

SN 78-489,133. FURKIDS, INC., ATLANTA, GA. FILED 9-24-2004.



THE MARK CONSISTS OF A STYLIZED GRAPHIC REPRESENTATION OF A CAT WITH A WAVEY LINE APPEARING ACROSS THE BOTTOM OF THE GRAPHIC WITH THE WORD "FURKIDS" APPEARING BELOW THE WAVEY LINE.

FOR ANIMAL ADOPTION SERVICE, NAMELY, ARRANGING FOR DOGS AND CATS FROM SHELTERS TO BE PLACED IN HOMES (U.S. CLS. 100 AND 101).

FIRST USE 3-25-2003; IN COMMERCE 3-25-2003.
PAM WILLIS, EXAMINING ATTORNEY

CLASS 45—(Continued).

SN 78-491,224. PING IDENTITY CORPORATION, DENVER, CO. FILED 9-29-2004.

PINGDEPLOY

THE MARK CONSISTS OF STANDARD CHARACTERS WITHOUT CLAIM TO ANY PARTICULAR FONT, STYLE, SIZE, OR COLOR.

OWNER OF U.S. REG. NO. 2,901,701.

FOR IDENTIFICATION VERIFICATION SERVICES, NAMELY, IDENTITY FEDERATION FOR SOFTWARE OF OTHERS IN THE FIELD OF DIGITAL SECURITY (U.S. CLS. 100 AND 101).

FIRST USE 10-26-2004; IN COMMERCE 10-26-2004.
ELIZABETH J. WINTER, EXAMINING ATTORNEY

SN 78-490,325. BE A HERO, KELOWNA, BRITISH COLUMBIA, CANADA, FILED 9-27-2004.

BE A HERO

THE MARK CONSISTS OF STANDARD CHARACTERS WITHOUT CLAIM TO ANY PARTICULAR FONT, STYLE, SIZE, OR COLOR.

FOR EVANGELISTIC AND MINISTERIAL SERVICES (U.S. CLS. 100 AND 101).

FIRST USE 11-0-2003; IN COMMERCE 11-0-2003.
ROBERT LAVACHE, EXAMINING ATTORNEY

SN 78-491,834. YANAITIS, MARK V., PLAINS, PA. FILED 9-29-2004.

**PRESERVING
TRADITIONS WHILE
FORGING NEW
TRADITIONS**

THE MARK CONSISTS OF STANDARD CHARACTERS WITHOUT CLAIM TO ANY PARTICULAR FONT, STYLE, SIZE, OR COLOR.

FOR FUNERAL PLANNING CONSULTATION SERVICES AND FUNERAL HOME SERVICES, NAMELY THE EMBALMING, REFRIGERATION, TRANSPORTATION, SHELTER, REFRIGERATION, AND PREPARATION OF THE DECEASED'S REMAINS; ORGANIZATION AND COORDINATION SERVICES FOR FUNERALS, WAKES, FUNERAL MASSES, MEMORIALS, AND BURIALS; CASKET AND BURIAL VAULT SERVICES; AND CREATION AND PLACEMENT OF OBITUARY NOTICES (U.S. CLS. 100 AND 101).

ANDREA K. NADELMAN, EXAMINING ATTORNEY

CLASS 45—(Continued).

SN 78-500,144. EMPLOYER LYNX, INC., CARSON CITY, NV.
FILED 10-14-2004.



FOR BACKGROUND INVESTIGATION, ASSET
SEARCHES AND SCREENING SERVICES FOR EM-
PLOYEES, EMPLOYERS, LANDLORDS, TENANTS, CLI-
ENTS, AND VENDORS (U.S. CLS. 100 AND 101).
FIRST USE 10-0-1998; IN COMMERCE 10-0-1998.
STEVEN JACKSON, EXAMINING ATTORNEY

CLASS 45—(Continued).

SN 78-504,420. FIESTA CATERING INTERNATIONAL, INC.,
CAVE HILL, BARBADOS, FILED 10-22-2004.

SEXSEARCH.COM

THE MARK CONSISTS OF STANDARD CHARACTERS
WITHOUT CLAIM TO ANY PARTICULAR FONT, STYLE,
SIZE, OR COLOR.
OWNER OF U.S. REG. NO. 2,733,701.
FOR DATING SERVICES (U.S. CLS. 100 AND 101).
FIRST USE 12-31-2003; IN COMMERCE 12-31-2003.
RONALD MCMORROW, EXAMINING ATTORNEY

SN 78-501,298. REGIS INC., MINNEAPOLIS, MN. FILED 10-
18-2004.

HEIDI'S

THE MARK CONSISTS OF STANDARD CHARACTERS
WITHOUT CLAIM TO ANY PARTICULAR FONT, STYLE,
SIZE, OR COLOR.
OWNER OF U.S. REG. NO. 1,301,006.
FOR HAIR SALON SERVICES (U.S. CLS. 100 AND 101).
FIRST USE 5-0-1967; IN COMMERCE 9-8-1982.
BRENDAN REGAN, EXAMINING ATTORNEY

SN 78-504,916. REDPHANTOM ENTERPRISES, INC., NAPA,
CA. FILED 10-24-2004.



REDPHANTOM

THE COLORS RED, BLACK AND YELLOW ARE
CLAIMED AS A FEATURE OF THE MARK.
THE MARK CONSISTS OF RED JET WITH YELLOW,
BLACK AND RED SURROUNDS.
FOR SECURITY GUARD SERVICES (U.S. CLS. 100
AND 101).
FIRST USE 2-1-2004; IN COMMERCE 6-1-2004.
MATTHEW KLINE, EXAMINING ATTORNEY

CLASS 45—(Continued).

SN 78-508,601. PEARCE, INES J., TACOMA, WA. FILED 10-29-2004.

Community Legacy

THE MARK CONSISTS OF STANDARD CHARACTERS WITHOUT CLAIM TO ANY PARTICULAR FONT, STYLE, SIZE, OR COLOR.

NO CLAIM IS MADE TO THE EXCLUSIVE RIGHT TO USE "COMMUNITY", APART FROM THE MARK AS SHOWN.

FOR PROVIDING CONSULTATION AND INFORMATION IN THE FIELD OF EMERGENCY RESPONSE FOR COMMUNITIES (U.S. CLS. 100 AND 101).

DEZMONA MIZELLE, EXAMINING ATTORNEY

SN 78-514,500. TRIAD BIOMETRICS LLC, BOCA RATON, FL. FILED 11-10-2004.

TEAMS

THE MARK CONSISTS OF STANDARD CHARACTERS WITHOUT CLAIM TO ANY PARTICULAR FONT, STYLE, SIZE, OR COLOR.

FOR ALARM RESPONSE AND VERIFICATION SERVICES; BAGGAGE HANDLING INSPECTIONS FOR AIRLINES; CIVIL PROTECTION; COMPUTER SECURITY SERVICES IN THE NATURE OF PROVIDING AN INTERNET TRUST CENTER, NAMELY, COMPUTER SECURITY ASSURANCE AND ADMINISTRATION OF BIOMETRIC DATA; CONSULTING SERVICES IN THE FIELD OF MAINTAINING THE SECURITY AND INTEGRITY OF DATABASES; CONTROL OF BUILDING ENVIRONMENTAL ACCESS AND SECURITY SYSTEMS; ELECTRONIC MONITORING SERVICES FOR SECURITY PURPOSES IN THE FIELD OF LOGICAL AND PHYSICAL SECURITY; FINANCIAL IDENTITY MONITORING SERVICE; FINGERPRINTING AND FINGERPRINT REGISTRATION OF CHILDREN AND OTHERS; FRAUD DETECTION SERVICES IN THE FIELD OF CREDIT CARDS FOR ON-LINE PURCHASING; FRAUD DETECTION SERVICES IN THE FIELD OF HEALTH CARE INSURANCE; IDENTIFICATION VERIFICATION SERVICES, NAMELY, PROVIDING AUTHENTICATION OF PERSONAL IDENTIFICATION INFORMATION VIA SECURE STORAGE AND TRANSMITTING SUCH INFORMATION VIA THE INTERNET; IDENTIFICATION VERIFICATION SERVICES, NAMELY, PROVIDING AUTHENTICATION OF PERSONAL IDENTIFICATION INFORMATION; INVESTIGATION OR SURVEILLANCE ON BACKGROUND PROFILES; INVESTIGATION SERVICES RELATED TO INSURANCE CLAIMS; MONITOR-

CLASS 45—(Continued).

ING ALARMS; MONITORING BURGLAR AND SECURITY ALARMS; MONITORING FIRE ALARMS; MONITORING OF COMPUTER SYSTEMS FOR SECURITY PURPOSES; ON-LINE MONITORING, NAMELY, ELECTRONIC MONITORING OF FACILITIES AND COMPUTER APPLICATIONS, VIEWABLE THROUGH A GLOBAL COMPUTER NETWORK; PRE-EMPLOYMENT BACKGROUND INVESTIGATION SERVICES; PROVIDING A DATABASE FEATURING INFORMATION ABOUT INDIVIDUALS AUTHORIZED TO ACCESS SECURE DATABASES AND APPLICATIONS; PROVIDING INFORMATION REGARDING PHARMACY ROBBERIES AND INFORMATION RELATING TO THOSE WHO COMMIT PRESCRIPTION DRUG THEFT, FRAUD, DIVERSION OR OTHER CRIMES INVOLVING PRESCRIPTION DRUGS; PROVIDING INFORMATION REGARDING UNDERSTANDING AND PREVENTING TERRORISM; PROVIDING INTELLIGENCE AND INFORMATION TO LOCAL, STATE, AND FEDERAL LAW ENFORCEMENT AGENCIES RELATING TO ORGANIZED CRIME NETWORKS THAT OPERATE ACROSS JURISDICTIONAL LINES; PROVIDING ANIMAL IDENTIFICATION TAGS; PROVIDING USER AUTHENTICATION SERVICES IN E-COMMERCE TRANSACTIONS; SECURITY CLEARANCE FOR PREPARATION OF IDENTIFICATION CARDS; SECURITY CONTROL OF PERSONS AND LUGGAGE IN AIRPORTS; SECURITY GUARD SERVICES; SECURITY GUARDING FOR FACILITIES; SECURITY SERVICES, NAMELY, PHYSICAL AND LOGICAL ACCESS CONTROL SERVICES (U.S. CLS. 100 AND 101).

KEVIN DINALLO, EXAMINING ATTORNEY

SN 78-515,661. CONTRINO, MARY LEE, HANOVER, MD. FILED 11-11-2004.

The logo features the word "Praise" in a large, elegant cursive script. Below it, the letters "-N-" are written in a smaller, simpler font. At the bottom, the word "FOUNDERS" is written in a bold, blocky, slightly distressed font.

FOR NON-PROFIT OUTREACH MINISTRY (U.S. CLS. 100 AND 101).

FIRST USE 5-1-2001; IN COMMERCE 5-1-2001.

CHARLES L. JENKINS, EXAMINING ATTORNEY

CLASS 45—(Continued).

SN 78-538,920. WALTERS, KEITH J., KAILUA-KONA, HI. FILED 12-28-2004.

CLASS 45—(Continued).

SN 78-574,362. PERSONA LLC, SPRINGVILLE, UT. FILED 2-24-2005.

LDSCENTER

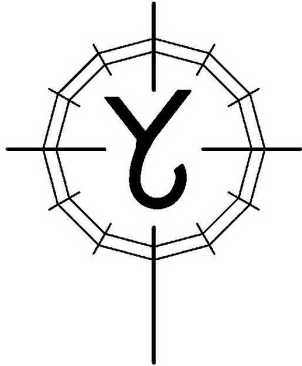

THE MARK CONSISTS OF STANDARD CHARACTERS WITHOUT CLAIM TO ANY PARTICULAR FONT, STYLE, SIZE, OR COLOR.

FOR SOCIAL INTRODUCTION SERVICES PROVIDED VIA A GLOBAL COMPUTER NETWORK (U.S. CLS. 100 AND 101).

BARBARA RUTLAND, EXAMINING ATTORNEY

SN 79-003,912. DESTINA JAPAN INC., JAPAN, FILED 6-17-2004.



PRIORITY DATE OF 12-19-2003 IS CLAIMED. OWNER OF INTERNATIONAL REGISTRATION 0829085 DATED 6-17-2004, EXPIRES 6-17-2014.

NO CLAIM IS MADE TO THE EXCLUSIVE RIGHT TO USE "JAPAN", APART FROM THE MARK AS SHOWN.

FOR MARRIAGE BUREAUX OR DATING SERVICES (U.S. CLS. 100 AND 101).

RUSS HERMAN, EXAMINING ATTORNE

FOR SPIRITUAL COUNSELING (U.S. CLS. 100 AND 101).

FIRST USE 3-18-1949; IN COMMERCE 9-16-2004. NAAKWAMA ANKRAH, EXAMINING ATTORNEY

* * * * *

SECTION 4.—PRIOR UNITED STATES CLASSIFICATION

APPLICATION IN ONE CLASS

COLLECTIVE MEMBERSHIP MARKS

CLASS 200—COLLECTIVE MEMBERSHIP
SN 76-559,476. AMERICAN HOTEL & LODGING ASSOCIATION, WASHINGTON, DC. FILED 11-12-2003.



OWNER OF U.S. REG. NOS. 1,820,308 AND 1,856,057.
NO CLAIM IS MADE TO THE EXCLUSIVE RIGHT TO USE HOTEL & LODGING ASSOCIATION, APART FROM THE MARK AS SHOWN.
SEC. 2(F) AS TO "AMERICAN".
FOR INDICATING MEMBERSHIP IN AN ORGANIZATION OF ASSOCIATIONS OF HOTEL AND LODGING PROFESSIONALS.
FIRST USE 12-0-2000; IN COMMERCE 12-0-2000.
CHRISTOPHER BUONGIORNO, EXAMINING ATTORNEY

SN 76-599,477. AMERICAN ACADEMY OF HIV MEDICINE, INC. (AAHIVM), WASHINGTON, DC. FILED 6-24-2004.

AAHIVM Member

THE MARK CONSISTS OF STANDARD CHARACTERS WITHOUT CLAIM TO ANY PARTICULAR FONT, STYLE, SIZE, OR COLOR.
OWNER OF U.S. REG. NOS. 2,873,242 AND 2,892,437.
NO CLAIM IS MADE TO THE EXCLUSIVE RIGHT TO USE "MEMBER", APART FROM THE MARK AS SHOWN.
FOR INDICATING MEMBERSHIP IN A MEMBERSHIP ASSOCIATION OF PHYSICIANS AND MEDICAL PROFESSIONALS WHO PROVIDE PATIENT CARE CONCERNING HUMAN IMMUNODEFICIENCY VIRUS/ACQUIRED IMMUNE DEFICIENCY SYNDROME (HIV/AIDS).
FIRST USE 4-0-2004; IN COMMERCE 4-0-2004.
JIM RINGLE, EXAMINING ATTORNEY

TM 1788

SN 78-422,982. PIPING INDUSTRY PROGRESS & EDUCATION LABOR-MANAGEMENT COOPERATION COMMITTEE, LOS ANGELES, CA. FILED 5-21-2004.



NO CLAIM IS MADE TO THE EXCLUSIVE RIGHT TO USE "PIPE", "PIPING INDUSTRY", "EDUCATION", "PLUMBING", "HEATING", "PIPING" AND "LABOR-MANAGEMENT COOPERATION COMMITTEE", APART FROM THE MARK AS SHOWN.
FOR INDICATING MEMBERSHIP IN A TRADE GROUP FOR THE PLUMBING, HEATING AND PIPING INDUSTRIES, FORMED TO IMPROVE COMMUNICATIONS BETWEEN LABOR AND MANAGEMENT.
FIRST USE 1-1-1985; IN COMMERCE 1-1-1985.
NELSON SNYDER, EXAMINING ATTORNEY

SN 78-502,857. IPC INTERNATIONAL, BANNOCKBURN, IL. FILED 10-20-2004.

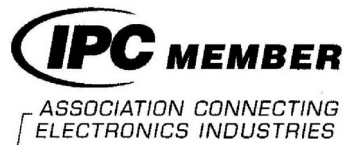

OWNER OF U.S. REG. NOS. 2,324,147 AND 2,397,058.
NO CLAIM IS MADE TO THE EXCLUSIVE RIGHT TO USE "MEMBER" AND "ASSOCIATION CONNECTING ELECTRONICS INDUSTRIES", APART FROM THE MARK AS SHOWN.
FOR INDICATING MEMBERSHIP IN A(N) ORGANIZATION WHICH PROMOTES THE INTERESTS OF THE PRINTED CIRCUIT BOARD MANUFACTURING AND DESIGN INDUSTRY AND THE ELECTRONICS MANUFACTURING INDUSTRY.
FIRST USE 2-1-1998; IN COMMERCE 2-1-1998.
CAROLINE WOOD, EXAMINING ATTORNEY

SN 78-644,563. B.A.S.S. (IP), LLC, BRISTOL, CT. FILED 6-6-2005.

SN 76-547,003. INTERTEK TESTING SERVICES NA, INC., BOXBOROUGH, MA. FILED 9-24-2003.

BASS INSIDER

THE MARK CONSISTS OF STANDARD CHARACTERS WITHOUT CLAIM TO ANY PARTICULAR FONT, STYLE, SIZE, OR COLOR.

OWNER OF U.S. REG. NO. 1,891,538.

NO CLAIM IS MADE TO THE EXCLUSIVE RIGHT TO USE "BASS", APART FROM THE MARK AS SHOWN.

FOR INDICATING MEMBERSHIP IN A(N) FISHING SOCIETY.

FIRST USE 4-26-2005; IN COMMERCE 4-26-2005.

KIMBERLY FRYE, EXAMINING ATTORNEY



CERTIFICATION MARKS

CLASS A—GOODS

SN 76-443,194. FISHER, RAYMOND A., MONROEVILLE, PA. FILED 8-23-2002.



THE STIPPLING IS A FEATURE OF THE MARK, AND DOES NOT INDICATE COLOR.

THE CERTIFICATION MARK, AS USED BY AUTHORIZED PERSONS, CERTIFIES GEOGRAPHIC ORIGIN OF THE GOODS IN THE AREA OF HONG KONG AS KOWLOON. THE CERTIFICATION MARK, AS USED BY AUTHORIZED PERSONS, CERTIFIES THAT TAILORS AND DESIGNER FROM THE KOWLOON AREA OF HONG KONG, BY MEMBERS OF THE TAILOR AND DESIGNER ASSOCIATION, PURSUANT TO SPECIFICATIONS DEVELOPED BY THE CERTIFIER, PROVIDE THE SERVICES BEARING THE MARK.

FOR CLOTHING AND CLOTHING ACCESSORIES.
INGRID C. EULIN, EXAMINING ATTORNEY

OWNER OF U.S. REG. NOS. 1,917,483, 2,573,161 AND OTHERS.

NO CLAIM IS MADE TO THE EXCLUSIVE RIGHT TO USE "LISTED", APART FROM THE MARK AS SHOWN.

THE CERTIFICATION MARK AS USED BY PERSONS AUTHORIZED BY THE CERTIFIER, CERTIFIES THAT THE GOODS AND SERVICES PROVIDED HAVE MET THE PRODUCT SAFETY STANDARDS ADOPTED BY THE CERTIFIER.

FOR TEXTILES, NAMELY, NATURAL AND SYNTHETIC FIBERS AND ARTICLES MANUFACTURED THERE FROM, PAPER, PAINT, VARNISHES, LACQUERS AND RELATED PRODUCTS, FERROUS AND NON-FERROUS MATERIALS, PLASTICS, GLASS, RUBBER AND VEHICULAR TIRES; STRUCTURAL EQUIPMENT; NAMELY, DOORS AND WINDOWS, LIGHTING, HEATING AND COOLING EQUIPMENT, RADIO AND TELEVISION EQUIPMENT, ELECTRIC CABLES, RUGS, MEDICAL AND DENTAL ELECTRICAL EQUIPMENT, REFRIGERATED DISPLAY CASES, SECURITY SYSTEMS, CHECK OUT STANDS (FOR STORES), REGULATED POWER DISTRIBUTION UNITS FOR COMPUTERS, POWER SUPPLY FOR COMPUTERS, COMPUTER PRINTERS, COMPUTER NETWORK INTERFACES, MODEM CARDS, TOUCH PANELS FOR USE IN CONNECTION WITH COMPUTERS, AUTOMATIC BANK TELLER MACHINES, ELECTRICAL CABLE AND RUGS.

FIRST USE 6-24-2003; IN COMMERCE 6-24-2003.
JIM RINGLE, EXAMINING ATTORNEY

SN 76-569,112. COMPOSITE PANEL ASSOCIATION, GAITHERSBURG, MD. FILED 12-29-2003.

SN 78-336,218. ARTISAN BAKERS' QUALITY ALLIANCE, GRIMSBY, CANADA, FILED 12-4-2003.



NO CLAIM IS MADE TO THE EXCLUSIVE RIGHT TO USE "CERTIFIED", APART FROM THE MARK AS SHOWN.

THE CERTIFICATION MARK, AS USED BY AUTHORIZED PERSONS, CERTIFIES THAT THE GOODS (IN THEIR USE AS BOARDS, PANELS OR REMANUFACTURED COMPONENTS) TO WHICH THE MARK IS APPLIED OR IN CONNECTION WITH WHICH THE MARK IS USED MEET CERTAIN STANDARDS SPECIFIED IN APPLICANT'S GRADEMARK PROGRAM MANUAL.

FOR PARTICLEBOARD, MEDIUM DENSITY FIBERBOARD, PLYWOOD AND HARDBOARD.

FIRST USE 2-9-1997; IN COMMERCE 2-9-1997. EVELYN BRADLEY, EXAMINING ATTORNEY



OWNER OF CANADA REG. NO. TMA633,755, DATED 2-24-2005, EXPIRES 2-24-2020.

NO CLAIM IS MADE TO THE EXCLUSIVE RIGHT TO USE ARTISAN BAKERS QUALITY ALLIANCE, APART FROM THE MARK AS SHOWN.

THE CERTIFICATION MARK, AS INTENDED TO BE USED BY PERSONS AUTHORIZED BY THE CERTIFIER, CERTIFIES THAT THE GOODS PROVIDED HAVE BEEN MADE WITH SPECIFIED INGREDIENTS (AND NOT MADE WITH PROHIBITED INGREDIENTS, SUCH AS CHEMICAL PRESERVATIVES) AND BY SPECIFIED BAKING TECHNIQUES.

FOR BAKERY PRODUCTS, NAMELY BREADS, ROLLS, CAKES, PIES, PASTRIES, COOKIES, DOUGHNUTS AND CRACKERS.

CHERYL CLAYTON, EXAMINING ATTORNEY

SN 78-314,038. MIDWEST ORGANIC SERVICES ASSOCIATION, INC., VIROQUA, WI. FILED 10-15-2003.

SN 78-378,402. BAKING INDUSTRY SANITATION STANDARDS COMMITTEE, CHICAGO, IL. FILED 3-4-2004.



NO CLAIM IS MADE TO THE EXCLUSIVE RIGHT TO USE "MIDWEST ORGANIC SERVICES ASSOCIATION CERTIFIED ORGANIC" AND "THE OUTLINE OF THE STATES OF NORTH DAKOTA, SOUTH DAKOTA, NEBRASKA, KANSAS, MINNESOTA, IOWA, MISSOURI, WISCONSIN, ILLINOIS, MICHIGAN, INDIANA AND OHIO", APART FROM THE MARK AS SHOWN.

THE CERTIFICATION MARK, AS USED BY PERSONS AUTHORIZED BY THE CERTIFIER, CERTIFIES THAT THE GOODS ARE CERTIFIED ORGANIC AND MEET THE FEDERAL NATIONAL ORGANIC STANDARDS (NOS) OF THE NATIONAL ORGANIC PROGRAM (NOP).

FOR PRODUCTS THAT ARE ORGANICALLY PRODUCED OR PROCESSED/HANDLED.

FIRST USE 3-26-1999; IN COMMERCE 3-26-1999. SCOTT BALDWIN, EXAMINING ATTORNEY



OWNER OF U.S. REG. NO. 2,033,232.

NO CLAIM IS MADE TO THE EXCLUSIVE RIGHT TO USE "CERTIFIED AND MANUFACTURER ATTESTS THAT THIS EQUIPMENT CONFORMS TO THE ANSI/BISSC/Z50.2 2003 STANDARD", APART FROM THE MARK AS SHOWN.

THE CERTIFICATION MARK, AS USED BY PERSONS AUTHORIZED BY APPLICANT, CERTIFIES THAT BAKING EQUIPMENT AND MACHINERY HAS BEEN MANUFACTURED IN ACCORDANCE WITH APPLICANT'S APPROVED SANITATION STANDARD.

SEC. 2(F) BAKING INDUSTRY SANITATION STANDARDS COMMITTEE.

FOR BAKING EQUIPMENT AND MACHINERY. KELLY BOULTON, EXAMINING ATTORNEY

SN 78-481,182. NATIONAL MARINE MANUFACTURERS ASSOCIATION, INC., CHICAGO, IL. FILED 9-9-2004.

SN 76-547,100. CELLULAR TELECOMMUNICATIONS & INTERNET ASSOCIATION, WASHINGTON, DC. FILED 9-10-2003.



NO CLAIM IS MADE TO THE EXCLUSIVE RIGHT TO USE "CERTIFIED", APART FROM THE MARK AS SHOWN. THE APPLICANT HAS A BONA FIDE INTENTION TO EXERCISE LEGITIMATE CONTROL OVER THE USE OF THE CERTIFICATION MARK IN COMMERCE AS OF THE FILING DATE OF THE APPLICATION OVER THE USE OF THE CERTIFICATION MARK IN INTERSTATE COMMERCE BY PERSONS AUTHORIZED BY THE CERTIFIER TO CERTIFY THAT THE GOODS RENDERED COMPLY WITH STANDARDS AND SAFETY REGULATIONS DEFINED BY APPLICANT WHICH SUPPLEMENT THOSE MINIMUM STANDARDS AND SAFETY REGULATIONS ESTABLISHED IN ACCORDANCE WITH STATE, FEDERAL AND LOCAL REGULATIONS IN FORCE AT THE TIME THE CERTIFICATION REQUIREMENTS ARE SET FORTH. APPLICANT WILL NOT ENGAGE IN THE PRODUCTION OR MARKETING OF THE GOODS TO WHICH THE MARK IS APPLIED.

FOR MOTOR LUBRICANTS AND MOTOR OILS.
SCOTT OSLICK, EXAMINING ATTORNEY

THE STIPPLING IS FOR SHADING PURPOSES. THE CERTIFICATION MARK, AS USED BY PERSONS AUTHORIZED BY APPLICANT, CERTIFIES THAT THEIR WIRELESS TELECOMMUNICATIONS EQUIPMENT AND SERVICES MEET THE QUALITY, SAFETY, AND RELIABILITY STANDARDS ESTABLISHED BY THE APPLICANT. SEC. 2(F) AS TO "WIRELESS QUALITY CONSUMER INFORMATION CODE".

FOR WIRELESS TELECOMMUNICATIONS SERVICES. FIRST USE 9-9-2003; IN COMMERCE 9-9-2003.
LEIGH CAROLINE CASE, EXAMINING ATTORNEY

SN 78-285,299. THE GOVERNMENT OF ANDHRA PRADESH, HYDERABAD, ANDHRA PRADESH, INDIA, FILED 8-8-2003.

CLASS B—SERVICES

SN 76-547,099. CELLULAR TELECOMMUNICATIONS & INTERNET ASSOCIATION, WASHINGTON, DC. FILED 9-10-2003.

**WIRELESS QUALITY
CONSUMER INFORMATION
CODE**

NO CLAIM IS MADE TO THE EXCLUSIVE RIGHT TO USE GENOME VALLEY, APART FROM THE MARK AS SHOWN.

THE CERTIFICATION MARK, AS USED BY PERSONS AUTHORIZED BY APPLICANT, CERTIFIES THAT THEIR WIRELESS TELECOMMUNICATIONS EQUIPMENT AND SERVICES MEET THE QUALITY, SAFETY, AND RELIABILITY STANDARDS ESTABLISHED BY THE APPLICANT. SEC. 2(F).

FOR WIRELESS TELECOMMUNICATIONS SERVICES. FIRST USE 9-9-2003; IN COMMERCE 9-9-2003.
RONALD MCMORROW, EXAMINING ATTORNEY



THE CERTIFICATION MARK, AS USED BY PERSONS AUTHORIZED BY THE CERTIFIER, IS INTENDED TO CERTIFY THAT THE FOLLOWING SERVICES— MANUFACTURING SERVICES IN THE FIELD OF BIOTECHNOLOGY; SCIENTIFIC RESEARCH AND DEVELOPMENT SERVICES IN THE FIELD OF BIOTECHNOLOGY; BUSINESS MANAGEMENT SERVICES IN THE FIELD OF BIOTECHNOLOGY; AND EDUCATIONAL SERVICES, NAMELY, CONFERENCES, WORKSHOPS AND EXHIBITIONS IN THE FIELD OF BIOTECHNOLOGY, ALL ORIGINATE FROM THE STATE OF ANDHRA PRADESH IN INDIA.

FOR SCIENTIFIC RESEARCH AND DEVELOPMENT SERVICES IN THE FIELD OF BIOTECHNOLOGY; BUSINESS MANAGEMENT SERVICES IN THE FIELD OF BIOTECHNOLOGY; AND EDUCATIONAL SERVICES, NAMELY, CONFERENCES, WORKSHOPS AND EXHIBITIONS IN THE FIELD OF BIOTECHNOLOGY.
ODESSA BIBBINS, EXAMINING ATTORNEY

SN 78-469,932. CHENAIL, MICHAEL J., MIDLOTHIAN, VA, VA. FILED 8-19-2004.

SN 78-509,214. ACADEMY FOR CERTIFICATION OF VISION REHABILITATION AND EDUCATION PROFESSIONALS, TUCSON, AZ. FILED 11-1-2004.



ORIENTATION AND MOBILITY SPECIALIST

THE MARK CONSISTS OF THE LETTER "UF" SUPERIMPOSED UPON THE OUTLINE OF AN ISOCELES TRIANGLE.

THE MARK CONSISTS OF STANDARD CHARACTERS WITHOUT CLAIM TO ANY PARTICULAR FONT, STYLE, SIZE, OR COLOR.

THE CERTIFICATION MARK, AS USED BY PERSONS AUTHORIZED BY THE CERTIFIER, IS INTENDED TO CERTIFY THAT THE FACILITIES SERVICES PROVIDED HAVE A HIGH LEVEL OF ACCESSIBILITY, CONVENIENCE, COMFORT AND USEFULNESS TO PEOPLE WHO ARE HANDICAPPED OR DISABLED.

THE CERTIFICATION MARK, AS USED BY PERSONS APPROVED BY THE CERTIFIER, CERTIFIES THE INDIVIDUAL DISPLAYING THE MARK HAS MET THE CERTIFIER'S REQUIREMENTS FOR FUNCTIONAL VISION ASSESSMENT AND VISION HABILITATION/REHABILITATION OF PERSONS WITH IMPAIRED VISION, AND THAT AS SUCH, EACH OF SUCH PERSONS (1) HAS MET THE SPECIFIC STANDARDS OF PERSONNEL PREPARATION IN EDUCATION AND EXPERIENCE ESTABLISHED BY THE CERTIFIER, (2) HAS PASSED A STANDARDIZED NATIONAL EXAMINATION PREPARED AND REVIEWED BY THE CERTIFIER, AND (3) HAS BEEN APPROVED BY THE CERTIFIER'S BOARD OF DIRECTORS.

FOR DESIGNING, CONSTRUCTING, FURNISHING, MAINTAINING AND OPERATING FACILITIES USED BY EMPLOYEES, GUESTS, AND OTHER MEMBERS OF THE PUBLIC, INCLUDING PEOPLE WHO ARE HANDICAPPED OR DISABLED AS WELL AS THOSE WHO ARE NOT.

SEC. 2(F). FOR INSTRUCTION IN THE FIELD OF ORIENTATION AND MOBILITY, THAT IS, TEACHING BLIND AND VISUALLY IMPAIRED PERSONS HOW TO TRAVEL SAFELY AND INDEPENDENTLY.

LEIGH LOWRY, EXAMINING ATTORNEY

FIRST USE 1-1-1997; IN COMMERCE 1-1-1997. KEVIN DINALLO, EXAMINING ATTORNEY

SN 78-500,068. NATIONAL SYSTEMS CONTRACTORS ASSOCIATION, CEDAR RAPIDS, IA. FILED 10-14-2004.

SN 78-525,773. AMERICAN FEED INDUSTRY ASSOCIATION, ARLINGTON, VA. FILED 12-2-2004.



OWNER OF U.S. REG. NO. 2,934,208. THE CERTIFICATION MARK AS USED BY PERSONS AUTHORIZED BY THE CERTIFIER, CERTIFIES THAT THEY POSSESS THE TRAINING AND EXPERIENCE NECESSARY TO PRACTICE AS ELECTRONIC SYSTEMS TECHNICIANS.

NO CLAIM IS MADE TO THE EXCLUSIVE RIGHT TO USE "CERTIFIED SAFE FEED" AND "SAFE FOOD", APART FROM THE MARK AS SHOWN.

FOR ELECTRONIC SYSTEMS TECHNICIAN SERVICES.

THAT THE ANIMAL FEED PROCESSING CONFORMS TO STANDARDS ESTABLISHED BY THE CERTIFIER. FOR ANIMAL FEED PROCESSING.

FIRST USE 3-0-2003; IN COMMERCE 3-0-2003. KATRINA EDGE, EXAMINING ATTORNEY

ELIZABETH PIGNATELLO, EXAMINING ATTORNE

TRADEMARK REGISTRATIONS ISSUED

PRINCIPAL REGISTER

SECTION 1.— INTERNATIONAL CLASSIFICATION

The short titles associated below with the international class numbers are terms designed merely for quick identification and are not an official part of the international classification. The full names of international classes are given in section 6.1 of the trademark rules of practice.

The designation "U.S. Cl." appearing in this section refers to the U.S. class in effect prior to Sep. 1, 1973 rather than the international class which applies to applications filed on or after that date. For adoption of international classification see notice in the OFFICIAL GAZETTE of Jun. 26, 1973 (911 O.G. TM 210).

CLASS 1—CHEMICALS

- 2,996,257. **ALWITRA**. ALWITRA GMBH & CO. KLAUS GOBEL, MULTIPLE CLASS, (INT. CLS. 1, 6, 17 AND 19), (U.S. CLS. 1, 2, 5, 6, 10, 12, 13, 14, 23, 25, 26, 33, 35, 46 AND 50). SN 76-228,551. PUB. 6-28-2005. FILED 3-21-2001.
- 2,996,277. **UMICORE**. UMICORE, MULTIPLE CLASS, (INT. CLS. 1, 2, 6, 9, 14, 40 AND 42), (U.S. CLS. 1, 2, 5, 6, 10, 11, 12, 13, 14, 16, 21, 23, 25, 26, 27, 28, 36, 38, 46, 50, 100, 101, 103 AND 106). SN 76-361,192. PUB. 4-19-2005. FILED 1-23-2002.
- 2,996,289. **MISCELLANEOUS DESIGN**. PURSELL TECHNOLOGIES, INC., MULTIPLE CLASS, (INT. CLS. 1 AND 40), (U.S. CLS. 1, 5, 6, 10, 26, 46, 100, 103 AND 106). SN 76-411,942. PUB. 6-28-2005. FILED 5-17-2002.
- 2,996,290. **DNT**. DENDRITIC NANOTECHNOLOGIES LIMITED, MULTIPLE CLASS, (INT. CLS. 1, 5 AND 42), (U.S. CLS. 1, 5, 6, 10, 18, 26, 44, 46, 51, 52, 100 AND 101). SN 76-412,715. PUB. 6-28-2005. FILED 5-22-2002.
- 2,996,359. **SUNBRIGHT MENP**. NOF CORPORATION, MULTIPLE CLASS, (INT. CLS. 1 AND 5), (U.S. CLS. 1, 5, 6, 10, 18, 26, 44, 46, 51 AND 52). SN 76-513,913. PUB. 6-28-2005. FILED 5-14-2003.
- 2,996,440. **ACE**. ADVANCED CHROMATOGRAPHY TECHNOLOGIES, MULTIPLE CLASS, (INT. CLS. 1 AND 9), (U.S. CLS. 1, 5, 6, 10, 21, 23, 26, 36, 38 AND 46). SN 76-547,024. PUB. 6-28-2005. FILED 9-25-2003.
- 2,996,519. **MEDISENSE AND DESIGN**. ABBOTT LABORATORIES, MULTIPLE CLASS, (INT. CLS. 1, 10 AND 16), (U.S. CLS. 1, 2, 5, 6, 10, 22, 23, 26, 29, 37, 38, 39, 44, 46 AND 50). SN 76-570,200. PUB. 6-28-2005. FILED 1-9-2004.
- 2,996,610. **SELECTFX (BLOCK FORM)**. MOLECULAR PROBES, INC., (U.S. CLS. 1, 5, 6, 10, 26 AND 46). SN 76-578,054. PUB. 6-28-2005. FILED 2-27-2004.
- 2,996,617. **TRINITY SPECIALTY COMPOUNDING, INC. (BLOCK FORM)**. TRINITY SPECIALTY COMPOUNDING, INC., (U.S. CLS. 1, 5, 6, 10, 26 AND 46). SN 76-578,850. PUB. 6-28-2005. FILED 3-3-2004.
- 2,996,671. **TECH PHOS (BLOCK FORM)**. NALCO COMPANY, (U.S. CLS. 1, 5, 6, 10, 26 AND 46). SN 76-590,246. PUB. 6-28-2005. FILED 5-3-2004.
- 2,996,705. **SUN CLEAR AND DESIGN**. SOLARSUN, INC., (U.S. CLS. 1, 5, 6, 10, 26 AND 46). SN 76-595,890. PUB. 6-28-2005. FILED 6-7-2004.
- 2,996,781. **PUREBRIGHT (BLOCK FORM)**. NOF CORPORATION, (U.S. CLS. 1, 5, 6, 10, 26 AND 46). SN 76-604,188. PUB. 6-28-2005. FILED 7-27-2004.
- 2,996,849. **FIREFIGHTER (BLOCK FORM)**. THE NOBLE COMPANY, (U.S. CLS. 1, 5, 6, 10, 26 AND 46). SN 76-605,701. PUB. 6-28-2005. FILED 8-5-2004.
- 2,996,873. **HIPAL (BLOCK FORM)**. SOUTHERN IONICS INCORPORATED, (U.S. CLS. 1, 5, 6, 10, 26 AND 46). SN 76-606,900. PUB. 6-28-2005. FILED 8-11-2004.
- 2,996,885. **HOLOGRAPHIC SHADOW PICTURE**. BUNDESDRUCKEREI GMBH, MULTIPLE CLASS, (INT. CLS. 1, 9, 17, 40, 42 AND 45), (U.S. CLS. 1, 5, 6, 10, 12, 13, 21, 23, 26, 35, 36, 38, 46, 50, 100, 101, 103 AND 106). SN 76-977,266. PUB. 6-28-2005. FILED 3-5-2002.
- 2,996,941. **MITOX**. PRIMAGEN HOLDING B.V., MULTIPLE CLASS, (INT. CLS. 1 AND 5), (U.S. CLS. 1, 5, 6, 10, 18, 26, 44, 46, 51 AND 52). SN 78-242,040. PUB. 6-28-2005. FILED 4-25-2003.
- 2,996,997. **MISCELLANEOUS DESIGN**. NANJING HONGBAOLI CO. LTD., (U.S. CLS. 1, 5, 6, 10, 26 AND 46). SN 78-295,299. PUB. 6-28-2005. FILED 9-3-2003.
- 2,997,003. **OMEFAS**. TILLOTTS PHARMA AG, MULTIPLE CLASS, (INT. CLS. 1 AND 5), (U.S. CLS. 1, 5, 6, 10, 18, 26, 44, 46, 51 AND 52). SN 78-297,925. PUB. 6-28-2005. FILED 9-9-2003.
- 2,997,122. **NORSOCRYL (BLOCK FORM)**. ATOFINA, (U.S. CLS. 1, 5, 6, 10, 26 AND 46). SN 78-348,979. PUB. 6-28-2005. FILED 1-7-2004.
- 2,997,134. **BAKUHAN (BLOCK FORM)**. WELLNESS ENTERPRISES, (U.S. CLS. 1, 5, 6, 10, 26 AND 46). SN 78-350,836. PUB. 6-28-2005. FILED 1-12-2004.
- 2,997,173. **STIMP UP (BLOCK FORM)**. LIQUID FERTILISER PTY LTD ACN 105 456 148, TA AGRICHEM, (U.S. CLS. 1, 5, 6, 10, 26 AND 46). SN 78-359,161. PUB. 6-28-2005. FILED 1-29-2004.
- 2,997,276. **ENCHOICE (BLOCK FORM)**. ENVIRONMENTAL CHOICES, INC., MULTIPLE CLASS, (INT. CLS. 1 AND 3), (U.S. CLS. 1, 4, 5, 6, 10, 26, 46, 50, 51 AND 52). SN 78-371,902. PUB. 6-28-2005. FILED 2-21-2004.
- 2,997,396. **PINK TORNADO (BLOCK FORM)**. ECOLAB INC., (U.S. CLS. 1, 5, 6, 10, 26 AND 46). SN 78-393,364. PUB. 6-28-2005. FILED 3-30-2004.
- 2,997,413. **HIT! AND DESIGN**. HI-TOUCH IMAGING TECHNOLOGIES, (U.S. CLS. 1, 5, 6, 10, 26 AND 46). SN 78-397,542. PUB. 6-28-2005. FILED 4-7-2004.
- 2,997,580. **DYE GRABBER (BLOCK FORM)**. DELTA CARBONA, L.P., (U.S. CLS. 1, 5, 6, 10, 26 AND 46). SN 78-432,563. PUB. 6-28-2005. FILED 6-9-2004.
- 2,997,640. **ADVANCED-PREP (BLOCK FORM)**. ADVANCED POOL AND SPA PRODUCTS, INC., (U.S. CLS. 1, 5, 6, 10, 26 AND 46). SN 78-440,519. PUB. 6-28-2005. FILED 6-24-2004.
- 2,997,686. **MYCOTOPIA (BLOCK FORM)**. HANNAFIN, GERALD, (U.S. CLS. 1, 5, 6, 10, 26 AND 46). SN 78-444,923. PUB. 6-28-2005. FILED 7-1-2004.
- 2,997,933. **MAGTHIO (BLOCK FORM)**. TESSENDERLO KERLEY, INC., (U.S. CLS. 1, 5, 6, 10, 26 AND 46). SN 78-458,255. PUB. 6-28-2005. FILED 7-28-2004.
- 2,998,062. **POLYSHIELD (BLOCK FORM)**. INVISTA NORTH AMERICA S. A R.L., (U.S. CLS. 1, 5, 6, 10, 26 AND 46). SN 78-460,433. PUB. 6-28-2005. FILED 8-2-2004.
- 2,998,143. **DUPONT (BLOCK FORM)**. E. I. DU PONT DE NEMOURS AND COMPANY, (U.S. CLS. 1, 5, 6, 10, 26 AND 46). SN 78-461,868. PUB. 6-28-2005. FILED 8-4-2004.
- 2,998,247. **MATRIX (BLOCK FORM)**. THE LUBRIZOL CORPORATION, (U.S. CLS. 1, 5, 6, 10, 26 AND 46). SN 78-465,744. PUB. 6-28-2005. FILED 8-11-2004.
- 2,998,266. **MISCELLANEOUS DESIGN**. MORTON INTERNATIONAL, INC., (U.S. CLS. 1, 5, 6, 10, 26 AND 46). SN 78-466,964. PUB. 6-28-2005. FILED 8-13-2004.
- 2,998,346. **AQUAPILL (BLOCK FORM)**. RECREATIONAL WATER TECHNOLOGIES, LLC, (U.S. CLS. 1, 5, 6, 10, 26 AND 46). SN 78-573,087. PUB. 6-28-2005. FILED 2-23-2005.
- 2,998,356. **HELIT (BLOCK FORM)**. NGL CLEANING TECHNOLOGY S.A., MULTIPLE CLASS, (INT. CLS. 1 AND 3), (U.S. CLS. 1, 4, 5, 6, 10, 26, 46, 50, 51 AND 52). SN 79-000,241. PUB. 6-28-2005. FILED 11-12-2003.

- 2,998,367. **ACTIPUR (BLOCK FORM)**. MERCK KGAA. (U.S. CLS. 1, 5, 6, 10, 26 AND 46). SN 79-000,582. PUB. 6-28-2005. FILED 12-19-2003.
- 2,998,385. **FOTOPUR (STYLIZED)**. MERCK; KOMMANDITGESELLSCHAFT AUF AKTIEN. (U.S. CLS. 1, 5, 6, 10, 26 AND 46). SN 79-001,269. PUB. 6-28-2005. FILED 1-31-2004.
- 2,998,408. **ASAHIKLIN (BLOCK FORM)**. ASahi GLASS COMPANY, LTD., MULTIPLE CLASS, (INT. CLS. 1 AND 3), (U.S. CLS. 1, 4, 5, 6, 10, 26, 46, 50, 51 AND 52). SN 79-001,782. PUB. 6-28-2005. FILED 1-6-2004.
- 2,998,412. **PHARAONE (BLOCK FORM)**. GIVAUDAN SA. (U.S. CLS. 1, 5, 6, 10, 26 AND 46). SN 79-001,917. PUB. 6-28-2005. FILED 3-24-2004.
- 2,998,433. **JUVEEL (BLOCK FORM)**. DR. SUWELACK SKIN & HEALTH CARE AG, MULTIPLE CLASS, (INT. CLS. 1 AND 3), (U.S. CLS. 1, 4, 5, 6, 10, 26, 46, 50, 51 AND 52). SN 79-002,509. PUB. 6-28-2005. FILED 4-15-2004.
- 2,998,446. **ATTENUASE (BLOCK FORM)**. NOVOZYMES A/S, (U.S. CLS. 1, 5, 6, 10, 26 AND 46). SN 79-002,859. PUB. 6-28-2005. FILED 4-21-2004.
- 2,998,453. **POPSCENT (BLOCK FORM)**. FIRMENICH SA, MULTIPLE CLASS, (INT. CLS. 1 AND 3), (U.S. CLS. 1, 4, 5, 6, 10, 26, 46, 50, 51 AND 52). SN 79-003,133. PUB. 6-28-2005. FILED 2-23-2004.
- 2,998,495. **BETOGLASS (BLOCK FORM)**. BÖE, HANS PETER, MULTIPLE CLASS, (INT. CLS. 1 AND 19), (U.S. CLS. 1, 5, 6, 10, 12, 26, 33, 46 AND 50). SN 79-005,837. PUB. 6-28-2005. FILED 2-6-2004.

CLASS 2—PAINTS

- 2,996,277 (*See Class 1 for this trademark*).
- 2,996,344. **MARSHALL'S. BRANDESS-KALT-AETNA GROUP, INC., MULTIPLE CLASS, (INT. CLS. 2, 3 AND 16), (U.S. CLS. 1, 2, 4, 5, 6, 11, 16, 22, 23, 29, 37, 38, 50, 51 AND 52).** SN 76-496,731. PUB. 5-3-2005. FILED 3-12-2003.
- 2,996,388. **EASY COAT. PRECISION TECHNOLOGY LLC, (U.S. CLS. 6, 11 AND 16).** SN 76-530,040. PUB. 6-28-2005. FILED 6-23-2003.
- 2,996,648. **COLOR SMART BY AND DESIGN. BEHR PROCESS CORPORATION, MULTIPLE CLASS, (INT. CLS. 2, 16 AND 20), (U.S. CLS. 2, 5, 6, 11, 13, 16, 22, 23, 25, 29, 32, 37, 38 AND 50).** SN 76-585,398. PUB. 6-28-2005. FILED 4-2-2004.
- 2,996,763. **HAMMER HEAD (BLOCK FORM)**. DMW, INC., (U.S. CLS. 6, 11 AND 16). SN 76-602,026. PUB. 6-28-2005. FILED 7-12-2004.
- 2,996,965. **REFINISHER'S CHOICE AND DESIGN. TCI PRODUCTS, INC., MULTIPLE CLASS, (INT. CLS. 2, 6, 16, 17 AND 21), (U.S. CLS. 1, 2, 5, 6, 11, 12, 13, 14, 16, 22, 23, 25, 29, 30, 33, 35, 37, 38, 40 AND 50).** SN 78-267,848. PUB. 6-28-2005. FILED 6-27-2003.
- 2,996,977. **LG CHEM AND DESIGN. LG CORP., (U.S. CLS. 6, 11 AND 16).** SN 78-276,565. PUB. 6-28-2005. FILED 7-21-2003.
- 2,997,073. **COSMICHROME (BLOCK FORM)**. COSMICHROME, INC., MULTIPLE CLASS, (INT. CLS. 2 AND 7), (U.S. CLS. 6, 11, 13, 16, 19, 21, 23, 31, 34 AND 35). SN 78-336,477. PUB. 6-28-2005. FILED 12-4-2003.
- 2,997,079. **KEL-KOTE (BLOCK FORM)**. KEL-KOTE, INC., (U.S. CLS. 6, 11 AND 16). SN 78-339,167. PUB. 6-28-2005. FILED 12-10-2003.
- 2,997,198. **BEHR PREMIUM PLUS WITH STYLE (BLOCK FORM)**. BEHR PROCESS CORPORATION, (U.S. CLS. 6, 11 AND 16). SN 78-361,470. PUB. 6-28-2005. FILED 2-3-2004.
- 2,997,256. **GAMBLIN ART STUDENT OIL COLORS AND DESIGN. GAMBLIN ARTISTS COLORS CO., (U.S. CLS. 6, 11 AND 16).** SN 78-368,630. PUB. 6-28-2005. FILED 2-16-2004.
- 2,997,377. **CIRCA 1850 (BLOCK FORM)**. SWING PAINTS LTD, MULTIPLE CLASS, (INT. CLS. 2 AND 3), (U.S. CLS. 1, 4, 6, 11, 16, 50, 51 AND 52). SN 78-390,888. PUB. 6-28-2005. FILED 3-25-2004.
- 2,997,460. **YOYAMART (BLOCK FORM)**. YOYAMART INC., MULTIPLE CLASS, (INT. CLS. 2, 25 AND 35), (U.S. CLS. 6, 11, 16, 22, 39, 100, 101 AND 102). SN 78-406,468. PUB. 6-28-2005. FILED 4-22-2004.
- 2,997,730. **TRIPLE X (BLOCK FORM)**. ECOLAB INC., (U.S. CLS. 6, 11 AND 16). SN 78-449,203. PUB. 6-28-2005. FILED 7-

- 12-2004.
- 2,997,781. **NUVOCOAT AND DESIGN. PROTECH CHIMIE LTEE/PROTECH CHEMICALS LTD., (U.S. CLS. 6, 11 AND 16).** SN 78-453,482. PUB. 6-28-2005. FILED 7-20-2004.
- 2,998,228. **POWERPATCH (BLOCK FORM)**. AMERICAN POLYWATER CORPORATION, (U.S. CLS. 6, 11 AND 16). SN 78-464,866. PUB. 6-28-2005. FILED 8-10-2004.
- 2,998,306. **ENVIRO-GRIP (BLOCK FORM)**. POLY-TUFF SYSTEMS INTERNATIONAL CORPORATION, (U.S. CLS. 6, 11 AND 16). SN 78-479,715. PUB. 6-28-2005. FILED 9-7-2004.
- 2,998,396. **VERIGARD (BLOCK FORM)**. AKZO NOBEL CHEMICALS B.V., (U.S. CLS. 6, 11 AND 16). SN 79-001,455. PUB. 6-28-2005. FILED 1-14-2004.

CLASS 3—COSMETICS AND CLEANING PREPARATIONS

- 2,996,241. **MISCELLANEOUS DESIGN. KABUSHIKI KAISHA SONY COMPUTER ENTERTAINMENT, TA SONY COMPUTER ENTERTAINMENT INC., (U.S. CLS. 1, 4, 6, 50, 51 AND 52).** SN 75-870,863. PUB. 6-28-2005. FILED 12-13-1999.
- 2,996,243. **LIPIZZANER. LECON TECHNISCHE KONSTRUKTIONEN UND -DESIGN GES.M.B.H., MULTIPLE CLASS, (INT. CLS. 3, 6, 8, 9, 14, 16, 18, 21, 24, 28, 29, 30, 32, 33, 34, 41 AND 43), (U.S. CLS. 1, 2, 3, 4, 5, 6, 8, 9, 12, 13, 14, 17, 21, 22, 23, 25, 26, 27, 28, 29, 30, 33, 36, 37, 38, 40, 41, 42, 44, 45, 46, 47, 48, 49, 50, 51, 52, 100, 101 AND 107).** SN 76-016,988. PUB. 6-28-2005. FILED 4-3-2000.
- 2,996,264. **ULTRA PLUS. SEARS BRANDS, LLC, (U.S. CLS. 1, 4, 6, 50, 51 AND 52).** SN 76-341,381. PUB. 6-28-2005. FILED 11-23-2001.
- 2,996,344 (*See Class 2 for this trademark*).
- 2,996,362. **ACRYLIONIC. LUSTRELAX LXR, INCORPORATED, (U.S. CLS. 1, 4, 6, 50, 51 AND 52).** SN 76-517,397. PUB. 6-28-2005. FILED 5-28-2003.
- 2,996,463. **LA BELLA AND DESIGN. GOLDEN SUN, INC., (U.S. CLS. 1, 4, 6, 50, 51 AND 52).** SN 76-561,480. PUB. 5-3-2005. FILED 11-24-2003.
- 2,996,466. **MELONHEAD (BLOCK FORM)**. MELONHEAD CORPORATION, (U.S. CLS. 1, 4, 6, 50, 51 AND 52). SN 76-562,371. PUB. 6-28-2005. FILED 12-1-2003.
- 2,996,529. **LUKE (STYLIZED)**. HANWOONG COATECH CO., LTD., (U.S. CLS. 1, 4, 6, 50, 51 AND 52). SN 76-570,765. PUB. 6-28-2005. FILED 1-20-2004.
- 2,996,557. **MISCELLANEOUS DESIGN. EMILIO PUCCI S.R.L., MULTIPLE CLASS, (INT. CLS. 3, 18 AND 25), (U.S. CLS. 1, 2, 3, 4, 6, 22, 39, 41, 50, 51 AND 52).** SN 76-572,447. PUB. 6-28-2005. FILED 1-23-2004.
- 2,996,571. **LEND A HAND SOAP (BLOCK FORM)**. MARIO RUSSO, INC., (U.S. CLS. 1, 4, 6, 50, 51 AND 52). SN 76-573,044. PUB. 6-28-2005. FILED 1-28-2004.
- 2,996,594. **VITIV AND DESIGN. VITIV, INC., (U.S. CLS. 1, 4, 6, 50, 51 AND 52).** SN 76-575,894. PUB. 6-28-2005. FILED 2-9-2004.
- 2,996,645. **BODYCOFFEE (BLOCK FORM)**. STEPHKA'S COLLECTION LLC, (U.S. CLS. 1, 4, 6, 50, 51 AND 52). SN 76-584,823. PUB. 1-4-2005. FILED 3-29-2004.
- 2,996,707. **B.E.S.T. (BLOCK FORM)**. A & B ASSOCIATES, INC., (U.S. CLS. 1, 4, 6, 50, 51 AND 52). SN 76-595,964. PUB. 6-28-2005. FILED 6-7-2004.
- 2,996,712. **DREAM LLAMA (STYLIZED)**. SMART GIRL INVESTMENTS, LLC, (U.S. CLS. 1, 4, 6, 50, 51 AND 52). SN 76-596,383. PUB. 6-28-2005. FILED 6-9-2004.
- 2,996,750. **ABSOLUTELY NATURAL (BLOCK FORM)**. RICHARDS DISTRIBUTING, INC., (U.S. CLS. 1, 4, 6, 50, 51 AND 52). SN 76-600,339. PUB. 6-28-2005. FILED 7-2-2004.
- 2,996,769. **AC 200 (STYLIZED)**. ZESTRON CORPORATION, (U.S. CLS. 1, 4, 6, 50, 51 AND 52). SN 76-603,087. PUB. 6-28-2005. FILED 7-20-2004.
- 2,996,801. **TRIPLE SILK (BLOCK FORM)**. SELECTED CHEMICAL PRODUCTS COMPANY, (U.S. CLS. 1, 4, 6, 50, 51 AND 52). SN 76-604,695. PUB. 6-28-2005. FILED 7-29-2004.
- 2,996,894. **ALMAY ORGANIC FLUORIDE PLUS**. REVLON CONSUMER PRODUCTS CORPORATION, (U.S. CLS. 1, 4, 6, 50, 51 AND 52). SN 78-113,208. PUB. 6-28-2005. FILED 3-7-2002.

- 2,996,908. **REPADENT**. HENKEL KGAA, MULTIPLE CLASS, (INT. CLS. 3 AND 5), (U.S. CLS. 1, 4, 6, 18, 44, 46, 50, 51 AND 52). SN 78-183,766. PUB. 3-8-2005. FILED 11-11-2002.
- 2,996,934. **FINGERNAIL FASHIONS**. LISA FRANK, INC., (U.S. CLS. 1, 4, 6, 50, 51 AND 52). SN 78-229,742. PUB. 6-28-2005. FILED 3-25-2003.
- 2,996,949. **INNOCENT**. THIERRY MUGLER PARFUMS S.A.S., (U.S. CLS. 1, 4, 6, 50, 51 AND 52). SN 78-254,042. PUB. 6-28-2005. FILED 5-23-2003.
- 2,996,962. **UN-DAMAGED GOODS**. PAVES' PROFESSIONAL, INC., (U.S. CLS. 1, 4, 6, 50, 51 AND 52). SN 78-264,818. PUB. 6-28-2005. FILED 6-19-2003.
- 2,996,986. **MG**. STELLA INDUSTRIES LLC, (U.S. CLS. 1, 4, 6, 50, 51 AND 52). SN 78-287,602. PUB. 6-28-2005. FILED 8-14-2003.
- 2,997,093. **EMAMI (BLOCK FORM)**. EMAMI LIMITED, (U.S. CLS. 1, 4, 6, 50, 51 AND 52). SN 78-342,759. PUB. 6-28-2005. FILED 12-18-2003.
- 2,997,127. **EARTH SCIENCE AND DESIGN**. THE TERRAPIN COMPANIES, (U.S. CLS. 1, 4, 6, 50, 51 AND 52). SN 78-349,789. PUB. 6-28-2005. FILED 1-9-2004.
- 2,997,136. **STOP ACNE SYSTEMS (BLOCK FORM)**. SCHELLING, CHRISTIANNE, MULTIPLE CLASS, (INT. CLS. 3 AND 5), (U.S. CLS. 1, 4, 6, 18, 44, 46, 50, 51 AND 52). SN 78-350,940. PUB. 6-28-2005. FILED 1-12-2004.
- 2,997,231. **LOVE LOTION (BLOCK FORM)**. DEAN MARKLEY STRINGS, INC., (U.S. CLS. 1, 4, 6, 50, 51 AND 52). SN 78-365,137. PUB. 6-28-2005. FILED 2-9-2004.
- 2,997,254. **VOVI (BLOCK FORM)**. ALPHA MEDICAL SYSTEMS, INC., (U.S. CLS. 1, 4, 6, 50, 51 AND 52). SN 78-368,387. PUB. 6-28-2005. FILED 2-15-2004.
- 2,997,276 (*See Class 1 for this trademark*).
- 2,997,322. **FOO-FOO (BLOCK FORM)**. MEEKS, JOSEPH A., AND MEEKS, MARY GROSSMAN, (U.S. CLS. 1, 4, 6, 50, 51 AND 52). SN 78-378,990. PUB. 6-28-2005. FILED 3-4-2004.
- 2,997,337. **EB5 (BLOCK FORM)**. EB5 CORPORATION, (U.S. CLS. 1, 4, 6, 50, 51 AND 52). SN 78-382,786. PUB. 6-28-2005. FILED 3-11-2004.
- 2,997,372. **MALEKIND (BLOCK FORM)**. NEDBOY, ROBIN L, (U.S. CLS. 1, 4, 6, 50, 51 AND 52). SN 78-389,419. PUB. 5-10-2005. FILED 3-23-2004.
- 2,997,377 (*See Class 2 for this trademark*).
- 2,997,436. **SOFT'N NICE AND DESIGN**. AMDX, LLC., (U.S. CLS. 1, 4, 6, 50, 51 AND 52). SN 78-402,680. PUB. 6-28-2005. FILED 4-15-2004.
- 2,997,471. **IBA (BLOCK FORM)**. IBA INC., MULTIPLE CLASS, (INT. CLS. 3 AND 5), (U.S. CLS. 1, 4, 6, 18, 44, 46, 50, 51 AND 52). SN 78-409,044. PUB. 6-28-2005. FILED 4-27-2004.
- 2,997,510. **MISCELLANEOUS DESIGN**. JOOP! GMBH, MULTIPLE CLASS, (INT. CLS. 3, 9, 14, 18 AND 25), (U.S. CLS. 1, 2, 3, 4, 6, 21, 22, 23, 26, 27, 28, 36, 38, 39, 41, 50, 51 AND 52). SN 78-416,931. PUB. 6-28-2005. FILED 5-11-2004.
- 2,997,628. **UP-STREAM (BLOCK FORM)**. ULTIMATE OUTDOOR SOLUTIONS INC., (U.S. CLS. 1, 4, 6, 50, 51 AND 52). SN 78-439,222. PUB. 6-28-2005. FILED 6-22-2004.
- 2,997,751. **STUF AND DESIGN**. STUF PRODUCTS LLC, (U.S. CLS. 1, 4, 6, 50, 51 AND 52). SN 78-451,140. PUB. 6-28-2005. FILED 7-15-2004.
- 2,997,761. **F.A.G FABULOUS AND GAY AND DESIGN**. GRAYSON FAIRBANKS, INC., (U.S. CLS. 1, 4, 6, 50, 51 AND 52). SN 78-451,780. PUB. 6-28-2005. FILED 7-16-2004.
- 2,997,820. **WET SHINE FUSION (BLOCK FORM)**. L'OREAL USA CREATIVE, INC., (U.S. CLS. 1, 4, 6, 50, 51 AND 52). SN 78-455,391. PUB. 6-28-2005. FILED 7-23-2004.
- 2,997,867. **DIY DO IT YOURSELF BEAUTY (BLOCK FORM)**. AZTEC FINANCE CORPORATION LIMITED, (U.S. CLS. 1, 4, 6, 50, 51 AND 52). SN 78-456,956. PUB. 6-28-2005. FILED 7-26-2004.
- 2,997,922. **PERFECT TEN (BLOCK FORM)**. BIOPHARMACEUTICALS, L.L.C., (U.S. CLS. 1, 4, 6, 50, 51 AND 52). SN 78-458,039. PUB. 6-28-2005. FILED 7-28-2004.
- 2,997,925. **COOL DOG (BLOCK FORM)**. BEAUTY ELITE GROUP, INC., (U.S. CLS. 1, 4, 6, 50, 51 AND 52). SN 78-458,111. PUB. 6-28-2005. FILED 7-28-2004.
- 2,997,991. **YOU LOOK SO YOUNG (BLOCK FORM)**. JACOBS, ERIC, (U.S. CLS. 1, 4, 6, 50, 51 AND 52). SN 78-459,438. PUB. 6-28-2005. FILED 7-30-2004.
- 2,997,998. **ABSOLUTE MIRACLE (BLOCK FORM)**. MCKENNEY, MICHELLE W., (U.S. CLS. 1, 4, 6, 50, 51 AND 52). SN 78-459,510. PUB. 6-28-2005. FILED 7-30-2004.
- 2,998,010. **BEDTIME CREAM (BLOCK FORM)**. JOHNSON & JOHNSON, (U.S. CLS. 1, 4, 6, 50, 51 AND 52). SN 78-459,650. PUB. 6-28-2005. FILED 7-30-2004.
- 2,998,040. **MISCELLANEOUS DESIGN**. THE PROCTER & GAMBLE COMPANY, (U.S. CLS. 1, 4, 6, 50, 51 AND 52). SN 78-460,227. PUB. 6-28-2005. FILED 8-2-2004.
- 2,998,041. **SHEA SOFT (BLOCK FORM)**. ADVANCED BEAUTY SYSTEMS, INC., (U.S. CLS. 1, 4, 6, 50, 51 AND 52). SN 78-460,240. PUB. 6-28-2005. FILED 8-2-2004.
- 2,998,043. **BETWEEN CLEAN WATERLESS DOG SHAMPOO (BLOCK FORM)**. KDP, INC., (U.S. CLS. 1, 4, 6, 50, 51 AND 52). SN 78-460,270. PUB. 6-28-2005. FILED 8-2-2004.
- 2,998,045. **COLOR REVITALIZER (BLOCK FORM)**. KAO KABUSHIKI KAISHA, TA KAO CORPORATION, (U.S. CLS. 1, 4, 6, 50, 51 AND 52). SN 78-460,279. PUB. 6-28-2005. FILED 8-2-2004.
- 2,998,061. **NO PASS-ALONG GERMS (BLOCK FORM)**. CAMOMILE LABORATORIES, INC., (U.S. CLS. 1, 4, 6, 50, 51 AND 52). SN 78-460,430. PUB. 6-28-2005. FILED 8-2-2004.
- 2,998,064. **SOAPETALS (BLOCK FORM)**. CAMOMILE LABORATORIES, INC., (U.S. CLS. 1, 4, 6, 50, 51 AND 52). SN 78-460,438. PUB. 6-28-2005. FILED 8-2-2004.
- 2,998,079. **VITAPOINTE (BLOCK FORM)**. KIWI EUROPEAN HOLDINGS B.V., (U.S. CLS. 1, 4, 6, 50, 51 AND 52). SN 78-460,892. PUB. 6-28-2005. FILED 8-3-2004.
- 2,998,090. **GALLERY (BLOCK FORM)**. SCENTESSENCE, INC., (U.S. CLS. 1, 4, 6, 50, 51 AND 52). SN 78-460,991. PUB. 6-28-2005. FILED 8-3-2004.
- 2,998,098. **LOVELY SKIN (STYLIZED)**. LOVELY SKIN, INC., (U.S. CLS. 1, 4, 6, 50, 51 AND 52). SN 78-461,131. PUB. 6-28-2005. FILED 8-3-2004.
- 2,998,119. **ISLAND CITRUS SPLASH (BLOCK FORM)**. ORANGE GLO INTERNATIONAL, INC., (U.S. CLS. 1, 4, 6, 50, 51 AND 52). SN 78-461,409. PUB. 6-28-2005. FILED 8-3-2004.
- 2,998,121. **HIDDEN COVE (BLOCK FORM)**. HIDDEN COVE HAIR DESIGN & SALES INC., (U.S. CLS. 1, 4, 6, 50, 51 AND 52). SN 78-461,417. PUB. 6-28-2005. FILED 8-3-2004.
- 2,998,193. **KERI (BLOCK FORM)**. E.R. SQUIBB & SONS LLC, (U.S. CLS. 1, 4, 6, 50, 51 AND 52). SN 78-463,368. PUB. 6-28-2005. FILED 8-6-2004.
- 2,998,203. **BIG ASS SOAP (BLOCK FORM)**. PLATT, STUART C, (U.S. CLS. 1, 4, 6, 50, 51 AND 52). SN 78-463,861. PUB. 6-28-2005. FILED 8-7-2004.
- 2,998,217. **BLOTION AND DESIGN**. SOUTHEASTERN DENTAL RESEARCH CORPORATION, (U.S. CLS. 1, 4, 6, 50, 51 AND 52). SN 78-464,562. PUB. 6-28-2005. FILED 8-9-2004.
- 2,998,252. **THE GOOD HOME CO. ESTABLISHED 1995 AND DESIGN**. THE GOOD HOME CO., INC., (U.S. CLS. 1, 4, 6, 50, 51 AND 52). SN 78-465,963. PUB. 6-28-2005. FILED 8-11-2004.
- 2,998,274. **KIMBERLY-CLARK PROFESSIONAL (BLOCK FORM)**. KIMBERLY-CLARK WORLDWIDE, INC., MULTIPLE CLASS, (INT. CLS. 3, 16, 21 AND 24), (U.S. CLS. 1, 2, 4, 5, 6, 13, 22, 23, 29, 30, 33, 37, 38, 40, 42, 50, 51 AND 52). SN 78-467,174. PUB. 6-28-2005. FILED 8-13-2004.
- 2,998,322. **WELLNESS IN BLOOM (BLOCK FORM)**. CALIFORNIA FRAGRANCE COMPANY, INC., (U.S. CLS. 1, 4, 6, 50, 51 AND 52). SN 78-503,442. PUB. 6-28-2005. FILED 10-21-2004.
- 2,998,336. **DOUBLE TALK (BLOCK FORM)**. JANE & COMPANY, LLC, (U.S. CLS. 1, 4, 6, 50, 51 AND 52). SN 78-539,217. PUB. 6-28-2005. FILED 12-28-2004.
- 2,998,351. **DS FACE & BODY "YOUR TEETH, BODY AND MIND WILL FEEL GREAT!" AND DESIGN**. DENTAL SPA, MULTIPLE CLASS, (INT. CLS. 3 AND 44), (U.S. CLS. 1, 4, 6, 50, 51, 52, 100 AND 101). SN 78-975,784. PUB. 6-28-2005. FILED 7-21-2003.
- 2,998,354. **FREE OIL (BLOCK FORM)**. APOTHEKER WALTER BOUHON GMBH, MULTIPLE CLASS, (INT. CLS. 3 AND 5), (U.S. CLS. 1, 4, 6, 18, 44, 46, 50, 51 AND 52). SN 79-000,153. PUB. 6-28-2005. FILED 11-20-2003.
- 2,998,356 (*See Class 1 for this trademark*).
- 2,998,357. **DANNEMANN AND DESIGN**. DANNEMANN AG, MULTIPLE CLASS, (INT. CLS. 3, 33 AND 34), (U.S. CLS. 1, 2, 4, 6, 8, 9, 17, 47, 49, 50, 51 AND 52). SN 79-000,353. PUB. 5-3-2005. FILED 12-12-2003.

2,998,363. **FROTTEE AND DESIGN**. RUFIN COSMETIC GMBH, (U.S. CLS. 1, 4, 6, 50, 51 AND 52). SN 79-000,484. PUB. 6-28-2005. FILED 12-2-2003.

2,998,369. **COCHLÉA (BLOCK FORM)**. CASTER. (U.S. CLS. 1, 4, 6, 50, 51 AND 52). SN 79-000,589. PUB. 6-28-2005. FILED 12-23-2003.

2,998,372. **UNE SOURIS VERTE (STYLIZED)**. G.L.B., (U.S. CLS. 1, 4, 6, 50, 51 AND 52). SN 79-000,747. PUB. 6-28-2005. FILED 12-29-2003.

2,998,386. **ESSENTIAL LOOKS (BLOCK FORM)**. HANS SCHWARZKOPF & HENKEL GMBH & CO. KG, MULTIPLE CLASS, (INT. CLS. 3, 41 AND 44), (U.S. CLS. 1, 4, 6, 50, 51, 52, 100, 101 AND 107). SN 79-001,283. PUB. 6-28-2005. FILED 12-12-2003.

2,998,408 (*See Class 1 for this trademark*).

2,998,414. **SAINT HILAIRE (BLOCK FORM)**. BRUNO SAINT HILAIRE, MULTIPLE CLASS, (INT. CLS. 3, 18 AND 25), (U.S. CLS. 1, 2, 3, 4, 6, 22, 39, 41, 50, 51 AND 52). SN 79-001,961. PUB. 6-28-2005. FILED 1-20-2004.

2,998,424. **EAU DE MARIAGE (STYLIZED)**. ATSUKO ANDO, (U.S. CLS. 1, 4, 6, 50, 51 AND 52). SN 79-002,235. PUB. 6-28-2005. FILED 1-12-2004.

2,998,433 (*See Class 1 for this trademark*).

2,998,437. **CELINE FEVER (BLOCK FORM)**. CELINE, (U.S. CLS. 1, 4, 6, 50, 51 AND 52). SN 79-002,590. PUB. 6-28-2005. FILED 4-23-2004.

2,998,451. **SATURNIA SPA (BLOCK FORM)**. TERME DI SATURNIA S.R.L., MULTIPLE CLASS, (INT. CLS. 3, 41 AND 42), (U.S. CLS. 1, 4, 6, 50, 51, 52, 100, 101 AND 107). SN 79-003,005. PUB. 6-28-2005. FILED 4-16-2004.

2,998,453 (*See Class 1 for this trademark*).

2,998,462. **"FOLLIA DI AQUARAMA" (STYLIZED)**. PAOLO TESTI, AND LUIGI SPAGGIARI, (U.S. CLS. 1, 4, 6, 50, 51 AND 52). SN 79-003,532. PUB. 6-28-2005. FILED 4-5-2004.

2,998,476. **ERIC ZEMMOUR (BLOCK FORM)**. ZEMMOUR ERIC, MULTIPLE CLASS, (INT. CLS. 3, 16, 26, 41, 42 AND 44), (U.S. CLS. 1, 2, 4, 5, 6, 22, 23, 29, 37, 38, 39, 40, 42, 50, 51, 52, 100, 101 AND 107). SN 79-004,179. PUB. 6-28-2005. FILED 2-16-2004.

CLASS 4—LUBRICANTS AND FUELS

2,996,325. **EXCELLA GREEN**. NIPPON SEIKO KABUSHIKI KAISHA, DBA NSK LTD., (U.S. CLS. 1, 6 AND 15). SN 76-479,049. PUB. 6-28-2005. FILED 12-27-2002.

2,996,639. **MISCELLANEOUS DESIGN**. DALLAS COWBOYS FOOTBALL CLUB, LTD., MULTIPLE CLASS, (INT. CLS. 4, 16, 18, 20 AND 24), (U.S. CLS. 1, 2, 3, 5, 6, 13, 15, 22, 23, 25, 29, 32, 37, 38, 41, 42 AND 50). SN 76-582,640. PUB. 6-28-2005. FILED 3-24-2004.

2,996,821. **LUBRIKO (BLOCK FORM)**. DYNAMIC INDUSTRIAL GROUP, INC., (U.S. CLS. 1, 6 AND 15). SN 76-605,082. PUB. 6-28-2005. FILED 7-30-2004.

2,996,867. **MISCELLANEOUS DESIGN**. ARCHIPELAGO, INC., (U.S. CLS. 1, 6 AND 15). SN 76-606,451. PUB. 6-28-2005. FILED 8-11-2004.

2,996,980. **THE ORIGINAL FAST-LITE INSTANT LIGHT-UP CANDLES AND DESIGN**. MYERCHIN ENTERPRISES INC., (U.S. CLS. 1, 6 AND 15). SN 78-278,214. PUB. 6-28-2005. FILED 7-24-2003.

2,997,160. **PROTECK (BLOCK FORM)**. THE MCPHERSON COMPANIES, INC., (U.S. CLS. 1, 6 AND 15). SN 78-357,695. PUB. 6-28-2005. FILED 1-26-2004.

2,997,258. **ANN'S CANDLES (BLOCK FORM)**. ANN'S CANDLES, INC., (U.S. CLS. 1, 6 AND 15). SN 78-368,690. PUB. 6-28-2005. FILED 2-16-2004.

2,997,334. **PREMIER PERFORMANCE (BLOCK FORM)**. TECH INCORPORATED, MULTIPLE CLASS, (INT. CLS. 4, 7, 8 AND 12), (U.S. CLS. 1, 6, 13, 15, 19, 21, 23, 28, 31, 34, 35 AND 44). SN 78-381,148. PUB. 6-28-2005. FILED 3-9-2004.

2,997,540. **COLONIAL CANDLE OF CAPE COD (BLOCK FORM)**. CANDLE CORPORATION OF AMERICA, (U.S. CLS. 1, 6 AND 15). SN 78-424,724. PUB. 6-28-2005. FILED 5-25-2004.

2,997,567. **SATARKI SCENTS (BLOCK FORM)**. GILREATH, KIM L., (U.S. CLS. 1, 6 AND 15). SN 78-430,135. PUB. 6-28-

2005. FILED 6-4-2004.

2,997,572. **CHARTREUSE (BLOCK FORM)**. MICHAELS, PHYLLIS, (U.S. CLS. 1, 6 AND 15). SN 78-430,500. PUB. 6-28-2005. FILED 6-5-2004.

2,997,723. **CANDLE BEE FARM (BLOCK FORM)**. CANDLE BEE FARM, LLC, (U.S. CLS. 1, 6 AND 15). SN 78-448,622. PUB. 6-28-2005. FILED 7-9-2004.

2,997,724. **CANDLE BEE (BLOCK FORM)**. CANDLE BEE FARM, LLC, (U.S. CLS. 1, 6 AND 15). SN 78-448,629. PUB. 6-28-2005. FILED 7-9-2004.

2,997,844. **REGAL (BLOCK FORM)**. TYLER CANDLE COMPANY, L.L.C., (U.S. CLS. 1, 6 AND 15). SN 78-456,207. PUB. 6-28-2005. FILED 7-24-2004.

2,997,845. **PMS (BLOCK FORM)**. TYLER CANDLE COMPANY, L.L.C., (U.S. CLS. 1, 6 AND 15). SN 78-456,210. PUB. 6-28-2005. FILED 7-24-2004.

2,997,848. **EXPERIENCE THE DIFFERENCE (BLOCK FORM)**. TYLER CANDLE COMPANY, L.L.C., (U.S. CLS. 1, 6 AND 15). SN 78-456,339. PUB. 6-28-2005. FILED 7-25-2004.

2,998,054. **BLUE PLANET (BLOCK FORM)**. FLINT HILLS RESOURCES, LLC, (U.S. CLS. 1, 6 AND 15). SN 78-460,350. PUB. 6-28-2005. FILED 8-2-2004.

2,998,399. **KLÜBERTEMP (BLOCK FORM)**. KLÜBER LUBRICATION MÜNCHEN KG, (U.S. CLS. 1, 6 AND 15). SN 79-001,503. PUB. 6-28-2005. FILED 2-3-2004.

2,998,445. **DAPHNE (BLOCK FORM)**. IDEMITSU KOSAN CO., LTD., (U.S. CLS. 1, 6 AND 15). SN 79-002,742. PUB. 6-28-2005. FILED 4-9-2004.

CLASS 5—PHARMACEUTICALS

2,996,247. **NICOTAB**. GELMEDIC HOLDING APS, (U.S. CLS. 6, 18, 44, 46, 51 AND 52). SN 76-054,926. PUB. 6-28-2005. FILED 5-23-2000.

2,996,290 (*See Class 1 for this trademark*).

2,996,359 (*See Class 1 for this trademark*).

2,996,369. **KARE STRIP AND DESIGN**. KOSMA-KARE CANADA INC., (U.S. CLS. 6, 18, 44, 46, 51 AND 52). SN 76-521,805. PUB. 6-28-2005. FILED 6-12-2003.

2,996,383. **CONFIDENCE ON DEMAND**. PHARMICA SCIENCES, INC., (U.S. CLS. 6, 18, 44, 46, 51 AND 52). SN 76-526,998. PUB. 6-28-2005. FILED 6-30-2003.

2,996,398. **PURITY PRODUCTS**. WATER PURE, INC., DBA PURITY PRODUCTS, (U.S. CLS. 6, 18, 44, 46, 51 AND 52). SN 76-533,988. PUB. 6-28-2005. FILED 7-31-2003.

2,996,422. **R AND DESIGN**. BIOGIA AB, MULTIPLE CLASS, (INT. CLS. 5, 29, 30 AND 32), (U.S. CLS. 6, 18, 44, 45, 46, 48, 51 AND 52). SN 76-540,488. PUB. 3-8-2005. FILED 8-27-2003.

2,996,429. **ASTATROL**. FUJI CHEMICAL INDUSTRY CO., LTD., MULTIPLE CLASS, (INT. CLS. 5 AND 29), (U.S. CLS. 6, 18, 44, 46, 51 AND 52). SN 76-543,798. PUB. 6-28-2005. FILED 9-9-2003.

2,996,444. **BIO TERAPICO AND DESIGN**. ANIDRAL S.R.L., (U.S. CLS. 6, 18, 44, 46, 51 AND 52). SN 76-548,089. PUB. 6-28-2005. FILED 9-29-2003.

2,996,445. **BIO TERAPEUTICO AND DESIGN**. ANIDRAL S.R.L., (U.S. CLS. 6, 18, 44, 46, 51 AND 52). SN 76-548,092. PUB. 6-28-2005. FILED 9-29-2003.

2,996,450. **PRAECIS AND DESIGN**. PRAECIS PHARMACEUTICALS, INC., (U.S. CLS. 6, 18, 44, 46, 51 AND 52). SN 76-550,952. PUB. 6-28-2005. FILED 9-22-2003.

2,996,512. **SUPER FRESH (BLOCK FORM)**. PACIFIC PACKAGING CONCEPTS, INC., DBA FRESH START VITAMINS CO. AND DBA C & A ENTERPRISES, INC., (U.S. CLS. 6, 18, 44, 46, 51 AND 52). SN 76-569,625. PUB. 6-28-2005. FILED 1-5-2004.

2,996,517. **2000 MILLENNIUM DRAGON BRAND AND DESIGN**. VITAPHARM INTERNATIONAL INC., (U.S. CLS. 6, 18, 44, 46, 51 AND 52). SN 76-569,979. PUB. 6-28-2005. FILED 1-14-2004.

2,996,528. **BE AND DESIGN**. BE UNLIMITED LTD., (U.S. CLS. 6, 18, 44, 46, 51 AND 52). SN 76-570,613. PUB. 6-28-2005. FILED 1-16-2004.

2,996,535. **WHITE BEAR (BLOCK FORM)**. MAX-CELL U.S.A., L.L.C., (U.S. CLS. 6, 18, 44, 46, 51 AND 52). SN 76-571,077. PUB. 6-28-2005. FILED 1-20-2004.

- 2,996,562. **GLYDIUM (STYLIZED)**. BIOFARMA. (U.S. CLS. 6, 18, 44, 46, 51 AND 52). SN 76-572,562. PUB. 6-28-2005. FILED 1-27-2004.
- 2,996,677. **EASY GLIDE (BLOCK FORM)**. VETERINARY ENTERPRISES, INC., (U.S. CLS. 6, 18, 44, 46, 51 AND 52). SN 76-591,016. PUB. 6-28-2005. FILED 5-7-2004.
- 2,996,724. **LIQUID SHOCK (BLOCK FORM)**. THE MIAMI PRODUCTS & CHEMICAL COMPANY, (U.S. CLS. 6, 18, 44, 46, 51 AND 52). SN 76-597,820. PUB. 6-28-2005. FILED 6-16-2004.
- 2,996,754. **GROW NUTRIENTS (BLOCK FORM)**. GROW COMPANY, INC., (U.S. CLS. 6, 18, 44, 46, 51 AND 52). SN 76-600,529. PUB. 6-28-2005. FILED 7-2-2004.
- 2,996,817. **GUARANTEED BURST OF ENERGY AND DESIGN**. NATURAL ORGANICS INC., (U.S. CLS. 6, 18, 44, 46, 51 AND 52). SN 76-604,989. PUB. 6-28-2005. FILED 8-2-2004.
- 2,996,887. **DISCERNA**. DISCERNA LIMITED, MULTIPLE CLASS, (INT. CLS. 5, 10 AND 42), (U.S. CLS. 6, 18, 26, 39, 44, 46, 51, 52, 100 AND 101). SN 78-072,439. PUB. 6-28-2005. FILED 7-5-2001.
- 2,996,899. **JOINTCARE**. AYURVEDIC CONCEPTS, LTD., DBA HIMALAYA USA, (U.S. CLS. 6, 18, 44, 46, 51 AND 52). SN 78-155,974. PUB. 6-28-2005. FILED 8-20-2002.
- 2,996,905. **BAZUKA**. DIOMED DEVELOPMENTS LIMITED, (U.S. CLS. 6, 18, 44, 46, 51 AND 52). SN 78-175,382. PUB. 6-28-2005. FILED 10-17-2002.
- 2,996,908 (*See Class 3 for this trademark*).
- 2,996,941 (*See Class 1 for this trademark*).
- 2,996,963. **DERMAVIVE**. DERMAVIVE INC., (U.S. CLS. 6, 18, 44, 46, 51 AND 52). SN 78-267,147. PUB. 3-8-2005. FILED 6-25-2003.
- 2,996,967. **VIACUTAN**. BOEHRINGER INGELHEIM VETMEDICA GMBH, (U.S. CLS. 6, 18, 44, 46, 51 AND 52). SN 78-270,316. PUB. 6-28-2005. FILED 7-3-2003.
- 2,997,003 (*See Class 1 for this trademark*).
- 2,997,009. **OM ORGANICS AND DESIGN**. OM ORGANICS, (U.S. CLS. 6, 18, 44, 46, 51 AND 52). SN 78-299,093. PUB. 6-28-2005. FILED 9-11-2003.
- 2,997,021. **LIQUIDCAINE**. FACE AND BODY PROFESSIONALS, INC., (U.S. CLS. 6, 18, 44, 46, 51 AND 52). SN 78-306,391. PUB. 1-4-2005. FILED 9-27-2003.
- 2,997,050. **SECRETLUX (BLOCK FORM)**. SANOCHEMIA DIAGNOSTICS DEUTSCHLAND GMBH, (U.S. CLS. 6, 18, 44, 46, 51 AND 52). SN 78-328,384. PUB. 6-28-2005. FILED 11-14-2003.
- 2,997,105. **VEGGIE-RX (BLOCK FORM)**. WINDOW ROCK ENTERPRISES, INC., (U.S. CLS. 6, 18, 44, 46, 51 AND 52). SN 78-346,214. PUB. 6-28-2005. FILED 12-29-2003.
- 2,997,123. **NORTIM (BLOCK FORM)**. BIOFARMA, (U.S. CLS. 6, 18, 44, 46, 51 AND 52). SN 78-349,006. PUB. 6-28-2005. FILED 1-7-2004.
- 2,997,136 (*See Class 3 for this trademark*).
- 2,997,158. **CLINSOL (BLOCK FORM)**. VIRBAC AH, INC., (U.S. CLS. 6, 18, 44, 46, 51 AND 52). SN 78-357,574. PUB. 6-28-2005. FILED 1-26-2004.
- 2,997,162. **CHIMERA (BLOCK FORM)**. OLIGOS ETC. INC., (U.S. CLS. 6, 18, 44, 46, 51 AND 52). SN 78-357,775. PUB. 6-28-2005. FILED 1-26-2004.
- 2,997,235. **NOVARTIS (BLOCK FORM)**. NOVARTIS AG, (U.S. CLS. 6, 18, 44, 46, 51 AND 52). SN 78-365,657. PUB. 6-28-2005. FILED 2-10-2004.
- 2,997,317. **PREMIUM PYRETHRUM (BLOCK FORM)**. MCLAUGHLIN GORMLEY KING COMPANY, (U.S. CLS. 6, 18, 44, 46, 51 AND 52). SN 78-377,591. PUB. 6-28-2005. FILED 3-3-2004.
- 2,997,347. **NATURAL PLAN STOMACH SOOTHER (BLOCK FORM)**. HEALTHMATE PRODUCTS, INC., (U.S. CLS. 6, 18, 44, 46, 51 AND 52). SN 78-385,586. PUB. 6-28-2005. FILED 3-16-2004.
- 2,997,392. **AC HEALTHCARE SUPPLY AND DESIGN**. AC HEALTHCARE SUPPLY, INC., MULTIPLE CLASS, (INT. CLS. 5, 9 AND 10), (U.S. CLS. 6, 18, 21, 23, 26, 36, 38, 39, 44, 46, 51 AND 52). SN 78-393,232. PUB. 6-28-2005. FILED 3-30-2004.
- 2,997,400. **SPARTAN (BLOCK FORM)**. HUMANICARE INTERNATIONAL, INC., (U.S. CLS. 6, 18, 44, 46, 51 AND 52). SN 78-393,997. PUB. 6-28-2005. FILED 3-31-2004.
- 2,997,471 (*See Class 3 for this trademark*).
- 2,997,491. **SNOWY CEDARS (BLOCK FORM)**. RECKITT BENCKISER INC., (U.S. CLS. 6, 18, 44, 46, 51 AND 52). SN 78-412,678. PUB. 6-28-2005. FILED 5-4-2004.
- 2,997,502. **AYURBLISS (BLOCK FORM)**. KELKAR, RUCHA, (U.S. CLS. 6, 18, 44, 46, 51 AND 52). SN 78-414,665. PUB. 6-28-2005. FILED 5-7-2004.
- 2,997,530. **MISCELLANEOUS DESIGN**. NUHERBS, INC., MULTIPLE CLASS, (INT. CLS. 5 AND 31), (U.S. CLS. 1, 6, 18, 44, 46, 51 AND 52). SN 78-421,917. PUB. 6-28-2005. FILED 5-19-2004.
- 2,997,573. **ARTHRITIS FREE (BLOCK FORM)**. YOUNG AGAIN PRODUCTS, INC., (U.S. CLS. 6, 18, 44, 46, 51 AND 52). SN 78-431,070. PUB. 6-28-2005. FILED 6-7-2004.
- 2,997,623. **PREDATOR SERIES PREDATOR ISLAND FRAGRANCES AND DESIGN**. JBS INDUSTRIES, INC., (U.S. CLS. 6, 18, 44, 46, 51 AND 52). SN 78-438,733. PUB. 6-28-2005. FILED 6-21-2004.
- 2,997,632. **FLAXLIC (BLOCK FORM)**. ANIMAL FEED SUPPLEMENT, INC., (U.S. CLS. 6, 18, 44, 46, 51 AND 52). SN 78-439,554. PUB. 6-28-2005. FILED 6-22-2004.
- 2,997,633. **CHECKCELL (BLOCK FORM)**. IMMUCOR INTELLECTUAL PROPERTIES, INC., (U.S. CLS. 6, 18, 44, 46, 51 AND 52). SN 78-439,605. PUB. 6-28-2005. FILED 6-22-2004.
- 2,997,642. **APEX MAX AND DESIGN**. APEX FITNESS, INC., (U.S. CLS. 6, 18, 44, 46, 51 AND 52). SN 78-440,646. PUB. 6-28-2005. FILED 6-24-2004.
- 2,997,661. **DR. BERNSTEIN HEALTH & DIET CLINICS (BLOCK FORM)**. BERNSTEIN, STANLEY K., (U.S. CLS. 6, 18, 44, 46, 51 AND 52). SN 78-443,181. PUB. 6-28-2005. FILED 6-29-2004.
- 2,997,829. **STRUCTUR (BLOCK FORM)**. VOCO GMBH, (U.S. CLS. 6, 18, 44, 46, 51 AND 52). SN 78-455,614. PUB. 6-28-2005. FILED 7-23-2004.
- 2,997,856. **VENKAST (BLOCK FORM)**. SMITHKLINE BEECHAM P.L.C., (U.S. CLS. 6, 18, 44, 46, 51 AND 52). SN 78-456,631. PUB. 6-28-2005. FILED 7-26-2004.
- 2,997,911. **HAIR AGAIN (BLOCK FORM)**. YOUNG AGAIN PRODUCTS, INC., (U.S. CLS. 6, 18, 44, 46, 51 AND 52). SN 78-457,810. PUB. 6-28-2005. FILED 7-28-2004.
- 2,997,924. **THE SCIENCE BEHIND THE SIZE (BLOCK FORM)**. ISI BRANDS, INC., (U.S. CLS. 6, 18, 44, 46, 51 AND 52). SN 78-458,064. PUB. 6-28-2005. FILED 7-28-2004.
- 2,997,950. **COX2N (BLOCK FORM)**. 4-U NUTRACEUTICALS, LLC, (U.S. CLS. 6, 18, 44, 46, 51 AND 52). SN 78-458,683. PUB. 6-28-2005. FILED 7-29-2004.
- 2,997,960. **EPOX-IT (BLOCK FORM)**. CBITE, INC., (U.S. CLS. 6, 18, 44, 46, 51 AND 52). SN 78-458,832. PUB. 6-28-2005. FILED 7-29-2004.
- 2,997,966. **RESIN-IT (BLOCK FORM)**. CBITE, INC., (U.S. CLS. 6, 18, 44, 46, 51 AND 52). SN 78-458,893. PUB. 6-28-2005. FILED 7-29-2004.
- 2,997,973. **GENF20 (BLOCK FORM)**. LEADING EDGE MARKETING INC., (U.S. CLS. 6, 18, 44, 46, 51 AND 52). SN 78-459,129. PUB. 6-28-2005. FILED 7-29-2004.
- 2,997,995. **METABOSURGE (BLOCK FORM)**. VITAMIN WORLD, INC., (U.S. CLS. 6, 18, 44, 46, 51 AND 52). SN 78-459,488. PUB. 6-28-2005. FILED 7-30-2004.
- 2,998,004. **IMMULIFE (BLOCK FORM)**. NEWMILK COMPANY, INC., (U.S. CLS. 6, 18, 44, 46, 51 AND 52). SN 78-459,563. PUB. 6-28-2005. FILED 7-30-2004.
- 2,998,020. **SEAPROSE S (BLOCK FORM)**. AMANO ENZYME USA CO., LTD., (U.S. CLS. 6, 18, 44, 46, 51 AND 52). SN 78-459,882. PUB. 6-28-2005. FILED 7-30-2004.
- 2,998,032. **NO-BOLIC PUMP (BLOCK FORM)**. SAMSON DISTRIBUTING INC., (U.S. CLS. 6, 18, 44, 46, 51 AND 52). SN 78-460,140. PUB. 6-28-2005. FILED 8-1-2004.
- 2,998,034. **CRE-X3 (BLOCK FORM)**. SAMSON DISTRIBUTING INC., (U.S. CLS. 6, 18, 44, 46, 51 AND 52). SN 78-460,142. PUB. 6-28-2005. FILED 8-1-2004.
- 2,998,051. **MYTI-HERBS (BLOCK FORM)**. KANG, CHING-KWEI, (U.S. CLS. 6, 18, 44, 46, 51 AND 52). SN 78-460,325. PUB. 6-28-2005. FILED 8-2-2004.
- 2,998,111. **STASIX (BLOCK FORM)**. HEMOCELLULAR THERAPEUTICS, INC., (U.S. CLS. 6, 18, 44, 46, 51 AND 52). SN 78-461,284. PUB. 6-28-2005. FILED 8-3-2004.
- 2,998,123. **EVOCLIN (BLOCK FORM)**. CONNETICS CORPORATION, (U.S. CLS. 6, 18, 44, 46, 51 AND 52). SN 78-461,420. PUB. 6-28-2005. FILED 8-3-2004.

- 2,998,137. **MISCELLANEOUS DESIGN**. MEDSPRING GROUP, INC., (U.S. CLS. 6, 18, 44, 46, 51 AND 52). SN 78-461,712. PUB. 6-28-2005. FILED 8-4-2004.
- 2,998,138. **HEALTHY COAT (BLOCK FORM)**. SOY INC., (U.S. CLS. 6, 18, 44, 46, 51 AND 52). SN 78-461,719. PUB. 6-28-2005. FILED 8-4-2004.
- 2,998,151. **BEARY GOOD (BLOCK FORM)**. BIOSAN LABORATORIES, INC., (U.S. CLS. 6, 18, 44, 46, 51 AND 52). SN 78-461,972. PUB. 6-28-2005. FILED 8-4-2004.
- 2,998,166. **LIPOVEX (BLOCK FORM)**. FORDHAM LABS LLC, (U.S. CLS. 6, 18, 44, 46, 51 AND 52). SN 78-462,271. PUB. 6-28-2005. FILED 8-4-2004.
- 2,998,169. **HECORIA (BLOCK FORM)**. NOVARTIS AG, (U.S. CLS. 6, 18, 44, 46, 51 AND 52). SN 78-462,385. PUB. 6-28-2005. FILED 8-5-2004.
- 2,998,191. **BUBBLI-PRED (BLOCK FORM)**. PADDOCK LABORATORIES, INC., (U.S. CLS. 6, 18, 44, 46, 51 AND 52). SN 78-463,348. PUB. 6-28-2005. FILED 8-6-2004.
- 2,998,202. **SEROMEL (BLOCK FORM)**. BANCROFT PHARMACEUTICALS, INC., (U.S. CLS. 6, 18, 44, 46, 51 AND 52). SN 78-463,853. PUB. 6-28-2005. FILED 8-7-2004.
- 2,998,259. **ACLAZPRE (BLOCK FORM)**. NOVARTIS AG, (U.S. CLS. 6, 18, 44, 46, 51 AND 52). SN 78-466,187. PUB. 6-28-2005. FILED 8-12-2004.
- 2,998,260. **ZOCLASTIC (BLOCK FORM)**. NOVARTIS AG, (U.S. CLS. 6, 18, 44, 46, 51 AND 52). SN 78-466,371. PUB. 6-28-2005. FILED 8-12-2004.
- 2,998,267. **VOPAC (BLOCK FORM)**. ATHLON PHARMACEUTICALS, INC., (U.S. CLS. 6, 18, 44, 46, 51 AND 52). SN 78-466,969. PUB. 6-28-2005. FILED 8-13-2004.
- 2,998,268. **NATURELINE (BLOCK FORM)**. SMITH, MICHAEL R., (U.S. CLS. 6, 18, 44, 46, 51 AND 52). SN 78-467,006. PUB. 6-28-2005. FILED 8-13-2004.
- 2,998,320. **GREEN-MAX (BLOCK FORM)**. BIO-NUTRA TECHNOLOGIES, LLC, (U.S. CLS. 6, 18, 44, 46, 51 AND 52). SN 78-500,327. PUB. 6-28-2005. FILED 10-15-2004.
- 2,998,344. **SPLASH OF RAIN (BLOCK FORM)**. THE YANKEE CANDLE COMPANY, INC., (U.S. CLS. 6, 18, 44, 46, 51 AND 52). SN 78-551,697. PUB. 6-28-2005. FILED 1-21-2005.
- 2,998,354 (*See Class 3 for this trademark*).
- 2,998,365. **NORBROOK (BLOCK FORM)**. NORBROOK LABORATORIES LIMITED, (U.S. CLS. 6, 18, 44, 46, 51 AND 52). SN 79-000,503. PUB. 6-28-2005. FILED 11-24-2003.
- 2,998,374. **VITASWISS (BLOCK FORM)**. VIFOR FRANCE SA, (U.S. CLS. 6, 18, 44, 46, 51 AND 52). SN 79-000,878. PUB. 6-28-2005. FILED 1-30-2004.
- 2,998,383. **OPTIBLE (STYLIZED)**. GENERALE BISCUIT, MULTIPLE CLASS, (INT. CLS. 5, 29 AND 30), (U.S. CLS. 6, 18, 44, 46, 51 AND 52). SN 79-001,213. PUB. 6-28-2005. FILED 2-5-2004.
- 2,998,405. **ARGINEA (STYLIZED)**. SCHWEPES INTERNATIONAL LIMITED, MULTIPLE CLASS, (INT. CLS. 5, 32 AND 33), (U.S. CLS. 6, 18, 44, 45, 46, 47, 48, 49, 51 AND 52). SN 79-001,708. PUB. 6-28-2005. FILED 1-26-2004.
- 2,998,407. **TB-CHECK-1 (BLOCK FORM)**. VEDALAB, (U.S. CLS. 6, 18, 44, 46, 51 AND 52). SN 79-001,744. PUB. 6-28-2005. FILED 3-2-2004.
- 2,998,425. **ORIVOCA (BLOCK FORM)**. BOEHRINGER INGELHEIM PHARMA GMBH & CO. KG, (U.S. CLS. 6, 18, 44, 46, 51 AND 52). SN 79-002,310. PUB. 6-28-2005. FILED 3-24-2004.
- 2,998,426. **BORSEC REGINA APELOR MINERALE AND DESIGN**. S.C. ROMAQUA GROUP S.A., MULTIPLE CLASS, (INT. CLS. 5, 32 AND 35), (U.S. CLS. 6, 18, 44, 45, 46, 48, 51, 52, 100, 101 AND 102). SN 79-002,361. PUB. 6-28-2005. FILED 3-17-2004.
- 2,998,429. **BONPRO (STYLIZED)**. SCHWARZ PHARMA AG, (U.S. CLS. 6, 18, 44, 46, 51 AND 52). SN 79-002,411. PUB. 6-28-2005. FILED 4-14-2004.
- 2,998,438. **BULKAMID (BLOCK FORM)**. CONTURA SA, MULTIPLE CLASS, (INT. CLS. 5 AND 10), (U.S. CLS. 6, 18, 26, 39, 44, 46, 51 AND 52). SN 79-002,593. PUB. 6-28-2005. FILED 4-26-2004.
- 2,998,441. **LARVADEX (BLOCK FORM)**. NOVARTIS AG, (U.S. CLS. 6, 18, 44, 46, 51 AND 52). SN 79-002,677. PUB. 6-28-2005. FILED 4-28-2004.
- 2,998,450. **VASOTOP (STYLIZED)**. INTERVET INTERNATIONAL BV, (U.S. CLS. 6, 18, 44, 46, 51 AND 52). SN 79-002,996. PUB. 6-28-2005. FILED 3-25-2004.
- 2,998,460. **FORTEKOR (STYLIZED)**. NOVARTIS AG, (U.S. CLS. 6, 18, 44, 46, 51 AND 52). SN 79-003,437. PUB. 6-28-2005. FILED 6-14-2004.
- 2,998,463. **RUBIO (BLOCK FORM)**. LABORATORIOS RUBIO, S.A., (U.S. CLS. 6, 18, 44, 46, 51 AND 52). SN 79-003,624. PUB. 6-28-2005. FILED 4-1-2004.
- 2,998,466. **TETRASPAN (BLOCK FORM)**. B. BRAUN MEL-SUNGEN AKTIENGESELLSCHAFT, (U.S. CLS. 6, 18, 44, 46, 51 AND 52). SN 79-003,744. PUB. 6-28-2005. FILED 5-13-2004.
- 2,998,473. **ECONOR (STYLIZED)**. NOVARTIS AG, (U.S. CLS. 6, 18, 44, 46, 51 AND 52). SN 79-004,010. PUB. 6-28-2005. FILED 4-27-2004.
- 2,998,475. **RUBIO AND DESIGN**. LABORATORIOS RUBIO, S.A., (U.S. CLS. 6, 18, 44, 46, 51 AND 52). SN 79-004,069. PUB. 6-28-2005. FILED 4-1-2004.
- 2,998,485. **TAPORAL (BLOCK FORM)**. BOEHRINGER INGELHEIM VETMEDICA GMBH, (U.S. CLS. 6, 18, 44, 46, 51 AND 52). SN 79-005,069. PUB. 6-28-2005. FILED 7-30-2004.
- 2,998,489. **PROCTOCLAIR (BLOCK FORM)**. SINCLAIR PHARMACEUTICALS LIMITED, (U.S. CLS. 6, 18, 44, 46, 51 AND 52). SN 79-005,221. PUB. 6-28-2005. FILED 7-16-2004.
- 2,998,490. **CARTROPHEN (BLOCK FORM)**. BIOPHARM AUSTRALIA PTY LIMITED, (U.S. CLS. 6, 18, 44, 46, 51 AND 52). SN 79-005,269. PUB. 6-28-2005. FILED 7-30-2004.
- 2,998,501. **TRANSAMIN (STYLIZED)**. DAHCHI PHARMACEUTICAL CO., LTD., (U.S. CLS. 6, 18, 44, 46, 51 AND 52). SN 79-007,710. PUB. 6-28-2005. FILED 8-10-2004.

CLASS 6—METAL GOODS

- 2,996,243 (*See Class 3 for this trademark*).
- 2,996,251. **SMARTCAP (STYLIZED)**. REDCLIFFE LIMITED, MULTIPLE CLASS, (INT. CLS. 6, 9 AND 20), (U.S. CLS. 2, 12, 13, 14, 21, 22, 23, 25, 26, 32, 36, 38 AND 50). SN 76-114,795. PUB. 6-28-2005. FILED 8-23-2000.
- 2,996,257 (*See Class 1 for this trademark*).
- 2,996,277 (*See Class 1 for this trademark*).
- 2,996,367. **SIGNONE**. SIGNONE CLIPSIN USA, L.L.C., (U.S. CLS. 2, 12, 13, 14, 23, 25 AND 50). SN 76-521,533. PUB. 6-28-2005. FILED 6-9-2003.
- 2,996,425. **NORTH CAROLINA STATE UNIVERSITY**. NORTH CAROLINA STATE UNIVERSITY, MULTIPLE CLASS, (INT. CLS. 6, 14, 16, 21, 25 AND 41), (U.S. CLS. 2, 5, 12, 13, 14, 22, 23, 25, 27, 28, 29, 30, 33, 37, 38, 39, 40, 50, 100, 101 AND 107). SN 76-541,666. PUB. 6-28-2005. FILED 9-2-2003.
- 2,996,549. **HB (STYLIZED)**. HOLBROOK MFG., INC., (U.S. CLS. 2, 12, 13, 14, 23, 25 AND 50). SN 76-571,895. PUB. 6-28-2005. FILED 1-26-2004.
- 2,996,604. **GENERAL ALUMINUM (STYLIZED)**. GENERAL ALUMINUM COMPANY OF TEXAS, LP, MULTIPLE CLASS, (INT. CLS. 6 AND 19), (U.S. CLS. 1, 2, 12, 13, 14, 23, 25, 33 AND 50). SN 76-577,151. PUB. 6-28-2005. FILED 2-23-2004.
- 2,996,613. **SIG.N.ATUR (STYLIZED)**. SIGNATURE PARTNERS, INC., (U.S. CLS. 2, 12, 13, 14, 23, 25 AND 50). SN 76-578,451. PUB. 6-28-2005. FILED 2-27-2004.
- 2,996,897. **AQUACLEAN AND DESIGN**. SMITH, JEFFREY A., (U.S. CLS. 2, 12, 13, 14, 23, 25 AND 50). SN 78-127,623. PUB. 6-28-2005. FILED 5-9-2002.
- 2,996,965 (*See Class 2 for this trademark*).
- 2,996,978. **CHANNEL LOK**. CANTAR/POLYAIR INC., (U.S. CLS. 2, 12, 13, 14, 23, 25 AND 50). SN 78-277,713. PUB. 6-28-2005. FILED 7-23-2003.
- 2,996,989. **STEELHEAD**. EASTSIDE STAPLE & NAIL, INC., (U.S. CLS. 2, 12, 13, 14, 23, 25 AND 50). SN 78-290,791. PUB. 6-28-2005. FILED 8-21-2003.
- 2,996,993. **HELIS**. HANS GROHE AG, MULTIPLE CLASS, (INT. CLS. 6, 11, 17 AND 19), (U.S. CLS. 1, 2, 5, 12, 13, 14, 21, 23, 25, 31, 33, 34, 35 AND 50). SN 78-291,798. PUB. 6-28-2005. FILED 8-25-2003.
- 2,997,004. **RAINSTORM**. HANS GROHE AG, MULTIPLE CLASS, (INT. CLS. 6, 11 AND 17), (U.S. CLS. 1, 2, 5, 12, 13, 14, 21, 23, 25, 31, 34, 35 AND 50). SN 78-298,339. PUB. 3-8-2005. FILED 9-10-2003.

2,997,005. **RAINWIND**. HANS GROHE AG, MULTIPLE CLASS, (INT. CLS. 6, 11 AND 17), (U.S. CLS. 1, 2, 5, 12, 13, 14, 21, 23, 25, 31, 34, 35 AND 50). SN 78-298,400. PUB. 3-8-2005. FILED 9-10-2003.

2,997,006. **RAINAIR**. HANS GROHE AG, MULTIPLE CLASS, (INT. CLS. 6, 11 AND 17), (U.S. CLS. 1, 2, 5, 12, 13, 14, 21, 23, 25, 31, 34, 35 AND 50). SN 78-298,433. PUB. 3-8-2005. FILED 9-10-2003.

2,997,064. **XCCENT (BLOCK FORM)**. MATHIESEN, LLC, (U.S. CLS. 2, 12, 13, 14, 23, 25 AND 50). SN 78-332,099. PUB. 6-28-2005. FILED 11-24-2003.

2,997,068. **COLOC (BLOCK FORM)**. HIGH TENSILE WIRE-LOC MFG., INC., (U.S. CLS. 2, 12, 13, 14, 23, 25 AND 50). SN 78-333,943. PUB. 6-28-2005. FILED 11-26-2003.

2,997,195. **WINTER WC CLASSICS (STYLIZED)**. SUMMER CLASSICS, INC., MULTIPLE CLASS, (INT. CLS. 6, 8, 11, 20 AND 21), (U.S. CLS. 2, 12, 13, 14, 21, 22, 23, 25, 28, 29, 30, 31, 32, 33, 34, 40, 44 AND 50). SN 78-361,078. PUB. 6-28-2005. FILED 2-2-2004.

2,997,344. **TWINTEC (BLOCK FORM)**. S.A. TWINTEC INTERNATIONAL, MULTIPLE CLASS, (INT. CLS. 6, 19 AND 27), (U.S. CLS. 1, 2, 12, 13, 14, 19, 20, 23, 25, 33, 37, 42 AND 50). SN 78-384,571. PUB. 6-28-2005. FILED 3-15-2004.

2,997,395. **BRUCIE BRACKET AND DESIGN**. NICO INNOVATIONS INC., (U.S. CLS. 2, 12, 13, 14, 23, 25 AND 50). SN 78-393,313. PUB. 6-28-2005. FILED 3-30-2004.

2,997,511. **U.S. EXPLOSIVE STORAGE AND DESIGN**. U.S. CHEMICAL STORAGE, LLC, (U.S. CLS. 2, 12, 13, 14, 23, 25 AND 50). SN 78-417,107. PUB. 6-28-2005. FILED 5-12-2004.

2,997,526. **SPEEDI-BOOT (BLOCK FORM)**. LANCE-LARKIN, LLC, (U.S. CLS. 2, 12, 13, 14, 23, 25 AND 50). SN 78-420,732. PUB. 6-28-2005. FILED 5-18-2004.

2,997,607. **ENAMELAIN (BLOCK FORM)**. KELVIN CHEN INTERNATIONAL LLC, (U.S. CLS. 2, 12, 13, 14, 23, 25 AND 50). SN 78-436,374. PUB. 6-28-2005. FILED 6-16-2004.

2,997,699. **WESWARE (BLOCK FORM)**. PREMIERE LOCK COMPANY LLC, MULTIPLE CLASS, (INT. CLS. 6 AND 21), (U.S. CLS. 2, 12, 13, 14, 23, 25, 29, 30, 33, 40 AND 50). SN 78-446,281. PUB. 6-28-2005. FILED 7-6-2004.

2,997,771. **MUSCLE WIRES (BLOCK FORM)**. MONDO-TRONICS, INC., (U.S. CLS. 2, 12, 13, 14, 23, 25 AND 50). SN 78-452,804. PUB. 6-28-2005. FILED 7-19-2004.

2,997,783. **TEKPIN (BLOCK FORM)**. ILLINOIS TOOL WORKS INC., (U.S. CLS. 2, 12, 13, 14, 23, 25 AND 50). SN 78-453,515. PUB. 6-28-2005. FILED 7-20-2004.

2,997,873. **FREUND CONTAINER AND DESIGN**. BERLIN PACKAGING, LLC, MULTIPLE CLASS, (INT. CLS. 6, 16 AND 21), (U.S. CLS. 2, 5, 12, 13, 14, 22, 23, 25, 29, 30, 33, 37, 38, 40 AND 50). SN 78-457,087. PUB. 6-28-2005. FILED 7-27-2004.

2,997,945. **MATRIX (BLOCK FORM)**. NEWELL OPERATING COMPANY, (U.S. CLS. 2, 12, 13, 14, 23, 25 AND 50). SN 78-458,570. PUB. 6-28-2005. FILED 7-29-2004.

2,998,086. **ATRIUM (BLOCK FORM)**. RUBBERMAID COMMERCIAL PRODUCTS LLC, (U.S. CLS. 2, 12, 13, 14, 23, 25 AND 50). SN 78-460,958. PUB. 6-28-2005. FILED 8-3-2004.

2,998,114. **STERLING (BLOCK FORM)**. BROWNING, (U.S. CLS. 2, 12, 13, 14, 23, 25 AND 50). SN 78-461,357. PUB. 6-28-2005. FILED 8-3-2004.

2,998,148. **SIGNPAST (BLOCK FORM)**. WINFIELD CONSUMER PRODUCTS, INC., (U.S. CLS. 2, 12, 13, 14, 23, 25 AND 50). SN 78-461,920. PUB. 6-28-2005. FILED 8-4-2004.

2,998,250. **EASYCHECK AND DESIGN**. BROOKSTONE PURCHASING, INC., (U.S. CLS. 2, 12, 13, 14, 23, 25 AND 50). SN 78-465,913. PUB. 6-28-2005. FILED 8-11-2004.

2,998,345. **FORMANEK DOOR (BLOCK FORM)**. FORMANEK CUSTOM DESIGNS AND DISTRIBUTING L.L.C., (U.S. CLS. 2, 12, 13, 14, 23, 25 AND 50). SN 78-559,570. PUB. 6-28-2005. FILED 2-3-2005.

2,998,402. **BLÜCHER COMPACT AND DESIGN**. BLÜCHER METAL APS, MULTIPLE CLASS, (INT. CLS. 6, 11 AND 19), (U.S. CLS. 1, 2, 12, 13, 14, 21, 23, 25, 31, 33, 34 AND 50). SN 79-001,601. PUB. 6-28-2005. FILED 3-16-2004.

2,998,417. **VACUCAST (BLOCK FORM)**. WALDEMAR LINK GMBH & CO. KG, MULTIPLE CLASS, (INT. CLS. 6 AND 10), (U.S. CLS. 2, 12, 13, 14, 23, 25, 26, 39, 44 AND 50). SN 79-002,036. PUB. 6-28-2005. FILED 12-10-2003.

2,998,418. **ECOBOND (BLOCK FORM)**. ALCAN SINGEN

GMBH, MULTIPLE CLASS, (INT. CLS. 6, 16 AND 17), (U.S. CLS. 1, 2, 5, 12, 13, 14, 22, 23, 25, 29, 35, 37, 38 AND 50). SN 79-002,055. PUB. 6-28-2005. FILED 2-3-2004.

2,998,423. **OMNISTOR AND DESIGN**. OMNISTOR ACCESSORIES N.V., MULTIPLE CLASS, (INT. CLS. 6, 12, 18 AND 22), (U.S. CLS. 1, 2, 3, 7, 12, 13, 14, 19, 21, 22, 23, 25, 31, 35, 41, 42, 44 AND 50). SN 79-002,215. PUB. 6-28-2005. FILED 2-3-2004.

2,998,456. **UGINE & ALZ (U&A) (BLOCK FORM)**. UGINE & ALZ FRANCE, MULTIPLE CLASS, (INT. CLS. 6 AND 40), (U.S. CLS. 2, 12, 13, 14, 23, 25, 50, 100, 103 AND 106). SN 79-003,290. PUB. 6-28-2005. FILED 12-27-2003.

2,998,480. **DRYFLEX (BLOCK FORM)**. SAES GETTERS S.P.A., MULTIPLE CLASS, (INT. CLS. 6 AND 9), (U.S. CLS. 2, 12, 13, 14, 21, 23, 25, 26, 36, 38 AND 50). SN 79-004,587. PUB. 6-28-2005. FILED 5-5-2004.

2,998,496. **ITAP-FIT (STYLIZED)**. ITAP SPA, MULTIPLE CLASS, (INT. CLS. 6 AND 19), (U.S. CLS. 1, 2, 12, 13, 14, 23, 25, 33 AND 50). SN 79-005,958. PUB. 6-28-2005. FILED 8-3-2004.

CLASS 7—MACHINERY

2,996,348. **LADYSHIP AND DESIGN**. KEN YING ENTERPRISE CO., LTD., (U.S. CLS. 13, 19, 21, 23, 31, 34 AND 35). SN 76-501,974. PUB. 6-28-2005. FILED 3-27-2003.

2,996,379. **ASPHALT MANAGER**. BOMAG GMBH, MULTIPLE CLASS, (INT. CLS. 7 AND 9), (U.S. CLS. 13, 19, 21, 23, 26, 31, 34, 35, 36 AND 38). SN 76-525,517. PUB. 6-28-2005. FILED 6-24-2003.

2,996,380. **FLOWLOGIC**. THE BELL GROUP, (U.S. CLS. 13, 19, 21, 23, 31, 34 AND 35). SN 76-525,957. PUB. 6-28-2005. FILED 6-26-2003.

2,996,406. **MISCELLANEOUS DESIGN**. AMANO CORPORATION, MULTIPLE CLASS, (INT. CLS. 7 AND 9), (U.S. CLS. 13, 19, 21, 23, 26, 31, 34, 35, 36 AND 38). SN 76-536,615. PUB. 6-28-2005. FILED 8-12-2003.

2,996,439. **OCTOPUS AND DESIGN**. SAINT-GOBAIN ABRASIVES LIMITED, (U.S. CLS. 13, 19, 21, 23, 31, 34 AND 35). SN 76-546,691. PUB. 6-28-2005. FILED 9-23-2003.

2,996,602. **BUNYAN INDUSTRIES (BLOCK FORM)**. BUNYAN INDUSTRIES, L.L.C., (U.S. CLS. 13, 19, 21, 23, 31, 34 AND 35). SN 76-576,973. PUB. 6-28-2005. FILED 2-2-2004.

2,996,603. **BUNYAN STRIKER (BLOCK FORM)**. BUNYAN INDUSTRIES, L.L.C., (U.S. CLS. 13, 19, 21, 23, 31, 34 AND 35). SN 76-576,974. PUB. 6-28-2005. FILED 2-2-2004.

2,996,615. **VILLAIN RACING AND DESIGN**. KONIG MOTORING ACCESSORIES, MULTIPLE CLASS, (INT. CLS. 7 AND 12), (U.S. CLS. 13, 19, 21, 23, 31, 34, 35 AND 44). SN 76-578,558. PUB. 6-28-2005. FILED 3-2-2004.

2,996,661. **MISCELLANEOUS DESIGN**. HOT RODS - MOTORCYCLE & AUTO PARTS CORPORATION, (U.S. CLS. 13, 19, 21, 23, 31, 34 AND 35). SN 76-588,639. PUB. 6-28-2005. FILED 4-26-2004.

2,996,675. **ATECO AND DESIGN**. ATECO, (U.S. CLS. 13, 19, 21, 23, 31, 34 AND 35). SN 76-590,699. PUB. 6-28-2005. FILED 5-4-2004.

2,996,738. **REPUBLIC BLOWER SYSTEMS AND DESIGN**. REPUBLIC SHEET METAL AND MANUFACTURING CO., INC., DBA REPUBLIC SALES & MANUFACTURING, (U.S. CLS. 13, 19, 21, 23, 31, 34 AND 35). SN 76-598,909. PUB. 6-28-2005. FILED 6-23-2004.

2,996,768. **OVATION PRODUCTS (BLOCK FORM)**. AIRLINE HYDRAULICS CORPORATION, (U.S. CLS. 13, 19, 21, 23, 31, 34 AND 35). SN 76-603,040. PUB. 6-28-2005. FILED 7-20-2004.

2,996,907. **REWORKS AND DESIGN**. BUM & ROH, INC., MULTIPLE CLASS, (INT. CLS. 7 AND 12), (U.S. CLS. 13, 19, 21, 23, 31, 34, 35 AND 44). SN 78-177,662. PUB. 6-28-2005. FILED 10-23-2002.

2,996,971. **FLOORBOT**. FLOORBOTICS, INC., MULTIPLE CLASS, (INT. CLS. 7 AND 9), (U.S. CLS. 13, 19, 21, 23, 26, 31, 34, 35, 36 AND 38). SN 78-274,144. PUB. 6-28-2005. FILED 7-14-2003.

2,997,026. **JETPROPEL (STYLIZED)**. SAMSUNG ELECTRONICS CO., LTD., (U.S. CLS. 13, 19, 21, 23, 31, 34 AND 35). SN

78-310,520. PUB. 6-28-2005. FILED 10-7-2003.

2,997,052. **DAVCO (BLOCK FORM)**. DAVCO MANUFACTURING LTD., (U.S. CLS. 13, 19, 21, 23, 31, 34 AND 35). SN 78-329,411. PUB. 6-28-2005. FILED 11-18-2003.

2,997,053. **PECO AND DESIGN**. PECO CORPORATION, (U.S. CLS. 13, 19, 21, 23, 31, 34 AND 35). SN 78-329,474. PUB. 6-28-2005. FILED 11-18-2003.

2,997,073 (*See Class 2 for this trademark*).

2,997,101. **MISCELLANEOUS DESIGN**. EDGE CRAFT CORPORATION, (U.S. CLS. 13, 19, 21, 23, 31, 34 AND 35). SN 78-345,921. PUB. 6-28-2005. FILED 12-29-2003.

2,997,185. **HR2 (BLOCK FORM)**. HIGH REACH COMPANY LLC, MULTIPLE CLASS, (INT. CLS. 7, 35 AND 37), (U.S. CLS. 13, 19, 21, 23, 31, 34, 35, 100, 101, 102, 103 AND 106). SN 78-359,997. PUB. 6-28-2005. FILED 1-30-2004.

2,997,186. **HR2 HIGH REACH (STYLIZED)**. HIGH REACH COMPANY LLC, MULTIPLE CLASS, (INT. CLS. 7, 35 AND 37), (U.S. CLS. 13, 19, 21, 23, 31, 34, 35, 100, 101, 102, 103 AND 106). SN 78-360,267. PUB. 6-28-2005. FILED 1-30-2004.

2,997,218. **ENGINEERED WITH AN ATTITUDE (BLOCK FORM)**. VORTECH ENGINEERING, INC., MULTIPLE CLASS, (INT. CLS. 7 AND 11), (U.S. CLS. 13, 19, 21, 23, 31, 34 AND 35). SN 78-363,491. PUB. 6-28-2005. FILED 2-5-2004.

2,997,319. **LR MATE (STYLIZED)**. FANUC LTD., (U.S. CLS. 13, 19, 21, 23, 31, 34 AND 35). SN 78-378,381. PUB. 6-28-2005. FILED 3-4-2004.

2,997,334 (*See Class 4 for this trademark*).

2,997,363. **EARLEX PURE STEAM (BLOCK FORM)**. EARLEX LIMITED, (U.S. CLS. 13, 19, 21, 23, 31, 34 AND 35). SN 78-388,298. PUB. 6-28-2005. FILED 3-22-2004.

2,997,444. **BELANGER AND DESIGN**. BELANGER INDUSTRIAL PRODUCTS, INC., (U.S. CLS. 13, 19, 21, 23, 31, 34 AND 35). SN 78-403,841. PUB. 6-28-2005. FILED 4-19-2004.

2,997,462. **TRUBIND (BLOCK FORM)**. PROBIND, INC., (U.S. CLS. 13, 19, 21, 23, 31, 34 AND 35). SN 78-406,581. PUB. 6-28-2005. FILED 4-22-2004.

2,997,472. **IBA (BLOCK FORM)**. IBA INC., MULTIPLE CLASS, (INT. CLS. 7, 11 AND 16), (U.S. CLS. 2, 5, 13, 19, 21, 22, 23, 29, 31, 34, 35, 37, 38 AND 50). SN 78-409,197. PUB. 6-28-2005. FILED 4-28-2004.

2,997,504. **DYNACRUISER (BLOCK FORM)**. BSH BOSCH UND SIEMENS HAUSGERATE GMBH, MULTIPLE CLASS, (INT. CLS. 7, 9 AND 11), (U.S. CLS. 13, 19, 21, 23, 26, 31, 34, 35, 36 AND 38). SN 78-414,963. PUB. 6-28-2005. FILED 5-7-2004.

2,997,505. **SPHERA MOBILITY (BLOCK FORM)**. BSH BOSCH UND SIEMENS HAUSGERATE GMBH, MULTIPLE CLASS, (INT. CLS. 7, 9 AND 11), (U.S. CLS. 13, 19, 21, 23, 26, 31, 34, 35, 36 AND 38). SN 78-414,998. PUB. 6-28-2005. FILED 5-7-2004.

2,997,508. **RIDER EQUIPMENT (BLOCK FORM)**. NORCO INDUSTRIES, INC., (U.S. CLS. 13, 19, 21, 23, 31, 34 AND 35). SN 78-415,924. PUB. 6-28-2005. FILED 5-10-2004.

2,997,531. **BRILL-BLADE (BLOCK FORM)**. FLEXOVIT USA, INC., (U.S. CLS. 13, 19, 21, 23, 31, 34 AND 35). SN 78-421,926. PUB. 6-28-2005. FILED 5-19-2004.

2,997,575. **ERGOPOWER (BLOCK FORM)**. BSH BOSCH UND SIEMENS HAUSGERATE GMBH, (U.S. CLS. 13, 19, 21, 23, 31, 34 AND 35). SN 78-431,495. PUB. 6-28-2005. FILED 6-8-2004.

2,997,603. **LASERWASH TOUCH FREE 4000 (BLOCK FORM)**. DELAWARE CAPITAL FORMATION, INC., (U.S. CLS. 13, 19, 21, 23, 31, 34 AND 35). SN 78-436,300. PUB. 6-28-2005. FILED 6-16-2004.

2,997,604. **GLOBAL BEARINGS, INC. AND DESIGN**. GLOBAL BEARINGS, INC., (U.S. CLS. 13, 19, 21, 23, 31, 34 AND 35). SN 78-436,301. PUB. 6-28-2005. FILED 6-16-2004.

2,997,624. **POWERSMITH (BLOCK FORM)**. ZHOU, LIFENG, (U.S. CLS. 13, 19, 21, 23, 31, 34 AND 35). SN 78-438,756. PUB. 6-28-2005. FILED 6-21-2004.

2,997,721. **MASTER QUALITY POWER AND DESIGN**. SMC-HEC CORP., MULTIPLE CLASS, (INT. CLS. 7 AND 8), (U.S. CLS. 13, 19, 21, 23, 28, 31, 34, 35 AND 44). SN 78-448,306. PUB. 6-28-2005. FILED 7-9-2004.

2,997,946. **COTTA (BLOCK FORM)**. COTTA TRANSMISSION COMPANY, LLC, MULTIPLE CLASS, (INT. CLS. 7 AND 12), (U.S. CLS. 13, 19, 21, 23, 31, 34, 35 AND 44). SN 78-458,594. PUB. 6-28-2005. FILED 7-29-2004.

2,997,977. **SPECIALIST (BLOCK FORM)**. FLEXOVIT USA, INC., (U.S. CLS. 13, 19, 21, 23, 31, 34 AND 35). SN 78-459,199. PUB. 6-28-2005. FILED 7-29-2004.

2,998,068. **HOM-TEC (BLOCK FORM)**. SMS MEER GMBH, (U.S. CLS. 13, 19, 21, 23, 31, 34 AND 35). SN 78-460,474. PUB. 6-28-2005. FILED 8-2-2004.

2,998,158. **C&S (BLOCK FORM)**. C&S BEARINGS, INC., (U.S. CLS. 13, 19, 21, 23, 31, 34 AND 35). SN 78-462,107. PUB. 6-28-2005. FILED 8-4-2004.

2,998,206. **DPC (BLOCK FORM)**. BANDAG LICENSING CORPORATION, (U.S. CLS. 13, 19, 21, 23, 31, 34 AND 35). SN 78-464,089. PUB. 6-28-2005. FILED 8-9-2004.

2,998,211. **PLUGR (BLOCK FORM)**. SOURCEONE, INC., (U.S. CLS. 13, 19, 21, 23, 31, 34 AND 35). SN 78-464,293. PUB. 6-28-2005. FILED 8-9-2004.

2,998,244. **TYGAR (BLOCK FORM)**. TYGAR MANUFACTURING, INC., (U.S. CLS. 13, 19, 21, 23, 31, 34 AND 35). SN 78-465,603. PUB. 6-28-2005. FILED 8-11-2004.

2,998,261. **IDLE-EZE (BLOCK FORM)**. BARRY GRANT, INC., (U.S. CLS. 13, 19, 21, 23, 31, 34 AND 35). SN 78-466,431. PUB. 6-28-2005. FILED 8-12-2004.

2,998,432. **CORRUDUR (BLOCK FORM)**. BHS CORRUGATED; MASCHINEN- UND ANLAGENBAU GMBH, (U.S. CLS. 13, 19, 21, 23, 31, 34 AND 35). SN 79-002,496. PUB. 6-28-2005. FILED 3-29-2004.

2,998,440. **GALILEO (BLOCK FORM)**. SEZ AG, (U.S. CLS. 13, 19, 21, 23, 31, 34 AND 35). SN 79-002,664. PUB. 6-28-2005. FILED 4-5-2004.

2,998,449. **BLUESTAR (BLOCK FORM)**. HÜLLER HILLE GMBH, (U.S. CLS. 13, 19, 21, 23, 31, 34 AND 35). SN 79-002,975. PUB. 6-28-2005. FILED 3-13-2004.

2,998,482. **MÜNCH AND DESIGN**. MÜNCH MOTORRAD TECHNIK (MMT) GMBH, MULTIPLE CLASS, (INT. CLS. 7, 9, 11 AND 12), (U.S. CLS. 13, 19, 21, 23, 26, 31, 34, 35, 36, 38 AND 44). SN 79-004,952. PUB. 6-28-2005. FILED 3-16-2004.

2,998,484. **PASTOLINE (BLOCK FORM)**. KOENIG & BAUER AKTIENGESELLSCHAFT, MULTIPLE CLASS, (INT. CLS. 7, 9 AND 37), (U.S. CLS. 13, 19, 21, 23, 26, 31, 34, 35, 36, 38, 100, 103 AND 106). SN 79-005,053. PUB. 6-28-2005. FILED 12-29-2003.

CLASS 8—HAND TOOLS

2,996,243 (*See Class 3 for this trademark*).

2,996,298. **STEELCRAFT**. ALLIED MARKETING GROUP, INC., (U.S. CLS. 23, 28 AND 44). SN 76-429,161. PUB. 6-28-2005. FILED 7-10-2002.

2,996,396. **DAVISON CATALYSTS AND DESIGN**. W. R. GRACE & CO.-CONN., MULTIPLE CLASS, (INT. CLS. 8, 11, 18, 21, 25 AND 28), (U.S. CLS. 1, 2, 3, 13, 21, 22, 23, 28, 29, 30, 31, 33, 34, 38, 39, 40, 41, 44 AND 50). SN 76-533,686. PUB. 6-28-2005. FILED 7-31-2003.

2,996,476. **HELLINE AND DESIGN**. HANDELSGESELLSCHAFT HEINRICH HEINE GMBH, MULTIPLE CLASS, (INT. CLS. 8, 14, 18, 20, 21, 24 AND 25), (U.S. CLS. 1, 2, 3, 13, 22, 23, 25, 27, 28, 29, 30, 32, 33, 39, 40, 41, 42, 44 AND 50). SN 76-565,779. PUB. 6-28-2005. FILED 12-4-2003.

2,996,756. **UTILITYTOOL AND DESIGN**. CAPEWELL COMPONENTS COMPANY, LLC, (U.S. CLS. 23, 28 AND 44). SN 76-600,580. PUB. 6-28-2005. FILED 7-2-2004.

2,996,919. **DURAGEAR AND DESIGN**. BJ GLOBAL DIRECT, INC., MULTIPLE CLASS, (INT. CLS. 8, 9 AND 21), (U.S. CLS. 2, 13, 21, 23, 26, 28, 29, 30, 33, 36, 38, 40, 44 AND 50). SN 78-211,717. PUB. 1-4-2005. FILED 2-6-2003.

2,997,059. **TREESAVE (BLOCK FORM)**. SHERRILL, INC., (U.S. CLS. 23, 28 AND 44). SN 78-330,761. PUB. 6-28-2005. FILED 11-20-2003.

2,997,195 (*See Class 6 for this trademark*).

2,997,250. **RE AND DESIGN**. KLAHWORN INDUSTRIES, INC., (U.S. CLS. 23, 28 AND 44). SN 78-368,054. PUB. 6-28-2005. FILED 2-13-2004.

2,997,334 (*See Class 4 for this trademark*).

2,997,617. **MASTER CUTLERY M AND DESIGN**. MASTER CUTLERY, INC., (U.S. CLS. 23, 28 AND 44). SN 78-437,098. PUB. 6-28-2005. FILED 6-17-2004.

2,997,658. **VIPER (BLOCK FORM)**. AMES TRUE TEMPER

PROPERTIES, INC., (U.S. CLS. 23, 28 AND 44). SN 78-442,757. PUB. 6-28-2005. FILED 6-29-2004.
 2,997,721 (*See Class 7 for this trademark*).
 2,997,764. **HAIR ERAZOR (BLOCK FORM)**. KOLINAS, TINA M., (U.S. CLS. 23, 28 AND 44). SN 78-452,392. PUB. 6-28-2005. FILED 7-18-2004.
 2,998,277. **MAX-I-MUM (BLOCK FORM)**. TAPCO INTERNATIONAL CORPORATION, (U.S. CLS. 23, 28 AND 44). SN 78-467,380. PUB. 6-28-2005. FILED 8-13-2004.
 2,998,286. **RAPALA (BLOCK FORM)**. NORMARK CORPORATION, (U.S. CLS. 23, 28 AND 44). SN 78-468,500. PUB. 6-28-2005. FILED 8-17-2004.

CLASS 9—ELECTRICAL AND SCIENTIFIC APPARATUS

2,996,233. **PARADIGM. QRS, INC.**, (U.S. CLS. 21, 23, 26, 36 AND 38). SN 75-390,285. PUB. 6-28-2005. FILED 11-14-1997.
 2,996,237. **ECOCAM. KARL STORZ GMBH & CO. KG.**, MULTIPLE CLASS, (INT. CLS. 9 AND 10), (U.S. CLS. 21, 23, 26, 36, 38, 39 AND 44). SN 75-576,683. PUB. 6-28-2005. FILED 10-27-1998.
 2,996,243 (*See Class 3 for this trademark*).
 2,996,244. **ANOTO. ANOTO AB**, MULTIPLE CLASS, (INT. CLS. 9, 16, 38 AND 42), (U.S. CLS. 2, 5, 21, 22, 23, 26, 29, 36, 37, 38, 50, 100, 101 AND 104). SN 76-018,235. PUB. 6-28-2005. FILED 4-5-2000.
 2,996,246. **IP CONNEXION. KÓNICA MINOLTA BUSINESS SOLUTIONS U.S.A., INC.**, (U.S. CLS. 21, 23, 26, 36 AND 38). SN 76-050,740. PUB. 6-28-2005. FILED 5-17-2000.
 2,996,251 (*See Class 6 for this trademark*).
 2,996,254. **TWO-WAY-TOOLS. BORLAND SOFTWARE CORPORATION**, (U.S. CLS. 21, 23, 26, 36 AND 38). SN 76-182,058. PUB. 6-28-2005. FILED 12-14-2000.
 2,996,258. **PAGE THREE. NEWS GROUP NEWSPAPERS LIMITED**, MULTIPLE CLASS, (INT. CLS. 9, 16, 35, 41 AND 42), (U.S. CLS. 2, 5, 21, 22, 23, 26, 29, 36, 37, 38, 50, 100, 101, 102 AND 107). SN 76-232,192. PUB. 10-29-2002. FILED 3-28-2001.
 2,996,271. **COMMSCO. COMMSCO HOLDING SA LUXEMBOURG**, MULTIPLE CLASS, (INT. CLS. 9, 35, 38 AND 42), (U.S. CLS. 21, 23, 26, 36, 38, 100, 101, 102 AND 104). SN 76-356,090. PUB. 6-28-2005. FILED 1-8-2002.
 2,996,272. **IKOM MULTICAST (STYLIZED)**. THE BRONSKILL GROUP, INC., (U.S. CLS. 21, 23, 26, 36 AND 38). SN 76-358,204. PUB. 6-28-2005. FILED 1-15-2002.
 2,996,277 (*See Class 1 for this trademark*).
 2,996,281. **VNAS. IVISION SOFTWARE, INC.**, (U.S. CLS. 21, 23, 26, 36 AND 38). SN 76-394,582. PUB. 6-28-2005. FILED 4-11-2002.
 2,996,284. **CUSTOMERPLACE. GETRONICS INTELLECTUAL PROPERTY B.V.**, MULTIPLE CLASS, (INT. CLS. 9, 35 AND 42), (U.S. CLS. 21, 23, 26, 36, 38, 100, 101 AND 102). SN 76-403,975. PUB. 6-28-2005. FILED 5-6-2002.
 2,996,285. **KNOWLEDGEPLACE. GETRONICS INTELLECTUAL PROPERTY B.V.**, MULTIPLE CLASS, (INT. CLS. 9, 35 AND 42), (U.S. CLS. 21, 23, 26, 36, 38, 100, 101 AND 102). SN 76-404,015. PUB. 6-28-2005. FILED 5-6-2002.
 2,996,301. **PACT. PACT INFORMATIONSTECHNOLOGIE GMBH**, MULTIPLE CLASS, (INT. CLS. 9, 38 AND 42), (U.S. CLS. 21, 23, 26, 36, 38, 100, 101 AND 104). SN 76-439,068. PUB. 6-28-2005. FILED 8-12-2002.
 2,996,304. **AUDIOPRESENTER. EDIAL, INC.**, (U.S. CLS. 21, 23, 26, 36 AND 38). SN 76-444,081. PUB. 6-28-2005. FILED 8-23-2002.
 2,996,306. **SALESPRO. SALESPRO TECHNOLOGIES, INC.**, (U.S. CLS. 21, 23, 26, 36 AND 38). SN 76-450,533. PUB. 6-28-2005. FILED 9-12-2002.
 2,996,310. **ASG-TMON. ALLEN SYSTEMS GROUP, INC.**, (U.S. CLS. 21, 23, 26, 36 AND 38). SN 76-462,759. PUB. 6-28-2005. FILED 10-28-2002.
 2,996,314. **SMARTABO (STYLIZED)**. DEUTSCHE TELEKOM AG, MULTIPLE CLASS, (INT. CLS. 9, 16, 35, 36, 38, 41 AND 42), (U.S. CLS. 2, 5, 21, 22, 23, 26, 29, 36, 37, 38, 50, 100, 101, 102, 104 AND 107). SN 76-467,100. PUB. 6-28-2005. FILED 11-6-2002.
 2,996,315. **AS AUTOMATIC SYSTEMS AND DESIGN. AUTOMATIC SYSTEMS**, (U.S. CLS. 21, 23, 26, 36 AND 38). SN 76-469,382. PUB. 6-28-2005. FILED 11-22-2002.
 2,996,316. **THE ATTENTION PROCESSOR AND DESIGN. STMICROELECTRONICS NV**, (U.S. CLS. 21, 23, 26, 36 AND 38). SN 76-470,286. PUB. 6-28-2005. FILED 11-26-2002.
 2,996,317. **FIRE ETC. AND DESIGN. FIRE ETC.**, MULTIPLE CLASS, (INT. CLS. 9, 16 AND 41), (U.S. CLS. 2, 5, 21, 22, 23, 26, 29, 36, 37, 38, 50, 100, 101 AND 107). SN 76-471,652. PUB. 6-28-2005. FILED 11-21-2002.
 2,996,318. **SPELL MASTER. ATRONIC INTERNATIONAL GMBH**, (U.S. CLS. 21, 23, 26, 36 AND 38). SN 76-471,739. PUB. 6-28-2005. FILED 10-15-2002.
 2,996,328. **VIEWPOINT. MARTIN AUDIO LIMITED**, MULTIPLE CLASS, (INT. CLS. 9, 16 AND 42), (U.S. CLS. 2, 5, 21, 22, 23, 26, 29, 36, 37, 38, 50, 100 AND 101). SN 76-482,943. PUB. 6-28-2005. FILED 1-16-2003.
 2,996,329. **MISCELLANEOUS DESIGN. R/D TECH INC.**, (U.S. CLS. 21, 23, 26, 36 AND 38). SN 76-484,132. PUB. 6-28-2005. FILED 1-22-2003.
 2,996,331. **THE NETWORK DANCE; N.E.T.W.O.R.K.**. REZAC, DARCY E., MULTIPLE CLASS, (INT. CLS. 9, 16, 35 AND 41), (U.S. CLS. 2, 5, 21, 22, 23, 26, 29, 36, 37, 38, 50, 100, 101, 102 AND 107). SN 76-485,748. PUB. 6-28-2005. FILED 1-23-2003.
 2,996,332. **SECRETS OF POSITIVE NETWORKING**. REZAC, DARCY E., MULTIPLE CLASS, (INT. CLS. 9, 16, 35 AND 41), (U.S. CLS. 2, 5, 21, 22, 23, 26, 29, 36, 37, 38, 50, 100, 101, 102 AND 107). SN 76-485,749. PUB. 6-28-2005. FILED 1-23-2003.
 2,996,358. **WOOD WORKING ...IN ACTION!!! AND DESIGN. TOOLBOX PRODUCTIONS INC.**, (U.S. CLS. 21, 23, 26, 36 AND 38). SN 76-513,537. PUB. 6-28-2005. FILED 5-12-2003.
 2,996,360. **TECHSTREET AND DESIGN. THOMAS SCIENTIFIC INC.**, MULTIPLE CLASS, (INT. CLS. 9 AND 16), (U.S. CLS. 2, 5, 21, 22, 23, 26, 29, 36, 37, 38 AND 50). SN 76-515,378. PUB. 6-28-2005. FILED 4-24-2003.
 2,996,365. **SHOFAR. HAGNER, LARRY**, MULTIPLE CLASS, (INT. CLS. 9 AND 41), (U.S. CLS. 21, 23, 26, 36, 38, 100, 101 AND 107). SN 76-520,745. PUB. 6-28-2005. FILED 5-27-2003.
 2,996,370. **TAXIVALET AND DESIGN. COVENTRY CONNECTIONS, INC.**, (U.S. CLS. 21, 23, 26, 36 AND 38). SN 76-521,923. PUB. 6-28-2005. FILED 6-3-2003.
 2,996,374. **RINGERS GLOVES. RINGERS RESOURCE, INC.**, (U.S. CLS. 21, 23, 26, 36 AND 38). SN 76-522,842. PUB. 6-28-2005. FILED 6-16-2003.
 2,996,379 (*See Class 7 for this trademark*).
 2,996,385. **BALANCE SHEET MONITOR. BAKER GROUP SOFTWARE SOLUTIONS, INC.**, THE, (U.S. CLS. 21, 23, 26, 36 AND 38). SN 76-527,490. PUB. 6-28-2005. FILED 7-3-2003.
 2,996,389. **CLIP WORDS (BLOCK FORM)**. EPIGRAPHICS SOFTWARE, INC., (U.S. CLS. 21, 23, 26, 36 AND 38). SN 76-530,189. PUB. 6-28-2005. FILED 7-3-2003.
 2,996,390. **HOBBES (STYLIZED)**. HOBBES COMPUTER NETWORK ACCESSORIES CORP., (U.S. CLS. 21, 23, 26, 36 AND 38). SN 76-530,986. PUB. 6-28-2005. FILED 7-21-2003.
 2,996,392. **DIGITAL COMIC BOOKS AND DESIGN. INTEC INTERACTIVE II, LLC**, (U.S. CLS. 21, 23, 26, 36 AND 38). SN 76-531,426. PUB. 6-28-2005. FILED 7-22-2003.
 2,996,397. **TRE AND DESIGN. TELE-RILEVAMENTO-EUROPA - T.R.E. S.R.L.**, MULTIPLE CLASS, (INT. CLS. 9, 42 AND 45), (U.S. CLS. 21, 23, 26, 36, 38, 100 AND 101). SN 76-533,939. PUB. 6-28-2005. FILED 7-31-2003.
 2,996,406 (*See Class 7 for this trademark*).
 2,996,407. **OCTAVIS. IFM ELECTRONIC GMBH**, MULTIPLE CLASS, (INT. CLS. 9 AND 42), (U.S. CLS. 21, 23, 26, 36, 38, 100 AND 101). SN 76-536,620. PUB. 6-28-2005. FILED 8-12-2003.
 2,996,410. **PRIDE. PRIDE MOBILITY PRODUCTS CORPORATION**, (U.S. CLS. 21, 23, 26, 36 AND 38). SN 76-536,818. PUB. 6-28-2005. FILED 8-11-2003.
 2,996,418. **METASHARE. SNELL & WILCOX LIMITED**, (U.S. CLS. 21, 23, 26, 36 AND 38). SN 76-538,660. PUB. 3-8-2005. FILED 8-15-2003.
 2,996,428. **SONASOFT. SONASOFT, INC.**, MULTIPLE CLASS, (INT. CLS. 9 AND 42), (U.S. CLS. 21, 23, 26, 36, 38, 100 AND 101). SN 76-543,452. PUB. 6-28-2005. FILED 9-8-2003.
 2,996,430. **THE SUCCESS CHURCH. FIREBAUGH, DOU-**

- GLAS, AND ANDROS, JODI M., MULTIPLE CLASS, (INT. CLS. 9 AND 16), (U.S. CLS. 2, 5, 21, 22, 23, 26, 29, 36, 37, 38 AND 50). SN 76-543,941. PUB. 6-28-2005. FILED 9-9-2003.
- 2,996,432. **SANTANA. CADESTANSA, LLC**, (U.S. CLS. 21, 23, 26, 36 AND 38). SN 76-544,570. PUB. 6-28-2005. FILED 9-12-2003.
- 2,996,440 (*See Class 1 for this trademark*).
- 2,996,453. **TAI. TINDALL ASSOCIATES, INC.**, (U.S. CLS. 21, 23, 26, 36 AND 38). SN 76-552,564. PUB. 6-28-2005. FILED 9-29-2003.
- 2,996,468. **MILESTONE (BLOCK FORM)**. CONCORD MUSIC GROUP, INC., (U.S. CLS. 21, 23, 26, 36 AND 38). SN 76-563,215. PUB. 6-28-2005. FILED 11-20-2003.
- 2,996,469. **CARIS (BLOCK FORM)**. BIOMEDICAL DIAGNOSTICS SA, (U.S. CLS. 21, 23, 26, 36 AND 38). SN 76-564,107. PUB. 6-28-2005. FILED 12-8-2003.
- 2,996,477. **NOKINK AND DESIGN**. LEVITON MANUFACTURING CO., INC., (U.S. CLS. 21, 23, 26, 36 AND 38). SN 76-566,062. PUB. 6-28-2005. FILED 12-12-2003.
- 2,996,513. **GTARS (BLOCK FORM)**. GREENWICH TRANSPORTATION UNDERWRITERS, INC., (U.S. CLS. 21, 23, 26, 36 AND 38). SN 76-569,628. PUB. 6-28-2005. FILED 1-5-2004.
- 2,996,516. **EVSTOR (STYLIZED)**. EVSERV TECH CORP., (U.S. CLS. 21, 23, 26, 36 AND 38). SN 76-569,975. PUB. 6-28-2005. FILED 1-14-2004.
- 2,996,556. **MOTOR E-ESTIMATING (BLOCK FORM)**. HEARST BUSINESS PUBLISHING, INC., (U.S. CLS. 21, 23, 26, 36 AND 38). SN 76-572,407. PUB. 6-28-2005. FILED 1-23-2004.
- 2,996,569. **SONG OF ANGELS (BLOCK FORM)**. CRYSTAL SEA RECORDS, INC., (U.S. CLS. 21, 23, 26, 36 AND 38). SN 76-572,947. PUB. 6-28-2005. FILED 1-28-2004.
- 2,996,574. **CENTRACT (STYLIZED)**. RYOSAN COMPANY LIMITED, (U.S. CLS. 21, 23, 26, 36 AND 38). SN 76-573,390. PUB. 6-28-2005. FILED 2-3-2004.
- 2,996,580. **STARBRIDGE AND DESIGN**. STAR BRIDGE SYSTEMS, INC., (U.S. CLS. 21, 23, 26, 36 AND 38). SN 76-574,605. PUB. 6-28-2005. FILED 2-5-2004.
- 2,996,585. **KILLER BEAZ (BLOCK FORM)**. KILLER BEAZ, INC., (U.S. CLS. 21, 23, 26, 36 AND 38). SN 76-575,163. PUB. 6-28-2005. FILED 2-10-2004.
- 2,996,591. **AU MEDS (STYLIZED)**. AUBURN UNIVERSITY, MULTIPLE CLASS, (INT. CLS. 9 AND 41), (U.S. CLS. 21, 23, 26, 36, 38, 100, 101 AND 107). SN 76-575,588. PUB. 6-28-2005. FILED 2-17-2004.
- 2,996,601. **NISSUN NISSUN CAP AND DESIGN**. NISSUN CAP, MULTIPLE CLASS, (INT. CLS. 9, 18, 25 AND 28), (U.S. CLS. 1, 2, 3, 21, 22, 23, 26, 36, 38, 39, 41 AND 50). SN 76-576,780. PUB. 6-28-2005. FILED 2-20-2004.
- 2,996,619. **MEMORY SWITCH (STYLIZED)**. MINDER RESEARCH CORPORATION, (U.S. CLS. 21, 23, 26, 36 AND 38). SN 76-578,894. PUB. 6-28-2005. FILED 3-3-2004.
- 2,996,631. **CRITEC (BLOCK FORM)**. ERICO INTERNATIONAL CORPORATION, (U.S. CLS. 21, 23, 26, 36 AND 38). SN 76-581,476. PUB. 6-28-2005. FILED 3-17-2004.
- 2,996,647. **CITALL (BLOCK FORM)**. RIVERLINK, INC., (U.S. CLS. 21, 23, 26, 36 AND 38). SN 76-585,263. PUB. 6-28-2005. FILED 4-6-2004.
- 2,996,650. **PERFORMANCE IMPACT (BLOCK FORM)**. ETALK CORPORATION, (U.S. CLS. 21, 23, 26, 36 AND 38). SN 76-585,899. PUB. 6-28-2005. FILED 4-9-2004.
- 2,996,664. **DAFIF (BLOCK FORM)**. NATIONAL GEOSPATIAL-INTELLIGENCE AGENCY, MULTIPLE CLASS, (INT. CLS. 9 AND 39), (U.S. CLS. 21, 23, 26, 36, 38, 100 AND 105). SN 76-588,795. PUB. 6-28-2005. FILED 4-16-2004.
- 2,996,674. **BOB ANDERSON'S SING LIKE THE STARS (BLOCK FORM)**. BOBMAC, LLC, (U.S. CLS. 21, 23, 26, 36 AND 38). SN 76-590,595. PUB. 6-14-2005. FILED 5-3-2004.
- 2,996,679. **SOLARFLARE (BLOCK FORM)**. SOLARFLARE COMMUNICATIONS, INC., (U.S. CLS. 21, 23, 26, 36 AND 38). SN 76-591,267. PUB. 6-28-2005. FILED 5-10-2004.
- 2,996,693. **ACCELEHEALTH (BLOCK FORM)**. HEALTHATION, LLC, (U.S. CLS. 21, 23, 26, 36 AND 38). SN 76-593,378. PUB. 6-28-2005. FILED 5-21-2004.
- 2,996,704. **EDIROL (BLOCK FORM)**. ROLAND CORPORATION, (U.S. CLS. 21, 23, 26, 36 AND 38). SN 76-595,876. PUB. 6-28-2005. FILED 6-7-2004.
- 2,996,716. **TOGETHERNESS RECORDS (BLOCK FORM)**. B.E.N. INTERNATIONAL, INC., MULTIPLE CLASS, (INT. CLS. 9 AND 41), (U.S. CLS. 21, 23, 26, 36, 38, 100, 101 AND 107). SN 76-596,715. PUB. 6-28-2005. FILED 6-9-2004.
- 2,996,721. **PROGRESSIVE POWER YOGA (STYLIZED)**. PROGRESSIVE POWER YOGA, INC., MULTIPLE CLASS, (INT. CLS. 9, 35 AND 41), (U.S. CLS. 21, 23, 26, 36, 38, 100, 101, 102 AND 107). SN 76-597,622. PUB. 6-28-2005. FILED 6-16-2004.
- 2,996,735. **WISTFUL VISTA TELEPHONE CO. (BLOCK FORM)**. JOHNSON, DAVID, DBA WISTFUL VISTA TELEPHONE CO., (U.S. CLS. 21, 23, 26, 36 AND 38). SN 76-598,722. PUB. 6-28-2005. FILED 6-23-2004.
- 2,996,739. **ACCELERATING THE DYNAMIC CHURCH (BLOCK FORM)**. FELLOWSHIP TECHNOLOGIES, LP, (U.S. CLS. 21, 23, 26, 36 AND 38). SN 76-598,927. PUB. 6-28-2005. FILED 6-23-2004.
- 2,996,755. **INBOX TO GO (BLOCK FORM)**. DATAVIZ, INC., (U.S. CLS. 21, 23, 26, 36 AND 38). SN 76-600,563. PUB. 6-28-2005. FILED 7-2-2004.
- 2,996,760. **BROAD THINKING. NARROWCASTING. (BLOCK FORM)**. REAL DIGITAL MEDIA, LLC, (U.S. CLS. 21, 23, 26, 36 AND 38). SN 76-601,180. PUB. 6-28-2005. FILED 7-8-2004.
- 2,996,788. **DRAKE (BLOCK FORM)**. R.L. DRAKE COMPANY, (U.S. CLS. 21, 23, 26, 36 AND 38). SN 76-604,375. PUB. 6-28-2005. FILED 7-26-2004.
- 2,996,812. **HYPERFEED (BLOCK FORM)**. MOTOMAN, INC., (U.S. CLS. 21, 23, 26, 36 AND 38). SN 76-604,918. PUB. 6-28-2005. FILED 7-30-2004.
- 2,996,830. **WEBRIDER (BLOCK FORM)**. STAMPEDE TECHNOLOGIES, INC., (U.S. CLS. 21, 23, 26, 36 AND 38). SN 76-605,203. PUB. 6-28-2005. FILED 8-2-2004.
- 2,996,845. **VFA.FACILITY (BLOCK FORM)**. VANDERWEIL FACILITY ADVISORS, INC., (U.S. CLS. 21, 23, 26, 36 AND 38). SN 76-605,605. PUB. 6-28-2005. FILED 8-4-2004.
- 2,996,853. **D D E R I N G (STYLIZED)**. THE DERING CORPORATION, (U.S. CLS. 21, 23, 26, 36 AND 38). SN 76-605,718. PUB. 6-28-2005. FILED 8-5-2004.
- 2,996,866. **CHEMVAC (BLOCK FORM)**. CHEMGLASS, INC., (U.S. CLS. 21, 23, 26, 36 AND 38). SN 76-606,314. PUB. 6-28-2005. FILED 8-10-2004.
- 2,996,870. **CF AND DESIGN**. LOVE AND LOGIC INSTITUTE, INC., MULTIPLE CLASS, (INT. CLS. 9, 16 AND 41), (U.S. CLS. 2, 5, 21, 22, 23, 26, 29, 36, 37, 38, 50, 100, 101 AND 107). SN 76-606,668. PUB. 6-28-2005. FILED 8-12-2004.
- 2,996,872. **REXUS (BLOCK FORM)**. REXUS CORP., (U.S. CLS. 21, 23, 26, 36 AND 38). SN 76-606,830. PUB. 6-28-2005. FILED 8-13-2004.
- 2,996,876. **BOWLING NIGHT (BLOCK FORM)**. ARISTOCRAT TECHNOLOGIES AUSTRALIA PTY LTD., (U.S. CLS. 21, 23, 26, 36 AND 38). SN 76-619,542. PUB. 6-28-2005. FILED 11-5-2004.
- 2,996,883. **FULL SAIL REAL WORLD EDUCATION AND DESIGN**. FULL SAIL, INC., MULTIPLE CLASS, (INT. CLS. 9, 16, 25 AND 41), (U.S. CLS. 2, 5, 21, 22, 23, 26, 29, 36, 37, 38, 39, 50, 100, 101 AND 107). SN 76-976,993. PUB. 6-28-2005. FILED 7-17-2003.
- 2,996,885 (*See Class 1 for this trademark*).
- 2,996,888. **NETACQUIRE**. NETACQUIRE CORPORATION, (U.S. CLS. 21, 23, 26, 36 AND 38). SN 78-077,811. PUB. 6-28-2005. FILED 8-6-2001.
- 2,996,889. **MULTISKAN SPECTRUM**. THERMO ELECTRON OY, MULTIPLE CLASS, (INT. CLS. 9 AND 10), (U.S. CLS. 21, 23, 26, 36, 38, 39 AND 44). SN 78-083,799. PUB. 6-28-2005. FILED 9-13-2001.
- 2,996,890. **APOGEE MINI-ME**. APOGEE ELECTRONICS CORPORATION, (U.S. CLS. 21, 23, 26, 36 AND 38). SN 78-093,837. PUB. 6-28-2005. FILED 11-16-2001.
- 2,996,891. **PROCAPP**. PHYSICAL PLANNING TECHNOLOGIES INC., MULTIPLE CLASS, (INT. CLS. 9 AND 42), (U.S. CLS. 21, 23, 26, 36, 38, 100 AND 101). SN 78-097,246. PUB. 6-28-2005. FILED 12-7-2001.
- 2,996,892. **ESS (STYLIZED)**. BISSON, JOHN A, (U.S. CLS. 21, 23, 26, 36 AND 38). SN 78-109,015. PUB. 6-28-2005. FILED 2-15-2002.
- 2,996,896. **WIRELESS DIMENSIONS**. WIRELESS ACCESSORIES, LLC, MULTIPLE CLASS, (INT. CLS. 9 AND 35), (U.S. CLS. 21, 23, 26, 36, 38, 100, 101 AND 102). SN 78-126,122.

- PUB. 6-28-2005. FILED 5-3-2002.
- 2,996,898. **ADITUS**. ADITUS MEDICAL AB, MULTIPLE CLASS, (INT. CLS. 9, 10 AND 44), (U.S. CLS. 21, 23, 26, 36, 38, 39, 44, 100 AND 101). SN 78-151,335. PUB. 6-28-2005. FILED 8-6-2002.
- 2,996,904. **AUTO-TUNE**. ANTARES AUDIO TECHNOLOGIES, (U.S. CLS. 21, 23, 26, 36 AND 38). SN 78-170,798. PUB. 6-28-2005. FILED 10-3-2002.
- 2,996,919 (*See Class 8 for this trademark*).
- 2,996,923. **VOYENCE**. VOYENCE, INC., MULTIPLE CLASS, (INT. CLS. 9 AND 42), (U.S. CLS. 21, 23, 26, 36, 38, 100 AND 101). SN 78-220,482. PUB. 6-28-2005. FILED 2-28-2003.
- 2,996,924. **FIRE 1ST DEFENSE**. MILLENIUM GLOBAL MARKETPLACE, INC., (U.S. CLS. 21, 23, 26, 36 AND 38). SN 78-221,311. PUB. 6-28-2005. FILED 3-4-2003.
- 2,996,927. **INGIS AND DESIGN**. NEXGEN LENDING, INC., (U.S. CLS. 21, 23, 26, 36 AND 38). SN 78-222,858. PUB. 6-28-2005. FILED 3-7-2003.
- 2,996,928. **I NEXT GENERATION INPUT SYSTEM AND DESIGN**. NEXGEN LENDING, INC., (U.S. CLS. 21, 23, 26, 36 AND 38). SN 78-222,862. PUB. 6-28-2005. FILED 3-7-2003.
- 2,996,940. **XI-FACTORY**. TECHNOLOGIES AZUR INC., (U.S. CLS. 21, 23, 26, 36 AND 38). SN 78-241,798. PUB. 6-28-2005. FILED 4-24-2003.
- 2,996,948. **PROSOLUTIONS**. SAPPHIRE AUDIO, LLC, (U.S. CLS. 21, 23, 26, 36 AND 38). SN 78-252,234. PUB. 6-28-2005. FILED 5-20-2003.
- 2,996,954. **MISCELLANEOUS DESIGN**. CELLECTRICON AB, MULTIPLE CLASS, (INT. CLS. 9, 35 AND 42), (U.S. CLS. 21, 23, 26, 36, 38, 100, 101 AND 102). SN 78-255,413. PUB. 6-28-2005. FILED 5-28-2003.
- 2,996,959. **WINTOP**. WINTOP INTERNATIONAL INDUSTRIAL CO., LTD, (U.S. CLS. 21, 23, 26, 36 AND 38). SN 78-259,744. PUB. 6-28-2005. FILED 6-9-2003.
- 2,996,960. **WAVE BIOTECH AND DESIGN**. PANACEA SOLUTIONS, INC., (U.S. CLS. 21, 23, 26, 36 AND 38). SN 78-260,511. PUB. 6-28-2005. FILED 6-10-2003.
- 2,996,964. **THE NEW FACE OF EARLY LEARNING**. THE BRAINY BABY COMPANY LLC, (U.S. CLS. 21, 23, 26, 36 AND 38). SN 78-267,437. PUB. 6-28-2005. FILED 6-26-2003.
- 2,996,969. **TECPRO**. DEDO WEIGERT FILM GMBH, MULTIPLE CLASS, (INT. CLS. 9 AND 11), (U.S. CLS. 13, 21, 23, 26, 31, 34, 36 AND 38). SN 78-272,699. PUB. 6-28-2005. FILED 7-10-2003.
- 2,996,970. **TF (STYLIZED)**. THERMOFLOW, INC, MULTIPLE CLASS, (INT. CLS. 9 AND 42), (U.S. CLS. 21, 23, 26, 36, 38, 100 AND 101). SN 78-273,265. PUB. 6-28-2005. FILED 7-11-2003.
- 2,996,971 (*See Class 7 for this trademark*).
- 2,996,983. **MOCHICO (BLOCK FORM)**. AMADOR, EDDIE, (U.S. CLS. 21, 23, 26, 36 AND 38). SN 78-283,015. PUB. 6-28-2005. FILED 8-4-2003.
- 2,996,994. **ECO-NOMIC AND DESIGN**. GLASSCO, JOHN M., (U.S. CLS. 21, 23, 26, 36 AND 38). SN 78-294,554. PUB. 6-28-2005. FILED 9-1-2003.
- 2,996,995. **SOLARONE**. SYSTEMS DESIGN AND TECHNOLOGY LLC, (U.S. CLS. 21, 23, 26, 36 AND 38). SN 78-294,773. PUB. 6-28-2005. FILED 9-2-2003.
- 2,997,000. **PRECESS 48**. BIO-RAD, MULTIPLE CLASS, (INT. CLS. 9 AND 10), (U.S. CLS. 21, 23, 26, 36, 38, 39 AND 44). SN 78-296,882. PUB. 6-28-2005. FILED 9-5-2003.
- 2,997,001. **PICODENTOR**. IMMOBILIENGESELLSCHAFT HELMUT FISCHER GMBH & CO. KG, (U.S. CLS. 21, 23, 26, 36 AND 38). SN 78-296,949. PUB. 3-8-2005. FILED 9-6-2003.
- 2,997,012. **SIVAC-X**. SIEMENS AKTIENGESELLSCHAFT, (U.S. CLS. 21, 23, 26, 36 AND 38). SN 78-301,186. PUB. 6-28-2005. FILED 9-16-2003.
- 2,997,016. **POCKET ROUTEPAD**. COAXIS, INC., (U.S. CLS. 21, 23, 26, 36 AND 38). SN 78-304,031. PUB. 6-28-2005. FILED 9-23-2003.
- 2,997,032. **POPS SPEAKERS (BLOCK FORM)**. DJL, (U.S. CLS. 21, 23, 26, 36 AND 38). SN 78-317,029. PUB. 6-28-2005. FILED 10-22-2003.
- 2,997,038. **ACUDOSE-RX (BLOCK FORM)**. MCKESSON AUTOMATION INC., (U.S. CLS. 21, 23, 26, 36 AND 38). SN 78-323,746. PUB. 6-28-2005. FILED 11-5-2003.
- 2,997,039. **PRO CLIP (BLOCK FORM)**. TJM DESIGN CORPORATION, (U.S. CLS. 21, 23, 26, 36 AND 38). SN 78-324,086. PUB. 6-28-2005. FILED 11-6-2003.
- 2,997,045. **SWISS FLY (BLOCK FORM)**. ITALEE OPTICS, INC., (U.S. CLS. 21, 23, 26, 36 AND 38). SN 78-327,812. PUB. 6-28-2005. FILED 11-13-2003.
- 2,997,062. **PC POWERCELL ENERGY PRODUCTS, INC. AND DESIGN**. POWERCELL ENERGY PRODUCTS, INC., (U.S. CLS. 21, 23, 26, 36 AND 38). SN 78-330,989. PUB. 6-28-2005. FILED 11-20-2003.
- 2,997,066. **ZONELINK (BLOCK FORM)**. HOLJERON CORPORATION, (U.S. CLS. 21, 23, 26, 36 AND 38). SN 78-332,842. PUB. 6-28-2005. FILED 11-25-2003.
- 2,997,075. **ARCHER VERIFICATION (BLOCK FORM)**. 0-IN DESIGN AUTOMATION, INC., (U.S. CLS. 21, 23, 26, 36 AND 38). SN 78-336,993. PUB. 6-28-2005. FILED 12-5-2003.
- 2,997,078. **QUANTOMIX (BLOCK FORM)**. QUANTOMIX LTD., (U.S. CLS. 21, 23, 26, 36 AND 38). SN 78-338,409. PUB. 6-28-2005. FILED 12-9-2003.
- 2,997,089. **VSTA (BLOCK FORM)**. COMMUNICATION MACHINERY CORPORATION, (U.S. CLS. 21, 23, 26, 36 AND 38). SN 78-342,489. PUB. 6-28-2005. FILED 12-17-2003.
- 2,997,090. **FSI NORTH AMERICA (BLOCK FORM)**. FIRE SAFETY INTERNATIONAL, INC., (U.S. CLS. 21, 23, 26, 36 AND 38). SN 78-342,584. PUB. 6-28-2005. FILED 12-18-2003.
- 2,997,097. **RF SMART (BLOCK FORM)**. INFORMATION & COMPUTING SERVICES, INC., (U.S. CLS. 21, 23, 26, 36 AND 38). SN 78-343,658. PUB. 6-28-2005. FILED 12-19-2003.
- 2,997,110. **NETMESH (BLOCK FORM)**. R-OBJECTS INC., (U.S. CLS. 21, 23, 26, 36 AND 38). SN 78-347,167. PUB. 6-28-2005. FILED 12-31-2003.
- 2,997,112. **G-XTREME (BLOCK FORM)**. GLOBE MANUFACTURING COMPANY, (U.S. CLS. 21, 23, 26, 36 AND 38). SN 78-347,443. PUB. 6-28-2005. FILED 1-2-2004.
- 2,997,113. **SURECELL (BLOCK FORM)**. ZELLWEGER ANALYTICS LIMITED, (U.S. CLS. 21, 23, 26, 36 AND 38). SN 78-347,650. PUB. 6-28-2005. FILED 1-5-2004.
- 2,997,114. **ECOSURE (BLOCK FORM)**. ZELLWEGER ANALYTICS LIMITED, (U.S. CLS. 21, 23, 26, 36 AND 38). SN 78-347,658. PUB. 6-28-2005. FILED 1-5-2004.
- 2,997,125. **REDNECK HORN (STYLIZED)**. LEWIS, RIK E., (U.S. CLS. 21, 23, 26, 36 AND 38). SN 78-349,596. PUB. 6-28-2005. FILED 1-8-2004.
- 2,997,130. **PROMOS TECHNOLOGIES (STYLIZED)**. PROMOS TECHNOLOGIES INC., (U.S. CLS. 21, 23, 26, 36 AND 38). SN 78-350,079. PUB. 6-28-2005. FILED 1-9-2004.
- 2,997,137. **MOBILEMS AND DESIGN**. CLAYTON I.D.S., INC., (U.S. CLS. 21, 23, 26, 36 AND 38). SN 78-351,009. PUB. 6-28-2005. FILED 1-13-2004.
- 2,997,138. **3 MINUTE VACATIONS (BLOCK FORM)**. ALSOP, CARLETON SCOTT, (U.S. CLS. 21, 23, 26, 36 AND 38). SN 78-351,223. PUB. 6-28-2005. FILED 1-13-2004.
- 2,997,144. **ORACLE (STYLIZED)**. ORACLE INTERNATIONAL CORPORATION, MULTIPLE CLASS, (INT. CLS. 9, 16, 41 AND 42), (U.S. CLS. 2, 5, 21, 22, 23, 26, 29, 36, 37, 38, 50, 100, 101 AND 107). SN 78-352,703. PUB. 6-28-2005. FILED 1-15-2004.
- 2,997,145. **SCULPTURE (BLOCK FORM)**. APPLE COMPUTER, INC., (U.S. CLS. 21, 23, 26, 36 AND 38). SN 78-352,708. PUB. 6-28-2005. FILED 1-15-2004.
- 2,997,152. **TYPE 2 DIABETES DIGEST (BLOCK FORM)**. MEDICAL WORLD BUSINESS PRESS, INC., MULTIPLE CLASS, (INT. CLS. 9 AND 16), (U.S. CLS. 2, 5, 21, 22, 23, 26, 29, 36, 37, 38 AND 50). SN 78-355,714. PUB. 6-28-2005. FILED 1-22-2004.
- 2,997,157. **EYEON VISION (BLOCK FORM)**. EYEON SOFTWARE INC., (U.S. CLS. 21, 23, 26, 36 AND 38). SN 78-357,376. PUB. 6-28-2005. FILED 1-26-2004.
- 2,997,161. **COMMISSION TRACK (BLOCK FORM)**. SHOWROOM SOLUTIONS, INC., (U.S. CLS. 21, 23, 26, 36 AND 38). SN 78-357,760. PUB. 6-28-2005. FILED 1-26-2004.
- 2,997,164. **MAJORSINE (BLOCK FORM)**. MAJORPOWER CORPORATION, (U.S. CLS. 21, 23, 26, 36 AND 38). SN 78-357,928. PUB. 6-28-2005. FILED 1-27-2004.
- 2,997,200. **COMMAND MASTER (BLOCK FORM)**. CLASS 1, INC., (U.S. CLS. 21, 23, 26, 36 AND 38). SN 78-361,535. PUB. 6-28-2005. FILED 2-3-2004.
- 2,997,212. **WVR (STYLIZED)**. ZERO SURGE INC., (U.S. CLS. 21, 23, 26, 36 AND 38). SN 78-362,973. PUB. 6-28-2005. FILED

- 2-5-2004.
- 2,997,220. **WISECORE (BLOCK FORM)**. KYOCERA MITA CORPORATION, (U.S. CLS. 21, 23, 26, 36 AND 38). SN 78-363,954. PUB. 6-28-2005. FILED 2-6-2004.
- 2,997,229. **SPIDERMAZE (BLOCK FORM)**. REYNOLDS AND REYNOLDS HOLDINGS, INC., (U.S. CLS. 21, 23, 26, 36 AND 38). SN 78-365,096. PUB. 6-28-2005. FILED 2-9-2004.
- 2,997,233. **THE GRAMMAR KEY (BLOCK FORM)**. RLC, LLC, MULTIPLE CLASS, (INT. CLS. 9 AND 16), (U.S. CLS. 2, 5, 21, 22, 23, 26, 29, 36, 37, 38 AND 50). SN 78-365,335. PUB. 6-28-2005. FILED 2-10-2004.
- 2,997,242. **DP DYNAMICPDF (STYLIZED)**. CETE SOFTWARE IP, LLC, (U.S. CLS. 21, 23, 26, 36 AND 38). SN 78-366,843. PUB. 6-28-2005. FILED 2-12-2004.
- 2,997,243. **MAGUS REAL TIME NAVIGATOR (BLOCK FORM)**. MAGUS MANAGEMENT CORPORATION, (U.S. CLS. 21, 23, 26, 36 AND 38). SN 78-367,064. PUB. 6-28-2005. FILED 2-12-2004.
- 2,997,264. **P3 (BLOCK FORM)**. UNIVERSITY TECHNOLOGIES INTERNATIONAL INC., (U.S. CLS. 21, 23, 26, 36 AND 38). SN 78-369,733. PUB. 6-28-2005. FILED 2-18-2004.
- 2,997,266. **MEGA HOT (BLOCK FORM)**. HP INTELLECTUAL CORP., (U.S. CLS. 21, 23, 26, 36 AND 38). SN 78-369,998. PUB. 6-28-2005. FILED 2-18-2004.
- 2,997,269. **I SUPPORT LEARNING AND DESIGN**. ISUPPORTLEARNING COM LLC, (U.S. CLS. 21, 23, 26, 36 AND 38). SN 78-370,301. PUB. 6-28-2005. FILED 2-19-2004.
- 2,997,271. **FTS (BLOCK FORM)**. UTR, INC., (U.S. CLS. 21, 23, 26, 36 AND 38). SN 78-370,682. PUB. 6-28-2005. FILED 2-19-2004.
- 2,997,273. **LOVE GOD. LOVE PEOPLE (BLOCK FORM)**. ACCESS, INC., DBA STUDENT LIFE, INC., MULTIPLE CLASS, (INT. CLS. 9 AND 41), (U.S. CLS. 21, 23, 26, 36, 38, 100, 101 AND 107). SN 78-370,788. PUB. 6-28-2005. FILED 2-19-2004.
- 2,997,286. **BIG HAMMER (BLOCK FORM)**. BIG HAMMER, LLC, (U.S. CLS. 21, 23, 26, 36 AND 38). SN 78-373,418. PUB. 6-28-2005. FILED 2-24-2004.
- 2,997,289. **PHOTOMIX (BLOCK FORM)**. DOROSHIN, VITALY, AND BOLGOV, MIKHAIL, AND SHAFIKOVA, LAISAN, (U.S. CLS. 21, 23, 26, 36 AND 38). SN 78-373,530. PUB. 6-28-2005. FILED 2-24-2004.
- 2,997,294. **AUTOTROL (BLOCK FORM)**. GE OSMONICS, INC., (U.S. CLS. 21, 23, 26, 36 AND 38). SN 78-374,782. PUB. 6-28-2005. FILED 2-26-2004.
- 2,997,296. **FINALESCRIPT (BLOCK FORM)**. MAKEMUSIC! INC., (U.S. CLS. 21, 23, 26, 36 AND 38). SN 78-375,102. PUB. 6-28-2005. FILED 2-27-2004.
- 2,997,300. **DCI DVR CONNECTION, INC (STYLIZED)**. DVR CONNECTION, INC., (U.S. CLS. 21, 23, 26, 36 AND 38). SN 78-375,963. PUB. 6-28-2005. FILED 2-29-2004.
- 2,997,302. **THE INANIMATE OBJECTS (BLOCK FORM)**. SCHROEDER, STEVAN E., MULTIPLE CLASS, (INT. CLS. 9 AND 41), (U.S. CLS. 21, 23, 26, 36, 38, 100, 101 AND 107). SN 78-376,040. PUB. 6-28-2005. FILED 3-1-2004.
- 2,997,303. **E + E ELEKTRONIK (STYLIZED)**. E + E ELEKTRONIK GES.M.B.H., (U.S. CLS. 21, 23, 26, 36 AND 38). SN 78-376,052. PUB. 6-28-2005. FILED 3-1-2004.
- 2,997,314. **ZFRAME (BLOCK FORM)**. CORNERSTONE SYSTEMS, INC., (U.S. CLS. 21, 23, 26, 36 AND 38). SN 78-377,443. PUB. 6-28-2005. FILED 3-2-2004.
- 2,997,315. **ZDEV (BLOCK FORM)**. CORNERSTONE SYSTEMS, INC., (U.S. CLS. 21, 23, 26, 36 AND 38). SN 78-377,448. PUB. 6-28-2005. FILED 3-2-2004.
- 2,997,332. **ARACOR (BLOCK FORM)**. ADVANCED RESEARCH & APPLICATIONS CORP., (U.S. CLS. 21, 23, 26, 36 AND 38). SN 78-380,245. PUB. 6-28-2005. FILED 3-8-2004.
- 2,997,343. **SCHEMALOGIC (BLOCK FORM)**. SCHEMALOGIC, INC., MULTIPLE CLASS, (INT. CLS. 9 AND 42), (U.S. CLS. 21, 23, 26, 36, 38, 100 AND 101). SN 78-384,520. PUB. 6-28-2005. FILED 3-15-2004.
- 2,997,348. **BEAUTIFUL GAME STUDIOS (BLOCK FORM)**. EIDOS INTERACTIVE LIMITED, (U.S. CLS. 21, 23, 26, 36 AND 38). SN 78-385,842. PUB. 6-28-2005. FILED 3-17-2004.
- 2,997,350. **OPTIONS 101 (BLOCK FORM)**. OPTIONS UNIVERSITY LLC, (U.S. CLS. 21, 23, 26, 36 AND 38). SN 78-385,956. PUB. 6-28-2005. FILED 3-17-2004.
- 2,997,352. **STARKING AND DESIGN**. STARKING TECHNOLOGY CORP., (U.S. CLS. 21, 23, 26, 36 AND 38). SN 78-386,416. PUB. 6-28-2005. FILED 3-18-2004.
- 2,997,358. **Q-ENCLOSURES (BLOCK FORM)**. ROCKFORD CORPORATION, (U.S. CLS. 21, 23, 26, 36 AND 38). SN 78-387,345. PUB. 6-28-2005. FILED 3-19-2004.
- 2,997,375. **GROWING MINDS WITH MUSIC (BLOCK FORM)**. TWIN SISTERS IP, LLC, MULTIPLE CLASS, (INT. CLS. 9 AND 16), (U.S. CLS. 2, 5, 21, 22, 23, 26, 29, 36, 37, 38 AND 50). SN 78-390,106. PUB. 6-28-2005. FILED 3-24-2004.
- 2,997,380. **MASTTONES AND DESIGN**. EMBIENCE, INC., MULTIPLE CLASS, (INT. CLS. 9 AND 42), (U.S. CLS. 21, 23, 26, 36, 38, 100 AND 101). SN 78-391,475. PUB. 6-28-2005. FILED 3-26-2004.
- 2,997,382. **357 (BLOCK FORM)**. OUTDOOR OPTICS, INC., DBA OLYMPIC OPTICAL CO., (U.S. CLS. 21, 23, 26, 36 AND 38). SN 78-391,657. PUB. 6-28-2005. FILED 3-26-2004.
- 2,997,385. **C CONNECTABLES AND DESIGN**. CONNECTABLES, L.L.C., (U.S. CLS. 21, 23, 26, 36 AND 38). SN 78-392,311. PUB. 3-8-2005. FILED 3-29-2004.
- 2,997,392 (See Class 5 for this trademark).
- 2,997,402. **NOMACHINE (BLOCK FORM)**. MEDIALOGIC S.P.A. MULTIPLE CLASS, (INT. CLS. 9, 38 AND 42), (U.S. CLS. 21, 23, 26, 36, 38, 100, 101 AND 104). SN 78-394,486. PUB. 6-28-2005. FILED 4-1-2004.
- 2,997,414. **YOUR ONE AND ONLY CARD FOR SAVINGS (BLOCK FORM)**. COUCH/BRAUNSDORF AFFINITY, INC., (U.S. CLS. 21, 23, 26, 36 AND 38). SN 78-397,873. PUB. 6-28-2005. FILED 4-7-2004.
- 2,997,415. **LUMERA (BLOCK FORM)**. LUMERA CORPORATION, (U.S. CLS. 21, 23, 26, 36 AND 38). SN 78-397,877. PUB. 6-28-2005. FILED 4-7-2004.
- 2,997,421. **GTR (BLOCK FORM)**. THERRES, GREGORY A., AND CAPOZZOLI, DAVID, MULTIPLE CLASS, (INT. CLS. 9 AND 25), (U.S. CLS. 21, 22, 23, 26, 36, 38 AND 39). SN 78-399,216. PUB. 6-28-2005. FILED 4-9-2004.
- 2,997,422. **AUO (STYLIZED)**. AU OPTRONICS CORP., (U.S. CLS. 21, 23, 26, 36 AND 38). SN 78-399,649. PUB. 6-28-2005. FILED 4-9-2004.
- 2,997,423. **SMARTSET (BLOCK FORM)**. ELO TOUCHSYSTEMS, INC., (U.S. CLS. 21, 23, 26, 36 AND 38). SN 78-399,673. PUB. 6-28-2005. FILED 4-9-2004.
- 2,997,424. **STATIK WAVE (BLOCK FORM)**. PATEREKAS, ANDREW, D, (U.S. CLS. 21, 23, 26, 36 AND 38). SN 78-399,796. PUB. 6-28-2005. FILED 4-10-2004.
- 2,997,441. **OPTIMISER (BLOCK FORM)**. ERNST, ALAN C, (U.S. CLS. 21, 23, 26, 36 AND 38). SN 78-403,011. PUB. 6-28-2005. FILED 4-16-2004.
- 2,997,445. **MIM AND DESIGN**. MIMVISTA CORP., (U.S. CLS. 21, 23, 26, 36 AND 38). SN 78-404,105. PUB. 6-28-2005. FILED 4-19-2004.
- 2,997,446. **LOST COUNTRY (BLOCK FORM)**. COLEGROVE, JAMES W., MULTIPLE CLASS, (INT. CLS. 9 AND 41), (U.S. CLS. 21, 23, 26, 36, 38, 100, 101 AND 107). SN 78-404,234. PUB. 6-28-2005. FILED 4-19-2004.
- 2,997,461. **RXL MAX (BLOCK FORM)**. DADE BEHRING INC., (U.S. CLS. 21, 23, 26, 36 AND 38). SN 78-406,524. PUB. 6-28-2005. FILED 4-22-2004.
- 2,997,498. **AXIOPE (BLOCK FORM)**. AXIOPE LIMITED, (U.S. CLS. 21, 23, 26, 36 AND 38). SN 78-414,231. PUB. 6-28-2005. FILED 5-6-2004.
- 2,997,504 (See Class 7 for this trademark).
- 2,997,505 (See Class 7 for this trademark).
- 2,997,510 (See Class 3 for this trademark).
- 2,997,516. **MUSIC COOKIE AND DESIGN**. O'RITE TECHNOLOGY CO., LTD., (U.S. CLS. 21, 23, 26, 36 AND 38). SN 78-418,607. PUB. 6-28-2005. FILED 5-14-2004.
- 2,997,519. **PUBSTER (BLOCK FORM)**. HAMILTON NEW MEDIA, (U.S. CLS. 21, 23, 26, 36 AND 38). SN 78-419,625. PUB. 6-28-2005. FILED 5-17-2004.
- 2,997,527. **RESOLVE (BLOCK FORM)**. EICHROM TECHNOLOGIES, INC., (U.S. CLS. 21, 23, 26, 36 AND 38). SN 78-420,963. PUB. 6-28-2005. FILED 5-18-2004.
- 2,997,536. **PADDINGTON BEAR (BLOCK FORM)**. PADDINGTON & COMPANY, (U.S. CLS. 21, 23, 26, 36 AND 38). SN 78-422,734. PUB. 6-28-2005. FILED 5-21-2004.
- 2,997,553. **MELEBUS (BLOCK FORM)**. MITSUBISHI ELECTRIC CORPORATION, (U.S. CLS. 21, 23, 26, 36 AND 38). SN 78-427,120. PUB. 6-28-2005. FILED 5-28-2004.

- 2,997,554. **MURCAL AND DESIGN**. MURPHY SWITCH OF CALIFORNIA, INC., (U.S. CLS. 21, 23, 26, 36 AND 38). SN 78-427,241. PUB. 6-28-2005. FILED 5-28-2004.
- 2,997,558. **HITMAN AND DESIGN**. EIDOS INTERACTIVE LIMITED, (U.S. CLS. 21, 23, 26, 36 AND 38). SN 78-428,222. PUB. 6-28-2005. FILED 6-1-2004.
- 2,997,576. **MISCELLANEOUS DESIGN**. DENTISTS MANAGEMENT CORPORATION, (U.S. CLS. 21, 23, 26, 36 AND 38). SN 78-431,593. PUB. 6-28-2005. FILED 6-8-2004.
- 2,997,581. **DOUBLE HEARTS (BLOCK FORM)**. IGT, (U.S. CLS. 21, 23, 26, 36 AND 38). SN 78-432,705. PUB. 6-28-2005. FILED 6-9-2004.
- 2,997,599. **VSMAXX (STYLIZED)**. SENARIO LLC, (U.S. CLS. 21, 23, 26, 36 AND 38). SN 78-436,037. PUB. 6-28-2005. FILED 6-16-2004.
- 2,997,614. **XTREME DEBIT (BLOCK FORM)**. DORF, ROBERT E., (U.S. CLS. 21, 23, 26, 36 AND 38). SN 78-436,982. PUB. 6-28-2005. FILED 6-17-2004.
- 2,997,616. **SINGLENTRY SINGLENTRY SYSTEMS CORP AND DESIGN**. SINGLENTRY SYSTEMS CORP, (U.S. CLS. 21, 23, 26, 36 AND 38). SN 78-437,062. PUB. 6-28-2005. FILED 6-17-2004.
- 2,997,665. **SPIN POKER DELUXE AND DESIGN**. IGT, (U.S. CLS. 21, 23, 26, 36 AND 38). SN 78-443,406. PUB. 6-28-2005. FILED 6-29-2004.
- 2,997,675. **JIMI HENDRIX (STYLIZED)**. EXPERIENCE HENDRIX, L.L.C., (U.S. CLS. 21, 23, 26, 36 AND 38). SN 78-444,377. PUB. 6-28-2005. FILED 7-1-2004.
- 2,997,687. **SMILEYCONS AND DESIGN**. CLOUDEIGHT INTERNET LLC, (U.S. CLS. 21, 23, 26, 36 AND 38). SN 78-444,947. PUB. 6-28-2005. FILED 7-1-2004.
- 2,997,694. **QUARTER MANIA AND DESIGN**. IGT, (U.S. CLS. 21, 23, 26, 36 AND 38). SN 78-445,523. PUB. 6-28-2005. FILED 7-2-2004.
- 2,997,698. **KARAOKE BOOM (BLOCK FORM)**. I.M. RECORDS INC., (U.S. CLS. 21, 23, 26, 36 AND 38). SN 78-446,207. PUB. 6-28-2005. FILED 7-6-2004.
- 2,997,703. **EMFIVA (BLOCK FORM)**. MERKATUM CORPORATION, (U.S. CLS. 21, 23, 26, 36 AND 38). SN 78-446,483. PUB. 6-28-2005. FILED 7-6-2004.
- 2,997,718. **CROWAWAY (BLOCK FORM)**. Q1 SOLUTIONS, (U.S. CLS. 21, 23, 26, 36 AND 38). SN 78-448,261. PUB. 6-28-2005. FILED 7-9-2004.
- 2,997,720. **SMARTFROG (BLOCK FORM)**. HEWLETT-PACKARD DEVELOPMENT COMPANY, L.P., (U.S. CLS. 21, 23, 26, 36 AND 38). SN 78-448,281. PUB. 6-28-2005. FILED 7-9-2004.
- 2,997,725. **SYSMARK (BLOCK FORM)**. BUSINESS APPLICATIONS PERFORMANCE CORPORATION, (U.S. CLS. 21, 23, 26, 36 AND 38). SN 78-448,780. PUB. 6-28-2005. FILED 7-9-2004.
- 2,997,728. **BEHAVIOR DEVELOPMENT STUDIO (BLOCK FORM)**. AMERICAN ANDROID CORP., (U.S. CLS. 21, 23, 26, 36 AND 38). SN 78-448,968. PUB. 6-28-2005. FILED 7-12-2004.
- 2,997,731. **COLLATERAL VISION (BLOCK FORM)**. FNC, INC., (U.S. CLS. 21, 23, 26, 36 AND 38). SN 78-449,262. PUB. 6-28-2005. FILED 7-12-2004.
- 2,997,732. **MISCELLANEOUS DESIGN**. SIMDESK TECHNOLOGIES, INC., MULTIPLE CLASS, (INT. CLS. 9 AND 42), (U.S. CLS. 21, 23, 26, 36, 38, 100 AND 101). SN 78-449,339. PUB. 6-28-2005. FILED 7-12-2004.
- 2,997,743. **BRIGHT LIGHTS. BRIGHT IDEAS. (BLOCK FORM)**. LAMINA CERAMICS, INC., (U.S. CLS. 21, 23, 26, 36 AND 38). SN 78-450,609. PUB. 6-28-2005. FILED 7-14-2004.
- 2,997,745. **REDI2 (BLOCK FORM)**. REDI2 TECHNOLOGIES, INC., (U.S. CLS. 21, 23, 26, 36 AND 38). SN 78-450,708. PUB. 6-28-2005. FILED 7-14-2004.
- 2,997,768. **ALLSPICE MUSIC (BLOCK FORM)**. SPICER, AMILIA K, (U.S. CLS. 21, 23, 26, 36 AND 38). SN 78-452,564. PUB. 6-28-2005. FILED 7-19-2004.
- 2,997,773. **RAGING TIGER: THE SECOND KOREAN WAR (BLOCK FORM)**. PROCTOR, PATRICK E., (U.S. CLS. 21, 23, 26, 36 AND 38). SN 78-452,877. PUB. 6-28-2005. FILED 7-19-2004.
- 2,997,797. **GIGAVAC (BLOCK FORM)**. GIGAVAC LLC, (U.S. CLS. 21, 23, 26, 36 AND 38). SN 78-454,308. PUB. 6-28-2005. FILED 7-21-2004.
- 2,997,803. **EXCLAIMER (BLOCK FORM)**. EXCLAIMER LTD, (U.S. CLS. 21, 23, 26, 36 AND 38). SN 78-454,488. PUB. 6-28-2005. FILED 7-21-2004.
- 2,997,812. **VERSATOOLS (BLOCK FORM)**. CARTÉGRAPH SYSTEMS, INC., (U.S. CLS. 21, 23, 26, 36 AND 38). SN 78-455,163. PUB. 6-28-2005. FILED 7-22-2004.
- 2,997,837. **DIGISIZER (BLOCK FORM)**. BURANDT, JASON T., AND BURANDT, CHARLOTTE L., (U.S. CLS. 21, 23, 26, 36 AND 38). SN 78-455,954. PUB. 6-28-2005. FILED 7-23-2004.
- 2,997,846. **APTIS (BLOCK FORM)**. APTIS HOLDINGS, INC., MULTIPLE CLASS, (INT. CLS. 9, 16, 35, 37, 41, 42 AND 45), (U.S. CLS. 2, 5, 21, 22, 23, 26, 29, 36, 37, 38, 50, 100, 101, 102, 103, 106 AND 107). SN 78-456,227. PUB. 6-28-2005. FILED 7-25-2004.
- 2,997,850. **SAFE STORE AND DESIGN**. MONARCH COMPUTER SYSTEMS, INC., (U.S. CLS. 21, 23, 26, 36 AND 38). SN 78-456,469. PUB. 6-28-2005. FILED 7-26-2004.
- 2,997,859. **SYNCPRO (BLOCK FORM)**. ILIUM SOFTWARE, INC., (U.S. CLS. 21, 23, 26, 36 AND 38). SN 78-456,768. PUB. 6-28-2005. FILED 7-26-2004.
- 2,997,862. **PROCESS ADVISOR (BLOCK FORM)**. SHAW, JAMES G., DBA SHAW RESOURCES, (U.S. CLS. 21, 23, 26, 36 AND 38). SN 78-456,844. PUB. 6-28-2005. FILED 7-26-2004.
- 2,997,871. **SW AND DESIGN**. MAXIMA TECHNOLOGIES & SYSTEMS, INC., (U.S. CLS. 21, 23, 26, 36 AND 38). SN 78-457,061. PUB. 6-28-2005. FILED 7-27-2004.
- 2,997,877. **MAXLINE (BLOCK FORM)**. SEMROCK, INC., (U.S. CLS. 21, 23, 26, 36 AND 38). SN 78-457,123. PUB. 6-28-2005. FILED 7-27-2004.
- 2,997,905. **CINEA (BLOCK FORM)**. CINEA, INC., MULTIPLE CLASS, (INT. CLS. 9 AND 42), (U.S. CLS. 21, 23, 26, 36, 38, 100 AND 101). SN 78-457,680. PUB. 6-28-2005. FILED 7-27-2004.
- 2,997,906. **BLIZZARD (BLOCK FORM)**. MICHAELS OF OREGON CO., (U.S. CLS. 21, 23, 26, 36 AND 38). SN 78-457,690. PUB. 6-28-2005. FILED 7-27-2004.
- 2,997,910. **THE DEAD (BLOCK FORM)**. GRATEFUL DEAD PRODUCTIONS, MULTIPLE CLASS, (INT. CLS. 9, 16, 25 AND 41), (U.S. CLS. 2, 5, 21, 22, 23, 26, 29, 36, 37, 38, 39, 50, 100, 101 AND 107). SN 78-457,759. PUB. 6-28-2005. FILED 7-28-2004.
- 2,997,917. **ISPELL (BLOCK FORM)**. PROVENIO SOFTWARE CORPORATION, (U.S. CLS. 21, 23, 26, 36 AND 38). SN 78-457,992. PUB. 6-28-2005. FILED 7-28-2004.
- 2,997,935. **FA (STYLIZED)**. SOUTHERN FOLGER DETENTION EQUIPMENT COMPANY, (U.S. CLS. 21, 23, 26, 36 AND 38). SN 78-458,267. PUB. 6-28-2005. FILED 7-28-2004.
- 2,997,936. **CORNERSTONE SENSORS (BLOCK FORM)**. CORNERSTONE SENSORS, INC., (U.S. CLS. 21, 23, 26, 36 AND 38). SN 78-458,312. PUB. 6-28-2005. FILED 7-28-2004.
- 2,997,938. **WRITESCREEN (BLOCK FORM)**. HI-TECH INSTRUMENTS, INC., (U.S. CLS. 21, 23, 26, 36 AND 38). SN 78-458,366. PUB. 6-28-2005. FILED 7-28-2004.
- 2,997,940. **JURISTUDENTS (BLOCK FORM)**. STARE DECISIS, LLC, (U.S. CLS. 21, 23, 26, 36 AND 38). SN 78-458,510. PUB. 6-28-2005. FILED 7-29-2004.
- 2,997,952. **UMI (BLOCK FORM)**. URBAN MINISTRIES, INC., MULTIPLE CLASS, (INT. CLS. 9, 16 AND 35), (U.S. CLS. 2, 5, 21, 22, 23, 26, 29, 36, 37, 38, 50, 100, 101 AND 102). SN 78-458,743. PUB. 6-28-2005. FILED 7-29-2004.
- 2,997,958. **V TRANSPORTATION TECHNOLOGY (STYLIZED)**. VERSATRANS SOLUTIONS, INC., (U.S. CLS. 21, 23, 26, 36 AND 38). SN 78-458,790. PUB. 6-28-2005. FILED 7-29-2004.
- 2,997,959. **EYEFIRE (BLOCK FORM)**. CAPO, INC., (U.S. CLS. 21, 23, 26, 36 AND 38). SN 78-458,828. PUB. 6-28-2005. FILED 7-29-2004.
- 2,997,963. **UMI COMMUNICATIONS AND DESIGN**. URBAN MINISTRIES, INC., (U.S. CLS. 21, 23, 26, 36 AND 38). SN 78-458,859. PUB. 6-28-2005. FILED 7-29-2004.
- 2,997,964. **ISOCLEAN (BLOCK FORM)**. E. I. DU PONT DE NEMOURS AND COMPANY, (U.S. CLS. 21, 23, 26, 36 AND 38). SN 78-458,864. PUB. 6-28-2005. FILED 7-29-2004.
- 2,997,965. **UMI COMMUNICATIONS (BLOCK FORM)**. URBAN MINISTRIES, INC., (U.S. CLS. 21, 23, 26, 36 AND 38). SN 78-458,876. PUB. 6-28-2005. FILED 7-29-2004.
- 2,997,972. **STREAMENGINE (BLOCK FORM)**. UBICOM, INC.,

- (U.S. CLS. 21, 23, 26, 36 AND 38). SN 78-459,098. PUB. 6-28-2005. FILED 7-29-2004.
- 2,997,981. **BOOSWEET RECORDS ONLINE AND DESIGN.** BOOSWEET ENTERPRISES, LLC. MULTIPLE CLASS, (INT. CLS. 9 AND 25), (U.S. CLS. 21, 22, 23, 26, 36, 38 AND 39). SN 78-459,259. PUB. 6-28-2005. FILED 7-29-2004.
- 2,997,987. **PLESK 7 RELOADED (BLOCK FORM).** SW-SOFT HOLDINGS, LTD., (U.S. CLS. 21, 23, 26, 36 AND 38). SN 78-459,386. PUB. 6-28-2005. FILED 7-30-2004.
- 2,998,002. **TOOL CHEST (BLOCK FORM).** GRUNDL ENTERPRISES INC., (U.S. CLS. 21, 23, 26, 36 AND 38). SN 78-459,543. PUB. 6-28-2005. FILED 7-30-2004.
- 2,998,008. **V-SIM AND DESIGN.** V-SIM INCORPORATED, (U.S. CLS. 21, 23, 26, 36 AND 38). SN 78-459,626. PUB. 6-28-2005. FILED 7-30-2004.
- 2,998,012. **JUSTICE LEAGUE (BLOCK FORM).** DC COMICS, (U.S. CLS. 21, 23, 26, 36 AND 38). SN 78-459,673. PUB. 6-28-2005. FILED 7-30-2004.
- 2,998,023. **XIONETIC (BLOCK FORM).** XIONETIC TECHNOLOGIES, INC., MULTIPLE CLASS, (INT. CLS. 9 AND 42), (U.S. CLS. 21, 23, 26, 36, 38, 100 AND 101). SN 78-459,930. PUB. 6-28-2005. FILED 7-30-2004.
- 2,998,024. **REBEAM (BLOCK FORM).** MATTHEWS, ROBERT C., (U.S. CLS. 21, 23, 26, 36 AND 38). SN 78-459,967. PUB. 6-28-2005. FILED 7-30-2004.
- 2,998,047. **W AND DESIGN.** WEGENER COMMUNICATIONS, INC., MULTIPLE CLASS, (INT. CLS. 9 AND 35), (U.S. CLS. 21, 23, 26, 36, 38, 100, 101 AND 102). SN 78-460,310. PUB. 6-28-2005. FILED 8-2-2004.
- 2,998,049. **THE NEW GENERATION FIRE EXTINGUISHER (BLOCK FORM).** MILLENNIUM GLOBAL MARKETPLACE, INC., (U.S. CLS. 21, 23, 26, 36 AND 38). SN 78-460,320. PUB. 6-28-2005. FILED 8-2-2004.
- 2,998,050. **COMPEL (BLOCK FORM).** WEGENER COMMUNICATIONS, INC., (U.S. CLS. 21, 23, 26, 36 AND 38). SN 78-460,321. PUB. 6-28-2005. FILED 8-2-2004.
- 2,998,057. **SOLITAIRE (BLOCK FORM).** KABA ILCO, INC., (U.S. CLS. 21, 23, 26, 36 AND 38). SN 78-460,381. PUB. 6-28-2005. FILED 8-2-2004.
- 2,998,063. **POWERED BY AOS (BLOCK FORM).** ALPHA AND OMEGA SEMICONDUCTOR LTD., (U.S. CLS. 21, 23, 26, 36 AND 38). SN 78-460,434. PUB. 6-28-2005. FILED 8-2-2004.
- 2,998,072. **DD AND DESIGN.** DONOHOE DIGITAL LLC, (U.S. CLS. 21, 23, 26, 36 AND 38). SN 78-460,594. PUB. 6-28-2005. FILED 8-2-2004.
- 2,998,088. **SWIFTEST (BLOCK FORM).** PINTAIL TECHNOLOGIES, INC., (U.S. CLS. 21, 23, 26, 36 AND 38). SN 78-460,966. PUB. 6-28-2005. FILED 8-3-2004.
- 2,998,118. **SEASONS OF THE HEART (BLOCK FORM).** TIM JANIS ENSEMBLE, INC., (U.S. CLS. 21, 23, 26, 36 AND 38). SN 78-461,408. PUB. 6-28-2005. FILED 8-3-2004.
- 2,998,128. **IM2 (BLOCK FORM).** IM2 LTD., (U.S. CLS. 21, 23, 26, 36 AND 38). SN 78-461,532. PUB. 6-28-2005. FILED 8-4-2004.
- 2,998,130. **THE WAY IT SHOULD BE (BLOCK FORM).** EZRAD.COM, INC., (U.S. CLS. 21, 23, 26, 36 AND 38). SN 78-461,610. PUB. 6-28-2005. FILED 8-4-2004.
- 2,998,139. **VOICEIN (BLOCK FORM).** FONIX CORPORATION, (U.S. CLS. 21, 23, 26, 36 AND 38). SN 78-461,781. PUB. 6-28-2005. FILED 8-4-2004.
- 2,998,163. **REVIVE (BLOCK FORM).** REVIVE PARTNERS, LLC, (U.S. CLS. 21, 23, 26, 36 AND 38). SN 78-462,209. PUB. 6-28-2005. FILED 8-4-2004.
- 2,998,173. **A AND DESIGN.** ALPHA AND OMEGA SEMICONDUCTOR LTD., (U.S. CLS. 21, 23, 26, 36 AND 38). SN 78-462,513. PUB. 6-28-2005. FILED 8-5-2004.
- 2,998,174. **TM3 AND DESIGN.** DEUTSCHE TELEKOM AG, (U.S. CLS. 21, 23, 26, 36 AND 38). SN 78-462,602. PUB. 6-28-2005. FILED 8-5-2004.
- 2,998,176. **HELPERLINK (BLOCK FORM).** WABTEC HOLDING CORPORATION, (U.S. CLS. 21, 23, 26, 36 AND 38). SN 78-462,644. PUB. 6-28-2005. FILED 8-5-2004.
- 2,998,186. **PATIENT SAFETY IS OUR PASSION. (BLOCK FORM).** PATIENT CARE TECHNOLOGY SYSTEMS, LLC., (U.S. CLS. 21, 23, 26, 36 AND 38). SN 78-462,979. PUB. 6-28-2005. FILED 8-5-2004.
- 2,998,200. **CELESTIA (BLOCK FORM).** COPERNICUS BUSINESS SYSTEMS, LLC, (U.S. CLS. 21, 23, 26, 36 AND 38). SN 78-463,708. PUB. 6-28-2005. FILED 8-6-2004.
- 2,998,204. **CHUBSTER (BLOCK FORM).** SOUND ENHANCEMENTS, INC., (U.S. CLS. 21, 23, 26, 36 AND 38). SN 78-464,050. PUB. 6-28-2005. FILED 8-9-2004.
- 2,998,213. **MTN AND DESIGN.** MARITIME TELECOMMUNICATIONS NETWORK, INC., (U.S. CLS. 21, 23, 26, 36 AND 38). SN 78-464,416. PUB. 6-28-2005. FILED 8-9-2004.
- 2,998,219. **FRANTONE (BLOCK FORM).** BLANCHE, FRANCES, (U.S. CLS. 21, 23, 26, 36 AND 38). SN 78-464,711. PUB. 6-28-2005. FILED 8-10-2004.
- 2,998,239. **EZSERVO (BLOCK FORM).** ALLMOTION, INC., (U.S. CLS. 21, 23, 26, 36 AND 38). SN 78-465,319. PUB. 6-28-2005. FILED 8-10-2004.
- 2,998,242. **HYT AND DESIGN.** SHENZHEN HYT SCIENCE & TECHNOLOGY CO., LTD, (U.S. CLS. 21, 23, 26, 36 AND 38). SN 78-465,377. PUB. 6-28-2005. FILED 8-11-2004.
- 2,998,255. **CRYPTOGRAMOPHONE AND DESIGN.** RADICAL MOODSWINGER MUSIC, DBA CRYPTOGRAMOPHONE, (U.S. CLS. 21, 23, 26, 36 AND 38). SN 78-466,044. PUB. 6-28-2005. FILED 8-11-2004.
- 2,998,269. **WAKE BLASTER AND DESIGN.** ACOUSTIC ARTISTRY, LLC, (U.S. CLS. 21, 23, 26, 36 AND 38). SN 78-467,071. PUB. 6-28-2005. FILED 8-13-2004.
- 2,998,273. **ARTIZEN (BLOCK FORM).** CREATIVE BEAUTY CONCEPTS, LTD., (U.S. CLS. 21, 23, 26, 36 AND 38). SN 78-467,126. PUB. 6-28-2005. FILED 8-13-2004.
- 2,998,275. **FOWL PLAY (BLOCK FORM).** GARDNER, MERLE F., (U.S. CLS. 21, 23, 26, 36 AND 38). SN 78-467,298. PUB. 6-28-2005. FILED 8-13-2004.
- 2,998,280. **AUTOTEST (BLOCK FORM).** LIGHTSPEED SEMICONDUCTOR CORP., (U.S. CLS. 21, 23, 26, 36 AND 38). SN 78-467,500. PUB. 6-28-2005. FILED 8-13-2004.
- 2,998,287. **RAPALA (BLOCK FORM).** NORMARK CORPORATION, (U.S. CLS. 21, 23, 26, 36 AND 38). SN 78-468,507. PUB. 6-28-2005. FILED 8-17-2004.
- 2,998,298. **ASPEX (BLOCK FORM).** ASPEX SEMICONDUCTOR LIMITED, MULTIPLE CLASS, (INT. CLS. 9 AND 42), (U.S. CLS. 21, 23, 26, 36, 38, 100 AND 101). SN 78-470,625. PUB. 6-28-2005. FILED 8-19-2004.
- 2,998,299. **WIFIWAVE (BLOCK FORM).** WIFIWAVE, INC., (U.S. CLS. 21, 23, 26, 36 AND 38). SN 78-470,632. PUB. 6-28-2005. FILED 8-19-2004.
- 2,998,329. **A AND DESIGN.** ALPHA AND OMEGA SEMICONDUCTOR LIMITED, (U.S. CLS. 21, 23, 26, 36 AND 38). SN 78-511,646. PUB. 6-28-2005. FILED 11-4-2004.
- 2,998,331. **MODERN ENGINEERING, INC. AND DESIGN.** MODERN ENGINEERING, INC., MULTIPLE CLASS, (INT. CLS. 9, 35 AND 42), (U.S. CLS. 21, 23, 26, 36, 38, 100, 101 AND 102). SN 78-524,569. PUB. 6-28-2005. FILED 11-30-2004.
- 2,998,334. **ORBITAL (BLOCK FORM).** ORBITAL DATA CORPORATION, (U.S. CLS. 21, 23, 26, 36 AND 38). SN 78-528,626. PUB. 6-28-2005. FILED 12-7-2004.
- 2,998,335. **BRINE AND DESIGN.** BRINE, INC., MULTIPLE CLASS, (INT. CLS. 9, 18, 25 AND 28), (U.S. CLS. 1, 2, 3, 21, 22, 23, 26, 36, 38, 39, 41 AND 50). SN 78-533,424. PUB. 6-28-2005. FILED 12-16-2004.
- 2,998,350. **YOU ARE YOUR PLAYLIST (BLOCK FORM).** HEWLETT-PACKARD DEVELOPMENT COMPANY, L.P., (U.S. CLS. 21, 23, 26, 36 AND 38). SN 78-975,772. PUB. 6-28-2005. FILED 7-22-2004.
- 2,998,359. **GOLDEN INTERSTAR AND DESIGN.** BOUCHAIB CHAKIR, (U.S. CLS. 21, 23, 26, 36 AND 38). SN 79-000,365. PUB. 6-28-2005. FILED 11-26-2003.
- 2,998,370. **COOLFLUX DSP (BLOCK FORM).** KONINKLIJKE PHILIPS ELECTRONICS N.V., (U.S. CLS. 21, 23, 26, 36 AND 38). SN 79-000,622. PUB. 6-28-2005. FILED 12-12-2003.
- 2,998,377. **SHAPE (BLOCK FORM).** KONINKLIJKE PHILIPS ELECTRONICS N.V., MULTIPLE CLASS, (INT. CLS. 9 AND 42), (U.S. CLS. 21, 23, 26, 36, 38, 100 AND 101). SN 79-000,981. PUB. 6-28-2005. FILED 11-19-2003.
- 2,998,389. **PRODUS (BLOCK FORM).** ASM; AUTOMATION SENSORIK MESSTECHNIK GMBH, (U.S. CLS. 21, 23, 26, 36 AND 38). SN 79-001,314. PUB. 6-28-2005. FILED 1-28-2004.
- 2,998,395. **T-ROLL AND DESIGN.** SMS DEMAG AG, MULTIPLE CLASS, (INT. CLS. 9 AND 42), (U.S. CLS. 21, 23, 26, 36, 38, 100 AND 101). SN 79-001,432. PUB. 6-28-2005. FILED 1-22-2004.

- 2,998,428. **SAMD (BLOCK FORM)**. C.E.I.A. - COSTRUZIONI ELETTRONICHE; INDUSTRIALI AUTOMATISMI - S.P.A., (U.S. CLS. 21, 23, 26, 36 AND 38). SN 79-002,374. PUB. 6-28-2005. FILED 1-21-2004.
- 2,998,436. **E+H AND DESIGN**. MESTRA AG, MULTIPLE CLASS, (INT. CLS. 9, 37, 39 AND 42), (U.S. CLS. 21, 23, 26, 36, 38, 100, 101, 103, 105 AND 106). SN 79-002,587. PUB. 6-28-2005. FILED 11-7-2003.
- 2,998,443. **SCHAFFNER (BLOCK FORM)**. SCHAFFNER EMV AG (SCHAFFNER EMV SA); (SCHAFFNER EMV LTD.), MULTIPLE CLASS, (INT. CLS. 9 AND 42), (U.S. CLS. 21, 23, 26, 36, 38, 100 AND 101). SN 79-002,686. PUB. 6-28-2005. FILED 2-6-2004.
- 2,998,474. **R.TOWN (BLOCK FORM)**. ALCEA (SOCIÉTÉ ANONYME), MULTIPLE CLASS, (INT. CLS. 9 AND 18), (U.S. CLS. 1, 2, 3, 21, 22, 23, 26, 36, 38 AND 41). SN 79-004,045. PUB. 6-28-2005. FILED 2-2-2004.
- 2,998,480 (*See Class 6 for this trademark*).
- 2,998,482 (*See Class 7 for this trademark*).
- 2,998,484 (*See Class 7 for this trademark*).
- 2,998,492. **STOR SENTRY (BLOCK FORM)**. HI-STOR TECHNOLOGIES SA, MULTIPLE CLASS, (INT. CLS. 9 AND 42), (U.S. CLS. 21, 23, 26, 36, 38, 100 AND 101). SN 79-005,584. PUB. 6-28-2005. FILED 8-5-2004.
- 2,998,499. **ARCTELLIGENT (BLOCK FORM)**. TRUMPF GMBH + CO. KG, (U.S. CLS. 21, 23, 26, 36 AND 38). SN 79-007,167. PUB. 6-28-2005. FILED 7-22-2004.
- 2,998,500. **REQUIEM OF HELL (STYLIZED)**. NOKIA CORPORATION, MULTIPLE CLASS, (INT. CLS. 9, 28 AND 41), (U.S. CLS. 21, 22, 23, 26, 36, 38, 50, 100, 101 AND 107). SN 79-007,689. PUB. 6-28-2005. FILED 7-23-2004.

CLASS 10—MEDICAL APPARATUS

- 2,996,237 (*See Class 9 for this trademark*).
- 2,996,338. **PLASMACUTE**. PLASMACUTE AS, MULTIPLE CLASS, (INT. CLS. 10, 42 AND 44), (U.S. CLS. 26, 39, 44, 100 AND 101). SN 76-490,129. PUB. 6-28-2005. FILED 2-13-2003.
- 2,996,519 (*See Class 1 for this trademark*).
- 2,996,572. **OCEAN PADDLE (BLOCK FORM)**. REIZ, IRA, (U.S. CLS. 26, 39 AND 44). SN 76-573,167. PUB. 6-28-2005. FILED 1-26-2004.
- 2,996,852. **ANS (BLOCK FORM)**. ADVANCED NEUROMODULATION SYSTEMS, INC., (U.S. CLS. 26, 39 AND 44). SN 76-605,708. PUB. 6-28-2005. FILED 8-5-2004.
- 2,996,887 (*See Class 5 for this trademark*).
- 2,996,889 (*See Class 9 for this trademark*).
- 2,996,898 (*See Class 9 for this trademark*).
- 2,996,913. **BD AND DESIGN**. BECTON, DICKINSON AND COMPANY, (U.S. CLS. 26, 39 AND 44). SN 78-195,276. PUB. 6-28-2005. FILED 12-17-2002.
- 2,996,979. **STREETS AHEAD**. DAYS MEDICAL AIDS LIMITED, MULTIPLE CLASS, (INT. CLS. 10 AND 12), (U.S. CLS. 19, 21, 23, 26, 31, 35, 39 AND 44). SN 78-278,109. PUB. 6-28-2005. FILED 7-24-2003.
- 2,996,992. **ISOSLEEVE**. C. R. BARD, INC., (U.S. CLS. 26, 39 AND 44). SN 78-291,273. PUB. 6-28-2005. FILED 8-22-2003.
- 2,997,000 (*See Class 9 for this trademark*).
- 2,997,192. **SPECIAL TOMATO AND DESIGN**. FLOCAST, LLC, DBA BERGERON HEALTH CARE, (U.S. CLS. 26, 39 AND 44). SN 78-360,826. PUB. 6-28-2005. FILED 2-2-2004.
- 2,997,240. **ACE ALIGN (BLOCK FORM)**. DEPUY, INC., (U.S. CLS. 26, 39 AND 44). SN 78-366,590. PUB. 6-28-2005. FILED 2-11-2004.
- 2,997,327. **BONK'ER (BLOCK FORM)**. BONK DESIGNS, INC., (U.S. CLS. 26, 39 AND 44). SN 78-379,742. PUB. 6-28-2005. FILED 3-5-2004.
- 2,997,373. **TRIBASIC (BLOCK FORM)**. ANITA DR. HELBIG GMBH, MULTIPLE CLASS, (INT. CLS. 10 AND 25), (U.S. CLS. 22, 26, 39 AND 44). SN 78-389,424. PUB. 6-28-2005. FILED 3-23-2004.
- 2,997,392 (*See Class 5 for this trademark*).
- 2,997,417. **ACCU-SPINA (BLOCK FORM)**. NORTH AMERICAN MEDICAL CORPORATION, (U.S. CLS. 26, 39 AND 44). SN 78-398,657. PUB. 6-28-2005. FILED 4-8-2004.
- 2,997,454. **DRI-LOK (BLOCK FORM)**. STRYKER CORPORATION, (U.S. CLS. 26, 39 AND 44). SN 78-405,293. PUB. 6-28-2005. FILED 4-20-2004.
- 2,997,545. **VISIONART'S AND DESIGN**. VISIONART'S, S.L., (U.S. CLS. 26, 39 AND 44). SN 78-425,296. PUB. 6-28-2005. FILED 5-26-2004.
- 2,997,549. **SONGER (BLOCK FORM)**. PIONEER LABORATORIES, INC., (U.S. CLS. 26, 39 AND 44). SN 78-426,348. PUB. 6-28-2005. FILED 5-27-2004.
- 2,997,594. **SONGER SPINAL CABLE SYSTEM (BLOCK FORM)**. PIONEER LABORATORIES, INC., (U.S. CLS. 26, 39 AND 44). SN 78-434,766. PUB. 6-28-2005. FILED 6-14-2004.
- 2,997,615. **ENCAPSULE XTRA (BLOCK FORM)**. RUBICOR MEDICAL, INC., (U.S. CLS. 26, 39 AND 44). SN 78-436,998. PUB. 6-28-2005. FILED 6-17-2004.
- 2,998,060. **THE MAGIC OF LIGHT (BLOCK FORM)**. ORION LASERS, INC., (U.S. CLS. 26, 39 AND 44). SN 78-460,400. PUB. 6-28-2005. FILED 8-2-2004.
- 2,998,083. **BIO-CORKSCREW (BLOCK FORM)**. ARTHREX, INC., (U.S. CLS. 26, 39 AND 44). SN 78-460,922. PUB. 6-28-2005. FILED 8-3-2004.
- 2,998,084. **CORKSCREW (BLOCK FORM)**. ARTHREX, INC., (U.S. CLS. 26, 39 AND 44). SN 78-460,925. PUB. 6-28-2005. FILED 8-3-2004.
- 2,998,104. **NEOLEAD (BLOCK FORM)**. NEOTECH PRODUCTS, INC., (U.S. CLS. 26, 39 AND 44). SN 78-461,237. PUB. 6-28-2005. FILED 8-3-2004.
- 2,998,125. **FASTSIZE (BLOCK FORM)**. AEA NETWORK, INC., (U.S. CLS. 26, 39 AND 44). SN 78-461,470. PUB. 6-28-2005. FILED 8-3-2004.
- 2,998,170. **BIO-LUCENT (BLOCK FORM)**. THAYER DENTAL LABORATORY, INC., (U.S. CLS. 26, 39 AND 44). SN 78-462,417. PUB. 6-28-2005. FILED 8-5-2004.
- 2,998,197. **CEMENTRALIZER (BLOCK FORM)**. DEPUY, INC., (U.S. CLS. 26, 39 AND 44). SN 78-463,536. PUB. 6-28-2005. FILED 8-6-2004.
- 2,998,296. **PEDISTAL (BLOCK FORM)**. POBRAN, DAVID H., MULTIPLE CLASS, (INT. CLS. 10 AND 28), (U.S. CLS. 22, 23, 26, 38, 39, 44 AND 50). SN 78-470,580. PUB. 6-28-2005. FILED 8-19-2004.
- 2,998,371. **HYPERBLADE (BLOCK FORM)**. AESCULAP AG & CO. KG, (U.S. CLS. 26, 39 AND 44). SN 79-000,703. PUB. 6-28-2005. FILED 11-26-2003.
- 2,998,398. **STAY SAFE AND DESIGN**. FRESENIUS MEDICAL CARE DEUTSCHLAND GMBH, (U.S. CLS. 26, 39 AND 44). SN 79-001,496. PUB. 6-28-2005. FILED 1-20-2004.
- 2,998,410. **MANATEE (BLOCK FORM)**. R82 A/S, MULTIPLE CLASS, (INT. CLS. 10 AND 12), (U.S. CLS. 19, 21, 23, 26, 31, 35, 39 AND 44). SN 79-001,818. PUB. 6-28-2005. FILED 2-6-2004.
- 2,998,417 (*See Class 6 for this trademark*).
- 2,998,420. **SPIRIVA (BLOCK FORM)**. BOEHRINGER INGELHEIM PHARMA GMBH & CO. KG, (U.S. CLS. 26, 39 AND 44). SN 79-002,090. PUB. 6-28-2005. FILED 3-18-2004.
- 2,998,430. **CORSINEL (BLOCK FORM)**. COLOPLAST A/S, (U.S. CLS. 26, 39 AND 44). SN 79-002,448. PUB. 6-28-2005. FILED 2-6-2004.
- 2,998,434. **MIRA (BLOCK FORM)**. GN RESOUND A/S, (U.S. CLS. 26, 39 AND 44). SN 79-002,516. PUB. 6-28-2005. FILED 12-11-2003.
- 2,998,438 (*See Class 5 for this trademark*).
- 2,998,454. **PVIBE.COM AND DESIGN**. ALEXANDER DORN, MULTIPLE CLASS, (INT. CLS. 10 AND 16), (U.S. CLS. 2, 5, 22, 23, 26, 29, 37, 38, 39, 44 AND 50). SN 79-003,239. PUB. 6-28-2005. FILED 4-5-2004.
- 2,998,483. **STAR EVOLUTION AND DESIGN**. SOCIETE DIAGNOSTICA-STAGO, (U.S. CLS. 26, 39 AND 44). SN 79-004,973. PUB. 6-28-2005. FILED 4-20-2004.
- 2,998,486. **NEURO SWING FUNCTIONAL SYSTEMS AND DESIGN**. FRESENIUS MEDICAL CARE; DEUTSCHLAND GMBH, (U.S. CLS. 26, 39 AND 44). SN 79-005,079. PUB. 6-28-2005. FILED 5-14-2004.

CLASS 11—ENVIRONMENTAL CONTROL APPARATUS

- 2,996,354. **ELETTO**. NITTO ELECTRIC WORKS, LTD., (U.S.

- CLS. 13, 21, 23, 31 AND 34). SN 76-509,813. PUB. 6-28-2005. FILED 4-28-2003.
- 2,996,376. **CENTURY AND DESIGN**. CENTURY BATHWORKS, INC. (U.S. CLS. 13, 21, 23, 31 AND 34). SN 76-524,040. PUB. 6-28-2005. FILED 6-20-2003.
- 2,996,384. **STORMDRAIN SOLUTIONS**. SHARPLESS, S. ROBERT, (U.S. CLS. 13, 21, 23, 31 AND 34). SN 76-527,039. PUB. 6-28-2005. FILED 6-30-2003.
- 2,996,387. **LEVA QUELL**. LEVA QUELL LEVITATIONS-UND KOLLOIDALTECHNOLOGIE AG, MULTIPLE CLASS, (INT. CLS. 11, 32 AND 44), (U.S. CLS. 13, 21, 23, 31, 34, 45, 46, 48, 100 AND 101). SN 76-529,864. PUB. 6-28-2005. FILED 7-16-2003.
- 2,996,394. **DROLET AND DESIGN**. FABRICANT DE POELES INTERNATIONAL INC., (U.S. CLS. 13, 21, 23, 31 AND 34). SN 76-532,289. PUB. 6-28-2005. FILED 7-24-2003.
- 2,996,396 (*See Class 8 for this trademark*).
- 2,996,402. **AMES FIRE & WATERWORKS**. WATTS REGULATOR CO., (U.S. CLS. 13, 21, 23, 31 AND 34). SN 76-536,095. PUB. 6-28-2005. FILED 7-22-2003.
- 2,996,403. **A AND DESIGN**. WATTS REGULATOR CO., (U.S. CLS. 13, 21, 23, 31 AND 34). SN 76-536,096. PUB. 6-28-2005. FILED 7-22-2003.
- 2,996,431. **JURA (STYLIZED)**. JURA ELEKTROAPPARATE AG, (U.S. CLS. 13, 21, 23, 31 AND 34). SN 76-544,515. PUB. 6-28-2005. FILED 9-12-2003.
- 2,996,438. **URBAN CAFÉ AND DESIGN**. GRAND HALL ENTERPRISE CO., LTD., (U.S. CLS. 13, 21, 23, 31 AND 34). SN 76-545,563. PUB. 6-28-2005. FILED 9-17-2003.
- 2,996,460. **WINJET AND DESIGN**. NEON G.D. INC., MULTIPLE CLASS, (INT. CLS. 11, 12, 27 AND 35), (U.S. CLS. 13, 19, 20, 21, 23, 31, 34, 35, 37, 42, 44, 50, 100, 101 AND 102). SN 76-560,532. PUB. 6-28-2005. FILED 11-3-2003.
- 2,996,525. **STATIM (BLOCK FORM)**. SCICAN, DIVISION OF LUX & ZWINGENBERGER LTD., (U.S. CLS. 13, 21, 23, 31 AND 34). SN 76-570,367. PUB. 6-28-2005. FILED 1-15-2004.
- 2,996,536. **FIRES OF TRADITION AND DESIGN**. FIRES OF TRADITION INC., MULTIPLE CLASS, (INT. CLS. 11 AND 19), (U.S. CLS. 1, 12, 13, 21, 23, 31, 33, 34 AND 50). SN 76-571,124. PUB. 6-28-2005. FILED 1-21-2004.
- 2,996,725. **NI INDUSTRIES (BLOCK FORM)**. NEBRASKA IRRIGATION INC., (U.S. CLS. 13, 21, 23, 31 AND 34). SN 76-597,916. PUB. 6-28-2005. FILED 6-17-2004.
- 2,996,730. **RUPP AIR MANAGEMENT SYSTEMS (BLOCK FORM)**. CAPTIVE-AIRE SYSTEMS, INC., (U.S. CLS. 13, 21, 23, 31 AND 34). SN 76-598,200. PUB. 6-28-2005. FILED 6-21-2004.
- 2,996,732. **BOSTON HARBOR (BLOCK FORM)**. SOUND INTERNATIONAL, INCORPORATED, (U.S. CLS. 13, 21, 23, 31 AND 34). SN 76-598,397. PUB. 6-28-2005. FILED 6-21-2004.
- 2,996,828. **H2 (BLOCK FORM)**. HAEGER INDUSTRIES, INC., (U.S. CLS. 13, 21, 23, 31 AND 34). SN 76-605,133. PUB. 6-28-2005. FILED 8-2-2004.
- 2,996,831. **CESSNA (STYLIZED)**. MINKA LIGHTING, INC., (U.S. CLS. 13, 21, 23, 31 AND 34). SN 76-605,245. PUB. 6-28-2005. FILED 8-2-2004.
- 2,996,942. **C ING. CASTALDI ILLUMINAZIONE AND DESIGN**. ING. CASTALDI ILLUMINAZIONE S.R.L., (U.S. CLS. 13, 21, 23, 31 AND 34). SN 78-243,366. PUB. 6-28-2005. FILED 4-29-2003.
- 2,996,943. **MISCELLANEOUS DESIGN**. SUNPENTOWN INTERNATIONAL INC., MULTIPLE CLASS, (INT. CLS. 11, 20 AND 21), (U.S. CLS. 2, 13, 21, 22, 23, 25, 29, 30, 31, 32, 33, 34, 40 AND 50). SN 78-243,560. PUB. 6-28-2005. FILED 4-29-2003.
- 2,996,969 (*See Class 9 for this trademark*).
- 2,996,993 (*See Class 6 for this trademark*).
- 2,997,004 (*See Class 6 for this trademark*).
- 2,997,005 (*See Class 6 for this trademark*).
- 2,997,006 (*See Class 6 for this trademark*).
- 2,997,007. **PANORAMA**. FPI FIREPLACE PRODUCTS INTERNATIONAL, LTD., (U.S. CLS. 13, 21, 23, 31 AND 34). SN 78-298,765. PUB. 6-28-2005. FILED 9-10-2003.
- 2,997,069. **RED TOBOGGAN (BLOCK FORM)**. WILLIS ELECTRIC CO., LTD., (U.S. CLS. 13, 21, 23, 31 AND 34). SN 78-334,381. PUB. 6-28-2005. FILED 12-1-2003.
- 2,997,131. **LOVEJET (BLOCK FORM)**. LUBECKI TECHNICAL HOLDINGS INC., (U.S. CLS. 13, 21, 23, 31 AND 34). SN 78-350,150. PUB. 6-28-2005. FILED 1-9-2004.
- 2,997,195 (*See Class 6 for this trademark*).
- 2,997,218 (*See Class 7 for this trademark*).
- 2,997,241. **MPL MODULAR PRISMATIC LITE (BLOCK FORM)**. FER FAHRZEUGELEKTRIK GMBH, (U.S. CLS. 13, 21, 23, 31 AND 34). SN 78-366,704. PUB. 6-28-2005. FILED 2-12-2004.
- 2,997,394. **ALLEVIATOR (BLOCK FORM)**. PAPPAS, PETER, (U.S. CLS. 13, 21, 23, 31 AND 34). SN 78-393,298. PUB. 6-28-2005. FILED 3-30-2004.
- 2,997,420. **LITTLE HOTTIES (BLOCK FORM)**. WOOD SALES, INC., (U.S. CLS. 13, 21, 23, 31 AND 34). SN 78-399,093. PUB. 6-28-2005. FILED 4-8-2004.
- 2,997,472 (*See Class 7 for this trademark*).
- 2,997,489. **NATUREBRIGHT (STYLIZED)**. NATURE BRIGHT COMPANY, (U.S. CLS. 13, 21, 23, 31 AND 34). SN 78-412,233. PUB. 6-28-2005. FILED 5-3-2004.
- 2,997,504 (*See Class 7 for this trademark*).
- 2,997,505 (*See Class 7 for this trademark*).
- 2,997,716. **MISCELLANEOUS DESIGN**. HUBBARDTON FORGE CORPORATION, MULTIPLE CLASS, (INT. CLS. 11 AND 21), (U.S. CLS. 2, 13, 21, 23, 29, 30, 31, 33, 34, 40 AND 50). SN 78-448,246. PUB. 6-28-2005. FILED 7-9-2004.
- 2,997,749. **JEWELS OF LIGHT (BLOCK FORM)**. J. KINDERMAN & SONS, INC., (U.S. CLS. 13, 21, 23, 31 AND 34). SN 78-451,054. PUB. 6-28-2005. FILED 7-15-2004.
- 2,997,763. **VALU CHOICE AND DESIGN**. OSRAM SYLVANIA INC., (U.S. CLS. 13, 21, 23, 31 AND 34). SN 78-452,327. PUB. 6-28-2005. FILED 7-17-2004.
- 2,997,806. **VORTFILTER (BLOCK FORM)**. VORTECHNICS, INC., (U.S. CLS. 13, 21, 23, 31 AND 34). SN 78-454,968. PUB. 6-28-2005. FILED 7-22-2004.
- 2,997,897. **IT'S NOT THE HEAT...IT'S THE HUMIDITY! (BLOCK FORM)**. AIR & ENERGY PRODUCTS, LLC, (U.S. CLS. 13, 21, 23, 31 AND 34). SN 78-457,367. PUB. 6-28-2005. FILED 7-27-2004.
- 2,997,984. **ULTRAGARD (BLOCK FORM)**. DREISON INTERNATIONAL, INC., (U.S. CLS. 13, 21, 23, 31 AND 34). SN 78-459,313. PUB. 6-28-2005. FILED 7-30-2004.
- 2,998,117. **LUCAS (BLOCK FORM)**. LUCAS INNOVATION, INC., (U.S. CLS. 13, 21, 23, 31 AND 34). SN 78-461,399. PUB. 6-28-2005. FILED 8-3-2004.
- 2,998,343. **SPLASH OF RAIN (BLOCK FORM)**. THE YANKEE CANDLE COMPANY, INC., (U.S. CLS. 13, 21, 23, 31 AND 34). SN 78-551,683. PUB. 6-28-2005. FILED 1-21-2005.
- 2,998,380. **SHARXS SHORT ARC EXTREME SEAL AND DESIGN**. OSRAM GESELLSCHAFT MIT BESCHRÄNKTER HAFTUNG, (U.S. CLS. 13, 21, 23, 31 AND 34). SN 79-001,089. PUB. 6-28-2005. FILED 1-28-2004.
- 2,998,402 (*See Class 6 for this trademark*).
- 2,998,482 (*See Class 7 for this trademark*).

CLASS 12—VEHICLES

- 2,996,240. **OUTFITTER**. CEQUENT TOWING PRODUCTS, INC., (U.S. CLS. 19, 21, 23, 31, 35 AND 44). SN 75-796,850. PUB. 6-28-2005. FILED 9-10-1999.
- 2,996,460 (*See Class 11 for this trademark*).
- 2,996,499. **SELECT-A-BALL (BLOCK FORM)**. U-HAUL INTERNATIONAL, INC., (U.S. CLS. 19, 21, 23, 31, 35 AND 44). SN 76-568,854. PUB. 6-28-2005. FILED 1-8-2004.
- 2,996,514. **HOLESLOT (STYLIZED)**. CARLISLE INTANGIBLE COMPANY, (U.S. CLS. 19, 21, 23, 31, 35 AND 44). SN 76-569,827. PUB. 6-28-2005. FILED 1-13-2004.
- 2,996,581. **AVOCET AND DESIGN**. AVOCET SPORTS TECHNOLOGY, INC., (U.S. CLS. 19, 21, 23, 31, 35 AND 44). SN 76-574,728. PUB. 6-28-2005. FILED 2-2-2004.
- 2,996,615 (*See Class 7 for this trademark*).
- 2,996,633. **GUIZZO (BLOCK FORM)**. KALLOY INDUSTRIAL CO., LTD., (U.S. CLS. 19, 21, 23, 31, 35 AND 44). SN 76-581,641. PUB. 6-28-2005. FILED 3-17-2004.
- 2,996,646. **EDGE FX (BLOCK FORM)**. PERRIN MANUFACTURING COMPANY, (U.S. CLS. 19, 21, 23, 31, 35 AND 44). SN 76-584,847. PUB. 6-28-2005. FILED 4-2-2004.
- 2,996,746. **STUTERTONE (BLOCK FORM)**. GROVER PRO-

- DUCTS COMPANY, (U.S. CLS. 19, 21, 23, 31, 35 AND 44). SN 76-600,026. PUB. 6-28-2005. FILED 6-28-2004.
- 2,996,791. **NO SPILL (BLOCK FORM)**. T.G. MANUFACTURING, INC., (U.S. CLS. 19, 21, 23, 31, 35 AND 44). SN 76-604,487. PUB. 6-28-2005. FILED 7-28-2004.
- 2,996,796. **TRIGON EXOTIC MATERIAL TECHNOLOGY AND DESIGN**. GREAT GO CYCLES INC., (U.S. CLS. 19, 21, 23, 31, 35 AND 44). SN 76-604,609. PUB. 6-28-2005. FILED 7-29-2004.
- 2,996,822. **VMAX (BLOCK FORM)**. CONTINENTAL AKTIENGESELLSCHAFT, (U.S. CLS. 19, 21, 23, 31, 35 AND 44). SN 76-605,088. PUB. 6-28-2005. FILED 7-30-2004.
- 2,996,907 (*See Class 7 for this trademark*).
- 2,996,926. **XBRAKE**. KARPOWICH, JOHN W., (U.S. CLS. 19, 21, 23, 31, 35 AND 44). SN 78-222,551. PUB. 6-28-2005. FILED 3-6-2003.
- 2,996,937. **SCOOTALONGS AND DESIGN**. SCOOTALONGS, INC., (U.S. CLS. 19, 21, 23, 31, 35 AND 44). SN 78-239,267. PUB. 6-28-2005. FILED 4-17-2003.
- 2,996,979 (*See Class 10 for this trademark*).
- 2,997,153. **OPTIMA (BLOCK FORM)**. OPTIMA BUS CORPORATION, (U.S. CLS. 19, 21, 23, 31, 35 AND 44). SN 78-355,949. PUB. 6-28-2005. FILED 1-22-2004.
- 2,997,159. **VICTOIRE (BLOCK FORM)**. TREK BICYCLE CORPORATION, (U.S. CLS. 19, 21, 23, 31, 35 AND 44). SN 78-357,581. PUB. 6-28-2005. FILED 1-26-2004.
- 2,997,193. **UNI-CAM (STYLIZED)**. UNICAM INCORPORATED, (U.S. CLS. 19, 21, 23, 31, 35 AND 44). SN 78-361,005. PUB. 3-1-2005. FILED 2-2-2004.
- 2,997,214. **AIRLESS AND DESIGN**. A.M.C.C. INTERNATIONAL, INC., (U.S. CLS. 19, 21, 23, 31, 35 AND 44). SN 78-363,070. PUB. 6-28-2005. FILED 2-5-2004.
- 2,997,306. **MK V (BLOCK FORM)**. VT HALTER MARINE, INC., (U.S. CLS. 19, 21, 23, 31, 35 AND 44). SN 78-376,541. PUB. 6-28-2005. FILED 3-1-2004.
- 2,997,316. **ALPHA Q AND DESIGN**. TRUE TEMPER SPORTS, INC., (U.S. CLS. 19, 21, 23, 31, 35 AND 44). SN 78-377,524. PUB. 6-28-2005. FILED 3-3-2004.
- 2,997,334 (*See Class 4 for this trademark*).
- 2,997,405. **TRAVELAIRE (BLOCK FORM)**. GLENDALE INTERNATIONAL CORP., (U.S. CLS. 19, 21, 23, 31, 35 AND 44). SN 78-395,012. PUB. 6-28-2005. FILED 4-1-2004.
- 2,997,428. **TREADGUARD (BLOCK FORM)**. WABTEC HOLDING CORPORATION, (U.S. CLS. 19, 21, 23, 31, 35 AND 44). SN 78-401,481. PUB. 6-28-2005. FILED 4-14-2004.
- 2,997,476. **TRACKER AMERICA'S FAVORITE BOATS (BLOCK FORM)**. TRACKER MARINE, L.L.C., (U.S. CLS. 19, 21, 23, 31, 35 AND 44). SN 78-410,564. PUB. 6-28-2005. FILED 4-29-2004.
- 2,997,515. **LENAR AND DESIGN**. HHU, INC., (U.S. CLS. 19, 21, 23, 31, 35 AND 44). SN 78-418,485. PUB. 6-28-2005. FILED 5-13-2004.
- 2,997,529. **RV SURESTEP (BLOCK FORM)**. B & D MANUFACTURING, INC., (U.S. CLS. 19, 21, 23, 31, 35 AND 44). SN 78-421,410. PUB. 6-28-2005. FILED 5-19-2004.
- 2,997,544. **POWER HOUSE (BLOCK FORM)**. MID-USA CYCLE PARTS, INC., (U.S. CLS. 19, 21, 23, 31, 35 AND 44). SN 78-424,923. PUB. 6-28-2005. FILED 5-25-2004.
- 2,997,590. **TEKTRO AQUILA AND DESIGN**. TEKTRO TECHNOLOGY CORPORATION, (U.S. CLS. 19, 21, 23, 31, 35 AND 44). SN 78-434,439. PUB. 6-28-2005. FILED 6-14-2004.
- 2,997,591. **TEKTRO AURIGA AND DESIGN**. TEKTRO TECHNOLOGY CORPORATION, (U.S. CLS. 19, 21, 23, 31, 35 AND 44). SN 78-434,442. PUB. 6-28-2005. FILED 6-14-2004.
- 2,997,710. **FORGE-TEK (STYLIZED)**. ADVANCED METAL-FORMING TECHNOLOGIES, INC., (U.S. CLS. 19, 21, 23, 31, 35 AND 44). SN 78-447,113. PUB. 6-28-2005. FILED 7-7-2004.
- 2,997,815. **TOURO (BLOCK FORM)**. TRUVATIV INTERNATIONAL CO., LTD., (U.S. CLS. 19, 21, 23, 31, 35 AND 44). SN 78-455,215. PUB. 6-28-2005. FILED 7-22-2004.
- 2,997,830. **RESOLUTE (BLOCK FORM)**. FLEETWOOD ENTERPRISES, INC., (U.S. CLS. 19, 21, 23, 31, 35 AND 44). SN 78-455,654. PUB. 6-28-2005. FILED 7-23-2004.
- 2,997,831. **VALOR (BLOCK FORM)**. FLEETWOOD ENTERPRISES, INC., (U.S. CLS. 19, 21, 23, 31, 35 AND 44). SN 78-455,671. PUB. 6-28-2005. FILED 7-23-2004.
- 2,997,832. **COLONIAL (BLOCK FORM)**. FLEETWOOD ENTERPRISES, INC., (U.S. CLS. 19, 21, 23, 31, 35 AND 44). SN 78-455,679. PUB. 6-28-2005. FILED 7-23-2004.
- 2,997,918. **ERADISPEED (BLOCK FORM)**. BAER, INC., (U.S. CLS. 19, 21, 23, 31, 35 AND 44). SN 78-457,995. PUB. 6-28-2005. FILED 7-28-2004.
- 2,997,946 (*See Class 7 for this trademark*).
- 2,997,997. **STYLO (BLOCK FORM)**. TRUVATIV INTERNATIONAL CO. LTD., (U.S. CLS. 19, 21, 23, 31, 35 AND 44). SN 78-459,498. PUB. 6-28-2005. FILED 7-30-2004.
- 2,997,999. **HUSSEFELT (BLOCK FORM)**. TRUVATIV INTERNATIONAL CO. LTD., (U.S. CLS. 19, 21, 23, 31, 35 AND 44). SN 78-459,514. PUB. 6-28-2005. FILED 7-30-2004.
- 2,998,000. **NUBARRO (BLOCK FORM)**. KEILHACK, HANS KRISTOPHER, (U.S. CLS. 19, 21, 23, 31, 35 AND 44). SN 78-459,521. PUB. 6-28-2005. FILED 7-30-2004.
- 2,998,033. **PERMA BRAKE (BLOCK FORM)**. HARTWELL, JOHN E., (U.S. CLS. 19, 21, 23, 31, 35 AND 44). SN 78-460,141. PUB. 6-28-2005. FILED 8-1-2004.
- 2,998,071. **ULTIMA (BLOCK FORM)**. MIDWEST MOTORCYCLE SUPPLY DISTRIBUTORS CORP., (U.S. CLS. 19, 21, 23, 31, 35 AND 44). SN 78-460,571. PUB. 6-28-2005. FILED 8-2-2004.
- 2,998,192. **ULTRA TOUR (BLOCK FORM)**. THE GOODYEAR TIRE & RUBBER COMPANY, (U.S. CLS. 19, 21, 23, 31, 35 AND 44). SN 78-463,355. PUB. 6-28-2005. FILED 8-6-2004.
- 2,998,232. **LUFTALARM (BLOCK FORM)**. TRUVATIV INTERNATIONAL CO. LTD., (U.S. CLS. 19, 21, 23, 31, 35 AND 44). SN 78-464,950. PUB. 6-28-2005. FILED 8-10-2004.
- 2,998,238. **REGATTA (BLOCK FORM)**. THE GOODYEAR TIRE & RUBBER COMPANY, (U.S. CLS. 19, 21, 23, 31, 35 AND 44). SN 78-465,187. PUB. 6-28-2005. FILED 8-10-2004.
- 2,998,278. **TRIAD (BLOCK FORM)**. TRIAD TRAILERS, INC., (U.S. CLS. 19, 21, 23, 31, 35 AND 44). SN 78-467,440. PUB. 6-28-2005. FILED 8-13-2004.
- 2,998,279. **TRIAD AND DESIGN**. TRIAD TRAILERS, INC., (U.S. CLS. 19, 21, 23, 31, 35 AND 44). SN 78-467,471. PUB. 6-28-2005. FILED 8-13-2004.
- 2,998,337. **ALL AMERICAN HOT DOG CARTS (BLOCK FORM)**. DIRAIMONDO, LOUIS, (U.S. CLS. 19, 21, 23, 31, 35 AND 44). SN 78-543,930. PUB. 6-28-2005. FILED 1-7-2005.
- 2,998,391. **LASERTEC (BLOCK FORM)**. PIRELLI DEUTSCHLAND AG, (U.S. CLS. 19, 21, 23, 31, 35 AND 44). SN 79-001,324. PUB. 6-28-2005. FILED 12-10-2003.
- 2,998,404. **COMFORT-LIFE (BLOCK FORM)**. CONTINENTAL AKTIENGESELLSCHAFT, (U.S. CLS. 19, 21, 23, 31, 35 AND 44). SN 79-001,623. PUB. 6-28-2005. FILED 2-23-2004.
- 2,998,409. **GOLF PLUS (BLOCK FORM)**. VOLKSWAGEN AG, MULTIPLE CLASS, (INT. CLS. 12, 35 AND 37), (U.S. CLS. 19, 21, 23, 31, 35, 44, 100, 101, 102, 103 AND 106). SN 79-001,807. PUB. 6-28-2005. FILED 3-10-2004.
- 2,998,410 (*See Class 10 for this trademark*).
- 2,998,423 (*See Class 6 for this trademark*).
- 2,998,461. **ESCADA (BLOCK FORM)**. ESCADA AG, (U.S. CLS. 19, 21, 23, 31, 35 AND 44). SN 79-003,520. PUB. 6-28-2005. FILED 5-4-2004.
- 2,998,482 (*See Class 7 for this trademark*).
- 2,998,494. **MISCELLANEOUS DESIGN**. JINBEI AUTOMOTIVE COMPANY LIMITED, (U.S. CLS. 19, 21, 23, 31, 35 AND 44). SN 79-005,764. PUB. 6-28-2005. FILED 8-5-2004.

CLASS 13—FIREARMS

- 2,996,637. **B AND DESIGN**. BRILEY MANUFACTURING CO, MULTIPLE CLASS, (INT. CLS. 13, 37 AND 40), (U.S. CLS. 2, 9, 100, 103 AND 106). SN 76-582,187. PUB. 6-28-2005. FILED 3-22-2004.
- 2,997,178. **BLUEGUNS (BLOCK FORM)**. RING'S STUDIO GUN RENTAL, INC., DBA RING'S MANUFACTURING, (U.S. CLS. 2 AND 9). SN 78-359,688. PUB. 6-28-2005. FILED 1-29-2004.
- 2,997,800. **TACTICAL LINK (BLOCK FORM)**. TACTICAL LINK, LLC, (U.S. CLS. 2 AND 9). SN 78-454,422. PUB. 6-28-2005. FILED 7-21-2004.
- 2,997,904. **UNCLE MIKE'S (BLOCK FORM)**. MICHAELS OF OREGON CO., (U.S. CLS. 2 AND 9). SN 78-457,679. PUB. 6-28-2005. FILED 7-27-2004.

- 2,998,067. **STEEL LIPS (BLOCK FORM)**. MICHAELS OF OREGON CO., (U.S. CLS. 2 AND 9). SN 78-460,460. PUB. 6-28-2005. FILED 8-2-2004.
- 2,998,101. **ENERGY (BLOCK FORM)**. U. S. REPEATING ARMS COMPANY, (U.S. CLS. 2 AND 9). SN 78-461,213. PUB. 6-28-2005. FILED 8-3-2004.
- 2,998,113. **SPEED PUMP (BLOCK FORM)**. U. S. REPEATING ARMS COMPANY, (U.S. CLS. 2 AND 9). SN 78-461,295. PUB. 6-28-2005. FILED 8-3-2004.

CLASS 14—JEWELRY

- 2,996,243 (*See Class 3 for this trademark*).
- 2,996,277 (*See Class 1 for this trademark*).
- 2,996,393. **DODO PARLA CON DODO. AND DESIGN**. LA ROGGIA S.R.L., (U.S. CLS. 2, 27, 28 AND 50). SN 76-532,244. PUB. 6-28-2005. FILED 7-25-2003.
- 2,996,413. **YEHUDA CLARITY ENHANCED DIAMOND (BLOCK FORM)**. DIASCIENCE CORP., (U.S. CLS. 2, 27, 28 AND 50). SN 76-537,939. PUB. 6-28-2005. FILED 8-4-2003.
- 2,996,414. **YEHUDA DIAMONDS (BLOCK FORM)**. DIASCIENCE CORP., DBA YEHUDA DIAMOND CO., (U.S. CLS. 2, 27, 28 AND 50). SN 76-537,940. PUB. 6-28-2005. FILED 8-4-2003.
- 2,996,415. **YEHUDA (BLOCK FORM)**. DIASCIENCE CORP., (U.S. CLS. 2, 27, 28 AND 50). SN 76-537,942. PUB. 6-28-2005. FILED 8-4-2003.
- 2,996,425 (*See Class 6 for this trademark*).
- 2,996,467. **MATTINA (BLOCK FORM)**. GRUPPO II GIOIELLO LIMITED, (U.S. CLS. 2, 27, 28 AND 50). SN 76-563,204. PUB. 6-28-2005. FILED 11-17-2003.
- 2,996,476 (*See Class 8 for this trademark*).
- 2,996,544. **AMBASSADOR LAPEL FLAGS (BLOCK FORM)**. TME CO., INC., (U.S. CLS. 2, 27, 28 AND 50). SN 76-571,571. PUB. 6-28-2005. FILED 1-15-2004.
- 2,996,688. **LE' CONTUR (BLOCK FORM)**. I.V. CORP., DBA I.V. DESIGNS, (U.S. CLS. 2, 27, 28 AND 50). SN 76-591,999. PUB. 6-28-2005. FILED 5-13-2004.
- 2,996,736. **EEBEADS.COM (STYLIZED)**. ECLECTIC ETC., INC., (U.S. CLS. 2, 27, 28 AND 50). SN 76-598,814. PUB. 6-28-2005. FILED 6-23-2004.
- 2,996,804. **JRG (BLOCK FORM)**. JR GOLD DESIGN, INC., (U.S. CLS. 2, 27, 28 AND 50). SN 76-604,754. PUB. 6-28-2005. FILED 7-29-2004.
- 2,996,864. **TELLING MORE THAN TIME (BLOCK FORM)**. FOSSIL, INC., (U.S. CLS. 2, 27, 28 AND 50). SN 76-606,143. PUB. 6-28-2005. FILED 8-6-2004.
- 2,996,925. **MARK CULLINAN**. CULLINAN ANSTALT, (U.S. CLS. 2, 27, 28 AND 50). SN 78-222,490. PUB. 6-28-2005. FILED 3-6-2003.
- 2,996,991. **LUMINARI DIAMONDS**. LUCENT DIAMONDS, INC., (U.S. CLS. 2, 27, 28 AND 50). SN 78-291,192. PUB. 6-28-2005. FILED 8-22-2003.
- 2,997,013. **URBAN MAILLE**. KIMBERLI J. BRYAN, MULTIPLE CLASS, (INT. CLS. 14 AND 28), (U.S. CLS. 2, 22, 23, 27, 28, 38 AND 50). SN 78-301,846. PUB. 6-28-2005. FILED 9-17-2003.
- 2,997,310. **NICSTYLE.COM (STYLIZED)**. NIC INC, (U.S. CLS. 2, 27, 28 AND 50). SN 78-376,837. PUB. 6-28-2005. FILED 3-2-2004.
- 2,997,386. **CHOOSE THE LEFT (BLOCK FORM)**. TWEDE, EVAN, (U.S. CLS. 2, 27, 28 AND 50). SN 78-392,521. PUB. 6-28-2005. FILED 3-29-2004.
- 2,997,510 (*See Class 3 for this trademark*).
- 2,997,571. **IW (BLOCK FORM)**. TAJ GIFTS & JEWELRY, INC., DBA IMPORT WORLD, (U.S. CLS. 2, 27, 28 AND 50). SN 78-430,490. PUB. 6-28-2005. FILED 6-5-2004.
- 2,997,793. **NIXON (BLOCK FORM)**. NIXON, INC., MULTIPLE CLASS, (INT. CLS. 14 AND 25), (U.S. CLS. 2, 22, 27, 28, 39 AND 50). SN 78-454,113. PUB. 6-28-2005. FILED 7-21-2004.
- 2,997,813. **Y AND DESIGN**. YEIDID INTERNATIONAL INC., (U.S. CLS. 2, 27, 28 AND 50). SN 78-455,180. PUB. 6-28-2005. FILED 7-22-2004.
- 2,997,932. **HOB (BLOCK FORM)**. H.O.B. JEWELRY COMPANY, (U.S. CLS. 2, 27, 28 AND 50). SN 78-458,244. PUB. 6-28-2005. FILED 7-28-2004.

- 2,998,295. **CLASSIC 28 (BLOCK FORM)**. MEL BERNIE AND COMPANY, INC., (U.S. CLS. 2, 27, 28 AND 50). SN 78-470,273. PUB. 6-28-2005. FILED 8-19-2004.
- 2,998,339. **MISCELLANEOUS DESIGN**. GRATEFUL DEAD PRODUCTIONS, MULTIPLE CLASS, (INT. CLS. 14, 16, 21 AND 25), (U.S. CLS. 2, 5, 13, 22, 23, 27, 28, 29, 30, 33, 37, 38, 39, 40 AND 50). SN 78-547,380. PUB. 6-28-2005. FILED 1-13-2005.
- 2,998,355. **MISCELLANEOUS DESIGN**. INSTITUT CURIE, MULTIPLE CLASS, (INT. CLS. 14, 25 AND 36), (U.S. CLS. 2, 22, 27, 28, 39, 50, 100, 101 AND 102). SN 79-000,191. PUB. 6-28-2005. FILED 11-27-2003.
- 2,998,373. **RACINE (BLOCK FORM)**. GALLET GROUP AG (GALLET GROUP SA), (GALLET GROUP LTD) (GALLET GROUP INC), (U.S. CLS. 2, 27, 28 AND 50). SN 79-000,763. PUB. 6-28-2005. FILED 1-23-2004.
- 2,998,382. **JUSTEX (BLOCK FORM)**. CHRISTIAN-GOLD-SCHMIEDE AG, (U.S. CLS. 2, 27, 28 AND 50). SN 79-001,142. PUB. 6-28-2005. FILED 1-14-2004.
- 2,998,393. **DOUBLE EAGLE (BLOCK FORM)**. OMEGA SA (OMEGA AG) (OMEGA LTD.), (U.S. CLS. 2, 27, 28 AND 50). SN 79-001,381. PUB. 6-28-2005. FILED 2-10-2004.
- 2,998,403. **GAUTRAY D.L.T. (BLOCK FORM)**. TIME MAX S.A., (U.S. CLS. 2, 27, 28 AND 50). SN 79-001,602. PUB. 6-28-2005. FILED 1-26-2004.
- 2,998,439. **ROCHET (STYLIZED)**. ZUCCOLO ROCHET & CIE.; SOCIÉTÉ ANONYME, (U.S. CLS. 2, 27, 28 AND 50). SN 79-002,607. PUB. 6-28-2005. FILED 4-15-2004.
- 2,998,448. **AIR FLOW (BLOCK FORM)**. RICHEMONT INTERNATIONAL SA, (U.S. CLS. 2, 27, 28 AND 50). SN 79-002,939. PUB. 6-28-2005. FILED 5-13-2004.
- 2,998,464. **GF GREUBEL FORSEY AND DESIGN**. COMPLI-TIME SA, (U.S. CLS. 2, 27, 28 AND 50). SN 79-003,636. PUB. 6-28-2005. FILED 3-26-2004.
- 2,998,470. **1755 (BLOCK FORM)**. RICHEMONT INTERNATIONAL SA, (U.S. CLS. 2, 27, 28 AND 50). SN 79-003,936. PUB. 6-28-2005. FILED 2-23-2004.
- 2,998,471. **JOUX-PERRET (BLOCK FORM)**. JAQUET S.A.; MANUFACTURE D'HORLOGERIE COMPLIQUÉE, (U.S. CLS. 2, 27, 28 AND 50). SN 79-003,952. PUB. 6-28-2005. FILED 5-6-2004.

CLASS 15—MUSICAL INSTRUMENTS

- 2,996,283. **V AND DESIGN**. VELENO, JOHN M., (U.S. CLS. 2, 21 AND 36). SN 76-402,792. PUB. 6-28-2005. FILED 5-2-2002.
- 2,996,547. **W WILLIAMS AND DESIGN**. GUITAR CENTER, INC., MULTIPLE CLASS, (INT. CLS. 15, 16 AND 20), (U.S. CLS. 2, 5, 13, 21, 22, 23, 25, 29, 32, 36, 37, 38 AND 50). SN 76-571,773. PUB. 6-28-2005. FILED 1-26-2004.
- 2,996,643. **A SAHDUOO (STYLIZED)**. TSAI, SHU CHI, (U.S. CLS. 2, 21 AND 36). SN 76-584,396. PUB. 6-28-2005. FILED 4-1-2004.
- 2,997,155. **SHAR AND DESIGN**. SHAR PRODUCTS COMPANY, MULTIPLE CLASS, (INT. CLS. 15, 35 AND 37), (U.S. CLS. 2, 21, 36, 100, 101, 102, 103 AND 106). SN 78-356,828. PUB. 6-28-2005. FILED 1-23-2004.
- 2,997,172. **HOUSE OF BLUES (BLOCK FORM)**. HOUSE OF BLUES BRANDS CORP, (U.S. CLS. 2, 21 AND 36). SN 78-358,931. PUB. 6-28-2005. FILED 1-28-2004.
- 2,997,351. **ALVAREZ YAIRI (BLOCK FORM)**. ST. LOUIS MUSIC, INC., (U.S. CLS. 2, 21 AND 36). SN 78-386,213. PUB. 6-28-2005. FILED 3-17-2004.
- 2,997,365. **MISCELLANEOUS DESIGN**. SABIAN LTD., (U.S. CLS. 2, 21 AND 36). SN 78-388,407. PUB. 6-28-2005. FILED 3-22-2004.
- 2,997,473. **WOOD BRIDGE MUSIC SHOP AND DESIGN**. WOOD BRIDGE MUSIC SHOP, INC., (U.S. CLS. 2, 21 AND 36). SN 78-409,461. PUB. 6-28-2005. FILED 4-28-2004.
- 2,998,007. **B (STYLIZED)**. BURNS LONDON LTD., (U.S. CLS. 2, 21 AND 36). SN 78-459,613. PUB. 6-28-2005. FILED 7-30-2004.

CLASS 16—PAPER GOODS AND PRINTED MATTER

- 2,996,229. **GALERIA**. COLART FINE ART & GRAPHICS LIMITED, (U.S. CLS. 2, 5, 22, 23, 29, 37, 38 AND 50). SN 74-645,084. PUB. 6-28-2005. FILED 3-7-1995.
- 2,996,243 (*See Class 3 for this trademark*).
- 2,996,244 (*See Class 9 for this trademark*).
- 2,996,245. **ENAVANT**. BUSINESS TO BUSINESS SOLUTIONS, LLC, MULTIPLE CLASS, (INT. CLS. 16, 41 AND 42), (U.S. CLS. 2, 5, 22, 23, 29, 37, 38, 50, 100, 101 AND 107). SN 76-033,141. PUB. 6-28-2005. FILED 4-24-2000.
- 2,996,258 (*See Class 9 for this trademark*).
- 2,996,267. **MISCELLANEOUS DESIGN**. NINTENDO CO., LTD., (U.S. CLS. 2, 5, 22, 23, 29, 37, 38 AND 50). SN 76-348,740. PUB. 6-28-2005. FILED 12-13-2001.
- 2,996,274. **MEDUSA MOTION PICTURE MEDUSA EMOTION PICTURE AND DESIGN**. MEDUSA FILM S.P.A., MULTIPLE CLASS, (INT. CLS. 16, 35 AND 38), (U.S. CLS. 2, 5, 22, 23, 29, 37, 38, 50, 100, 101, 102 AND 104). SN 76-360,316. PUB. 6-28-2005. FILED 1-16-2002.
- 2,996,291. **GOODSPORTS**. GOODSPORTS FOR LIFE, INC., (U.S. CLS. 2, 5, 22, 23, 29, 37, 38 AND 50). SN 76-413,451. PUB. 6-28-2005. FILED 5-28-2002.
- 2,996,308. **DIGITAL FIRST**. KARL STORZ GMBH & CO. KG, (U.S. CLS. 2, 5, 22, 23, 29, 37, 38 AND 50). SN 76-459,267. PUB. 6-28-2005. FILED 10-11-2002.
- 2,996,314 (*See Class 9 for this trademark*).
- 2,996,317 (*See Class 9 for this trademark*).
- 2,996,322. **LIAISON COUNCIL ON CERTIFICATION FOR THE SURGICAL TECHNOLOGIST**. LIAISON COUNCIL ON CERTIFICATION FOR THE SURGICAL TECHNOLOGIST, MULTIPLE CLASS, (INT. CLS. 16 AND 42), (U.S. CLS. 2, 5, 22, 23, 29, 37, 38, 50, 100 AND 101). SN 76-475,794. PUB. 6-28-2005. FILED 12-16-2002.
- 2,996,324. **ACTIVE LIFESTYLES**. MORRIS PUBLISHING GROUP, LLC, MULTIPLE CLASS, (INT. CLS. 16 AND 41), (U.S. CLS. 2, 5, 22, 23, 29, 37, 38, 50, 100, 101 AND 107). SN 76-478,942. PUB. 6-28-2005. FILED 12-30-2002.
- 2,996,328 (*See Class 9 for this trademark*).
- 2,996,331 (*See Class 9 for this trademark*).
- 2,996,332 (*See Class 9 for this trademark*).
- 2,996,344 (*See Class 2 for this trademark*).
- 2,996,346. **ADOPTIVE FAMILIES TOGETHER**. ADOPTIVE FAMILIES TOGETHER, INC., MULTIPLE CLASS, (INT. CLS. 16, 38 AND 41), (U.S. CLS. 2, 5, 22, 23, 29, 37, 38, 50, 100, 101, 104 AND 107). SN 76-499,567. PUB. 6-28-2005. FILED 3-21-2003.
- 2,996,360 (*See Class 9 for this trademark*).
- 2,996,368. **VBALL**. MATRIX GROUP LIMITED, INC., MULTIPLE CLASS, (INT. CLS. 16 AND 35), (U.S. CLS. 2, 5, 22, 23, 29, 37, 38, 50, 100, 101 AND 102). SN 76-521,565. PUB. 6-28-2005. FILED 6-9-2003.
- 2,996,391. **MICROBIOLOGY ABSTRACTS**. CAMBRIDGE SCIENTIFIC ABSTRACTS, MULTIPLE CLASS, (INT. CLS. 16 AND 42), (U.S. CLS. 2, 5, 22, 23, 29, 37, 38, 50, 100 AND 101). SN 76-531,419. PUB. 6-28-2005. FILED 7-21-2003.
- 2,996,401. **THE JOINT**. T-SHIRT CELLAR, INC., MULTIPLE CLASS, (INT. CLS. 16 AND 35), (U.S. CLS. 2, 5, 22, 23, 29, 37, 38, 50, 100, 101 AND 102). SN 76-535,828. PUB. 6-28-2005. FILED 7-30-2003.
- 2,996,405. **NATIONAL SOCCER HALL OF FAME ONEONTA, N.Y. AND DESIGN**. NATIONAL SOCCER HALL OF FAME, (U.S. CLS. 2, 5, 22, 23, 29, 37, 38 AND 50). SN 76-536,426. PUB. 6-28-2005. FILED 7-30-2003.
- 2,996,412. **G!MAN (BLOCK FORM)**. CNF INC., MULTIPLE CLASS, (INT. CLS. 16, 35 AND 39), (U.S. CLS. 2, 5, 22, 23, 29, 37, 38, 50, 100, 101, 102 AND 105). SN 76-537,247. PUB. 6-28-2005. FILED 8-14-2003.
- 2,996,420. **PRIORITY! (STYLIZED)**. THE SALVATION ARMY, USA EASTERN TERRITORY, (U.S. CLS. 2, 5, 22, 23, 29, 37, 38 AND 50). SN 76-539,187. PUB. 6-28-2005. FILED 8-21-2003.
- 2,996,425 (*See Class 6 for this trademark*).
- 2,996,430 (*See Class 9 for this trademark*).
- 2,996,470. **GENERAL REVIEW (BLOCK FORM)**. GENERAL RE CORPORATION, (U.S. CLS. 2, 5, 22, 23, 29, 37, 38 AND 50). SN 76-564,125. PUB. 6-28-2005. FILED 12-9-2003.
- 2,996,480. **THE PERPETUAL GIVING CARD (BLOCK FORM)**. SNYDER, DAVID W., (U.S. CLS. 2, 5, 22, 23, 29, 37, 38 AND 50). SN 76-566,557. PUB. 6-28-2005. FILED 12-23-2003.
- 2,996,501. **GEN Y HEALTH CLUB AND DESIGN**. INDEPENDENCE BLUE CROSS, MULTIPLE CLASS, (INT. CLS. 16 AND 44), (U.S. CLS. 2, 5, 22, 23, 29, 37, 38, 50, 100 AND 101). SN 76-569,005. PUB. 6-28-2005. FILED 1-9-2004.
- 2,996,505. **LAYOUT (BLOCK FORM)**. GENERAL PENCIL COMPANY, INC., (U.S. CLS. 2, 5, 22, 23, 29, 37, 38 AND 50). SN 76-569,385. PUB. 6-28-2005. FILED 1-2-2004.
- 2,996,519 (*See Class 1 for this trademark*).
- 2,996,546. **KATALOG AND DESIGN**. CATALOGOS ESTRATEGICOS, S.A. DE C.V., MULTIPLE CLASS, (INT. CLS. 16, 35 AND 42), (U.S. CLS. 2, 5, 22, 23, 29, 37, 38, 50, 100, 101 AND 102). SN 76-571,730. PUB. 6-28-2005. FILED 1-23-2004.
- 2,996,547 (*See Class 15 for this trademark*).
- 2,996,639 (*See Class 4 for this trademark*).
- 2,996,641. **SHREDDER ESSENTIALS (BLOCK FORM)**. EXECUTIVE MACHINES, INC., (U.S. CLS. 2, 5, 22, 23, 29, 37, 38 AND 50). SN 76-584,020. PUB. 6-28-2005. FILED 3-30-2004.
- 2,996,648 (*See Class 2 for this trademark*).
- 2,996,653. **SPIRIT OF CHRIST MINISTRIES (BLOCK FORM)**. FISCHER, ROBERT E., (U.S. CLS. 2, 5, 22, 23, 29, 37, 38 AND 50). SN 76-586,897. PUB. 6-28-2005. FILED 4-15-2004.
- 2,996,655. **AGA THE AMERICAN GASTROENTEROLOGICAL ASSOCIATION CENTER FOR GI PRACTICE MANAGEMENT AND ECONOMICS AND DESIGN**. AMERICAN GASTROENTEROLOGICAL ASSOCIATION, MULTIPLE CLASS, (INT. CLS. 16 AND 35), (U.S. CLS. 2, 5, 22, 23, 29, 37, 38, 50, 100, 101 AND 102). SN 76-587,303. PUB. 6-14-2005. FILED 4-19-2004.
- 2,996,668. **ATLANTA JAZZ FESTIVAL (BLOCK FORM)**. CITY OF ATLANTA BUREAU OF CULTURAL AFFAIRS, MULTIPLE CLASS, (INT. CLS. 16, 25 AND 41), (U.S. CLS. 2, 5, 22, 23, 29, 37, 38, 39, 50, 100, 101 AND 107). SN 76-589,781. PUB. 6-28-2005. FILED 4-30-2004.
- 2,996,683. **RADIOLOGY LIABILITY ALERT (BLOCK FORM)**. JURY VERDICT REVIEW PUBLICATIONS, INC., (U.S. CLS. 2, 5, 22, 23, 29, 37, 38 AND 50). SN 76-591,664. PUB. 6-28-2005. FILED 5-10-2004.
- 2,996,684. **PRIMARY CARE LIABILITY ALERT (BLOCK FORM)**. JURY VERDICT REVIEW PUBLICATIONS, INC., (U.S. CLS. 2, 5, 22, 23, 29, 37, 38 AND 50). SN 76-591,665. PUB. 6-28-2005. FILED 5-10-2004.
- 2,996,685. **SURGEON'S LIABILITY ALERT (BLOCK FORM)**. JURY VERDICT REVIEW PUBLICATIONS, INC., (U.S. CLS. 2, 5, 22, 23, 29, 37, 38 AND 50). SN 76-591,666. PUB. 6-28-2005. FILED 5-10-2004.
- 2,996,690. **HISTORYBAG (BLOCK FORM)**. HISTORYBAG LLC, (U.S. CLS. 2, 5, 22, 23, 29, 37, 38 AND 50). SN 76-593,135. PUB. 6-28-2005. FILED 5-18-2004.
- 2,996,722. **DECO AURORA (BLOCK FORM)**. GHENT MANUFACTURING, INC., (U.S. CLS. 2, 5, 22, 23, 29, 37, 38 AND 50). SN 76-597,793. PUB. 6-28-2005. FILED 6-16-2004.
- 2,996,740. **GRAPHIC GRANITE (BLOCK FORM)**. J-WALKER STUDIO, INC., (U.S. CLS. 2, 5, 22, 23, 29, 37, 38 AND 50). SN 76-599,154. PUB. 6-28-2005. FILED 6-25-2004.
- 2,996,761. **TIDALGEANON (BLOCK FORM)**. PRESCOTT, CORRIE D., (U.S. CLS. 2, 5, 22, 23, 29, 37, 38 AND 50). SN 76-601,585. PUB. 6-28-2005. FILED 7-12-2004.
- 2,996,777. **NECROSCOPE (BLOCK FORM)**. LUMLEY, BRIAN, (U.S. CLS. 2, 5, 22, 23, 29, 37, 38 AND 50). SN 76-603,749. PUB. 6-28-2005. FILED 7-23-2004.
- 2,996,857. **HACHAI PUBLISHING AND DESIGN**. TZIVOS HASHEM, DBA HACHAI HOTZAOS SEFORIM/PUBLISHING, (U.S. CLS. 2, 5, 22, 23, 29, 37, 38 AND 50). SN 76-605,798. PUB. 6-28-2005. FILED 8-6-2004.
- 2,996,862. **LITMUS PRESS (BLOCK FORM)**. GRINNELL, E. TRACY, (U.S. CLS. 2, 5, 22, 23, 29, 37, 38 AND 50). SN 76-606,134. PUB. 6-28-2005. FILED 8-6-2004.
- 2,996,868. **FANS OF THE GAME (BLOCK FORM)**. DONRUSS PLAYOFF, L.P., (U.S. CLS. 2, 5, 22, 23, 29, 37, 38 AND 50). SN 76-606,521. PUB. 6-28-2005. FILED 8-5-2004.
- 2,996,870 (*See Class 9 for this trademark*).
- 2,996,883 (*See Class 9 for this trademark*).
- 2,996,914. **DRURY UNIVERSITY AND DESIGN**. DRURY UNIVERSITY, MULTIPLE CLASS, (INT. CLS. 16, 25 AND 41), (U.S. CLS. 2, 5, 22, 23, 29, 37, 38, 39, 50, 100, 101 AND 107). SN 78-195,559. PUB. 6-28-2005. FILED 12-17-2002.

- 2,996,953. **YOUR HEALTH & FITNESS**. M.I.T. FINANCIAL GROUP, INC., DBA GENERAL LEARNING CORPORATION, (U.S. CLS. 2, 5, 22, 23, 29, 37, 38 AND 50). SN 78-254,899. PUB. 6-28-2005. FILED 5-27-2003.
- 2,996,965 (*See Class 2 for this trademark*).
- 2,997,023. **FLORIDA SPACE INSTITUTE**. UNIVERSITY OF CENTRAL FLORIDA, MULTIPLE CLASS, (INT. CLS. 16, 25, 41 AND 42), (U.S. CLS. 2, 5, 22, 23, 29, 37, 38, 39, 50, 100, 101 AND 107). SN 78-308,730. PUB. 6-28-2005. FILED 10-2-2003.
- 2,997,043. **PEO SHIPS (BLOCK FORM)**. UNITED STATES NAVY, NAVAL SEA SYSTEMS COMMAND, MULTIPLE CLASS, (INT. CLS. 16, 41 AND 42), (U.S. CLS. 2, 5, 22, 23, 29, 37, 38, 50, 100, 101 AND 107). SN 78-324,526. PUB. 6-28-2005. FILED 11-7-2003.
- 2,997,046. **LIU FENG SHUI CHI ART C. J. LIU AND DESIGN**. LIU, JULIE T., (U.S. CLS. 2, 5, 22, 23, 29, 37, 38 AND 50). SN 78-327,858. PUB. 6-28-2005. FILED 11-14-2003.
- 2,997,047. **EXECUTIVE THINK TIME (BLOCK FORM)**, FREDERICKS, ELLEN, AND PROFESSIONAL COACHING AND TRAINING, INC., MULTIPLE CLASS, (INT. CLS. 16 AND 41), (U.S. CLS. 2, 5, 22, 23, 29, 37, 38, 50, 100, 101 AND 107). SN 78-327,960. PUB. 6-28-2005. FILED 11-14-2003.
- 2,997,055. **STRATA-TAC (BLOCK FORM)**. STRATA-TAC, INC., (U.S. CLS. 2, 5, 22, 23, 29, 37, 38 AND 50). SN 78-329,717. PUB. 6-28-2005. FILED 11-18-2003.
- 2,997,058. **V-FLUENCE IT STARTS ONLINE AND DESIGN**. V-FLUENCE INTERACTIVE PUBLIC RELATIONS, INC., (U.S. CLS. 2, 5, 22, 23, 29, 37, 38 AND 50). SN 78-330,331. PUB. 6-28-2005. FILED 11-19-2003.
- 2,997,063. **SIMPLY MJ (BLOCK FORM)**. BUTTERS, MARY JANE, (U.S. CLS. 2, 5, 22, 23, 29, 37, 38 AND 50). SN 78-331,474. PUB. 6-28-2005. FILED 11-21-2003.
- 2,997,103. **MATH WINDOW AND DESIGN**. WOLF, ROGER P., (U.S. CLS. 2, 5, 22, 23, 29, 37, 38 AND 50). SN 78-346,018. PUB. 6-28-2005. FILED 12-29-2003.
- 2,997,135. **REPORTERO INDUSTRIAL (BLOCK FORM)**. KELLER INTERNATIONAL PUBLISHING LLC, (U.S. CLS. 2, 5, 22, 23, 29, 37, 38 AND 50). SN 78-350,904. PUB. 6-28-2005. FILED 1-12-2004.
- 2,997,143. **AMERICA SAY JESUS! (BLOCK FORM)**. AMERICA'S CHURCH - DAVID ALLBRITTON MINISTRIES, INC., (U.S. CLS. 2, 5, 22, 23, 29, 37, 38 AND 50). SN 78-352,695. PUB. 6-28-2005. FILED 1-15-2004.
- 2,997,144 (*See Class 9 for this trademark*).
- 2,997,148. **GOLD FROST (BLOCK FORM)**. LINZER PRODUCTS CORP., (U.S. CLS. 2, 5, 22, 23, 29, 37, 38 AND 50). SN 78-354,759. PUB. 6-28-2005. FILED 1-21-2004.
- 2,997,152 (*See Class 9 for this trademark*).
- 2,997,168. **HYVOL (BLOCK FORM)**. LEHMAN BROTHERS INC., (U.S. CLS. 2, 5, 22, 23, 29, 37, 38 AND 50). SN 78-358,198. PUB. 6-28-2005. FILED 1-27-2004.
- 2,997,174. **MISCELLANEOUS DESIGN**. DEERE & COMPANY, (U.S. CLS. 2, 5, 22, 23, 29, 37, 38 AND 50). SN 78-359,445. PUB. 6-28-2005. FILED 1-29-2004.
- 2,997,213. **GRAND OLE OPRY (BLOCK FORM)**. GAYLORD ENTERTAINMENT COMPANY, (U.S. CLS. 2, 5, 22, 23, 29, 37, 38 AND 50). SN 78-363,000. PUB. 6-28-2005. FILED 2-5-2004.
- 2,997,216. **COLOR-BOX (BLOCK FORM)**. COLOR-BOX, LLC, MULTIPLE CLASS, (INT. CLS. 16 AND 40), (U.S. CLS. 2, 5, 22, 23, 29, 37, 38, 50, 100, 103 AND 106). SN 78-363,254. PUB. 6-28-2005. FILED 2-5-2004.
- 2,997,224. **NLM AND DESIGN**. NATIONAL LIBRARY OF MEDICINE, THE, MULTIPLE CLASS, (INT. CLS. 16, 36, 41, 42 AND 44), (U.S. CLS. 2, 5, 22, 23, 29, 37, 38, 50, 100, 101, 102 AND 107). SN 78-364,616. PUB. 6-28-2005. FILED 2-9-2004.
- 2,997,227. **CONTRACTOR TRADER (BLOCK FORM)**. WHITE CAP INDUSTRIES II, INC., (U.S. CLS. 2, 5, 22, 23, 29, 37, 38 AND 50). SN 78-365,086. PUB. 6-28-2005. FILED 2-9-2004.
- 2,997,233 (*See Class 9 for this trademark*).
- 2,997,236. **WINDOW CANVAS (BLOCK FORM)**. LIFE CAPTURED CORPORATION, (U.S. CLS. 2, 5, 22, 23, 29, 37, 38 AND 50). SN 78-366,322. PUB. 6-28-2005. FILED 2-11-2004.
- 2,997,277. **GAME SET HEALTH (BLOCK FORM)**. BED BATH & BEYOND PROCUREMENT CO. INC., MULTIPLE CLASS, (INT. CLS. 16, 25 AND 35), (U.S. CLS. 2, 5, 22, 23, 29, 37, 38, 39, 50, 100, 101 AND 102). SN 78-372,113. PUB. 6-28-2005. FILED 2-23-2004.
- 2,997,285. **CURTIS LAKE MYSTERIES (BLOCK FORM)**. LACHACZ, FRANK ANTHONY, (U.S. CLS. 2, 5, 22, 23, 29, 37, 38 AND 50). SN 78-373,353. PUB. 6-28-2005. FILED 2-24-2004.
- 2,997,308. **CHEAP TICKETS GOLD (BLOCK FORM)**. CHEAP TICKETS, INC., MULTIPLE CLASS, (INT. CLS. 16, 35, 39 AND 43), (U.S. CLS. 2, 5, 22, 23, 29, 37, 38, 50, 100, 101, 102 AND 105). SN 78-376,750. PUB. 6-28-2005. FILED 3-2-2004.
- 2,997,318. **DREDGING CONTRACT NEWS (BLOCK FORM)**. LITTLE HORSE ENTERPRISES, INC., (U.S. CLS. 2, 5, 22, 23, 29, 37, 38 AND 50). SN 78-377,668. PUB. 6-28-2005. FILED 3-3-2004.
- 2,997,346. **GRACELAND (BLOCK FORM)**. ELVIS PRESLEY ENTERPRISES, INC., (U.S. CLS. 2, 5, 22, 23, 29, 37, 38 AND 50). SN 78-385,289. PUB. 6-28-2005. FILED 3-16-2004.
- 2,997,355. **MEASURABLE MANAGEMENT (BLOCK FORM)**. BYRNE, ROBIN, MULTIPLE CLASS, (INT. CLS. 16 AND 41), (U.S. CLS. 2, 5, 22, 23, 29, 37, 38, 50, 100, 101 AND 107). SN 78-387,014. PUB. 6-28-2005. FILED 3-18-2004.
- 2,997,362. **ABECADLO (BLOCK FORM)**. MARCHEL, WOJCIECH, (U.S. CLS. 2, 5, 22, 23, 29, 37, 38 AND 50). SN 78-387,948. PUB. 6-28-2005. FILED 3-20-2004.
- 2,997,375 (*See Class 9 for this trademark*).
- 2,997,404. **DA VINCI WRITER (BLOCK FORM)**. NEW PRODUCT DESIGNS, LLC, (U.S. CLS. 2, 5, 22, 23, 29, 37, 38 AND 50). SN 78-394,663. PUB. 6-28-2005. FILED 4-1-2004.
- 2,997,463. **WORLDCLASS HOLIDAY (BLOCK FORM)**. DEUTSCHE TELEKOM AG, (U.S. CLS. 2, 5, 22, 23, 29, 37, 38 AND 50). SN 78-406,628. PUB. 6-28-2005. FILED 4-22-2004.
- 2,997,472 (*See Class 7 for this trademark*).
- 2,997,503. **PAL PUBLICATIONS AND DESIGN**. PAL PUBLICATIONS, INC., (U.S. CLS. 2, 5, 22, 23, 29, 37, 38 AND 50). SN 78-414,832. PUB. 6-28-2005. FILED 5-7-2004.
- 2,997,541. **AFS (STYLIZED)**. AUTOMATED FINANCIAL SYSTEMS, INC., (U.S. CLS. 2, 5, 22, 23, 29, 37, 38 AND 50). SN 78-424,781. PUB. 6-28-2005. FILED 5-25-2004.
- 2,997,543. **BYU BRIGHAM YOUNG UNIVERSITY, REXBURG, IDAHO 1888 IDAHO AND DESIGN**. BRIGHAM YOUNG UNIVERSITY, (U.S. CLS. 2, 5, 22, 23, 29, 37, 38 AND 50). SN 78-424,914. PUB. 6-28-2005. FILED 5-25-2004.
- 2,997,561. **DOCUMENTING THE FUTURE OF AMERICAN HEALTHCARE (BLOCK FORM)**. MEDICAL WORLD COMMUNICATIONS, INC., (U.S. CLS. 2, 5, 22, 23, 29, 37, 38 AND 50). SN 78-429,222. PUB. 6-28-2005. FILED 6-3-2004.
- 2,997,600. **THE OUTDOORS AT YOUR DOORSTEP (BLOCK FORM)**. RODALE INC., MULTIPLE CLASS, (INT. CLS. 16 AND 41), (U.S. CLS. 2, 5, 22, 23, 29, 37, 38, 50, 100, 101 AND 107). SN 78-436,105. PUB. 6-28-2005. FILED 6-16-2004.
- 2,997,601. **WHO INSPIRES YOU?? CHRISTINSPIRED.COM AND DESIGN**. CHRIST INSPIRED, INC., (U.S. CLS. 2, 5, 22, 23, 29, 37, 38 AND 50). SN 78-436,108. PUB. 6-28-2005. FILED 6-16-2004.
- 2,997,627. **BIGFOOT (BLOCK FORM)**. AMERICAN MEDIA OPERATIONS, INC., (U.S. CLS. 2, 5, 22, 23, 29, 37, 38 AND 50). SN 78-439,163. PUB. 6-28-2005. FILED 6-22-2004.
- 2,997,638. **MR. SAUNDERS' STORIES AND DESIGN**. KOOKOGUEY, KEVIN S., (U.S. CLS. 2, 5, 22, 23, 29, 37, 38 AND 50). SN 78-440,346. PUB. 6-28-2005. FILED 6-23-2004.
- 2,997,655. **A BALANCED LIFE TURTLE AND CRANE AND DESIGN**. MINNESOTA DEPARTMENT OF HEALTH, MULTIPLE CLASS, (INT. CLS. 16 AND 41), (U.S. CLS. 2, 5, 22, 23, 29, 37, 38, 50, 100, 101 AND 107). SN 78-442,532. PUB. 6-28-2005. FILED 6-28-2004.
- 2,997,667. **BOTTOM LINE DIGEST (BLOCK FORM)**. BOARDROOM, INC., (U.S. CLS. 2, 5, 22, 23, 29, 37, 38 AND 50). SN 78-443,550. PUB. 6-28-2005. FILED 6-30-2004.
- 2,997,670. **MACCHINA VELOCE (BLOCK FORM)**. PAPEMAN, PHILIP LEO, MULTIPLE CLASS, (INT. CLS. 16 AND 25), (U.S. CLS. 2, 5, 22, 23, 29, 37, 38, 39 AND 50). SN 78-443,847. PUB. 6-28-2005. FILED 6-30-2004.
- 2,997,671. **GOT A MINUTE? (BLOCK FORM)**. LUBOW, MIKE, (U.S. CLS. 2, 5, 22, 23, 29, 37, 38 AND 50). SN 78-443,940. PUB. 6-28-2005. FILED 6-30-2004.
- 2,997,677. **DRIVING YOUR SUCCESS AND DESIGN**. CHARAPP & WEISS, LLP, MULTIPLE CLASS, (INT. CLS. 16 AND 42), (U.S. CLS. 2, 5, 22, 23, 29, 37, 38, 50, 100 AND 101). SN 78-444,394. PUB. 6-28-2005. FILED 7-1-2004.

- 2,997,681. **THE QUICK COOK AND DESIGN**. RODALE INC., (U.S. CLS. 2, 5, 22, 23, 29, 37, 38 AND 50). SN 78-444,677. PUB. 6-28-2005. FILED 7-1-2004.
- 2,997,685. **BENEFITS ROUNDTABLE (BLOCK FORM)**. THE CORPORATE EXECUTIVE BOARD COMPANY, (U.S. CLS. 2, 5, 22, 23, 29, 37, 38 AND 50). SN 78-444,863. PUB. 6-28-2005. FILED 7-1-2004.
- 2,997,704. **MODERN-POST (BLOCK FORM)**. WHITESELL, WENDY S., (U.S. CLS. 2, 5, 22, 23, 29, 37, 38 AND 50). SN 78-446,633. PUB. 6-28-2005. FILED 7-6-2004.
- 2,997,738. **COMPASS POINT BOOKS AND DESIGN**. COMPASS POINT BOOKS, INC., (U.S. CLS. 2, 5, 22, 23, 29, 37, 38 AND 50). SN 78-450,231. PUB. 6-28-2005. FILED 7-13-2004.
- 2,997,753. **MOTO-MAPS (BLOCK FORM)**. MOTO-MAPS, (U.S. CLS. 2, 5, 22, 23, 29, 37, 38 AND 50). SN 78-451,156. PUB. 6-28-2005. FILED 7-15-2004.
- 2,997,766. **NEW YORK LIVING (BLOCK FORM)**. CHIBA PUBLICATIONS, INC., (U.S. CLS. 2, 5, 22, 23, 29, 37, 38 AND 50). SN 78-452,554. PUB. 6-28-2005. FILED 7-19-2004.
- 2,997,782. **A LOOK YOU CAN FEEL (BLOCK FORM)**. HIX CORPORATION, (U.S. CLS. 2, 5, 22, 23, 29, 37, 38 AND 50). SN 78-453,502. PUB. 6-28-2005. FILED 7-20-2004.
- 2,997,784. **MAINEBIZ (BLOCK FORM)**. MAINEBIZ PUBLICATIONS, INC., (U.S. CLS. 2, 5, 22, 23, 29, 37, 38 AND 50). SN 78-453,595. PUB. 6-28-2005. FILED 7-20-2004.
- 2,997,816. **BUSINESS OFFICER (BLOCK FORM)**. NATIONAL ASSOCIATION OF COLLEGE AND UNIVERSITY BUSINESS OFFICERS, (U.S. CLS. 2, 5, 22, 23, 29, 37, 38 AND 50). SN 78-455,282. PUB. 6-28-2005. FILED 7-22-2004.
- 2,997,834. **ELEMENTS OF ANALYSIS (BLOCK FORM)**. HELMERS PUBLISHING, INC., (U.S. CLS. 2, 5, 22, 23, 29, 37, 38 AND 50). SN 78-455,754. PUB. 6-28-2005. FILED 7-23-2004.
- 2,997,846 (*See Class 9 for this trademark*).
- 2,997,861. **PASTORS IN FOCUS (BLOCK FORM)**. FOCUS ON THE FAMILY, (U.S. CLS. 2, 5, 22, 23, 29, 37, 38 AND 50). SN 78-456,776. PUB. 6-28-2005. FILED 7-26-2004.
- 2,997,863. **HOW MANY HOURS 168 CAN YOU FIT IN A WEEK? WWW.168MAG.COM AND DESIGN**. TELEGRAPH PUBLISHING COMPANY, (U.S. CLS. 2, 5, 22, 23, 29, 37, 38 AND 50). SN 78-456,848. PUB. 6-28-2005. FILED 7-26-2004.
- 2,997,870. **STOOP'N SCOOPER (BLOCK FORM)**. GENIX INTERNATIONAL CORPORATION, (U.S. CLS. 2, 5, 22, 23, 29, 37, 38 AND 50). SN 78-457,042. PUB. 6-28-2005. FILED 7-26-2004.
- 2,997,873 (*See Class 6 for this trademark*).
- 2,997,892. **THE BOARDROOM (BLOCK FORM)**. WOOD, JODY MARQUEZ, (U.S. CLS. 2, 5, 22, 23, 29, 37, 38 AND 50). SN 78-457,334. PUB. 6-28-2005. FILED 7-27-2004.
- 2,997,903. **WELCOME SAVINGS (BLOCK FORM)**. DENNIS GARBERG & ASSOCIATES, INC., MULTIPLE CLASS, (INT. CLS. 16 AND 35), (U.S. CLS. 2, 5, 22, 23, 29, 37, 38, 50, 100, 101 AND 102). SN 78-457,579. PUB. 6-28-2005. FILED 7-27-2004.
- 2,997,910 (*See Class 9 for this trademark*).
- 2,997,914. **BATTLEZONE BIBLE (BLOCK FORM)**. GOOD NEWS PUBLISHERS, (U.S. CLS. 2, 5, 22, 23, 29, 37, 38 AND 50). SN 78-457,894. PUB. 6-28-2005. FILED 7-28-2004.
- 2,997,942. **WOMEN KNOW... (BLOCK FORM)**. WILLIAMS, NATHANIEL, (U.S. CLS. 2, 5, 22, 23, 29, 37, 38 AND 50). SN 78-458,559. PUB. 6-28-2005. FILED 7-29-2004.
- 2,997,952 (*See Class 9 for this trademark*).
- 2,997,980. **MI CULTURA (BLOCK FORM)**. ULTIMATE COMMUNICATIONS, INC., (U.S. CLS. 2, 5, 22, 23, 29, 37, 38 AND 50). SN 78-459,244. PUB. 6-28-2005. FILED 7-29-2004.
- 2,997,982. **THE MEANING OF LILA (BLOCK FORM)**. AGC, INC., (U.S. CLS. 2, 5, 22, 23, 29, 37, 38 AND 50). SN 78-459,310. PUB. 6-28-2005. FILED 7-30-2004.
- 2,998,001. **SUSHINERY (BLOCK FORM)**. BOHN, HOLLY A., (U.S. CLS. 2, 5, 22, 23, 29, 37, 38 AND 50). SN 78-459,536. PUB. 6-28-2005. FILED 7-30-2004.
- 2,998,005. **BOWMAX (BLOCK FORM)**. BOWATER INCORPORATED, (U.S. CLS. 2, 5, 22, 23, 29, 37, 38 AND 50). SN 78-459,595. PUB. 6-28-2005. FILED 7-30-2004.
- 2,998,026. **FE "LINES" (BLOCK FORM)**. MILLER, RITA M., (U.S. CLS. 2, 5, 22, 23, 29, 37, 38 AND 50). SN 78-460,045. PUB. 6-28-2005. FILED 7-31-2004.
- 2,998,027. **BUSINESS MINDER (BLOCK FORM)**. GUEST, PAMELA YVONNE, (U.S. CLS. 2, 5, 22, 23, 29, 37, 38 AND 50). SN 78-460,056. PUB. 6-28-2005. FILED 7-31-2004.
- 2,998,030. **JEWISH IMAGE (BLOCK FORM)**. JMS MARKETING, INC., (U.S. CLS. 2, 5, 22, 23, 29, 37, 38 AND 50). SN 78-460,123. PUB. 6-28-2005. FILED 8-1-2004.
- 2,998,036. **BLESSING COIN (BLOCK FORM)**. ANGELSTAR INSPIRED PRODUCTS, INC., (U.S. CLS. 2, 5, 22, 23, 29, 37, 38 AND 50). SN 78-460,162. PUB. 6-28-2005. FILED 8-1-2004.
- 2,998,055. **THE LADDER (BLOCK FORM)**. WEINSTEIN, STEVEN P., (U.S. CLS. 2, 5, 22, 23, 29, 37, 38 AND 50). SN 78-460,363. PUB. 6-28-2005. FILED 8-2-2004.
- 2,998,066. **UNCLE MIKE'S AND DESIGN**. MICHAELS OF OREGON CO., (U.S. CLS. 2, 5, 22, 23, 29, 37, 38 AND 50). SN 78-460,449. PUB. 6-28-2005. FILED 8-2-2004.
- 2,998,073. **PROMARX (BLOCK FORM)**. KITTRICH CORPORATION, (U.S. CLS. 2, 5, 22, 23, 29, 37, 38 AND 50). SN 78-460,595. PUB. 6-28-2005. FILED 8-2-2004.
- 2,998,087. **GRAFTON (BLOCK FORM)**. FIBERMARK, INC., (U.S. CLS. 2, 5, 22, 23, 29, 37, 38 AND 50). SN 78-460,959. PUB. 6-28-2005. FILED 8-3-2004.
- 2,998,092. **RAPID-ROLL (BLOCK FORM)**. AVERY DENNISON CORPORATION, (U.S. CLS. 2, 5, 22, 23, 29, 37, 38 AND 50). SN 78-461,028. PUB. 6-28-2005. FILED 8-3-2004.
- 2,998,093. **RAPID-ROLL (BLOCK FORM)**. AVERY DENNISON CORPORATION, (U.S. CLS. 2, 5, 22, 23, 29, 37, 38 AND 50). SN 78-461,040. PUB. 6-28-2005. FILED 8-3-2004.
- 2,998,126. **BRIDGING CULTURES (BLOCK FORM)**. WESTED, MULTIPLE CLASS, (INT. CLS. 16 AND 41), (U.S. CLS. 2, 5, 22, 23, 29, 37, 38, 50, 100, 101 AND 107). SN 78-461,502. PUB. 6-28-2005. FILED 8-3-2004.
- 2,998,150. **PROPAQUE (BLOCK FORM)**. AIR WAVES, INC., (U.S. CLS. 2, 5, 22, 23, 29, 37, 38 AND 50). SN 78-461,957. PUB. 6-28-2005. FILED 8-4-2004.
- 2,998,154. **DSST AND DESIGN**. THE CHAUNCEY GROUP INTERNATIONAL LTD., MULTIPLE CLASS, (INT. CLS. 16 AND 42), (U.S. CLS. 2, 5, 22, 23, 29, 37, 38, 50, 100 AND 101). SN 78-462,058. PUB. 6-28-2005. FILED 8-4-2004.
- 2,998,164. **WELOR PRODUCTION (BLOCK FORM)**. WELCOME HOME AMERICA, INC., (U.S. CLS. 2, 5, 22, 23, 29, 37, 38 AND 50). SN 78-462,216. PUB. 6-28-2005. FILED 8-4-2004.
- 2,998,177. **HUSTLER'S BACKDOOR BABES (BLOCK FORM)**. L.F.P., INC., (U.S. CLS. 2, 5, 22, 23, 29, 37, 38 AND 50). SN 78-462,704. PUB. 6-28-2005. FILED 8-5-2004.
- 2,998,190. **SOCK MONKEY LADY (BLOCK FORM)**. LINDNER, DELORES P., (U.S. CLS. 2, 5, 22, 23, 29, 37, 38 AND 50). SN 78-463,179. PUB. 6-28-2005. FILED 8-6-2004.
- 2,998,205. **IST MARK (BLOCK FORM)**. NULL, MILDRED, (U.S. CLS. 2, 5, 22, 23, 29, 37, 38 AND 50). SN 78-464,054. PUB. 6-28-2005. FILED 8-9-2004.
- 2,998,254. **I SEE ME! (BLOCK FORM)**. I SEE ME! INC., (U.S. CLS. 2, 5, 22, 23, 29, 37, 38 AND 50). SN 78-466,029. PUB. 6-28-2005. FILED 8-11-2004.
- 2,998,257. **AMERICAN HERO (STYLIZED)**. SUNDARAM MULTI PAP LIMITED, (U.S. CLS. 2, 5, 22, 23, 29, 37, 38 AND 50). SN 78-466,139. PUB. 6-28-2005. FILED 8-12-2004.
- 2,998,274 (*See Class 3 for this trademark*).
- 2,998,292. **BUILD TO BE... (BLOCK FORM)**. BLACKWELL, DEVAN M., (U.S. CLS. 2, 5, 22, 23, 29, 37, 38 AND 50). SN 78-469,496. PUB. 6-28-2005. FILED 8-18-2004.
- 2,998,326. **GRAINGER AND DESIGN**. W.W. GRAINGER, INC., MULTIPLE CLASS, (INT. CLS. 16 AND 35), (U.S. CLS. 2, 5, 22, 23, 29, 37, 38, 50, 100, 101 AND 102). SN 78-505,296. PUB. 6-28-2005. FILED 10-25-2004.
- 2,998,338. **NASCAR INSIDER (BLOCK FORM)**. NATIONAL ASSOCIATION FOR STOCK CAR AUTO RACING, INC., (U.S. CLS. 2, 5, 22, 23, 29, 37, 38 AND 50). SN 78-546,245. PUB. 6-28-2005. FILED 1-12-2005.
- 2,998,339 (*See Class 14 for this trademark*).
- 2,998,347. **HUEVOCARTOON.COM AND DESIGN**. COMUNIDAD HUEVO, S.A. DE C.V., (U.S. CLS. 2, 5, 22, 23, 29, 37, 38 AND 50). SN 78-573,570. PUB. 6-28-2005. FILED 2-23-2005.
- 2,998,415. **NPNBET! AND DESIGN**. HOLA, S.A., (U.S. CLS. 2, 5, 22, 23, 29, 37, 38 AND 50). SN 79-001,969. PUB. 6-28-2005. FILED 12-11-2003.
- 2,998,418 (*See Class 6 for this trademark*).
- 2,998,419. **PICTORICO (BLOCK FORM)**. ASAHI GLASS COMPANY, LTD., MULTIPLE CLASS, (INT. CLS. 16

AND 17), (U.S. CLS. 1, 2, 5, 12, 13, 22, 23, 29, 35, 37, 38 AND 50). SN 79-002,086. PUB. 6-28-2005. FILED 3-9-2004.
 2,998,427. **PRINT MEDIA MESSE DRUPA (BLOCK FORM)**. MESSE DÜSSELDORF GMBH, MULTIPLE CLASS, (INT. CLS. 16, 35 AND 41), (U.S. CLS. 2, 5, 22, 23, 29, 37, 38, 50, 100, 101, 102 AND 107). SN 79-002,369. PUB. 6-28-2005. FILED 2-17-2004.
 2,998,454 (*See Class 10 for this trademark*).
 2,998,476 (*See Class 3 for this trademark*).
 2,998,478. **ULTRALOC (BLOCK FORM)**. MULTIBRANDS INTERNATIONAL LTD, (U.S. CLS. 2, 5, 22, 23, 29, 37, 38 AND 50). SN 79-004,408. PUB. 6-28-2005. FILED 3-13-2004.

CLASS 17—RUBBER GOODS

2,996,257 (*See Class 1 for this trademark*).
 2,996,339. **DURATOOL ECLIPSE**. IMAGE PRODUCTS GROUP, LLC, (U.S. CLS. 1, 5, 12, 13, 35 AND 50). SN 76-490,607. PUB. 6-28-2005. FILED 2-19-2003.
 2,996,351. **ULTRA-CORR**. UPONOR INNOVATION AB, (U.S. CLS. 1, 5, 12, 13, 35 AND 50). SN 76-503,517. PUB. 6-28-2005. FILED 4-2-2003.
 2,996,698. **SNAP TAP NO TOOLS NEEDED AND DESIGN**. KING TECHNOLOGY OF MISSOURI, INC., (U.S. CLS. 1, 5, 12, 13, 35 AND 50). SN 76-594,981. PUB. 6-28-2005. FILED 6-1-2004.
 2,996,800. **TWO-IN-ONE (BLOCK FORM)**. AWI LICENSING COMPANY, (U.S. CLS. 1, 5, 12, 13, 35 AND 50). SN 76-604,668. PUB. 6-28-2005. FILED 7-28-2004.
 2,996,885 (*See Class 1 for this trademark*).
 2,996,965 (*See Class 2 for this trademark*).
 2,996,993 (*See Class 6 for this trademark*).
 2,997,004 (*See Class 6 for this trademark*).
 2,997,005 (*See Class 6 for this trademark*).
 2,997,006 (*See Class 6 for this trademark*).
 2,997,187. **SPRAYTITE (BLOCK FORM)**. FOAM ENTERPRISES, LLC, (U.S. CLS. 1, 5, 12, 13, 35 AND 50). SN 78-360,312. PUB. 6-28-2005. FILED 1-30-2004.
 2,997,225. **LMOPS (BLOCK FORM)**. PLASTIC SUPPLIERS, INC., (U.S. CLS. 1, 5, 12, 13, 35 AND 50). SN 78-364,853. PUB. 6-28-2005. FILED 2-9-2004.
 2,997,547. **KPS (BLOCK FORM)**. KUNGSORS PLAST AB, MULTIPLE CLASS, (INT. CLS. 17 AND 19), (U.S. CLS. 1, 5, 12, 13, 33, 35 AND 50). SN 78-425,706. PUB. 6-28-2005. FILED 5-26-2004.
 2,997,562. **DESIMAX SLF (BLOCK FORM)**. MULTISORB TECHNOLOGIES, INC., (U.S. CLS. 1, 5, 12, 13, 35 AND 50). SN 78-429,266. PUB. 6-28-2005. FILED 6-3-2004.
 2,997,858. **INSTACRETE (BLOCK FORM)**. POLYMERIC SYSTEMS, INC., (U.S. CLS. 1, 5, 12, 13, 35 AND 50). SN 78-456,761. PUB. 6-28-2005. FILED 7-26-2004.
 2,998,097. **RAPID-ROLL (BLOCK FORM)**. AVERY DENNISON CORPORATION, (U.S. CLS. 1, 5, 12, 13, 35 AND 50). SN 78-461,099. PUB. 6-28-2005. FILED 8-3-2004.
 2,998,418 (*See Class 6 for this trademark*).
 2,998,419 (*See Class 16 for this trademark*).
 2,998,431. **UNIDELTA (BLOCK FORM)**. UNIDELTA S.P.A., (U.S. CLS. 1, 5, 12, 13, 35 AND 50). SN 79-002,484. PUB. 6-28-2005. FILED 1-21-2004.

CLASS 18—LEATHER GOODS

2,996,243 (*See Class 3 for this trademark*).
 2,996,252. **KIDDY LOOP**. BENETTON GROUP S.P.A., MULTIPLE CLASS, (INT. CLS. 18, 25 AND 28), (U.S. CLS. 1, 2, 3, 22, 23, 38, 39, 41 AND 50). SN 76-122,714. PUB. 6-28-2005. FILED 9-1-2000.
 2,996,366. **BEST EQUIPMENT**. BEST EQUIPMENT INTERNATIONAL, INC., MULTIPLE CLASS, (INT. CLS. 18, 25 AND 28), (U.S. CLS. 1, 2, 3, 22, 23, 38, 39, 41 AND 50). SN 76-521,488. PUB. 6-28-2005. FILED 6-9-2003.
 2,996,395. **PINKO SUNDAY MORNING AND DESIGN**. CRIS CONF S.P.A., MULTIPLE CLASS, (INT. CLS. 18 AND 25),

(U.S. CLS. 1, 2, 3, 22, 39 AND 41), SN 76-533,338. PUB. 6-28-2005. FILED 7-17-2003.
 2,996,396 (*See Class 8 for this trademark*).
 2,996,476 (*See Class 8 for this trademark*).
 2,996,557 (*See Class 3 for this trademark*).
 2,996,601 (*See Class 9 for this trademark*).
 2,996,639 (*See Class 4 for this trademark*).
 2,996,752. **PANDA LUGGAGE (STYLIZED)**. PANDA LUGGAGE & HANDBAG (U.S.A.), INC., (U.S. CLS. 1, 2, 3, 22 AND 41). SN 76-600,393. PUB. 6-28-2005. FILED 6-29-2004.
 2,996,811. **BURNING PLANET (BLOCK FORM)**. BURNING PLANET, INC., (U.S. CLS. 1, 2, 3, 22 AND 41). SN 76-604,916. PUB. 6-28-2005. FILED 7-30-2004.
 2,996,984. **PUPPIA**. HAK-DONG KIM, (U.S. CLS. 1, 2, 3, 22 AND 41). SN 78-283,355. PUB. 6-28-2005. FILED 8-5-2003.
 2,997,057. **UMBRELLAS UNLIMITED (BLOCK FORM)**. SYNDIX, INC., (U.S. CLS. 1, 2, 3, 22 AND 41). SN 78-330,227. PUB. 6-28-2005. FILED 11-19-2003.
 2,997,263. **WT AND DESIGN**. WOMEN OF TOMORROW MENTOR AND SCHOLARSHIP PROGRAM, INC., MULTIPLE CLASS, (INT. CLS. 18, 25, 35, 36 AND 41), (U.S. CLS. 1, 2, 3, 22, 39, 41, 100, 101, 102 AND 107). SN 78-369,633. PUB. 6-28-2005. FILED 2-18-2004.
 2,997,278. **BELLA B (BLOCK FORM)**. BLOCK, MARY, (U.S. CLS. 1, 2, 3, 22 AND 41). SN 78-372,244. PUB. 6-28-2005. FILED 2-23-2004.
 2,997,510 (*See Class 3 for this trademark*).
 2,997,678. **JANSPORT (STYLIZED)**. JANSPORT APPAREL CORP., MULTIPLE CLASS, (INT. CLS. 18 AND 25), (U.S. CLS. 1, 2, 3, 22, 39 AND 41). SN 78-444,401. PUB. 6-28-2005. FILED 7-1-2004.
 2,997,833. **630 LENOX AND DESIGN**. OUATTARA, AYESHA, (U.S. CLS. 1, 2, 3, 22 AND 41). SN 78-455,711. PUB. 6-28-2005. FILED 7-23-2004.
 2,998,082. **BAGGY BRITCHES (BLOCK FORM)**. DODSON, BETTY, (U.S. CLS. 1, 2, 3, 22 AND 41). SN 78-460,912. PUB. 6-28-2005. FILED 8-3-2004.
 2,998,149. **ARCACHON (BLOCK FORM)**. LA MAISON DU KELSCH SARL, (U.S. CLS. 1, 2, 3, 22 AND 41). SN 78-461,956. PUB. 6-28-2005. FILED 8-4-2004.
 2,998,156. **BIGIO COLLECTION (BLOCK FORM)**. THE BIGIO GROUP LLC, MULTIPLE CLASS, (INT. CLS. 18 AND 25), (U.S. CLS. 1, 2, 3, 22, 39 AND 41). SN 78-462,099. PUB. 6-28-2005. FILED 8-4-2004.
 2,998,209. **SAMANTHA MACK (BLOCK FORM)**. MCDERMOTT, SAMANTHA, (U.S. CLS. 1, 2, 3, 22 AND 41). SN 78-464,258. PUB. 6-28-2005. FILED 8-9-2004.
 2,998,335 (*See Class 9 for this trademark*).
 2,998,352. **ARMANI JUNIOR (BLOCK FORM)**. GA MODE-FINE S.A., MULTIPLE CLASS, (INT. CLS. 18, 25 AND 35), (U.S. CLS. 1, 2, 3, 22, 39, 41, 100, 101 AND 102). SN 79-000,009. PUB. 6-28-2005. FILED 11-5-2003.
 2,998,414 (*See Class 3 for this trademark*).
 2,998,423 (*See Class 6 for this trademark*).
 2,998,458. **MAURO KRIEGER (BLOCK FORM)**. RAVIZZA MAURO, MULTIPLE CLASS, (INT. CLS. 18 AND 25), (U.S. CLS. 1, 2, 3, 22, 39 AND 41). SN 79-003,361. PUB. 6-28-2005. FILED 2-9-2004.
 2,998,459. **JOKAPI (BLOCK FORM)**. PIERRET JOHAN MARIA ALFONS; PIERRET KAREL LYDIA WILLEM, (U.S. CLS. 1, 2, 3, 22 AND 41). SN 79-003,411. PUB. 6-28-2005. FILED 3-26-2004.
 2,998,469. **ROBERTO DEL CARLO (BLOCK FORM)**. CALZATURIFICIO ROBERTO DEL CARLO S.R.L., MULTIPLE CLASS, (INT. CLS. 18 AND 25), (U.S. CLS. 1, 2, 3, 22, 39 AND 41). SN 79-003,917. PUB. 6-28-2005. FILED 5-5-2004.
 2,998,474 (*See Class 9 for this trademark*).
 2,998,502. **DIRTY DUST (BLOCK FORM)**. TREVER WEIPPER JEANSWEAR S.P.A., MULTIPLE CLASS, (INT. CLS. 18 AND 25), (U.S. CLS. 1, 2, 3, 22, 39 AND 41). SN 79-007,857. PUB. 6-28-2005. FILED 7-29-2004.

CLASS 19—NON-METALLIC BUILDING MATERIALS

2,996,257 (*See Class 1 for this trademark*).

- 2,996,433. **PARETO**. SEOLU NASSAU (UK) LTD, MULTIPLE CLASS, (INT. CLS. 19, 27 AND 28), (U.S. CLS. 1, 12, 19, 20, 22, 23, 33, 37, 38, 42 AND 50). SN 76-544,602. PUB. 6-28-2005. FILED 8-27-2003.
- 2,996,448. **CERALIN**. BSM DEVELOPPEMENT, (U.S. CLS. 1, 12, 33 AND 50). SN 76-549,983. PUB. 6-28-2005. FILED 10-6-2003.
- 2,996,457. **BOIS FRANC VERITAS HARDWOOD AND DESIGN**. MATERIAUX A BAS PRIX LTEE/ BARGAIN BUILDING MATERIALS LTD., (U.S. CLS. 1, 12, 33 AND 50). SN 76-558,048. PUB. 6-14-2005. FILED 11-7-2003.
- 2,996,493. **SAVE-T (STYLIZED)**. TMI INCORPORATED, (U.S. CLS. 1, 12, 33 AND 50). SN 76-568,333. PUB. 6-28-2005. FILED 1-6-2004.
- 2,996,530. **UNI-GUN (BLOCK FORM)**. UNITED REFRACTORIES CO., (U.S. CLS. 1, 12, 33 AND 50). SN 76-570,817. PUB. 6-28-2005. FILED 1-13-2004.
- 2,996,531. **UNI-CAST (BLOCK FORM)**. UNITED REFRACTORIES CO., (U.S. CLS. 1, 12, 33 AND 50). SN 76-570,818. PUB. 6-28-2005. FILED 1-13-2004.
- 2,996,536 (*See Class 11 for this trademark*).
- 2,996,545. **CHEM PRUF DOOR COMPANY, LTD. AND DESIGN**. CHEM PRUF DOOR CO., LTD., (U.S. CLS. 1, 12, 33 AND 50). SN 76-571,655. PUB. 6-28-2005. FILED 1-23-2004.
- 2,996,604 (*See Class 6 for this trademark*).
- 2,996,718. **FARMHOUSE (BLOCK FORM)**. WORLDWIDE CREATIONS, L.L.C., (U.S. CLS. 1, 12, 33 AND 50). SN 76-597,232. PUB. 6-28-2005. FILED 6-14-2004.
- 2,996,774. **HABITAT (BLOCK FORM)**. WILLIAMS, SCOTT, (U.S. CLS. 1, 12, 33 AND 50). SN 76-603,395. PUB. 6-28-2005. FILED 7-22-2004.
- 2,996,993 (*See Class 6 for this trademark*).
- 2,997,141. **GOLDENVINYL (BLOCK FORM)**. GOLDEN WINDOWS LIMITED, (U.S. CLS. 1, 12, 33 AND 50). SN 78-351,792. PUB. 6-28-2005. FILED 1-14-2004.
- 2,997,165. **ARROWHEAD STONE MANUFACTURING (BLOCK FORM)**. ARROWHEAD STONE MANUFACTURING, INC., (U.S. CLS. 1, 12, 33 AND 50). SN 78-358,085. PUB. 6-28-2005. FILED 1-27-2004.
- 2,997,344 (*See Class 6 for this trademark*).
- 2,997,354. **AMERICAN SPLENDOR XL (BLOCK FORM)**. NAPCO, INC., (U.S. CLS. 1, 12, 33 AND 50). SN 78-386,833. PUB. 6-28-2005. FILED 3-18-2004.
- 2,997,547 (*See Class 17 for this trademark*).
- 2,997,772. **VIBROCAST (BLOCK FORM)**. RESCO PRODUCTS, INC., (U.S. CLS. 1, 12, 33 AND 50). SN 78-452,856. PUB. 6-28-2005. FILED 7-19-2004.
- 2,997,955. **TEMPERSTONE (BLOCK FORM)**. SLR, (U.S. CLS. 1, 12, 33 AND 50). SN 78-458,755. PUB. 6-28-2005. FILED 7-29-2004.
- 2,998,140. **AGGCOTE (BLOCK FORM)**. AMERICAN GILSONITE CO., (U.S. CLS. 1, 12, 33 AND 50). SN 78-461,785. PUB. 6-28-2005. FILED 8-4-2004.
- 2,998,198. **PANTHEON (BLOCK FORM)**. PANTHEON FLOOR SOLUTIONS, (U.S. CLS. 1, 12, 33 AND 50). SN 78-463,613. PUB. 6-28-2005. FILED 8-6-2004.
- 2,998,358. **BO KLOK (BLOCK FORM)**. SKANSKA AB, MULTIPLE CLASS, (INT. CLS. 19, 36 AND 37), (U.S. CLS. 1, 12, 33, 50, 100, 101, 102, 103 AND 106). SN 79-000,363. PUB. 6-28-2005. FILED 12-23-2003.
- 2,998,402 (*See Class 6 for this trademark*).
- 2,998,495 (*See Class 1 for this trademark*).
- 2,998,496 (*See Class 6 for this trademark*).
- 6-28-2005. FILED 12-5-2002.
- 2,996,323. **HAG SWING**. HAG ASA, (U.S. CLS. 2, 13, 22, 25, 32 AND 50). SN 76-476,570. PUB. 6-28-2005. FILED 12-18-2002.
- 2,996,341. **THE ORIGINAL MIRACLE MATT**. THE ORIGINAL MIRACLE MATT, (U.S. CLS. 2, 13, 22, 25, 32 AND 50). SN 76-493,761. PUB. 6-28-2005. FILED 2-28-2003.
- 2,996,476 (*See Class 8 for this trademark*).
- 2,996,481. **CAMPER CADDIE (BLOCK FORM)**. FLEETWOOD ENTERPRISES, INC., (U.S. CLS. 2, 13, 22, 25, 32 AND 50). SN 76-566,637. PUB. 6-28-2005. FILED 12-22-2003.
- 2,996,496. **AR-DUE AND DESIGN**. AR-DUE S.P.A., (U.S. CLS. 2, 13, 22, 25, 32 AND 50). SN 76-568,662. PUB. 6-28-2005. FILED 12-24-2003.
- 2,996,547 (*See Class 15 for this trademark*).
- 2,996,570. **CRAB ISLAND (BLOCK FORM)**. T-REX PRODUCTS, INC., MULTIPLE CLASS, (INT. CLS. 20, 21 AND 31), (U.S. CLS. 1, 2, 13, 22, 23, 25, 29, 30, 32, 33, 40, 46 AND 50). SN 76-573,043. PUB. 6-28-2005. FILED 1-28-2004.
- 2,996,639 (*See Class 4 for this trademark*).
- 2,996,648 (*See Class 2 for this trademark*).
- 2,996,662. **SWEET PEA (BLOCK FORM)**. PACIFIC COAST FEATHER COMPANY, (U.S. CLS. 2, 13, 22, 25, 32 AND 50). SN 76-588,671. PUB. 3-8-2005. FILED 4-26-2004.
- 2,996,700. **SHADES OF THE FUTURE (BLOCK FORM)**. SHADES OF THE FUTURE, INC., (U.S. CLS. 2, 13, 22, 25, 32 AND 50). SN 76-595,188. PUB. 6-28-2005. FILED 6-1-2004.
- 2,996,764. **SLEEP ESSENTIALS (BLOCK FORM)**. SLEEP-TECH LLC, (U.S. CLS. 2, 13, 22, 25, 32 AND 50). SN 76-602,570. PUB. 6-28-2005. FILED 7-16-2004.
- 2,996,782. **LUNAR (BLOCK FORM)**. STUDIO RTA, INC., (U.S. CLS. 2, 13, 22, 25, 32 AND 50). SN 76-604,193. PUB. 6-28-2005. FILED 7-26-2004.
- 2,996,789. **EVEN EDGE (BLOCK FORM)**. PACIFIC COAST FEATHER CO., (U.S. CLS. 2, 13, 22, 25, 32 AND 50). SN 76-604,392. PUB. 6-28-2005. FILED 7-26-2004.
- 2,996,810. **THE REAR VIEW MIRROR (BLOCK FORM)**. EVERYDAY SOLUTIONS, LLC, (U.S. CLS. 2, 13, 22, 25, 32 AND 50). SN 76-604,895. PUB. 6-28-2005. FILED 7-30-2004.
- 2,996,943 (*See Class 11 for this trademark*).
- 2,997,010. **MX IMAGE AND DESIGN**. MX IMAGE, LLC, (U.S. CLS. 2, 13, 22, 25, 32 AND 50). SN 78-300,066. PUB. 6-28-2005. FILED 9-13-2003.
- 2,997,017. **VANYPLAS**. INDUSTRIAS VANYPLAS S.A., MULTIPLE CLASS, (INT. CLS. 20 AND 21), (U.S. CLS. 2, 13, 22, 23, 25, 29, 30, 32, 33, 40 AND 50). SN 78-304,379. PUB. 6-28-2005. FILED 9-23-2003.
- 2,997,041. **HOMECREST CABINetry AND DESIGN**. OMEGA IP CO., (U.S. CLS. 2, 13, 22, 25, 32 AND 50). SN 78-324,245. PUB. 6-28-2005. FILED 11-6-2003.
- 2,997,088. **WIT (BLOCK FORM)**. HAWORTH LTD., DBA SMED INTERNATIONAL, (U.S. CLS. 2, 13, 22, 25, 32 AND 50). SN 78-342,121. PUB. 6-28-2005. FILED 12-17-2003.
- 2,997,195 (*See Class 6 for this trademark*).
- 2,997,369. **URBAN JUNGLE (BLOCK FORM)**. BEL AIR INDUSTRIES, MULTIPLE CLASS, (INT. CLS. 20 AND 24), (U.S. CLS. 2, 13, 22, 25, 32, 42 AND 50). SN 78-388,872. PUB. 6-28-2005. FILED 3-23-2004.
- 2,997,403. **MINIPATH (BLOCK FORM)**. HARRIS, NEAL C., (U.S. CLS. 2, 13, 22, 25, 32 AND 50). SN 78-394,490. PUB. 6-28-2005. FILED 4-1-2004.
- 2,997,470. **ORTHO MATTRESS AND DESIGN**. ORTHO MATTRESS INC., (U.S. CLS. 2, 13, 22, 25, 32 AND 50). SN 78-408,935. PUB. 6-28-2005. FILED 4-27-2004.
- 2,997,485. **KITCHEN SENSE AND DESIGN**. WELL TRAVELED IMPORTS, INC., (U.S. CLS. 2, 13, 22, 25, 32 AND 50). SN 78-411,690. PUB. 6-28-2005. FILED 4-30-2004.
- 2,997,619. **PERMAGRAVE (BLOCK FORM)**. PERMAR SYSTEMS, INC., (U.S. CLS. 2, 13, 22, 25, 32 AND 50). SN 78-437,664. PUB. 6-28-2005. FILED 6-18-2004.
- 2,997,629. **SPLASH (BLOCK FORM)**. KIN PRODUCTS, INC., (U.S. CLS. 2, 13, 22, 25, 32 AND 50). SN 78-439,271. PUB. 6-28-2005. FILED 6-22-2004.
- 2,997,827. **CONTOUR (BLOCK FORM)**. OWENS-ILLINOIS CLOSURE INC., (U.S. CLS. 2, 13, 22, 25, 32 AND 50). SN 78-455,553. PUB. 6-28-2005. FILED 7-23-2004.
- 2,997,949. **R AND DESIGN**. RAYNOR MARKETING LTD., DBA THE RAYNOR GROUP, (U.S. CLS. 2, 13, 22, 25, 32 AND 50). SN 78-458,647. PUB. 6-28-2005. FILED 7-29-2004.

CLASS 20—FURNITURE AND ARTICLES NOT OTHERWISE CLASSIFIED

- 2,996,251 (*See Class 6 for this trademark*).
- 2,996,270. **METRO SUPERFOLD**. METRO INDUSTRIES, INC., (U.S. CLS. 2, 13, 22, 25, 32 AND 50). SN 76-354,539. PUB. 6-28-2005. FILED 12-27-2001.
- 2,996,300. **ROOMMATE**. TIFFIN METAL PRODUCTS CO., (U.S. CLS. 2, 13, 22, 25, 32 AND 50). SN 76-436,822. PUB. 6-28-2005. FILED 8-2-2002.
- 2,996,320. **BIT BULL AND DESIGN**. THE MIBRO GROUP, L.C., (U.S. CLS. 2, 13, 22, 25, 32 AND 50). SN 76-473,549. PUB.

- 2,998,303. **LA ROUTE DE LA SOIE AND DESIGN**. BEL AIR INDUSTRIES, MULTIPLE CLASS, (INT. CLS. 20 AND 24), (U.S. CLS. 2, 13, 22, 25, 32, 42 AND 50). SN 78-472,092. PUB. 6-28-2005. FILED 8-23-2004.
- 2,998,342. **SMART SPIN AND DESIGN**. MERCHANT MEDIA, LLC, (U.S. CLS. 2, 13, 22, 25, 32 AND 50). SN 78-551,071. PUB. 6-28-2005. FILED 1-20-2005.
- 2,998,487. **MORELATO (BLOCK FORM)**. MORELATO S.R.L., (U.S. CLS. 2, 13, 22, 25, 32 AND 50). SN 79-005,126. PUB. 6-28-2005. FILED 5-12-2004.

CLASS 21—HOUSEWARES AND GLASS

- 2,996,243 (*See Class 3 for this trademark*).
- 2,996,353. **DICK AND JANE**. PEARSON EDUCATION, INC., (U.S. CLS. 2, 13, 23, 29, 30, 33, 40 AND 50). SN 76-508,632. PUB. 6-28-2005. FILED 4-22-2003.
- 2,996,396 (*See Class 8 for this trademark*).
- 2,996,425 (*See Class 6 for this trademark*).
- 2,996,465. **BABY SAFE FEEDER (BLOCK FORM)**. BERRY, DONALD P., SR., (U.S. CLS. 2, 13, 23, 29, 30, 33, 40 AND 50). SN 76-561,862. PUB. 6-28-2005. FILED 11-24-2003.
- 2,996,476 (*See Class 8 for this trademark*).
- 2,996,568. **SYMETRICIZE (BLOCK FORM)**. PROVEN WINNERS NORTH AMERICA LLC, (U.S. CLS. 2, 13, 23, 29, 30, 33, 40 AND 50). SN 76-572,900. PUB. 6-28-2005. FILED 1-28-2004.
- 2,996,570 (*See Class 20 for this trademark*).
- 2,996,729. **SALAD TO GO (STYLIZED)**. MEDIACORP WORLDWIDE, L.L.C., (U.S. CLS. 2, 13, 23, 29, 30, 33, 40 AND 50). SN 76-598,178. PUB. 6-28-2005. FILED 6-18-2004.
- 2,996,790. **COVERT COOLER (BLOCK FORM)**. SWC DISTRIBUTORS, INC., (U.S. CLS. 2, 13, 23, 29, 30, 33, 40 AND 50). SN 76-604,442. PUB. 6-28-2005. FILED 7-28-2004.
- 2,996,919 (*See Class 8 for this trademark*).
- 2,996,943 (*See Class 11 for this trademark*).
- 2,996,965 (*See Class 2 for this trademark*).
- 2,997,017 (*See Class 20 for this trademark*).
- 2,997,195 (*See Class 6 for this trademark*).
- 2,997,247. **SANTA FLOSS (BLOCK FORM)**. DENTAL EXCELLANCE, (U.S. CLS. 2, 13, 23, 29, 30, 33, 40 AND 50). SN 78-367,592. PUB. 6-28-2005. FILED 2-13-2004.
- 2,997,312. **THE SPIN THAT'S IN (BLOCK FORM)**. ZYLISS USA CORPORATION, (U.S. CLS. 2, 13, 23, 29, 30, 33, 40 AND 50). SN 78-377,320. PUB. 6-28-2005. FILED 3-2-2004.
- 2,997,593. **XEONIC (STYLIZED)**. DAEWOO TECH CO., LTD, (U.S. CLS. 2, 13, 23, 29, 30, 33, 40 AND 50). SN 78-434,727. PUB. 6-28-2005. FILED 6-14-2004.
- 2,997,699 (*See Class 6 for this trademark*).
- 2,997,716 (*See Class 11 for this trademark*).
- 2,997,759. **PROSPERITY JARS (BLOCK FORM)**. COTTAGE GREEN, LLC, (U.S. CLS. 2, 13, 23, 29, 30, 33, 40 AND 50). SN 78-451,719. PUB. 6-28-2005. FILED 7-16-2004.
- 2,997,811. **THERMOTASTIC (BLOCK FORM)**. KAHN.KAHN, INC., (U.S. CLS. 2, 13, 23, 29, 30, 33, 40 AND 50). SN 78-455,106. PUB. 6-28-2005. FILED 7-22-2004.
- 2,997,873 (*See Class 6 for this trademark*).
- 2,997,978. **SHAPE-ITS (BLOCK FORM)**. PANPALS, INC., (U.S. CLS. 2, 13, 23, 29, 30, 33, 40 AND 50). SN 78-459,211. PUB. 6-28-2005. FILED 7-29-2004.
- 2,998,056. **MUGWORLD (BLOCK FORM)**. MUG WORLD INC., (U.S. CLS. 2, 13, 23, 29, 30, 33, 40 AND 50). SN 78-460,375. PUB. 6-28-2005. FILED 8-2-2004.
- 2,998,105. **LOBBY-PRO (BLOCK FORM)**. RUBBERMAID COMMERCIAL PRODUCTS LLC, (U.S. CLS. 2, 13, 23, 29, 30, 33, 40 AND 50). SN 78-461,238. PUB. 6-28-2005. FILED 8-3-2004.
- 2,998,189. **BOTTLE BANGER (BLOCK FORM)**. FIORE, JOSEPH F. JR., (U.S. CLS. 2, 13, 23, 29, 30, 33, 40 AND 50). SN 78-463,177. PUB. 6-28-2005. FILED 8-6-2004.
- 2,998,274 (*See Class 3 for this trademark*).
- 2,998,339 (*See Class 14 for this trademark*).
- 2,998,421. **LACOR AND DESIGN**. MARCOS LARRAÑAGA Y CIA, S.A., (U.S. CLS. 2, 13, 23, 29, 30, 33, 40 AND 50). SN 79-002,120. PUB. 6-28-2005. FILED 12-18-2003.
- 2,998,472. **DIETELLA (BLOCK FORM)**. ILSA SRL, (U.S. CLS.

2, 13, 23, 29, 30, 33, 40 AND 50). SN 79-003,983. PUB. 6-28-2005. FILED 4-21-2004.

CLASS 22—CORDAGE AND FIBERS

- 2,996,490. **WEATHER-PAC (BLOCK FORM)**. MID-STATES ASPHALT AND CAN'T STRIP, INC., (U.S. CLS. 1, 2, 7, 19, 22, 42 AND 50). SN 76-567,849. PUB. 6-28-2005. FILED 12-31-2003.
- 2,997,646. **SKEETA (BLOCK FORM)**. WAYS, DAVID E., MULTIPLE CLASS, (INT. CLS. 22 AND 25), (U.S. CLS. 1, 2, 7, 19, 22, 39, 42 AND 50). SN 78-441,248. PUB. 6-28-2005. FILED 6-25-2004.
- 2,997,929. **VISTRAP (BLOCK FORM)**. ESSICK, INC., (U.S. CLS. 1, 2, 7, 19, 22, 42 AND 50). SN 78-458,222. PUB. 6-28-2005. FILED 7-28-2004.
- 2,998,423 (*See Class 6 for this trademark*).

CLASS 23—YARNS AND THREADS

- 2,996,312. **PRESENCIA HILATURAS, S.A. AND DESIGN**. PRESENCIA HILATURAS, S. A., (U.S. CL. 43). SN 76-465,358. PUB. 6-28-2005. FILED 11-7-2002.
- 2,997,087. **MANETTO HILL YARNERY (BLOCK FORM)**. BUTTONS, ETC., INC., (U.S. CL. 43). SN 78-341,971. PUB. 6-28-2005. FILED 12-17-2003.

CLASS 24—FABRICS

- 2,996,243 (*See Class 3 for this trademark*).
- 2,996,279. **STAY-IN-PLACE MAT**. NEAT SOLUTIONS, INC, (U.S. CLS. 42 AND 50). SN 76-373,773. PUB. 6-28-2005. FILED 2-22-2002.
- 2,996,476 (*See Class 8 for this trademark*).
- 2,996,639 (*See Class 4 for this trademark*).
- 2,996,657. **LEGAL AND DESIGN**. AVERY, DONALD RAY, (U.S. CLS. 42 AND 50). SN 76-587,678. PUB. 6-28-2005. FILED 4-16-2004.
- 2,996,673. **US AND DESIGN**. JONDY CHEMICALS, INC., (U.S. CLS. 42 AND 50). SN 76-590,295. PUB. 6-28-2005. FILED 5-3-2004.
- 2,996,748. **ANNE TAINTOR (BLOCK FORM)**. ANNE TAINTOR, INC., (U.S. CLS. 42 AND 50). SN 76-600,060. PUB. 6-14-2005. FILED 7-1-2004.
- 2,996,955. **SNUGTIME**. C. STUART PTY. LTD., MULTIPLE CLASS, (INT. CLS. 24 AND 25), (U.S. CLS. 22, 39, 42 AND 50). SN 78-256,584. PUB. 6-28-2005. FILED 5-31-2003.
- 2,997,024. **DUCK HOME AND DESIGN**. LEE, HAROLD D, (U.S. CLS. 42 AND 50). SN 78-310,078. PUB. 6-28-2005. FILED 10-7-2003.
- 2,997,369 (*See Class 20 for this trademark*).
- 2,997,481. **JELI DELI AND DESIGN**. SANTORO, LUCIO AND SANTORO, MEERA, (U.S. CLS. 42 AND 50). SN 78-411,090. PUB. 6-28-2005. FILED 4-30-2004.
- 2,997,656. **DIVINE DIMENSIONS INC. (BLOCK FORM)**. DIVINE DIMENSIONS INC., (U.S. CLS. 42 AND 50). SN 78-442,620. PUB. 6-28-2005. FILED 6-28-2004.
- 2,998,006. **LIGHTS OUT (BLOCK FORM)**. ROCKLAND INDUSTRIES, INC., (U.S. CLS. 42 AND 50). SN 78-459,611. PUB. 6-28-2005. FILED 7-30-2004.
- 2,998,274 (*See Class 3 for this trademark*).
- 2,998,284. **TUTTI CUTI AND DESIGN**. SANTORO, LUCIO AND SANTORO, MEERA, (U.S. CLS. 42 AND 50). SN 78-467,815. PUB. 6-28-2005. FILED 8-16-2004.
- 2,998,303 (*See Class 20 for this trademark*).

CLASS 25—CLOTHING

- 2,996,252 (*See Class 18 for this trademark*).

- 2,996,287. **CASTER. HODGMAN, INC.**, (U.S. CLS. 22 AND 39). SN 76-407,036. PUB. 6-28-2005. FILED 5-10-2002.
- 2,996,292. **TOWN & COUNTRY. WOLVERINE WORLD WIDE, INC.**, (U.S. CLS. 22 AND 39). SN 76-413,978. PUB. 6-28-2005. FILED 5-24-2002.
- 2,996,305. **EXTREME SAILING. MOGILNICKI, MILOSZ**, (U.S. CLS. 22 AND 39). SN 76-445,950. PUB. 6-28-2005. FILED 8-30-2002.
- 2,996,342. **JM JAIME MASCARO MENORCA 1918 AND DESIGN. JAIME MASCARO, S.A.**, (U.S. CLS. 22 AND 39). SN 76-495,193. PUB. 6-28-2005. FILED 3-6-2003.
- 2,996,357. **BONOBO. BORJA, CARL**, (U.S. CLS. 22 AND 39). SN 76-513,199. PUB. 6-28-2005. FILED 5-9-2003.
- 2,996,366 (*See Class 18 for this trademark*).
- 2,996,373. **UNDER X. RINGERS RESOURCE, INC.**, (U.S. CLS. 22 AND 39). SN 76-522,841. PUB. 6-28-2005. FILED 6-16-2003.
- 2,996,395 (*See Class 18 for this trademark*).
- 2,996,396 (*See Class 8 for this trademark*).
- 2,996,425 (*See Class 6 for this trademark*).
- 2,996,442. **VANEAQUI. BANE, STEFFANY**, (U.S. CLS. 22 AND 39). SN 76-547,279. PUB. 6-28-2005. FILED 9-26-2003.
- 2,996,458. **VASSAR (BLOCK FORM). VASSAR COLLEGE, MULTIPLE CLASS, (INT. CLS. 25 AND 41), (U.S. CLS. 22, 39, 100, 101 AND 107)**. SN 76-559,288. PUB. 6-28-2005. FILED 11-12-2003.
- 2,996,476 (*See Class 8 for this trademark*).
- 2,996,483. **P-TEC AND DESIGN. COLOTEX INDUSTRIAL CO., LTD.**, (U.S. CLS. 22 AND 39). SN 76-566,902. PUB. 6-28-2005. FILED 12-24-2003.
- 2,996,497. **PAPILLON BY LADYBERG AND DESIGN. LADYBERG S.P.A.**, (U.S. CLS. 22 AND 39). SN 76-568,716. PUB. 6-28-2005. FILED 12-29-2003.
- 2,996,550. **SVEVO (BLOCK FORM). MAVI S.R.L.**, (U.S. CLS. 22 AND 39). SN 76-571,909. PUB. 6-28-2005. FILED 1-26-2004.
- 2,996,552. **MISCELLANEOUS DESIGN. K-SWISS INC.**, (U.S. CLS. 22 AND 39). SN 76-572,114. PUB. 6-28-2005. FILED 1-20-2004.
- 2,996,557 (*See Class 3 for this trademark*).
- 2,996,584. **CALIDAD DOGI AND DESIGN. MARES, FRANCISCO JAVIER CANALES**, (U.S. CLS. 22 AND 39). SN 76-575,142. PUB. 6-28-2005. FILED 2-11-2004.
- 2,996,593. **PINK SUGAR (BLOCK FORM). PINK SUGAR, LLC**, (U.S. CLS. 22 AND 39). SN 76-575,872. PUB. 6-28-2005. FILED 2-12-2004.
- 2,996,597. **BLUME AND DESIGN. INTAPOL INDUSTRIES, INC.**, (U.S. CLS. 22 AND 39). SN 76-576,164. PUB. 6-28-2005. FILED 2-19-2004.
- 2,996,601 (*See Class 9 for this trademark*).
- 2,996,614. **PHILADELPHIA AMERICANS (BLOCK FORM). SMART PARTS, INC.**, MULTIPLE CLASS, (INT. CLS. 25 AND 41), (U.S. CLS. 22, 39, 100, 101 AND 107). SN 76-578,472. PUB. 6-28-2005. FILED 3-1-2004.
- 2,996,623. **RATED X (BLOCK FORM). HAPROFF, BRAD**, (U.S. CLS. 22 AND 39). SN 76-580,328. PUB. 6-28-2005. FILED 3-11-2004.
- 2,996,634. **ROYAL TEES AND DESIGN. PURE & SIMPLE CLOTHING INC.**, (U.S. CLS. 22 AND 39). SN 76-581,941. PUB. 6-28-2005. FILED 3-19-2004.
- 2,996,652. **PROFESSIONAL LACROSSE PLAYERS' ASSOCIATION (BLOCK FORM). PROFESSIONAL LACROSSE PLAYERS' ASSOCIATION**, (U.S. CLS. 22 AND 39). SN 76-586,041. PUB. 6-28-2005. FILED 4-8-2004.
- 2,996,668 (*See Class 16 for this trademark*).
- 2,996,818. **TESTA-CALLS (BLOCK FORM). CHRIVIA, WESLEY B.**, MULTIPLE CLASS, (INT. CLS. 25 AND 28), (U.S. CLS. 22, 23, 38, 39 AND 50). SN 76-605,043. PUB. 6-28-2005. FILED 7-30-2004.
- 2,996,819. **PREMIO SPORT (BLOCK FORM). ESPORTIA INTERNATIONAL, INC.**, (U.S. CLS. 22 AND 39). SN 76-605,050. PUB. 6-28-2005. FILED 7-30-2004.
- 2,996,826. **FISHPOND (BLOCK FORM). FISHPOND, LLC**, (U.S. CLS. 22 AND 39). SN 76-605,128. PUB. 6-28-2005. FILED 8-2-2004.
- 2,996,843. **BODY BLEU (BLOCK FORM). ESPORTIA INTERNATIONAL, INC.**, (U.S. CLS. 22 AND 39). SN 76-605,572. PUB. 6-28-2005. FILED 7-30-2004.
- 2,996,865. **STARR WESTERN WEAR AND DESIGN. STARR WESTERN WEAR, INC.**, MULTIPLE CLASS, (INT. CLS. 25 AND 35), (U.S. CLS. 22, 39, 100, 101 AND 102). SN 76-606,173. PUB. 6-28-2005. FILED 8-3-2004.
- 2,996,871. **MISCELLANEOUS DESIGN. COOGI PARTNERS, LLC**, (U.S. CLS. 22 AND 39). SN 76-606,761. PUB. 6-28-2005. FILED 8-10-2004.
- 2,996,878. **UNITED STATES POSTAL SERVICE AND DESIGN. UNITED STATES POSTAL SERVICE**, (U.S. CLS. 22 AND 39). SN 76-620,315. PUB. 6-28-2005. FILED 11-12-2004.
- 2,996,883 (*See Class 9 for this trademark*).
- 2,996,884. **BG AND DESIGN. BERKLEY GIRL, LLC, MULTIPLE CLASS, (INT. CLS. 25 AND 35), (U.S. CLS. 22, 39, 100, 101 AND 102)**. SN 76-977,007. PUB. 6-28-2005. FILED 7-3-2003.
- 2,996,914 (*See Class 16 for this trademark*).
- 2,996,915. **FUGAMEX PHUONG DONG PHUONG DONG AND DESIGN. PHUONG DONG GARMENT COMPANY**, (U.S. CLS. 22 AND 39). SN 78-199,973. PUB. 6-28-2005. FILED 1-3-2003.
- 2,996,929. **PAVO PROFESSIONAL ASSOCIATION OF VOLLEYBALL OFFICIALS AND DESIGN. PROFESSIONAL ASSOCIATION OF VOLLEYBALL OFFICIALS**, (U.S. CLS. 22 AND 39). SN 78-223,708. PUB. 6-28-2005. FILED 3-10-2003.
- 2,996,935. **VITALI (BLOCK FORM). VITALI CORP.**, (U.S. CLS. 22 AND 39). SN 78-237,756. PUB. 6-28-2005. FILED 4-15-2003.
- 2,996,950. **MISCELLANEOUS DESIGN. GRAHAM RICHARD A.**, (U.S. CLS. 22 AND 39). SN 78-254,132. PUB. 6-28-2005. FILED 5-24-2003.
- 2,996,955 (*See Class 24 for this trademark*).
- 2,996,988. **AMANDAFREESTYLE AND DESIGN. FRIEDLAND, AMANDA, DBA AMANDAFREESTYLE**, (U.S. CLS. 22 AND 39). SN 78-290,733. PUB. 6-28-2005. FILED 8-21-2003.
- 2,997,018. **MEILI & ME AND DESIGN. KATANALI, LLC**, (U.S. CLS. 22 AND 39). SN 78-305,857. PUB. 6-28-2005. FILED 9-26-2003.
- 2,997,023 (*See Class 16 for this trademark*).
- 2,997,029. **BODY CUSHION (BLOCK FORM). POLYMER DYNAMICS TECHNOLOGY INC.**, (U.S. CLS. 22 AND 39). SN 78-313,839. PUB. 6-14-2005. FILED 10-15-2003.
- 2,997,056. **CRAZYWHITEBOYS (BLOCK FORM). SHARPE & OSBURN**, (U.S. CLS. 22 AND 39). SN 78-329,765. PUB. 1-4-2005. FILED 11-18-2003.
- 2,997,082. **DYNAMO HOCKEY AND DESIGN. SHOWCASE ENTERPRISES, INC.**, MULTIPLE CLASS, (INT. CLS. 25 AND 41), (U.S. CLS. 22, 39, 100, 101 AND 107). SN 78-340,298. PUB. 6-28-2005. FILED 12-12-2003.
- 2,997,111. **OC 16 (BLOCK FORM). TIME WARNER ENTERTAINMENT CO., L.P., DBA OCEANIC TIME WARNER CABLE**, MULTIPLE CLASS, (INT. CLS. 25 AND 41), (U.S. CLS. 22, 39, 100, 101 AND 107). SN 78-347,436. PUB. 6-28-2005. FILED 1-2-2004.
- 2,997,117. **FCS AND DESIGN. FIN CONTROL SYSTEMS PTY. LIMITED**, (U.S. CLS. 22 AND 39). SN 78-348,421. PUB. 6-28-2005. FILED 1-6-2004.
- 2,997,124. **MEASUREME (BLOCK FORM). MARSHALL, FELICITY RUTH**, MULTIPLE CLASS, (INT. CLS. 25 AND 44), (U.S. CLS. 22, 39, 100 AND 101). SN 78-349,236. PUB. 6-28-2005. FILED 1-8-2004.
- 2,997,147. **LIL CITY GAME SPITTERS AND DESIGN. HARVEY, TOMMY**, (U.S. CLS. 22 AND 39). SN 78-353,163. PUB. 6-28-2005. FILED 1-16-2004.
- 2,997,150. **SOFIA BEAN AND DESIGN. FOX, AMY E.**, (U.S. CLS. 22 AND 39). SN 78-354,997. PUB. 6-28-2005. FILED 1-21-2004.
- 2,997,163. **MISCELLANEOUS DESIGN. EVANS AND DAVIS**, (U.S. CLS. 22 AND 39). SN 78-357,846. PUB. 6-28-2005. FILED 1-26-2004.
- 2,997,170. **Y'A BON ESPRESSO AND DESIGN. SUSIDKO, LYNN DRENNON**, (U.S. CLS. 22 AND 39). SN 78-358,537. PUB. 6-28-2005. FILED 1-28-2004.
- 2,997,207. **F FORMULA AND DESIGN. FORMULAWERKS, INC.**, (U.S. CLS. 22 AND 39). SN 78-362,068. PUB. 6-28-2005. FILED 2-3-2004.
- 2,997,210. **GRAND OLE OPRY (BLOCK FORM). GAYLORD ENTERTAINMENT COMPANY**, (U.S. CLS. 22 AND 39). SN 78-362,918. PUB. 6-28-2005. FILED 2-5-2004.
- 2,997,215. **MISCELLANEOUS DESIGN. BERRYHILL, JENNIFER C.**, (U.S. CLS. 22 AND 39). SN 78-363,149. PUB. 6-28-

2005. FILED 2-5-2004.
- 2,997,249. **MISCELLANEOUS DESIGN. LUXURY APPAREL GROUP, L.L.C.**, (U.S. CLS. 22 AND 39). SN 78-367,918. PUB. 6-28-2005. FILED 2-13-2004.
- 2,997,252. **URÖK (STYLIZED)**. VRVV, INC., (U.S. CLS. 22 AND 39). SN 78-368,186. PUB. 6-28-2005. FILED 2-14-2004.
- 2,997,253. **WITCHY (BLOCK FORM)**. DAVIDGE, MATTHEW, (U.S. CLS. 22 AND 39). SN 78-368,381. PUB. 6-28-2005. FILED 2-15-2004.
- 2,997,263 (*See Class 18 for this trademark*).
- 2,997,270. **DIVA BY ALLURE LEATHER AND DESIGN. ALLURE LINGERIE INC.**, (U.S. CLS. 22 AND 39). SN 78-370,418. PUB. 6-28-2005. FILED 2-19-2004.
- 2,997,277 (*See Class 16 for this trademark*).
- 2,997,282. **GRACIE (BLOCK FORM)**. GRACIE, RORION, (U.S. CLS. 22 AND 39). SN 78-372,450. PUB. 6-28-2005. FILED 2-23-2004.
- 2,997,295. **UD (STYLIZED)**. BRADCAL, INC., (U.S. CLS. 22 AND 39). SN 78-374,982. PUB. 6-28-2005. FILED 2-26-2004.
- 2,997,324. **ZIPWRAP (BLOCK FORM)**. CHRISTINA AMERICA INC., (U.S. CLS. 22 AND 39). SN 78-379,377. PUB. 6-28-2005. FILED 3-5-2004.
- 2,997,326. **RHINO TRACK AND DESIGN. PARADISE CREEK INVESTMENTS 71 (PTY) LIMITED**, (U.S. CLS. 22 AND 39). SN 78-379,619. PUB. 6-28-2005. FILED 3-5-2004.
- 2,997,330. **SWEARWEAR (BLOCK FORM)**. SWEARWEAR, LLC, (U.S. CLS. 22 AND 39). SN 78-379,889. PUB. 6-28-2005. FILED 3-7-2004.
- 2,997,338. **THE TOY BUNKER (BLOCK FORM)**. LARI, DAVID B., MULTIPLE CLASS, (INT. CLS. 25 AND 28), (U.S. CLS. 22, 23, 38, 39 AND 50). SN 78-383,078. PUB. 6-28-2005. FILED 3-12-2004.
- 2,997,345. **IBEX (BLOCK FORM)**. IBEX OUTDOOR CLOTHING, LLC, (U.S. CLS. 22 AND 39). SN 78-385,078. PUB. 6-28-2005. FILED 3-16-2004.
- 2,997,357. **PP PRECIOUS PREEMIES, INC. AND DESIGN. PRECIOUS PREEMIES, INC.**, (U.S. CLS. 22 AND 39). SN 78-387,191. PUB. 6-28-2005. FILED 3-19-2004.
- 2,997,373 (*See Class 10 for this trademark*).
- 2,997,378. **NETTLETON (BLOCK FORM)**. NETTLETON SHOES, INC., (U.S. CLS. 22 AND 39). SN 78-390,934. PUB. 6-28-2005. FILED 3-25-2004.
- 2,997,379. **BEAR USA AND DESIGN. BEAR U.S.A., INC.**, (U.S. CLS. 22 AND 39). SN 78-391,423. PUB. 6-28-2005. FILED 3-26-2004.
- 2,997,381. **MILLERSVILLE UNIVERSITY (BLOCK FORM)**. MILLERSVILLE UNIVERSITY OF PENNSYLVANIA OF THE STATE SYSTEM OF HIGHER EDUCATION, MULTIPLE CLASS, (INT. CLS. 25 AND 41), (U.S. CLS. 22, 39, 100, 101 AND 107). SN 78-391,656. PUB. 6-28-2005. FILED 3-26-2004.
- 2,997,388. **STAIN-FIGHTER (BLOCK FORM)**. DESIGNS APPAREL, INC., (U.S. CLS. 22 AND 39). SN 78-393,105. PUB. 6-28-2005. FILED 3-30-2004.
- 2,997,389. **FLEX-ZONE (BLOCK FORM)**. DESIGNS APPAREL, INC., (U.S. CLS. 22 AND 39). SN 78-393,114. PUB. 6-28-2005. FILED 3-30-2004.
- 2,997,390. **BEACHBONES (BLOCK FORM)**. MARTIN, DAVID L., (U.S. CLS. 22 AND 39). SN 78-393,182. PUB. 6-28-2005. FILED 3-30-2004.
- 2,997,397. **FRESH PRODUCE (STYLIZED)**. FRESH PRODUCE SPORTSWEAR, INC., (U.S. CLS. 22 AND 39). SN 78-393,430. PUB. 6-28-2005. FILED 3-30-2004.
- 2,997,398. **MAGIC 32 (BLOCK FORM)**. JUNE BUG ENTERPRISES, INC., (U.S. CLS. 22 AND 39). SN 78-393,467. PUB. 6-28-2005. FILED 3-30-2004.
- 2,997,421 (*See Class 9 for this trademark*).
- 2,997,427. **RUSS K MAKAHA AND DESIGN. CRK, INC.**, DBA RUSS K MAKAHA, MULTIPLE CLASS, (INT. CLS. 25 AND 28), (U.S. CLS. 22, 23, 38, 39 AND 50). SN 78-401,312. PUB. 6-28-2005. FILED 4-13-2004.
- 2,997,430. **CARIBBEAN SURF CO. AND DESIGN. BELCHER, JOB O. III**, (U.S. CLS. 22 AND 39). SN 78-401,944. PUB. 6-28-2005. FILED 4-14-2004.
- 2,997,433. **CYPRESS CLUB AND DESIGN. DESIGN IN MOTION, INC.**, (U.S. CLS. 22 AND 39). SN 78-402,262. PUB. 6-28-2005. FILED 4-15-2004.
- 2,997,456. **INSIGNIA AND DESIGN. PEARISON, INC.**, (U.S. CLS. 22 AND 39). SN 78-405,493. PUB. 6-28-2005. FILED 4-21-2004.
- 2,997,460 (*See Class 2 for this trademark*).
- 2,997,475. **PRAIRIE RIDER (BLOCK FORM)**. PAUL, ALISA VINCENT, (U.S. CLS. 22 AND 39). SN 78-410,516. PUB. 6-28-2005. FILED 4-29-2004.
- 2,997,495. **PB SURF AND DESIGN. BUNTEMAYER, PETE W.**, (U.S. CLS. 22 AND 39). SN 78-413,311. PUB. 6-28-2005. FILED 5-5-2004.
- 2,997,496. **PHENOMENAL FITNESS PERSONAL TRAINING AND DESIGN. ARMSTEAD, ANTHONY S.**, MULTIPLE CLASS, (INT. CLS. 25 AND 41), (U.S. CLS. 22, 39, 100, 101 AND 107). SN 78-413,628. PUB. 6-28-2005. FILED 5-5-2004.
- 2,997,510 (*See Class 3 for this trademark*).
- 2,997,523. **ELB AND DESIGN. ELB DESIGNS**, (U.S. CLS. 22 AND 39). SN 78-420,334. PUB. 6-28-2005. FILED 5-17-2004.
- 2,997,568. **MISCELLANEOUS DESIGN. EXTREME TEAM INC.**, MULTIPLE CLASS, (INT. CLS. 25 AND 28), (U.S. CLS. 22, 23, 38, 39 AND 50). SN 78-430,176. PUB. 5-3-2005. FILED 6-4-2004.
- 2,997,577. **SHRIMPO (BLOCK FORM)**. CURRY, CHRISTOPHER, MULTIPLE CLASS, (INT. CLS. 25 AND 42), (U.S. CLS. 22, 39, 100 AND 101). SN 78-431,978. PUB. 6-28-2005. FILED 6-8-2004.
- 2,997,583. **LOOKWELL BIKE FASHION (BLOCK FORM)**. CBS, INC, DBA MOTO IMPORTS, (U.S. CLS. 22 AND 39). SN 78-433,240. PUB. 6-28-2005. FILED 6-10-2004.
- 2,997,605. **IN THE PAINT (BLOCK FORM)**. AZZOLINI, JOSEPH, (U.S. CLS. 22 AND 39). SN 78-436,304. PUB. 6-28-2005. FILED 6-16-2004.
- 2,997,626. **LANCASTER COUNTY CHOPPERS (BLOCK FORM)**. JUST SAY ROCK, INC., (U.S. CLS. 22 AND 39). SN 78-439,096. PUB. 6-28-2005. FILED 6-22-2004.
- 2,997,634. **APARTMENT (BLOCK FORM)**. APARTMENT AGENCIES LTD., (U.S. CLS. 22 AND 39). SN 78-439,708. PUB. 6-28-2005. FILED 6-22-2004.
- 2,997,639. **REV'N (STYLIZED)**. XTEE ENTERPRISES, INC., (U.S. CLS. 22 AND 39). SN 78-440,369. PUB. 6-28-2005. FILED 6-23-2004.
- 2,997,646 (*See Class 22 for this trademark*).
- 2,997,666. **MISCELLANEOUS DESIGN. CANTRELL, OSSIO-LA A.** (U.S. CLS. 22 AND 39). SN 78-443,466. PUB. 6-28-2005. FILED 6-29-2004.
- 2,997,670 (*See Class 16 for this trademark*).
- 2,997,678 (*See Class 18 for this trademark*).
- 2,997,679. **MISCELLANEOUS DESIGN. GAYNOR MINDEN, INC.**, (U.S. CLS. 22 AND 39). SN 78-444,559. PUB. 6-28-2005. FILED 7-1-2004.
- 2,997,680. **SMOOCH HIP HOP AND DESIGN. SMOOCH, INC.**, MULTIPLE CLASS, (INT. CLS. 25 AND 41), (U.S. CLS. 22, 39, 100, 101 AND 107). SN 78-444,560. PUB. 6-28-2005. FILED 7-1-2004.
- 2,997,688. **SMOOCH COUNTRY AND DESIGN. SMOOCH, INC.**, MULTIPLE CLASS, (INT. CLS. 25 AND 41), (U.S. CLS. 22, 39, 100, 101 AND 107). SN 78-444,953. PUB. 6-28-2005. FILED 7-1-2004.
- 2,997,689. **SMOOCH JAZZ (BLOCK FORM)**. SMOOCH, INC., MULTIPLE CLASS, (INT. CLS. 25 AND 41), (U.S. CLS. 22, 39, 100, 101 AND 107). SN 78-444,985. PUB. 6-28-2005. FILED 7-1-2004.
- 2,997,717. **CAMEL HAIR PLUS (BLOCK FORM)**. WEBER-ARIES, INC., (U.S. CLS. 22 AND 39). SN 78-448,259. PUB. 6-28-2005. FILED 7-9-2004.
- 2,997,719. **CASHMERE ULTRA (BLOCK FORM)**. WEBER-ARIES, INC., (U.S. CLS. 22 AND 39). SN 78-448,265. PUB. 6-28-2005. FILED 7-9-2004.
- 2,997,767. **CLOG MASTER (BLOCK FORM)**. CLOG MASTER OF SWEDEN, INC., (U.S. CLS. 22 AND 39). SN 78-452,562. PUB. 6-28-2005. FILED 7-19-2004.
- 2,997,793 (*See Class 14 for this trademark*).
- 2,997,795. **KULANUI (BLOCK FORM)**. UNIVERSITY OF HAWAII, (U.S. CLS. 22 AND 39). SN 78-454,222. PUB. 6-28-2005. FILED 7-21-2004.
- 2,997,818. **OROC (BLOCK FORM)**. OROC, INC., MULTIPLE CLASS, (INT. CLS. 25 AND 36), (U.S. CLS. 22, 39, 100, 101 AND 102). SN 78-455,311. PUB. 6-28-2005. FILED 7-22-2004.
- 2,997,835. **LOSE THE CARBS. NOT THE RACE. (BLOCK FORM)**. ANHEUSER-BUSCH, INCORPORATED, (U.S.

- CLS. 22 AND 39). SN 78-455,757. PUB. 6-28-2005. FILED 7-23-2004.
- 2,997,874. **EAST FIFTH (BLOCK FORM)**. J. C. PENNEY PRIVATE BRANDS, INC., (U.S. CLS. 22 AND 39). SN 78-457,096. PUB. 6-28-2005. FILED 7-27-2004.
- 2,997,887. **SO INVISIBLE (BLOCK FORM)**. MAYER/BERKSHIRE CORPORATION, (U.S. CLS. 22 AND 39). SN 78-457,244. PUB. 6-28-2005. FILED 7-27-2004.
- 2,997,907. **SMOOCH ROCK AND DESIGN**. SMOOCH, INC., MULTIPLE CLASS, (INT. CLS. 25 AND 41), (U.S. CLS. 22, 39, 100, 101 AND 107). SN 78-457,704. PUB. 6-28-2005. FILED 7-27-2004.
- 2,997,908. **SMOOCH OLDIES AND DESIGN**. SMOOCH, INC., MULTIPLE CLASS, (INT. CLS. 25 AND 41), (U.S. CLS. 22, 39, 100, 101 AND 107). SN 78-457,714. PUB. 6-28-2005. FILED 7-27-2004.
- 2,997,909. **SMOOCH LATINO AND DESIGN**. SMOOCH, INC., MULTIPLE CLASS, (INT. CLS. 25 AND 41), (U.S. CLS. 22, 39, 100, 101 AND 107). SN 78-457,723. PUB. 6-28-2005. FILED 7-27-2004.
- 2,997,910 (*See Class 9 for this trademark*).
- 2,997,981 (*See Class 9 for this trademark*).
- 2,997,983. **SW AND DESIGN**. MAXIMA TECHNOLOGIES & SYSTEMS, INC., (U.S. CLS. 22 AND 39). SN 78-459,311. PUB. 6-28-2005. FILED 7-30-2004.
- 2,998,021. **JUSTICE LEAGUE (BLOCK FORM)**. DC COMICS, (U.S. CLS. 22 AND 39). SN 78-459,924. PUB. 6-28-2005. FILED 7-30-2004.
- 2,998,039. **IA IRON AGE AND DESIGN**. IRON AGE CORPORATION, (U.S. CLS. 22 AND 39). SN 78-460,215. PUB. 6-28-2005. FILED 8-2-2004.
- 2,998,065. **HOODIO (BLOCK FORM)**. GAP (APPAREL), LLC, (U.S. CLS. 22 AND 39). SN 78-460,444. PUB. 6-28-2005. FILED 8-2-2004.
- 2,998,069. **LA MARCA DEL DIABLO (BLOCK FORM)**. RAMIREZ, RICARDO, (U.S. CLS. 22 AND 39). SN 78-460,522. PUB. 6-28-2005. FILED 8-2-2004.
- 2,998,091. **TISHA (BLOCK FORM)**. LE MYSTERE GROUP LLC, (U.S. CLS. 22 AND 39). SN 78-460,995. PUB. 6-28-2005. FILED 8-3-2004.
- 2,998,100. **IRONMAN AND DESIGN**. WORLD TRIATHLON CORPORATION, (U.S. CLS. 22 AND 39). SN 78-461,212. PUB. 6-28-2005. FILED 8-3-2004.
- 2,998,129. **WRANGLER (BLOCK FORM)**. WRANGLER APPAREL CORP., (U.S. CLS. 22 AND 39). SN 78-461,590. PUB. 6-28-2005. FILED 8-4-2004.
- 2,998,144. **HAUTE COQ AND DESIGN**. ARMSTRONG, RODERICK, J, (U.S. CLS. 22 AND 39). SN 78-461,869. PUB. 6-28-2005. FILED 8-4-2004.
- 2,998,156 (*See Class 18 for this trademark*).
- 2,998,160. **INBRED (BLOCK FORM)**. LITZ, JOHN, (U.S. CLS. 22 AND 39). SN 78-462,129. PUB. 6-28-2005. FILED 8-4-2004.
- 2,998,178. **SAM'S TOWN (BLOCK FORM)**. BOYD GAMING CORPORATION, (U.S. CLS. 22 AND 39). SN 78-462,764. PUB. 6-28-2005. FILED 8-5-2004.
- 2,998,215. **SAVE YOUR SOLE (BLOCK FORM)**. DANCE PAWS, LLC, (U.S. CLS. 22 AND 39). SN 78-464,496. PUB. 6-28-2005. FILED 8-9-2004.
- 2,998,221. **SORBOALIGN (BLOCK FORM)**. SORBOTHANE, INC., (U.S. CLS. 22 AND 39). SN 78-464,779. PUB. 6-28-2005. FILED 8-10-2004.
- 2,998,230. **MUNKYBONE (BLOCK FORM)**. ANDRE, ROB, (U.S. CLS. 22 AND 39). SN 78-464,891. PUB. 6-28-2005. FILED 8-10-2004.
- 2,998,231. **LANDERWOOD (BLOCK FORM)**. LANDERWOOD CORPORATION, (U.S. CLS. 22 AND 39). SN 78-464,903. PUB. 6-28-2005. FILED 8-10-2004.
- 2,998,258. **WRANGLER RUGGED WEAR (BLOCK FORM)**. WRANGLER APPAREL CORP., (U.S. CLS. 22 AND 39). SN 78-466,171. PUB. 6-28-2005. FILED 8-12-2004.
- 2,998,270. **PALADIN (BLOCK FORM)**. D'ACCORD, INC., (U.S. CLS. 22 AND 39). SN 78-467,072. PUB. 6-28-2005. FILED 8-13-2004.
- 2,998,281. **MING DO AND DESIGN**. CHEN, GUOLIN, (U.S. CLS. 22 AND 39). SN 78-467,522. PUB. 6-28-2005. FILED 8-13-2004.
- 2,998,290. **HUEVOCARTOON.COM AND DESIGN**. COMUNIDAD HUEVO, S.A. DE C.V., (U.S. CLS. 22 AND 39). SN 78-469,262. PUB. 6-28-2005. FILED 8-18-2004.
- 2,998,301. **ABOLOGY (BLOCK FORM)**. POW WOW INC., (U.S. CLS. 22 AND 39). SN 78-470,921. PUB. 6-28-2005. FILED 8-20-2004.
- 2,998,305. **KIRRA AND DESIGN**. PACIFIC SUNWEAR OF CALIFORNIA, (U.S. CLS. 22 AND 39). SN 78-478,188. PUB. 6-28-2005. FILED 9-2-2004.
- 2,998,307. **SMOOCH R&B (BLOCK FORM)**. SMOOCH, INC., MULTIPLE CLASS, (INT. CLS. 25 AND 41), (U.S. CLS. 22, 39, 100, 101 AND 107). SN 78-492,315. PUB. 6-28-2005. FILED 9-30-2004.
- 2,998,308. **SMOOCH R&B AND DESIGN**. SMOOCH, INC., MULTIPLE CLASS, (INT. CLS. 25 AND 41), (U.S. CLS. 22, 39, 100, 101 AND 107). SN 78-492,474. PUB. 6-28-2005. FILED 9-30-2004.
- 2,998,309. **SMOOCH SOUL (BLOCK FORM)**. SMOOCH, INC., MULTIPLE CLASS, (INT. CLS. 25 AND 41), (U.S. CLS. 22, 39, 100, 101 AND 107). SN 78-492,504. PUB. 6-28-2005. FILED 9-30-2004.
- 2,998,310. **SMOOCH SOUL AND DESIGN**. SMOOCH, INC., MULTIPLE CLASS, (INT. CLS. 25 AND 41), (U.S. CLS. 22, 39, 100, 101 AND 107). SN 78-492,520. PUB. 6-28-2005. FILED 9-30-2004.
- 2,998,311. **SMOOCH POP (BLOCK FORM)**. SMOOCH, INC., MULTIPLE CLASS, (INT. CLS. 25 AND 41), (U.S. CLS. 22, 39, 100, 101 AND 107). SN 78-492,559. PUB. 6-28-2005. FILED 9-30-2004.
- 2,998,312. **SMOOCH POP AND DESIGN**. SMOOCH, INC., MULTIPLE CLASS, (INT. CLS. 25 AND 41), (U.S. CLS. 22, 39, 100, 101 AND 107). SN 78-492,565. PUB. 6-28-2005. FILED 9-30-2004.
- 2,998,313. **SMOOCH MUSIC (BLOCK FORM)**. SMOOCH, INC., MULTIPLE CLASS, (INT. CLS. 25 AND 41), (U.S. CLS. 22, 39, 100, 101 AND 107). SN 78-492,582. PUB. 6-28-2005. FILED 9-30-2004.
- 2,998,314. **SMOOCH MUSIC AND DESIGN**. SMOOCH, INC., MULTIPLE CLASS, (INT. CLS. 25 AND 41), (U.S. CLS. 22, 39, 100, 101 AND 107). SN 78-492,594. PUB. 6-28-2005. FILED 9-30-2004.
- 2,998,315. **SMOOCH BLUES (BLOCK FORM)**. SMOOCH, INC., MULTIPLE CLASS, (INT. CLS. 25 AND 41), (U.S. CLS. 22, 39, 100, 101 AND 107). SN 78-497,934. PUB. 6-28-2005. FILED 10-11-2004.
- 2,998,316. **SMOOCH BLUES AND DESIGN**. SMOOCH, INC., MULTIPLE CLASS, (INT. CLS. 25 AND 41), (U.S. CLS. 22, 39, 100, 101 AND 107). SN 78-497,940. PUB. 6-28-2005. FILED 10-11-2004.
- 2,998,317. **SMOOCH MANIA (BLOCK FORM)**. SMOOCH, INC., MULTIPLE CLASS, (INT. CLS. 25 AND 41), (U.S. CLS. 22, 39, 100, 101 AND 107). SN 78-497,965. PUB. 6-28-2005. FILED 10-11-2004.
- 2,998,318. **SMOOCH CLASSICS (BLOCK FORM)**. SMOOCH, INC., MULTIPLE CLASS, (INT. CLS. 25 AND 41), (U.S. CLS. 22, 39, 100, 101 AND 107). SN 78-497,975. PUB. 6-28-2005. FILED 10-11-2004.
- 2,998,323. **SMOOCH CLASSICS AND DESIGN**. SMOOCH, INC., MULTIPLE CLASS, (INT. CLS. 25 AND 41), (U.S. CLS. 22, 39, 100, 101 AND 107). SN 78-504,640. PUB. 6-28-2005. FILED 10-22-2004.
- 2,998,324. **SMOOCH USA (BLOCK FORM)**. SMOOCH, INC., MULTIPLE CLASS, (INT. CLS. 25 AND 41), (U.S. CLS. 22, 39, 100, 101 AND 107). SN 78-504,657. PUB. 6-28-2005. FILED 10-22-2004.
- 2,998,325. **SMOOCH USA AND DESIGN**. SMOOCH, INC., MULTIPLE CLASS, (INT. CLS. 25 AND 41), (U.S. CLS. 22, 39, 100, 101 AND 107). SN 78-504,665. PUB. 6-28-2005. FILED 10-22-2004.
- 2,998,327. **DOSHO (BLOCK FORM)**. SHIFFERAW, TESSEMA DOSHO, MULTIPLE CLASS, (INT. CLS. 25 AND 28), (U.S. CLS. 22, 23, 38, 39 AND 50). SN 78-507,437. PUB. 6-28-2005. FILED 10-28-2004.
- 2,998,332. **WRANGLER HERO (BLOCK FORM)**. WRANGLER APPAREL CORP., (U.S. CLS. 22 AND 39). SN 78-527,744. PUB. 6-28-2005. FILED 12-6-2004.
- 2,998,335 (*See Class 9 for this trademark*).
- 2,998,339 (*See Class 14 for this trademark*).
- 2,998,352 (*See Class 18 for this trademark*).
- 2,998,355 (*See Class 14 for this trademark*).

- 2,998,362. **MISCELLANEOUS DESIGN**. COLORBLIND S.A., (U.S. CLS. 22 AND 39). SN 79-000,469. PUB. 6-28-2005. FILED 12-23-2003.
- 2,998,376. **PROTECTIVE AND DESIGN**. THALER EVENT GBR, (U.S. CLS. 22 AND 39). SN 79-000,959. PUB. 6-28-2005. FILED 1-7-2004.
- 2,998,378. **SXEY (BLOCK FORM)**. OZ E TRADING POST PTY LTD, (U.S. CLS. 22 AND 39). SN 79-001,008. PUB. 6-28-2005. FILED 2-6-2004.
- 2,998,384. **ZIPÈ (STYLIZED)**. MR OSCAR ALEXANDER VOKES, (U.S. CLS. 22 AND 39). SN 79-001,219. PUB. 6-28-2005. FILED 2-18-2004.
- 2,998,401. **KATE MILLER (BLOCK FORM)**. WE S.N.C., (U.S. CLS. 22 AND 39). SN 79-001,566. PUB. 6-28-2005. FILED 1-16-2004.
- 2,998,413. **CF AND DESIGN**. CALZATURIFICIO F.LLI CAPONI S.R.L., (U.S. CLS. 22 AND 39). SN 79-001,948. PUB. 6-28-2005. FILED 2-27-2004.
- 2,998,414 (*See Class 3 for this trademark*).
- 2,998,416. **COCCAPANI (STYLIZED)**. IL MARCHESE COCCAPANI S.P.A., (U.S. CLS. 22 AND 39). SN 79-001,974. PUB. 6-28-2005. FILED 2-26-2004.
- 2,998,455. **STREETBANDIT (BLOCK FORM)**. EXEL OY, MULTIPLE CLASS, (INT. CLS. 25, 28 AND 41), (U.S. CLS. 22, 23, 38, 39, 50, 100, 101 AND 107). SN 79-003,272. PUB. 6-28-2005. FILED 12-17-2003.
- 2,998,458 (*See Class 18 for this trademark*).
- 2,998,465. **WOMEN WILL (BLOCK FORM)**. SALOMON S.A., MULTIPLE CLASS, (INT. CLS. 25, 28 AND 35), (U.S. CLS. 22, 23, 38, 39, 50, 100, 101 AND 102). SN 79-003,645. PUB. 6-28-2005. FILED 3-25-2004.
- 2,998,467. **NADI ATMA (BLOCK FORM)**. SHANGHAI RUNDAN TRADING CO., LTD., (U.S. CLS. 22 AND 39). SN 79-003,884. PUB. 6-28-2005. FILED 5-9-2004.
- 2,998,468. **NADI (BLOCK FORM)**. SHANGHAI RUNDAN TRADING CO., LTD., (U.S. CLS. 22 AND 39). SN 79-003,885. PUB. 6-28-2005. FILED 5-9-2004.
- 2,998,469 (*See Class 18 for this trademark*).
- 2,998,502 (*See Class 18 for this trademark*).
- 2,998,503. **RESET RESIST SETTLING DOWN. AND DESIGN**. I.M.C. INTERNATIONAL MANUFACTURING; COMPANY S.R.L., (U.S. CLS. 22 AND 39). SN 79-008,250. PUB. 6-28-2005. FILED 8-3-2004.

CLASS 26—FANCY GOODS

- 2,996,598. **SCREAMING BEAUTY. (BLOCK FORM)**. MASCHIO, VALERIE, (U.S. CLS. 37, 39, 40, 42 AND 50). SN 76-576,220. PUB. 6-28-2005. FILED 2-13-2004.
- 2,996,630. **PIGLETS (BLOCK FORM)**. STRAUSS, KAREN, (U.S. CLS. 37, 39, 40, 42 AND 50). SN 76-581,403. PUB. 6-28-2005. FILED 3-15-2004.
- 2,998,476 (*See Class 3 for this trademark*).

CLASS 27—FLOOR COVERINGS

- 2,996,386. **INTEGRATED CUSHION THERMOBOND**. BI PROPERTIES I INC., (U.S. CLS. 19, 20, 37, 42 AND 50). SN 76-528,353. PUB. 6-28-2005. FILED 7-10-2003.
- 2,996,433 (*See Class 19 for this trademark*).
- 2,996,460 (*See Class 11 for this trademark*).
- 2,996,815. **MOMENTUM (BLOCK FORM)**. TRIEXE MANAGEMENT GROUP INC., (U.S. CLS. 19, 20, 37, 42 AND 50). SN 76-604,970. PUB. 6-28-2005. FILED 8-2-2004.
- 2,997,344 (*See Class 6 for this trademark*).
- 2,998,142. **NEED NEW CARPET OR FLOORING? (BLOCK FORM)**. SMART CARPET, INCORPORATED, (U.S. CLS. 19, 20, 37, 42 AND 50). SN 78-461,867. PUB. 6-28-2005. FILED 8-4-2004.
- 2,998,224. **SURFACES CONTRACT WALLCOVERING (BLOCK FORM)**. STARK CARPET CORP., (U.S. CLS. 19, 20, 37, 42 AND 50). SN 78-464,820. PUB. 6-28-2005. FILED 8-10-2004.

- 2,998,227. **SURFACES CONTRACT WALLCOVERING (STYLIZED)**. STARK CARPET CORP., (U.S. CLS. 19, 20, 37, 42 AND 50). SN 78-464,853. PUB. 6-28-2005. FILED 8-10-2004.

CLASS 28—TOYS AND SPORTING GOODS

- 2,996,243 (*See Class 3 for this trademark*).
- 2,996,252 (*See Class 18 for this trademark*).
- 2,996,282. **IMPACT**. ARMINIUS SELECT SERVICES CORPORATION, (U.S. CLS. 22, 23, 38 AND 50). SN 76-396,916. PUB. 6-28-2005. FILED 4-17-2002.
- 2,996,321. **PINELAND**. BARCANA, INC., DBA BARTHELMESS U.S.A., (U.S. CLS. 22, 23, 38 AND 50). SN 76-475,012. PUB. 6-28-2005. FILED 12-11-2002.
- 2,996,366 (*See Class 18 for this trademark*).
- 2,996,396 (*See Class 8 for this trademark*).
- 2,996,433 (*See Class 19 for this trademark*).
- 2,996,449. **MISCELLANEOUS DESIGN**. KYOSHO CORPORATION, (U.S. CLS. 22, 23, 38 AND 50). SN 76-550,022. PUB. 6-28-2005. FILED 10-8-2003.
- 2,996,484. **POWERLOCK (BLOCK FORM)**. NEIL PRYDE LIMITED, (U.S. CLS. 22, 23, 38 AND 50). SN 76-567,695. PUB. 6-28-2005. FILED 12-17-2003.
- 2,996,500. **TIGER ELECTRONICS AND DESIGN**. HASBRO, INC., (U.S. CLS. 22, 23, 38 AND 50). SN 76-568,955. PUB. 6-28-2005. FILED 1-8-2004.
- 2,996,537. **VECTOR MI (BLOCK FORM)**. SAEILO ENTERPRISES, INC., (U.S. CLS. 22, 23, 38 AND 50). SN 76-571,337. PUB. 6-28-2005. FILED 1-22-2004.
- 2,996,548. **ELEMENTS (BLOCK FORM)**. GREENE PLASTICS CORPORATION, (U.S. CLS. 22, 23, 38 AND 50). SN 76-571,838. PUB. 6-28-2005. FILED 1-26-2004.
- 2,996,592. **WERKS RACING (BLOCK FORM)**. RC IMPORTS, (U.S. CLS. 22, 23, 38 AND 50). SN 76-575,678. PUB. 6-14-2005. FILED 2-2-2004.
- 2,996,599. **PHAT PACK (BLOCK FORM)**. RADICA GAMES LTD., (U.S. CLS. 22, 23, 38 AND 50). SN 76-576,246. PUB. 6-28-2005. FILED 2-12-2004.
- 2,996,601 (*See Class 9 for this trademark*).
- 2,996,611. **IMPREST (BLOCK FORM)**. IMPREST PTY LTD, (U.S. CLS. 22, 23, 38 AND 50). SN 76-578,273. PUB. 6-28-2005. FILED 2-27-2004.
- 2,996,642. **KARAOKE KRITTERS (BLOCK FORM)**. CYI, INC., (U.S. CLS. 22, 23, 38 AND 50). SN 76-584,275. PUB. 6-28-2005. FILED 3-29-2004.
- 2,996,681. **SLOT-LOC (BLOCK FORM)**. DOSKOCIL MANUFACTURING COMPANY, INC., (U.S. CLS. 22, 23, 38 AND 50). SN 76-591,567. PUB. 6-28-2005. FILED 5-10-2004.
- 2,996,713. **DREAM LLAMA (STYLIZED)**. SMART GIRL INVESTMENTS, LLC, (U.S. CLS. 22, 23, 38 AND 50). SN 76-596,384. PUB. 6-28-2005. FILED 6-9-2004.
- 2,996,818 (*See Class 25 for this trademark*).
- 2,996,839. **GAMEWRIGHT (BLOCK FORM)**. CEACO, INC., (U.S. CLS. 22, 23, 38 AND 50). SN 76-605,479. PUB. 6-28-2005. FILED 8-4-2004.
- 2,996,840. **CEACO (BLOCK FORM)**. CEACO, INC., (U.S. CLS. 22, 23, 38 AND 50). SN 76-605,481. PUB. 6-28-2005. FILED 8-4-2004.
- 2,996,886. **BLIZZARD**. WHAM-O, INC., (U.S. CLS. 22, 23, 38 AND 50). SN 78-054,818. PUB. 6-28-2005. FILED 3-23-2001.
- 2,996,901. **ZODIAC GIRLZ**. 3 MUSES, LLC, (U.S. CLS. 22, 23, 38 AND 50). SN 78-165,130. PUB. 6-28-2005. FILED 9-17-2002.
- 2,996,921. **ROD HUKI**. HUKI CORPORATION, (U.S. CLS. 22, 23, 38 AND 50). SN 78-215,193. PUB. 6-28-2005. FILED 2-14-2003.
- 2,997,013 (*See Class 14 for this trademark*).
- 2,997,036. **MISCELLANEOUS DESIGN**. GENERAL MOTORS CORPORATION, (U.S. CLS. 22, 23, 38 AND 50). SN 78-321,366. PUB. 6-28-2005. FILED 10-31-2003.
- 2,997,118. **FCS AND DESIGN**. FIN CONTROL SYSTEMS PTY. LIMITED, (U.S. CLS. 22, 23, 38 AND 50). SN 78-348,439. PUB. 6-28-2005. FILED 1-6-2004.
- 2,997,211. **GRAND OLE OPRÝ (BLOCK FORM)**. GAYLORD ENTERTAINMENT COMPANY, (U.S. CLS. 22, 23, 38 AND 50). SN 78-362,971. PUB. 6-28-2005. FILED 2-5-2004.
- 2,997,338 (*See Class 25 for this trademark*).

2,997,341. **PEAKPILATES (BLOCK FORM)**. PEAK BODY SYSTEMS, INC., (U.S. CLS. 22, 23, 38 AND 50). SN 78-384,139. PUB. 6-28-2005. FILED 3-15-2004.

2,997,427 (*See Class 25 for this trademark*).

2,997,477. **D-CLEATER (BLOCK FORM)**. DECLEATER, INC., (U.S. CLS. 22, 23, 38 AND 50). SN 78-410,775. PUB. 6-28-2005. FILED 4-29-2004.

2,997,568 (*See Class 25 for this trademark*).

2,997,579. **BENTLEY (BLOCK FORM)**. COMPETITION SPORTS CORP., (U.S. CLS. 22, 23, 38 AND 50). SN 78-432,477. PUB. 6-28-2005. FILED 6-9-2004.

2,997,659. **DIABLO ROJO (BLOCK FORM)**. RICHMOND GOLF CORP., (U.S. CLS. 22, 23, 38 AND 50). SN 78-442,825. PUB. 6-28-2005. FILED 6-29-2004.

2,997,760. **WALLAMOPPI (BLOCK FORM)**. OUT OF THE BOX PUBLISHING, INC., (U.S. CLS. 22, 23, 38 AND 50). SN 78-451,731. PUB. 6-28-2005. FILED 7-16-2004.

2,997,828. **GAMELAB (STYLIZED)**. GAMELAB LLC, (U.S. CLS. 22, 23, 38 AND 50). SN 78-455,584. PUB. 6-28-2005. FILED 7-23-2004.

2,997,852. **BOB TOMAN (BLOCK FORM)**. TOMAN, ROBERT NORRIS, (U.S. CLS. 22, 23, 38 AND 50). SN 78-456,529. PUB. 6-28-2005. FILED 7-26-2004.

2,997,868. **AEROGLASS (BLOCK FORM)**. SHIMANO INC., (U.S. CLS. 22, 23, 38 AND 50). SN 78-457,002. PUB. 6-28-2005. FILED 7-26-2004.

2,997,869. **AEROGLASS CONSTRUCTION AND DESIGN**. SHIMANO INC., (U.S. CLS. 22, 23, 38 AND 50). SN 78-457,014. PUB. 6-28-2005. FILED 7-26-2004.

2,997,893. **TOT (BLOCK FORM)**. THOMAS, KIM, (U.S. CLS. 22, 23, 38 AND 50). SN 78-457,336. PUB. 6-28-2005. FILED 7-27-2004.

2,997,916. **SURE TOUCH (BLOCK FORM)**. ARGO CENTURY, USA, (U.S. CLS. 22, 23, 38 AND 50). SN 78-457,974. PUB. 6-28-2005. FILED 7-28-2004.

2,997,919. **MY GIRL (BLOCK FORM)**. SCOTT CAMERON GOLF DESIGN, INC., (U.S. CLS. 22, 23, 38 AND 50). SN 78-457,996. PUB. 6-28-2005. FILED 7-28-2004.

2,997,920. **STUFFED SMELLIES (BLOCK FORM)**. ACREE, DELORES F., (U.S. CLS. 22, 23, 38 AND 50). SN 78-458,013. PUB. 6-28-2005. FILED 7-28-2004.

2,997,962. **D DOSHO (STYLIZED)**. SHIFFERAW, TESSEMA DOSHO, (U.S. CLS. 22, 23, 38 AND 50). SN 78-458,842. PUB. 6-28-2005. FILED 7-29-2004.

2,998,022. **JUSTICE LEAGUE (BLOCK FORM)**. DC COMICS, (U.S. CLS. 22, 23, 38 AND 50). SN 78-459,927. PUB. 6-28-2005. FILED 7-30-2004.

2,998,096. **QUICKWORD (BLOCK FORM)**. THE OXFORD TOY COMPANY LIMITED, (U.S. CLS. 22, 23, 38 AND 50). SN 78-461,086. PUB. 6-28-2005. FILED 8-3-2004.

2,998,127. **QUADRACHESS (BLOCK FORM)**. SAUBERMAN, HERMINA, (U.S. CLS. 22, 23, 38 AND 50). SN 78-461,517. PUB. 6-28-2005. FILED 8-4-2004.

2,998,171. **PUPPY VET KIT (BLOCK FORM)**. BATTAT INCORPORATED, (U.S. CLS. 22, 23, 38 AND 50). SN 78-462,452. PUB. 6-28-2005. FILED 8-5-2004.

2,998,188. **SOCK MONKEY LADY (BLOCK FORM)**. LINDNER, DELORES P., (U.S. CLS. 22, 23, 38 AND 50). SN 78-463,170. PUB. 6-28-2005. FILED 8-6-2004.

2,998,264. **DAVE'S (BLOCK FORM)**. DAVE'S LURES, LLC, (U.S. CLS. 22, 23, 38 AND 50). SN 78-466,862. PUB. 6-28-2005. FILED 8-12-2004.

2,998,265. **WINNING STREAK (BLOCK FORM)**. DAVE'S LURES, LLC, (U.S. CLS. 22, 23, 38 AND 50). SN 78-466,864. PUB. 6-28-2005. FILED 8-12-2004.

2,998,285. **TUTTI CUTI (BLOCK FORM)**. SANTORO, LUCIO AND SANTORO, MEERA, (U.S. CLS. 22, 23, 38 AND 50). SN 78-468,397. PUB. 6-28-2005. FILED 8-17-2004.

2,998,288. **RAPALA (BLOCK FORM)**. NORMARK CORPORATION, (U.S. CLS. 22, 23, 38 AND 50). SN 78-468,509. PUB. 6-28-2005. FILED 8-17-2004.

2,998,296 (*See Class 10 for this trademark*).

2,998,319. **DO IT RIGHT THE FIRST TIME (BLOCK FORM)**. LASERTRON, INC., (U.S. CLS. 22, 23, 38 AND 50). SN 78-499,535. PUB. 6-28-2005. FILED 10-14-2004.

2,998,327 (*See Class 25 for this trademark*).

2,998,335 (*See Class 9 for this trademark*).

2,998,455 (*See Class 25 for this trademark*).

2,998,465 (*See Class 25 for this trademark*).

2,998,500 (*See Class 9 for this trademark*).

CLASS 29—MEATS AND PROCESSED FOODS

2,996,243 (*See Class 3 for this trademark*).

2,996,259. **PRIMADONNA**. LIDL STIFTUNG & CO. KG, MULTIPLE CLASS, (INT. CLS. 29, 30, 31 AND 32), (U.S. CLS. 1, 45, 46 AND 48). SN 76-232,951. PUB. 6-28-2005. FILED 3-29-2001.

2,996,297. **TEA ZONE**. LOLLICUP USA, INC., MULTIPLE CLASS, (INT. CLS. 29, 30 AND 32), (U.S. CLS. 45, 46 AND 48). SN 76-429,116. PUB. 6-28-2005. FILED 7-9-2002.

2,996,302. **KLEIN'S DELIGHTS**. KLEIN'S NATURALS, LTD., MULTIPLE CLASS, (INT. CLS. 29 AND 31), (U.S. CLS. 1 AND 46). SN 76-440,598. PUB. 6-28-2005. FILED 8-12-2002.

2,996,311. **DAKOTA NATURAL**. BRUNER, E. JOHN, (U.S. CL. 46). SN 76-465,315. PUB. 6-28-2005. FILED 11-6-2002.

2,996,422 (*See Class 5 for this trademark*).

2,996,429 (*See Class 5 for this trademark*).

2,996,443. **MYCRYO**. BARRY CALLEBAUT AG, (U.S. CL. 46). SN 76-548,069. PUB. 6-28-2005. FILED 9-30-2003.

2,996,464. **HPTS (BLOCK FORM)**. HEARTLAND FIELDS, LLC, (U.S. CL. 46). SN 76-561,506. PUB. 6-28-2005. FILED 11-21-2003.

2,996,498. **RUSSLER (BLOCK FORM)**. ZARTIC, INC., (U.S. CL. 46). SN 76-568,743. PUB. 6-28-2005. FILED 1-7-2004.

2,996,503. **DOUBLE TWIST (BLOCK FORM)**. DAIRY FARMERS OF AMERICA, INC., (U.S. CL. 46). SN 76-569,251. PUB. 6-28-2005. FILED 1-12-2004.

2,996,542. **ALBEMARLE FARM (BLOCK FORM)**. KLUGE ESTATE WINERY AND VINEYARD, L.L.C., MULTIPLE CLASS, (INT. CLS. 29 AND 30), (U.S. CL. 46). SN 76-571,383. PUB. 6-28-2005. FILED 1-22-2004.

2,996,579. **NAGARAJ AND DESIGN**. APEX PRODUCTS COMPANY LIMITED, MULTIPLE CLASS, (INT. CLS. 29 AND 30), (U.S. CL. 46). SN 76-574,469. PUB. 6-28-2005. FILED 2-9-2004.

2,996,651. **DARNA (BLOCK FORM)**. THE NATIONAL COMPANY FOR FOODS N.F.C., (U.S. CL. 46). SN 76-585,927. PUB. 6-28-2005. FILED 4-9-2004.

2,996,695. **WHO SAYS SNACK FOOD HAS TO BE JUNK FOOD? (BLOCK FORM)**. BASIC GRAIN PRODUCTS, INC., (U.S. CL. 46). SN 76-593,784. PUB. 6-28-2005. FILED 5-24-2004.

2,996,747. **NAKED SMOKED SALMON (BLOCK FORM)**. SMOKIN GOURMET, (U.S. CL. 46). SN 76-600,042. PUB. 6-28-2005. FILED 6-28-2004.

2,996,783. **CAPE CRUNCHERS AND DESIGN**. SAMBAND OF ICELAND CORPORATION, (U.S. CL. 46). SN 76-604,230. PUB. 6-28-2005. FILED 7-27-2004.

2,996,850. **DISFRUTE LA DIFERENCIA ENJOY THE DIFFERENCE (STYLIZED)**. V&V SUPREMO FOODS, INC., (U.S. CL. 46). SN 76-605,704. PUB. 6-28-2005. FILED 8-5-2004.

2,996,879. **PERFECT CHOICE (BLOCK FORM)**. THE PENN TRAFFIC COMPANY, (U.S. CL. 46). SN 76-627,013. PUB. 6-28-2005. FILED 1-5-2005.

2,996,930. **CAPE HARVEST**. SEA HARVEST CORPORATION LIMITED, (U.S. CL. 46). SN 78-224,124. PUB. 6-28-2005. FILED 3-11-2003.

2,996,957. **BONOBO'S REAL FOOD**. BONOBO'S LLC, MULTIPLE CLASS, (INT. CLS. 29 AND 31), (U.S. CLS. 1 AND 46). SN 78-257,834. PUB. 6-28-2005. FILED 6-3-2003.

2,996,958. **MISCELLANEOUS DESIGN**. COMPAGNIE LAITIERE EUROPEENNE, (U.S. CL. 46). SN 78-258,741. PUB. 6-28-2005. FILED 6-5-2003.

2,997,054. **BAKEOVER (BLOCK FORM)**. PARADISE FARM ORGANICS, INC., (U.S. CL. 46). SN 78-329,693. PUB. 6-28-2005. FILED 11-18-2003.

2,997,196. **CANDELITA AND DESIGN**. EXPORSEVILLA, S.A., (U.S. CL. 46). SN 78-361,151. PUB. 6-28-2005. FILED 2-2-2004.

2,997,239. **HASUNJUNG (BLOCK FORM)**. HASUNJUNG GENERAL FOOD CO., LTD, (U.S. CL. 46). SN 78-366,573. PUB. 6-28-2005. FILED 2-11-2004.

2,997,305. **ZONE CUISINE (BLOCK FORM)**. SEARS, BARRY D., (U.S. CL. 46). SN 78-376,370. PUB. 6-28-2005. FILED 3-1-

- 2004.
- 2,997,336. **FAIRBURY BRAND AND DESIGN**. WIMMER'S MEAT PRODUCTS, INC., (U.S. CL. 46). SN 78-382,260. PUB. 6-28-2005. FILED 3-11-2004.
- 2,997,416. **SGT. PEPPERONI'S (BLOCK FORM)**. ALPHA FOODS COMPANY INC., MULTIPLE CLASS, (INT. CLS. 29 AND 30), (U.S. CL. 46). SN 78-397,954. PUB. 6-28-2005. FILED 4-7-2004.
- 2,997,458. **ADVANTAGE GOURMET (BLOCK FORM)**. ADVANTAGE INTERNATIONAL FOODS CORP., (U.S. CL. 46). SN 78-405,893. PUB. 6-28-2005. FILED 4-21-2004.
- 2,997,563. **WISE POULTRY AND DESIGN**. WISE KOSHER NATURAL POULTRY, INC., (U.S. CL. 46). SN 78-429,466. PUB. 6-28-2005. FILED 6-3-2004.
- 2,997,609. **MISCELLANEOUS DESIGN**. TOP RISE COMPANY, INC., (U.S. CL. 46). SN 78-436,464. PUB. 6-28-2005. FILED 6-16-2004.
- 2,997,747. **MORRIS GRASSFED BEEF (BLOCK FORM)**. T.O. CATTLE COMPANY, (U.S. CL. 46). SN 78-450,772. PUB. 6-28-2005. FILED 7-14-2004.
- 2,997,778. **NORTHERN GULF (BLOCK FORM)**. WILLIAMS, PAUL E., (U.S. CL. 46). SN 78-453,355. PUB. 6-28-2005. FILED 7-20-2004.
- 2,997,821. **CEDAR RIVER FARMS NATURAL BEEF AND DESIGN**. SKIPPACK CREEK CORPORATION, (U.S. CL. 46). SN 78-455,422. PUB. 6-28-2005. FILED 7-23-2004.
- 2,997,836. **CLASSIC PERFECTION (BLOCK FORM)**. SARA LEE FOODS, INC., (U.S. CL. 46). SN 78-455,790. PUB. 6-28-2005. FILED 7-23-2004.
- 2,997,884. **CHARLIE'S (BLOCK FORM)**. DEL MONTE CORPORATION, (U.S. CL. 46). SN 78-457,161. PUB. 6-28-2005. FILED 7-27-2004.
- 2,997,885. **THE FARMERS DINER AND DESIGN**. FARMER'S DINER, LLC, MULTIPLE CLASS, (INT. CLS. 29 AND 43), (U.S. CLS. 46, 100 AND 101). SN 78-457,182. PUB. 6-28-2005. FILED 7-27-2004.
- 2,998,135. **SWISS VALLEY (BLOCK FORM)**. SWISS VALLEY FARMS CO., MULTIPLE CLASS, (INT. CLS. 29 AND 32), (U.S. CLS. 45, 46 AND 48). SN 78-461,695. PUB. 6-28-2005. FILED 8-4-2004.
- 2,998,214. **SB SIGNATURE BRANDS, LLC (BLOCK FORM)**. SIGNATURE BRANDS, LLC, MULTIPLE CLASS, (INT. CLS. 29 AND 30), (U.S. CL. 46). SN 78-464,427. PUB. 6-28-2005. FILED 8-9-2004.
- 2,998,353. **ALPENDORF (BLOCK FORM)**. LIDL STIFTUNG & CO. KG, (U.S. CL. 46). SN 79-000,147. PUB. 6-28-2005. FILED 11-4-2003.
- 2,998,383 (*See Class 5 for this trademark*).
- 2,998,422. **MILDESSA (BLOCK FORM)**. RICH. HENGSTENBERG GMBH & CO. KG, (U.S. CL. 46). SN 79-002,206. PUB. 6-28-2005. FILED 3-31-2004.
- 2,998,442. **IGOR AND DESIGN**. IGOR S.R.L., (U.S. CL. 46). SN 79-002,685. PUB. 6-28-2005. FILED 2-23-2004.
- 2,998,457. **ILATRAIA (BLOCK FORM)**. BRINO-HOLDING AG, MULTIPLE CLASS, (INT. CLS. 29 AND 33), (U.S. CLS. 46, 47 AND 49). SN 79-003,317. PUB. 6-28-2005. FILED 4-29-2004.
- 2,996,542 (*See Class 29 for this trademark*).
- 2,996,551. **ADAMS (BLOCK FORM)**. ADAMS EXTRACT & SPICE, LLC, (U.S. CL. 46). SN 76-571,964. PUB. 6-28-2005. FILED 1-22-2004.
- 2,996,579 (*See Class 29 for this trademark*).
- 2,996,618. **100% AND DESIGN**. FARMERS' RICE COOPERATIVE, (U.S. CL. 46). SN 76-578,886. PUB. 6-28-2005. FILED 3-3-2004.
- 2,996,636. **YAKULT (BLOCK FORM)**. KABUSHIKI KAISHA YAKULT HONSHA, MULTIPLE CLASS, (INT. CLS. 30 AND 32), (U.S. CLS. 45, 46 AND 48). SN 76-582,173. PUB. 6-28-2005. FILED 3-22-2004.
- 2,996,694. **THIRSTY FOR BARBEQUE... YEAH! IT'S THAT GOOD. (BLOCK FORM)**. GREENE, RAY, (U.S. CL. 46). SN 76-593,674. PUB. 6-28-2005. FILED 5-20-2004.
- 2,996,765. **BEE-LICIOUS (BLOCK FORM)**. BEE LINE COURIER SERVICES, INC., (U.S. CL. 46). SN 76-602,728. PUB. 6-28-2005. FILED 7-19-2004.
- 2,996,770. **D DEWEY'S PIZZA AND DESIGN**. AED ENTERPRISES, LLC, MULTIPLE CLASS, (INT. CLS. 30 AND 43), (U.S. CLS. 46, 100 AND 101). SN 76-603,107. PUB. 6-28-2005. FILED 7-19-2004.
- 2,996,772. **SNACK PACK (BLOCK FORM)**. CONAGRA BRANDS, INC., (U.S. CL. 46). SN 76-603,200. PUB. 6-28-2005. FILED 7-19-2004.
- 2,996,902. **S. ROSEN'S MARY ANN AND DESIGN**. ALPHA BAKING CO., INC., (U.S. CL. 46). SN 78-169,480. PUB. 6-28-2005. FILED 9-30-2002.
- 2,996,956. **DELI FRUITY**. HELADOS MI CANITA, INC., (U.S. CL. 46). SN 78-257,753. PUB. 6-28-2005. FILED 6-3-2003.
- 2,996,973. **POWER ROOT AND DESIGN**. MAYAKA INTERNATIONAL INC., (U.S. CL. 46). SN 78-274,833. PUB. 6-28-2005. FILED 7-16-2003.
- 2,997,206. **TEALIGHTFUL TREASURES AND DESIGN**. TEALIGHTFUL TREASURES, INC., (U.S. CL. 46). SN 78-362,063. PUB. 6-28-2005. FILED 2-3-2004.
- 2,997,230. **BACI (BLOCK FORM)**. SOCIETE DES PRODUITS NESTLE S.A., (U.S. CL. 46). SN 78-365,126. PUB. 6-28-2005. FILED 2-9-2004.
- 2,997,290. **VINO DE MILO (BLOCK FORM)**. MILO'S WHOLE WORLD GOURMET, LLC, (U.S. CL. 46). SN 78-373,566. PUB. 6-28-2005. FILED 2-25-2004.
- 2,997,328. **ANDIAMO COFFEE GREAT COFFEE.....SALUTE! AND DESIGN**. ANDIAMO COFFEE, INC., MULTIPLE CLASS, (INT. CLS. 30 AND 35), (U.S. CLS. 46, 100, 101 AND 102). SN 78-379,785. PUB. 6-28-2005. FILED 3-6-2004.
- 2,997,340. **RAINBOW DUST (BLOCK FORM)**. BLACKWELL, SANDRA, (U.S. CL. 46). SN 78-384,100. PUB. 6-28-2005. FILED 3-15-2004.
- 2,997,366. **THE LONDON CUPPA AND DESIGN**. LONDON CUPPA, LIMITED, THE, (U.S. CL. 46). SN 78-388,430. PUB. 6-28-2005. FILED 3-22-2004.
- 2,997,416 (*See Class 29 for this trademark*).
- 2,997,426. **WHITE VELVET (BLOCK FORM)**. TEAL, DARIN, (U.S. CL. 46). SN 78-400,904. PUB. 6-28-2005. FILED 4-13-2004.
- 2,997,452. **BA CHUÔNG VÀNG (BLOCK FORM)**. D & D GOLD PRODUCT CORPORATION, (U.S. CL. 46). SN 78-405,289. PUB. 6-28-2005. FILED 4-20-2004.
- 2,997,453. **3 CLOCHES DOREES (BLOCK FORM)**. D & D GOLD PRODUCT CORPORATION, (U.S. CL. 46). SN 78-405,292. PUB. 6-28-2005. FILED 4-20-2004.
- 2,997,467. **DARE AND DESIGN**. DARE FOODS LIMITED, (U.S. CL. 46). SN 78-407,810. PUB. 6-28-2005. FILED 4-26-2004.
- 2,997,479. **CITAVO CAFE SPECIALTY COFFEES (BLOCK FORM)**. SYSCO CORPORATION, (U.S. CL. 46). SN 78-410,929. PUB. 6-28-2005. FILED 4-30-2004.
- 2,997,499. **BLIMPIE BLAST. (BLOCK FORM)**. BLIMPIE INTERNATIONAL, INC., (U.S. CL. 46). SN 78-414,362. PUB. 6-28-2005. FILED 5-6-2004.
- 2,997,559. **NOCW NEW ORLEANS COFFEE WORKS AND DESIGN**. NEW ORLEANS COFFEE WORKS, LLC, (U.S. CL. 46). SN 78-428,529. PUB. 6-28-2005. FILED 6-2-2004.
- 2,997,740. **GOT BROWNIES ON YOUR MIND? (BLOCK FORM)**. GRANNY'S BAKERY, LLC, (U.S. CL. 46). SN 78-450,427. PUB. 6-28-2005. FILED 7-14-2004.
- 2,997,786. **GOURMET DONUT (BLOCK FORM)**. EURO COF-

CLASS 30—STAPLE FOODS

- 2,996,243 (*See Class 3 for this trademark*).
- 2,996,259 (*See Class 29 for this trademark*).
- 2,996,263. **WAFU AND DESIGN**. KAI CONVENI GLOBAL INC., (U.S. CL. 46). SN 76-322,830. PUB. 6-28-2005. FILED 10-9-2001.
- 2,996,266. **ADIRONDACK COFFEE TRADERS**. IMCOF CORPORATION, (U.S. CL. 46). SN 76-344,780. PUB. 6-28-2005. FILED 11-29-2001.
- 2,996,297 (*See Class 29 for this trademark*).
- 2,996,299. **VIVIDENT**. PERFETTI VAN MELLE S.P.A., (U.S. CL. 46). SN 76-429,904. PUB. 6-28-2005. FILED 7-3-2002.
- 2,996,303. **EASY DOES IT**. GGB ENTERPRISES, INC., (U.S. CL. 46). SN 76-443,699. PUB. 6-28-2005. FILED 8-16-2002.
- 2,996,421. **CONVERSATION COOKIES**. ELEN'S NYC, INC., (U.S. CL. 46). SN 76-539,978. PUB. 6-28-2005. FILED 8-7-2003.
- 2,996,422 (*See Class 5 for this trademark*).

FEE, A PARTNERSHIP, (U.S. CL. 46). SN 78-453,611. PUB. 6-28-2005. FILED 7-20-2004.

2,997,791. **BEEKIST NATURAL PURE HONEY AND DESIGN.** BEE MAID HONEY LIMITED, (U.S. CL. 46). SN 78-453,891. PUB. 6-28-2005. FILED 7-21-2004.

2,997,792. **JAKE'S (BLOCK FORM).** SINGLE SERVE TEA CORP., (U.S. CL. 46). SN 78-453,945. PUB. 6-28-2005. FILED 7-21-2004.

2,997,804. **ISLAND HONEY (BLOCK FORM).** ISLAND HONEY LLC, (U.S. CL. 46). SN 78-454,626. PUB. 6-28-2005. FILED 7-22-2004.

2,997,817. **CARB CURBER (BLOCK FORM).** THE BREAD GARDEN LIMITED, (U.S. CL. 46). SN 78-455,294. PUB. 6-28-2005. FILED 7-22-2004.

2,997,854. **VIDARE VAN (BLOCK FORM).** VIRGINIA DARE EXTRACT CO., INC., (U.S. CL. 46). SN 78-456,610. PUB. 6-28-2005. FILED 7-26-2004.

2,997,855. **VIDARE VAN (BLOCK FORM).** VIRGINIA DARE EXTRACT CO., INC., (U.S. CL. 46). SN 78-456,627. PUB. 6-28-2005. FILED 7-26-2004.

2,998,109. **OLD TOWN PIZZA AND DESIGN.** MILNE, INC., MULTIPLE CLASS, (INT. CLS. 30, 39 AND 43), (U.S. CLS. 46, 100, 101 AND 105). SN 78-461,271. PUB. 6-28-2005. FILED 8-3-2004.

2,998,136. **PEEL, PLACE AND BAKE (BLOCK FORM).** THE PILLSBURY COMPANY, (U.S. CL. 46). SN 78-461,703. PUB. 6-28-2005. FILED 8-4-2004.

2,998,152. **HIP HOP CANDYSHOP (BLOCK FORM).** HIP HOP CANDYSHOP, LLC, (U.S. CL. 46). SN 78-461,986. PUB. 6-28-2005. FILED 8-4-2004.

2,998,172. **HISSEE FIT (BLOCK FORM).** FOREIGN CANDY COMPANY, INC., THE, (U.S. CL. 46). SN 78-462,512. PUB. 6-28-2005. FILED 8-5-2004.

2,998,194. **VIDAPRO (BLOCK FORM).** VIRGINIA DARE EXTRACT CO., INC., (U.S. CL. 46). SN 78-463,422. PUB. 6-28-2005. FILED 8-6-2004.

2,998,195. **VIDAPRO (BLOCK FORM).** VIRGINIA DARE EXTRACT CO., INC., (U.S. CL. 46). SN 78-463,431. PUB. 6-28-2005. FILED 8-6-2004.

2,998,214 (*See Class 29 for this trademark*).

2,998,223. **ARCTIC STAR AND DESIGN.** ICE CREAM SPECIALTIES, INC., (U.S. CL. 46). SN 78-464,817. PUB. 6-28-2005. FILED 8-10-2004.

2,998,225. **JIMMY'S FIERCE AMERICAN (BLOCK FORM).** FIERCE AMERICAN PRODUCTS, LLC, (U.S. CL. 46). SN 78-464,824. PUB. 6-28-2005. FILED 8-10-2004.

2,998,226. **KOALA (BLOCK FORM).** KEMPS LLC, (U.S. CL. 46). SN 78-464,850. PUB. 6-28-2005. FILED 8-10-2004.

2,998,233. **BIG FAT HISSEE FIT (BLOCK FORM).** THE FOREIGN CANDY COMPANY, INC., (U.S. CL. 46). SN 78-464,977. PUB. 6-28-2005. FILED 8-10-2004.

2,998,383 (*See Class 5 for this trademark*).

2,998,387. **BEES'PRIDE AND DESIGN.** ALTIPARMAK PAZARLAMA KOLLEKTIF; SIRKETI ÖZEN - ÖZGÜR ALTIPARMAK, (U.S. CL. 46). SN 79-001,302. PUB. 6-28-2005. FILED 1-7-2004.

2,998,388. **HONEYBUNCH (STYLIZED).** ALTIPARMAK PAZARLAMA KOLLEKTIF; SIRKETI ÖZEN - ÖZGÜR ALTIPARMAK, (U.S. CL. 46). SN 79-001,313. PUB. 6-28-2005. FILED 1-7-2004.

2,998,411. **MOCAFINO (STYLIZED).** HACO AG, (U.S. CL. 46). SN 79-001,881. PUB. 6-28-2005. FILED 3-17-2004.

2,998,479. **FISH & CHIPS (BLOCK FORM).** MEDERER GMBH, (U.S. CL. 46). SN 79-004,575. PUB. 6-28-2005. FILED 6-9-2004.

2,998,493. **FIT 21 (BLOCK FORM).** ULDO-BACKMITTEL GMBH, MULTIPLE CLASS, (INT. CLS. 30, 35 AND 43), (U.S. CLS. 46, 100, 101 AND 102). SN 79-005,663. PUB. 6-28-2005. FILED 7-26-2004.

CLASS 31—NATURAL AGRICULTURAL PRODUCTS

2,996,259 (*See Class 29 for this trademark*).

2,996,302 (*See Class 29 for this trademark*).

2,996,570 (*See Class 20 for this trademark*).

2,996,832. **MAYAN DELIGHT (BLOCK FORM).** CENTRAL AMERICAN PRODUCE, INC., (U.S. CLS. 1 AND 46). SN 76-605,289. PUB. 6-28-2005. FILED 7-26-2004.

2,996,957 (*See Class 29 for this trademark*).

2,997,104. **INSTANT BLOOMS (BLOCK FORM).** BRECK'S LLC, (U.S. CLS. 1 AND 46). SN 78-346,028. PUB. 3-8-2005. FILED 12-29-2003.

2,997,459. **DAYBRIGHT (BLOCK FORM).** EXTENDAY IP LIMITED, (U.S. CLS. 1 AND 46). SN 78-405,926. PUB. 6-28-2005. FILED 4-21-2004.

2,997,530 (*See Class 5 for this trademark*).

2,997,742. **RESIDUE PROVEN (BLOCK FORM).** MONSANTO TECHNOLOGY LLC, (U.S. CLS. 1 AND 46). SN 78-450,475. PUB. 6-28-2005. FILED 7-14-2004.

2,998,133. **WORKING FOR THE HEALTH OF BIRDS (BLOCK FORM).** LAFEBER, TED, (U.S. CLS. 1 AND 46). SN 78-461,640. PUB. 6-28-2005. FILED 8-4-2004.

2,998,146. **MASTER CHEF AND DESIGN.** HEARTLAND DESIGN ASSOCIATES, LLC, (U.S. CLS. 1 AND 46). SN 78-461,904. PUB. 6-28-2005. FILED 8-4-2004.

2,998,161. **HEALTH ALERT (BLOCK FORM).** CYCLE GROUP, LTD., (U.S. CLS. 1 AND 46). SN 78-462,163. PUB. 6-28-2005. FILED 8-4-2004.

2,998,272. **CARUBA (BLOCK FORM).** ANTHONY TESSELAAR PLANTS PTY LTD., (U.S. CLS. 1 AND 46). SN 78-467,120. PUB. 6-28-2005. FILED 8-13-2004.

2,998,379. **TWINKLE STARS (BLOCK FORM).** HANDELSK-WEKERIJ EXCEPTIO B.V., MULTIPLE CLASS, (INT. CLS. 31 AND 44), (U.S. CLS. 1, 46, 100 AND 101). SN 79-001,010. PUB. 6-28-2005. FILED 1-14-2004.

CLASS 32—LIGHT BEVERAGES

2,996,243 (*See Class 3 for this trademark*).

2,996,249. **WHOO ASS ENERGY COLA.** JONES SODA CO. (USA) INC., (U.S. CLS. 45, 46 AND 48). SN 76-087,794. PUB. 3-2-2004. FILED 7-10-2000.

2,996,259 (*See Class 29 for this trademark*).

2,996,269. **CLASSIC SPRITZ.** BICKFORD'S AUSTRALIA PTY. LTD., (U.S. CLS. 45, 46 AND 48). SN 76-351,242. PUB. 6-28-2005. FILED 12-18-2001.

2,996,297 (*See Class 29 for this trademark*).

2,996,337. **STRATHLOMOND.** MACKELLAR, DUNCAN LIVINGSTONE, MULTIPLE CLASS, (INT. CLS. 32 AND 33), (U.S. CLS. 45, 46, 47, 48 AND 49). SN 76-490,065. PUB. 6-28-2005. FILED 2-14-2003.

2,996,387 (*See Class 11 for this trademark*).

2,996,422 (*See Class 5 for this trademark*).

2,996,636 (*See Class 30 for this trademark*).

2,996,665. **ENERGEN POWER ASSIST REACH YOUR SUMMIT AND DESIGN.** OTSUKA PHARMACEUTICAL CO., LTD., (U.S. CLS. 45, 46 AND 48). SN 76-588,889. PUB. 6-28-2005. FILED 4-23-2004.

2,996,749. **POE'S PHANTASTIC SOUR MIX (STYLIZED).** W. W. DISTRIBUTORS, INC., (U.S. CLS. 45, 46 AND 48). SN 76-600,285. PUB. 6-28-2005. FILED 7-1-2004.

2,996,976. **FERNANDITO.** FRATELLI BRANCA DISTILLERIE S.R.L., MULTIPLE CLASS, (INT. CLS. 32 AND 33), (U.S. CLS. 45, 46, 47, 48 AND 49). SN 78-276,134. PUB. 6-28-2005. FILED 7-18-2003.

2,997,129. **THE SOFTER SENSATION (BLOCK FORM).** CALPIS CO., LTD., (U.S. CLS. 45, 46 AND 48). SN 78-349,990. PUB. 6-28-2005. FILED 1-9-2004.

2,997,248. **BIG GULP SODA FLOAT (BLOCK FORM).** 7-ELEVEN, INC., (U.S. CLS. 45, 46 AND 48). SN 78-367,791. PUB. 6-28-2005. FILED 2-13-2004.

2,997,272. **M METROMINT AND DESIGN.** SOMA BEVERAGE COMPANY, LLC, (U.S. CLS. 45, 46 AND 48). SN 78-370,698. PUB. 6-28-2005. FILED 2-19-2004.

2,997,335. **MISCELLANEOUS DESIGN.** JAMBA JUICE COMPANY, (U.S. CLS. 45, 46 AND 48). SN 78-381,249. PUB. 6-28-2005. FILED 3-9-2004.

2,997,391. **GOLDEN DENAR (BLOCK FORM).** BROWAR NAMYSLOW SP.Z O.O., (U.S. CLS. 45, 46 AND 48). SN 78-393,184. PUB. 6-28-2005. FILED 3-30-2004.

2,997,442. **ASI DE FRIA (BLOCK FORM).** COORS GLOBAL

- PROPERTIES, INC., (U.S. CLS. 45, 46 AND 48). SN 78-403,030. PUB. 6-28-2005. FILED 4-16-2004.
- 2,997,976. **OREGON TRAIL (BLOCK FORM)**. BREWING NORTHWEST, LTD., DBA OREGON TRAIL BREWERY, (U.S. CLS. 45, 46 AND 48). SN 78-459,187. PUB. 6-28-2005. FILED 7-29-2004.
- 2,998,075. **ANTIOXIDANCE (BLOCK FORM)**. ODWALLA, INC., (U.S. CLS. 45, 46 AND 48). SN 78-460,689. PUB. 6-28-2005. FILED 8-2-2004.
- 2,998,135 (*See Class 29 for this trademark*).
- 2,998,187. **ACADIA (BLOCK FORM)**. AHOLD RETAIL SERVICES AG, (U.S. CLS. 45, 46 AND 48). SN 78-463,096. PUB. 6-28-2005. FILED 8-6-2004.
- 2,998,392. **APPLETISER (BLOCK FORM)**. SABMILLER FINANCE B.V., (U.S. CLS. 45, 46 AND 48). SN 79-001,369. PUB. 6-28-2005. FILED 1-23-2004.
- 2,998,400. **GRAPETISER (BLOCK FORM)**. SABMILLER FINANCE B.V., (U.S. CLS. 45, 46 AND 48). SN 79-001,529. PUB. 6-28-2005. FILED 1-23-2004.
- 2,998,405 (*See Class 5 for this trademark*).
- 2,998,426 (*See Class 5 for this trademark*).
- 2,998,444. **HARBIN BEER AND DESIGN**. HARBIN BREWING CO., LTD., (U.S. CLS. 45, 46 AND 48). SN 79-002,699. PUB. 6-28-2005. FILED 11-26-2003.
- 2,998,477. **REDLIGHT (STYLIZED)**. REDLIGHT BEER LIMITED, (U.S. CLS. 45, 46 AND 48). SN 79-004,361. PUB. 6-28-2005. FILED 5-18-2004.
- 2,998,491. **MISCELLANEOUS DESIGN**. SHANGHAI TOHKIN BEVERAGE COMPANY LIMITED, (U.S. CLS. 45, 46 AND 48). SN 79-005,450. PUB. 6-28-2005. FILED 5-31-2004.

CLASS 33—WINES AND SPIRITS

- 2,996,236. **LIMONCELLO MEDITERRANEO BELTION LEMON LIQUEUR AND DESIGN**. MERAK SRL, (U.S. CLS. 47 AND 49). SN 75-548,180. PUB. 6-28-2005. FILED 9-4-1998.
- 2,996,243 (*See Class 3 for this trademark*).
- 2,996,337 (*See Class 32 for this trademark*).
- 2,996,340. **ABSOLUT COUNTRY OF SWEDEN VANILIA (STYLIZED)**. V&S VIN & SPRIT AKTIEBOLAG, (U.S. CLS. 47 AND 49). SN 76-492,793. PUB. 6-28-2005. FILED 2-25-2003.
- 2,996,364. **PESHTERSKA MATURED RAKIA AND DESIGN**. VINPROM PESHTERA, (U.S. CLS. 47 AND 49). SN 76-518,602. PUB. 6-28-2005. FILED 6-2-2003.
- 2,996,436. **VINTAGE CAPITAL WINE (STYLIZED)**. VINTAGE CAPITAL LLC, (U.S. CLS. 47 AND 49). SN 76-545,278. PUB. 6-28-2005. FILED 9-8-2003.
- 2,996,472. **PISTACHIO DELIGHT (BLOCK FORM)**. PISTACHIO TREE RANCH, (U.S. CLS. 47 AND 49). SN 76-565,023. PUB. 6-28-2005. FILED 12-12-2003.
- 2,996,510. **CHATEAU PIPEAU (BLOCK FORM)**. MASCIARIELLI, NICOLA, (U.S. CLS. 47 AND 49). SN 76-569,508. PUB. 6-28-2005. FILED 12-29-2003.
- 2,996,539. **KLUGE ESTATE (STYLIZED)**. KLUGE ESTATE WINERY AND VINEYARD, L.L.C., (U.S. CLS. 47 AND 49). SN 76-571,377. PUB. 6-28-2005. FILED 1-22-2004.
- 2,996,540. **CRU KLUGE ESTATE (BLOCK FORM)**. KLUGE ESTATE WINERY AND VINEYARD, L.L.C., (U.S. CLS. 47 AND 49). SN 76-571,379. PUB. 6-28-2005. FILED 1-22-2004.
- 2,996,541. **KLUGE ESTATE 2001 NEW WORLD RED WINE ALBEMARLE COUNTY VIRGINIA AND DESIGN**. KLUGE ESTATE WINERY AND VINEYARD, L.L.C., (U.S. CLS. 47 AND 49). SN 76-571,381. PUB. 6-28-2005. FILED 1-22-2004.
- 2,996,666. **PIO CESARE AND DESIGN**. PIO CESARE S.R.L., (U.S. CLS. 47 AND 49). SN 76-588,934. PUB. 6-28-2005. FILED 4-27-2004.
- 2,996,869. **XS AND DESIGN**. F. KORBEL & BROS., (U.S. CLS. 47 AND 49). SN 76-606,667. PUB. 6-28-2005. FILED 8-12-2004.
- 2,996,903. **THE WINE TENT CO.**. RAISIN SOCIAL LIMITED, MULTIPLE CLASS. (INT. CLS. 33 AND 35), (U.S. CLS. 47, 49, 100, 101 AND 102). SN 78-170,703. PUB. 6-28-2005. FILED 10-3-2002.
- 2,996,975. **CRUSE**. LES CAVES DE LANDIRAS-LOUIS ESCHENAUER, (U.S. CLS. 47 AND 49). SN 78-275,665. PUB. 6-28-2005. FILED 7-17-2003.

- 2,996,976 (*See Class 32 for this trademark*).
- 2,997,076. **NOBLE HOUSE (BLOCK FORM)**. PAULY, PETER, (U.S. CLS. 47 AND 49). SN 78-337,463. PUB. 6-28-2005. FILED 12-7-2003.
- 2,997,116. **COHETE (BLOCK FORM)**. DRINKS AMERICAS, INC., (U.S. CLS. 47 AND 49). SN 78-348,238. PUB. 6-28-2005. FILED 1-6-2004.
- 2,997,121. **THE LIBERTY BOURBON (BLOCK FORM)**. FONBELLE AMERICAS, (U.S. CLS. 47 AND 49). SN 78-348,960. PUB. 3-8-2005. FILED 1-7-2004.
- 2,997,284. **VIÑA CATRALA (BLOCK FORM)**. SOCIEDAD AGRICOLA DON MANUEL, (U.S. CLS. 47 AND 49). SN 78-373,209. PUB. 6-28-2005. FILED 2-24-2004.
- 2,997,535. **RIGHT BANK (BLOCK FORM)**. LANG & REED LLC, (U.S. CLS. 47 AND 49). SN 78-422,578. PUB. 6-28-2005. FILED 5-20-2004.
- 2,997,560. **TEQUILA CAZADORES BLANCO AND DESIGN**. BACARDI & COMPANY LIMITED, (U.S. CLS. 47 AND 49). SN 78-429,074. PUB. 6-28-2005. FILED 6-2-2004.
- 2,997,824. **SOUTHERN ROO (BLOCK FORM)**. HEATH WINES PTY LTD, (U.S. CLS. 47 AND 49). SN 78-455,461. PUB. 6-28-2005. FILED 7-23-2004.
- 2,997,864. **IA (BLOCK FORM)**. HAND PICKED SELECTIONS, INC., (U.S. CLS. 47 AND 49). SN 78-456,895. PUB. 6-28-2005. FILED 7-26-2004.
- 2,997,888. **DR. MCGILLICUDDY'S FIREBALL (BLOCK FORM)**. SAZERAC COMPANY, INC., (U.S. CLS. 47 AND 49). SN 78-457,249. PUB. 6-28-2005. FILED 7-27-2004.
- 2,997,915. **REDNECK WINE CELLER (BLOCK FORM)**. HARPER, CLETE D., (U.S. CLS. 47 AND 49). SN 78-457,965. PUB. 6-28-2005. FILED 7-28-2004.
- 2,997,939. **WILD GRAPE (BLOCK FORM)**. VALIANT VINEYARDS, INC., (U.S. CLS. 47 AND 49). SN 78-458,484. PUB. 6-28-2005. FILED 7-28-2004.
- 2,997,971. **MISCELLANEOUS DESIGN**. UNITED DISTILLERS MANUFACTURING, INC., (U.S. CLS. 47 AND 49). SN 78-459,041. PUB. 6-28-2005. FILED 7-29-2004.
- 2,997,989. **RUCAHUE (BLOCK FORM)**. VINOS DEL SUR S.A., (U.S. CLS. 47 AND 49). SN 78-459,426. PUB. 6-28-2005. FILED 7-30-2004.
- 2,998,141. **LOUIS BOURON (BLOCK FORM)**. DES ANGES, LLC, (U.S. CLS. 47 AND 49). SN 78-461,804. PUB. 6-28-2005. FILED 8-4-2004.
- 2,998,165. **NELSON FAMILY VINEYARDS (BLOCK FORM)**. NELSON AND SONS, INC., DBA NELSON FAMILY VINEYARDS, (U.S. CLS. 47 AND 49). SN 78-462,254. PUB. 6-28-2005. FILED 8-4-2004.
- 2,998,212. **MISCELLANEOUS DESIGN**. MARTHA CLARA VINEYARDS, (U.S. CLS. 47 AND 49). SN 78-464,319. PUB. 6-28-2005. FILED 8-9-2004.
- 2,998,357 (*See Class 3 for this trademark*).
- 2,998,360. **INDIS (BLOCK FORM)**. PASSCHENDAELE RIDGE PTY LTD, (U.S. CLS. 47 AND 49). SN 79-000,422. PUB. 6-28-2005. FILED 12-24-2003.
- 2,998,366. **MISCELLANEOUS DESIGN**. SICHUAN YIBIN WULIANGYE GROUP CO., LTD.; (SICHUANGSHENG YIBIN; WULIANGYE JITUAN YOUXIAN GONGSI), (U.S. CLS. 47 AND 49). SN 79-000,543. PUB. 6-28-2005. FILED 12-26-2003.
- 2,998,394. **LA NIETA (BLOCK FORM)**. VIÑEDOS DE PÁGANOS, S.L., (U.S. CLS. 47 AND 49). SN 79-001,406. PUB. 6-28-2005. FILED 1-26-2004.
- 2,998,405 (*See Class 5 for this trademark*).
- 2,998,452. **YALUMBA (BLOCK FORM)**. S. SMITH & SON PTY LTD., (U.S. CLS. 47 AND 49). SN 79-003,046. PUB. 6-28-2005. FILED 2-26-2004.
- 2,998,457 (*See Class 29 for this trademark*).
- 2,998,498. **SUN-VIEW (BLOCK FORM)**. G. ROCCISANO & SONS PTY LTD, (U.S. CLS. 47 AND 49). SN 79-005,966. PUB. 6-28-2005. FILED 8-10-2004.

CLASS 34—SMOKERS' ARTICLES

- 2,996,243 (*See Class 3 for this trademark*).
- 2,996,720. **BOGAR LITTLE CIGARS AND DESIGN**. ROYAL TOBACCO, INC., (U.S. CLS. 2, 8, 9 AND 17). SN 76-597,522.

- PUB. 6-28-2005. FILED 6-14-2004.
 2,997,091. **TALISMAN (BLOCK FORM)**. COMPANIA CERILERA LA CENTRAL, S.A. DE C.V., (U.S. CLS. 2, 8, 9 AND 17). SN 78-342,589. PUB. 6-28-2005. FILED 12-18-2003.
 2,997,492. **CONDOR (BLOCK FORM)**. GALLAGHER LIMITED, (U.S. CLS. 2, 8, 9 AND 17). SN 78-412,941. PUB. 6-28-2005. FILED 5-4-2004.
 2,997,789. **KING MOASSEL (BLOCK FORM)**. KASSIR IMPORT-EXPORT CO., INC., (U.S. CLS. 2, 8, 9 AND 17). SN 78-453,703. PUB. 6-28-2005. FILED 7-20-2004.
 2,998,199. **TEXAS HOLD'EM (BLOCK FORM)**. CALICO BRANDS, INC., (U.S. CLS. 2, 8, 9 AND 17). SN 78-463,695. PUB. 6-28-2005. FILED 8-6-2004.
 2,998,201. **TEXAS HOLD'EM AND DESIGN**. CALICO BRANDS, INC., (U.S. CLS. 2, 8, 9 AND 17). SN 78-463,717. PUB. 6-28-2005. FILED 8-6-2004.
 2,998,357 (*See Class 3 for this trademark*).
 2,998,364. **SILHOUETTE (STYLIZED)**. AGIO SIGARENFABRIEKEN N.V., (U.S. CLS. 2, 8, 9 AND 17). SN 79-000,493. PUB. 6-28-2005. FILED 11-25-2003.
 2,998,397. **MEHARI'S (STYLIZED)**. AGIO SIGARENFABRIEKEN N.V., (U.S. CLS. 2, 8, 9 AND 17). SN 79-001,482. PUB. 6-28-2005. FILED 12-29-2003.
 2,998,481. **MISCELLANEOUS DESIGN**. HENRI WINTERMANS CIGARS B.V., (U.S. CLS. 2, 8, 9 AND 17). SN 79-004,716. PUB. 6-28-2005. FILED 5-3-2004.
 (U.S. CLS. 100, 101 AND 102). SN 76-503,045. PUB. 6-28-2005. FILED 4-1-2003.
 2,996,355. **SIGNATORY PAINTING CONTRACTORS ORGANIZATION, INC. APPRENTICESHIP AND TRAINING "THE INDUSTRY LEADERS" SPCO AND DESIGN**. SIGNATORY PAINTING CONTRACTORS ORGANIZATION, INC., (U.S. CLS. 100, 101 AND 102). SN 76-512,969. PUB. 6-28-2005. FILED 5-9-2003.
 2,996,361. **CALL OR CLICK WWW.IVFFONLINE.COM AND DESIGN**. IVFFONLINE.COM, LLC, (U.S. CLS. 100, 101 AND 102). SN 76-516,637. PUB. 6-28-2005. FILED 4-30-2003.
 2,996,363. **CASTELLA IMPORTS**. CASTELLA IMPORTS, INC., (U.S. CLS. 100, 101 AND 102). SN 76-518,335. PUB. 6-28-2005. FILED 6-2-2003.
 2,996,368 (*See Class 16 for this trademark*).
 2,996,372. **W AND DESIGN**. WIZARD STUDIOS INTERNATIONAL, INC., (U.S. CLS. 100, 101 AND 102). SN 76-522,436. PUB. 6-28-2005. FILED 6-13-2003.
 2,996,401 (*See Class 16 for this trademark*).
 2,996,411. **NEW LEADSUSA AND DESIGN**. INFOUSA, (U.S. CLS. 100, 101 AND 102). SN 76-537,029. PUB. 6-28-2005. FILED 8-13-2003.
 2,996,412 (*See Class 16 for this trademark*).
 2,996,435. **SBC WEALTH MANAGEMENT**. UBS AG, MULTIPLE CLASS, (INT. CLS. 35 AND 36), (U.S. CLS. 100, 101 AND 102). SN 76-545,274. PUB. 6-28-2005. FILED 8-15-2003.
 2,996,441. **AMERICAN SOCIETY FOR MANAGEMENT AND DESIGN**. AMERICAN SOCIETY FOR MANAGEMENT, INC., (U.S. CLS. 100, 101 AND 102). SN 76-547,214. PUB. 6-28-2005. FILED 9-26-2003.
 2,996,451. **COMMAND ATTENTION**. VICTORY MEDIA, INC., (U.S. CLS. 100, 101 AND 102). SN 76-551,779. PUB. 6-28-2005. FILED 10-14-2003.
 2,996,452. **PARTNERS IN CHANGE (STYLIZED)**. PARTNERS IN CHANGE, INC., (U.S. CLS. 100, 101 AND 102). SN 76-551,871. PUB. 6-28-2005. FILED 10-15-2003.
 2,996,455. **CRUISE THE LOOP**. WILLIAMS MAIN STREET ASSOCIATION, INC., (U.S. CLS. 100, 101 AND 102). SN 76-556,284. PUB. 6-28-2005. FILED 10-30-2003.
 2,996,460 (*See Class 11 for this trademark*).
 2,996,475. **JOHNNY LOOPHOLE (STYLIZED)**. LARSEN, JOHN M., (U.S. CLS. 100, 101 AND 102). SN 76-565,735. PUB. 6-28-2005. FILED 12-17-2003.
 2,996,478. **ARTSOPOLIS (BLOCK FORM)**. ARTS COUNCIL SILICON VALLEY, MULTIPLE CLASS, (INT. CLS. 35, 41 AND 42), (U.S. CLS. 100, 101, 102 AND 107). SN 76-566,175. PUB. 6-28-2005. FILED 12-19-2003.
 2,996,479. **MOBILE SOURCE 555-1818 (BLOCK FORM)**. GRAPE TECHNOLOGY GROUP, INC., (U.S. CLS. 100, 101 AND 102). SN 76-566,197. PUB. 6-28-2005. FILED 12-19-2003.
 2,996,508. **MERK & TYLER COMPANY (BLOCK FORM)**. AMERISTAR CASINOS, INC., (U.S. CLS. 100, 101 AND 102). SN 76-569,504. PUB. 6-28-2005. FILED 12-29-2003.
 2,996,520. **JFYNETWORKS INNOVATIVE LEARNING SOLUTIONS AND DESIGN**. JFYNETWORKS, (U.S. CLS. 100, 101 AND 102). SN 76-570,232. PUB. 6-28-2005. FILED 1-15-2004.
 2,996,521. **TIMESHARE SAVER.COM AND DESIGN**. TRADER PUBLISHING COMPANY, (U.S. CLS. 100, 101 AND 102). SN 76-570,244. PUB. 6-28-2005. FILED 1-15-2004.
 2,996,524. **TDS ONSITE (STYLIZED)**. TOTAL DOCUMENT SOLUTIONS, INC., (U.S. CLS. 100, 101 AND 102). SN 76-570,330. PUB. 6-28-2005. FILED 1-15-2004.
 2,996,526. **IMPROVING ANIMAL PERFORMANCE (BLOCK FORM)**. BIOPRODUCTS, INC., (U.S. CLS. 100, 101 AND 102). SN 76-570,387. PUB. 6-28-2005. FILED 1-12-2004.
 2,996,538. **CHAT (BLOCK FORM)**. ORIGINAL HONEY BAKED HAM CO. OF GEORGIA, INC., THE, MULTIPLE CLASS, (INT. CLS. 35 AND 41), (U.S. CLS. 100, 101, 102 AND 107). SN 76-571,350. PUB. 6-28-2005. FILED 1-22-2004.
 2,996,546 (*See Class 16 for this trademark*).
 2,996,558. **UNIVERSAL DATABASE (BLOCK FORM)**. GLADSON & ASSOCIATES, INC., DBA GLADSON INTERACTIVE SERVICES, (U.S. CLS. 100, 101 AND 102). SN 76-572,459. PUB. 6-28-2005. FILED 1-26-2004.
 2,996,563. **DISCOVERY WORLD FURNITURE AND DESIGN**. WATERFALL INDUSTRIES, INC., (U.S. CLS. 100, 101 AND 102). SN 76-572,578. PUB. 6-28-2005. FILED 1-27-2004.

SERVICE MARKS

CLASS 35—ADVERTISING AND BUSINESS

- 2,996,235. **MONEYLAB**. KEGAN, DANIEL L., MULTIPLE CLASS, (INT. CLS. 35 AND 41), (U.S. CLS. 100, 101, 102 AND 107). SN 75-530,549. PUB. 6-28-2005. FILED 8-4-1998.
 2,996,253. **APPALACHIAN STANDARD FLOORS**. APPALACHIAN STANDARD FLOORS, INC., (U.S. CLS. 100, 101 AND 102). SN 76-147,425. PUB. 6-28-2005. FILED 10-16-2000.
 2,996,255. **BRANDSTOCK**. LEO BURNETT WORLDWIDE, INC., (U.S. CLS. 100, 101 AND 102). SN 76-191,855. PUB. 6-28-2005. FILED 1-9-2001.
 2,996,258 (*See Class 9 for this trademark*).
 2,996,268. **TERASEN**. TERASEN INC., (U.S. CLS. 100, 101 AND 102). SN 76-351,219. PUB. 6-28-2005. FILED 12-19-2001.
 2,996,271 (*See Class 9 for this trademark*).
 2,996,274 (*See Class 16 for this trademark*).
 2,996,280. **COMPASS NAVIGATOR**. COMPASS PUBLISHING BV, MULTIPLE CLASS, (INT. CLS. 35 AND 42), (U.S. CLS. 100, 101 AND 102). SN 76-392,092. PUB. 3-29-2005. FILED 4-8-2002.
 2,996,284 (*See Class 9 for this trademark*).
 2,996,285 (*See Class 9 for this trademark*).
 2,996,286. **CORPORATE UNIVERSITY WEEK**. HREVENTS LLC, (U.S. CLS. 100, 101 AND 102). SN 76-405,796. PUB. 6-28-2005. FILED 5-6-2002.
 2,996,288. **ONSITE AVIATION AND DESIGN**. AEROTEK, INC., (U.S. CLS. 100, 101 AND 102). SN 76-411,210. PUB. 6-28-2005. FILED 5-20-2002.
 2,996,314 (*See Class 9 for this trademark*).
 2,996,331 (*See Class 9 for this trademark*).
 2,996,332 (*See Class 9 for this trademark*).
 2,996,334. **RES RECRUITMENT ENHANCEMENT SERVICES**. BERNARD HODES GROUP INC., (U.S. CLS. 100, 101 AND 102). SN 76-487,883. PUB. 6-28-2005. FILED 2-6-2003.
 2,996,335. **LASSEN WINDOW FASHIONS INC. AND DESIGN**. LASSEN WINDOW FASHIONS INC, (U.S. CLS. 100, 101 AND 102). SN 76-488,930. PUB. 6-14-2005. FILED 2-10-2003.
 2,996,336. **4 WHEEL PARTS AND DESIGN**. TRANSAMERICAN AUTO PARTS CO., INC., (U.S. CLS. 100, 101 AND 102). SN 76-488,941. PUB. 6-28-2005. FILED 2-10-2003.
 2,996,345. **SMARTCLOSE**. PRICEWATERHOUSECOOPERS LLP, MULTIPLE CLASS, (INT. CLS. 35 AND 36), (U.S. CLS. 100, 101 AND 102). SN 76-498,523. PUB. 6-28-2005. FILED 3-18-2003.
 2,996,349. **IP AND DESIGN**. LEON'S FURNITURE LIMITED,

- 2,996,567. **HOME PLUS AND DESIGN**. SOUTHWEST BUSINESS CORPORATION, MULTIPLE CLASS, (INT. CLS. 35 AND 36), (U.S. CLS. 100, 101 AND 102). SN 76-572,888. PUB. 3-8-2005. FILED 1-30-2004.
- 2,996,577. **NATIONAL FEDERATION OF REPUBLICAN WOMEN (BLOCK FORM)**. NATIONAL FEDERATION OF REPUBLICAN WOMEN, MULTIPLE CLASS, (INT. CLS. 35 AND 41), (U.S. CLS. 100, 101, 102 AND 107). SN 76-573,984. PUB. 6-28-2005. FILED 2-3-2004.
- 2,996,586. **PLUS FACTOR (STYLIZED)**. AMC, INC., (U.S. CLS. 100, 101 AND 102). SN 76-575,277. PUB. 6-28-2005. FILED 2-12-2004.
- 2,996,587. **TIBET GALLERY (BLOCK FORM)**. PASSANG, TENZIN, (U.S. CLS. 100, 101 AND 102). SN 76-575,284. PUB. 6-28-2005. FILED 2-12-2004.
- 2,996,596. **SIGMANET AND DESIGN**. SIGMA-INTERNET, INC., MULTIPLE CLASS, (INT. CLS. 35, 37 AND 42), (U.S. CLS. 100, 101, 102, 103 AND 106). SN 76-576,156. PUB. 6-28-2005. FILED 2-19-2004.
- 2,996,606. **BOILER SUPPLY (STYLIZED)**. BOILER SUPPLY COMPANY, INC., MULTIPLE CLASS, (INT. CLS. 35 AND 37), (U.S. CLS. 100, 101, 102, 103 AND 106). SN 76-577,263. PUB. 6-28-2005. FILED 2-17-2004.
- 2,996,625. **MISCELLANEOUS DESIGN**. THE FRANTZ GROUP, INC., (U.S. CLS. 100, 101 AND 102). SN 76-581,015. PUB. 6-28-2005. FILED 3-12-2004.
- 2,996,626. **THE FRANTZ GROUP (BLOCK FORM)**. THE FRANTZ GROUP, INC., (U.S. CLS. 100, 101 AND 102). SN 76-581,016. PUB. 6-28-2005. FILED 3-12-2004.
- 2,996,629. **RE-DEFINING VALUE IN PROFESSIONAL SERVICES (BLOCK FORM)**. TITUS GROUP, INC., THE, (U.S. CLS. 100, 101 AND 102). SN 76-581,316. PUB. 6-28-2005. FILED 2-23-2004.
- 2,996,644. **BPA BENTLEY PRICE ASSOCIATES AND DESIGN**. BENTLEY PRICE ASSOCIATES, INC., (U.S. CLS. 100, 101 AND 102). SN 76-584,517. PUB. 6-28-2005. FILED 3-31-2004.
- 2,996,655 (*See Class 16 for this trademark*).
- 2,996,658. **BEL-AQUA AND DESIGN**. BEL-AQUA POOL SUPPLY, INC., (U.S. CLS. 100, 101 AND 102). SN 76-588,178. PUB. 6-28-2005. FILED 4-22-2004.
- 2,996,660. **DATA GROUP SELECT (BLOCK FORM)**. DATA GROUP SELECT, LLC, (U.S. CLS. 100, 101 AND 102). SN 76-588,471. PUB. 6-28-2005. FILED 4-23-2004.
- 2,996,663. **TRANSCOMMERCE (BLOCK FORM)**. TRANSGROUP EXPRESS, INC., DBA TRANSGROUP WORLDWIDE LOGISTICS, (U.S. CLS. 100, 101 AND 102). SN 76-588,688. PUB. 6-28-2005. FILED 4-26-2004.
- 2,996,670. **TEAM LOGISTICS (BLOCK FORM)**. TEAM AIR EXPRESS, INC., (U.S. CLS. 100, 101 AND 102). SN 76-590,066. PUB. 6-28-2005. FILED 4-30-2004.
- 2,996,676. **BANKRUPTCY WAREHOUSE: THE GOING OUT OF BUSINESS, BUSINESS (BLOCK FORM)**. CHEAP THRILLS, LLC., (U.S. CLS. 100, 101 AND 102). SN 76-590,780. PUB. 6-28-2005. FILED 5-5-2004.
- 2,996,678. **PAYROLL USA AND DESIGN**. PAYROLL USA, INC., (U.S. CLS. 100, 101 AND 102). SN 76-591,188. PUB. 6-28-2005. FILED 5-10-2004.
- 2,996,692. **CDOMARKETING (BLOCK FORM)**. CDOMARKETING, (U.S. CLS. 100, 101 AND 102). SN 76-593,298. PUB. 6-28-2005. FILED 5-20-2004.
- 2,996,696. **ONE MIND ONE VISION, ONE GOAL, ONE DIRECTION, AND DESIGN**. ONE MIND, LLC, (U.S. CLS. 100, 101 AND 102). SN 76-594,381. PUB. 6-28-2005. FILED 5-27-2004.
- 2,996,706. **PATHWAYS TO GOOD HEALTH AND NUTRITION (BLOCK FORM)**. S&L SOLUTIONS LLC, (U.S. CLS. 100, 101 AND 102). SN 76-595,954. PUB. 6-28-2005. FILED 6-4-2004.
- 2,996,708. **TWO PEAS IN A BUCKET (BLOCK FORM)**. TWO PEAS IN A BUCKET, INC., MULTIPLE CLASS, (INT. CLS. 35 AND 38), (U.S. CLS. 100, 101, 102 AND 104). SN 76-595,975. PUB. 6-28-2005. FILED 6-7-2004.
- 2,996,721 (*See Class 9 for this trademark*).
- 2,996,727. **CAUSEEFFECTS (STYLIZED)**. CAUSEEFFECTS, INC., (U.S. CLS. 100, 101 AND 102). SN 76-597,973. PUB. 6-28-2005. FILED 6-18-2004.
- 2,996,734. **WISTFUL VISTA TELEPHONE CO. (BLOCK FORM)**. JOHNSON, DAVID, DBA WISTFUL VISTA TELEPHONE CO., (U.S. CLS. 100, 101 AND 102). SN 76-598,721. PUB. 6-28-2005. FILED 6-23-2004.
- 2,996,737. **ESCORT (BLOCK FORM)**. ESCORT INC., (U.S. CLS. 100, 101 AND 102). SN 76-598,884. PUB. 6-28-2005. FILED 6-23-2004.
- 2,996,753. **PRIMARIS (BLOCK FORM)**. MISSOURI PATIENT CARE REVIEW FOUNDATION, (U.S. CLS. 100, 101 AND 102). SN 76-600,513. PUB. 6-28-2005. FILED 7-2-2004.
- 2,996,766. **EVERYTHING PEOPLE (BLOCK FORM)**. AMERICAN SOCIETY OF EMPLOYERS, (U.S. CLS. 100, 101 AND 102). SN 76-602,849. PUB. 6-28-2005. FILED 7-19-2004.
- 2,996,792. **IR AND DESIGN**. INFORELIANCE CORPORATION, (U.S. CLS. 100, 101 AND 102). SN 76-604,509. PUB. 6-28-2005. FILED 7-28-2004.
- 2,996,793. **INFO RELIANCE AND DESIGN**. INFORELIANCE CORPORATION, (U.S. CLS. 100, 101 AND 102). SN 76-604,512. PUB. 6-28-2005. FILED 7-28-2004.
- 2,996,803. **TALENT RETRIEVER (BLOCK FORM)**. TALENT RETRIEVER, LLC, (U.S. CLS. 100, 101 AND 102). SN 76-604,709. PUB. 6-28-2005. FILED 7-27-2004.
- 2,996,825. **KEEPING YOUR BUSINESS FRESH (BLOCK FORM)**. THE PERISHABLES GROUP, INC., (U.S. CLS. 100, 101 AND 102). SN 76-605,121. PUB. 6-28-2005. FILED 8-2-2004.
- 2,996,836. **CREATE COMMUNITY RESPECT AND OPPORTUNITY FOR ALL AND DESIGN**. CITY OF ST. CLOUD, MINNESOTA, (U.S. CLS. 100, 101 AND 102). SN 76-605,385. PUB. 6-28-2005. FILED 8-2-2004.
- 2,996,847. **A GOOD DEAL BUY TO GIVE FOR A GOOD CAUSE TOGETHER WE CAN AND DESIGN**. JUST RIGHT, LLC, (U.S. CLS. 100, 101 AND 102). SN 76-605,625. PUB. 6-28-2005. FILED 8-4-2004.
- 2,996,851. **LIGHTSPEED HOBBIES (STYLIZED)**. LIGHTSPEED HOBBIES, INC., (U.S. CLS. 100, 101 AND 102). SN 76-605,705. PUB. 6-28-2005. FILED 8-5-2004.
- 2,996,860. **HONOLULU COOKIE COMPANY (BLOCK FORM)**. K & S HAWAIIAN CREATIONS, INCORPORATED, DBA HONOLULU COOKIE COMPANY, (U.S. CLS. 100, 101 AND 102). SN 76-605,977. PUB. 6-28-2005. FILED 8-5-2004.
- 2,996,865 (*See Class 25 for this trademark*).
- 2,996,884 (*See Class 25 for this trademark*).
- 2,996,895. **CUSTOMFLIX**. CUSTOMFLIX LABS, INC., (U.S. CLS. 100, 101 AND 102). SN 78-121,878. PUB. 6-28-2005. FILED 4-15-2002.
- 2,996,896 (*See Class 9 for this trademark*).
- 2,996,900. **CASTELLA**. CASTELLA IMPORTS, INC., (U.S. CLS. 100, 101 AND 102). SN 78-164,725. PUB. 6-28-2005. FILED 9-17-2002.
- 2,996,903 (*See Class 33 for this trademark*).
- 2,996,906. **MIDWEST CONNECT**. YX PROPERTIES, LLC, MULTIPLE CLASS, (INT. CLS. 35 AND 39), (U.S. CLS. 100, 101, 102 AND 105). SN 78-177,261. PUB. 6-28-2005. FILED 10-22-2002.
- 2,996,909. **THE OFFICIAL TICKET CENTER**. BRUCE A. CARTER, (U.S. CLS. 100, 101 AND 102). SN 78-184,021. PUB. 6-28-2005. FILED 11-12-2002.
- 2,996,910. **FINDMYJEWELER.COM AND DESIGN**. DIAMONDREVIEW.COM, INC., MULTIPLE CLASS, (INT. CLS. 35 AND 42), (U.S. CLS. 100, 101 AND 102). SN 78-187,126. PUB. 6-28-2005. FILED 11-20-2002.
- 2,996,911. **SENERGY**. INTEGRATED ANIMAL PRODUCTION PTY LTD, (U.S. CLS. 100, 101 AND 102). SN 78-187,862. PUB. 6-28-2005. FILED 11-22-2002.
- 2,996,918. **ASK THE BUSINESS SPECIALIST AND DESIGN**. FIND/SVP, INC., (U.S. CLS. 100, 101 AND 102). SN 78-208,753. PUB. 6-28-2005. FILED 1-30-2003.
- 2,996,920. **FLYING A. EMPIRE BRANDS, INC.**, (U.S. CLS. 100, 101 AND 102). SN 78-213,514. PUB. 6-28-2005. FILED 2-11-2003.
- 2,996,922. **MISCELLANEOUS DESIGN**. GENERAL CHURCH OF THE NEW JERUSALEM, MULTIPLE CLASS, (INT. CLS. 35, 41 AND 45), (U.S. CLS. 100, 101, 102 AND 107). SN 78-217,443. PUB. 6-28-2005. FILED 2-21-2003.
- 2,996,933. **KEY MRO AND DESIGN**. KEYMRO, MULTIPLE CLASS, (INT. CLS. 35, 36, 38 AND 42), (U.S. CLS. 100, 101, 102 AND 104). SN 78-226,347. PUB. 6-28-2005. FILED 3-17-

- 2003.
- 2,996,939. **REACTION SEARCH INTERNATIONAL. BOROFF, ROBERT**, (U.S. CLS. 100, 101 AND 102). SN 78-241,704. PUB. 6-28-2005. FILED 4-24-2003.
- 2,996,944. **A SMART CHOICE FOR SAVINGS. DOLLAR SMART AND DESIGN. SUPERVALU INC.**, (U.S. CLS. 100, 101 AND 102). SN 78-243,633. PUB. 6-28-2005. FILED 4-30-2003.
- 2,996,952. **HEALTH RISK INDEX HRI. CAREMARK INTERNATIONAL INC.**, (U.S. CLS. 100, 101 AND 102). SN 78-254,607. PUB. 6-28-2005. FILED 5-27-2003.
- 2,996,954 (*See Class 9 for this trademark*).
- 2,996,968. **TVHOST AND DESIGN. TVHOST, L.L.C.**, (U.S. CLS. 100, 101 AND 102). SN 78-272,248. PUB. 6-28-2005. FILED 7-9-2003.
- 2,996,981. **SOUTH WATER MARKET. SOUTH WATER MARKET, INC.**, (U.S. CLS. 100, 101 AND 102). SN 78-280,442. PUB. 6-28-2005. FILED 7-29-2003.
- 2,996,982. **HOUSEVALUES.COM. HOUSEVALUES, INC.**, (U.S. CLS. 100, 101 AND 102). SN 78-281,495. PUB. 6-28-2005. FILED 7-31-2003.
- 2,996,985. **VALUECURVE TECHNOLOGIES AND DESIGN. VALUECURVE TECHNOLOGIES, INC.**, MULTIPLE CLASS, (INT. CLS. 35 AND 42), (U.S. CLS. 100, 101 AND 102). SN 78-283,411. PUB. 6-28-2005. FILED 8-5-2003.
- 2,996,987. **CLICKCASH. WEBPOWER, INC.**, MULTIPLE CLASS, (INT. CLS. 35 AND 42), (U.S. CLS. 100, 101 AND 102). SN 78-288,197. PUB. 6-28-2005. FILED 8-15-2003.
- 2,996,990. **MISCELLANEOUS DESIGN. ECONOMIC DEVELOPMENT BOARD, MULTIPLE CLASS, (INT. CLS. 35 AND 41), (U.S. CLS. 100, 101, 102 AND 107)**. SN 78-291,060. PUB. 6-28-2005. FILED 8-22-2003.
- 2,996,998. **MAILNOW. USA DIRECT, INC.**, MULTIPLE CLASS, (INT. CLS. 35 AND 42), (U.S. CLS. 100, 101 AND 102). SN 78-295,551. PUB. 6-28-2005. FILED 9-3-2003.
- 2,997,002. **HRGURU.BIZ AND DESIGN. HRGURU.BIZ CORPORATION, MULTIPLE CLASS, (INT. CLS. 35 AND 41), (U.S. CLS. 100, 101, 102 AND 107)**. SN 78-297,668. PUB. 6-28-2005. FILED 9-9-2003.
- 2,997,008. **CHAMBER PERKS. KNIGHT IMAGES, INC.**, (U.S. CLS. 100, 101 AND 102). SN 78-298,991. PUB. 6-28-2005. FILED 9-11-2003.
- 2,997,015. **WESTYE. SUB-ZERO FREEZER COMPANY, INC.**, MULTIPLE CLASS, (INT. CLS. 35 AND 41), (U.S. CLS. 100, 101, 102 AND 107). SN 78-303,836. PUB. 6-28-2005. FILED 9-22-2003.
- 2,997,020. **SPINSANITY. KEEFER, BRYAN R., AND NYHAN, BRENDAN, AND FRITZ, BENJAMIN**, (U.S. CLS. 100, 101 AND 102). SN 78-306,233. PUB. 6-28-2005. FILED 9-26-2003.
- 2,997,028. **CLARITUS. CLARITUS, INC.**, MULTIPLE CLASS, (INT. CLS. 35 AND 42), (U.S. CLS. 100, 101 AND 102). SN 78-313,498. PUB. 6-28-2005. FILED 10-14-2003.
- 2,997,037. **MISCELLANEOUS DESIGN. BRAINSTORM DESIGN, INC., DBA BRAINSTORM**, (U.S. CLS. 100, 101 AND 102). SN 78-322,746. PUB. 6-28-2005. FILED 11-4-2003.
- 2,997,048. **WEBTRAILBLAZERS (BLOCK FORM). AAA WORLD CALLING INC. MULTIPLE CLASS, (INT. CLS. 35 AND 42), (U.S. CLS. 100, 101 AND 102)**. SN 78-328,217. PUB. 6-28-2005. FILED 11-14-2003.
- 2,997,049. **REVENUE ACCELERATION (BLOCK FORM). UNFAIR ADVANTAGE, INC.**, (U.S. CLS. 100, 101 AND 102). SN 78-328,316. PUB. 6-28-2005. FILED 11-14-2003.
- 2,997,060. **OPERATION CRAYON (BLOCK FORM). ADOP-TAPLATOON SOLDIER SUPPORT EFFORT, INCORPORATED**, (U.S. CLS. 100, 101 AND 102). SN 78-330,838. PUB. 6-28-2005. FILED 11-20-2003.
- 2,997,061. **ADOPTAPLATOON (BLOCK FORM). ADOPTAPLATOON SOLDIER SUPPORT EFFORT, INCORPORATED**, (U.S. CLS. 100, 101 AND 102). SN 78-330,858. PUB. 6-28-2005. FILED 11-20-2003.
- 2,997,070. **CROSSFIRE (BLOCK FORM). REALPAGE, INC.**, MULTIPLE CLASS, (INT. CLS. 35 AND 38), (U.S. CLS. 100, 101, 102 AND 104). SN 78-334,451. PUB. 6-28-2005. FILED 12-1-2003.
- 2,997,072. **UNSCENE2 (STYLIZED). GAUSPOHL, CHRISTOPHER M.**, (U.S. CLS. 100, 101 AND 102). SN 78-335,057. PUB. 6-28-2005. FILED 12-2-2003.
- 2,997,084. **WELCOMEMAT SERVICES INC. AND DESIGN. WELCOMEMAT SERVICES, INC.**, (U.S. CLS. 100, 101 AND 102). SN 78-341,105. PUB. 6-28-2005. FILED 12-15-2003.
- 2,997,095. **HOLLYWOOD COLLECTORS SHOW, INC. (BLOCK FORM). HOLLYWOOD COLLECTORS SHOW, INC.**, (U.S. CLS. 100, 101 AND 102). SN 78-342,943. PUB. 6-28-2005. FILED 12-18-2003.
- 2,997,109. **FETCHBOOK (BLOCK FORM). CYGNUS SOFTWARE LTD.**, (U.S. CLS. 100, 101 AND 102). SN 78-346,879. PUB. 6-28-2005. FILED 12-31-2003.
- 2,997,119. **UWG (STYLIZED). UNIWORLD GROUP, INC.**, (U.S. CLS. 100, 101 AND 102). SN 78-348,445. PUB. 6-28-2005. FILED 1-6-2004.
- 2,997,120. **ISOTEC (BLOCK FORM). ISOTEC, INC.**, (U.S. CLS. 100, 101 AND 102). SN 78-348,489. PUB. 6-28-2005. FILED 1-6-2004.
- 2,997,126. **FENCES 4 LESS .COM (BLOCK FORM). ASH, GARY W.**, (U.S. CLS. 100, 101 AND 102). SN 78-349,621. PUB. 6-28-2005. FILED 1-8-2004.
- 2,997,139. **GREAT PLACES TO LIVE, WORK, SHOP & PLAY (BLOCK FORM). TOWNE PROPERTIES, INC., MULTIPLE CLASS, (INT. CLS. 35, 36 AND 37), (U.S. CLS. 100, 101, 102, 103 AND 106)**. SN 78-351,676. PUB. 6-28-2005. FILED 1-14-2004.
- 2,997,140. **MISCELLANEOUS DESIGN. NAVIGANT CONSULTING, INC., MULTIPLE CLASS, (INT. CLS. 35, 36 AND 42), (U.S. CLS. 100, 101 AND 102)**. SN 78-351,718. PUB. 6-28-2005. FILED 1-14-2004.
- 2,997,146. **WIRELESSIQ (BLOCK FORM). ALLIED BUSINESS INTELLIGENCE, INC.**, (U.S. CLS. 100, 101 AND 102). SN 78-352,900. PUB. 6-28-2005. FILED 1-16-2004.
- 2,997,154. **CIC COMPETITIVE INTELLIGENCE & CONSULTING AND DESIGN. COMPETITIVE INTELLIGENCE & CONSULTING LIMITED**, (U.S. CLS. 100, 101 AND 102). SN 78-356,047. PUB. 6-28-2005. FILED 1-22-2004.
- 2,997,155 (*See Class 15 for this trademark*).
- 2,997,176. **P AND DESIGN. JRC INDUSTRIES, INC.**, (U.S. CLS. 100, 101 AND 102). SN 78-359,626. PUB. 6-28-2005. FILED 1-29-2004.
- 2,997,179. **IMAGINE YOUR LIFE WITH A PERSONAL ASSISTANT (BLOCK FORM). INFONE LLC**, (U.S. CLS. 100, 101 AND 102). SN 78-359,782. PUB. 6-28-2005. FILED 1-29-2004.
- 2,997,184. **TRAJEN (BLOCK FORM). CLANTON, JOHN W.**, MULTIPLE CLASS, (INT. CLS. 35 AND 37), (U.S. CLS. 100, 101, 102, 103 AND 106). SN 78-359,964. PUB. 6-28-2005. FILED 1-30-2004.
- 2,997,185 (*See Class 7 for this trademark*).
- 2,997,186 (*See Class 7 for this trademark*).
- 2,997,189. **V-DAY (BLOCK FORM). V-DAY, MULTIPLE CLASS, (INT. CLS. 35, 36 AND 41), (U.S. CLS. 100, 101, 102 AND 107)**. SN 78-360,388. PUB. 6-28-2005. FILED 1-30-2004.
- 2,997,190. **THEBIDPOST (BLOCK FORM). BLACK, GENE**, (U.S. CLS. 100, 101 AND 102). SN 78-360,507. PUB. 6-28-2005. FILED 1-30-2004.
- 2,997,202. **GOLDEN HOUR AND DESIGN. GOLDEN HOUR DATA SYSTEMS, INC.**, MULTIPLE CLASS, (INT. CLS. 35 AND 42), (U.S. CLS. 100, 101 AND 102). SN 78-361,650. PUB. 6-28-2005. FILED 2-3-2004.
- 2,997,205. **DEZENHALL RESOURCES (BLOCK FORM). DEZENHALL RESOURCES, INC.**, (U.S. CLS. 100, 101 AND 102). SN 78-362,012. PUB. 6-28-2005. FILED 2-3-2004.
- 2,997,232. **SANCTIFIED 7 AND DESIGN. PEOPLE FOR THE AMERICAN WAY FOUNDATION**, (U.S. CLS. 100, 101 AND 102). SN 78-365,234. PUB. 6-28-2005. FILED 2-10-2004.
- 2,997,234. **PS AND DESIGN. ROWE ENTERPRISES, INC.**, (U.S. CLS. 100, 101 AND 102). SN 78-365,468. PUB. 6-28-2005. FILED 2-10-2004.
- 2,997,257. **HYDROHARRYS (BLOCK FORM). HARRY'S GARDEN CENTER, INC.**, (U.S. CLS. 100, 101 AND 102). SN 78-368,684. PUB. 6-28-2005. FILED 2-16-2004.
- 2,997,259. **RIOTHOUSE (BLOCK FORM). HANSON, MICHAEL F.**, (U.S. CLS. 100, 101 AND 102). SN 78-368,782. PUB. 6-28-2005. FILED 2-16-2004.
- 2,997,262. **JUMPONDEALS (BLOCK FORM). CONSUMER RELATIONS, INC.**, (U.S. CLS. 100, 101 AND 102). SN 78-369,433. PUB. 6-28-2005. FILED 2-17-2004.
- 2,997,263 (*See Class 18 for this trademark*).
- 2,997,275. **MOVIEBALL (BLOCK FORM). PEST DESIGN AB**,

- MULTIPLE CLASS, (INT. CLS. 35, 41 AND 45), (U.S. CLS. 100, 101, 102 AND 107). SN 78-371,668. PUB. 6-28-2005. FILED 2-20-2004.
- 2,997,277 (*See Class 16 for this trademark*).
- 2,997,298. **RIFFS (BLOCK FORM)**. GENEVA MEDIA, LLC, MULTIPLE CLASS, (INT. CLS. 35 AND 42), (U.S. CLS. 100, 101 AND 102). SN 78-375,419. PUB. 6-28-2005. FILED 2-27-2004.
- 2,997,299. **BAREFOOT WEALTH MANAGEMENT (BLOCK FORM)**. BAREFOOT WEALTH MANAGEMENT, INC., MULTIPLE CLASS, (INT. CLS. 35 AND 36), (U.S. CLS. 100, 101 AND 102). SN 78-375,671. PUB. 6-28-2005. FILED 2-27-2004.
- 2,997,308 (*See Class 16 for this trademark*).
- 2,997,309. **MISCELLANEOUS DESIGN**. INTEGRATED DOCUMENT TECHNOLOGIES, INC., MULTIPLE CLASS, (INT. CLS. 35 AND 42), (U.S. CLS. 100, 101 AND 102). SN 78-376,774. PUB. 6-28-2005. FILED 3-2-2004.
- 2,997,320. **PRINCETON (BLOCK FORM)**. PRINCETON ENTERPRISES LTD, LLC, (U.S. CLS. 100, 101 AND 102). SN 78-378,545. PUB. 6-28-2005. FILED 3-4-2004.
- 2,997,328 (*See Class 30 for this trademark*).
- 2,997,342. **TOOLS FOR SCHOOLS (BLOCK FORM)**. GOOD SOURCE SOLUTIONS, INC, (U.S. CLS. 100, 101 AND 102). SN 78-384,193. PUB. 6-28-2005. FILED 3-15-2004.
- 2,997,353. **DREAM HOME TOUR AND DESIGN**. DREAM HOME TOUR, LLC, (U.S. CLS. 100, 101 AND 102). SN 78-386,796. PUB. 6-28-2005. FILED 3-18-2004.
- 2,997,374. **UNDERGROUND MESSENGER: ENTERTAINMENT/LIFESTYLE PROMOTIONS (BLOCK FORM)**. UNDERGROUND MESSENGER, INC., (U.S. CLS. 100, 101 AND 102). SN 78-389,800. PUB. 6-28-2005. FILED 3-24-2004.
- 2,997,376. **TA HSING AND DESIGN**. TA HSING ELECTRIC WIRE & CABLE CO., LTD., (U.S. CLS. 100, 101 AND 102). SN 78-390,392. PUB. 6-28-2005. FILED 3-25-2004.
- 2,997,383. **ONECALL (BLOCK FORM)**. HUPPIN'S HI-FI, PHOTO AND VIDEO, INC., (U.S. CLS. 100, 101 AND 102). SN 78-391,799. PUB. 6-28-2005. FILED 3-26-2004.
- 2,997,387. **THE WINE EXPERT AND DESIGN**. THE WINE EXPERT PTY LTD, MULTIPLE CLASS, (INT. CLS. 35 AND 42), (U.S. CLS. 100, 101 AND 102). SN 78-392,624. PUB. 6-28-2005. FILED 3-29-2004.
- 2,997,393. **AMERICAN RABBIT HOUND ASSOCIATION (BLOCK FORM)**. MORGAN, DELBERT, (U.S. CLS. 100, 101 AND 102). SN 78-393,278. PUB. 6-28-2005. FILED 3-30-2004.
- 2,997,401. **BLUE STONE HOME (BLOCK FORM)**. LUVOGT, TRACY, (U.S. CLS. 100, 101 AND 102). SN 78-394,441. PUB. 6-28-2005. FILED 3-31-2004.
- 2,997,409. **MISCELLANEOUS DESIGN**. MR. AQUARIUM, L.P., (U.S. CLS. 100, 101 AND 102). SN 78-396,554. PUB. 6-28-2005. FILED 4-5-2004.
- 2,997,411. **DEALERSHIP CSI (BLOCK FORM)**. DEALERSHIP CONSULTING SERVICES, INC., (U.S. CLS. 100, 101 AND 102). SN 78-397,033. PUB. 6-28-2005. FILED 4-6-2004.
- 2,997,418. **GENERATION CHESS (BLOCK FORM)**. GENERATION CHESS, LLC, MULTIPLE CLASS, (INT. CLS. 35 AND 41), (U.S. CLS. 100, 101, 102 AND 107). SN 78-398,863. PUB. 6-28-2005. FILED 4-8-2004.
- 2,997,435. **KBR (BLOCK FORM)**. KELLOGG BROWN & ROOT, INC., MULTIPLE CLASS, (INT. CLS. 35, 37 AND 42), (U.S. CLS. 100, 101, 102, 103 AND 106). SN 78-402,448. PUB. 6-28-2005. FILED 4-15-2004.
- 2,997,437. **THE CANNERY (BLOCK FORM)**. CANNED INTERACTIVE, INC., MULTIPLE CLASS, (INT. CLS. 35, 41 AND 42), (U.S. CLS. 100, 101, 102 AND 107). SN 78-402,824. PUB. 6-28-2005. FILED 4-15-2004.
- 2,997,439. **HOT GROOVES (BLOCK FORM)**. MILLER, CRAIG, (U.S. CLS. 100, 101 AND 102). SN 78-402,947. PUB. 6-28-2005. FILED 4-16-2004.
- 2,997,455. **BUY IT.GOV THE BETTER WAY TO BUY IT AND DESIGN**. U.S. DEPARTMENT OF VETERANS AFFAIRS, (U.S. CLS. 100, 101 AND 102). SN 78-405,429. PUB. 6-28-2005. FILED 4-21-2004.
- 2,997,460 (*See Class 2 for this trademark*).
- 2,997,464. **A.M.A. CAR (STYLIZED)**. MAACO ENTERPRISES, INC., (U.S. CLS. 100, 101 AND 102). SN 78-407,104. PUB. 6-28-2005. FILED 4-23-2004.
- 2,997,465. **MARKET DAY GOURMET (BLOCK FORM)**. MARKET DAY CORPORATION, (U.S. CLS. 100, 101 AND 102). SN 78-407,363. PUB. 6-28-2005. FILED 4-23-2004.
- 2,997,469. **FASTFORWARD LTD. (BLOCK FORM)**. PIRRONE, DOUGLAS, (U.S. CLS. 100, 101 AND 102). SN 78-408,819. PUB. 6-28-2005. FILED 4-27-2004.
- 2,997,484. **JOSS VISION (BLOCK FORM)**. JOSS VISION CARE LTD., (U.S. CLS. 100, 101 AND 102). SN 78-411,522. PUB. 6-28-2005. FILED 4-30-2004.
- 2,997,487. **TRUSTED STRATEGIES (BLOCK FORM)**. TRUSTED STRATEGIES LLC, (U.S. CLS. 100, 101 AND 102). SN 78-412,040. PUB. 6-28-2005. FILED 5-3-2004.
- 2,997,493. **LEGAL AUTHORITY IT'S HOW ATTORNEYS GET JOBS (BLOCK FORM)**. LEGALAUTHORITY.COM, (U.S. CLS. 100, 101 AND 102). SN 78-413,140. PUB. 6-28-2005. FILED 5-4-2004.
- 2,997,497. **EXPECT MORE (BLOCK FORM)**. FOMO PRODUCTS, INC., (U.S. CLS. 100, 101 AND 102). SN 78-414,095. PUB. 6-28-2005. FILED 5-6-2004.
- 2,997,500. **STEMCOR (BLOCK FORM)**. STEMCOR USA, INC., MULTIPLE CLASS, (INT. CLS. 35, 36 AND 39), (U.S. CLS. 100, 101, 102 AND 105). SN 78-414,451. PUB. 6-28-2005. FILED 5-6-2004.
- 2,997,507. **YOUR MILK MARKETERS ... AND A WHOLE LOT MORE (BLOCK FORM)**. GRANDE CHEESE COMPANY, MULTIPLE CLASS, (INT. CLS. 35 AND 42), (U.S. CLS. 100, 101 AND 102). SN 78-415,767. PUB. 6-28-2005. FILED 5-10-2004.
- 2,997,517. **PIUG (BLOCK FORM)**. PATENT INFORMATION USERS GROUP, INC., (U.S. CLS. 100, 101 AND 102). SN 78-419,448. PUB. 6-28-2005. FILED 5-15-2004.
- 2,997,518. **MASTERWORKS IN MINIATURE (BLOCK FORM)**. GALLERY ONE, LTD., COMPANY, (U.S. CLS. 100, 101 AND 102). SN 78-419,505. PUB. 6-28-2005. FILED 5-16-2004.
- 2,997,520. **WHERE PERFUME LOVERS GO (BLOCK FORM)**. TRAN, JACQUELYN, (U.S. CLS. 100, 101 AND 102). SN 78-420,105. PUB. 6-28-2005. FILED 5-17-2004.
- 2,997,522. **PLATINUM PREFERENCE REWARDS (BLOCK FORM)**. NEIMAN MARCUS GROUP, INC., THE, (U.S. CLS. 100, 101 AND 102). SN 78-420,272. PUB. 6-28-2005. FILED 5-17-2004.
- 2,997,524. **KEY WHOLESALER GROUP ASSOCIATION (BLOCK FORM)**. KEY WHOLESALER GROUP ASSOCIATION, (U.S. CLS. 100, 101 AND 102). SN 78-420,629. PUB. 6-28-2005. FILED 5-18-2004.
- 2,997,525. **OPEIU AND DESIGN**. OFFICE AND PROFESSIONAL EMPLOYEES INTERNATIONAL UNION, (U.S. CLS. 100, 101 AND 102). SN 78-420,647. PUB. 6-28-2005. FILED 5-18-2004.
- 2,997,533. **DISCOVER THE DIFFERENCE (BLOCK FORM)**. LIA, DON, (U.S. CLS. 100, 101 AND 102). SN 78-422,268. PUB. 6-28-2005. FILED 5-20-2004.
- 2,997,539. **TRUCKIN' AMERICA AND DESIGN**. JIMONI INC., DBA TRUCKIN' AMERICA, (U.S. CLS. 100, 101 AND 102). SN 78-423,892. PUB. 6-28-2005. FILED 5-24-2004.
- 2,997,550. **GLOBALINDUSTRIAL.COM (BLOCK FORM)**. SYSTEMAX INC., (U.S. CLS. 100, 101 AND 102). SN 78-426,417. PUB. 6-28-2005. FILED 5-27-2004.
- 2,997,551. **DISCOVER DIVERSITY (BLOCK FORM)**. PENDER NURSERY, INC., (U.S. CLS. 100, 101 AND 102). SN 78-426,693. PUB. 6-28-2005. FILED 5-28-2004.
- 2,997,555. **MAKE SUN SAFETY YOUR GOAL! AND DESIGN**. AMERICAN ACADEMY OF DERMATOLOGY, (U.S. CLS. 100, 101 AND 102). SN 78-427,395. PUB. 6-28-2005. FILED 5-29-2004.
- 2,997,557. **NEXTLEVEL (STYLIZED)**. CARRIER CORPORATION, (U.S. CLS. 100, 101 AND 102). SN 78-428,073. PUB. 6-28-2005. FILED 6-1-2004.
- 2,997,564. **RREEF (BLOCK FORM)**. RREEF AMERICA L.L.C., MULTIPLE CLASS, (INT. CLS. 35, 36, 37 AND 42), (U.S. CLS. 100, 101, 102, 103 AND 106). SN 78-429,881. PUB. 6-28-2005. FILED 6-4-2004.
- 2,997,565. **THE SCIENCE OF MOTIVATION (BLOCK FORM)**. AIRPOINTS, INC., (U.S. CLS. 100, 101 AND 102). SN 78-429,930. PUB. 6-28-2005. FILED 6-4-2004.
- 2,997,566. **EBILLINGHUB (BLOCK FORM)**. IGD SYSTEMS, LLC, (U.S. CLS. 100, 101 AND 102). SN 78-429,978. PUB. 6-28-2005. FILED 6-4-2004.

- 2,997,578. **BIDZOOKA (BLOCK FORM)**. PLANET CASH LLC, MULTIPLE CLASS, (INT. CLS. 35, 36 AND 39), (U.S. CLS. 100, 101, 102 AND 105). SN 78-432,451. PUB. 6-28-2005. FILED 6-9-2004.
- 2,997,584. **LANCASTER ARCHERY SUPPLY AND DESIGN**. LANCASTER ARCHERY SUPPLY, INC., (U.S. CLS. 100, 101 AND 102). SN 78-433,793. PUB. 6-28-2005. FILED 6-11-2004.
- 2,997,586. **LANA'I HAWAII'S MOST ENTICING ISLAND AND DESIGN**. DESTINATION LANA'I, (U.S. CLS. 100, 101 AND 102). SN 78-434,257. PUB. 6-28-2005. FILED 6-11-2004.
- 2,997,611. **WE TAKE THE CHAOS OUT OF SUBSCRIPTION MANAGEMENT (BLOCK FORM)**. WOLPER SUBSCRIPTION SERVICES, INC., (U.S. CLS. 100, 101 AND 102). SN 78-436,635. PUB. 6-28-2005. FILED 6-17-2004.
- 2,997,620. **T TOOL CRIB AND DESIGN**. TOOL CRIB, INC., MULTIPLE CLASS, (INT. CLS. 35 AND 42), (U.S. CLS. 100, 101 AND 102). SN 78-437,817. PUB. 6-28-2005. FILED 6-18-2004.
- 2,997,635. **WAITEX AND DESIGN**. WAITEX INTERNATIONAL CO. LTD., MULTIPLE CLASS, (INT. CLS. 35, 39 AND 42), (U.S. CLS. 100, 101, 102 AND 105). SN 78-439,884. PUB. 6-28-2005. FILED 6-23-2004.
- 2,997,637. **AUSTIN: THE HUMAN CAPITAL (BLOCK FORM)**. GREATER AUSTIN CHAMBER OF COMMERCE, (U.S. CLS. 100, 101 AND 102). SN 78-440,295. PUB. 6-28-2005. FILED 6-23-2004.
- 2,997,651. **STAR CONSORTIUM ALLIANCE (BLOCK FORM)**. CORPORATE EXPRESS, INC., (U.S. CLS. 100, 101 AND 102). SN 78-441,776. PUB. 6-28-2005. FILED 6-25-2004.
- 2,997,673. **THE SCIENCE OF RECRUITING (BLOCK FORM)**. VIRGO PACIFIC LTD., (U.S. CLS. 100, 101 AND 102). SN 78-444,293. PUB. 6-28-2005. FILED 7-1-2004.
- 2,997,674. **SCIREC (BLOCK FORM)**. VIRGO PACIFIC LTD., (U.S. CLS. 100, 101 AND 102). SN 78-444,295. PUB. 6-28-2005. FILED 7-1-2004.
- 2,997,683. **UHS (BLOCK FORM)**. UNIVERSAL HOSPITAL SERVICES, INC., (U.S. CLS. 100, 101 AND 102). SN 78-444,685. PUB. 6-28-2005. FILED 7-1-2004.
- 2,997,695. **OPENING OF THE HEART (BLOCK FORM)**. OPENING OF THE HEART, MULTIPLE CLASS, (INT. CLS. 35 AND 41), (U.S. CLS. 100, 101, 102 AND 107). SN 78-445,606. PUB. 6-28-2005. FILED 7-2-2004.
- 2,997,696. **O.U.C.H. (STYLIZED)**. ORGANIZATION FOR UNDERSTANDING CLUSTER HEADACHES, (U.S. CLS. 100, 101 AND 102). SN 78-445,790. PUB. 6-28-2005. FILED 7-3-2004.
- 2,997,700. **MISCELLANEOUS DESIGN**. BLUE CROSS AND BLUE SHIELD OF VERMONT, MULTIPLE CLASS, (INT. CLS. 35 AND 36), (U.S. CLS. 100, 101 AND 102). SN 78-446,282. PUB. 6-28-2005. FILED 7-6-2004.
- 2,997,705. **UHS AND DESIGN**. UNIVERSAL HOSPITAL SERVICES, INC., MULTIPLE CLASS, (INT. CLS. 35 AND 44), (U.S. CLS. 100, 101 AND 102). SN 78-446,763. PUB. 6-28-2005. FILED 7-7-2004.
- 2,997,706. **UHS UNIVERSAL HOSPITAL SERVICES SERVICE YOU CAN COUNT ON. AND DESIGN**. UNIVERSAL HOSPITAL SERVICES, INC., MULTIPLE CLASS, (INT. CLS. 35 AND 44), (U.S. CLS. 100, 101 AND 102). SN 78-446,774. PUB. 6-28-2005. FILED 7-7-2004.
- 2,997,707. **UHS AND DESIGN**. UNIVERSAL HOSPITAL SERVICES, INC., MULTIPLE CLASS, (INT. CLS. 35 AND 44), (U.S. CLS. 100, 101 AND 102). SN 78-446,788. PUB. 6-28-2005. FILED 7-7-2004.
- 2,997,708. **CATALINA WEENÁ (BLOCK FORM)**. ZOOZMANIA INC., (U.S. CLS. 100, 101 AND 102). SN 78-446,838. PUB. 6-28-2005. FILED 7-7-2004.
- 2,997,729. **TOTALTICKETS.COM (BLOCK FORM)**. TOTAL TRAVEL & TICKETS, INC., (U.S. CLS. 100, 101 AND 102). SN 78-449,129. PUB. 6-28-2005. FILED 7-12-2004.
- 2,997,733. **GROWING COMPANY SOLUTIONS AND DESIGN**. GROWING COMPANY SOLUTIONS, (U.S. CLS. 100, 101 AND 102). SN 78-449,518. PUB. 6-28-2005. FILED 7-12-2004.
- 2,997,734. **HELLO KAHLO (BLOCK FORM)**. KAHLO JEEP EAGLE, INC., (U.S. CLS. 100, 101 AND 102). SN 78-449,713. PUB. 6-28-2005. FILED 7-13-2004.
- 2,997,746. **5 MINUTE FOLLOW-THROUGH (BLOCK FORM)**. FORT HILL COMPANY, (U.S. CLS. 100, 101 AND 102). SN 78-450,725. PUB. 6-28-2005. FILED 7-14-2004.
- 2,997,754. **COTTAGE CHIC A LIFESTYLE STORE (BLOCK FORM)**. COTTAGE CHIC, INC., (U.S. CLS. 100, 101 AND 102). SN 78-451,166. PUB. 6-28-2005. FILED 7-15-2004.
- 2,997,757. **AMERICA'S HOME FOR COLLEGE SPORTS (BLOCK FORM)**. INTERNATIONAL SPORTS PROPERTIES, INC., MULTIPLE CLASS, (INT. CLS. 35 AND 41), (U.S. CLS. 100, 101, 102 AND 107). SN 78-451,534. PUB. 6-28-2005. FILED 7-15-2004.
- 2,997,758. **SUPERFASTCARZ.COM AND DESIGN**. SUPERFASTCARZ INC., (U.S. CLS. 100, 101 AND 102). SN 78-451,657. PUB. 6-28-2005. FILED 7-16-2004.
- 2,997,770. **MOMSWIN (BLOCK FORM)**. MOMSWIN, INC., (U.S. CLS. 100, 101 AND 102). SN 78-452,799. PUB. 6-28-2005. FILED 7-19-2004.
- 2,997,779. **MAYFAIR CHEMISTS (BLOCK FORM)**. DUANE READE INTERNATIONAL, INC., (U.S. CLS. 100, 101 AND 102). SN 78-453,378. PUB. 6-28-2005. FILED 7-20-2004.
- 2,997,790. **EXPRESS CONTACTS (BLOCK FORM)**. LANGE EYE CARE & ASSOCIATES, P.A., (U.S. CLS. 100, 101 AND 102). SN 78-453,811. PUB. 6-28-2005. FILED 7-21-2004.
- 2,997,796. **FIRSTREG (BLOCK FORM)**. OPUS SOLUTIONS, LLC, (U.S. CLS. 100, 101 AND 102). SN 78-454,279. PUB. 6-28-2005. FILED 7-21-2004.
- 2,997,802. **GSW WORLDWIDE (BLOCK FORM)**. GERBIG SNELL/WEISHEIMER ADVERTISING, LLC, (U.S. CLS. 100, 101 AND 102). SN 78-454,467. PUB. 6-28-2005. FILED 7-21-2004.
- 2,997,805. **BEST DEALS. DELIVERED. (BLOCK FORM)**. EVERTEK COMPUTER CORPORATION, (U.S. CLS. 100, 101 AND 102). SN 78-454,774. PUB. 6-28-2005. FILED 7-22-2004.
- 2,997,809. **ENHANCED MANAGEMENT SERVICES (BLOCK FORM)**. ENHANCED MANAGEMENT SERVICES, INC., (U.S. CLS. 100, 101 AND 102). SN 78-455,045. PUB. 6-28-2005. FILED 7-22-2004.
- 2,997,810. **AISLE I (BLOCK FORM)**. RALEY'S TM, INC., (U.S. CLS. 100, 101 AND 102). SN 78-455,087. PUB. 6-28-2005. FILED 7-22-2004.
- 2,997,814. **CONVERTING EXECUTIVE ACCESS TO VALUE (BLOCK FORM)**. EXECUTIVE PRESENTATION L.L.C., (U.S. CLS. 100, 101 AND 102). SN 78-455,193. PUB. 6-28-2005. FILED 7-22-2004.
- 2,997,819. **G AND DESIGN**. GLOBEOP FINANCIAL SERVICES, LLC, MULTIPLE CLASS, (INT. CLS. 35, 36 AND 42), (U.S. CLS. 100, 101 AND 102). SN 78-455,330. PUB. 6-28-2005. FILED 7-22-2004.
- 2,997,822. **COLLABORACT (BLOCK FORM)**. COLLABORACT CONSULTING, LLC, (U.S. CLS. 100, 101 AND 102). SN 78-455,445. PUB. 6-28-2005. FILED 7-23-2004.
- 2,997,846 (*See Class 9 for this trademark*).
- 2,997,851. **GNILLES (BLOCK FORM)**. PEARLMAN, DANIEL ALEXANDER, (U.S. CLS. 100, 101 AND 102). SN 78-456,509. PUB. 6-28-2005. FILED 7-26-2004.
- 2,997,857. **IDETAILING (BLOCK FORM)**. MARKETRX INC., (U.S. CLS. 100, 101 AND 102). SN 78-456,697. PUB. 6-28-2005. FILED 7-26-2004.
- 2,997,875. **NEWS AMERICA MARKETING (BLOCK FORM)**. NEWS AMERICA MARKETING PROPERTIES, INC., (U.S. CLS. 100, 101 AND 102). SN 78-457,105. PUB. 6-28-2005. FILED 7-27-2004.
- 2,997,876. **QUICK FACTS (BLOCK FORM)**. RETAIL FORWARD, INC., (U.S. CLS. 100, 101 AND 102). SN 78-457,115. PUB. 6-28-2005. FILED 7-27-2004.
- 2,997,895. **FREE FORMZ (BLOCK FORM)**. FALA DIRECT MARKETING, INC., MULTIPLE CLASS, (INT. CLS. 35 AND 40), (U.S. CLS. 100, 101, 102, 103 AND 106). SN 78-457,360. PUB. 6-28-2005. FILED 7-27-2004.
- 2,997,898. **JUST THE BASICS (BLOCK FORM)**. JUST THE BASICS, INC., (U.S. CLS. 100, 101 AND 102). SN 78-457,374. PUB. 6-28-2005. FILED 7-27-2004.
- 2,997,900. **API INTELLI-RATE (BLOCK FORM)**. AUTOMOTIVE PROFESSIONALS, INC., (U.S. CLS. 100, 101 AND 102). SN 78-457,442. PUB. 6-28-2005. FILED 7-27-2004.
- 2,997,903 (*See Class 16 for this trademark*).
- 2,997,913. **A AND DESIGN**. ALLSTATES TECHNICAL SER-

- VICES, INC., (U.S. CLS. 100, 101 AND 102). SN 78-457,840. PUB. 6-28-2005. FILED 7-28-2004.
- 2,997,923. **TTI (BLOCK FORM)**. TTI, INC., (U.S. CLS. 100, 101 AND 102). SN 78-458,051. PUB. 6-28-2005. FILED 7-28-2004.
- 2,997,926. **A GREAT DENTIST CAN CHANGE YOUR LIFE (BLOCK FORM)**. FUTUREDONTICS, INC., (U.S. CLS. 100, 101 AND 102). SN 78-458,114. PUB. 6-28-2005. FILED 7-28-2004.
- 2,997,937. **PSS ADVANTAGE CLUB THE ADVANTAGE IS SAVING YOU MONEY AND DESIGN**. PSS WORLD MEDICAL, INC., (U.S. CLS. 100, 101 AND 102). SN 78-458,331. PUB. 6-28-2005. FILED 7-28-2004.
- 2,997,943. **PICO AND DESIGN**. THE AVICON GROUP, INC., (U.S. CLS. 100, 101 AND 102). SN 78-458,560. PUB. 6-28-2005. FILED 7-29-2004.
- 2,997,944. **1-800-FLEXIES (BLOCK FORM)**. HAMEL MANUFACTURING COMPANY, INC., (U.S. CLS. 100, 101 AND 102). SN 78-458,564. PUB. 6-28-2005. FILED 7-29-2004.
- 2,997,947. **MISCELLANEOUS DESIGN**. MG TAYLOR CORPORATION, MULTIPLE CLASS, (INT. CLS. 35 AND 41), (U.S. CLS. 100, 101, 102 AND 107). SN 78-458,636. PUB. 6-28-2005. FILED 7-29-2004.
- 2,997,951. **FANNIE MAE PAC AND DESIGN**. FEDERAL NATIONAL MORTGAGE ASSOCIATION, DBA FANNIE MAE, (U.S. CLS. 100, 101 AND 102). SN 78-458,721. PUB. 6-28-2005. FILED 7-29-2004.
- 2,997,952 (*See Class 9 for this trademark*).
- 2,997,953. **INTERNATIONAL ROOFING EXPO AND DESIGN**. HANLEY-WOOD, LLC, (U.S. CLS. 100, 101 AND 102). SN 78-458,749. PUB. 6-28-2005. FILED 7-29-2004.
- 2,997,957. **HANLEY WOOD INTERNATIONAL ROOFING EXPO AND DESIGN**. HANLEY-WOOD, LLC, (U.S. CLS. 100, 101 AND 102). SN 78-458,763. PUB. 6-28-2005. FILED 7-29-2004.
- 2,997,988. **SERVICE SO COMPLETE...ALL YOU ADD IS POSTAGE (BLOCK FORM)**. HUNTER-MCMAIN, INC., (U.S. CLS. 100, 101 AND 102). SN 78-459,413. PUB. 6-28-2005. FILED 7-30-2004.
- 2,997,996. **COBBLESTONE (BLOCK FORM)**. COBBLESTONE AUTO SPA & MARKET I, L.L.C., (U.S. CLS. 100, 101 AND 102). SN 78-459,494. PUB. 6-28-2005. FILED 7-30-2004.
- 2,998,013. **LINKADAGE (BLOCK FORM)**. WEB ORIGINATIONS LLC, (U.S. CLS. 100, 101 AND 102). SN 78-459,703. PUB. 6-28-2005. FILED 7-30-2004.
- 2,998,014. **RESORTQUEST VANTAGES (BLOCK FORM)**. RESORTQUEST INTERNATIONAL, INC., (U.S. CLS. 100, 101 AND 102). SN 78-459,705. PUB. 6-28-2005. FILED 7-30-2004.
- 2,998,017. **LEATHER POST (BLOCK FORM)**. LP VENTURES, LLC, (U.S. CLS. 100, 101 AND 102). SN 78-459,809. PUB. 6-28-2005. FILED 7-30-2004.
- 2,998,028. **GRUBHUB (BLOCK FORM)**. MALONEY, MATTHEW M., (U.S. CLS. 100, 101 AND 102). SN 78-460,059. PUB. 6-28-2005. FILED 7-31-2004.
- 2,998,035. **TODDLETAILS (BLOCK FORM)**. TODDLETAILS, LLC, (U.S. CLS. 100, 101 AND 102). SN 78-460,155. PUB. 6-28-2005. FILED 8-1-2004.
- 2,998,044. **BRANDWATCH (BLOCK FORM)**. MALANDRINO, QUIRINO, (U.S. CLS. 100, 101 AND 102). SN 78-460,274. PUB. 6-28-2005. FILED 8-2-2004.
- 2,998,047 (*See Class 9 for this trademark*).
- 2,998,048. **BRANDBITS (BLOCK FORM)**. MALANDRINO, QUIRINO, (U.S. CLS. 100, 101 AND 102). SN 78-460,317. PUB. 6-28-2005. FILED 8-2-2004.
- 2,998,094. **ZAPPOS COUTURE (BLOCK FORM)**. ZAPPOS-COM, INC., (U.S. CLS. 100, 101 AND 102). SN 78-461,058. PUB. 6-28-2005. FILED 8-3-2004.
- 2,998,099. **MEDTRACK (BLOCK FORM)**. MEDTURN, (U.S. CLS. 100, 101 AND 102). SN 78-461,198. PUB. 6-28-2005. FILED 8-3-2004.
- 2,998,103. **SCHOOLSPRING (BLOCK FORM)**. SCHOOLS-SPRING, INC., (U.S. CLS. 100, 101 AND 102). SN 78-461,219. PUB. 6-28-2005. FILED 8-3-2004.
- 2,998,106. **SCHOOLS-SPRING AND DESIGN**. SCHOOLS-SPRING, INC., (U.S. CLS. 100, 101 AND 102). SN 78-461,242. PUB. 6-28-2005. FILED 8-3-2004.
- 2,998,107. **ACCOUNTANTS LOOK AT THE NUMBERS. FORENSIC ACCOUNTANTS LOOK BEHIND THE NUMBERS. (BLOCK FORM)**. MICHAEL G. KESSLER & ASSOCIATES, LTD., (U.S. CLS. 100, 101 AND 102). SN 78-461,251. PUB. 6-28-2005. FILED 8-3-2004.
- 2,998,110. **EAGLEVISION (BLOCK FORM)**. THE GOODYEAR TIRE & RUBBER COMPANY, (U.S. CLS. 100, 101 AND 102). SN 78-461,279. PUB. 6-28-2005. FILED 8-3-2004.
- 2,998,115. **4INKJETS (BLOCK FORM)**. LEON, AARON, (U.S. CLS. 100, 101 AND 102). SN 78-461,394. PUB. 6-28-2005. FILED 8-3-2004.
- 2,998,120. **LEISUREMAX LIVE BETTER AND DESIGN**. LEISUREMAX, INC., (U.S. CLS. 100, 101 AND 102). SN 78-461,415. PUB. 6-28-2005. FILED 8-3-2004.
- 2,998,147. **E. B. HARRIS AND DESIGN**. E.B. HARRIS INC., (U.S. CLS. 100, 101 AND 102). SN 78-461,909. PUB. 6-28-2005. FILED 8-4-2004.
- 2,998,175. **CALA AND DESIGN**. AMERICAN TORT REFORM ASSOCIATION INCORPORATED, (U.S. CLS. 100, 101 AND 102). SN 78-462,633. PUB. 6-28-2005. FILED 8-5-2004.
- 2,998,216. **EK (STYLIZED)**. APC WORKFORCE SOLUTIONS, LLC, DBA, ZEROCHAOS, MULTIPLE CLASS, (INT. CLS. 35 AND 45), (U.S. CLS. 100, 101 AND 102). SN 78-464,511. PUB. 6-28-2005. FILED 8-9-2004.
- 2,998,245. **LUSH (BLOCK FORM)**. LUSH ADVERTISING, INC., (U.S. CLS. 100, 101 AND 102). SN 78-465,680. PUB. 6-28-2005. FILED 8-11-2004.
- 2,998,246. **THE MIND BODY STORE (BLOCK FORM)**. AMIN, CYRIL, (U.S. CLS. 100, 101 AND 102). SN 78-465,713. PUB. 6-28-2005. FILED 8-11-2004.
- 2,998,248. **MEETING INDUSTRY EXCHANGE BY MPI AND DESIGN**. MEETING PROFESSIONALS INTERNATIONAL, (U.S. CLS. 100, 101 AND 102). SN 78-465,799. PUB. 6-28-2005. FILED 8-11-2004.
- 2,998,249. **STOVESDEPOT (BLOCK FORM)**. FAUCETDIRECT, INC., (U.S. CLS. 100, 101 AND 102). SN 78-465,890. PUB. 6-28-2005. FILED 8-11-2004.
- 2,998,253. **INITIATE AND NAVIGATE STRATEGIC CHANGE (BLOCK FORM)**. RESULTANT CONSULTING GROUP, LLC, (U.S. CLS. 100, 101 AND 102). SN 78-466,012. PUB. 6-28-2005. FILED 8-11-2004.
- 2,998,256. **CORNERFIVE (BLOCK FORM)**. THE BLACK DOG TAVERN COMPANY, INC., (U.S. CLS. 100, 101 AND 102). SN 78-466,056. PUB. 6-28-2005. FILED 8-11-2004.
- 2,998,262. **IT'S YOU (BLOCK FORM)**. UV SALES, INC., (U.S. CLS. 100, 101 AND 102). SN 78-466,448. PUB. 6-28-2005. FILED 8-12-2004.
- 2,998,263. **RED SPADE (BLOCK FORM)**. RED SPADE, (U.S. CLS. 100, 101 AND 102). SN 78-466,796. PUB. 6-28-2005. FILED 8-12-2004.
- 2,998,271. **ACCOONA AND DESIGN**. ACCOONA CORP., MULTIPLE CLASS, (INT. CLS. 35 AND 42), (U.S. CLS. 100, 101 AND 102). SN 78-467,080. PUB. 6-28-2005. FILED 8-13-2004.
- 2,998,276. **CFOUR (BLOCK FORM)**. KORS, MARLAR, SAVAGE & ASSOCIATES, INC., (U.S. CLS. 100, 101 AND 102). SN 78-467,376. PUB. 6-28-2005. FILED 8-13-2004.
- 2,998,291. **TUBEDEPOT (BLOCK FORM)**. TUBEDEPOT, LLC, (U.S. CLS. 100, 101 AND 102). SN 78-469,352. PUB. 6-28-2005. FILED 8-18-2004.
- 2,998,297. **ETEEONLINE.COM (BLOCK FORM)**. MISSION IMPRINTABLES, INC., (U.S. CLS. 100, 101 AND 102). SN 78-470,585. PUB. 6-28-2005. FILED 8-19-2004.
- 2,998,302. **TOUGH TRUCKS. TOUGH DRIVERS. TOUGH TOOLS. (BLOCK FORM)**. SEARS BRANDS, LLC, (U.S. CLS. 100, 101 AND 102). SN 78-471,279. PUB. 6-28-2005. FILED 8-20-2004.
- 2,998,326 (*See Class 16 for this trademark*).
- 2,998,328. **BREW ELITE AND DESIGN**. QUALCOMM INCORPORATED, (U.S. CLS. 100, 101 AND 102). SN 78-510,974. PUB. 6-28-2005. FILED 11-3-2004.
- 2,998,331 (*See Class 9 for this trademark*).
- 2,998,341. **BALANCED CHOICES TASTE THE POSSIBILITIES AND DESIGN**. COMPASS GROUP USA, INC., MULTIPLE CLASS, (INT. CLS. 35 AND 42), (U.S. CLS. 100, 101 AND 102). SN 78-549,781. PUB. 6-28-2005. FILED 1-19-2005.
- 2,998,352 (*See Class 18 for this trademark*).
- 2,998,361. **THE SPA COLLECTION HOTELS & RESORTS AND DESIGN**. AXEL KAUS, MULTIPLE CLASS, (INT.

CLS. 35, 39 AND 43), (U.S. CLS. 100, 101, 102 AND 105). SN 79-000,442. PUB. 6-28-2005. FILED 11-11-2003.
 2,998,406. **SINGER & HAMILTON (BLOCK FORM)**. SINGER & HAMILTON, (U.S. CLS. 100, 101 AND 102). SN 79-001,723. PUB. 6-28-2005. FILED 11-27-2003.
 2,998,409 (*See Class 12 for this trademark*).
 2,998,426 (*See Class 5 for this trademark*).
 2,998,427 (*See Class 16 for this trademark*).
 2,998,435. **GREENHEART AND DESIGN**. FUNDACION POR EL FUTURO, MULTIPLE CLASS, (INT. CLS. 35 AND 41), (U.S. CLS. 100, 101, 102 AND 107). SN 79-002,564. PUB. 6-28-2005. FILED 1-21-2004.
 2,998,465 (*See Class 25 for this trademark*).
 2,998,493 (*See Class 30 for this trademark*).
 2,998,497. **DOTPLANET (STYLIZED)**. DOMENESHOP AS, MULTIPLE CLASS, (INT. CLS. 35, 38 AND 42), (U.S. CLS. 100, 101, 102 AND 104). SN 79-005,960. PUB. 6-28-2005. FILED 5-18-2004.

CLASS 36—INSURANCE AND FINANCIAL

2,996,238. **NEWRIVER**. NEWRIVER, INC., MULTIPLE CLASS, (INT. CLS. 36 AND 38), (U.S. CLS. 100, 101, 102 AND 104). SN 75-630,633. PUB. 6-28-2005. FILED 1-29-1999.
 2,996,242. **CITY NATIONAL ELINK**. CITY NATIONAL BANK, (U.S. CLS. 100, 101 AND 102). SN 75-874,213. PUB. 6-28-2005. FILED 12-18-1999.
 2,996,250. **CLEARCARD**. CYBERNET WORLD BUSINESS, INC., (U.S. CLS. 100, 101 AND 102). SN 76-095,141. PUB. 3-8-2005. FILED 7-24-2000.
 2,996,262. **MEMBERS CHOICE CREDIT UNION**. MEMBERS CHOICE CREDIT UNION, (U.S. CLS. 100, 101 AND 102). SN 76-321,340. PUB. 8-27-2002. FILED 10-5-2001.
 2,996,265. **MISCELLANEOUS DESIGN**. GLOBAL HOME LOANS AND FINANCE INC., (U.S. CLS. 100, 101 AND 102). SN 76-344,322. PUB. 6-28-2005. FILED 12-4-2001.
 2,996,293. **LIBRA**. LIBRA ADVISORS LLC, (U.S. CLS. 100, 101 AND 102). SN 76-418,081. PUB. 6-28-2005. FILED 6-7-2002.
 2,996,294. **LIBRA ADVISORS**. LIBRA ADVISORS LLC, (U.S. CLS. 100, 101 AND 102). SN 76-418,424. PUB. 6-28-2005. FILED 6-7-2002.
 2,996,295. **KEYOSK**. VISTAR INSURANCE SERVICES, (U.S. CLS. 100, 101 AND 102). SN 76-420,989. PUB. 5-3-2005. FILED 6-14-2002.
 2,996,296. **APPRAISAL RESEARCH COUNSELORS (STYLIZED)**. STUNARD APPRAISAL RESEARCH COUNSELORS, LTD., MULTIPLE CLASS, (INT. CLS. 36 AND 42), (U.S. CLS. 100, 101 AND 102). SN 76-423,730. PUB. 6-28-2005. FILED 6-20-2002.
 2,996,307. **AT ASSISTANT TREASURER REDEFINING TREASURY MANAGEMENT AND DESIGN**. J.M. CORPORATION, (U.S. CLS. 100, 101 AND 102). SN 76-455,499. PUB. 6-28-2005. FILED 9-20-2002.
 2,996,313. **EXPRESSLOCK**. FIRST MAGNUS FINANCIAL CORPORATION, (U.S. CLS. 100, 101 AND 102). SN 76-465,442. PUB. 6-28-2005. FILED 11-7-2002.
 2,996,314 (*See Class 9 for this trademark*).
 2,996,319. **LIFEWAYS**. AETNA INC., (U.S. CLS. 100, 101 AND 102). SN 76-472,985. PUB. 6-28-2005. FILED 12-9-2002.
 2,996,333. **CM CENTURY MANAGEMENT FOUNDED IN 1974 AND DESIGN**. VAN DEN BERG MANAGEMENT, INC., (U.S. CLS. 100, 101 AND 102). SN 76-486,317. PUB. 6-28-2005. FILED 1-31-2003.
 2,996,345 (*See Class 35 for this trademark*).
 2,996,352. **HFG HARRIS FINANCIAL GROUP (STYLIZED)**. HARRIS FINANCIAL GROUP, INC., (U.S. CLS. 100, 101 AND 102). SN 76-504,199. PUB. 8-10-2004. FILED 4-1-2003.
 2,996,371. **NOVASTARIS**. NOVASTAR FINANCIAL, INC., (U.S. CLS. 100, 101 AND 102). SN 76-522,189. PUB. 6-28-2005. FILED 6-12-2003.
 2,996,435 (*See Class 35 for this trademark*).
 2,996,459. **SPARE KEY (BLOCK FORM)**. SPARE KEY, (U.S. CLS. 100, 101 AND 102). SN 76-560,334. PUB. 6-28-2005. FILED 11-10-2003.
 2,996,462. **COSTAR PROPERTY PROFESSIONAL (BLOCK FORM)**. COSTAR REALTY INFORMATION, INC., (U.S. CLS. 100, 101 AND 102). SN 76-561,450. PUB. 6-28-2005. FILED 11-24-2003.
 2,996,474. **PRE-AUTH (BLOCK FORM)**. GENERAL ELECTRIC COMPANY, (U.S. CLS. 100, 101 AND 102). SN 76-565,450. PUB. 6-28-2005. FILED 12-4-2003.
 2,996,489. **SELECT UTILITY INDEX (BLOCK FORM)**. MERRILL LYNCH & CO., INC., (U.S. CLS. 100, 101 AND 102). SN 76-567,835. PUB. 6-28-2005. FILED 12-31-2003.
 2,996,564. **AMSURG AMERICA'S SINGLE SPECIALTY SURGERY CENTER LEADER (STYLIZED)**. AMSURG, (U.S. CLS. 100, 101 AND 102). SN 76-572,588. PUB. 6-28-2005. FILED 1-27-2004.
 2,996,567 (*See Class 35 for this trademark*).
 2,996,573. **MISCELLANEOUS DESIGN**. NORTHWESTERN MEMORIAL HEALTHCARE, (U.S. CLS. 100, 101 AND 102). SN 76-573,335. PUB. 6-28-2005. FILED 2-2-2004.
 2,996,576. **G GILBERT ADVANCED ASSET MANAGEMENT, INC. SPECIALIZING IN PRUDENT ALL-WEATHER INVESTMENT STRATEGIES AND DESIGN**. GILBERT ADVANCED ASSET MANAGEMENT, INC., (U.S. CLS. 100, 101 AND 102). SN 76-573,968. PUB. 6-28-2005. FILED 2-2-2004.
 2,996,589. **SPANISH PEAKS BIG SKY, MONTANA AND DESIGN**. THE CLUB AT SPANISH PEAKS, LLC, MULTIPLE CLASS, (INT. CLS. 36, 37 AND 41), (U.S. CLS. 100, 101, 102, 103, 106 AND 107). SN 76-575,391. PUB. 6-28-2005. FILED 2-13-2004.
 2,996,595. **BLUE ORCHID GROUP (BLOCK FORM)**. BLUE ORCHID GROUP LLC, (U.S. CLS. 100, 101 AND 102). SN 76-575,931. PUB. 6-28-2005. FILED 2-17-2004.
 2,996,627. **GTM HOUSEHOLD EMPLOYMENT EXPERTS (BLOCK FORM)**. GTM PAYROLL SERVICES, INC., (U.S. CLS. 100, 101 AND 102). SN 76-581,266. PUB. 6-28-2005. FILED 3-15-2004.
 2,996,628. **GTM (BLOCK FORM)**. GTM PAYROLL SERVICES, INC., (U.S. CLS. 100, 101 AND 102). SN 76-581,268. PUB. 6-28-2005. FILED 3-15-2004.
 2,996,635. **HD MERCHANT SERVICES (BLOCK FORM)**. DEMPSIE, HERBERT, DBA HD MERCHANT SERVICES, (U.S. CLS. 100, 101 AND 102). SN 76-581,975. PUB. 6-28-2005. FILED 3-19-2004.
 2,996,656. **GO FOR TWO (STYLIZED)**. HOME DISCOVERE REAL ESTATE SERVICES CORPORATION, (U.S. CLS. 100, 101 AND 102). SN 76-587,574. PUB. 6-28-2005. FILED 4-20-2004.
 2,996,667. **FEDACH INTERNATIONAL (BLOCK FORM)**. FEDERAL RESERVE BANKS, (U.S. CLS. 100, 101 AND 102). SN 76-588,944. PUB. 6-28-2005. FILED 4-27-2004.
 2,996,669. **FOCUS RECEIVABLES MANAGEMENT (BLOCK FORM)**. FOCUS RECEIVABLES MANAGEMENT, L.L.C., (U.S. CLS. 100, 101 AND 102). SN 76-589,795. PUB. 6-28-2005. FILED 4-29-2004.
 2,996,672. **HME AND DESIGN**. HUNT MIDWEST ENTERPRISES, INC., MULTIPLE CLASS, (INT. CLS. 36 AND 37), (U.S. CLS. 100, 101, 102, 103 AND 106). SN 76-590,247. PUB. 6-28-2005. FILED 5-3-2004.
 2,996,680. **LAKE FOREST CAPITAL MANAGEMENT (BLOCK FORM)**. WINTRUST FINANCIAL CORPORATION, (U.S. CLS. 100, 101 AND 102). SN 76-591,462. PUB. 6-28-2005. FILED 5-10-2004.
 2,996,691. **S AND DESIGN**. SECURITY PACIFIC HOME LOANS, INC., (U.S. CLS. 100, 101 AND 102). SN 76-593,147. PUB. 6-28-2005. FILED 5-18-2004.
 2,996,702. **MISCELLANEOUS DESIGN**. CHOICE INVESTMENT MANAGEMENT, LLC, (U.S. CLS. 100, 101 AND 102). SN 76-595,559. PUB. 6-28-2005. FILED 6-4-2004.
 2,996,741. **TOUCHDOWN PLUS (BLOCK FORM)**. NATIONAL CITY CORPORATION, (U.S. CLS. 100, 101 AND 102). SN 76-599,277. PUB. 6-28-2005. FILED 6-25-2004.
 2,996,742. **TOUCHDOWN PACKAGE (BLOCK FORM)**. NATIONAL CITY CORPORATION, (U.S. CLS. 100, 101 AND 102). SN 76-599,278. PUB. 6-28-2005. FILED 6-25-2004.
 2,996,745. **BUDDY CARD (BLOCK FORM)**. LAROSA'S, INC., (U.S. CLS. 100, 101 AND 102). SN 76-599,878. PUB. 6-28-2005. FILED 6-29-2004.
 2,996,762. **PERFECT MORTGAGE (BLOCK FORM)**. BERGIN FINANCIAL INC., DBA PERFECT MORTGAGE, INC., (U.S. CLS. 100, 101 AND 102). SN 76-601,968. PUB. 6-28-2005.

- FILED 7-12-2004.
- 2,996,767. **EPICENTER (BLOCK FORM)**. GORDON GROUP HOLDINGS, LLC, MULTIPLE CLASS, (INT. CLS. 36 AND 37), (U.S. CLS. 100, 101, 102, 103 AND 106). SN 76-602,946. PUB. 6-28-2005. FILED 7-16-2004.
- 2,996,794. **PAISANO (BLOCK FORM)**. KANG'S DISTRIBUTION, INC., (U.S. CLS. 100, 101 AND 102). SN 76-604,521. PUB. 6-28-2005. FILED 7-28-2004.
- 2,996,802. **K.I.S.S. KICK IN TO STOP SARCOIDOSIS (BLOCK FORM)**. FOUNDATION FOR SARCOIDOSIS RESEARCH, (U.S. CLS. 100, 101 AND 102). SN 76-604,697. PUB. 6-28-2005. FILED 7-29-2004.
- 2,996,809. **RATEWISE (BLOCK FORM)**. KRAFT FOODS FEDERAL CREDIT UNION, (U.S. CLS. 100, 101 AND 102). SN 76-604,869. PUB. 6-28-2005. FILED 7-30-2004.
- 2,996,824. **ONESTRIKE (BLOCK FORM)**. POWER FINANCIAL GROUP, INC., (U.S. CLS. 100, 101 AND 102). SN 76-605,111. PUB. 6-28-2005. FILED 7-29-2004.
- 2,996,833. **THE GRANGE BANK (BLOCK FORM)**. GRANGE MUTUAL CASUALTY COMPANY, (U.S. CLS. 100, 101 AND 102). SN 76-605,343. PUB. 6-28-2005. FILED 8-3-2004.
- 2,996,834. **G THE GRANGE BANK AND DESIGN**. GRANGE MUTUAL CASUALTY COMPANY, (U.S. CLS. 100, 101 AND 102). SN 76-605,344. PUB. 6-28-2005. FILED 8-3-2004.
- 2,996,835. **GMH CAPITAL PARTNERS (BLOCK FORM)**. GMH ASSOCIATES, INC., MULTIPLE CLASS, (INT. CLS. 36 AND 37), (U.S. CLS. 100, 101, 102, 103 AND 106). SN 76-605,374. PUB. 6-28-2005. FILED 8-3-2004.
- 2,996,842. **SMILECARE (BLOCK FORM)**. COMMUNITY DENTAL SERVICES, INC., DBA SMILECARE DENTAL GROUP, (U.S. CLS. 100, 101 AND 102). SN 76-605,520. PUB. 6-28-2005. FILED 8-4-2004.
- 2,996,854. **PROFIT.POINT AND DESIGN**. PROFITPOINT, INC., (U.S. CLS. 100, 101 AND 102). SN 76-605,720. PUB. 6-28-2005. FILED 8-5-2004.
- 2,996,855. **PROFITPOINT (BLOCK FORM)**. PROFITPOINT, INC., (U.S. CLS. 100, 101 AND 102). SN 76-605,721. PUB. 6-28-2005. FILED 8-5-2004.
- 2,996,861. **PROTECCIÓN A TU ALCANCE (BLOCK FORM)**. SBLI USA MUTUAL LIFE INSURANCE COMPANY, INC., (U.S. CLS. 100, 101 AND 102). SN 76-606,103. PUB. 6-28-2005. FILED 8-6-2004.
- 2,996,912. **MFC GLOBAL INVESTMENT MANAGEMENT AND DESIGN**. MANUFACTURERS LIFE INSURANCE COMPANY, THE, MULTIPLE CLASS, (INT. CLS. 36 AND 41), (U.S. CLS. 100, 101, 102 AND 107). SN 78-194,959. PUB. 6-28-2005. FILED 12-16-2002.
- 2,996,916. **GOLDEN EAGLE INSURANCE MEMBER OF LIBERTY MUTUAL GROUP AND DESIGN**. LIBERTY MUTUAL INSURANCE COMPANY, (U.S. CLS. 100, 101 AND 102). SN 78-201,146. PUB. 6-28-2005. FILED 1-8-2003.
- 2,996,933 (*See Class 35 for this trademark*).
- 2,996,966. **FLORIDA SURETY BONDS, INC. AND DESIGN**. FLORIDA SURETY BONDS, INC., (U.S. CLS. 100, 101 AND 102). SN 78-269,869. PUB. 6-28-2005. FILED 7-2-2003.
- 2,996,972. **FUND APPRECIATION RIGHT**. OPTCAPITAL, LLC, (U.S. CLS. 100, 101 AND 102). SN 78-274,206. PUB. 6-28-2005. FILED 7-15-2003.
- 2,996,999. **MAJESTIC COMMUNITIES**. MAJESTIC COMMUNITIES, INC., MULTIPLE CLASS, (INT. CLS. 36 AND 37), (U.S. CLS. 100, 101, 102, 103 AND 106). SN 78-296,332. PUB. 6-28-2005. FILED 9-4-2003.
- 2,997,019. **OPTILINK**. ARGO TURBOSERVE CORPORATION, (U.S. CLS. 100, 101 AND 102). SN 78-305,872. PUB. 6-28-2005. FILED 9-26-2003.
- 2,997,030. **CONGRESSIONAL BLACK CAUCUS FOUNDATION**. CONGRESSIONAL BLACK CAUCUS FOUNDATION, INC., MULTIPLE CLASS, (INT. CLS. 36 AND 41), (U.S. CLS. 100, 101, 102 AND 107). SN 78-314,943. PUB. 6-28-2005. FILED 10-17-2003.
- 2,997,074. **MS WEALTH MANAGEMENT AND DESIGN**. MITSUBISHI TOKYO WEALTH MANAGEMENT SECURITIES, LTD., (U.S. CLS. 100, 101 AND 102). SN 78-336,876. PUB. 6-28-2005. FILED 12-5-2003.
- 2,997,080. **AMERICAN EMPIRE REALTY (BLOCK FORM)**. LUEVANOS, LUPE, (U.S. CLS. 100, 101 AND 102). SN 78-339,470. PUB. 6-28-2005. FILED 12-11-2003.
- 2,997,081. **MILLENNIUM PLAN (BLOCK FORM)**. MILLENNIUM MARKETING GROUP, LLC, (U.S. CLS. 100, 101 AND 102). SN 78-339,563. PUB. 6-28-2005. FILED 12-11-2003.
- 2,997,086. **REALTYTEAM.COM YOUR GATEWAY TO ALL THINGS REAL ESTATE AND DESIGN**. REALTYTEAM.COM, INC., (U.S. CLS. 100, 101 AND 102). SN 78-341,800. PUB. 6-28-2005. FILED 12-16-2003.
- 2,997,139 (*See Class 35 for this trademark*).
- 2,997,140 (*See Class 35 for this trademark*).
- 2,997,142. **FARMTRAC (BLOCK FORM)**. UNITED BANK & TRUST COMPANY, (U.S. CLS. 100, 101 AND 102). SN 78-351,972. PUB. 6-28-2005. FILED 1-14-2004.
- 2,997,171. **ITSAM (BLOCK FORM)**. EXPETEC CORPORATION, (U.S. CLS. 100, 101 AND 102). SN 78-358,553. PUB. 6-28-2005. FILED 1-28-2004.
- 2,997,181. **M AND DESIGN**. MILLENNIUM MARKETING GROUP, LLC, MULTIPLE CLASS, (INT. CLS. 36 AND 41), (U.S. CLS. 100, 101, 102 AND 107). SN 78-359,824. PUB. 6-28-2005. FILED 1-29-2004.
- 2,997,189 (*See Class 35 for this trademark*).
- 2,997,217. **BOARD-ALERT SYSTEM (BLOCK FORM)**. INDEPENDENT ANALYTICS & RESEARCH, LLC, (U.S. CLS. 100, 101 AND 102). SN 78-363,402. PUB. 6-28-2005. FILED 2-5-2004.
- 2,997,223. **CYBEX (BLOCK FORM)**. CYBEX INTERNATIONAL, INC., (U.S. CLS. 100, 101 AND 102). SN 78-364,599. PUB. 6-28-2005. FILED 2-9-2004.
- 2,997,224 (*See Class 16 for this trademark*).
- 2,997,237. **FORCE 5 (BLOCK FORM)**. ENDURA PRODUCTS, INC., (U.S. CLS. 100, 101 AND 102). SN 78-366,351. PUB. 6-28-2005. FILED 2-11-2004.
- 2,997,245. **IGROK (BLOCK FORM)**. IGROK TRADING INTERNATIONAL, LLC, (U.S. CLS. 100, 101 AND 102). SN 78-367,441. PUB. 6-28-2005. FILED 2-12-2004.
- 2,997,263 (*See Class 18 for this trademark*).
- 2,997,280. **DYNAMIC (BLOCK FORM)**. DUNDEE BANCORP INC., (U.S. CLS. 100, 101 AND 102). SN 78-372,402. PUB. 6-28-2005. FILED 2-23-2004.
- 2,997,299 (*See Class 35 for this trademark*).
- 2,997,321. **BOW RIVER CAPITAL PARTNERS AND DESIGN**. BOW RIVER CAPITAL PARTNERS, (U.S. CLS. 100, 101 AND 102). SN 78-378,903. PUB. 6-28-2005. FILED 3-4-2004.
- 2,997,349. **SALLIE MAE'S BUSINESS OFFICE SUITE (BLOCK FORM)**. SALLIE MAE, INC., (U.S. CLS. 100, 101 AND 102). SN 78-385,925. PUB. 6-28-2005. FILED 3-17-2004.
- 2,997,370. **BEXLEY CROSSING AT PROVIDENCE (BLOCK FORM)**. WEINSTEIN MANAGEMENT CO., INC., (U.S. CLS. 100, 101 AND 102). SN 78-389,133. PUB. 6-28-2005. FILED 3-23-2004.
- 2,997,407. **MANARA MINISTRIES (BLOCK FORM)**. MANARA MINISTRIES, (U.S. CLS. 100, 101 AND 102). SN 78-395,665. PUB. 6-28-2005. FILED 4-2-2004.
- 2,997,466. **ASSURITY (BLOCK FORM)**. ASSURITY FINANCIAL SERVICES, LLC, (U.S. CLS. 100, 101 AND 102). SN 78-407,417. PUB. 6-28-2005. FILED 4-23-2004.
- 2,997,474. **RETIRE . . . RELAX (BLOCK FORM)**. ROSENBERG, STEPHEN MARK, (U.S. CLS. 100, 101 AND 102). SN 78-409,655. PUB. 6-28-2005. FILED 4-28-2004.
- 2,997,478. **MISCELLANEOUS DESIGN**. LOS ANGELES BIOMEDICAL RESEARCH INSTITUTE AT HARBOR-UCLA MEDICAL CENTER, MULTIPLE CLASS, (INT. CLS. 36, 41, 42 AND 44), (U.S. CLS. 100, 101, 102 AND 107). SN 78-410,778. PUB. 6-28-2005. FILED 4-29-2004.
- 2,997,480. **CLIENTDIRECT (BLOCK FORM)**. THE HAYS GROUP INC., (U.S. CLS. 100, 101 AND 102). SN 78-411,078. PUB. 6-28-2005. FILED 4-30-2004.
- 2,997,483. **MEDICAL PROPERTIES TRUST (BLOCK FORM)**. MEDICAL PROPERTIES TRUST, MULTIPLE CLASS, (INT. CLS. 36 AND 37), (U.S. CLS. 100, 101, 102, 103 AND 106). SN 78-411,351. PUB. 6-28-2005. FILED 4-30-2004.
- 2,997,500 (*See Class 35 for this trademark*).
- 2,997,546. **GOT CASH ? (BLOCK FORM)**. RASMUSSEN, MICHELLE D., (U.S. CLS. 100, 101 AND 102). SN 78-425,410. PUB. 6-28-2005. FILED 5-26-2004.
- 2,997,564 (*See Class 35 for this trademark*).
- 2,997,578 (*See Class 35 for this trademark*).
- 2,997,625. **NYCHARITIES.ORG (BLOCK FORM)**. NYCHARITIES.ORG, (U.S. CLS. 100, 101 AND 102). SN 78-438,979. PUB. 6-28-2005. FILED 6-21-2004.

- 2,997,630. **DEDICATED TO BUILDING & PRESERVING WEALTH (BLOCK FORM)**. PRIVATEBANCORP, INC., (U.S. CLS. 100, 101 AND 102). SN 78-439,430. PUB. 6-28-2005. FILED 6-22-2004.
- 2,997,631. **FOCUS EXECUTION CONTINUITY CONFIDENTIALITY LIFETIME RELATIONSHIPS (BLOCK FORM)**. PRIVATEBANCORP, INC., (U.S. CLS. 100, 101 AND 102). SN 78-439,435. PUB. 6-28-2005. FILED 6-22-2004.
- 2,997,644. **HOMES 2 PICK AND DESIGN**. HENDERSON AND CO., (U.S. CLS. 100, 101 AND 102). SN 78-441,039. PUB. 6-28-2005. FILED 6-24-2004.
- 2,997,649. **YOUR E-BILL (STYLIZED)**. ALLIANT ENERGY CORPORATION, (U.S. CLS. 100, 101 AND 102). SN 78-441,529. PUB. 6-28-2005. FILED 6-25-2004.
- 2,997,684. **SHOPPING NEVER FELT SO GOOD (BLOCK FORM)**. FINANCIAL TECHNOLOGIES LLC, (U.S. CLS. 100, 101 AND 102). SN 78-444,764. PUB. 6-28-2005. FILED 7-1-2004.
- 2,997,700 (*See Class 35 for this trademark*).
- 2,997,735. **IMERICA LIFE AND HEALTH INSURANCE COMPANY AND DESIGN**. IMERICA LIFE AND HEALTH INSURANCE COMPANY, (U.S. CLS. 100, 101 AND 102). SN 78-449,758. PUB. 6-28-2005. FILED 7-13-2004.
- 2,997,739. **FEDERATED LIFE (BLOCK FORM)**. FEDERATED MUTUAL INSURANCE COMPANY, (U.S. CLS. 100, 101 AND 102). SN 78-450,360. PUB. 6-28-2005. FILED 7-14-2004.
- 2,997,755. **FBIT (BLOCK FORM)**. TRUST MANAGEMENT GROUP, INC., (U.S. CLS. 100, 101 AND 102). SN 78-451,235. PUB. 6-28-2005. FILED 7-15-2004.
- 2,997,769. **FIRE BASE EAGLE VIETNAM WAR HISTORY CENTER FIRE BASE EAGLE ALTOONA, PA AND DESIGN**. FIRE BASE EAGLE, (U.S. CLS. 100, 101 AND 102). SN 78-452,798. PUB. 6-28-2005. FILED 7-19-2004.
- 2,997,787. **MORE CASH FOR MORE REAL ESTATE (BLOCK FORM)**. UMT HOLDINGS, L.P., (U.S. CLS. 100, 101 AND 102). SN 78-453,655. PUB. 6-28-2005. FILED 7-20-2004.
- 2,997,788. **W WESTWOOD HOLDINGS GROUP, INC. AND DESIGN**. WESTWOOD HOLDINGS GROUP, INC., (U.S. CLS. 100, 101 AND 102). SN 78-453,698. PUB. 6-28-2005. FILED 7-20-2004.
- 2,997,794. **RENTALERT (BLOCK FORM)**. COZMOFON INC., (U.S. CLS. 100, 101 AND 102). SN 78-454,193. PUB. 6-28-2005. FILED 7-21-2004.
- 2,997,799. **THE OSPRAIE FUND L.P. (BLOCK FORM)**. OSPRAIE MANAGEMENT, LLC, (U.S. CLS. 100, 101 AND 102). SN 78-454,387. PUB. 6-28-2005. FILED 7-21-2004.
- 2,997,818 (*See Class 25 for this trademark*).
- 2,997,819 (*See Class 35 for this trademark*).
- 2,997,823. **THINK EASIER (BLOCK FORM)**. PROGRESSIVE CASUALTY INSURANCE COMPANY, (U.S. CLS. 100, 101 AND 102). SN 78-455,452. PUB. 6-28-2005. FILED 7-23-2004.
- 2,997,826. **THINK PROGRESSIVE (BLOCK FORM)**. PROGRESSIVE CASUALTY INSURANCE COMPANY, (U.S. CLS. 100, 101 AND 102). SN 78-455,512. PUB. 6-28-2005. FILED 7-23-2004.
- 2,997,839. **DON'T BE BROKE (BLOCK FORM)**. DOLLAR LOAN CENTER, LLC, (U.S. CLS. 100, 101 AND 102). SN 78-455,978. PUB. 6-28-2005. FILED 7-23-2004.
- 2,997,843. **WE'RE HERE FOR YOU, TEXAS (BLOCK FORM)**. TEXAS MUTUAL INSURANCE COMPANY, (U.S. CLS. 100, 101 AND 102). SN 78-456,150. PUB. 6-28-2005. FILED 7-24-2004.
- 2,997,866. **TAXISURE EXCHANGE (BLOCK FORM)**. TAXISURE EXCHANGE, (U.S. CLS. 100, 101 AND 102). SN 78-456,944. PUB. 6-28-2005. FILED 7-26-2004.
- 2,997,881. **FIRST GENERATION (BLOCK FORM)**. THE COCA-COLA COMPANY, (U.S. CLS. 100, 101 AND 102). SN 78-457,148. PUB. 6-28-2005. FILED 7-27-2004.
- 2,997,894. **KEEPSAKE (BLOCK FORM)**. AVIVA LIFE INSURANCE COMPANY, (U.S. CLS. 100, 101 AND 102). SN 78-457,359. PUB. 6-28-2005. FILED 7-27-2004.
- 2,997,901. **TILLIT (BLOCK FORM)**. TILLIT GROUP, LLC, (U.S. CLS. 100, 101 AND 102). SN 78-457,532. PUB. 6-28-2005. FILED 7-27-2004.
- 2,997,930. **STOCKSHIELD (BLOCK FORM)**. B.G. YOLLES & COMPANY, (U.S. CLS. 100, 101 AND 102). SN 78-458,233. PUB. 6-28-2005. FILED 7-28-2004.
- 2,997,931. **MISCELLANEOUS DESIGN**. GEODE CAPITAL MANAGEMENT, LLC, (U.S. CLS. 100, 101 AND 102). SN 78-458,240. PUB. 6-28-2005. FILED 7-28-2004.
- 2,997,956. **FAMILY SAFEGUARD DEFERRED ANNUITY (BLOCK FORM)**. AVIVA LIFE INSURANCE COMPANY, (U.S. CLS. 100, 101 AND 102). SN 78-458,760. PUB. 6-28-2005. FILED 7-29-2004.
- 2,997,968. **RETIREMENT INCOME BUILDER (BLOCK FORM)**. TRANSAMERICA LIFE INSURANCE COMPANY, (U.S. CLS. 100, 101 AND 102). SN 78-458,916. PUB. 6-28-2005. FILED 7-29-2004.
- 2,997,969. **CONDITIONOMICS, LLC (BLOCK FORM)**. CONDITIONOMICS, LLC, (U.S. CLS. 100, 101 AND 102). SN 78-458,919. PUB. 6-28-2005. FILED 7-29-2004.
- 2,997,986. **SMOOTH SELLING (BLOCK FORM)**. THE MAHER TEAM, LLC, (U.S. CLS. 100, 101 AND 102). SN 78-459,362. PUB. 6-28-2005. FILED 7-30-2004.
- 2,998,078. **B A BEST ADDRESS AND DESIGN**. BEST ADDRESS REAL ESTATE, LLC, (U.S. CLS. 100, 101 AND 102). SN 78-460,811. PUB. 6-28-2005. FILED 8-2-2004.
- 2,998,080. **ECAUS.COM (BLOCK FORM)**. MORSE, CHARLES T., JR. CLU, (U.S. CLS. 100, 101 AND 102). SN 78-460,895. PUB. 6-28-2005. FILED 8-3-2004.
- 2,998,116. **OPERATION HOMECOMING USA AND DESIGN**. OPERATION HOMECOMING USA, (U.S. CLS. 100, 101 AND 102). SN 78-461,395. PUB. 6-28-2005. FILED 8-3-2004.
- 2,998,132. **TEDDI "T" SPORTS FEST (BLOCK FORM)**. CAMP GOOD DAYS AND SPECIAL TIMES, INC., (U.S. CLS. 100, 101 AND 102). SN 78-461,631. PUB. 6-28-2005. FILED 8-4-2004.
- 2,998,134. **THE STARVING ARTISTS BALL (BLOCK FORM)**. STUDIO 42, INC., (U.S. CLS. 100, 101 AND 102). SN 78-461,685. PUB. 6-28-2005. FILED 8-4-2004.
- 2,998,153. **WOODSTONE CREDIT UNION WHERE RELATIONSHIPS MEAN MORE (BLOCK FORM)**. WOODSTONE CREDIT UNION, (U.S. CLS. 100, 101 AND 102). SN 78-462,052. PUB. 6-28-2005. FILED 8-4-2004.
- 2,998,155. **"FROM START TO FINISH...WE'RE THE ONE TO CHOOSE" (BLOCK FORM)**. MARATHON MORTGAGE COMPANY, INC., (U.S. CLS. 100, 101 AND 102). SN 78-462,083. PUB. 6-28-2005. FILED 8-4-2004.
- 2,998,196. **NIF AND DESIGN**. N.I.F. GROUP, INC., (U.S. CLS. 100, 101 AND 102). SN 78-463,454. PUB. 6-28-2005. FILED 8-6-2004.
- 2,998,220. **FLOODASSIST (BLOCK FORM)**. ISO PROPERTIES, INC., (U.S. CLS. 100, 101 AND 102). SN 78-464,777. PUB. 6-28-2005. FILED 8-10-2004.
- 2,998,222. **MISCELLANEOUS DESIGN**. CENTEX CORPORATION, (U.S. CLS. 100, 101 AND 102). SN 78-464,807. PUB. 6-28-2005. FILED 8-10-2004.
- 2,998,240. **MISSION MATCH (BLOCK FORM)**. EMPTY TOMB, INC., (U.S. CLS. 100, 101 AND 102). SN 78-465,337. PUB. 6-28-2005. FILED 8-10-2004.
- 2,998,321. **RESORTQUEST REAL ESTATE (BLOCK FORM)**. RESORTQUEST INTERNATIONAL, INC., (U.S. CLS. 100, 101 AND 102). SN 78-501,518. PUB. 6-28-2005. FILED 10-18-2004.
- 2,998,348. **MISSION MATCH AN EXPENSE (BLOCK FORM)**. EMPTY TOMB, INC., (U.S. CLS. 100, 101 AND 102). SN 78-580,464. PUB. 6-28-2005. FILED 3-4-2005.
- 2,998,349. **AFTER-SCHOOL ALL-STARS (BLOCK FORM)**. AFTER-SCHOOL ALL-STARS, (U.S. CLS. 100, 101 AND 102). SN 78-975,638. PUB. 6-28-2005. FILED 5-2-2003.
- 2,998,355 (*See Class 14 for this trademark*).
- 2,998,358 (*See Class 19 for this trademark*).
- 2,998,390. **REDBURN PARTNERS LLP AND DESIGN**. REDBURN PARTNERS LLP, (U.S. CLS. 100, 101 AND 102). SN 79-001,321. PUB. 6-28-2005. FILED 2-25-2004.

CLASS 37—CONSTRUCTION AND REPAIR

- 2,996,471. **USA SECURITY SERVICES, INC. SERVING THE NY/NJ METROPOLITAN AREA SINCE 1978 AND DESIGN**. USA SECURITY SERVICES, INC., MULTIPLE CLASS, (INT. CLS. 37 AND 45), (U.S. CLS. 100, 101, 103 AND 106). SN 76-564,161. PUB. 6-28-2005. FILED 11-26-2003.
- 2,996,482. **FLOOR COVERING ASSOCIATES (BLOCK**

- FORM). FLOOR COVERING ASSOCIATES, INC., MULTIPLE CLASS, (INT. CLS. 37 AND 42), (U.S. CLS. 100, 101, 103 AND 106). SN 76-566,747. PUB. 6-28-2005. FILED 12-16-2003.
- 2,996,494. **PALM BEACH YACHT CENTER AND DESIGN**. PALM BEACH YACHT CENTER, MULTIPLE CLASS, (INT. CLS. 37 AND 39), (U.S. CLS. 100, 103, 105 AND 106). SN 76-568,558. PUB. 6-28-2005. FILED 1-7-2004.
- 2,996,532. **MISCELLANEOUS DESIGN**. AVCRAFT AVIATION, L.L.C., MULTIPLE CLASS, (INT. CLS. 37 AND 40), (U.S. CLS. 100, 103 AND 106). SN 76-570,825. PUB. 6-28-2005. FILED 1-14-2004.
- 2,996,533. **AVCRAFT (STYLIZED)**. AVCRAFT AVIATION, L.L.C., MULTIPLE CLASS, (INT. CLS. 37 AND 40), (U.S. CLS. 100, 103 AND 106). SN 76-570,826. PUB. 6-28-2005. FILED 1-14-2004.
- 2,996,534. **WISE ENGINEERING, INC. AND DESIGN**. WISE LEASING COMPANY, LLC, (U.S. CLS. 100, 103 AND 106). SN 76-571,021. PUB. 6-28-2005. FILED 1-20-2004.
- 2,996,555. **MOTOR E-TECH ONLINE (BLOCK FORM)**. HEARST BUSINESS PUBLISHING, INC., (U.S. CLS. 100, 103 AND 106). SN 76-572,405. PUB. 6-28-2005. FILED 1-23-2004.
- 2,996,589 (*See Class 36 for this trademark*).
- 2,996,596 (*See Class 35 for this trademark*).
- 2,996,606 (*See Class 35 for this trademark*).
- 2,996,622. **B.R.C. HEATING & COOLING FEEL GOOD INDOORS AND DESIGN**. BUILDING RESOURCES, INC., DBA B.R.C. HEATING/COOLING, MULTIPLE CLASS, (INT. CLS. 37 AND 42), (U.S. CLS. 100, 101, 103 AND 106). SN 76-579,027. PUB. 6-28-2005. FILED 3-1-2004.
- 2,996,637 (*See Class 13 for this trademark*).
- 2,996,649. **BLUE TAG CENTER (BLOCK FORM)**. MERCER VALVE COMPANY, INC., (U.S. CLS. 100, 103 AND 106). SN 76-585,406. PUB. 6-28-2005. FILED 4-7-2004.
- 2,996,672 (*See Class 36 for this trademark*).
- 2,996,733. **WISTFUL VISTA TELEPHONE CO. (BLOCK FORM)**. JOHNSON, DAVID, DBA WISTFUL VISTA TELEPHONE CO., (U.S. CLS. 100, 103 AND 106). SN 76-598,720. PUB. 6-28-2005. FILED 6-23-2004.
- 2,996,743. **MISCELLANEOUS DESIGN**. KIMBALL HILL, INC., (U.S. CLS. 100, 103 AND 106). SN 76-599,325. PUB. 6-28-2005. FILED 6-25-2004.
- 2,996,767 (*See Class 36 for this trademark*).
- 2,996,780. **WE'LL TAKE IT FROM HERE. (BLOCK FORM)**. MANHEIM AUCTIONS, INC., (U.S. CLS. 100, 103 AND 106). SN 76-604,022. PUB. 6-28-2005. FILED 7-26-2004.
- 2,996,813. **RIDE & SHINE (STYLIZED)**. BOWIE ENTERPRISES, (U.S. CLS. 100, 103 AND 106). SN 76-604,932. PUB. 6-28-2005. FILED 7-30-2004.
- 2,996,823. **BECO AND DESIGN**. BECO CONSTRUCTION, INC., (U.S. CLS. 100, 103 AND 106). SN 76-605,109. PUB. 6-28-2005. FILED 7-29-2004.
- 2,996,835 (*See Class 36 for this trademark*).
- 2,996,846. **CANBURY HOMES AND DESIGN**. CANBURY HOMES, INC., (U.S. CLS. 100, 103 AND 106). SN 76-605,606. PUB. 6-28-2005. FILED 8-4-2004.
- 2,996,863. **THE FLOORING STORE AT YOUR DOOR (BLOCK FORM)**. FLOORCOVERINGS INTERNATIONAL, LTD., MULTIPLE CLASS, (INT. CLS. 37 AND 42), (U.S. CLS. 100, 101, 103 AND 106). SN 76-606,139. PUB. 6-28-2005. FILED 8-6-2004.
- 2,996,936. **LEISUREWOODS**. THOMAS HASTINGS CO., LLC, (U.S. CLS. 100, 103 AND 106). SN 78-237,864. PUB. 6-28-2005. FILED 4-15-2003.
- 2,996,999 (*See Class 36 for this trademark*).
- 2,997,014. **CROSS COUNTRY TIRE ASSIST**. THE CROSS COUNTRY GROUP, LLC, (U.S. CLS. 100, 103 AND 106). SN 78-302,578. PUB. 6-28-2005. FILED 9-19-2003.
- 2,997,027. **EBDS**. BIOQUELL UK LIMITED, MULTIPLE CLASS, (INT. CLS. 37 AND 40), (U.S. CLS. 100, 103 AND 106). SN 78-312,997. PUB. 6-28-2005. FILED 10-13-2003.
- 2,997,092. **GESUNDEHEIT (BLOCK FORM)**. STEIBLI, MANFRED G., AND STEIBLI, MARY B., MULTIPLE CLASS, (INT. CLS. 37 AND 40), (U.S. CLS. 100, 103 AND 106). SN 78-342,661. PUB. 6-28-2005. FILED 12-18-2003.
- 2,997,133. **PRINTCARE (BLOCK FORM)**. TEXTRON FINANCIAL CORPORATION, (U.S. CLS. 100, 103 AND 106). SN 78-350,693. PUB. 6-28-2005. FILED 1-12-2004.
- 2,997,139 (*See Class 35 for this trademark*).
- 2,997,151. **MAXUTILS (BLOCK FORM)**. SHELL TRADEMARK MANAGEMENT B.V., MULTIPLE CLASS, (INT. CLS. 37 AND 42), (U.S. CLS. 100, 101, 103 AND 106). SN 78-355,234. PUB. 6-28-2005. FILED 1-21-2004.
- 2,997,155 (*See Class 15 for this trademark*).
- 2,997,169. **HANDY HUSBAND AND DESIGN**. H SQUARED CORP., MULTIPLE CLASS, (INT. CLS. 37 AND 41), (U.S. CLS. 100, 101, 103, 106 AND 107). SN 78-358,296. PUB. 6-28-2005. FILED 1-27-2004.
- 2,997,184 (*See Class 35 for this trademark*).
- 2,997,185 (*See Class 7 for this trademark*).
- 2,997,186 (*See Class 7 for this trademark*).
- 2,997,260. **SAIIA (BLOCK FORM)**. SAIHA CONSTRUCTION, LLC, (U.S. CLS. 100, 103 AND 106). SN 78-368,872. PUB. 6-28-2005. FILED 2-17-2004.
- 2,997,279. **BUILDING A CONCRETE FUTURE (BLOCK FORM)**. CORESLAB HOLDINGS U.S., INC., (U.S. CLS. 100, 103 AND 106). SN 78-372,379. PUB. 6-28-2005. FILED 2-23-2004.
- 2,997,281. **FAIR (BLOCK FORM)**. SHELL TRADEMARK MANAGEMENT B.V., MULTIPLE CLASS, (INT. CLS. 37, 41 AND 42), (U.S. CLS. 100, 101, 103, 106 AND 107). SN 78-372,412. PUB. 6-28-2005. FILED 2-23-2004.
- 2,997,297. **SHOP IN A BOX (BLOCK FORM)**. COLLISION SERVICES, INC., MULTIPLE CLASS, (INT. CLS. 37, 41 AND 42), (U.S. CLS. 100, 101, 103, 106 AND 107). SN 78-375,137. PUB. 6-28-2005. FILED 2-27-2004.
- 2,997,364. **EXCEPTIONAL EMPLOYEES. SUPERIOR PERFORMANCE. EXTRAORDINARY RESULTS. (BLOCK FORM)**. SAIHA CONSTRUCTION, LLC, (U.S. CLS. 100, 103 AND 106). SN 78-388,320. PUB. 6-28-2005. FILED 3-22-2004.
- 2,997,368. **OK3AIR (BLOCK FORM)**. AH AVIATION L.L.C., (U.S. CLS. 100, 103 AND 106). SN 78-388,786. PUB. 6-28-2005. FILED 3-22-2004.
- 2,997,406. **ONCE TRIED... ALWAYS PREFERRED! (BLOCK FORM)**. BARCLAY ENTERPRISES, INC., (U.S. CLS. 100, 103 AND 106). SN 78-395,044. PUB. 6-28-2005. FILED 4-1-2004.
- 2,997,435 (*See Class 35 for this trademark*).
- 2,997,438. **ANKLE DEEP (BLOCK FORM)**. FLETCHER, HAROLD H., (U.S. CLS. 100, 103 AND 106). SN 78-402,847. PUB. 6-28-2005. FILED 4-16-2004.
- 2,997,440. **ROAD TO REWARDS (BLOCK FORM)**. SHELL TRADEMARK MANAGEMENT B.V., (U.S. CLS. 100, 103 AND 106). SN 78-402,960. PUB. 6-28-2005. FILED 4-16-2004.
- 2,997,483 (*See Class 36 for this trademark*).
- 2,997,564 (*See Class 35 for this trademark*).
- 2,997,612. **BOARDROOM IN A BOX (BLOCK FORM)**. NELSON WHITE SYSTEMS, INC., MULTIPLE CLASS, (INT. CLS. 37 AND 42), (U.S. CLS. 100, 101, 103 AND 106). SN 78-436,714. PUB. 6-28-2005. FILED 6-17-2004.
- 2,997,692. **LEVITATOR (BLOCK FORM)**. LEVITATOR, INC., MULTIPLE CLASS, (INT. CLS. 37 AND 42), (U.S. CLS. 100, 101, 103 AND 106). SN 78-445,228. PUB. 6-28-2005. FILED 7-2-2004.
- 2,997,693. **LEVITATOR AND DESIGN**. LEVITATOR, INC., MULTIPLE CLASS, (INT. CLS. 37 AND 42), (U.S. CLS. 100, 101, 103 AND 106). SN 78-445,241. PUB. 6-28-2005. FILED 7-2-2004.
- 2,997,701. **DESTROY MOSQUITOES WITH THE TOUCH OF A BUTTON (BLOCK FORM)**. ARROW EXTERMINATORS, INC., (U.S. CLS. 100, 103 AND 106). SN 78-446,337. PUB. 6-28-2005. FILED 7-6-2004.
- 2,997,744. **"A DRY CRACK IS A HAPPY CRACK" (BLOCK FORM)**. CRACK TEAM USA, INC., (U.S. CLS. 100, 103 AND 106). SN 78-450,635. PUB. 6-28-2005. FILED 7-14-2004.
- 2,997,840. **24 AND DESIGN**. CARSTAR FRANCHISE SYSTEMS, INC., (U.S. CLS. 100, 103 AND 106). SN 78-455,995. PUB. 6-28-2005. FILED 7-23-2004.
- 2,997,841. **TEAM RED (BLOCK FORM)**. WESTCOAST HOTELS, INC., (U.S. CLS. 100, 103 AND 106). SN 78-456,024. PUB. 6-28-2005. FILED 7-23-2004.
- 2,997,846 (*See Class 9 for this trademark*).
- 2,997,849. **CRYOJETIC (BLOCK FORM)**. MPW INDUSTRIAL SERVICES, INC., MULTIPLE CLASS, (INT. CLS. 37 AND 40), (U.S. CLS. 100, 103 AND 106). SN 78-456,384. PUB. 6-28-

2005. FILED 7-26-2004.
 2,997,948. **MISCELLANEOUS DESIGN. BASTAS' INC.**, (U.S. CLS. 100, 103 AND 106). SN 78-458,637. PUB. 6-28-2005. FILED 7-29-2004.
 2,997,961. **SIXTEEN WEST (BLOCK FORM)**. RENFRO SAVANNAH DEVELOPMENT, LLC, (U.S. CLS. 100, 103 AND 106). SN 78-458,840. PUB. 6-28-2005. FILED 7-29-2004.
 2,997,967. **CENTRAL GARAGE (BLOCK FORM)**. FLORIDA AUTOMOTIVE DISTRIBUTING, INC., (U.S. CLS. 100, 103 AND 106). SN 78-458,912. PUB. 6-28-2005. FILED 7-29-2004.
 2,998,074. **THE RESERVE AT LAKE TYLER AND DESIGN**. NEPTUNE PROPERTIES, LP, (U.S. CLS. 100, 103 AND 106). SN 78-460,646. PUB. 6-28-2005. FILED 8-2-2004.
 2,998,102. **LIGHT UP YOUR HOLIDAYS (BLOCK FORM)**. FITZSIMMONS, KELLY E., (U.S. CLS. 100, 103 AND 106). SN 78-461,215. PUB. 6-28-2005. FILED 8-3-2004.
 2,998,108. **LET US AND DESIGN. LET US, INC.**, (U.S. CLS. 100, 103 AND 106). SN 78-461,262. PUB. 6-28-2005. FILED 8-3-2004.
 2,998,131. **POTHOLE MEDIC (BLOCK FORM)**. G. A. WOODLAND, INC., (U.S. CLS. 100, 103 AND 106). SN 78-461,629. PUB. 6-28-2005. FILED 8-4-2004.
 2,998,159. **WE'RE OUT HERE. SO YOU DON'T HAVE TO BE. (BLOCK FORM)**. COPELAND CORPORATION, (U.S. CLS. 100, 103 AND 106). SN 78-462,109. PUB. 6-28-2005. FILED 8-4-2004.
 2,998,358 (*See Class 19 for this trademark*).
 2,998,409 (*See Class 12 for this trademark*).
 2,998,436 (*See Class 9 for this trademark*).
 2,998,447. **CONNOX (STYLIZED)**. OUTOKUMPU OYJ, MULTIPLE CLASS, (INT. CLS. 37 AND 42), (U.S. CLS. 100, 101, 103 AND 106). SN 79-002,915. PUB. 6-28-2005. FILED 2-2-2004.
 2,998,484 (*See Class 7 for this trademark*).

CLASS 38—COMMUNICATION

2,996,238 (*See Class 36 for this trademark*).
 2,996,244 (*See Class 9 for this trademark*).
 2,996,248. **BUGTRAQ. SYMATEC SF CORPORATION**, MULTIPLE CLASS, (INT. CLS. 38 AND 42), (U.S. CLS. 100, 101 AND 104). SN 76-077,730. PUB. 3-20-2001. FILED 6-26-2000.
 2,996,261. **INNER CITY. INNER CITY BROADCASTING CORPORATION**, MULTIPLE CLASS, (INT. CLS. 38 AND 41), (U.S. CLS. 100, 101, 104 AND 107). SN 76-271,552. PUB. 6-28-2005. FILED 6-5-2001.
 2,996,271 (*See Class 9 for this trademark*).
 2,996,274 (*See Class 16 for this trademark*).
 2,996,301 (*See Class 9 for this trademark*).
 2,996,314 (*See Class 9 for this trademark*).
 2,996,346 (*See Class 16 for this trademark*).
 2,996,419. **PERSONAL ALERT. THOMAS SCIENTIFIC INC.**, (U.S. CLS. 100, 101 AND 104). SN 76-538,738. PUB. 6-28-2005. FILED 8-21-2003.
 2,996,590. **SOLD800.COM (BLOCK FORM)**. DX/DY VOICE PROCESSING, INC., (U.S. CLS. 100, 101 AND 104). SN 76-575,474. PUB. 6-28-2005. FILED 2-17-2004.
 2,996,624. **ALTITUDE SPORTS & ENTERTAINMENT (STYLIZED)**. KSE MEDIA VENTURES, LLC, MULTIPLE CLASS, (INT. CLS. 38 AND 41), (U.S. CLS. 100, 101, 104 AND 107). SN 76-580,840. PUB. 6-28-2005. FILED 3-15-2004.
 2,996,659. **FROM YOU FLOWERS (BLOCK FORM)**. FROM YOU FLOWERS, LLC, (U.S. CLS. 100, 101 AND 104). SN 76-588,236. PUB. 6-28-2005. FILED 4-22-2004.
 2,996,708 (*See Class 35 for this trademark*).
 2,996,773. **THE SOURCE (BLOCK FORM)**. TELENOR SATELLITE SERVICES, INC., (U.S. CLS. 100, 101 AND 104). SN 76-603,220. PUB. 6-28-2005. FILED 7-19-2004.
 2,996,816. **WORSHIP (STYLIZED)**. THE CHRISTIAN NETWORK, INC., (U.S. CLS. 100, 101 AND 104). SN 76-604,987. PUB. 6-28-2005. FILED 8-2-2004.
 2,996,844. **TODAY'S SOUTHERN GOSPEL MUSIC (BLOCK FORM)**. POSITIVE ALTERNATIVE RADIO, INC., (U.S. CLS. 100, 101 AND 104). SN 76-605,598. PUB. 6-28-2005. FILED 8-5-2004.
 2,996,933 (*See Class 35 for this trademark*).

2,997,051. **OMOMMY.COM (BLOCK FORM)**. NOBLE GRACE LLC, (U.S. CLS. 100, 101 AND 104). SN 78-329,243. PUB. 6-28-2005. FILED 11-18-2003.
 2,997,070 (*See Class 35 for this trademark*).
 2,997,071. **MASTERCARD (BLOCK FORM)**. MASTERCARD INTERNATIONAL INCORPORATED, MULTIPLE CLASS, (INT. CLS. 38 AND 42), (U.S. CLS. 100, 101 AND 104). SN 78-334,709. PUB. 6-28-2005. FILED 12-1-2003.
 2,997,100. **HANMAIL (BLOCK FORM)**. DAUM COMMUNICATIONS CORP., (U.S. CLS. 100, 101 AND 104). SN 78-345,362. PUB. 6-28-2005. FILED 12-24-2003.
 2,997,251. **ATLANTIC BROADBAND (BLOCK FORM)**. ATLANTIC BROADBAND FINANCE, LLC, (U.S. CLS. 100, 101 AND 104). SN 78-368,165. PUB. 6-28-2005. FILED 2-13-2004.
 2,997,267. **FASTSERVERS.NET (BLOCK FORM)**. POWER-SURGE TECHNOLOGIES, INC., MULTIPLE CLASS, (INT. CLS. 38 AND 42), (U.S. CLS. 100, 101 AND 104). SN 78-370,062. PUB. 5-3-2005. FILED 2-18-2004.
 2,997,268. **ATLANTIC BROADBAND AND DESIGN. ATLANTIC BROADBAND FINANCE, LLC**, (U.S. CLS. 100, 101 AND 104). SN 78-370,075. PUB. 6-28-2005. FILED 2-18-2004.
 2,997,333. **BEYOND THE ORDINARY DOT NET - KRSE (BLOCK FORM)**. ELENA YOUNG AND NANCY A. LORENZ PARTNERSHIP, THE, (U.S. CLS. 100, 101 AND 104). SN 78-381,099. PUB. 6-28-2005. FILED 3-9-2004.
 2,997,402 (*See Class 9 for this trademark*).
 2,997,596. **MCLEODUSA AND DESIGN. MCLEODUSA INCORPORATED**, (U.S. CLS. 100, 101 AND 104). SN 78-435,340. PUB. 6-28-2005. FILED 6-15-2004.
 2,997,597. **MCLEODUSA AND DESIGN. MCLEODUSA INCORPORATED**, (U.S. CLS. 100, 101 AND 104). SN 78-435,352. PUB. 6-28-2005. FILED 6-15-2004.
 2,997,765. **COMOBILE (BLOCK FORM)**. CENCOURSE, (U.S. CLS. 100, 101 AND 104). SN 78-452,432. PUB. 6-28-2005. FILED 7-18-2004.
 2,998,368. **BOOMTOWN AND DESIGN. TDC TOTALLØSNIN-GER A/S**, (U.S. CLS. 100, 101 AND 104). SN 79-000,586. PUB. 6-28-2005. FILED 12-17-2003.
 2,998,497 (*See Class 35 for this trademark*).

CLASS 39—TRANSPORTATION AND STORAGE

2,996,231. **WINNING TRAVEL GROUP. LA JOLLA HOLDING GROUP, L.L.C.**, (U.S. CLS. 100 AND 105). SN 75-331,151. PUB. 6-28-2005. FILED 7-28-1997.
 2,996,256. **CENTER PARCS AND DESIGN. CENTER PARCS EUROPE N.V.**, MULTIPLE CLASS, (INT. CLS. 39, 41 AND 42), (U.S. CLS. 100, 101, 105 AND 107). SN 76-213,177. PUB. 6-28-2005. FILED 2-20-2001.
 2,996,273. **EDELWEISS AND DESIGN. KUONI REISEN AG**, (U.S. CLS. 100 AND 105). SN 76-360,004. PUB. 6-28-2005. FILED 1-17-2002.
 2,996,412 (*See Class 16 for this trademark*).
 2,996,494 (*See Class 37 for this trademark*).
 2,996,640. **CIRCLE THE GLOBE (BLOCK FORM)**. EVER-TSEN, EIMERD, (U.S. CLS. 100 AND 105). SN 76-583,686. PUB. 6-28-2005. FILED 3-29-2004.
 2,996,664 (*See Class 9 for this trademark*).
 2,996,689. **GUARDIAN (BLOCK FORM)**. GUARDIAN MOVING AND STORAGE, INC., (U.S. CLS. 100 AND 105). SN 76-592,113. PUB. 6-28-2005. FILED 5-13-2004.
 2,996,709. **DIVA LIMOUSINE LTD. (BLOCK FORM)**. DIVA LIMOUSINE LTD., (U.S. CLS. 100 AND 105). SN 76-596,002. PUB. 6-28-2005. FILED 6-7-2004.
 2,996,714. **MISCELLANEOUS DESIGN. AUBURN UNIVERSITY**, (U.S. CLS. 100 AND 105). SN 76-596,457. PUB. 6-28-2005. FILED 6-9-2004.
 2,996,717. **INDIANA HARBOR BELT "IHB CONNECTION" PROUD PAST - BRIGHT FUTURE SAFETY IS OUR PRIORITY - SERVICE IS OUR SPECIALTY (BLOCK FORM)**. INDIANA HARBOR BELT RAILROAD COMPANY, (U.S. CLS. 100 AND 105). SN 76-597,200. PUB. 6-7-2005. FILED 6-10-2004.
 2,996,875. **TRANSFURNITURE (BLOCK FORM)**. TRANS-

GROUP EXPRESS, INC., DBA TRANSGROUP WORLD-WIDE LOGISTICS, (U.S. CLS. 100 AND 105). SN 76-608,217. PUB. 6-28-2005. FILED 8-23-2004.

2,996,906 (*See Class 35 for this trademark*).

2,996,996. **BEDROCK FREIGHT BROKERAGE**. BEDROCK FREIGHT BROKERAGE, LP, (U.S. CLS. 100 AND 105). SN 78-295,255. PUB. 6-28-2005. FILED 9-3-2003.

2,997,067. **SSA STREAMLINE SHIPPERS ASSOCIATION INC. AND DESIGN**. STREAMLINE SHIPPERS ASSOCIATION, INC., (U.S. CLS. 100 AND 105). SN 78-333,428. PUB. 6-14-2005. FILED 11-26-2003.

2,997,149. **SNE SYSTEMS (BLOCK FORM)**. FKI LOGISTEX INTEGRATION INC., MULTIPLE CLASS, (INT. CLS. 39 AND 45), (U.S. CLS. 100, 101 AND 105). SN 78-354,966. PUB. 6-28-2005. FILED 1-21-2004.

2,997,156. **CENTRAL REFRIGERATED SERVICE, INC. (BLOCK FORM)**. CENTRAL REFRIGERATED SERVICE, INC., (U.S. CLS. 100 AND 105). SN 78-357,236. PUB. 6-28-2005. FILED 1-25-2004.

2,997,197. **LAN AMERICA (BLOCK FORM)**. LAN AIRLINES S.A., (U.S. CLS. 100 AND 105). SN 78-361,180. PUB. 6-28-2005. FILED 2-2-2004.

2,997,274. **PALMETTO STATE TRANSPORTATION CO., INC. (BLOCK FORM)**. PALMETTO STATE TRANSPORTATION CO., INC., (U.S. CLS. 100 AND 105). SN 78-371,160. PUB. 6-28-2005. FILED 2-20-2004.

2,997,308 (*See Class 16 for this trademark*).

2,997,325. **TRANSCONEX (BLOCK FORM)**. TRANSCONEX, INC., (U.S. CLS. 100 AND 105). SN 78-379,457. PUB. 6-28-2005. FILED 3-5-2004.

2,997,356. **STRINGER'S (BLOCK FORM)**. STRINGER'S, LLC, (U.S. CLS. 100 AND 105). SN 78-387,104. PUB. 6-28-2005. FILED 3-18-2004.

2,997,360. **OPTERNITY (BLOCK FORM)**. OPTERNITY STORAGE, INC., (U.S. CLS. 100 AND 105). SN 78-387,650. PUB. 6-28-2005. FILED 3-19-2004.

2,997,500 (*See Class 35 for this trademark*).

2,997,548. **BECAUSE IT'S THAT IMPORTANT. (BLOCK FORM)**. UNIGROUP, INC., (U.S. CLS. 100 AND 105). SN 78-426,294. PUB. 6-28-2005. FILED 5-27-2004.

2,997,578 (*See Class 35 for this trademark*).

2,997,635 (*See Class 35 for this trademark*).

2,997,636. **WE KNOW HOTELS INSIDE AND OUT. (BLOCK FORM)**. HOTELS.COM, L.P., MULTIPLE CLASS, (INT. CLS. 39 AND 43), (U.S. CLS. 100, 101 AND 105). SN 78-440,039. PUB. 6-28-2005. FILED 6-23-2004.

2,997,645. **THE SAVVY CRUISER (BLOCK FORM)**. BENJAMIN, MILTON R., (U.S. CLS. 100 AND 105). SN 78-441,145. PUB. 6-28-2005. FILED 6-24-2004.

2,997,702. **GRADCITY.COM (BLOCK FORM)**. STUDENTCITY.COM, INC., MULTIPLE CLASS, (INT. CLS. 39 AND 42), (U.S. CLS. 100, 101 AND 105). SN 78-446,445. PUB. 6-28-2005. FILED 7-6-2004.

2,997,865. **TRAVELMAKERS (BLOCK FORM)**. SZCZEPANSKI, ZYGMUNT, (U.S. CLS. 100 AND 105). SN 78-456,912. PUB. 6-28-2005. FILED 7-26-2004.

2,997,883. **BUSHTRACKS EXPEDITIONS AND DESIGN**. TETT, DAVID, DBA BUSHTRACKS AFRICAN EXPEDITIONS, INC., (U.S. CLS. 100 AND 105). SN 78-457,159. PUB. 6-28-2005. FILED 7-27-2004.

2,998,109 (*See Class 30 for this trademark*).

2,998,124. **MYSTIC LAKE CASINO . HOTEL AND DESIGN**. SHAKOPEE MDEWAKANTON SIOUX COMMUNITY, MULTIPLE CLASS, (INT. CLS. 39, 41 AND 43), (U.S. CLS. 100, 101, 105 AND 107). SN 78-461,439. PUB. 6-28-2005. FILED 8-3-2004.

2,998,237. **GENMAR (BLOCK FORM)**. GENMAR INDUSTRIES, INC., (U.S. CLS. 100 AND 105). SN 78-465,173. PUB. 6-28-2005. FILED 8-10-2004.

2,998,361 (*See Class 35 for this trademark*).

2,998,436 (*See Class 9 for this trademark*).

2,998,488. **AVINODE (BLOCK FORM)**. AVINODE AB, (U.S. CLS. 100 AND 105). SN 79-005,200. PUB. 6-28-2005. FILED 8-2-2004.

CLASS 40—MATERIAL TREATMENT

2,996,277 (*See Class 1 for this trademark*).

2,996,289 (*See Class 1 for this trademark*).

2,996,416. **GF AND DESIGN**. GOLDEN FUTURE WEDDING BAND, INC., (U.S. CLS. 100, 103 AND 106). SN 76-538,426. PUB. 6-28-2005. FILED 8-19-2003.

2,996,532 (*See Class 37 for this trademark*).

2,996,533 (*See Class 37 for this trademark*).

2,996,588. **BREAKING NEW GROUND IN FENCING (BLOCK FORM)**. TRUMETA CORPORATION, (U.S. CLS. 100, 103 AND 106). SN 76-575,388. PUB. 6-28-2005. FILED 2-13-2004.

2,996,637 (*See Class 13 for this trademark*).

2,996,682. **PARADATA (BLOCK FORM)**. PARADATA SYSTEMS INC., (U.S. CLS. 100, 103 AND 106). SN 76-591,582. PUB. 6-28-2005. FILED 5-11-2004.

2,996,687. **ROSEVINE 1810 WINERY LET'S MAKE WINE AND DESIGN**. ROSEVINE ENTERPRISES, LLC, (U.S. CLS. 100, 103 AND 106). SN 76-591,791. PUB. 6-28-2005. FILED 5-12-2004.

2,996,711. **CEP (BLOCK FORM)**. KAUFMANN, KENNETH W., (U.S. CLS. 100, 103 AND 106). SN 76-596,178. PUB. 6-28-2005. FILED 6-4-2004.

2,996,784. **THERMALLOY (BLOCK FORM)**. EXLINE, INC., (U.S. CLS. 100, 103 AND 106). SN 76-604,287. PUB. 6-28-2005. FILED 7-26-2004.

2,996,848. **PHOTOGEMIC (BLOCK FORM)**. SCCI MARKETING INC., (U.S. CLS. 100, 103 AND 106). SN 76-605,640. PUB. 6-28-2005. FILED 8-4-2004.

2,996,885 (*See Class 1 for this trademark*).

2,997,027 (*See Class 37 for this trademark*).

2,997,092 (*See Class 37 for this trademark*).

2,997,098. **CUSTOM TRACK (BLOCK FORM)**. TRACK CORP., (U.S. CLS. 100, 103 AND 106). SN 78-344,065. PUB. 6-28-2005. FILED 12-22-2003.

2,997,216 (*See Class 16 for this trademark*).

2,997,450. **PREMIUM WATERS INC. BOTTLED WATER SOLUTIONS (BLOCK FORM)**. PREMIUM WATERS, INC., (U.S. CLS. 100, 103 AND 106). SN 78-404,936. PUB. 6-28-2005. FILED 4-20-2004.

2,997,494. **NOTH'N TO IT (BLOCK FORM)**. NOTH'N TO IT, INC., (U.S. CLS. 100, 103 AND 106). SN 78-413,265. PUB. 6-28-2005. FILED 5-5-2004.

2,997,780. **BLUE DIGITAL YOUR DIGITAL COPY CENTER @ BLUE LAGOON AND DESIGN**. BLUE DIGITAL CORP, (U.S. CLS. 100, 103 AND 106). SN 78-453,421. PUB. 6-28-2005. FILED 7-20-2004.

2,997,849 (*See Class 37 for this trademark*).

2,997,860. **CHESAPEAKE (BLOCK FORM)**. CHESAPEAKE CORPORATION, MULTIPLE CLASS, (INT. CLS. 40 AND 42), (U.S. CLS. 100, 101, 103 AND 106). SN 78-456,771. PUB. 6-28-2005. FILED 7-26-2004.

2,997,895 (*See Class 35 for this trademark*).

2,998,282. **AIRLOK (BLOCK FORM)**. PROTECTIVE COATINGS TECHNOLOGIES INC, (U.S. CLS. 100, 103 AND 106). SN 78-467,579. PUB. 6-28-2005. FILED 8-14-2004.

2,998,283. **AIRLOK FLEX (BLOCK FORM)**. PROTECTIVE COATINGS TECHNOLOGIES INC, (U.S. CLS. 100, 103 AND 106). SN 78-467,581. PUB. 6-28-2005. FILED 8-14-2004.

2,998,456 (*See Class 6 for this trademark*).

CLASS 41—EDUCATION AND ENTERTAINMENT

2,996,230. **THE ROCKXCHANGE**. FLYNN, JOEL, DBA VERGE ENTERTAINMENT, (U.S. CLS. 100, 101 AND 107). SN 75-234,724. PUB. 6-28-2005. FILED 1-30-1997.

2,996,232. **FLAT EARTH PRODUCTIONS, INC.. FLAT EARTH PRODUCTIONS, INC.**, (U.S. CLS. 100, 101 AND 107). SN 75-369,195. PUB. 6-28-2005. FILED 10-6-1997.

2,996,235 (*See Class 35 for this trademark*).

2,996,243 (*See Class 3 for this trademark*).

2,996,245 (*See Class 16 for this trademark*).

2,996,256 (*See Class 39 for this trademark*).

2,996,258 (*See Class 9 for this trademark*).

2,996,261 (*See Class 38 for this trademark*).

- 2,996,314 (*See Class 9 for this trademark.*)
 2,996,317 (*See Class 9 for this trademark.*)
 2,996,324 (*See Class 16 for this trademark.*)
 2,996,327. **ON THE MOVE. FRIENDS OF THE COLORADO CENTER FOR HUMAN NUTRITION**, (U.S. CLS. 100, 101 AND 107). SN 76-479,270. PUB. 6-28-2005. FILED 12-30-2002.
 2,996,331 (*See Class 9 for this trademark.*)
 2,996,332 (*See Class 9 for this trademark.*)
 2,996,346 (*See Class 16 for this trademark.*)
 2,996,356. **MUC. MOUNT UNION COLLEGE**, (U.S. CLS. 100, 101 AND 107). SN 76-513,172. PUB. 6-28-2005. FILED 5-9-2003.
 2,996,365 (*See Class 9 for this trademark.*)
 2,996,378. **COMMERCE U C UNIVERSITY (STYLIZED). COMMERCE BANCORP, INC.**, (U.S. CLS. 100, 101 AND 107). SN 76-524,611. PUB. 6-28-2005. FILED 6-23-2003.
 2,996,381. **BLACKSONBLONDES. ROSENBERG, CABLE**, (U.S. CLS. 100, 101 AND 107). SN 76-526,310. PUB. 6-28-2005. FILED 6-27-2003.
 2,996,382. **DECORATING MASTERS INSTITUTE. DMI FRANCHISE, INC.**, (U.S. CLS. 100, 101 AND 107). SN 76-526,474. PUB. 6-28-2005. FILED 6-20-2003.
 2,996,399. **HOOP STARS. HOOP STARS, NFP**, (U.S. CLS. 100, 101 AND 107). SN 76-534,072. PUB. 6-28-2005. FILED 8-1-2003.
 2,996,400. **HOOP STARS AND DESIGN. HOOP STARS, NFP**, (U.S. CLS. 100, 101 AND 107). SN 76-534,073. PUB. 6-28-2005. FILED 8-1-2003.
 2,996,404. **NATIONAL SOCCER HALL OF FAME ONEONTA, N.Y. AND DESIGN. NATIONAL SOCCER HALL OF FAME**, (U.S. CLS. 100, 101 AND 107). SN 76-536,425. PUB. 6-28-2005. FILED 7-30-2003.
 2,996,409. **BROTHER. RICHARDSON, HAMISH, AND RICHARDSON, ANGUS**, (U.S. CLS. 100, 101 AND 107). SN 76-536,767. PUB. 6-28-2005. FILED 7-21-2003.
 2,996,423. **WATER WORKS AND DESIGN. PARAMOUNT PARKS INC.**, (U.S. CLS. 100, 101 AND 107). SN 76-540,926. PUB. 6-28-2005. FILED 8-18-2003.
 2,996,425 (*See Class 6 for this trademark.*)
 2,996,426. **THE COURAGE TO SPEAK. THE COURAGE TO SPEAK FOUNDATION, INC.**, (U.S. CLS. 100, 101 AND 107). SN 76-542,483. PUB. 6-28-2005. FILED 9-4-2003.
 2,996,434. **HARRINGTON COLLEGE OF DESIGN. HARRINGTON INSTITUTE OF INTERIOR DESIGN, INC.**, (U.S. CLS. 100, 101 AND 107). SN 76-545,056. PUB. 6-28-2005. FILED 9-16-2003.
 2,996,446. **ACE LEADERSHIP PROGRAM AND DESIGN. UNIVERSITY OF NOTRE DAME DU LAC**, (U.S. CLS. 100, 101 AND 107). SN 76-548,829. PUB. 6-28-2005. FILED 10-3-2003.
 2,996,454. **SIGMA ALPHA LAMBDA. SIGMA ALPHA LAMBDA, INC.**, (U.S. CLS. 100, 101 AND 107). SN 76-552,603. PUB. 3-8-2005. FILED 10-20-2003.
 2,996,458 (*See Class 25 for this trademark.*)
 2,996,473. **TEXAS BEEF QUALITY PRODUCER AND DESIGN. TEXAS AND SOUTHWESTERN CATTLE RAISERS ASSOCIATION**, (U.S. CLS. 100, 101 AND 107). SN 76-565,302. PUB. 6-28-2005. FILED 12-15-2003.
 2,996,478 (*See Class 35 for this trademark.*)
 2,996,485. **MISCELLANEOUS DESIGN. MEADWESTVACO CORPORATION**, (U.S. CLS. 100, 101 AND 107). SN 76-567,755. PUB. 6-28-2005. FILED 12-31-2003.
 2,996,486. **CALENDAR AND DESIGN. MEADWESTVACO CORPORATION**, (U.S. CLS. 100, 101 AND 107). SN 76-567,757. PUB. 6-28-2005. FILED 12-31-2003.
 2,996,487. **MISCELLANEOUS DESIGN. MEADWESTVACO CORPORATION**, (U.S. CLS. 100, 101 AND 107). SN 76-567,759. PUB. 6-28-2005. FILED 12-31-2003.
 2,996,488. **MISCELLANEOUS DESIGN. MEADWESTVACO CORPORATION**, (U.S. CLS. 100, 101 AND 107). SN 76-567,801. PUB. 6-28-2005. FILED 12-31-2003.
 2,996,518. **CHIOLOGY (STYLIZED). HIRT, JOSEPH B.**, (U.S. CLS. 100, 101 AND 107). SN 76-570,030. PUB. 6-28-2005. FILED 12-23-2003.
 2,996,522. **FLORIDA COMPREHENSIVE ASSESSMENT TEST (BLOCK FORM). FLORIDA DEPARTMENT OF EDUCATION**, (U.S. CLS. 100, 101 AND 107). SN 76-570,310. PUB. 6-28-2005. FILED 1-12-2004.
 2,996,523. **OUR PEOPLE MAKE THE DIFFERENCE (STYLIZED). TOTAL DOCUMENT SOLUTIONS, INC.**, (U.S. CLS. 100, 101 AND 107). SN 76-570,329. PUB. 6-28-2005. FILED 1-15-2004.
 2,996,527. **THE NEW YORK SUBWAY A CENTURY OF PROGRESS IN MOTION 1904-2004 MTA AND DESIGN. METROPOLITAN TRANSPORTATION AUTHORITY**, (U.S. CLS. 100, 101 AND 107). SN 76-570,436. PUB. 6-28-2005. FILED 1-12-2004.
 2,996,538 (*See Class 35 for this trademark.*)
 2,996,543. **CUTS FITNESS FOR MEN (BLOCK FORM). CUTS FITNESS FOR MEN**, (U.S. CLS. 100, 101 AND 107). SN 76-571,482. PUB. 6-28-2005. FILED 1-21-2004.
 2,996,565. **PHILLY-NUTT-CRAK-UP (BLOCK FORM). CONTEMPRADANCE THEATRE, INC.**, (U.S. CLS. 100, 101 AND 107). SN 76-572,641. PUB. 6-28-2005. FILED 1-26-2004.
 2,996,566. **T AND DESIGN. S B ICE, LLC, MULTIPLE CLASS**, (INT. CLS. 41 AND 43), (U.S. CLS. 100, 101 AND 107). SN 76-572,788. PUB. 6-28-2005. FILED 1-28-2004.
 2,996,575. **INTERACTIVE GAMING NEWS (BLOCK FORM). THE RIVER CITY GROUP, LLC**, (U.S. CLS. 100, 101 AND 107). SN 76-573,564. PUB. 6-28-2005. FILED 2-2-2004.
 2,996,577 (*See Class 35 for this trademark.*)
 2,996,578. **PROFESSOR HAROLD (STYLIZED). WEITZBERG CONSULTING, INC.**, (U.S. CLS. 100, 101 AND 107). SN 76-574,241. PUB. 6-28-2005. FILED 2-5-2004.
 2,996,589 (*See Class 36 for this trademark.*)
 2,996,591 (*See Class 9 for this trademark.*)
 2,996,609. **THE WEATHER NOTEBOOK AND DESIGN. MOUNT WASHINGTON OBSERVATORY**, (U.S. CLS. 100, 101 AND 107). SN 76-578,027. PUB. 6-28-2005. FILED 2-23-2004.
 2,996,614 (*See Class 25 for this trademark.*)
 2,996,616. **RA VOL AND DESIGN. MEXICAN FINE ARTS CENTER MUSEUM**, (U.S. CLS. 100, 101 AND 107). SN 76-578,664. PUB. 6-28-2005. FILED 3-1-2004.
 2,996,624 (*See Class 38 for this trademark.*)
 2,996,632. **MID-AMERICAN SOCCER CLASSIC (BLOCK FORM). FAIRFIELD OPTIMIST CLUB**, (U.S. CLS. 100, 101 AND 107). SN 76-581,502. PUB. 6-28-2005. FILED 3-15-2004.
 2,996,654. **NO DRAWING-SENSORY MARK. TIVO INC.**, (U.S. CLS. 100, 101 AND 107). SN 76-587,005. PUB. 6-28-2005. FILED 4-16-2004.
 2,996,668 (*See Class 16 for this trademark.*)
 2,996,697. **FESTIVAL RAICES HISPANAS (BLOCK FORM). SPANISH BROADCASTING SYSTEM, INC.**, (U.S. CLS. 100, 101 AND 107). SN 76-594,746. PUB. 6-28-2005. FILED 5-28-2004.
 2,996,699. **PIQUES (BLOCK FORM). KOSLOW ENTERPRISES, INC. DBA PIQUES DIETS AND DESSERTS, MULTIPLE CLASS, (INT. CLS. 41, 43 AND 44)**, (U.S. CLS. 100, 101 AND 107). SN 76-595,002. PUB. 6-28-2005. FILED 6-1-2004.
 2,996,701. **TAKE CHARGE! (BLOCK FORM). COX COMMUNICATIONS, INC.**, (U.S. CLS. 100, 101 AND 107). SN 76-595,255. PUB. 6-28-2005. FILED 6-3-2004.
 2,996,710. **JET DIRECT (BLOCK FORM). DELTA CONNECTION ACADEMY, INC.**, (U.S. CLS. 100, 101 AND 107). SN 76-596,145. PUB. 6-28-2005. FILED 6-8-2004.
 2,996,716 (*See Class 9 for this trademark.*)
 2,996,719. **THOSE THREESISTERS (BLOCK FORM). SISTER GIRL ENTERPRISES, INC.**, (U.S. CLS. 100, 101 AND 107). SN 76-597,296. PUB. 6-28-2005. FILED 6-14-2004.
 2,996,721 (*See Class 9 for this trademark.*)
 2,996,723. **UP YOUR STACK (BLOCK FORM). GEORGE ZAWACKI ENTERPRISES, LLC**, (U.S. CLS. 100, 101 AND 107). SN 76-597,818. PUB. 6-28-2005. FILED 6-16-2004.
 2,996,731. **HELMSBRISCOE (BLOCK FORM). HELMS BRISCOE PERFORMANCE GROUP, INC.**, (U.S. CLS. 100, 101 AND 107). SN 76-598,296. PUB. 6-28-2005. FILED 6-21-2004.
 2,996,751. **SELECT PARTNER (BLOCK FORM). VCAMPUS CORPORATION**, (U.S. CLS. 100, 101 AND 107). SN 76-600,340. PUB. 6-28-2005. FILED 7-2-2004.
 2,996,758. **CARING PHOTOGRAPHY AND DESIGN. NATIONAL ASSOCIATION FOR HOME CARE & HOSPICE**, (U.S. CLS. 100, 101 AND 107). SN 76-600,798. PUB. 6-28-2005. FILED 7-6-2004.

- 2,996,759. **TRAD GANG (BLOCK FORM)**. TRAD GANG, LLC, (U.S. CLS. 100, 101 AND 107). SN 76-600,966. PUB. 6-28-2005. FILED 7-7-2004.
- 2,996,771. **POWERFUL CONVERSATIONS ABOUT PROFESSIONAL DEVELOPMENT (BLOCK FORM)**. ALABAMA BEST PRACTICES CENTER, (U.S. CLS. 100, 101 AND 107). SN 76-603,125. PUB. 6-28-2005. FILED 7-20-2004.
- 2,996,775. **BOSSIER-SHREVEPORT BATTLEWINGS (BLOCK FORM)**. AF2 ENTERPRISES, LLC, (U.S. CLS. 100, 101 AND 107). SN 76-603,411. PUB. 6-28-2005. FILED 7-22-2004.
- 2,996,785. **MISCELLANEOUS DESIGN**. WORLD LEAGUE LICENSING, L.L.C., (U.S. CLS. 100, 101 AND 107). SN 76-604,369. PUB. 6-28-2005. FILED 7-26-2004.
- 2,996,786. **FRANKFURT GALAXY (BLOCK FORM)**. WORLD LEAGUE LICENSING, L.L.C., (U.S. CLS. 100, 101 AND 107). SN 76-604,372. PUB. 6-28-2005. FILED 7-26-2004.
- 2,996,787. **MISCELLANEOUS DESIGN**. WORLD LEAGUE LICENSING, L.L.C., (U.S. CLS. 100, 101 AND 107). SN 76-604,373. PUB. 6-28-2005. FILED 7-26-2004.
- 2,996,795. **VIRGINIA READING ASSESSMENT AND DESIGN**. NATIONAL EVALUATION SYSTEMS, INC., (U.S. CLS. 100, 101 AND 107). SN 76-604,563. PUB. 6-28-2005. FILED 7-28-2004.
- 2,996,797. **SWEET & SASSY (BLOCK FORM)**. SWEET & SASSY, INC., (U.S. CLS. 100, 101 AND 107). SN 76-604,625. PUB. 6-28-2005. FILED 7-29-2004.
- 2,996,798. **KNEEHIGH NINJA (BLOCK FORM)**. JHOON RHEE INTERNATIONAL, (U.S. CLS. 100, 101 AND 107). SN 76-604,637. PUB. 6-28-2005. FILED 7-29-2004.
- 2,996,807. **CREATING CHARACTER IN THE GROWING YEARS (BLOCK FORM)**. CREATING CHARACTER LLC, (U.S. CLS. 100, 101 AND 107). SN 76-604,852. PUB. 6-28-2005. FILED 7-30-2004.
- 2,996,808. **PEDDLESFOOTS (BLOCK FORM)**. CREATING CHARACTER LLC, (U.S. CLS. 100, 101 AND 107). SN 76-604,853. PUB. 6-28-2005. FILED 7-30-2004.
- 2,996,814. **MISCELLANEOUS DESIGN**. DR. JOANNE WHITE CONSULTING SERVICES, LLC, (U.S. CLS. 100, 101 AND 107). SN 76-604,941. PUB. 6-28-2005. FILED 7-30-2004.
- 2,996,829. **RED (BLOCK FORM)**. ARMSTRONG, ANTHONY, AND ARMSTRONG, RANDY, AND BARNES, MICHAEL, AND HENDRIX, ANDREW, AND RAUCH, JASEN, (U.S. CLS. 100, 101 AND 107). SN 76-605,188. PUB. 6-28-2005. FILED 8-2-2004.
- 2,996,837. **ENABLING THE WORLD TO THINK THERMALLY (BLOCK FORM)**. JOHN SNELL & ASSOCIATES, INC., (U.S. CLS. 100, 101 AND 107). SN 76-605,439. PUB. 6-28-2005. FILED 8-4-2004.
- 2,996,856. **TUTORIALS FOR EXCELLENCE (BLOCK FORM)**. TUTORIALS FOR EXCELLENCE, INC., (U.S. CLS. 100, 101 AND 107). SN 76-605,763. PUB. 6-28-2005. FILED 8-3-2004.
- 2,996,858. **CASQA (BLOCK FORM)**. CALIFORNIA STORM-WATER QUALITY ASSOCIATION, (U.S. CLS. 100, 101 AND 107). SN 76-605,908. PUB. 6-28-2005. FILED 8-6-2004.
- 2,996,859. **GQ (BLOCK FORM)**. E R CLASSIC PRODUCTIONS, INC., (U.S. CLS. 100, 101 AND 107). SN 76-605,927. PUB. 6-28-2005. FILED 8-6-2004.
- 2,996,870 (*See Class 9 for this trademark*).
- 2,996,883 (*See Class 9 for this trademark*).
- 2,996,912 (*See Class 36 for this trademark*).
- 2,996,914 (*See Class 16 for this trademark*).
- 2,996,917. **JUST CAUSE I WANNA**. JCW ENTERPRISES, INC., (U.S. CLS. 100, 101 AND 107). SN 78-203,501. PUB. 6-28-2005. FILED 1-15-2003.
- 2,996,922 (*See Class 35 for this trademark*).
- 2,996,931. **DIAMOND DIVIDENDS AND DESIGN**. LUMMI COMMERCIAL COMPANY, (U.S. CLS. 100, 101 AND 107). SN 78-224,337. PUB. 6-28-2005. FILED 3-11-2003.
- 2,996,938. **CANINE BRAIN**. CANTRELL, KRISTA, (U.S. CLS. 100, 101 AND 107). SN 78-240,263. PUB. 6-28-2005. FILED 4-21-2003.
- 2,996,945. **COOPERSTOWN DREAMS PARK (BLOCK FORM)**. COOPERSTOWN PROPERTIES, L.L.C., (U.S. CLS. 100, 101 AND 107). SN 78-243,921. PUB. 6-28-2005. FILED 4-30-2003.
- 2,996,961. **P PREMIUM CLUB AND DESIGN**. HORN ABBOT LTD., (U.S. CLS. 100, 101 AND 107). SN 78-263,212. PUB. 6-28-2005. FILED 6-17-2003.
- 2,996,974. **SEAN PAUL**. HENRIQUES, SEAN PAUL, (U.S. CLS. 100, 101 AND 107). SN 78-275,616. PUB. 6-28-2005. FILED 7-17-2003.
- 2,996,990 (*See Class 35 for this trademark*).
- 2,997,002 (*See Class 35 for this trademark*).
- 2,997,011. **NATIONAL OLDTIME FIDDLERS' CONTEST AND DESIGN**. WEISER CHAMBER OF COMMERCE, (U.S. CLS. 100, 101 AND 107). SN 78-301,024. PUB. 6-28-2005. FILED 9-16-2003.
- 2,997,015 (*See Class 35 for this trademark*).
- 2,997,022. **CANNABIS CULTURE TOKERS' BOWL**. AVALON SUNSPASH LTD., DBA CANNABIS CULTURE, (U.S. CLS. 100, 101 AND 107). SN 78-308,274. PUB. 6-28-2005. FILED 10-1-2003.
- 2,997,023 (*See Class 16 for this trademark*).
- 2,997,025. **DOG TRAINING IN YOUR HOME AND DESIGN**. DOG TRAINING IN YOUR HOME, (U.S. CLS. 100, 101 AND 107). SN 78-310,300. PUB. 6-28-2005. FILED 10-7-2003.
- 2,997,030 (*See Class 36 for this trademark*).
- 2,997,035. **SHOW DOGS OF THE YEAR**. BOWTIE, INC., (U.S. CLS. 100, 101 AND 107). SN 78-320,213. PUB. 6-28-2005. FILED 10-29-2003.
- 2,997,040. **CELLULAR GEOMETRY (BLOCK FORM)**. ORTIZ, LEROY, (U.S. CLS. 100, 101 AND 107). SN 78-324,225. PUB. 6-28-2005. FILED 11-6-2003.
- 2,997,043 (*See Class 16 for this trademark*).
- 2,997,047 (*See Class 16 for this trademark*).
- 2,997,082 (*See Class 25 for this trademark*).
- 2,997,083. **PRINTABLE TECHNOLOGIES (BLOCK FORM)**. PRINTABLE TECHNOLOGIES, INC., (U.S. CLS. 100, 101 AND 107). SN 78-340,865. PUB. 6-28-2005. FILED 12-15-2003.
- 2,997,096. **EARTHRIGHTS INTERNATIONAL (BLOCK FORM)**. EARTHRIGHTS INTERNATIONAL, (U.S. CLS. 100, 101 AND 107). SN 78-343,585. PUB. 6-28-2005. FILED 12-19-2003.
- 2,997,099. **GUARANTEED WATT SAVER (BLOCK FORM)**. GUARANTEED WATT SAVER SYSTEMS - WEST, INC., (U.S. CLS. 100, 101 AND 107). SN 78-344,403. PUB. 6-28-2005. FILED 12-22-2003.
- 2,997,106. **WORLDVIEW ACADEMY (BLOCK FORM)**. WORLDVIEW ACADEMY INCORPORATED, (U.S. CLS. 100, 101 AND 107). SN 78-346,248. PUB. 6-28-2005. FILED 12-29-2003.
- 2,997,107. **KUAMP AND DESIGN**. KUAMP, INC., (U.S. CLS. 100, 101 AND 107). SN 78-346,750. PUB. 6-28-2005. FILED 12-30-2003.
- 2,997,111 (*See Class 25 for this trademark*).
- 2,997,132. **NOTHING REMAINS (BLOCK FORM)**. BERRY, BRIAN D, AND VIGNOGNA, JAMES R, (U.S. CLS. 100, 101 AND 107). SN 78-350,545. PUB. 6-28-2005. FILED 1-12-2004.
- 2,997,144 (*See Class 9 for this trademark*).
- 2,997,166. **RUCKUS NETWORK (BLOCK FORM)**. RUCKUS NETWORK, INC., (U.S. CLS. 100, 101 AND 107). SN 78-358,116. PUB. 6-28-2005. FILED 1-27-2004.
- 2,997,169 (*See Class 37 for this trademark*).
- 2,997,181 (*See Class 36 for this trademark*).
- 2,997,182. **THE STEREO TYPE AND DESIGN**. QUALLO, DENNIS E., (U.S. CLS. 100, 101 AND 107). SN 78-359,920. PUB. 6-28-2005. FILED 1-30-2004.
- 2,997,189 (*See Class 35 for this trademark*).
- 2,997,194. **TAXANALYSTS (BLOCK FORM)**. TAX ANALYSTS, (U.S. CLS. 100, 101 AND 107). SN 78-361,023. PUB. 6-28-2005. FILED 2-2-2004.
- 2,997,199. **HPCP (BLOCK FORM)**. CITPRO CORPORATION, (U.S. CLS. 100, 101 AND 107). SN 78-361,478. PUB. 6-28-2005. FILED 2-3-2004.
- 2,997,203. **BETTER PROPAGANDA AND DESIGN**. RADIANT INTERACTIVE, INC., (U.S. CLS. 100, 101 AND 107). SN 78-361,725. PUB. 6-28-2005. FILED 2-3-2004.
- 2,997,204. **OUTLOOK MEDIA AND DESIGN**. OUTLOOK MEDIA INCORPORATED, (U.S. CLS. 100, 101 AND 107). SN 78-361,928. PUB. 6-28-2005. FILED 2-3-2004.
- 2,997,221. **US OPEN SERIES AND DESIGN**. UNITED STATES TENNIS ASSOCIATION INCORPORATED, (U.S. CLS. 100, 101 AND 107). SN 78-364,040. PUB. 6-28-2005. FILED 2-6-2004.
- 2,997,224 (*See Class 16 for this trademark*).
- 2,997,244. **CACHE CREEK CASINO RESORT (BLOCK FORM)**. CACHE CREEK CASINO RESORT, (U.S. CLS.

- 100, 101 AND 107). SN 78-367,378. PUB. 6-28-2005. FILED 2-12-2004.
- 2,997,255. **BETHUNE-COOKMAN (BLOCK FORM)**. BETHUNE-COOKMAN COLLEGE, INC., (U.S. CLS. 100, 101 AND 107). SN 78-368,474. PUB. 6-28-2005. FILED 2-16-2004.
- 2,997,263 (*See Class 18 for this trademark*).
- 2,997,265. **ERSKINE COLLEGE (BLOCK FORM)**. ERSKINE COLLEGE, MULTIPLE CLASS, (INT. CLS. 41 AND 43), (U.S. CLS. 100, 101 AND 107). SN 78-369,996. PUB. 6-28-2005. FILED 2-18-2004.
- 2,997,273 (*See Class 9 for this trademark*).
- 2,997,275 (*See Class 35 for this trademark*).
- 2,997,281 (*See Class 37 for this trademark*).
- 2,997,283. **LEMAY COLLECTION AMERICA'S CAR MUSEUM AND DESIGN**. THE HAROLD E. LEMAY MUSEUM, (U.S. CLS. 100, 101 AND 107). SN 78-373,065. PUB. 6-28-2005. FILED 2-24-2004.
- 2,997,287. **IN RARE FORM (BLOCK FORM)**. LEKAS, ERIK, AND LEKAS, MARK, AND MILLER, TIM, (U.S. CLS. 100, 101 AND 107). SN 78-373,444. PUB. 6-28-2005. FILED 2-24-2004.
- 2,997,292. **SOCIETYWEST AND DESIGN**. SOCIETYWEST LLC, MULTIPLE CLASS, (INT. CLS. 41 AND 45), (U.S. CLS. 100, 101 AND 107). SN 78-374,214. PUB. 6-28-2005. FILED 2-25-2004.
- 2,997,293. **GRANDMASTER SIN KWANG THE SHAOLIN DO AND DESIGN**. THE SIN KWANG, (U.S. CLS. 100, 101 AND 107). SN 78-374,677. PUB. 6-28-2005. FILED 2-26-2004.
- 2,997,297 (*See Class 37 for this trademark*).
- 2,997,301. **GILBERT'S GAZELLES (BLOCK FORM)**. TUHABONYE, GILBERT, (U.S. CLS. 100, 101 AND 107). SN 78-376,010. PUB. 6-28-2005. FILED 2-29-2004.
- 2,997,302 (*See Class 9 for this trademark*).
- 2,997,307. **WELLORIA (BLOCK FORM)**. WELLORIA, (U.S. CLS. 100, 101 AND 107). SN 78-376,632. PUB. 6-28-2005. FILED 3-1-2004.
- 2,997,313. **SPYRO (BLOCK FORM)**. UNIVERSAL INTERACTIVE, INC., (U.S. CLS. 100, 101 AND 107). SN 78-377,365. PUB. 6-28-2005. FILED 3-2-2004.
- 2,997,339. **LORDZ OF BROOKLYN AND DESIGN**. MCLEER, MICHAEL, (U.S. CLS. 100, 101 AND 107). SN 78-384,073. PUB. 6-28-2005. FILED 3-15-2004.
- 2,997,355 (*See Class 16 for this trademark*).
- 2,997,367. **DREAMQUEST EVENTS (BLOCK FORM)**. DREAMQUEST EVENTS, LLC, (U.S. CLS. 100, 101 AND 107). SN 78-388,533. PUB. 6-28-2005. FILED 3-22-2004.
- 2,997,381 (*See Class 25 for this trademark*).
- 2,997,384. **BD VACUTAINER INSTRUCT (BLOCK FORM)**. BECTON, DICKINSON AND COMPANY, (U.S. CLS. 100, 101 AND 107). SN 78-392,182. PUB. 6-28-2005. FILED 3-29-2004.
- 2,997,399. **WALDORF (BLOCK FORM)**. ASSOCIATION OF WALDORF SCHOOLS OF NORTH AMERICA, (U.S. CLS. 100, 101 AND 107). SN 78-393,942. PUB. 6-28-2005. FILED 3-31-2004.
- 2,997,408. **NATIONAL BOARD OF CHIROPRACTIC EXAMINERS (BLOCK FORM)**. NATIONAL BOARD OF CHIROPRACTIC EXAMINERS, (U.S. CLS. 100, 101 AND 107). SN 78-396,333. PUB. 6-28-2005. FILED 4-5-2004.
- 2,997,410. **SNC AND DESIGN**. ST. NORBERT COLLEGE, INC., (U.S. CLS. 100, 101 AND 107). SN 78-396,960. PUB. 6-28-2005. FILED 4-6-2004.
- 2,997,418 (*See Class 35 for this trademark*).
- 2,997,429. **EMPHASIS ON EXERCISE PERSONAL TRAINING SERVICE AND DESIGN**. ROSS, CELESTINE, (U.S. CLS. 100, 101 AND 107). SN 78-401,562. PUB. 6-28-2005. FILED 4-14-2004.
- 2,997,432. **BAKER COLLEGE BC SINCE 1911 AND DESIGN**. BAKER COLLEGE, (U.S. CLS. 100, 101 AND 107). SN 78-402,155. PUB. 6-28-2005. FILED 4-15-2004.
- 2,997,434. **TRAMP (BLOCK FORM)**. LIQUID LIVING LLC, (U.S. CLS. 100, 101 AND 107). SN 78-402,290. PUB. 6-28-2005. FILED 4-15-2004.
- 2,997,437 (*See Class 35 for this trademark*).
- 2,997,446 (*See Class 9 for this trademark*).
- 2,997,448. **CASTLEVIEW PRODUCTIONS (BLOCK FORM)**. BARNHILL PRODUCTIONS, INC., (U.S. CLS. 100, 101 AND 107). SN 78-404,679. PUB. 6-28-2005. FILED 4-20-2004.
- 2,997,451. **GLOBE (BLOCK FORM)**. AMERICAN MEDIA OPERATIONS, INC., (U.S. CLS. 100, 101 AND 107). SN 78-405,037. PUB. 6-28-2005. FILED 4-20-2004.
- 2,997,457. **SHAPE EN ESPANOL (BLOCK FORM)**. WEIDER PUBLICATIONS, LLC, (U.S. CLS. 100, 101 AND 107). SN 78-405,527. PUB. 6-28-2005. FILED 4-21-2004.
- 2,997,468. **CELEBRATE YOURSELF (BLOCK FORM)**. GOULD, MITCHELL SANTINE, (U.S. CLS. 100, 101 AND 107). SN 78-407,932. PUB. 6-28-2005. FILED 4-26-2004.
- 2,997,478 (*See Class 36 for this trademark*).
- 2,997,486. **SOUND WAVE JUNKIES (BLOCK FORM)**. SCHRAMM, JACOB W., (U.S. CLS. 100, 101 AND 107). SN 78-411,879. PUB. 6-28-2005. FILED 5-2-2004.
- 2,997,488. **EBSCO A TO Z AND DESIGN**. EBSCO INDUSTRIES, INC., (U.S. CLS. 100, 101 AND 107). SN 78-412,076. PUB. 6-28-2005. FILED 5-3-2004.
- 2,997,496 (*See Class 25 for this trademark*).
- 2,997,501. **JORDAN RIVER BOYS (BLOCK FORM)**. HUGGINS, KENNETH P., (U.S. CLS. 100, 101 AND 107). SN 78-414,543. PUB. 6-28-2005. FILED 5-6-2004.
- 2,997,506. **SPA ESCAPE (BLOCK FORM)**. BC INTERNATIONAL COSMETIC & IMAGE SERVICES, INC., (U.S. CLS. 100, 101 AND 107). SN 78-415,140. PUB. 6-28-2005. FILED 5-7-2004.
- 2,997,509. **U. AWARDS (BLOCK FORM)**. TIME INC., (U.S. CLS. 100, 101 AND 107). SN 78-416,827. PUB. 6-28-2005. FILED 5-11-2004.
- 2,997,512. **ADWEEK (BLOCK FORM)**. VNU BUSINESS MEDIA, INC., (U.S. CLS. 100, 101 AND 107). SN 78-417,213. PUB. 6-28-2005. FILED 5-12-2004.
- 2,997,514. **EMOTIONAL TOOLKIT (BLOCK FORM)**. MININNI, DARLENE M., (U.S. CLS. 100, 101 AND 107). SN 78-417,799. PUB. 6-28-2005. FILED 5-13-2004.
- 2,997,521. **MOYERS (BLOCK FORM)**. MOYERS, GAYLE, (U.S. CLS. 100, 101 AND 107). SN 78-420,108. PUB. 6-28-2005. FILED 5-17-2004.
- 2,997,532. **CASHMAKERS - THE TRUTH ABOUT MAKING MONEY IN REAL ESTATE (BLOCK FORM)**. VERCILLO, ANTHONY M., (U.S. CLS. 100, 101 AND 107). SN 78-421,947. PUB. 6-28-2005. FILED 5-19-2004.
- 2,997,534. **MOVES DANCE STUDIO AND DESIGN**. MOVES, A DANCE AND FITNESS STUDIO, INC., (U.S. CLS. 100, 101 AND 107). SN 78-422,505. PUB. 6-28-2005. FILED 5-20-2004.
- 2,997,542. **FOTO QUICK AND DESIGN**. UNITED RECOVERY SYSTEMS INC., (U.S. CLS. 100, 101 AND 107). SN 78-424,809. PUB. 6-28-2005. FILED 5-25-2004.
- 2,997,552. **THOUGHT POWER CENTER (BLOCK FORM)**. AMEZQUITA, HECTOR A., (U.S. CLS. 100, 101 AND 107). SN 78-427,037. PUB. 6-28-2005. FILED 5-28-2004.
- 2,997,569. **ANIME ANGIE (BLOCK FORM)**. FULD, JOHN W., (U.S. CLS. 100, 101 AND 107). SN 78-430,212. PUB. 6-28-2005. FILED 6-4-2004.
- 2,997,570. **IG INSTITUTE FOR BUILDING ORGANIZATIONAL CAPACITY (BLOCK FORM)**. THE INNOVATION GROUPS, INC., (U.S. CLS. 100, 101 AND 107). SN 78-430,283. PUB. 6-28-2005. FILED 6-4-2004.
- 2,997,582. **ORBIT AND DESIGN**. ORBIT PRODUCTIONS LLC, (U.S. CLS. 100, 101 AND 107). SN 78-432,733. PUB. 6-28-2005. FILED 6-9-2004.
- 2,997,592. **DR. LESLIE (BLOCK FORM)**. VAN ROMER, LESLIE, (U.S. CLS. 100, 101 AND 107). SN 78-434,639. PUB. 6-28-2005. FILED 6-14-2004.
- 2,997,595. **AMERICAN ASSOCIATION OF MEDICAL HYPNOTHERAPISTS AND DESIGN**. THESSALONIA, DEPRINCE, (U.S. CLS. 100, 101 AND 107). SN 78-435,053. PUB. 6-28-2005. FILED 6-14-2004.
- 2,997,600 (*See Class 16 for this trademark*).
- 2,997,608. **STARZ! TICKET AND DESIGN**. STARZ ENTERTAINMENT GROUP LLC, (U.S. CLS. 100, 101 AND 107). SN 78-436,449. PUB. 6-28-2005. FILED 6-16-2004.
- 2,997,610. **STARZ! TICKET (BLOCK FORM)**. STARZ ENTERTAINMENT GROUP LLC, (U.S. CLS. 100, 101 AND 107). SN 78-436,574. PUB. 6-28-2005. FILED 6-16-2004.
- 2,997,613. **NMMA B.O.A.T. BOATING ONLINE ADVOCATING TOOL AND DESIGN**. NATIONAL MARINE MANUFACTURERS ASSOCIATION, INC., (U.S. CLS. 100, 101 AND 107). SN 78-436,855. PUB. 6-28-2005. FILED 6-17-2004.

- 2,997,618. **DON K. REED'S DOO WOPP SHOP (BLOCK FORM)**. REED, DONALD K., SR., (U.S. CLS. 100, 101 AND 107). SN 78-437,648. PUB. 6-28-2005. FILED 6-18-2004.
- 2,997,621. **GTAC (BLOCK FORM)**. ALABAMA SPACE SCIENCE EXHIBIT COMMISSION, (U.S. CLS. 100, 101 AND 107). SN 78-437,900. PUB. 6-28-2005. FILED 6-18-2004.
- 2,997,641. **OFFICE BUILDINGS (BLOCK FORM)**. YALE ROBBINS INC., (U.S. CLS. 100, 101 AND 107). SN 78-440,563. PUB. 6-28-2005. FILED 6-24-2004.
- 2,997,643. **DJ RAGMAN (BLOCK FORM)**. RAGLAND, CARY, (U.S. CLS. 100, 101 AND 107). SN 78-440,876. PUB. 6-28-2005. FILED 6-24-2004.
- 2,997,650. **DEATH FROM ABOVE (BLOCK FORM)**. DFA, LLC, (U.S. CLS. 100, 101 AND 107). SN 78-441,652. PUB. 6-28-2005. FILED 6-25-2004.
- 2,997,655 (*See Class 16 for this trademark*).
- 2,997,657. **MISS ASIAN GLOBAL (BLOCK FORM)**. MISS ASIAN PAGEANT, (U.S. CLS. 100, 101 AND 107). SN 78-442,734. PUB. 6-28-2005. FILED 6-29-2004.
- 2,997,660. **JILL (BLOCK FORM)**. JEFFERSON INSTITUTE FOR LIFELONG LEARNING, (U.S. CLS. 100, 101 AND 107). SN 78-442,977. PUB. 6-28-2005. FILED 6-29-2004.
- 2,997,662. **REALITY REVUE (BLOCK FORM)**. QUILL, JAMES, (U.S. CLS. 100, 101 AND 107). SN 78-443,275. PUB. 6-28-2005. FILED 6-29-2004.
- 2,997,664. **TRAININGPASS AND DESIGN**. TRAININGPASS SALES CORP., (U.S. CLS. 100, 101 AND 107). SN 78-443,379. PUB. 6-28-2005. FILED 6-29-2004.
- 2,997,668. **I B C E INTERNATIONAL BOARD OF CHIROPRACTIC EXAMINERS AND DESIGN**. NATIONAL BOARD OF CHIROPRACTIC EXAMINERS, (U.S. CLS. 100, 101 AND 107). SN 78-443,648. PUB. 6-28-2005. FILED 6-30-2004.
- 2,997,669. **AFROLEZ PRODUCTIONS (BLOCK FORM)**. SIMMONS, AISHAH SHAHIDAH, (U.S. CLS. 100, 101 AND 107). SN 78-443,703. PUB. 6-28-2005. FILED 6-30-2004.
- 2,997,676. **JIMI HENDRIX (BLOCK FORM)**. EXPERIENCE HENDRIX, L.L.C., (U.S. CLS. 100, 101 AND 107). SN 78-444,381. PUB. 6-28-2005. FILED 7-1-2004.
- 2,997,680 (*See Class 25 for this trademark*).
- 2,997,688 (*See Class 25 for this trademark*).
- 2,997,689 (*See Class 25 for this trademark*).
- 2,997,695 (*See Class 35 for this trademark*).
- 2,997,697. **ISFCE (BLOCK FORM)**. ISFCE CORP., (U.S. CLS. 100, 101 AND 107). SN 78-446,098. PUB. 6-28-2005. FILED 7-6-2004.
- 2,997,714. **MISCELLANEOUS DESIGN**. VTH SEASON, (U.S. CLS. 100, 101 AND 107). SN 78-447,905. PUB. 6-28-2005. FILED 7-8-2004.
- 2,997,722. **FREESCALE MARATHON (BLOCK FORM)**. FREESCALE SEMICONDUCTOR, INC., (U.S. CLS. 100, 101 AND 107). SN 78-448,354. PUB. 6-28-2005. FILED 7-9-2004.
- 2,997,726. **YOU 24 (STYLIZED)**. 24 HOUR FITNESS USA, INC., (U.S. CLS. 100, 101 AND 107). SN 78-448,784. PUB. 6-28-2005. FILED 7-9-2004.
- 2,997,727. **HYPER HARP (BLOCK FORM)**. GROSSBERG, JEFFREY, A., (U.S. CLS. 100, 101 AND 107). SN 78-448,960. PUB. 6-28-2005. FILED 7-12-2004.
- 2,997,736. **THE BEACH TOYS (BLOCK FORM)**. MOYNAHAN, MICHAEL B., (U.S. CLS. 100, 101 AND 107). SN 78-449,915. PUB. 6-28-2005. FILED 7-13-2004.
- 2,997,737. **TONUS RESTORATION TECHNIQUE (BLOCK FORM)**. SAMUELS, ROCHELLE, (U.S. CLS. 100, 101 AND 107). SN 78-449,934. PUB. 6-28-2005. FILED 7-13-2004.
- 2,997,741. **PROJECT STRATEGIX (BLOCK FORM)**. PROJECT STRATEGIX, LLC, (U.S. CLS. 100, 101 AND 107). SN 78-450,439. PUB. 6-28-2005. FILED 7-14-2004.
- 2,997,748. **MISCELLANEOUS DESIGN**. PACIFIC INSTITUTE FOR COMMUNITY ORGANIZATIONS, (U.S. CLS. 100, 101 AND 107). SN 78-451,045. PUB. 6-28-2005. FILED 7-15-2004.
- 2,997,756. **INSPIRING YOUR CREATIVE EVOLUTION (BLOCK FORM)**. ROB GOLDMAN, INC., (U.S. CLS. 100, 101 AND 107). SN 78-451,431. PUB. 6-28-2005. FILED 7-15-2004.
- 2,997,757 (*See Class 35 for this trademark*).
- 2,997,762. **WORLD WOODS GOLF CLUB AND DESIGN**. WORLD WOODS CORPORATION, (U.S. CLS. 100, 101 AND 107). SN 78-452,166. PUB. 6-28-2005. FILED 7-16-2004.
- 2,997,775. **START TO FINISH FITNESS (BLOCK FORM)**. START TO FINISH FITNESS, LLC, MULTIPLE CLASS, (INT. CLS. 41 AND 44), (U.S. CLS. 100, 101 AND 107). SN 78-453,123. PUB. 6-28-2005. FILED 7-20-2004.
- 2,997,785. **CORPORATE ROCK STARS (BLOCK FORM)**. GROOVE LABS LLC, (U.S. CLS. 100, 101 AND 107). SN 78-453,605. PUB. 6-28-2005. FILED 7-20-2004.
- 2,997,846 (*See Class 9 for this trademark*).
- 2,997,872. **NEW ENGLAND OYSTER FESTIVAL AND DESIGN**. AMERICAN MUSSEL HARVESTERS, INC., (U.S. CLS. 100, 101 AND 107). SN 78-457,066. PUB. 6-28-2005. FILED 7-27-2004.
- 2,997,890. **PEACE RIOT (BLOCK FORM)**. CHILI RECORDS, INC., (U.S. CLS. 100, 101 AND 107). SN 78-457,295. PUB. 6-28-2005. FILED 7-27-2004.
- 2,997,891. **PROJECT BOOMERANG (BLOCK FORM)**. CYPRESS COVE AT HEALTHPARK FLORIDA, INC, (U.S. CLS. 100, 101 AND 107). SN 78-457,325. PUB. 6-28-2005. FILED 7-27-2004.
- 2,997,907 (*See Class 25 for this trademark*).
- 2,997,908 (*See Class 25 for this trademark*).
- 2,997,909 (*See Class 25 for this trademark*).
- 2,997,910 (*See Class 9 for this trademark*).
- 2,997,927. **MIDWESTRACK (BLOCK FORM)**. LAW BULLETIN PUBLISHING COMPANY, (U.S. CLS. 100, 101 AND 107). SN 78-458,148. PUB. 6-28-2005. FILED 7-28-2004.
- 2,997,941. **CTO (STYLIZED)**. WORLD ENTERTAINMENT, INC., (U.S. CLS. 100, 101 AND 107). SN 78-458,548. PUB. 6-28-2005. FILED 7-29-2004.
- 2,997,947 (*See Class 35 for this trademark*).
- 2,997,954. **SWORDS AND ROSES (BLOCK FORM)**. ROMINEKANTOR, MARIA B., (U.S. CLS. 100, 101 AND 107). SN 78-458,751. PUB. 6-28-2005. FILED 7-29-2004.
- 2,997,974. **THE RHYTHM SHOP (BLOCK FORM)**. SILVER, DAVID, (U.S. CLS. 100, 101 AND 107). SN 78-459,162. PUB. 6-28-2005. FILED 7-29-2004.
- 2,997,975. **WIDE EYE PRODUCTIONS (BLOCK FORM)**. WIDE EYE PRODUCTIONS, (U.S. CLS. 100, 101 AND 107). SN 78-459,179. PUB. 6-28-2005. FILED 7-29-2004.
- 2,997,979. **BILLIONAIRE BOYS CLUB (BLOCK FORM)**. NELSON, LEIGH, AND LEWIS, MATTHEW, AND SANDERLIN, MARK, AND FANOUS, SHERIF, (U.S. CLS. 100, 101 AND 107). SN 78-459,221. PUB. 6-28-2005. FILED 7-29-2004.
- 2,997,990. **SABAH (BLOCK FORM)**. SKATING ASSOCIATION FOR THE BLIND AND HANDICAPPED, INC., (U.S. CLS. 100, 101 AND 107). SN 78-459,428. PUB. 6-28-2005. FILED 7-30-2004.
- 2,997,994. **IT'S A GIMME! (STYLIZED)**. FUNDAMENTAL VALUES, LLC, (U.S. CLS. 100, 101 AND 107). SN 78-459,460. PUB. 6-28-2005. FILED 7-30-2004.
- 2,998,011. **JUSTICE LEAGUE (BLOCK FORM)**. DC COMICS, (U.S. CLS. 100, 101 AND 107). SN 78-459,657. PUB. 6-28-2005. FILED 7-30-2004.
- 2,998,025. **AN EVENING OF ESTROGEN (BLOCK FORM)**. SHARGAA, JILL R., (U.S. CLS. 100, 101 AND 107). SN 78-460,014. PUB. 6-28-2005. FILED 7-31-2004.
- 2,998,029. **SELF DYNAMICS (BLOCK FORM)**. CHATMAN, PATRICIA RENEE, (U.S. CLS. 100, 101 AND 107). SN 78-460,115. PUB. 6-28-2005. FILED 8-1-2004.
- 2,998,031. **TEHCURB (STYLIZED)**. TEHCURB LLC, (U.S. CLS. 100, 101 AND 107). SN 78-460,134. PUB. 6-28-2005. FILED 8-1-2004.
- 2,998,046. **HAWAIIAN MOVING COMPANY (BLOCK FORM)**. EMMIS TELEVISION BROADCASTING, L.P., (U.S. CLS. 100, 101 AND 107). SN 78-460,292. PUB. 6-28-2005. FILED 8-2-2004.
- 2,998,058. **JIMIHENDRIX.COM (STYLIZED)**. EXPERIENCE HENDRIX, L.L.C., (U.S. CLS. 100, 101 AND 107). SN 78-460,385. PUB. 6-28-2005. FILED 8-2-2004.
- 2,998,059. **JIMIHENDRIX.COM (BLOCK FORM)**. EXPERIENCE HENDRIX, L.L.C., (U.S. CLS. 100, 101 AND 107). SN 78-460,387. PUB. 6-28-2005. FILED 8-2-2004.
- 2,998,076. **ROTATIONS (BLOCK FORM)**. UNITED STATES VOLLEYBALL ASSOCIATION, (U.S. CLS. 100, 101 AND 107). SN 78-460,759. PUB. 6-28-2005. FILED 8-2-2004.
- 2,998,077. **ROTATIONS AND DESIGN**. UNITED STATES VOLLEYBALL ASSOCIATION, (U.S. CLS. 100, 101 AND

- 107). SN 78-460,761. PUB. 6-28-2005. FILED 8-2-2004.
- 2,998,081. **ELYSE (BLOCK FORM)**. KEENAN, ELYSE, M., (U.S. CLS. 100, 101 AND 107). SN 78-460,905. PUB. 6-28-2005. FILED 8-3-2004.
- 2,998,085. **BIG DEALS (BLOCK FORM)**. COURTROOM TELEVISION NETWORK LLC, (U.S. CLS. 100, 101 AND 107). SN 78-460,940. PUB. 6-28-2005. FILED 8-3-2004.
- 2,998,089. **I'D DO ANYTHING (BLOCK FORM)**. TRANS WORLD INTERNATIONAL, INC., (U.S. CLS. 100, 101 AND 107). SN 78-460,972. PUB. 6-28-2005. FILED 8-3-2004.
- 2,998,095. **RETIRE SOUTH (BLOCK FORM)**. OWENS, CHARLES DANIEL, (U.S. CLS. 100, 101 AND 107). SN 78-461,066. PUB. 6-28-2005. FILED 8-3-2004.
- 2,998,112. **WISE WOMEN AND WEALTH (BLOCK FORM)**. MOSER, MARY FAITH, (U.S. CLS. 100, 101 AND 107). SN 78-461,285. PUB. 6-28-2005. FILED 8-3-2004.
- 2,998,122. **DANGER BOY (BLOCK FORM)**. WILLIAMS, MARK LONDON, (U.S. CLS. 100, 101 AND 107). SN 78-461,418. PUB. 6-28-2005. FILED 8-3-2004.
- 2,998,124 (*See Class 39 for this trademark*).
- 2,998,126 (*See Class 16 for this trademark*).
- 2,998,145. **BUILDING CHAMPIONS...ONE AT A TIME (BLOCK FORM)**. HARITOS, SERGIO, (U.S. CLS. 100, 101 AND 107). SN 78-461,903. PUB. 6-28-2005. FILED 8-4-2004.
- 2,998,167. **KINSHIP AND DESIGN**. KINSHIP, INC., (U.S. CLS. 100, 101 AND 107). SN 78-462,380. PUB. 6-28-2005. FILED 8-5-2004.
- 2,998,168. **KINSHIP (BLOCK FORM)**. KINSHIP, INC., (U.S. CLS. 100, 101 AND 107). SN 78-462,384. PUB. 6-28-2005. FILED 8-5-2004.
- 2,998,207. **FOODSTOCK (BLOCK FORM)**. LETTUCE ENTERTAIN YOU ENTERPRISES, INC., (U.S. CLS. 100, 101 AND 107). SN 78-464,160. PUB. 6-28-2005. FILED 8-9-2004.
- 2,998,235. **MISCELLANEOUS DESIGN**. OTSEGO SKI CLUB - HIDDEN VALLEY, INC., (U.S. CLS. 100, 101 AND 107). SN 78-465,054. PUB. 6-28-2005. FILED 8-10-2004.
- 2,998,241. **PLANETWIDE GAMES (BLOCK FORM)**. PLANETWIDE GAMES, INC., (U.S. CLS. 100, 101 AND 107). SN 78-465,353. PUB. 6-28-2005. FILED 8-10-2004.
- 2,998,243. **PET SHENANIGANS (BLOCK FORM)**. BUSCH ENTERTAINMENT CORPORATION, (U.S. CLS. 100, 101 AND 107). SN 78-465,453. PUB. 6-28-2005. FILED 8-11-2004.
- 2,998,251. **RECHARGER (BLOCK FORM)**. 101COMMUNICATIONS LLC, (U.S. CLS. 100, 101 AND 107). SN 78-465,919. PUB. 6-28-2005. FILED 8-11-2004.
- 2,998,294. **SOCIETY OF THE CROWN (BLOCK FORM)**. DIAGEO NORTH AMERICA, INC., (U.S. CLS. 100, 101 AND 107). SN 78-469,736. PUB. 6-28-2005. FILED 8-18-2004.
- 2,998,300. **THE VOICE OF ST. LOUIS (BLOCK FORM)**. INFINITY BROADCASTING CORPORATION, (U.S. CLS. 100, 101 AND 107). SN 78-470,853. PUB. 6-28-2005. FILED 8-20-2004.
- 2,998,304. **NSREC (BLOCK FORM)**. THE INSTITUTE OF ELECTRICAL AND ELECTRONICS ENGINEERS, INC., (U.S. CLS. 100, 101 AND 107). SN 78-472,777. PUB. 6-28-2005. FILED 8-24-2004.
- 2,998,307 (*See Class 25 for this trademark*).
- 2,998,308 (*See Class 25 for this trademark*).
- 2,998,309 (*See Class 25 for this trademark*).
- 2,998,310 (*See Class 25 for this trademark*).
- 2,998,311 (*See Class 25 for this trademark*).
- 2,998,312 (*See Class 25 for this trademark*).
- 2,998,313 (*See Class 25 for this trademark*).
- 2,998,314 (*See Class 25 for this trademark*).
- 2,998,315 (*See Class 25 for this trademark*).
- 2,998,316 (*See Class 25 for this trademark*).
- 2,998,317 (*See Class 25 for this trademark*).
- 2,998,318 (*See Class 25 for this trademark*).
- 2,998,323 (*See Class 25 for this trademark*).
- 2,998,324 (*See Class 25 for this trademark*).
- 2,998,325 (*See Class 25 for this trademark*).
- 2,998,333. **BET: BLUEPRINT (BLOCK FORM)**. BLACK ENTERTAINMENT TELEVISION, INC., (U.S. CLS. 100, 101 AND 107). SN 78-528,249. PUB. 6-28-2005. FILED 12-7-2004.
- 2,998,340. **YARROW BAY (BLOCK FORM)**. GUSTAFSON, TIMI (IRIS), (U.S. CLS. 100, 101 AND 107). SN 78-548,260. PUB. 6-28-2005. FILED 1-15-2005.
- 2,998,386 (*See Class 3 for this trademark*).
- 2,998,427 (*See Class 16 for this trademark*).
- 2,998,435 (*See Class 35 for this trademark*).
- 2,998,451 (*See Class 3 for this trademark*).
- 2,998,455 (*See Class 25 for this trademark*).
- 2,998,476 (*See Class 3 for this trademark*).
- 2,998,500 (*See Class 9 for this trademark*).

CLASS 42—SCIENTIFIC, COMPUTER AND LEGAL SERVICES

- 2,996,234. **SHORE PEDIATRICS AND DESIGN**. SHORE HEALTH SYSTEM, INC., (U.S. CLS. 100 AND 101). SN 75-504,273. PUB. 6-28-2005. FILED 6-18-1998.
- 2,996,239. **JONES STUDIO**. JONES STUDIO LIMITED, (U.S. CLS. 100 AND 101). SN 75-730,580. PUB. 6-28-2005. FILED 7-15-1999.
- 2,996,244 (*See Class 9 for this trademark*).
- 2,996,245 (*See Class 16 for this trademark*).
- 2,996,248 (*See Class 38 for this trademark*).
- 2,996,256 (*See Class 39 for this trademark*).
- 2,996,258 (*See Class 9 for this trademark*).
- 2,996,260. **RELATIONSTRIPS**. THE LIFESKILLS COMPANY, (U.S. CLS. 100 AND 101). SN 76-241,759. PUB. 6-28-2005. FILED 4-16-2001.
- 2,996,271 (*See Class 9 for this trademark*).
- 2,996,275. **BLUE STAR**. BLUE STAR LIMITED, (U.S. CLS. 100 AND 101). SN 76-360,806. PUB. 6-28-2005. FILED 1-7-2002.
- 2,996,276. **BLUE STAR AND DESIGN**. BLUE STAR LIMITED, (U.S. CLS. 100 AND 101). SN 76-360,807. PUB. 6-28-2005. FILED 1-7-2002.
- 2,996,277 (*See Class 1 for this trademark*).
- 2,996,280 (*See Class 35 for this trademark*).
- 2,996,284 (*See Class 9 for this trademark*).
- 2,996,285 (*See Class 9 for this trademark*).
- 2,996,290 (*See Class 1 for this trademark*).
- 2,996,296 (*See Class 36 for this trademark*).
- 2,996,301 (*See Class 9 for this trademark*).
- 2,996,314 (*See Class 9 for this trademark*).
- 2,996,322 (*See Class 16 for this trademark*).
- 2,996,328 (*See Class 9 for this trademark*).
- 2,996,330. **RAM**. RAM SYSTEMS, INC., (U.S. CLS. 100 AND 101). SN 76-484,313. PUB. 6-28-2005. FILED 1-23-2003.
- 2,996,338 (*See Class 10 for this trademark*).
- 2,996,343. **CONSOL AND DESIGN**. SCHWANENGEL, ULRICH, (U.S. CLS. 100 AND 101). SN 76-496,290. PUB. 10-21-2003. FILED 3-10-2003.
- 2,996,347. **COREMATRIX AND DESIGN**. COREMATRIX SYSTEMS LLC, (U.S. CLS. 100 AND 101). SN 76-500,396. PUB. 6-28-2005. FILED 3-14-2003.
- 2,996,375. **COGENIX AND DESIGN**. JAM DEVELOPERS INC, (U.S. CLS. 100 AND 101). SN 76-523,564. PUB. 6-28-2005. FILED 6-2-2003.
- 2,996,377. **CANNONDESIGN (STYLIZED)**. THE CANNON CORPORATION, (U.S. CLS. 100 AND 101). SN 76-524,307. PUB. 6-28-2005. FILED 6-13-2003.
- 2,996,391 (*See Class 16 for this trademark*).
- 2,996,397 (*See Class 9 for this trademark*).
- 2,996,407 (*See Class 9 for this trademark*).
- 2,996,408. **SOFTIZM AND DESIGN**. KESZI, JULIUS E, (U.S. CLS. 100 AND 101). SN 76-536,637. PUB. 6-28-2005. FILED 8-11-2003.
- 2,996,427. **BLAST (STYLIZED)**. BOATSTOCK.COM, LLC, (U.S. CLS. 100 AND 101). SN 76-543,111. PUB. 6-28-2005. FILED 8-25-2003.
- 2,996,428 (*See Class 9 for this trademark*).
- 2,996,437. **ORGANIZATIONAL MENTORING**. KEVIN KENNEDY AND ASSOCIATES, (U.S. CLS. 100 AND 101). SN 76-545,295. PUB. 6-28-2005. FILED 9-8-2003.
- 2,996,456. **WEBMEDX**. WEBMEDX, INC., (U.S. CLS. 100 AND 101). SN 76-556,975. PUB. 5-3-2005. FILED 10-22-2003.
- 2,996,478 (*See Class 35 for this trademark*).
- 2,996,482 (*See Class 37 for this trademark*).
- 2,996,491. **MISCELLANEOUS DESIGN**. DOVETAIL BUSINESS SOLUTIONS, INC., (U.S. CLS. 100 AND 101). SN 76-567,965. PUB. 6-28-2005. FILED 1-2-2004.
- 2,996,506. **FIERCEBIOTECH (STYLIZED)**. FIERCEMAR-

- KETS, INC., (U.S. CLS. 100 AND 101), SN 76-569,497. PUB. 6-28-2005. FILED 1-12-2004.
- 2,996,546 (*See Class 16 for this trademark.*).
- 2,996,553. **SMITH ANDERSON AND DESIGN.** SMITH, ANDERSON, BLOUNT, DORSETT, MITCHELL & JERNIGAN, L.L.P., (U.S. CLS. 100 AND 101). SN 76-572,325. PUB. 6-28-2005. FILED 1-26-2004.
- 2,996,554. **MISCELLANEOUS DESIGN.** SMITH, ANDERSON, BLOUNT, DORSETT, MITCHELL & JERNIGAN, L.L.P., (U.S. CLS. 100 AND 101). SN 76-572,326. PUB. 6-28-2005. FILED 1-26-2004.
- 2,996,559. **CDFS (STYLIZED).** CARTER, DELUCA, FARRELL & SCHMIDT, LLP, (U.S. CLS. 100 AND 101). SN 76-572,482. PUB. 6-28-2005. FILED 1-26-2004.
- 2,996,560. **CARTER, DELUCA, FARRELL & SCHMIDT (BLOCK FORM).** CARTER, DELUCA, FARRELL & SCHMIDT, LLP, (U.S. CLS. 100 AND 101). SN 76-572,483. PUB. 6-28-2005. FILED 1-26-2004.
- 2,996,561. **CDFS (STYLIZED).** CARTER, DELUCA, FARRELL & SCHMIDT, LLP, (U.S. CLS. 100 AND 101). SN 76-572,484. PUB. 6-28-2005. FILED 1-26-2004.
- 2,996,583. **WATER CONFIDENCE (BLOCK FORM).** TROJAN TECHNOLOGIES INC., (U.S. CLS. 100 AND 101). SN 76-575,125. PUB. 6-28-2005. FILED 2-11-2004.
- 2,996,596 (*See Class 35 for this trademark.*).
- 2,996,600. **CORPORATE ALERT (BLOCK FORM).** THOMAS SCIENTIFIC INC., (U.S. CLS. 100 AND 101). SN 76-576,309. PUB. 6-28-2005. FILED 2-19-2004.
- 2,996,607. **HAUPTMAN, O'BRIEN, WOLF & LATHROP, P.C. AND DESIGN.** HAUPTMAN, O'BRIEN, WOLF & LATHROP, P.C., (U.S. CLS. 100 AND 101). SN 76-577,392. PUB. 6-28-2005. FILED 2-9-2004.
- 2,996,608. **MISCELLANEOUS DESIGN.** HAUPTMAN, O'BRIEN, WOLF & LATHROP, P.C., (U.S. CLS. 100 AND 101). SN 76-577,393. PUB. 6-28-2005. FILED 2-9-2004.
- 2,996,621. **OMNICALENDAR (BLOCK FORM).** CARAWORKS, INC., (U.S. CLS. 100 AND 101). SN 76-579,016. PUB. 6-28-2005. FILED 3-2-2004.
- 2,996,622 (*See Class 37 for this trademark.*).
- 2,996,638. **YOUR FLORIDA CONNECTION AND DESIGN.** LEESFIELD, LEIGHTON, RUBIO, MAHFOOD & BOYERS, P.A., (U.S. CLS. 100 AND 101). SN 76-582,562. PUB. 6-28-2005. FILED 3-19-2004.
- 2,996,703. **SRD AND DESIGN.** INTERNATIONAL BUSINESS MACHINES CORPORATION, AKA IBM CORPORATION, (U.S. CLS. 100 AND 101). SN 76-595,684. PUB. 6-28-2005. FILED 6-4-2004.
- 2,996,744. **GENOME EXPLORER (BLOCK FORM).** GENOME INTERNATIONAL CORPORATION, (U.S. CLS. 100 AND 101). SN 76-599,737. PUB. 6-28-2005. FILED 6-29-2004.
- 2,996,799. **UNITE-IT PARTNERS NETWORK, L.L.C. (BLOCK FORM).** UNITE-IT PARTNERS NETWORK, L.L.C., (U.S. CLS. 100 AND 101). SN 76-604,638. PUB. 6-28-2005. FILED 7-29-2004.
- 2,996,820. **VFA.FACILITY (BLOCK FORM).** VANDERWEIL FACILITY ADVISORS, INC., (U.S. CLS. 100 AND 101). SN 76-605,073. PUB. 6-28-2005. FILED 7-30-2004.
- 2,996,863 (*See Class 37 for this trademark.*).
- 2,996,880. **GRANGE AGENTWARE EXPRESS (BLOCK FORM).** GRANGE MUTUAL CASUALTY COMPANY, (U.S. CLS. 100 AND 101). SN 76-627,110. PUB. 6-28-2005. FILED 1-7-2005.
- 2,996,881. **GRANGE AGENTWARE (BLOCK FORM).** GRANGE MUTUAL CASUALTY COMPANY, (U.S. CLS. 100 AND 101). SN 76-627,111. PUB. 6-28-2005. FILED 1-7-2005.
- 2,996,882. **GRANGE AGENTWARE YOUR SOURCE FOR REAL SOLUTIONS (BLOCK FORM).** GRANGE MUTUAL CASUALTY COMPANY, (U.S. CLS. 100 AND 101). SN 76-627,131. PUB. 6-28-2005. FILED 1-7-2005.
- 2,996,885 (*See Class 1 for this trademark.*).
- 2,996,887 (*See Class 5 for this trademark.*).
- 2,996,891 (*See Class 9 for this trademark.*).
- 2,996,893. **XCELERON.** XCELERON LIMITED, MULTIPLE CLASS, (INT. CLS. 42 AND 44), (U.S. CLS. 100 AND 101). SN 78-110,448. PUB. 6-28-2005. FILED 2-22-2002.
- 2,996,910 (*See Class 35 for this trademark.*).
- 2,996,923 (*See Class 9 for this trademark.*).
- 2,996,933 (*See Class 35 for this trademark.*).
- 2,996,946. **CYBERZONE THE INTERNET AT WORK & PLAY (STYLIZED).** CYBERZONE INTERACTIVE ENTERTAINMENT INC., (U.S. CLS. 100 AND 101). SN 78-245,392. PUB. 6-28-2005. FILED 5-3-2003.
- 2,996,951. **AFFINITY ACCESS.** BERTHOLON-ROWLAND, INC., DBA USI COLBURN INSURANCE SERVICE, (U.S. CLS. 100 AND 101). SN 78-254,401. PUB. 6-28-2005. FILED 5-27-2003.
- 2,996,954 (*See Class 9 for this trademark.*).
- 2,996,970 (*See Class 9 for this trademark.*).
- 2,996,985 (*See Class 35 for this trademark.*).
- 2,996,987 (*See Class 35 for this trademark.*).
- 2,996,998 (*See Class 35 for this trademark.*).
- 2,997,023 (*See Class 16 for this trademark.*).
- 2,997,028 (*See Class 35 for this trademark.*).
- 2,997,033. **LASERSOFT IMAGING AND DESIGN.** LASERSOFT IMAGING USA, (U.S. CLS. 100 AND 101). SN 78-317,074. PUB. 6-28-2005. FILED 10-22-2003.
- 2,997,042. **CHICAGO AND DESIGN.** TAKEDA PHARMACEUTICALS NORTH AMERICA, INC., (U.S. CLS. 100 AND 101). SN 78-324,342. PUB. 6-28-2005. FILED 11-6-2003.
- 2,997,043 (*See Class 16 for this trademark.*).
- 2,997,048 (*See Class 35 for this trademark.*).
- 2,997,071 (*See Class 38 for this trademark.*).
- 2,997,077. **PRACTICING THE LAWS OF SCIENCE (BLOCK FORM).** GRAYBEAL JACKSON HALEY LLP, (U.S. CLS. 100 AND 101). SN 78-338,076. PUB. 6-28-2005. FILED 12-8-2003.
- 2,997,094. **ANGELSPEECH (BLOCK FORM).** TANG, YI, (U.S. CLS. 100 AND 101). SN 78-342,786. PUB. 6-28-2005. FILED 12-18-2003.
- 2,997,140 (*See Class 35 for this trademark.*).
- 2,997,144 (*See Class 9 for this trademark.*).
- 2,997,151 (*See Class 37 for this trademark.*).
- 2,997,177. **FARM RX AND DESIGN.** FARMRX, LLC, (U.S. CLS. 100 AND 101). SN 78-359,627. PUB. 6-28-2005. FILED 1-29-2004.
- 2,997,188. **N! NOTORIOUS INK AND DESIGN.** FARRELL, JENNIFER, (U.S. CLS. 100 AND 101). SN 78-360,378. PUB. 6-28-2005. FILED 1-30-2004.
- 2,997,191. **DITEC (BLOCK FORM).** FIND MY SPECIALIST, INC., (U.S. CLS. 100 AND 101). SN 78-360,801. PUB. 6-28-2005. FILED 2-2-2004.
- 2,997,202 (*See Class 35 for this trademark.*).
- 2,997,208. **VBRIEF (BLOCK FORM).** AVISTAR COMMUNICATIONS CORPORATION, (U.S. CLS. 100 AND 101). SN 78-362,417. PUB. 6-28-2005. FILED 2-4-2004.
- 2,997,219. **CHRIS MADDEN (BLOCK FORM).** CHRIS MADDEN INC., (U.S. CLS. 100 AND 101). SN 78-363,603. PUB. 6-28-2005. FILED 2-6-2004.
- 2,997,224 (*See Class 16 for this trademark.*).
- 2,997,226. **REMOTE ACCESS TECHNOLOGY AND DESIGN.** REMOTE ACCESS TECHNOLOGY, (U.S. CLS. 100 AND 101). SN 78-365,015. PUB. 6-28-2005. FILED 2-9-2004.
- 2,997,228. **MORE LEADS. MORE CONTROL. MORE RESULTS. (BLOCK FORM).** REYNOLDS AND REYNOLDS HOLDINGS, INC., (U.S. CLS. 100 AND 101). SN 78-365,094. PUB. 6-28-2005. FILED 2-9-2004.
- 2,997,261. **DONALD A. GARDNER, INC. ARCHITECTS PLANNERS (BLOCK FORM).** DONALD A. GARDNER, INC., (U.S. CLS. 100 AND 101). SN 78-368,982. PUB. 6-28-2005. FILED 2-17-2004.
- 2,997,267 (*See Class 38 for this trademark.*).
- 2,997,281 (*See Class 37 for this trademark.*).
- 2,997,288. **CORE COUNSEL (BLOCK FORM).** LEONARD, STREET AND DEINARD PROFESSIONAL ASSOCIATION, (U.S. CLS. 100 AND 101). SN 78-373,491. PUB. 6-28-2005. FILED 2-24-2004.
- 2,997,291. **IMPERVA (BLOCK FORM).** IMPERVA, INC., (U.S. CLS. 100 AND 101). SN 78-373,914. PUB. 6-28-2005. FILED 2-25-2004.
- 2,997,297 (*See Class 37 for this trademark.*).
- 2,997,298 (*See Class 35 for this trademark.*).
- 2,997,304. **DESIGN FORCE (BLOCK FORM).** DESIGN FORCE, INC., (U.S. CLS. 100 AND 101). SN 78-376,315. PUB. 6-28-2005. FILED 3-1-2004.
- 2,997,309 (*See Class 35 for this trademark.*).

- 2,997,323. **PANDEMIC AND DESIGN**. PANDEMIC STUDIOS, LLC, (U.S. CLS. 100 AND 101). SN 78-379,338. PUB. 6-28-2005. FILED 3-5-2004.
- 2,997,329. **3IS AND DESIGN**. 3IS, INC., (U.S. CLS. 100 AND 101). SN 78-379,820. PUB. 6-28-2005. FILED 3-6-2004.
- 2,997,331. **IF TECHNOLOGY DOESN'T WORK FOR PEOPLE, IT DOESN'T WORK (BLOCK FORM)**. USER CENTRIC, INC., (U.S. CLS. 100 AND 101). SN 78-380,228. PUB. 6-28-2005. FILED 3-8-2004.
- 2,997,343 (*See Class 9 for this trademark*).
- 2,997,361. **RF SAVVY AND DESIGN**. SMITH, NORMAN, JAMES, (U.S. CLS. 100 AND 101). SN 78-387,929. PUB. 6-28-2005. FILED 3-20-2004.
- 2,997,380 (*See Class 9 for this trademark*).
- 2,997,387 (*See Class 35 for this trademark*).
- 2,997,402 (*See Class 9 for this trademark*).
- 2,997,419. **ALERTED (BLOCK FORM)**. JANCU, ROBERT, AND MCCONVILLE, DAN, (U.S. CLS. 100 AND 101). SN 78-399,067. PUB. 6-28-2005. FILED 4-8-2004.
- 2,997,435 (*See Class 35 for this trademark*).
- 2,997,437 (*See Class 35 for this trademark*).
- 2,997,478 (*See Class 36 for this trademark*).
- 2,997,490. **MISCELLANEOUS DESIGN**. DEUTSCHE TELEKOM AG, (U.S. CLS. 100 AND 101). SN 78-412,383. PUB. 6-28-2005. FILED 5-3-2004.
- 2,997,507 (*See Class 35 for this trademark*).
- 2,997,537. **TRANSSYNC (BLOCK FORM)**. MOTIONPOINT CORPORATION, (U.S. CLS. 100 AND 101). SN 78-422,763. PUB. 6-28-2005. FILED 5-21-2004.
- 2,997,538. **TRANSCOPE (BLOCK FORM)**. MOTIONPOINT CORPORATION, (U.S. CLS. 100 AND 101). SN 78-422,767. PUB. 6-28-2005. FILED 5-21-2004.
- 2,997,556. **TELETECHIE; MAKING TECHNOLOGY WORK AND DESIGN**. INFORMATION TECHNOLOGY GROUP, (U.S. CLS. 100 AND 101). SN 78-427,547. PUB. 6-28-2005. FILED 5-31-2004.
- 2,997,564 (*See Class 35 for this trademark*).
- 2,997,574. **MISCELLANEOUS DESIGN**. IRON MOUNTAIN INCORPORATED, (U.S. CLS. 100 AND 101). SN 78-431,490. PUB. 6-28-2005. FILED 6-8-2004.
- 2,997,577 (*See Class 25 for this trademark*).
- 2,997,587. **INCNOW (BLOCK FORM)**. AGENTS AND CORPORATIONS, INC., (U.S. CLS. 100 AND 101). SN 78-434,321. PUB. 6-28-2005. FILED 6-12-2004.
- 2,997,602. **BRIGGS BRIGGS AND MORGAN AND DESIGN**. BRIGGS & MORGAN, PROFESSIONAL ASSOCIATION, (U.S. CLS. 100 AND 101). SN 78-436,203. PUB. 6-28-2005. FILED 6-16-2004.
- 2,997,612 (*See Class 37 for this trademark*).
- 2,997,620 (*See Class 35 for this trademark*).
- 2,997,622. **SNAPFILES (BLOCK FORM)**. WEBATTACK INC., (U.S. CLS. 100 AND 101). SN 78-438,443. PUB. 6-28-2005. FILED 6-21-2004.
- 2,997,635 (*See Class 35 for this trademark*).
- 2,997,648. **1031 ACCESS (BLOCK FORM)**. THE 1031 EXCHANGE EXPERTS, LLC, (U.S. CLS. 100 AND 101). SN 78-441,355. PUB. 6-28-2005. FILED 6-25-2004.
- 2,997,672. **JAMES RIVER CONSULTING (BLOCK FORM)**. JAMES RIVER CONSULTING LLC, (U.S. CLS. 100 AND 101). SN 78-444,210. PUB. 6-28-2005. FILED 6-30-2004.
- 2,997,677 (*See Class 16 for this trademark*).
- 2,997,692 (*See Class 37 for this trademark*).
- 2,997,693 (*See Class 37 for this trademark*).
- 2,997,702 (*See Class 39 for this trademark*).
- 2,997,711. **NEAR-SITE (BLOCK FORM)**. ANEXINET, (U.S. CLS. 100 AND 101). SN 78-447,446. PUB. 6-28-2005. FILED 7-8-2004.
- 2,997,712. **EASYBOOKER.COM (BLOCK FORM)**. EASYBOOKER.COM, LLC, (U.S. CLS. 100 AND 101). SN 78-447,501. PUB. 6-28-2005. FILED 7-8-2004.
- 2,997,713. **THE HOST WITH THE MOST (BLOCK FORM)**. HOSTWAY CORPORATION, (U.S. CLS. 100 AND 101). SN 78-447,618. PUB. 6-28-2005. FILED 7-8-2004.
- 2,997,732 (*See Class 9 for this trademark*).
- 2,997,776. **LEADIX (BLOCK FORM)**. CEONEX, INC., (U.S. CLS. 100 AND 101). SN 78-453,224. PUB. 6-28-2005. FILED 7-20-2004.
- 2,997,807. **INFRAOPT (BLOCK FORM)**. AMERICAN INTER-NATIONAL GROUP, INC., (U.S. CLS. 100 AND 101). SN 78-454,991. PUB. 6-28-2005. FILED 7-22-2004.
- 2,997,819 (*See Class 35 for this trademark*).
- 2,997,846 (*See Class 9 for this trademark*).
- 2,997,853. **OCEAN (BLOCK FORM)**. WOLF, JOHN, (U.S. CLS. 100 AND 101). SN 78-456,608. PUB. 6-28-2005. FILED 7-26-2004.
- 2,997,860 (*See Class 40 for this trademark*).
- 2,997,878. **COMPLIANCEPIPELINE (BLOCK FORM)**. CMP MEDIA LLC, (U.S. CLS. 100 AND 101). SN 78-457,130. PUB. 6-28-2005. FILED 7-27-2004.
- 2,997,879. **DESKTOPPIPELINE (BLOCK FORM)**. CMP MEDIA LLC, (U.S. CLS. 100 AND 101). SN 78-457,142. PUB. 6-28-2005. FILED 7-27-2004.
- 2,997,882. **ENVISION SUITE (BLOCK FORM)**. BROOKHOUSE, DAVID, (U.S. CLS. 100 AND 101). SN 78-457,149. PUB. 6-28-2005. FILED 7-27-2004.
- 2,997,896. **ISEBA (BLOCK FORM)**. IPROSPECT.COM, INC., (U.S. CLS. 100 AND 101). SN 78-457,366. PUB. 6-28-2005. FILED 7-27-2004.
- 2,997,899. **BROWN LAW GROUP (BLOCK FORM)**. BROWN, JANICE, (U.S. CLS. 100 AND 101). SN 78-457,376. PUB. 6-28-2005. FILED 7-27-2004.
- 2,997,905 (*See Class 9 for this trademark*).
- 2,998,023 (*See Class 9 for this trademark*).
- 2,998,037. **MEETEXPO (BLOCK FORM)**. MEETEXPO, INC., (U.S. CLS. 100 AND 101). SN 78-460,181. PUB. 6-28-2005. FILED 8-1-2004.
- 2,998,070. **MISCELLANEOUS DESIGN**. RESORTQUEST INTERNATIONAL, INC., (U.S. CLS. 100 AND 101). SN 78-460,557. PUB. 6-28-2005. FILED 8-2-2004.
- 2,998,154 (*See Class 16 for this trademark*).
- 2,998,157. **SMARTRABBIT (BLOCK FORM)**. SON INTEGRATION, INC., (U.S. CLS. 100 AND 101). SN 78-462,106. PUB. 6-28-2005. FILED 8-4-2004.
- 2,998,180. **SERVERPIPELINE (BLOCK FORM)**. CMP MEDIA LLC, (U.S. CLS. 100 AND 101). SN 78-462,875. PUB. 6-28-2005. FILED 8-5-2004.
- 2,998,181. **DEVELOPERPIPELINE (BLOCK FORM)**. CMP MEDIA LLC, (U.S. CLS. 100 AND 101). SN 78-462,884. PUB. 6-28-2005. FILED 8-5-2004.
- 2,998,182. **SMALLBIZPIPELINE (BLOCK FORM)**. CMP MEDIA LLC, (U.S. CLS. 100 AND 101). SN 78-462,905. PUB. 6-28-2005. FILED 8-5-2004.
- 2,998,183. **DATABASEPIPELINE (BLOCK FORM)**. CMP MEDIA LLC, (U.S. CLS. 100 AND 101). SN 78-462,930. PUB. 6-28-2005. FILED 8-5-2004.
- 2,998,184. **ENTERPRISEAPPSPIPELINE (BLOCK FORM)**. CMP MEDIA LLC, (U.S. CLS. 100 AND 101). SN 78-462,938. PUB. 6-28-2005. FILED 8-5-2004.
- 2,998,185. **NETWORKINGPIPELINE (BLOCK FORM)**. CMP MEDIA LLC, (U.S. CLS. 100 AND 101). SN 78-462,962. PUB. 6-28-2005. FILED 8-5-2004.
- 2,998,271 (*See Class 35 for this trademark*).
- 2,998,289. **PANTEK AND DESIGN**. PANTEK, INC., (U.S. CLS. 100 AND 101). SN 78-468,942. PUB. 6-28-2005. FILED 8-17-2004.
- 2,998,298 (*See Class 9 for this trademark*).
- 2,998,330. **CUSTOMFORCE.COM (BLOCK FORM)**. SALESFORCE.COM, INC., (U.S. CLS. 100 AND 101). SN 78-517,743. PUB. 6-28-2005. FILED 11-16-2004.
- 2,998,331 (*See Class 9 for this trademark*).
- 2,998,341 (*See Class 35 for this trademark*).
- 2,998,375. **MISCELLANEOUS DESIGN**. IKEGOSHI AKIHIRO, (U.S. CLS. 100 AND 101). SN 79-000,925. PUB. 6-28-2005. FILED 1-19-2004.
- 2,998,377 (*See Class 9 for this trademark*).
- 2,998,381. **MISCELLANEOUS DESIGN**. IKEGOSHI AKIHIRO, (U.S. CLS. 100 AND 101). SN 79-001,092. PUB. 6-28-2005. FILED 1-19-2004.
- 2,998,395 (*See Class 9 for this trademark*).
- 2,998,436 (*See Class 9 for this trademark*).
- 2,998,443 (*See Class 9 for this trademark*).
- 2,998,447 (*See Class 37 for this trademark*).
- 2,998,451 (*See Class 3 for this trademark*).
- 2,998,476 (*See Class 3 for this trademark*).
- 2,998,492 (*See Class 9 for this trademark*).
- 2,998,497 (*See Class 35 for this trademark*).

CLASS 43—HOTEL AND RESTAURANT SERVICES

- 2,996,243 (*See Class 3 for this trademark*).
- 2,996,278. **A MASTERPIECE**. TRAPPERS TURN, INC., (U.S. CLS. 100 AND 101). SN 76-372,153. PUB. 6-28-2005. FILED 2-19-2002.
- 2,996,309. **SAFE HARBOR ROOM**. MUSICARES FOUNDATION, INC., MULTIPLE CLASS, (INT. CLS. 43 AND 44), (U.S. CLS. 100 AND 101). SN 76-462,087. PUB. 6-28-2005. FILED 10-28-2002.
- 2,996,495. **CANOE BAY (BLOCK FORM)**. GOLF MEDIA, INC., (U.S. CLS. 100 AND 101). SN 76-568,580. PUB. 6-28-2005. FILED 1-7-2004.
- 2,996,502. **MARZONI'S BRICK OVEN & BREWING CO. (STYLIZED)**. HOSS'S ENTERPRISES, INC., (U.S. CLS. 100 AND 101). SN 76-569,083. PUB. 6-28-2005. FILED 1-9-2004.
- 2,996,507. **UGLY OYSTER DRAFFTHAUS (BLOCK FORM)**. O.C. LOCAL, INC., (U.S. CLS. 100 AND 101). SN 76-569,499. PUB. 6-28-2005. FILED 1-12-2004.
- 2,996,509. **LANDMARK BUFFET (BLOCK FORM)**. AMERISTAR CASINOS, INC., (U.S. CLS. 100 AND 101). SN 76-569,505. PUB. 6-28-2005. FILED 12-29-2003.
- 2,996,511. **THE EXPLOREAN KOHUNLICH AND DESIGN**. POSADAS DE MEXICO, S.A. DE C.V., (U.S. CLS. 100 AND 101). SN 76-569,585. PUB. 6-28-2005. FILED 1-8-2004.
- 2,996,515. **GTM (BLOCK FORM)**. GTM PAYROLL SERVICES, INC., (U.S. CLS. 100 AND 101). SN 76-569,878. PUB. 6-28-2005. FILED 1-12-2004.
- 2,996,566 (*See Class 41 for this trademark*).
- 2,996,605. **LIGHTHOUSE SUITES (BLOCK FORM)**. MARTIN RESORTS, INC., (U.S. CLS. 100 AND 101). SN 76-577,210. PUB. 6-28-2005. FILED 2-18-2004.
- 2,996,612. **CAFFE BRASS MONKEY (BLOCK FORM)**. CAFFE BRASS MONKEY, (U.S. CLS. 100 AND 101). SN 76-578,281. PUB. 6-28-2005. FILED 2-27-2004.
- 2,996,686. **RESTFUL PAWS (STYLIZED)**. KORNY, BARBARA, AND KORNY, RAYMOND, (U.S. CLS. 100 AND 101). SN 76-591,790. PUB. 6-28-2005. FILED 5-12-2004.
- 2,996,699 (*See Class 41 for this trademark*).
- 2,996,715. **U AND DESIGN**. UNIDINE CORPORATION, (U.S. CLS. 100 AND 101). SN 76-596,649. PUB. 6-28-2005. FILED 6-10-2004.
- 2,996,770 (*See Class 30 for this trademark*).
- 2,996,778. **BRIO (BLOCK FORM)**. BRAVO DEVELOPMENT, INC., (U.S. CLS. 100 AND 101). SN 76-603,870. PUB. 6-28-2005. FILED 7-23-2004.
- 2,996,779. **HULA SHORES (BLOCK FORM)**. BLUE ISLAND PROPERTY HOLDINGS, LLC, (U.S. CLS. 100 AND 101). SN 76-603,924. PUB. 6-28-2005. FILED 7-26-2004.
- 2,996,827. **CHOO CHOO JOHNNY'S (BLOCK FORM)**. CHOO CHOO JOHNNY'S, INC., (U.S. CLS. 100 AND 101). SN 76-605,132. PUB. 6-28-2005. FILED 8-2-2004.
- 2,996,874. **MISCELLANEOUS DESIGN**. SFC DELI, INC., DBA ZAMBONI'S, (U.S. CLS. 100 AND 101). SN 76-607,253. PUB. 6-28-2005. FILED 8-11-2004.
- 2,996,932. **ONE MARKET RESTAURANT SAN FRANCISCO AND DESIGN**. ONE MARKET RESTAURANT PARTNERS L.P., (U.S. CLS. 100 AND 101). SN 78-224,932. PUB. 6-28-2005. FILED 3-12-2003.
- 2,996,947. **WE DO OUTDOORS RIGHT!**. LOVE THE BEER, INC., (U.S. CLS. 100 AND 101). SN 78-247,562. PUB. 6-28-2005. FILED 5-8-2003.
- 2,997,044. **AUNT SARAH'S (BLOCK FORM)**. ASF, LLC, (U.S. CLS. 100 AND 101). SN 78-324,555. PUB. 3-8-2005. FILED 11-7-2003.
- 2,997,065. **SVR SANGEETHA (STYLIZED)**. RAJAGOPAL, PADMANABHAHPOTTI, (U.S. CLS. 100 AND 101). SN 78-332,568. PUB. 6-28-2005. FILED 11-24-2003.
- 2,997,128. **HAR LAM KEE AND DESIGN**. NU SQUARE CORP., (U.S. CLS. 100 AND 101). SN 78-349,842. PUB. 6-28-2005. FILED 1-9-2004.
- 2,997,167. **B. GOOD REAL.FOOD.FAST AND DESIGN**. B. GOOD LLC, (U.S. CLS. 100 AND 101). SN 78-358,196. PUB. 6-28-2005. FILED 1-27-2004.
- 2,997,175. **THE BEST "FU" IN TOWN (BLOCK FORM)**. MOE'S SOUTHWEST GRILL, LLC, (U.S. CLS. 100 AND 101). SN 78-359,497. PUB. 6-28-2005. FILED 1-29-2004.
- 2,997,183. **DESERT MOON FRESH MEXICAN GRILLE AND DESIGN**. DESERT MOON CAFE FRANCHISE CORPORATION, (U.S. CLS. 100 AND 101). SN 78-359,925. PUB. 6-28-2005. FILED 1-30-2004.
- 2,997,201. **LITTLE SCOOPS AND DESIGN**. LITTLE SCOOPS, INC., (U.S. CLS. 100 AND 101). SN 78-361,590. PUB. 6-28-2005. FILED 2-3-2004.
- 2,997,209. **ELEPHANT BAR RESTAURANT A DINING ADVENTURE AND DESIGN**. S. B. RESTAURANT CO., (U.S. CLS. 100 AND 101). SN 78-362,739. PUB. 6-28-2005. FILED 2-4-2004.
- 2,997,222. **HARVEST BUFFET AND DESIGN**. CACHE CREEK CASINO RESORT, (U.S. CLS. 100 AND 101). SN 78-364,466. PUB. 6-28-2005. FILED 2-8-2004.
- 2,997,246. **COOP DU JOUR (BLOCK FORM)**. TYSON FOODS, INC., (U.S. CLS. 100 AND 101). SN 78-367,554. PUB. 6-28-2005. FILED 2-13-2004.
- 2,997,265 (*See Class 41 for this trademark*).
- 2,997,308 (*See Class 16 for this trademark*).
- 2,997,311. **TERI & YAKI MARINATED CHICKEN AND DESIGN**. TERI & YAKI CHICKEN HOUSE #2, INC., (U.S. CLS. 100 AND 101). SN 78-377,017. PUB. 6-28-2005. FILED 3-2-2004.
- 2,997,359. **LOVE PAK (BLOCK FORM)**. DAVID LIVINGSTONE MISSIONARY FOUNDATION, INC., (U.S. CLS. 100 AND 101). SN 78-387,549. PUB. 6-28-2005. FILED 3-19-2004.
- 2,997,425. **THE COSMETIC MARKET & TAKEOUT CAFE (BLOCK FORM)**. ROBERTS, LINDA, (U.S. CLS. 100 AND 101). SN 78-399,845. PUB. 6-28-2005. FILED 4-10-2004.
- 2,997,443. **RANDY'S FISHMARKET RESTAURANT (BLOCK FORM)**. ESSIG, JOHN R., (U.S. CLS. 100 AND 101). SN 78-403,558. PUB. 6-28-2005. FILED 4-16-2004.
- 2,997,513. **CITY KITCHEN CATERING FINE FOOD AND DESIGN**. CK FRANCHISE SYSTEMS, INC., (U.S. CLS. 100 AND 101). SN 78-417,363. PUB. 6-28-2005. FILED 5-12-2004.
- 2,997,528. **SCHMIZZA (BLOCK FORM)**. PIZZA SCHMIZZA, INC., (U.S. CLS. 100 AND 101). SN 78-421,088. PUB. 6-28-2005. FILED 5-18-2004.
- 2,997,585. **ZIA MIA'S (BLOCK FORM)**. ZIA MIA'S CUCINA ITALIANA, INC., (U.S. CLS. 100 AND 101). SN 78-434,167. PUB. 6-28-2005. FILED 6-11-2004.
- 2,997,598. **GO RAW (BLOCK FORM)**. RODLU INC, (U.S. CLS. 100 AND 101). SN 78-435,859. PUB. 6-28-2005. FILED 6-16-2004.
- 2,997,606. **-NEW YORK- -SUB HUB- SUB SANDWICHES & SALADS B'KLYN EST 1979 AND DESIGN**. HUNTER-DENVER, INC., (U.S. CLS. 100 AND 101). SN 78-436,336. PUB. 6-28-2005. FILED 6-16-2004.
- 2,997,636 (*See Class 39 for this trademark*).
- 2,997,647. **ED & JOE'S RESTAURANT & PIZZERIA (BLOCK FORM)**. CLARK, MICHAEL E., (U.S. CLS. 100 AND 101). SN 78-441,331. PUB. 6-28-2005. FILED 6-25-2004.
- 2,997,652. **PIZZA POWER AND DESIGN**. GIOVANNI'S PIZZA, INC., (U.S. CLS. 100 AND 101). SN 78-442,185. PUB. 6-28-2005. FILED 6-28-2004.
- 2,997,682. **"GOOD FRIENDS...GOOD COMPANY...GOOD FOOD" "EAT WELL MY FRIENDS" (BLOCK FORM)**. TOMNIK FOOD SERVICES, INC., (U.S. CLS. 100 AND 101). SN 78-444,681. PUB. 6-28-2005. FILED 7-1-2004.
- 2,997,690. **SOUTHPAW'S SPORTS BAR & GRILL AND DESIGN**. SPORTS BAR, LLC, (U.S. CLS. 100 AND 101). SN 78-445,208. PUB. 6-28-2005. FILED 7-2-2004.
- 2,997,691. **LONE STAR STEAKHOUSE & SALOON (BLOCK FORM)**. LONE STAR STEAKHOUSE & SALOON, INC., (U.S. CLS. 100 AND 101). SN 78-445,215. PUB. 6-28-2005. FILED 7-2-2004.
- 2,997,750. **MACARONI GRILL (BLOCK FORM)**. BRINKER INTERNATIONAL HOLDINGS, L.P., (U.S. CLS. 100 AND 101). SN 78-451,124. PUB. 6-28-2005. FILED 7-15-2004.
- 2,997,752. **RESTAURANT STARLU (BLOCK FORM)**. I DIG PIG, LLC, (U.S. CLS. 100 AND 101). SN 78-451,152. PUB. 6-28-2005. FILED 7-15-2004.
- 2,997,774. **HOMESTYLE. YOUR STYLE. (BLOCK FORM)**. BUFFETS, INC., (U.S. CLS. 100 AND 101). SN 78-452,905. PUB. 6-28-2005. FILED 7-19-2004.
- 2,997,777. **PIZZA "GALLERY WHERE EVERY PIE IS A MASTERPIECE" AND DESIGN**. FARAJ, ZAHER, (U.S.

- CLS. 100 AND 101). SN 78-453,314. PUB. 6-28-2005. FILED 7-20-2004.
- 2,997,801. **EYEBAR. AND DESIGN.** LD1, LLC, DBA EYEBAR, (U.S. CLS. 100 AND 101). SN 78-454,438. PUB. 6-28-2005. FILED 7-21-2004.
- 2,997,842. **TEAM RED (BLOCK FORM).** WESTCOAST HOTELS, INC., (U.S. CLS. 100 AND 101). SN 78-456,037. PUB. 6-28-2005. FILED 7-23-2004.
- 2,997,847. **CUBANITAS AND DESIGN.** DOS BONITAS, LLC, (U.S. CLS. 100 AND 101). SN 78-456,268. PUB. 6-28-2005. FILED 7-25-2004.
- 2,997,880. **FOOD GOTTA COOK DON'T COME OUT OF A CAN! AND DESIGN.** THE TOMATO HEAD, INC., (U.S. CLS. 100 AND 101). SN 78-457,147. PUB. 6-28-2005. FILED 7-27-2004.
- 2,997,885 (*See Class 29 for this trademark*).
- 2,997,886. **SUITE SEASONS (BLOCK FORM).** MARRIOTT INTERNATIONAL, INC., (U.S. CLS. 100 AND 101). SN 78-457,227. PUB. 6-28-2005. FILED 7-27-2004.
- 2,997,921. **PERK PLACE COFFEE SHOP AND DESIGN.** MURPHY, LAURA VALENTINI, (U.S. CLS. 100 AND 101). SN 78-458,014. PUB. 6-28-2005. FILED 7-28-2004.
- 2,997,928. **BROPHY BROS. SANTA BARBARA CALIFORNIA CLAM BAR & RESTAURANT AND DESIGN.** BENNETT, SUSAN A., (U.S. CLS. 100 AND 101). SN 78-458,174. PUB. 6-28-2005. FILED 7-28-2004.
- 2,997,934. **LAST MINUTE GOURMET (BLOCK FORM).** GOURMET KITCHENS, INC., (U.S. CLS. 100 AND 101). SN 78-458,264. PUB. 6-28-2005. FILED 7-28-2004.
- 2,997,985. **VICTOR'S (BLOCK FORM).** THE RITZ-CARLTON HOTEL COMPANY, L.L.C., (U.S. CLS. 100 AND 101). SN 78-459,339. PUB. 6-28-2005. FILED 7-30-2004.
- 2,997,992. **ITALIAN NEVER TASTED SO FUN. (BLOCK FORM).** AT YOUR SERVICE RESTAURANTS, (U.S. CLS. 100 AND 101). SN 78-459,439. PUB. 6-28-2005. FILED 7-30-2004.
- 2,997,993. **PHAT THAI AND DESIGN.** THREE 43 MAIN LTD., (U.S. CLS. 100 AND 101). SN 78-459,455. PUB. 6-28-2005. FILED 7-30-2004.
- 2,998,003. **GET THE SCOOP (BLOCK FORM).** IZOR ENTERPRISES, INC., (U.S. CLS. 100 AND 101). SN 78-459,549. PUB. 6-28-2005. FILED 7-30-2004.
- 2,998,015. **KIMPTON INTOUCH (BLOCK FORM).** KIMPTON HOTEL & RESTAURANT GROUP, LLC, (U.S. CLS. 100 AND 101). SN 78-459,756. PUB. 6-28-2005. FILED 7-30-2004.
- 2,998,016. **KIMPTON EVERY HOTEL TELLS A STORY (BLOCK FORM).** KIMPTON HOTEL & RESTAURANT GROUP, LLC, (U.S. CLS. 100 AND 101). SN 78-459,783. PUB. 6-28-2005. FILED 7-30-2004.
- 2,998,018. **JOSEPH'S CAFE AND DESIGN.** JOSEPH'S CAFE, INC., (U.S. CLS. 100 AND 101). SN 78-459,812. PUB. 6-28-2005. FILED 7-30-2004.
- 2,998,109 (*See Class 30 for this trademark*).
- 2,998,124 (*See Class 39 for this trademark*).
- 2,998,208. **DESIGNERS AND BUILDERS OF EXCEPTIONAL OVEN-BAKED SANDWICHES (BLOCK FORM).** J.D. COGGINS SM LLC, (U.S. CLS. 100 AND 101). SN 78-464,207. PUB. 6-28-2005. FILED 8-9-2004.
- 2,998,210. **MISCELLANEOUS DESIGN.** PROXIMO RESTAURANTS LLC, (U.S. CLS. 100 AND 101). SN 78-464,260. PUB. 6-28-2005. FILED 8-9-2004.
- 2,998,293. **MISCELLANEOUS DESIGN.** ELEPHANT & CASTLE GROUP, INC., (U.S. CLS. 100 AND 101). SN 78-469,656. PUB. 6-28-2005. FILED 8-18-2004.
- 2,998,361 (*See Class 35 for this trademark*).
- 2,998,493 (*See Class 30 for this trademark*).
- 2,996,424. **ORGANIC SOLUTIONS.** HARRINGTON, TODD, (U.S. CLS. 100 AND 101). SN 76-541,163. PUB. 6-28-2005. FILED 8-18-2003.
- 2,996,447. **MISCELLANEOUS DESIGN.** ROY L. ESKOW, D.D.S., P.A., DBA BETHESDA DENTAL IMPLANT CENTER, (U.S. CLS. 100 AND 101). SN 76-549,605. PUB. 6-28-2005. FILED 10-6-2003.
- 2,996,501 (*See Class 16 for this trademark*).
- 2,996,504. **SMART (BLOCK FORM).** HEALTH DIALOG SERVICES CORPORATION, (U.S. CLS. 100 AND 101). SN 76-569,291. PUB. 6-28-2005. FILED 1-12-2004.
- 2,996,620. **PURESTORATION (BLOCK FORM).** TEXAS IDEAGROUP, INC., (U.S. CLS. 100 AND 101). SN 76-578,989. PUB. 6-28-2005. FILED 3-3-2004.
- 2,996,699 (*See Class 41 for this trademark*).
- 2,996,726. **MILES AHEAD (BLOCK FORM).** QUALITY LIVING INC., (U.S. CLS. 100 AND 101). SN 76-597,969. PUB. 6-28-2005. FILED 6-18-2004.
- 2,996,728. **THE LOOK. THE FEEL. (BLOCK FORM).** BELLE TOUCHE, LLC, (U.S. CLS. 100 AND 101). SN 76-598,090. PUB. 6-28-2005. FILED 6-18-2004.
- 2,996,757. **SKOOGIES (BLOCK FORM).** SKOOG, WAYNE ANTHONY, (U.S. CLS. 100 AND 101). SN 76-600,589. PUB. 6-28-2005. FILED 7-2-2004.
- 2,996,776. **WISDOM TEETH & GENERAL DENTISTRY AND DESIGN.** YOUNG, WAYNE, (U.S. CLS. 100 AND 101). SN 76-603,635. PUB. 6-28-2005. FILED 7-22-2004.
- 2,996,805. **HAIRM (STYLIZED).** CELTRA, INC., (U.S. CLS. 100 AND 101). SN 76-604,821. PUB. 6-28-2005. FILED 7-30-2004.
- 2,996,806. **HAIRM (BLOCK FORM).** CELTRA, INC., (U.S. CLS. 100 AND 101). SN 76-604,822. PUB. 6-28-2005. FILED 7-30-2004.
- 2,996,838. **GMF GRAVES MILL FARM GRASS-FED CATTLE AND BISON AND DESIGN.** CHANRICK, INC., (U.S. CLS. 100 AND 101). SN 76-605,478. PUB. 6-28-2005. FILED 8-4-2004.
- 2,996,841. **SMILECARE (BLOCK FORM).** COMMUNITY DENTAL SERVICES, INC., DBA SMILECARE DENTAL GROUP, (U.S. CLS. 100 AND 101). SN 76-605,519. PUB. 6-28-2005. FILED 8-4-2004.
- 2,996,893 (*See Class 42 for this trademark*).
- 2,996,898 (*See Class 9 for this trademark*).
- 2,997,031. **FAMILY MOTIVATION TO CHANGE.** LINKING HUMAN SYSTEMS, LLC, (U.S. CLS. 100 AND 101). SN 78-316,357. PUB. 6-28-2005. FILED 10-21-2003.
- 2,997,034. **GARDENVISION NATURE NEVER LOOKED BETTER AND DESIGN.** COSTA COLOR MERCHANDISING INC., (U.S. CLS. 100 AND 101). SN 78-319,540. PUB. 6-28-2005. FILED 10-28-2003.
- 2,997,102. **BODYFIX METHOD (BLOCK FORM).** BOLAND, WILLIAM M., (U.S. CLS. 100 AND 101). SN 78-345,955. PUB. 6-28-2005. FILED 12-29-2003.
- 2,997,108. **MDS GURU (BLOCK FORM).** BRIGGS MEDICAL SERVICE COMPANY, DBA BRIGGS CORPORATION, (U.S. CLS. 100 AND 101). SN 78-346,842. PUB. 6-28-2005. FILED 12-31-2003.
- 2,997,115. **RESEARCH MEDICAL CENTER AND DESIGN.** C/ HCA, INC., (U.S. CLS. 100 AND 101). SN 78-348,056. PUB. 6-28-2005. FILED 1-6-2004.
- 2,997,124 (*See Class 25 for this trademark*).
- 2,997,224 (*See Class 16 for this trademark*).
- 2,997,238. **VALLEY CREST TREE COMPANY THE TREE GROWING & TREE MOVING COMPANY AND DESIGN.** VALLEYCREST COMPANIES, (U.S. CLS. 100 AND 101). SN 78-366,361. PUB. 6-28-2005. FILED 2-11-2004.
- 2,997,371. **NB NATURAL BODY SPA AND SHOPPE AND DESIGN.** NATURAL BODY INTERNATIONAL, INC., (U.S. CLS. 100 AND 101). SN 78-389,307. PUB. 6-28-2005. FILED 3-23-2004.
- 2,997,412. **TRUTH IN FITNESS A NOT FOR PROFIT CORPORATION AND DESIGN.** WEAVER, CHARLES T, (U.S. CLS. 100 AND 101). SN 78-397,374. PUB. 6-28-2005. FILED 4-6-2004.
- 2,997,447. **CC: MY DOCTOR (BLOCK FORM).** RESOLUTION HEALTH, INC., (U.S. CLS. 100 AND 101). SN 78-404,539. PUB. 6-28-2005. FILED 4-20-2004.
- 2,997,449. **TREE CARE BECAUSE WE CARE (BLOCK FORM).** ARMSTRONG GREEN AND EMBREY, (U.S. CLS. 100

CLASS 44—MEDICAL, BEAUTY AND AGRICULTURAL SERVICES

- 2,996,309 (*See Class 43 for this trademark*).
- 2,996,326. **ON THE MOVE.** FRIENDS OF THE COLORADO CENTER FOR HUMAN NUTRITION, (U.S. CLS. 100 AND 101). SN 76-479,053. PUB. 6-28-2005. FILED 12-30-2002.
- 2,996,338 (*See Class 10 for this trademark*).
- 2,996,387 (*See Class 11 for this trademark*).

AND 101). SN 78-404,769. PUB. 6-28-2005. FILED 4-20-2004.
 2,997,478 (*See Class 36 for this trademark*).
 2,997,482. **EXECUTIVE TANS (BLOCK FORM)**. COLORADO SPECIAL EVENTS, INC., (U.S. CLS. 100 AND 101). SN 78-411,093. PUB. 6-28-2005. FILED 4-30-2004.
 2,997,588. **SPECTRUM AND DESIGN**. METCALF, LISA MORONEY, (U.S. CLS. 100 AND 101). SN 78-434,412. PUB. 6-28-2005. FILED 6-13-2004.
 2,997,589. **SPECTRUM THERAPY CENTER AND TRAINING INSTITUTE (BLOCK FORM)**. METCALF, LISA MORONEY, (U.S. CLS. 100 AND 101). SN 78-434,416. PUB. 6-28-2005. FILED 6-13-2004.
 2,997,653. **SUPRALASE (BLOCK FORM)**. RAMPONA, DOUGLAS M., (U.S. CLS. 100 AND 101). SN 78-442,280. PUB. 6-28-2005. FILED 6-28-2004.
 2,997,654. **REAL MEDICINE (BLOCK FORM)**. ST. JOHN HEALTH, (U.S. CLS. 100 AND 101). SN 78-442,448. PUB. 6-28-2005. FILED 6-28-2004.
 2,997,663. **TENET (BLOCK FORM)**. TENET HEALTHCARE CORPORATION, (U.S. CLS. 100 AND 101). SN 78-443,299. PUB. 6-28-2005. FILED 6-29-2004.
 2,997,705 (*See Class 35 for this trademark*).
 2,997,706 (*See Class 35 for this trademark*).
 2,997,707 (*See Class 35 for this trademark*).
 2,997,709. **ITA PARTNERS (BLOCK FORM)**. ITA PARTNERS LLC, MULTIPLE CLASS, (INT. CLS. 44 AND 45), (U.S. CLS. 100 AND 101). SN 78-447,001. PUB. 6-28-2005. FILED 7-7-2004.
 2,997,715. **BRINGING MEDICINE AND BEAUTY TOGETHER (BLOCK FORM)**. VASCULAR AND COSMETIC SPECIALISTS, P.C., (U.S. CLS. 100 AND 101). SN 78-448,240. PUB. 6-28-2005. FILED 7-9-2004.
 2,997,775 (*See Class 41 for this trademark*).
 2,997,798. **PREVAKIDS (BLOCK FORM)**. TAP PHARMACEUTICAL PRODUCTS INC., (U.S. CLS. 100 AND 101). SN 78-454,373. PUB. 6-28-2005. FILED 7-21-2004.
 2,997,808. **BONEBALANCE (BLOCK FORM)**. ROCHE THERAPEUTICS INC., (U.S. CLS. 100 AND 101). SN 78-455,022. PUB. 6-28-2005. FILED 7-22-2004.
 2,997,838. **THE FIVE MINUTE CURE (BLOCK FORM)**. PARCELL, KEVIN J., (U.S. CLS. 100 AND 101). SN 78-455,975. PUB. 6-28-2005. FILED 7-23-2004.
 2,997,889. **CURESOURCE (BLOCK FORM)**. CURE SOURCE, INC., (U.S. CLS. 100 AND 101). SN 78-457,276. PUB. 6-28-2005. FILED 7-27-2004.
 2,997,912. **CURESOURCE AND DESIGN**. CURE SOURCE, INC., (U.S. CLS. 100 AND 101). SN 78-457,833. PUB. 6-28-2005. FILED 7-28-2004.
 2,997,970. **THE FEEL GOOD PLACE (BLOCK FORM)**. NEW JERSEY PRIMARY CARE ASSOCIATION, INC., (U.S. CLS. 100 AND 101). SN 78-458,973. PUB. 6-28-2005. FILED 7-29-2004.
 2,998,009. **PROJECT DIABETES GIVING YOU THE POWER (BLOCK FORM)**. TENET HEALTHCARE CORPORATION, (U.S. CLS. 100 AND 101). SN 78-459,628. PUB. 6-28-2005. FILED 7-30-2004.
 2,998,019. **PLASTIC SURGERY SCIENCE, MEDICINE & ART (BLOCK FORM)**. GOLDMAN, STEVEN A., (U.S. CLS. 100 AND 101). SN 78-459,869. PUB. 6-28-2005. FILED 7-30-2004.
 2,998,038. **IT'S GOOD TO BE HOME. (BLOCK FORM)**. ADVANTAGE HOME CARE, INC., (U.S. CLS. 100 AND 101). SN 78-460,207. PUB. 6-28-2005. FILED 8-2-2004.
 2,998,042. **M MAYHILL DIAGNOSTIC CENTER AT DENTON REGIONAL MEDICAL CENTER AND DESIGN**. C/HCA, INC., (U.S. CLS. 100 AND 101). SN 78-460,269. PUB. 6-28-2005. FILED 8-2-2004.
 2,998,052. **MISCELLANEOUS DESIGN**. C/HCA, INC., (U.S. CLS. 100 AND 101). SN 78-460,345. PUB. 6-28-2005. FILED 8-2-2004.
 2,998,053. **DENTON REGIONAL MEDICAL CENTER AND DESIGN**. C/HCA, INC., (U.S. CLS. 100 AND 101). SN 78-460,349. PUB. 6-28-2005. FILED 8-2-2004.
 2,998,162. **DENTAL SALON AND DESIGN**. MORRIS, MARK, (U.S. CLS. 100 AND 101). SN 78-462,191. PUB. 6-28-2005. FILED 8-4-2004.
 2,998,179. **TULIPLIFT (BLOCK FORM)**. RAHIMI, AFSHIN DAVID, (U.S. CLS. 100 AND 101). SN 78-462,832. PUB. 6-28-2005. FILED 8-5-2004.

2,998,218. **TAN FACTORY AND DESIGN**. THE TAN FACTORY, LLC, (U.S. CLS. 100 AND 101). SN 78-464,585. PUB. 6-28-2005. FILED 8-9-2004.
 2,998,229. **NORTHWEST DENTAL ASSOCIATES (BLOCK FORM)**. NORTHWEST DENTAL ASSOCIATES, (U.S. CLS. 100 AND 101). SN 78-464,886. PUB. 6-28-2005. FILED 8-10-2004.
 2,998,236. **IPEC THERAPY (BLOCK FORM)**. KENIG, URI, (U.S. CLS. 100 AND 101). SN 78-465,144. PUB. 6-28-2005. FILED 8-10-2004.
 2,998,351 (*See Class 3 for this trademark*).
 2,998,379 (*See Class 31 for this trademark*).
 2,998,386 (*See Class 3 for this trademark*).
 2,998,476 (*See Class 3 for this trademark*).

CLASS 45—PERSONAL SERVICES

2,996,350. **BAPTIST WORLD ALLIANCE ONE LORD ONE FAITH ONE BAPTISM BAPTIST WORLD ALLIANCE AND DESIGN**. BAPTIST WORLD ALLIANCE, (U.S. CLS. 100 AND 101). SN 76-503,349. PUB. 6-28-2005. FILED 4-3-2003.
 2,996,397 (*See Class 9 for this trademark*).
 2,996,417. **BETHEL DELIVERANCE OUTREACH MINISTRIES AND DESIGN**. BETHEL DELIVERANCE OUTREACH MINISTRIES, (U.S. CLS. 100 AND 101). SN 76-538,535. PUB. 6-28-2005. FILED 8-18-2003.
 2,996,461. **5-DAY CLUB (BLOCK FORM)**. CHILD EVANGELISM FELLOWSHIP INCORPORATED, (U.S. CLS. 100 AND 101). SN 76-561,058. PUB. 6-28-2005. FILED 11-19-2003.
 2,996,471 (*See Class 37 for this trademark*).
 2,996,877. **UNITED STATES POSTAL SERVICE AND DESIGN**. UNITED STATES POSTAL SERVICE, (U.S. CLS. 100 AND 101). SN 76-620,159. PUB. 6-28-2005. FILED 11-12-2004.
 2,996,885 (*See Class 1 for this trademark*).
 2,996,922 (*See Class 35 for this trademark*).
 2,997,085. **MYJEWISHLEARNING.COM (BLOCK FORM)**. MYJEWISHLEARNING, INC., (U.S. CLS. 100 AND 101). SN 78-341,359. PUB. 6-28-2005. FILED 12-16-2003.
 2,997,149 (*See Class 39 for this trademark*).
 2,997,180. **IMAGINE YOUR LIFE WITH A PERSONAL ASSISTANT (BLOCK FORM)**. INFONE LLC, (U.S. CLS. 100 AND 101). SN 78-359,794. PUB. 6-28-2005. FILED 1-29-2004.
 2,997,275 (*See Class 35 for this trademark*).
 2,997,292 (*See Class 41 for this trademark*).
 2,997,709 (*See Class 44 for this trademark*).
 2,997,846 (*See Class 9 for this trademark*).
 2,997,902. **FIRST ALERT (BLOCK FORM)**. VERIFIED PERSON, (U.S. CLS. 100 AND 101). SN 78-457,541. PUB. 6-28-2005. FILED 7-27-2004.
 2,998,216 (*See Class 35 for this trademark*).
 2,998,234. **SUITS TO SELF-SUFFICIENCY (BLOCK FORM)**. DRESS FOR SUCCESS WORLDWIDE INC., (U.S. CLS. 100 AND 101). SN 78-465,006. PUB. 6-28-2005. FILED 8-10-2004.

* * * * *

SECTION 2.—PRIOR UNITED STATES CLASSIFICATION

COLLECTIVE MEMBERSHIP MARKS

COMPANY, SN 76-574,814. PUB. 6-28-2005. FILED 2-6-2004.

CLASS 200—COLLECTIVE MEMBERSHIP

2,997,431. **CONSUMERVOTED.ORG MEMBER AND DESIGN.** CONSUMERVOTED.ORG, LLC, SN 78-402,150. PUB. 6-28-2005. FILED 4-15-2004.

CERTIFICATION MARKS

CLASS A—GOODS

2,996,582. **EARTH ADVANTAGE MARK OF CERTIFICATION AND DESIGN.** PORTLAND GENERAL ELECTRIC

CLASS B—SERVICES

2,996,492. **DIPLOMATE AMERICAN COLLEGE OF VETERINARY OPHTHALMOLOGISTS (BLOCK FORM).** AMERICAN COLLEGE OF VETERINARY OPHTHALMOLOGISTS, INC., SN 76-567,980. PUB. 6-28-2005. FILED 1-2-2004.

2,997,825. **CSEP (BLOCK FORM).** INTERNATIONAL SPECIAL EVENTS SOCIETY, INC., SN 78-455,478. PUB. 6-28-2005. FILED 7-23-2004.

* * * * *

TRADEMARK REGISTRATIONS ISSUED UNDER SECTION 1(d)

The following marks have registered on the Principal Register pursuant to the intent-to-use provisions of Section 1(d) of the Trademark Act of 1946, as amended.

SECTION 1.— INTERNATIONAL CLASSIFICATION

The short titles associated below with the international class numbers are terms designed merely for quick identification and are not an official part of the international classification. The full names of international classes are given in section 6.1 of the trademark rules of practice.

The designation "U.S. Cl." appearing in this section refers to the U.S. class in effect prior to Sep. 1, 1973 rather than the international class which applies to applications filed on or after that date. For adoption of international classification see notice in the OFFICIAL GAZETTE of Jun. 26, 1973 (911 O.G. TM 210).

Application in more than one class

2,998,507. TOPCO ASSOCIATES, INC., SKOKIE, IL. SN 75-742,968. PUB. 8-7-2001, FILED 7-6-1999.

2,998,511. MYSTIC SEAPORT MUSEUM, INC., MYSTIC, CT. SN 75-811,767. PUB. 12-12-2000, FILED 9-29-1999.

FOOD CLUB FULL CIRCLE

OWNER OF U.S. REG. NOS. 588,434, 1,610,701, AND OTHERS.

NO CLAIM IS MADE TO THE EXCLUSIVE RIGHT TO USE "FOOD", APART FROM THE MARK AS SHOWN.

CLASS 29—MEATS AND PROCESSED FOODS

FOR VEGETABLE SHORTING, SANDWICH SPREAD, NAMELY, FRUIT-BASED SANDWICH SPREAD AND MEAT-BASED SANDWICH SPREAD, CANNED AND FROZEN FRUITS AND VEGETABLES, FROZEN FISH AND POULTRY, DAIRY PRODUCTS, NAMELY, CHEESE, BUTTER, AND CANNED EVAPORATED MILK, AND MISCELLANEOUS GROCERY PRODUCTS, NAMELY, MINCEMEAT, SHELLED NUTS, APPLESAUCE, JELLIES AND JAMS, DRIED FRUITS, UNFLAVORED AND UNSWEETENED GELATIN, PROCESSED OLIVES, PEANUT BUTTER, OLIVE OIL, AND PICKLES (U.S. CL. 46).

FIRST USE 8-0-2001; IN COMMERCE 8-0-2001.

CLASS 30—STAPLE FOODS

FOR COFFEE, TEA, SALAD DRESSING, TARTAR SAUCE, WHEAT FLOUR, SPAGHETTI, MACARONI AND NOODLES, RICE, CATSUP, TABLE SYRUP, AND FLAVORED AND SWEETENED GELATIN (U.S. CL. 46).

FIRST USE 2-0-2001; IN COMMERCE 2-0-2001.

CLASS 32—LIGHT BEVERAGES

FOR CANNED AND FROZEN FRUIT JUICES, NAMELY ORANGE JUICE, GRAPEFRUIT JUICE, APPLE JUICE, AND A BLEND OF ORANGE JUICE AND GRAPEFRUIT JUICE, BOTTLED APPLE JUICE, AND BOTTLED PRUNE JUICE (U.S. CLS. 45, 46 AND 48).

FIRST USE 8-0-2001; IN COMMERCE 8-0-2001.

MYSTIC E-PORT

NO CLAIM IS MADE TO THE EXCLUSIVE RIGHT TO USE "MYSTIC", APART FROM THE MARK AS SHOWN.

CLASS 39—TRANSPORTATION AND STORAGE

FOR CONDUCTING NARRATED SIGHTSEEING BOAT RIDES FOR OTHERS; RIVER TRANSPORT BY COMMUTER BOAT; BOAT CRUISES; BOAT RENTAL SERVICES (U.S. CLS. 100 AND 105).

FIRST USE 3-4-2004; IN COMMERCE 3-4-2004.

CLASS 41—EDUCATION AND ENTERTAINMENT

FOR ENTERTAINMENT AND RECREATION SERVICES, NAMELY, PROVIDING BOAT RIDES AND PUPPET SHOWS (U.S. CLS. 100, 101 AND 107).

FIRST USE 3-4-2004; IN COMMERCE 3-4-2004.

2,998,516. PASTIFICIO ARTIGIANO CAV. GIUSEPPE COCCO S.N.C., FARA S. MARTINO (CH), ITALY. SN 75-940,872. PUB. 11-13-2001, FILED 3-10-2000.



NO CLAIM IS MADE TO THE EXCLUSIVE RIGHT TO USE "ARTIGIANO PASTAIO" AND "ABRUZZI ITALY", APART FROM THE MARK AS SHOWN.

THE NAME "CAV. GIUSEPPE COCCO" IDENTIFIES A LIVING INDIVIDUAL WHOSE CONSENT IS OF RECORD.

THE ENGLISH TRANSLATION OF "ARTIGIANO PASTAIO" IS "ARTISAN PASTA MAKER".

CLASS 29—MEATS AND PROCESSED FOODS

FOR CANNED, COOKED AND PRESERVED TOMATOES; TOMATO PULP, TOMATO PUREE, TOMATO PASTE, OLIVE OIL FOR FOOD (U.S. CL. 46).
FIRST USE 1-0-2005; IN COMMERCE 1-0-2005.

CLASS 30—STAPLE FOODS

FOR OLIVE DRESSING, NOODLES, PASTA, EGG PASTA, TOMATO SAUCES (U.S. CL. 46).
FIRST USE 12-0-1990; IN COMMERCE 12-0-1990.

2,998,522. NANOPHASE TECHNOLOGIES CORPORATION, ROMEOVILLE, IL. SN 76-095,588. PUB. 6-8-2004, FILED 7-24-2000.

NANODUR**CLASS 1—CHEMICALS**

FOR CERAMIC PARTICLES CAPABLE OF BEING FORMED INTO FINISHED PRODUCTS (U.S. CLS. 1, 5, 6, 10, 26 AND 46).
FIRST USE 7-1-2004; IN COMMERCE 7-1-2004.

CLASS 6—METAL GOODS

FOR METAL AND METAL OXIDE PARTICLES CAPABLE OF BEING FORMED INTO FINISHED PRODUCTS (U.S. CLS. 2, 12, 13, 14, 23, 25 AND 50).
FIRST USE 7-1-2004; IN COMMERCE 7-1-2004.

2,998,524. APS HEALTHCARE BETHESDA, INC., SILVER SPRING, MD. SN 76-103,228. PUB. 5-6-2003, FILED 8-4-2000.

APS HEALTHCARE

NO CLAIM IS MADE TO THE EXCLUSIVE RIGHT TO USE "HEALTHCARE", APART FROM THE MARK AS SHOWN.

CLASS 35—ADVERTISING AND BUSINESS

FOR PROVIDING EMPLOYEE ASSISTANCE PROGRAMS IN THE NATURE OF REFERRALS FOR BEHAVIORAL HEALTH COUNSELING AND REFERRALS FOR LEGAL SERVICES (U.S. CLS. 100, 101 AND 102).
FIRST USE 1-1-2001; IN COMMERCE 1-1-2001.

CLASS 42—SCIENTIFIC, COMPUTER AND LEGAL SERVICES

FOR PROVIDING HEALTH CARE, MANAGED HEALTHCARE AND PREVENTIVE HEALTHCARE SERVICES; PROVIDING INFORMATION ABOUT HEALTHCARE; CHILD CARE AND ELDER CARE SERVICES; PROVIDING EMPLOYEE ASSISTANCE PROGRAMS IN THE NATURE OF BEHAVIORAL HEALTH COUNSELING AND LEGAL INFORMATION, MANAGED BEHAVIORAL HEALTHCARE PROGRAMS AND WORKLIFE PROGRAMS FOR EMPLOYERS, EMPLOYEES, GROUP MEMBERS, AND CONSUMERS; PROVIDING ON-LINE PSYCHOLOGICAL CONSULTATION AND TESTING SERVICES IN THE NATURE OF INTERACTIVE, ON-LINE SELF-ASSESSMENT, AND SELF-HELP EVALUATION SERVICES (U.S. CLS. 100 AND 101).
FIRST USE 1-1-2001; IN COMMERCE 1-1-2001.

2,998,525. APS HEALTHCARE BETHESDA, INC., SILVER SPRING, MD. SN 76-103,229. PUB. 6-3-2003, FILED 8-4-2000.

APS HEALTHCARE INC.

NO CLAIM IS MADE TO THE EXCLUSIVE RIGHT TO USE "HEALTHCARE INC.", APART FROM THE MARK AS SHOWN.

CLASS 35—ADVERTISING AND BUSINESS

FOR PROVIDING EMPLOYEE ASSISTANCE PROGRAMS IN THE NATURE OF REFERRALS FOR BEHAVIORAL HEALTH COUNSELING AND REFERRALS FOR LEGAL SERVICES (U.S. CLS. 100, 101 AND 102).
FIRST USE 1-1-2001; IN COMMERCE 1-1-2001.

CLASS 42—SCIENTIFIC, COMPUTER AND LEGAL SERVICES

FOR PROVIDING HEALTHCARE, MANAGED HEALTHCARE AND PREVENTIVE HEALTHCARE SERVICES; PROVIDING INFORMATION ABOUT HEALTHCARE; CHILD CARE AND ELDER CARE SERVICES; PROVIDING EMPLOYEE ASSISTANCE PROGRAMS IN THE NATURE OF BEHAVIORAL HEALTH COUNSELING AND LEGAL INFORMATION, MANAGED BEHAVIORAL HEALTHCARE PROGRAMS AND WORK LIFE PROGRAMS FOR EMPLOYERS, EMPLOYEES, GROUP MEMBERS, AND CONSUMERS; PROVIDING ON-LINE PSYCHOLOGICAL CONSULTATION AND TESTING SERVICES IN THE NATURE OF INTERACTIVE, ON-LINE SELF-ASSESSMENT, AND SELF-HELP EVALUATION SERVICES (U.S. CLS. 100 AND 101).
FIRST USE 1-1-2001; IN COMMERCE 1-1-2001.

2,998,526. APS HEALTHCARE BETHESDA, INC., SILVER SPRING, MD. SN 76-103,237. PUB. 9-23-2003, FILED 8-4-2000.

HELPING PEOPLE LEAD HEALTHIER LIVES**CLASS 35—ADVERTISING AND BUSINESS**

FOR PROVIDING EMPLOYEE ASSISTANCE PROGRAMS IN THE NATURE OF REFERRALS FOR BEHAVIORAL HEALTH COUNSELING AND REFERRALS FOR LEGAL SERVICES (U.S. CLS. 100, 101 AND 102).
FIRST USE 1-1-2001; IN COMMERCE 1-1-2001.

CLASS 42—SCIENTIFIC, COMPUTER AND LEGAL SERVICES

FOR PROVIDING HEALTHCARE, MANAGED HEALTHCARE, AND PREVENTIVE HEALTHCARE SERVICES; PROVIDING INFORMATION ABOUT HEALTHCARE; CHILD CARE AND ELDER CARE SERVICES; PROVIDING EMPLOYEE ASSISTANCE PROGRAMS IN THE NATURE OF BEHAVIORAL HEALTH COUNSELING AND LEGAL INFORMATION, MANAGED BEHAVIORAL HEALTHCARE PROGRAMS AND WORK-LIFE PROGRAMS FOR EMPLOYERS, EMPLOYEES, GROUP MEMBERS AND CONSUMERS; PROVIDING ON-LINE PSYCHOLOGICAL CONSULTATION AND TESTING SERVICES IN THE NATURE OF INTERACTIVE, ON-LINE SELF-ASSESSMENT, AND SELF-HELP EVALUATION SERVICES (U.S. CLS. 100 AND 101).
FIRST USE 1-1-2001; IN COMMERCE 1-1-2001.

2,998,528. HEADSPROUT, INC., SEATTLE, WA. SN 76-124,504. PUB. 4-23-2002, FILED 9-8-2000.

GROW TO KNOW

CLASS 9—ELECTRICAL AND SCIENTIFIC APPARATUS

FOR EDUCATIONAL SOFTWARE FOR CHILDREN; DOWNLOADABLE SOFTWARE AND CD'S AND CD-ROM'S FEATURING INSTRUCTION IN READING, WRITING, LITERATURE, MATHEMATICS, SCIENCE, SOCIAL SCIENCES, LANGUAGES, HEALTH, COMPUTERS, BASIC LIVING SKILLS, TRADE SKILLS, STUDY HABITS AND COLLEGE PREPARATION SKILLS, AND INSTRUCTION MANUALS AND WORKBOOKS SOLD AS A UNIT WITH THE AFORESAID GOODS (U.S. CLS. 21, 23, 26, 36 AND 38).

FIRST USE 7-18-2005; IN COMMERCE 7-18-2005.

CLASS 16—PAPER GOODS AND PRINTED MATTER

FOR BOOKS, MAGAZINES, LEARNING GUIDES, WORKBOOKS, TEACHER GUIDES, PAMPHLETS, POSTERS, CHARTS, WORKSHEETS, EXAM BOOKS, FLASH CARDS, TEMPLATES AND TEST SHEETS, ALL FEATURING GAMES AND INSTRUCTION IN CHILDHOOD EDUCATION, CHILD DEVELOPMENT, READING AND LITERATURE SKILLS, EDUCATIONAL TESTING AND SOCIAL SKILLS DEVELOPMENT (U.S. CLS. 2, 5, 22, 23, 29, 37, 38 AND 50).

FIRST USE 7-18-2005; IN COMMERCE 7-18-2005.

CLASS 41—EDUCATION AND ENTERTAINMENT

FOR EDUCATIONAL SERVICES AND EDUCATIONAL TESTING SERVICES, NAMELY PROVIDING CLASSES, SEMINARS, WORKSHOPS, TRAINING PROGRAMS AND STUDENT DEVELOPMENT PROGRAMS IN PERSON, ON-LINE OVER A NETWORK, AND BY A GLOBAL COMPUTER NETWORK, FEATURING INSTRUCTION IN CHILDHOOD EDUCATION, CHILD DEVELOPMENT, READING AND LITERATURE SKILLS, EDUCATIONAL TESTING AND SOCIAL SKILLS DEVELOPMENT (U.S. CLS. 100, 101 AND 107).

FIRST USE 7-18-2005; IN COMMERCE 7-18-2005.

2,998,534. IMAGE HUNTER PUBLISHING, INC., MCLEAN, VA. SN 76-175,090. PUB. 5-7-2002, FILED 12-4-2000.

NATURE'S BEST FOUNDATION

NO CLAIM IS MADE TO THE EXCLUSIVE RIGHT TO USE "FOUNDATION", APART FROM THE MARK AS SHOWN.

CLASS 16—PAPER GOODS AND PRINTED MATTER

FOR PRINTED PUBLICATIONS, NAMELY MAGAZINES AND BOOKS IN THE FIELD OF PHOTOGRAPHY, CONSERVATION AND THE NATURAL WORLD; CALENDARS (U.S. CLS. 2, 5, 22, 23, 29, 37, 38 AND 50).

FIRST USE 1-0-2000; IN COMMERCE 1-0-2000.

CLASS 35—ADVERTISING AND BUSINESS

FOR PROMOTING PUBLIC AWARENESS OF THE NEED FOR GREATER UNDERSTANDING AND STEWARDSHIP OF THE NATURAL WORLD (U.S. CLS. 100, 101 AND 102).

FIRST USE 1-0-2000; IN COMMERCE 1-0-2000.

2,998,535. TV AZTECA, S.A. DE C.V., MEXICO, MEXICO. SN 76-187,595. PUB. 5-21-2002, FILED 12-28-2000.

AZTECA AMERICA

OWNER OF U.S. REG. NOS. 2,289,909, 2,289,910, AND 2,428,683.

NO CLAIM IS MADE TO THE EXCLUSIVE RIGHT TO USE "AMERICA", APART FROM THE MARK AS SHOWN.

THE ENGLISH TRANSLATION OF "AZTECA" IS "AZTEC".

CLASS 16—PAPER GOODS AND PRINTED MATTER

FOR PRINTED MATTER AND PRINTED PUBLICATIONS, NAMELY, POSTERS, MAGAZINES AND BOOKS FEATURING TELEVISION PROGRAMS, TELEVISION AND THEATRICAL PERFORMERS, ACTORS, COMEDY PERFORMANCES, CONTESTS, CARTOONS, CULTURAL AND EDUCATIONAL PROGRAMS AND TELEVISION VARIETY SHOWS (U.S. CLS. 2, 5, 22, 23, 29, 37, 38 AND 50).

FIRST USE 7-28-2001; IN COMMERCE 7-28-2001.

CLASS 38—COMMUNICATION

FOR BROADCASTING OF RADIO AND TELEVISION PROGRAMS VIA SATELLITE AND CABLE TRANSMISSION AND A GLOBAL COMPUTER NETWORK; TELEPHONE AND CELLULAR TELEPHONE COMMUNICATIONS VIA OPTICAL FIBERS; CABLE RADIO TRANSMISSION OF LOCALIZED SIGNALS; ELECTRONIC MAIL SERVICES (U.S. CLS. 100, 101 AND 104).

FIRST USE 7-28-2001; IN COMMERCE 7-28-2001.

CLASS 41—EDUCATION AND ENTERTAINMENT

FOR ENTERTAINMENT SERVICES, NAMELY, AN ONGOING VARIETY SHOW DISTRIBUTED OVER TELEVISION AND RADIO BY MEANS OF CABLE, SATELLITE AND A GLOBAL COMPUTER NETWORK, FEATURING LIVE MUSICAL AND DANCE PERFORMANCES, PERSONAL INTERVIEWS, NEWS REPORTS, COMEDY, CONTESTS, COMPETITIONS, DOCUMENTARIES, EDUCATION, AND CULTURE AND SPORTING EVENTS; PRODUCTION OF RADIO AND TELEVISION PROGRAMS FEATURING CINEMA, THEATER, MUSICALS AND AUDIOVISUAL WORKS, NAMELY, FILMS AND TAPED RECORDINGS; RECORD, VIDEOTAPE AND AUDIO PRODUCTION FEATURING MUSIC; RENTAL OF PRODUCTION EQUIPMENT NECESSARY FOR RADIO AND TELEVISION, NAMELY, RENTAL OF TELEVISION SETS; RENTAL OF DRESSING ROOMS; RENTAL OF STAGE SCENERY; RENTAL OF ORCHESTRAS; RENTAL OF CHORAL AND MUSICAL GROUPS; RENTAL OF THEATERS; DUBBING SERVICES (U.S. CLS. 100, 101 AND 107).

FIRST USE 7-28-2001; IN COMMERCE 7-28-2001.

2,998,546. NOBLE FIBER TECHNOLOGIES, INC., CLARK SUMMIT, PA. SN 76-257,545. PUB. 3-23-2004, FILED 5-15-2001.

X-STATIC

OWNER OF U.S. REG. NOS. 962,315 AND 1,852,431.

CLASS 11—ENVIRONMENTAL CONTROL APPARATUS

FOR WATER FILTERS AND WATER PURIFYING UNITS FOR DOMESTIC, INDUSTRIAL AND MEDICAL USE (U.S. CLS. 13, 21, 23, 31 AND 34).

FIRST USE 6-0-2002; IN COMMERCE 6-0-2002.

CLASS 14—JEWELRY

FOR WATCH BANDS (U.S. CLS. 2, 27, 28 AND 50).
FIRST USE 7-0-1996; IN COMMERCE 7-0-1996.

CLASS 20—FURNITURE AND ARTICLES NOT OTHERWISE CLASSIFIED

FOR WINDOW BLINDS AND PILLOWS (U.S. CLS. 2, 13, 22, 25, 32 AND 50).

FIRST USE 8-0-1996; IN COMMERCE 8-0-1996.

CLASS 21—HOUSEWARES AND GLASS

FOR CAT LITTER BOXES, CUTTING BOARDS, GLOVES FOR GENERAL HOUSEHOLD USE, HAIR BRUSHES, COSMETIC BRUSHES, TOOTHBRUSH HOLDERS, ELECTRIC AND NON-ELECTRIC TOOTHBRUSHES, AUTOMATIC PERSONAL REHYDRATION SYSTEM COMPRISING A PLASTIC BLADDER SOLD EMPTY FOR HOLDING LIQUID (U.S. CLS. 2, 13, 23, 29, 30, 33, 40 AND 50).

FIRST USE 1-0-2000; IN COMMERCE 1-0-2000.

CLASS 25—CLOTHING

FOR BATHING SUITS, INFANT CLOTH DIAPERS, GLOVES, HATS, INSOLES, UNIFORMS, SHOES, SHORTS, SOCKS, PANTYHOSE, UNDERWEAR, DRIVING GLOVES, SKI GLOVES, SNOWBOARD GLOVES, SNOW-MOBILING GLOVES, AND WAISTBANDS (U.S. CLS. 22 AND 39).

FIRST USE 1-1-1996; IN COMMERCE 1-1-1996.

CLASS 26—FANCY GOODS

FOR ELASTIC RIBBONS AND FABRIC COVERS FOR KITCHEN APPLIANCES (U.S. CLS. 37, 39, 40, 42 AND 50).

FIRST USE 1-0-2000; IN COMMERCE 1-0-2000.

2,998,572. NANOINK, INC., CHICAGO, IL. SN 76-378,029. PUB. 10-14-2003, FILED 3-6-2002.

DPN

CLASS 1—CHEMICALS

FOR DIAGNOSTIC REAGENTS AND SUBSTRATES FOR SCIENTIFIC AND RESEARCH USE IN PATTERNING AT NANO SCALE OR NEAR NANO SCALE; REAGENTS AND SUBSTRATES FOR COMMERCIAL USE, NAMELY CHEMICAL COMPOUNDS FOR USE IN PATTERNING AT NANO SCALE OR NEAR NANO SCALE (U.S. CLS. 1, 5, 6, 10, 26 AND 46).

FIRST USE 5-1-2002; IN COMMERCE 5-1-2002.

CLASS 9—ELECTRICAL AND SCIENTIFIC APPARATUS

FOR ELECTRICAL AND SCIENTIFIC APPARATUS, NAMELY, ATOMIC FORCE MICROSCOPES, SCANNING PROBE MICROSCOPES, SCANNERS, PLOTTERS AND ASSOCIATED SOFTWARE AND HARDWARE FOR USE IN THE MANUFACTURING, DESIGN AND OPERATION OF A WIDE VARIETY OF MICRO SCALE AND NANO SCALE ELECTRONIC PRODUCTS, AND PRINTED USER MANUALS SOLD AS A UNIT; SCANNING PROBE MICROSCOPE TIPS COATED WITH CHEMICAL REAGENTS FOR USE WITH ELECTRICAL AND SCIENTIFIC APPARATUS IN PATTERNING AT NANO SCALE OR NEAR NANO SCALE; MICRO FLUIDIC DEVICES, NAMELY REAGENT RESERVOIRS IN THE NATURE OF WELLS AND CHANNELS FOR THE CONTAINMENT AND TRANSFER OF CHEMICAL REAGENTS (U.S. CLS. 21, 23, 26, 36 AND 38).

FIRST USE 6-10-2002; IN COMMERCE 6-10-2002.

CLASS 41—EDUCATION AND ENTERTAINMENT

FOR PROVIDING ONLINE MAGAZINES FEATURING NEWS AND INFORMATION IN THE FIELD OF NANOTECHNOLOGY; EDUCATIONAL RESEARCH AND TRAINING IN THE FIELD OF NANOLITHOGRAPHIC PRINTING (U.S. CLS. 100, 101 AND 107).

FIRST USE 4-18-2002; IN COMMERCE 4-18-2002.

CLASS 42—SCIENTIFIC, COMPUTER AND LEGAL SERVICES

FOR TECHNICAL CONSULTATION, RESEARCH AND SUPPORT IN THE FIELD OF NANOLITHOGRAPHIC PRINTING (U.S. CLS. 100 AND 101).

FIRST USE 6-10-2002; IN COMMERCE 6-10-2002.

2,998,574. ELECTRONICS FOR IMAGING, INC., FOSTER CITY, CA. SN 76-381,035. PUB. 4-29-2003, FILED 3-11-2002.

CHANGING THE WAY THE WORLD PRINTS

CLASS 41—EDUCATION AND ENTERTAINMENT

FOR TRAINING IN THE INSTALLATION OF COMPUTER SOFTWARE, NETWORK SERVERS, IMAGE PROCESSORS, COMPUTER PRINTERS, PRINTER CONTROLLERS AND INTERPRETERS, PHOTOCOPIERS AND ADD-ON CONTROLLERS FOR PHOTOCOPIERS, SCANNERS, SCANNER CONTROLLERS, COMPUTER HARDWARE AND COMPUTER FIRMWARE; CONDUCTING SEMINARS, CONFERENCES AND WORKSHOPS IN THE FIELD OF NETWORK PRINTING, COLOR THEORY AND COLOR PRINTING (U.S. CLS. 100, 101 AND 107).

FIRST USE 4-30-2000; IN COMMERCE 4-30-2000.

CLASS 42—SCIENTIFIC, COMPUTER AND LEGAL SERVICES

FOR COMPUTER SERVICES—NAMELY, PROVIDING INFORMATION VIA A GLOBAL COMPUTER NETWORK IN THE FIELDS OF STORING, ACCESSING, MANAGING, PRINTING AND TRANSMITTING DOCUMENTS, COLOR AND IMAGE PROCESSING, NETWORKING, IMAGE EDITING, GRAPHICS AND PRINTING SYSTEMS; COMPUTER CONSULTATION SERVICES IN THE FIELD OF DIGITAL PRINTING, PUBLISHING AND DOCUMENT DELIVERY (U.S. CLS. 100 AND 101).

FIRST USE 4-30-2000; IN COMMERCE 4-30-2000.

2,998,579. NAUTILUS OFFSHORE COMPANY, INC., THE WOODLANDS, TX. SN 76-395,496. PUB. 6-3-2003, FILED 4-15-2002.



NO CLAIM IS MADE TO THE EXCLUSIVE RIGHT TO USE "OFFSHORE COMPANY, INC.", APART FROM THE MARK AS SHOWN.

STIPPLING IS A FEATURE OF THE MARK AND NOT INTENDED TO INDICATE COLOR.

CLASS 37—CONSTRUCTION AND REPAIR

FOR MARINE CONSTRUCTION AND RENTAL OF OIL WELL DRILLING TOOLS (U.S. CLS. 100, 103 AND 106).

FIRST USE 4-10-2002; IN COMMERCE 4-10-2002.

CLASS 42—SCIENTIFIC, COMPUTER AND LEGAL SERVICES

FOR ENGINEERING SERVICES (U.S. CLS. 100 AND 101).

FIRST USE 4-10-2002; IN COMMERCE 4-10-2002.

2,998,581. BREMBO INTERNATIONAL S.A., LUXEMBOURG. SN 76-399,147. PUB. 9-23-2003, FILED 4-23-2002.



OWNER OF U.S. REG. NO. 1,948,567.

CLASS 1—CHEMICALS

FOR BRAKE FLUID (U.S. CLS. 1, 5, 6, 10, 26 AND 46). FIRST USE 0-0-2001; IN COMMERCE 0-0-2001.

CLASS 14—JEWELRY

FOR WATCHES AND CLOCKS (U.S. CLS. 2, 27, 28 AND 50).

FIRST USE 0-0-2001; IN COMMERCE 0-0-2001.

CLASS 18—LEATHER GOODS

FOR ALL PURPOSE ATHLETIC BAGS, CARRY-ON BAGS, LUGGAGE, BACK PACKS, RUCKSACKS (U.S. CLS. 1, 2, 3, 22 AND 41).

FIRST USE 0-0-2001; IN COMMERCE 0-0-2001.

CLASS 25—CLOTHING

FOR SKIRTS, SHIRTS, BLOUSES, TROUSERS, PANTS, JACKETS, CAPS, HATS, CARDIGANS, SWEATERS, T-SHIRTS (U.S. CLS. 22 AND 39).

FIRST USE 0-0-2001; IN COMMERCE 0-0-2001.

CLASS 28—TOYS AND SPORTING GOODS

FOR MECHANICAL ACTION TOYS (U.S. CLS. 22, 23, 38 AND 50).

FIRST USE 1-0-2005; IN COMMERCE 1-0-2005.

2,998,582. REGAL CINEMEDIA CORPORATION, ENGLEWOOD, CO. SN 76-399,170. PUB. 7-27-2004, FILED 4-23-2002.

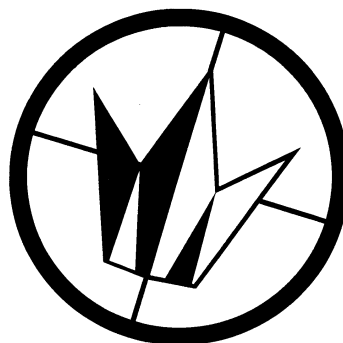

CLASS 35—ADVERTISING AND BUSINESS

FOR BUSINESS SERVICES, NAMELY, DEVELOPMENT, MARKETING AND IMPLEMENTATION OF ADVERTISING AND PROMOTIONAL ACTIVITIES FOR OTHERS RELATED TO THE USE OF THEATERS FOR MEETINGS AND EVENTS OTHER THAN THE EXHIBITION OF MOTION PICTURES; RETAIL STORE SERVICES FEATURING GENERAL CONSUMER GOODS AND MERCHANDISE FOR OTHERS; CONCESSION STAND SERVICES FEATURING FOOD, DRINK, SOUVENIRS AND GENERAL CONSUMER GOODS; THEATRICAL TICKET AGENCY; PROVIDING FACILITIES FOR CONCESSIONS AND BOOK SIGNINGS (U.S. CLS. 100, 101 AND 102).

FIRST USE 4-1-2002; IN COMMERCE 4-1-2002.

CLASS 41—EDUCATION AND ENTERTAINMENT

FOR ENTERTAINMENT SERVICES, NAMELY, PROVIDING FACILITIES FOR ENTERTAINMENT AND EDUCATIONAL PURPOSES, NAMELY, DRAMATIC READINGS, DEBATES, LECTURES, SPEECHES, PARTIES, DANCES AND RECREATION; ARRANGING FOR TICKET RESERVATIONS FOR SHOWS AND OTHER ENTERTAINMENT EVENTS (U.S. CLS. 100, 101 AND 107).

FIRST USE 4-1-2002; IN COMMERCE 4-1-2002.

CLASS 43—HOTEL AND RESTAURANT SERVICES

FOR PROVIDING FACILITIES FOR SOCIAL GATHERINGS (U.S. CLS. 100 AND 101).

FIRST USE 4-1-2002; IN COMMERCE 4-1-2002.

2,998,586. KABUSHIKI KAISHA SEGA, DBA SEGA CORPORATION, TOKYO 144-8531, JAPAN. SN 76-405,724. PUB. 3-18-2003, FILED 5-10-2002.

SEGA

OWNER OF U.S. REG. NOS. 2,106,258, 2,562,365, AND OTHERS.

CLASS 9—ELECTRICAL AND SCIENTIFIC APPARATUS

FOR DOWNLOADABLE AND EMBEDDED SOFTWARE FOR PLAYING VIDEO, COMPUTER AND ON-LINE GAMES (U.S. CLS. 21, 23, 26, 36 AND 38).
FIRST USE 8-0-2002; IN COMMERCE 8-0-2002.

CLASS 42—SCIENTIFIC, COMPUTER AND LEGAL SERVICES

FOR PROVIDING TEMPORARY ACCESS TO NON-DOWNLOADABLE SOFTWARE FOR PLAYING VIDEO, COMPUTER AND ONLINE GAMES (U.S. CLS. 100 AND 101).
FIRST USE 10-0-2002; IN COMMERCE 10-0-2002.

2,998,592. EGS GAUGING, INC., BILLERICA, MA. SN 76-414,981. PUB. 10-14-2003, FILED 5-20-2002.

SOLUTION 21

NO CLAIM IS MADE TO THE EXCLUSIVE RIGHT TO USE "SOLUTION", APART FROM THE MARK AS SHOWN.

CLASS 7—MACHINERY

FOR PRODUCT AND PROCESS SYSTEM COMPRISING INDUSTRIAL MACHINERY, NAMELY, EXTRUSION MACHINES, COATING MACHINES AND CALENDARING MACHINES (U.S. CLS. 13, 19, 21, 23, 31, 34 AND 35).
FIRST USE 1-20-2004; IN COMMERCE 1-20-2004.

CLASS 9—ELECTRICAL AND SCIENTIFIC APPARATUS

FOR COMPUTER HARDWARE AND INDUSTRIAL PROCESS CONTROL COMPUTER SOFTWARE TO MEASURE AND CONTROL THE QUALITY OF THE PRODUCT MANUFACTURED IN THE FIELDS OF SHEET MARKET, COATING AND CO-EXTRUSION (U.S. CLS. 21, 23, 26, 36 AND 38).
FIRST USE 1-20-2004; IN COMMERCE 1-20-2004.

CLASS 42—SCIENTIFIC, COMPUTER AND LEGAL SERVICES

FOR MEASUREMENT EVALUATIONS OF PROCESSES THAT MANUFACTURE WEBS OF PLASTICS, NONWOVEN MATERIALS AND RUBBER AND METALS PROCESSES (U.S. CLS. 100 AND 101).
FIRST USE 1-20-2004; IN COMMERCE 1-20-2004.

2,998,601. CONTENTSCAN, LLC, SAN DIEGO, CA. SN 76-433,092. PUB. 7-27-2004, FILED 7-22-2002.

DOME**CLASS 9—ELECTRICAL AND SCIENTIFIC APPARATUS**

FOR COMPUTER SOFTWARE CONTAINING SEARCH ENGINE AND DATABASE FOR SCIENTIFIC, EDUCATIONAL, TEACHING, AND RESEARCH PURPOSES, RECORDED ON CD ROMS AND SOFTWARE (U.S. CLS. 21, 23, 26, 36 AND 38).
FIRST USE 3-0-2002; IN COMMERCE 9-0-2002.

CLASS 35—ADVERTISING AND BUSINESS

FOR COMPUTERIZED ON-LINE PROFESSION-SPECIFIC SEARCHABLE DATABASE AND PUBLICATION BROKER FEATURING NON-DOWNLOADABLE REPRESENTATION OF PUBLICATION SUCH AS BOOKS, JOURNAL ARTICLES, DISSERTATION, WEBSITES, CONTINUING EDUCATION COURSES, AND CONFERENCES PROCEEDINGS, INCLUDING LINKAGES TO THIRD-PARTY ON-LINE RETAILERS WHO SELL THE PUBLICATIONS, AND INCLUDING CONNECTIONS FROM PUBLICATIONS TO RELATED INFORMATION SUCH AS AUTHOR BIOGRAPHICAL INFORMATION AND PUBLICATION LISTS, AUTHOR CONTACT INFORMATION, COURSE INFORMATION, RESEARCH INSTITUTION NAME, ASSOCIATED MEMBER LISTINGS, AND CONTACT INFORMATION (U.S. CLS. 100, 101 AND 102).
FIRST USE 3-0-2002; IN COMMERCE 9-0-2002.

CLASS 38—COMMUNICATION

FOR COMPUTER TELECOMMUNICATION SERVICES, NAMELY, ELECTRONIC TRANSMISSION OF DATA VIA A GLOBAL COMPUTER NETWORK; COMPUTER TELECOMMUNICATION SERVICES, NAMELY, PROVIDING ON-LINE GATEWAY LINKS TO COLLECTIONS OF TEXTUAL INFORMATION FOR ACADEMIC, EDUCATIONAL, AND PRACTICAL PURPOSES, INCLUDING USE RELATING TO GENERAL RESEARCH, PATIENT SAVINGS AND EDUCATION, LITERATURE REVIEW, EDUCATIONAL RESOURCE IDENTIFICATION, LIBRARY COLLECTIONS IDENTIFICATION, PEER TO PEER (COLLEAGUES AND STUDENTS) INFORMATION EXCHANGE, AND CONTINUING CLINICAL EDUCATION (U.S. CLS. 100, 101 AND 104).
FIRST USE 3-0-2002; IN COMMERCE 9-0-2002.

CLASS 41—EDUCATION AND ENTERTAINMENT

FOR ON-LINE PROFESSION-SPECIFIC INFORMATION SERVICES CONTAINING PUBLICATION COLLECTIONS, NAMELY, BOOKS, JOURNAL ARTICLES, DISSERTATIONS, WEBSITES, CONTINUING EDUCATION COURSES, AND CONFERENCE PROCEEDINGS, INCLUDING LINKAGES TO THIRD-PARTY ON-LINE RETAILERS WHO SELL THE PUBLICATIONS; ELECTRONIC PUBLISHING SERVICES, NAMELY, PUBLICATION OF TEXT AND GRAPHIC WORKS OF OTHERS ON-LINE FEATURING PERSONAL AND PROFESSIONAL COMMENTARY AND REFERENCE LISTS (U.S. CLS. 100, 101 AND 107).
FIRST USE 3-0-2002; IN COMMERCE 9-0-2002.

CLASS 42—SCIENTIFIC, COMPUTER AND LEGAL SERVICES

FOR PROVIDING SEARCH ENGINES FOR OBTAINING DATA; CONSULTANCY SERVICES RELATED TO ON-LINE PUBLICATION IDENTIFICATION; CONSULTANCY SERVICES RELATED TO LIBRARY COLLECTIONS IDENTIFICATION; HOSTING OF WEBSITES OF OTHERS ON A COMPUTER SERVER FOR A GLOBAL COMPUTER NETWORK; PROVIDING SEARCH ENGINES WHICH SEARCH, RETRIEVE, AND PROVIDE COLLECTIONS OF TEXTURAL INFORMATION ON COMPUTER NETWORKS FOR OTHERS AND WHICH LIMIT THE SPECIFIC COLLECTIONS OF DATA SEARCHED BY APPLYING LIMITING PARAMETERS AND PRE-EXISTING FRAMEWORKS, SUCH AS TABLE OF CONTENTS, INDEXES, AND REFERENCES, TO DEFINE THE SCOPE OF SEARCHES AND TO AID IN LOCATING INFORMATION THAT IS RELEVANT AND USEFUL TO THE USER (U.S. CLS. 100 AND 101).
FIRST USE 3-0-2002; IN COMMERCE 9-0-2002.

CLASS 44—MEDICAL, BEAUTY AND AGRICULTURAL SERVICES

FOR COMPUTERIZED ON-LINE DESCRIPTIONS OF POTENTIALLY HELPFUL REFERENCE SOURCES (U.S. CLS. 100 AND 101).
FIRST USE 3-0-2002; IN COMMERCE 9-0-2002.

2,998,608. UNITED CANCER FRONT, INC., BEVERLY HILLS, CA. SN 76-439,893. PUB. 3-2-2004, FILED 8-13-2002.

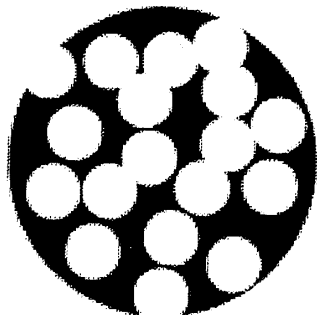

THE MARK CONSISTS OF SMALL CIRCLES WITHIN A LARGE CIRCLE.

CLASS 36—INSURANCE AND FINANCIAL

FOR CHARITABLE FUND RAISING SERVICES (U.S. CLS. 100, 101 AND 102).
FIRST USE 10-27-2003; IN COMMERCE 10-27-2003.

CLASS 42—SCIENTIFIC, COMPUTER AND LEGAL SERVICES

FOR MEDICAL RESEARCH RELATING TO CANCER (U.S. CLS. 100 AND 101).
FIRST USE 10-27-2003; IN COMMERCE 10-27-2003.

CLASS 44—MEDICAL, BEAUTY AND AGRICULTURAL SERVICES

FOR PROVIDING ONLINE INFORMATION SERVICES IN THE FIELD OF MEDICINE, NAMELY, PROVIDING INFORMATION ON THE CLINICAL PROBLEMS AND DIFFERENT STAGES OF VARIOUS FORMS OF CANCER AND INSTRUCTIONS ON HOW TO ACCESS DIAGNOSTIC AND THERAPEUTIC APPROACHES TO CANCER (U.S. CLS. 100 AND 101).
FIRST USE 10-27-2003; IN COMMERCE 10-27-2003.

CLASS 35—ADVERTISING AND BUSINESS

FOR BUSINESS MANAGEMENT CONSULTATION; LEGAL ADMINISTRATION AND LEGAL SUPPORT SERVICES, NAMELY, PROVIDING LEGAL MANAGEMENT SERVICES FOR OTHERS; BUSINESS CONSULTATION REGARDING BUSINESS DEVELOPMENT, TECHNOLOGY, COMMERCIALIZATION, TECHNOLOGY EXPLOITATION AND MARKETING; TAX ADVISORY AND CONSULTING SERVICES, NAMELY, TAX CONSULTATION AND PREPARATION (U.S. CLS. 100, 101 AND 102).

FIRST USE 7-1-1987; IN COMMERCE 7-1-1987.

CLASS 36—INSURANCE AND FINANCIAL

FOR LEGAL RISK MANAGEMENT SERVICES (U.S. CLS. 100, 101 AND 102).

FIRST USE 7-1-1987; IN COMMERCE 7-1-1987.

CLASS 41—EDUCATION AND ENTERTAINMENT

FOR TRAINING SERVICES IN THE FIELD OF LAW AND LEGAL COMPLIANCE, BUSINESS, TAXATION AND REGULATORY MATTERS; EDUCATION AND TRAINING SERVICES, NAMELY, PROVIDING CLASSES, SEMINARS, CONFERENCES, SYMPOSIUMS AND WORKSHOPS IN THE FIELD OF LAW AND LEGAL COMPLIANCE, BUSINESS, TAXATION AND REGULATORY MATTERS; PUBLICATION OF MAGAZINE ARTICLES, JOURNALS, PERIODICALS, TEXT BOOKS AND BOOKS PERTAINING TO LAW AND LEGAL COMPLIANCE, BUSINESS, TAXATION AND REGULATORY MATTERS (U.S. CLS. 100, 101 AND 107).

FIRST USE 7-1-1987; IN COMMERCE 7-1-1987.

CLASS 42—SCIENTIFIC, COMPUTER AND LEGAL SERVICES

FOR LEGAL SERVICES; REVIEWING STANDARDS AND PRACTICES TO ASSURE COMPLIANCE WITH LAWS AND REGULATIONS; LEGAL SERVICES IN THE FORM OF LITIGATION SERVICES; LEGAL SERVICES IN THE FORM OF DISPUTE MANAGEMENT; PROVIDING DATABASES FEATURING INFORMATION ON LEGAL SERVICES, LEGISLATION AND LEGAL CASE LAW; ARBITRATION AND DISPUTE RESOLUTION SERVICES; TECHNOLOGY MANAGEMENT CONSULTANCY AND ADVISORY SERVICES, NAMELY, DEVELOPMENT OF NEW TECHNOLOGY FOR OTHERS IN THE FIELD OF LAW AND LEGAL COMPLIANCE; INTELLECTUAL PROPERTY SERVICES, NAMELY, PROVIDING LEGAL SERVICES IN THE FIELD OF PATENTS, TRADEMARKS AND DESIGN; COMPUTER PROJECT MANAGEMENT SERVICES; PUBLIC DOCUMENT RETRIEVAL (U.S. CLS. 100 AND 101).

FIRST USE 7-1-1987; IN COMMERCE 7-1-1987.

2,998,611. MALLESONS STEPHEN JAQUES, NEW SOUTH WALES 2000, AUSTRALIA. SN 76-447,740. PUB. 2-10-2004, FILED 9-9-2002.

**MALLESONS STEPHEN
JAQUES**

PRIORITY CLAIMED UNDER SEC. 44(D) ON AUSTRALIA APPLICATION NO. 914685, FILED 5-29-2002, REG. NO. 914685, DATED 5-29-2002, EXPIRES 5-29-2012.
OWNER OF U.S. REG. NO. 1,531,395.

2,998,612. MALLESONS STEPHEN JAQUES, PARTNERSHIP, THE, NEW SOUTH WALES 2000, AUSTRALIA. SN 76-447,747. PUB. 1-20-2004, FILED 9-9-2002.

MALLESONS

PRIORITY CLAIMED UNDER SEC. 44(D) ON AUSTRALIA APPLICATION NO. 914,596, FILED 5-29-2002, REG. NO. 914596, DATED 5-29-2002, EXPIRES 5-29-2012.
OWNER OF U.S. REG. NO. 1,531,395.

CLASS 35—ADVERTISING AND BUSINESS

FOR BUSINESS MANAGEMENT CONSULTATION; LEGAL ADMINISTRATION AND LEGAL SUPPORT SERVICES, NAMELY, PROVIDING LEGAL MANAGEMENT SERVICES FOR OTHERS; BUSINESS CONSULTATION REGARDING BUSINESS DEVELOPMENT, TECHNOLOGY, COMMERCIALIZATION, TECHNOLOGY EXPLOITATION AND MARKETING; TAX ADVISORY AND CONSULTING SERVICES, NAMELY, TAX CONSULTATION AND PREPARATION (U.S. CLS. 100, 101 AND 102).

FIRST USE 3-29-2004; IN COMMERCE 3-29-2004.

CLASS 36—INSURANCE AND FINANCIAL

FOR LEGAL RISK MANAGEMENT SERVICES (U.S. CLS. 100, 101 AND 102).

FIRST USE 3-29-2004; IN COMMERCE 3-29-2004.

CLASS 41—EDUCATION AND ENTERTAINMENT

FOR TRAINING SERVICES IN THE FIELD OF LAW AND LEGAL COMPLIANCE, BUSINESS, TAXATION AND REGULATORY MATTERS; EDUCATION AND TRAINING SERVICES, NAMELY, PROVIDING CLASSES, SEMINARS, CONFERENCES, SYMPOSIUMS AND WORKSHOPS IN THE FIELD OF LAW AND LEGAL COMPLIANCE, BUSINESS, TAXATION AND REGULATORY MATTERS; PUBLICATION OF MAGAZINE ARTICLES, JOURNALS, PERIODICALS, TEXT BOOKS AND BOOKS PERTAINING TO LAW AND LEGAL COMPLIANCE, BUSINESS, TAXATION AND REGULATORY MATTERS (U.S. CLS. 100, 101 AND 107).

FIRST USE 3-29-2004; IN COMMERCE 3-29-2004.

CLASS 42—SCIENTIFIC, COMPUTER AND LEGAL SERVICES

FOR LEGAL SERVICES; REVIEWING STANDARDS AND PRACTICES TO ASSURE COMPLIANCE WITH LAWS AND REGULATIONS; LEGAL SERVICES IN THE FORM OF LITIGATION SERVICES; LEGAL SERVICES IN THE FORM OF DISPUTE MANAGEMENT; PROVIDING DATABASES FEATURING INFORMATION ON LEGAL SERVICES, LEGISLATION AND LEGAL CASE LAW; ARBITRATION AND DISPUTE RESOLUTION SERVICES; TECHNOLOGY MANAGEMENT CONSULTANCY AND ADVISORY SERVICES, NAMELY, DEVELOPMENT OF NEW TECHNOLOGY FOR OTHERS IN THE FIELD OF LAW AND LEGAL COMPLIANCE; INTELLECTUAL PROPERTY SERVICES, NAMELY, PROVIDING LEGAL SERVICES IN THE FIELD OF PATENTS, TRADEMARKS AND DESIGN; COMPUTER PROJECT MANAGEMENT SERVICES; PUBLIC DOCUMENT RETRIEVAL (U.S. CLS. 100 AND 101).

FIRST USE 3-29-2004; IN COMMERCE 3-29-2004.

2,998,613. PENGUIN GROUP (USA) INC., NEW YORK, NY. SN 76-448,997. PUB. 10-7-2003, FILED 9-9-2002.

BERKLEY SENSATION

OWNER OF U.S. REG. NOS. 1,079,356 AND 2,132,303.

CLASS 9—ELECTRICAL AND SCIENTIFIC APPARATUS

FOR DOWNLOADABLE ELECTRONIC PUBLICATIONS IN THE NATURE OF FICTION BOOKS IN THE FIELD OF ROMANCE (U.S. CLS. 21, 23, 26, 36 AND 38).

FIRST USE 1-24-2005; IN COMMERCE 1-24-2005.

CLASS 16—PAPER GOODS AND PRINTED MATTER

FOR PRINTED FICTION BOOKS IN THE FIELD OF ROMANCE (U.S. CLS. 2, 5, 22, 23, 29, 37, 38 AND 50).

FIRST USE 6-0-2003; IN COMMERCE 6-0-2003.

2,998,618. TOPCO ASSOCIATES, INC., SKOKIE, IL. SN 76-457,619. PUB. 3-15-2005, FILED 10-11-2002.

OWNER OF U.S. REG. NOS. 688,066, 2,552,874, AND OTHERS.

CLASS 29—MEATS AND PROCESSED FOODS

FOR VEGETABLE-BASED RICE BOWLS; MEAT-BASED RICE BOWLS; POULTRY-BASED RICE BOWLS; POULTRY-BASED SKILLET DINNERS; MEAT-BASED SKILLET DINNERS; CHIPPED BEEF, STUFFED GREEN PEPPERS, MEAT LOAF, CHICKEN BREAST AND POTATO DINNERS; SALISBURY STEAK ENTREES; BEEF STIR FRY; SHRIMP AND LINGUINI; CHICKEN STIR FRY; SHRIMP ALFREDO; SHRIMP STIR FRY; REFRIGERATED ENTREES CONSISTING PRIMARILY OF MEAT OR POULTRY; FROZEN BEEF BURGERS, FROZEN CHICKEN TENDERS; FROZEN MEAT, POULTRY, FISH AND SEAFOOD, BEEF CHILI; FROZEN POTATOES, VEGETABLE SALADS AND SOUP (U.S. CL. 46).

FIRST USE 10-0-2002; IN COMMERCE 10-0-2002.

CLASS 30—STAPLE FOODS

FOR BEEF AND POULTRY POT PIES, AND SHRIMP FRIED RICE (U.S. CL. 46).

FIRST USE 10-0-2002; IN COMMERCE 10-0-2002.

2,998,633. PARIS ACCESSORIES, INC., NEW YORK, NY. SN 76-470,959. PUB. 4-13-2004, FILED 11-29-2002.

FOR AMERICA'S GREAT HUNTERS

THE MARK CONSISTS OF STANDARD CHARACTERS WITHOUT CLAIM TO ANY PARTICULAR FONT, STYLE, SIZE, OR COLOR.

CLASS 13—FIREARMS

FOR RIFLE CASES, GUN CASES, PISTOL CASES AND AMMUNITION BELTS (U.S. CLS. 2 AND 9).

FIRST USE 4-27-2003; IN COMMERCE 4-27-2003.

CLASS 25—CLOTHING

FOR GLOVES, SCARVES, HATS, VESTS, FACE MASKS, GAITERS AND BALACLAVAS (U.S. CLS. 22 AND 39).

FIRST USE 4-27-2003; IN COMMERCE 4-27-2003.

2,998,639. REGENAT USA HOLDING CORP., GREENWICH, CT. SN 76-477,283. PUB. 11-18-2003, FILED 12-19-2002.

REGENAT

CLASS 37—CONSTRUCTION AND REPAIR

FOR COLLECTING DISCARDED MATERIALS FOR RECYCLING (U.S. CLS. 100, 103 AND 106).
FIRST USE 10-14-2004; IN COMMERCE 10-14-2004.

CLASS 40—MATERIAL TREATMENT

FOR RECYCLING OF WOOD WASTE, FORESTRY WOOD REMNANTS AND DISCARDED MATERIALS; WATER TREATMENT SERVICES IN THE NATURE OF CLEANSING WATER OF POLLUTANTS AND CONTAMINANTS; ELECTRICITY GENERATION SERVICES TO GENERATE ELECTRICITY FOR OTHERS FROM THE RECYCLING OF THE WOOD WASTE, FORESTRY WOOD REMNANTS AND DISCARDED MATERIALS AND FROM CLEANSING OF WATER OF POLLUTANTS AND CONTAMINANTS (U.S. CLS. 100, 103 AND 106).
FIRST USE 10-14-2004; IN COMMERCE 10-14-2004.

2,998,643. TANIMURA & ANTLE, INC., SALINAS, CA. SN 76-481,917. PUB. 8-24-2004, FILED 1-13-2003.

OWNER OF U.S. REG. NOS. 2,179,013, 2,309,410, AND 2,309,439.

CLASS 29—MEATS AND PROCESSED FOODS

FOR PRE-CUT FRESH VEGETABLES AND PRE-CUT GARDEN SALADS (U.S. CL. 46).
FIRST USE 6-3-2003; IN COMMERCE 6-3-2003.

CLASS 31—NATURAL AGRICULTURAL PRODUCTS

FOR FRESH VEGETABLES (U.S. CLS. 1 AND 46).
FIRST USE 3-3-2003; IN COMMERCE 3-3-2003.

CLASS 35—ADVERTISING AND BUSINESS

FOR WHOLESALE DISTRIBUTORSHIP SERVICES IN THE FIELD OF FRESH VEGETABLES, VEGETABLE SALADS, AND OTHER FRESH FOOD PRODUCTS; BUSINESS CONSULTATION AND BUSINESS MANAGEMENT SERVICES IN THE FIELD OF AGRICULTURE, NAMELY, PROVIDING BUSINESS CONSULTATION AND MANAGEMENT FOR PRODUCERS OF FRESH VEGETABLES, VEGETABLE SALADS, AND OTHER FRESH PRODUCTS; CUSTOMER SERVICES IN THE FIELD OF FRESH PRODUCE AND OTHER FRESH FOODS; PURCHASING AGENTS; BUSINESS MARKETING CONSULTING SERVICES; BUSINESS INFORMATION SERVICES IN THE FIELD OF AGRICULTURE, NAMELY, PROVIDING BUSINESS INFORMATION FEATURING PRODUCTION OF FRESH VEGETABLES, VEGETABLE SALADS, AND OTHER FRESH FOODS PRODUCTS; MARKET ANALYSIS; PREPARING BUSINESS REPORTS CONCERNING PRODUCTION AND DEVELOPMENT; ASSOCIATION SERVICES, NAMELY, PROMOTING THE INTERESTS OF THE AGRICULTURE INDUSTRY THROUGH A COMBINATION OF SERVICES, AND MEMBER BENEFIT PROGRAMS, NAMELY, ADMINISTRATION OF A DISCOUNT PROGRAM FOR ENABLING PARTICIPANTS TO OBTAIN DISCOUNTS ON GOODS AND SERVICES THROUGH USE OF A DISCOUNT MEMBERSHIP CARD; RETAIL STORES IN THE FIELD OF AGRICULTURE SEED, NURSERY STOCK; AGRICULTURAL CHEMICALS, AND AGRICULTURAL SUPPLIES; PROCUREMENT, NAMELY, PURCHASING FARM PRODUCTS AFTER HARVEST FOR OTHERS, NAMELY, FRUITS, GRAINS, HAY, NUTS, VEGETABLES, ANIMAL PRODUCTS, NAMELY, ANIMAL FEED, AND OTHER FARMS PRODUCTS, NAMELY, COMPOST (U.S. CLS. 100, 101 AND 102).

FIRST USE 6-3-2003; IN COMMERCE 6-3-2003.

2,998,650. JUICING FOR JOCKS, LLC, CHICAGO, IL. SN 76-483,116. PUB. 5-11-2004, FILED 1-17-2003.

JUICING FOR JOCKS

CLASS 35—ADVERTISING AND BUSINESS

FOR PROMOTING PUBLIC AWARENESS OF THE NEED FOR GOOD NUTRITION (U.S. CLS. 100, 101 AND 102).

FIRST USE 6-22-2005; IN COMMERCE 6-22-2005.

CLASS 41—EDUCATION AND ENTERTAINMENT

FOR PROVIDING SEMINARS DEALING WITH NUTRITION AND GENERAL HEALTH CARE ISSUES (U.S. CLS. 100, 101 AND 107).

FIRST USE 6-22-2005; IN COMMERCE 6-22-2005.

2,998,654. NATIONAL ASSEMBLY OF HEALTH & HUMAN SERVICE ORGANIZATIONS, WASHINGTON, DC. SN 76-487,644. PUB. 5-25-2004, FILED 2-5-2003.

FAMILY STRENGTHENING POLICY CENTER

NO CLAIM IS MADE TO THE EXCLUSIVE RIGHT TO USE "FAMILY" AND "POLICY CENTER", APART FROM THE MARK AS SHOWN.

CLASS 16—PAPER GOODS AND PRINTED MATTER

FOR PRINTED PUBLICATIONS, NAMELY, NEWSLETTERS AND BROCHURES PERTAINING TO FAMILY AND SOCIAL ISSUES (U.S. CLS. 2, 5, 22, 23, 29, 37, 38 AND 50).
FIRST USE 11-0-2003; IN COMMERCE 11-0-2003.

CLASS 41—EDUCATION AND ENTERTAINMENT

FOR EDUCATIONAL SERVICES, NAMELY CONDUCTING SEMINARS AND WORKSHOPS IN THE AREA OF PROMOTING AWARENESS OF FAMILY AND SOCIAL ISSUES (U.S. CLS. 100, 101 AND 107).
FIRST USE 9-0-2004; IN COMMERCE 9-0-2004.

CLASS 42—SCIENTIFIC, COMPUTER AND LEGAL SERVICES

FOR PROVIDING INFORMATION AND RESEARCH ON GOVERNMENT AND SOCIAL PROGRAMS AND POLICIES RELATING TO LOW INCOME FAMILIES; PROVIDING SOCIAL AND FAMILY RESEARCH AND STUDIES; GOVERNMENT POLICY ANALYSIS AND CONSULTING AND LOBBYING; PROMOTING PUBLIC AWARENESS OF FAMILY AND SOCIAL ISSUES (U.S. CLS. 100 AND 101).
FIRST USE 11-0-2003; IN COMMERCE 11-0-2003.

2,998,678. PARK LANE CONSERVATORIES LTD., POYN-
TON, CHESHIRE SK1 21YL, UNITED KINGDOM. SN
76-520,032. PUB. 9-21-2004, FILED 6-6-2003.

PARK LANE

CLASS 6—METAL GOODS

FOR METAL ROOFING MATERIALS FOR RESIDENTIAL AND COMMERCIAL GREENHOUSES, NAMELY, TRUSSES, RAFTERS, HIPS, VENTS, MULLIONS, SPIDER BRACKETS AND BRACKETS (U.S. CLS. 2, 12, 13, 14, 23, 25 AND 50).
FIRST USE 12-1-2000; IN COMMERCE 12-1-2000.

CLASS 19—NON-METALLIC BUILDING MATERIALS

FOR NON-METAL ROOFING MATERIALS FOR RESIDENTIAL AND COMMERCIAL GREENHOUSES, NAMELY, ROOF COVERINGS, TRUSSES, RAFTERS, HIPS, VENTS, MULLIONS, SPIDER BRACKETS, BRACKETS, PANELS AND TILES (U.S. CLS. 1, 12, 33 AND 50).
FIRST USE 12-1-2000; IN COMMERCE 12-1-2000.

2,998,680. J2 PRODUCTIONS, INC., LOS ANGELES, CA. SN
76-521,492. PUB. 1-20-2004, FILED 6-9-2003.

J2 FARMS

NO CLAIM IS MADE TO THE EXCLUSIVE RIGHT TO USE "FARMS", APART FROM THE MARK AS SHOWN.

CLASS 31—NATURAL AGRICULTURAL PRODUCTS

FOR RARE FRESH FRUIT (U.S. CLS. 1 AND 46).
FIRST USE 3-2-2004; IN COMMERCE 3-2-2004.

CLASS 41—EDUCATION AND ENTERTAINMENT

FOR TRAINING OF HUNTER-JUMPER HORSES (U.S. CLS. 100, 101 AND 107).
FIRST USE 4-5-2004; IN COMMERCE 4-5-2004.

2,998,681. WHITTMANHART, INC., CHICAGO, IL. SN 76-
522,370. PUB. 3-22-2005, FILED 5-29-2003.

**THE RESULT OF
POSSIBILITY**

CLASS 35—ADVERTISING AND BUSINESS

FOR ELECTRONIC BUSINESS CONSULTING SERVICES (U.S. CLS. 100, 101 AND 102).
FIRST USE 5-30-2003; IN COMMERCE 5-30-2003.

CLASS 42—SCIENTIFIC, COMPUTER AND LEGAL SERVICES

FOR INFORMATION TECHNOLOGY CONSULTING SERVICES FOR OTHERS (U.S. CLS. 100 AND 101).
FIRST USE 5-30-2003; IN COMMERCE 5-30-2003.

2,998,690. UNITED AGRI PRODUCTS, INC., GREELEY, CO.
SN 76-525,391. PUB. 8-31-2004, FILED 6-25-2003.

VERDICON

CLASS 1—CHEMICALS

FOR FERTILIZERS, MICRONUTRIENTS FOR ORNAMENTAL, TURF, DOMESTIC, COMMERCIAL AND AGRICULTURAL USES; SOIL WETTING AGENTS FOR DOMESTIC, COMMERCIAL AND AGRICULTURAL USE; AND ADJUVANTS FOR USE IN THE MANUFACTURE OF FERTILIZERS (U.S. CLS. 1, 5, 6, 10, 26 AND 46).
FIRST USE 7-7-2003; IN COMMERCE 7-7-2003.

CLASS 5—PHARMACEUTICALS

FOR PESTICIDES, INSECTICIDES, RODENTICIDES, FUNGICIDES AND HERBICIDES FOR ORNAMENTAL, TURF, DOMESTIC, COMMERCIAL AND AGRICULTURAL USES (U.S. CLS. 6, 18, 44, 46, 51 AND 52).
FIRST USE 7-7-2003; IN COMMERCE 7-7-2003.

CLASS 31—NATURAL AGRICULTURAL PRODUCTS

FOR GRASS AND WILDFLOWER SEEDS (U.S. CLS. 1 AND 46).
FIRST USE 7-7-2003; IN COMMERCE 7-7-2003.

2,998,696. TWELVE INCH LP, INC., EAST WINDSOR, NJ. SN 76-529,078. PUB. 6-15-2004, FILED 7-11-2003.

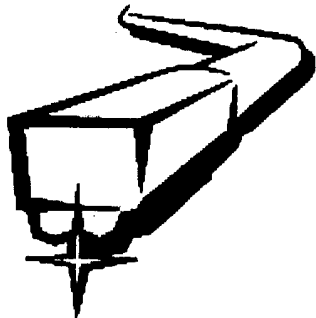

CLASS 25—CLOTHING

FOR ARTICLES OF CLOTHING, NAMELY, JACKETS, COATS, VESTS, BLAZERS, JERSEYS, ANORAKS, PULL-OVERS, TRACK SUITS, PANTS, TROUSERS, SLACKS, SWEATERS, SWEAT SHIRTS, SWEAT PANTS, T-SHIRTS, TANK TOPS, SHORTS, JEANS, SUITS, TURTLE NECKS, UNDERWEAR, BRIEFS, BOXER BRIEFS, AND BOXER SHORTS; WEARING ACCESSORIES, NAMELY, KERICHS AND BELTS; HEADWEAR, NAMELY, HATS, CAPS, SWEAT BANDS, SUN-VISORS, BERETS, BANDANNAS, HOODS, AND HEAD BANDS (U.S. CLS. 22 AND 39).

FIRST USE 6-1-2003; IN COMMERCE 6-1-2003.

CLASS 35—ADVERTISING AND BUSINESS

FOR RETAIL STORE SERVICES AND WHOLESALE DISTRIBUTORSHIPS FEATURING, APPAREL, APPAREL ACCESSORIES, LEATHER AND IMITATION LEATHER GOODS; ON-LINE RETAIL SERVICES, NAMELY FEATURING, APPAREL, APPAREL ACCESSORIES, LEATHER AND IMITATION LEATHER GOODS (U.S. CLS. 100, 101 AND 102).

FIRST USE 6-1-2003; IN COMMERCE 6-1-2003.

2,998,697. TWELVE INCH LP, INC., EAST WINDSOR, NJ. SN 76-529,079. PUB. 9-28-2004, FILED 7-11-2003.

TWELVE
I N C H LP

NO CLAIM IS MADE TO THE EXCLUSIVE RIGHT TO USE "LP", APART FROM THE MARK AS SHOWN.

THE MARK CONSISTS OF THE TERM "TWELVE" IN LARGE BOLD FONT. DIRECTLY BELOW SUCH TERM ARE THE TERMS "INCH LP".

CLASS 25—CLOTHING

FOR ARTICLES OF CLOTHING, NAMELY, JACKETS, COATS, VESTS, BLAZERS, JERSEYS, ANORAKS, PULL-OVERS, TRACK SUITS, PANTS, TROUSERS, SLACKS, SWEATERS, SWEAT SHIRTS, SWEAT PANTS, T-SHIRTS, TANK TOPS, SHORTS, JEANS, SUITS, TURTLE NECKS, UNDERWEAR, BRIEFS, BOXER BRIEFS, AND BOXER SHORTS; WEARING ACCESSORIES, NAMELY, KERICHS AND BELTS; HEADWEAR, NAMELY, HATS, CAPS, SWEAT BANDS, SUN-VISORS, BERETS, BANDANNAS, HOODS, AND HEAD BANDS (U.S. CLS. 22 AND 39).

FIRST USE 6-1-2003; IN COMMERCE 6-1-2003.

CLASS 35—ADVERTISING AND BUSINESS

FOR RETAIL STORE SERVICES AND WHOLESALE DISTRIBUTORSHIP SERVICES FEATURING, APPAREL, APPAREL ACCESSORIES, LEATHER AND IMITATION LEATHER GOODS; ON-LINE RETAIL SERVICES, NAMELY FEATURING, APPAREL, APPAREL ACCESSORIES, LEATHER AND IMITATION LEATHER GOODS (U.S. CLS. 100, 101 AND 102).

FIRST USE 6-1-2003; IN COMMERCE 6-1-2003.

2,998,701. COUNCIL OF INSURANCE AGENTS & BROKERS, THE, WASHINGTON, DC. SN 76-530,115. PUB. 4-20-2004, FILED 7-15-2003.

LEADER'S EDGE

CLASS 16—PAPER GOODS AND PRINTED MATTER

FOR PRINTED PUBLICATIONS REGARDING NEWS AND TOPICS OF INTEREST IN THE NATURE OF COMMERCIAL INSURANCE (U.S. CLS. 2, 5, 22, 23, 29, 37, 38 AND 50).

FIRST USE 1-0-2004; IN COMMERCE 1-0-2004.

CLASS 41—EDUCATION AND ENTERTAINMENT

FOR ONLINE PUBLICATIONS REGARDING NEWS AND TOPICS OF INTEREST IN THE NATURE OF COMMERCIAL INSURANCE (U.S. CLS. 100, 101 AND 107).

FIRST USE 1-0-2004; IN COMMERCE 1-0-2004.

2,998,709. SHEAKLEY RESOLUTION SYSTEMS, L.L.C., CINCINNATI, OH. SN 76-534,451. PUB. 10-19-2004, FILED 8-4-2003.

SHEAKLEY RESOLUTION SYSTEMS

NO CLAIM IS MADE TO THE EXCLUSIVE RIGHT TO USE "RESOLUTION SYSTEMS", APART FROM THE MARK AS SHOWN.

CLASS 35—ADVERTISING AND BUSINESS

FOR MEDICAL CLAIMS MANAGEMENT SERVICES AND ACCOUNTS RECEIVABLE MANAGEMENT SERVICES, NAMELY, MEDICAL INSURANCE CLAIMS AUDITING, MEDICAL INSURANCE CLAIMS DENIAL AUDITING, UTILIZATION REVIEW, AND PRE-CERTIFICATION SERVICES (U.S. CLS. 100, 101 AND 102).

FIRST USE 2-20-2004; IN COMMERCE 2-20-2004.

CLASS 36—INSURANCE AND FINANCIAL

FOR MEDICAL INSURANCE CLAIMS CONSULTING (U.S. CLS. 100, 101 AND 102).
FIRST USE 2-20-2004; IN COMMERCE 2-20-2004.

2,998,723. MEDIMPACT HEALTHCARE SYSTEMS, INC., SAN DIEGO, CA. SN 76-540,479. PUB. 8-31-2004, FILED 8-27-2003.

2,998,712. ILINK TECHNOLOGIES CORPORATION, VANCOUVER, BRITISH COLUMBIA, CANADA. SN 76-535,103. PUB. 11-30-2004, FILED 8-7-2003.

MEDIA THAT MOVES YOU

PRIORITY CLAIMED UNDER SEC. 44(D) ON CANADA APPLICATION NO. 1168075, FILED 2-13-2003, REG. NO. TMA617247, DATED 8-20-2004, EXPIRES 8-20-2019.

CLASS 9—ELECTRICAL AND SCIENTIFIC APPARATUS

FOR (BASED ON USE IN COMMERCE) COMPUTER HARDWARE; COMPUTER SOFTWARE WHICH PROVIDES INTERACTION AND COMMUNICATES WITH ELECTRONIC DATA FOR THE TRANSPORTATION INDUSTRY (U.S. CLS. 21, 23, 26, 36 AND 38).
FIRST USE 9-0-2003; IN COMMERCE 9-0-2003.

CLASS 42—SCIENTIFIC, COMPUTER AND LEGAL SERVICES

FOR (BASED ON USE IN COMMERCE AND BASED ON 44(E)) CUSTOM DESIGN, SELECTION AND IMPLEMENTATION OF COMPUTER HARDWARE AND SOFTWARE WHICH PROVIDES INTERACTION AND COMMUNICATES WITH ELECTRONIC DATA FOR THE TRANSPORTATION INDUSTRY (U.S. CLS. 100 AND 101).
FIRST USE 9-0-2003; IN COMMERCE 9-0-2003.

2,998,717. PRYM-DRITZ CORPORATION, SPARTANBURG, SC. SN 76-537,181. PUB. 12-28-2004, FILED 8-4-2003.

ELIZABETH'S VINTAGE NOTIONS

NO CLAIM IS MADE TO THE EXCLUSIVE RIGHT TO USE "VINTAGE NOTIONS", APART FROM THE MARK AS SHOWN.

CLASS 8—HAND TOOLS

FOR SCISSORS AND SCISSORS CASES (U.S. CLS. 23, 28 AND 44).
FIRST USE 1-1-2004; IN COMMERCE 1-1-2004.

CLASS 9—ELECTRICAL AND SCIENTIFIC APPARATUS

FOR TAPE MEASURES AND MAGNIFYING LENSES (U.S. CLS. 21, 23, 26, 36 AND 38).
FIRST USE 1-1-2004; IN COMMERCE 1-1-2004.

CLASS 26—FANCY GOODS

FOR SEAM RIPPERS, CHATELAINE PINS, NEEDLE CASES, SPOOL KNAVES, NEEDLES, RIBBON BODKINS, THIMBLES, NEEDLE THREADERS AND PIN CUSHIONS (U.S. CLS. 37, 39, 40, 42 AND 50).
FIRST USE 1-1-2004; IN COMMERCE 1-1-2004.

MEDACCESS

THE MARK CONSISTS OF STANDARD CHARACTERS WITHOUT CLAIM TO ANY PARTICULAR FONT, STYLE, SIZE, OR COLOR.

CLASS 36—INSURANCE AND FINANCIAL

FOR PROVIDING INFORMATION AND CONSULTATION IN THE AREA OF HEALTHCARE BENEFIT AND INSURANCE CLAIMS (U.S. CLS. 100, 101 AND 102).
FIRST USE 4-1-1993; IN COMMERCE 5-1-1996.

CLASS 42—SCIENTIFIC, COMPUTER AND LEGAL SERVICES

FOR PROVIDING TEMPORARY USE OF NON-DOWNLOADABLE COMPUTER SOFTWARE TO REVIEW DATED CLAIMS, MANIPULATED BENEFIT DESIGNS, MONITOR, CHANGE, UPDATE, APPROVE OR DENY CLAIMS, TRACK BENEFIT INFORMATION, AND EXPEDITE PRIOR AUTHORIZATIONS, ALL OVER COMPUTER NETWORKS (U.S. CLS. 100 AND 101).
FIRST USE 4-1-1993; IN COMMERCE 5-1-1996.

2,998,726. FINETRE CORPORATION, HERNDON, VA. SN 76-542,282. PUB. 9-28-2004, FILED 9-3-2003.

FINETRE**CLASS 36—INSURANCE AND FINANCIAL**

FOR FINANCIAL SERVICES, NAMELY, COMPUTERIZED FINANCIAL DATA MANAGEMENT, AND FINANCIAL INFORMATION AND REPORT PROCESSING (U.S. CLS. 100, 101 AND 102).
FIRST USE 2-23-2005; IN COMMERCE 2-23-2005.

CLASS 41—EDUCATION AND ENTERTAINMENT

FOR FINANCIAL PUBLISHING, NAMELY, PUBLICATION OF FINANCIAL REPORTS AND RESEARCH IN THE FIELD OF ANNUITIES, LIFE INSURANCE, AND MUTUAL FUNDS (U.S. CLS. 100, 101 AND 107).
FIRST USE 2-23-2005; IN COMMERCE 2-23-2005.

2,998,729. FASTEMS OY AB, 33840 TAMPERE, FINLAND.
SN 76-543,857. PUB. 2-8-2005, FILED 8-29-2003.



PRIORITY CLAIMED UNDER SEC. 44(D) ON ERP
CMNTY TM OFC APPLICATION NO. 003079746, FILED 3-
3-2003, REG. NO. 003079746, DATED 7-26-2004, EXPIRES 3-13-
2013.

CLASS 7—MACHINERY

FOR CRANES, CONVEYORS AND PALLET LOAD-
ING/UNLOADING STATION MACHINES FOR MA-
CHINE PALLET AND MATERIAL PALLET HANDLING
(U.S. CLS. 13, 19, 21, 23, 31, 34 AND 35).
FIRST USE 3-11-2005; IN COMMERCE 5-0-2005.

CLASS 9—ELECTRICAL AND SCIENTIFIC APPARATUS

FOR COMPUTER HARDWARE AND ELECTRONIC
ACCESSORIES COMPRISING DISPLAYS, CENTRAL
PROCESSING UNITS, COMPUTER MODULES, KEY-
BOARDS, MICE, MODEMS, ELECTRONIC SENSORS
AND CABLES FOR CONTROLLING AUTOMATED IN-
DUSTRIAL MATERIAL HANDLING SYSTEMS; COM-
PUTER SOFTWARE AND PROGRAMS TO INTEGRATE
MANUFACTURING MACHINE OPERATIONS AND MA-
TERIAL HANDLING OPERATIONS; FACTORY AUTO-
MATION SOFTWARE AND COMPUTER PROGRAMS,
NAMELY, FACTORY AUTOMATION SOFTWARE AND
COMPUTER PROGRAMS FOR MATERIAL MANAGE-
MENT, PRODUCTION ORDERS, CAPACITY SIMULA-
TION, RESOURCE MANAGEMENT, REMOTE
ALARMING, MONITORING, CONTROLLING AND
MANAGING OF MANUFACTURING SYSTEMS AND
INDUSTRIAL MATERIAL HANDLING SYSTEMS (U.S.
CLS. 21, 23, 26, 36 AND 38).
FIRST USE 3-11-2005; IN COMMERCE 5-0-2005.

CLASS 37—CONSTRUCTION AND REPAIR

FOR REPAIR AND INSTALLATION SERVICES,
NAMELY, INSTALLATION, MAINTENANCE, AND RE-
PAIR OF MANUFACTURING SYSTEMS AND INDUS-
TRIAL MATERIAL HANDLING SYSTEMS IN THE
FIELDS OF MACHINERY, MACHINE, METAL, AND
PLASTIC INDUSTRIES (U.S. CLS. 100, 103 AND 106).
FIRST USE 1-0-2005; IN COMMERCE 5-0-2005.

2,998,738. TOTALVID, INC., NORFOLK, VA. SN 76-549,212.
PUB. 1-18-2005, FILED 10-6-2003.

TOTALVID

CLASS 35—ADVERTISING AND BUSINESS

FOR OPERATING ONLINE MARKETPLACES FOR
SELLERS OF GOODS AND/OR SERVICES IN THE
FIELD OF VIDEOCASSETTES AND DVDS; ONLINE
RETAIL STORE SERVICES FEATURING VIDEOCAS-
SETTES AND DVDS (U.S. CLS. 100, 101 AND 102).
FIRST USE 12-31-2003; IN COMMERCE 12-31-2003.

CLASS 38—COMMUNICATION

FOR STREAMING OF AUDIOVISUAL MATERIAL ON
THE INTERNET; ELECTRONIC DISTRIBUTION OF
DOWNLOADABLE AUDIOVISUAL FILES (U.S. CLS.
100, 101 AND 104).
FIRST USE 12-31-2003; IN COMMERCE 12-31-2003.

2,998,766. US TOO INTERNATIONAL, INC., DOWNERS
GROVE, IL. SN 76-565,682. PUB. 4-5-2005, FILED 12-8-
2003.



OWNER OF U.S. REG. NOS. 1,670,676 AND 1,837,867.

CLASS 9—ELECTRICAL AND SCIENTIFIC APPARATUS

FOR DOWNLOADABLE ELECTRONIC PUBLICA-
TIONS, NAMELY, NEWSLETTERS IN THE FIELD OF
PROSTATE CANCER; ELECTRONIC PUBLICATIONS,
NAMELY, NEWSLETTERS FEATURING INFORMA-
TION REGARDING PROSTATE CANCER RECORDED
ON COMPUTER MEDIA; DOWNLOADABLE VIDEO
RECORDINGS IN THE NATURE OF MAGAZINE FEAT-
URING INFORMATION REGARDING PROSTATE
CANCER; PRERECORDED VIDEO TAPES AND CAS-
SETTES FEATURING INFORMATION REGARDING
PROSTATE CANCER (U.S. CLS. 21, 23, 26, 36 AND 38).
FIRST USE 12-0-2003; IN COMMERCE 12-0-2003.

CLASS 16—PAPER GOODS AND PRINTED MATTER

FOR MAGAZINES AND BOOKLETS FEATURING
INFORMATION RELATING TO PROSTATE CANCER
(U.S. CLS. 2, 5, 22, 23, 29, 37, 38 AND 50).
FIRST USE 12-0-2003; IN COMMERCE 12-0-2003.

CLASS 41—EDUCATION AND ENTERTAIN- MENT

FOR NON-DOWNLOADABLE ELECTRONIC PUBLI-
CATIONS, NAMELY, PROVIDING ON-LINE NEWSLET-
TERS IN THE FIELD OF PROSTATE CANCER;
EDUCATIONAL SERVICES, NAMELY, CONDUCTING
CLASSES, SEMINARS, CONFERENCES, AND WORK-
SHOPS IN THE FIELD OF PROSTATE CANCER (U.S.
CLS. 100, 101 AND 107).
FIRST USE 12-0-2003; IN COMMERCE 12-0-2003.

2,998,771. TEAM 02 INVESTMENTS, LLC, COLORADO SPRINGS, CO. SN 76-566,788. PUB. 10-26-2004, FILED 12-8-2003.



CLASS 25—CLOTHING

FOR T-SHIRTS; HATS (U.S. CLS. 22 AND 39).
FIRST USE 5-1-2003; IN COMMERCE 5-1-2003.

CLASS 41—EDUCATION AND ENTERTAINMENT

FOR RECREATIONAL SERVICES IN THE NATURE OF WATER PARKS (U.S. CLS. 100, 101 AND 107).
FIRST USE 5-1-2003; IN COMMERCE 5-1-2003.

CLASS 43—HOTEL AND RESTAURANT SERVICES

FOR RESORT HOTELS; PROVIDING CONVENTION FACILITIES FOR GENERAL PURPOSES (U.S. CLS. 100 AND 101).
FIRST USE 5-1-2003; IN COMMERCE 5-1-2003.

2,998,784. IDATECH, LLC, BEND, OR. SN 76-571,170. PUB. 10-26-2004, FILED 1-12-2004.

ηGEN

CLASS 9—ELECTRICAL AND SCIENTIFIC APPARATUS

FOR ELECTRICAL POWER GENERATION EQUIPMENT, NAMELY, FUEL CELLS, PROTON EXCHANGE MEMBRANE FUEL CELLS, FUEL CELL STACKS, AND FUEL CELL SYSTEMS AND COMPONENTS FOR STATIONARY AND PORTABLE ELECTRIC POWER GENERATION COMPRISED OF FUEL CELL STACKS AND FUEL PROCESSORS TO PRODUCE FUEL STREAMS FOR THE FUEL CELL STACKS (U.S. CLS. 21, 23, 26, 36 AND 38).
FIRST USE 4-11-2005; IN COMMERCE 4-11-2005.

CLASS 11—ENVIRONMENTAL CONTROL APPARATUS

FOR HYDROGEN-GENERATION EQUIPMENT AND COMPONENTS, NAMELY, HYDROGEN GENERATORS, HYDROGEN PURIFIERS, HYDROGEN PURIFICATION MEMBRANES, FUEL PROCESSORS, STEAM REFORMERS, AND FUEL PROCESSING SYSTEMS COMPRISED OF FUEL PROCESSORS AND ANCILLARY COMPONENTS (U.S. CLS. 13, 21, 23, 31 AND 34).
FIRST USE 4-11-2005; IN COMMERCE 4-11-2005.

2,998,789. DOLLAR THRIFTY AUTOMOTIVE GROUP, INC., TULSA, OK. SN 76-574,568. PUB. 11-16-2004, FILED 2-9-2004.

VALUE EVERY TIME

THE MARK CONSISTS OF STANDARD CHARACTERS WITHOUT CLAIM TO ANY PARTICULAR FONT, STYLE, SIZE, OR COLOR.

CLASS 35—ADVERTISING AND BUSINESS

FOR RENDERING TECHNICAL AID AND ASSISTANCE IN THE ESTABLISHMENT AND OPERATION OF VEHICLE RENTING AND LEASING BUSINESSES (U.S. CLS. 100, 101 AND 102).
FIRST USE 2-28-2004; IN COMMERCE 2-28-2004.

CLASS 39—TRANSPORTATION AND STORAGE

FOR VEHICLE RENTING AND LEASING SERVICES (U.S. CLS. 100 AND 105).
FIRST USE 2-28-2004; IN COMMERCE 2-28-2004.

2,998,792. WOODSTOCK PERCUSSION, INC., SHOKON, NY. SN 76-576,767. PUB. 12-7-2004, FILED 2-23-2004.

WOODSTOCK ENVIRONMENTS

THE MARK CONSISTS OF STANDARD CHARACTERS WITHOUT CLAIM TO ANY PARTICULAR FONT, STYLE, SIZE, OR COLOR.

CLASS 6—METAL GOODS

FOR METAL GOODS, NAMELY, METAL GARDEN STAKES, METAL BIRD BATHS, METAL MAIL BOXES, METAL WEATHER VANES, METAL WINDOW FRAMES, METAL WINDOWS AND INDOOR AND OUTDOOR ORNAMENTS MADE OF METAL (U.S. CLS. 2, 12, 13, 14, 23, 25 AND 50).
FIRST USE 10-1-2004; IN COMMERCE 10-1-2004.

CLASS 19—NON-METALLIC BUILDING MATERIALS

FOR NON-METALLIC BUILDING MATERIALS, NAMELY, NON-METAL WINDOWS, NON-METAL WINDOW FRAMES NAMELY WOOD WINDOW FRAMES, NON-METAL WINDOW SCREENS, NONMETAL WINDOW SHUTTERS, BIRD BATHS MADE OF WOOD AND BIRD BATHS MADE OF CONCRETE (U.S. CLS. 1, 12, 33 AND 50).
FIRST USE 1-14-2005; IN COMMERCE 1-14-2005.

CLASS 21—HOUSEWARES AND GLASS

FOR HOUSEWARES AND GLASS, NAMELY, WATERING CANS, CONTAINERS FOR HOUSEHOLD AND KITCHEN USE NOT OF PRECIOUS METAL; BIRD FEEDERS, BIRD HOUSES AND BIRD BATHS THAT ARE NOT STRUCTURES (U.S. CLS. 2, 13, 23, 29, 30, 33, 40 AND 50).
FIRST USE 1-14-2005; IN COMMERCE 1-14-2005.

2,998,799. BEIERSDORF AKTIENGESELLSCHAFT, 20245 HAMBURG, FED REP GERMANY. SN 76-579,178. PUB. 11-30-2004, FILED 3-4-2004.

INSPIRED BY THE WAY SKIN WORKS

THE MARK CONSISTS OF STANDARD CHARACTERS WITHOUT CLAIM TO ANY PARTICULAR FONT, STYLE, SIZE, OR COLOR.

CLASS 3—COSMETICS AND CLEANING PREPARATIONS

FOR PREPARATIONS FOR BODY AND BEAUTY CARE, NAMELY, SKIN CREAMS, GELS AND LOTIONS; SKIN CLEANSING CREAMS, GELS AND LOTIONS; FACE LOTIONS (U.S. CLS. 1, 4, 6, 50, 51 AND 52).
FIRST USE 2-0-2004; IN COMMERCE 2-0-2004.

CLASS 44—MEDICAL, BEAUTY AND AGRICULTURAL SERVICES

FOR PROVIDING INFORMATION RELATING TO BODY AND BEAUTY CARE (U.S. CLS. 100 AND 101).
FIRST USE 2-0-2004; IN COMMERCE 2-0-2004.

2,998,803. SHABBY CHIC, INC., LOS ANGELES, CA. SN 76-580,952. PUB. 12-21-2004, FILED 3-15-2004.



OWNER OF U.S. REG. NOS. 1,753,006, 2,757,921, AND OTHERS.

CLASS 11—ENVIRONMENTAL CONTROL APPARATUS

FOR LAMP SHADES AND LAMPS (U.S. CLS. 13, 21, 23, 31 AND 34).
FIRST USE 2-29-2004; IN COMMERCE 2-29-2004.

CLASS 16—PAPER GOODS AND PRINTED MATTER

FOR PAPER NAPKINS, SERIES OF BOOKS ABOUT INTERIOR DECORATION AND HOME FURNISHINGS, WALL POSTERS, PENCILS, PENCIL HOLDERS, PEN CLIPS, PENCIL CASES, WRITING PAPER, NOTE PAD PAPER, PLASTIC AND FABRIC PEN AND PENCIL CASES, BATHROOM TISSUES, WALLPAPER PATTERN BOOKS, CALENDARS AND STATIONERY (U.S. CLS. 2, 5, 22, 23, 29, 37, 38 AND 50).
FIRST USE 2-29-2004; IN COMMERCE 2-29-2004.

CLASS 18—LEATHER GOODS

FOR FABRIC TOTE BAGS, BACKPACKS, ALL PURPOSE SPORTS BAGS, UMBRELLAS, LEATHER KEY FOBS, LUGGAGE TAGS, DUFFLE BAGS, TRAVELING BAGS, GARMENT BAGS FOR TRAVEL, LUGGAGE, WALLETS, PURSES AND HANDBAGS (U.S. CLS. 1, 2, 3, 22 AND 41).
FIRST USE 2-29-2004; IN COMMERCE 2-29-2004.

CLASS 20—FURNITURE AND ARTICLES NOT OTHERWISE CLASSIFIED

FOR FURNITURE; NAMELY, CHAIR PADS, WALL UNITS, END TABLES, NIGHT STANDS, VANITY TABLES, COFFEE TABLES, DINING TABLES, ARMOIRES, BOOKCASES, CHAIRS, SOFAS, OTTOMANS, COUCHES, PILLOWS, LOVE SEATS, TABLES, ROOM DIVIDER SCREENS, FIRE PLACE SCREENS, WALL CABINETS, DRESSERS AND FITTED FABRIC COVERS FOR FURNITURE, FABRIC CHAIR PADS, AND NON-METAL SHOWER HOOKS (U.S. CLS. 2, 13, 22, 25, 32 AND 50).
FIRST USE 2-29-2004; IN COMMERCE 2-29-2004.

CLASS 21—HOUSEWARES AND GLASS

FOR TOOTHBRUSH HOLDERS; TOOTHBRUSHES; TUMBLERS; MEAL TRAYS—LOTION DISPENSERS AND PUMPS; SOAP DISHES; FITTED VANITY CASES; WASTEBASKETS; SHOWER HOOKS; TOWEL BARS; SHOWER CADDIES; PERFUME SPRAYERS SOLD EMPTY; MUGS; MUG TREES; GLASS AND PORCELAIN FABRIC MITTS FOR CLEANING; NAPKIN HOLDERS; NAIL BRUSHES; HAIR COMBS; HAIR BRUSHES; BOTTLE OPENERS; CHINA, CRYSTAL, GLASS, PORCELAIN, AND TERRA COTTA CHRISTMAS, HOLIDAY AND THEME ORNAMENTS NOT BEING TREE ORNAMENTS; MOPS; BROOMS; DINNERWARE; CHINA DINNERWARE; DISHES; CUPS; DRINKING GLASSES; GLASS BOWLS; GLASS PANS; PAPER CUPS AND PLATES; PITCHERS; PLATES; SALT AND PEPPER SHAKERS; SERVING SPOONS; SPICE RACKS; LUNCH BOXES; JUGS; NON-METAL KEEPSAKE BOXES; NON-METAL DECORATIVE BOXES; DECORATIVE GLASS BOXES; NON-METAL TRINKET BOXES; CANDLE HOLDERS NOT OF PRECIOUS METAL; CANDLE STICKS NOT OF PRECIOUS METAL (U.S. CLS. 2, 13, 23, 29, 30, 33, 40 AND 50).
FIRST USE 2-29-2004; IN COMMERCE 2-29-2004.

CLASS 24—FABRICS

FOR FABRIC NAPKINS, FABRICS, LINENS AND TEXTILES FOR THE FURTHER MANUFACTURE OF HOUSEWARES; FABRIC, LINEN AND TEXTILE PIECES FOR THE FURTHER MANUFACTURE OF HOUSEWARES; FABRICS, LINENS AND TEXTILES FOR THE FURTHER MANUFACTURE OF BEDDING, BATHWARE, FURNITURE, HOME FURNISHINGS, HOUSEHOLD GOODS, WINDOW TREATMENTS AND CLOTHING; BED SPREADS; BED SHEETS; FITTED BED SHEETS; FLAT BED SHEETS; POPLIN AND T-SHIRT BED SHEETS; BED BLANKETS; RECEIVING BLANKETS; BED CANOPIES; DUVETS; DUVET COVERS; BED PADS; BEDDING LINEN; DUST RUFFLES; PILLOW CASES; PILLOW SHAMS; POTATOSACK PILLOW CASES; PILLOW CASES WITH RUFFLES; PILLOW SHAMS WITH RUFFLES; RUFFLED BEDSKIRTS; BEDSKIRTS; COMFORTERS; TEXTILE BATH MATS; TOWELS; HOODED TOWELS; BATH LINENS; BATH MATS; CLOTH BANNERS; FABRIC CURTAINS; DRAPERIES; DRAPERY PANELS; DISH CLOTHS; CLOTH DOILIES; CLOTH AND TEXTILE NAPKINS; WASH CLOTHS; CLOTH AND TEXTILE PLACEMATS; PUFFS FOR WINDOW TREATMENTS; FABRIC TABLE RUNNERS; SHROUDS; TABLE CLOTHS NOT OF PAPER; TEXTILE TAPESTRIES; FABRIC VALANCES; FABRIC CHAIR PADS; QUILTS; QUILTED SHAMS; SHOWER CURTAINS; TOWELS; BATHROOM TOWELS; HAND TOWELS; WASH TOWELS; KITCHEN TOWELS; POT HOLDERS; AND MATTRESS PADS (U.S. CLS. 42 AND 50).
FIRST USE 2-29-2004; IN COMMERCE 2-29-2004.

CLASS 25—CLOTHING

FOR WOMEN'S CLOTHING, NAMELY, SHIRTS, JACKETS, SLACKS, PANTS, SHORTS, SWEATERS, SWIM WEAR, SKIRTS, SUITS, TANK TOPS, T-SHIRTS, HALTERS, JACK SHIRTS, COMBINATION SHIRT AND JACKETS, BELTS, SWEATSHIRTS, SWEAT PANTS, JERSEYS, SPORT SHIRTS, SWEATERS, NIGHTSHIRTS, WARM-UP SUITS, PARKAS, COATS, POLO SHIRTS, BODY SUITS, JOGGING SUITS, ROBES, SOCKS, GOLF SHIRTS, JEANS, FOOTWEAR, UNDERWEAR, GLOVES, HEAD WEAR, CAPS, SLEEP WEAR, HEADBANDS, WRISTBANDS, AND SWEAT BANDS (U.S. CLS. 22 AND 39).

FIRST USE 2-29-2004; IN COMMERCE 2-29-2004.

CLASS 27—FLOOR COVERINGS

FOR RUGS, CARPETS, DOORMATS, RUBBER PLASTIC BATH MATS, CARPET PADDING, BATHROOM RUGS AND TEXTILE FLOOR MATS FOR USE IN HOME, TEXTILE BATH MATS; AND BATH MATS (U.S. CLS. 19, 20, 37, 42 AND 50).

FIRST USE 2-29-2004; IN COMMERCE 2-29-2004.

2,998,817. THE KROGER CO. OF MICHIGAN, LIVONIA, MI. SN 76-585,802. PUB. 10-26-2004, FILED 4-8-2004.

HOLIDAY HOME

THE MARK CONSISTS OF STANDARD CHARACTERS WITHOUT CLAIM TO ANY PARTICULAR FONT, STYLE, SIZE, OR COLOR.

OWNER OF U.S. REG. NOS. 2,253,726, 2,640,116, AND OTHERS.

CLASS 11—ENVIRONMENTAL CONTROL APPARATUS

FOR FOG MAKING MACHINES, DECORATIVE STRINGS OF ELECTRIC LIGHTS AND ELECTRIC LIGHTS IN THE SHAPE OF DECORATIVE FIGURES (U.S. CLS. 13, 21, 23, 31 AND 34).

FIRST USE 9-0-1993; IN COMMERCE 9-0-1993.

CLASS 15—MUSICAL INSTRUMENTS

FOR MUSIC BOXES (U.S. CLS. 2, 21 AND 36).
FIRST USE 10-0-2002; IN COMMERCE 10-0-2002.

CLASS 20—FURNITURE AND ARTICLES NOT OTHERWISE CLASSIFIED

FOR SEASONAL DECORATIONS, NAMELY TABLETOP FIGURINES MADE OF WOOD, RESIN AND FABRIC (U.S. CLS. 2, 13, 22, 25, 32 AND 50).

FIRST USE 11-0-1999; IN COMMERCE 11-0-1999.

CLASS 21—HOUSEWARES AND GLASS

FOR CANDLE HOLDERS NOT OF PRECIOUS METAL; SEASONAL DECORATIONS, NAMELY TABLETOP FIGURINES MADE OF CLAY AND GLASS (U.S. CLS. 2, 13, 23, 29, 30, 33, 40 AND 50).

FIRST USE 11-0-1999; IN COMMERCE 11-0-1999.

CLASS 28—TOYS AND SPORTING GOODS

FOR SNOW GLOBES (U.S. CLS. 22, 23, 38 AND 50).
FIRST USE 3-0-1997; IN COMMERCE 3-0-1997.

2,998,830. BENESOLUTIONS, INC., WASHINGTON, DC. SN 76-976,754. PUB. 5-13-2003, FILED 1-18-2001.

MEDICARE ADVANTAGE PPO

NO CLAIM IS MADE TO THE EXCLUSIVE RIGHT TO USE "MEDICARE" AND "PPO", APART FROM THE MARK AS SHOWN.

CLASS 35—ADVERTISING AND BUSINESS

FOR PROVIDING BUSINESS CONSULTATION SERVICES IN THE FIELDS OF ORGANIZATION AND ADMINISTRATION OF PREFERRED PROVIDER PLANS AND ORGANIZED CARE SYSTEMS (U.S. CLS. 100, 101 AND 102).

FIRST USE 1-1-2001; IN COMMERCE 1-1-2001.

CLASS 36—INSURANCE AND FINANCIAL

FOR ORGANIZING PREFERRED PROVIDER PLAN AND ORGANIZED CARE SYSTEMS IN THE FIELD OF HEALTHCARE FOR OTHERS (U.S. CLS. 100, 101 AND 102).

FIRST USE 1-1-2001; IN COMMERCE 2-1-2001.

2,998,832. ITOCHU CORPORATION, OSAKA-SHI, OSAKA, JAPAN. SN 76-977,302. PUB. 6-1-2004, FILED 12-31-2002.

MOGU

CLASS 10—MEDICAL APPARATUS

FOR BEDS FOR PREVENTING PRESSURE SORES ON PATIENT BODIES, CUSHIONS FOR PREVENTING PRESSURE SORES ON PATIENT BODIES, MEDICAL BAGS DESIGNED TO HOLD MEDICAL INSTRUMENTS SOLD EMPTY, MEDICAL PATIENT TREATMENT CHAIRS AND BIRTHING CHAIRS; SUPPORTS FOR BACK, ANKLE AND WRIST FOR MEDICAL USE; HEATING PADS, MATTRESSES OF CLOTH FOR PREVENTING PRESSURE SORES ON PATIENT BODIES, AND PILLOWS OF CLOTH FOR PREVENTING PRESSURE SORES ON PATIENT BODIES (U.S. CLS. 26, 39 AND 44).

FIRST USE 4-2-2004; IN COMMERCE 4-2-2004.

CLASS 20—FURNITURE AND ARTICLES NOT OTHERWISE CLASSIFIED

FOR BEDS, BED FITTINGS, BENCHES, CHAIRS, SEATS, DIVANS, EASY CHAIRS, SOFAS AND OTHER ITEMS OF FURNITURE, NAMELY TABLES, ARMCHAIRS, COUNTERS AND DESKS, BOLSTER CUSHIONS, CRADLES, CUSHIONS, MATTRESSES, PILLOWS, SLEEPING BAGS AND BEDS FOR HOUSEHOLD PETS; MATTRESSES OF CLOTH FOR BACK SUPPORT (U.S. CLS. 2, 13, 22, 25, 32 AND 50).

FIRST USE 9-15-2001; IN COMMERCE 12-25-2002.

2,998,834. RFR MANAGEMENT LLC, NEW YORK, NY. SN 76-977,677. PUB. 10-19-2004, FILED 2-17-2004.

KAY UNGER

THE MARK CONSISTS OF STANDARD CHARACTERS WITHOUT CLAIM TO ANY PARTICULAR FONT, STYLE, SIZE, OR COLOR.

OWNER OF U.S. REG. NOS. 1,984,160, 1,988,483, AND 2,500,982.

"KAY UNGER" IS A LIVING INDIVIDUAL WHOSE CONSENT IS OF RECORD.

CLASS 20—FURNITURE AND ARTICLES NOT OTHERWISE CLASSIFIED

FOR PICTURE FRAMES, PILLOWS, DECORATIVE PILLOWS, BATH PILLOWS AND MIRRORS (U.S. CLS. 2, 13, 22, 25, 32 AND 50).

FIRST USE 6-1-2005; IN COMMERCE 6-1-2005.

CLASS 24—FABRICS

FOR DUVETS WITH COORDINATING DUST RUFFLES, COMFORTERS, QUILTS AND COVERLETS, SHEETS, BLANKET THROWS, PILLOW SHAMS, DRAPERIES AND CURTAINS, TOWELS, MATTRESS PADS, SHOWER CURTAINS, TABLE LINENS, WINDOW TREATMENTS, NAMELY POUFS AND SWAGS (U.S. CLS. 42 AND 50).

FIRST USE 6-1-2005; IN COMMERCE 6-1-2005.

2,998,837. HUXHOLD, JAMES B., INDIANAPOLIS, IN. SN 78-026,135. PUB. 2-12-2002, FILED 9-15-2000.

STAY FOCUSED

CLASS 16—PAPER GOODS AND PRINTED MATTER

FOR PAPER GOODS AND PRINTED MATTER; NAMELY, BUMPER STICKERS, NOTE PADS, POSTERS, AND PAPER BANNERS (U.S. CLS. 2, 5, 22, 23, 29, 37, 38 AND 50).

FIRST USE 5-7-2005; IN COMMERCE 5-7-2005.

CLASS 28—TOYS AND SPORTING GOODS

FOR GOLF BALLS; GOLF CLUB HEADS; GOLF CLUB SHAFTS; GOLF BAGS; GOLF CLUB HEAD COVERS; AND OTHER RELATED GOLF PRODUCTS, NAMELY, TEES; DIVOT REPAIR TOOLS; GOLF BALL MARKERS; GOLF BALL RETRIEVERS; GOLF BALL SLEEVES; GOLF BAG COVERS; GOLF BAGS TAGS; GOLF CLUB GRIPS; GOLF CARTS; GOLF GLOVES; GOLF TOWELS; AND GOLF UMBELLAS (U.S. CLS. 22, 23, 38 AND 50).

FIRST USE 5-7-2005; IN COMMERCE 5-7-2005.

2,998,838. MARIKA GROUP, INC., THE, SAN DIEGO, CA. SN 78-033,562. PUB. 11-5-2002, FILED 11-2-2000.

MARIKA.COM

CLASS 35—ADVERTISING AND BUSINESS

FOR COMPUTERIZED ON-LINE RETAIL SERVICES IN THE FIELDS OF CLOTHING, SPORTS EQUIPMENT AND GENERAL MERCHANDISE (U.S. CLS. 100, 101 AND 102).

FIRST USE 5-31-2005; IN COMMERCE 5-31-2005.

CLASS 41—EDUCATION AND ENTERTAINMENT

FOR PROVIDING INFORMATION VIA WEBSITES ON GLOBAL COMPUTER NETWORKS IN THE FIELDS OF FITNESS AND EXERCISE INSTRUCTION, ENTERTAINMENT, RECREATION, AND SPORTS (U.S. CLS. 100, 101 AND 107).

FIRST USE 5-31-2005; IN COMMERCE 5-31-2005.

CLASS 42—SCIENTIFIC, COMPUTER AND LEGAL SERVICES

FOR PROVIDING INFORMATION VIA WEBSITES ON GLOBAL COMPUTER NETWORKS IN THE FIELDS OF FITNESS CONSULTATION, HEALTH, FASHION, AND CLOTHING (U.S. CLS. 100 AND 101).

FIRST USE 5-31-2005; IN COMMERCE 5-31-2005.

2,998,839. BIOMAX INFORMATICS AG, 82152 MARTINSRIED, FED REP GERMANY. SN 78-035,194. PUB. 8-17-2004, FILED 11-14-2000.

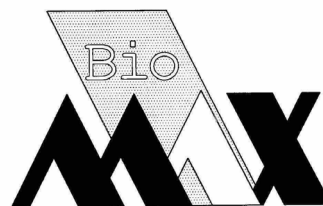

OWNER OF FED REP GERMANY REG. NO. 39843806, DATED 2-12-1999, EXPIRES 8-31-2008.

NO CLAIM IS MADE TO THE EXCLUSIVE RIGHT TO USE "BIO", APART FROM THE MARK AS SHOWN.

THE STIPPLING IS FOR SHADING PURPOSES ONLY AND DOES NOT INDICATE COLOR.

CLASS 9—ELECTRICAL AND SCIENTIFIC APPARATUS

FOR SOFTWARE TO ANALYZE AND MANAGE BIOLOGICAL AND CHEMICAL DATA (U.S. CLS. 21, 23, 26, 36 AND 38).

FIRST USE 0-0-1998; IN COMMERCE 0-0-1998.

CLASS 42—SCIENTIFIC, COMPUTER AND LEGAL SERVICES

FOR CONSULTATION AND DEVELOPING OF SOFTWARE USED TO ANALYZE AND MANAGE DATA GENERATED FROM PROTEIN AND NUCLEIC ACID SEQUENCES, GENE EXPRESSION, PROTEOMICS, AND BIOCHEMICAL PROCESS EXPERIMENTS (U.S. CLS. 100 AND 101).

FIRST USE 0-0-1998; IN COMMERCE 0-0-1998.

2,998,842. HENRY, STEVEN C., GENEVA, IL. SN 78-073,429.
PUB. 3-25-2003, FILED 7-11-2001.

ITSDIVORCE

CLASS 9—ELECTRICAL AND SCIENTIFIC APPARATUS

FOR COMPUTER SOFTWARE AND INSTRUCTIONAL MANUALS SOLD AS A UNIT DESIGNED TO FACILITATE PRO SE, MEDIATED OR ATTORNEY - BASED DIVORCE PROCEEDINGS BY PERFORMING FINANCIAL CALCULATIONS TO DETERMINE NET WORTH, ALIMONY, MAINTENANCE, AND CHILD SUPPORT FOR A DIVORCE PROCEEDING; COMPUTER SOFTWARE TO ASSIST IN THE MECHANICS OF FILLING OUT FORMS PERTAINING TO DIVORCE FOR PRO SE, MEDIATED, OR ATTORNEY-BASED PROCEEDINGS; DOWNLOADABLE ELECTRONIC PUBLICATIONS IN THE NATURE OF PROCEDURAL DOCUMENTS, FORMS, NEWSLETTERS AND MANUALS AFFILIATED WITH DIVORCE AND DIVORCE PROCEEDINGS WITH ANCILLARY HELP PAGES FOR USING THE SOFTWARE AND THE WEBSITE; ALL OF THE AFORESAID SOFTWARE RECORDED ON CD'S AND COMPUTER DISCS (U.S. CLS. 21, 23, 26, 36 AND 38).

FIRST USE 12-17-2003; IN COMMERCE 12-17-2003.

CLASS 35—ADVERTISING AND BUSINESS

FOR LAWYER REFERRAL SERVICES; ON-LINE BUSINESS DIRECTORIES FEATURING SERVICES AND RESOURCES ASSISTING IN DIVORCE (U.S. CLS. 100, 101 AND 102).

FIRST USE 12-17-2003; IN COMMERCE 12-17-2003.

CLASS 42—SCIENTIFIC, COMPUTER AND LEGAL SERVICES

FOR LEGAL SERVICES; COMPUTER SERVICES, NAMELY PROVIDING ON-LINE PUBLICATIONS NAMELY, NEWSLETTERS AND MANUALS AFFILIATED WITH DIVORCE AND DIVORCE PROCEEDINGS, HELP MANUALS FOR SERVICES AND SOFTWARE, ATTORNEY COMMENTARIES AND RELATED ARTICLES ON DIVORCE (U.S. CLS. 100 AND 101).

FIRST USE 12-13-2003; IN COMMERCE 12-13-2003.

2,998,852. THE CONSULTANT COMPANY, STONE MOUNTAIN, GA. SN 78-125,970. PUB. 6-3-2003, FILED 5-3-2002.

THE CONSULTANT

CLASS 9—ELECTRICAL AND SCIENTIFIC APPARATUS

FOR MUSICAL SOUND RECORDINGS; PRERECORDED RECORDS, AUDIO CASSETTES, PRERECORDED VINYL PHONOGRAPH RECORDS, COMPACT DISCS CD-ROMS AND DVDS FEATURING MUSIC AND LYRICS; PRERECORDED VIDEO TAPES FEATURING MUSICAL ENTERTAINMENT; LASER DISCS FEATURING MUSICAL ENTERTAINMENT; VIDEO DISCS FEATURING MUSICAL ENTERTAINMENT; MULTIMEDIA SOFTWARE RECORDED ON CD-ROM FEATURING MUSICAL ENTERTAINMENT (U.S. CLS. 21, 23, 26, 36 AND 38).

FIRST USE 2-1-2004; IN COMMERCE 2-8-2004.

CLASS 41—EDUCATION AND ENTERTAINMENT

FOR PROVIDING AN ON-LINE COMPUTER DATABASE VIA A GLOBAL COMPUTER NETWORK FEATURING INFORMATION, GRAPHICS AND DATA ABOUT A MUSICAL ARTIST FEATURING NEWS, INTERVIEWS, SCHEDULES OF RELEASES OF SOUND RECORDINGS, SCHEDULES OF RELEASES OF VIDEO RECORDINGS, SCHEDULES OF RELEASES OF LASER AND DIGITAL RECORDINGS, SCHEDULES OF RELEASES OF MULTI-MEDIA SOFTWARE, SCHEDULES OF RELEASES OF COLLECTIBLE, FASHION, APPAREL, JEWELRY AND PRINTED MATTER MERCHANDISE, SCHEDULES OF TOURS, SCHEDULES OF TRAVEL, SCHEDULES OF LIVE AND PRERECORDED MUSICAL PERFORMANCES, SCHEDULES OF LIVE AND PERSONAL APPEARANCES; PROVIDING AN ON-LINE COMPUTER DATABASE VIA A GLOBAL COMPUTER NETWORK FEATURING MUSIC, MUSIC CONCERTS, MUSIC VIDEOS AND MUSIC VIDEO CLIPS OF A MUSICAL ARTIST; ENTERTAINMENT IN THE NATURE OF LIVE PERFORMANCES BY A MUSICAL ARTIST (U.S. CLS. 100, 101 AND 107).

FIRST USE 2-1-2002; IN COMMERCE 2-8-2004.

2,998,853. TRECO HOLDINGS, INC., VANCOUVER, BRITISH COLUMBIA. SN 78-126,901. PUB. 1-21-2003, FILED 5-7-2002.



The Real Estate Consulting Office

NO CLAIM IS MADE TO THE EXCLUSIVE RIGHT TO USE "THE REAL ESTATE CONSULTING OFFICE", APART FROM THE MARK AS SHOWN.

THE COLOR(S) GREEN AND LIGHT YELLOW IS/ARE CLAIMED AS A FEATURE OF THE MARK.

ALL LETTERS TO BE COLORED DARK GREEN, THE SQUARE OUTLINING THE SEVEN CIRCLES TO BE COLORED GREEN, THE OUTLINES OF THE SEVEN CIRCLES TO BE COLORED GREEN AND THE INSIDE OF THE SEVEN CIRCLES TO BE COLORED LIGHT YELLOW.

ALL LETTERS TO BE COLORED DARK GREEN, THE SQUARE OUTLINING THE SEVEN CIRCLES TO BE COLORED GREEN, THE OUTLINES OF THE SEVEN CIRCLES TO BE COLORED GREEN AND THE INSIDE OF THE SEVEN CIRCLES TO BE COLORED LIGHT YELLOW.

CLASS 36—INSURANCE AND FINANCIAL

FOR REAL ESTATE CONSULTATION (U.S. CLS. 100, 101 AND 102).

FIRST USE 5-11-2002; IN COMMERCE 5-11-2002.

CLASS 37—CONSTRUCTION AND REPAIR

FOR REAL ESTATE DEVELOPMENT (U.S. CLS. 100, 103 AND 106).

FIRST USE 5-11-2002; IN COMMERCE 5-11-2002.

2,998,857. PONTICELLI, ROBERT, J., CAMARILLO, CA. SN 78-135,478. PUB. 9-14-2004, FILED 6-13-2002.

2,998,863. REDCATS USA, L.P., INDIANAPOLIS, IN. SN 78-148,207. PUB. 9-30-2003, FILED 7-28-2002.

Light  Tape

NO CLAIM IS MADE TO THE EXCLUSIVE RIGHT TO USE "LIGHT" AND "TAPE", APART FROM THE MARK AS SHOWN.

CLASS 9—ELECTRICAL AND SCIENTIFIC APPARATUS

FOR INVERTERS AND ELECTROLUMINESCENT SIGNS (U.S. CLS. 21, 23, 26, 36 AND 38).
FIRST USE 5-25-2005; IN COMMERCE 5-25-2005.

CLASS 11—ENVIRONMENTAL CONTROL APPARATUS

FOR ELECTROLUMINESCENT LAMPS (U.S. CLS. 13, 21, 23, 31 AND 34).
FIRST USE 5-25-2005; IN COMMERCE 5-25-2005.

2,998,862. RITTAL GMBH & CO., 35745 HERBORN, FED REP GERMANY. SN 78-147,065. PUB. 10-12-2004, FILED 7-24-2002.

ALPHA-LINE

PRIORITY CLAIMED UNDER SEC. 44(D) ON FED REP GERMANY APPLICATION NO. 30209473.3, FILED 2-22-2002, REG. NO. 30209473, DATED 4-25-2002, EXPIRES 2-29-2012.

CLASS 6—METAL GOODS

FOR CASINGS MADE OF SHEET METAL, NAMELY FOR DOORS AND WALL PANELS; METAL LOCKING MECHANISMS, NAMELY DOOR LOCKS; METAL ROLLERS, NAMELY CASTORS (U.S. CLS. 2, 12, 13, 14, 23, 25 AND 50).
FIRST USE 3-1-2002; IN COMMERCE 3-1-2002.

CLASS 9—ELECTRICAL AND SCIENTIFIC APPARATUS

FOR METAL AND PLASTIC COMPUTER AND SWITCHGEAR CABINETS, RACKS, HOUSINGS, AND BRACKET DEVICES SPECIALLY DESIGNED FOR HOLDING ELECTRONICS, COMPUTERS AND INTERACTIVE TERMINAL COMPUTER SYSTEMS AND THAT ARE AIR-CONDITIONED, EARTHQUAKE-RESISTANT, VANDAL-RESISTANT AND EXPLOSION-RESISTANT; ELECTRICAL DEVICES AND INSTRUMENTS, NAMELY FOR CONDUCTING, CONVERTING, STORING, REGULATING AND CONTROLLING ELECTRICAL SYSTEMS AND CONTROLS, NAMELY ELECTROMECHANICAL SUB-RACKS FOR PLUG-IN COMPONENTS WITH ELECTRONIC CIRCUITS; VENDING MACHINES; TERMINAL SYSTEMS, NAMELY INTERACTIVE TERMINAL SYSTEMS, NAMELY COMPUTER HARDWARE AND MONITORS; DATA PROCESSING EQUIPMENT, NAMELY DATA PROCESSORS AND COMPUTERS; METAL FASTENING DEVICES, NAMELY ANGLED SECURING BRACKETS; POWER SUPPLIES, NAMELY ELECTRICAL POWER SUPPLY PACKS (U.S. CLS. 21, 23, 26, 36 AND 38).
FIRST USE 3-1-2002; IN COMMERCE 3-1-2002.



OWNER OF U.S. REG. NOS. 1,169,405 AND 2,654,196.

CLASS 25—CLOTHING

FOR WOMEN'S CLOTHING, NAMELY, DRESSES, SUITS, 3-PIECE SETS COMPRISED OF JACKET AND PANTS AND SKIRT, 3-PIECE SETS COMPRISED OF JACKET AND PANTS AND DRESS, SHIRTS, SKIRTS, PANTS, JEANS, BLAZERS, SHORTS, NIGHTGOWNS, PAJAMAS, SWEATERS, KNIT TOPS, KNIT BOTTOMS, SWIMWEAR, CAPES, VESTS, DUSTERS, JACKETS, RAINWEAR, AND COATS (U.S. CLS. 22 AND 39).
FIRST USE 11-1-2002, 06/30/1932.; IN COMMERCE 11-1-2002, 06/30/1932..

CLASS 35—ADVERTISING AND BUSINESS

FOR ON-LINE RETAIL STORE SERVICES FEATURING WOMEN'S APPAREL, FOOTWEAR, AND ACCESSORIES (U.S. CLS. 100, 101 AND 102).
FIRST USE 6-28-2004; IN COMMERCE 6-28-2004.

2,998,864. PAULSEN, LEIGH A., MANCHESTER, NH. SN 78-150,141. PUB. 6-3-2003, FILED 8-2-2002.

DIRECTTOP

CLASS 19—NON-METALLIC BUILDING MATERIALS

FOR BUILDING MATERIALS, NAMELY COUNTER TOPS COMPOSED OF DECORATIVE LAMINATE BONDED TO PARTICLE BOARD OR PLYWOOD AND COUNTER TOPS COMPOSED OF A BLEND OF POLYESTER, ACRYLIC AND MINERAL FILLERS FORMING SOLID SURFACE COUNTER TOPS (U.S. CLS. 1, 12, 33 AND 50).
FIRST USE 7-7-2004; IN COMMERCE 7-7-2004.

CLASS 40—MATERIAL TREATMENT

FOR CONSTRUCTION SERVICES NAMELY PLANNING, LAYOUT AND CUSTOM CONSTRUCTION OF COUNTER TOPS COMPOSED OF DECORATIVE LAMINATE BONDED TO PARTICLE BOARD OR PLYWOOD AND COUNTER TOPS COMPOSED OF A BLEND OF POLYESTER, ACRYLIC AND MINERAL FILLERS FORMING SOLID SURFACE COUNTER TOPS (U.S. CLS. 100, 103 AND 106).
FIRST USE 7-7-2004; IN COMMERCE 7-7-2004.

2,998,880. SWEETAPPLE, MATTHEW, JOHN, WELWYN, UNITED KINGDOM. SN 78-184,644. PUB. 10-5-2004, FILED 11-13-2002.

PEEBALL

CLASS 28—TOYS AND SPORTING GOODS

FOR GAMES INVOLVING CONTROLLING THE MOVEMENT OF A LIGHTWEIGHT BALL WITH A FLUID STREAM; BALLS FOR GAMES, NAMELY READILY DEGRADABLE BALLS FOR BREAKDOWN BY A FLUID STREAM; PLAYING BALLS, NAMELY READILY DEGRADABLE BALLS FOR BREAKDOWN BY A FLUID STREAM; LIGHTWEIGHT FLOATING BALLS IN THE NATURE OF READILY DEGRADABLE BALLS FOR BREAKDOWN BY A FLUID STREAM; NOVELTY GAMES AND PLAYTHINGS, NAMELY RISQUE GAMES IN THE NATURE OF LAVATORIAL GAMES INVOLVING READILY DEGRADABLE BALLS (U.S. CLS. 22, 23, 38 AND 50).

FIRST USE 11-22-2002; IN COMMERCE 12-18-2004.

CLASS 36—INSURANCE AND FINANCIAL

FOR CHARITABLE FUND RAISING (U.S. CLS. 100, 101 AND 102).

FIRST USE 11-22-2002; IN COMMERCE 12-18-2004.

2,998,889. PLANT RESEARCH INTERNATIONAL B.V., 6708 AA WAGENINGEN, NETHERLANDS. SN 78-197,400. PUB. 10-26-2004, FILED 12-23-2002.

PHEROBANK

OWNER OF BENELUX REG. NO. 0687059, DATED 8-4-2000, EXPIRES 8-4-2010.

CLASS 1—CHEMICALS

FOR CHEMICALS FOR USE IN THE MANUFACTURE OF PESTICIDES FOR AGRICULTURAL, COMMERCIAL, INDUSTRIAL AND DOMESTIC USE FOR THE PURPOSE OF OBSERVATION, CONTROL, EXTERMINATION, AND/OR CATCHING OF VERMIN, INSECTS, SNAILS AND MITES (U.S. CLS. 1, 5, 6, 10, 26 AND 46).

FIRST USE 2-1-1996; IN COMMERCE 2-1-1996.

CLASS 5—PHARMACEUTICALS

FOR PHARMACEUTICAL AND VETERINARY PREPARATIONS, NAMELY, PESTICIDES FOR AGRICULTURAL, COMMERCIAL, INDUSTRIAL, AND DOMESTIC USE FOR THE PURPOSE OF OBSERVATION, CONTROL, EXTERMINATION AND/OR CATCHING OF VERMIN, INSECTS, SNAILS AND MITES; SANITARY PREPARATIONS, NAMELY, PESTICIDES FOR AGRICULTURAL, COMMERCIAL, INDUSTRIAL AND DOMESTIC USE FOR THE PURPOSE OF OBSERVATION, CONTROL, EXTERMINATION AND/OR CATCHING OF VERMIN, INSECTS, SNAILS AND MITES (U.S. CLS. 6, 18, 44, 46, 51 AND 52).

FIRST USE 2-1-1996; IN COMMERCE 2-1-1996.

CLASS 42—SCIENTIFIC, COMPUTER AND LEGAL SERVICES

FOR LABORATORY SERVICES, NAMELY, RESEARCH AND DEVELOPMENT OF PESTICIDES FOR AGRICULTURAL, COMMERCIAL, INDUSTRIAL AND DOMESTIC USE FOR THE PURPOSE OF OBSERVATION, CONTROL, EXTERMINATION AND/OR CATCHING OF VERMIN, INSECTS, SNAILS AND MITES (U.S. CLS. 100 AND 101).

FIRST USE 2-1-1996; IN COMMERCE 2-1-1996.

2,998,894. AUCTIONDROP, INC., FREMONT, CA. SN 78-207,307. PUB. 4-27-2004, FILED 1-27-2003.

AUCTIONDROP

CLASS 35—ADVERTISING AND BUSINESS

FOR LISTING OF ITEMS FOR ONLINE AUCTIONS, NAMELY, PROVIDING INFORMATION ABOUT THE GOODS OF OTHERS AVAILABLE VIA ONLINE AUCTIONS; TRANSPORTATION LOGISTICS SERVICES, NAMELY, ARRANGING FOR THE TRANSPORTATION OF THE GOODS OF OTHERS PURCHASED VIA ONLINE AUCTIONS (U.S. CLS. 100, 101 AND 102).

FIRST USE 3-1-2003; IN COMMERCE 3-1-2003.

CLASS 36—INSURANCE AND FINANCIAL

FOR ELECTRONIC PAYMENT, NAMELY, ELECTRONIC PROCESSING AND TRANSMISSION OF BILL PAYMENT DATA FOR GOODS PURCHASED VIA ONLINE AUCTIONS (U.S. CLS. 100, 101 AND 102).

FIRST USE 3-1-2003; IN COMMERCE 3-1-2003.

CLASS 39—TRANSPORTATION AND STORAGE

FOR STORAGE OF THE GOODS OF OTHERS TO BE OFFERED VIA ONLINE AUCTIONS (U.S. CLS. 100 AND 105).

FIRST USE 3-1-2003; IN COMMERCE 3-1-2003.

2,998,895. JAFFE, MAX, DALLAS, TX. SN 78-207,535. PUB. 4-20-2004, FILED 1-27-2003.

SPENDING SOLUTIONS

NO CLAIM IS MADE TO THE EXCLUSIVE RIGHT TO USE SPENDING, APART FROM THE MARK AS SHOWN.

CLASS 36—INSURANCE AND FINANCIAL

FOR FINANCE CONSULTING, NAMELY, CONSULTING WITH INDIVIDUALS IN REGARD TO THEIR PERSONAL FINANCE (U.S. CLS. 100, 101 AND 102).

FIRST USE 5-0-2004; IN COMMERCE 5-0-2004.

CLASS 41—EDUCATION AND ENTERTAINMENT

FOR EDUCATIONAL SERVICES, NAMELY, CONDUCTING CLASSES, CONFERENCES AND WORKSHOPS IN THE FIELD OF PERSONAL FINANCE (U.S. CLS. 100, 101 AND 107).

FIRST USE 5-22-2004; IN COMMERCE 5-0-2004.

2,998,925. GMR PROTECTION RESOURCES, INC., ROCKWALL, TX. SN 78-227,701. PUB. 1-18-2005, FILED 3-19-2003.

GMR PROTECTION RESOURCES, INC.

NO CLAIM IS MADE TO THE EXCLUSIVE RIGHT TO USE PROTECTION RESOURCES, INC., APART FROM THE MARK AS SHOWN.

CLASS 41—EDUCATION AND ENTERTAINMENT

FOR EMERGENCY PREPAREDNESS IN THE WORKPLACE, NAMELY, CONDUCTING TRAINING FOR OCCUPANT RESPONSE TO FIRES, SMOKE, WEATHER, MEDICAL AND OTHER RELATED EMERGENCIES IN THE WORKPLACE (U.S. CLS. 100, 101 AND 107).

FIRST USE 0-0-1993; IN COMMERCE 0-0-1993.

CLASS 42—SCIENTIFIC, COMPUTER AND LEGAL SERVICES

FOR LIFE SAFETY SERVICES, NAMELY, AUTOMATIC TELLER MACHINES (ATM) SECURITY AND SAFETY COMPLIANCE REVIEWS RELATED TO LIGHTING LEVELS AND COMPARISON TO ESTABLISHED STATUTES AND STANDARDS TO ENSURE COMPLIANCE WITH SAFETY REGULATIONS, PROPERTY MAINTENANCE INSPECTIONS FOR COMPLIANCE WITH SAFETY REGULATIONS TO ASSIST PROPERTY MANAGERS WITH REGULAR PREMISE REVIEWS FOR A RANGE OF FACILITY ISSUES, WRITING EMERGENCY PREPAREDNESS PLANS FOR THE WORKPLACE, CONDUCTING TESTING FOR OCCUPANT RESPONSE TO FIRES, SMOKE, WEATHER, MEDICAL AND OTHER RELATED EMERGENCIES IN THE WORKPLACE, LIGHTING DESIGN CONSULTATION FOR BANKING CENTER LOCATIONS TO ASSIST CLIENTS IN ACHIEVING AND MAINTAINING COMPLIANCE WITH MINIMUM LIGHTING SAFETY REQUIREMENTS (U.S. CLS. 100 AND 101).

FIRST USE 0-0-1991; IN COMMERCE 0-0-1991.

CLASS 45—PERSONAL SERVICES

FOR COMPILING INVENTORIES OF EQUIPMENT OF BANKING PREMISES FOR INSURANCE OR SECURITY PURPOSES, PROJECT MANAGEMENT CRIME STATISTICAL INFORMATION RELATED TO VIOLENT CRIME AT BANKING LOCATIONS (U.S. CLS. 100 AND 101).

FIRST USE 0-0-1996; IN COMMERCE 0-0-1996.

2,998,927. SUCCESS DNA, INC, MINDEN, NV. SN 78-230,366. PUB. 11-18-2003, FILED 3-26-2003.

WEALTH GENE**CLASS 16—PAPER GOODS AND PRINTED MATTER**

FOR EDUCATIONAL BOOKS IN THE FIELD OF BUSINESS AND PERSONAL GROWTH (U.S. CLS. 2, 5, 22, 23, 29, 37, 38 AND 50).

FIRST USE 11-0-2003; IN COMMERCE 11-0-2003.

CLASS 35—ADVERTISING AND BUSINESS

FOR BUSINESS SERVICES, NAMELY, BUSINESS CONSULTING ON THE DEVELOPMENT, MANAGEMENT AND UTILIZATION OF BUSINESS CONCEPTS AND PREPARATION OF BUSINESS PLANS (U.S. CLS. 100, 101 AND 102).

FIRST USE 5-0-2003; IN COMMERCE 5-0-2003.

2,998,931. CRABTREE & EVELYN, LTD., WOODSTOCK, CT. SN 78-233,475. PUB. 1-6-2004, FILED 4-3-2003.

**CRABTREE & EVELYN
HOME**

OWNER OF U.S. REG. NOS. 1,036,523, 2,491,057, AND

OTHERS.

NO CLAIM IS MADE TO THE EXCLUSIVE RIGHT TO USE "HOME", APART FROM THE MARK AS SHOWN.

CLASS 20—FURNITURE AND ARTICLES NOT OTHERWISE CLASSIFIED

FOR FURNITURE, CLOTHES HANGERS, PILLOWS, CUSHIONS, NON-METAL BOXES (U.S. CLS. 2, 13, 22, 25, 32 AND 50).

FIRST USE 1-0-2005; IN COMMERCE 1-0-2005.

CLASS 21—HOUSEWARES AND GLASS

FOR CUPS, SOAP DISHES, SOAP HOLDERS, DRINKING VESSELS, FLOWER POTS, NON-ELECTRIC TEAPOTS NOT OF PRECIOUS METAL, COLANDERS FOR HOUSEHOLD USE, CONTAINERS FOR HOUSEHOLD USE NOT OF PRECIOUS METAL, BOWLS, BUCKETS, JUGS, MUGS, PITCHERS, PLATES, SERVING PLATTERS, CANISTER SETS, CRUET STANDS FOR OIL AND VINEGAR NOT OF PRECIOUS METAL, SERVING TRAYS NOT OF PRECIOUS METAL, CUTTING BOARDS, TRIVETS, CANDLE HOLDERS NOT OF PRECIOUS METAL, SERVING FORKS, SERVING SPOONS, KITCHEN LADLES, DOMESTIC LIGHTBULB RING BURNERS TO WHICH FRAGRANT ESSENTIAL OILS CAN BE ADDED, HAIR BRUSHES AND HAIR COMBS (U.S. CLS. 2, 13, 23, 29, 30, 33, 40 AND 50).

FIRST USE 1-0-2005; IN COMMERCE 1-0-2005.

CLASS 24—FABRICS

FOR TOWELS, BED SHEETS, PILLOW CASES, PILLOW SHAMS, BED SKIRTS, COMFORTERS, BED BLANKETS, COMFORTER AND BLANKET COVERS, CURTAINS, SHOWER CURTAINS, TABLE CLOTHS NOT OF PAPER, TEXTILE NAPKINS, TEXTILE PLACE-MATS (U.S. CLS. 42 AND 50).

FIRST USE 1-0-2005; IN COMMERCE 1-0-2005.

CLASS 35—ADVERTISING AND BUSINESS

FOR RETAIL STORE SERVICES, ONLINE RETAIL STORE SERVICES ALL FEATURING FURNITURE, BATHROOM ACCESSORIES, HOUSEWARES, TEXTILE PRODUCTS, TOILETRIES, FOODS, POTPOURRI, SCENTED ESSENTIAL OILS, SCENTED CANDLES AND CLOTHING (U.S. CLS. 100, 101 AND 102).

FIRST USE 1-0-2005; IN COMMERCE 1-0-2005.

2,998,941. B&B ISLAND DISTRIBUTING, LLC, HONOLULU, HI. SN 78-239,862. PUB. 2-24-2004, FILED 4-20-2003.

BODY QUOTIENT (BODY Q)

NO CLAIM IS MADE TO THE EXCLUSIVE RIGHT TO USE BODY, APART FROM THE MARK AS SHOWN.

CLASS 8—HAND TOOLS

FOR MANICURE IMPLEMENTS NAMELY NAIL FILES, NAIL CLIPPERS, CUTICLE PUSHERS, TWEEZERS NAIL AND CUTICLE SCISSORS, CALLUS CUTTERS, EYELASH CURLERS, SCISSORS, NAIL BUFFERS, MUSTACHE AND BEARD TRIMMERS (U.S. CLS. 23, 28 AND 44).

FIRST USE 12-1-2003; IN COMMERCE 5-28-2004.

CLASS 21—HOUSEWARES AND GLASS

FOR BRUSHES NAMELY NAIL BRUSHES, BACK BRUSH SCRUBBERS, BATH BRUSHES, NATURAL SEA SPONGES, LOOFAH SPONGES, BODY SPONGES (U.S. CLS. 2, 13, 23, 29, 30, 33, 40 AND 50).

FIRST USE 12-1-2003; IN COMMERCE 5-28-2004.

CLASS 24—FABRICS

FOR WASH CLOTHS NAMELY NYLON WASH CLOTHS, WASHING MITTS (U.S. CLS. 42 AND 50).
FIRST USE 12-1-2003; IN COMMERCE 5-28-2004.

2,998,953. NATURA WORLD, INC., CAMBRIDGE, ONTARIO, CANADA. SN 78-249,482. PUB. 10-19-2004, FILED 5-14-2003.

BABY NATURA

2,998,946. TAKARA CO., LTD., TOKYO, JAPAN. SN 78-242,378. PUB. 12-28-2004, FILED 4-25-2003.

BowLingual

THE MARK CONSISTS OF STANDARD CHARACTERS WITHOUT CLAIM TO ANY PARTICULAR FONT, STYLE, SIZE, OR COLOR.

OWNER OF U.S. REG. NOS. 2,204,260, 2,451,576, AND OTHERS.

NO CLAIM IS MADE TO THE EXCLUSIVE RIGHT TO USE "BABY", APART FROM THE MARK AS SHOWN.

CLASS 9—ELECTRICAL AND SCIENTIFIC APPARATUS

FOR ANIMAL SOUND INTERPRETER, NAMELY, AN AUDIO PICKUP MICROPHONE FOR ATTACHMENT TO AN ANIMAL FOR TRANSMITTING A SIGNAL REPRESENTATIVE OF A SOUND AND A RECEIVER FOR PROVIDING AN OUTPUT REPRESENTATIVE OF THE SIGNAL (U.S. CLS. 21, 23, 26, 36 AND 38).
FIRST USE 8-0-2002; IN COMMERCE 8-0-2003.

CLASS 20—FURNITURE AND ARTICLES NOT OTHERWISE CLASSIFIED

FOR BABY MATTRESSES (U.S. CLS. 2, 13, 22, 25, 32 AND 50).

FIRST USE 12-31-2002; IN COMMERCE 12-31-2002.

CLASS 24—FABRICS

FOR BABY BEDDING, NAMELY, COMFORTERS, MATTRESS PADS, CRIB BUMPER PADS, CRIB CANOPIES, CRIB SHEETS, CRIB SKIRTS, CRIB DUVETS, AND DUVET COVERS (U.S. CLS. 42 AND 50).
FIRST USE 12-31-2002; IN COMMERCE 12-31-2002.

CLASS 28—TOYS AND SPORTING GOODS

FOR TOYS FOR DOMESTIC PETS (U.S. CLS. 22, 23, 38 AND 50).

FIRST USE 8-0-2002; IN COMMERCE 8-0-2003.

2,998,962. ACHIEVEGLOBAL, INC., TAMPA, FL. SN 78-258,269. PUB. 8-17-2004, FILED 6-4-2003.

**CLARIFYING
PERFORMANCE
EXPECTATIONS**

2,998,948. HOMEGOODS, INC., FRAMINGHAM, MA. SN 78-243,837. PUB. 9-7-2004, FILED 4-30-2003.

CHEFOLOGY

CLASS 8—HAND TOOLS

FOR CARVING KNIVES AND ZESTERS (U.S. CLS. 23, 28 AND 44).

FIRST USE 11-30-2003; IN COMMERCE 11-30-2003.

CLASS 21—HOUSEWARES AND GLASS

FOR COOKWARE AND BAKEWARE, NAMELY, POTS, PANS, SKILLETS, SAUTE PANS, ROASTING PANS, COLANDERS, MIXING BOWLS; SERVING TRAYS NOT MADE OF PRECIOUS METAL; CUTTING BOARDS; WOVEN BASKETS; KITCHEN UTENSILS, NAMELY, SPATULAS, MIXING SPOONS, AND GARLIC PRESSES (U.S. CLS. 2, 13, 23, 29, 30, 33, 40 AND 50).
FIRST USE 11-30-2003; IN COMMERCE 11-30-2003.

CLASS 9—ELECTRICAL AND SCIENTIFIC APPARATUS

FOR PRERECORDED VIDEOTAPES, AUDIO TAPES AND CD-ROMS FEATURING TRAINING MATERIALS AND PRESENTATIONS IN THE FIELDS OF MANAGEMENT, SUPERVISORY AND INTERPERSONAL SKILLS, SALES, CUSTOMER SERVICE, BUSINESS MANAGEMENT, BUSINESS TRAINING AND BUSINESS EDUCATION; COMPUTER SOFTWARE FOR USE IN TRAINING AND EDUCATION IN THE FIELDS OF MANAGEMENT, SUPERVISORY AND INTERPERSONAL SKILLS, SALES, CUSTOMER SERVICE, BUSINESS MANAGEMENT, BUSINESS TRAINING AND BUSINESS EDUCATION (U.S. CLS. 21, 23, 26, 36 AND 38).
FIRST USE 1-1-2003; IN COMMERCE 1-1-2003.

CLASS 24—FABRICS

FOR KITCHEN TEXTILES, NAMELY, OVEN MITTS, KITCHEN TOWELS, TABLECLOTHS, AND NAPKINS (U.S. CLS. 42 AND 50).

FIRST USE 11-30-2003; IN COMMERCE 11-30-2003.

CLASS 16—PAPER GOODS AND PRINTED MATTER

FOR PUBLICATIONS, NAMELY, TEXTBOOKS, PAMPHLETS, BROCHURES, NEWSLETTERS, JOURNALS AND MAGAZINES ON THE SUBJECT OF MANAGEMENT, SUPERVISORY AND INTERPERSONAL SKILLS, SALES, CUSTOMER SERVICE, BUSINESS MANAGEMENT, BUSINESS TRAINING AND BUSINESS EDUCATION (U.S. CLS. 2, 5, 22, 23, 29, 37, 38 AND 50).
FIRST USE 1-1-2003; IN COMMERCE 1-1-2003.

CLASS 41—EDUCATION AND ENTERTAINMENT

FOR EDUCATIONAL SERVICES, NAMELY, ARRANGING AND CONDUCTING TRAINING CLASSES AND SEMINARS IN THE FIELDS OF MANAGEMENT, SUPERVISORY AND INTERPERSONAL SKILLS, SALES, CUSTOMER SERVICE, BUSINESS MANAGEMENT; PROVIDING EDUCATIONAL TRAINING SERVICES VIA A GLOBAL COMPUTER NETWORK ON THE SUBJECT OF MANAGEMENT, SUPERVISORY AND INTERPERSONAL SKILLS, SALES, CUSTOMER SERVICE, BUSINESS MANAGEMENT (U.S. CLS. 100, 101 AND 107).

FIRST USE 1-1-2003; IN COMMERCE 1-1-2003.

2,998,963. CHEN HSIANG FOODS INDUSTRIAL CO., LTD., CHIA-YI HSIEN, TAIWAN. SN 78-258,464. PUB. 9-28-2004, FILED 6-4-2003.

**CLASS 29—MEATS AND PROCESSED FOODS**

FOR PORK BALLS; MEAT BALLS; FISH BALLS; FISH PASTE; CUTTLEFISH BALLS; SHRIMP BALLS; FISH PASTE PREPARATIONS; FROZEN INSTANT MEAT PREPARATIONS; INSTANT MEAT PREPARATIONS; FROZEN INSTANT SEAFOOD PREPARATIONS; FRENCH FRIES; INSTANT SEAFOOD PREPARATIONS; FRIED POTATO CHIPS; FROZEN INSTANT VEGETABLE PREPARATIONS; INSTANT VEGETABLE PREPARATIONS; CHICKEN LOAF; CHICKEN CHOPS; SHRIMPS; EELS; FROZEN ROASTED EELS; CUTTLEFISH; SHREDDED CUTTLEFISH; POTATO CHIPS; POTATO CAKES; EEL LUNCH BOXES, NAMELY, PREPARED LUNCH BOX MEALS CONSISTING PRIMARILY OF EEL (U.S. CL. 46).

FIRST USE 1-24-2005; IN COMMERCE 1-24-2005.

CLASS 30—STAPLE FOODS

FOR MINCEMEAT CAKES; STEAMED BREADS; STEAMED STUFFED-BUNS; STEAMED STUFFED-BUNS WITH MEAT; STEAMED STUFFED-BUNS WITH VEGETABLE; BEAN PASTE BUNS; SESAME BUNS; WATER FRIED BUNS; CUP SHAPE FLOUR DOUGH POUCH WITH MINCED PORK AND SHRIMP FILLINGS; GLUTINOUS RICE BALLS; SPRING ROLLS; SPRING ROLL SKINS; SHRIMP ROLLS; WATER FRIED DUMPLINGS; CH' A SHAO PAO, NAMELY, A CHINESE STEAMED BUN STUFFED WITH ROAST PORK; STEAMED TURNIP CAKES; PEARL PORK GLUTINOUS RICE BALLS; GLUTINOUS RICE BALLS; BUNS; FISH DUMPLINGS; EGG DUMPLINGS; SHRIMP DUMPLINGS; CUTTLEFISH DUMPLINGS; FRESH SHRIMP DUMPLINGS; CRYSTAL DUMPLINGS; PORRIDGE; GLUTINOUS RICE WRAPPED IN BAMBOO LEAVES; DUMPLINGS; HUN-TUN, NAMELY, CHINESE DUMPLINGS MADE FROM WONTON WRAPPERS FILLED WITH MEAT, SEAFOOD OR VEGETABLE MIXTURES; NOODLES; MACARONI; SPAGHETTI; FROZEN DUMPLINGS; FROZEN HUN-TUN, NAMELY, FROZEN CHINESE DUMPLINGS MADE FROM WONTON WRAPPERS FILLED WITH MEAT; SUSHI; RICE WITH EEL (U.S. CL. 46).

FIRST USE 1-24-2005; IN COMMERCE 1-24-2005.

2,998,968. MISSLER, CHARLES W., COEUR D'ALENE, ID. SN 78-264,692. PUB. 9-28-2004, FILED 6-19-2003.

KOINONIA INSTITUTE

OWNER OF U.S. REG. NOS. 1,893,852 AND 2,317,472.
NO CLAIM IS MADE TO THE EXCLUSIVE RIGHT TO USE INSTITUTE, APART FROM THE MARK AS SHOWN.
THE ENGLISH TRANSLATION OF THE WORD KOINONIA IN THE MARK IS COMMUNITY OR FELLOWSHIP.

CLASS 16—PAPER GOODS AND PRINTED MATTER

FOR PAPER GOODS AND PRINTED MATTER, NAMELY, PAMPHLETS, NEWSLETTERS, JOURNALS, MAGAZINES, TEXT BOOKS, WORKBOOKS, TEACHING AIDS, CALENDARS, FLYERS, STATIONERY AND BOOKS ON THE SUBJECT OF RELIGION AND BIBLE INTERPRETATION (U.S. CLS. 2, 5, 22, 23, 29, 37, 38 AND 50).

FIRST USE 3-19-2004; IN COMMERCE 3-19-2004.

CLASS 41—EDUCATION AND ENTERTAINMENT

FOR EDUCATION SERVICES, NAMELY, CLASSES AND SEMINARS IN THE FIELD OF RELIGION (U.S. CLS. 100, 101 AND 107).

FIRST USE 3-19-2004; IN COMMERCE 3-19-2004.

2,998,972. BOHLER-UDDEHOLM PRECISION STRIP AKTIEBOLAG, S-684 28 MUNKFORS, SWEDEN. SN 78-266,005. PUB. 10-5-2004, FILED 6-23-2003.

000 UDDEHOLM 000

OWNER OF U.S. REG. NO. 212,595.

CLASS 6—METAL GOODS

FOR COMMON METALS AND THEIR ALLOYS FOR FURTHER MANUFACTURING; COLD-ROLLED STRIP STEEL; HOT-ROLLED STRIP STEEL; WIRES AND METAL CABLE WIRES, NON-ELECTRICAL STAINLESS STEEL IN THE FORM OF BARS, BLOCKS, PLATES, RINGS, WIRES, STRIPS AND TUBES (U.S. CLS. 2, 12, 13, 14, 23, 25 AND 50).
FIRST USE 12-0-1978; IN COMMERCE 12-0-1980.

CLASS 7—MACHINERY

FOR SAW BLADES FOR MACHINE SAWS AND BAND SAWS; AND MACHINE PARTS, NAMELY, DOCTOR BLADES FOR PRINTING MACHINES (U.S. CLS. 13, 19, 21, 23, 31, 34 AND 35).
FIRST USE 12-0-1978; IN COMMERCE 12-0-1980.

2,998,994. CIRCLE ATHLETICS, INC., PLAINFIELD, IL. SN 78-277,887. PUB. 3-8-2005, FILED 7-23-2003.

CIRCLE ATHLETICS

NO CLAIM IS MADE TO THE EXCLUSIVE RIGHT TO USE "ATHLETICS", APART FROM THE MARK AS SHOWN.

CLASS 25—CLOTHING

FOR SPORTING BOWLING APPAREL, NAMELY SHIRTS, HATS, JACKETS, SHORTS, AND HEADBANDS (U.S. CLS. 22 AND 39).
FIRST USE 2-28-2004; IN COMMERCE 2-28-2004.

CLASS 28—TOYS AND SPORTING GOODS

FOR SPORTING EQUIPMENT, NAMELY BOWLING BALLS, AND BOWLING BAGS; SPORTING ACCESSORIES, NAMELY, BOWLER'S WRIST LINERS FOR ATHLETIC USE, BOWLER'S WATER-RESISTANT SHOE COVERS AND WRIST SUPPORTS FOR ATHLETIC USE (U.S. CLS. 22, 23, 38 AND 50).
FIRST USE 2-28-2004; IN COMMERCE 2-28-2004.

2,998,999. CHOU, BELLE, UNION CITY, CA. SN 78-278,732. PUB. 6-15-2004, FILED 7-24-2003.

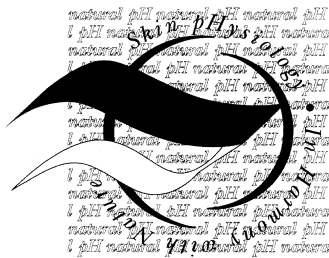

NO CLAIM IS MADE TO THE EXCLUSIVE RIGHT TO USE "PH NATURAL", APART FROM THE MARK AS SHOWN.

CLASS 9—ELECTRICAL AND SCIENTIFIC APPARATUS

FOR PROTECTIVE METAL GLOVES FOR MEAT CUTTING; PROTECTIVE GLOVES FOR INDUSTRIAL USE (U.S. CLS. 21, 23, 26, 36 AND 38).
FIRST USE 6-21-2004; IN COMMERCE 6-21-2004.

CLASS 10—MEDICAL APPARATUS

FOR GLOVES FOR MEDICAL USE, SURGICAL GLOVES (U.S. CLS. 26, 39 AND 44).
FIRST USE 6-21-2004; IN COMMERCE 6-21-2004.

2,999,000. MAD DOC SOFTWARE, LLC, LAWERANCE, MA. SN 78-279,045. PUB. 9-28-2004, FILED 7-25-2003.

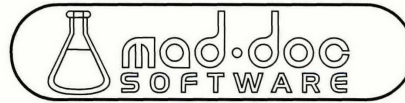

OWNER OF U.S. REG. NO. 2,743,996.
NO CLAIM IS MADE TO THE EXCLUSIVE RIGHT TO USE "SOFTWARE", APART FROM THE MARK AS SHOWN.

CLASS 9—ELECTRICAL AND SCIENTIFIC APPARATUS

FOR COMPUTER SOFTWARE, NAMELY, COMPUTER GAME SOFTWARE, COMPUTER GRAPHICS SOFTWARE, VIDEO GAME SOFTWARE, COMPUTER SOFTWARE FOR NETWORKING, CODE DEVELOPMENT, AND INTERFERENCE ENGINES, AND COMPUTER SOFTWARE DEVELOPMENT TOOLS COMPRISING OF VIDEO GAME ENGINES AND TEXT PARSING TOOLS (U.S. CLS. 21, 23, 26, 36 AND 38).
FIRST USE 3-31-2002; IN COMMERCE 3-31-2002.

CLASS 42—SCIENTIFIC, COMPUTER AND LEGAL SERVICES

FOR COMPUTER SOFTWARE DESIGNING AND DEVELOPMENT SERVICES FOR OTHERS RELATING TO GAMES SOFTWARE, GRAPHICS SOFTWARE, COMPUTER SOFTWARE DEVELOPMENT TOOLS, VIDEO GAMES AND VIDEO GAME ENGINES; COMPUTER SOFTWARE DESIGNING AND DEVELOPMENT SERVICES FOR OTHERS RELATING TO COMPUTER SOFTWARE FOR NETWORKING, CODE DEVELOPMENT AND INTERFERENCE ENGINES; COMPUTER SOFTWARE RENTAL AND LEASING SERVICES FOR OTHERS; AND PROVIDING COMPUTER SOFTWARE CONSULTATION AND ADVICE (U.S. CLS. 100 AND 101).
FIRST USE 8-31-2001; IN COMMERCE 8-31-2001.

2,999,005. THE TJX COMPANIES, INC., FRAMINGHAM, MA. SN 78-281,505. PUB. 8-31-2004, FILED 7-31-2003.

HAYMARKET SQUARE

CLASS 8—HAND TOOLS

FOR SPOONS (U.S. CLS. 23, 28 AND 44).
FIRST USE 5-1-2005; IN COMMERCE 5-1-2005.

CLASS 21—HOUSEWARES AND GLASS

FOR COOKWARE, NAMELY, POTS AND PANS NAMELY, FRYING PANS, SAUTÉ PANS AND SAUCE PANS; KITCHEN TOOLS AND GADGETS, NAMELY, SPATULAS, COLANDERS, TEA KETTLES, SALT AND PEPPER SHAKERS, PEPPER MILLS, TRAYS NAMELY SERVING TRAYS, CRUMB TRAYS, AND MEAL TRAYS MADE OF PLASTIC, NON-PRECIOUS METAL, AND WICKER; COASTERS FOR DRINKS MADE OF CORK, CERAMIC, PORCELAIN, WOOD OR GLASS; AND BASKETS NAMELY, SERVING BASKETS, BREAD BASKETS, MADE OF WOVEN MATERIALS, NAMELY, WOOD GLASS AND WICKER (U.S. CLS. 2, 13, 23, 29, 30, 33, 40 AND 50).

FIRST USE 5-1-2005; IN COMMERCE 5-1-2005.

2,999,007. TAIWAN FU HSING INDUSTRIAL CO., LTD., KAOHSIUNG HSIEN, TAIWAN. SN 78-284,345. PUB. 10-19-2004, FILED 8-7-2003.

VANGUARD

THE MARK CONSISTS OF STANDARD CHARACTERS WITHOUT CLAIM TO ANY PARTICULAR FONT, STYLE, SIZE, OR COLOR.

CLASS 6—METAL GOODS

FOR LOCKS; LOCK-SET, NAMELY, METAL LOCKS AND KEYS THEREFORE; DOOR LOCK; CYLINDRICAL LOCK; LEVER LOCK; DOOR HANDLES; TUBULAR LOCK; LOCK CORE; KEY; ALL MADE OF METAL (U.S. CLS. 2, 12, 13, 14, 23, 25 AND 50).

FIRST USE 5-11-2004; IN COMMERCE 8-30-2004.

CLASS 7—MACHINERY

FOR NON-ELECTRIC METAL PNEUMATIC DOOR CLOSER, NON-ELECTRIC METAL HYDRAULIC DOOR CLOSER (U.S. CLS. 13, 19, 21, 23, 31, 34 AND 35).

FIRST USE 5-11-2004; IN COMMERCE 8-30-2004.

2,999,020. CIRCLE ATHLETICS, INC., PLAINFIELD, IL. SN 78-292,685. PUB. 9-7-2004, FILED 8-27-2003.



CIRCLE ATHLETICS

CLASS 25—CLOTHING

FOR SPORTING BOWLING APPAREL, NAMELY SHIRTS, HATS, JACKETS, SHORTS, AND HEADBANDS (U.S. CLS. 22 AND 39).

FIRST USE 2-28-2004; IN COMMERCE 2-28-2004.

CLASS 28—TOYS AND SPORTING GOODS

FOR SPORTING EQUIPMENT, NAMELY BOWLING BALLS, AND BOWLING BAGS; SPORTING ACCESSORIES, NAMELY, BOWLER'S WRIST LINERS FOR ATHLETIC USE, BOWLER'S WATER-RESISTANT SHOE COVERS AND WRIST SUPPORTS FOR ATHLETIC USE (U.S. CLS. 22, 23, 38 AND 50).

FIRST USE 2-28-2004; IN COMMERCE 2-28-2004.

2,999,048. HOPE ACRES FARM, LLC, BROGUE, PA. SN 78-304,578. PUB. 6-15-2004, FILED 9-24-2003.

"THE WAY NATURE INTENDED"

CLASS 29—MEATS AND PROCESSED FOODS

FOR DAIRY PRODUCTS, NAMELY MILK AND FLAVORED MILKS, EGG NOG, SOUR CREAM, COTTAGE CHEESE, WHIPPING CREAM, HALF AND HALF, BUTTER, AND DIPS (U.S. CL. 46).

FIRST USE 9-0-2000; IN COMMERCE 9-0-2000.

CLASS 30—STAPLE FOODS

FOR ICE CREAM, SHERBET, FROZEN YOGURT, ICE CREAM BARS, ICE CREAM SANDWICHES AND FROZEN CONFECTIONS (U.S. CL. 46).

FIRST USE 9-0-2000; IN COMMERCE 9-0-2000.

2,999,055. QVC, INC., WEST CHESTER, PA. SN 78-313,143. PUB. 11-9-2004, FILED 10-14-2003.

TECHNIQUE

CLASS 7—MACHINERY

FOR KITCHEN PRODUCTS, NAMELY, JUICE MACHINES, ELECTRICAL PASTA MAKERS FOR DOMESTIC USE AND ELECTRICAL FOOD PROCESSORS, ELECTRICAL MIXERS, ELECTRICAL BLENDERS, ELECTRIC HAND MIXERS, ELECTRIC STAND MIXERS, ELECTRIC ICE CRUSHERS, ELECTRIC ICE SHAVERS, ELECTRIC FRUIT AND VEGETABLE PEELERS, ELECTRIC CAN OPENERS AND VACUUM SEALERS, POWER OPERATED MISTERS AND ELECTRIC KNIVES (U.S. CLS. 13, 19, 21, 23, 31, 34 AND 35).

FIRST USE 4-11-2004; IN COMMERCE 4-11-2004.

CLASS 8—HAND TOOLS

FOR NON-ELECTRICAL PASTA MAKERS FOR DOMESTIC USE, NON-ELECTRIC FOOD PROCESSORS, HAND PUMPED EMPTY SPRAY CONTAINERS, CUTLERY, KITCHEN FLATWARE AND KITCHEN KNIVES (U.S. CLS. 23, 28 AND 44).

FIRST USE 4-11-2004; IN COMMERCE 4-11-2004.

CLASS 11—ENVIRONMENTAL CONTROL APPARATUS

FOR ELECTRICAL SKILLETS, ELECTRIC ROTISERIES, AUTOMATIC BREAD MACHINES FOR DOMESTIC USE, ELECTRIC DEEP FRYERS, ELECTRIC PRESSURE COOKERS, BARBECUE GRILLS, ELECTRIC TOASTERS, ELECTRIC TOASTER OVENS, ELECTRIC COFFEE MAKERS, ELECTRIC SLOW-COOK CASSEROLES, ELECTRIC WOKS, ELECTRIC FRYING PANS, ELECTRIC GRILLS, ELECTRIC GRIDDLES, OUTDOOR ELECTRIC GRILLS, SMOKELESS BARBEQUE GRILLS, CONVENTION OVENS FOR DOMESTIC USE, MICROWAVE OVENS FOR COOKING, ELECTRIC WAFFLE IRONS, ELECTRIC ROASTER OVENS, ELECTRIC RICE COOKERS, ELECTRIC FOOD STEAMERS AND ELECTRIC ICE CREAM MACHINE (U.S. CLS. 13, 21, 23, 31 AND 34).

FIRST USE 4-11-2004; IN COMMERCE 4-11-2004.

CLASS 21—HOUSEWARES AND GLASS

FOR STAINLESS STEEL NON-STICK COOKWARE, STAINLESS STEEL COOKWARE, ALUMINUM ENAMEL COATED NON-STICK COOKWARE AND ANODIZED ALUMINUM COOKWARE ALL COMPOSED OF POTS, PANS, SAUTE PANS, FRY PANS, STOCK POTS, SAUCE PANS, WOKS, COLANDERS, NON-ELECTRICAL FOOD STEAMERS, STOVE TOP GRILLS AND GRIDDLES, STAINLESS STEEL AND ALUMINUM BAKEWARE, NAMELY COOKIE SHEETS, CAKE PANS, MUFFIN AND PIE PANS, LOAF PANS, ROAST PANS, PIZZA PANS AND EXPANDABLE CAKE PANS, TEA KETTLES, INSULATED FOOD CONTAINERS, CORK SCREWS, ICE CREAM SCOOPS, GARLIC PRESS, STAINLESS STEEL AND POLURETHANE/PLASTIC KITCHEN SERVING UTENSILS, NAMELY SPOONS, SPATULAS, WHISKS, TONGS, LADLES AND FORKS AND HAND OPERATED KITCHEN APPLIANCES; NAMELY, NON-ELECTRIC MIXERS, NON-ELECTRIC HAND MIXERS, NON-ELECTRIC STAND MIXERS AND NON-ELECTRIC ICE CRUSHERS (U.S. CLS. 2, 13, 23, 29, 30, 33, 40 AND 50).

FIRST USE 4-11-2004; IN COMMERCE 4-11-2004.

2,999,056. THE LLOYD GROUP, INC., NEW YORK, NY. SN 78-315,196. PUB. 10-26-2004, FILED 10-17-2003.

LLOYDCARE**CLASS 37—CONSTRUCTION AND REPAIR**

FOR MAINTENANCE OF INFORMATION TECHNOLOGY AND VOICE, COMPUTER, AND DATA NETWORKS (U.S. CLS. 100, 103 AND 106).

FIRST USE 1-1-2004; IN COMMERCE 1-1-2004.

CLASS 38—COMMUNICATION

FOR CONSULTATION IN THE FIELD OF VOICE NETWORKS FOR TELECOMMUNICATIONS (U.S. CLS. 100, 101 AND 104).

FIRST USE 1-1-2004; IN COMMERCE 1-1-2004.

CLASS 42—SCIENTIFIC, COMPUTER AND LEGAL SERVICES

FOR MANAGEMENT OF INFORMATION TECHNOLOGY SERVICES SYSTEMS FOR OTHERS, NAMELY, MONITORING OF INFORMATION TECHNOLOGY AND VOICE, COMPUTER AND DATA NETWORKS, TECHNICAL SUPPORT SERVICES FOR INFORMATION TECHNOLOGY AND VOICE, COMPUTER, AND DATA NETWORKS, AND CONSULTING SERVICES RELATED TO INFORMATION TECHNOLOGY, COMPUTER, AND DATA NETWORKS (U.S. CLS. 100 AND 101).

FIRST USE 1-1-2004; IN COMMERCE 1-1-2004.

2,999,070. NEW YORK DOG SPA & HOTEL, INC., NEW YORK, NY. SN 78-326,089. PUB. 11-2-2004, FILED 11-11-2003.

DOG SPA

THE MARK CONSISTS OF STANDARD CHARACTERS WITHOUT CLAIM TO ANY PARTICULAR FONT, STYLE, SIZE, OR COLOR.

OWNER OF U.S. REG. NO. 2,700,846.

NO CLAIM IS MADE TO THE EXCLUSIVE RIGHT TO USE "DOG", APART FROM THE MARK AS SHOWN.

CLASS 35—ADVERTISING AND BUSINESS

FOR RETAIL STORE SERVICES AND COMPUTERIZED ON-LINE RETAIL SERVICES FEATURING PET ACCESSORIES, NAMELY, CLOTHING, COLLARS, LEASHES, CARRIERS, FEEDING DISHES AND BOWLS, FOOD AND TREATS, GROOMING IMPLEMENTS, TOYS AND BEDS; PROVIDING A WEB SITE FEATURING CONSUMER PRODUCT INFORMATION ABOUT PET PRODUCTS (U.S. CLS. 100, 101 AND 102).

FIRST USE 9-30-2003; IN COMMERCE 9-30-2003.

CLASS 44—MEDICAL, BEAUTY AND AGRICULTURAL SERVICES

FOR PROVIDING A WEB SITE FEATURING INFORMATION ABOUT PETS AND PET CARE (U.S. CLS. 100 AND 101).

FIRST USE 2-28-2002; IN COMMERCE 2-28-2002.

2,999,074. RECKITT BENCKISER INC., PARSIPPANY, NJ. SN 78-326,863. PUB. 2-15-2005, FILED 11-12-2003.

MOBIL'AIR

THE MARK CONSISTS OF STANDARD CHARACTERS WITHOUT CLAIM TO ANY PARTICULAR FONT, STYLE, SIZE, OR COLOR.

CLASS 3—COSMETICS AND CLEANING PREPARATIONS

FOR PERFUMING PREPARATIONS FOR THE ATMOSPHERE IN THE NATURE OF PERFUMES FOR THE HOME, POTPOURRI, PERFUMERY PREPARATIONS IN THE NATURE OF PERFUMES FOR THE HOME; POMANDERS FOR SCENTING THE ATMOSPHERE AND DISPENSING ROOM PERFUMES (U.S. CLS. 1, 4, 6, 50, 51 AND 52).

FIRST USE 6-15-2004; IN COMMERCE 6-15-2004.

CLASS 5—PHARMACEUTICALS

FOR ROOM DEODORIZER, ROOM FRESHENERS; AIR FRESHENING PREPARATIONS, NAMELY, AIR FRESHENERS (U.S. CLS. 6, 18, 44, 46, 51 AND 52).

FIRST USE 6-15-2004; IN COMMERCE 6-15-2004.

CLASS 11—ENVIRONMENTAL CONTROL APPARATUS

FOR ELECTRIC PLUG-IN DISPENSERS FOR DISPENSING AIR FRESHENER INTO THE AMBIENT ATMOSPHERE (U.S. CLS. 13, 21, 23, 31 AND 34).

FIRST USE 6-15-2004; IN COMMERCE 6-15-2004.

2,999,075. AEROVIAS DE MEXICO, S.A. DE C.V., MEXICO, COLONIA CUAUHEMOC, MEXICO. SN 78-327,505. PUB. 10-12-2004, FILED 11-13-2003.

**BOLETO BENEFICIO
SIEMPRE**

THE MARK CONSISTS OF STANDARD CHARACTERS WITHOUT CLAIM TO ANY PARTICULAR FONT, STYLE, SIZE, OR COLOR.

PRIORITY CLAIMED UNDER SEC. 44(D) ON MEXICO APPLICATION NO. 614031, FILED 8-11-2003.

PRIORITY CLAIMED UNDER SEC. 44(D) ON MEXICO APPLICATION NO. 621321, FILED 9-29-2003.

NO CLAIM IS MADE TO THE EXCLUSIVE RIGHT TO USE "BOLETO", APART FROM THE MARK AS SHOWN.

THE FOREIGN WORDING IN THE MARK TRANSLATES INTO ENGLISH AS TICKET AVAILABLE IN ANY CASE.

CLASS 16—PAPER GOODS AND PRINTED MATTER

FOR PRINTED MATTER NAMELY AIRLINE TICKETS, FOLDERS, FORMS, PUBLICATIONS, NAMELY MAGAZINES, NEWSPAPERS, BULLETINS, CATALOGS AND MANUALS RELATING TO THE AIRLINE INDUSTRY, TABLETS WITH LETTERHEAD, WRITING PAPER, OFFICE SUPPLIES NAMELY PENS, PENCILS, PEN AND PENCIL CASES, NOTEPADS, NOTEBOOKS, ERASERS, FOLDERS FOR DOCUMENTS, CARDBOARD AND PAPER BOXES, DECALS, CALENDARS, POCKET NOTEBOOKS, POSTERS, PAPER NAPKINS, MAPS, SIGNBOARD OF PAPERS AND CARDBOARD, PAPER AND CARDBOARD POUCHES FOR PACKAGING (U.S. CLS. 2, 5, 22, 23, 29, 37, 38 AND 50).

FIRST USE 3-27-2003; IN COMMERCE 3-27-2003.

CLASS 39—TRANSPORTATION AND STORAGE

FOR TRANSPORTATION OF PASSENGERS, FREIGHT GOODS AND MAIL BY AIR, LAND AND SEA, STORAGE OF GOODS OF ALL KINDS IN WAREHOUSES AND SHIPPING CONTAINERS, CRATING AND DELIVERY OF GOODS BY AIR, TRUCK, CAR, TRAIN AND SHIP, PARCEL DELIVERY (U.S. CLS. 100 AND 105).

FIRST USE 3-27-2003; IN COMMERCE 3-27-2003.

2,999,092. ENERFLEX SYSTEMS LTD., CALGARY, CANADA. SN 78-337,310. PUB. 11-9-2004, FILED 12-5-2003.

JIRO

THE MARK CONSISTS OF STANDARD CHARACTERS WITHOUT CLAIM TO ANY PARTICULAR FONT, STYLE, SIZE, OR COLOR.

CLASS 7—MACHINERY

FOR MANUFACTURED OILFIELD EQUIPMENT, NAMELY SCREW COMPRESSORS FOR WELLHEAD OPTIMIZATION AND SAMPLERS (U.S. CLS. 13, 19, 21, 23, 31, 34 AND 35).

FIRST USE 7-0-2002; IN COMMERCE 5-0-2003.

CLASS 40—MATERIAL TREATMENT

FOR CUSTOM MANUFACTURED OF OILFIELD COMPRESSION EQUIPMENT TO CUSTOMER SPECIFICATION (U.S. CLS. 100, 103 AND 106).

FIRST USE 7-0-2002; IN COMMERCE 5-0-2005.

2,999,093. MARCHEX, INC., SEATTLE, WA. SN 78-337,341. PUB. 9-21-2004, FILED 12-5-2003.

**ENHANCE
INTERACTIVE**

THE MARK CONSISTS OF STANDARD CHARACTERS WITHOUT CLAIM TO ANY PARTICULAR FONT, STYLE, SIZE, OR COLOR.

NO CLAIM IS MADE TO THE EXCLUSIVE RIGHT TO USE "INTERACTIVE", APART FROM THE MARK AS

SHOWN.

2,999,099. VIALOGY CORP., ALTADENA, CA. SN 78-340,767.
PUB. 10-12-2004, FILED 12-15-2003.**CLASS 35—ADVERTISING AND BUSINESS**

FOR BUSINESS SERVICES, NAMELY PROVIDING COMPUTER DATABASES REGARDING THE PURCHASE AND SALE OF A WIDE VARIETY OF PRODUCTS AND SERVICES OF OTHERS; PROMOTING THE GOODS AND SERVICES OF OTHERS BY PROVIDING LINKS TO THE WEB SITES OF OTHERS; PROMOTING THE GOODS AND SERVICES OF OTHERS BY PROVIDING A WEB SITE AT WHICH USERS CAN LINK TO INFORMATION PERTAINING TO THE GOODS AND SERVICES OFFERED BY MERCHANTS; PROMOTING A WEB SITE WHICH FEATURES ADVERTISEMENTS FOR THE GOODS AND SERVICES OF OTHERS ON A GLOBAL COMPUTER NETWORK; DISSEMINATION OF ADVERTISING MATTER; DISSEMINATION OF ADVERTISING FOR OTHERS VIA THE INTERNET (U.S. CLS. 100, 101 AND 102).

FIRST USE 11-28-2003; IN COMMERCE 11-28-2003.

CLASS 42—SCIENTIFIC, COMPUTER AND LEGAL SERVICES

FOR COMPUTER SERVICES, NAMELY SEARCHING AND RETRIEVING INFORMATION ON THE PRODUCTS AND SERVICES OF OTHERS, AND CREATING INDEXES OF INFORMATION AND WEB SITES FOR OTHERS (U.S. CLS. 100 AND 101).

FIRST USE 11-28-2003; IN COMMERCE 11-28-2003.

THE MARK CONSISTS OF STANDARD CHARACTERS WITHOUT CLAIM TO ANY PARTICULAR FONT, STYLE, SIZE, OR COLOR.

CLASS 9—ELECTRICAL AND SCIENTIFIC APPARATUS

FOR COMPUTER SOFTWARE FOR CHARACTERIZING THE PERFORMANCE OF A SENSOR; DATA ANALYSIS SOFTWARE FOR USE IN ANALYZING DATA OUTPUT FROM A SENSOR; DRUG DISCOVERY SOFTWARE, NAMELY, SOFTWARE TO ANALYZE MICRARRAYS (U.S. CLS. 21, 23, 26, 36 AND 38).

FIRST USE 3-31-2004; IN COMMERCE 3-31-2004.

2,999,097. MAG INSTRUMENT, INC., ONTARIO, CA. SN 78-340,422. PUB. 10-12-2004, FILED 12-12-2003.

CLASS 42—SCIENTIFIC, COMPUTER AND LEGAL SERVICES

FOR DIGITAL DATA ANALYSIS SERVICES FOR OTHERS IN THE FIELD OF DATA ACQUISITION; ARRAYED PLATFORM DATA ANALYSIS FOR OTHERS; SENSOR DATA ANALYSIS FOR OTHERS; MASS SPECTROSCOPY DATA ANALYSIS FOR OTHERS; LIFE SCIENCES DATA ANALYSIS FOR OTHERS (U.S. CLS. 100 AND 101).

FIRST USE 3-31-2004; IN COMMERCE 3-31-2004.

THE MARK CONSISTS OF STANDARD CHARACTERS WITHOUT CLAIM TO ANY PARTICULAR FONT, STYLE, SIZE, OR COLOR.

OWNER OF U.S. REG. NOS. 1,154,816, 1,987,841, AND OTHERS.

NO CLAIM IS MADE TO THE EXCLUSIVE RIGHT TO USE "CHARGER", APART FROM THE MARK AS SHOWN.

CLASS 9—ELECTRICAL AND SCIENTIFIC APPARATUS

FOR ELECTRIC FLASHLIGHT ACCESSORIES SOLD TOGETHER OR SEPARATELY, NAMELY, RECHARGEABLE BATTERIES, CHARGER CRADLES, ELECTRICAL CONVERTERS, POWER CORDS, FLASHLIGHT RECHARGER ADAPTERS FOR USE WITH VEHICLE CIGARETTE LIGHTERS, FOREIGN PLUG ADAPTERS (U.S. CLS. 21, 23, 26, 36 AND 38).

FIRST USE 9-0-1982; IN COMMERCE 9-0-1982.

2,999,100. TAB COMPUTER SYSTEMS, INC., SOUTH WINDSOR, CT. SN 78-340,927. PUB. 10-26-2004, FILED 12-15-2003.

CLASS 11—ENVIRONMENTAL CONTROL APPARATUS

FOR FLASHLIGHTS AND RELATED PARTS, COMPONENT PARTS AND ACCESSORIES THEREFOR, NAMELY REPLACEMENT FLASHLIGHT LAMPS, FLASHLIGHT MOUNTING BRACKETS (U.S. CLS. 13, 21, 23, 31 AND 34).

FIRST USE 9-0-1982; IN COMMERCE 9-0-1982.

THE MARK CONSISTS OF STANDARD CHARACTERS WITHOUT CLAIM TO ANY PARTICULAR FONT, STYLE, SIZE, OR COLOR.

CLASS 9—ELECTRICAL AND SCIENTIFIC APPARATUS

FOR SOFTWARE FOR MONITORING FILE SERVER FUNCTIONS IN A COMPUTER NETWORK (U.S. CLS. 21, 23, 26, 36 AND 38).

FIRST USE 11-0-2003; IN COMMERCE 1-17-2005.

CLASS 42—SCIENTIFIC, COMPUTER AND LEGAL SERVICES

FOR COMPUTER NETWORK FILE SERVER MONITORING AND REPORTING SERVICES (U.S. CLS. 100 AND 101).

FIRST USE 11-0-2003; IN COMMERCE 1-17-2005.

2,999,105. VIVOMETRICS, INC., VENTURA, CA. SN 78-341,776. PUB. 9-28-2004, FILED 12-16-2003.

MONITORING LIFE

THE MARK CONSISTS OF STANDARD CHARACTERS WITHOUT CLAIM TO ANY PARTICULAR FONT, STYLE, SIZE, OR COLOR.

CLASS 10—MEDICAL APPARATUS

FOR MEDICAL APPARATUS, NAMELY, A PORTABLE AND WEARABLE ELECTRONIC DEVICE THAT COLLECTS AND RECORDS PHYSIOLOGIC DATA, INCLUDING RESPIRATORY, CARDIAC, POSTURE, ACTIVITY, TEMPERATURE, GLOBAL POSITION AND OTHER AMBULATORY AND PHYSIOLOGIC PARAMETERS, THAT ARE THEN STORED, DISPLAYED LOCALLY ON THE INDIVIDUAL, AND/OR TRANSMITTED WIRELESSLY, INCLUDING IN REAL TIME, TO A REMOTE DATA CENTER, A PERSONAL, WEB SITE, AND/OR OTHER LOCATIONS FOR DISPLAY AND/OR ANALYSIS, IN EACH CASE (U.S. CLS. 26, 39 AND 44).

FIRST USE 8-1-2001; IN COMMERCE 6-1-2004.

CLASS 44—MEDICAL, BEAUTY AND AGRICULTURAL SERVICES

FOR PROVIDING HEALTHCARE SERVICES, NAMELY, CONTINUOUS AMBULATORY MONITORING OF PHYSIOLOGIC PARAMETERS OF INDIVIDUALS, INCLUDING RESPIRATORY, CARDIAC, POSTURE, ACTIVITY, TEMPERATURE, GLOBAL POSITION, AND OTHER AMBULATORY AND PHYSIOLOGIC PARAMETERS THAT ARE THEN STORED, DISPLAYED LOCALLY ON THE INDIVIDUAL, AND/OR TRANSMITTED WIRELESSLY, INCLUDING IN REAL TIME, TO A REMOTE DATA CENTER, PERSONAL WEB SITE, AND/OR OTHER LOCATIONS FOR DISPLAY AND/OR ANALYSIS (U.S. CLS. 100 AND 101).

FIRST USE 8-1-2001; IN COMMERCE 6-1-2004.

2,999,108. SPANGLER, AMY, ATLANTA, GA. SN 78-343,600. PUB. 11-2-2004, FILED 12-19-2003.

AMY'S BABY

THE MARK CONSISTS OF STANDARD CHARACTERS WITHOUT CLAIM TO ANY PARTICULAR FONT, STYLE, SIZE, OR COLOR.

NO CLAIM IS MADE TO THE EXCLUSIVE RIGHT TO USE "BABY", APART FROM THE MARK AS SHOWN.

CLASS 9—ELECTRICAL AND SCIENTIFIC APPARATUS

FOR PRE-RECORDED CD'S, VIDEO TAPES, AND DVD'S FEATURING BREASTFEEDING INSTRUCTIONS AND INFORMATION; PHOTOGRAPHIC SLIDE TRANSPARENCY SETS FEATURING BREASTFEEDING INSTRUCTIONS AND INFORMATION (U.S. CLS. 21, 23, 26, 36 AND 38).

FIRST USE 1-0-2005; IN COMMERCE 1-0-2005.

CLASS 16—PAPER GOODS AND PRINTED MATTER

FOR BOOKS, BOOKMARKS, BROCHURES, AND POCKET GUIDES FEATURING BREASTFEEDING INSTRUCTIONS AND INFORMATION (U.S. CLS. 2, 5, 22, 23, 29, 37, 38 AND 50).

FIRST USE 1-0-2005; IN COMMERCE 1-0-2005.

2,999,109. SPANGLER, AMY, ATLANTA, GA. SN 78-343,622. PUB. 11-2-2004, FILED 12-19-2003.

**CLASS 9—ELECTRICAL AND SCIENTIFIC APPARATUS**

FOR PRE-RECORDED CD'S, VIDEO TAPES, AND DVD'S FEATURING INSTRUCTIONS AND INFORMATION ON BREASTFEEDING AND INFANT CARE; PHOTOGRAPHIC SLIDE TRANSPARENCY SETS FEATURING INSTRUCTIONS AND INFORMATION ON BREASTFEEDING AND INFANT CARE (U.S. CLS. 21, 23, 26, 36 AND 38).

FIRST USE 1-0-1995; IN COMMERCE 1-0-1995.

CLASS 16—PAPER GOODS AND PRINTED MATTER

FOR BOOKS, BOOKMARKS, BROCHURES, AND POCKET GUIDES FEATURING INSTRUCTIONS AND INFORMATION ON BREASTFEEDING AND INFANT CARE (U.S. CLS. 2, 5, 22, 23, 29, 37, 38 AND 50).
FIRST USE 1-0-1995; IN COMMERCE 1-0-1995.

2,999,118. CLEAR DIRECTIONS, INC., UKIAH, CA. SN 78-347,070. PUB. 12-21-2004, FILED 12-31-2003.

Directed Conversations

2,999,111. RIVERMINE SOFTWARE, INC., FAIRFAX, VA. SN 78-343,986. PUB. 10-26-2004, FILED 12-21-2003.

THE MARK CONSISTS OF STANDARD CHARACTERS WITHOUT CLAIM TO ANY PARTICULAR FONT, STYLE, SIZE, OR COLOR.

RIVERMINE

CLASS 41—EDUCATION AND ENTERTAINMENT

FOR EDUCATIONAL AND ENTERTAINMENT- FOR ARRANGING AND CONDUCTING EDUCATIONAL SEMINARS AND TRAINING IN THE FIELD OF EMOTIONAL HEALTH AND SELF AWARENESS (U.S. CLS. 100, 101 AND 107).
FIRST USE 8-18-2003; IN COMMERCE 8-18-2003.

CLASS 45—PERSONAL SERVICES

FOR PERSONAL SERVICES RENDERED TO MEET INDIVIDUAL NEEDS, NAMELY CONSULTATION IN THE FIELDS OF PERSONAL PERFORMANCE (U.S. CLS. 100 AND 101).
FIRST USE 8-18-2003; IN COMMERCE 8-18-2003.

THE MARK CONSISTS OF STANDARD CHARACTERS WITHOUT CLAIM TO ANY PARTICULAR FONT, STYLE, SIZE, OR COLOR.

2,999,145. SPARLING, JOSEPH J., CHAPEL HILL, NC. SN 78-356,043. PUB. 11-2-2004, FILED 1-22-2004.

CLASS 9—ELECTRICAL AND SCIENTIFIC APPARATUS

FOR COMPUTER SOFTWARE THAT ENABLES ENTERPRISES TO MANAGE VOICE, DATA, TELECOMMUNICATIONS, AND INFORMATION TECHNOLOGY ASSETS, EXPENSES, OPERATIONS AND PROCESSES (U.S. CLS. 21, 23, 26, 36 AND 38).
FIRST USE 3-0-2004; IN COMMERCE 3-0-2004.

Cradle to Classroom

CLASS 42—SCIENTIFIC, COMPUTER AND LEGAL SERVICES

FOR TECHNICAL SUPPORT, NAMELY, SOFTWARE MAINTENANCE AND TROUBLESHOOTING OF SOFTWARE PROBLEMS; CUSTOM DEVELOPMENT OF SOFTWARE FOR OTHERS; COMPUTER SERVICES, NAMELY, IMPLEMENTING, INSTALLING, UPGRADING AND CONFIGURING COMPUTER SOFTWARE; PROVIDING TEMPORARY USE OF ON-LINE NON-DOWNLOADABLE SOFTWARE THAT ENABLES ENTERPRISES TO MANAGE VOICE, DATA, TELECOMMUNICATIONS AND INFORMATION TECHNOLOGY ASSETS, EXPENSES, OPERATIONS AND PROCESSES; COMPUTER SOFTWARE CONSULTATION IN THE NATURE OF SOFTWARE THAT ENABLES ENTERPRISES TO MANAGE VOICE, DATA, TELECOMMUNICATIONS AND INFORMATION TECHNOLOGY ASSETS, EXPENSES, OPERATIONS AND PROCESSES (U.S. CLS. 100 AND 101).
FIRST USE 1-0-2004; IN COMMERCE 1-0-2004.

THE MARK CONSISTS OF STANDARD CHARACTERS WITHOUT CLAIM TO ANY PARTICULAR FONT, STYLE, SIZE, OR COLOR.

CLASS 16—PAPER GOODS AND PRINTED MATTER

FOR EDUCATIONAL PUBLICATIONS, NAMELY, TRAINING MANUALS IN THE FIELD OF PARENTING AND EARLY CHILDHOOD EDUCATION (U.S. CLS. 2, 5, 22, 23, 29, 37, 38 AND 50).
FIRST USE 0-0-2000; IN COMMERCE 5-1-2005.

CLASS 41—EDUCATION AND ENTERTAINMENT

FOR TRAINING SERVICES IN THE FIELD OF PARENTING AND EARLY CHILDHOOD EDUCATION (U.S. CLS. 100, 101 AND 107).

FIRST USE 0-0-2000; IN COMMERCE 6-1-2005.

2,999,282. MICROSOFT CORPORATION, REDMOND, WA. SN 78-976,281. PUB. 4-6-2004, FILED 11-25-2002.

2,999,245. S&S BRANDS, INC., WILMINGTON, DE. SN 78-409,172. PUB. 2-22-2005, FILED 4-28-2004.

COTTONTAILS

THE MARK CONSISTS OF STANDARD CHARACTERS WITHOUT CLAIM TO ANY PARTICULAR FONT, STYLE, SIZE, OR COLOR.

OWNER OF U.S. REG. NO. 2,379,640.

CLASS 3—COSMETICS AND CLEANING PREPARATIONS

FOR BABY SHAMPOO, BABY SKIN AND BODY LOTION, BABY BODY WASH, BABY OIL, BABY POWDER, BABY WIPES, NON-MEDICATED DIAPER RASH OINTMENT AND LOTION, ALL-PURPOSE COTTON SWABS FOR PERSONAL USE (U.S. CLS. 1, 4, 6, 50, 51 AND 52).

FIRST USE 9-1-2004; IN COMMERCE 9-1-2004.

CLASS 5—PHARMACEUTICALS

FOR MEDICATED DIAPER RASH OINTMENT AND LOTION (U.S. CLS. 6, 18, 44, 46, 51 AND 52).

FIRST USE 9-1-2004; IN COMMERCE 9-1-2004.

CLASS 10—MEDICAL APPARATUS

FOR DISPOSABLE BABY BOTTLES, THERMOMETERS FOR MEDICAL USE (U.S. CLS. 26, 39 AND 44).

FIRST USE 9-7-2004; IN COMMERCE 9-7-2004.

CLASS 16—PAPER GOODS AND PRINTED MATTER

FOR DISPOSABLE DIAPERS (U.S. CLS. 2, 5, 22, 23, 29, 37, 38 AND 50).

FIRST USE 4-21-2003; IN COMMERCE 4-21-2003.

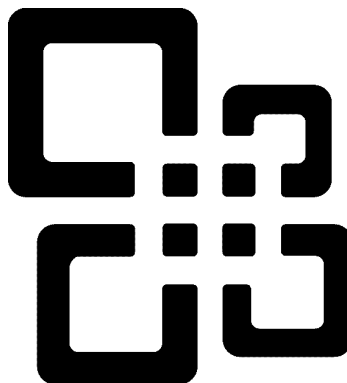

THE MARK CONSISTS OF FOUR SQUARES EACH HAVING A GENERALLY SQUARE-SHAPED FRAME EXTENDING OUTWARDLY THEREFROM.

CLASS 38—COMMUNICATION

FOR COMMUNICATION SERVICES, NAMELY, TRANSMITTING TEXT, SOUND, GRAPHICS AND VIDEO VIA COMPUTER NETWORKS, WIRELESS NETWORKS AND THE INTERNET; CONSULTING SERVICES IN THE FIELD OF TELECOMMUNICATIONS; AND PROVIDING INFORMATION IN THE FIELD OF WEB ACCESS VIA COMPUTER NETWORKS, WIRELESS NETWORKS AND THE INTERNET (U.S. CLS. 100, 101 AND 104).

FIRST USE 2-19-2003; IN COMMERCE 2-19-2003.

CLASS 42—SCIENTIFIC, COMPUTER AND LEGAL SERVICES

FOR PROVIDING TEMPORARY USE OF ON-LINE NON-DOWNLOADABLE SOFTWARE FOR USE IN DATABASE MANAGEMENT, PREPARATION OF SPREADSHEETS, AND WORD PROCESSING; COMPUTER SOFTWARE CONSULTATION; PROVIDING INFORMATION IN THE FIELDS OF THE DEVELOPMENT OF COMPUTER SYSTEMS, NETWORKS AND SOFTWARE, OVER COMPUTER NETWORKS, WIRELESS NETWORKS AND GLOBAL COMMUNICATIONS NETWORKS; TECHNICAL SUPPORT SERVICES, NAMELY, PROVIDING TECHNICAL ASSISTANCE TO OTHERS IN THE FIELD OF WEBSITE MANAGEMENT AND EMAIL MANAGEMENT SERVICES; AND PROVIDING TECHNICAL INFORMATION IN THE FIELD OF WEBSITE MANAGEMENT AND EMAIL MANAGEMENT VIA COMPUTER NETWORKS AND GLOBAL COMMUNICATIONS NETWORKS (U.S. CLS. 100 AND 101).

FIRST USE 2-19-2003; IN COMMERCE 2-19-2003.

CLASS 45—PERSONAL SERVICES

FOR PROVIDING INFORMATION IN THE FIELD OF SECURITY SERVICES FOR WEBSITES, VIA COMPUTER NETWORKS AND GLOBAL COMMUNICATIONS NETWORKS (U.S. CLS. 100 AND 101).

FIRST USE 2-19-2003; IN COMMERCE 2-19-2003.

2,999,283. MICROSOFT CORPORATION, REDMOND, WA. SN 78-976,282. PUB. 4-6-2004, FILED 11-25-2002.

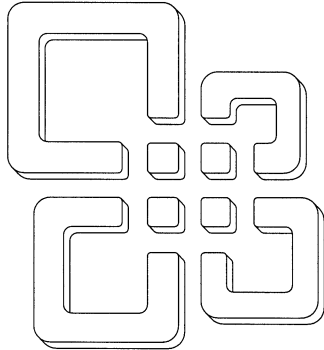

THE MARK CONSISTS OF FOUR SQUARE CROSS-SECTION SOLIDS EACH HAVING A GENERALLY SQUARE-SHAPED FRAME EXTENDING OUTWARDLY THEREFROM

CLASS 38—COMMUNICATION

FOR COMMUNICATION SERVICES, NAMELY, TRANSMITTING TEXT, SOUND, GRAPHICS AND VIDEO VIA COMPUTER NETWORKS, WIRELESS NETWORKS AND THE INTERNET; CONSULTING SERVICES IN THE FIELD OF TELECOMMUNICATIONS; AND PROVIDING INFORMATION IN THE FIELD OF WEB ACCESS VIA COMPUTER NETWORKS, WIRELESS NETWORKS AND THE INTERNET (U.S. CLS. 100, 101 AND 104).

FIRST USE 2-19-2003; IN COMMERCE 2-19-2003.

CLASS 42—SCIENTIFIC, COMPUTER AND LEGAL SERVICES

FOR PROVIDING TEMPORARY USE OF ON-LINE NON-DOWNLOADABLE SOFTWARE FOR USE IN DATABASE MANAGEMENT, PREPARATION OF SPREADSHEETS, AND WORD PROCESSING; COMPUTER SOFTWARE CONSULTATION; PROVIDING INFORMATION IN THE FIELDS OF THE DEVELOPMENT OF COMPUTER SYSTEMS, NETWORKS AND SOFTWARE, OVER COMPUTER NETWORKS, WIRELESS NETWORKS AND GLOBAL COMMUNICATIONS NETWORKS; TECHNICAL SUPPORT SERVICES, NAMELY, PROVIDING TECHNICAL ASSISTANCE TO OTHERS IN THE FIELD OF WEBSITE MANAGEMENT AND EMAIL MANAGEMENT SERVICES; AND PROVIDING TECHNICAL INFORMATION IN THE FIELD OF WEBSITE MANAGEMENT AND EMAIL MANAGEMENT VIA COMPUTER NETWORKS AND GLOBAL COMMUNICATIONS NETWORKS (U.S. CLS. 100 AND 101).

FIRST USE 2-19-2003; IN COMMERCE 2-19-2003.

CLASS 45—PERSONAL SERVICES

FOR PROVIDING INFORMATION IN THE FIELD OF SECURITY SERVICES FOR WEBSITES, VIA COMPUTER NETWORKS AND GLOBAL COMMUNICATIONS NETWORKS (U.S. CLS. 100 AND 101).

FIRST USE 2-19-2003; IN COMMERCE 2-19-2003.

2,999,284. SNAP TV, INC., SANTA MONICA, CA. SN 78-976,283. PUB. 9-7-2004, FILED 9-8-2003.

SNAP TV

NO CLAIM IS MADE TO THE EXCLUSIVE RIGHT TO USE "TV", APART FROM THE MARK AS SHOWN.

CLASS 9—ELECTRICAL AND SCIENTIFIC APPARATUS

FOR ELECTRONIC GAME PROGRAMS; VIDEO GAME PROGRAMS; VIDEO GAME SOFTWARE; COMPUTER AND VIDEO GAME PROGRAMS IN THE FORM OF DVDS AND SOFTWARE PROGRAMS FOR VIDEO GAMES (U.S. CLS. 21, 23, 26, 36 AND 38).

FIRST USE 2-1-2005; IN COMMERCE 2-1-2005.

CLASS 42—SCIENTIFIC, COMPUTER AND LEGAL SERVICES

FOR PROVIDING TEMPORARY USE OF ON-LINE NON-DOWNLOADABLE SOFTWARE FOR USE IN PLAYING ONLINE COMPUTER GAMES (U.S. CLS. 100 AND 101).

FIRST USE 1-1-2005; IN COMMERCE 1-1-2005.

* * * * *

SECTION 2.— INTERNATIONAL CLASSIFICATION

The short titles associated below with the international class numbers are terms designed merely for quick identification and are not an official part of the international classification. The full names of international classes are given in section 6.1 of the trademark rules of practice.

The designation "U.S. Cl." appearing in this section refers to the U.S. class in effect prior to Sep. 1, 1973 rather than the international class which applies to applications filed on or after that date. For adoption of international classification see notice in the OFFICIAL GAZETTE of Jun. 26, 1973 (911 O.G. TM 210).

Application in one class

CLASS 1—CHEMICALS

2,998,515. JOHNSON & JOHNSON, NEW BRUNSWICK, NJ. SN 75-934,728. PUB. 6-11-2002, FILED 3-3-2000.

PRIMACRYL

FOR CHEMICALS, NAMELY, ABSORBABLE POLYMERS USED AS AN INTEGRAL COMPONENT OF ARTIFICIAL SURGICAL IMPLANTS (U.S. CLS. 1, 5, 6, 10, 26 AND 46).

FIRST USE 8-0-2003; IN COMMERCE 8-0-2003.

CLASS 1—(Continued).

2,998,621. TAMURA CORPORATION, TOKYO, JAPAN. SN 76-460,579. PUB. 10-21-2003, FILED 10-16-2002.

The logo for TAMURA features the word "TAMURA" in a bold, black, sans-serif font. Above the letter "U", there is a stylized, curved graphic element that resembles a swoosh or a partial circle, also in black.

2,998,571. FRONTIER FERTILIZER & CHEMICAL COMPANY, JOHNSTOWN, CO. SN 76-374,285. PUB. 9-24-2002, FILED 2-22-2002.

THE WEEKENDER

FOR FERTILIZERS FOR DOMESTIC USE (U.S. CLS. 1, 5, 6, 10, 26 AND 46).

FIRST USE 4-7-2005; IN COMMERCE 4-7-2005.

FOR SOLDERING FLUXES; SOLDERING CHEMICALS; BRAZING FLUXES; CHEMICAL PREPARATIONS FOR BRAZING; INDUSTRIAL CHEMICALS, NAMELY, SURFACE ACTIVE AGENTS, PLASTIC ADHESIVES, AND ADHESIVES FOR MANUFACTURING USES (U.S. CLS. 1, 5, 6, 10, 26 AND 46).

FIRST USE 5-1-2002; IN COMMERCE 10-1-2003.

2,998,615. NOVOZYMES A/S, BAGSVAERD, DENMARK. SN 76-450,003. PUB. 2-25-2003, FILED 9-16-2002.

LONGGREEN

FOR FERTILIZERS AND SOIL AMENDMENTS FOR DOMESTIC AND AGRICULTURAL USE (U.S. CLS. 1, 5, 6, 10, 26 AND 46).

FIRST USE 0-0-2002; IN COMMERCE 0-0-2002.

2,998,672. STAR NURSERY, INC., HENDERSON, NV. SN 76-510,582. PUB. 12-23-2003, FILED 5-1-2003.

DR. Q'S TRIPLE PLAY

FOR LAWN AND GARDEN FERTILIZER FOR DOMESTIC USE (U.S. CLS. 1, 5, 6, 10, 26 AND 46).

FIRST USE 2-0-2005; IN COMMERCE 2-0-2005.

CLASS 1—(Continued).

2,998,813. CELL SIGNALING TECHNOLOGY, INC., BEVERLY, MA. SN 76-584,503. PUB. 2-1-2005, FILED 3-31-2004.

PHOSPHOSCAN

THE MARK CONSISTS OF STANDARD CHARACTERS WITHOUT CLAIM TO ANY PARTICULAR FONT, STYLE, SIZE, OR COLOR.

OWNER OF U.S. REG. NO. 2,825,805.

FOR REAGENTS FOR SCIENTIFIC AND CLINICAL RESEARCH USE, NAMELY, KITS CONTAINING ANTIBODIES AND/OR NUCLEIC ACIDS FOR THE DETECTION OF PROTEIN MODIFICATION, ACTIVITY, OR EXPRESSION (U.S. CLS. 1, 5, 6, 10, 26 AND 46).

FIRST USE 2-7-2005; IN COMMERCE 2-7-2005.

2,998,926. CONGOLEUM CORPORATION, MERCERVILLE, NJ. SN 78-229,161. PUB. 2-17-2004, FILED 3-24-2003.

DS100 DURASET

FOR ADHESIVES FOR APPLYING FLOOR TILES (U.S. CLS. 1, 5, 6, 10, 26 AND 46).

FIRST USE 7-16-2003; IN COMMERCE 7-16-2003.

2,998,952. AIR PRODUCTS AND CHEMICALS, INC., ALLENTOWN, PA. SN 78-248,450. PUB. 12-9-2003, FILED 5-12-2003.

PDEMS

FOR CHEMICALS FOR PRODUCTION OF POROUS INSULATING DIELECTRIC FILMS IN INTEGRATED CIRCUIT FABRICATION (U.S. CLS. 1, 5, 6, 10, 26 AND 46).

FIRST USE 12-31-2003; IN COMMERCE 4-11-2005.

2,998,966. SHAW MUDGE & COMPANY, SHELTON, CT. SN 78-262,256. PUB. 4-13-2004, FILED 6-13-2003.

SCENTMATRIX

FOR PERFUME COMPOSITIONS, NAMELY, FRAGRANCES USED IN MAKING TOILETRIES, COSMETICS, HOUSEHOLD PRODUCTS, CANDLES AND AIR FRESHENERS (U.S. CLS. 1, 5, 6, 10, 26 AND 46).

FIRST USE 2-0-2005; IN COMMERCE 2-0-2005.

CLASS 1—(Continued).

2,999,140. BIOLAB SERVICES, INC., WILMINGTON, DE. SN 78-354,090. PUB. 11-2-2004, FILED 1-20-2004.

WONDER TAB

THE MARK CONSISTS OF STANDARD CHARACTERS WITHOUT CLAIM TO ANY PARTICULAR FONT, STYLE, SIZE, OR COLOR.

FOR WATER TREATMENT CHEMICALS FOR SWIMMING POOLS AND SPAS (U.S. CLS. 1, 5, 6, 10, 26 AND 46).

FIRST USE 4-5-2005; IN COMMERCE 4-5-2005.

2,999,268. MACHEREY, NAGEL & CO. HANDELSGESELLSCHAFT, DUEREN, FED REP GERMANY. SN 78-433,600. PUB. 4-19-2005, FILED 6-11-2004.

AQUADUR

THE MARK CONSISTS OF STANDARD CHARACTERS WITHOUT CLAIM TO ANY PARTICULAR FONT, STYLE, SIZE, OR COLOR.

FOR INDICATOR PAPERS, PARTICULARLY TEST STICKS FOR FAST DETECTION OF WATER HARDNESS (U.S. CLS. 1, 5, 6, 10, 26 AND 46).

FIRST USE 1-1-2004; IN COMMERCE 7-1-2004.

CLASS 2—PAINTS

CLASS 2—(Continued).

2,998,637. ADVANTIS TECHNOLOGIES, INC., ALPHARETTA, GA. SN 76-472,787. PUB. 9-28-2004, FILED 12-9-2002.



FOR WATER SOLUBLE DYES FOR USE IN COLORING WATER IN NATURAL AND MAN MADE PONDS, LAKES, FOUNTAINS, DECORATIVE POOLS AND OTHER IMPOUNDED BODIES OF WATER AND LIMITED OUTFLOW (U.S. CLS. 6, 11 AND 16).
FIRST USE 1-25-2003; IN COMMERCE 1-25-2003.

2,998,735. INSL-X PRODUCTS CORPORATION, STONY POINT, NY. SN 76-546,893. PUB. 6-1-2004, FILED 9-10-2003.

MEGALAQ

OWNER OF U.S. REG. NO. 2,674,877.
FOR COATINGS IN THE NATURE OF CLEAR AND PIGMENTED FINISHES FOR USE ON INTERIOR AND EXTERIOR SURFACES OF WOOD, PARTICLE BOARD, AND PLYWOOD (U.S. CLS. 6, 11 AND 16).
FIRST USE 2-15-2005; IN COMMERCE 2-15-2005.

2,998,773. MADISON CHEMICAL INDUSTRIES INC., MILTON, ONTARIO L9T 3Y5, CANADA. SN 76-567,405. PUB. 1-11-2005, FILED 12-29-2003.

WHERE PAINT JUST ISN'T GOOD ENOUGH

THE MARK CONSISTS OF STANDARD CHARACTERS WITHOUT CLAIM TO ANY PARTICULAR FONT, STYLE, SIZE, OR COLOR.

OWNER OF CANADA REG. NO. TMA306663, DATED 9-6-1985, RENEWED AS REG. NO. TMA306663, DATED 9-6-2000, EXPIRES 9-6-2015.

FOR CORROSION RESISTANT PROTECTIVE COATINGS (U.S. CLS. 6, 11 AND 16).
FIRST USE 7-0-1984; IN COMMERCE 7-0-1984.

CLASS 2—(Continued).

2,998,960. CONSORCIO COMEX, S.A. DE C.V., MEXICO, D.F., MEXICO. SN 78-257,637. PUB. 12-21-2004, FILED 6-3-2003.

100 GOLD

THE MARK CONSISTS OF STANDARD CHARACTERS WITHOUT CLAIM TO ANY PARTICULAR FONT, STYLE, SIZE, OR COLOR.

OWNER OF MEXICO REG. NO. 757418, DATED 7-30-2002, EXPIRES 7-9-2012.

NO CLAIM IS MADE TO THE EXCLUSIVE RIGHT TO USE "GOLD", APART FROM THE MARK AS SHOWN.

THE MARK IS PRESENTED IN STANDARD CHARACTERS, WITHOUT CLAIM TO ANY PARTICULAR FONT, STYLE, SIZE OR COLOR

FOR ALKYDALIC ENAMEL IN THE NATURE OF PAINT FOR INTERIOR AND EXTERIOR USE TO BE USED OVER METAL, WOOD, CONCRETE AND/OR PLASTER (U.S. CLS. 6, 11 AND 16).

FIRST USE 3-9-2004; IN COMMERCE 3-9-2004.

CLASS 3—COSMETICS AND CLEANING PREPARATIONS

2,998,552. YANKEE CANDLE COMPANY, INC., THE, SOUTH DEERFIELD, MA. SN 76-302,045. PUB. 11-19-2002, FILED 8-20-2001.

YANKEE CANDLE

THE MARK CONSISTS OF STANDARD CHARACTERS WITHOUT CLAIM TO ANY PARTICULAR FONT, STYLE, SIZE, OR COLOR.

OWNER OF U.S. REG. NOS. 1,490,759 AND 1,959,907.
NO CLAIM IS MADE TO THE EXCLUSIVE RIGHT TO USE "CANDLE", APART FROM THE MARK AS SHOWN.

FOR PERSONAL CARE AND BATH ITEMS, NAMELY, BATH SALTS, LAUNDRY DETERGENT, SKIN WASH, SKIN LOTIONS, CLEANSING SKIN GEL, BATH AND TOILET SOAP IN ALL FORMS, NAMELY, LIQUID, GEL, WASH AND POWDER, ROOM FRAGRANCES; POT-POURRI; SACHETS (U.S. CLS. 1, 4, 6, 50, 51 AND 52).

FIRST USE 9-19-2001; IN COMMERCE 9-19-2001.

2,998,603. JIMLAR CORPORATION, GREAT NECK, NY. SN 76-434,885. PUB. 3-23-2004, FILED 7-26-2002.

FRYE

OWNER OF U.S. REG. NOS. 1,084,873, 1,244,640, AND 1,990,286.

SEC. 2(F).
FOR SHOE AND BOOT POLISH AND WAXES (U.S. CLS. 1, 4, 6, 50, 51 AND 52).

FIRST USE 6-8-2005; IN COMMERCE 6-8-2005.

CLASS 3—(Continued).

2,998,605. CABOODLES, LLC, MEMPHIS, TN. SN 76-436,636.
PUB. 6-24-2003, FILED 8-1-2002.



FOR COSMETICS (U.S. CLS. 1, 4, 6, 50, 51 AND 52).
FIRST USE 7-31-2002; IN COMMERCE 7-31-2002.

2,998,651. CRA INTERNATIONAL, CO., MIAMI, FL. SN 76-
484,482. PUB. 9-30-2003, FILED 1-22-2003.

NO CLAIM IS MADE TO THE EXCLUSIVE RIGHT TO
USE "CREAM", APART FROM THE MARK AS SHOWN.
FOR COSMETICS, NAMELY SKIN CARE PRODUCTS
IN THE NATURE OF A CREAM APPLIED TOPICALLY
FOR TEMPORARY CELLULITE REDUCTION (U.S. CLS.
1, 4, 6, 50, 51 AND 52).
FIRST USE 2-15-2003; IN COMMERCE 2-15-2003.

2,998,661. ZIMMERMAN-GALE, TONYA, LEWES, DE. SN 76-
496,737. PUB. 5-11-2004, FILED 3-12-2003.

TONYA'S TUMMY

NO CLAIM IS MADE TO THE EXCLUSIVE RIGHT TO
USE TUMMY, APART FROM THE MARK AS SHOWN.
FOR SKIN LOTION (U.S. CLS. 1, 4, 6, 50, 51 AND 52).
FIRST USE 7-18-2005; IN COMMERCE 7-18-2005.

CLASS 3—(Continued).

2,998,716. VAERELANDT-ICON PRODUCTS LLC, NEW
YORK, NY. SN 76-536,959. PUB. 5-11-2004, FILED 7-31-2003.

ELANICON YOUTHING

FOR FACIAL PRODUCTS; NAMELY, FACIAL
CREAMS; FACIAL CLEANSERS; FACIAL LOTIONS;
NON-MEDICATED FACIAL SERUMS; FACIAL OILS;
FACIAL MISTS; FACIAL MASKS; FACIAL SUN
BLOCKS; FACIAL SOAPS; FACIAL TONERS; FACIAL
ASTRINGENTS FOR COSMETIC PURPOSES; BODY
CARE PRODUCTS; NAMELY, BODY CREAMS; BODY
OILS; BODY POWDERS; BODY LOTIONS; NON-MEDI-
CATED BODY SERUMS; BODY MISTS; BODY MASKS;
BODY SUN BLOCKS; BODY SOAPS; BODY TONERS;
BODY POWDERS; BODY SCRUBS; HAIR CARE PRO-
DUCTS; NAMELY, HAIR SHAMPOOS; HAIR CONDI-
TIONERS; HAIR GELS; HAIR RINSES; HAIR COLORS;
NAIL CARE PRODUCTS; NAMELY, NAIL POLISH;
NAIL POLISH REMOVERS; NAIL WRAPS; BATH PRO-
DUCTS; NAMELY, BATH GELS, NON-MEDICATED
BATH OILS; BUBBLE-BATH PREPARATIONS; NON-
MEDICATED BATH SALTS; NON-MEDICATED HER-
BAL SOAPS; LIQUID SOAPS; NON-MEDICATED BOT-
ANICAL BATH SOOTHING LIQUIDS; COSMETICS;
NAMELY, MAKE-UP FOUNDATION, POWDER AND
BLUSH; EYE LINER; EYE MAKE-UP; EYE SHADOW;
EYE AND EYEBROW PENCILS; MASCARA; UNDER
EYE COVER STICKS AND FOUNDATIONS; LIPSTICK;
LIP GLOSSES; LIP LINERS; MAKE-UP REMOVER;
PERSONAL CARE PREPARATION PRODUCTS;
NAMELY, PERFUMES; COLOGNES; TOILET WATER;
POTPOURRIS; NON-MEDICATED HERBAL SACHETS
(U.S. CLS. 1, 4, 6, 50, 51 AND 52).
FIRST USE 12-6-2003; IN COMMERCE 12-6-2003.

2,998,759. LAURICE EL BADRY RAHME LTD., DBA LAUR-
ICE & CO., NEW YORK, NY. SN 76-564,049. PUB. 12-21-
2004, FILED 12-8-2003.

CENTRAL PARK

THE MARK CONSISTS OF STANDARD CHARACTERS
WITHOUT CLAIM TO ANY PARTICULAR FONT, STYLE,
SIZE, OR COLOR.

FOR FRAGRANCES FOR PERSONAL USE, NAMELY,
PERFUME, COLOGNES, AFTER BATH SPLASHES,
BODY SPRAYS, SHOWER GELS, SOAPS, BODY LO-
TIONS, MASSAGE OILS; COSMETICS, NAMELY SKIN
CARE PREPARATIONS, MAKEUP, LIPSTICK, FOUN-
DATION POWDERS, EYESHADOW, NAIL POLISH,
MASCARA AND EYE PENCILS (U.S. CLS. 1, 4, 6, 50, 51
AND 52).

FIRST USE 7-0-2004; IN COMMERCE 7-0-2004.

CLASS 3—(Continued).

2,998,793. WAGH, ASHER, BROOKLYN, NY. SN 76-577,132.
PUB. 4-12-2005, FILED 2-24-2004.

PURE USA

NO CLAIM IS MADE TO THE EXCLUSIVE RIGHT TO USE "USA", APART FROM THE MARK AS SHOWN.
FOR SKIN MOISTURIZING CREAM, HAIR SHAMPOO
(U.S. CLS. 1, 4, 6, 50, 51 AND 52).
FIRST USE 4-12-2005; IN COMMERCE 4-12-2005.

2,998,808. STAR-BRITE DISTRIBUTING, INC., FORT LAUDERDALE, FL. SN 76-582,462. PUB. 3-15-2005, FILED 3-23-2004.

SALT OFF

THE MARK CONSISTS OF STANDARD CHARACTERS WITHOUT CLAIM TO ANY PARTICULAR FONT, STYLE, SIZE, OR COLOR.

NO CLAIM IS MADE TO THE EXCLUSIVE RIGHT TO USE "SALT", APART FROM THE MARK AS SHOWN.

FOR CLEANING PREPARATION FOR REMOVING SALT FROM BOATS, ENGINES, AND MARINE EQUIPMENT (U.S. CLS. 1, 4, 6, 50, 51 AND 52).

FIRST USE 2-28-2004; IN COMMERCE 2-28-2004.

CLASS 3—(Continued).

2,998,882. BOOTS COMPANY USA HOLDINGS INC., THE, WILMINGTON, DE. SN 78-186,848. PUB. 11-18-2003, FILED 11-20-2002.

BOOTS MEDITERRANEAN

OWNER OF U.S. REG. NOS. 2,026,134, 2,427,728, AND 2,515,976.

FOR NON-MEDICATED TOILET PREPARATIONS, NAMELY, AFTER-SHAVE LOTIONS, ANTI-PERSPIRANTS, BODY WASH, BUBBLE BATH, BATH CRYSTALS, BODY MASK, BODY SCRUB, SHOWER GEL, EXFOLIATING BODY WASH, BREATH FRESHENERS, TOOTH GELS, TOOTHPASTE, TOOTH POLISH AND TOOTH POWDERS, MOUTHWASH, COLOGNE, SHAVING CREAM, SHAVING GEL, SHAVING LOTION; COSMETIC PREPARATIONS, NAMELY, BLUSHER, FOUNDATION, BODY CREAMS; BODY POWDER, COLD CREAM, FACE POWDER, MAKE-UP, EYE COLOUR, MASCARA, EYE LINER, LIP COLOUR, SKIN MOISTURIZER, HAND CREAM, FOOT CARE, NAMELY EXFOLIATING, MOISTURIZING AND CLEANSING PREPARATIONS; NAMELY EXFOLIATING AND MOISTURIZING PREPARATIONS, NAIL GROOMING PRODUCTS, NAMELY, NAIL POLISH, NAIL CREAM, AND NAIL VARNISH REMOVERS; SKIN CARE PRODUCTS, NAMELY SKIN LOTIONS, CREAMS AND GELS, SKIN CLEANSERS, SKIN TONERS, AND FACE MASKS; SKIN SOAPS, PERFUMES, ESSENTIAL OILS FOR PERSONAL USE; DEODORANTS FOR PERSONAL USE; NON-MEDICATED HAIR CARE PREPARATIONS, INCLUDING SHAMPOO, CONDITIONER, WAX, GEL, HAIRSPRAY, MOUSSE (U.S. CLS. 1, 4, 6, 50, 51 AND 52).
FIRST USE 5-29-2005; IN COMMERCE 5-29-2005.

2,998,907. AVON PRODUCTS, INC., NEW YORK, NY. SN 78-214,936. PUB. 4-27-2004, FILED 2-14-2003.

CLEAN MACHINE

NO CLAIM IS MADE TO THE EXCLUSIVE RIGHT TO USE "CLEAN", APART FROM THE MARK AS SHOWN.

FOR SKIN CARE PRODUCTS, NAMELY, FACIAL CLEANSER (U.S. CLS. 1, 4, 6, 50, 51 AND 52).

FIRST USE 7-31-2003; IN COMMERCE 7-31-2003.

CLASS 3—(Continued).

2,998,955. KIDS CARE INC., VIENNA, VA. SN 78-251,700.
PUB. 10-12-2004, FILED 5-19-2003.



FOR HAIR CARE PREPARATIONS (U.S. CLS. 1, 4, 6,
50, 51 AND 52).
FIRST USE 7-23-2003; IN COMMERCE 7-23-2003.

2,998,956. SHISEIDO COMPANY, LTD., TOKYO, JAPAN. SN
78-255,600. PUB. 7-27-2004, FILED 5-29-2003.

SHEER ENHANCER BASE

NO CLAIM IS MADE TO THE EXCLUSIVE RIGHT TO
USE ENHANCER BASE, APART FROM THE MARK AS
SHOWN.

FOR NON-MEDICATED SKIN CARE PREPARATIONS;
HAIR CARE PREPARATIONS; BODY CARE PRODUCTS,
NAMESLY, BODY SOAPS, BODY CREAMS, BODY LO-
TIONS, BODY POWDERS, NON-MEDICATED DEODOR-
ANTS AND ANTI-PERSPIRANTS; SUNCARE
PRODUCTS, NAMESLY, SUNSCREEN, SUN BLOCK
AND SUN TANNING PREPARATIONS; PREPARATIONS
TO PROTECT THE SKIN FROM THE SUN; BATH
PRODUCTS, NAMESLY, BATH BEADS, BATH FOAM,
BATH GELS, BATH LOTION, BATH OIL, BATH POW-
DER, AND NON-MEDICATED BATH SALTS; PERFUME,
COLOGNE, COSMETICS AND MAKEUP (U.S. CLS. 1, 4,
6, 50, 51 AND 52).

FIRST USE 1-31-2003; IN COMMERCE 1-31-2003.

2,998,961. JAFER LIMITED, HAMILTON, BERMUDA. SN 78-
257,763. PUB. 1-27-2004, FILED 6-3-2003.

YANBAL MAQ-OFF

OWNER OF U.S. REG. NO. 1,241,758.
FOR MAKEUP REMOVERS, FACIAL CLEANSERS,
EYE MAKEUP REMOVERS, EYELASH MAKEUP RE-
MOVER, EYEBROW MAKEUP REMOVER, FACIAL
MAKEUP REMOVERS, SKIN MASKS, SKIN CLEANS-
ING LOTIONS, SKIN CLEANSING CREAM (U.S. CLS. 1,
4, 6, 50, 51 AND 52).
FIRST USE 10-1-2001; IN COMMERCE 10-9-2003.

CLASS 3—(Continued).

2,998,988. FF TRADEMARK, LLC, NEW YORK, NY. SN 78-
274,991. PUB. 10-26-2004, FILED 7-16-2003.

**FREDERIC FEKKAI SHEER
HOLD**

OWNER OF U.S. REG. NOS. 2,130,740, 2,515,683, AND
OTHERS.

NO CLAIM IS MADE TO THE EXCLUSIVE RIGHT TO
USE SHEER HOLD, APART FROM THE MARK AS SHOWN.
THE NAME "FREDERIC FEKKAI" IDENTIFIES A PAR-
TICULAR LIVING INDIVIDUAL WHOSE CONSENT IS OF
RECORD.

FOR HAIR CARE PRODUCTS, NAMESLY HAIRSPRAY
(U.S. CLS. 1, 4, 6, 50, 51 AND 52).
FIRST USE 9-30-2003; IN COMMERCE 9-30-2003.

2,998,996. AVON PRODUCTS, INC., NEW YORK, NY. SN 78-
278,180. PUB. 3-16-2004, FILED 7-24-2003.

SECRETS OF INDIA

FOR MASSAGE LOTION, AND HAIR CONDITIONING
OIL (U.S. CLS. 1, 4, 6, 50, 51 AND 52).
FIRST USE 8-0-2004; IN COMMERCE 8-0-2004.

2,999,034. LE DEKOR, INC., SANTA FE SPRINGS, CA. SN 78-
296,535. PUB. 3-15-2005, FILED 9-5-2003.

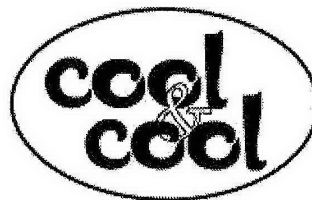

THE STIPPLING IS FOR SHADING PURPOSES ONLY.
FOR BABY WIPES, PRE-MOISTENED COSMETIC
WIPES, DISPOSABLE WIPES WITH CHEMICALS OR
COMPOUNDS, PRE-MOISTENED COSMETIC TISSUES,
COSMETIC PADS, PATCHES CONTAINING SUN
SCREEN AND SUN BLOCK FOR USE ON THE SKIN,
FACIAL CLEANSERS, FACE CREAM, MAKEUP RE-
MOVING PREPARATIONS, FACIAL MASKS, FOOT
SCRUB AND BODY WASH (U.S. CLS. 1, 4, 6, 50, 51
AND 52).
FIRST USE 11-30-2003; IN COMMERCE 11-30-2003.

CLASS 3—(Continued).

2,999,067. STILA COSMETICS, INC., LOS ANGELES, CA. SN 78-324,604. PUB. 8-10-2004, FILED 11-7-2003.

CLASS 3—(Continued).

2,999,091. TAIWAN SALT COMPANY, TAINAN CITY, TAIWAN. SN 78-335,937. PUB. 9-7-2004, FILED 12-3-2003.

LU-MIEL

STILA

THE MARK CONSISTS OF STANDARD CHARACTERS WITHOUT CLAIM TO ANY PARTICULAR FONT, STYLE, SIZE, OR COLOR.

FOR COSMETICS (U.S. CLS. 1, 4, 6, 50, 51 AND 52).
FIRST USE 12-1-2003; IN COMMERCE 12-1-2003.

2,999,174. CAMBRIDGE DIAGNOSTIC PRODUCTS, INC., FORT LAUDERDALE, FL. SN 78-370,168. PUB. 12-14-2004, FILED 2-18-2004.

THE MARK CONSISTS OF STANDARD CHARACTERS WITHOUT CLAIM TO ANY PARTICULAR FONT, STYLE, SIZE, OR COLOR.

OWNER OF U.S. REG. NOS. 2,024,328, 2,423,080, AND 2,565,973.

FOR SKIN CARE PREPARATIONS, NAMELY ANTI-PERSPIRANT/DEODORANTS, BATH GRAINS, BATH OILS, BATH POWDERS, BATH SALTS, BODY CREAMS, BODY OILS, CLEANSING LOTIONS, CLEANSING CREAMS, CLEANSING GELS, EYE CREAMS, EYE GELS, EYE MAKEUP REMOVERS, FACE CREAMS, FACE GELS, FACE LOTIONS, FACE MASKS, FACIAL CLEANSERS, FACIAL EMULSIONS, FACIAL EXFOLIATING PREPARATIONS, FACIAL MAKEUP REMOVERS, FACIAL MOISTURIZERS, FACIAL SOAPS, FACIAL TONERS, NON-MEDICATED ANTI-WRINKLE CREAMS, LOTIONS AND GELS, NON-MEDICATED FACIAL SKIN OIL CONTROLLERS, NON-MEDICATED SKIN BLEMISH PREPARATIONS, NON-MEDICATED SKIN RENEWAL CREAMS, NON-MEDICATED SKIN REPAIR CREAMS, LOTIONS AND GELS, SKIN BALANCING LOTION, SKIN BRONZING CREAMS, LOTIONS AND GELS, SKIN FIRMING PREPARATIONS, SKIN BRIGHTENERS, SKIN LIGHTENERS, SKIN REFRESHERS, SUNSCREENS FOR THE BODY, SUNSCREENS FOR THE FACE (U.S. CLS. 1, 4, 6, 50, 51 AND 52).

FIRST USE 6-15-2005; IN COMMERCE 6-15-2005.

YOUR PRESCRIPTION FOR STAIN RELIEF

THE MARK CONSISTS OF STANDARD CHARACTERS WITHOUT CLAIM TO ANY PARTICULAR FONT, STYLE, SIZE, OR COLOR.

FOR STAIN REMOVER, SPOT REMOVER, PET STAIN REMOVER (U.S. CLS. 1, 4, 6, 50, 51 AND 52).
FIRST USE 9-30-2004; IN COMMERCE 9-30-2004.

CLASS 3—(Continued).

2,999,255. THE PROCTER & GAMBLE COMPANY, CINCINNATI, OH. SN 78-422,186. PUB. 4-5-2005, FILED 5-20-2004.

SOFT OCEAN MIST

THE MARK CONSISTS OF STANDARD CHARACTERS WITHOUT CLAIM TO ANY PARTICULAR FONT, STYLE, SIZE, OR COLOR.

FOR LAUNDRY DETERGENT; FRAGRANCE INGREDIENT SOLD AS A COMPONENT OF LAUNDRY DETERGENT (U.S. CLS. 1, 4, 6, 50, 51 AND 52).

FIRST USE 8-16-2004; IN COMMERCE 8-16-2004.

2,999,260. L'OREAL USA CREATIVE, INC., NEW YORK, NY. SN 78-423,948. PUB. 2-15-2005, FILED 5-24-2004.

AQUAFY

THE MARK CONSISTS OF STANDARD CHARACTERS WITHOUT CLAIM TO ANY PARTICULAR FONT, STYLE, SIZE, OR COLOR.

FOR HAIR CARE PREPARATION, NAMELY, SHAMPOO (U.S. CLS. 1, 4, 6, 50, 51 AND 52).

FIRST USE 10-0-2004; IN COMMERCE 10-0-2004.

2,999,274. BOOTS COMPANY USA HOLDINGS INC., THE, WILMINGTON, DE. SN 78-975,598. PUB. 12-23-2003, FILED 11-18-2002.

**BOTANICS**

OWNER OF U.S. REG. NOS. 2,026,134, 2,427,728, AND

CLASS 3—(Continued).

2,515,976.

NO CLAIM IS MADE TO THE EXCLUSIVE RIGHT TO USE "BOTANICS", APART FROM THE MARK AS SHOWN. THE MARK CONSISTS OF THE WORD "BOTANICS" AND THE WORD "BOOTS" IN AN OVAL APPEARING ABOVE THE WORD "BOTANICS".

FOR NON-MEDICATED TOILET PREPARATIONS, NAMELY, BODY WASH, BUBBLE BATH, BATH CRYSTALS, BODY MASK, BODY SCRUB, SHOWER GEL, EXFOLIATING BODY WASH, COSMETIC PREPARATIONS, NAMELY, BLUSHER, FOUNDATION, BODY CREAMS; FACE POWDER, MAKE-UP, EYE COLOUR, MASCARA, EYE LINER, LIP COLOUR, SKIN MOISTURIZER, HAND CREAM, FOOT CARE, NAMELY EXFOLIATING AND MOISTURIZING PREPARATIONS, NAIL GROOMING PRODUCTS, NAMELY, NAIL POLISH, NAIL CREAM, AND SKIN CARE PRODUCTS, NAMELY SKIN LOTIONS, CREAMS AND GELS, SKIN CLEANSERS, SKIN TONERS, AND FACE MASKS; PERFUMES, ESSENTIAL OILS FOR PERSONAL USE; NON-MEDICATED HAIR CARE PREPARATIONS, INCLUDING SHAMPOO, CONDITIONER, WAX, GEL, HAIRSPRAY (U.S. CLS. 1, 4, 6, 50, 51 AND 52).

FIRST USE 2-14-2004; IN COMMERCE 2-14-2002.

2,999,287. HM MANE SOLUTIONS, LLC, WESTON, CT. SN 78-976,328. PUB. 12-21-2004, FILED 10-6-2003.

EASY STRAIGHT

FOR HAIR CARE PREPARATIONS, NAMELY CHEMICAL STRAIGHTENING PREPARATIONS, STYLING PREPARATIONS, SHAMPOOS AND CONDITIONERS (U.S. CLS. 1, 4, 6, 50, 51 AND 52).

FIRST USE 1-0-2004; IN COMMERCE 1-0-2004.

CLASS 4—LUBRICANTS AND FUELS

2,998,544. LUSH CANDLES, INC., DALLAS, TX. SN 76-239,586. PUB. 9-11-2001, FILED 4-10-2001.

LUSH

FOR CANDLES (U.S. CLS. 1, 6 AND 15).
FIRST USE 12-1-2002; IN COMMERCE 12-1-2002.

2,998,558. 7-ELEVEN, INC., DALLAS, TX. SN 76-320,978. PUB. 3-26-2002, FILED 10-3-2001.

SUPER-7

OWNER OF U.S. REG. NOS. 1,156,664, 1,495,541, AND OTHERS.

FOR GASOLINE (U.S. CLS. 1, 6 AND 15).
FIRST USE 6-15-2005; IN COMMERCE 6-15-2005.

CLASS 4—(Continued).

2,998,588. PERFORMANCE PRODUCTS, LLC, OAKDALE, CA. SN 76-410,218. PUB. 12-16-2003, FILED 5-21-2002.



NO CLAIM IS MADE TO THE EXCLUSIVE RIGHT TO USE "RACING FUEL", APART FROM THE MARK AS SHOWN.

FOR LEADED AND UNLEADED GASOLINE RACING FUEL FOR MOTOR VEHICLES (U.S. CLS. 1, 6 AND 15). FIRST USE 5-1-2002; IN COMMERCE 5-1-2002.

2,998,676. ECOLOGICAL TECHNOLOGIES, LLC, DELRAY, FL. SN 76-518,242. PUB. 12-7-2004, FILED 5-29-2003.

HEAT CELL

FOR CHAFING DISH FUEL; AND FUEL FOR FOOD WARMING OR COOKING PURPOSES CONTAINING GLYCOLS AND OLEFINS (U.S. CLS. 1, 6 AND 15). FIRST USE 5-0-2003; IN COMMERCE 5-0-2003.

2,998,997. JAFER LIMITED, HAMILTON, BERMUDA. SN 78-278,462. PUB. 12-9-2003, FILED 7-24-2003.



OWNER OF U.S. REG. NO. 1,241,758. THE MARK CONSISTS OF AN ORANGE RECTANGLE WITH A RED SLASH WITH THE WORD "YANBAL" IN WHITE LETTERING.

FOR PERFUMED CANDLE LIGHTS; CANDLES; STICKS AND WICKS FOR LIGHTING (U.S. CLS. 1, 6 AND 15).

FIRST USE 6-23-2003; IN COMMERCE 8-31-2004.

CLASS 4—(Continued).

2,999,131. DAIMLERCHRYSLER CORPORATION, AUBURN HILLS, MI. SN 78-351,182. PUB. 10-26-2004, FILED 1-13-2004.

MOPAR MAX PRO

THE MARK CONSISTS OF STANDARD CHARACTERS WITHOUT CLAIM TO ANY PARTICULAR FONT, STYLE, SIZE, OR COLOR.

OWNER OF U.S. REG. NOS. 363,794, 538,078, AND OTHERS.

FOR MOTOR OIL (U.S. CLS. 1, 6 AND 15).

FIRST USE 1-31-2004; IN COMMERCE 1-31-2004.

2,999,139. FLINT HILLS RESOURCES, LLC, WICHITA, KS. SN 78-353,901. PUB. 10-19-2004, FILED 1-20-2004.

**ENERGY FORTIFIED
DISTILLATE**

THE MARK CONSISTS OF STANDARD CHARACTERS WITHOUT CLAIM TO ANY PARTICULAR FONT, STYLE, SIZE, OR COLOR.

NO CLAIM IS MADE TO THE EXCLUSIVE RIGHT TO USE DISTILLATE, APART FROM THE MARK AS SHOWN.

FOR FUEL (U.S. CLS. 1, 6 AND 15).

FIRST USE 12-5-2003; IN COMMERCE 2-24-2004.

CLASS 5—PHARMACEUTICALS

2,998,554. OCUSOFT, INC., RICHMOND, TX. SN 76-306,902. PUB. 2-12-2002, FILED 8-29-2001.

CURA TEARS

THE MARK CONSISTS OF STANDARD CHARACTERS WITHOUT CLAIM TO ANY PARTICULAR FONT, STYLE, SIZE, OR COLOR.

FOR MEDICATED EYE PRODUCTS, NAMELY, LUBRICANTS, DROPS, OINTMENTS, GELS, IRRIGATING SOLUTIONS, CREAMS, AND PRE-MOISTENED MEDICAL WIPES (U.S. CLS. 6, 18, 44, 46, 51 AND 52).

FIRST USE 4-1-2005; IN COMMERCE 4-1-2005.

CLASS 5—(Continued).

2,998,563. OCUSOFT, INC., RICHMOND, TX. SN 76-337,495. PUB. 1-7-2003, FILED 11-14-2001.

LASER COAT

NO CLAIM IS MADE TO THE EXCLUSIVE RIGHT TO USE "COAT", APART FROM THE MARK AS SHOWN. FOR OPHTHALMIC LUBRICANT IN THE FORM OF GELS, SOLUTIONS, AND LUBRICATING OINTMENTS (U.S. CLS. 6, 18, 44, 46, 51 AND 52). FIRST USE 4-25-2005; IN COMMERCE 4-25-2005.

2,998,614. NOTHING BUT HEALTH LLC, TEMPE, AZ. SN 76-449,544. PUB. 2-25-2003, FILED 9-13-2002.

DRINKWELL TO LIVE WELL

OWNER OF U.S. REG. NOS. 2,867,970 AND 2,923,762. FOR DIETARY AND NUTRITIONAL SUPPLEMENTS (U.S. CLS. 6, 18, 44, 46, 51 AND 52). FIRST USE 1-1-2003; IN COMMERCE 7-1-2003.

2,998,624. TRIARCO INDUSTRIES, INC., WAYNE, NJ. SN 76-461,777. PUB. 4-22-2003, FILED 10-21-2002.

LACTOGEST

FOR VITAMINS, MINERAL, NUTRITIONAL AND DIETARY SUPPLEMENTS (U.S. CLS. 6, 18, 44, 46, 51 AND 52). FIRST USE 10-21-2002; IN COMMERCE 10-21-2002.

2,998,626. UPSHER-SMITH LABORATORIES, INC., MAPLE GROVE, MN. SN 76-465,737. PUB. 4-29-2003, FILED 11-12-2002.

NYAMYC

FOR PHARMACEUTICAL PREPARATIONS FOR THE TREATMENT OF FUNGAL AND MYCOTIC INFECTIONS AND SKIN CONDITIONS (U.S. CLS. 6, 18, 44, 46, 51 AND 52). FIRST USE 5-18-2005; IN COMMERCE 5-18-2005.

2,998,664. ABKIT INC., NEW YORK, NY. SN 76-498,759. PUB. 4-13-2004, FILED 3-18-2003.

CAMOCLEAR

FOR NON-MEDICATED EYEWASH (U.S. CLS. 6, 18, 44, 46, 51 AND 52). FIRST USE 9-0-2004; IN COMMERCE 5-6-2005.

CLASS 5—(Continued).

2,998,666. WATSON PHARMACEUTICALS, INC., CORONA, CA. SN 76-505,310. PUB. 11-25-2003, FILED 4-9-2003.

LEENA

FOR PHARMACEUTICALS, NAMELY, ORAL CONTRACEPTIVES (U.S. CLS. 6, 18, 44, 46, 51 AND 52). FIRST USE 1-13-2005; IN COMMERCE 1-13-2005.

2,998,734. IMS TRADING, LLC, STUDIO CITY, CA. SN 76-545,625. PUB. 6-29-2004, FILED 9-22-2003.

MALIBU BREEZE

FOR AIR FRESHENERS (U.S. CLS. 6, 18, 44, 46, 51 AND 52). FIRST USE 9-1-2004; IN COMMERCE 9-1-2004.

2,998,764. VITA POWER LIMITED, WANGANUI, NEW ZEALAND. SN 76-564,861. PUB. 6-29-2004, FILED 12-12-2003.



THE MARK IS IN BLACK AND WHITE AND THE COLORS ARE NOT A FEATURE OF THE MARK.

THE MARK CONSISTS OF A TERM IN A STYLIZED DEPICTION OF TWO MOUNTAIN PEAKS ENCIRCLED BY A CARRIER INCORPORATING THE TERMS PALAMOUNTAINS.

FOR ANIMAL FOOD SUPPLEMENTS; ANIMAL CONDITIONING SUPPLEMENTS (U.S. CLS. 6, 18, 44, 46, 51 AND 52).

FIRST USE 6-0-2002; IN COMMERCE 1-0-2004.

2,998,795. NATURAL ORGANICS INC., MELVILLE, NY. SN 76-577,693. PUB. 10-26-2004, FILED 2-25-2004.

BUBBLE GUMMIES

THE MARK CONSISTS OF STANDARD CHARACTERS WITHOUT CLAIM TO ANY PARTICULAR FONT, STYLE, SIZE, OR COLOR.

FOR DIETARY SUPPLEMENTS (U.S. CLS. 6, 18, 44, 46, 51 AND 52).

FIRST USE 5-1-2005; IN COMMERCE 5-17-2004.

CLASS 5—(Continued).

2,998,798. WALGREEN CO., DEERFIELD, IL. SN 76-579,068.
PUB. 12-7-2004, FILED 3-4-2004.

ALLER-MELTS

FOR ALLERGY RELIEF MEDICATION (U.S. CLS. 6,
18, 44, 46, 51 AND 52).
FIRST USE 3-31-2004; IN COMMERCE 3-31-2004.

2,998,811. LIFELINK FOUNDATION, INC., TAMPA, FL. SN
76-583,407. PUB. 12-28-2004, FILED 3-26-2004.

LIFEGRAFT

THE MARK CONSISTS OF STANDARD CHARACTERS
WITHOUT CLAIM TO ANY PARTICULAR FONT, STYLE,
SIZE, OR COLOR.
OWNER OF U.S. REG. NO. 2,484,196.
FOR HUMAN ALLOGRAFT BONE AND TISSUE (U.S.
CLS. 6, 18, 44, 46, 51 AND 52).
FIRST USE 7-1-2004; IN COMMERCE 7-1-2004.

2,998,816. TISHCON CORP., WESTBURY, NY. SN 76-585,143.
PUB. 1-4-2005, FILED 4-1-2004.

CARNISPAN

THE MARK CONSISTS OF STANDARD CHARACTERS
WITHOUT CLAIM TO ANY PARTICULAR FONT, STYLE,
SIZE, OR COLOR.

THE MARK IS PRESENTED IN STANDARD CHARACTERS,
WITHOUT CLAIM TO ANY PARTICULAR FONT, STYLE,
SIZE OR COLOR.
FOR NUTRITIONAL SUPPLEMENTS (U.S. CLS. 6, 18,
44, 46, 51 AND 52).
FIRST USE 4-22-2005; IN COMMERCE 4-22-2005.

CLASS 5—(Continued).

2,998,835. MERRIMACK PHARMACEUTICALS, INC., CAM-
BRIDGE, MA. SN 76-977,678. PUB. 4-20-2004, FILED 9-12-
2003.



THE MARK CONSISTS OF A STYLIZED DEPICTION OF
THE LETTER "M".

FOR PHARMACEUTICAL PREPARATIONS FOR USE
IN THE PREVENTION, DIAGNOSIS AND/OR TREAT-
MENT OF DISEASES, NAMELY, THOSE IN THE AREAS
OF IMMUNOLOGY (U.S. CLS. 6, 18, 44, 46, 51 AND 52).
FIRST USE 2-23-2005; IN COMMERCE 2-23-2005.

2,998,854. YEAGER, LISA C., MISSOULA, MT. SN 78-128,821.
PUB. 11-19-2002, FILED 5-15-2002.

Flötrel

FOR DIETARY SUPPLEMENT FOR INCONTINENCE
(U.S. CLS. 6, 18, 44, 46, 51 AND 52).
FIRST USE 5-17-2002; IN COMMERCE 5-17-2002.

2,998,877. PHARMANEX, LLC., PROVO, UT. SN 78-179,934.
PUB. 12-2-2003, FILED 10-30-2002.

THEAPURE

OWNER OF NORWAY REG. NO. 215733, DATED 9-5-2002,
EXPIRES 9-5-2012.

FOR L-THEANINE SOLD AS AN INTEGRAL COMPON-
ENT OF NUTRITIONAL AND DIETARY SUPPLE-
MENTS (U.S. CLS. 6, 18, 44, 46, 51 AND 52).
FIRST USE 3-1-2004; IN COMMERCE 3-1-2004.

CLASS 5—(Continued).

2,998,887. KETTENBACH GMBH & CO. KG, ESCHENBURG, FED REP GERMANY. SN 78-196,737. PUB. 11-16-2004, FILED 12-20-2002.

LASTIC

OWNER OF FED REP GERMANY REG. NO. 681460, DATED 10-9-1955, RENEWED AS REG. NO. 681460, DATED 7-16-2004, EXPIRES 7-16-2014.

FOR FILLINGS FOR TEETH AND DENTAL IMPRESSION MATERIALS (U.S. CLS. 6, 18, 44, 46, 51 AND 52). FIRST USE 7-16-1954; IN COMMERCE 1-0-2002.

2,998,910. DOW AGROSCIENCES LLC, INDIANAPOLIS, IN. SN 78-216,904. PUB. 10-14-2003, FILED 2-20-2003.

SURMOUNT

FOR PESTICIDES AND PREPARATIONS FOR DESTROYING VERMIN, NAMELY HERBICIDES, INSECTICIDES AND FUNGICIDES FOR AGRICULTURE, HORTICULTURE, FORESTRY, TURF AND ORNAMENTAL, COMMERCIAL, INDUSTRIAL AND DOMESTIC USE (U.S. CLS. 6, 18, 44, 46, 51 AND 52). FIRST USE 6-30-2004; IN COMMERCE 6-30-2004.

2,998,970. ROYAL BODYCARE, INC., IRVING, TX. SN 78-265,033. PUB. 10-19-2004, FILED 6-20-2003.

10 DAYS OF CHOCOLATE

NO CLAIM IS MADE TO THE EXCLUSIVE RIGHT TO USE "CHOCOLATE", APART FROM THE MARK AS SHOWN.

FOR NUTRITIONAL SUPPLEMENTS (U.S. CLS. 6, 18, 44, 46, 51 AND 52).

FIRST USE 7-31-2004; IN COMMERCE 7-31-2004.

2,998,978. NOVARTIS AG, BASEL, SWITZERLAND. SN 78-269,788. PUB. 3-16-2004, FILED 7-2-2003.

XOLAIR

OWNER OF SWITZERLAND REG. NO. 489088, DATED 9-13-2001, EXPIRES 8-23-2011.

OWNER OF U.S. REG. NO. 2,707,154.

FOR PHARMACEUTICAL PREPARATIONS FOR USE IN THE TREATMENT OF ASTHMA (U.S. CLS. 6, 18, 44, 46, 51 AND 52).

FIRST USE 7-7-2003; IN COMMERCE 7-7-2003.

CLASS 5—(Continued).

2,998,979. SHENZHEN TAITAI PHARMACEUTICAL INDUSTRY COMPANY LIMITED, SHENZHEN, GUANGDONG PROVINCE, CHINA. SN 78-270,085. PUB. 10-19-2004, FILED 7-2-2003.



THE MARK CONSISTS OF TWO CHINESE CHARACTERS IN STYLIZED FORM.

THE NON-LATIN CHARACTERS IN THE MARK TRANSLATE TO: FOR NUTRITIONALLY FORTIFIED BEVERAGES; NUTRITIONAL DRINK MIX FOR USE AS A MEAL REPLACEMENT; NUTRITIONAL SUPPLEMENTS; FOOD SUPPLEMENTS; HERBAL SUPPLEMENTS; BABY FOOD; CHINESE HERBAL MEDICINES FOR THE TREATMENT OF MENOPAUSAL SYMPTOMS; CHINESE MEDICINES FOR HUMAN USE FOR THE TREATMENT OF MENOPAUSAL SYMPTOMS; CHINESE PHARMACEUTICAL PREPARATIONS FOR THE TREATMENT OF MENOPAUSAL SYMPTOMS (U.S. CLS. 6, 18, 44, 46, 51 AND 52).

FIRST USE 8-31-1998; IN COMMERCE 7-31-2002.

2,998,981. BLISTEX INC., OAK BROOK, IL. SN 78-272,005. PUB. 5-4-2004, FILED 7-9-2003.

LIP INFUSION

NO CLAIM IS MADE TO THE EXCLUSIVE RIGHT TO USE LIP, APART FROM THE MARK AS SHOWN.

FOR MEDICATED TOPICAL CREAMS, LOTIONS, GELS, AND/OR OINTMENTS FOR HUMAN USE FOR LIP AND SKIN DRYNESS, COLD SORES, BURNS, ITCHING, FOR LIP AND SKIN CARE, TOPICAL ANALGESIC PREPARATIONS, TOPICAL ANTIBIOTIC CREAMS, LOTIONS, GELS, AND/OR OINTMENTS AND MEDICATED TOPICAL SUN SCREEN CREAMS, LOTIONS, GELS, AND/OR OINTMENTS FOR USE ON THE LIPS AND SKIN (U.S. CLS. 6, 18, 44, 46, 51 AND 52). FIRST USE 5-6-2005; IN COMMERCE 5-6-2005.

2,998,991. ISOICHEM CORPORATION, WEST LINN, OR. SN 78-276,066. PUB. 5-4-2004, FILED 7-18-2003.

ADVANCED HYDRATION

NO CLAIM IS MADE TO THE EXCLUSIVE RIGHT TO USE "HYDRATION", APART FROM THE MARK AS SHOWN.

FOR DIETARY SUPPLEMENTS, DIETARY SUPPLEMENTAL DRINKS (U.S. CLS. 6, 18, 44, 46, 51 AND 52).

FIRST USE 6-20-2003; IN COMMERCE 6-20-2003.

CLASS 5—(Continued).

2,999,019. NOVARTIS AG, BASEL, SWITZERLAND. SN 78-292,351. PUB. 5-4-2004, FILED 8-26-2003.

TRIAMINIC CLINIC

FOR COUGH, COLD AND ALLERGY PREPARATIONS (U.S. CLS. 6, 18, 44, 46, 51 AND 52).
FIRST USE 8-31-2004; IN COMMERCE 8-31-2004.

2,999,060. EASTMAN KODAK COMPANY, ROCHESTER, NY. SN 78-319,644. PUB. 8-24-2004, FILED 10-28-2003.

ZORCAINE

FOR ANESTHETICS FOR NON-SURGICAL USE, NAMELY, DENTAL ANESTHETICS (U.S. CLS. 6, 18, 44, 46, 51 AND 52).
FIRST USE 4-4-2005; IN COMMERCE 4-4-2005.

2,999,071. ADEZA BIOMEDICAL CORPORATION, SUNNYVALE, CA. SN 78-326,373. PUB. 8-10-2004, FILED 11-11-2003.

FULL TERM

THE MARK CONSISTS OF STANDARD CHARACTERS WITHOUT CLAIM TO ANY PARTICULAR FONT, STYLE, SIZE, OR COLOR.

FOR DIAGNOSTIC PREPARATIONS AND REAGENTS FOR CLINICAL OR MEDICAL LABORATORY USE; MEDICAL DIAGNOSTIC REAGENTS (U.S. CLS. 6, 18, 44, 46, 51 AND 52).
FIRST USE 12-31-2004; IN COMMERCE 12-31-2004.

CLASS 5—(Continued).

2,999,080. LIFELINE NUTRACEUTICALS, INC., ENGLEWOOD, CO. SN 78-329,893. PUB. 8-31-2004, FILED 11-19-2003.

protandim

THE MARK CONSISTS OF STANDARD CHARACTERS WITHOUT CLAIM TO ANY PARTICULAR FONT, STYLE, SIZE, OR COLOR.

FOR ORAL DIETARY SUPPLEMENT AND DIETARY SUPPLEMENT INGREDIENT FOR ANTIOXIDANT EFFECT (U.S. CLS. 6, 18, 44, 46, 51 AND 52).
FIRST USE 11-23-2003; IN COMMERCE 2-28-2005.

2,999,116. ESSENTIAL LIVING FOODS, INC., SAN LUIS OBISPO, CA. SN 78-346,545. PUB. 2-8-2005, FILED 12-30-2003.

**Indigenous
Medicinals**

THE MARK CONSISTS OF STANDARD CHARACTERS WITHOUT CLAIM TO ANY PARTICULAR FONT, STYLE, SIZE, OR COLOR.

NO CLAIM IS MADE TO THE EXCLUSIVE RIGHT TO USE MEDICINALS, APART FROM THE MARK AS SHOWN. FOR MEDICINAL HERBS FOR HUMAN CONSUMPTION (U.S. CLS. 6, 18, 44, 46, 51 AND 52).
FIRST USE 1-1-2005; IN COMMERCE 1-1-2005.

CLASS 5—(Continued).

2,999,168. TRIARCO INDUSTRIES, INC., WAYNE, NJ. SN 78-364,568. PUB. 11-9-2004, FILED 2-9-2004.

CLASS 5—(Continued).

2,999,205. ISORAY MEDICAL, INC., RICHLAND, WA. SN 78-382,288. PUB. 12-21-2004, FILED 3-11-2004.

IT IS WHAT IT IS

ISORAY

THE MARK CONSISTS OF STANDARD CHARACTERS WITHOUT CLAIM TO ANY PARTICULAR FONT, STYLE, SIZE, OR COLOR.

FOR VITAMINS, MINERALS, NUTRITIONAL AND DIETARY SUPPLEMENTS (U.S. CLS. 6, 18, 44, 46, 51 AND 52).

FIRST USE 2-9-2004; IN COMMERCE 2-9-2004.

THE MARK CONSISTS OF STANDARD CHARACTERS WITHOUT CLAIM TO ANY PARTICULAR FONT, STYLE, SIZE, OR COLOR.

FOR RADIOISOTOPES FOR THE TREATMENT AND DIAGNOSIS OF MAMMALIAN DISEASES (U.S. CLS. 6, 18, 44, 46, 51 AND 52).

FIRST USE 5-0-1998; IN COMMERCE 5-0-1998.

2,999,198. NATURE'S SUNSHINE PRODUCTS, INC., PROVO, UT. SN 78-380,518. PUB. 3-29-2005, FILED 3-8-2004.

2,999,213. BURZYNSKI, STANISLAW R., HOUSTON, TX. SN 78-388,943. PUB. 1-11-2005, FILED 3-23-2004.

BRAINIACS

BUGENAL

THE MARK CONSISTS OF STANDARD CHARACTERS WITHOUT CLAIM TO ANY PARTICULAR FONT, STYLE, SIZE, OR COLOR.

FOR DIETARY SUPPLEMENTS FOR CHILDREN (U.S. CLS. 6, 18, 44, 46, 51 AND 52).

FIRST USE 9-9-2004; IN COMMERCE 9-9-2004.

THE MARK CONSISTS OF STANDARD CHARACTERS WITHOUT CLAIM TO ANY PARTICULAR FONT, STYLE, SIZE, OR COLOR.

FOR PHARMACEUTICAL PREPARATIONS FOR THE TREATMENT OF HYPERAMMONEMIA IN CHILDREN (U.S. CLS. 6, 18, 44, 46, 51 AND 52).

FIRST USE 6-3-2005; IN COMMERCE 6-7-2005.

CLASS 5—(Continued).

2,999,232. SHERWOOD SERVICES AG, SCHAFFHAUSEN, SWITZERLAND. SN 78-399,227. PUB. 2-15-2005, FILED 4-9-2004.

DERMACEA

THE MARK CONSISTS OF STANDARD CHARACTERS WITHOUT CLAIM TO ANY PARTICULAR FONT, STYLE, SIZE, OR COLOR.

FOR WOUND DRESSINGS (U.S. CLS. 6, 18, 44, 46, 51 AND 52).

FIRST USE 10-1-2004; IN COMMERCE 10-1-2004.

2,999,246. PDK LABS, INC., HAUPPAUGE, NY. SN 78-411,200. PUB. 2-15-2005, FILED 4-30-2004.

PSEUDO 30's

THE MARK CONSISTS OF STANDARD CHARACTERS WITHOUT CLAIM TO ANY PARTICULAR FONT, STYLE, SIZE, OR COLOR.

OWNER OF U.S. REG. NO. 1,979,774.
FOR PHARMACEUTICALS, NAMELY NASAL DE-
CONGESTANTS (U.S. CLS. 6, 18, 44, 46, 51 AND 52).
FIRST USE 6-24-2004; IN COMMERCE 6-24-2004.

CLASS 5—(Continued).

2,999,247. FACE & BODY, INC., PORTLAND, OR. SN 78-411,778. PUB. 2-8-2005, FILED 5-1-2004.

SJ3

THE MARK CONSISTS OF STANDARD CHARACTERS WITHOUT CLAIM TO ANY PARTICULAR FONT, STYLE, SIZE, OR COLOR.

FOR TOPICAL ANESTHETIC SKIN PREPARATION FOR USE DURING PAINFUL PROCEDURES SUCH AS TATTOOING AND PERMANENT MAKEUP (U.S. CLS. 6, 18, 44, 46, 51 AND 52).

FIRST USE 7-1-2004; IN COMMERCE 7-1-2004.

2,999,273. STRESSGEN BIOTECHNOLOGIES CORPORATION, VICTORIA BRITISH COLUMBIA, CANADA. SN 78-975,086. PUB. 9-23-2003, FILED 7-10-2002.

COVAL

FOR PHARMACEUTICAL PREPARATIONS FOR THE TREATMENT OF CANCER AND INFECTIOUS DISEASES (U.S. CLS. 6, 18, 44, 46, 51 AND 52).

FIRST USE 7-15-2004; IN COMMERCE 7-15-2004.

2,999,277. PHILIPP, TIMOTHY, P., BRIDGETON, MO. SN 78-976,205. PUB. 9-14-2004, FILED 10-21-2002.

BANDSHADES

FOR COLOR-COORDINATED ADHESIVE BANDAGES FOR DARK SKINNED INDIVIDUALS (U.S. CLS. 6, 18, 44, 46, 51 AND 52).

FIRST USE 5-15-2004; IN COMMERCE 5-15-2004.

CLASS 6—METAL GOODS

CLASS 6—(Continued).

2,998,560. ALEMITE LLC, FORT MILL, SC. SN 76-334,212. PUB. 6-18-2002, FILED 11-5-2001.

CLASS 6—(Continued).

2,999,173. MARVIN LUMBER AND CEDAR COMPANY, WARROAD, MN. SN 78-370,158. PUB. 12-14-2004, FILED 2-18-2004.

ZERK-MATE

FOR HAND OPERATED TOOLS NAMELY GREASE FITTING ADAPTORS FOR USE AS A GREASE FITTING AND JOINT CLEANER (U.S. CLS. 2, 12, 13, 14, 23, 25 AND 50).
FIRST USE 11-15-2004; IN COMMERCE 11-15-2004.

CLEAR VIEW

2,998,720. MEDECO SECURITY LOCKS, INC., SALEM, VA. SN 76-538,658. PUB. 10-12-2004, FILED 8-15-2003.

THE MARK CONSISTS OF STANDARD CHARACTERS WITHOUT CLAIM TO ANY PARTICULAR FONT, STYLE, SIZE, OR COLOR.

FOR HINGES MADE OF METAL; HINGES MADE OF METAL SOLD AS CUSTOMER OPTION ON WINDOWS AND DOORS (U.S. CLS. 2, 12, 13, 14, 23, 25 AND 50).
FIRST USE 4-15-2004; IN COMMERCE 4-15-2004.

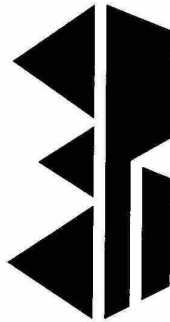

CLASS 7—MACHINERY

2,998,530. MITSUBISHI MATERIALS CORPORATION, TOKYO 100, JAPAN. SN 76-139,113. PUB. 4-20-2004, FILED 10-2-2000.

STAR POINT

THE MARK CONSISTS OF A DESIGN ELEMENT OF A PORTION OF A CUT KEY, WHICH IS PLACED VERTICALLY WITH THE BITS FACING LEFT, SOMEWHAT RESEMBLING THE NUMERAL 3.

FOR METAL LOCKS, METAL SECURITY LOCK CYLINDERS AND KEYS (U.S. CLS. 2, 12, 13, 14, 23, 25 AND 50).
FIRST USE 7-0-2003; IN COMMERCE 7-0-2003.

PRIORITY CLAIMED UNDER SEC. 44(D) ON JAPAN APPLICATION NO. 2000-88544, FILED 8-10-2000, REG. NO. 4497642, DATED 8-10-2001, EXPIRES 8-10-2011.

FOR POWER OPERATED DRILLS AND POWER OPERATED TOOLS FOR CUTTING, TURNING, AND MILLING INDUSTRIAL METALS (U.S. CLS. 13, 19, 21, 23, 31, 34 AND 35).
FIRST USE 10-0-2000; IN COMMERCE 10-0-2000.

2,998,551. TOOLOVATION, LLC, BEACHWOOD, OH. SN 76-281,907. PUB. 4-16-2002, FILED 7-9-2001.

2,998,874. MASCO CORPORATION, TAYLOR, MI. SN 78-174,134. PUB. 9-9-2003, FILED 10-14-2002.



home products

ASPEN

FOR DOOR HARDWARE, NAMELY, DOOR LOCKS, DOOR HANDLES AND DOOR LEVERS (U.S. CLS. 2, 12, 13, 14, 23, 25 AND 50).
FIRST USE 1-19-2004; IN COMMERCE 1-19-2004.

NO CLAIM IS MADE TO THE EXCLUSIVE RIGHT TO USE "HOME PRODUCTS", APART FROM THE MARK AS SHOWN.

FOR POWER-OPERATED TOOLS, NAMELY, DRILLING MACHINES AND PARTS THEREFORE, SCREWDRIVERS, SAWS, GRINDERS, AND STAPLE GUNS (U.S. CLS. 13, 19, 21, 23, 31, 34 AND 35).
FIRST USE 9-0-2001; IN COMMERCE 9-0-2001.

CLASS 7—(Continued).

2,998,587. MORRIS MATERIALS HANDLING LTD., LOUGHBOROUGH LE11 1RL, LEICESTERSHIRE, UNITED KINGDOM. SN 76-406,725. PUB. 4-20-2004, FILED 5-2-2002.

HOISTMASTER

FOR MATERIAL HANDLING EQUIPMENT, NAMELY, CRANES, HOISTS, AND PARTS THEREFOR (U.S. CLS. 13, 19, 21, 23, 31, 34 AND 35).
FIRST USE 5-2-2002; IN COMMERCE 5-2-2002.

2,998,609. FSI INTERNATIONAL, INC., CHASKA, MN. SN 76-446,826. PUB. 11-18-2003, FILED 9-4-2002.

SYMFLOW

FOR MICROELECTRONIC DEVICE MANUFACTURING EQUIPMENT, NAMELY, MACHINES FOR PERFORMING A CHEMICAL TREATMENT METHOD USED IN THE MANUFACTURE OF SEMICONDUCTOR AND MICROELECTRONIC DEVICES (U.S. CLS. 13, 19, 21, 23, 31, 34 AND 35).
FIRST USE 8-27-2004; IN COMMERCE 8-27-2004.

2,998,647. VALENITE, LLC, MADISON HEIGHTS, MI. SN 76-482,853. PUB. 7-27-2004, FILED 1-16-2003.

VALGROOVE

FOR TOOLS FOR POWER OPERATED METAL CUTTING MACHINES, NAMELY GROOVING TOOLS; AND CUTTING INSERTS AND TOOL HOLDERS FOR POWER OPERATED METAL CUTTING MACHINES AND TOOLS; AND COMPONENT PARTS THEREFOR (U.S. CLS. 13, 19, 21, 23, 31, 34 AND 35).
FIRST USE 3-31-2003; IN COMMERCE 7-31-2003.

2,998,692. FANIMATION DESIGN & MANUFACTURING, INC., LEBANON, IN. SN 76-526,395. PUB. 10-5-2004, FILED 6-30-2003.

KERAMOS

THE ENGLISH TRANSLATION OF THE WORD "KERAMOS" IN THE MARK IS "CERAMIC".
FOR MOTOR HOUSINGS FOR ELECTRIC CEILING FANS (U.S. CLS. 13, 19, 21, 23, 31, 34 AND 35).
FIRST USE 6-15-2003; IN COMMERCE 6-15-2003.

CLASS 7—(Continued).

2,998,703. REMY INC., ANDERSON, IN. SN 76-532,793. PUB. 4-6-2004, FILED 7-15-2003.

35SI

FOR GENERATORS FOR USE ON LAND AND MARINE VEHICLES (U.S. CLS. 13, 19, 21, 23, 31, 34 AND 35).
FIRST USE 2-14-2005; IN COMMERCE 2-14-2005.

2,998,704. REMY INC., ANDERSON, IN. SN 76-532,795. PUB. 4-6-2004, FILED 7-15-2003.

35SI HP

FOR GENERATORS FOR USE ON LAND AND MARINE VEHICLES (U.S. CLS. 13, 19, 21, 23, 31, 34 AND 35).
FIRST USE 4-7-2005; IN COMMERCE 4-7-2005.

2,998,705. REMY INC., ANDERSON, IN. SN 76-532,798. PUB. 4-6-2004, FILED 7-15-2003.

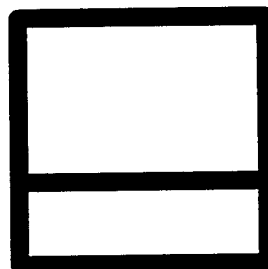

OWNER OF U.S. REG. NO. 2,695,461.
FOR STARTERS FOR LAND AND MARINE VEHICLE MOTORS AND ENGINES; GENERATORS FOR USE ON LAND AND MARINE VEHICLES (U.S. CLS. 13, 19, 21, 23, 31, 34 AND 35).
FIRST USE 2-19-2004; IN COMMERCE 2-19-2004.

2,998,728. ACE CONTROLS, INC., FARMINGTON, MI. SN 76-542,614. PUB. 4-13-2004, FILED 9-4-2003.

NUCUSHION

FOR DECELERATION CONTROL FOR AN AIR CYLINDER (U.S. CLS. 13, 19, 21, 23, 31, 34 AND 35).
FIRST USE 5-0-2005; IN COMMERCE 5-0-2005.

CLASS 7—(Continued).

2,998,777. KWIK PRODUCTS, INC., PHOENIX, AZ. SN 76-568,897. PUB. 12-21-2004, FILED 1-8-2004.

GRASS SAMURAI

THE MARK CONSISTS OF STANDARD CHARACTERS WITHOUT CLAIM TO ANY PARTICULAR FONT, STYLE, SIZE, OR COLOR.

NO CLAIM IS MADE TO THE EXCLUSIVE RIGHT TO USE GRASS, APART FROM THE MARK AS SHOWN.

FOR HEADS FOR WEED TRIMMERS; ADAPTOR KITS FOR MOUNTING HEADS TO WEED TRIMMERS CONSISTING OF AN ADAPTOR, A SPACER, AND BOLTS, ALL SOLD AS A UNIT (U.S. CLS. 13, 19, 21, 23, 31, 34 AND 35).

FIRST USE 4-1-2005; IN COMMERCE 4-1-2005.

2,998,856. OWENS-CORNING FIBERGLAS TECHNOLOGY INC., SUMMIT, IL. SN 78-134,681. PUB. 11-11-2003, FILED 6-11-2002.

SILENTEX

FOR MACHINES FOR THE MANUFACTURE OF INDUSTRIAL SILENCERS, AUTOMOTIVE MUFFLERS, AND HIGH TEMPERATURE INSULATION (U.S. CLS. 13, 19, 21, 23, 31, 34 AND 35).

FIRST USE 7-1-2005; IN COMMERCE 7-1-2005.

2,998,875. KASSBOHRER GELANDEFahrZEUG AG, LAUPHEIM, FED REP GERMANY. SN 78-176,874. PUB. 12-16-2003, FILED 10-22-2002.

PIPE MAGICIAN

THE MARK CONSISTS OF STANDARD CHARACTERS WITHOUT CLAIM TO ANY PARTICULAR FONT, STYLE, SIZE, OR COLOR.

FOR MACHINES AND IMPLEMENTS AND STRUCTURAL PARTS THEREFOR FOR PLOWING, SMOOTHING AND SCRAPING SKI RUNS AND SNOW TRAILS (U.S. CLS. 13, 19, 21, 23, 31, 34 AND 35).

FIRST USE 1-26-2001; IN COMMERCE 1-26-2001.

CLASS 7—(Continued).

2,998,965. REGAL-BELOIT CORPORATION, BELOIT, WI. SN 78-261,168. PUB. 9-21-2004, FILED 6-11-2003.

WET-LINC

FOR ELECTRIC MOTORS FOR INDUSTRIAL MACHINES (U.S. CLS. 13, 19, 21, 23, 31, 34 AND 35).
FIRST USE 3-15-2004; IN COMMERCE 3-15-2004.

2,998,973. BUEHLER LTD., LAKE BLUFF, IL. SN 78-266,353. PUB. 9-14-2004, FILED 6-24-2003.

POWERPRO

FOR GRINDER AND POLISHER MACHINES USED IN THE PREPARATION OF SAMPLES OF METAL, ROCK, PLASTICS, CERAMICS AND GLASS FOR MICROSTRUCTURAL EVALUATION (U.S. CLS. 13, 19, 21, 23, 31, 34 AND 35).

FIRST USE 6-30-2004; IN COMMERCE 6-30-2004.

2,998,993. CATERPILLAR INC., PEORIA, IL. SN 78-277,699. PUB. 7-13-2004, FILED 7-23-2003.

K SERIES

NO CLAIM IS MADE TO THE EXCLUSIVE RIGHT TO USE SERIES, APART FROM THE MARK AS SHOWN.

FOR GROUND ENGAGING TEETH FOR USE ON BUCKETS FOR USE ON EARTH MOVING MACHINERY (U.S. CLS. 13, 19, 21, 23, 31, 34 AND 35).

FIRST USE 3-1-2003; IN COMMERCE 6-1-2003.

2,999,130. SPRAYING SYSTEMS CO., WHEATON, IL. SN 78-351,072. PUB. 11-2-2004, FILED 1-13-2004.

ZMEG

THE MARK CONSISTS OF STANDARD CHARACTERS WITHOUT CLAIM TO ANY PARTICULAR FONT, STYLE, SIZE, OR COLOR.

FOR SPRAY NOZZLES AS PART OF POWER OPERATED SPRAYERS FOR INDUSTRIAL AND AGRICULTURAL USES (U.S. CLS. 13, 19, 21, 23, 31, 34 AND 35).

FIRST USE 1-31-2004; IN COMMERCE 1-31-2004.

CLASS 7—(Continued).

2,999,148. DYNAPOWERNAMICS INC., ST. LOUIS, MO. SN 78-356,928. PUB. 11-2-2004, FILED 1-23-2004.



NO CLAIM IS MADE TO THE EXCLUSIVE RIGHT TO USE INC., APART FROM THE MARK AS SHOWN.

THE COLORS BLACK, YELLOW, GREEN, RED, ARE CLAIMED AS A FEATURE OF THE MARK.

THE MARK CONSISTS OF A CIRCLE WITH A BLACK BORDER FILLED WITH COLOR YELLOW. HAVING THE CORPORATE NAME ARCED AT THE TOP IN BLACK TEXT AND A COMPANY SLOGAN ARCED AT THE BOTTOM IN BLACK TEXT. ALSO HAVING A SOLID BLACK SHAPE PLACED IN THE MIDDLE OF THE SAID CIRCLE WITH TWO GREEN BANDS PLACED IN THE MIDDLE OF THE SOLID BLACK SHAPE. SETTING ON THESE TWO GREEN BANDS IS A RED SCOPE SITE AND BOTH THE RED AND GREEN ITEMS HAVE GLOW SPARKS AT THE ENDS OF EACH THAT ANIMATE WHEN IT IS ON THE INTERNET, BY MEANS OF AN ANIMATION EFFECT.

THE MARK CONSISTS OF A CIRCLE WITH A BLACK BORDER FILLED WITH COLOR YELLOW.

FOR METALWORKING MACHINE TOOLS (U.S. CLS. 13, 19, 21, 23, 31, 34 AND 35).

FIRST USE 12-22-2003; IN COMMERCE 9-25-2004.

CLASS 8—HAND TOOLS

2,998,644. EPILADY 2000 L.L.C., HATZOR HAGLILIT, ISRAEL. SN 76-482,174. PUB. 4-27-2004, FILED 1-14-2003.

DUET

FOR ELECTRICAL HAND-HELD DEVICES FOR THE CUTTING AND REMOVAL OF HAIR, NAMELY, ELECTRIC SHAVERS AND EPILATORS (U.S. CLS. 23, 28 AND 44).

FIRST USE 4-29-2004; IN COMMERCE 4-29-2004.

CLASS 8—(Continued).

2,998,860. PIEH, AMY LYNNE, CAMP VERDE, AZ. SN 78-144,970. PUB. 11-25-2003, FILED 7-17-2002.

THE PIEH LEGACY COLLECTION

NO CLAIM IS MADE TO THE EXCLUSIVE RIGHT TO USE "COLLECTION", APART FROM THE MARK AS SHOWN.

FOR FARRIER AND BLACKSMITH TOOLS, NAMELY, HOOF KNIVES, RASPS, TONGS, NIPPERS AND HAMMERS (U.S. CLS. 23, 28 AND 44).

FIRST USE 10-27-2002; IN COMMERCE 5-17-2003.

2,998,936. PACTIV CORPORATION, LAKE FOREST, IL. SN 78-235,925. PUB. 11-18-2003, FILED 4-9-2003.

FUNTENSILS

FOR TABLEWARE, NAMELY, FORKS, KNIVES AND SPOONS (U.S. CLS. 23, 28 AND 44).

FIRST USE 6-7-2004; IN COMMERCE 6-7-2004.

2,999,001. INGENIOUS DESIGNS LLC, ST. PETERSBURG, FL. SN 78-279,081. PUB. 4-27-2004, FILED 7-25-2003.

THE HAND SHELL

NO CLAIM IS MADE TO THE EXCLUSIVE RIGHT TO USE "HAND", APART FROM THE MARK AS SHOWN.

FOR MANICURE IMPLEMENTS, NAMELY, NAIL FILES, NAIL CLIPPERS, CUTICLE PUSHERS, TWEEZERS, NAIL AND CUTICLE SCISSORS AND A HAND REST (U.S. CLS. 23, 28 AND 44).

FIRST USE 11-19-2003; IN COMMERCE 11-19-2003.

2,999,179. ANGEL SALES, INC., CHICAGO, IL. SN 78-371,689. PUB. 12-21-2004, FILED 2-20-2004.

BIKINI BABY

THE MARK CONSISTS OF STANDARD CHARACTERS WITHOUT CLAIM TO ANY PARTICULAR FONT, STYLE, SIZE, OR COLOR.

FOR RAZORS (U.S. CLS. 23, 28 AND 44).

FIRST USE 2-13-2004; IN COMMERCE 10-12-2004.

CLASS 9—ELECTRICAL AND SCIENTIFIC APPARATUS

2,998,504. RONCO INVENTIONS, LLC, CHATSWORTH, CA. SN 75-399,369. PUB. 2-2-1999, FILED 12-3-1997.

MINDVISION

FOR PRERECORDED AUDIO AND VIDEO CASSETTE TAPES FEATURING SELF-IMPROVEMENT, ELECTRONIC DEVICE WHICH IS ATTACHED BETWEEN A TV AND A VCR FOR TRANSMITTING AUDIO AND VIDEO SUBLIMINAL MESSAGES TO A VIDEOTAPE PLAYER (U.S. CLS. 21, 23, 26, 36 AND 38).
FIRST USE 10-31-1992; IN COMMERCE 10-31-1992.

2,998,510. APPLERA CORPORATION, NORWALK, CT. SN 75-806,893. PUB. 12-12-2000, FILED 9-22-1999.



FOR COMPUTER SOFTWARE AND COMPUTER SOFTWARE DEVELOPMENT TOOLS FOR ANALYSIS AND DATABASE MANAGEMENT OF GENOMIC, PROTEOMIC AND DISEASE INFORMATION IN THE FIELDS OF SCIENCE, TECHNOLOGY, MEDICINE, HEALTH AND THEIR RELATED BUSINESS, LAW AND PUBLIC POLICY AREAS; COMPUTER SOFTWARE AND COMPUTER SOFTWARE DEVELOPMENT TOOLS FOR ANALYSIS AND MANAGEMENT OF DATABASES ON THE SUBJECTS OF GENOMES, PROTEOMES AND DISEASES MULTIMEDIA SOFTWARE RECORDED ON CD-ROM FEATURING GENOMIC, PROTEOMIC AND DISEASE INFORMATION THE FIELDS OF SCIENCE, TECHNOLOGY, MEDICINE, HEALTH AND THEIR RELATED BUSINESS, LAW AND PUBLIC POLICY AREAS; COMPACT DISCS, PRE-RECORDED AUDIO AND VIDEO TAPES AND CASSETTES ON THE SUBJECTS OF GENOMES, PROTEOMES AND DISEASES; IN THE FIELDS IF SCIENCE, TECHNOLOGY, MEDICINE, HEALTH AND THEIR RELATED BUSINESS LAW AND PUBLIC POLICY AREAS (U.S. CLS. 21, 23, 26, 36 AND 38).
FIRST USE 3-24-2000; IN COMMERCE 3-24-2000.

CLASS 9—(Continued).

2,998,514. LEVITON MANUFACTURING CO., INC., LITTLE NECK, NY. SN 75-934,186. PUB. 5-7-2002, FILED 3-2-2000.

DECORA DIGITAL

OWNER OF U.S. REG. NO. 1,004,736.
NO CLAIM IS MADE TO THE EXCLUSIVE RIGHT TO USE "DIGITAL", APART FROM THE MARK AS SHOWN.
FOR AUDIO CONTROLS (U.S. CLS. 21, 23, 26, 36 AND 38).
FIRST USE 9-1-1999; IN COMMERCE 9-1-1999.

2,998,542. AIPTEK, INC., IRVINE, CA. SN 76-222,296. PUB. 6-25-2002, FILED 3-9-2001.

FIDELITY

FOR COMPUTER HARDWARE; COMPUTER DISC DRIVES; COMPUTER INTERFACE CARDS; COMPUTER MEMORY CARDS; VIDEO CAMERAS, MULTI-PURPOSE DIGITAL CAMERAS, PHOTOGRAPHIC CAMERAS, AND COMPUTER SOFTWARE FOR PHOTO AND VIDEO PROCESSING (U.S. CLS. 21, 23, 26, 36 AND 38).
FIRST USE 7-28-2003; IN COMMERCE 7-28-2003.

2,998,550. VANTAGE TECHNOLOGIES, INC., BOSTON, MA. SN 76-275,812. PUB. 9-24-2002, FILED 6-22-2001.

PARTNERSMITH

FOR COMPUTER PROGRAMS FOR USE IN MANAGING BUSINESS RELATIONSHIPS, NAMELY, STRATEGIC RELATIONSHIP MANAGEMENT COMPUTER PROGRAMS FOR ONLINE ANALYTICAL PROCESSING, TAKING SURVEYS, PROVIDING REPORTS, DATA INTEGRATION, DATA MANAGEMENT, CONTENT DELIVERY, PROVIDING TRAINING AND COACHING FOR BUSINESS PARTNERS AND CUSTOMERS AND TO ALLOW COLLABORATIVE WORK AMONG PARTNERS, SUPPLIERS, AND CUSTOMERS (U.S. CLS. 21, 23, 26, 36 AND 38).
FIRST USE 9-24-2004; IN COMMERCE 9-24-2004.

2,998,557. INTERACTIX CORPORATION, CHICAGO, IL. SN 76-319,493. PUB. 10-15-2002, FILED 9-29-2001.

INTERACTIX

FOR COMPUTER SOFTWARE PROGRAMS AND USER MANUALS SOLD AS A UNIT IN THE FIELDS OF PRODUCTIVITY, COMMUNICATIONS, AND INTERNET TOOLS FOR EMAIL PROCESSING, DATA MANAGEMENT, NEWS MANAGEMENT, AND DEVELOPMENT TOOLS, TO BE MARKETED ONLY IN DIRECT CHANNELS CONSISTING OF APPLICANT'S INTERNET WEB SITES (U.S. CLS. 21, 23, 26, 36 AND 38).
FIRST USE 7-5-2005; IN COMMERCE 7-5-2005.

CLASS 9—(Continued).

2,998,564. PANDUIT CORP., TINLEY PARK, IL. SN 76-347,249. PUB. 9-28-2004, FILED 12-7-2001.

NETKEY

FOR COMMUNICATION CABLING DEVICES, NAMELY, MODULAR JACKS, MODULAR PLUGS, MODULES, FACEPLATES, BEZELS, SURFACE MOUNT BOXES, PATCH PANELS, OPTICAL FIBER PLUGS, OPTICAL FIBER JACKS, OPTICAL FIBER ENCLOSURES, PATCH CORDS, ADAPTERS, COUPLERS, EXTENDERS, AND INTERCONNECT TRAYS (U.S. CLS. 21, 23, 26, 36 AND 38).

FIRST USE 1-31-2002; IN COMMERCE 1-31-2002.

2,998,565. PANDUIT CORP., TINLEY PARK, IL. SN 76-347,250. PUB. 9-28-2004, FILED 12-7-2001.



FOR COMMUNICATION CABLING DEVICES, NAMELY, MODULAR JACKS, MODULAR PLUGS, MODULES, FACEPLATES, BEZELS, SURFACE MOUNT BOXES, PATCH PANELS, OPTICAL FIBER PLUGS, OPTICAL FIBER JACKS, OPTICAL FIBER ENCLOSURES, PATCH CORDS, ADAPTERS, COUPLERS, EXTENDERS, AND INTERCONNECT TRAYS (U.S. CLS. 21, 23, 26, 36 AND 38).

FIRST USE 1-31-2002; IN COMMERCE 1-31-2002.

2,998,567. EZ-TEK INDUSTRIES, INC., DEER PARK, NY. SN 76-348,832. PUB. 12-3-2002, FILED 12-14-2001.

SCORPION

FOR HEAT SEALING MACHINES TO SEAL PLASTIC PACKAGES (U.S. CLS. 21, 23, 26, 36 AND 38).

FIRST USE 7-20-2004; IN COMMERCE 7-20-2004.

CLASS 9—(Continued).

2,998,568. DIPO, SOCIETE ANONYME, 34830 CLAPIERS, FRANCE. SN 76-368,835. PUB. 10-29-2002, FILED 2-11-2002.

Dipo

FOR ANTI-INTRUSION ALARMS, BURGLAR ALARMS, AND FIRE ALARMS; COMPUTER SOFTWARE FOR OPERATING ANTI-INTRUSION, BURGLAR, AND FIRE ALARMS (U.S. CLS. 21, 23, 26, 36 AND 38).

FIRST USE 1-0-2005; IN COMMERCE 1-0-2005.

2,998,570. JOHNSON & JOHNSON, NEW BRUNSWICK, NJ. SN 76-372,175. PUB. 9-24-2002, FILED 2-20-2002.

**COLOURS-WRAPPED
-IN-COMFORT**

FOR CONTACT LENSES (U.S. CLS. 21, 23, 26, 36 AND 38).

FIRST USE 0-0-2002; IN COMMERCE 0-0-2002.

2,998,589. SLEEP SOLUTIONS, INC., PALO ALTO, CA. SN 76-411,763. PUB. 9-7-2004, FILED 5-24-2002.

MEDITRACK

FOR COMPUTER SOFTWARE FOR NETWORK ENABLED TESTING LOGISTICS AND DATABASE SYSTEM COMPRISING COMPUTER HARDWARE AND SOFTWARE FOR MANAGING DIAGNOSTIC TESTING, ORDER ENTRY, MEDICAL RECORDS, TEST SYSTEM LOGISTICS, PATIENT INFORMATION AND REPORTS, IN THE FIELD OF MEDICAL TESTING (U.S. CLS. 21, 23, 26, 36 AND 38).

FIRST USE 2-19-2005; IN COMMERCE 2-19-2005.

2,998,610. KOVAR'S INC., CARMICHAEL, CA. SN 76-447,548. PUB. 4-8-2003, FILED 8-30-2002.

HOME SAFE STREET SAFE

FOR INSTRUCTIONAL PRERECORDED VIDEOTAPES FOR TEACHING KARATE TECHNIQUES (U.S. CLS. 21, 23, 26, 36 AND 38).

FIRST USE 9-0-2002; IN COMMERCE 9-0-2002.

CLASS 9—(Continued).

2,998,616. IPFLEX INC., TOKYO 150-0021, JAPAN. SN 76-450,795. PUB. 7-27-2004, FILED 9-18-2002.

DAP/DNA

FOR COMPUTER HARDWARE, NAMELY, INTEGRATED CIRCUITS WITH AND WITHOUT SOFTWARE, INCLUDING LARGE SCALE INTEGRATED (LSI'S), VERY LARGE SCALE INTEGRATED (VLSI'S), SYSTEM LSI'S, CENTRAL PROCESSING UNITS, RECONFIGURABLE PROGRAMMABLE LOGIC DEVICES, MICROPROCESSORS, PERIPHERAL CHIPS, MICROPROCESSOR CORES, MACRO CELLS, MICROCONTROLLERS AND BUS INTERFACES, FOR COMPUTERS, COMPUTER PERIPHERAL, COMPUTER COMMUNICATIONS, NETWORKING AND PROGRAMMABLE LOGICS APPARATUS, CIRCUIT BOARDS, MEMORY AND MEMORY BOARDS; COMMUNICATION DEVICES, NAMELY, INTEGRATED CIRCUITS AND CIRCUIT BOARDS FOR TELEPHONES, WIRELESS COMMUNICATION, MOBILE PHONES, TELEPHONES VIA COMPUTER NETWORK SUCH AS INTERNET PHONES, AND FOR COMMUNICATION VIA RADIO AND/OR TELEVISION TRANSMISSION; NETWORKING DEVICES, NAMELY, INTEGRATED CIRCUITS AND CIRCUIT BOARDS FOR ROUTING AND/OR MANAGING COMPUTER NETWORKS, AND FOR USE WITH COMPUTER NETWORKS; PERSONAL DATA PROCESSING DEVICES, NAMELY, INTEGRATED CIRCUITS AND CIRCUIT BOARDS FOR MOBILE AND PERSONAL COMPUTING AND COMMUNICATION; MULTIMEDIA DEVICES, NAMELY, INTEGRATED CIRCUITS AND CIRCUIT BOARDS FOR CODING AND ENCODING VISUAL AND SOUND DATA, VOICE CONTROL AND TRANSLATION; INTEGRATED CIRCUITS AND CIRCUIT BOARDS FOR APPARATUS FOR GAMES; INTEGRATED CIRCUITS AND CIRCUIT BOARDS FOR APPARATUS FOR NAVIGATION SYSTEMS; COMPUTER SOFTWARE USED IN OPERATING INTEGRATED CIRCUITS INCLUDING LARGE SCALE INTEGRATED (LSI'S), VERY LARGE SCALE INTEGRATED (VLSI'S) SYSTEM LSI'S, CENTRAL PROCESSING UNITS, RECONFIGURABLE PROGRAMMABLE LOGIC DEVICES, MICROPROCESSORS, PERIPHERAL CHIPS, MICROPROCESSOR CORES, MACRO CELLS, MICROCONTROLLERS AND BUS INTERFACES, AND CIRCUIT BOARDS; COMPILERS, SIMULATORS AND COMPUTER SOFTWARE FOR USE IN THE DESIGN AND DEVELOPMENT OF INTEGRATED CIRCUITS INCLUDING LARGE SCALE INTEGRATED (LSI'S), VERY LARGE SCALE INTEGRATED (VLSI'S) SYSTEM LSI'S, CENTRAL PROCESSING UNITS, RECONFIGURABLE PROGRAMMABLE LOGIC DEVICES, MICROPROCESSORS, PERIPHERAL CHIPS, MICROPROCESSOR CORES, MACRO CELLS, MICROCONTROLLERS AND BUS INTERFACES, AND CIRCUIT BOARDS; COMPUTER SOFTWARE FOR USE IN THE DESIGN AND DEVELOPMENT OF APPLICATION SOFTWARE AND OPERATING SYSTEM SOFTWARE; APPARATUS FOR TESTING AND PROGRAMMING INTEGRATED CIRCUITS; AND USER MANUALS FOR USE WITH THE ABOVE GOODS, MANUALS SOLD AS A UNIT WITH THE REFERENCED GOODS AND DOWNLOADABLE FROM A COMPUTER NETWORK (U.S. CLS. 21, 23, 26, 36 AND 38).

FIRST USE 6-7-2004; IN COMMERCE 6-7-2004.

CLASS 9—(Continued).

2,998,638. LIFELINE INTERNATIONAL, INC., FORT WAYNE, IN. SN 76-474,782. PUB. 10-26-2004, FILED 12-9-2002.



NO CLAIM IS MADE TO THE EXCLUSIVE RIGHT TO USE "LIFELINE", APART FROM THE MARK AS SHOWN.

FOR SAFETY THROWS IN THE NATURE OF ROPE THROWS WITH A RESCUE SLING FOR USE IN WATER RESCUES (U.S. CLS. 21, 23, 26, 36 AND 38).

FIRST USE 11-28-2002; IN COMMERCE 11-28-2002.

2,998,653. IMPACT TECHNOLOGIES GROUP, INC., CHARLOTTE, NC. SN 76-486,267. PUB. 5-11-2004, FILED 1-30-2003.

PLANLABX3

OWNER OF U.S. REG. NO. 2,583,631.

FOR COMPUTER SOFTWARE AND INSTRUCTIONAL MANUALS SOLD AS A UNIT IN THE FIELD OF FINANCIAL SERVICES FOR THE ELECTRONIC COLLECTION, MANAGEMENT, COLLABORATION AND TRANSFER OF FINANCIAL INFORMATION ASSOCIATED WITH CASE PLANNING AND ANALYSIS FOR FINANCIAL PLANNING, ESTATE PLANNING, BUSINESS PLANNING, NEEDS ANALYSIS, INSURANCE PLANNING, INVESTMENT ANALYSIS, RISK PROFILING, ASSET ALLOCATION, DEBT MANAGEMENT, LONG-TERM CARE PLANNING, DISABILITY INCOME PLANNING, EDUCATION FUNDING PLANNING, RETIREMENT PLANNING, SPECIAL NEEDS PLANNING, FINANCIAL ANALYSIS USING MONTE CARLO SIMULATION AND MONTE CARLO METHOD, INSURANCE POLICY ILLUSTRATIONS AND WORKSITE MARKETING (U.S. CLS. 21, 23, 26, 36 AND 38).

FIRST USE 9-15-2003; IN COMMERCE 9-15-2003.

2,998,656. INTERSIL AMERICAS INC., MILPITAS, CA. SN 76-489,926. PUB. 5-18-2004, FILED 2-13-2003.

THERMAGUARD

FOR SEMICONDUCTORS AND INTEGRATED CIRCUIT DEVICES (U.S. CLS. 21, 23, 26, 36 AND 38).

FIRST USE 1-31-2003; IN COMMERCE 3-17-2005.

CLASS 9—(Continued).

2,998,659. CENTURION TECHNOLOGIES, INC., FENTON, MO. SN 76-495,816. PUB. 6-29-2004, FILED 3-10-2003.

MACSHIELD

FOR COMPUTER SOFTWARE FOR USE IN PROTECTING A HARD DRIVE FROM ACCIDENTAL OR UNAUTHORIZED ALTERATIONS AND DELETIONS (U.S. CLS. 21, 23, 26, 36 AND 38).

FIRST USE 6-0-2003; IN COMMERCE 6-0-2003.

2,998,674. PALTRONICS, INC., LAS VEGAS, NV. SN 76-513,368. PUB. 4-27-2004, FILED 4-22-2003.

ONE LINK TABLE SYSTEMS

NO CLAIM IS MADE TO THE EXCLUSIVE RIGHT TO USE "TABLE SYSTEMS", APART FROM THE MARK AS SHOWN.

FOR GAMING EQUIPMENT, NAMELY, A NETWORKED GAMING SYSTEM COMPRISED PRIMARILY OF COMPUTER HARDWARE AND SOFTWARE FOR CALCULATING PAYOUTS, JACKPOTS AND OTHER FINANCIAL INFORMATION FOR PROGRESSIVE GAMES, MYSTERY JACKPOTS AND BONUS GAMES AND FOR COMMUNICATING INFORMATION WITH THE GAMING EQUIPMENT, NAMELY GAMING TABLES AND TABLE GAMES AND WITH DISPLAYS ASSOCIATED WITH GAMING EQUIPMENT (U.S. CLS. 21, 23, 26, 36 AND 38).

FIRST USE 9-16-2003; IN COMMERCE 9-16-2003.

2,998,686. ALTER YOUR LIFE, LLC, CLARKESVILLE, GA. SN 76-524,804. PUB. 4-27-2004, FILED 6-16-2003.

ALTER YOUR LIFE

FOR AUDIO AND VIDEO TAPES, DVDS AND CD-ROMS FEATURING LECTURES IN THE FIELD OF PERSONAL SPIRITUAL GROWTH, HEALING AND WELLNESS (U.S. CLS. 21, 23, 26, 36 AND 38).

FIRST USE 6-1-2003; IN COMMERCE 10-1-2003.

2,998,687. OMTOOL, LTD., SALEM, NH. SN 76-525,081. PUB. 3-23-2004, FILED 6-23-2003.

SWIFTWRITER

FOR COMPUTER SOFTWARE WHICH, USED WITH DOCUMENT MANAGEMENT SYSTEMS, ALLOWS USERS TO CONVERT PRINT-READY DOCUMENTS INTO PORTABLE DOCUMENT FORMAT (PDF) DOCUMENTS AND TO SAVE PDF DOCUMENTS TO DOCUMENT MANAGEMENT SYSTEMS WITH AN ACCOMPANYING PROFILE (U.S. CLS. 21, 23, 26, 36 AND 38).

FIRST USE 8-15-2003; IN COMMERCE 8-15-2003.

CLASS 9—(Continued).

2,998,694. MILLENNIUM RECORDS, LLC, INDIANAPOLIS, IN. SN 76-527,175. PUB. 10-12-2004, FILED 7-1-2003.

DISC-GO

FOR COMPACT DISC RECORDERS, COMPACT DISC RECORDER VENDING MACHINES (U.S. CLS. 21, 23, 26, 36 AND 38).

FIRST USE 8-0-2003; IN COMMERCE 12-0-2004.

2,998,698. SUZUKI TECHNO AMERICA, INC., CHERRY HILL, NJ. SN 76-529,608. PUB. 3-23-2004, FILED 7-11-2003.



FOR ALUMINUM ELECTROLYTIC CAPACITORS (U.S. CLS. 21, 23, 26, 36 AND 38).

FIRST USE 9-9-2003; IN COMMERCE 9-9-2003.

2,998,724. ARISTOCRAT TECHNOLOGIES AUSTRALIA PTY LTD, LANE COVE, NEW SOUTH WALES 2066, AUSTRALIA. SN 76-541,153. PUB. 7-6-2004, FILED 8-29-2003.

FLAME OF OLYMPUS

FOR GAMING DEVICES, NAMELY, GAMING MACHINES AND COMPUTER SOFTWARE USED THEREWITH TO ENABLE THE GAMING MACHINE TO RUN (U.S. CLS. 21, 23, 26, 36 AND 38).

FIRST USE 9-17-2002; IN COMMERCE 9-17-2002.

CLASS 9—(Continued).

2,998,745. ICOM INCORPORATED, OSAKA-SHI, OSAKA, JAPAN. SN 76-556,814. PUB. 11-30-2004, FILED 10-20-2003.



NO CLAIM IS MADE TO THE EXCLUSIVE RIGHT TO USE "AUDIO", APART FROM THE MARK AS SHOWN. FOR COMMUNICATION EQUIPMENT, NAMELY, TRANSCEIVERS, COMMUNICATION RECEIVERS, RADIO FREQUENCY RECEIVERS, RADIOTELEPHONE, MOBILE TRANSCEIVERS, MARINE-BAND TRANSCEIVER, AIR-BAND TRANSCEIVER AND AMATEUR RADIO TRANSCEIVER; AND COMPONENTS OF THE FOREGOING AND ACCESSORIES THEREOF, NAMELY MICROPHONE, SPEAKERS, HEADPHONES (U.S. CLS. 21, 23, 26, 36 AND 38).
FIRST USE 10-22-2003; IN COMMERCE 10-22-2003.

CLASS 9—(Continued).

2,998,768. MAXTEK GO-GO CO., LTD., SHINDIAN CITY, TAIPEI HSIEN, TAIWAN. SN 76-565,860. PUB. 9-7-2004, FILED 12-18-2003.



FOR SUPPORT BELTS FOR WORKERS; PROTECTIVE GLOVES FOR INDUSTRIAL USE; BULLET-PROOF VESTS AND CLOTHING; KNEE PADS FOR WORKERS; PROTECTIVE CLOTHING; ELECTRIC CORDS (U.S. CLS. 21, 23, 26, 36 AND 38).
FIRST USE 3-18-2005; IN COMMERCE 3-18-2005.

2,998,752. POWELL ELECTRICAL SYSTEMS, INC., HOUSTON, TX. SN 76-560,554. PUB. 8-3-2004, FILED 10-28-2003.

POWLOGIC

FOR PRE-FABRICATED ELECTRICAL SUBSTATIONS AND SWITCHGEAR (U.S. CLS. 21, 23, 26, 36 AND 38).
FIRST USE 10-17-2001; IN COMMERCE 10-17-2001.

2,998,785. MWH SOFT, INC., PASADENA, CA. SN 76-571,878. PUB. 10-26-2004, FILED 1-26-2004.

INFOSWMM

2,998,767. MAXTEK GO-GO CO., LTD., SHINDIAN CITY, TAIPEI HSIEN, TAIWAN. SN 76-565,856. PUB. 8-31-2004, FILED 12-18-2003.



FOR SUPPORT BELTS FOR WORKERS; PROTECTIVE GLOVES FOR INDUSTRIAL USE; BULLET-PROOF VESTS AND CLOTHING; KNEE PADS FOR WORKERS; PROTECTIVE CLOTHING; ELECTRIC CORDS (U.S. CLS. 21, 23, 26, 36 AND 38).
FIRST USE 3-18-2005; IN COMMERCE 3-18-2005.

THE MARK CONSISTS OF STANDARD CHARACTERS WITHOUT CLAIM TO ANY PARTICULAR FONT, STYLE, SIZE, OR COLOR.
FOR COMPUTER PROGRAMS THAT INTEGRATE GEOGRAPHIC INFORMATION SYSTEMS FOR USE BY WATER RESOURCES ENGINEERS IN THE HYDRAULIC ANALYSIS AND MASTER PLANNING OF STORM SEWER COLLECTION SYSTEMS AND STORM WATER MANAGEMENT (U.S. CLS. 21, 23, 26, 36 AND 38).
FIRST USE 1-26-2004; IN COMMERCE 1-14-2005.

CLASS 9—(Continued).

2,998,786. MWH SOFT, INC., PASADENA, CA. SN 76-571,879.
PUB. 10-26-2004, FILED 1-26-2004.

INFOSURGE

THE MARK CONSISTS OF STANDARD CHARACTERS WITHOUT CLAIM TO ANY PARTICULAR FONT, STYLE, SIZE, OR COLOR.

FOR COMPUTER PROGRAMS THAT INTEGRATE GEOGRAPHIC INFORMATION SYSTEMS FOR USE BY WATER RESOURCES ENGINEERS IN THE HYDRAULIC TRANSIENT ANALYSIS AND DESIGN OF WATER DISTRIBUTION SYSTEMS (U.S. CLS. 21, 23, 26, 36 AND 38).

FIRST USE 1-26-2004; IN COMMERCE 2-27-2004.

2,998,797. AAMP OF FLORIDA, INC., CLEARWATER, FL.
SN 76-578,950. PUB. 3-15-2005, FILED 3-3-2004.

SOUND QUEST

THE MARK CONSISTS OF STANDARD CHARACTERS WITHOUT CLAIM TO ANY PARTICULAR FONT, STYLE, SIZE, OR COLOR.

OWNER OF U.S. REG. NO. 2,005,942.

NO CLAIM IS MADE TO THE EXCLUSIVE RIGHT TO USE "SOUND", APART FROM THE MARK AS SHOWN.

FOR HOME INWALL AUDIO SPEAKERS (U.S. CLS. 21, 23, 26, 36 AND 38).

FIRST USE 5-31-2004; IN COMMERCE 5-31-2004.

2,998,818. SOFT-WORLD INTERNATIONAL CORPORATION, KAOHSIUNG, TAIWAN. SN 76-586,620. PUB. 1-18-2005, FILED 4-12-2004.

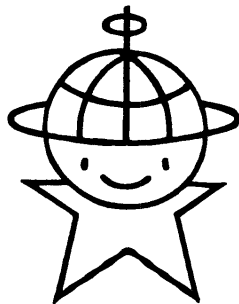
**CLASS 9—(Continued).**

OWNER OF U.S. REG. NO. 2,616,567.

THE MARK CONSISTS OF A STYLIZED CHILD FORMED BY A STYLIZED GLOBE AND STAR DESIGN.

FOR COMPUTER GAME DISCS; COMPUTER GAME SOFTWARE RECORDED ON CD-ROM; MOTION PICTURE FILM FEATURING ANIMATION AND EDUCATION; PRERECORDED VIDEO TAPES FEATURING MUSIC, LANDSCAPES, EDUCATION AND ANIMATION; MUSICAL SOUND RECORDINGS; PRERECORDED AUDIO TAPES FEATURING MUSIC (U.S. CLS. 21, 23, 26, 36 AND 38).

FIRST USE 11-10-1996; IN COMMERCE 11-10-1996.

2,998,822. RIGAKU INDUSTRIAL CORPORATION, OSAKA 569-1146, JAPAN. SN 76-587,544. PUB. 2-8-2005, FILED 4-20-2004.

Ultra Carry

THE MARK CONSISTS OF STANDARD CHARACTERS WITHOUT CLAIM TO ANY PARTICULAR FONT, STYLE, SIZE, OR COLOR.

FOR SAMPLE HOLDER FOR INDUSTRIAL USE X-RAY SPECTROMETER (U.S. CLS. 21, 23, 26, 36 AND 38).

FIRST USE 7-2-2004; IN COMMERCE 7-2-2004.

2,998,829. L.C. LICENSING, INC., NEW YORK, NY. SN 76-976,302. PUB. 4-20-2004, FILED 6-24-2002.

a x c e s s

THE MARK CONSISTS OF THE WORD AXCESS IN WHICH THE LETTERS "A", "X", "E", "S" AND "S" ARE WRITTEN IN WHITE AND THE LETTER "C" IS WRITTEN IN RED AND SAID LETTER "C" IS UNDERLINED.

FOR EYEWEAR, NAMELY, EYEGLASSES, EYEGLASS FRAMES, EYEGLASS CASES AND EYEGLASS CORDS; CELLULAR TELEPHONE CASES (U.S. CLS. 21, 23, 26, 36 AND 38).

FIRST USE 12-15-2002; IN COMMERCE 12-15-2002.

CLASS 9—(Continued).

2,998,831. ATRONIC INTERNATIONAL GMBH, LUBBECKE, FED REP GERMANY. SN 76-977,278. PUB. 3-23-2004, FILED 11-30-2001.

HI!BILITY

PRIORITY CLAIMED UNDER SEC. 44(D) ON ERPN CMNTY TM OFC APPLICATION NO. 2240885, FILED 5-31-2001, REG. NO. 2240885, DATED 10-28-2002, EXPIRES 5-31-2011.

FOR GAMING EQUIPMENT, NAMELY, GAMING MACHINES, SLOT MACHINES, CASINO GAMBLING MACHINES AND PARTS THEREFORE; ELECTRIC AND ELECTRONIC GAMING AND GAMBLING MACHINES; GAMING MACHINES; GAMING MACHINES FEATURING SLOT MACHINE TYPE GAMES VIA VIDEO DISPLAYS; COIN-OPERATED GAMING EQUIPMENT, NAMELY, GAMBLING MACHINES, SLOT MACHINES, VIDEO SLOT MACHINES, CASINO GAMBLING MACHINES, VIDEO GAME CARTRIDGES AND DISCS; FIRMWARE AND SOFTWARE FEATURING ACTION FILMS AND SIMULATED GAMES FOR USE IN ELECTRIC AND ELECTRONIC GAME, AMUSEMENT AND GAMBLING APPARATUS, DEVICES AND MACHINES; DATA RECORDING APPARATUS, NAMELY, MAGNETIC DISK DRIVES, MAGNETIC TAPE DRIVES AND SEMICONDUCTOR MEMORY FOR OPERATING ELECTRIC AND ELECTRONIC GAMES, AMUSEMENT AND GAMBLING APPARATUS, DEVICES AND MACHINES; VENDING MACHINES FEATURING CD ROM GAMES, CASSETTE GAMES, CARTRIDGE GAMES, VIDEO GAMES (U.S. CLS. 21, 23, 26, 36 AND 38).

FIRST USE 5-7-2003; IN COMMERCE 11-25-2003.

2,998,836. MATSUSHITA ELECTRIC INDUSTRIAL CO., LTD., OSAKA-FU, JAPAN. SN 76-977,679. PUB. 10-21-2003, FILED 4-3-2003.



FOR COMPUTER SOFTWARE FOR DOWNLOADING, STORAGE, SELECTION, RETRIEVAL, CUSTOMIZATION AND PLAYBACK OF MUSIC (U.S. CLS. 21, 23, 26, 36 AND 38).
FIRST USE 12-31-2002; IN COMMERCE 4-30-2003.

CLASS 9—(Continued).

2,998,840. SYNTHETIC ENVIRONMENTS, INC., MCLEAN, VA. SN 78-057,281. PUB. 3-19-2002, FILED 4-6-2001.

PIXELPUSHER

FOR COMPUTER HARDWARE AND PERIPHERAL, NAMELY AN ELECTRONIC VIDEO FRAME GRABBER FOR CONVERTING ANALOG AND DIGITAL VIDEO SIGNALS GENERATED BY A VIDEO CAMERA INTO DIGITIZED VIDEO FRAMES CONSTITUTING ARRAYS OF PIXEL DATA AND ELECTRONICALLY TRANSMITTING THESE DATA TO A COMPUTER (U.S. CLS. 21, 23, 26, 36 AND 38).

FIRST USE 5-16-2005; IN COMMERCE 5-16-2005.

2,998,846. ORIENT POWER HOLDINGS LIMITED, KOWLOON, HONG KONG. SN 78-086,784. PUB. 10-1-2002, FILED 10-3-2001.

JSI

FOR ALL PORTABLE, HOME OR MOBILE AUDIO, VIDEO, HOME THEATER, AND NAVIGATIONAL PRODUCTS OF ANY NATURE, NAMELY, MP3 PLAYERS AND RECORDERS; AUDIO PLAYERS AND RECORDERS; TELEVISIONS; GLOBAL POSITIONING SATELLITE SYSTEMS, COMPRISED OF ANTENNA, DECODER, READER, PROCESSOR AND MONITOR; PERSONAL VIDEO RECORDERS; SATELLITE RECEIVERS ALL PORTABLE, HOME OR MOBILE AUDIO, VIDEO, HOME THEATER, AND NAVIGATIONAL PRODUCTS OF ANY NATURE, NAMELY, RADIOS; COMPACT DISC PLAYERS AND RECORDERS; AUDIO AMPLIFIERS; SATELLITE AMPLIFIERS AND DECODERS; CLOCK RADIOS; HOME STEREOS; BOOM BOXES; AUDIO RECEIVERS, AUDIO SPEAKERS AND AUDIO TUNERS; POWER INVERTERS; LIQUID CRYSTAL DISPLAYS; DVD PLAYERS AND RECORDERS; SET TOP INTERFACE BOXES; AND COMPUTER AND VIDEO FLAT SCREEN MONITORS (U.S. CLS. 21, 23, 26, 36 AND 38).

FIRST USE 1-0-2001; IN COMMERCE 1-0-2001.

2,998,850. IVIVITY INC., NORCROSS, GA. SN 78-115,215. PUB. 10-15-2002, FILED 3-15-2002.

**THE INTELLIGENT
CONVERGENCE OF
STORAGE AND
NETWORKING**

FOR COMPUTER HARDWARE AND COMPUTER SOFTWARE FOR DATA MANAGEMENT (U.S. CLS. 21, 23, 26, 36 AND 38).
FIRST USE 3-22-2005; IN COMMERCE 3-22-2005.

CLASS 9—(Continued).

2,998,868. ZENASIS TECHNOLOGIES, INC., CAMPBELL, CA. SN 78-154,766. PUB. 3-18-2003, FILED 8-15-2002.

ZENASIS

FOR ELECTRONIC DESIGN AUTOMATION SOFTWARE FOR DESIGN OF VLSI (VERY LARGE SCALE INTEGRATION) CIRCUITS (U.S. CLS. 21, 23, 26, 36 AND 38).

FIRST USE 12-9-2003; IN COMMERCE 12-9-2003.

2,998,870. IGT, RENO, NV. SN 78-159,214. PUB. 10-21-2003, FILED 8-29-2002.

DOUBLE DRAW ACES

FOR GAMING MACHINES, NAMELY, SLOT MACHINES WITH OR WITHOUT A VIDEO OUTPUT (U.S. CLS. 21, 23, 26, 36 AND 38).

FIRST USE 7-28-2004; IN COMMERCE 8-28-2004.

2,998,876. LOCKHEED MARTIN CORPORATION, BETHESDA, MD. SN 78-176,943. PUB. 5-27-2003, FILED 10-22-2002.

SNIFFERSTAR

FOR CHEMICAL SENSOR FOR DETECTING CHEMICAL WARFARE AGENTS EMPLOYING RAM AIRFLOW OVER SURFACE ACOUSTIC WAVE ARRAYS (U.S. CLS. 21, 23, 26, 36 AND 38).

FIRST USE 10-18-2002; IN COMMERCE 6-1-2004.

2,998,884. ICONIC MANUFACTURING COMPANY LLC, LUMMI ISLAND, WA. SN 78-188,253. PUB. 10-21-2003, FILED 11-22-2002.

TANGERINE

FOR PHASING TRANSDUCERS FOR LOUDSPEAKERS; LOUDSPEAKER COMPONENT PARTS NAMELY L, HORNS, TRANSDUCERS, AND RAW FRAME DRIVERS; LOUDSPEAKER ACCESSORIES, SPECIFICALLY LOUDSPEAKER SYSTEMS COMPRISING ONE OR MORE COMPONENT LOUDSPEAKERS, FOREGOING LOUDSPEAKER COMPONENT PARTS, AND/OR FOREGOING ACCESSORIES; AND INSTRUCTION MANUALS SOLD THEREWITH AS A UNIT (U.S. CLS. 21, 23, 26, 36 AND 38).

FIRST USE 5-31-2005; IN COMMERCE 5-31-2005.

CLASS 9—(Continued).

2,998,885. AUTOMATED SYSTEMS, INC., TAMPA, FL. SN 78-195,274. PUB. 7-13-2004, FILED 12-17-2002.



THE MARK CONSISTS OF THE PRODUCT NAME "WAREHOUSE PARTNER" DIVIDED BY A RADIO FREQUENCY BEAM.

FOR PC BASED WAREHOUSE MANAGEMENT SOFTWARE PACKAGE DESIGNED FOR THE MANAGEMENT OF MATERIALS AND INVENTORY ASSOCIATED WITH THE WAREHOUSE INDUSTRY; THE SOFTWARE PACKAGE IS MODULAR, WHERE ADDITIONAL MODULES OR COMPONENTS ARE CAPABLE OF SEAMLESS INTEGRATION (U.S. CLS. 21, 23, 26, 36 AND 38).

FIRST USE 12-17-2002; IN COMMERCE 12-17-2002.

2,998,888. AIMWARE, INC., BOSTON, MA. SN 78-196,816. PUB. 3-16-2004, FILED 12-20-2002.

BRIGHTWORK

FOR COMPUTER SOFTWARE FOR USE IN SENDING AND SHARING INFORMATION AND DATA TO FACILITATE COLLABORATION WITHIN AND BETWEEN ENTERPRISES (U.S. CLS. 21, 23, 26, 36 AND 38).

FIRST USE 12-17-2002; IN COMMERCE 1-29-2003.

CLASS 9—(Continued).

2,998,899. OLIVE TREE MEDIA, L.L.C., HOUSTON, TX. SN 78-211,450. PUB. 6-1-2004, FILED 2-6-2003.

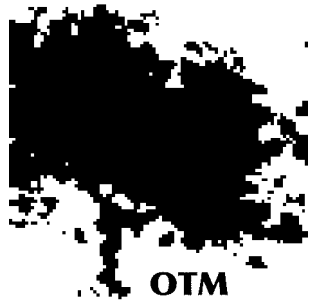

THE MARK CONSISTS OF AN IMAGE OF A OLIVE TREE.

FOR COMPUTER PROGRAMS AND SOFTWARE FOR IMAGE ANALYSIS IN BIOLOGY AND BIOMEDICAL SCIENCES; ELECTRONIC PUBLICATIONS, NAMELY BOOKS AND JOURNALS RELATED TO HEALTH, MEDICINE WITH ITS VARIOUS SPECIALTIES, NAMELY, BIOLOGY, BIOMEDICAL SCIENCES, PHYSIOLOGY, COOKING, TRAVEL, AND COMPUTER SCIENCES (U.S. CLS. 21, 23, 26, 36 AND 38).

FIRST USE 7-12-2005; IN COMMERCE 7-12-2005.

2,998,900. OLIVE TREE MEDIA, L.L.C., HOUSTON, TX. SN 78-211,452. PUB. 4-27-2004, FILED 2-6-2003.

OTMIAS

FOR COMPUTER PROGRAMS OR SOFTWARE FOR IMAGE ANALYSIS IN BIOMEDICAL SCIENCES (U.S. CLS. 21, 23, 26, 36 AND 38).

FIRST USE 7-12-2005; IN COMMERCE 7-12-2005.

CLASS 9—(Continued).

2,998,905. VK CORPORATION, PYONGTAEK-CITY, KYONGGI-DO, REPUBLIC OF KOREA. SN 78-214,486. PUB. 10-28-2003, FILED 2-13-2003.



NO CLAIM IS MADE TO THE EXCLUSIVE RIGHT TO USE "MOBILE", APART FROM THE MARK AS SHOWN.

FOR CELLULAR PHONES; DIGITAL CELLULAR PHONES; PERSONAL DIGITAL ASSISTANTS; WIRELESS MODEMS; RECHARGEABLE BATTERIES; BATTERY CHARGERS; CAR NAVIGATION COMPUTERS; NAVIGATION APPARATUS FOR VEHICLES IN THE NATURE OF ON-BOARD COMPUTERS; SATELLITE NAVIGATIONAL SYSTEM, NAMELY, A GLOBAL POSITIONING SYSTEM (GPS) (U.S. CLS. 21, 23, 26, 36 AND 38).

FIRST USE 3-31-2002; IN COMMERCE 7-31-2004.

2,998,909. GENERAL ELECTRIC COMPANY, SCHENECTADY, NY. SN 78-216,439. PUB. 10-14-2003, FILED 2-19-2003.

PACSYSTEMS

FOR FACTORY AUTOMATION COMPUTER HARDWARE AND SOFTWARE, NAMELY, SOFTWARE TO INTEGRATE MANUFACTURING MACHINE OPERATIONS, CONTROL PROCESSES, PROVIDE DATA FOR VISUALIZATION, TRACK PROBLEMS AND GENERATE PRODUCTION REPORTS (U.S. CLS. 21, 23, 26, 36 AND 38).

FIRST USE 3-3-2003; IN COMMERCE 3-3-2003.

2,998,912. GENERAL ELECTRIC COMPANY, SCHENECTADY, NY. SN 78-217,586. PUB. 10-14-2003, FILED 2-21-2003.

VISTANET

FOR COMPUTER SOFTWARE, NAMELY, CUSTOM SOFTWARE PROGRAMS FOR INSTALLING, CONFIGURING, CONTROLLING, MONITORING, AND OPERATING MULTIPLEXORS (U.S. CLS. 21, 23, 26, 36 AND 38).

FIRST USE 10-19-2003; IN COMMERCE 10-19-2003.

CLASS 9—(Continued).

2,998,920. SONY COMPUTER ENTERTAINMENT EUROPE LIMITED, LONDON, UNITED KINGDOM. SN 78-224,078. PUB. 10-12-2004, FILED 3-11-2003.



FOR COMPUTER HARDWARE; COMPUTER AND VIDEO GAME MACHINES FOR USE WITH TELEVISIONS; COMPUTER GAME CONSOLES; COMPUTER AND VIDEO GAME DISCS, CASSETTES AND CARTRIDGES; COMPUTER GAME PROGRAMS AND VIDEO GAME PROGRAMS; COMPUTER PERIPHERALS; PRE-RECORDED COMPACT DISCS, DVDS AND VIDEO DISCS FEATURING INTERACTIVE GAMES; ELECTRONIC APPARATUS AND INSTRUMENTS NAMELY WEB CAMERAS; OPTICAL APPARATUS AND INSTRUMENTS NAMELY OPTICAL LENSES; CAMERAS (U.S. CLS. 21, 23, 26, 36 AND 38).

FIRST USE 7-22-2003; IN COMMERCE 11-4-2003.

2,998,922. IBAK HELMUT HUNGER GMBH & CO KG, D-24148 KIEL, FED REP GERMANY. SN 78-224,209. PUB. 4-27-2004, FILED 3-11-2003.

PANORAMO

FOR SEWER INSPECTION SYSTEMS, CONSISTING OF A MOTORIZED CAMERA TRACTOR WITH AT LEAST ONE CAMERA, AND A CAMERA CABLE FOR TRANSMITTING PICTURES TO THE OPERATING AND STORAGE CONTROL ON THE STREET (U.S. CLS. 21, 23, 26, 36 AND 38).

FIRST USE 2-23-2005; IN COMMERCE 2-23-2005.

2,998,934. APJET, INC., SANTA FE, NM. SN 78-235,184. PUB. 6-22-2004, FILED 4-8-2003.

APPJ

NO CLAIM IS MADE TO THE EXCLUSIVE RIGHT TO USE THE LETTER "J", APART FROM THE MARK AS SHOWN.

FOR PLASMA TREATMENT APPARATUS USING AN ATMOSPHERIC PRESSURE, LOW TEMPERATURE PLASMA FOR CLEANING, DECONTAMINATION, STRIPPING, ASHING, STERILIZATION, ETCHING AND COATING SURFACES (U.S. CLS. 21, 23, 26, 36 AND 38).

FIRST USE 1-23-1997; IN COMMERCE 7-8-2003.

CLASS 9—(Continued).

2,998,937. IMOVE, INC., PORTLAND, OR. SN 78-236,018. PUB. 12-16-2003, FILED 4-10-2003.

LOOK EVERYWHERE. SEE EVERYTHING. ALL THE TIME.

FOR COMPUTER HARDWARE; COMPUTER SOFTWARE FOR THE CAPTURE, CREATION, MANIPULATION, EVALUATION, MONITORING, AND PRESENTATION OF GRAPHICAL, IMAGE, VIDEO AND AUDIO DATA; SYSTEMS COMPRISED OF CAMERAS, COMPUTER SOFTWARE AND CONNECTING CABLES FOR THE CAPTURE, CREATION, MANIPULATION, EVALUATION, MONITORING, AND PRESENTATION OF GRAPHICAL, IMAGE, VIDEO AND AUDIO DATA (U.S. CLS. 21, 23, 26, 36 AND 38).

FIRST USE 4-28-2005; IN COMMERCE 4-28-2005.

2,998,940. MED-EL ELEKTRO-MEDIZINISCHE GERATE GMBH, A-6020 INNSBRUCK, AUSTRIA. SN 78-239,067. PUB. 2-22-2005, FILED 4-17-2003.

Baby BTE

PRIORITY CLAIMED UNDER SEC. 44(D) ON ERP N CMNTY TM OFC APPLICATION NO. 003137742, FILED 4-17-2003, REG. NO. 003137742, DATED 8-25-2004, EXPIRES 8-25-2014.

NO CLAIM IS MADE TO THE EXCLUSIVE RIGHT TO USE "BABY" AND "BTE", APART FROM THE MARK AS SHOWN.

FOR SPEECH AND LANGUAGE PROCESSORS (U.S. CLS. 21, 23, 26, 36 AND 38).

FIRST USE 11-30-2004; IN COMMERCE 11-30-2004.

CLASS 9—(Continued).

2,998,943. WYETH, MADISON, NJ. SN 78-241,070. PUB. 7-27-2004, FILED 4-23-2003.



NO CLAIM IS MADE TO THE EXCLUSIVE RIGHT TO USE "SAVE THE DUNG BEETLE", APART FROM THE MARK AS SHOWN.

FOR PRE-RECORDED VIDEO TAPES AND DVDS AND COMPUTER PROGRAMS, DEALING WITH THE CARE OF DUNG BEETLES AND THE USE OF DUNG BEETLES FOR DISPOSING OF DUNG FROM EQUINE, BOVINE AND OVINE ANIMALS TO MAINTAIN CLEAN ENVIRONMENTS (U.S. CLS. 21, 23, 26, 36 AND 38).
FIRST USE 4-1-2005; IN COMMERCE 4-1-2005.

2,998,977. CBS BROADCASTING INC., NEW YORK, NY. SN 78-269,719. PUB. 9-21-2004, FILED 7-2-2003.



OWNER OF U.S. REG. NO. 1,715,262.
FOR CURRENCY AND CREDIT OPERATED SLOT MACHINES AND GAMING DEVICES, NAMELY GAMING MACHINES FOR USE IN GAMING ESTABLISHMENTS; CELL PHONE COVERS; MAGNETS (U.S. CLS. 21, 23, 26, 36 AND 38).
FIRST USE 12-5-2000; IN COMMERCE 12-5-2000.

2,998,983. UNIVERSAL DISPLAY CORPORATION, EWING, NJ. SN 78-274,545. PUB. 10-26-2004, FILED 7-15-2003.

T-PHOLED

OWNER OF U.S. REG. NOS. 2,789,048 AND 2,789,049.
FOR LIGHT EMITTING DIODES (U.S. CLS. 21, 23, 26, 36 AND 38).
FIRST USE 4-22-2005; IN COMMERCE 4-22-2005.

CLASS 9—(Continued).

2,998,984. UNIVERSAL DISPLAY CORPORATION, EWING, NJ. SN 78-274,547. PUB. 10-26-2004, FILED 7-15-2003.

F-PHOLED

OWNER OF U.S. REG. NO. 2,789,048.
FOR LIGHT EMITTING DIODES (U.S. CLS. 21, 23, 26, 36 AND 38).
FIRST USE 4-22-2005; IN COMMERCE 4-22-2005.

2,998,985. UNIVERSAL DISPLAY CORPORATION, EWING, NJ. SN 78-274,549. PUB. 10-26-2004, FILED 7-15-2003.

TF-PHOLED

OWNER OF U.S. REG. NO. 2,789,048.
FOR LIGHT EMITTING DIODES (U.S. CLS. 21, 23, 26, 36 AND 38).
FIRST USE 4-22-2005; IN COMMERCE 4-22-2005.

2,998,986. INFOCUS CORPORATION, WILSONVILLE, OR. SN 78-274,830. PUB. 3-22-2005, FILED 7-16-2003.



FOR HOME AND BUSINESS AUDIO AND VIDEO PROJECTORS AND PROJECTION SYSTEMS (U.S. CLS. 21, 23, 26, 36 AND 38).
FIRST USE 10-31-2003; IN COMMERCE 10-31-2003.

2,998,989. TOTAL TEAM SOLUTIONS, ORLANDO, FL. SN 78-275,189. PUB. 4-20-2004, FILED 7-16-2003.

TOTAL PROTECTION FOR LIFE

FOR ELECTRIC POWER REGULATION DEVICES, NAMELY, TRANSIENT VOLTAGE SURGE SUPPRESSION DEVICES (U.S. CLS. 21, 23, 26, 36 AND 38).
FIRST USE 7-16-2003; IN COMMERCE 7-16-2003.

CLASS 9—(Continued).

2,999,008. TAIWAN FU HSING INDUSTRIAL CO., LTD., KAOHSIUNG HSIEN, TAIWAN. SN 78-284,351. PUB. 10-26-2004, FILED 8-7-2003.

VANGUARD

THE MARK CONSISTS OF STANDARD CHARACTERS WITHOUT CLAIM TO ANY PARTICULAR FONT, STYLE, SIZE, OR COLOR.

FOR ELECTRIC LOCK; ELECTRONIC LOCK; MAGNETIC CARD LOCK; ELECTRIC DOOR CLOSER; ALL ELECTRICAL IN NATURE (U.S. CLS. 21, 23, 26, 36 AND 38).

FIRST USE 5-11-2004; IN COMMERCE 8-30-2004.

2,999,012. INTERNATIONAL ELECTRONICS, INC., CANTON, MA. SN 78-287,761. PUB. 10-12-2004, FILED 8-14-2003.

232

FOR COMPUTER BASED ACCESS CONTROL SYSTEMS COMPRISING COMPUTER HARDWARE SUCH AS CONTROLLERS, ENTRY KEY PADS, PROXIMITY DETECTORS, AND LOCK SETS; AND SOFTWARE FOR USE IN CONTROLLING ACCESS BY INDIVIDUALS TO ENTRY WAYS AND DEVICES (U.S. CLS. 21, 23, 26, 36 AND 38).

FIRST USE 1-1-1995; IN COMMERCE 1-1-1995.

2,999,013. INTERNATIONAL ELECTRONICS, INC., CANTON, MA. SN 78-287,762. PUB. 10-12-2004, FILED 8-14-2003.

242

FOR COMPUTER BASED ACCESS CONTROL SYSTEMS COMPRISING COMPUTER HARDWARE SUCH AS CONTROLLERS, ENTRY KEY PADS, PROXIMITY DETECTORS, AND LOCK SETS; AND SOFTWARE FOR USE IN CONTROLLING ACCESS BY INDIVIDUALS TO ENTRY WAYS AND DEVICES (U.S. CLS. 21, 23, 26, 36 AND 38).

FIRST USE 7-1-2002; IN COMMERCE 7-1-2002.

2,999,017. NVIDIA CORPORATION, SANTA CLARA, CA. SN 78-290,481. PUB. 4-27-2004, FILED 8-21-2003.

FORCEWARE

FOR COMPUTER HARDWARE AND COMPUTER SOFTWARE FOR OPERATING MULTIMEDIA APPLICATIONS, PRODUCING MULTIMEDIA CONTENT, AND FOR ENHANCING AUDIO CLARITY AND VIDEO AND GRAPHIC DISPLAY (U.S. CLS. 21, 23, 26, 36 AND 38).

FIRST USE 10-0-2003; IN COMMERCE 10-0-2003.

CLASS 9—(Continued).

2,999,023. EQUITY RECORDS, INC., NASHVILLE, TN. SN 78-293,345. PUB. 10-12-2004, FILED 8-28-2003.

EQUITY MUSIC GROUP

NO CLAIM IS MADE TO THE EXCLUSIVE RIGHT TO USE MUSIC GROUP, APART FROM THE MARK AS SHOWN.

FOR SERIES OF MUSICAL SOUND RECORDINGS AND AUDIOVISUAL RECORDINGS, ALL FEATURING MUSIC AND MUSICAL ENTERTAINMENT (U.S. CLS. 21, 23, 26, 36 AND 38).

FIRST USE 9-0-2003; IN COMMERCE 9-0-2003.

2,999,026. GROK, INC., NEVADA CITY, CA. SN 78-293,689. PUB. 4-12-2005, FILED 8-28-2003.

HIGHWIRE

FOR COMPUTER SOFTWARE, NAMELY CLIENT SOFTWARE THAT IMPLEMENTS AND MANAGES A GRAPHIC USER INTERFACE, TYPICALLY PURCHASED IN BULK BY LARGE CORPORATIONS RUNNING MAINFRAME-BASED ENTERPRISE APPLICATIONS TO IMPLEMENT AND MANAGE A GRAPHIC USER INTERFACE ON SERVER-CONNECTED PERSONAL COMPUTERS, NOTEBOOK COMPUTERS AND PERSONAL DIGITAL ASSISTANTS FOR USE BY EMPLOYEES, SALESPERSONS AND CUSTOMERS IN THE CONDUCT OF BUSINESS TRANSACTIONS (U.S. CLS. 21, 23, 26, 36 AND 38).

FIRST USE 2-1-2005; IN COMMERCE 6-1-2004.

2,999,029. HARRIS CORPORATION, MELBOURNE, FL. SN 78-294,208. PUB. 5-25-2004, FILED 8-29-2003.

STL PLUS

FOR MULTIPLEXERS FOR BI-DIRECTIONAL TRANSPORT OF PROGRAM AUDIO AND OTHER SIGNALS BETWEEN BROADCAST STUDIO AND REMOTE TRANSMITTER SITES (U.S. CLS. 21, 23, 26, 36 AND 38).

FIRST USE 12-5-1994; IN COMMERCE 12-5-1994.

2,999,035. LI-COR, INC., LINCOLN, NE. SN 78-297,231. PUB. 1-4-2005, FILED 9-8-2003.

AERIUS

FOR OPTICAL IMAGING INSTRUMENT FOR DETECTING NUCLEIC ACIDS AND PROTEINS FOR SCIENTIFIC AND LABORATORY RESEARCH (U.S. CLS. 21, 23, 26, 36 AND 38).

FIRST USE 11-19-2004; IN COMMERCE 11-19-2004.

CLASS 9—(Continued).

2,999,036. AMTROL INC., WEST WARWICK, RI. SN 78-297,807. PUB. 2-22-2005, FILED 9-9-2003.

FIRE-X-TROL

OWNER OF U.S. REG. NOS. 731,732, 843,060, AND 1,322,022.

FOR FIRE PROTECTION SYSTEMS FOR COMMERCIAL, RESIDENTIAL AND INDUSTRIAL USE COMPRISING PRESSURIZED, SEAL-IN AIR CUSHION TANKS, HYDRAULICALLY STABLE FIRE PROTECTION SPRINKLER SYSTEM EXPANSION VESSEL, AND EXPANDABLE MEMBRANES (U.S. CLS. 21, 23, 26, 36 AND 38).

FIRST USE 9-0-2004; IN COMMERCE 12-0-2004.

CLASS 9—(Continued).

2,999,065. COMPUTERIZED SECURITY SYSTEMS, INC., TROY, MI. SN 78-322,844. PUB. 10-5-2004, FILED 11-4-2003.

SMARTLINC

2,999,038. QLOGIC CORPORATION, ALISO VIEJO, CA. SN 78-298,796. PUB. 9-7-2004, FILED 9-10-2003.



OWNER OF U.S. REG. NOS. 2,500,569, 2,645,956, AND 2,726,962.

THE MARK CONSISTS OF THE WORDING "QLOGIC" ON A STYLIZED FONT UNDERNEATH THE CORPORATE LOGO "QCC".

FOR INTEGRATED CIRCUITS; CONTROLLER CIRCUIT BOARDS; TELECOMMUNICATION SWITCHES, NAMELY FIBER CHANNEL SWITCHES; SOFTWARE AND FIRMWARE ALL USED FOR CONTROLLING AND INTERFACING WITH THE AFORESAID GOODS AND INSTRUCTIONAL MANUALS SOLD AS A UNIT THEREWITH (U.S. CLS. 21, 23, 26, 36 AND 38).

FIRST USE 12-1-2003; IN COMMERCE 12-1-2003.

THE MARK CONSISTS OF STANDARD CHARACTERS WITHOUT CLAIM TO ANY PARTICULAR FONT, STYLE, SIZE, OR COLOR.

FOR ELECTRONIC LOCKS AND ELECTRONIC DOOR SAFE LOCKS (U.S. CLS. 21, 23, 26, 36 AND 38).

FIRST USE 5-19-2004; IN COMMERCE 5-19-2004.

2,999,083. SCORPION SPORTS, INC., COTO DE CAZA, CA. SN 78-332,288. PUB. 4-19-2005, FILED 11-24-2003.

SpeedShift

2,999,052. TRS QUALITY, INC., FORT WORTH, TX. SN 78-308,158. PUB. 9-14-2004, FILED 10-1-2003.

ACCURIAN

FOR CONSUMER ELECTRONIC PRODUCTS, NAMELY, AUDIO, VIDEO, MINI-USB AND DIGITAL CABLES; USB HUBS; WIRED/WIRELESS ROUTERS AND ELECTRIC NODES/PLUGS; AUDIO/VIDEO ELECTRIC DISTRIBUTION SWITCHES; ASB COMPUTER NETWORK ADAPTERS; GAMING MACHINE COMPONENTS, NAMELY, GAMING MODULATORS AND ELECTRIC GAMING SWITCHES; OUTDOOR ANTENNAS AND INDOOR AMPLIFIED/NON-AMPLIFIED ANTENNAS (U.S. CLS. 21, 23, 26, 36 AND 38).

FIRST USE 6-3-2005; IN COMMERCE 6-3-2005.

THE MARK CONSISTS OF STANDARD CHARACTERS WITHOUT CLAIM TO ANY PARTICULAR FONT, STYLE, SIZE, OR COLOR.

FOR PARTS OF MOTORCYCLE HELMETS, NAMELY DEVICE TO REMOVE AND INSTALL FACE SHIELD FROM AND ONTO HELMETS (U.S. CLS. 21, 23, 26, 36 AND 38).

FIRST USE 2-14-2004; IN COMMERCE 2-14-2004.

CLASS 9—(Continued).

2,999,101. BIOCEPT, INC., SAN DIEGO, CA. SN 78-341,146.
PUB. 9-28-2004, FILED 12-15-2003.

CLASS 9—(Continued).

2,999,113. AEROBAT-TERIES, INC., TYLER, TX. SN 78-345,235. PUB. 3-22-2005, FILED 12-23-2003.

CHIPCALC

THE MARK CONSISTS OF STANDARD CHARACTERS WITHOUT CLAIM TO ANY PARTICULAR FONT, STYLE, SIZE, OR COLOR.

FOR COMPUTER SOFTWARE FOR THE ANALYSIS OF MICROARRAYS FOR USE IN SCIENTIFIC, DIAGNOSTIC OR RESEARCH USE (U.S. CLS. 21, 23, 26, 36 AND 38).

FIRST USE 2-20-2004; IN COMMERCE 2-20-2004.

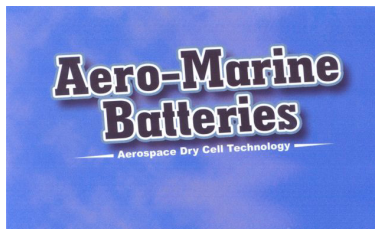

NO CLAIM IS MADE TO THE EXCLUSIVE RIGHT TO USE BATTERIES AND AEROSPACE DRY CELL TECHNOLOGY, APART FROM THE MARK AS SHOWN.

THE COLOR(S) BLACK, WHITE, AND BLUE IS/ARE CLAIMED AS A FEATURE OF THE MARK.

THE MARK CONSISTS OF STYLIZED BLACK LETTERING SPELLING AERO-MARINE BATTERIES WHICH IS OUTLINED IN WHITE AND AGAIN IN BLUE. BENEATH ARE THE WORDS, AEROSPACE DRY CELL TECHNOLOGY, WRITTEN WITH SMALLER WHITE LETTERS AND ACCENTUATED ON THE LEFT AND RIGHT BY WHITE TRIANGULAR DASH MARKS. THE ENTIRE IMAGE IS ON A BLUE BACKGROUND RESEMBLING A SKY.

FOR BATTERIES FOR VEHICLES (U.S. CLS. 21, 23, 26, 36 AND 38).

FIRST USE 1-1-2004; IN COMMERCE 1-1-2004.

2,999,119. ESALEN INSTITUTE, BIG SUR, CA. SN 78-347,089.
PUB. 10-19-2004, FILED 12-31-2003.

2,999,103. ARTOGRAPH, INC., PLYMOUTH, MN. SN 78-341,490. PUB. 10-19-2004, FILED 12-16-2003.

GLO-ANYWHERE

THE MARK CONSISTS OF STANDARD CHARACTERS WITHOUT CLAIM TO ANY PARTICULAR FONT, STYLE, SIZE, OR COLOR.

FOR ELECTRONIC DEVICE FOR ARTISTS AND CRAFTERS FOR TRACING DESIGNS AND PATTERNS, NAMELY, A LIGHT BOX (U.S. CLS. 21, 23, 26, 36 AND 38).

FIRST USE 4-30-2004; IN COMMERCE 4-30-2004.

ESALEN

THE MARK CONSISTS OF STANDARD CHARACTERS WITHOUT CLAIM TO ANY PARTICULAR FONT, STYLE, SIZE, OR COLOR.

OWNER OF U.S. REG. NOS. 1,801,176 AND 2,017,377.
FOR INSTRUCTIONAL VIDEO TAPES AND DVDS IN THE FIELDS OF MASSAGE THERAPY AND HUMAN BODY WORK (U.S. CLS. 21, 23, 26, 36 AND 38).

FIRST USE 6-0-1997; IN COMMERCE 6-0-1997.

CLASS 9—(Continued).

2,999,122. MCCAULEY BROTHERS, INC., VERSAILLES, KY.
SN 78-348,141. PUB. 10-19-2004, FILED 1-6-2004.

CLASS 9—(Continued).

2,999,137. KADENA SYSTEMS, INC., SAN JOSE, CA. SN 78-
353,356. PUB. 10-26-2004, FILED 1-16-2004.

ON TRACK

POCKETCACHE

THE MARK CONSISTS OF STANDARD CHARACTERS
WITHOUT CLAIM TO ANY PARTICULAR FONT, STYLE,
SIZE, OR COLOR.

FOR COMPUTER SOFTWARE FOR USE IN DATA-
BASE MANAGEMENT IN THE EQUINE FIELD (U.S.
CLS. 21, 23, 26, 36 AND 38).
FIRST USE 10-20-2003; IN COMMERCE 10-20-2003.

THE MARK CONSISTS OF STANDARD CHARACTERS
WITHOUT CLAIM TO ANY PARTICULAR FONT, STYLE,
SIZE, OR COLOR.

FOR COMPUTER HARDWARE AND SOFTWARE FOR
DATA STORAGE, DATA MANAGEMENT, AND DATA
BACKUP (U.S. CLS. 21, 23, 26, 36 AND 38).
FIRST USE 5-4-2004; IN COMMERCE 5-4-2004.

2,999,136. YOKOGAWA CORPORATION OF AMERICA,
NEWNAN, GA. SN 78-352,771. PUB. 11-9-2004, FILED 1-
16-2004.

2,999,159. MULTIMEDIA GAMES, INC., AUSTIN, TX. AND
EMT WORLDWIDE, INC., MOORPARK, CA. SN 78-
361,687. PUB. 11-9-2004, FILED 2-3-2004.

O2MATION

STAR MAGIC

THE MARK CONSISTS OF STANDARD CHARACTERS
WITHOUT CLAIM TO ANY PARTICULAR FONT, STYLE,
SIZE, OR COLOR.

OWNER OF U.S. REG. NO. 2,058,684.
FOR APPARATUS FOR DETECTING AND ANALYZ-
ING GAS CONCENTRATIONS FOR INDUSTRIAL PRO-
CESS CONTROL (U.S. CLS. 21, 23, 26, 36 AND 38).
FIRST USE 10-7-2004; IN COMMERCE 10-7-2004.

THE MARK CONSISTS OF STANDARD CHARACTERS
WITHOUT CLAIM TO ANY PARTICULAR FONT, STYLE,
SIZE, OR COLOR.

FOR GAMING MACHINES FOR PLAYING ELECTRO-
NIC GAMES OF CHANCE; ELECTRONIC SLOT MA-
CHINES; VIDEO LOTTERY TERMINALS (U.S. CLS. 21,
23, 26, 36 AND 38).
FIRST USE 7-30-2004; IN COMMERCE 7-30-2004.

CLASS 9—(Continued).

2,999,172. WMS GAMING INC., WAUKEGAN, IL. SN 78-370,030. PUB. 4-19-2005, FILED 2-18-2004.

CLASS 9—(Continued).

2,999,184. PIXOLOGIC, INC., LOS ANGELES, CA. SN 78-374,187. PUB. 3-22-2005, FILED 2-25-2004.

GREAT SCOT

THE MARK CONSISTS OF STANDARD CHARACTERS WITHOUT CLAIM TO ANY PARTICULAR FONT, STYLE, SIZE, OR COLOR.

FOR GAMING DEVICES, NAMELY, GAMING MACHINES (U.S. CLS. 21, 23, 26, 36 AND 38).

FIRST USE 10-5-2004; IN COMMERCE 10-5-2004.

2,999,176. CROSS MATCH TECHNOLOGIES, INC., PALM BEACH GARDENS, FL. SN 78-370,904. PUB. 3-22-2005, FILED 2-19-2004.

ZBRUSH

THE MARK CONSISTS OF STANDARD CHARACTERS WITHOUT CLAIM TO ANY PARTICULAR FONT, STYLE, SIZE, OR COLOR.

OWNER OF U.S. REG. NOS. 2,484,332 AND 2,487,422.
FOR GRAPHICS APPLICATIONS COMPUTER SOFTWARE FOR GENERAL COMMERCIAL, INDUSTRIAL, ARTISTIC AND EDUCATIONAL USE AND MANUALS THEREFOR (U.S. CLS. 21, 23, 26, 36 AND 38).

FIRST USE 12-0-1999; IN COMMERCE 12-0-1999.

2,999,185. LIBERTY GLOVE, INC., CITY OF INDUSTRY, CA. SN 78-374,580. PUB. 12-7-2004, FILED 2-26-2004.

ID 442

THE MARK CONSISTS OF STANDARD CHARACTERS WITHOUT CLAIM TO ANY PARTICULAR FONT, STYLE, SIZE, OR COLOR.

OWNER OF U.S. REG. NOS. 2,556,703 AND 2,612,647.

NO CLAIM IS MADE TO THE EXCLUSIVE RIGHT TO USE "ID", APART FROM THE MARK AS SHOWN.

FOR FINGERPRINT SCANNERS (U.S. CLS. 21, 23, 26, 36 AND 38).

FIRST USE 1-23-2002; IN COMMERCE 1-23-2002.

PolyGard

THE MARK CONSISTS OF STANDARD CHARACTERS WITHOUT CLAIM TO ANY PARTICULAR FONT, STYLE, SIZE, OR COLOR.

FOR PROTECTIVE CLOTHING, FOOTWEAR AND HEADGEAR FOR PROTECTION AGAINST ACCIDENTS, FIRE AND RADIATION; NAMELY, COVERALLS, FACE MASKS, GLOVES AND SHOE COVERS (U.S. CLS. 21, 23, 26, 36 AND 38).

FIRST USE 10-26-2004; IN COMMERCE 10-26-2004.

CLASS 9—(Continued).

2,999,186. LIBERTY GLOVE, INC., CITY OF INDUSTRY, CA. SN 78-374,617. PUB. 12-14-2004, FILED 2-26-2004.

CLASS 9—(Continued).

2,999,192. SANYO NORTH AMERICA CORPORATION, CHATSWORTH, CA. SN 78-378,411. PUB. 12-7-2004, FILED 3-4-2004.

PureGard

POWER BAR

THE MARK CONSISTS OF STANDARD CHARACTERS WITHOUT CLAIM TO ANY PARTICULAR FONT, STYLE, SIZE, OR COLOR.

FOR PROTECTIVE CLOTHING, FOOTWEAR AND HEADGEAR FOR PROTECTION AGAINST ACCIDENTS, FIRE AND RADIATION; NAMELY, COVERALLS, FACE MASKS, GLOVES AND SHOE COVERS (U.S. CLS. 21, 23, 26, 36 AND 38).

FIRST USE 12-3-2004; IN COMMERCE 12-3-2004.

THE MARK CONSISTS OF STANDARD CHARACTERS WITHOUT CLAIM TO ANY PARTICULAR FONT, STYLE, SIZE, OR COLOR.

FOR TELEPHONES (U.S. CLS. 21, 23, 26, 36 AND 38). FIRST USE 2-4-2005; IN COMMERCE 2-4-2005.

2,999,189. WMS GAMING INC., WAUKEGAN, IL. SN 78-375,388. PUB. 4-19-2005, FILED 2-27-2004.

2,999,201. WMS GAMING INC., WAUKEGAN, IL. SN 78-381,418. PUB. 4-12-2005, FILED 3-10-2004.

LUCKY SEALS

REEL RICHES

THE MARK CONSISTS OF STANDARD CHARACTERS WITHOUT CLAIM TO ANY PARTICULAR FONT, STYLE, SIZE, OR COLOR.

FOR GAMING DEVICES, NAMELY, GAMING MACHINES (U.S. CLS. 21, 23, 26, 36 AND 38).

FIRST USE 10-5-2004; IN COMMERCE 10-5-2004.

THE MARK CONSISTS OF STANDARD CHARACTERS WITHOUT CLAIM TO ANY PARTICULAR FONT, STYLE, SIZE, OR COLOR.

FOR GAMING DEVICES, NAMELY, GAMING MACHINES (U.S. CLS. 21, 23, 26, 36 AND 38).

FIRST USE 10-5-2004; IN COMMERCE 10-5-2004.

CLASS 9—(Continued).

2,999,202. WMS GAMING INC., WAUKEGAN, IL. SN 78-381,422. PUB. 4-12-2005, FILED 3-10-2004.

CLASS 9—(Continued).

2,999,220. IGT, RENO, NV. SN 78-392,879. PUB. 1-11-2005, FILED 3-29-2004.

WILD SHOT

THE MARK CONSISTS OF STANDARD CHARACTERS WITHOUT CLAIM TO ANY PARTICULAR FONT, STYLE, SIZE, OR COLOR.

FOR GAMING DEVICES, NAMELY, GAMING MACHINES (U.S. CLS. 21, 23, 26, 36 AND 38).

FIRST USE 10-5-2004; IN COMMERCE 10-5-2004.

DOUBLE CRYSTAL SEVENS

THE MARK CONSISTS OF STANDARD CHARACTERS WITHOUT CLAIM TO ANY PARTICULAR FONT, STYLE, SIZE, OR COLOR.

OWNER OF U.S. REG. NO. 2,780,183.

FOR GAMING MACHINES, NAMELY, DEVICES WHICH ACCEPT A WAGER AND COMPONENTS THEREFOR, NAMELY, CONTROLLERS, DISPLAYS, BUTTON PANELS, BOLSTERS, ELECTRICAL WIRING, AND COMPUTER HARDWARE AND SOFTWARE ASSOCIATED THEREWITH (U.S. CLS. 21, 23, 26, 36 AND 38).

FIRST USE 11-22-2004; IN COMMERCE 12-3-2004.

2,999,226. ORAK, ZEKI, SAN FRANCISCO, CA. SN 78-395,458. PUB. 3-1-2005, FILED 4-2-2004.

2,999,217. WMS GAMING INC., WAUKEGAN, IL. SN 78-391,211. PUB. 3-1-2005, FILED 3-26-2004.

SLOOP puzzle**LUCKY LIZARD**

THE MARK CONSISTS OF STANDARD CHARACTERS WITHOUT CLAIM TO ANY PARTICULAR FONT, STYLE, SIZE, OR COLOR.

NO CLAIM IS MADE TO THE EXCLUSIVE RIGHT TO USE "PUZZLE", APART FROM THE MARK AS SHOWN.

FOR COMPUTER GAME SOFTWARE FEATURING SLIDING AND LOOPING COLOR TILES WHERE PLAYER MUST MATCH COLORS TO MAKE POINTS FOR CONTINUOUS SCORING OPPORTUNITIES (U.S. CLS. 21, 23, 26, 36 AND 38).

FIRST USE 1-23-2004; IN COMMERCE 10-26-2004.

THE MARK CONSISTS OF STANDARD CHARACTERS WITHOUT CLAIM TO ANY PARTICULAR FONT, STYLE, SIZE, OR COLOR.

FOR GAMING MACHINES (U.S. CLS. 21, 23, 26, 36 AND 38).

FIRST USE 10-5-2004; IN COMMERCE 10-5-2004.

CLASS 9—(Continued).

2,999,229. ELECTRONIC CONTROLS DESIGN, INC., MILWAUKIE, OR. SN 78-396,633. PUB. 2-8-2005, FILED 4-5-2004.

BAKEWATCH

THE MARK CONSISTS OF STANDARD CHARACTERS WITHOUT CLAIM TO ANY PARTICULAR FONT, STYLE, SIZE, OR COLOR.

OWNER OF U.S. REG. NO. 2,725,472.

FOR COMPUTER HARDWARE DEVICES, NAMELY, PROCESS MONITORS AND DATA COLLECTORS FOR USE IN COLLECTING, MEASURING, ANALYZING, CONTROLLING AND REPORTING ON THE PERFORMANCE OF SOLDERING MACHINES, COMMERCIAL COOKING OVENS, COMMERCIAL BAKING OVENS, LINE OVENS USED IN A WIDE VARIETY OF FIELDS AND INDUSTRIAL APPLICATIONS, AND STATIC OVENS USED IN A WIDE VARIETY OF FIELDS AND INDUSTRIAL APPLICATIONS; COMPUTER SOFTWARE FOR USE IN COLLECTING, MEASURING, ANALYZING, CONTROLLING AND REPORTING ON THE PERFORMANCE OF SOLDERING MACHINES, COMMERCIAL COOKING OVENS, COMMERCIAL BAKING OVENS, LINE OVENS USED IN A WIDE VARIETY OF FIELDS AND INDUSTRIAL APPLICATIONS, AND STATIC OVENS USED IN A WIDE VARIETY OF FIELDS AND INDUSTRIAL APPLICATIONS (U.S. CLS. 21, 23, 26, 36 AND 38).

FIRST USE 8-15-2004; IN COMMERCE 8-15-2004.

CLASS 9—(Continued).

2,999,238. FIRSTLOGIC, INC., LACROSSE, WI. SN 78-403,698. PUB. 2-15-2005, FILED 4-18-2004.

POSTSORT.DAT MANAGER

THE MARK CONSISTS OF STANDARD CHARACTERS WITHOUT CLAIM TO ANY PARTICULAR FONT, STYLE, SIZE, OR COLOR.

NO CLAIM IS MADE TO THE EXCLUSIVE RIGHT TO USE "MANAGER", APART FROM THE MARK AS SHOWN.

FOR MAILING, SHIPPING, AND FREIGHT MANAGEMENT SOFTWARE, NAMELY SOFTWARE FOR CREATING AND EDITING INFORMATION WITHIN A MAILING, CALCULATING MAILING AND DELIVERY COSTS, DETERMINING LEAST-COST MAILING AND DELIVERY OPTIONS, GENERATING COST INVOICES FOR MAILING AND DELIVERY, GENERATING POSTAL AND DELIVERY LABELS, TAGS, AND PLACARDS, AND GENERATING INVENTORY, STATUS, AND COST REPORTS FOR MAILINGS AND DELIVERIES (U.S. CLS. 21, 23, 26, 36 AND 38).

FIRST USE 3-17-2005; IN COMMERCE 3-17-2005.

2,999,242. FIRSTLOGIC, INC., LACROSSE, WI. SN 78-407,316. PUB. 2-1-2005, FILED 4-23-2004.

SPATIALIQ

THE MARK CONSISTS OF STANDARD CHARACTERS WITHOUT CLAIM TO ANY PARTICULAR FONT, STYLE, SIZE, OR COLOR.

FOR COMPUTER SOFTWARE FOR GENERATION, PROCESSING AND ANALYSIS OF GEOSPATIAL, ADDRESS, AND POSTAL CODE DATA (U.S. CLS. 21, 23, 26, 36 AND 38).

FIRST USE 6-15-2004; IN COMMERCE 6-15-2004.

CLASS 9—(Continued).

2,999,250. GOLDEN SOFTWARE, INC., GOLDEN, CO. SN 78-415,253. PUB. 3-15-2005, FILED 5-7-2004.

CLASS 9—(Continued).

2,999,258. IVIS TECHNOLOGIES, INC., PHOENIX, AZ. SN 78-423,321. PUB. 4-12-2005, FILED 5-21-2004.

Voxler

XBOOST

THE MARK CONSISTS OF STANDARD CHARACTERS WITHOUT CLAIM TO ANY PARTICULAR FONT, STYLE, SIZE, OR COLOR.

FOR COMPUTER SOFTWARE USED FOR DATA ANALYSIS, VISUALIZATION, AND GEOMETRY RECONSTRUCTION (U.S. CLS. 21, 23, 26, 36 AND 38).

FIRST USE 12-9-2003; IN COMMERCE 12-9-2003.

THE MARK CONSISTS OF STANDARD CHARACTERS WITHOUT CLAIM TO ANY PARTICULAR FONT, STYLE, SIZE, OR COLOR.

FOR DOWNLOADABLE AND PACKAGED CONTROLLER PROXY SOFTWARE THAT FACILITATES COMMUNICATIONS BETWEEN SOFTWARE PROGRAMS (U.S. CLS. 21, 23, 26, 36 AND 38).

FIRST USE 10-19-2004; IN COMMERCE 10-19-2004.

2,999,252. GENCACHE LLC, IRVINE, CA. SN 78-417,783. PUB. 3-29-2005, FILED 5-12-2004.

2,999,264. SHENICK SOFTWARE SYSTEMS INC., BURLINGAME, CA. SN 78-428,001. PUB. 4-19-2005, FILED 6-1-2004.

GENCACHE

diversifEye

THE MARK CONSISTS OF STANDARD CHARACTERS WITHOUT CLAIM TO ANY PARTICULAR FONT, STYLE, SIZE, OR COLOR.

FOR HEALTHCARE SEARCH ENGINE SOFTWARE (U.S. CLS. 21, 23, 26, 36 AND 38).

FIRST USE 5-1-2004; IN COMMERCE 5-1-2004.

THE MARK CONSISTS OF STANDARD CHARACTERS WITHOUT CLAIM TO ANY PARTICULAR FONT, STYLE, SIZE, OR COLOR.

FOR COMPUTER HARDWARE AND SOFTWARE FOR TESTING NETWORKS (U.S. CLS. 21, 23, 26, 36 AND 38).

FIRST USE 1-1-2001; IN COMMERCE 1-1-2002.

CLASS 9—(Continued).

2,999,267. RAPPAPORT, ALEXANDER, SAN FRANCISCO, CA. SN 78-432,398. PUB. 4-19-2005, FILED 6-9-2004.

CLASS 9—(Continued).

2,999,271. TOGUN, ADEWALE A, DOUGLASVILLE, GA. SN 78-440,425. PUB. 4-26-2005, FILED 6-24-2004.

Flocabulary

TEGMAX

THE MARK CONSISTS OF STANDARD CHARACTERS WITHOUT CLAIM TO ANY PARTICULAR FONT, STYLE, SIZE, OR COLOR.

FOR AUDIO SOUND RECORDINGS AND COMPUTER SOFTWARE BOTH CONTAINING EDUCATIONAL SONGS AND STUDY GUIDES FOR PREPARATION FOR THE SAT EXAMINATION (U.S. CLS. 21, 23, 26, 36 AND 38).

FIRST USE 12-4-2004; IN COMMERCE 4-11-2005.

THE MARK CONSISTS OF STANDARD CHARACTERS WITHOUT CLAIM TO ANY PARTICULAR FONT, STYLE, SIZE, OR COLOR.

FOR COMPUTERS AND DESKTOP COMPUTERS (U.S. CLS. 21, 23, 26, 36 AND 38).

FIRST USE 1-5-2005; IN COMMERCE 1-5-2005.

2,999,270. VELASTAR, LLC, ADDISON, TX. SN 78-434,572. PUB. 4-19-2005, FILED 6-14-2004.

2,999,275. MULTNOMAH PUBLISHERS, INC., SISTERS, OR. SN 78-975,815. PUB. 3-9-2004, FILED 7-29-2003.

VelaStar

THE DREAM GIVER

THE MARK CONSISTS OF STANDARD CHARACTERS WITHOUT CLAIM TO ANY PARTICULAR FONT, STYLE, SIZE, OR COLOR.

FOR COMPUTER SOFTWARE FOR THE MONITORING, RECORDING AND REPORTING OF DATA PERTAINING TO NETWORK CONNECTIVITY, COMPUTER SYSTEM AND NETWORK RESOURCES, AND FOR THE USER NOTIFICATION OF THE AVAILABILITY OF GENERAL AND USER SPECIFIC MESSAGING (U.S. CLS. 21, 23, 26, 36 AND 38).

FIRST USE 12-11-2003; IN COMMERCE 5-1-2004.

FOR PRERECORDED AUDIO TAPES AND COMPACT DISCS FEATURING DRAMATIC AND NON-DRAMATIC WORKS OF NON-FICTION; VIDEO RECORDINGS IN THE AREA OF SPIRITUAL ENLIGHTENMENT AND CHRISTIAN THEMES (U.S. CLS. 21, 23, 26, 36 AND 38).

FIRST USE 9-8-2003; IN COMMERCE 9-8-2003.

CLASS 9—(Continued).

2,999,281. MICROSOFT CORPORATION, REDMOND, WA. SN 78-976,277. PUB. 10-5-2004, FILED 11-25-2002.

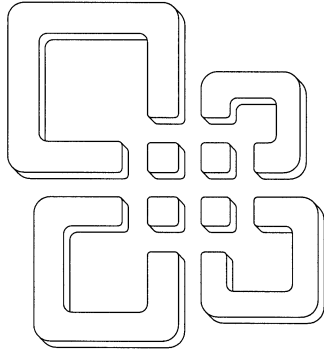

THE MARK CONSISTS OF FOUR SQUARE CROSS-SECTION SOLIDS EACH HAVING A GENERALLY SQUARE-SHAPED FRAME EXTENDING OUTWARDLY THEREFROM.

FOR COMPUTER SOFTWARE, NAMELY, COMPUTER SERVER SOFTWARE FOR USE IN REAL-TIME COMMUNICATIONS FEATURING INSTANT MESSAGING, AUDIO, VIDEO AND DATA EXCHANGE, WEB CONFERENCING AND DOCUMENT SHARING; COMPUTER UTILITY PROGRAMS; COMPUTER SOFTWARE DEVELOPMENT PROGRAMS; COMPUTER SECURITY AND AUTHENTICATION SOFTWARE FOR CONTROLLING ACCESS TO AND COMMUNICATIONS WITH COMPUTERS; APPLICATION AND BUSINESS SOFTWARE FOR USE IN WORD PROCESSING, SPREADSHEETS, DATABASE MANAGEMENT, DATA COLLECTION, DATA ANALYSIS, GRAPHICS, CAD/CAM FOR GENERAL USE, PRESENTATION GRAPHICS, EMAIL, CALENDAR, SCHEDULING, MANAGING MAILING ADDRESS, TELEPHONE, EMAIL ADDRESS AND OTHER CONTACT INFORMATION, MAPPING, GEOGRAPHICAL LOCATIONS, ACCOUNTING, CUSTOMER RELATIONSHIP MANAGEMENT, PROJECT MANAGEMENT, DESKTOP PUBLISHING, AND WEB PUBLISHING; COMPUTER SOFTWARE FOR MANIPULATING VIDEO, AUDIO AND GRAPHICS; COMPUTER GAME SOFTWARE; COMPUTER COMMUNICATIONS SOFTWARE FOR MANAGING THE EXCHANGE OF COMMUNICATIONS AND DATA AND INFORMATION OVER COMPUTER NETWORKS, WIRELESS NETWORKS, AND GLOBAL COMMUNICATIONS NETWORKS; COMPUTER COMMUNICATIONS SOFTWARE FOR USE IN ACCESSING WEBSITES AND EXCHANGING INFORMATION AND DATA AND OBTAINING SERVICES FROM WEBSITES, ALL IN THE FIELDS OF BUSINESS AND BUSINESS MANAGEMENT AND INFORMATION; COMPUTER SOFTWARE FOR USE IN DEVELOPING WEBSITES, OPERATING ELECTRONIC MAIL AND PROVIDING COMPUTER SECURITY; COMPUTER E-COMMERCE SOFTWARE TO ALLOW USERS TO PERFORM ELECTRONIC BUSINESS TRANSACTIONS VIA A GLOBAL COMPUTER NETWORK; COMPUTER SOFTWARE FOR NOTE-TAKING, NAMELY, COMPUTER SOFTWARE FOR RECORDING, ORGANIZING, EDITING AND TRANSMITTING INFORMATION IN TYPED, HANDWRITTEN AND VOICE FORMAT; COMPUTER COMMUNICATIONS SOFTWARE FOR ACCESSING WEB MESSAGING AND SHARED DOCUMENTS FROM WEBSITES ON THE INTERNET; AND HOUSE MARK FOR A FULL LINE OF BUSINESS SOFTWARE APPLICATIONS (U.S. CLS. 21, 23, 26, 36 AND 38).

FIRST USE 2-19-2003; IN COMMERCE 2-19-2003.

CLASS 10—MEDICAL APPARATUS**CLASS 10—(Continued).**

2,998,519. PROFILE RESPIRATORY SYSTEMS LIMITED, WEST SUSSEX, UNITED KINGDOM. SN 76-000,465. PUB. 4-23-2002, FILED 3-15-2000.

AAD

FOR SURGICAL, MEDICAL, DENTAL AND VETERINARY APPARATUS AND INSTRUMENTS, NAMELY, NEBULIZERS FOR MEDICAL PURPOSES; DRUG DELIVERY APPARATUS; AND PARTS AND FITTINGS FOR THE AFORESAID GOODS (U.S. CLS. 26, 39 AND 44).

FIRST USE 3-17-2004; IN COMMERCE 3-17-2004.

2,998,527. DORNIER MEDTECH AMERICA, INC., KENNESAW, GA. SN 76-118,611. PUB. 4-16-2002, FILED 8-28-2000.

EPOS SHOCK WAVE THERAPY

NO CLAIM IS MADE TO THE EXCLUSIVE RIGHT TO USE "SHOCK WAVE THERAPY", APART FROM THE MARK AS SHOWN.

FOR MEDICAL DEVICE FOR PERFORMING SHOCK-WAVE THERAPY FOR ORTHOPEDIC INDICATIONS (U.S. CLS. 26, 39 AND 44).

FIRST USE 5-4-2005; IN COMMERCE 5-4-2005.

2,998,529. REX MEDICAL, L.P., RADNOR, PA. SN 76-133,008. PUB. 2-12-2002, FILED 9-21-2000.

REX MEDICAL

NO CLAIM IS MADE TO THE EXCLUSIVE RIGHT TO USE "MEDICAL", APART FROM THE MARK AS SHOWN, FOR HOUSEMARK FOR SURGICAL DEVICES, NAMELY VASCULAR DEVICES AND MINIMALLY INVASIVE AND PERCUTANEOUS DEVICES (U.S. CLS. 26, 39 AND 44).

FIRST USE 11-3-2004; IN COMMERCE 11-3-2004.

2,998,543. ACORN CARDIOVASCULAR, INC., ST. PAUL, MN. SN 76-236,350. PUB. 3-5-2002, FILED 4-6-2001.

CORCAP

FOR MEDICAL TOOLS AND INSTRUMENTS FOR THE SURGICAL TREATMENT OF CONGESTIVE HEART FAILURE, NAMELY, JACKETS FOR PLACEMENT OVER THE HEART TO RESTRAIN DIASTOLIC EXPANSION OF THE HEART AND TOOLS AND INSTRUMENTS FOR USE IN PLACEMENT OF SUCH JACKETS (U.S. CLS. 26, 39 AND 44).

FIRST USE 6-16-2000; IN COMMERCE 6-16-2000.

CLASS 10—(Continued).

2,998,545. WILSON-COOK MEDICAL INC., WINSTON-SALEM, NC. SN 76-253,438. PUB. 9-25-2001, FILED 5-7-2001.

CONQUEST

FOR LITHOTRIPTORS (U.S. CLS. 26, 39 AND 44).
FIRST USE 6-20-2001; IN COMMERCE 6-20-2001.

2,998,640. COHN, SALOMON, SAN FRANCISCO, CA. SN 76-477,596. PUB. 4-19-2005, FILED 12-23-2002.

EAC 2 DUO TECH

FOR HAND HELD ELECTRONIC MEDICAL DEVICE FOR RADIATING HEAT IN ORDER TO NON-INVASIVELY RELIEVE PAIN AND PROMOTE HEALING (U.S. CLS. 26, 39 AND 44).
FIRST USE 1-3-2005; IN COMMERCE 1-3-2005.

2,998,722. ANTI SNOR PTY LTD., QUEENSLAND, 4217, AUSTRALIA. SN 76-539,006. PUB. 9-14-2004, FILED 8-19-2003.

ANTISNOR

NO CLAIM IS MADE TO THE EXCLUSIVE RIGHT TO USE ANTISNOR, APART FROM THE MARK AS SHOWN. THE STIPPLING IS FOR SHADING PURPOSES. FOR MEDICAL APPARATUS, NAMELY, THERAPEUTIC RINGS FOR HELPING THE RELIEF OF SNORING (U.S. CLS. 26, 39 AND 44).
FIRST USE 10-0-2002; IN COMMERCE 11-0-2004.

2,998,748. APPLIED SYSTEMS DEVELOPMENT CORPORATION, GAINESVILLE, GA. SN 76-558,176. PUB. 10-12-2004, FILED 10-22-2003.

ACOUSTIC EAR

FOR HEARING AIDS (U.S. CLS. 26, 39 AND 44).
FIRST USE 6-1-2004; IN COMMERCE 6-1-2004.

CLASS 10—(Continued).

2,998,755. CARDIAC PACEMAKERS, INC., ST. PAUL, MN. SN 76-562,194. PUB. 8-10-2004, FILED 11-10-2003.

RAPIDO ADVANCE

THE MARK CONSISTS OF STANDARD CHARACTERS WITHOUT CLAIM TO ANY PARTICULAR FONT, STYLE, SIZE, OR COLOR.

OWNER OF U.S. REG. NO. 2,743,651.
THE ENGLISH TRANSLATION OF THE WORD RAPIDO IN THE MARK IS RAPID.
FOR CARDIAC RHYTHM MANAGEMENT DEVICES, NAMELY CARDIAC LEADS AND ELECTRODES (U.S. CLS. 26, 39 AND 44).
FIRST USE 4-28-2004; IN COMMERCE 5-0-2004.

2,998,791. WINMARK CONCEPTS INC., WASHINGTON, DC. SN 76-576,591. PUB. 11-30-2004, FILED 2-20-2004.

E-MALE

THE MARK CONSISTS OF STANDARD CHARACTERS WITHOUT CLAIM TO ANY PARTICULAR FONT, STYLE, SIZE, OR COLOR.

OWNER OF U.S. REG. NOS. 2,007,197 AND 2,865,605.
FOR CONDOMS (U.S. CLS. 26, 39 AND 44).
FIRST USE 6-21-2005; IN COMMERCE 6-21-2005.

2,998,871. ZONARE MEDICAL SYSTEMS, INC., MOUNTAIN VIEW, CA. SN 78-161,936. PUB. 4-1-2003, FILED 9-9-2002.



FOR MEDICAL ULTRASOUND APPARATUS (U.S. CLS. 26, 39 AND 44).
FIRST USE 2-25-2005; IN COMMERCE 2-25-2005.

CLASS 10—(Continued).

2,998,897. ADVANCED BIONICS CORPORATION, SYLMAR, CA. SN 78-210,378. PUB. 7-20-2004, FILED 2-3-2003.

BION OPTIMUS

OWNER OF U.S. REG. NO. 2,455,608.
FOR MEDICAL APPARATUS COMPRISING HARDWARE AND SOFTWARE SYSTEMS USED TO PROGRAM AND MONITOR AN IMPLANTABLE MICROSTIMULATOR; NAMELY A HOUSING CONTAINING A PROCESSOR, MEMORY DISPLAY, TRANSCIEVER, I/O MEANS, ANTENNA AND POWER SOURCE; AND SOFTWARE FOR USING AND CONTROLLING THE SAME, ALL ADAPTED FOR USE WITH AN IMPLANTABLE MICROSTIMULATOR FOR THE PURPOSE OF STIMULATING NERVES, MUSCLES, AND NERVES AND MUSCLES (U.S. CLS. 26, 39 AND 44).
FIRST USE 4-24-2003; IN COMMERCE 4-24-2003.

2,998,903. SIMCRO TECH LIMITED, HAMILTON, NEW ZEALAND. SN 78-214,194. PUB. 9-7-2004, FILED 2-12-2003.

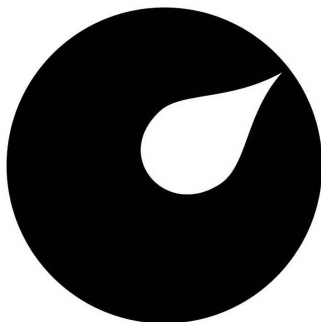

THE MARK CONSISTS OF A DROPLET SHAPE CONTAINED INSIDE A CIRCLE.

FOR ANIMAL HEALTH DELIVERY SYSTEMS FOR VETERINARY PURPOSES COMPRISING CONTAINMENT VESSELS, POUR-ON APPLICATORS, DRENCHERS AND INJECTORS FOR DISPENSING VETERINARY PREPARATIONS, AND DRAW-OFF AND DELIVERY DEVICES CONNECTING CONTAINMENT VESSELS TO THE POUR-ON APPLICATORS, DRENCHERS AND INJECTORS (U.S. CLS. 26, 39 AND 44).
FIRST USE 11-0-2002; IN COMMERCE 11-0-2002.

2,998,958. EDWARDS LIFESCIENCES CORPORATION, IRVINE, CA. SN 78-257,322. PUB. 2-3-2004, FILED 6-2-2003.

GEOFORM

FOR MEDICAL DEVICES, NAMELY ANNULOPLASTY RING (U.S. CLS. 26, 39 AND 44).
FIRST USE 3-1-2004; IN COMMERCE 3-1-2004.

CLASS 10—(Continued).

2,998,980. HAGELE, JAMES, NEVADA CITY, CA. SN 78-271,941. PUB. 5-11-2004, FILED 7-9-2003.

ACU-I-DROP

FOR EYE DROPPER BOTTLES FOR ADMINISTERING MEDICATION, SOLD EMPTY; AND TIPS FOR EYE DROPPER BOTTLES (U.S. CLS. 26, 39 AND 44).
FIRST USE 6-1-2005; IN COMMERCE 6-1-2005.

2,998,982. SILIPOS INC., NEW YORK, NY. SN 78-274,426. PUB. 4-6-2004, FILED 7-15-2003.

GELUSCIOUS

FOR MEDICAL PRODUCTS FOR SKIN CARE AND SCAR MANAGEMENT, NAMELY GLOVES, SOCKS, FINGER AND TOE CAPS LINED WITH A MINERAL OIL GEL FOR MOISTURIZING, TREATING AND PROVIDING COMFORT TO BURNT OR SCARED TISSUE (U.S. CLS. 26, 39 AND 44).
FIRST USE 10-23-2004; IN COMMERCE 10-23-2004.

2,999,069. ASTHMATX, INC., MOUNTAIN VIEW, CA. SN 78-325,822. PUB. 9-14-2004, FILED 11-10-2003.



THE MARK CONSISTS OF GEOMETRIC SLOPING BANDS IN THE SHAPE OF THE CAPITAL A.

FOR MEDICAL THERAPEUTIC DEVICES FOR USE IN THE TREATMENT OF PULMONARY DISEASES, NAMELY CATHETERS, PROBES, GENERATORS AND ELECTRODES (U.S. CLS. 26, 39 AND 44).
FIRST USE 1-31-2004; IN COMMERCE 1-31-2004.

CLASS 10—(Continued).

2,999,249. ESSENTIAL MEDICAL SUPPLY, INC., WINTER PARK, FL. SN 78-412,683. PUB. 2-22-2005, FILED 5-4-2004.

**EVERYDAY
ESSENTIALS**

THE MARK CONSISTS OF STANDARD CHARACTERS WITHOUT CLAIM TO ANY PARTICULAR FONT, STYLE, SIZE, OR COLOR.

FOR INVALID AND HANDICAPPED PRODUCTS, NAMELY, PILL SPLITTERS, PILL CRUSHERS AND LEG LIFTERS; METAL BASKETS ADAPTED FOR ATTACHMENT TO INVALID WALKERS; AND BELTS USED TO ASSIST AN INDIVIDUAL IN STANDING, SITTING AND WALKING, CONTAINING HAND GRIPS WHICH ALLOW ANOTHER INDIVIDUAL TO PROVIDE ASSISTANCE IN STANDING, SITTING AND WALKING (U.S. CLS. 26, 39 AND 44).
FIRST USE 10-17-2003; IN COMMERCE 10-17-2003.

2,999,262. USGI MEDICAL, INC., SAN CLEMENTE, CA. SN 78-426,002. PUB. 4-19-2005, FILED 5-27-2004.

SHAPELOCK

THE MARK CONSISTS OF STANDARD CHARACTERS WITHOUT CLAIM TO ANY PARTICULAR FONT, STYLE, SIZE, OR COLOR.

FOR MEDICAL DEVICES, NAMELY LAPROSCOPIC/ENDOSCOPIC DIAGNOSTIC AND SURGICAL INSTRUMENTS (U.S. CLS. 26, 39 AND 44).
FIRST USE 5-14-2004; IN COMMERCE 5-14-2004.

**CLASS 11—ENVIRONMENTAL CONTROL AP-
PARATUS**

CLASS 11—(Continued).

2,998,521. BRUNO SANTERRE, INC., QUEBEC, CANADA. SN 76-080,167. PUB. 2-26-2002, FILED 6-26-2000.

BEAU SOLEIL

FOR TANNING BEDS AND TANNING BOOTHS (U.S. CLS. 13, 21, 23, 31 AND 34).
FIRST USE 5-11-2005; IN COMMERCE 5-11-2005.

2,998,607. CALGON CARBON CORPORATION, PITTSBURGH, PA. SN 76-437,849. PUB. 5-27-2003, FILED 8-5-2002.

REVOLVER-Z

OWNER OF U.S. REG. NO. 2,084,717.
FOR CONTINUOUSLY ROTATABLE SUBSTRATE FORMED FROM A POROUS MATERIAL HAVING HIGH EFFICIENCY VOLATILE ORGANIC COMPOUND (VOC) REMOVAL THROUGH ADSORPTION (U.S. CLS. 13, 21, 23, 31 AND 34).
FIRST USE 1-28-2002; IN COMMERCE 1-28-2002.

2,998,721. MECO CORPORATION, GREENEVILLE, TN. SN 76-538,822. PUB. 9-14-2004, FILED 8-20-2003.

BONDI

FOR BARBECUE GRILLS (U.S. CLS. 13, 21, 23, 31 AND 34).
FIRST USE 5-15-2003; IN COMMERCE 3-15-2004.

2,998,740. SONAR AUTO PARTS CO., LTD., PANCHIAO, TAIPEI, TAIWAN. SN 76-551,550. PUB. 7-20-2004, FILED 10-16-2003.

YANGSON

FOR LAMP REFLECTORS; ELECTRIC LIGHT BULBS; FLUORESCENT ELECTRIC LIGHT BULBS; HALOGEN LIGHT BULBS; LIGHT PROJECTORS; LIGHT DIFFUSERS; LIGHT PANELS FOR AUTOMOBILES AND MOTORCYCLES; LIGHT REFLECTORS (U.S. CLS. 13, 21, 23, 31 AND 34).
FIRST USE 1-7-2005; IN COMMERCE 1-7-2005.

CLASS 11—(Continued).

2,998,769. POWERCOLD CORPORATION, LA VERNIA, TX. SN 76-566,065. PUB. 12-14-2004, FILED 12-12-2003.

PlexCoil

FOR PLASTIC FAN COIL THAT IS USED IN AIR CONDITIONING, HEATING, VENTILATING, AND REFRIGERATION SYSTEMS (U.S. CLS. 13, 21, 23, 31 AND 34).

FIRST USE 1-14-2005; IN COMMERCE 1-14-2005.

2,998,770. EBAC LIMITED, CO. DURHAM DL14 9AL, UNITED KINGDOM. SN 76-566,328. PUB. 10-12-2004, FILED 12-22-2003.

EASYLOADER

THE MARK CONSISTS OF STANDARD CHARACTERS WITHOUT CLAIM TO ANY PARTICULAR FONT, STYLE, SIZE, OR COLOR.

FOR BEVERAGE DISPENSERS, PARTICULARLY WATER COOLERS (U.S. CLS. 13, 21, 23, 31 AND 34).

FIRST USE 3-0-2003; IN COMMERCE 1-0-2005.

2,998,787. HAMILTON BEACH/PROCTOR-SILEX, INC., GLEN ALLEN, VA. SN 76-572,195. PUB. 1-11-2005, FILED 1-23-2004.

HAMILTON BEACH

THE MARK CONSISTS OF STANDARD CHARACTERS WITHOUT CLAIM TO ANY PARTICULAR FONT, STYLE, SIZE, OR COLOR.

OWNER OF U.S. REG. NOS. 259,231, 943,562, AND OTHERS.

FOR DRINKING WATER DISPENSERS, NAMELY, HOT AND COLD WATER DISPENSERS (U.S. CLS. 13, 21, 23, 31 AND 34).

FIRST USE 12-29-2003; IN COMMERCE 12-29-2003.

CLASS 11—(Continued).

2,998,802. NAN SHAN INTERNATIONAL CO., LTD., TAIPEI, TAIWAN. SN 76-580,300. PUB. 1-18-2005, FILED 3-11-2004.

TROPICAL GRILL

THE MARK CONSISTS OF STANDARD CHARACTERS WITHOUT CLAIM TO ANY PARTICULAR FONT, STYLE, SIZE, OR COLOR.

NO CLAIM IS MADE TO THE EXCLUSIVE RIGHT TO USE GRILL, APART FROM THE MARK AS SHOWN.

FOR FIREPLACES, BARBECUE GRILLS, CHARCOAL GRILLS, ELECTRIC GRILLS, ELECTRIC OUTDOOR GRILLS, GAS GRILLS, LAVA ROCK FOR USE IN BARBECUE GRILLS, HEAT GUNS (U.S. CLS. 13, 21, 23, 31 AND 34).

FIRST USE 2-0-2004; IN COMMERCE 2-0-2004.

2,998,827. EXHART ENVIRONMENTAL SYSTEMS, INC., CHATSWORTH, CA. SN 76-591,143. PUB. 2-22-2005, FILED 5-10-2004.

BLOOM-LITES

THE MARK CONSISTS OF STANDARD CHARACTERS WITHOUT CLAIM TO ANY PARTICULAR FONT, STYLE, SIZE, OR COLOR.

FOR GARDEN NOVELTY LIGHTS (U.S. CLS. 13, 21, 23, 31 AND 34).

FIRST USE 6-10-2004; IN COMMERCE 6-10-2004.

2,998,873. SUPER RADIATOR COILS LIMITED PARTNERSHIP, CHASKA, MN. SN 78-169,805. PUB. 8-19-2003, FILED 10-1-2002.

XFIN

FOR AIR COOLING WATER COILS FOR HEAT TRANSFER BETWEEN CIRCULATING WATER AND AIR, FOR USE AS CONDENSERS, EVAPORATORS, OR HEATING COILS; HEATING, VENTILATING, AND AIR CONDITIONING COMPONENTS, NAMELY, CONDENSER COILS, WATER COILS, STEAM COILS, AND EVAPORATOR COILS (U.S. CLS. 13, 21, 23, 31 AND 34).

FIRST USE 3-0-2003; IN COMMERCE 3-0-2003.

CLASS 11—(Continued).

2,998,901. ZURN INDUSTRIES, INC., ERIE, PA. SN 78-212,095. PUB. 10-14-2003, FILED 2-7-2003.

EZ-SET

FOR HARDWARE ASSOCIATED WITH TOILETS, NAMELY, A METAL STATIONARY CARRIER FOR SUPPORTING A TOILET (U.S. CLS. 13, 21, 23, 31 AND 34).

FIRST USE 2-1-2005; IN COMMERCE 2-1-2005.

2,998,924. TURBO POWER, INC., FLUSHING, NY. SN 78-227,642. PUB. 12-2-2003, FILED 3-19-2003.

MEGA POWER

OWNER OF U.S. REG. NO. 2,487,842.
NO CLAIM IS MADE TO THE EXCLUSIVE RIGHT TO USE "POWER", APART FROM THE MARK AS SHOWN.
FOR ELECTRIC HAND-HELD HAIR DRYERS (U.S. CLS. 13, 21, 23, 31 AND 34).

FIRST USE 7-1-2005; IN COMMERCE 7-1-2005.

2,998,930. THE YANKEE CANDLE COMPANY, INC., SOUTH DEERFIELD, MA. SN 78-231,494. PUB. 1-20-2004, FILED 3-28-2003.

YANKEE CANDLE

NO CLAIM IS MADE TO THE EXCLUSIVE RIGHT TO USE "CANDLE", APART FROM THE MARK AS SHOWN.

FOR ELECTRIC FRAGRANCE DISPENSERS, CANDLE LANTERNS, CERAMIC FRAGRANT WAX WARMERS, CERAMIC AND METAL FRAGRANT WAX WARMERS AND ELECTRIC FRAGRANT WAX WARMERS (U.S. CLS. 13, 21, 23, 31 AND 34).

FIRST USE 6-0-1989; IN COMMERCE 6-0-1989.

2,998,964. AQUAPAC INTERNATIONAL LIMITED, LONDON, UNITED KINGDOM. SN 78-259,517. PUB. 8-31-2004, FILED 6-6-2003.

FLASHPAC

FOR FLASHLIGHTS AND HAND HELD TORCHES FOR ILLUMINATION; FLASHLIGHTS AND HAND HELD TORCHES FOR ILLUMINATION ENCASED IN INFLATABLE, WATERPROOF PLASTIC ALLOWING THE FLASHLIGHTS AND HAND HELD TORCHES FOR ILLUMINATION TO FLOAT ON WATER (U.S. CLS. 13, 21, 23, 31 AND 34).

FIRST USE 7-9-2003; IN COMMERCE 12-23-2003.

CLASS 11—(Continued).

2,999,025. THOMPSON, JAMES L., ST. THOMAS, US VIRGIN ISLANDS. AND LOCKER, MATTHEW, WANAQUE, NJ. SN 78-293,616. PUB. 7-27-2004, FILED 8-28-2003.



FOR SPECIALIZED FLUORESCENT AND OTHER LAMPS (U.S. CLS. 13, 21, 23, 31 AND 34).

FIRST USE 6-10-2004; IN COMMERCE 11-16-2004.

2,999,033. CLIMATE TECHNOLOGIES PTY LTD, SOUTH AUSTRALIA, AUSTRALIA. SN 78-295,592. PUB. 9-21-2004, FILED 9-3-2003.

PROFILE

FOR EVAPORATIVE AIR CONDITIONERS (U.S. CLS. 13, 21, 23, 31 AND 34).

FIRST USE 12-31-1983; IN COMMERCE 1-31-2000.

2,999,059. THE GREAT AMERICAN WATERFALL COMPANY, SPRING HILL, FL. SN 78-316,386. PUB. 9-21-2004, FILED 10-21-2003.

AQUA SHEER

NO CLAIM IS MADE TO THE EXCLUSIVE RIGHT TO USE "SHEER", APART FROM THE MARK AS SHOWN.

FOR WATERFALLS FOR POOLS, SPAS AND FOUNTAINS FOR RESIDENTIAL, COMMERCIAL AND EXHIBITION INDUSTRIES (U.S. CLS. 13, 21, 23, 31 AND 34).

FIRST USE 9-16-2003; IN COMMERCE 9-16-2003.

CLASS 11—(Continued).

2,999,161. CHRIS MADDEN INC., PORT CHESTER, NY. SN 78-363,642. PUB. 11-9-2004, FILED 2-6-2004.

CHRIS MADDEN

THE MARK CONSISTS OF STANDARD CHARACTERS WITHOUT CLAIM TO ANY PARTICULAR FONT, STYLE, SIZE, OR COLOR.

THE NAME SHOWN IN THE MARK IDENTIFIES CHRIS MADDEN, A LIVING INDIVIDUAL WHOSE CONSENT IS OF RECORD.

FOR LAMPS, ELECTRIC LIGHT FIXTURES (U.S. CLS. 13, 21, 23, 31 AND 34).

FIRST USE 5-0-2004; IN COMMERCE 5-0-2004.

CLASS 12—(Continued).

2,998,591. HAENIMTOYS. CO., LTD., BUSAN, REPUBLIC OF KOREA. SN 76-414,874. PUB. 2-17-2004, FILED 5-30-2002.



NO CLAIM IS MADE TO THE EXCLUSIVE RIGHT TO USE "TOYS", APART FROM THE MARK AS SHOWN.

FOR CHILDREN'S CAR SEATS; VEHICLE SEAT COVERS; SEAT COVERS FOR BABY CARRIAGES AND STROLLERS; BICYCLES; BICYCLES FRAMES; RIMS FOR BICYCLE WHEELS (U.S. CLS. 19, 21, 23, 31, 35 AND 44).

FIRST USE 11-15-1997; IN COMMERCE 11-15-1997.

2,999,236. SIGMA ELECTRIC MANUFACTURING CORPORATION, GARNER, NC. SN 78-401,888. PUB. 1-18-2005, FILED 4-14-2004.

SPIKE-A-LITE

THE MARK CONSISTS OF STANDARD CHARACTERS WITHOUT CLAIM TO ANY PARTICULAR FONT, STYLE, SIZE, OR COLOR.

FOR ELECTRIC LIGHTING FIXTURES (U.S. CLS. 13, 21, 23, 31 AND 34).

FIRST USE 9-7-2004; IN COMMERCE 9-7-2004.

2,998,736. EAZ-LIFT SPRING CORPORATION, SUN VALLEY, CA. SN 76-547,156. PUB. 11-16-2004, FILED 9-26-2003.



OWNER OF U.S. REG. NO. 1,484,198.

FOR HITCHES, SWAY CONTROLS AND HITCH BALLS FOR USE WITH TRAILERS, AND TOW BARS FOR TOWING VEHICLES (U.S. CLS. 19, 21, 23, 31, 35 AND 44).

FIRST USE 4-1-2004; IN COMMERCE 4-1-2004.

CLASS 12—VEHICLES

2,998,561. HANKOOK TIRE CO., LTD., SEOUL, REPUBLIC OF KOREA. SN 76-334,344. PUB. 7-23-2002, FILED 11-6-2001.

DYNASPORT

FOR TIRES, TIRE INNER TUBES FOR VEHICLES, EXCLUDING MOTORCYCLE TIRES AND MOTORCYCLE TIRE INNER TUBES (U.S. CLS. 19, 21, 23, 31, 35 AND 44).

FIRST USE 3-25-2005; IN COMMERCE 3-25-2005.

2,998,737. LENCO INDUSTRIES, INC., PITTSFIELD, MA. SN 76-548,478. PUB. 6-29-2004, FILED 10-2-2003.

LENCO PROCAT

OWNER OF U.S. REG. NOS. 2,480,906 AND 2,694,035. FOR ARMORED TRUCKS FOR PERSONAL PROTECTION AND FOR POLICE RESPONSE AND RESCUE TEAMS (U.S. CLS. 19, 21, 23, 31, 35 AND 44).

FIRST USE 11-24-2003; IN COMMERCE 11-24-2003.

CLASS 12—(Continued).

2,998,807. WINNEBAGO INDUSTRIES, INC., FOREST CITY, IA. SN 76-582,048. PUB. 3-15-2005, FILED 3-18-2004.

NAVION

THE MARK CONSISTS OF STANDARD CHARACTERS WITHOUT CLAIM TO ANY PARTICULAR FONT, STYLE, SIZE, OR COLOR.

FOR MOTOR HOMES (U.S. CLS. 19, 21, 23, 31, 35 AND 44).

FIRST USE 6-16-2005; IN COMMERCE 6-16-2005.

2,998,848. FORD MOTOR COMPANY, DEARBORN, MI. SN 78-105,131. PUB. 9-17-2002, FILED 1-28-2002.

FORD GT

OWNER OF U.S. REG. NOS. 115,500, 119,956, AND 232,051. NO CLAIM IS MADE TO THE EXCLUSIVE RIGHT TO USE "GT", APART FROM THE MARK AS SHOWN.

FOR MOTOR VEHICLES, NAMELY, AUTOMOBILES, AND THEIR STRUCTURAL PARTS AND ENGINES (U.S. CLS. 19, 21, 23, 31, 35 AND 44).

FIRST USE 1-2-2004; IN COMMERCE 1-2-2004.

2,998,851. MCMAHAN, JEFFERY A., PIQUA, OH. SN 78-125,950. PUB. 6-3-2003, FILED 5-3-2002.

ECOSEAT

FOR BICYCLE SADDLE (U.S. CLS. 19, 21, 23, 31, 35 AND 44).

FIRST USE 6-3-2003; IN COMMERCE 6-3-2003.

2,998,892. RUBBERMAID COMMERCIAL PRODUCTS LLC, FREEPORT, IL. SN 78-199,692. PUB. 10-7-2003, FILED 1-3-2003.

MEDIAMASTER

FOR NON-MOTORIZED CARTS, NAMELY, UTILITY CARTS, STORAGE CARTS, FOOD AND BEVERAGE CARTS, APPLIANCE CARTS, COOKING CARTS, AUDIO VISUAL CARTS, TELEVISION CARTS, MULTIMEDIA CARTS (U.S. CLS. 19, 21, 23, 31, 35 AND 44).

FIRST USE 1-1-2003; IN COMMERCE 1-1-2003.

CLASS 12—(Continued).

2,999,061. ROSCO INC., JAMAICA, NY. SN 78-320,070. PUB. 7-20-2004, FILED 10-29-2003.

DUO STYLE

FOR TRUCK AND BUS SIDE VIEW MIRRORS (U.S. CLS. 19, 21, 23, 31, 35 AND 44).

FIRST USE 3-1-2004; IN COMMERCE 3-1-2004.

2,999,062. ROSCO INC., JAMAICA, NY. SN 78-320,071. PUB. 7-20-2004, FILED 10-29-2003.

ACCU STYLE

FOR TRUCK AND BUS SIDE VIEW MIRRORS (U.S. CLS. 19, 21, 23, 31, 35 AND 44).

FIRST USE 3-1-2004; IN COMMERCE 3-1-2004.

2,999,076. SEVEN SEAS, INC., WINSTON-SALEM, NC. SN 78-327,910. PUB. 8-3-2004, FILED 11-14-2003.



CLASS 12—(Continued).

2,999,082. DAIMLERCHRYSLER CORPORATION, AUBURN HILLS, MI. SN 78-332,272. PUB. 10-5-2004, FILED 11-24-2003.



OWNER OF U.S. REG. NO. 1,762,717.
 THE MARK CONSISTS OF A RAM'S HEAD WITHIN A SHIELD.
 FOR AUTOMOBILES, TRUCKS, SPORT UTILITY VEHICLES, VANS AND MINIVANS, AND STRUCTURAL PARTS AND ENGINES THEREFOR (U.S. CLS. 19, 21, 23, 31, 35 AND 44).
 FIRST USE 7-12-2004, THE MARK WAS FIRST USED ANYWHERE IN A DIFFERENT FORM OTHER THAN THAT SOUGHT TO BE REGISTERED ON 09/00/1988.; IN COMMERCE 7-12-2004, THE MARK WAS FIRST USED IN COMMERCE IN A DIFFERENT FORM OTHER THAN THAT SOUGHT TO BE REGISTERED ON 09/00/1988..

2,999,104. NO FEAR, INC., CARLSBAD, CA. SN 78-341,689. PUB. 3-29-2005, FILED 12-16-2003.

NF-155

THE MARK CONSISTS OF STANDARD CHARACTERS WITHOUT CLAIM TO ANY PARTICULAR FONT, STYLE, SIZE, OR COLOR.
 FOR AUTOMOBILES AND TRUCKS; AUTOMOBILE AND TRUCK BODIES; AUTOMOBILE AND TRUCK SPARE STRUCTURAL AND BODY PARTS (U.S. CLS. 19, 21, 23, 31, 35 AND 44).
 FIRST USE 12-1-2002; IN COMMERCE 2-1-2003.

CLASS 12—(Continued).

2,999,124. HANKOOK TIRE CO., LTD., SEOUL, REPUBLIC OF KOREA. SN 78-349,513. PUB. 11-23-2004, FILED 1-8-2004.



OWNER OF U.S. REG. NOS. 1,122,303 AND 2,635,778.
 THE COLOR(S) RED, BLACK AND WHITE IS/ARE CLAIMED AS A FEATURE OF THE MARK.
 THE MARK CONSISTS OF A STYLIZED REPRESENTATION OF A BIRD WING OR AN AIRPLANE IN RED, TO THE RIGHT OF WHICH IS THE WORD HANKOOK IN STYLIZED LETTERS ALL SUPERIMPOSED WITHIN A BLACK RECTANGLE.
 FOR TIRES AND TIRE INNER TUBES FOR VEHICLES (U.S. CLS. 19, 21, 23, 31, 35 AND 44).
 FIRST USE 3-1-2004; IN COMMERCE 3-1-2004.

CLASS 14—JEWELRY

2,998,569. EQUITY INDUSTRIES CORP., VIRGINIA BEACH, VA. SN 76-371,094. PUB. 9-28-2004, FILED 2-14-2002.



NO CLAIM IS MADE TO THE EXCLUSIVE RIGHT TO USE "NIGHT VISION TECHNOLOGY", APART FROM THE MARK AS SHOWN.
 FOR CLOCKS (U.S. CLS. 2, 27, 28 AND 50).
 FIRST USE 4-18-2003; IN COMMERCE 4-18-2003.

CLASS 14—(Continued).

2,998,635. DEPARTMENT OF THE ARMY, ARLINGTON, VA. SN 76-472,304. PUB. 3-30-2004, FILED 11-20-2002.



OWNER OF U.S. REG. NOS. 2,866,064 AND 2,882,582. FOR COMMEMORATIVE AND NON-MONETARY COINS AND MEDALLIONS; ORNAMENTAL PINS; LAPEL PINS; MEDALS; CHRONOMETRIC INSTRUMENTS, NAMELY, WATCHES AND CLOCKS (U.S. CLS. 2, 27, 28 AND 50).
FIRST USE 11-0-2003; IN COMMERCE 11-0-2003.

2,998,648. WAL-MART STORES, INC., BENTONVILLE, AR. SN 76-482,906. PUB. 9-23-2003, FILED 1-16-2003.

PURITAN

THE MARK CONSISTS OF THE WORD "PURITAN" FOR WATCHES (U.S. CLS. 2, 27, 28 AND 50).
FIRST USE 11-26-2004; IN COMMERCE 11-26-2004.

2,998,665. HEARTS ON FIRE COMPANY, LLC, BOSTON, MA. SN 76-501,980. PUB. 10-21-2003, FILED 3-27-2003.

HOW MEMORIES ARE HELD

THE MARK CONSISTS OF STANDARD CHARACTERS WITHOUT CLAIM TO ANY PARTICULAR FONT, STYLE, SIZE, OR COLOR.
FOR JEWELRY (U.S. CLS. 2, 27, 28 AND 50).
FIRST USE 1-1-2005; IN COMMERCE 1-1-2005.

2,998,670. FREDERICK GOLDMAN, INC., NEW YORK, NY. SN 76-508,283. PUB. 1-6-2004, FILED 4-10-2003.

ERGOFIT

FOR MEN'S AND LADIES' RINGS (U.S. CLS. 2, 27, 28 AND 50).
FIRST USE 2-27-2004; IN COMMERCE 2-27-2004.

CLASS 14—(Continued).

2,998,695. CAROLINA HERRERA, LTD., NEW YORK, NY. SN 76-528,472. PUB. 4-13-2004, FILED 7-9-2003.

CH
CAROLINA HERRERA

THE NAME CAROLINA HERRERA IDENTIFIES A LIVING INDIVIDUAL WHOSE CONSENT IS OF RECORD. FOR JEWELRY, NAMELY, RINGS, NECKLACES, BRACELETS AND PINS (U.S. CLS. 2, 27, 28 AND 50).
FIRST USE 3-31-2001; IN COMMERCE 10-14-2002.

2,998,725. PICK UP STICKS JEWELRY COMPANY, LLC, CLOVIS, NM. SN 76-541,869. PUB. 5-25-2004, FILED 9-2-2003.

PICK UP STICKS JEWELRY COMPANY, LLC

NO CLAIM IS MADE TO THE EXCLUSIVE RIGHT TO USE "JEWELRY COMPANY, LLC", APART FROM THE MARK AS SHOWN.

FOR JEWELRY, NAMELY, HEAVY CHAIN BRACELETS; FINE CHAIN- NECKLACES AND BRACELETS; BALL CHAIN- NECKLACES; SEMI-PRECIOUS STRAND BRACELETS AND NECKLACES; LEATHER NECKLACES; VINTAGE PHOTO CHARMS; CUSTOM PHOTO CHARMS, CUSTOM RELIC CHARMS; VINTAGE PHOTO EARRINGS; WORD CHARMS; ALPHABET TILES BEING JEWELRY; CHINA SHARDS AND BACKSTAMPS BEING JEWELRY; DOMINOES BEING JEWELRY; PRECIOUS STONES USED AS BUTTONS, NAMELY, MOTHER OF PEARL BUTTONS; SEMI-PRECIOUS DROPS BEING JEWELRY; LARGE TURQUOISE DROPS BEING JEWELRY; STERLING SILVER CHARMS; FLEUR DE LIS CHARM PINS IN THE NATURE OF BROOCHES (U.S. CLS. 2, 27, 28 AND 50).
FIRST USE 5-20-2004; IN COMMERCE 5-20-2004.

2,998,779. JOSEPH, TERESA, BROOKLYN, NY. SN 76-570,116. PUB. 3-1-2005, FILED 1-14-2004.

LONG MEADOW

THE MARK CONSISTS OF STANDARD CHARACTERS WITHOUT CLAIM TO ANY PARTICULAR FONT, STYLE, SIZE, OR COLOR.

FOR JEWELRY, NAMELY NECKLACES, PENDANTS, CHAINS, BRACELETS, ANKLE BRACELETS, CHARMS, EARRINGS, PINS, ORNAMENTAL PINS, BROOCHES, RINGS AND CUFFLINKS (U.S. CLS. 2, 27, 28 AND 50).
FIRST USE 6-21-2003; IN COMMERCE 6-21-2003.

CLASS 14—(Continued).

2,998,976. CBS BROADCASTING INC., NEW YORK, NY. SN 78-269,716. PUB. 9-21-2004, FILED 7-2-2003.

CLASS 14—(Continued).

2,999,110. WESTMORELAND, PAUL T., TUJUNGA, CA. SN 78-343,921. PUB. 1-18-2005, FILED 12-20-2003.



OWNER OF U.S. REG. NO. 1,715,262.
FOR JEWELRY, NAMELY CHARMS, BRACELETS;
WATCHES (U.S. CLS. 2, 27, 28 AND 50).
FIRST USE 7-9-2003; IN COMMERCE 7-9-2003.

Silveralder

THE MARK CONSISTS OF STANDARD CHARACTERS
WITHOUT CLAIM TO ANY PARTICULAR FONT, STYLE,
SIZE, OR COLOR.
FOR SILVER AND GOLD JEWELRY INCLUDING
SILVER AND GOLD PLATED JEWELRY (U.S. CLS. 2,
27, 28 AND 50).
FIRST USE 5-29-2004; IN COMMERCE 3-9-2005.

2,999,072. HEARTS ON FIRE COMPANY, BOSTON, MA. SN 78-326,820. PUB. 8-10-2004, FILED 11-12-2003.

2,999,169. HEARTS ON FIRE COMPANY, BOSTON, MA. SN 78-364,720. PUB. 11-9-2004, FILED 2-9-2004.

FIREBURST

SENSATION

THE MARK CONSISTS OF STANDARD CHARACTERS
WITHOUT CLAIM TO ANY PARTICULAR FONT, STYLE,
SIZE, OR COLOR.
FOR GEMSTONES, NAMELY CUT DIAMONDS, AND
JEWELRY CONTAINING CUT DIAMONDS (U.S. CLS. 2,
27, 28 AND 50).
FIRST USE 1-1-2005; IN COMMERCE 1-1-2005.

THE MARK CONSISTS OF STANDARD CHARACTERS
WITHOUT CLAIM TO ANY PARTICULAR FONT, STYLE,
SIZE, OR COLOR.
FOR JEWELRY (U.S. CLS. 2, 27, 28 AND 50).
FIRST USE 6-1-2004; IN COMMERCE 9-1-2004.

CLASS 15—MUSICAL INSTRUMENTS

CLASS 15—(Continued).

2,998,814. MIDI MUSIC CENTER, INC., DBA LOWREY ORGAN COMPANY, LAGRANGE PARK, IL. SN 76-585,048. PUB. 2-1-2005, FILED 4-5-2004.

ODYSSEY

THE MARK CONSISTS OF STANDARD CHARACTERS WITHOUT CLAIM TO ANY PARTICULAR FONT, STYLE, SIZE, OR COLOR.

FOR ELECTRIC ORGANS AND COMPONENT PARTS THEREFOR (U.S. CLS. 2, 21 AND 36).

FIRST USE 1-0-2004; IN COMMERCE 6-0-2004.

2,999,044. AVEDIS ZILDJIAN CO., NORWELL, MA. SN 78-303,506. PUB. 3-8-2005, FILED 9-22-2003.

MASTERSOUND ANTI-LOCK SERIES

NO CLAIM IS MADE TO THE EXCLUSIVE RIGHT TO USE "SERIES", APART FROM THE MARK AS SHOWN.

FOR MUSICAL PERCUSSION INSTRUMENTS, NAMELY, CYMBALS (U.S. CLS. 2, 21 AND 36).

FIRST USE 1-21-2004; IN COMMERCE 1-21-2004.

2,999,200. CHERUB TECHNOLOGY CO., LTD., SHENZHEN, CHINA. SN 78-381,374. PUB. 12-21-2004, FILED 3-10-2004.



THE MARK CONSISTS OF THE WORD "CHERUB" AND AN ANGEL DEVICE HOLDING A DEVICE OF A MUSICAL NOTE.

FOR MUSICAL INSTRUMENTS IN GENERAL; ELECTRONIC MUSICAL INSTRUMENTS IN GENERAL; DRUMS; PERCUSSION INSTRUMENTS IN GENERAL; KETTLEDRUMS; MUSIC PITCH PIPES; SHEET MUSIC STANDS; TUNERS FOR MUSICAL INSTRUMENTS; ELECTRONIC PIANOS (U.S. CLS. 2, 21 AND 36).

FIRST USE 1-5-1998; IN COMMERCE 12-1-1999.

CLASS 16—PAPER GOODS AND PRINTED MATTER**CLASS 16—(Continued).**

2,998,523. WOLFF OLINS LIMITED, LONDON, N1 9RL, UNITED KINGDOM. SN 76-098,829. PUB. 8-20-2002, FILED 7-27-2000.

WOLFF OLINS

FOR PRINTED MATTER, NAMELY, BOOKS, MANUALS, MAGAZINES, JOURNALS, NEWSLETTERS, BROCHURES, AND POSTERS IN THE FIELD OF MARKET RESEARCH, BUSINESS MANAGEMENT, BRAND MANAGEMENT, ADVERTISING AND PUBLIC RELATIONS; PRINTED INSTRUCTIONAL AND TEACHING MATERIAL IN THE FIELD OF MARKET RESEARCH, BUSINESS MANAGEMENT, BRAND MANAGEMENT, ADVERTISING AND PUBLIC RELATIONS; PRINTS; POSTCARDS; GREETING CARDS; NOTE PADS; PRINTED LABELS; STATIONERY; ENVELOPES; BINDERS AND FOLDERS; PHOTOGRAPHS AND PHOTOGRAPH ALBUMS; DIARIES; AND BOOKMARKS (U.S. CLS. 2, 5, 22, 23, 29, 37, 38 AND 50).

FIRST USE 11-1-1998; IN COMMERCE 11-1-1998.

2,998,548. CARACAS PAPER COMPANY, S.A., MARACAY, EDO. ARAGUA, VENEZUELA. SN 76-271,712. PUB. 9-17-2002, FILED 6-14-2001.

CARIBE

FOR BINDERS, LOOSELEAF BINDERS, MECHANICAL BINDER SETS COMPRISED OF RINGS, FASTENERS, DIVIDERS, FOLDERS; STATIONERY TYPE PORTFOLIOS, PROTECTIVE COVERS FOR SHEETS OR PAPER AND PAGES OF BOOKS AND THE LIKE; NOTEBOOK DIVIDERS, INDEX BOOKS, INDEX CARDS, INDEX DIVIDERS, STATIONERY TYPE PORTFOLIOS INCORPORATING WRITING PADS, CARRYING CASES MADE OF PAPER, STATIONERY TYPE PORTFOLIO CASES, CARD FILES, DESK FILE TRAYS, DESK TOP REVOLVING ROTARY CARD FILES, DOCUMENT FILE RACKS, FILE TRAYS, DOCUMENTS FILES, FILE BOXES FOR STORAGE OF BUSINESS AND PERSONAL RECORDS, FILE CARDS, FILE FOLDERS, FILE POCKETS FOR STATIONERY USE, FILE SORTERS, FILLER PAPER, LETTER FILES, PAPER EXPANDING FILES, PAPER FILE JACKETS, FOLDERS, HANGING FILE FOLDER RACKS, HANGING FOLDERS, ENVELOPES, KRAFT PAPER, CARDBOARD MAILING TUBES, PAPER MAIL POUCHES, NOTE BOOKS, WRITING PADS, SKETCH PADS, ART PADS, CALENDAR DESK PADS, DESK PADS, DRAWING PADS, LEGAL PADS, NOTE PADS, COMPOSITION BOOKS, WRITING TABLETS, MEMO PADS, MEMORANDUM BOOKS, SELF-STICK NOTE PADS, STENOGRAPHERS' NOTE BOOKS, BLANK THEME BOOKS, STENOGRAPHERS' NOTE PADS, BOND PAPER, COMPUTER PAPER, CONSTRUCTION PAPER, COPY PAPER, GRAPH PAPER, PRINTING

CLASS 16—(Continued).

PAPER, MEMO PAPER, POSTER BOARD, TYPING PAPER; SCHOOL AND OFFICE SUPPLIES, NAMELY, STAPLERS, STAPLES, THUMBSTACKS, PAPER FASTENERS, PAPERCLIPS, CORRECTING FLUID FOR TYPE, PAPER PUNCHES, DRAWING RULERS, RUBBER BANDS; BOOK COVERS, CRAYONS, BOOKMARKS, STATIONERY, STATIONERY BOXES, STATIONERY WRITING PAPER AND ENVELOPES, ADHESIVE FLAGS AND TAGS FOR MARKING PAGES, BLANK AND PRINTED LABELS NOT OF TEXTILE, ADHESIVES AND ADHESIVE TAPES FOR STATIONERY AND HOUSEHOLD USE, GLUE STICKS FOR STATIONERY AND HOUSEHOLD USE, ERASERS, PENS, PENCILS, MARKERS, HIGHLIGHTING MARKERS AND PENS; CARDBOARD, CARDBOARD BOXES AND CARDBOARD CONTAINERS; PHOTOGRAPHS, PAINT BRUSHES, ELECTRIC AND NON-ELECTRIC TYPEWRITERS, PLASTIC BUBBLE PACKS FOR PACKAGING, PLASTIC BAGS FOR MERCHANDISE PACKAGING; PLAYING CARDS, PRINTING TYPE, AND PRINTING BLOCKS (U.S. CLS. 2, 5, 22, 23, 29, 37, 38 AND 50).

FIRST USE 12-0-2003; IN COMMERCE 12-0-2003.

2,998,576. HANNA-BARBERA PRODUCTIONS, INC., SHERMAN OAKS, CA. SN 76-387,887. PUB. 10-29-2002, FILED 3-26-2002.

WHAT'S NEW SCOOBY-DOO

FOR PRINTED MATTER AND PAPER GOODS—NAMELY, BOOKS FEATURING CHARACTERS FROM ANIMATED, ACTION ADVENTURE, COMEDY AND/OR DRAMA FEATURES, COMIC BOOKS, CHILDREN'S BOOKS, MAGAZINES FEATURING CHARACTERS FROM ANIMATED, ACTION ADVENTURE, COMEDY AND/OR DRAMA FEATURES, COLORING BOOKS, CHILDREN'S ACTIVITY BOOKS; STATIONERY, WRITING PAPER, ENVELOPES, NOTEBOOKS, DIARIES, NOTE CARDS, GREETING CARDS, TRADING CARDS; LITHOGRAPHS; PENS, PENCILS, CASES THEREFOR, ERASERS, CRAYONS, MARKERS, COLORED PENCILS, PAINTING SETS, CHALK AND CHALKBOARDS; DECALS, HEAT TRANSFERS; POSTERS; MOUNTED AND/OR UNMOUNTED PHOTOGRAPHS; BOOK COVERS, BOOK MARKS, CALENDARS, GIFT WRAPPING PAPER; PAPER PARTY FAVORS AND PAPER PARTY DECORATIONS—NAMELY, PAPER NAPKINS, PAPER DOILIES, PAPER PLACE MATS, CREPE PAPER, PAPER HATS, INVITATIONS, PAPER TABLE CLOTHS, PAPER CAKE DECORATIONS; PRINTED TRANSFERS FOR EMBROIDERY OR FABRIC APPLIQUES; PRINTED PATTERNS FOR COSTUMES, PAJAMAS, SWEATSHIRTS AND T-SHIRTS (U.S. CLS. 2, 5, 22, 23, 29, 37, 38 AND 50).

FIRST USE 9-0-2003; IN COMMERCE 9-0-2003.

2,998,628. NOTHING TO IT!!!, RENO, NV. SN 76-467,533. PUB. 4-5-2005, FILED 11-18-2002.

KITCHEN COACH

FOR BOOKS, NAMELY, A SERIES OF NON-FICTION BOOKS HAVING TO DO WITH COOKING (U.S. CLS. 2, 5, 22, 23, 29, 37, 38 AND 50).

FIRST USE 7-1-2004; IN COMMERCE 7-1-2004.

CLASS 16—(Continued).

2,998,629. FTLC-LLC, PERU, IN. SN 76-467,916. PUB. 3-29-2005, FILED 11-19-2002.

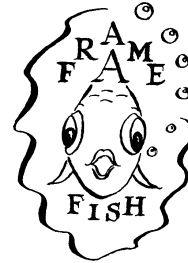
**Frame A Fish**

NO CLAIM IS MADE TO THE EXCLUSIVE RIGHT TO USE FISH, APART FROM THE MARK AS SHOWN.

FOR WALL MOUNTED AQUARIUM (U.S. CLS. 2, 5, 22, 23, 29, 37, 38 AND 50).

FIRST USE 1-1-2004; IN COMMERCE 1-1-2004.

2,998,631. BIRTH TO THREE, EUGENE, OR. SN 76-470,377. PUB. 8-5-2003, FILED 11-29-2002.

WORDS TO LOVE BY

FOR DECK OF 52 CARDS AND 4 ADDITIONAL CARDS, BROKEN INTO 4 SUITS AND CONTAINING PARENTING AFFIRMATION AND INSIGHTFUL QUOTES USED FOR ENCOURAGEMENT, BUT NOT AS PLAYING CARDS (U.S. CLS. 2, 5, 22, 23, 29, 37, 38 AND 50).

FIRST USE 12-21-2002; IN COMMERCE 12-21-2002.

2,998,655. RIVERDEEP INTERACTIVE LEARNING LIMITED, DUBLIN 2, IRELAND. SN 76-488,490. PUB. 9-30-2003, FILED 2-10-2003.

READER RABBIT

OWNER OF U.S. REG. NOS. 2,191,554, 2,194,347, AND OTHERS.

FOR SERIES OF FICTION AND NON-FICTION BOOKS ON A VARIETY OF TOPICS AND FOR CHILDREN'S EDUCATIONAL ACTIVITY BOOKS (U.S. CLS. 2, 5, 22, 23, 29, 37, 38 AND 50).

FIRST USE 7-1-2004; IN COMMERCE 7-1-2004.

CLASS 16—(Continued).

2,998,673. GLEN ELLYN INDUSTRIES, LLC, GLEN ELLYN, IL. SN 76-511,670. PUB. 5-4-2004, FILED 5-5-2003.



NO CLAIM IS MADE TO THE EXCLUSIVE RIGHT TO USE "TRASH PAK", APART FROM THE MARK AS SHOWN.

FOR CARDBOARD SUPPORT FOR DISPOSAL COLLECTION BAG (U.S. CLS. 2, 5, 22, 23, 29, 37, 38 AND 50). FIRST USE 2-17-2005; IN COMMERCE 2-17-2005.

2,998,685. ALTER YOUR LIFE, LLC, CLARKESVILLE, GA. SN 76-524,803. PUB. 5-18-2004, FILED 6-16-2003.

ALTER YOUR LIFE

FOR PRINTED MATERIALS, NAMELY, NEWSLETTERS, JOURNALS, MAGAZINES, BOOKLETS, AND BOOKS FEATURING INFORMATION ON PERSONAL SPIRITUAL GROWTH, HEALING AND WELLNESS; CATALOGS FEATURING BOOKS, RECORDS, CD ROMS, VIDEOS AND OTHER PRODUCTS IN THE FIELD OF STATUARY FIGURINES, DEVOTIONAL BELLS, PERSONAL SPIRITUAL GROWTH AND HEALING AND WELLNESS (U.S. CLS. 2, 5, 22, 23, 29, 37, 38 AND 50).

FIRST USE 6-1-2003; IN COMMERCE 10-1-2003.

2,998,688. SEE IT SO L.L.C., AUSTIN, TX. SN 76-525,165. PUB. 10-19-2004, FILED 6-24-2003.

SEE IT SO

FOR SERIES OF PRINTED TEACHING AND INSTRUCTIONAL MATERIALS, NAMELY, FICTION AND NON-FICTION BOOKS, PRINTED SCRIPTS FOR PLAYS AND MOTION PICTURES, PAMPHLETS, BROCHURES, TEACHING GUIDES AND WORKBOOKS ALL FEATURING CORE EDUCATIONAL SUBJECTS SUCH AS MATHEMATICS, GEOGRAPHY, HISTORY, NATURAL AND ECOLOGICAL SCIENCES, ASTROLOGY, PHYSICAL EDUCATION, PHYSICS AND METAPHYSICS, SOCIAL STUDIES, ARTS, LANGUAGE ARTS, MUSIC, ANTHROPOLOGY, AND MYTHOLOGY, AND ALTERNATIVE CORE EDUCATIONAL SUBJECTS IN THE NATURE OF HOLISTIC PEDAGOGY AND HEALTH STUDIES, INTERGENERATIONAL STUDIES, SCHOOL REFORM, PARENTING, CHILD DEVELOPMENT AND CHILD PSYCHOLOGY STUDIES, INTUITIVE AND CREATIVITY DEVELOPMENT STUDIES, SPIRITUALITY STUDIES, FANTASY AND FAIRYTALES, TRAVEL STUDIES, EMOTIONAL INTELLIGENCE STUDIES, KINETICS, HUMANITARIAN AND BEHAVIORAL STUDIES, PERSONAL EMPOWERMENT, PERSONAL COMMUNICATION AND INTRA-PERSONAL SKILLS STUDIES (U.S. CLS. 2, 5, 22, 23, 29, 37, 38 AND 50).

FIRST USE 6-0-2003; IN COMMERCE 6-0-2003.

CLASS 16—(Continued).

2,998,689. SEE IT SO L.L.C., AUSTIN, TX. SN 76-525,166. PUB. 10-19-2004, FILED 6-24-2003.

CARING WINDS

FOR SERIES OF PRINTED TEACHING AND INSTRUCTIONAL MATERIALS, NAMELY, FICTION AND NON-FICTION BOOKS, PRINTED SCRIPTS FOR PLAYS AND MOTION PICTURES, PAMPHLETS, BROCHURES, TEACHING GUIDES AND WORKBOOKS ALL FEATURING CORE EDUCATIONAL SUBJECTS SUCH AS MATHEMATICS, GEOGRAPHY, HISTORY, NATURAL AND ECOLOGICAL SCIENCES, ASTROLOGY, PHYSICAL EDUCATION, PHYSICS AND METAPHYSICS, SOCIAL STUDIES, ARTS, LANGUAGE ARTS, MUSIC, ANTHROPOLOGY, AND MYTHOLOGY, AND ALTERNATIVE CORE EDUCATIONAL SUBJECTS IN THE NATURE OF HOLISTIC PEDAGOGY AND HEALTH STUDIES, INTERGENERATIONAL STUDIES, SCHOOL REFORM, PARENTING, CHILD DEVELOPMENT AND CHILD PSYCHOLOGY STUDIES, INTUITIVE AND CREATIVITY DEVELOPMENT STUDIES, SPIRITUALITY STUDIES, FANTASY AND FAIRYTALES, TRAVEL STUDIES, EMOTIONAL INTELLIGENCE STUDIES, KINETICS, HUMANITARIAN AND BEHAVIORAL STUDIES, PERSONAL EMPOWERMENT, PERSONAL COMMUNICATION AND INTRA-PERSONAL SKILLS STUDIES (U.S. CLS. 2, 5, 22, 23, 29, 37, 38 AND 50).

FIRST USE 6-0-2003; IN COMMERCE 6-0-2003.

2,998,706. GOEINS WILLIAMS ASSOCIATES INC., WILMINGTON, DE. SN 76-532,948. PUB. 6-22-2004, FILED 7-28-2003.

SPICE OF LIFE

FOR CARD DECKS FOR USE IN TRAINING, WORKSHOPS OR OTHER ENVIRONMENTS DEALING WITH INTERPERSONAL ISSUES ARISING IN THE WORKPLACE, CLASSROOM OR WITHIN ORGANIZATIONS (U.S. CLS. 2, 5, 22, 23, 29, 37, 38 AND 50).

FIRST USE 11-1-2003; IN COMMERCE 11-1-2003.

2,998,710. JONES, ROBERT, DALLAS, TX. SN 76-534,551. PUB. 4-27-2004, FILED 8-5-2003.

ROBERT JONES SIMPLE BEAUTÉ

FOR PRINTED PUBLICATIONS, NAMELY A SERIES OF BOOKS, BOOKLETS, PAMPHLETS AND BROCHURES IN THE FIELD OF BEAUTY (U.S. CLS. 2, 5, 22, 23, 29, 37, 38 AND 50).

FIRST USE 3-31-2004; IN COMMERCE 3-31-2004.

CLASS 16—(Continued).

2,998,714. MANISOPRA MANAGEMENT CORPORAT, NEW YORK, NY. SN 76-535,637. PUB. 9-21-2004, FILED 8-8-2003.

OUR WAVES WHISPER OUR LUXURY ROARS

FOR ADVERTISING CIRCULARS IN THE FIELD OF SPA SERVICES AND HEALTH AND WELLNESS; PAMPHLETS ON SPA SERVICES AND HEALTH AND WELLNESS; MAGAZINE SECTIONS ADVERTISING SPA SERVICES AND HEALTH AND WELLNESS, POSTERS; PRESENTATION BOARDS; PRESENTATION FOLDERS; PRINTED GUIDES ON SPA AND HEALTH AND WELLNESS SERVICES; PRINTED MATERIALS, NAMELY, PRESS RELEASES FEATURING INFORMATION ON SPA AND HEALTH AND WELLNESS SERVICES (U.S. CLS. 2, 5, 22, 23, 29, 37, 38 AND 50).

FIRST USE 11-0-2004; IN COMMERCE 11-0-2004.

2,998,805. MATURE ADVANTAGE CORPORATION, NEW YORK, NY. SN 76-580,966. PUB. 12-21-2004, FILED 3-15-2004.

MATURE ADVANTAGE

THE MARK CONSISTS OF STANDARD CHARACTERS WITHOUT CLAIM TO ANY PARTICULAR FONT, STYLE, SIZE, OR COLOR.

FOR PRINTED MATERIALS, NAMELY NEWSLETTERS AND PUBLICATIONS PERTAINING TO LIFE AND HEALTH INSURANCE, HEALTHCARE ISSUES, PRESCRIPTION DRUG ISSUES, LONG TERM CARE, ESTATE PLANNING, LIFESTYLE, TRAVEL, AND DIET, ALL FOR SENIOR CITIZENS (U.S. CLS. 2, 5, 22, 23, 29, 37, 38 AND 50).

FIRST USE 6-0-2004; IN COMMERCE 6-0-2004.

2,998,898. SMART BUSINESS NETWORK, INC., WESTLAKE, OH. SN 78-210,512. PUB. 5-11-2004, FILED 2-4-2003.

SMART BUSINESS MAGAZINE

NO CLAIM IS MADE TO THE EXCLUSIVE RIGHT TO USE "BUSINESS MAGAZINE", APART FROM THE MARK AS SHOWN.

FOR MONTHLY, CONTROLLED-CIRCULATION, LOCAL BUSINESS MAGAZINE FOR SENIOR DECISION MAKERS OF MID-SIZED COMPANIES, FEATURING BUSINESS MANAGEMENT ARTICLES, BUSINESS RESOURCES AND BUSINESS DATA (U.S. CLS. 2, 5, 22, 23, 29, 37, 38 AND 50).

FIRST USE 2-1-2005; IN COMMERCE 2-1-2005.

CLASS 16—(Continued).

2,998,904. LIFESYSTEMS, SAN JOSE, CA. SN 78-214,225. PUB. 2-24-2004, FILED 2-12-2003.

LIFESYSTEMS

FOR PRINTED TIME, GOAL AND JOURNAL MANAGEMENT PRODUCTS FOR CORPORATIONS, INSTITUTIONS, AND INDIVIDUALS, NAMELY, DAILY PLANNERS, TASK LISTS, CALENDARS, CONTACT MANAGEMENT LISTS, PRINTED DATABASES, JOURNALS; INSTRUCTION MANUALS IN THE FIELD OF CORPORATE MANAGEMENT AND CONSULTATION (U.S. CLS. 2, 5, 22, 23, 29, 37, 38 AND 50).

FIRST USE 11-15-2004; IN COMMERCE 11-15-2004.

2,998,919. VIACOM INTERNATIONAL INC., NEW YORK, NY. SN 78-223,102. PUB. 6-8-2004, FILED 3-7-2003.

EVERPOWER!

THE MARK CONSISTS OF STANDARD CHARACTERS WITHOUT CLAIM TO ANY PARTICULAR FONT, STYLE, SIZE, OR COLOR.

FOR PRINTED MATTER, NAMELY, NOTEPAPER AND LOOSE LEAF PAPER, SERIES OF FICTION BOOKS, DECALS, BUMPER STICKERS, TRADING CARDS, NOTE CARDS, POSTERS, FOLDERS, PENCILS, PENS, AND CALENDARS (U.S. CLS. 2, 5, 22, 23, 29, 37, 38 AND 50).

FIRST USE 7-19-2004; IN COMMERCE 7-19-2004.

2,998,929. AKRON BOARD OF EDUCATION, AKRON, OH. SN 78-231,302. PUB. 4-13-2004, FILED 3-28-2003.

ASK GILBY

FOR COLORING BOOKS; CHILDREN'S BOOKS; SONG BOOKS; CALENDARS; FLASH CARDS; CARTOON STRIPS; CHILDREN'S ACTIVITY BOOKS; COMIC STRIPS; DRAWING RULERS AND UNGRADUATED RULERS; EDUCATIONAL BOOKS IN THE FIELD OF PRESCHOOL EDUCATION; MAGAZINES AND NEWSLETTERS IN THE FIELD OF PRESCHOOL EDUCATION (U.S. CLS. 2, 5, 22, 23, 29, 37, 38 AND 50).

FIRST USE 12-4-2003; IN COMMERCE 12-4-2003.

CLASS 16—(Continued).

2,998,939. VIACOM INTERNATIONAL INC., NEW YORK, NY. SN 78-239,042. PUB. 11-4-2003, FILED 4-17-2003.

EVERDREAMER!

THE MARK CONSISTS OF STANDARD CHARACTERS WITHOUT CLAIM TO ANY PARTICULAR FONT, STYLE, SIZE, OR COLOR.

FOR PRINTED MATTER, NAMELY, NOTEPAPER AND LOOSE LEAF PAPER, SERIES OF FICTION BOOKS, DECALS, BUMPER STICKERS, TRADING CARDS, NOTE CARDS, POSTERS, FOLDERS, PENCILS, PENS, AND CALENDARS (U.S. CLS. 2, 5, 22, 23, 29, 37, 38 AND 50).

FIRST USE 7-19-2004; IN COMMERCE 7-19-2004.

CLASS 16—(Continued).

2,999,043. HEALY MEDIA, INC., CHULA VISTA, CA. SN 78-303,087. PUB. 12-28-2004, FILED 9-19-2003.



2,998,992. VIACOM INTERNATIONAL INC., NEW YORK, NY. SN 78-276,570. PUB. 4-20-2004, FILED 7-21-2003.



OWNER OF U.S. REG. NOS. 1,391,119, 2,537,600, AND OTHERS.

FOR PRINTED MATTER, NAMELY POSTERS AND POSTCARDS; STATIONERY, NAMELY WRITING PAPER, ENVELOPES AND CARDS; BUMPER STICKERS; CALENDARS (U.S. CLS. 2, 5, 22, 23, 29, 37, 38 AND 50).

FIRST USE 10-5-2004; IN COMMERCE 10-5-2004.

NO CLAIM IS MADE TO THE EXCLUSIVE RIGHT TO USE "DIARIO LATINO", APART FROM THE MARK AS SHOWN.

THE ENGLISH TRANSLATION OF THE WORD LA VOZ NEUESTRA COMUNIDAD IN THE MARK IS LATINO DAILY. THE VOICE OF OUR COMMUNITY.

FOR PRINTED MATTER, NAMELY NEWSPAPERS FOR GENERAL CIRCULATION (U.S. CLS. 2, 5, 22, 23, 29, 37, 38 AND 50).

FIRST USE 10-20-2003; IN COMMERCE 10-20-2003.

2,999,095. ROSE ART INDUSTRIES, INC., LIVINGSTON, NJ. SN 78-338,440. PUB. 9-14-2004, FILED 12-9-2003.

CLICK & SLIDE

2,999,010. AVODAH PUBLISHING, INC., WHITEFISH, MT. SN 78-285,388. PUB. 3-22-2005, FILED 8-9-2003.

FLATHEAD LIVING

NO CLAIM IS MADE TO THE EXCLUSIVE RIGHT TO USE "FLATHEAD", APART FROM THE MARK AS SHOWN.

FOR GENERAL FEATURE MAGAZINE (U.S. CLS. 2, 5, 22, 23, 29, 37, 38 AND 50).

FIRST USE 4-28-2004; IN COMMERCE 6-23-2004.

THE MARK CONSISTS OF STANDARD CHARACTERS WITHOUT CLAIM TO ANY PARTICULAR FONT, STYLE, SIZE, OR COLOR.

FOR WRITING INSTRUMENTS (U.S. CLS. 2, 5, 22, 23, 29, 37, 38 AND 50).

FIRST USE 9-22-2004; IN COMMERCE 9-22-2004.

CLASS 16—(Continued).

2,999,102. HARTMANN, JENNIFER L, BELLEVUE, WA. SN 78-341,370. PUB. 10-5-2004, FILED 12-16-2003.

Nutrition Reality

THE MARK CONSISTS OF STANDARD CHARACTERS WITHOUT CLAIM TO ANY PARTICULAR FONT, STYLE, SIZE, OR COLOR.

NO CLAIM IS MADE TO THE EXCLUSIVE RIGHT TO USE "NUTRITION", APART FROM THE MARK AS SHOWN.

FOR INFORMATIONAL FLYERS AND SHEETS ABOUT NUTRITION; NOTE PADS (U.S. CLS. 2, 5, 22, 23, 29, 37, 38 AND 50).

FIRST USE 1-10-2005; IN COMMERCE 1-10-2005.

2,999,138. MEREDITH CORPORATION, DES MOINES, IA. SN 78-353,457. PUB. 10-26-2004, FILED 1-17-2004.

FUNNY LADIES WE LOVE

THE MARK CONSISTS OF STANDARD CHARACTERS WITHOUT CLAIM TO ANY PARTICULAR FONT, STYLE, SIZE, OR COLOR.

FOR PRINTED PUBLICATIONS, NAMELY A SECTION OF A MAGAZINE FEATURING ARTICLES ABOUT WELL-KNOWN FEMALE PERSONALITIES (U.S. CLS. 2, 5, 22, 23, 29, 37, 38 AND 50).

FIRST USE 2-10-2004; IN COMMERCE 2-10-2004.

2,999,162. CHRIS MADDEN INC., PORT CHESTER, NY. SN 78-363,668. PUB. 11-9-2004, FILED 2-6-2004.

CHRIS MADDEN

THE MARK CONSISTS OF STANDARD CHARACTERS WITHOUT CLAIM TO ANY PARTICULAR FONT, STYLE,

CLASS 16—(Continued).

SIZE, OR COLOR.

THE NAME SHOWN IN THE MARK IDENTIFIES CHRIS MADDEN, A LIVING INDIVIDUAL WHOSE CONSENT IS OF RECORD.

FOR WALL COVERING SAMPLE BOOKS; MAGAZINES, NAMELY, LIFESTYLE, FASHION, HOME AND OFFICE DESIGN, DECORATING AND GENERAL INTEREST MAGAZINES, PHOTOGRAPHS, PAINTINGS, PAPER TABLECLOTHS AND MATS (U.S. CLS. 2, 5, 22, 23, 29, 37, 38 AND 50).

FIRST USE 5-0-2005; IN COMMERCE 5-0-2005.

2,999,180. BLUMENTHAL LANSING COMPANY, CARLSTADT, NJ. SN 78-372,876. PUB. 12-7-2004, FILED 2-24-2004.

TWINKLE TAPE

THE MARK CONSISTS OF STANDARD CHARACTERS WITHOUT CLAIM TO ANY PARTICULAR FONT, STYLE, SIZE, OR COLOR.

NO CLAIM IS MADE TO THE EXCLUSIVE RIGHT TO USE TAPE, APART FROM THE MARK AS SHOWN.

FOR DECORATIVE TRIMMINGS, NAMELY, MULTI-COLORED SELF-ADHESIVE STICKER STRIPS (U.S. CLS. 2, 5, 22, 23, 29, 37, 38 AND 50).

FIRST USE 12-4-2004; IN COMMERCE 12-4-2004.

2,999,181. INTEGRITY MEDIA, INC., MOBILE, AL. SN 78-373,200. PUB. 1-18-2005, FILED 2-24-2004.

SCRAPBOOK OF MEMORIES

THE MARK CONSISTS OF STANDARD CHARACTERS WITHOUT CLAIM TO ANY PARTICULAR FONT, STYLE, SIZE, OR COLOR.

NO CLAIM IS MADE TO THE EXCLUSIVE RIGHT TO USE "SCRAPBOOK", APART FROM THE MARK AS SHOWN.

FOR SCRAPBOOKS (U.S. CLS. 2, 5, 22, 23, 29, 37, 38 AND 50).

FIRST USE 1-28-2004; IN COMMERCE 1-28-2004.

CLASS 16—(Continued).

2,999,212. INDIANA TICKET COMPANY, INC., MUNCIE, IN. SN 78-388,368. PUB. 12-28-2004, FILED 3-22-2004.

BONUS PLAY BRISTOL

THE MARK CONSISTS OF STANDARD CHARACTERS WITHOUT CLAIM TO ANY PARTICULAR FONT, STYLE, SIZE, OR COLOR.
FOR PRINTED TICKETS (U.S. CLS. 2, 5, 22, 23, 29, 37, 38 AND 50).
FIRST USE 3-2-2004; IN COMMERCE 3-2-2004.

2,999,218. HOLLAND USA, INC., NORTH MANKATO, MN. SN 78-392,150. PUB. 2-15-2005, FILED 3-28-2004.

ARLINGTON

THE MARK CONSISTS OF STANDARD CHARACTERS WITHOUT CLAIM TO ANY PARTICULAR FONT, STYLE, SIZE, OR COLOR.
FOR PENS (U.S. CLS. 2, 5, 22, 23, 29, 37, 38 AND 50).
FIRST USE 1-31-2005; IN COMMERCE 1-31-2005.

2,999,233. RESTORE MEDIA LLC, WASHINGTON, DC. SN 78-400,319. PUB. 3-29-2005, FILED 4-12-2004.

**OLD-HOUSE
JOURNAL'S NEW OLD
HOUSE**

THE MARK CONSISTS OF STANDARD CHARACTERS WITHOUT CLAIM TO ANY PARTICULAR FONT, STYLE, SIZE, OR COLOR.
OWNER OF U.S. REG. NO. 2,227,859.
NO CLAIM IS MADE TO THE EXCLUSIVE RIGHT TO USE "NEW OLD HOUSE", APART FROM THE MARK AS

CLASS 16—(Continued).

SHOWN.
SEC. 2(F) AS TO "OLD-HOUSE JOURNAL'S".
FOR MAGAZINE SERVING THE NEEDS OF PEOPLE INTERESTED IN DESIGNING AND BUILDING NEW HOMES INSPIRED BY CLASSIC RESIDENTIAL HOUSING STYLES AND INCORPORATING TRADITIONAL DESIGN PRINCIPLES AND PERIOD AND REPRODUCTION PRODUCTS (U.S. CLS. 2, 5, 22, 23, 29, 37, 38 AND 50).
FIRST USE 10-1-2004; IN COMMERCE 10-1-2004.

2,999,234. AMERICAN OSTEOPATHIC ASSOCIATION, CHICAGO, IL. SN 78-401,001. PUB. 2-8-2005, FILED 4-13-2004.

**AOA'S WOMEN AND
WELLNESS**

THE MARK CONSISTS OF STANDARD CHARACTERS WITHOUT CLAIM TO ANY PARTICULAR FONT, STYLE, SIZE, OR COLOR.
NO CLAIM IS MADE TO THE EXCLUSIVE RIGHT TO USE "WOMEN AND WELLNESS", APART FROM THE MARK AS SHOWN.
FOR NEWSLETTERS IN THE FIELD OF HEALTH (U.S. CLS. 2, 5, 22, 23, 29, 37, 38 AND 50).
FIRST USE 6-0-2004; IN COMMERCE 6-0-2004.

2,999,276. S. C. JOHNSON HOME STORAGE, INC., RACINE, WI. SN 78-976,200. PUB. 9-21-2004, FILED 11-19-2003.

**DESIGNED WITH YOU
IN MIND**

THE MARK CONSISTS OF STANDARD CHARACTERS WITHOUT CLAIM TO ANY PARTICULAR FONT, STYLE, SIZE, OR COLOR.
FOR PLASTIC BAGS FOR HOUSEHOLD USE; PLASTIC WRAP AND PLASTIC FILM NOT FOR COMMERCIAL OR INDUSTRIAL PURPOSES; AND DISPOSABLE CUTTING SHEETS, NAMELY, A CUTTING SHEET COMPRISED OF PAPER AND PLASTIC FOR HOUSEHOLD PURPOSES (U.S. CLS. 2, 5, 22, 23, 29, 37, 38 AND 50).
FIRST USE 5-2-2005; IN COMMERCE 5-2-2005.

CLASS 16—(Continued).

2,999,278. IDEASTREAM CONSUMER PRODUCTS LLC, PARMA, OH. SN 78-976,260. PUB. 9-14-2004, FILED 6-25-2003.

CLASS 17—(Continued).

2,999,187. TEIJIN KABUSHIKI KAISHA (TEIJIN LIMITED), OSAKA, JAPAN. SN 78-375,124. PUB. 1-18-2005, FILED 2-27-2004.

FREEFORM

FOR WRITING INSTRUMENTS; PENS, BALL POINT PENS, INK PENS, PEN INK REFILLS, AND ROLLER BALL PENS (U.S. CLS. 2, 5, 22, 23, 29, 37, 38 AND 50).
FIRST USE 9-0-2003; IN COMMERCE 9-0-2003.

TEIJIN**CLASS 17—RUBBER GOODS**

2,998,559. BOLTARON PERFORMANCE PRODUCTS, LLC, NEWCOMERTOWN, OH. SN 76-334,117. PUB. 7-23-2002, FILED 11-6-2001.

THE MARK CONSISTS OF STANDARD CHARACTERS WITHOUT CLAIM TO ANY PARTICULAR FONT, STYLE, SIZE, OR COLOR.

OWNER OF U.S. REG. NOS. 796,972, 2,488,714, AND OTHERS.

FOR PLASTICS IN EXTRUDED FORM FOR USE IN MANUFACTURE (U.S. CLS. 1, 5, 12, 13, 35 AND 50).

FIRST USE 1-15-2005; IN COMMERCE 1-15-2005.

SURPRINT

OWNER OF U.S. REG. NO. 2,000,265.
FOR POLYVINYL CHLORIDE PLASTIC SHEETING FOR GRAPHIC ARTS PRINTING (U.S. CLS. 1, 5, 12, 13, 35 AND 50).
FIRST USE 4-0-2004; IN COMMERCE 4-0-2004.

2,999,230. CRANE & CO., INC., DALTON, MA. SN 78-396,821. PUB. 1-4-2005, FILED 4-6-2004.

2,999,073. HUDSON SOLID SURFACES INTERNATIONAL, LLC, CATOOSA, OK. SN 78-326,847. PUB. 2-15-2005, FILED 11-12-2003.

SWITCH**MYSTERA**

THE MARK CONSISTS OF STANDARD CHARACTERS WITHOUT CLAIM TO ANY PARTICULAR FONT, STYLE, SIZE, OR COLOR.

FOR PLASTIC SHEETS FOR USE IN COUNTERTOPS AND MANUFACTURING (U.S. CLS. 1, 5, 12, 13, 35 AND 50).

FIRST USE 11-12-2003; IN COMMERCE 11-12-2003.

THE MARK CONSISTS OF STANDARD CHARACTERS WITHOUT CLAIM TO ANY PARTICULAR FONT, STYLE, SIZE, OR COLOR.

FOR SECURITY THREAD PRIMARILY COMPOSED OF A PLASTIC SUBSTRATE CONTAINING A METAL LAYER SUITABLE FOR CODING OR MOUNTING ON OR AT LEAST PARTIALLY EMBEDDING IN SECURITY DOCUMENTS OR MEANS OF IDENTIFICATION SUCH AS LABELS (U.S. CLS. 1, 5, 12, 13, 35 AND 50).

FIRST USE 5-2-2004; IN COMMERCE 5-2-2004.

CLASS 17—(Continued).

2,999,231. CRANE & CO., INC., DALTON, MA. SN 78-396,823.
PUB. 1-11-2005, FILED 4-6-2004.

SECURATEX

THE MARK CONSISTS OF STANDARD CHARACTERS WITHOUT CLAIM TO ANY PARTICULAR FONT, STYLE, SIZE, OR COLOR.

FOR SECURITY THREAD PRIMARILY COMPOSED OF A PLASTIC SUBSTRATE CONTAINING A METAL LAYER SUITABLE FOR CODING FOR MOUNTING ON OR AT LEAST PARTIALLY EMBEDDING IN SECURITY DOCUMENTS OR MEANS OF IDENTIFICATION SUCH AS LABELS (U.S. CLS. 1, 5, 12, 13, 35 AND 50).
FIRST USE 5-2-2004; IN COMMERCE 5-2-2004.

CLASS 18—LEATHER GOODS

2,998,820. COCOS INTERNATIONAL TRADING INC, LOS ANGELES, CA. SN 76-587,104. PUB. 4-12-2005, FILED 4-12-2004.

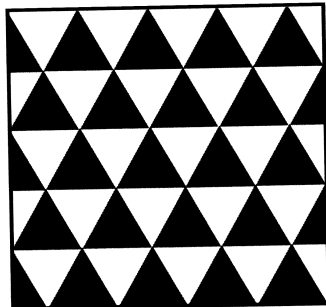

FOR HANDBAGS, BRIEFCASES, WALLETS, BACKPACKS, LUGGAGE, COSMETIC CASES SOLD EMPTY, AND COIN PURSES (U.S. CLS. 1, 2, 3, 22 AND 41).
FIRST USE 12-1-2004; IN COMMERCE 12-30-2004.

2,998,886. NISSAN JIDOSHA KABUSHIKI, TA NISSAN MOTOR CO., LTD., TOKYO, JAPAN. SN 78-196,449. PUB. 10-5-2004, FILED 12-19-2002.

NISMO

OWNER OF U.S. REG. NO. 1,536,313.
FOR LUGGAGE, TOTE BAGS AND TRAVEL BAGS (U.S. CLS. 1, 2, 3, 22 AND 41).
FIRST USE 6-30-2003; IN COMMERCE 6-30-2003.

CLASS 18—(Continued).

2,998,914. TUMI, INC., SOUTH PLAINFIELD, NJ. SN 78-218,555. PUB. 11-4-2003, FILED 2-25-2003.



OWNER OF U.S. REG. NOS. 1,356,646, 2,588,479, AND OTHERS.

THE FOREIGN WORDING IN THE MARK TRANSLATES INTO ENGLISH AS NOTHING BUT APPLICATION BELIEVES IT IS THE NAME OF A PERUVIAN GOD.

FOR PURSES, WOMEN'S HANDBAGS, CLUTCHES, SHOULDER BAGS, TOILETRY CASES SOLD EMPTY, MAKE-UP BAGS SOLD EMPTY, LEATHER SHOPPING BAGS, SUITCASES, CARRY ON LUGGAGE, TRAVEL KITS SOLD EMPTY, BACK PACKS, BOOK BAGS, WAIST PACKS, KEY CASES, POCKET WALLETS, SCHOOL BAGS, ALL PURPOSE SPORTS BAGS, TOTE BAGS, ATTACHE CASES, BRIEFCASE-TYPE PORTFOLIOS AND BRIEFCASES (U.S. CLS. 1, 2, 3, 22 AND 41).
FIRST USE 10-31-2003; IN COMMERCE 10-31-2003.

2,999,125. WRIGHT, MARK, PITTSBURG, CA. SN 78-349,515.
PUB. 11-16-2004, FILED 1-8-2004.

BOOM BAGS

THE MARK CONSISTS OF STANDARD CHARACTERS WITHOUT CLAIM TO ANY PARTICULAR FONT, STYLE, SIZE, OR COLOR.

NO CLAIM IS MADE TO THE EXCLUSIVE RIGHT TO USE "BAGS", APART FROM THE MARK AS SHOWN.

FOR LUGGAGE ARTICLES WITH INTEGRAL AUDIO SPEAKERS, NAMELY, SUITCASE AND BRIEFCASE SIZE LUGGAGE (U.S. CLS. 1, 2, 3, 22 AND 41).
FIRST USE 1-14-2005; IN COMMERCE 1-14-2005.

CLASS 19—NON-METALLIC BUILDING MATERIALS

CLASS 19—(Continued).

2,998,620. SPC RESOURCES INC., HARTSVILLE, SC. SN 76-459,121. PUB. 8-3-2004, FILED 10-9-2002.

FINISH FREE

FOR NON-METAL FIBER TUBES USED AS CONCRETE CONSTRUCTION FORMS (U.S. CLS. 1, 12, 33 AND 50).

FIRST USE 11-1-2000; IN COMMERCE 11-1-2000.

2,998,625. LAFARGE NORTH AMERICA INC., HERNDON, VA. SN 76-465,702. PUB. 11-16-2004, FILED 11-12-2002.

ULTRASTREET

FOR READY MIX CONCRETE (U.S. CLS. 1, 12, 33 AND 50).

FIRST USE 12-11-2002; IN COMMERCE 12-11-2002.

2,998,707. U.S. TECHNOLOGY CORPORATION, CANTON, OH. SN 76-533,133. PUB. 3-8-2005, FILED 7-28-2003.



FOR MASONRY BLOCKS FOR USE IN CONSTRUCTION AND LANDSCAPING MANUFACTURED PRIMARILY OF POLYMERS AND CONCRETE (U.S. CLS. 1, 12, 33 AND 50).

FIRST USE 1-19-2004; IN COMMERCE 1-19-2004.

2,998,760. MATHIOS REFRACTORIES S.A., RENIS 18233, GREECE. SN 76-564,144. PUB. 9-14-2004, FILED 12-9-2003.

ONLY NATURE CAN COPY US

THE MARK CONSISTS OF STANDARD CHARACTERS WITHOUT CLAIM TO ANY PARTICULAR FONT, STYLE, SIZE, OR COLOR.

FOR BUILDING MATERIALS, NAMELY MANUFACTURED STONE VENEER (U.S. CLS. 1, 12, 33 AND 50).

FIRST USE 1-1-2004; IN COMMERCE 1-1-2004.

CLASS 19—(Continued).

2,998,772. MP GLOBAL PRODUCTS, LLC, NORFOLK, NE. SN 76-567,173. PUB. 10-12-2004, FILED 12-29-2003.

QUIET WARMTH

THE MARK CONSISTS OF STANDARD CHARACTERS WITHOUT CLAIM TO ANY PARTICULAR FONT, STYLE, SIZE, OR COLOR.

FOR FLOORING UNDERLAYMENTS WITH ATTACHED HEATING ELEMENTS (U.S. CLS. 1, 12, 33 AND 50).

FIRST USE 3-0-2004; IN COMMERCE 3-0-2004.

2,998,775. MATCON TRADING CORP., MIAMI, FL. SN 76-568,005. PUB. 10-12-2004, FILED 12-31-2003.



FOR ROOFING MATERIALS, NAMELY, ROOFING FELT, ROOFING ASPHALT (U.S. CLS. 1, 12, 33 AND 50).

FIRST USE 3-0-2004; IN COMMERCE 3-0-2004.

2,998,883. THE PLASTIC LUMBER COMPANY, INC., AKRON, OH. SN 78-187,495. PUB. 10-5-2004, FILED 11-21-2002.

LEISURE DECK

NO CLAIM IS MADE TO THE EXCLUSIVE RIGHT TO USE "DECK", APART FROM THE MARK AS SHOWN.

FOR PLASTIC AND NON-METALLIC COMPOSITE LUMBER USED AS BUILDING MATERIALS (U.S. CLS. 1, 12, 33 AND 50).

FIRST USE 12-31-2002; IN COMMERCE 1-31-2003.

CLASS 19—(Continued).

2,999,066. TERAGREN LLC, BAINBRIDGE ISLAND, WA. SN 78-323,336. PUB. 7-27-2004, FILED 11-5-2003.



THE MARK CONSISTS OF DECORATIVE SWIRLING IN AN INCOMPLETE CIRCLE.

FOR BUILDING MATERIALS MADE FROM BAMBOO, TIMBER PRODUCTS AND/OR CORK, NAMELY, BEAMS, JOINTS, JOISTS, MOLDINGS, POSTS, SUPPORTS, SIDING, TRIM, PLANKS, BOARDS, TILES, VENEER, FLOORING, FLOORING UNDERLAYMENTS, WINDOW FRAMES, WINDOW CASEMENTS, WINDOW PANES, WINDOW SILLS, DOORS, DOOR FRAMES, DOOR PANELS, DOOR UNITS, THRESHOLDS, PANELS AND PANELING, AND ENGINEERED COMPOSITE AND/OR LAMINATE MATERIAL MADE PRIMARILY OF BAMBOO, WOOD AND/OR CORK (U.S. CLS. 1, 12, 33 AND 50).

FIRST USE 9-9-2003; IN COMMERCE 9-9-2003.

2,999,175. ASSOCIATED MATERIALS, INC., DBA ALSIDE, CUYAHOGA FALLS, OH. SN 78-370,408. PUB. 1-18-2005, FILED 2-19-2004.

**CHARTER OAK ENERGY
ELITE**

THE MARK CONSISTS OF STANDARD CHARACTERS WITHOUT CLAIM TO ANY PARTICULAR FONT, STYLE, SIZE, OR COLOR.

OWNER OF U.S. REG. NO. 2,764,215.
FOR VINYL SIDING (U.S. CLS. 1, 12, 33 AND 50).
FIRST USE 3-0-2004; IN COMMERCE 3-0-2004.

CLASS 19—(Continued).

2,999,266. PROTECTIVE STRUCTURES, LTD., ROSWELL, GA. SN 78-429,644. PUB. 4-12-2005, FILED 6-3-2004.

SecureAll

FOR FIBERGLASS, BULLET RESISTANT PANELS USED IN CONSTRUCTION OF "SAFE" ROOMS AND SECURE DOORS; CAN BE USED IN BOTH CONSTRUCTION AND AUTOMOTIVE APPLICATIONS (U.S. CLS. 1, 12, 33 AND 50).

FIRST USE 6-2-2004; IN COMMERCE 6-2-2004.

CLASS 20—FURNITURE AND ARTICLES NOT OTHERWISE CLASSIFIED

2,998,539. NORTH AMERICAN ENCLOSURES, INC., CENTRAL ISLIP, NY. SN 76-205,710. PUB. 9-28-2004, FILED 2-7-2001.

PHOTO TRADITIONS

NO CLAIM IS MADE TO THE EXCLUSIVE RIGHT TO USE "PHOTO", APART FROM THE MARK AS SHOWN.
FOR PICTURE FRAMES (U.S. CLS. 2, 13, 22, 25, 32 AND 50).

FIRST USE 3-0-2001; IN COMMERCE 3-0-2001.

2,998,623. ICEBERG ENTERPRISES, LLC, GLENDALE HEIGHTS, IL. SN 76-461,421. PUB. 5-6-2003, FILED 10-23-2002.

ROUGH N READY

FOR FURNITURE (U.S. CLS. 2, 13, 22, 25, 32 AND 50).
FIRST USE 2-1-2005; IN COMMERCE 2-1-2005.

2,998,732. WAL-MART STORES, INC., BENTONVILLE, AR. SN 76-545,486. PUB. 6-1-2004, FILED 9-17-2003.

PAGENT

FOR PATIO FURNITURE (U.S. CLS. 2, 13, 22, 25, 32 AND 50).
FIRST USE 1-31-2002; IN COMMERCE 1-31-2002.

CLASS 20—(Continued).

2,998,733. WAL-MART STORES, INC., BENTONVILLE, AR.
SN 76-545,522. PUB. 6-1-2004, FILED 9-17-2003.

VILLAGE CROSS

FOR PATIO FURNITURE (U.S. CLS. 2, 13, 22, 25, 32
AND 50).
FIRST USE 12-27-2004; IN COMMERCE 12-27-2004.

2,998,749. PENCO PRODUCTS, INC., OAKS, PA. SN 76-
558,379. PUB. 8-31-2004, FILED 11-7-2003.

PROTOUGH

THE MARK CONSISTS OF STANDARD CHARACTERS
WITHOUT CLAIM TO ANY PARTICULAR FONT, STYLE,
SIZE, OR COLOR.
FOR LOCKERS (U.S. CLS. 2, 13, 22, 25, 32 AND 50).
FIRST USE 11-10-2004; IN COMMERCE 11-10-2004.

2,998,751. EUROWALLS, LLC, LOCKPORT, NY. SN 76-
560,148. PUB. 9-28-2004, FILED 11-13-2003.

SALON IN A BOX

THE MARK CONSISTS OF STANDARD CHARACTERS
WITHOUT CLAIM TO ANY PARTICULAR FONT, STYLE,
SIZE, OR COLOR.

FOR FURNITURE, NAMELY, MODULAR PARTI-
TIONS, DESKS, CREDENZAS, CABINETS, SALES AND
DISPLAY COUNTERS, SHELVES AND SHELVING
UNITS, STORAGE CABINETS, DISPLAY RACKS, TO-
WEL CABINETS, AND BENCHES (U.S. CLS. 2, 13, 22, 25,
32 AND 50).

FIRST USE 12-8-2003; IN COMMERCE 12-8-2003.

2,998,826. KRUEGER INTERNATIONAL, INC., GREEN
BAY, WI. SN 76-590,848. PUB. 3-15-2005, FILED 5-6-2004.

VALUELITE**CLASS 20—(Continued).**

THE MARK CONSISTS OF STANDARD CHARACTERS
WITHOUT CLAIM TO ANY PARTICULAR FONT, STYLE,
SIZE, OR COLOR.

FOR FURNITURE (U.S. CLS. 2, 13, 22, 25, 32 AND 50).
FIRST USE 8-11-2004; IN COMMERCE 8-11-2004.

2,998,935. THE SPRING AIR COMPANY, ELK GROVE
VILLAGE, IL. SN 78-235,301. PUB. 3-2-2004, FILED 4-8-2003.

EUROPEAN CLASS

FOR MATTRESSES AND BOX SPRINGS (U.S. CLS. 2,
13, 22, 25, 32 AND 50).
FIRST USE 8-0-2003; IN COMMERCE 8-0-2003.

2,998,944. GROUPE LACASSE LLC, HOLLAND, MI. SN 78-
241,583. PUB. 12-2-2003, FILED 4-24-2003.

TANGO

FOR OFFICE CHAIRS (U.S. CLS. 2, 13, 22, 25, 32 AND
50).
FIRST USE 6-0-2004; IN COMMERCE 6-0-2004.

2,999,004. HILL-ROM SERVICES, INC., BATESVILLE, IN. SN
78-281,478. PUB. 5-4-2004, FILED 7-31-2003.

DINING CHAIR

FOR HOSPITAL BEDS; MOTORIZED MECHANISMS
FOR CHANGING THE POSITION OF A BED TO FACIL-
ITATE THE POSITIONING OF A PERSONS USING THE
BED SOLD AS A COMPONENT OF BEDS (U.S. CLS. 2, 13,
22, 25, 32 AND 50).

FIRST USE 6-0-2004; IN COMMERCE 6-0-2004.

2,999,063. LOUISVILLE LADDER GROUP LLC, LOUIS-
VILLE, KY. SN 78-321,811. PUB. 4-6-2004, FILED 10-31-2003.

LOGOLOCK

FOR NON-METAL LADDERS (U.S. CLS. 2, 13, 22, 25,
32 AND 50).
FIRST USE 7-5-2005; IN COMMERCE 7-5-2005.

CLASS 20—(Continued).

2,999,064. TECHLINE USA, LLC, MADISON, WI. SN 78-322,427. PUB. 7-20-2004, FILED 11-3-2003.

CLASS 20—(Continued).

2,999,251. CLAMP SWING PRICING CO., OAKLAND, CA. SN 78-416,136. PUB. 4-5-2005, FILED 5-10-2004.

FUNCTIONAL. BY DESIGN.

THE MARK CONSISTS OF STANDARD CHARACTERS WITHOUT CLAIM TO ANY PARTICULAR FONT, STYLE, SIZE, OR COLOR.

FOR HOUSEHOLD AND OFFICE FURNITURE (U.S. CLS. 2, 13, 22, 25, 32 AND 50).
FIRST USE 12-19-2003; IN COMMERCE 12-19-2003.

2,999,106. VOTYPKA, EDWARD A., CHAGRIN FALLS, OH. SN 78-342,086. PUB. 10-12-2004, FILED 12-17-2003.

HÖSTER

THE MARK CONSISTS OF STANDARD CHARACTERS WITHOUT CLAIM TO ANY PARTICULAR FONT, STYLE, SIZE, OR COLOR.

FOR NON-METAL HOLDERS FOR GARDEN HOSES (U.S. CLS. 2, 13, 22, 25, 32 AND 50).
FIRST USE 5-0-2004; IN COMMERCE 5-0-2004.

2,999,222. E P ENTERPRISES, LLC, GREENFIELD, WI. SN 78-393,159. PUB. 1-4-2005, FILED 3-30-2004.

BONKERS

THE MARK CONSISTS OF STANDARD CHARACTERS WITHOUT CLAIM TO ANY PARTICULAR FONT, STYLE, SIZE, OR COLOR.

FOR BENCHES (U.S. CLS. 2, 13, 22, 25, 32 AND 50).
FIRST USE 10-3-2004; IN COMMERCE 10-3-2004.

CHALK-IT UP

THE MARK CONSISTS OF STANDARD CHARACTERS WITHOUT CLAIM TO ANY PARTICULAR FONT, STYLE, SIZE, OR COLOR.

FOR PRINTED PLASTIC SIGNS USED TO IDENTIFY AND PRICE FOODS (U.S. CLS. 2, 13, 22, 25, 32 AND 50).
FIRST USE 4-16-2003; IN COMMERCE 4-16-2003.

CLASS 21—HOUSEWARES AND GLASS

2,998,646. HAGEMEYER NORTH AMERICA, INC., ALPHARETTA, GA. SN 76-482,668. PUB. 12-2-2003, FILED 1-16-2003.

CAMBAR

FOR SCRATCH BRUSHES FOR USE IN PAINT, RUST, AND DIRT REMOVAL; ACID AND PIPE DOPE BRUSHES FOR USE IN SOLDERING AND PLUMBING; AND FLOOR BRUSHES, MOPS, BROOMS, AND SCRUB BRUSHES FOR GENERAL CLEANING PURPOSES (U.S. CLS. 2, 13, 23, 29, 30, 33, 40 AND 50).
FIRST USE 1-1-2003; IN COMMERCE 1-1-2003.

2,998,713. JOHNSON & JOHNSON, NEW BRUNSWICK, NJ. SN 76-535,180. PUB. 5-11-2004, FILED 8-7-2003.

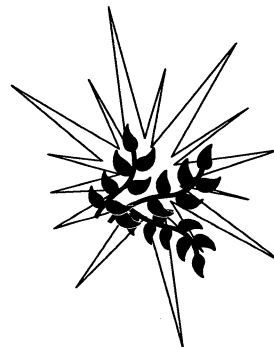

FOR DENTAL FLOSS (U.S. CLS. 2, 13, 23, 29, 30, 33, 40 AND 50).
FIRST USE 8-25-2003; IN COMMERCE 8-25-2003.

CLASS 21—(Continued).

2,998,742. MOORE, MARK, TALLAHASSEE, FL. SN 76-554,174. PUB. 7-27-2004, FILED 10-27-2003.

RAZORGATOR

NO CLAIM IS MADE TO THE EXCLUSIVE RIGHT TO USE "GATOR OR RAZOR", APART FROM THE MARK AS SHOWN.

FOR COSMETIC PRODUCTS, PERSONAL GROOMING AND HYGIENE PRODUCTS NAMELY CLEANING TOOL AND BRUSHES FOR SUCH PRODUCTS SUCH AS RAZORS, SHAVERS AND GROOMERS (U.S. CLS. 2, 13, 23, 29, 30, 33, 40 AND 50).

FIRST USE 10-1-2002; IN COMMERCE 3-1-2003.

2,998,756. TWO'S COMPANY, INC., MOUNT VERNON, NY. SN 76-563,057. PUB. 9-14-2004, FILED 12-3-2003.

CUPCAKES & CARTWHEELS

THE MARK CONSISTS OF STANDARD CHARACTERS WITHOUT CLAIM TO ANY PARTICULAR FONT, STYLE, SIZE, OR COLOR.

FOR HOUSEWARES AND GLASS, NAMELY, BEVERAGE GLASSWARE, EARTHENWARE, NAMELY, MUGS, CUPS, SAUCERS, PLATES, PLATTERS, PITCHERS, TRAYS, CAKE PLATTERS, FIGURINES AND SCULPTURES; VASES, FLOWER POTS AND FLOWER POT HOLDERS, CANDLE HOLDERS NOT OF PRECIOUS METAL; HAND EMBROIDERED AND NEEDLE-POINTED FABRIC HOUSEHOLD BOXES FOR HOLDING TISSUES AND STORING HATS (U.S. CLS. 2, 13, 23, 29, 30, 33, 40 AND 50).

FIRST USE 1-1-2004; IN COMMERCE 1-1-2004.

2,998,878. KARSTEN MANUFACTURING CORPORATION, PHOENIX, AZ. SN 78-184,239. PUB. 11-4-2003, FILED 11-12-2002.

PING

OWNER OF U.S. REG. NOS. 704,552, 1,638,323, AND OTHERS.

FOR WASTEPAPER BASKETS (U.S. CLS. 2, 13, 23, 29, 30, 33, 40 AND 50).

FIRST USE 12-18-2002; IN COMMERCE 12-18-2002.

2,998,913. CORRINGTON'S ALASKAN IVORY LTD., SKAGWAY, AK. SN 78-217,655. PUB. 2-24-2004, FILED 2-21-2003.

ALASKA EAGLE CLAWS

NO CLAIM IS MADE TO THE EXCLUSIVE RIGHT TO USE "ALASKA" AND "CLAWS", APART FROM THE MARK AS SHOWN.

FOR KITCHEN UTENSILS NAMELY, WOODEN SALAD CLAWS (U.S. CLS. 2, 13, 23, 29, 30, 33, 40 AND 50).

FIRST USE 5-0-2003; IN COMMERCE 5-0-2003.

CLASS 21—(Continued).

2,998,967. BIA CORDON BLEU, INC., SOUTH SAN FRANCISCO, CA. SN 78-263,290. PUB. 11-9-2004, FILED 6-17-2003.



OWNER OF U.S. REG. NOS. 2,092,798, 2,135,257, AND OTHERS.

THE MARK CONSISTS OF THE LETTERS BIA IN STYLIZED FORMAT IN A STYLIZED OVAL.

FOR CULINARY AND COOKING TOOLS AND UTENSILS FOR KITCHEN, PANTRY, BAR, AND TABLE USE, NAMELY COOKING UTENSILS, NAMELY COLANDERS FOR HOUSEHOLD USE, COOKERY MOLDS, COOKWARE, NAMELY POTS, CASSEROLES, ROASTING PANS, STEW POTS, SOUP POTS, STOCK POTS, DUTCH OVENS, SAUCEPANS, TANGINES; FLOUR SIFTERS; BAKEWARE, NAMELY BAKING PANS, BAKING MOLDS, BAKING CASSEROLES, PIE SERVING PLATES, CUPS, JUGS, MUGS, UTENSILS, NAMELY PLATTERS, TRAYS NOT OF PRECIOUS METAL, SERVING BOWLS, SALAD BOWLS, SERVING DISHES, SOUP TUREENS, TERRINES, QUICHE DISHES, SOUFFLÉ DISHES, BRULÉE DISHES, CERAMIC RAMEKINS, CUSTARD CUPS, BUTTER DISHES, SUGAR BOWLS, CREAMER PITCHERS, GRAVY BOATS, LADLES, SERVING SPOONS, CAKE STANDS, PIE PLATES, SAUCERS, NON-ELECTRIC COFFEE POTS AND COFFEE SERVERS NOT OF PRECIOUS METAL, NON-ELECTRIC TEA POTS AND TEA SERVERS NOT OF PRECIOUS METAL, COFFEE SERVICES NOT OF PRECIOUS METAL, TEA SERVICES NOT OF PRECIOUS METAL, CRUETS AND CRUET STANDS NOT OF PRECIOUS METAL, OLIVE OIL BOTTLES, VINEGAR BOTTLES, TRIVETS, VASES, SALT AND PEPPER BOWLS, AND SALT AND PEPPER SHAKERS, CHEESE SHAKERS, CHEESE SERVERS, EGG HOLDERS, DEVILED EGG PLATES, ARTICHOKE PLATES, ESCARGOT DISHES, FONDUE PLATES, OYSTER PLATES, CORN DISHES, POPCORN BOWLS, PASTA BOWLS, TORTILLA WARMERS, SALSA BOWLS, CHILI BOWLS, CHIP AND DIP PLATTERS; CANISTERS, CONTAINERS FOR FOOD AND BEVERAGES; DINNERWARE, NAMELY DISHES, BOWLS, CUPS, SAUCERS, MUGS, EGG CUPS; TABLE ORNAMENTS MADE OF CHINA, PORCELAIN, CERAMIC, AND GLASS; AND ACCESSORIES, NAMELY PLATE CHARGERS, NAPKIN RINGS NOT OF PRECIOUS METAL, CANDLE HOLDERS AND CANDLE STICKS NOT OF PRECIOUS METAL, KNIFE RESTS, SPOON RESTS, EARTHENWARE COASTERS, FLOWER POTS (U.S. CLS. 2, 13, 23, 29, 30, 33, 40 AND 50).

FIRST USE 5-23-2000; IN COMMERCE 5-26-2000.

CLASS 21—(Continued).

2,999,039. BRADSHAW INTERNATIONAL, INC., RANCHO CUCAMONGA, CA. SN 78-301,719. PUB. 9-21-2004, FILED 9-17-2003.



NO CLAIM IS MADE TO THE EXCLUSIVE RIGHT TO USE KITCHEN, APART FROM THE MARK AS SHOWN.
FOR KITCHEN BRUSHES (U.S. CLS. 2, 13, 23, 29, 30, 33, 40 AND 50).
FIRST USE 5-25-2003; IN COMMERCE 5-25-2003.

CLASS 21—(Continued).

2,999,086. HANA COBI CO., LTD., INCHEON, REPUBLIC OF KOREA. SN 78-333,682. PUB. 10-19-2004, FILED 11-26-2003.



OWNER OF U.S. REG. NOS. 2,509,283 AND 2,848,901.
NO CLAIM IS MADE TO THE EXCLUSIVE RIGHT TO USE "LOCK", APART FROM THE MARK AS SHOWN.
THE MARK CONSISTS OF "LOCK & LOCK SENSOR" IN STYLIZED CHARACTER FORM AND DESIGN.
FOR HOUSEHOLD UTENSILS NOT OF PRECIOUS METAL, NAMELY, SOAP DISHES; TRASH CANS; COOKING POTS; NON-ELECTRIC FRYING PANS; BOWLS; DISHES; PLATES; PLASTIC CUPS; GLASSES; CRUETS; KITCHEN LADLES; NON-ELECTRIC KITCHEN CONTAINERS; SERVING TRAYS; BUCKETS; ICE BUCKETS; BASINS; DRINKING VESSELS; THERMAL INSULATED BOTTLES FOR BEVERAGES AND FOOD FOR KEEPING WARM; PICNIC BOX CONTAINERS FOR FOODS AND HOUSEHOLD USE; NON-ELECTRIC KETTLES; TOOTHBRUSH CASES (U.S. CLS. 2, 13, 23, 29, 30, 33, 40 AND 50).
FIRST USE 9-23-2004; IN COMMERCE 9-23-2004.

2,999,050. WHITEHILL ORAL TECHNOLOGIES, INC., STAFFORD, TX. SN 78-307,237. PUB. 6-8-2004, FILED 9-30-2003.

40 PLUS

FOR DENTAL DEVICES, NAMELY DENTAL FLOSS AND TOOTHBRUSHES (U.S. CLS. 2, 13, 23, 29, 30, 33, 40 AND 50).
FIRST USE 9-24-2003; IN COMMERCE 11-30-2004.

2,999,121. CONAIR CORPORATION, STAMFORD, CT. SN 78-347,750. PUB. 10-12-2004, FILED 1-5-2004.

CLASSIC WOOD

THE MARK CONSISTS OF STANDARD CHARACTERS WITHOUT CLAIM TO ANY PARTICULAR FONT, STYLE, SIZE, OR COLOR.
NO CLAIM IS MADE TO THE EXCLUSIVE RIGHT TO USE "WOOD", APART FROM THE MARK AS SHOWN.
FOR HAIR BRUSHES AND COMBS (U.S. CLS. 2, 13, 23, 29, 30, 33, 40 AND 50).
FIRST USE 1-1-2004; IN COMMERCE 1-1-2004.

CLASS 21—(Continued).

2,999,142. ERGONOMIC DENTAL TECHNOLOGIES, INC., SAN FRANCISCO, CA. SN 78-354,830. PUB. 10-19-2004, FILED 1-21-2004.

CURVEX II

THE MARK CONSISTS OF STANDARD CHARACTERS WITHOUT CLAIM TO ANY PARTICULAR FONT, STYLE, SIZE, OR COLOR.

FOR TOOTHBRUSHES (U.S. CLS. 2, 13, 23, 29, 30, 33, 40 AND 50).

FIRST USE 11-4-2003; IN COMMERCE 11-4-2003.

CLASS 21—(Continued).

2,999,253. CGE ENTERPRISES, LLC, WESTON, VT. SN 78-419,144. PUB. 4-5-2005, FILED 5-14-2004.

GILHOLIE

THE MARK CONSISTS OF STANDARD CHARACTERS WITHOUT CLAIM TO ANY PARTICULAR FONT, STYLE, SIZE, OR COLOR.

FOR KITCHEN UTENSILS, NAMELY, BOTTLE AND JAR OPENERS (U.S. CLS. 2, 13, 23, 29, 30, 33, 40 AND 50). FIRST USE 2-0-2005; IN COMMERCE 2-0-2005.

CLASS 22—CORDAGE AND FIBERS

2,998,747. B.A.G. CORP., DALLAS, TX. SN 76-557,291. PUB. 10-5-2004, FILED 11-5-2003.

FLEXISTAK

THE MARK CONSISTS OF STANDARD CHARACTERS WITHOUT CLAIM TO ANY PARTICULAR FONT, STYLE, SIZE, OR COLOR.

FOR FLEXIBLE INTERMEDIATE BULK CONTAINERS IN THE NATURE OF BAGS USED FOR RECEIVING, TRANSPORTING, AND STORING FLOWABLE SOLID MATERIALS (U.S. CLS. 1, 2, 7, 19, 22, 42 AND 50). FIRST USE 4-30-2004; IN COMMERCE 4-30-2004.

2,999,207. OZERKOVSKY, ALEJANDRO PODOSWA, COLONIA CONDESA, D.F., MEXICO. SN 78-382,673. PUB. 1-4-2005, FILED 3-11-2004.

BALANCE ECONOCLEAN

THE MARK CONSISTS OF STANDARD CHARACTERS WITHOUT CLAIM TO ANY PARTICULAR FONT, STYLE, SIZE, OR COLOR.

FOR CLEANING WIPES MADE OF SYNTHETIC AND NATURAL ABSORBENT TEXTILES FOR CLEANING SURFACES AND ABSORBING LIQUIDS (U.S. CLS. 2, 13, 23, 29, 30, 33, 40 AND 50).

FIRST USE 6-0-2005; IN COMMERCE 6-0-2005.

2,998,757. HATTERAS HAMMOCKS, INC., GREENVILLE, NC. SN 76-563,450. PUB. 9-7-2004, FILED 12-5-2003.

DURAYARN

FOR FABRIC SOLD AS A COMPONENT PART OF HAMMOCKS (U.S. CLS. 1, 2, 7, 19, 22, 42 AND 50). FIRST USE 1-4-2005; IN COMMERCE 1-4-2005.

CLASS 22—(Continued).

2,999,239. SALISBURY, CLYDE E., CARLISLE, PA. SN 78-403,997. PUB. 2-22-2005, FILED 4-19-2004.

VENISON NECKTIE

THE MARK CONSISTS OF STANDARD CHARACTERS WITHOUT CLAIM TO ANY PARTICULAR FONT, STYLE, SIZE, OR COLOR.

NO CLAIM IS MADE TO THE EXCLUSIVE RIGHT TO USE "VENISON", APART FROM THE MARK AS SHOWN.

FOR NON-METAL SLINGS FOR MOVING GAME SUCH AS DEER, ELK AND THE LIKE (U.S. CLS. 1, 2, 7, 19, 22, 42 AND 50).

FIRST USE 7-1-2004; IN COMMERCE 11-18-2004.

CLASS 23—YARNS AND THREADS

2,998,718. ABSECON MILLS, INC., COLOGNE, NJ. SN 76-537,315. PUB. 4-13-2004, FILED 8-14-2003.

DUROVAY

FOR YARN FOR PRODUCING UPHOLSTERY FABRIC AND WALLCOVERINGS (U.S. CL. 43).

FIRST USE 7-0-2004; IN COMMERCE 7-0-2004.

CLASS 24—FABRICS

2,998,954. BRAVO FABRICS INTERNATIONAL, LLC, NEW YORK, NY. SN 78-251,146. PUB. 7-20-2004, FILED 5-16-2003.

BRAVO FABRICS

NO CLAIM IS MADE TO THE EXCLUSIVE RIGHT TO USE "FABRICS", APART FROM THE MARK AS SHOWN.

FOR FABRICS AND FABRIC TEXTILES USED IN THE MANUFACTURE OF DRAPERIES AND BED SPREADS (U.S. CLS. 42 AND 50).

FIRST USE 7-17-2003; IN COMMERCE 7-17-2003.

CLASS 24—(Continued).

2,999,078. ARMY AND AIR FORCE EXCHANGE SERVICE, DALLAS, TX. SN 78-328,685. PUB. 11-16-2004, FILED 11-17-2003.

Cherish the Luxury

THE MARK CONSISTS OF STANDARD CHARACTERS WITHOUT CLAIM TO ANY PARTICULAR FONT, STYLE, SIZE, OR COLOR.

FOR BATH TOWELS AND BEDDING, NAMELY, COMFORTERS, BED SHEETS, PILLOW CASES, PILLOW SHAMS, AND DUST RUFFLES (U.S. CLS. 42 AND 50).

FIRST USE 10-1-2004; IN COMMERCE 10-1-2004.

2,999,163. CHRIS MADDEN INC., PORT CHESTER, NY. SN 78-363,692. PUB. 11-9-2004, FILED 2-6-2004.

CHRIS MADDEN

THE MARK CONSISTS OF STANDARD CHARACTERS WITHOUT CLAIM TO ANY PARTICULAR FONT, STYLE, SIZE, OR COLOR.

THE NAME SHOWN IN THE MARK IDENTIFIES CHRIS MADDEN, A LIVING INDIVIDUAL WHOSE CONSENT IS OF RECORD.

FOR BATH LINENS, TOWELS, TEXTILE NAPKINS, PILLOW CASES AND SHAMS, TEXTILE OR PLASTIC PLACEMATS, CURTAINS, TAPESTRIES OF TEXTILE, TABLE LINEN AND CLOTHS, TEXTILE TABLE MATS (U.S. CLS. 42 AND 50).

FIRST USE 5-0-2004; IN COMMERCE 5-0-2004.

2,999,214. BALTIC LINEN COMPANY, INC., VALLEY STREAM, NY. SN 78-389,025. PUB. 12-21-2004, FILED 3-23-2004.

CHELSEA COLLECTION

THE MARK CONSISTS OF STANDARD CHARACTERS WITHOUT CLAIM TO ANY PARTICULAR FONT, STYLE,

CLASS 24—(Continued).

SIZE, OR COLOR.

OWNER OF U.S. REG. NO. 2,583,238.

NO CLAIM IS MADE TO THE EXCLUSIVE RIGHT TO USE "COLLECTION", APART FROM THE MARK AS SHOWN.

FOR BED BLANKETS, THROWS, BED SHEETS, MATTRESS COVERS, BED SPREADS, QUILTS, PILLOW CASES, SHAMS, COMFORTERS, COMFORTER SETS, DUVET COVERS, DUST RUFFLES, WASH CLOTHS, SHOWER CURTAINS, FABRIC CURTAINS, FABRIC VALANCES, DISH CLOTHS, KITCHEN TOWELS AND TABLE MATS NOT OF PAPER (U.S. CLS. 42 AND 50).
FIRST USE 6-30-2004; IN COMMERCE 6-30-2004.

2,999,240. KREICK, CHRISTINA, PISCATAWAY, NJ. SN 78-405,959. PUB. 1-25-2005, FILED 4-21-2004.

COVERMEES

THE MARK CONSISTS OF STANDARD CHARACTERS WITHOUT CLAIM TO ANY PARTICULAR FONT, STYLE, SIZE, OR COLOR.

FOR FABRIC COVERS FOR WINDOW BLINDS (U.S. CLS. 42 AND 50).

FIRST USE 5-1-2004; IN COMMERCE 5-1-2004.

CLASS 25—CLOTHING

2,998,508. PADRES L.P., SAN DIEGO, CA. SN 75-786,554. PUB. 11-20-2001, FILED 8-27-1999.

WESTERN METAL SUPPLY CO.

NO CLAIM IS MADE TO THE EXCLUSIVE RIGHT TO USE CO., APART FROM THE MARK AS SHOWN.

FOR CLOTHING NAMELY, SHIRTS, CAPS, T-SHIRTS, VISORS, HATS (U.S. CLS. 22 AND 39).

FIRST USE 4-0-2004; IN COMMERCE 4-0-2004.

2,998,547. KOLON FASHION CORPORATION, KWACHEON-CITY, REPUBLIC OF KOREA. SN 76-260,144. PUB. 4-20-2004, FILED 5-22-2001.

QUA

FOR CLOTHING, NAMELY, T-SHIRTS, UNDERWEAR, HATS, BELTS, AND OUTER WEAR, NAMELY, JACKETS (U.S. CLS. 22 AND 39).

FIRST USE 6-1-2001; IN COMMERCE 7-1-2001.

CLASS 25—(Continued).

2,998,634. NEW BALANCE ATHLETIC SHOE, INC., BOSTON, MA. SN 76-470,968. PUB. 4-13-2004, FILED 11-29-2002.

ISS

FOR FOOTWEAR (U.S. CLS. 22 AND 39).
FIRST USE 3-1-2003; IN COMMERCE 3-1-2003.

2,998,675. GEORGIEV, PLAMEN ZHELIAZKOV, NASHVILLE, TN. SN 76-515,161. PUB. 9-21-2004, FILED 5-19-2003.

VOODOO

FOR MEN AND WOMEN'S WEARING APPAREL, NAMELY, SHIRTS, GOLF SHIRTS, T-SHIRTS, SWEATSHIRTS, SWEATERS, JERSEYS, TURTLE-NECKS, GOLF SHIRTS, SHORTS, SWEATPANTS, WARM-UP SUITS, SPORT COATS, PANTS, JEANS, SKIRTS, SUITS, VESTS, JACKETS, COATS, PARKAS, PONCHOS, SWIMWEAR, BIKINIS, SWIM TRUNKS, OVERCOATS, RAINWEAR, WIND RESISTANT JACKETS, SLEEPWEAR, ROBES, UNDERWEAR, LINGERIE, BOXER SHIRTS, BELTS, TIES, HATS, WOOL HATS, CAPS, SCARVES, HEADBANDS, EAR MUFFS, WRISTBANDS, BATHROBES, BOXER SHORTS, PAJAMAS, CLOTH BIBS, TIES, SOCKS, HOSIERY, GLOVES, BRIEFS, UNDERSHIRTS, BOXER BRIEFS, SPORT SHORT (U.S. CLS. 22 AND 39).
FIRST USE 4-1-2005; IN COMMERCE 5-5-2002.

2,998,677. STREETCARS, INC., IRVING, TX. SN 76-520,025. PUB. 10-5-2004, FILED 6-6-2003.



NO CLAIM IS MADE TO THE EXCLUSIVE RIGHT TO USE ARCH SUPPORT COMFORT, APART FROM THE MARK AS SHOWN.

FOR FOOTWEAR (U.S. CLS. 22 AND 39).
FIRST USE 7-0-2003; IN COMMERCE 7-0-2003.

CLASS 25—(Continued).

2,998,700. E. LAND WORLD LTD., SEOUL, REPUBLIC OF KOREA. SN 76-529,893. PUB. 8-24-2004, FILED 7-16-2003.

petit lin

NO CLAIM IS MADE TO THE EXCLUSIVE RIGHT TO USE "LIN", APART FROM THE MARK AS SHOWN.

THE ENGLISH TRANSLATION OF PETIT LIN IS "SMALL FLAX".

FOR BATHROBES; BABIES' CLOTHING, NAMELY, PAJAMAS, BABY BUNTING, BOOTIES, INFANT CLOTH DIAPERS, NIGHT SHIRTS, NIGHTGOWNS, PLAYSUITS, ROMPERS, SLEEP SHIRTS, SLEEPWEAR, SNOWSUITS, JACKETS, SWEATERS, SHORTS AND SHIRTS; UNDERWEAR, PAJAMAS; BRASSIERES; UNDERPANTS, T-SHIRTS; PANTS, SWIMSUITS; BEACH CLOTHES, NAMELY, BEACH COVER-UPS; STOCKINGS; SOCKS; HATS AND CAPS; BATH SLIPPERS; AND GYMNASTIC SHOES (U.S. CLS. 22 AND 39).

FIRST USE 4-26-2003; IN COMMERCE 5-9-2005.

2,998,702. SHIMAMURA, SEIICHIRO, TOKYO, JAPAN. SN 76-530,251. PUB. 11-2-2004, FILED 7-7-2003.

0044

FOR CLOTHING, NAMELY, BELTS, CAPS, COATS, FOOTWEAR, HATS, JACKETS, OVERCOATS, PANTS, PULLOVERS, SHIRTS, SHOES, SKIRTS, SWEATERS, TEE-SHIRTS, TROUSERS, AND KNITWEAR, NAMELY, SWEATERS, MITTENS, KNIT SHIRTS, WAISTCOATS, VESTS, CARDIGANS, SHAWLS, SCARVES, KNIT CAPS, JUMPERS, AND KNIT HATS (U.S. CLS. 22 AND 39).

FIRST USE 7-30-1997; IN COMMERCE 12-30-2002.

2,998,708. SPORT ELLE, INC., NEW YORK, NY. SN 76-533,388. PUB. 4-13-2004, FILED 7-17-2003.

PRIMA BELLA

THE ENGLISH TRANSLATION OF PRIMA BELLA IS "FIRST BEAUTIFUL".

FOR CLOTHING FOR WOMEN, NAMELY, PANTS AND SLACKS (U.S. CLS. 22 AND 39).

FIRST USE 11-3-2004; IN COMMERCE 11-3-2004.

CLASS 25—(Continued).

2,998,744. RFR MANAGEMENT LLC, NEW YORK, NY. SN 76-556,779. PUB. 9-21-2004, FILED 10-21-2003.

UNGER

OWNER OF U.S. REG. NOS. 1,984,160, 2,500,982, AND OTHERS.

SEC. 2(F).

FOR WOMEN'S CLOTHING, NAMELY, BLAZERS, BLOUSES, DRESSES, JACKETS, PANTS, SUITS, SWEATERS, SHORTS, T-SHIRTS, SHIRTS, TOPS, BOTTOMS, JEANS, SKIRTS, PANT SUITS, AND RAINWEAR; MEN'S CLOTHING, NAMELY, BATHROBES, BELTS, COATS, HOSIERY, JACKETS, SLACKS, SHIRTS, SLEEPWEAR, SWEATERS, UNDERGARMENTS, AND FOOTWEAR (U.S. CLS. 22 AND 39).

FIRST USE 3-1-2004; IN COMMERCE 11-29-2004.

2,998,758. PRAIRIE MOUNTAIN, LOCKWOOD, MO. SN 76-563,977. PUB. 9-14-2004, FILED 12-8-2003.

ECO MOUNTAIN

THE MARK CONSISTS OF STANDARD CHARACTERS WITHOUT CLAIM TO ANY PARTICULAR FONT, STYLE, SIZE, OR COLOR.

FOR CLOTHING, NAMELY, T-SHIRTS AND SWEATSHIRTS (U.S. CLS. 22 AND 39).

FIRST USE 3-1-2004; IN COMMERCE 3-1-2004.

2,998,847. BLACKHAT, INC., SEATTLE, WA. SN 78-092,266. PUB. 3-18-2003, FILED 11-7-2001.

BLACK HAT

FOR CLOTHING, NAMELY, T-SHIRTS, JACKETS, AND SWEATSHIRTS (U.S. CLS. 22 AND 39).

FIRST USE 12-31-1996; IN COMMERCE 7-9-1997.

2,998,971. KREUZER, TANYA, MESA, AZ. SN 78-265,178. PUB. 4-13-2004, FILED 6-20-2003.

BASSNBABE

FOR CLOTHING AND HEADGEAR FOR ADULTS AND CHILDREN SUITABLE FOR WEAR DURING FISHING ACTIVITIES, NAMELY, BASEBALL CAPS, VISORS, T-SHIRTS, TANK TOPS, BUTTON DOWN DRESS FISHING TEAM SHIRTS, WIND RESISTANT PANTS, AND WIND-RESISTANT JACKETS; CLOTHING FOR BABIES, NAMELY, SHIRTS, JACKETS, PANTS AND ONE-PIECE T-SHIRTS (U.S. CLS. 22 AND 39).

FIRST USE 3-1-2005; IN COMMERCE 3-1-2005.

CLASS 25—(Continued).

2,998,987. AIRWAIR INTERNATIONAL LTD., WOLLASTON, NORTHAMPTONSHIRE, UNITED KINGDOM. SN 78-274,905. PUB. 11-9-2004, FILED 7-16-2003.

SoftWair

OWNER OF U.S. REG. NOS. 1,940,547, 1,940,548, AND 1,946,294.
FOR FOOTWEAR (U.S. CLS. 22 AND 39).
FIRST USE 12-1-2003; IN COMMERCE 12-1-2003.

2,998,995. CROWN PRINCE, INC., FRANKLIN, WI. SN 78-278,167. PUB. 3-22-2005, FILED 7-24-2003.



FOR CLOTHING, NAMELY, SHIRTS, T-SHIRTS, SWEAT SHIRTS, JERSEYS, PANTS, SWEAT PANTS, SHORTS, PULLOVERS, JACKETS (U.S. CLS. 22 AND 39).
FIRST USE 7-1-2003; IN COMMERCE 10-1-2003.

CLASS 25—(Continued).

2,999,003. PROCOVAL USA, LLC, WESTON, FL. SN 78-279,486. PUB. 7-20-2004, FILED 7-28-2003.



FOR CLOTHING, NAMELY, SHIRTS, PANTS, SHORTS, ATHLETIC UNIFORMS, FOOTWEAR, HATS, AND CAPS (U.S. CLS. 22 AND 39).
FIRST USE 4-1-2005; IN COMMERCE 4-1-2005.

2,999,006. CHARLES KOMAR & SONS, INC., NEW YORK, NY. SN 78-284,021. PUB. 9-28-2004, FILED 8-6-2003.

MOON DANCE

FOR CLOTHING, NAMELY, UNDERWEAR, SLEEPWEAR, LOUNGEWEAR, LINGERIE, JUMPSUITS, PANTS, PAJAMAS, ROMPERS, ROBES, NIGHTSHIRTS, DRESSES, SKIRTS, TOPS, SHIRTS, DUSTERS, SOCKS AND SLIPPERS (U.S. CLS. 22 AND 39).
FIRST USE 8-0-2003; IN COMMERCE 8-0-2003.

2,999,014. CARDEN TRAN, NEW YORK, NY. SN 78-288,822. PUB. 11-9-2004, FILED 8-18-2003.

TRUST FUND BABY

NO CLAIM IS MADE TO THE EXCLUSIVE RIGHT TO USE BABY, APART FROM THE MARK AS SHOWN.
FOR INFANT, TODDLER'S AND CHILDREN'S APPAREL, NAMELY TOPS, SHORTS, PANTS, JACKETS, JUMPERS, LAYETTES, INFANTWEAR, SWEATERS, HATS, SWIMWEAR, HOSIERY, SHIRTS AND T-SHIRTS (U.S. CLS. 22 AND 39).
FIRST USE 9-20-2004; IN COMMERCE 9-20-2004.

CLASS 25—(Continued).

2,999,085. YO LATINO, INC., ORLANDO, FL. SN 78-333,307.
PUB. 9-21-2004, FILED 11-25-2003.

YO LATINO

THE MARK CONSISTS OF STANDARD CHARACTERS WITHOUT CLAIM TO ANY PARTICULAR FONT, STYLE, SIZE, OR COLOR.

THE FOREIGN WORDING IN THE MARK TRANSLATES INTO ENGLISH AS I AM AN HISPANIC MAN.

FOR MEN'S, WOMEN'S AND CHILDREN'S CLOTHING, NAMELY, SHIRTS AND T-SHIRTS (U.S. CLS. 22 AND 39).

FIRST USE 4-23-2005; IN COMMERCE 6-13-2005.

CLASS 25—(Continued).

2,999,115. GIRLS WHEREVER, KNOXVILLE, TN. SN 78-346,531. PUB. 10-26-2004, FILED 12-30-2003.

GIRLS WHEREVER

THE MARK CONSISTS OF STANDARD CHARACTERS WITHOUT CLAIM TO ANY PARTICULAR FONT, STYLE, SIZE, OR COLOR.

NO CLAIM IS MADE TO THE EXCLUSIVE RIGHT TO USE "GIRLS", APART FROM THE MARK AS SHOWN.

FOR CLOTHING, NAMELY SHIRTS, HATS, JACKETS, CLOTH BIBS, SCARVES, SOCKS, GLOVES, HEADBANDS, PANTS, AND LINGERIE (U.S. CLS. 22 AND 39).

FIRST USE 2-21-2004; IN COMMERCE 2-21-2004.

2,999,090. WALLS, TIMOTHY ROBERT, WEST BADEN SPRINGS, IN. SN 78-335,192. PUB. 10-26-2004, FILED 12-2-2003.

A.P.B.T. RACING FRENCH LICK, IN.

THE MARK CONSISTS OF STANDARD CHARACTERS WITHOUT CLAIM TO ANY PARTICULAR FONT, STYLE, SIZE, OR COLOR.

NO CLAIM IS MADE TO THE EXCLUSIVE RIGHT TO USE "FRENCH LICK, IN.", APART FROM THE MARK AS SHOWN.

FOR CLOTHING, NAMELY, T-SHIRTS, SWEAT SHIRTS, TOBOGGANS, HATS, COATS, SHORTS, PANTIES, SWEAT BANDS, SWEAT PANTS, SWEAT SHORTS, AND SWEAT SUITS (U.S. CLS. 22 AND 39).

FIRST USE 3-0-2004; IN COMMERCE 3-0-2005.

2,999,154. WAX, INC., NEW YORK, NY. SN 78-359,502. PUB. 11-2-2004, FILED 1-29-2004.



FOR ATHLETIC SHOES, BATHING SUITS, BATH-ROBES, BEACHWEAR, COATS, GLOVES, HATS, HOSIERY, JACKETS, JEANS, PAJAMAS, PANTS, SANDALS, SHIRTS, SOCKS, SWEATERS, SWEATSUITS, SWEAT-SHIRTS, T-SHIRTS, UNDERWEAR (U.S. CLS. 22 AND 39).

FIRST USE 8-19-2004; IN COMMERCE 8-19-2004.

CLASS 25—(Continued).

2,999,155. HILLERICH & BRADSBY CO., LOUISVILLE, KY.
SN 78-360,379. PUB. 10-26-2004, FILED 1-30-2004.

CLASS 25—(Continued).

2,999,190. THE TJX COMPANIES, INC., FRAMINGHAM,
MA. SN 78-376,062. PUB. 9-21-2004, FILED 3-1-2004.

YOUR HANDS ARE THE
MOST PRECIOUS TOOL
YOU OWN.

PIPER & POSIE

THE MARK CONSISTS OF STANDARD CHARACTERS
WITHOUT CLAIM TO ANY PARTICULAR FONT, STYLE,
SIZE, OR COLOR.

FOR GLOVES (U.S. CLS. 22 AND 39).
FIRST USE 10-14-2002; IN COMMERCE 10-14-2002.

THE MARK CONSISTS OF STANDARD CHARACTERS
WITHOUT CLAIM TO ANY PARTICULAR FONT, STYLE,
SIZE, OR COLOR.

FOR CHILDREN'S APPAREL, NAMELY, TOPS, BOT-
TOMS, SWEATERS, DRESSES, JUMPERS, PAJAMAS,
ROBES, NIGHTGOWNS, JACKETS AND OVERALLS
(U.S. CLS. 22 AND 39).

FIRST USE 10-12-2004; IN COMMERCE 10-12-2004.

2,999,170. CARHARTT, INC., DEARBORN, MI. SN 78-366,921.
PUB. 11-9-2004, FILED 2-12-2004.

2,999,215. CARHARTT, INC., DEARBORN, MI. SN 78-389,458.
PUB. 4-12-2005, FILED 3-23-2004.

CARHARTT

Carhartt 

THE MARK CONSISTS OF STANDARD CHARACTERS
WITHOUT CLAIM TO ANY PARTICULAR FONT, STYLE,
SIZE, OR COLOR.

OWNER OF U.S. REG. NOS. 1,193,235, 1,861,628, AND
OTHERS.

SEC. 2(F).
FOR FOOTWEAR (U.S. CLS. 22 AND 39).
FIRST USE 1-31-2005; IN COMMERCE 1-31-2005.

OWNER OF U.S. REG. NOS. 1,193,235, 1,836,639, AND
OTHERS.

THE COLOR(S) BROWN AND RED IS/ARE CLAIMED AS
A FEATURE OF THE MARK.

THE MARK CONSISTS OF THE WORD "CARHARTT"
AND A LABEL DISPLAYING THE STYLIZED LETTER "C"
IN BROWN AND THE WORD "CARHARTT" IN RED.

FOR FOOTWEAR (U.S. CLS. 22 AND 39).
FIRST USE 1-31-2005; IN COMMERCE 1-31-2005.

CLASS 25—(Continued).

2,999,219. EPNER, PAUL, RAMONA, CA. SN 78-392,454. PUB. 1-4-2005, FILED 3-29-2004.

CLASS 25—(Continued).

2,999,221. ROBLES, CARLOS ALBERTO, LOS ANGELES, CA. SN 78-392,936. PUB. 2-8-2005, FILED 3-30-2004.



Paolo

THE COLOR(S) RED, YELLOW, LIGHT BROWN, BLACK, LIGHT PEACH, WHITE IS/ARE CLAIMED AS A FEATURE OF THE MARK.

THE COLOR RED APPEARS IN THE COWBOY HATS, GLOVES, SHIRT SLEEVES, BOOTS, AND WOODEN PLANKS AT CENTER OF THE DESIGN; THE COLOR YELLOW APPEARS IN EACH ONE OF THE LEMON FIGURES, IN THE LETTERS "L", "E", "M", AND "N" OF THE WORD "LEMON"; THE COLOR BROWN APPEARS IN THE GUN BELTS, IN THE MUSTACHE OF THE UPPER LEFT FIGURE, IN THE HAIR AND FRECKLES OF THE LOWER RIGHT FIGURE, IN THE WORDING "THE" AND "COWBOYS"; THE COLOR PEACH APPEARS IN THE ARMS AND LEGS OF THE FIGURES; THE COLOR BLACK APPEARS IN THE GLASSES OF THE FIGURES, IN THE MUSTACHE AND EYEBROWS OF THE UPPER RIGHT FIGURE, IN THE MUSTACHE OF THE LOWER LEFT FIGURE, AND IN GUN(S) THAT EACH FIGURE CARRIES.

THE MARK CONSISTS OF FIVE YELLOW LEMONS WEARING RED COWBOY HAT'S AND GLOVE'S AND BOOTS AND RED T-SHIRT SLEEVES AND WEARING A LIGHT BROWN BELT HOLDING BLACK GUN, WITH ARMS AND LEGS IN LIGHT PEACH COLOR TWO LEMONS WITH BLACK MUSTACHE (ONE BLACK MUSTACHE AND BLACK BIG EYEBROWS), ONLY ONE WITH LIGHT BROWN MUSTACHE AND BLACK GLASSES, AND ONE WITH BLACK GLASSES, AND ONE WITH LIGHT BROWN FRECKLES AND HAIR AND BIG TOOTH, AND A LOGO ON THE CENTER THAT SAYS THE LEMON COWBOYS.

FOR MENS, WOMENS, AND CHILDREN'S CLOTHING, NAMELY, SHIRTS, T-SHIRTS, SWEATERS, SHOES, CAPS, BANDANNAS, SHORTS, SWEATSHIRTS, PANTS, SOCKS, SWIM WEAR, JACKETS, RAIN WEAR, BLOUSES, DRESSES, FOOTWEAR, HATS, HEAD BANDS, WRIST BANDS, PAJAMAS AND SLEEP WEAR (U.S. CLS. 22 AND 39).

FIRST USE 1-5-2005; IN COMMERCE 1-5-2005.

2,999,224. CLUETT PEABODY RESOURCES CORPORATION, NEW YORK, NY. SN 78-393,868. PUB. 10-19-2004, FILED 3-31-2004.



THE MARK CONSISTS OF STANDARD CHARACTERS WITHOUT CLAIM TO ANY PARTICULAR FONT, STYLE, SIZE, OR COLOR.

FOR CLOTHING, NAMELY PANTS, SHIRTS, JACKETS, UNDERWEAR, SOCKS AND HATS (U.S. CLS. 22 AND 39).

FIRST USE 1-5-2004; IN COMMERCE 1-5-2004.

OWNER OF U.S. REG. NOS. 1,307,135, 1,833,378, AND 1,879,843.

FOR JACKETS; LEATHER JACKETS (U.S. CLS. 22 AND 39).

FIRST USE 7-31-2004; IN COMMERCE 7-31-2004.

CLASS 25—(Continued).

2,999,285. L.C. LICENSING, INC., NEW YORK, NY. SN 78-976,315. PUB. 8-31-2004, FILED 4-26-2004.

SWE

THE MARK CONSISTS OF STANDARD CHARACTERS WITHOUT CLAIM TO ANY PARTICULAR FONT, STYLE, SIZE, OR COLOR.

FOR SHIRTS, BLOUSES, AND SWEATERS (U.S. CLS. 22 AND 39).

FIRST USE 7-1-2004; IN COMMERCE 7-1-2004.

2,999,286. GFY BEVERAGES COMPANY, NEW YORK, NY. SN 78-976,326. PUB. 11-9-2004, FILED 9-26-2003.



OWNER OF U.S. REG. NOS. 2,498,605, 2,577,395, AND OTHERS.

NO CLAIM IS MADE TO THE EXCLUSIVE RIGHT TO USE "AUTENTICO", APART FROM THE MARK AS SHOWN.

THE STIPPLING IS FOR SHADING PURPOSES ONLY. THE FOREIGN WORDING IN THE MARK TRANSLATES INTO ENGLISH AS AUTHENTIC.

FOR CLOTHING NAMELY, T-SHIRTS (U.S. CLS. 22 AND 39).

FIRST USE 11-30-2001; IN COMMERCE 11-30-2001.

CLASS 26—FANCY GOODS**CLASS 26—(Continued).**

2,999,040. LISA FRANK, INC., TUCSON, AZ. SN 78-302,335. PUB. 6-29-2004, FILED 9-18-2003.

HAIR GLAM

NO CLAIM IS MADE TO THE EXCLUSIVE RIGHT TO USE "HAIR", APART FROM THE MARK AS SHOWN.

FOR HAIR ACCESSORIES, NAMELY HAIR CLIPS AND CLAW CLIPS, HAIR SCRUNCHIES, PONY TAIL HOLDERS, BOWS FOR HAIR, BEADS FOR HAIR, ELASTIC CORDING FOR HAIR, HAIR ACCESSORY KITS CONSISTING PRIMARILY OF HAIR CLIPS, HAIR SCRUNCHIES, HAIR BOWS, HAIR BEADS, OR ELASTIC CORDING FOR HAIR AND HAIR COMB, HAIR BRUSH, OR A COMPACT MIRROR (U.S. CLS. 37, 39, 40, 42 AND 50).

FIRST USE 2-6-2003; IN COMMERCE 2-6-2003.

2,999,164. CHRIS MADDEN INC., PORT CHESTER, NY. SN 78-363,712. PUB. 11-9-2004, FILED 2-6-2004.

CHRIS MADDEN

THE MARK CONSISTS OF STANDARD CHARACTERS WITHOUT CLAIM TO ANY PARTICULAR FONT, STYLE, SIZE, OR COLOR.

THE NAME SHOWN IN THE MARK IDENTIFIES CHRIS MADDEN, A LIVING INDIVIDUAL WHOSE CONSENT IS OF RECORD.

FOR ARTIFICIAL FLOWERS, WREATHS AND GARLANDS (U.S. CLS. 37, 39, 40, 42 AND 50).

FIRST USE 5-0-2004; IN COMMERCE 5-0-2004.

CLASS 27—FLOOR COVERINGS

2,998,821. MANNINGTON MILLS, INC., SALEM, NJ. SN 76-587,396. PUB. 1-25-2005, FILED 4-20-2004.

CAMEO

THE MARK CONSISTS OF STANDARD CHARACTERS WITHOUT CLAIM TO ANY PARTICULAR FONT, STYLE, SIZE, OR COLOR.

FOR VINYL FLOOR COVERINGS (U.S. CLS. 19, 20, 37, 42 AND 50).

FIRST USE 5-1-2005; IN COMMERCE 5-1-2005.

CLASS 27—(Continued).

2,999,011. VERA BRADLEY DESIGNS, INC., FORT WAYNE, IN. SN 78-287,680. PUB. 5-11-2004, FILED 8-14-2003.



OWNER OF U.S. REG. NO. 1,745,799.
THE NAME(S), PORTRAIT(S), AND/OR SIGNATURE(S)
SHOWN IN THE MARK DOES NOT IDENTIFY A PARTICULAR LIVING INDIVIDUAL.
FOR RUGS (U.S. CLS. 19, 20, 37, 42 AND 50).
FIRST USE 4-0-2005; IN COMMERCE 4-0-2005.

CLASS 28—TOYS AND SPORTING GOODS

2,998,513. BRUNSWICK BOWLING & BILLIARDS CORPORATION, LAKE FOREST, IL. SN 75-931,839. PUB. 7-31-2001, FILED 2-28-2000.

MONSTER

FOR BOWLING BALLS (U.S. CLS. 22, 23, 38 AND 50).
FIRST USE 6-15-2000; IN COMMERCE 6-15-2000.

2,998,556. KONAMI CORPORATION, TOKYO, JAPAN. SN 76-319,453. PUB. 4-16-2002, FILED 9-28-2001.

BEAST OF GILFER

FOR *BOARD GAMES, CARD GAMES, ACTION FIGURES AND DOLLS (U.S. CLS. 22, 23, 38 AND 50).
FIRST USE 7-0-2004; IN COMMERCE 7-0-2004.

2,998,600. DAVIES, GARTH W., LUXEMBURG, WI. AND PERONTO, ALVIN L., LUXEMBURG, WI. SN 76-431,000. PUB. 5-25-2004, FILED 7-15-2002.

FROZEN TUNDRA

FOR NOVELTY ITEM, NAMELY AN ARTIFICIAL REPRESENTATION OF FROZEN SOIL WITH VEGETATION (U.S. CLS. 22, 23, 38 AND 50).
FIRST USE 11-15-2002; IN COMMERCE 11-15-2002.

CLASS 28—(Continued).

2,998,606. HASBRO, INC., PAWTUCKET, RI. SN 76-436,996. PUB. 4-15-2003, FILED 8-2-2002.

FIRE-BOT

FOR TOY ACTION FIGURES AND TOY VEHICLES AND TOY ROBOTS CONVERTIBLE INTO OTHER VISUAL FORMS (U.S. CLS. 22, 23, 38 AND 50).
FIRST USE 12-5-2002; IN COMMERCE 12-5-2002.

2,998,619. GEN-X SPORTS SARL, CH-1630, BULLE, SWITZERLAND. SN 76-457,879. PUB. 6-1-2004, FILED 10-7-2002.

RAM LASER

OWNER OF U.S. REG. NOS. 1,089,318, 1,366,847, AND 2,439,218.

FOR GOLF CLUBS, GOLF CLUB HEAD COVERS, GOLF BAGS, GOLF ACCESSORIES, NAMELY, GOLF BALLS AND GOLF GLOVES (U.S. CLS. 22, 23, 38 AND 50).

FIRST USE 3-29-2005; IN COMMERCE 3-29-2005.

2,998,683. SWINGSCOPE INC., TORONTO, ONTARIO, CANADA. SN 76-523,755. PUB. 10-26-2004, FILED 6-16-2003.

SWINGSCOPE

PRIORITY CLAIMED UNDER SEC. 44(D) ON CANADA APPLICATION NO. 1162805, FILED 12-18-2002.

FOR GOLF ACCESSORIES AND EQUIPMENT, NAMELY A GOLF SWING TRAINING AID IN THE NATURE OF A HIP AND LEG SENSOR TO BE WORN BY A GOLFER (U.S. CLS. 22, 23, 38 AND 50).

FIRST USE 9-22-2003; IN COMMERCE 9-22-2003.

2,998,693. PRIME NOVELTY, L.L.C., PORT NECHES, TX. SN 76-526,742. PUB. 5-18-2004, FILED 6-23-2003.

POOTER TOOTER

FOR NOVELTY ITEM IN THE NATURE OF A HAND-HELD, AIR-FILLED RUBBER CYLINDER WITH A PLASTIC TOP THAT MAKES A FUNNY NOISE WHEN SQUEEZED (U.S. CLS. 22, 23, 38 AND 50).

FIRST USE 12-1-1982; IN COMMERCE 12-1-1982.

2,998,727. HASBRO, INC., PAWTUCKET, RI. SN 76-542,506. PUB. 6-29-2004, FILED 9-4-2003.

SUPER SCRABBLE

OWNER OF U.S. REG. NOS. 802,995, 1,136,336, AND OTHERS.

FOR BOARD GAMES (U.S. CLS. 22, 23, 38 AND 50).
FIRST USE 9-8-2003; IN COMMERCE 9-8-2003.

CLASS 28—(Continued).

2,998,790. HASBRO, INC., PAWTUCKET, RI. SN 76-575,597.
PUB. 11-9-2004, FILED 2-17-2004.

BARRICADE

THE MARK CONSISTS OF STANDARD CHARACTERS WITHOUT CLAIM TO ANY PARTICULAR FONT, STYLE, SIZE, OR COLOR.

FOR TOY ACTION FIGURES, TOY VEHICLES AND TOY ROBOTS CONVERTIBLE INTO OTHER VISUAL TOY FORMS (U.S. CLS. 22, 23, 38 AND 50).

FIRST USE 2-4-2005; IN COMMERCE 2-4-2005.

2,998,794. LANARD TOYS LIMITED, HONG KONG SAR, HONG KONG. SN 76-577,390. PUB. 3-29-2005, FILED 2-9-2004.

MUSCLE CHALLENGE

THE MARK CONSISTS OF STANDARD CHARACTERS WITHOUT CLAIM TO ANY PARTICULAR FONT, STYLE, SIZE, OR COLOR.

NO CLAIM IS MADE TO THE EXCLUSIVE RIGHT TO USE "MUSCLE", APART FROM THE MARK AS SHOWN.

FOR TOY VEHICLES AND ACCESSORIES THEREFOR; TOY VEHICLE PLAYSETS (U.S. CLS. 22, 23, 38 AND 50).

FIRST USE 7-3-2004; IN COMMERCE 7-3-2004.

2,998,801. HASBRO, INC., PAWTUCKET, RI. SN 76-580,224.
PUB. 12-21-2004, FILED 3-10-2004.

ENERGON KICKER

THE MARK CONSISTS OF STANDARD CHARACTERS WITHOUT CLAIM TO ANY PARTICULAR FONT, STYLE, SIZE, OR COLOR.

OWNER OF U.S. REG. NO. 2,872,403.

FOR TOY ACTION FIGURES, TOY VEHICLES AND TOY ROBOTS CONVERTIBLE INTO OTHER VISUAL TOY FORMS (U.S. CLS. 22, 23, 38 AND 50).

FIRST USE 12-3-2004; IN COMMERCE 12-3-2004.

CLASS 28—(Continued).

2,998,841. LIGHT WAVE, LTD., RENO, NV. SN 78-058,350.
PUB. 9-2-2003, FILED 4-13-2001.

WAVE IN A BOX

FOR AMUSEMENT PARK RIDES, NAMELY, SIMULATED SURFING WATER RIDES; SPORTING GOODS, NAMELY, FLOW BOARDS AND FLOW-BOARD BAGS, AND BODY BOARDS AND BODY-BOARD BAGS (U.S. CLS. 22, 23, 38 AND 50).

FIRST USE 1-0-2002; IN COMMERCE 1-0-2002.

2,998,865. SYNAPSE FITNESS, INC., ALISO VIEJO, CA. SN 78-150,280. PUB. 11-9-2004, FILED 8-2-2002.



FOR EXERCISE EQUIPMENT, NAMELY AN APPARATUS USED TO ASSIST WITH ABDOMINAL EXERCISES (U.S. CLS. 22, 23, 38 AND 50).

FIRST USE 6-30-2003; IN COMMERCE 6-30-2003.

2,998,915. KB HOLDINGS, LLC, LAS VEGAS, NV. SN 78-219,253. PUB. 10-21-2003, FILED 2-26-2003.

CRITTER CORNER

FOR PLUSH TOYS (U.S. CLS. 22, 23, 38 AND 50).
FIRST USE 5-31-2003; IN COMMERCE 5-31-2003.

2,998,938. BODY-SOLID, INC., FOREST PARK, IL. SN 78-236,264. PUB. 9-14-2004, FILED 4-10-2003.

POWERLINE

OWNER OF U.S. REG. NO. 2,000,771.

FOR EXERCISE MACHINES, EXERCISE BENCHES, MANUALLY OPERATED EXERCISE EQUIPMENT, STATIONARY EXERCISE BICYCLES, EXERCISE STAIR-STEPPING MACHINES, EXERCISE TREADMILLS AND MANUALLY OPERATED AEROBIC EXERCISE EQUIPMENT (U.S. CLS. 22, 23, 38 AND 50).

FIRST USE 3-9-2002; IN COMMERCE 3-9-2002.

CLASS 28—(Continued).

2,998,950. WNBA ENTERPRISES, LLC, SECAUCUS, NJ. SN 78-246,396. PUB. 4-13-2004, FILED 5-6-2003.



NO CLAIM IS MADE TO THE EXCLUSIVE RIGHT TO USE "CONNECTICUT", APART FROM THE MARK AS SHOWN.

FOR TOYS, GAMES AND SPORTING GOODS, NAMELY BASKETBALLS, GOLF BALLS, PLAYGROUND BALLS, SPORTS BALLS, RUBBER ACTION BALLS AND FOAM ACTION BALLS, PLUSH BALLS, BASKETBALL NETS, BASKETBALL BACKBOARDS, PUMPS FOR INFLATING BASKETBALLS, AND NEEDLES THEREFOR, GOLF CLUBS, GOLF BAGS, GOLF PUTTERS, GOLF ACCESSORIES, NAMELY, DIVOT REPAIR TOOLS, TEES, BALL MARKERS, GOLF BAG COVERS, CLUB HEAD COVERS, GOLF GLOVES, GOLF BALL SLEEVES, ELECTRONIC BASKETBALL TABLE TOP GAMES, BASKETBALL TABLE TOP GAMES, BASKETBALL BOARD GAMES, ACTION SKILL GAMES, ADULT'S AND CHILDREN'S PARTY GAMES, TRIVIA INFORMATION GAMES AND ELECTRONIC VIDEO ARCADE GAME MACHINES, BASKETBALL KIT COMPRISED OF A NET AND WHISTLE, DOLLS, DECORATIVE DOLLS, COLLECTIBLE DOLLS, TOY ACTION FIGURES, BOBBLEHEAD ACTION FIGURES, STUFFED TOYS, JIGSAW PUZZLES AND CHRISTMAS TREE ORNAMENTS, CHRISTMAS STOCKINGS; TOY VEHICLES IN THE NATURE OF CARS, TRUCKS AND VANS, ALL CONTAINING BASKETBALL THEMES, TOY FINGERS AND PLAYING CARDS (U.S. CLS. 22, 23, 38 AND 50).

FIRST USE 5-6-2003; IN COMMERCE 5-6-2003.

CLASS 28—(Continued).

2,998,975. CBS BROADCASTING INC., NEW YORK, NY. SN 78-269,614. PUB. 10-12-2004, FILED 7-2-2003.



OWNER OF U.S. REG. NO. 1,715,262.
FOR TOYS, NAMELY STUFFED TOYS, STUFFED ANIMALS, PLUSH TOYS, AND PLAY FIGURES; DECORATIONS FOR CHRISTMAS TREES (U.S. CLS. 22, 23, 38 AND 50).

FIRST USE 3-16-2000; IN COMMERCE 6-16-2000.

2,999,015. MATTEL, INC., EL SEGUNDO, CA. SN 78-289,674. PUB. 10-12-2004, FILED 8-20-2003.

CRUNCH

OWNER OF U.S. REG. NOS. 2,333,802, 2,411,332, AND 2,457,398.

FOR TOYS, GAMES, AND PLAYTHINGS, NAMELY, TOY FIGURES AND ACCESSORIES THEREFOR (U.S. CLS. 22, 23, 38 AND 50).

FIRST USE 12-2-2003; IN COMMERCE 12-2-2003.

2,999,016. MATTEL, INC., EL SEGUNDO, CA. SN 78-289,733. PUB. 10-5-2004, FILED 8-20-2003.

STRETCH-U-V

FOR TOYS, GAMES AND PLAYTHINGS, NAMELY, DOLLS, DOLL CLOTHING AND DOLL ACCESSORIES, TOY VEHICLES AND ACCESSORIES (U.S. CLS. 22, 23, 38 AND 50).

FIRST USE 12-9-2003; IN COMMERCE 12-9-2003.

2,999,042. SILBER, ROGER, SAN DIEGO, CA. SN 78-303,062. PUB. 12-28-2004, FILED 9-19-2003.

STRANGE ATTRACTORS

FOR CONSTRUCTION TOYS, AND STRUCTURAL MODELING SYSTEMS COMPRISED OF RODS OR TUBES WITH MAGNETIC TIPS AND FERROMAGNETIC BALLS (U.S. CLS. 22, 23, 38 AND 50).

FIRST USE 7-14-2005; IN COMMERCE 7-14-2005.

CLASS 28—(Continued).

2,999,094. HOMEGROWN KIDS, INC., MANHATTAN BEACH, CA. SN 78-338,031. PUB. 1-25-2005, FILED 12-8-2003.

TOY TACO

THE MARK CONSISTS OF STANDARD CHARACTERS WITHOUT CLAIM TO ANY PARTICULAR FONT, STYLE, SIZE, OR COLOR.

NO CLAIM IS MADE TO THE EXCLUSIVE RIGHT TO USE "TOY", APART FROM THE MARK AS SHOWN.

FOR CARRYING CASES FOR TOYS AND PLAY MATS CONTAINING INFANT TOYS AND FOR USE WITH CHILDREN'S GAMES AND TOYS (U.S. CLS. 22, 23, 38 AND 50).

FIRST USE 2-29-2004; IN COMMERCE 11-30-2004.

2,999,127. PEARSON, KENT D., ANTELOPE, CA. AND PEARSON, MELANIE A., ANTELOPE, CA. SN 78-349,904. PUB. 11-9-2004, FILED 1-9-2004.



NO CLAIM IS MADE TO THE EXCLUSIVE RIGHT TO USE "3D POOL", APART FROM THE MARK AS SHOWN.

THE MARK CONSISTS OF THE STYLIZED NUMBER 3 NEXT TO THE STYLIZED LETTER D ABOVE TWO CURVED SHAPES SURROUNDING THE NUMBER 8 WITH THE STYLIZED LETTERS POOL BELOW THE CURVED SHAPES.

FOR PLASTIC GAME TABLES (U.S. CLS. 22, 23, 38 AND 50).

FIRST USE 2-15-2004; IN COMMERCE 12-10-2004.

CLASS 28—(Continued).

2,999,227. PUNCH FITNESS, INC., MIAMI BEACH, FL. SN 78-395,580. PUB. 1-11-2005, FILED 4-2-2004.

HAWKS

THE MARK CONSISTS OF STANDARD CHARACTERS WITHOUT CLAIM TO ANY PARTICULAR FONT, STYLE, SIZE, OR COLOR.

FOR BOXING EQUIPMENT, NAMELY, BOXING GLOVES (U.S. CLS. 22, 23, 38 AND 50).

FIRST USE 2-0-2002; IN COMMERCE 2-0-2002.

2,999,228. PUNCH FITNESS, INC., MIAMI BEACH, FL. SN 78-395,591. PUB. 1-11-2005, FILED 4-2-2004.



FOR BOXING EQUIPMENT, NAMELY, BOXING GLOVES (U.S. CLS. 22, 23, 38 AND 50).

FIRST USE 2-0-2002; IN COMMERCE 2-0-2002.

CLASS 29—MEATS AND PROCESSED FOODS

2,998,518. ARCHER DANIELS MIDLAND COMPANY, DECATUR, IL. SN 75-982,405. PUB. 4-8-2003, FILED 6-22-1999.

NUTRISOY

OWNER OF U.S. REG. NO. 1,686,614.
FOR ISOLATED SOY PROTEINS FOR USE AS FOOD ADDITIVES, FOOD FILLERS, AND MEAT EXTENDERS OR SUBSTITUTES (U.S. CL. 46).

FIRST USE 5-0-2000; IN COMMERCE 5-0-2000.

CLASS 29—(Continued).

2,998,602. ARTHUR AVENUE ITALIAN DELI, INC., BRONX, NY. SN 76-433,584. PUB. 10-12-2004, FILED 7-22-2002.



NO CLAIM IS MADE TO THE EXCLUSIVE RIGHT TO USE "DELI," "ORIGINAL ARTHUR AVE. ITALIAN DELI" AND "BRONX", APART FROM THE MARK AS SHOWN. THE NAME(S), PORTRAIT(S), AND/OR SIGNATURE(S) SHOWN IN THE MARK DOES NOT IDENTIFY A PARTICULAR LIVING INDIVIDUAL. FOR MEATS AND PROCESSED FOODS, NAMELY, OLIVE OIL, MOZZARELLA CHEESE, AND DRIED SAUSAGE (U.S. CL. 46). FIRST USE 3-31-2002; IN COMMERCE 3-31-2002.

2,998,828. CARL BUDDIG AND COMPANY, HOMEWOOD, IL. SN 76-593,193. PUB. 4-5-2005, FILED 5-20-2004.



OWNER OF U.S. REG. NO. 1,166,688. NO CLAIM IS MADE TO THE EXCLUSIVE RIGHT TO USE "ULTRA THIN" "SINCE 1940" "OVER 60 SLICES" AND "PREMIUM DELI CUTS", APART FROM THE MARK AS SHOWN. FOR HAM, CHICKEN AND TURKEY (U.S. CL. 46). FIRST USE 7-1-2004; IN COMMERCE 7-1-2004.

2,998,845. REINHART FOODSERVICE, L.L.C., LA CROSSE, WI. SN 78-086,668. PUB. 4-30-2002, FILED 10-3-2001.

SAN PABLO

OWNER OF U.S. REG. NOS. 1,727,902 AND 1,835,592. THE ENGLISH TRANSLATION OF THE WORD "SAN PABLO" IN THE MARK IS "SAINT PAUL". FOR PROCESSED JALAPENO PEPPERS, PROCESSED GREEN CHILES (U.S. CL. 46). FIRST USE 1-0-2004; IN COMMERCE 1-0-2004.

CLASS 29—(Continued).

2,998,858. ATSOCA, INC., JACKSONVILLE, FL. SN 78-138,073. PUB. 12-24-2002, FILED 6-24-2002.

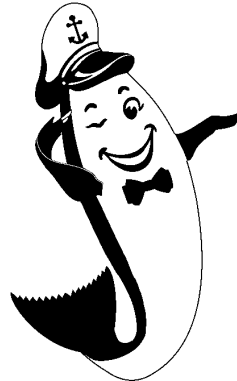

FOR SALMON [FOR FOOD PURPOSES] (U.S. CL. 46). FIRST USE 10-1-1952; IN COMMERCE 10-1-1952.

2,999,177. FRANK BRUNCKHORST CO., L.L.C., BROOKLYN, NY. SN 78-371,116. PUB. 11-16-2004, FILED 2-20-2004.

LONDONPORT

THE MARK CONSISTS OF STANDARD CHARACTERS WITHOUT CLAIM TO ANY PARTICULAR FONT, STYLE, SIZE, OR COLOR. FOR PROCESSED MEATS (U.S. CL. 46). FIRST USE 8-0-2004; IN COMMERCE 8-0-2004.

CLASS 29—(Continued).

2,999,193. ACH FOOD COMPANIES, INC., CORDOVA, TN.
SN 78-379,553. PUB. 3-29-2005, FILED 3-5-2004.

FRYMAX

THE MARK CONSISTS OF STANDARD CHARACTERS
WITHOUT CLAIM TO ANY PARTICULAR FONT, STYLE,
SIZE, OR COLOR.

OWNER OF U.S. REG. NOS. 654,231 AND 1,746,509.
FOR EDIBLE OILS AND EDIBLE OIL BASED COOK-
ING SPRAYS (U.S. CL. 46).
FIRST USE 7-0-2002; IN COMMERCE 7-0-2002.

2,999,244. BALANCE BAR COMPANY, NORTHFIELD, IL.
SN 78-409,022. PUB. 1-25-2005, FILED 4-27-2004.

BALANCE BAR GOLD

THE MARK CONSISTS OF STANDARD CHARACTERS
WITHOUT CLAIM TO ANY PARTICULAR FONT, STYLE,
SIZE, OR COLOR.

OWNER OF U.S. REG. NO. 2,659,753.
NO CLAIM IS MADE TO THE EXCLUSIVE RIGHT TO
USE "BAR", APART FROM THE MARK AS SHOWN.
FOR PROTEIN-BASED, NUTRIENT-DENSE SNACK
BARS (U.S. CL. 46).
FIRST USE 5-0-2005; IN COMMERCE 5-0-2005.

2,999,263. GRANDE CHEESE COMPANY, BROWNSVILLE,
WI. SN 78-427,164. PUB. 4-19-2005, FILED 5-28-2004.

GRANDE WPCRISP

CLASS 29—(Continued).

THE MARK CONSISTS OF STANDARD CHARACTERS
WITHOUT CLAIM TO ANY PARTICULAR FONT, STYLE,
SIZE, OR COLOR.

OWNER OF U.S. REG. NOS. 1,051,976, 1,933,573, AND
OTHERS.

THE FOREIGN WORDING IN THE MARK TRANSLATES
INTO ENGLISH AS "GREAT".

FOR TEXTURED WHEY PROTEINS USED AS INGRE-
DIENTS IN FOOD PRODUCTS (U.S. CL. 46).
FIRST USE 12-7-2004; IN COMMERCE 12-7-2004.

CLASS 30—STAPLE FOODS

2,998,506. BALANCE BAR COMPANY, CARPINTERIA, CA.
SN 75-639,682. PUB. 1-11-2000, FILED 2-9-1999.

**NEVER BE OUT OF
BALANCE**

FOR CEREAL-BASED, RICE-BASED, OR GRANOLA-
BASED SNACK BARS AND SNACK FOODS; FROZEN,
PREPARED AND PACKAGED CEREAL-BASED, RICE-
BASED, OR GRANOLA-BASED SNACK FOODS (U.S. CL.
46).

FIRST USE 3-1-2000; IN COMMERCE 3-1-2000.

2,998,509. FRIENDLY ICE CREAM CORPORATION, WIL-
BRAHAM, MA. SN 75-804,057. PUB. 12-9-2003, FILED 9-20-
1999.

FRIEND-Z

FOR SOFT SERVE ICE CREAM WITH COOKIES AND
CANDY CONFECTIONS (U.S. CL. 46).

FIRST USE 5-24-2004; IN COMMERCE 5-24-2004.

2,998,585. ARCHDUKE LORENZ D'AUSTRIA ESTE, BRUX-
ELLES, BELGIUM. SN 76-404,720. PUB. 9-16-2003, FILED 5-
8-2002.

**SOPRAFFINO DEGLI
ESTENSI**

PRIORITY CLAIMED UNDER SEC. 44(D) ON ITALY
APPLICATION NO. 000020, FILED 2-15-2002, REG. NO.
00868062, DATED 5-27-2002, EXPIRES 2-15-2012.

NO CLAIM IS MADE TO THE EXCLUSIVE RIGHT TO
USE "SOPRAFFINO", APART FROM THE MARK AS
SHOWN.

THE TERM "SOPRAFFINO DEGLI ESTENSI" IS ITALIAN
FOR "ESTENSI'S SUPERFINE".

FOR VINEGAR; SAUCES; SALT; MUSTARD, HONEY;
AND TREACLE (U.S. CL. 46).

FIRST USE 0-0-2002; IN COMMERCE 7-12-2004.

CLASS 30—(Continued).

2,998,598. WIBERG CORPORATION, OAKVILLE, ONTARIO, CANADA. SN 76-428,828. PUB. 9-9-2003, FILED 7-5-2002.

CLASS 30—(Continued).

2,998,682. HALL, SANDRA, PORT CHARLOTTE, FL. SN 76-523,285. PUB. 2-24-2004, FILED 6-12-2003.

PIZZARETTES



THE MARK CONSISTS OF STANDARD CHARACTERS WITHOUT CLAIM TO ANY PARTICULAR FONT, STYLE, SIZE, OR COLOR.

FOR SPICE PACKS USED TO MAKE SAUSAGE STICKS (U.S. CL. 46).

FIRST USE 5-20-2005; IN COMMERCE 5-20-2005.

NO CLAIM IS MADE TO THE EXCLUSIVE RIGHT TO USE "KAKES", APART FROM THE MARK AS SHOWN, FOR BAKERY GOODS, NAMELY, VARIOUS FLAVORS OF CREAM CAKE (U.S. CL. 46).

FIRST USE 9-1-2002; IN COMMERCE 3-1-2003.

2,998,663. DAL TAM S.N.C. DI PEDROLI IRMA & C., MATTARELLO - TRENTO, ITALY. SN 76-498,568. PUB. 9-28-2004, FILED 3-19-2003.

2,998,739. MELKONYAN, OGANES, HOLLYWOOD, CA. SN 76-550,568. PUB. 6-15-2004, FILED 9-22-2003.

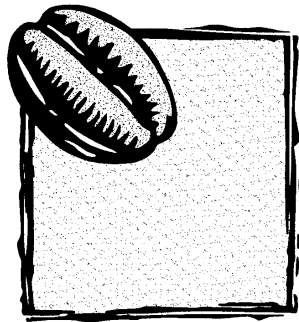

NO CLAIM IS MADE TO THE EXCLUSIVE RIGHT TO USE THE DESIGN OF THE COFFEE BEAN, APART FROM THE MARK AS SHOWN.

THE STIPPLING IS NOT A FEATURE OF THE MARK BUT MERELY DENOTES VARIATIONS IN SHADING AND COLOR.

FOR COFFEE, TEA, COCOA, SUGAR, RICE, TAPIOCA, SAGO, ARTIFICIAL COFFEE; FLOUR AND PREPARATIONS MADE FROM CEREALS, NAMELY, BREAD, PASTRY AND CONFECTIONERY; FLAVORED ICES; HONEY; TREACLE; YEAST, BAKING POWDER; SALT, MUSTARD; VINEGAR, SAUCES USED AS CONDIMENTS; SPICES; ICE (U.S. CL. 46).

FIRST USE 6-4-2003; IN COMMERCE 8-5-2003.

NO CLAIM IS MADE TO THE EXCLUSIVE RIGHT TO USE "CRISPY CRUST", APART FROM THE MARK AS SHOWN.

FOR HOT PIZZA MADE TO ORDER FOR CONSUMPTION OFF THE PREMISES (U.S. CL. 46).

FIRST USE 9-24-2003; IN COMMERCE 9-24-2003.

CLASS 30—(Continued).

2,998,743. NATIONAL FEDERATION OF COFFEE GROWERS OF COLOMBIA, SANTAFE DE BOGOTA, COLOMBIA. SN 76-555,009. PUB. 8-3-2004, FILED 10-15-2003.

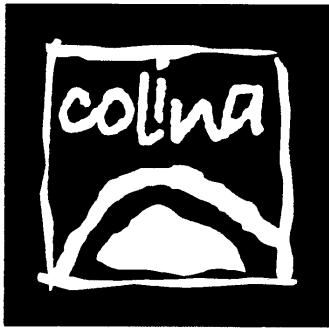

THE MARK CONSISTS, IN PART, OF A "STYLIZED HILL".

THE ENGLISH TRANSLATION OF THE WORD COLINA IN THE MARK IS "HILL".

FOR COFFEE (U.S. CL. 46).
FIRST USE 9-13-2004; IN COMMERCE 9-13-2004.

2,998,788. TEXAS DAIRY QUEEN OPERATORS' COUNCIL, BEDFORD, TX. SN 76-572,254. PUB. 11-16-2004, FILED 1-26-2004.

PEPPER PEPPER HUNGR-BUSTER

THE MARK CONSISTS OF STANDARD CHARACTERS WITHOUT CLAIM TO ANY PARTICULAR FONT, STYLE, SIZE, OR COLOR.

OWNER OF U.S. REG. NOS. 1,037,933 AND 1,146,917.
NO CLAIM IS MADE TO THE EXCLUSIVE RIGHT TO USE "PEPPER", APART FROM THE MARK AS SHOWN.

FOR FOOD PRODUCTS, NAMELY BURGER-TYPE SANDWICHES FOR CONSUMPTION ON OR OFF THE PREMISES (U.S. CL. 46).

FIRST USE 3-1-2004; IN COMMERCE 3-1-2004.

2,998,879. MCALPINE, DAVID B. FORT WORTH, TX. SN 78-184,585. PUB. 12-23-2003, FILED 11-13-2002.

ALL GOLD

FOR JAMS; JELLIES; FRUIT-BASED FILLING FOR PIES (U.S. CL. 46).
FIRST USE 1-14-2005; IN COMMERCE 1-14-2005.

CLASS 30—(Continued).

2,998,916. GARDENS OF TAXCO, INC., WEST HOLLYWOOD, CA. SN 78-219,734. PUB. 10-28-2003, FILED 2-27-2003.

BOOORN IN THE SAUCE

FOR MEXICAN-STYLE SAUCE FOR USE WITH FOOD (U.S. CL. 46).
FIRST USE 7-1-2005; IN COMMERCE 7-1-2005.

2,999,037. GRUPO BIMBO, S.A. DE C.V., MEXICO CITY, MEXICO. SN 78-298,598. PUB. 5-25-2004, FILED 9-10-2003.

MORSAS

THE FOREIGN WORDING IN THE MARK TRANSLATES INTO ENGLISH AS "WALRUS".

FOR BAKERY PRODUCTS, NAMELY SNACK CAKES (U.S. CL. 46).

FIRST USE 8-15-2004; IN COMMERCE 8-15-2004.

2,999,053. LANCE MFG. LLC, CHARLOTTE, NC. SN 78-309,620. PUB. 10-12-2004, FILED 10-6-2003.

LANCE

OWNER OF U.S. REG. NOS. 614,055, 2,263,503, AND OTHERS.

FOR CEREAL-BASED SNACK FOOD BARS (U.S. CL. 46).

FIRST USE 1-31-2004; IN COMMERCE 1-31-2004.

2,999,114. KRAFT FOODS HOLDINGS, INC., NORTHFIELD, IL. SN 78-345,681. PUB. 11-23-2004, FILED 12-26-2003.

SNACK 'N SEAL

THE MARK CONSISTS OF STANDARD CHARACTERS WITHOUT CLAIM TO ANY PARTICULAR FONT, STYLE, SIZE, OR COLOR.

FOR COOKIES (U.S. CL. 46).

FIRST USE 6-11-2005; IN COMMERCE 6-11-2005.

CLASS 30—(Continued).

2,999,146. AMERICAN ITALIAN PASTA COMPANY, KANSAS CITY, MO. SN 78-356,691. PUB. 10-26-2004, FILED 1-23-2004.

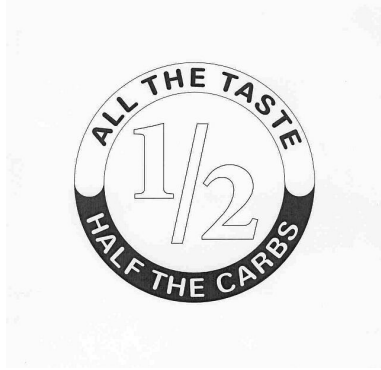

FOR PASTA (U.S. CL. 46).
FIRST USE 9-28-2004; IN COMMERCE 9-28-2004.

2,999,223. SOY VAY ENTERPRISES, INC., FELTON, CA. SN 78-393,595. PUB. 3-29-2005, FILED 3-30-2004.



THE MARK CONSISTS OF THE PRODUCT NAME, "WASABIYAKI", SPELLED OUT IN A TYPE STYLE SIMILAR TO HEBREW LETTERING.
FOR SAUCES AND MARINADES (U.S. CL. 46).
FIRST USE 11-1-2004; IN COMMERCE 11-1-2004.

2,999,225. U.S. MILLS, INC., NEEDHAM, MA. SN 78-394,081. PUB. 3-1-2005, FILED 3-31-2004.

UNCLE SAM

THE MARK CONSISTS OF STANDARD CHARACTERS WITHOUT CLAIM TO ANY PARTICULAR FONT, STYLE, SIZE, OR COLOR.
FOR CEREAL BARS (U.S. CL. 46).
FIRST USE 11-18-2004; IN COMMERCE 11-18-2004.

CLASS 30—(Continued).

2,999,254. RICH PRODUCTS CORPORATION, BUFFALO, NY. SN 78-422,129. PUB. 4-5-2005, FILED 5-20-2004.

CINN-SATIONAL

THE MARK CONSISTS OF STANDARD CHARACTERS WITHOUT CLAIM TO ANY PARTICULAR FONT, STYLE, SIZE, OR COLOR.
FOR FROZEN DOUGH; FROZEN PRE-BAKED AND PAR-BAKED BAKERY PRODUCTS (U.S. CL. 46).
FIRST USE 6-1-2004; IN COMMERCE 6-1-2004.

2,999,257. JELLY BELLY CANDY COMPANY, FAIRFIELD, CA. SN 78-422,903. PUB. 4-5-2005, FILED 5-21-2004.

WRECKING BALL

THE MARK CONSISTS OF STANDARD CHARACTERS WITHOUT CLAIM TO ANY PARTICULAR FONT, STYLE, SIZE, OR COLOR.
FOR CANDY, NAMELY A JAWBREAKER (U.S. CL. 46).
FIRST USE 11-30-2004; IN COMMERCE 11-30-2004.

CLASS 30—(Continued).

2,999,265. DRIGGS FARMS OF INDIANA, INC., DECATUR, IN. SN 78-429,143. PUB. 4-5-2005, FILED 6-3-2004.

AMERICAN PRIDE

THE MARK CONSISTS OF STANDARD CHARACTERS WITHOUT CLAIM TO ANY PARTICULAR FONT, STYLE, SIZE, OR COLOR.

NO CLAIM IS MADE TO THE EXCLUSIVE RIGHT TO USE "AMERICAN", APART FROM THE MARK AS SHOWN.

FOR ICE CREAM, LOW FAT ICE CREAM, SHERBET, ICE CREAM BARS, ICE CREAM SANDWICHES, ICE CREAM SUNDAE NUT CONES, FUDGE BARS, FLAVORED ICES, AND FLAVORED ICE BARS; FROZEN DESSERTS, NAMELY, MELLORINE, FROZEN YOGURT, AND FROZEN CONFECTIONS (U.S. CL. 46).

FIRST USE 12-29-2004; IN COMMERCE 12-29-2004.

2,999,272. WELLS' DAIRY, INC., LE MARS, IA. SN 78-484,845. PUB. 3-1-2005, FILED 9-16-2004.

ULTIMATE REWARDS

THE MARK CONSISTS OF STANDARD CHARACTERS WITHOUT CLAIM TO ANY PARTICULAR FONT, STYLE, SIZE, OR COLOR.

FOR FROZEN CONFECTIONS (U.S. CL. 46).

FIRST USE 1-30-2005; IN COMMERCE 1-30-2005.

CLASS 31—NATURAL AGRICULTURAL PRODUCTS

2,998,555. LANDEC AG, INC., MONTICELLO, IN. SN 76-318,715. PUB. 3-23-2004, FILED 9-27-2001.

RELAY

FOR AGRICULTURAL SEEDS, FEATURING A COATING FOR ENHANCING PERFORMANCE CHARACTERISTICS OF THE SEED (U.S. CLS. 1 AND 46).

FIRST USE 11-30-2004; IN COMMERCE 11-30-2004.

CLASS 31—(Continued).

2,998,657. SPORTY K9, LTD., NEW YORK, NY. SN 76-491,279. PUB. 10-14-2003, FILED 2-21-2003.

CURVEBALL LIVER TREATS

NO CLAIM IS MADE TO THE EXCLUSIVE RIGHT TO USE "LIVER TREATS", APART FROM THE MARK AS SHOWN.

FOR EDIBLE DOG TREATS AND BISCUITS (U.S. CLS. 1 AND 46).

FIRST USE 6-22-2005; IN COMMERCE 6-22-2005.

2,998,843. AJINOMOTO U.S.A., INC., NEW YORK, NY. SN 78-074,097. PUB. 4-16-2002, FILED 7-16-2001.

COT-N-ANI

FOR NON-MEDICATED ANIMAL FEED (U.S. CLS. 1 AND 46).

FIRST USE 6-30-2005; IN COMMERCE 6-30-2005.

2,998,855. SYNGENTA PARTICIPATIONS AG, BASEL, SWITZERLAND. SN 78-133,559. PUB. 12-3-2002, FILED 6-6-2002.

OCEANA

FOR FLOWER SEEDS, SEEDLINGS, LIVING PLANTS, NATURAL FLOWERS, YOUNG PLANTS, CUTTINGS AND OTHER PARTS OF PLANTS OR YOUNG PLANTS SUITABLE FOR MULTIPLICATION; ALL AFOREMENTIONED PRODUCTS WITH THE EXCLUSION OF ROSES AND ROSE TREES (U.S. CLS. 1 AND 46).

FIRST USE 10-1-2004; IN COMMERCE 10-1-2004.

2,998,872. HARRISON, SCOTT, BAKERSFIELD, CA. SN 78-169,517. PUB. 1-27-2004, FILED 9-30-2002.

SFM

FOR WOOD CHIPS AND MULCH COMBINED WITH POLYMERS FOR USE AS GROUND COVER TO PREVENT SOIL EROSION (U.S. CLS. 1 AND 46).

FIRST USE 10-1-2001; IN COMMERCE 12-1-2002.

CLASS 31—(Continued).

2,999,208. SPRING MEADOW NURSERY, INC., GRAND HAVEN, MI. SN 78-384,378. PUB. 1-11-2005, FILED 3-15-2004.

GOLDEN SHADOWS

THE MARK CONSISTS OF STANDARD CHARACTERS WITHOUT CLAIM TO ANY PARTICULAR FONT, STYLE, SIZE, OR COLOR.

NO CLAIM IS MADE TO THE EXCLUSIVE RIGHT TO USE GOLDEN, APART FROM THE MARK AS SHOWN.

FOR LIVE ORNAMENTAL PLANTS (U.S. CLS. 1 AND 46).

FIRST USE 8-1-2004; IN COMMERCE 4-15-2005.

CLASS 32—LIGHT BEVERAGES

2,998,517. VOSLAUER HEILQUELLEN VERWERTUNG AKTIENGESELLSCHAFT, PAITZRIEGELGASSE 2, AUSTRIA. SN 75-941,065. PUB. 4-2-2002, FILED 3-10-2000.



NO CLAIM IS MADE TO THE EXCLUSIVE RIGHT TO USE "NATURAL MINERAL WATER", APART FROM THE MARK AS SHOWN.

THE WORDING "VOSLAUER" HAS NO ENGLISH TRANSLATION.

FOR MINERAL WATER (U.S. CLS. 45, 46 AND 48).

FIRST USE 4-30-2004; IN COMMERCE 4-30-2004.

2,998,532. BOWERS, J. MICHAEL, PLANO, TX. SN 76-171,115. PUB. 4-29-2003, FILED 11-27-2000.

SIMPATICO

FOR ALCOHOLIC AND NON-ALCOHOLIC BEER, SODA WATER; AND NON-ALCOHOLIC COCKTAIL MIXES (U.S. CLS. 45, 46 AND 48).

FIRST USE 7-7-2005; IN COMMERCE 7-7-2005.

CLASS 32—(Continued).

2,998,765. BASHAS' INC., CHANDLER, AZ. SN 76-565,542. PUB. 9-14-2004, FILED 12-5-2003.

DR. BASH

THE MARK CONSISTS OF STANDARD CHARACTERS WITHOUT CLAIM TO ANY PARTICULAR FONT, STYLE, SIZE, OR COLOR.

FOR BEVERAGES, NAMELY CARBONATED AND NON-CARBONATED SOFT DRINKS AND DRINKING WATER (U.S. CLS. 45, 46 AND 48).

FIRST USE 6-25-2004; IN COMMERCE 6-25-2004.

2,998,825. THE PEP BOYS MANNY, MOE & JACK OF CALIFORNIA, PHILADELPHIA, PA. SN 76-590,163. PUB. 2-22-2005, FILED 5-3-2004.

PURE PEP

THE MARK CONSISTS OF STANDARD CHARACTERS WITHOUT CLAIM TO ANY PARTICULAR FONT, STYLE, SIZE, OR COLOR.

FOR BOTTLED WATER (U.S. CLS. 45, 46 AND 48).

FIRST USE 5-0-2004; IN COMMERCE 5-0-2004.

2,998,918. HEINEKEN ITALIA S.P.A., 11020 POLLEIN (AO), ITALY. SN 78-221,904. PUB. 5-25-2004, FILED 3-5-2003.



OWNER OF U.S. REG. NOS. 1,321,135, 2,214,462, AND OTHERS.

THE FOREIGN WORDING IN THE MARK TRANSLATES INTO ENGLISH AS QUALITY AND TRADITION MORETTI BEER SINCE 1859.

FOR BEERS (U.S. CLS. 45, 46 AND 48).

FIRST USE 3-0-2003; IN COMMERCE 11-0-2003.

CLASS 32—(Continued).

2,999,144. MORNINGSTAR FELLOWSHIP CHURCH, WILKESBORO, NC. SN 78-355,435. PUB. 10-19-2004, FILED 1-22-2004.

ZAO

THE MARK CONSISTS OF STANDARD CHARACTERS WITHOUT CLAIM TO ANY PARTICULAR FONT, STYLE, SIZE, OR COLOR.

FOR BOTTLED WATER (U.S. CLS. 45, 46 AND 48).
FIRST USE 9-21-2004; IN COMMERCE 9-21-2004.

CLASS 33—WINES AND SPIRITS

2,998,549. HARDY WINE COMPANY LIMITED, REYNELLA, SOUTH AUSTRALIA, AUSTRALIA. SN 76-275,308. PUB. 5-7-2002, FILED 6-22-2001.

OMNI

FOR WINES (U.S. CLS. 47 AND 49).
FIRST USE 8-0-1995; IN COMMERCE 2-0-2005.

2,998,580. ROUST TRADING LIMITED, HAMILTON, BERMUDA. SN 76-396,021. PUB. 5-6-2003, FILED 4-16-2002.

IMPERIA

FOR ALCOHOLIC BEVERAGES, NAMELY, VODKA (U.S. CLS. 47 AND 49).
FIRST USE 4-11-2005; IN COMMERCE 4-11-2005.

2,998,660. OLD BRIDGE CELLARS, NAPA, CA. SN 76-496,371. PUB. 11-18-2003, FILED 3-10-2003.

SHOO FLY

FOR WINE (U.S. CLS. 47 AND 49).
FIRST USE 5-20-2005; IN COMMERCE 5-20-2005.

CLASS 33—(Continued).

2,998,731. APRUTINA VINI S.P.A., ROSETO DEGLI ABRUZZI (TERAMO), ITALY. SN 76-544,905. PUB. 4-13-2004, FILED 9-4-2003.

CHORUS

FOR WINES (U.S. CLS. 47 AND 49).
FIRST USE 4-4-2003; IN COMMERCE 4-4-2003.

2,998,782. KUNDE ENTERPRISES, INC., KENWOOD, CA. SN 76-571,086. PUB. 12-7-2004, FILED 1-15-2004.

CHARDONNAY NU

THE MARK CONSISTS OF STANDARD CHARACTERS WITHOUT CLAIM TO ANY PARTICULAR FONT, STYLE, SIZE, OR COLOR.

NO CLAIM IS MADE TO THE EXCLUSIVE RIGHT TO USE CHARDONNAY, APART FROM THE MARK AS SHOWN.

FOR WINE (U.S. CLS. 47 AND 49).
FIRST USE 8-3-2004; IN COMMERCE 8-3-2004.

2,998,859. VALLE DE LA PUERTA S.A., LA RIOJA, ARGENTINA. SN 78-144,349. PUB. 4-22-2003, FILED 7-16-2002.

TENORIO

THE ENGLISH TRANSLATION OF THE MARK IS "LADY KILLER" AND "DON JUAN".

FOR WINES (U.S. CLS. 47 AND 49).
FIRST USE 7-6-2005; IN COMMERCE 7-6-2005.

2,998,861. MCGUIGAN SIMEON WINES LIMITED, CESSNOCK, AUSTRALIA. SN 78-146,547. PUB. 2-1-2005, FILED 7-23-2002.

CROCODILE ROCK

FOR WINES (U.S. CLS. 47 AND 49).
FIRST USE 12-1-2002; IN COMMERCE 12-1-2002.

2,999,054. GUNTHER SCHLINK GMBH, BAD KREUZNACH, FED REP GERMANY. SN 78-311,629. PUB. 6-8-2004, FILED 10-9-2003.

ST. GOTTARDI

FOR WINE (U.S. CLS. 47 AND 49).
FIRST USE 4-30-2005; IN COMMERCE 4-30-2005.

CLASS 33—(Continued).

2,999,123. VINICON, INC., SAN RAFAEL, CA. SN 78-348,831.
PUB. 10-19-2004, FILED 1-7-2004.

QUARTIER 116

THE MARK CONSISTS OF STANDARD CHARACTERS WITHOUT CLAIM TO ANY PARTICULAR FONT, STYLE, SIZE, OR COLOR.

THE FOREIGN WORDING IN THE MARK TRANSLATES INTO ENGLISH AS "DISTRICT".

FOR WINE (U.S. CLS. 47 AND 49).

FIRST USE 6-1-2005; IN COMMERCE 6-1-2005.

2,999,135. HARDY WINE COMPANY LIMITED, REYNELLA, AUSTRALIA. SN 78-352,598. PUB. 10-19-2004, FILED 1-15-2004.

WALTZING VINES

THE MARK CONSISTS OF STANDARD CHARACTERS WITHOUT CLAIM TO ANY PARTICULAR FONT, STYLE, SIZE, OR COLOR.

NO CLAIM IS MADE TO THE EXCLUSIVE RIGHT TO USE "VINES", APART FROM THE MARK AS SHOWN.

FOR WINES (U.S. CLS. 47 AND 49).

FIRST USE 4-25-2005; IN COMMERCE 4-25-2005.

2,999,241. SIDNEY FRANK IMPORTING CO., INC., NEW ROCHELLE, NY. SN 78-406,228. PUB. 4-12-2005, FILED 4-22-2004.

A SIDNEY FRANK SELECTION

THE MARK CONSISTS OF STANDARD CHARACTERS WITHOUT CLAIM TO ANY PARTICULAR FONT, STYLE, SIZE, OR COLOR.

NO CLAIM IS MADE TO THE EXCLUSIVE RIGHT TO

CLASS 33—(Continued).

USE "SELECTION", APART FROM THE MARK AS SHOWN. THE NAME SIDNEY FRANK IDENTIFIES A LIVING INDIVIDUAL WHOSE CONSENT IS OF RECORD. FOR WINES (U.S. CLS. 47 AND 49). FIRST USE 6-0-2005; IN COMMERCE 6-0-2005.

CLASS 34—SMOKERS' ARTICLES

2,998,658. K. HANSOTIA & CO., INC., MIAMI, FL. SN 76-493,714. PUB. 10-21-2003, FILED 2-28-2003.

HIGHLANDER

FOR TOBACCO, CIGARETTES, CIGARS; ARTICLES FOR SMOKERS NOT OF PRECIOUS METAL, NAMELY, CIGARETTE LIGHTERS, CIGARETTE CASES, CIGAR CASES, CIGARETTE HOLDERS, AND CIGAR HOLDERS (U.S. CLS. 2, 8, 9 AND 17).

FIRST USE 5-15-2004; IN COMMERCE 5-15-2004.

2,998,881. USA MILLENNIUM, L.P., BEAUMONT, TX. SN 78-184,797. PUB. 7-22-2003, FILED 11-13-2002.

MANDATE

FOR CIGARETTES (U.S. CLS. 2, 8, 9 AND 17). FIRST USE 2-23-2005; IN COMMERCE 2-23-2005.

2,998,928. LA TABACALERA, C. POR A., SANTO DOMINGO, DOMINICAN REP. SN 78-230,685. PUB. 4-27-2004, FILED 3-27-2003.

**LA TABACALERA, C.POR A.**

NO CLAIM IS MADE TO THE EXCLUSIVE RIGHT TO USE LA TABACALERA, C.POR A., APART FROM THE MARK AS SHOWN.

THE LINING IS A FEATURE OF THE MARK AND DOES NOT INDICATE COLOR.

THE MARK CONSISTS OF A UNITARY COMBINATION OF A STYLIZED REPRESENTATION OF THE LETTER T AND A STYLIZED REPRESENTATION OF A TOBACCO LEAF, WITH THE WORD PORTION LA TABACALERA, C. POR A. WRITTEN UNDERNEATH.

THE TRANSLATION OF THE SPANISH TERM "LA" IS "THE". THE TRANSLATION OF THE SPANISH TERM "TABACALERA" IS (A) TOBACCO GROWER OR DEALER; TOBACCONIST; (2) STATE TOBACCO MONOPOLY (OBSOLETE USE LIMITED TO SPAIN); OR (3), AS AN ADJECTIVE, "PERTAINING TO TOBACCO". THE TRANSLATION OF THE SPANISH DESIGNATION C. POR A. IS STOCK COMPANY.

FOR CIGARS MADE FROM CUBAN SEED TOBACCO (U.S. CLS. 2, 8, 9 AND 17).

FIRST USE 4-4-2000; IN COMMERCE 6-14-2004.

CLASS 34—(Continued).

2,999,141. LIBERTY BRANDS LLC, MELVILLE, NY. SN 78-354,364. PUB. 11-2-2004, FILED 1-20-2004.

LIBERTY SELECT

THE MARK CONSISTS OF STANDARD CHARACTERS WITHOUT CLAIM TO ANY PARTICULAR FONT, STYLE, SIZE, OR COLOR.

NO CLAIM IS MADE TO THE EXCLUSIVE RIGHT TO USE SELECT, APART FROM THE MARK AS SHOWN.

FOR CIGARETTES (U.S. CLS. 2, 8, 9 AND 17).
FIRST USE 6-18-2004; IN COMMERCE 6-18-2004.

2,999,191. C.A.O. INTERNATIONAL, INC., NASHVILLE, TN. SN 78-378,364. PUB. 12-21-2004, FILED 3-4-2004.

CAO ITALIA

THE MARK CONSISTS OF STANDARD CHARACTERS WITHOUT CLAIM TO ANY PARTICULAR FONT, STYLE, SIZE, OR COLOR.

OWNER OF U.S. REG. NOS. 2,108,848, 2,674,854, AND 2,757,030.

NO CLAIM IS MADE TO THE EXCLUSIVE RIGHT TO USE "ITALIA", APART FROM THE MARK AS SHOWN.

THE ENGLISH TRANSLATION OF THE WORD ITALIA IN THE MARK IS ITALIAN.

FOR CIGARS AND SMOKING TOBACCO (U.S. CLS. 2, 8, 9 AND 17).

FIRST USE 7-26-2004; IN COMMERCE 7-26-2004.

SERVICE MARKS

CLASS 35—ADVERTISING AND BUSINESS

CLASS 35—(Continued).

2,998,531. PURPLE BOOK, LLC, THE, BEVERLY HILLS, CA. SN 76-152,833. PUB. 3-19-2002, FILED 10-25-2000.

THEPURPLEBOOK

FOR SHOPPING GUIDES ACCESSIBLE OVER THE INTERNET PRINCIPALLY FEATURING INFORMATION ABOUT ONLINE RETAILERS OF CONSUMER GOODS (U.S. CLS. 100, 101 AND 102).

FIRST USE 6-8-2005; IN COMMERCE 6-8-2005.

2,998,536. ABBOTT SPECIALTY STAFFING, INC., TUSTIN, CA. SN 76-192,508. PUB. 8-31-2004, FILED 1-11-2001.

ABBOTT'S LABOR LINK

NO CLAIM IS MADE TO THE EXCLUSIVE RIGHT TO USE "LABOR", APART FROM THE MARK AS SHOWN.

FOR EMPLOYEE AGENCY SERVICES; CONSULTING SERVICES IN THE FIELDS OF EMPLOYMENT AND PERSONNEL MANAGEMENT; EMPLOYEE PLACEMENT SERVICES; AND BUSINESS MANAGEMENT CONSULTATION SERVICES (U.S. CLS. 100, 101 AND 102).

FIRST USE 5-1-2002; IN COMMERCE 5-1-2002.

2,998,573. STRATEGICELEVATION, LLC, PALATINE, IL. SN 76-380,023. PUB. 10-22-2002, FILED 3-8-2002.

MEGA-RAINMAKER

FOR BUSINESS CONSULTING SERVICES AND PROVIDING BUSINESS PROCESS SOLUTIONS IN THE FIELDS OF STRATEGIC PLANNING, SALES, SALES MANAGEMENT, MARKETING, BUSINESS DEVELOPMENT, STRATEGIC ACCOUNT ACQUISITION, SALES FORCE COMPENSATION PLAN BENCHMARKING, WORKFLOW ANALYSIS, MARKETING ASSESSMENT AND BUSINESS OPERATIONS (U.S. CLS. 100, 101 AND 102).

FIRST USE 7-13-2005; IN COMMERCE 7-13-2005.

CLASS 35—(Continued).

2,998,584. CREDIT UNION CAREERS, INC., TALLAHASSEE, FL. SN 76-401,534. PUB. 7-15-2003, FILED 4-29-2002.

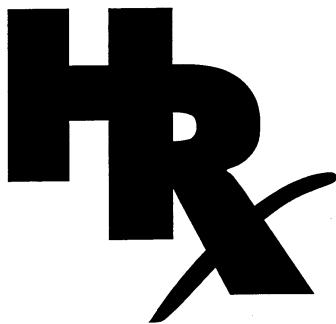

THE MARK CONSISTS OF THE LETTERS "HRX" AS SHOWN, WITH THE LETTER X FORMED FROM PART OF THE 'R' INTERSECTED BY A SLASH. THE SLASH IS GREEN. COLOR IS A FEATURE OF THE MARK.

FOR JOB PLACEMENT SERVICES FOR CREDIT UNIONS; OUTSOURCING FOR CREDIT UNIONS IN THE FIELDS OF HUMAN RESOURCES, PAYROLL AND EMPLOYEE BENEFITS; AND SALARY ADMINISTRATION FOR CREDIT UNIONS (U.S. CLS. 100, 101 AND 102).

FIRST USE 5-11-2005; IN COMMERCE 5-11-2005.

2,998,593. SCOTTSDALE CONVENTION AND VISITORS BUREAU, INC., SCOTTSDALE, AZ. SN 76-415,051. PUB. 9-7-2004, FILED 6-6-2002.

SCOTTSDALE CONVENTION BUREAU

NO CLAIM IS MADE TO THE EXCLUSIVE RIGHT TO USE "CONVENTION BUREAU", APART FROM THE MARK AS SHOWN.

SEC. 2(F) AS TO "SCOTTSDALE".
FOR CONSULTING AND PLANNING SERVICES RELATING TO BUSINESS MEETINGS AND TRADE SHOWS IN A WIDE VARIETY OF FIELDS, NAMELY, ASSISTING OTHERS TO PLAN, PROMOTE AND CONDUCT BUSINESS MEETINGS AND BUSINESS TRADE SHOWS IN A WIDE VARIETY OF FIELDS (U.S. CLS. 100, 101 AND 102).

FIRST USE 3-0-2005; IN COMMERCE 3-0-2005.

CLASS 35—(Continued).

2,998,594. SCOTTSDALE CONVENTION AND VISITORS BUREAU, INC., SCOTTSDALE, AZ. SN 76-415,202. PUB. 9-7-2004, FILED 6-6-2002.

SCOTTSDALE CONVENTION BUREAU

NO CLAIM IS MADE TO THE EXCLUSIVE RIGHT TO USE "CONVENTION BUREAU", APART FROM THE MARK AS SHOWN.

SEC. 2(F) AS TO "SCOTTSDALE".
FOR PROMOTING TOURISM AND BUSINESS TRAVEL TO AND IN THE AREA OF SCOTTSDALE, ARIZONA AND SURROUNDING AREAS; PROVIDING TRAVEL MANAGEMENT (U.S. CLS. 100, 101 AND 102).
FIRST USE 3-0-2005; IN COMMERCE 3-0-2005.

2,998,596. XEROX CORPORATION, STAMFORD, CT. SN 76-425,676. PUB. 7-22-2003, FILED 6-26-2002.



NO CLAIM IS MADE TO THE EXCLUSIVE RIGHT TO USE "LEAN DOCUMENT PRODUCTION", APART FROM THE MARK AS SHOWN.

FOR BUSINESS MANAGEMENT AND CONSULTATION IN THE FIELD OF DOCUMENT PRODUCTION, FINISHING, AND BINDING (U.S. CLS. 100, 101 AND 102).

FIRST USE 10-21-2002; IN COMMERCE 10-21-2002.

2,998,604. AMERICAN SPORTS LICENSING, INC., WILMINGTON, DE. SN 76-436,069. PUB. 6-8-2004, FILED 7-31-2002.

POWER BUYS

NO CLAIM IS MADE TO THE EXCLUSIVE RIGHT TO USE "BUYS", APART FROM THE MARK AS SHOWN.

FOR RETAIL STORE SERVICES IN THE FIELD OF CLOTHING AND SPORTING GOODS (U.S. CLS. 100, 101 AND 102).

FIRST USE 9-20-2003; IN COMMERCE 9-20-2003.

2,998,617. ANDVENTURE, INC., HARRISBURG, PA. SN 76-456,162. PUB. 4-22-2003, FILED 10-7-2002.

LINKS2CARE

FOR TEMPORARY STAFFING SERVICES IN THE HEALTH CARE FIELD (U.S. CLS. 100, 101 AND 102).
FIRST USE 10-1-2002; IN COMMERCE 10-1-2002.

CLASS 35—(Continued).

2,998,622. STEIN MART BUYING CORP., JACKSONVILLE, FL. SN 76-460,925. PUB. 9-14-2004, FILED 10-21-2002.

COLLECTIONS OF STEIN MART

OWNER OF U.S. REG. NOS. 1,204,955, 2,152,544, AND OTHERS.

NO CLAIM IS MADE TO THE EXCLUSIVE RIGHT TO USE "MART", APART FROM THE MARK AS SHOWN.

FOR RETAIL DEPARTMENT STORE SERVICES (U.S. CLS. 100, 101 AND 102).

FIRST USE 10-0-2002; IN COMMERCE 10-0-2002.

2,998,630. TODAY'S WINDOW FASHIONS, FRAZIER PARK, CA. SN 76-470,109. PUB. 1-11-2005, FILED 11-26-2002.

TODAY'S SHUTTERS AND BLINDS

OWNER OF U.S. REG. NO. 2,074,284.

NO CLAIM IS MADE TO THE EXCLUSIVE RIGHT TO USE "SHUTTERS AND BLINDS", APART FROM THE MARK AS SHOWN.

FOR RETAIL STORE SERVICES FEATURING WINDOW COVERINGS (U.S. CLS. 100, 101 AND 102).

FIRST USE 1-22-2005; IN COMMERCE 1-22-2005.

2,998,636. SPORTS IDENTITY, INC., BOSTON, MA. SN 76-472,693. PUB. 10-26-2004, FILED 12-9-2002.

BRANDMATCH

FOR BUSINESS MARKETING CONSULTING SERVICES, NAMELY TO ENTERTAINMENT AND CORPORATE CLIENTS (U.S. CLS. 100, 101 AND 102).

FIRST USE 8-15-2002; IN COMMERCE 1-1-2003.

2,998,668. DRAFT WORLDWIDE, INC, CHICAGO, IL. SN 76-507,365. PUB. 6-15-2004, FILED 4-17-2003.

DRAFT

OWNER OF U.S. REG. NOS. 2,100,871, 2,696,386, AND OTHERS.

FOR ADVERTISING AGENCIES AND DIRECT MARKETING ADVERTISING FOR OTHERS (U.S. CLS. 100, 101 AND 102).

FIRST USE 5-5-2004; IN COMMERCE 5-5-2004.

2,998,669. DRAFT WORLDWIDE, INC, CHICAGO, IL. SN 76-507,366. PUB. 6-15-2004, FILED 4-17-2003.

DRAFT

CLASS 35—(Continued).

OWNER OF U.S. REG. NOS. 2,100,871, 2,696,386, AND OTHERS.

FOR ADVERTISING AGENCIES AND DIRECT MARKETING ADVERTISING FOR OTHERS (U.S. CLS. 100, 101 AND 102).

FIRST USE 5-5-2004; IN COMMERCE 5-5-2004.

2,998,671. LUXURYHUT IMPORTS INC. / LES IMPORTATIONS LUXURYHUT INC., MONTREAL, PROVINCE OF QUEBEC, CANADA. SN 76-508,498. PUB. 7-13-2004, FILED 4-10-2003.

LUXURYHUT

OWNER OF CANADA REG. NO. TMA602680, DATED 2-19-2004, EXPIRES 2-19-2019.

FOR IMPORT AND EXPORT SERVICES; RETAIL STORE SERVICES FEATURING SUNGLASSES AND LEATHER GOODS, NAMELY, WALLETS AND KEYCHAINS, PERFUMES, SOAP SETS, BELTS, CUFFLINKS, CREDIT CARD HOLDERS, TIE CLIPS, POCKET KNIVES, WATCHES, HANDBAGS AND JEWELRY (U.S. CLS. 100, 101 AND 102).

FIRST USE 4-11-2003; IN COMMERCE 4-11-2003.

2,998,679. THE PRESIDENT'S COUNCIL, LLC, CLEVELAND, OH. SN 76-520,451. PUB. 4-5-2005, FILED 5-27-2003.

BOARDROOM - T O - B O A R D R O O M

FOR BUSINESS MANAGEMENT CONSULTING SERVICES, NAMELY, BRINGING TOGETHER AFRICAN-AMERICAN AND OTHER MINORITY ENTERPRISES WITH CHIEF EXECUTIVE OFFICERS OF MAJORITY-OWNED COMPANIES IN ORDER TO HELP MINORITY ENTREPRENEURS OVERCOME MARKETPLACE OBSTACLES (U.S. CLS. 100, 101 AND 102).

FIRST USE 9-16-2004; IN COMMERCE 9-16-2004.

2,998,715. B & H MANUFACTURING COMPANY, INC., CERES, CA. SN 76-536,894. PUB. 5-4-2004, FILED 8-11-2003.

INNOVATION FOR THE LONG RUN

FOR DISTRIBUTORSHIP IN THE FIELD OF COMMERCIAL AND INDUSTRIAL MACHINES (U.S. CLS. 100, 101 AND 102).

FIRST USE 6-0-2005; IN COMMERCE 6-0-2005.

CLASS 35—(Continued).

2,998,750. MEIJER, INC., GRAND RAPIDS, MI. SN 76-559,145. PUB. 7-13-2004, FILED 11-10-2003.



OWNER OF U.S. REG. NOS. 1,018,895, 1,333,646, AND OTHERS.

FOR RETAIL STORE AND RETAIL DEPARTMENT STORE SERVICES FEATURING A WIDE VARIETY OF CONSUMER GOODS OF OTHERS, NAMELY, GROCERY, GENERAL CONSUMER MERCHANDISE, SOFT DRINKS AND BOTTLED WATERS, DAIRY PRODUCTS, LIQUOR, WINE, BAKERY, DELICATESSEN, MEAT, SEAFOOD, BULK FOODS, ELECTRONIC PRODUCTS AND ACCESSORIES, AUTOMOTIVE AND VEHICLE PARTS, AND ACCESSORIES, PETS AND PET SUPPLIES, FURNITURE, FOOTWEAR, CLOTHING, BABY CARE PRODUCTS, COSMETICS, LUGGAGE, HAND TOOLS, LAWN AND GARDEN ACCESSORIES, TOYS AND PLAYTHINGS, LIGHTING, GOLFING EQUIPMENT, SPORTING GOODS, SCHOOL SUPPLIES AND STATIONERY, SEASONAL AND HOLIDAY PRODUCTS, HARDWARE, HOME REPAIR SUPPLIES, GASOLINE, OIL, PLUMBING AND ELECTRICAL SUPPLIES, BOOKS AND MAGAZINES, MUSIC, SMALL APPLIANCES, OPTICAL GOODS, TOBACCO, JEWELRY, RETAIL PHARMACY SERVICES, ONLINE PRESCRIPTION REFILL SERVICES, ONLINE RETAIL STORE AND RETAIL DEPARTMENT STORE SERVICES FEATURING A WIDE VARIETY OF CONSUMER GOODS OF OTHERS (U.S. CLS. 100, 101 AND 102).

FIRST USE 11-15-2003; IN COMMERCE 11-15-2003.

2,998,774. MUSE NETWORK, LLC, NEW CANAAN, CT. SN 76-567,548. PUB. 10-12-2004, FILED 12-17-2003.



THE MARK CONSISTS OF STANDARD CHARACTERS WITHOUT CLAIM TO ANY PARTICULAR FONT, STYLE, SIZE, OR COLOR.

FOR EMPLOYMENT HIRING, RECRUITING, PLACEMENT, STAFFING AND CAREER NETWORKING SERVICES FOR OTHERS AND EXECUTIVE SEARCH AND PLACEMENT SERVICES FOR OTHERS (U.S. CLS. 100, 101 AND 102).

FIRST USE 1-0-2004; IN COMMERCE 1-0-2004.

CLASS 35—(Continued).

2,998,783. VENVEST, INC., ST. LOUIS, MO. SN 76-571,164. PUB. 10-19-2004, FILED 1-20-2004.



NO CLAIM IS MADE TO THE EXCLUSIVE RIGHT TO USE GROUP INTERNATIONAL, APART FROM THE MARK AS SHOWN.

FOR BUSINESS AND MARKETING CONSULTATION SERVICES (U.S. CLS. 100, 101 AND 102).

FIRST USE 10-0-2004; IN COMMERCE 10-0-2004.

2,998,796. SAVE NOW DISCOUNT PHARMACY, INC., SNOHOMISH, WA. SN 76-578,932. PUB. 1-11-2005, FILED 3-2-2004.



THE MARK CONSISTS OF STANDARD CHARACTERS WITHOUT CLAIM TO ANY PARTICULAR FONT, STYLE, SIZE, OR COLOR.

NO CLAIM IS MADE TO THE EXCLUSIVE RIGHT TO USE "SAVE", APART FROM THE MARK AS SHOWN.

FOR DISCOUNT RETAIL PHARMACY SERVICES (U.S. CLS. 100, 101 AND 102).

FIRST USE 5-10-2004; IN COMMERCE 6-1-2004.

2,998,823. PHOENIX INTANGIBLES HOLDING COMPANY, GREENVILLE, DE. SN 76-587,657. PUB. 1-25-2005, FILED 4-16-2004.



THE MARK CONSISTS OF STANDARD CHARACTERS WITHOUT CLAIM TO ANY PARTICULAR FONT, STYLE, SIZE, OR COLOR.

FOR RETAIL SUPERMARKET SERVICES; RETAIL CONVENIENCE STORE SERVICES, FEATURING FUEL; PROMOTING THE GOODS AND SERVICES OF OTHERS BY OFFERING DISCOUNTS ON THE PRICE OF GASOLINE TO PURCHASERS OF THOSE GOODS (U.S. CLS. 100, 101 AND 102).

FIRST USE 4-29-2004; IN COMMERCE 4-29-2004.

CLASS 35—(Continued).

2,998,896. CH2M HILL, INC., ENGLEWOOD, CO. SN 78-208,522. PUB. 5-4-2004, FILED 1-29-2003.



FOR ORGANIZATION OF WRITTEN COMMUNICATIONS, AND GENERATION AND ORGANIZATION OF RESPONSES TO WRITTEN COMMUNICATIONS (U.S. CLS. 100, 101 AND 102).
FIRST USE 7-14-2005; IN COMMERCE 7-14-2005.

2,998,902. INFRINGEMENT SOLUTIONS, INC., GREENVILLE, SC. SN 78-213,246. PUB. 12-21-2004, FILED 2-11-2003.



NO CLAIM IS MADE TO THE EXCLUSIVE RIGHT TO USE INFRINGEMENT SOLUTIONS, APART FROM THE MARK AS SHOWN.
FOR BUSINESS INVESTIGATION SERVICES IN THE FIELD OF INTELLECTUAL PROPERTY COPYRIGHTS, AND COPYRIGHT MONITORING IN THE FIELD OF ARCHITECTURAL DESIGN WORKS (U.S. CLS. 100, 101 AND 102).
FIRST USE 8-1-2002; IN COMMERCE 8-1-2002.

2,998,911. GEORGIA-PACIFIC CORPORATION, ATLANTA, GA. SN 78-217,524. PUB. 2-17-2004, FILED 2-21-2003.

SIGNATURE SUMMARY

THE MARK CONSISTS OF STANDARD CHARACTERS WITHOUT CLAIM TO ANY PARTICULAR FONT, STYLE, SIZE, OR COLOR.
FOR ORDER TRACKING AND MONITORING SERVICES FOR USE BY CUSTOMERS (U.S. CLS. 100, 101 AND 102).
FIRST USE 8-31-2003; IN COMMERCE 8-31-2003.

CLASS 35—(Continued).

2,998,923. NATIONAL HOSPICE AND PALLIATIVE CARE ORGANIZATION, ALEXANDRIA, VA. SN 78-225,178. PUB. 8-24-2004, FILED 3-13-2003.



APPLICANT CLAIMS COLOR AS A FEATURE OF THE MARK THAT CONSISTS OF A SIMPLE LOOP OF RIBBON: LENGTHWISE HALF OF THE RIBBON IS COMPRISED OF A GREEN STRIPE AND NEXT TO IT A PURPLE STRIPE RUNS LENGTHWISE; BOTH STRIPES ARE BORDERED ON ALL SIDES BY THE COLOR GOLD.
FOR PROMOTING AWARENESS OF HOSPICE SERVICES (U.S. CLS. 100, 101 AND 102).
FIRST USE 4-4-2005; IN COMMERCE 4-4-2005.

2,998,932. ARC RISK MANAGEMENT GROUP PLC, WOKINGHAM, UNITED KINGDOM. SN 78-234,968. PUB. 6-29-2004, FILED 4-8-2003.



FOR BUSINESS RESEARCH RELATING TO PHYSICAL SECURITY (U.S. CLS. 100, 101 AND 102).
FIRST USE 5-31-2004; IN COMMERCE 5-31-2004.

2,998,949. BENNETT BROTHERS, INC., CHICAGO, IL. SN 78-246,066. PUB. 7-20-2004, FILED 5-6-2003.

CONVENIENT GIFTS

NO CLAIM IS MADE TO THE EXCLUSIVE RIGHT TO USE GIFTS, APART FROM THE MARK AS SHOWN.
FOR MAIL ORDER SERVICES FOR GENERAL MERCHANDISE (U.S. CLS. 100, 101 AND 102).
FIRST USE 5-9-2003; IN COMMERCE 6-6-2003.

CLASS 35—(Continued).

2,998,969. BAEK, JOUNG-HYUN, SEOUL, REPUBLIC OF KOREA. SN 78-264,766. PUB. 9-7-2004, FILED 6-19-2003.

CLASS 35—(Continued).

2,999,079. DECKY COMPANY, INC., COMPTON, CA. SN 78-329,611. PUB. 9-14-2004, FILED 11-18-2003.

BOSOUNG

FOR IMPORT-EXPORT AGENCIES, RETAIL STORE SERVICES AND COMPUTERIZED ON-LINE RETAIL SERVICES FOR AIR CLEANERS AND AIR CLEANING SYSTEMS; DISTRIBUTORSHIPS FOR AIR CLEANERS AND AIR CLEANING SYSTEMS, AIR FILTERING INSTALLATIONS, AIR PURIFYING APPARATUS (U.S. CLS. 100, 101 AND 102).
FIRST USE 0-0-1985; IN COMMERCE 1-0-2005.

Cap Zone

2,999,009. BURLINGTON COAT FACTORY WAREHOUSE CORPORATION, BURLINGTON, NJ. SN 78-285,028. PUB. 5-11-2004, FILED 8-8-2003.

**STYLES TO LIVE FOR,
PRICES TO DIE FOR**

THE MARK CONSISTS OF STANDARD CHARACTERS WITHOUT CLAIM TO ANY PARTICULAR FONT, STYLE, SIZE, OR COLOR.
NO CLAIM IS MADE TO THE EXCLUSIVE RIGHT TO USE "CAP", APART FROM THE MARK AS SHOWN.
FOR RETAIL CLOTHING STORE SERVICES; MAIL ORDER CATALOG SERVICES FEATURING CLOTHING; AND TELEPHONE SHOP-AT-HOME SERVICES IN THE FIELD OF CLOTHING (U.S. CLS. 100, 101 AND 102).
FIRST USE 12-31-2003; IN COMMERCE 12-31-2003.

FOR RETAIL SHOE STORE SERVICES (U.S. CLS. 100, 101 AND 102).
FIRST USE 10-31-2004; IN COMMERCE 10-31-2004.

2,999,084. AMERICAN SOCIETY OF SAFETY ENGINEERS, DES PLAINES, IL. SN 78-333,172. PUB. 9-28-2004, FILED 11-25-2003.

2,999,046. ROBINSON, BYRON M SR., SOPERTON, GA. AND HARPER, TALLY S, SOPERTON, GA. SN 78-303,900. PUB. 11-9-2004, FILED 9-22-2003.



NO CLAIM IS MADE TO THE EXCLUSIVE RIGHT TO USE "ENTERTAINMENT", APART FROM THE MARK AS SHOWN.
FOR PERSONAL MANAGEMENT SERVICES FOR ARTISTS AND ENTERTAINERS (U.S. CLS. 100, 101 AND 102).
FIRST USE 5-25-2005; IN COMMERCE 5-25-2005.

THE MARK CONSISTS OF A PORTION OF A GLOBE.
FOR ASSOCIATION SERVICES, NAMELY, PROMOTING THE INTERESTS OF SAFETY ENGINEERS, SAFETY CONSULTANTS AND OTHER SAFETY AND HEALTH PRACTITIONERS (U.S. CLS. 100, 101 AND 102).
FIRST USE 8-0-2003; IN COMMERCE 8-0-2003.

CLASS 35—(Continued).

2,999,098. TKL RESEARCH INC., PARAMUS, NJ. SN 78-340,673. PUB. 10-26-2004, FILED 12-15-2003.

OUR EXPERIENCE
DEFINES YOUR
SUCCESS

THE MARK CONSISTS OF STANDARD CHARACTERS WITHOUT CLAIM TO ANY PARTICULAR FONT, STYLE, SIZE, OR COLOR.

FOR PATIENT RECRUITMENT FOR CLINICAL TRIALS (U.S. CLS. 100, 101 AND 102).

FIRST USE 2-1-2005; IN COMMERCE 2-1-2005.

CLASS 35—(Continued).

2,999,126. COOKIE TRAIL CONNECTION, MANSFIELD CENTER, CT. SN 78-349,832. PUB. 11-9-2004, FILED 1-9-2004.



NO CLAIM IS MADE TO THE EXCLUSIVE RIGHT TO USE "COOKIE", APART FROM THE MARK AS SHOWN.

FOR MAIL ORDER SERVICES FEATURING A SELECTION OF COOKIES (U.S. CLS. 100, 101 AND 102).

FIRST USE 2-1-2004; IN COMMERCE 3-20-2004.

2,999,120. REAL MARKET EXPERTS FRANCHISE, INC., THE, SCOTTSDALE, AZ. SN 78-347,119. PUB. 10-12-2004, FILED 12-31-2003.



NO CLAIM IS MADE TO THE EXCLUSIVE RIGHT TO USE "MARKET EXPERTS", APART FROM THE MARK AS SHOWN.

THE MARK CONSISTS OF A QUARTER MOON, A PARTIAL BUILDING OUTLINE WITH SMALL WINDOWS INSET, A PARTIAL HOUSE OUTLINE WITH A DOOR AND SMALL WINDOWS, A PALM TREE, AND THE WORDS THE REAL MARKET EXPERTS.

FOR FRANCHISE SERVICES, NAMELY OFFERING TECHNICAL ASSISTANCE IN ESTABLISHING AND/OR OPERATING BUSINESSES TO LOCATE, SELL, LEASE, FINANCE, AND/OR EXCHANGE RESIDENTIAL AND/OR COMMERCIAL PROPERTIES FOR INVESTMENT PURPOSES (U.S. CLS. 100, 101 AND 102).

FIRST USE 12-1-2003; IN COMMERCE 12-1-2003.

2,999,129. CARETRUST NETWORKS, FOLSOM, CA. SN 78-350,074. PUB. 12-28-2004, FILED 1-9-2004.

CareTrust Networks

THE MARK CONSISTS OF STANDARD CHARACTERS WITHOUT CLAIM TO ANY PARTICULAR FONT, STYLE, SIZE, OR COLOR.

NO CLAIM IS MADE TO THE EXCLUSIVE RIGHT TO USE "NETWORKS", APART FROM THE MARK AS SHOWN.

FOR ORGANIZING A NETWORK OF HOSPITALS, PHYSICIANS, AND ANCILLARY HEALTH CARE PROVIDERS TO OFFER HOSPITAL AND MEDICAL SERVICES AT PREFERRED RATES (U.S. CLS. 100, 101 AND 102).

FIRST USE 1-1-2004; IN COMMERCE 1-1-2004.

CLASS 35—(Continued).

2,999,132. SLEEP COUNTRY USA, INC., KENT, WA. SN 78-351,503. PUB. 11-2-2004, FILED 1-13-2004.

**REST ASSURED
GUARANTEE**

THE MARK CONSISTS OF STANDARD CHARACTERS WITHOUT CLAIM TO ANY PARTICULAR FONT, STYLE, SIZE, OR COLOR.

NO CLAIM IS MADE TO THE EXCLUSIVE RIGHT TO USE "GUARANTEE", APART FROM THE MARK AS SHOWN.

FOR RETAIL FURNITURE STORES (U.S. CLS. 100, 101 AND 102).

FIRST USE 1-31-2001; IN COMMERCE 1-31-2001.

2,999,133. CARDINAL HEALTH TECHNOLOGIES, LLC, LAS VEGAS, NV. SN 78-351,939. PUB. 10-26-2004, FILED 1-14-2004.

LOGISTICSOURCE

THE MARK CONSISTS OF STANDARD CHARACTERS WITHOUT CLAIM TO ANY PARTICULAR FONT, STYLE, SIZE, OR COLOR.

FOR MEDICAL, SURGICAL AND PHARMACEUTICAL SUPPLY CHAIN MANAGEMENT SERVICES FOR MAINTAINING AND REPLENISHING INVENTORY UTILIZING INFORMATION INTEGRATION AND CONSULTING, AUTOMATED REPLENISHMENT AT THE POINT-OF-CARE WITH PATIENT BEDSIDE VERIFICATION TECHNOLOGY, JUST-IN-TIME DELIVERY SYSTEMS, POINT-OF-USE DISPENSING SYSTEMS, SUPPLY STANDARDIZATION AND UTILIZATION AND PHARMACEUTICAL FORMULARY (U.S. CLS. 100, 101 AND 102).

FIRST USE 6-1-2003; IN COMMERCE 6-1-2003.

CLASS 35—(Continued).

2,999,134. DAIMLERCHRYSLER CORPORATION, AUBURN HILLS, MI. SN 78-352,543. PUB. 11-2-2004, FILED 1-15-2004.



OWNER OF U.S. REG. NOS. 526,175, 1,081,322, AND 1,129,553.

THE MARK CONSISTS OF THE WORDS JEEP EVERYDAY HEROES ADORNED WITH RIBBONS AND STARS.

FOR PROMOTING THE SALE OF MOTOR VEHICLES THROUGH THE ADMINISTRATION OF AN INCENTIVE AWARD PROGRAM, NAMELY, PROVIDING VEHICLE PURCHASE OR LEASE INCENTIVES TO FIRE, POLICE, PARAMEDIC OR MILITARY PERSONNEL (U.S. CLS. 100, 101 AND 102).

FIRST USE 2-1-2004; IN COMMERCE 2-1-2004.

2,999,143. HSI SERVICE CORP., NEWARK, DE. SN 78-355,261. PUB. 11-9-2004, FILED 1-21-2004.

EVERYTHING DENTAL

THE MARK CONSISTS OF STANDARD CHARACTERS WITHOUT CLAIM TO ANY PARTICULAR FONT, STYLE, SIZE, OR COLOR.

NO CLAIM IS MADE TO THE EXCLUSIVE RIGHT TO USE "DENTAL", APART FROM THE MARK AS SHOWN.

FOR WHOLESALE DISTRIBUTORSHIP SERVICES IN THE FIELD OF DENTAL EQUIPMENT, SUPPLIES AND TECHNOLOGIES (U.S. CLS. 100, 101 AND 102).

FIRST USE 1-0-2004; IN COMMERCE 1-0-2004.

CLASS 35—(Continued).

2,999,147. T.M. SCHULTZ TRAILER SALES, INC., BRANDON, SD. SN 78-356,861. PUB. 10-26-2004, FILED 1-23-2004.

CLASS 35—(Continued).

2,999,153. RSC THE QUALITY MEASUREMENT COMPANY, EVANSVILLE, IN. SN 78-359,498. PUB. 10-26-2004, FILED 1-29-2004.

THE RIGHT WAY TO
GO

THE MARK CONSISTS OF STANDARD CHARACTERS WITHOUT CLAIM TO ANY PARTICULAR FONT, STYLE, SIZE, OR COLOR.

FOR RETAIL STORE SERVICES FEATURING TRAILERS AND BOATS (U.S. CLS. 100, 101 AND 102).
FIRST USE 0-0-2004; IN COMMERCE 0-0-2004.

2,999,151. PATRIOT HEALTH INC., PLAINVIEW, NY. SN 78-358,725. PUB. 10-26-2004, FILED 1-28-2004.

PATRIOTHEALTH

THE MARK CONSISTS OF STANDARD CHARACTERS WITHOUT CLAIM TO ANY PARTICULAR FONT, STYLE, SIZE, OR COLOR.

FOR ADMINISTRATION OF A DISCOUNT PROGRAM FOR ENABLING PARTICIPANTS TO OBTAIN DISCOUNTS ON MEDICAL, PHARMACEUTICAL, DENTAL, VISION AND HEALTH CARE GOODS AND SERVICES THROUGH USE OF A DISCOUNT MEMBERSHIP CARD (U.S. CLS. 100, 101 AND 102).
FIRST USE 2-15-2005; IN COMMERCE 2-15-2005.

APM

THE MARK CONSISTS OF STANDARD CHARACTERS WITHOUT CLAIM TO ANY PARTICULAR FONT, STYLE, SIZE, OR COLOR.

FOR RESEARCH AND CONSULTING SERVICES IN THE FIELD OF EVALUATING AND MEASURING CONSUMER REACTION TO AND THE EFFECTIVENESS OF ADVERTISING; PERFORMING CONSUMER RESEARCH ON TELEVISION ADVERTISING (U.S. CLS. 100, 101 AND 102).
FIRST USE 1-21-2004; IN COMMERCE 1-21-2004.

2,999,183. ACTIVE FEET, INC., SOLANA BEACH, CA. SN 78-373,643. PUB. 3-15-2005, FILED 2-25-2004.

THE ACTIVE FOOT
STORE

THE MARK CONSISTS OF STANDARD CHARACTERS WITHOUT CLAIM TO ANY PARTICULAR FONT, STYLE, SIZE, OR COLOR.

NO CLAIM IS MADE TO THE EXCLUSIVE RIGHT TO USE "STORE", APART FROM THE MARK AS SHOWN.

FOR RETAIL STORE SERVICES FEATURING ORTHOTIC INSERTS FOR SHOES, ARCH SUPPORTS, SHOES, SOCKS AND FOOT HEALTH-RELATED PRODUCTS (U.S. CLS. 100, 101 AND 102).
FIRST USE 5-1-2004; IN COMMERCE 5-1-2004.

CLASS 35—(Continued).

2,999,203. PROMO INK, NEW YORK, NY. SN 78-381,627. PUB. 2-15-2005, FILED 3-10-2004.

CLASS 35—(Continued).

2,999,206. BEMUSIC, INC., NEW YORK, NY. SN 78-382,289. PUB. 12-21-2004, FILED 3-11-2004.

VIP OFFERS

LISTEN TO MORE. LISTEN FOR LESS.

THE MARK CONSISTS OF STANDARD CHARACTERS WITHOUT CLAIM TO ANY PARTICULAR FONT, STYLE, SIZE, OR COLOR.

NO CLAIM IS MADE TO THE EXCLUSIVE RIGHT TO USE "OFFERS", APART FROM THE MARK AS SHOWN.

FOR PROVIDING A WIDE RANGE OF CONSUMER PRODUCT INFORMATION ABOUT THE GOODS AND SERVICES OF OTHERS VIA A GLOBAL COMPUTER NETWORK (U.S. CLS. 100, 101 AND 102).

FIRST USE 1-15-2005; IN COMMERCE 1-15-2005.

THE MARK CONSISTS OF STANDARD CHARACTERS WITHOUT CLAIM TO ANY PARTICULAR FONT, STYLE, SIZE, OR COLOR.

FOR MUSIC CLUB ORDERING SERVICES FEATURING MUSICAL SOUND RECORDINGS (U.S. CLS. 100, 101 AND 102).

FIRST USE 11-4-2004; IN COMMERCE 11-4-2004.

2,999,204. FIRST NONPROFIT MUTUAL HOLDING COMPANY, CHICAGO, IL. SN 78-382,167. PUB. 12-28-2004, FILED 3-11-2004.

2,999,269. THE NATIONAL OSTEOPOROSIS FOUNDATION, WASHINGTON, DC, DC. SN 78-433,683. PUB. 4-19-2005, FILED 6-11-2004.

STANDING TALL FOR YOU

TOUCHSTONE

THE MARK CONSISTS OF STANDARD CHARACTERS WITHOUT CLAIM TO ANY PARTICULAR FONT, STYLE, SIZE, OR COLOR.

FOR PROMOTING PUBLIC AWARENESS ABOUT OSTEOPOROSIS TO THE PUBLIC, PATIENTS, AND HEALTH CARE PROFESSIONALS (U.S. CLS. 100, 101 AND 102).

FIRST USE 7-27-2004; IN COMMERCE 7-27-2004.

THE MARK CONSISTS OF STANDARD CHARACTERS WITHOUT CLAIM TO ANY PARTICULAR FONT, STYLE, SIZE, OR COLOR.

FOR PROVIDING DATABASES FEATURING AGGREGATED PRE-EMPLOYMENT TESTING RESULTS AND BENCHMARKS (U.S. CLS. 100, 101 AND 102).

FIRST USE 8-19-2004; IN COMMERCE 8-19-2004.

CLASS 36—INSURANCE AND FINANCIAL

CLASS 36—(Continued).

2,998,505. WASHINGTON MUTUAL, INC., SEATTLE, WA.
SN 75-442,730. PUB. 9-3-2002, FILED 3-2-1998.

WM MUTUAL FUNDS

NO CLAIM IS MADE TO THE EXCLUSIVE RIGHT TO USE "MUTUAL FUNDS", APART FROM THE MARK AS SHOWN.

FOR INVESTMENT SECURITIES; MUTUAL FUNDS; INVESTMENT ADVISORY SERVICES; MANAGEMENT AND MAINTENANCE OF MUTUAL FUNDS AND INVESTMENT SECURITIES; ALL OF THE AFOREMENTIONED SERVICES PROVIDED TO THE INVESTING PUBLIC, CONSISTING OF INDIVIDUAL RETAIL AND INDIVIDUAL AND CORPORATE COMMERCIAL CUSTOMERS, BUT NOT INVESTMENT PROFESSIONALS (U.S. CLS. 100, 101 AND 102).

FIRST USE 4-0-2004; IN COMMERCE 4-0-2004.

2,998,575. CALTIUS HOLDINGS LLC, LOS ANGELES, CA.
SN 76-385,196. PUB. 10-29-2002, FILED 3-20-2002.

CALTIUS EQUITY

NO CLAIM IS MADE TO THE EXCLUSIVE RIGHT TO USE "EQUITY", APART FROM THE MARK AS SHOWN.

FOR INVESTMENT MANAGEMENT SERVICES (U.S. CLS. 100, 101 AND 102).

FIRST USE 6-0-2005; IN COMMERCE 6-0-2005.

2,998,590. STANDARD LIFE INVESTMENTS LIMITED,
EDINBURGH, EH2 2LL, UNITED KINGDOM. SN 76-
411,899. PUB. 3-23-2004, FILED 5-24-2002.

**EXCEPTIONAL
INVESTMENTS,
EXTRAORDINARY WORLD**

FOR BANKING SERVICES; FUND INVESTMENT MANAGEMENT SERVICES; FINANCIAL INVESTMENT IN THE FIELD OF REAL ESTATE, SECURITIES, CASH AND FOREIGN CURRENCIES; FINANCIAL MANAGEMENT SERVICES (U.S. CLS. 100, 101 AND 102).

FIRST USE 1-22-2003; IN COMMERCE 6-9-2003.

2,998,595. LOANSTAR FUNDING GROUP, INC., BRYAN,
TX. SN 76-423,705. PUB. 4-15-2003, FILED 6-20-2002.

MORTGEDGE

FOR FINANCIAL SERVICES, NAMELY PROVIDING RESIDENTIAL MORTGAGES (U.S. CLS. 100, 101 AND 102).

FIRST USE 7-15-2005; IN COMMERCE 7-15-2005.

CLASS 36—(Continued).

2,998,599. WELLS FARGO & COMPANY, MINNEAPOLIS,
MN. SN 76-430,495. PUB. 2-18-2003, FILED 7-15-2002.

**WELLS FARGO BUSINESS
BALANCE PLUS**

OWNER OF U.S. REG. NOS. 779,187, 2,433,473, AND OTHERS.

NO CLAIM IS MADE TO THE EXCLUSIVE RIGHT TO USE "BUSINESS BALANCE", APART FROM THE MARK AS SHOWN.

FOR BANKING SERVICES, NAMELY, OVERDRAFT PROTECTION FOR BUSINESS DEPOSIT ACCOUNTS (U.S. CLS. 100, 101 AND 102).

FIRST USE 12-9-1999; IN COMMERCE 12-9-1999.

2,998,641. PENN CAPITAL, INC., ANNAPOLIS, MD. SN 76-
478,507. PUB. 4-27-2004, FILED 12-24-2002.

**PAYBILLSBUILDRE
DIT.COM**

FOR CONSUMER CREDIT REPORTING AND FINANCIAL SERVICES, NAMELY, PROVIDING INFORMATION VIA A GLOBAL COMPUTER NETWORK REGARDING BILL PAYMENT, CREDIT CARD, MORTGAGE, AND TAX PAYMENT SERVICES (U.S. CLS. 100, 101 AND 102).

FIRST USE 1-24-2005; IN COMMERCE 1-24-2005.

2,998,645. THE FIELD GENERALS, LLC, ATLANTA, GA. SN
76-482,340. PUB. 4-20-2004, FILED 1-14-2003.

THE FIELD GENERALS

FOR CHARITABLE FUND RAISING SERVICES FOR COMMUNITY INVESTMENT INITIATIVES AND EDUCATIONAL SCHOLARSHIPS (U.S. CLS. 100, 101 AND 102).

FIRST USE 1-0-2004; IN COMMERCE 1-0-2004.

2,998,652. SKYLINE COMMERCIAL REAL ESTATE, LLC,
CONSHOCKEN, PA. SN 76-484,724. PUB. 5-25-2004,
FILED 1-24-2003.

**KEEP US ON YOUR RADAR
SCREEN**

FOR REAL ESTATE SERVICES; NAMELY, REPRESENTING TENANTS IN THE NEGOTIATION AND RENEGOTIATION OF LEASES AND SUBLEASES AND THE PURCHASE AND SALE OF BUILDINGS (U.S. CLS. 100, 101 AND 102).

FIRST USE 9-15-2003; IN COMMERCE 9-15-2003.

CLASS 36—(Continued).

2,998,746. SUNRISE SENIOR LIVING, INC., MCLEAN, VA.
SN 76-556,916. PUB. 11-30-2004, FILED 11-5-2003.



NO CLAIM IS MADE TO THE EXCLUSIVE RIGHT TO USE "FUND", APART FROM THE MARK AS SHOWN.

FOR CHARITABLE SERVICES, NAMELY, PROVIDING FINANCIAL ASSISTANCE TO INDIVIDUALS SUFFERING HARDSHIP AS A RESULT OF PERSONAL CATASTROPHE (U.S. CLS. 100, 101 AND 102).

FIRST USE 12-0-2002; IN COMMERCE 12-0-2002.

2,998,776. WOODMEN INSURANCE AGENCY, INC., OMAHA, NE. SN 76-568,892. PUB. 10-26-2004, FILED 1-8-2004.



FOR GENERAL INSURANCE AGENCY (U.S. CLS. 100, 101 AND 102).

FIRST USE 1-26-2004; IN COMMERCE 1-26-2004.

2,998,780. THE FOREST HIGHLANDS ASSOCIATION, FLAGSTAFF, AZ. SN 76-570,892. PUB. 10-26-2004, FILED 1-16-2004.

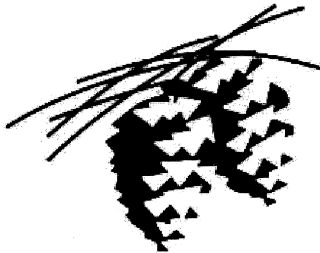

FOR REAL ESTATE SERVICES, NAMELY, REAL ESTATE AGENCY AND BROKERAGE (U.S. CLS. 100, 101 AND 102).

FIRST USE 1-1-1985; IN COMMERCE 1-1-1988.

CLASS 36—(Continued).

2,998,809. ASSURED GUARANTY LTD., HAMILTON HM 08, BERMUDA. SN 76-582,740. PUB. 12-28-2004, FILED 3-22-2004.



FOR INSURANCE SERVICES, NAMELY, PROVIDING FINANCIAL GUARANTY INSURANCE AND REINSURANCE FOR MUNICIPAL AND STRUCTURED FINANCE OBLIGATIONS AND MORTGAGE GUARANTY INSURANCE AND REINSURANCE (U.S. CLS. 100, 101 AND 102).

FIRST USE 1-7-2003; IN COMMERCE 1-7-2003.

2,998,815. THE WESTERN AND SOUTHERN LIFE INSURANCE COMPANY, CINCINNATI, OH. SN 76-585,082. PUB. 2-22-2005, FILED 4-5-2004.

NAUTICAL TERM

THE MARK CONSISTS OF STANDARD CHARACTERS WITHOUT CLAIM TO ANY PARTICULAR FONT, STYLE, SIZE, OR COLOR.

NO CLAIM IS MADE TO THE EXCLUSIVE RIGHT TO USE "TERM", APART FROM THE MARK AS SHOWN.

FOR UNDERWRITING SERVICES FOR LIFE INSURANCE POLICIES AND ANNUITIES (U.S. CLS. 100, 101 AND 102).

FIRST USE 6-11-2004; IN COMMERCE 6-11-2004.

2,998,849. VALX, LLC, LAKEWOOD, CO. SN 78-111,253. PUB. 10-8-2002, FILED 2-26-2002.

VALX

FOR REAL ESTATE APPRAISAL SERVICES (U.S. CLS. 100, 101 AND 102).

FIRST USE 6-20-2004; IN COMMERCE 12-24-2004.

CLASS 36—(Continued).

2,998,866. BLACKROCK CAPITAL CORPORATION, LAS VEGAS, NV. SN 78-153,361. PUB. 4-22-2003, FILED 8-12-2002.

STONEHEDGE FINANCIAL

OWNER OF U.S. REG. NO. 2,549,843.
NO CLAIM IS MADE TO THE EXCLUSIVE RIGHT TO USE "FINANCIAL", APART FROM THE MARK AS SHOWN.

FOR REAL ESTATE INVESTMENT AND MORTGAGE LENDING SERVICES (U.S. CLS. 100, 101 AND 102).
FIRST USE 7-13-2005; IN COMMERCE 7-13-2005.

2,998,908. GENERAL ELECTRIC COMPANY, SCHENECTADY, NY. SN 78-215,235. PUB. 8-31-2004, FILED 2-14-2003.

CLASSIC SELECT

NO CLAIM IS MADE TO THE EXCLUSIVE RIGHT TO USE SELECT, APART FROM THE MARK AS SHOWN.

FOR LONG TERM CARE INSURANCE PLANS; UNDERWRITING SERVICES FOR LONG TERM CARE INSURANCE AND REINSURANCE; ADMINISTERING SERVICES FOR LONG TERM CARE INSURANCE AND REINSURANCE PLANS (U.S. CLS. 100, 101 AND 102).
FIRST USE 12-31-2003; IN COMMERCE 12-31-2003.

2,998,998. HALBERT, HARGROVE/RUSSELL LLC, LONG BEACH, CA. SN 78-278,675. PUB. 5-25-2004, FILED 7-24-2003.

FIDUCIARY ADVICE. A PERSONAL RELATIONSHIP.

THE MARK CONSISTS OF STANDARD CHARACTERS WITHOUT CLAIM TO ANY PARTICULAR FONT, STYLE, SIZE, OR COLOR.

FOR INVESTMENT MANAGEMENT (U.S. CLS. 100, 101 AND 102).
FIRST USE 1-5-2005; IN COMMERCE 1-5-2005.

2,999,018. FIRST HORIZON NATIONAL CORPORATION, MEMPHIS, TN. SN 78-291,231. PUB. 4-27-2004, FILED 8-22-2003.

WE DO THE DIFFICULT WELL

FOR BANKING SERVICES; FINANCIAL SERVICES, NAMELY, PAYMENT PROCESSING SERVICES FOR CREDIT CARDS, DEBIT CARDS, CHECK CARDS, STORED VALUE CARDS AND CHECKS (U.S. CLS. 100, 101 AND 102).

FIRST USE 7-17-2005; IN COMMERCE 7-17-2005.

CLASS 36—(Continued).

2,999,022. A. G. EDWARDS & SONS, INC., ST. LOUIS, MO. SN 78-292,777. PUB. 6-22-2004, FILED 8-27-2003.

FULLY INVESTED IN OUR CLIENTS

FOR FINANCIAL SERVICES, NAMELY FINANCIAL ANALYSIS AND CONSULTATION, FINANCIAL INFORMATION PROVIDED BY ELECTRONIC MEANS, FINANCIAL MANAGEMENT, FINANCIAL PLANNING, FINANCIAL PORTFOLIO MANAGEMENT, FINANCIAL RESEARCH, FINANCIAL SERVICES IN THE NATURE OF AN INVESTMENT SECURITY, PROVIDING ONLINE STORED VALUE ACCOUNTS IN AN ELECTRONIC ENVIRONMENT, INVESTMENT FUND TRANSFER AND TRANSACTION SERVICES, COMMODITY INVESTMENT ADVICE, INVESTMENT CONSULTATION, FUNDS INVESTMENT CONSULTATION, FUNDS INVESTMENT, INVESTMENT ADVICE, INVESTMENT BANKING SERVICES, INVESTMENT BROKERAGE, INVESTMENT MANAGEMENT, INVESTMENT OF FUNDS FOR OTHERS, AND MUTUAL FUND INVESTMENT; FINANCIAL INVESTMENT SERVICES IN THE FIELDS OF SECURITIES, COMMODITIES, FUTURES, AND MUTUAL FUNDS; FINANCIAL BROKERAGE SERVICES IN THE FIELDS OF INVESTMENTS, SECURITIES, COMMODITIES, FUTURES, AND MUTUAL FUNDS (U.S. CLS. 100, 101 AND 102).

FIRST USE 9-30-2003; IN COMMERCE 9-30-2003.

2,999,087. INDEX POWERED FINANCIAL SERVICES, LLC, DENVER, CO. SN 78-333,917. PUB. 3-22-2005, FILED 11-26-2003.

IPFS eTransaction Network

THE MARK CONSISTS OF STANDARD CHARACTERS WITHOUT CLAIM TO ANY PARTICULAR FONT, STYLE, SIZE, OR COLOR.

NO CLAIM IS MADE TO THE EXCLUSIVE RIGHT TO USE "ETRACTION NETWORK", APART FROM THE MARK AS SHOWN.

FOR AUTOMATED ORDER ENTRY AND CLEARING SERVICES TO FACILITATE WHOLESALE BANKING TRANSACTIONS AMONG PARTICIPATING FINANCIAL INSTITUTIONS (U.S. CLS. 100, 101 AND 102).

FIRST USE 2-6-2004; IN COMMERCE 2-6-2004.

CLASS 36—(Continued).

2,999,089. SOUNDEXCHANGE, INC., WASHINGTON, DC. SN 78-334,527. PUB. 11-2-2004, FILED 12-1-2003.

PLAYS

THE MARK CONSISTS OF STANDARD CHARACTERS WITHOUT CLAIM TO ANY PARTICULAR FONT, STYLE, SIZE, OR COLOR.

FOR PROVIDING FINANCIAL INFORMATION VIA A GLOBAL COMPUTER NETWORK TO REGISTERED SUBSCRIBERS WITH REGARD TO ROYALTIES DERIVED FROM THE USE OF COPYRIGHTED MATERIALS (U.S. CLS. 100, 101 AND 102).

FIRST USE 12-31-2004; IN COMMERCE 12-31-2004.

2,999,158. AMERICAN EXPRESS COMPANY, NEW YORK, NY. SN 78-361,616. PUB. 11-16-2004, FILED 2-3-2004.

LIFETIME OPTIMIZER

THE MARK CONSISTS OF STANDARD CHARACTERS WITHOUT CLAIM TO ANY PARTICULAR FONT, STYLE, SIZE, OR COLOR.

FOR FINANCIAL PLANNING SERVICES (U.S. CLS. 100, 101 AND 102).

FIRST USE 5-31-2004; IN COMMERCE 5-31-2004.

2,999,178. KERR, CRISTIE, CORAL GABLES, FL. SN 78-371,600. PUB. 3-22-2005, FILED 2-20-2004.

**BIRDIES FOR BREAST
CANCER**

THE MARK CONSISTS OF STANDARD CHARACTERS WITHOUT CLAIM TO ANY PARTICULAR FONT, STYLE, SIZE, OR COLOR.

CLASS 36—(Continued).

NO CLAIM IS MADE TO THE EXCLUSIVE RIGHT TO USE "BREAST CANCER", APART FROM THE MARK AS SHOWN.

FOR CHARITABLE FUNDRAISING, NAMELY, CONDUCTING GOLF EVENTS TO RAISE FUNDS FOR BREAST CANCER RESEARCH (U.S. CLS. 100, 101 AND 102).

FIRST USE 3-1-2004; IN COMMERCE 3-1-2004.

2,999,209. PLACER SIERRA BANCSHARES, SACRAMENTO, CA. SN 78-385,387. PUB. 3-15-2005, FILED 3-16-2004.

**PLACER SIERRA
BANCSHARES**

THE MARK CONSISTS OF STANDARD CHARACTERS WITHOUT CLAIM TO ANY PARTICULAR FONT, STYLE, SIZE, OR COLOR.

NO CLAIM IS MADE TO THE EXCLUSIVE RIGHT TO USE "BANCSHARES", APART FROM THE MARK AS SHOWN.

FOR BANKING AND FINANCIAL INSTITUTION HOLDING COMPANY SERVICES, NAMELY, PROVIDING OWNERSHIP, FINANCIAL CONTROL AND REPORTING SERVICES FOR ONE OR MORE FINANCIAL INSTITUTIONS, ENGAGING IN RELATED BANKING SERVICES AND ENGAGING IN THE FINANCIAL ACTIVITIES OF A BANK HOLDING COMPANY (U.S. CLS. 100, 101 AND 102).

FIRST USE 2-1-2005; IN COMMERCE 2-1-2005.

2,999,210. PLACER SIERRA BANCSHARES, SACRAMENTO, CA. SN 78-385,465. PUB. 2-22-2005, FILED 3-16-2004.



OWNER OF U.S. REG. NO. 2,469,356.

NO CLAIM IS MADE TO THE EXCLUSIVE RIGHT TO USE "BANCSHARES", APART FROM THE MARK AS SHOWN.

FOR BANKING AND FINANCIAL INSTITUTION HOLDING COMPANY SERVICES, NAMELY, PROVIDING OWNERSHIP, FINANCIAL CONTROL AND REPORTING SERVICES FOR ONE OR MORE FINANCIAL INSTITUTIONS, ENGAGING IN RELATED BANKING SERVICES AND ENGAGING IN THE FINANCIAL ACTIVITIES OF A BANK HOLDING COMPANY (U.S. CLS. 100, 101 AND 102).

FIRST USE 2-1-2005; IN COMMERCE 2-1-2005.

CLASS 36—(Continued).

2,999,216. LOANSTAR FUNDING GROUP, INC., BRYAN, TX. SN 78-389,513. PUB. 3-15-2005, FILED 3-23-2004.

**EDGEUCATIONAL
BENEFITS**

THE MARK CONSISTS OF STANDARD CHARACTERS WITHOUT CLAIM TO ANY PARTICULAR FONT, STYLE, SIZE, OR COLOR.

OWNER OF U.S. REG. NO. 2,858,504.
NO CLAIM IS MADE TO THE EXCLUSIVE RIGHT TO USE "BENEFITS", APART FROM THE MARK AS SHOWN.
FOR PROVIDING CORPORATE EMPLOYEE STUDENT LOAN PROGRAMS (U.S. CLS. 100, 101 AND 102).
FIRST USE 4-1-2005; IN COMMERCE 4-1-2005.

2,999,243. PRIMESTAR REALTY, LLC., MESA, AZ. SN 78-408,418. PUB. 3-8-2005, FILED 4-27-2004.

PrimeStar ★ Realty, LLC.

NO CLAIM IS MADE TO THE EXCLUSIVE RIGHT TO USE REALTY, LLC., APART FROM THE MARK AS SHOWN.
FOR REAL ESTATE BROKERAGE (U.S. CLS. 100, 101 AND 102).
FIRST USE 5-4-2004; IN COMMERCE 5-4-2004.

CLASS 37—CONSTRUCTION AND REPAIR

CLASS 37—(Continued).

2,998,642. ANDERSON-MARTIN MACHINE COMPANY, FORT SMITH, AR. SN 76-481,114. PUB. 3-30-2004, FILED 1-9-2003.

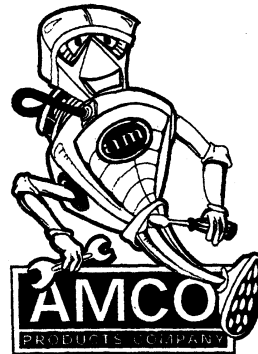

NO CLAIM IS MADE TO THE EXCLUSIVE RIGHT TO USE "PRODUCTS COMPANY", APART FROM THE MARK AS SHOWN.

THE MARK CONSISTS OF A FUNNEL SHAPED BODY WITH A HOSE CONNECTING A BACK TANK INTO THE FUNNEL SHAPED BODY WITH CHEST RIBBING BEHIND A CENTRAL EMBLEM INCLUDING THE LETTERS "AM", THE BODY HAVING A FUNNEL SHAPED HEAD SHOWING FACIAL FEATURES INCLUDING TWO EYES AND A MOUTH, FURTHER FEATURES INCLUDING A SINGLE EXTENDING LEG ENDING IN A FOOT WITH A PERFORATED BASE, A LEFT ARM ENDING IN A GLOVED HAND HOLDING A SCREWDRIVER, A RIGHT ARM ENDING IN A GLOVED HAND HOLDING A WRENCH, WITH THE BODY PLACED ABOVE AND OVER THE TOP OF A RECTANGULAR BLOCK OUTLINING THE WORDS "AMCO PRODUCTS COMPANY".

FOR MAINTENANCE AND REPAIR OF BOTTLING MACHINES AND ASSOCIATED COMPONENTS THEREOF (U.S. CLS. 100, 103 AND 106).
FIRST USE 1-0-2000; IN COMMERCE 1-0-2000.

2,998,667. DOUGHERTY, MARY ANN, VALENCIA, PA. AND MOLETZ, FIORE, VALENCIA, PA. SN 76-506,611. PUB. 11-4-2003, FILED 4-15-2003.

NEAT FLEET

FOR WINDOW CLEANING, RESIDENTIAL CLEANING, RESIDENTIAL AND COMMERCIAL BUILDING CLEANING, INTERIOR AND EXTERIOR BUILDING CLEANING, RUG CLEANING, WALL WASHING, MAINTENANCE OF FLOORS, MAINTENANCE AND REPAIR OF BUILDINGS (U.S. CLS. 100, 103 AND 106).
FIRST USE 3-1-2004; IN COMMERCE 3-1-2004.

CLASS 37—(Continued).

2,998,691. VENVEST, INC., ST. LOUIS, MO. SN 76-525,849.
PUB. 9-28-2004, FILED 6-19-2003.

WE'LL BE OUT TODAY OR YOU DON'T PAY

OWNER OF U.S. REG. NO. 2,625,175.
FOR REPAIR, MAINTENANCE AND INSTALLATION
SERVICES IN THE FIELD OF PLUMBING, HEATING,
VENTILATION AND AIR CONDITIONING; REPAIR,
MAINTENANCE AND INSTALLATION SERVICES IN
THE FIELD OF ELECTRICAL WIRING, ELECTRICAL
MOTORS AND HEATERS (U.S. CLS. 100, 103 AND 106).
FIRST USE 5-14-2004; IN COMMERCE 5-14-2004.

2,998,942. BOEING MANAGEMENT COMPANY, SEAL
BEACH, CA. SN 78-240,769. PUB. 12-2-2003, FILED 4-22-
2003.

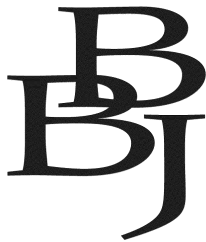

FOR REPAIR AND MAINTENANCE OF AIRCRAFT
AND AIRCRAFT PARTS (U.S. CLS. 100, 103 AND 106).
FIRST USE 2-0-2001; IN COMMERCE 2-0-2001.

2,999,002. LEWIS, BRIAN CHARLES, VENTURA, CA. SN 78-
279,225. PUB. 10-12-2004, FILED 7-25-2003.

DING DOC

NO CLAIM IS MADE TO THE EXCLUSIVE RIGHT TO
USE "DING", APART FROM THE MARK AS SHOWN.

FOR AUTOMOBILE REPAIR SERVICES, NAMELY,
ONE DAY MOBILE SERVICE TO REPAIR MINOR AUTO
DAMAGE, NAMELY, MINOR DENTS REMOVED WITH-
OUT PAINTING, SCUFFED/DAMAGED BUMPER RE-
PAIR, CHIPPED AND SCRATCHED PAINT REPAIR,
DENT AND DOOR DING REPAIR, LEATHER AND
VINYL REPAIR, DASHBOARD, DOOR AND PANEL,
PLASTIC PARTS REPAIR, MISCELLANEOUS SCUFF,
SCRAPE, NICK, CUT, TEAR, HOLE, AND GASH RE-
PAIR, VANDALISM, HAIL DAMAGE AND OVER
SPRAY REPAIR (U.S. CLS. 100, 103 AND 106).
FIRST USE 7-25-2003; IN COMMERCE 7-25-2003.

CLASS 37—(Continued).

2,999,021. VERIDIAN HOMES, LLC, MADISON, WI. SN 78-
292,760. PUB. 11-9-2004, FILED 8-27-2003.



THE MARK CONSISTS OF A STYLIZED V INSIDE OF A
CIRCLE.

FOR RESIDENTIAL BUILDING CONSTRUCTION
(U.S. CLS. 100, 103 AND 106).

FIRST USE 6-3-2003; IN COMMERCE 6-4-2003.

2,999,047. CASA BELLA DESIGN CENTER, LLC, NAPER-
VILLE, IL. SN 78-304,312. PUB. 8-31-2004, FILED 9-23-2003.

CASA BELLA DESIGN CENTER

NO CLAIM IS MADE TO THE EXCLUSIVE RIGHT TO
USE "CASA" OR "DESIGN CENTER", APART FROM THE
MARK AS SHOWN.

THE ENGLISH TRANSLATION OF CASA BELLA IS
HOUSE BEAUTIFUL.

FOR RESIDENTIAL HOME CONSTRUCTION AND
RENOVATION IN THE FIELD OF RESIDENTIAL
HOMES (U.S. CLS. 100, 103 AND 106).
FIRST USE 7-0-2004; IN COMMERCE 7-0-2004.

CLASS 38—COMMUNICATION

2,998,538. ONFIBER COMMUNICATIONS, INC., ENGLE-
WOOD, CO. SN 76-205,660. PUB. 6-17-2003, FILED 2-6-2001.

HOMERUN FIBER

NO CLAIM IS MADE TO THE EXCLUSIVE RIGHT TO
USE "FIBER", APART FROM THE MARK AS SHOWN.

FOR TELECOMMUNICATIONS SERVICES, NAMELY,
TRANSMISSION OF DATA AND VOICE COMMUNICA-
TIONS VIA FIBER OPTIC CABLE NETWORKS (U.S. CLS.
100, 101 AND 104).

FIRST USE 3-1-2000; IN COMMERCE 3-1-2000.

CLASS 38—(Continued).

2,998,753. THOR TECH, INC., SAGINAW, MI. SN 76-561,261.
PUB. 10-12-2004, FILED 11-24-2003.

AIRSTREAMER

THE MARK CONSISTS OF STANDARD CHARACTERS WITHOUT CLAIM TO ANY PARTICULAR FONT, STYLE, SIZE, OR COLOR.

OWNER OF U.S. REG. NOS. 607,224, 2,709,540, AND OTHERS.

FOR RECEIPT AND DELIVERY OF MESSAGES, DOCUMENTS, IMAGES AND OTHER DATA BY ELECTRONIC TRANSMISSION, AND PROVIDING MULTIPLE USER ACCESS TO A GLOBAL COMPUTER INFORMATION NETWORK (U.S. CLS. 100, 101 AND 104).

FIRST USE 0-0-2004; IN COMMERCE 0-0-2004.

2,998,917. THE SKOLL COMMUNITY FUND, SAN JOSE, CA.
SN 78-219,912. PUB. 11-30-2004, FILED 2-27-2003.

SOCIALEDGE

FOR PROVIDING ONLINE BULLETIN BOARDS FOR TRANSMISSION OF MESSAGES AMONG COMMUNITY MEMBER USERS CONCERNING SOCIAL ENTREPRENEURSHIP, COMMUNITY SERVICES, PHILANTHROPY, AND NON-PROFIT ORGANIZATIONS (U.S. CLS. 100, 101 AND 104).

FIRST USE 6-1-2003; IN COMMERCE 6-1-2003.

2,998,921. GRASSROOTS COMMUNICATIONS, INC., PALM DESERT, CA. SN 78-224,100. PUB. 12-2-2003, FILED 3-11-2003.

GRCLIVE

THE MARK CONSISTS OF STANDARD CHARACTERS WITHOUT CLAIM TO ANY PARTICULAR FONT, STYLE, SIZE, OR COLOR.

FOR WEB-BASED MULTIMEDIA TELECONFERENCING SERVICES, AND WEB-BASED REAL-TIME MULTIMEDIA COMMUNICATIONS SERVICES, WHICH ALLOWS USERS TO SIMULTANEOUSLY VIEW AND EDIT ELECTRONIC DATA, AND TO CONTROL SOFTWARE APPLICATIONS, WHEN THE DATA IS STORED, OR APPLICATIONS ARE RUNNING, ON A REMOTE COMPUTER (U.S. CLS. 100, 101 AND 104).

FIRST USE 6-12-2004; IN COMMERCE 6-12-2004.

CLASS 38—(Continued).

2,998,945. AT&T CORP., NEW YORK, NY. SN 78-241,957.
PUB. 11-11-2003, FILED 4-25-2003.

THE SPIRIT OF COMMUNICATION

NO CLAIM IS MADE TO THE EXCLUSIVE RIGHT TO USE "COMMUNICATION", APART FROM THE MARK AS SHOWN.

FOR TELECOMMUNICATIONS SERVICES, NAMELY, THE ELECTRONIC TRANSMISSION OF VOICE, DATA, FACSIMILE AND INFORMATION; INTERNET ACCESS SERVICES (U.S. CLS. 100, 101 AND 104).

FIRST USE 6-30-2005; IN COMMERCE 6-30-2005.

2,999,031. TELEPHONE ELECTRONICS CORPORATION, JACKSON, MS. SN 78-294,255. PUB. 1-11-2005, FILED 8-29-2003.

BSCI

FOR TELECOMMUNICATION SERVICES, NAMELY, LOCAL EXCHANGE CARRIER TELEPHONY SERVICES (U.S. CLS. 100, 101 AND 104).

FIRST USE 7-17-2003; IN COMMERCE 7-17-2003.

2,999,166. INTRADO INC., LONGMONT, CO. SN 78-364,004.
PUB. 11-2-2004, FILED 2-6-2004.

V9-1-1

THE MARK CONSISTS OF STANDARD CHARACTERS WITHOUT CLAIM TO ANY PARTICULAR FONT, STYLE, SIZE, OR COLOR.

OWNER OF U.S. REG. NOS. 2,173,471, 2,204,802, AND OTHERS.

FOR INTERNET TELEPHONY SERVICES; TELECOMMUNICATION SERVICES, NAMELY, LOCAL AND LONG DISTANCE TRANSMISSION OF VOICE, DATA, GRAPHICS, IMAGES, MESSAGES BY MEANS OF TELEPHONE, CABLE, INTERNET, SATELLITE AND GLOBAL COMMUNICATIONS NETWORKS; ELECTRONIC TRANSMISSION OF MESSAGES AND DATA; ELECTRONIC VOICE MESSAGING, NAMELY, THE RECORDING AND SUBSEQUENT TRANSMISSION OF VOICE MESSAGES BY TELEPHONE AND GLOBAL COMPUTER NETWORKS; ELECTRONIC, ELECTRIC, AND DIGITAL TRANSMISSION OF VOICE, DATA, IMAGES, SIGNALS, AND MESSAGES (U.S. CLS. 100, 101 AND 104).

FIRST USE 2-1-2005; IN COMMERCE 2-1-2005.

CLASS 38—(Continued).

2,999,237. SPRINT COMMUNICATIONS COMPANY L.P., OVERLAND PARK, KS. SN 78-402,125. PUB. 2-8-2005, FILED 4-15-2004.

CLASS 39—(Continued).

2,999,259. KLEIN, ELLIOT, NEW YORK, NY. SN 78-423,559. PUB. 5-3-2005, FILED 5-24-2004.

Sprint PCS Fair & Flexible America

APPEND

THE MARK CONSISTS OF STANDARD CHARACTERS WITHOUT CLAIM TO ANY PARTICULAR FONT, STYLE, SIZE, OR COLOR.

OWNER OF U.S. REG. NOS. 1,104,943, 2,833,134, AND OTHERS.

NO CLAIM IS MADE TO THE EXCLUSIVE RIGHT TO USE "PCS" OR "AMERICA", APART FROM THE MARK AS SHOWN.

FOR TELECOMMUNICATIONS SERVICES, NAMELY, WIRELESS PERSONAL COMMUNICATION SERVICES AND LONG DISTANCE TELEPHONE COMMUNICATION SERVICES FEATURING A RATE PLAN (U.S. CLS. 100, 101 AND 104).

FIRST USE 5-0-2004; IN COMMERCE 5-0-2004.

THE MARK CONSISTS OF STANDARD CHARACTERS WITHOUT CLAIM TO ANY PARTICULAR FONT, STYLE, SIZE, OR COLOR.

FOR PROVIDING INFORMATION ABOUT POSTAL DELIVERY, PACKAGING, AND TRANSPORTATION SERVICES, VIA THE INTERNET (U.S. CLS. 100 AND 105).

FIRST USE 5-24-2004; IN COMMERCE 3-21-2005.

CLASS 39—TRANSPORTATION AND STORAGE

2,999,117. WATERFRONT TRAVEL SERVICE, INC., BOSTON, MA. SN 78-346,608. PUB. 10-26-2004, FILED 12-30-2003.

CLASS 40—MATERIAL TREATMENT

2,998,844. FRANK'S SEPTIC SERVICE, INC., VACAVILLE, CA. SN 78-085,451. PUB. 9-3-2002, FILED 9-25-2001.



BIOPROTECH

THE MARK CONSISTS OF THE WORD "ILLUME" IN STYLIZED LETTERS WITH THREE CUT OUT CIRCLES TO THE LEFT OF THE WORD.

FOR ARRANGING TRAVEL TOURS (U.S. CLS. 100 AND 105).

FIRST USE 7-5-2005; IN COMMERCE 7-5-2005.

FOR ENVIRONMENTAL REMEDIATION SERVICES, NAMELY SOIL, WASTE AND/OR WATER TREATMENT SERVICES AND/OR CONSULTATIONS IN THE FIELD OF FOCUSED AND/OR SPECIFIC APPLICATIONS OF EFFECTIVE AND BENEFICIAL MICROORGANISMS OR MICROBIAL INOCULANTS FOR ENVIRONMENTALLY SAFE REMEDIATION, PROTECTION OR ENHANCEMENT PURPOSES IN AGRICULTURE, COMMERCIAL, INDUSTRIAL AND HOUSEHOLD USES (U.S. CLS. 100, 103 AND 106).

FIRST USE 11-1-2002; IN COMMERCE 5-1-2003.

CLASS 40—(Continued).

2,999,197. 2SOURCE MANUFACTURING, INC., MISSISSAUGA, CANADA. SN 78-380,496. PUB. 12-21-2004, FILED 3-8-2004.

2SOURCE

THE MARK CONSISTS OF STANDARD CHARACTERS WITHOUT CLAIM TO ANY PARTICULAR FONT, STYLE, SIZE, OR COLOR.

FOR PRECISION MACHINING OF PARTS ON A CONTRACT OR CUSTOM BASIS FOR OTHERS (U.S. CLS. 100, 103 AND 106).

FIRST USE 1-26-2004; IN COMMERCE 1-26-2004.

CLASS 41—EDUCATION AND ENTERTAINMENT

2,998,533. IMAGE HUNTER PUBLISHING, INC., MCLEAN, VA. SN 76-174,580. PUB. 5-28-2002, FILED 12-4-2000.

NATURE'S BEST SCHOOL OF PHOTOGRAPHY

NO CLAIM IS MADE TO THE EXCLUSIVE RIGHT TO USE "SCHOOL OF PHOTOGRAPHY", APART FROM THE MARK AS SHOWN.

FOR INSTRUCTION AND TRAINING THROUGH SEMINARS, CLASSES AND WORKSHOPS ALL IN THE FIELD OF PHOTOGRAPHY (U.S. CLS. 100, 101 AND 107).

FIRST USE 9-0-2000; IN COMMERCE 9-0-2000.

2,998,537. KELLEY, KEVIN W., SAN RAFAEL, CA. SN 76-204,720. PUB. 9-11-2001, FILED 2-1-2001.

THE HOME PLANET

FOR ENTERTAINMENT SERVICES, NAMELY, AMUSEMENT PARK SERVICES, PRODUCTION OF CABLE TELEVISION PROGRAMS, CABLE TELEVISION PROGRAMMING SERVICES, PRODUCTION OF AUDIOVISUAL WORKS, INCLUDING FILM AND VIDEO WORKS, AND EXHIBITION OF AUDIOVISUAL WORKS, INCLUDING FILM AND VIDEO WORKS (U.S. CLS. 100, 101 AND 107).

FIRST USE 7-12-2005; IN COMMERCE 7-12-2005.

CLASS 41—(Continued).

2,998,553. PLATYPUS WEAR, INC., SAN DIEGO, CA. SN 76-304,102. PUB. 4-9-2002, FILED 8-23-2001.

BAD GIRL

OWNER OF U.S. REG. NOS. 1,564,707 AND 2,095,747. FOR ENTERTAINMENT IN THE NATURE OF LIVE PERFORMANCES BY A MUSICAL GROUP (U.S. CLS. 100, 101 AND 107).

FIRST USE 8-23-2001; IN COMMERCE 6-4-2005.

2,998,577. THE TRUSTEES OF THE HOPKINS TRUST DATED FEBRUARY 9, 2001, A CALIFORNIA TRUST, THE TRUSTEES COMPRISING VINCENT R. HOPKINS AND DANETTE L. HOPKINS, BOTH U.S. CITIZENS., CAMARILLO, CA. SN 76-390,944. PUB. 7-22-2003, FILED 4-3-2002.

METAPHORIC STUNTS

FOR CONDUCTING WORKSHOPS AND SEMINARS IN THE FIELDS OF PERSUASION AND SALES. (U.S. CLS. 100, 101 AND 107).

FIRST USE 4-12-2004; IN COMMERCE 4-12-2004.

2,998,578. THE TRUSTEES OF THE HOPKINS TRUST DATED FEBRUARY 9, 2001, A CALIFORNIA TRUST, THE TRUSTEES COMPRISING VINCENT R. HOPKINS AND DANETTE L. HOPKINS, BOTH U.S. CITIZENS., CAMARILLO, CA. SN 76-390,945. PUB. 7-22-2003, FILED 4-3-2002.

AWAKENING BUYER/SELLER "CHEMISTRY"

FOR CONDUCTING WORKSHOPS AND SEMINARS IN THE FIELDS OF PERSUASION AND SALES (U.S. CLS. 100, 101 AND 107).

FIRST USE 4-12-2004; IN COMMERCE 4-12-2004.

2,998,627. BOLESKY/NOLTE INTENTION, INC., DBA SOMA INSTITUTE OF NEUROMUSCULAR INTEGRATION, BUCKLEY, WA. SN 76-466,562. PUB. 9-28-2004, FILED 11-13-2002.

SNI

FOR PROVIDING CLASSES, SEMINARS, WORKSHOPS, AND TRAINING IN SOMA NEUROMUSCULAR INTEGRATION BODYWORK (U.S. CLS. 100, 101 AND 107).

FIRST USE 2-8-2003; IN COMMERCE 3-29-2003.

CLASS 41—(Continued).

2,998,699. DARE TO BE FIT, INC, BEVERLY HILLS, CA. SN 76-529,876. PUB. 9-28-2004, FILED 7-16-2003.

CLASS 41—(Continued).

2,998,781. FOUNDATIONS, INC., MOORESTOWN, NJ. SN 76-571,018. PUB. 10-19-2004, FILED 1-20-2004.

WALK ON WATER

FOR EXERCISE SERVICES, NAMELY, CONDUCTING EXERCISE CLASSES AND SEMINARS FOR CRUISE SHIP PASSENGERS (U.S. CLS. 100, 101 AND 107).
FIRST USE 12-0-2003; IN COMMERCE 12-0-2003.

OSASIP

THE MARK CONSISTS OF STANDARD CHARACTERS WITHOUT CLAIM TO ANY PARTICULAR FONT, STYLE, SIZE, OR COLOR.

FOR EDUCATIONAL CONSULTATION SERVICES, NAMELY, PROVIDING ASSESSMENTS OF SCHOOLS AND SCHOOL DISTRICTS AND OFFERING SUGGESTIONS ON IMPROVEMENTS (U.S. CLS. 100, 101 AND 107).
FIRST USE 6-7-2004; IN COMMERCE 6-7-2004.

2,998,762. WYNN RESORTS HOLDINGS, LLC, LAS VEGAS, NV. SN 76-564,783. PUB. 7-27-2004, FILED 11-28-2003.



2,998,800. UNIVERSAL CITY STUDIOS LLLP, UNIVERSAL CITY, CA. SN 76-579,779. PUB. 3-1-2005, FILED 3-5-2004.

REVENGE OF THE MUMMY

OWNER OF U.S. REG. NO. 2,585,021.
SEC. 2(F).
FOR CASINO SERVICES AND ENTERTAINMENT SERVICES, NAMELY LIVE PERFORMANCES FEATURING SINGERS, DANCERS, MAGICIANS, ACTORS, ACROBATS, AND COMEDIANS, INTEGRATED WITH PRERECORDED MUSIC AND VIDEO (U.S. CLS. 100, 101 AND 107).
FIRST USE 4-28-2005; IN COMMERCE 4-28-2005.

THE MARK CONSISTS OF STANDARD CHARACTERS WITHOUT CLAIM TO ANY PARTICULAR FONT, STYLE, SIZE, OR COLOR.

FOR AMUSEMENT PARK SERVICES (U.S. CLS. 100, 101 AND 107).
FIRST USE 9-0-2003; IN COMMERCE 9-0-2003.

2,998,778. VOIGHT ENTERPRISES, INC., LIVONIA, MI. SN 76-569,675. PUB. 9-28-2004, FILED 12-29-2003.

2,998,812. XM SATELLITE RADIO INC., WASHINGTON, DC. SN 76-584,002. PUB. 2-22-2005, FILED 3-30-2004.

EL CHEAPO

THEN...AGAIN...LIVE!

THE MARK CONSISTS OF STANDARD CHARACTERS WITHOUT CLAIM TO ANY PARTICULAR FONT, STYLE, SIZE, OR COLOR.
FOR ENTERTAINMENT SERVICES IN THE NATURE OF BOWLING LEAGUES (U.S. CLS. 100, 101 AND 107).
FIRST USE 6-30-2004; IN COMMERCE 6-30-2004.

THE MARK CONSISTS OF STANDARD CHARACTERS WITHOUT CLAIM TO ANY PARTICULAR FONT, STYLE, SIZE, OR COLOR.

FOR ENTERTAINMENT SERVICES, NAMELY, PROVIDING ON-GOING RADIO PROGRAMS FEATURING TALK AND MUSIC (U.S. CLS. 100, 101 AND 107).
FIRST USE 9-1-2004; IN COMMERCE 9-1-2004.

CLASS 41—(Continued).

2,998,833. EEG SPECTRUM INTERNATIONAL, INC., CANOGA PARK, CA. SN 76-977,670. PUB. 10-19-2004, FILED 1-9-2004.

**TRANSFORMING PERSONAL AND
PROFESSIONAL OUTCOMES**

THE MARK CONSISTS OF STANDARD CHARACTERS WITHOUT CLAIM TO ANY PARTICULAR FONT, STYLE, SIZE, OR COLOR.

FOR EDUCATIONAL SERVICES, NAMELY, CONDUCTING EDUCATIONAL CLASSES, TRAINING SEMINARS AND WORKSHOPS TO TRAIN PROFESSIONAL PRACTITIONERS IN THE USE OF NEUROFEEDBACK TECHNOLOGY (U.S. CLS. 100, 101 AND 107).

FIRST USE 3-18-2005; IN COMMERCE 3-18-2005.

CLASS 41—(Continued).

2,998,906. CREATIVE EDUCATIONAL CONCEPTS, INC., LEXINGTON, KY. SN 78-214,841. PUB. 7-13-2004, FILED 2-14-2003.

CE CONCEPTS

THE MARK CONSISTS OF STANDARD CHARACTERS WITHOUT CLAIM TO ANY PARTICULAR FONT, STYLE, SIZE, OR COLOR.

NO CLAIM IS MADE TO THE EXCLUSIVE RIGHT TO USE "CE", APART FROM THE MARK AS SHOWN.

THE MARK IS PRESENTED IN STANDARD CHARACTERS, WITHOUT CLAIM TO ANY PARTICULAR FONT, STYLE, SIZE OR COLOR.

FOR EDUCATIONAL SERVICES, NAMELY CONDUCTING CLASS AND SEMINARS IN THE FIELD OF HEALTHCARE (U.S. CLS. 100, 101 AND 107).

FIRST USE 1-2-2002; IN COMMERCE 1-2-2002.

2,998,890. CORPORATE MENTORING SOLUTIONS, INC., SAANICHTON, BRITISH COLUMBIA, CANADA. SN 78-197,417. PUB. 8-26-2003, FILED 12-23-2002.

JUST-IN-TIME MENTORING

NO CLAIM IS MADE TO THE EXCLUSIVE RIGHT TO USE "MENTORING", APART FROM THE MARK AS SHOWN.

FOR EDUCATIONAL SERVICES, NAMELY, PROVIDING SELF-DIRECTED TRAINING AND EDUCATIONAL PROGRAMS IN THE FIELDS OF HUMAN RESOURCES, CAREER DEVELOPMENT, PERSONAL AWARENESS, COACHING, EXECUTIVE DEVELOPMENT AND LEADERSHIP (U.S. CLS. 100, 101 AND 107).

FIRST USE 6-7-2004; IN COMMERCE 7-1-2005.

2,998,933. VICKERY, MAUREEN M., HOUSTON, TX. SN 78-235,000. PUB. 6-8-2004, FILED 4-8-2003.

BALLPOINT ELEGANCE

NO CLAIM IS MADE TO THE EXCLUSIVE RIGHT TO USE "BALLPOINT", APART FROM THE MARK AS SHOWN.

FOR HANDWRITING INSTRUCTION IN THE FORM OF SEMINARS, WORKSHOPS, CLASSES, AND RELATED INSTRUCTIONAL MATERIALS PROVIDED THEREWITH (U.S. CLS. 100, 101 AND 107).

FIRST USE 1-1-2005; IN COMMERCE 1-1-2005.

2,998,893. PERLMAN, MELISSA, PHOENIX, AZ. SN 78-203,574. PUB. 10-14-2003, FILED 1-15-2003.

BIKINI BOOT CAMP

FOR HEALTH CLUB SERVICES, NAMELY, PROVIDING INSTRUCTION IN THE FIELD OF PHYSICAL EXERCISE (U.S. CLS. 100, 101 AND 107).

FIRST USE 7-1-2002; IN COMMERCE 8-1-2002.

2,998,947. WAGT TELEVISION, INC., AUGUSTA, GA. SN 78-242,848. PUB. 12-9-2003, FILED 4-28-2003.

RIVERBLAST

FOR ENTERTAINMENT SERVICES; NAMELY, RECREATIONAL SERVICES IN CONNECTION WITH AN ANNUAL PUBLIC FIREWORKS DISPLAY AND FESTIVAL (U.S. CLS. 100, 101 AND 107).

FIRST USE 6-7-2003; IN COMMERCE 6-7-2003.

CLASS 41—(Continued).

2,998,957. TV ONE, LLC, SILVER SPRING, MD. SN 78-257,306. PUB. 11-2-2004, FILED 6-2-2003.

TV ONE

NO CLAIM IS MADE TO THE EXCLUSIVE RIGHT TO USE "TV", APART FROM THE MARK AS SHOWN.

FOR PROVIDING ON-LINE NEWSLETTERS AND MAGAZINES IN THE FIELDS OF MUSIC, FASHION, COMEDY, SPORTS, NEWS, DRAMA, DANCE, TALK SHOWS, GAME SHOWS, REALITY SHOWS, VARIETY SHOWS, LIVE PERFORMANCES, HEALTH AND FITNESS, LIFESTYLE, TRAVEL, AND TOPICS OF GENERAL INTEREST; DISSEMINATION OF INFORMATION ON NEWS, ENTERTAINMENT, SPORTS, FASHION AND MUSIC VIA A GLOBAL COMPUTER NETWORK; CHARITABLE SERVICES, NAMELY, PROVIDING MUSICAL INSTRUMENTS TO OTHERS (U.S. CLS. 100, 101 AND 107).

FIRST USE 4-1-2005; IN COMMERCE 4-1-2005.

2,998,959. JAMES FRANK JAROLIMEK, ESTES PARK, CO. SN 78-257,610. PUB. 4-13-2004, FILED 6-3-2003.

**NATURAL CONCEPTS
PHOTOGRAPHY**

NO CLAIM IS MADE TO THE EXCLUSIVE RIGHT TO USE PHOTOGRAPHY, APART FROM THE MARK AS SHOWN.

FOR PHOTOGRAPHY SERVICES (U.S. CLS. 100, 101 AND 107).

FIRST USE 6-3-2003; IN COMMERCE 5-17-2005.

2,998,974. RUGGIERO, CHRISTIAN, NEW YORK, NY. AND JASPER, GEREY, NEW YORK, NY. SN 78-267,492. PUB. 7-20-2004, FILED 6-26-2003.

THE FEVER

FOR ENTERTAINMENT SERVICES, NAMELY, LIVE PERFORMANCES BY A MUSICAL BAND (U.S. CLS. 100, 101 AND 107).

FIRST USE 0-0-2001; IN COMMERCE 0-0-2001.

CLASS 41—(Continued).

2,999,024. EQUITY RECORDS, INC., NASHVILLE, TN. SN 78-293,350. PUB. 10-12-2004, FILED 8-28-2003.

EQUITY MUSIC GROUP

NO CLAIM IS MADE TO THE EXCLUSIVE RIGHT TO USE "MUSIC GROUP", APART FROM THE MARK AS SHOWN.

FOR ENTERTAINMENT SERVICES, NAMELY, MUSICAL SOUND RECORDING PRODUCTION AND AUDIO-VISUAL RECORDING PRODUCTION; MUSIC PUBLISHING SERVICES; FAN CLUB SERVICES; AND PROVIDING A WEB SITE FEATURING ENTERTAINMENT IN THE NATURE OF PRERECORDED MUSIC, MUSICAL PERFORMANCES, VIDEO CLIPS, PHOTOGRAPHS, NEWS, REVIEWS AND OTHER MULTIMEDIA ARTICLES IN CONNECTION WITH A RECORD LABEL, MUSICAL GROUPS AND SOLO RECORDINGS ARTISTS (U.S. CLS. 100, 101 AND 107).

FIRST USE 9-0-2003; IN COMMERCE 9-0-2003.

2,999,027. ROGERS BLUE JAYS BASEBALL PARTNERSHIP, TORONTO, ONTARIO, CANADA. SN 78-294,159. PUB. 10-19-2004, FILED 8-29-2003.



OWNER OF U.S. REG. NOS. 1,147,361, 2,619,938, AND OTHERS.

FOR ENTERTAINMENT SERVICES, NAMELY, BASEBALL GAMES, COMPETITIONS AND EXHIBITIONS RENDERED LIVE AND THROUGH BROADCAST MEDIA INCLUDING TELEVISION AND RADIO, AND VIA A GLOBAL COMPUTER NETWORK OR A COMMERCIAL ON-LINE SERVICE; INFORMATION SERVICES, NAMELY, PROVIDING INFORMATION IN THE FIELD OF SPORTS, ENTERTAINMENT AND RELATED TOPICS, AND PROVIDING FOR INFORMATIONAL MESSAGES RELATING THERETO; ENTERTAINMENT SERVICES, NAMELY, PROVIDING MULTI-USER INTERACTIVE COMPUTER GAMES ALL VIA A GLOBAL COMPUTER NETWORK OR A COMMERCIAL ON-LINE SERVICE; EDUCATIONAL SERVICES IN THE NATURE OF BASEBALL SKILLS PROGRAMS, BASEBALL CAMPS, SEMINARS AND CLINICS OFFERED LIVE AND THROUGH ON-LINE INSTRUCTION; ENTERTAINMENT SERVICES, NAMELY, PRODUCTION OF PROGRAMMING BROADCAST VIA TELEVISION, RADIO AND A GLOBAL COMPUTER NETWORK OR A COMMERCIAL ON-LINE SERVICE; ORGANIZING COMMUNITY SPORTING EVENTS; PROVIDING FACILITIES FOR SPORTS TOURNAMENTS AND COMPETITIONS RELATING TO BASEBALL; ORGANIZING AND CONDUCTING FANTASY SPORTS, SPORTS CONTESTS AND SWEEPSTAKES; FAN CLUBS; PROVIDING ON-LINE NON-DOWNLOADABLE NEWSLETTERS IN THE FIELD OF BASEBALL (U.S. CLS. 100, 101 AND 107).

FIRST USE 1-1-2004; IN COMMERCE 1-1-2004.

CLASS 41—(Continued).

2,999,028. ROGERS BLUE JAYS BASEBALL PARTNERSHIP, TORONTO, ONTARIO, CANADA. SN 78-294,172. PUB. 10-19-2004, FILED 8-29-2003.

CLASS 41—(Continued).

2,999,030. ROGERS BLUE JAYS BASEBALL PARTNERSHIP, TORONTO, CANADA. SN 78-294,223. PUB. 11-9-2004, FILED 8-29-2003.

Toronto



OWNER OF U.S. REG. NOS. 1,147,361, 2,619,938, AND OTHERS.

FOR ENTERTAINMENT SERVICES, NAMELY, BASEBALL GAMES, COMPETITIONS AND EXHIBITIONS RENDERED LIVE AND THROUGH BROADCAST MEDIA INCLUDING TELEVISION AND RADIO, AND VIA A GLOBAL COMPUTER NETWORK OR A COMMERCIAL ON-LINE SERVICE; INFORMATION SERVICES, NAMELY, PROVIDING INFORMATION IN THE FIELD OF SPORTS, ENTERTAINMENT AND RELATED TOPICS, AND PROVIDING FOR INFORMATIONAL MESSAGES RELATING THERETO; ENTERTAINMENT SERVICES, NAMELY, PROVIDING MULTI-USER INTERACTIVE COMPUTER GAMES ALL VIA A GLOBAL COMPUTER NETWORK OR A COMMERCIAL ON-LINE SERVICE; EDUCATIONAL SERVICES IN THE NATURE OF BASEBALL SKILLS PROGRAMS, BASEBALL CAMPS, SEMINARS AND CLINICS OFFERED LIVE AND THROUGH ON-LINE INSTRUCTION; ENTERTAINMENT SERVICES, NAMELY, PRODUCTION OF PROGRAMMING BROADCAST VIA TELEVISION, RADIO AND A GLOBAL COMPUTER NETWORK OR A COMMERCIAL ON-LINE SERVICE; ORGANIZING COMMUNITY SPORTING EVENTS; PROVIDING FACILITIES FOR SPORTS TOURNAMENTS AND COMPETITIONS RELATING TO BASEBALL; ORGANIZING AND CONDUCTING FANTASY SPORTS, SPORTS CONTESTS AND SWEEPSTAKES; FAN CLUBS; PROVIDING ON-LINE NEWSLETTERS IN THE FIELD OF BASEBALL (U.S. CLS. 100, 101 AND 107).

FIRST USE 1-1-2004; IN COMMERCE 1-1-2004.

2,999,032. ANDERSON, CHRISTINE D., FRAZIER PARK, CA. SN 78-295,400. PUB. 4-19-2005, FILED 9-3-2003.

VOICES IN BRONZE

OWNER OF U.S. REG. NOS. 1,147,361, 1,552,755, AND 1,591,105.

SEC. 2(F).

FOR ENTERTAINMENT SERVICES, NAMELY, BASEBALL GAMES, COMPETITIONS AND EXHIBITIONS RENDERED LIVE AND THROUGH BROADCAST MEDIA INCLUDING TELEVISION AND RADIO, AND VIA A GLOBAL COMPUTER NETWORK OR A COMMERCIAL ON-LINE SERVICE; ENTERTAINMENT SERVICES, NAMELY, PRODUCTION OF PROGRAMMING BROADCAST VIA TELEVISION, RADIO AND A GLOBAL COMPUTER NETWORK OR A COMMERCIAL ON-LINE SERVICE; FAN CLUBS; PROVIDING ON-LINE NON-DOWNLOADABLE NEWSLETTERS IN THE FIELD OF BASEBALL; ALL RELATING TO OR PROMOTING A BASEBALL TEAM (U.S. CLS. 100, 101 AND 107).

FIRST USE 2-0-2004; IN COMMERCE 2-0-2004.

FOR PROVIDING EDUCATIONAL SERVICES, NAMELY, CLINICS ON THE SUBJECT OF HANDBELL PERFORMANCE; CONDUCTING ENTERTAINMENT IN THE NATURE OF HANDBELL CONCERTS; LIVE PERFORMANCES BY A HANDBELL ARTIST; CONSULTING IN THE FIELD OF HANDBELL MUSIC (U.S. CLS. 100, 101 AND 107).

FIRST USE 5-20-1980; IN COMMERCE 9-1-1981.

CLASS 41—(Continued).

2,999,045. VISIONOPS, HIGHLANDS RANCH, CO. SN 78-303,543. PUB. 9-28-2004, FILED 9-22-2003.

EVERYDAY MANAGER

NO CLAIM IS MADE TO THE EXCLUSIVE RIGHT TO USE "MANAGER", APART FROM THE MARK AS SHOWN. FOR EDUCATIONAL SEMINARS IN THE FIELD OF BUSINESS MANAGEMENT AND DISTRIBUTION OF COURSE MATERIALS IN CONNECTION THEREWITH (U.S. CLS. 100, 101 AND 107).

FIRST USE 5-31-2003; IN COMMERCE 8-15-2003.

2,999,049. CPI COMPANIES, INC., BROOKFIELD, WI. SN 78-306,881. PUB. 8-10-2004, FILED 9-29-2003.

RESPECT, SERVICE AND SAFETY AT WORK

FOR EDUCATIONAL AND TRAINING SERVICES, NAMELY PROVIDING SEMINARS, CONFERENCE SESSIONS AND ONLINE TUTORIALS IN THE AREA OF WORKPLACE RELATIONSHIPS, INCLUDING PREVENTION OF AND RESPONSES TO IRRATIONAL, DISRUPTIVE, HOSTILE AND AGGRESSIVE BEHAVIOR AND DISTRIBUTING COURSE MATERIALS IN CONNECTION THEREWITH (U.S. CLS. 100, 101 AND 107).

FIRST USE 8-12-2003; IN COMMERCE 8-12-2003.

2,999,051. VENTURA FOODS, LLC, BREA, CA. SN 78-307,767. PUB. 7-6-2004, FILED 9-30-2003.

SPIRIT OF INNOVATION AWARDS

FOR PROVIDING RECOGNITION AND INCENTIVES BY THE WAY OF AWARDS TO DEMONSTRATE EXCELLENCE IN THE FIELDS OF FOODS, FOOD INGREDIENTS, AND PREPARATION OF FOODS (U.S. CLS. 100, 101 AND 107).

FIRST USE 10-15-2003; IN COMMERCE 10-15-2003.

CLASS 41—(Continued).

2,999,068. GAME SHOW NETWORK, LLC, SANTA MONICA, CA. SN 78-325,044. PUB. 3-22-2005, FILED 11-7-2003.

WORLD SERIES OF BLACKJACK

THE MARK CONSISTS OF STANDARD CHARACTERS WITHOUT CLAIM TO ANY PARTICULAR FONT, STYLE, SIZE, OR COLOR.

NO CLAIM IS MADE TO THE EXCLUSIVE RIGHT TO USE BLACKJACK, APART FROM THE MARK AS SHOWN. FOR ENTERTAINMENT SERVICES; NAMELY, PROVIDING A TELEVISION GAME SHOW PROGRAM (U.S. CLS. 100, 101 AND 107).

FIRST USE 3-15-2004; IN COMMERCE 3-15-2004.

2,999,077. MCDONALD'S CORPORATION, OAK BROOK, IL. SN 78-327,968. PUB. 7-27-2004, FILED 11-14-2003.

GET MOVING WITH RONALD MCDONALD

THE MARK CONSISTS OF STANDARD CHARACTERS WITHOUT CLAIM TO ANY PARTICULAR FONT, STYLE, SIZE, OR COLOR.

THE NAME(S), PORTRAIT(S), AND/OR SIGNATURE(S) SHOWN IN THE MARK DOES NOT IDENTIFY A PARTICULAR LIVING INDIVIDUAL.

FOR ENTERTAINMENT SERVICES, NAMELY, PERFORMANCES BY AN INDIVIDUAL IN A CLOWN COSTUME (U.S. CLS. 100, 101 AND 107).

FIRST USE 10-30-2003; IN COMMERCE 10-30-2003.

CLASS 41—(Continued).

2,999,096. REMAX VOGUE REALTY, INC., HOLLAND, MI. SN 78-339,590. PUB. 3-15-2005, FILED 12-11-2003.

Taste of Holland
Festival

THE MARK CONSISTS OF STANDARD CHARACTERS WITHOUT CLAIM TO ANY PARTICULAR FONT, STYLE, SIZE, OR COLOR.

NO CLAIM IS MADE TO THE EXCLUSIVE RIGHT TO USE HOLLAND FESTIVAL, APART FROM THE MARK AS SHOWN.

FOR ENTERTAINMENT IN THE NATURE OF ANNUAL ONE-DAY EVENTS CONSISTING OF A VARIETY OF FOODS, FOOD BOOTHS, AND MUSICAL ENTERTAINMENT IN AN OUTDOOR SETTING IN HOLLAND, MICHIGAN (U.S. CLS. 100, 101 AND 107).

FIRST USE 8-1-2004; IN COMMERCE 8-1-2004.

2,999,152. A&E TELEVISION NETWORKS, NEW YORK, NY. SN 78-359,024. PUB. 2-1-2005, FILED 1-28-2004.

TOOLBOX

THE MARK CONSISTS OF STANDARD CHARACTERS WITHOUT CLAIM TO ANY PARTICULAR FONT, STYLE, SIZE, OR COLOR.

FOR ENTERTAINMENT IN THE NATURE OF ONGOING CABLE TELEVISION PROGRAMS FEATURING THE HISTORY OF TOOLS AND PROVIDING ENTERTAINMENT AND EDUCATIONAL INFORMATION ON THE BACKGROUND AND EVOLUTION OF TOOLS (U.S. CLS. 100, 101 AND 107).

FIRST USE 7-31-2004; IN COMMERCE 7-31-2004.

CLASS 41—(Continued).

2,999,157. SAFETY MANAGEMENT SOLUTIONS, CHICAGO, IL. SN 78-361,568. PUB. 2-1-2005, FILED 2-3-2004.



NO CLAIM IS MADE TO THE EXCLUSIVE RIGHT TO USE "DRIVERS", APART FROM THE MARK AS SHOWN.

THE COLORS BLUE AND TEAL ARE CLAIMED AS A FEATURE OF THE MARK.

THE COLOR BLUE APPEARS IN THE WORDING INTELLIGENT DRIVER, AND THE COLOR TEAL APPEARS IN THE DESIGN CONSISTING OF A FEMALE HEAD IMPOSED ON A MALE HEAD WITH A VERTICAL HIGHWAY THROUGH THE HEADS.

FOR EDUCATION, TRAINING AND CONSULTING SERVICES IN THE FIELD OF DRIVING INSTRUCTION IN THE FLEET INDUSTRY (U.S. CLS. 100, 101 AND 107).

FIRST USE 2-1-2004; IN COMMERCE 4-10-2004.

2,999,160. CORE COMMUNITIES, LLC, PORT ST. LUCIE, FL. SN 78-363,360. PUB. 3-8-2005, FILED 2-5-2004.

TRADITION FIELD

THE MARK CONSISTS OF STANDARD CHARACTERS WITHOUT CLAIM TO ANY PARTICULAR FONT, STYLE, SIZE, OR COLOR.

NO CLAIM IS MADE TO THE EXCLUSIVE RIGHT TO USE "FIELD", APART FROM THE MARK AS SHOWN.

FOR ENTERTAINMENT SERVICES, NAMELY, PROVIDING STADIUM AND ATHLETIC FIELD FACILITIES FOR SPORTING AND ENTERTAINMENT EVENTS (U.S. CLS. 100, 101 AND 107).

FIRST USE 2-23-2004; IN COMMERCE 2-23-2004.

CLASS 41—(Continued).

2,999,194. MAY, EDWARD, J., MIDDLE VILLAGE, NY. SN 78-379,981. PUB. 1-11-2005, FILED 3-8-2004.

CLASS 41—(Continued).

2,999,211. NOAHS ARK ANIMAL WORKSHOP, CRESTWOOD, IL. SN 78-387,638. PUB. 3-1-2005, FILED 3-19-2004.

"The King Of Karaoke"

Stuff-N-Fluff

THE MARK CONSISTS OF STANDARD CHARACTERS WITHOUT CLAIM TO ANY PARTICULAR FONT, STYLE, SIZE, OR COLOR.

NO CLAIM IS MADE TO THE EXCLUSIVE RIGHT TO USE KARAOKE, APART FROM THE MARK AS SHOWN.

FOR CONDUCTING ENTERTAINMENT EXHIBITIONS IN THE NATURE OF KARAOKE SHOWS (U.S. CLS. 100, 101 AND 107).

FIRST USE 4-18-2005; IN COMMERCE 4-18-2005.

THE MARK CONSISTS OF STANDARD CHARACTERS WITHOUT CLAIM TO ANY PARTICULAR FONT, STYLE, SIZE, OR COLOR.

FOR CONDUCTING WORKSHOPS IN THE NATURE OF PARTIES FOR CREATING STUFFED TOY ANIMALS, PLUSH TOY ANIMALS, STUFFED TOYS DOLLS, PLUSH TOY DOLLS, STUFFED PLUSH ANIMAL PILLOWS, AND STUFFED AND PLUSH TOY ANIMAL AND DOLL ACCESSORIES, NAMELY BANDANNAS, T-SHIRTS, CLOTHING, SUNGLASSES, SOUND CHIPS, JEWELRY, SHOES, BACKPACKS, HAND BAGS, TOTE BAGS, PURSES, ANIMAL AND DOLL CARRYING CASES, BIRTH CERTIFICATE, WISH STARS (U.S. CLS. 100, 101 AND 107).

FIRST USE 3-1-2003; IN COMMERCE 3-1-2003.

2,999,199. MCDAVID ELKINS, ELIZABETH, ATLANTA, GA. SN 78-380,560. PUB. 12-21-2004, FILED 3-8-2004.

2,999,248. MEDTRONIC, INC., MINNEAPOLIS, MN. SN 78-412,162. PUB. 2-8-2005, FILED 5-3-2004.

The Swear

MOVEMENT FOR LIVING

THE MARK CONSISTS OF STANDARD CHARACTERS WITHOUT CLAIM TO ANY PARTICULAR FONT, STYLE, SIZE, OR COLOR.

FOR ENTERTAINMENT IN THE NATURE OF LIVE PERFORMANCES BY A MUSICAL GROUP (U.S. CLS. 100, 101 AND 107).

FIRST USE 12-1-2003; IN COMMERCE 12-13-2004.

THE MARK CONSISTS OF STANDARD CHARACTERS WITHOUT CLAIM TO ANY PARTICULAR FONT, STYLE, SIZE, OR COLOR.

FOR EDUCATIONAL SERVICES IN THE NATURE OF SEMINARS AND WORKSHOPS ON SPASTICITY AND INTRATHECAL BACLOFEN THERAPY (U.S. CLS. 100, 101 AND 107).

FIRST USE 6-30-2004; IN COMMERCE 6-30-2004.

CLASS 41—(Continued).

2,999,256. JAZZ AT LINCOLN CENTER, INC., NEW YORK, NY. SN 78-422,392. PUB. 4-5-2005, FILED 5-20-2004.

WEBOP

THE MARK CONSISTS OF STANDARD CHARACTERS WITHOUT CLAIM TO ANY PARTICULAR FONT, STYLE, SIZE, OR COLOR.

FOR MUSIC EDUCATION PROGRAM DIRECTED TO CHILDREN, PARENTS, AND FAMILIES (U.S. CLS. 100, 101 AND 107).

FIRST USE 10-23-2004; IN COMMERCE 10-23-2004.

2,999,280. VENETIAN CASINO RESORT, LLC, LAS VEGAS, NV. SN 78-976,274. PUB. 4-6-2004, FILED 7-9-2003.

PAIZA

FOR CASINO AND GAMING SERVICES; PROVIDING CASINO AND GAMING FACILITIES (U.S. CLS. 100, 101 AND 107).

FIRST USE 4-27-2005; IN COMMERCE 4-27-2005.

CLASS 42—SCIENTIFIC, COMPUTER AND LEGAL SERVICES

2,998,512. PROGENESIS, INC., JEFFERSON CITY, MO. SN 75-850,921. PUB. 3-26-2002, FILED 11-17-1999.

PROGENESIS

FOR PRODUCT RESEARCH AND DEVELOPMENT; DESIGN AND TESTING FOR NEW PRODUCT DEVELOPMENT (U.S. CLS. 100 AND 101).

FIRST USE 9-27-1999; IN COMMERCE 9-27-1999.

CLASS 42—(Continued).

2,998,520. LOVE MY WORLD, INC., MADISON, CT. SN 76-027,035. PUB. 6-4-2002, FILED 4-17-2000.

LOVE MY WORLD

FOR PROVIDING TEMPORARY USE OF ON-LINE NON-DOWNLOADABLE SOFTWARE FOR CREATING SITES FOR ONLINE COMMUNITIES FEATURING USER-DEFINED INFORMATION ON A GLOBAL COMPUTER NETWORK (U.S. CLS. 100 AND 101).

FIRST USE 4-15-2000; IN COMMERCE 1-1-2004.

2,998,540. BEALE, ALAN J., MILWAUKEE, WI. SN 76-211,843. PUB. 12-25-2001, FILED 2-19-2001.

ARJIBUS

FOR COMPUTER SOFTWARE DESIGN FOR OTHERS (U.S. CLS. 100 AND 101).

FIRST USE 3-17-2005; IN COMMERCE 3-17-2005.

2,998,541. RICE, JOHN T, RALEIGH, NC. SN 76-215,988. PUB. 8-28-2001, FILED 2-26-2001.

GODSPEED TRAVELERS

FOR PROVIDERS OF IN-HOME AND PRIVATE DUTY NURSING CARE (U.S. CLS. 100 AND 101).

FIRST USE 5-15-2001; IN COMMERCE 5-15-2001.

2,998,562. K-FOUR, INC., ROCKVILLE, MD. SN 76-334,884. PUB. 10-29-2002, FILED 11-6-2001.

BIOMETRICS HEALTH

NO CLAIM IS MADE TO THE EXCLUSIVE RIGHT TO USE "HEALTH", APART FROM THE MARK AS SHOWN.

FOR WEIGHT REDUCTION DIET PLANNING AND SUPERVISION; CONSULTATION IN THE FIELDS OF PHYSICAL FITNESS AND NUTRITION (U.S. CLS. 100 AND 101).

FIRST USE 1-25-2001; IN COMMERCE 1-25-2001.

CLASS 42—(Continued).

2,998,566. B-KIN SOFTWARE, S.L., LEIOA (VIZCAYA), SPAIN. SN 76-347,262. PUB. 1-11-2005, FILED 12-10-2001.

B-KIN

FOR COMPUTER SERVICES, NAMELY, COMPUTER SOFTWARE DESIGN FOR OTHERS, COMPUTER PROGRAMMING FOR OTHERS, COMPUTER CONSULTATION, COMPUTER DIAGNOSTIC SERVICES, DESIGNING AND IMPLEMENTING WEBSITES FOR OTHERS, AND CREATING INDEXES OF INFORMATION, SITES AND OTHER RESOURCES AVAILABLE ON COMPUTER NETWORKS (U.S. CLS. 100 AND 101).
FIRST USE 10-31-2001; IN COMMERCE 10-31-2001.

2,998,597. HAWKEYE HOME INSPECTIONS, INC., PARKLAND, FL. SN 76-428,442. PUB. 3-4-2003, FILED 7-5-2002.



NO CLAIM IS MADE TO THE EXCLUSIVE RIGHT TO USE "HOME INSPECTIONS", APART FROM THE MARK AS SHOWN.
FOR HOME INSPECTIONS (U.S. CLS. 100 AND 101).
FIRST USE 1-0-1986; IN COMMERCE 0-0-1986.

2,998,662. PHOENIX TECHNOLOGIES LTD., MILPITAS, CA. SN 76-496,905. PUB. 10-5-2004, FILED 3-13-2003.

CME

FOR PROVIDING TECHNICAL CONSULTATION AND SUPPORT SERVICES, NAMELY, MANAGING COMPUTER SOFTWARE; PROVIDING TECHNICAL CONSULTING SERVICES WITH RESPECT TO COMPUTER SOFTWARE AND TROUBLESHOOTING OF COMPUTER SOFTWARE FOR OTHERS (U.S. CLS. 100 AND 101).
FIRST USE 2-17-2003; IN COMMERCE 2-17-2003.

2,998,684. VALCO ENGINEERS LLC, MCDONALD, PA. SN 76-524,632. PUB. 10-12-2004, FILED 6-23-2003.

FIT SYSTEM

CLASS 42—(Continued).

NO CLAIM IS MADE TO THE EXCLUSIVE RIGHT TO USE "SYSTEM", APART FROM THE MARK AS SHOWN.

FOR APPLICATION SERVICE PROVIDER (ASP) FEATURING SOFTWARE IN THE FIELD OF BUSINESS SERVICES FOR USE IN MANAGING, DISSEMINATING, VIEWING, AND INTERACTING WITH ON-LINE DOCUMENTS COMPRISING CONSTRUCTION BLUEPRINTS, GRAPHICS, AND TEXT; AND PROVIDING TEMPORARY USE OF ON-LINE NON-DOWNLOADABLE SOFTWARE FOR BUSINESS SERVICES FOR USE IN MANAGING, DISSEMINATING, VIEWING, AND INTERACTING WITH ON-LINE DOCUMENTS COMPRISING CONSTRUCTION BLUEPRINTS, GRAPHICS, AND TEXT (U.S. CLS. 100 AND 101).
FIRST USE 6-27-2003; IN COMMERCE 6-27-2003.

2,998,719. MENOW, STEVEN, YARDLEY, PA. SN 76-537,859. PUB. 4-6-2004, FILED 8-15-2003.

SNACK KNACK

NO CLAIM IS MADE TO THE EXCLUSIVE RIGHT TO USE "SNACK", APART FROM THE MARK AS SHOWN.
FOR DESIGN FOR OTHERS IN THE FIELD OF SPECIALTY PACKAGES FOR FOOD AND BEVERAGE PRODUCTS (U.S. CLS. 100 AND 101).
FIRST USE 12-15-2004; IN COMMERCE 12-15-2004.

2,998,804. HARVEY CRANE, INC., DAYTONA BEACH, FL. SN 76-580,959. PUB. 1-11-2005, FILED 3-15-2004.

NO-PULSE

THE MARK CONSISTS OF STANDARD CHARACTERS WITHOUT CLAIM TO ANY PARTICULAR FONT, STYLE, SIZE, OR COLOR.
FOR ENGINEERING SERVICES FOR DESIGNING CAM PROFILES (U.S. CLS. 100 AND 101).
FIRST USE 1-24-2004; IN COMMERCE 1-24-2004.

CLASS 42—(Continued).

2,998,806. HARVEY CRANE, INC., DAYTONA BEACH, FL. SN 76-580,967. PUB. 12-21-2004, FILED 3-15-2004.

CAMCHECK

THE MARK CONSISTS OF STANDARD CHARACTERS WITHOUT CLAIM TO ANY PARTICULAR FONT, STYLE, SIZE, OR COLOR.

FOR ENGINEERING SERVICES FOR DESIGNING CAM PROFILES (U.S. CLS. 100 AND 101).
FIRST USE 2-3-2004; IN COMMERCE 2-3-2004.

2,998,824. NAVESINK CONSULTING GROUP, LITTLE SILVER, NJ. SN 76-589,246. PUB. 2-8-2005, FILED 4-27-2004.

FIRST-TIME, ON-TIME

FOR CONSULTING SERVICES RELATED TO DATA SUPPLY, DATA MANAGEMENT, AND THE IMPROVEMENT OF DATA QUALITY AND COMPREHENSION FOR PUBLISHED AND STORED DATA, NAMELY DATA QUALITY ASSESSMENT, STRATEGIC DATA QUALITY CONSULTING, DATA WAREHOUSE PLANNING AND DEVELOPMENT AND DATA QUALITY IMPROVEMENT (U.S. CLS. 100 AND 101).
FIRST USE 1-1-2005; IN COMMERCE 1-1-2005.

2,998,867. CRUPAIN, DANIEL, NEW YORK, NY. SN 78-153,760. PUB. 6-8-2004, FILED 8-13-2002.

MAJOR INJURY-LAWYERS

NO CLAIM IS MADE TO THE EXCLUSIVE RIGHT TO USE "INJURY-LAWYERS", APART FROM THE MARK AS SHOWN.

FOR LEGAL SERVICES (U.S. CLS. 100 AND 101).
FIRST USE 9-14-2004; IN COMMERCE 9-14-2004.

CLASS 42—(Continued).

2,999,057. THE KAPLAN CONSULTING GROUP, WALNUT CREEK, CA. SN 78-315,482. PUB. 10-26-2004, FILED 10-18-2003.

**CREATING
COLLABORATIVE
COMMUNITIES**

NO CLAIM IS MADE TO THE EXCLUSIVE RIGHT TO USE "COMMUNITIES", APART FROM THE MARK AS SHOWN.

FOR APPLICATION SERVICE PROVIDER (ASP) FEATURING SOFTWARE IN THE FIELD OF PROVIDING ONLINE COMMUNITIES THROUGH WEB CONFERENCES, TELECONFERENCES, CHAT, DOCUMENT MANAGEMENT, SHARED DATABASES AND ONLINE BULLETIN BOARDS (U.S. CLS. 100 AND 101).
FIRST USE 1-1-2003; IN COMMERCE 6-1-2003.

2,999,081. ELECTRONIC INTELLECT, LLC, PITTSBURGH, PA. SN 78-332,228. PUB. 9-14-2004, FILED 11-24-2003.

**ELECTRONIC
INTELLECT**

THE MARK CONSISTS OF STANDARD CHARACTERS WITHOUT CLAIM TO ANY PARTICULAR FONT, STYLE, SIZE, OR COLOR.

FOR INFORMATION TECHNOLOGY CONSULTATION IN THE FIELDS OF DISTRIBUTED INFORMATION SYSTEMS, AUTOMATED TRANSACTION SYSTEMS, DATA MINING, MAINTENANCE OF COMPUTER NETWORKS, DATABASE DESIGN AND HOSTING, AND ASSOCIATED SOFTWARE DEVELOPMENT (U.S. CLS. 100 AND 101).

FIRST USE 5-31-2000; IN COMMERCE 5-31-2000.

CLASS 42—(Continued).

2,999,107. BRAKEFIELD, H. CHRISTOPHER, BIRMINGHAM, AL. SN 78-342,496. PUB. 10-26-2004, FILED 12-17-2003.

Snow Registry

THE MARK CONSISTS OF STANDARD CHARACTERS WITHOUT CLAIM TO ANY PARTICULAR FONT, STYLE, SIZE, OR COLOR.
FOR GRAPHIC ART DESIGN (U.S. CLS. 100 AND 101).
FIRST USE 7-4-2005; IN COMMERCE 7-4-2005.

2,999,150. SUMMERS-PERRY, BROOKE, HOUSTON, TX. AND HOLBROOK, SARAH, CYPRESS, TX. SN 78-358,645. PUB. 10-26-2004, FILED 1-28-2004.

ROOM WITH A HUE

THE MARK CONSISTS OF STANDARD CHARACTERS WITHOUT CLAIM TO ANY PARTICULAR FONT, STYLE, SIZE, OR COLOR.
FOR INTERIOR DESIGN AND DECORATION CONSULTING (U.S. CLS. 100 AND 101).
FIRST USE 3-0-2004; IN COMMERCE 3-0-2004.

CLASS 43—HOTEL AND RESTAURANT SERVICES

2,998,730. MAKING DOUGH BY CHANCE, L.L.C., LA PORTE, IN. SN 76-544,466. PUB. 4-20-2004, FILED 9-3-2003.

BRU-GO'S

FOR RESTAURANT SERVICES (U.S. CLS. 100 AND 101).
FIRST USE 9-1-2003; IN COMMERCE 9-1-2003.

CLASS 43—(Continued).

2,998,741. CARPEDIEM MANAGEMENT COMPANY, NEW ALBANY, OH. SN 76-553,187. PUB. 6-22-2004, FILED 9-30-2003.

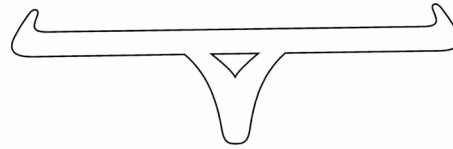

FOR RESTAURANT SERVICES (U.S. CLS. 100 AND 101).
FIRST USE 4-23-2005; IN COMMERCE 4-23-2005.

2,998,763. WYNN RESORTS HOLDINGS, LLC, LAS VEGAS, NV. SN 76-564,784. PUB. 7-27-2004, FILED 11-28-2003.



OWNER OF U.S. REG. NO. 2,585,021. SEC. 2(F).
FOR RESORT HOTEL, HOTEL, RESTAURANT, BAR, LOUNGE SERVICES, ARENA SERVICES, NAMELY PROVIDING FACILITIES FOR SPORTS, CONCERTS, CONVENTIONS AND EXHIBITION; CAFES; CAFETERIAS; CATERING; CHILD CARE; COCKTAIL LOUNGE BUFFETS; COCKTAIL LOUNGES; HOTEL SERVICES FOR PREFERRED CUSTOMERS; PROVIDING BANQUET AND SOCIAL FUNCTION FACILITIES FOR SPECIAL OCCASIONS; PROVIDING CONVENTION FACILITIES; PROVIDING FACILITIES FOR EXHIBITIONS; AND SNACK BARS (U.S. CLS. 100 AND 101).
FIRST USE 4-28-2005; IN COMMERCE 4-28-2005.

2,998,810. THE GREAT AMERICAN BAGEL ENTERPRISES, INC., WESTMONT, IL. SN 76-582,756. PUB. 12-28-2004, FILED 3-22-2004.



OWNER OF U.S. REG. NO. 1,882,384 AND OTHERS. NO CLAIM IS MADE TO THE EXCLUSIVE RIGHT TO USE "CATERING", APART FROM THE MARK AS SHOWN. FOR CATERING SERVICES (U.S. CLS. 100 AND 101).
FIRST USE 9-15-2004; IN COMMERCE 12-15-2004.

CLASS 43—(Continued).

2,998,819. CARR, H. THOMAS, JOHNSON CITY, TN. SN 76-587,084. PUB. 9-7-2004, FILED 4-15-2004.

RED PIG BAR-B-Q

THE MARK CONSISTS OF STANDARD CHARACTERS WITHOUT CLAIM TO ANY PARTICULAR FONT, STYLE, SIZE, OR COLOR.

NO CLAIM IS MADE TO THE EXCLUSIVE RIGHT TO USE "BAR-B-Q", APART FROM THE MARK AS SHOWN.

FOR RESTAURANTS TO PREPARE FOOD AND DRINK FOR CONSUMPTION (U.S. CLS. 100 AND 101).
FIRST USE 3-7-2003; IN COMMERCE 3-7-2003.

CLASS 43—(Continued).

2,999,088. DOC GREEN'S GOURMET SALADS, INC., ATLANTA, GA. SN 78-334,384. PUB. 10-5-2004, FILED 12-1-2003.

**DOC GREEN'S
GOURMET SALADS**

THE MARK CONSISTS OF STANDARD CHARACTERS WITHOUT CLAIM TO ANY PARTICULAR FONT, STYLE, SIZE, OR COLOR.

NO CLAIM IS MADE TO THE EXCLUSIVE RIGHT TO USE GOURMET SALADS, APART FROM THE MARK AS SHOWN.

"DOC GREEN" AS USED IN THE MARK IS NOT THE NAME OF A LIVING INDIVIDUAL.

FOR RESTAURANT SERVICES (U.S. CLS. 100 AND 101).

FIRST USE 5-1-2004; IN COMMERCE 11-1-2004.

2,998,869. GRAF WOLF DEVELOPMENT, INC., FREDERICK, MD. SN 78-155,124. PUB. 9-2-2003, FILED 8-16-2002.

**WAY COOL ICE CREAM
COMPANY**

NO CLAIM IS MADE TO THE EXCLUSIVE RIGHT TO USE "ICE CREAM COMPANY", APART FROM THE MARK AS SHOWN.

FOR RESTAURANT SERVICES IN THE NATURE OF AN ICE CREAM SHOP (U.S. CLS. 100 AND 101).

FIRST USE 3-1-2005; IN COMMERCE 3-1-2005.

2,998,891. MARRIOTT INTERNATIONAL, INC., BETHESDA, MD. SN 78-199,075. PUB. 4-13-2004, FILED 12-31-2002.

PREFERRED PLUS

OWNER OF U.S. REG. NO. 1,310,519.

FOR HOTEL SERVICES; HOTEL RESERVATION SERVICES; ARRANGING AND PROVIDING TEMPORARY HOUSING ACCOMMODATIONS (U.S. CLS. 100 AND 101).

FIRST USE 4-17-2003; IN COMMERCE 4-17-2003.

2,999,112. CABOS ENTERPRISES, INC., ENCINO, CA. SN 78-344,376. PUB. 10-26-2004, FILED 12-22-2003.



2,999,058. VERMILLION, L.L.C., CHICAGO, IL. SN 78-316,291. PUB. 7-6-2004, FILED 10-21-2003.

VERMILION

THE MARK CONSISTS OF STANDARD CHARACTERS WITHOUT CLAIM TO ANY PARTICULAR FONT, STYLE, SIZE, OR COLOR.

FOR RESTAURANT SERVICES (U.S. CLS. 100 AND 101).

FIRST USE 12-21-2003; IN COMMERCE 12-21-2003.

NO CLAIM IS MADE TO THE EXCLUSIVE RIGHT TO USE FISH AND FRESH SEAFOOD GRILL, APART FROM THE MARK AS SHOWN.

THE COLOR(S) BLUE AND ORANGE IS/ARE CLAIMED AS A FEATURE OF THE MARK.

THE MARK CONSISTS OF THE TERM "THINK" APPEARS IN BLUE; THE FLAME DESIGN AND THE TERM "FISH!" APPEAR IN ORANGE.

FOR RESTAURANT SERVICES (U.S. CLS. 100 AND 101).

FIRST USE 2-29-2004; IN COMMERCE 2-29-2004.

CLASS 43—(Continued).

2,999,149. ARDEN INTERNATIONAL, LLC, LAKEVILLE, MN. SN 78-357,552. PUB. 10-26-2004, FILED 1-26-2004.

**We Bring Menus to
Life**

THE MARK CONSISTS OF STANDARD CHARACTERS WITHOUT CLAIM TO ANY PARTICULAR FONT, STYLE, SIZE, OR COLOR.

FOR PREPARATION OF FOODS AND FROZEN FOODS FOR OTHERS (U.S. CLS. 100 AND 101).
FIRST USE 0-0-2003; IN COMMERCE 0-0-2003.

2,999,165. DRURY PROPERTIES, INC., SPRINGFIELD, MO. SN 78-363,956. PUB. 11-9-2004, FILED 2-6-2004.

**KRYSTAL AIRE INN &
SUITES**

THE MARK CONSISTS OF STANDARD CHARACTERS WITHOUT CLAIM TO ANY PARTICULAR FONT, STYLE, SIZE, OR COLOR.

NO CLAIM IS MADE TO THE EXCLUSIVE RIGHT TO USE INN & SUITES, APART FROM THE MARK AS SHOWN.
FOR HOTEL AND MOTEL SERVICES; PROVISION OF GENERAL PURPOSE FACILITIES FOR MEETINGS, CONFERENCES AND EXHIBITIONS; PROVISION OF BANQUET AND SOCIAL FUNCTION FACILITIES FOR SPECIAL OCCASIONS; AND RESERVATION SERVICES FOR HOTEL ACCOMMODATIONS FOR OTHERS (U.S. CLS. 100 AND 101).
FIRST USE 3-1-2004; IN COMMERCE 3-1-2004.

2,999,167. DELTA CORPORATE IDENTITY, INC., ATLANTA, GA. SN 78-364,055. PUB. 3-22-2005, FILED 2-6-2004.

SAVORINGS

CLASS 43—(Continued).

THE MARK CONSISTS OF STANDARD CHARACTERS WITHOUT CLAIM TO ANY PARTICULAR FONT, STYLE, SIZE, OR COLOR.

FOR IN-FLIGHT FOOD SERVICES IN CONJUNCTION WITH PASSENGER AIR TRANSPORTATION SERVICES (U.S. CLS. 100 AND 101).
FIRST USE 2-19-2004; IN COMMERCE 2-19-2004.

2,999,171. COUNTRY INNS & SUITES BY CARLSON, INC., MINNEAPOLIS, MN. SN 78-369,316. PUB. 4-12-2005, FILED 2-17-2004.

**SUMMER FAMILY
BOOKBREAK PACKAGE**

THE MARK CONSISTS OF STANDARD CHARACTERS WITHOUT CLAIM TO ANY PARTICULAR FONT, STYLE, SIZE, OR COLOR.

NO CLAIM IS MADE TO THE EXCLUSIVE RIGHT TO USE FAMILY AND PACKAGE, APART FROM THE MARK AS SHOWN.

FOR HOTEL SERVICES, NAMELY, A PROGRAM OFFERING A VALUE-ADDED PACKAGE OF AMENITIES AND DISCOUNTS (U.S. CLS. 100 AND 101).
FIRST USE 5-1-2004; IN COMMERCE 5-1-2004.

2,999,182. JO TO GO AMERICA, INC., GREEN BAY, WI. SN 78-373,205. PUB. 12-14-2004, FILED 2-24-2004.

JO TO GO COFFEE

THE MARK CONSISTS OF STANDARD CHARACTERS WITHOUT CLAIM TO ANY PARTICULAR FONT, STYLE, SIZE, OR COLOR.

OWNER OF U.S. REG. NOS. 2,420,608 AND 2,800,893.
NO CLAIM IS MADE TO THE EXCLUSIVE RIGHT TO USE "COFFEE", APART FROM THE MARK AS SHOWN.

FOR FOOD SERVICES IN THE NATURE OF A CARRYOUT COFFEE AND SNACK BAR (U.S. CLS. 100 AND 101).
FIRST USE 7-6-2005; IN COMMERCE 7-6-2005.

CLASS 43—(Continued).

2,999,188. CAESARS WORLD, INC., LAS VAGAS, NV. SN 78-375,280. PUB. 12-14-2004, FILED 2-27-2004.

CYPRESS STREET MARKETPLACE

THE MARK CONSISTS OF STANDARD CHARACTERS WITHOUT CLAIM TO ANY PARTICULAR FONT, STYLE, SIZE, OR COLOR.

NO CLAIM IS MADE TO THE EXCLUSIVE RIGHT TO USE "MARKETPLACE", APART FROM THE MARK AS SHOWN.

FOR RESTAURANT, BAR SERVICES (U.S. CLS. 100 AND 101).

FIRST USE 3-24-2003; IN COMMERCE 3-24-2003.

2,999,196. FOOD FOR LIFE GLOBAL, POTOMAC, MD. SN 78-380,434. PUB. 2-15-2005, FILED 3-8-2004.



NO CLAIM IS MADE TO THE EXCLUSIVE RIGHT TO USE "HARE KRISHNA", APART FROM THE MARK AS SHOWN.

THE COLOR(S) ORANGE, RED, YELLOW, GREEN, AND BLACK IS/ARE CLAIMED AS A FEATURE OF THE MARK. THE MARK CONSISTS OF "HARE KRISHNA FOOD FOR LIFE" IS GREEN; SUN IS A COMBINATION OF RED, YELLOW, AND ORANGE; BACKGROUND IS ORANGE WITH A RED BORDER.

FOR CHARITABLE SERVICES, NAMELY, PROVIDING FOOD TO NEEDY PERSONS (U.S. CLS. 100 AND 101).

FIRST USE 1-1-1985; IN COMMERCE 1-1-1985.

CLASS 43—(Continued).

2,999,235. BARTENDERGIRL, INC, HIGHLAND, CA. SN 78-401,791. PUB. 2-1-2005, FILED 4-14-2004.

BartenderGirl

THE MARK CONSISTS OF STANDARD CHARACTERS WITHOUT CLAIM TO ANY PARTICULAR FONT, STYLE, SIZE, OR COLOR.

NO CLAIM IS MADE TO THE EXCLUSIVE RIGHT TO USE "BARTENDER", APART FROM THE MARK AS SHOWN.

SEC. 2(F).
FOR CATERING AND BARTENDING SERVICES (U.S. CLS. 100 AND 101).

FIRST USE 10-1-2001; IN COMMERCE 10-16-2001.

2,999,279. VENETIAN CASINO RESORT, LLC, LAS VEGAS, NV. SN 78-976,273. PUB. 10-19-2004, FILED 7-9-2003.

PAIZA

FOR HOTELS; RESTAURANTS; BAR SERVICES; CATERING SERVICES (U.S. CLS. 100 AND 101).

FIRST USE 4-27-2005; IN COMMERCE 4-27-2005.

CLASS 44—MEDICAL, BEAUTY AND AGRICULTURAL SERVICES

2,998,583. UCB, S.A., BRUSSELS, BELGIUM. SN 76-401,252. PUB. 9-23-2003, FILED 4-26-2002.

POLLENWATCH

FOR E-MAIL NOTIFICATION SERVICES, NAMELY, PROVIDING ALLERGEN LEVEL AND ALLERGEN COUNT (U.S. CLS. 100 AND 101).

FIRST USE 5-0-2002; IN COMMERCE 5-0-2002.

CLASS 44—(Continued).

2,998,632. SAVACOR, INC., LOS ANGELES, CA. SN 76-470,609. PUB. 7-29-2003, FILED 11-29-2002.

DYNAMICRX

FOR MEDICATION EVALUATION SERVICES, NAMELY, ADJUSTING PRESCRIBED MEDICATIONS BASED ON CHANGING PHYSIOLOGICAL CONDITIONS TO ASSURE OPTIMAL RESULTS (U.S. CLS. 100 AND 101).

FIRST USE 10-9-2004; IN COMMERCE 10-9-2004.

2,998,711. JONES, ROBERT, DALLAS, TX. SN 76-534,553. PUB. 4-27-2004, FILED 8-5-2003.

ROBERT JONES SIMPLE BEAUTÉ

FOR BEAUTY CONSULTATION SERVICES IN THE SELECTION AND USE OF COSMETICS, BEAUTY PRODUCTS AND TOILETRIES (U.S. CLS. 100 AND 101).

FIRST USE 3-31-2004; IN COMMERCE 3-31-2004.

2,998,754. HIBISCUS CHILDREN'S CENTER, JENSEN BEACH, FL. SN 76-562,190. PUB. 2-8-2005, FILED 11-21-2003.

HIBISCUS CHILDREN'S CENTER

THE MARK CONSISTS OF STANDARD CHARACTERS WITHOUT CLAIM TO ANY PARTICULAR FONT, STYLE, SIZE, OR COLOR.

NO CLAIM IS MADE TO THE EXCLUSIVE RIGHT TO USE "CHILDREN'S CENTER", APART FROM THE MARK AS SHOWN.

FOR PROVIDING COUNSELING SERVICES FOR CHILDREN AND FAMILIES TO PREVENT AND REDUCE ABUSE OF CHILDREN (U.S. CLS. 100 AND 101).

FIRST USE 10-24-1994; IN COMMERCE 10-24-1994.

2,998,761. REMINGTON STOP SMOKING CENTER, LLC., DBA ANNE PENMAN LASER THERAPY, ALPHARETTA, GA. SN 76-564,388. PUB. 10-19-2004, FILED 11-28-2003.



NO CLAIM IS MADE TO THE EXCLUSIVE RIGHT TO USE "LASER THERAPY", APART FROM THE MARK AS SHOWN.

CLASS 44—(Continued).

THE NAME "ANNE PENMAN" IDENTIFIES A LIVING INDIVIDUAL WHOSE CONSENT IS OF RECORD.

FOR THERAPEUTIC SERVICES, NAMELY COUNSELING AND TREATMENT OF PERSONS ADDICTED TO NICOTINE THROUGH TOBACCO USAGE (U.S. CLS. 100 AND 101).

FIRST USE 3-25-2002; IN COMMERCE 4-2-2004.

2,998,990. STATE STREET BARBERS, LLC, CHICAGO, IL. SN 78-275,374. PUB. 10-26-2004, FILED 7-17-2003.

STATE ST BARBERS

THE MARK CONSISTS OF STANDARD CHARACTERS WITHOUT CLAIM TO ANY PARTICULAR FONT, STYLE, SIZE, OR COLOR.

NO CLAIM IS MADE TO THE EXCLUSIVE RIGHT TO USE "BARBERS", APART FROM THE MARK AS SHOWN.

FOR BARBER SHOP AND BEAUTY AND HAIRDRESSING SALON SERVICES (U.S. CLS. 100 AND 101).

FIRST USE 10-31-2003; IN COMMERCE 12-9-2003.

2,999,128. STORANDT PANN MARGOLIS & PARTNERS, LA GRANGE, IL. SN 78-349,950. PUB. 10-19-2004, FILED 1-9-2004.

WHERE ANSWERS ARE FOUND

THE MARK CONSISTS OF STANDARD CHARACTERS WITHOUT CLAIM TO ANY PARTICULAR FONT, STYLE, SIZE, OR COLOR.

FOR HOSPITAL AND HEALTHCARE SERVICES (U.S. CLS. 100 AND 101).

FIRST USE 3-1-2004; IN COMMERCE 3-1-2004.

2,999,195. B.J. EQUIPMENT, LTD., DBA RENT-A-JOHN, COLUMBUS, OH. SN 78-380,336. PUB. 12-14-2004, FILED 3-8-2004.

PRIVIES WITH PIZZAZZ

CLASS 45—(Continued).

THE MARK CONSISTS OF STANDARD CHARACTERS WITHOUT CLAIM TO ANY PARTICULAR FONT, STYLE, SIZE, OR COLOR.

NO CLAIM IS MADE TO THE EXCLUSIVE RIGHT TO USE "PRIVIES", APART FROM THE MARK AS SHOWN.

FOR RENTAL OF PORTABLE TOILETS (U.S. CLS. 100 AND 101).

FIRST USE 5-14-2004; IN COMMERCE 4-11-2005.



2,999,261. ROTECH HEALTHCARE INC., ORLANDO, FL. SN 78-425,299. PUB. 11-23-2004, FILED 5-26-2004.

ROTECH

THE MARK CONSISTS OF STANDARD CHARACTERS WITHOUT CLAIM TO ANY PARTICULAR FONT, STYLE, SIZE, OR COLOR.

OWNER OF U.S. REG. NOS. 2,797,679, 2,802,395, AND 2,802,396.

FOR HEALTH CARE AND MEDICAL SERVICES, INCLUDING INHALATION THERAPY SERVICES AND INHALATION THERAPY MEDICATION RELATED SERVICES (U.S. CLS. 100 AND 101).

FIRST USE 3-26-2002; IN COMMERCE 3-26-2002.



CLASS 45—PERSONAL SERVICES

CLASS 45—(Continued).

2,998,649. CORREDOIRA, CARLOS A., FORT MYERS, FL. AND SAPP, STEVEN D., FORT MYERS, FL. SN 76-482,956. PUB. 9-28-2004, FILED 1-17-2003.



NO CLAIM IS MADE TO THE EXCLUSIVE RIGHT TO USE "1800LOSTDOG", APART FROM THE MARK AS SHOWN.

FOR DOG IDENTIFICATION AND RECOVERY SERVICES, NAMELY, TAGGING AND REGISTERING DOGS AND POSTING LOST AND FOUND DOG INFORMATION ON THE INTERNET TO AID IN THE RECOVERY OF LOST DOGS (U.S. CLS. 100 AND 101).

FIRST USE 12-31-2003; IN COMMERCE 12-31-2003.



2,999,041. CYBERDUCTIONS, INC., NORWELL, MA. SN 78-302,441. PUB. 7-6-2004, FILED 9-18-2003.

CYBERDUCTION

FOR DATING SERVICES (U.S. CLS. 100 AND 101). FIRST USE 7-5-2005; IN COMMERCE 7-5-2005.



2,999,156. SANDY DENNIS INCORPORATED, VALLEY STREAM, NY. SN 78-361,300. PUB. 11-9-2004, FILED 2-2-2004.



THE ENGLISH TRANSLATION OF THE WORD "AMORE" IN THE MARK IS "LOVE."

FOR DATING SERVICE (U.S. CLS. 100 AND 101). FIRST USE 3-15-2005; IN COMMERCE 3-15-2005.

PRIOR UNITED STATES CLASSIFICATION

APPLICATION IN ONE CLASS

CERTIFICATION MARKS

CLASS B—SERVICES

2,998,951. INTERNATIONAL RESEARCH ASSOCIATION,
LLC, CAMBRIDGE, MA. SN 78-248,359. PUB. 4-13-2004,
FILED 4-9-2003.

LIFA

THE CERTIFICATION MARK AS USED BY PERSONS AUTHORIZED BY THE CERTIFIER, CERTIFIES THAT THE PERSON DISPLAYING SAID MARK HAS COMPLETED EDUCATIONAL COURSE WORK REQUIREMENTS AND WORK EXPERIENCE REQUIREMENTS OF THE CERTIFIER, HAS COMPLETED EXAMINATIONS ADMINISTERED BY THE CERTIFIER IN A SATISFACTORY MANNER, HAS AGREED TO ADHERE TO THE CERTIFIER'S STANDARDS FOR PROFESSIONAL RESPONSIBILITY, CONTINUING EDUCATION AND OTHER POST-CERTIFICATION REQUIREMENTS.

FOR FINANCIAL ANALYSIS SERVICES (U.S. CL. B).
FIRST USE 9-1-2004; IN COMMERCE 9-1-2004.

* * * * *

SUPPLEMENTAL REGISTER

These registrations are not subject to opposition.

SECTION 1.— INTERNATIONAL CLASSIFICATION

The short titles associated below with the international class numbers are terms designed merely for quick identification and are not an official part of the international classification. The full names of international classes are given in section 6.1 of the trademark rules of practice.

The designation "U.S. Cl." appearing in this section refers to the U.S. class in effect prior to Sep. 1, 1973 rather than the international class which applies to applications filed on or after that date. For adoption of international classification see notice in the OFFICIAL GAZETTE of Jun. 26, 1973 (911 O.G. TM 210).

Application in more than one class

2,999,300. SCHLUMBERGER TECHNOLOGY CORPORATION, SUGAR LAND, TX. SN 76-555,644. FILED P.R. 10-30-2003; AM. S.R. 7-18-2005.

VIRTUAL LAB

CLASS 9—ELECTRICAL AND SCIENTIFIC APPARATUS

FOR COMPUTER SOFTWARE FOR SIMULATING THE TREATMENT OF CORES AND RESERVOIRS IN THE FIELD OF OIL, GAS AND WATER EXPLORATION AND PRODUCTION (U.S. CLS. 21, 23, 26, 36 AND 38).
FIRST USE 2-28-2000; IN COMMERCE 2-28-2000.

CLASS 42—SCIENTIFIC, COMPUTER AND LEGAL SERVICES

FOR CONSULTATION REGARDING TREATMENT OF CORES AND RESERVOIRS IN THE FIELD OF OIL, GAS AND WATER EXPLORATION (U.S. CLS. 100 AND 101).
FIRST USE 2-28-2000; IN COMMERCE 2-28-2000.

2,999,318. CHICAGO COSMETOLOGISTS ASSOCIATION, INC., CHICAGO, IL. SN 76-605,057. FILED P.R. 7-30-2004; AM. S.R. 7-28-2005.

AMERICAN ASSOCIATION FOR ESTHETICS EDUCATION

THE MARK CONSISTS OF STANDARD CHARACTERS WITHOUT CLAIM TO ANY PARTICULAR FONT, STYLE, SIZE, OR COLOR.
NO CLAIM IS MADE TO THE EXCLUSIVE RIGHT TO USE "ASSOCIATION" AND "EDUCATION", APART FROM THE MARK AS SHOWN.

CLASS 35—ADVERTISING AND BUSINESS

FOR ASSOCIATION SERVICES, NAMELY, PROMOTING THE INTERESTS OF COSMETOLOGISTS (U.S. CLS. 100, 101 AND 102).
FIRST USE 5-22-2004; IN COMMERCE 5-22-2004.

CLASS 41—EDUCATION AND ENTERTAINMENT

FOR EDUCATIONAL SERVICES, NAMELY CONDUCTING WORKSHOPS, SEMINARS AND CLASSES IN THE FIELD OF COSMETOLOGY (U.S. CLS. 100, 101 AND 107).
FIRST USE 5-16-2005; IN COMMERCE 5-16-2005.

2,999,329. O.C. SECRETS, OCEAN CITY, MD. SN 76-977,055. FILED P.R. 6-21-2001; AM. S.R. 1-29-2003.

PAIN IN DE ASS

THE MARK CONSISTS OF STANDARD CHARACTERS WITHOUT CLAIM TO ANY PARTICULAR FONT, STYLE, SIZE, OR COLOR.

CLASS 21—HOUSEWARES AND GLASS

FOR CUPS (U.S. CLS. 2, 13, 23, 29, 30, 33, 40 AND 50).
FIRST USE 6-0-1998; IN COMMERCE 6-0-1998.

CLASS 33—WINES AND SPIRITS

FOR ALCOHOLIC BEVERAGES, NAMELY, PREPARED ALCOHOLIC COCKTAILS (U.S. CLS. 47 AND 49).
FIRST USE 6-0-1998; IN COMMERCE 6-0-1998.

2,999,330. IN NEW YORK, LLC, AUGUSTA, GA. SN 76-977,521. FILED P.R. 8-18-2003; AM. S.R. 9-3-2004.

IN CHICAGO

THE MARK CONSISTS OF STANDARD CHARACTERS WITHOUT CLAIM TO ANY PARTICULAR FONT, STYLE, SIZE, OR COLOR.

CLASS 41—EDUCATION AND ENTERTAINMENT

FOR PROVIDING ONLINE INFORMATION TO READERS VIA A GLOBAL COMPUTER INFORMATION NETWORK ON THE NEW AND FAVORITE ARTS, MUSIC, NIGHT LIFE, AND POPULAR ENTERTAINMENT THAT DEFINES CHICAGO (U.S. CLS. 100, 101 AND 107).
FIRST USE 8-2-2004; IN COMMERCE 8-2-2004.

CLASS 43—HOTEL AND RESTAURANT SERVICES

FOR PROVIDING ONLINE INFORMATION TO READERS VIA A GLOBAL COMPUTER INFORMATION NETWORK ON THE NEW AND FAVORITE RESTAURANTS THAT DEFINE CHICAGO (U.S. CLS. 100 AND 101).
FIRST USE 8-2-2004; IN COMMERCE 8-2-2004.

2,999,337. ASSET MARKETING SYSTEMS, INC., SAN DIEGO, CA. SN 78-255,371. FILED P.R. 5-28-2003; AM. S.R. 1-31-2005.

IMAGE BRANDER

CLASS 35—ADVERTISING AND BUSINESS

FOR DIRECT MAIL, EMAIL, PRINT, RADIO AND TELEVISION ADVERTISING, AND BUSINESS MANAGEMENT SERVICES IN THE FIELDS OF FINANCIAL PLANNING AND FINANCIAL PRODUCTS (U.S. CLS. 100, 101 AND 102).
FIRST USE 5-1-2003; IN COMMERCE 5-1-2003.

CLASS 36—INSURANCE AND FINANCIAL

FOR PROVIDING FINANCIAL INFORMATION, ANALYSIS AND CONSULTATION (U.S. CLS. 100, 101 AND 102).
FIRST USE 5-1-2003; IN COMMERCE 5-1-2003.
2,999,339. DAVID OPPENHEIMER AND ASSOCIATES PARTNERSHIP, COQUITLAM BRITISH COLUMBIA, CANADA. SN 78-265,901. FILED P.R. 6-23-2003; AM. S.R. 12-23-2004.

THE OPPENHEIMER GROUP

NO CLAIM IS MADE TO THE EXCLUSIVE RIGHT TO USE "GROUP", APART FROM THE MARK AS SHOWN.

CLASS 31—NATURAL AGRICULTURAL PRODUCTS

FOR FRESH FRUIT AND VEGETABLES (U.S. CLS. 1 AND 46).
FIRST USE 11-11-2002; IN COMMERCE 11-11-2002.

CLASS 35—ADVERTISING AND BUSINESS

FOR ADVERTISING SERVICES, PROMOTIONAL SERVICES AND MARKETING SERVICES, NAMELY, MARKET ANALYSIS, RESEARCH, DIRECT MARKETING ADVERTISING AND PROMOTING THE SALE OF GOODS OF OTHERS THROUGH THE WHOLESALE AND RETAIL DISTRIBUTION OF FRESH FRUIT AND VEGETABLES (U.S. CLS. 100, 101 AND 102).
FIRST USE 1-28-2002; IN COMMERCE 1-28-2002.

2,999,341. ROCKLER COMPANIES, INC., MEDIA, MN. SN 78-290,417. FILED P.R. 8-21-2003; AM. S.R. 7-18-2005.

WOMEN IN WOODWORKING

CLASS 35—ADVERTISING AND BUSINESS

FOR COMPUTERIZED ONLINE RETAIL SERVICES FEATURING WOODWORKING TOOLS, EQUIPMENT, BOOKS, PLANS AND SUPPLIES (U.S. CLS. 100, 101 AND 102).
FIRST USE 5-0-2000; IN COMMERCE 5-0-2000.

CLASS 41—EDUCATION AND ENTERTAINMENT

FOR EDUCATIONAL SERVICES, NAMELY PROVIDING CLASSES, WORKSHOPS AND DISCUSSION FORUMS IN THE FIELD OF WOODWORKING, AND PROVIDING INSTRUCTION IN THE FIELD OF WOODWORKING (U.S. CLS. 100, 101 AND 107).
FIRST USE 5-0-2000; IN COMMERCE 5-0-2000.

2,999,348. INTERNATIONAL BUSINESS MACHINES CORPORATION, ARMONK, NY. SN 78-317,997. FILED P.R. 10-23-2003; AM. S.R. 8-3-2005.

LEARNING OPTIMIZATION MODEL

NO CLAIM IS MADE TO THE EXCLUSIVE RIGHT TO USE "MODEL", APART FROM THE MARK AS SHOWN.

CLASS 16—PAPER GOODS AND PRINTED MATTER

FOR PRINTED MATTER, NAMELY, BROCHURES, INSTRUCTIONAL MANUALS, WRITTEN PRESENTATIONS AND TEACHING MATERIALS IN THE FIELD OF APPLYING A NEW METHODOLOGY TO ANY TEACHING SITUATION (U.S. CLS. 2, 5, 22, 23, 29, 37, 38 AND 50).
FIRST USE 6-0-2004; IN COMMERCE 6-0-2004.

CLASS 38—COMMUNICATION

FOR COMPUTER SERVICES, NAMELY, OFFERING WEBCASTS AND ONLINE CHATS FOR OTHERS (U.S. CLS. 100, 101 AND 104).

FIRST USE 6-0-2004; IN COMMERCE 6-0-2004.

CLASS 41—EDUCATION AND ENTERTAINMENT

FOR EDUCATION SERVICES, NAMELY, CONDUCTING EDUCATIONAL SEMINARS, PEER-TO-PEER PROGRAMS, MENTORING, TECHNICAL DEMONSTRATIONS, AND NETWORKING EVENTS; ALL IN THE FIELD OF APPLYING A NEW TEACHING METHODOLOGY TO ANY TEACHING SITUATION; COMPUTER EDUCATION SERVICES, NAMELY, COMPUTER BASED AND ONLINE TUTORIALS, ELECTRONIC CONFERENCING, VIRTUAL CLASSROOMS, COMPUTER BASED AND ONLINE SIMULATIONS AND DRILLS TO DEMONSTRATE APPLYING A NEW TEACHING METHODOLOGY TO ANY TEACHING SITUATION (U.S. CLS. 100, 101 AND 107).

FIRST USE 6-0-2004; IN COMMERCE 6-0-2004.

2,999,367. SOUTH PUGET SOUND COMMUNITY COLLEGE, OLYMPIA, WA. SN 78-421,749. FILED P.R. 5-19-2004; AM. S.R. 6-20-2005.

**SOUTH PUGET SOUND
COMMUNITY
COLLEGE**

THE MARK CONSISTS OF STANDARD CHARACTERS WITHOUT CLAIM TO ANY PARTICULAR FONT, STYLE, SIZE, OR COLOR.

NO CLAIM IS MADE TO THE EXCLUSIVE RIGHT TO USE "COMMUNITY COLLEGE", APART FROM THE MARK AS SHOWN.

CLASS 16—PAPER GOODS AND PRINTED MATTER

FOR PAPER PRODUCTS, PRINTS AND PUBLICATIONS, NAMELY; CLASS SCHEDULES; COURSE CATALOGS; PRINTED PROGRAMS FOR ATHLETIC EVENTS, EXHIBITS, CONCERTS, LECTURES, DANCE AND THEATRICAL EVENTS; YEARBOOKS; NOTEBOOKS; BINDERS; NOTEPADS; ENVELOPES; INVITATIONS; STATIONERY; DECALS; PENNANTS; POSTERS; CALENDARS; BUSINESS FORMS; PRINTED INVITATIONS; NAPKINS AND BUMPER STICKERS (U.S. CLS. 2, 5, 22, 23, 29, 37, 38 AND 50).

FIRST USE 12-31-1984; IN COMMERCE 12-31-1984.

CLASS 25—CLOTHING

FOR CLOTHING FOR MEN, WOMEN AND CHILDREN, NAMELY, HATS, CAPS, SHIRTS, T-SHIRTS, SWEATSHIRTS, JACKETS AND SHORTS (U.S. CLS. 22 AND 39).

FIRST USE 10-31-1999; IN COMMERCE 10-31-1999.

CLASS 41—EDUCATION AND ENTERTAINMENT

FOR EDUCATIONAL SERVICES, NAMELY, PROVIDING COURSES OF INSTRUCTION AT THE UNDERGRADUATE LEVEL; ENTERTAINMENT SERVICES, NAMELY, ARRANGING AND CONDUCTING ATHLETIC EVENTS AND EXHIBITS, LIVE MUSICAL CONCERTS, LECTURES AND DANCE AND THEATRICAL EVENTS (U.S. CLS. 100, 101 AND 107).

FIRST USE 12-31-1984; IN COMMERCE 12-31-1984.

2,999,373. BATH & BODY WORKS, INC., REYNOLDSBURG, OH. SN 78-423,666. FILED P.R. 5-24-2004; AM. S.R. 6-30-2005.

CINNAMON FROSTING

THE MARK CONSISTS OF STANDARD CHARACTERS WITHOUT CLAIM TO ANY PARTICULAR FONT, STYLE, SIZE, OR COLOR.

2,999,360. INTEGRITY MEDIA, INC., MOBILE, AL. SN 78-411,158. FILED P.R. 4-30-2004; AM. S.R. 10-22-2004.

VERTICALMUSIC.COM

THE MARK CONSISTS OF STANDARD CHARACTERS WITHOUT CLAIM TO ANY PARTICULAR FONT, STYLE, SIZE, OR COLOR.

OWNER OF U.S. REG. NOS. 2,322,532 AND 2,422,285.

CLASS 35—ADVERTISING AND BUSINESS

FOR ONLINE RETAIL STORE SERVICES FEATURING PRE-RECORDED CDS AND AUDIO CASSETTES (U.S. CLS. 100, 101 AND 102).

FIRST USE 5-0-2004; IN COMMERCE 5-0-2004.

CLASS 41—EDUCATION AND ENTERTAINMENT

FOR PUBLICATION OF SONG LYRICS AND SHEET MUSIC VIA THE INTERNET FOR USE IN LEADING WORSHIP (U.S. CLS. 100, 101 AND 107).

FIRST USE 5-0-2004; IN COMMERCE 5-0-2004.

CLASS 45—PERSONAL SERVICES

FOR PROVIDING INFORMATION VIA THE INTERNET IN THE FIELD OF MINISTERIAL SERVICES AND RELIGIOUS WORSHIP (U.S. CLS. 100 AND 101).

FIRST USE 5-0-2004; IN COMMERCE 5-0-2004.

NO CLAIM IS MADE TO THE EXCLUSIVE RIGHT TO USE "FROSTING", APART FROM THE MARK AS SHOWN.

CLASS 3—COSMETICS AND CLEANING PREPARATIONS

FOR PERSONAL CARE PRODUCTS, NAMELY BATH MILK, BATH POWDER, BATH SALTS, NON-MEDICATED BODY SOAKS, BATH SUGAR, BLUSH, BODY BUFF, BODY CREAM, BODY LOTION, BODY MILK, BODY MOUSSE, BODY POLISH, BODY SCRUB, BODY SOUFFLE, BODY WASH, HAIR CONDITIONER, EAU DE TOILETTE, EFFERVESCENT BATH CUBES, EYE LINER, EYE SHADOW, EYE BROW PENCIL, FACE MASK, FACIAL CLEANSER, FOOT CREAM, FOOT LOTION, FRAGRANT BODY SPRAY, FRAGRANT ROOM SPRAY, HAIR STYLING AIDS, NAMELY, HAIR SPRAY, HAIR GEL, HAIR MOUSSE, HAND CREAM, HAND LOTION, HONEY BATH, NON-MEDICATED LIP BALM, LIP GLOSS, LIP LINER, LIPSTICK, LIQUID FOUNDATION FOR THE FACE, MASCARA, POTPOURI, POWDER FOUNDATION FOR THE FACE, REFILLS FOR ELECTRIC FRAGRANCE DISPENSERS, SALT SCRUB, SHAMPOO, SHIMMER BODY LOTION, SHIMMER BODY POWDER, SHOWER GEL, SOAP FOR THE BODY, SOAP FOR THE FACE, SOAP FOR THE HANDS AND SUGAR SCRUB (U.S. CLS. 1, 4, 6, 50, 51 AND 52).
FIRST USE 10-18-2004; IN COMMERCE 10-18-2004.

CLASS 4—LUBRICANTS AND FUELS

FOR CANDLES (U.S. CLS. 1, 6 AND 15).
FIRST USE 1-22-2005; IN COMMERCE 1-22-2005.

2,999,383, REACH MEDIA, INC., DALLAS, TX. SN 78-449,122.
FILED P.R. 7-12-2004; AM. S.R. 7-22-2005.

**BLACKAMERICAWEB.
COM**

THE MARK CONSISTS OF STANDARD CHARACTERS WITHOUT CLAIM TO ANY PARTICULAR FONT, STYLE, SIZE, OR COLOR.

CLASS 35—ADVERTISING AND BUSINESS

FOR PROMOTING THE GOODS AND SERVICES OF OTHERS BY PROVIDING HYPERTEXT LINKS TO THE WEB SITES OF OTHERS; PROVIDING INFORMATION VIA THE INTERNET IN THE FIELD OF CAREERS; PROVIDING A WEB SITE WHICH FEATURES ADVERTISEMENTS FOR THE GOODS AND SERVICES OF OTHERS ON THE INTERNET (U.S. CLS. 100, 101 AND 102).
FIRST USE 6-0-2001; IN COMMERCE 6-0-2001.

CLASS 36—INSURANCE AND FINANCIAL

FOR PROVIDING INFORMATION VIA THE INTERNET IN THE FIELD OF FINANCE (U.S. CLS. 100, 101 AND 102).
FIRST USE 6-0-2001; IN COMMERCE 6-0-2001.

CLASS 38—COMMUNICATION

FOR PROVIDING MULTI-USER ACCESS TO THE INTERNET; ELECTRONIC MAIL SERVICES (U.S. CLS. 100, 101 AND 104).
FIRST USE 6-0-2001; IN COMMERCE 6-0-2001.

CLASS 41—EDUCATION AND ENTERTAINMENT

FOR PROVIDING INFORMATION VIA THE INTERNET IN THE FIELDS OF NEWS IN THE NATURE OF CURRENT EVENTS REPORTING (U.S. CLS. 100, 101 AND 107).
FIRST USE 6-0-2001; IN COMMERCE 6-0-2001.

CLASS 44—MEDICAL, BEAUTY AND AGRICULTURAL SERVICES

FOR PROVIDING INFORMATION VIA THE INTERNET IN THE FIELD OF HEALTH AND MEDICINE (U.S. CLS. 100 AND 101).
FIRST USE 6-0-2001; IN COMMERCE 6-0-2001.

CLASS 45—PERSONAL SERVICES

FOR PROVIDING INFORMATION VIA THE INTERNET IN THE FIELDS OF RELIGION, PRAISE AND INSPIRATION (U.S. CLS. 100 AND 101).
FIRST USE 6-0-2001; IN COMMERCE 6-0-2001.

* * * * *

SECTION 2.— INTERNATIONAL CLASSIFICATION

The short titles associated below with the international class numbers are terms designed merely for quick identification and are not an official part of the international classification. The full names of international classes are given in section 6.1 of the trademark rules of practice.

The designation "U.S. Cl." appearing in this section refers to the U.S. class in effect prior to Sep. 1, 1973 rather than the international class which applies to applications filed on or after that date. For adoption of international classification see notice in the OFFICIAL GAZETTE of Jun. 26, 1973 (911 O.G. TM 210).

Application in one class

CLASS 2—PAINTS

2,999,323. GREENE, LEONARD M., KINGS PARK, NY. SN 76-618,288. FILED P.R. 10-28-2004; AM. S.R. 7-13-2005.

FREE INK 4 LIFE

THE MARK CONSISTS OF STANDARD CHARACTERS WITHOUT CLAIM TO ANY PARTICULAR FONT, STYLE, SIZE, OR COLOR.

FOR INK JET CARTRIDGES FILLED WITH BLACK, RED, BLUE, AND YELLOW INK (U.S. CLS. 6, 11 AND 16).

FIRST USE 9-1-2004; IN COMMERCE 9-1-2004.

CLASS 5—(Continued).

2,999,319. JAQUEZ, RAMON E., BRENTWOOD, NY. SN 76-607,020. FILED P.R. 8-12-2004; AM. S.R. 7-18-2005.

NATURAL HEALTHY WATER

THE MARK CONSISTS OF STANDARD CHARACTERS WITHOUT CLAIM TO ANY PARTICULAR FONT, STYLE, SIZE, OR COLOR.

NO CLAIM IS MADE TO THE EXCLUSIVE RIGHT TO USE "WATER", APART FROM THE MARK AS SHOWN.

FOR BOTTLED VITAMIN ENRICHED WATER (U.S. CLS. 6, 18, 44, 46, 51 AND 52).

FIRST USE 8-10-2004; IN COMMERCE 8-10-2004.

CLASS 3—COSMETICS AND CLEANING PREPARATIONS

2,999,365. FREDERIC FEKKAI & CO., LLC, NEW YORK, NY. SN 78-421,259. FILED 5-19-2004.

SHEER HOLD

THE MARK CONSISTS OF STANDARD CHARACTERS WITHOUT CLAIM TO ANY PARTICULAR FONT, STYLE, SIZE, OR COLOR.

FOR HAIR CARE PREPARATIONS, NAMELY HAIR-SPRAY (U.S. CLS. 1, 4, 6, 50, 51 AND 52).

FIRST USE 9-0-2003; IN COMMERCE 9-0-2003.

CLASS 6—METAL GOODS

2,999,352. HURST, LARRY, PEACHTREE CITY, GA. SN 78-339,193. FILED P.R. 12-11-2003; AM. S.R. 7-20-2005.

DEBRIS GUARD

THE MARK CONSISTS OF STANDARD CHARACTERS WITHOUT CLAIM TO ANY PARTICULAR FONT, STYLE, SIZE, OR COLOR.

FOR GUTTER CAPS (U.S. CLS. 2, 12, 13, 14, 23, 25 AND 50).

FIRST USE 3-10-2004; IN COMMERCE 11-3-2004.

CLASS 5—PHARMACEUTICALS

TM 2008

CLASS 6—(Continued).

2,999,353. PRO-TECH ARMORED PRODUCTS OF MASSACHUSETTS, INC., JACKSONVILLE BEACH, FL. SN 78-357,715. FILED P.R. 1-26-2004; AM. S.R. 3-2-2005.

BALLISTIC RESISTANT ENCLOSURE

THE MARK CONSISTS OF STANDARD CHARACTERS WITHOUT CLAIM TO ANY PARTICULAR FONT, STYLE, SIZE, OR COLOR.

FOR STRUCTURAL ARMOR FOR GUARD BOOTHS AND FORTIFIED ARMORED POSITIONS; BULLET-RESISTANT MODULAR WALL SYSTEMS (U.S. CLS. 2, 12, 13, 14, 23, 25 AND 50).

FIRST USE 2-28-2002; IN COMMERCE 2-28-2002.

CLASS 9—ELECTRICAL AND SCIENTIFIC APPARATUS

2,999,293. STAPLOE LIMITED, IPSWICH, SUFFOLK IP3 8SG, UNITED KINGDOM. SN 76-459,955. FILED P.R. 10-10-2002; AM. S.R. 11-2-2004.

LOADLOGGER

OWNER OF UNITED KINGDOM REG. NO. 2229576, DATED 4-15-2000, EXPIRES 4-15-2010.

FOR UNDERGROUND PIPE INSTALLATION SYSTEM COMPRISING AN ATTACHMENT FOR PIPES BEING INSTALLED UNDERGROUND CONSISTING OF A LOAD CELL, AN INCLINOMETER, A PRESSURE TRANSDUCER AND AN ELECTRIC POWER SUPPLY, AND DATA STORAGE SOFTWARE THAT REPORTS PULL FORCE AND ANNULAR FLUID PRESSURE IN THE BORE DURING THE INSTALLATION AND THE DUCT GRADE ALL AFOREMENTIONED GOODS SOLD AS A UNIT (U.S. CLS. 21, 23, 26, 36 AND 38).

CLASS 9—(Continued).

2,999,303. VONAGE HOLDING CORP., EDISON, NJ. SN 76-562,127. FILED P.R. 11-26-2003; AM. S.R. 12-7-2004.

Click-2-Call

THE MARK CONSISTS OF STANDARD CHARACTERS WITHOUT CLAIM TO ANY PARTICULAR FONT, STYLE, SIZE, OR COLOR.

FOR DOWNLOADABLE COMPUTER SOFTWARE FOR PROVIDING VOICE COMMUNICATION SERVICES VIA THE INTERNET (U.S. CLS. 21, 23, 26, 36 AND 38).

FIRST USE 3-17-2002; IN COMMERCE 3-17-2002.

2,999,308. DOWNSTREAM TECHNOLOGIES, LLC, BOLTON, MA. SN 76-580,412. FILED P.R. 3-10-2004; AM. S.R. 4-4-2005.

BLUEPRINT

THE MARK CONSISTS OF STANDARD CHARACTERS WITHOUT CLAIM TO ANY PARTICULAR FONT, STYLE, SIZE, OR COLOR.

FOR COMPUTER PROGRAM CONFIGURED TO GENERATE DOCUMENTATION FOR MANUFACTURING PRINTED CIRCUIT BOARDS AND USER MANUALS ASSOCIATED THEREWITH (U.S. CLS. 21, 23, 26, 36 AND 38).

FIRST USE 3-8-2005; IN COMMERCE 3-8-2005.

2,999,321. COMMVAULT SYSTEMS, INC., OCEANPORT, NJ. SN 76-609,626. FILED P.R. 8-30-2004; AM. S.R. 7-18-2005.

UNIFIED DATA MANAGEMENT

THE MARK CONSISTS OF STANDARD CHARACTERS WITHOUT CLAIM TO ANY PARTICULAR FONT, STYLE, SIZE, OR COLOR.

NO CLAIM IS MADE TO THE EXCLUSIVE RIGHT TO USE DATA MANAGEMENT, APART FROM THE MARK AS SHOWN.

FOR COMPUTER SOFTWARE FOR DATA AND STORAGE MANAGEMENT NAMELY, TO BACK-UP, RETRIEVE, RECOVER, REPLICATE, MIGRATE, ARCHIVE AND MANAGE RESOURCES (U.S. CLS. 21, 23, 26, 36 AND 38).

FIRST USE 4-1-2004; IN COMMERCE 4-1-2004.

CLASS 9—(Continued).

2,999,326. MICROSMARTS LLC, OLYMPIA FIELDS, IL. SN 76-622,160. FILED P.R. 11-24-2004; AM. S.R. 7-18-2005.

CLASS 9—(Continued).

2,999,349. ANALOG DEVICES, INC., NORWOOD, MA. SN 78-322,332. FILED P.R. 11-3-2003; AM. S.R. 6-30-2005.

SPYWARE VANISHER

THE MARK CONSISTS OF STANDARD CHARACTERS WITHOUT CLAIM TO ANY PARTICULAR FONT, STYLE, SIZE, OR COLOR.

NO CLAIM IS MADE TO THE EXCLUSIVE RIGHT TO USE "SPYWARE", APART FROM THE MARK AS SHOWN.

FOR COMPUTER SOFTWARE FOR SCANNING COMPUTERS FOR INFECTIONS, ALERTING ABOUT SOFTWARE INFECTIONS, REMOVING SOFTWARE INFECTIONS AND/OR PREVENTING FUTURE SOFTWARE INFECTIONS (U.S. CLS. 21, 23, 26, 36 AND 38).

FIRST USE 10-19-2004; IN COMMERCE 10-19-2004.

NANODAC

THE MARK CONSISTS OF STANDARD CHARACTERS WITHOUT CLAIM TO ANY PARTICULAR FONT, STYLE, SIZE, OR COLOR.

FOR INTEGRATED CIRCUITS (U.S. CLS. 21, 23, 26, 36 AND 38).

FIRST USE 5-1-2005; IN COMMERCE 5-1-2005.

2,999,344. ANDREW CORPORATION, ORLAND PARK, IL. SN 78-303,532. FILED P.R. 9-22-2003; AM. S.R. 7-27-2005.

SMARTMAC

FOR CUSTOMIZED MONITOR AND CONTROL SOFTWARE THAT PROVIDES REAL TIME NETWORK MANAGEMENT AND EARTH STATION EQUIPMENT MANAGEMENT, FOR USE ON SATELLITE COMMUNICATION SYSTEMS (U.S. CLS. 21, 23, 26, 36 AND 38).

FIRST USE 7-7-2005; IN COMMERCE 7-7-2005.

2,999,354. BOMGAARS, JOEL, RIDGELAND, MS. SN 78-366,462. FILED P.R. 2-11-2004; AM. S.R. 11-15-2004.

NETWORKSTREAMING

THE MARK CONSISTS OF STANDARD CHARACTERS WITHOUT CLAIM TO ANY PARTICULAR FONT, STYLE, SIZE, OR COLOR.

FOR COMPUTER SOFTWARE FOR USE IN DELIVERING AND DEPLOYING SOFTWARE APPLICATIONS AND DATA OVER THE INTERNET AND/OR TO REMOTE USERS; COMPUTER SOFTWARE FOR USE IN ACCESSING, USING AND CONTROLLING REMOTE COMPUTER SYSTEMS AND SOFTWARE; COMPUTER SOFTWARE FOR USE IN MONITORING, DIAGNOSING AND TROUBLESHOOTING REMOTE COMPUTER SYSTEMS AND SOFTWARE; COMPUTER SOFTWARE FOR USE IN ADMINISTERING AND AUDITING COMPUTER SYSTEMS AND SOFTWARE; COMPUTER SOFTWARE FOR USE IN EDUCATING REMOTE USERS CONCERNING THE USE OF COMPUTER SOFTWARE; COMPUTER SOFTWARE FOR USE IN INSTALLING AND UNINSTALLING COMPUTER SOFTWARE (U.S. CLS. 21, 23, 26, 36 AND 38).

FIRST USE 2-9-2004; IN COMMERCE 2-9-2004.

2,999,345. TERALINK COMMUNICATIONS, INC., YU-SEONG-GU, DAEJEON, REPUBLIC OF KOREA. SN 78-304,848. FILED P.R. 9-24-2003; AM. S.R. 7-20-2005.

"true" OSNR

NO CLAIM IS MADE TO THE EXCLUSIVE RIGHT TO USE "OSNR", APART FROM THE MARK AS SHOWN.

FOR OPTO-ELECTRONIC SYSTEMS COMPRISED OF OPTICAL SIGNAL TO NOISE RATIO MONITORS; AND COMPONENTS, NAMELY OPTICAL SIGNAL TO NOISE RATIO MONITORS USED AS OPTICAL PERFORMANCE MONITORS, OPTICAL PERFORMANCE ANALYZERS, OPTICAL CHANNEL MONITORS AND OPTICAL WAVELENGTH MANAGERS, TO MONITOR, RECORD, ANALYZE AND MANAGE OPTICAL NETWORK PERFORMANCE (U.S. CLS. 21, 23, 26, 36 AND 38).

FIRST USE 3-26-2003; IN COMMERCE 3-26-2003.

CLASS 9—(Continued).

2,999,363. REFLECTIONS INTERACTIVE LIMITED, NEW-CASTLE UPON TYNE NE1 2AZ, UNITED KINGDOM. SN 78-416,915. FILED P.R. 5-11-2004; AM. S.R. 6-21-2005.

DRIV3R

THE MARK CONSISTS OF STANDARD CHARACTERS WITHOUT CLAIM TO ANY PARTICULAR FONT, STYLE, SIZE, OR COLOR.

FOR INTERACTIVE MULTIMEDIA GAME SOFTWARE FOR USE ON PERSONAL COMPUTERS AND ELECTRONIC GAME-PLAYING UNITS (U.S. CLS. 21, 23, 26, 36 AND 38).

FIRST USE 6-21-2004; IN COMMERCE 6-21-2004.

2,999,376. BOARDROOM SOFTWARE, INC., CARROLLTON, TX. SN 78-428,417. FILED P.R. 6-2-2004; AM. S.R. 7-18-2005.

EQUITY ENTERPRISE

THE MARK CONSISTS OF STANDARD CHARACTERS WITHOUT CLAIM TO ANY PARTICULAR FONT, STYLE, SIZE, OR COLOR.

FOR SOFTWARE, NAMELY SOFTWARE FOR THE MAINTENANCE AND MANAGEMENT OF CORPORATE STOCKS AND EQUITY ACCOUNTING (U.S. CLS. 21, 23, 26, 36 AND 38).

FIRST USE 4-0-2003; IN COMMERCE 4-0-2003.

CLASS 9—(Continued).

2,999,378. KEYNAMICS LLC, LAKEWAY, TX. SN 78-432,052. FILED P.R. 6-9-2004; AM. S.R. 7-12-2005.

**For Laptops On The
Desktop**

THE MARK CONSISTS OF STANDARD CHARACTERS WITHOUT CLAIM TO ANY PARTICULAR FONT, STYLE, SIZE, OR COLOR.

FOR STAND FOR LAPTOPS, KEYBOARDS AND OTHER DATA ENTRY DEVICES, TO BE USED IN CONJUNCTION WITH THE THE DEVICES ON TOP OF A DESK OR TABLE SURFACE (U.S. CLS. 21, 23, 26, 36 AND 38).

FIRST USE 6-2-2004; IN COMMERCE 6-2-2004.

2,999,394. THE MARKET SHARE OF MONROE COUNTY INCORPORATED, KEY WEST, FL. SN 78-529,318. FILED P.R. 12-8-2004; AM. S.R. 7-20-2005.

KEY WEST JOURNAL

THE MARK CONSISTS OF STANDARD CHARACTERS WITHOUT CLAIM TO ANY PARTICULAR FONT, STYLE, SIZE, OR COLOR.

NO CLAIM IS MADE TO THE EXCLUSIVE RIGHT TO USE "JOURNAL", APART FROM THE MARK AS SHOWN.

FOR DOWNLOADABLE ELECTRONIC PUBLICATIONS, IN THE NATURE OF JOURNALS FEATURING INFORMATIONAL ARTICLES, INFORMATION ABOUT SPECIAL EVENTS AND COMMERCIAL ADVERTISEMENTS REGARDING KEY WEST, FLORIDA (U.S. CLS. 21, 23, 26, 36 AND 38).

FIRST USE 1-24-2005; IN COMMERCE 1-24-2005.

CLASS 10—MEDICAL APPARATUS

2,999,342. BRAUN GMBH, KRÖNBERG IM TAUNUS D-61476, FED REP GERMANY. SN 78-300,524. FILED P.R. 9-15-2003; AM. S.R. 6-27-2005.

EXACTEMP

PRIORITY CLAIMED UNDER SEC. 44(D) ON FED REP GERMANY APPLICATION NO. 30314456, FILED 3-18-2003, REG. NO. 30314456, DATED 7-11-2003, EXPIRES 3-31-2013.

FOR THERMOMETERS FOR MEDICAL PURPOSES, NAMELY RADIATION THERMOMETERS, INFRARED THERMOMETERS, EAR THERMOMETERS AND PARTS OF THE ABOVEMENTIONED GOODS SOLD TOGETHER AS A UNIT (U.S. CLS. 26, 39 AND 44).

CLASS 10—(Continued).

2,999,346. ASTHMATX, INC., MOUNTAIN VIEW, CA. SN 78-309,332. FILED P.R. 10-3-2003; AM. S.R. 6-20-2005.

ASTHMATX

FOR MEDICAL THERAPEUTIC DEVICES FOR USE IN THE TREATMENT OF PULMONARY DISEASES, NAMELY CATHETERS, PROBES, GENERATORS, AND ELECTRODES (U.S. CLS. 26, 39 AND 44).

FIRST USE 1-31-2004; IN COMMERCE 1-31-2004.

CLASS 12—VEHICLES

2,999,291. DOVER WELDING & MACHINE, INC., DOVER, FL. SN 76-354,067. FILED P.R. 12-21-2001; AM. S.R. 4-8-2003.

PIGGY BACK

FOR MOTORCYCLE CARRIERS FOR VEHICLES (U.S. CLS. 19, 21, 23, 31, 35 AND 44).

FIRST USE 6-15-2002; IN COMMERCE 6-15-2002.

CLASS 13—FIREARMS

2,999,315. KIMBER IP, LLC, YONKERS, NY. SN 76-601,523. FILED P.R. 7-12-2004; AM. S.R. 6-10-2005.

LOADED CHAMBER INDICATOR PORT

THE MARK CONSISTS OF STANDARD CHARACTERS WITHOUT CLAIM TO ANY PARTICULAR FONT, STYLE, SIZE, OR COLOR.

FOR SAFETY DEVICE COMPRISED OF A SLOT IN THE BARREL OF A FIREARM FOR VIEWING CONTENTS OF BARREL SOLD AS INTEGRAL COMPONENT OF A FIREARM (U.S. CLS. 2 AND 9).

FIRST USE 4-1-2003; IN COMMERCE 4-1-2003.

CLASS 14—JEWELRY

2,999,312. VAUGHAN, SARABETH, LAFAYETTE, IN. SN 76-594,157. FILED P.R. 5-24-2004; AM. S.R. 6-24-2004.

'CARS & CUFFLINKS.

THE MARK CONSISTS OF STANDARD CHARACTERS WITHOUT CLAIM TO ANY PARTICULAR FONT, STYLE, SIZE, OR COLOR.

FOR JEWELRY (U.S. CLS. 2, 27, 28 AND 50).

FIRST USE 5-1-2004; IN COMMERCE 5-1-2004.

CLASS 16—PAPER GOODS AND PRINTED MATTER**CLASS 16—(Continued).**

2,999,304. ROBBINS-GIOIA, LLC, ALEXANDRIA, VA. SN 76-562,326. FILED P.R. 12-1-2003; AM. S.R. 7-7-2005.

PM REPORT

THE MARK CONSISTS OF STANDARD CHARACTERS WITHOUT CLAIM TO ANY PARTICULAR FONT, STYLE, SIZE, OR COLOR.

NO CLAIM IS MADE TO THE EXCLUSIVE RIGHT TO USE "REPORT", APART FROM THE MARK AS SHOWN.

FOR PRINTED MATERIALS AND PUBLICATIONS, NAMELY, JOURNALS AND PERIODICALS ALL IN THE FIELD OF BEST PRACTICES IN THE AREAS OF PROJECT AND PROGRAM MANAGEMENT AND BUSINESS PROCESSES (U.S. CLS. 2, 5, 22, 23, 29, 37, 38 AND 50).

FIRST USE 2-15-2004; IN COMMERCE 2-15-2004.

2,999,305. MRS. GROSSMAN'S PAPER COMPANY, PETALUMA, CA. SN 76-564,093. FILED P.R. 12-8-2003; AM. S.R. 5-20-2005.

STUFFED STICKERS

THE MARK CONSISTS OF STANDARD CHARACTERS WITHOUT CLAIM TO ANY PARTICULAR FONT, STYLE, SIZE, OR COLOR.

NO CLAIM IS MADE TO THE EXCLUSIVE RIGHT TO USE "STICKERS", APART FROM THE MARK AS SHOWN.

FOR STICKERS, COLLECTION OF STICKERS AND STRIPS OF STICKERS (U.S. CLS. 2, 5, 22, 23, 29, 37, 38 AND 50).

FIRST USE 9-1-2003; IN COMMERCE 9-1-2003.

2,999,309. FAMILY HISTORY DVD, L.L.C., ADDISON, TX. SN 76-582,301. FILED P.R. 3-22-2004; AM. S.R. 3-31-2005.

FAMILY HISTORY DVD

THE MARK CONSISTS OF STANDARD CHARACTERS WITHOUT CLAIM TO ANY PARTICULAR FONT, STYLE, SIZE, OR COLOR.

FOR PRINTED EDUCATIONAL AND GUIDE BOOKS ON THE SUBJECT OF USING THIRD-PARTY COMPUTER SOFTWARE TO CONVERT PHOTOS, DOCUMENTS, MOVIES AND VIDEOS INTO MULTIMEDIA DVD PRESENTATIONS (U.S. CLS. 2, 5, 22, 23, 29, 37, 38 AND 50).

FIRST USE 3-15-2004; IN COMMERCE 3-15-2004.

CLASS 16—(Continued).

2,999,371. CUSTOM BUILT PUBLISHING LLC, MINNEAPOLIS, MN. SN 78-422,350. FILED P.R. 5-20-2004; AM. S.R. 6-28-2005.

CLASS 16—(Continued).

2,999,379. COMMAND PACKAGING, LOS ANGELES, CA. SN 78-436,560. FILED P.R. 6-16-2004; AM. S.R. 7-25-2005.

LBM JOURNAL

CUSTOM BAG EXPRESS

THE MARK CONSISTS OF STANDARD CHARACTERS WITHOUT CLAIM TO ANY PARTICULAR FONT, STYLE, SIZE, OR COLOR.

NO CLAIM IS MADE TO THE EXCLUSIVE RIGHT TO USE "JOURNAL", APART FROM THE MARK AS SHOWN.

FOR MAGAZINE DEVOTED TO LUMBER, BUILDING MATERIALS AND BUILDING CONSTRUCTION (U.S. CLS. 2, 5, 22, 23, 29, 37, 38 AND 50).

FIRST USE 6-11-2003; IN COMMERCE 6-11-2003.

NO CLAIM IS MADE TO THE EXCLUSIVE RIGHT TO USE "CUSTOM BAG", APART FROM THE MARK AS SHOWN.

FOR ON-LINE RETAIL STORE SERVICES FEATURING CUSTOM PLASTIC BAGS (U.S. CLS. 2, 5, 22, 23, 29, 37, 38 AND 50).

FIRST USE 2-10-2002; IN COMMERCE 2-15-2002.

2,999,382. THE MARKET SHARE OF MONROE COUNTY INCORPORATED, KEY WEST, FL. SN 78-447,230. FILED P.R. 7-7-2004; AM. S.R. 7-20-2005.

2,999,374. SIMON & SCHUSTER, INC., NEW YORK, NY. SN 78-425,988. FILED P.R. 5-27-2004; AM. S.R. 6-22-2005.

KEY WEST MAGAZINE



THE MARK CONSISTS OF STANDARD CHARACTERS WITHOUT CLAIM TO ANY PARTICULAR FONT, STYLE, SIZE, OR COLOR.

NO CLAIM IS MADE TO THE EXCLUSIVE RIGHT TO USE "MAGAZINE", APART FROM THE MARK AS SHOWN.

FOR PRINTED MATTER, NAMELY MAGAZINES FEATURING INFORMATIONAL ARTICLES, INFORMATION ABOUT SPECIAL EVENTS AND COMMERCIAL ADVERTISEMENTS REGARDING KEY WEST, FLORIDA (U.S. CLS. 2, 5, 22, 23, 29, 37, 38 AND 50).

FIRST USE 5-1-2003; IN COMMERCE 5-1-2003.

FOR SERIES OF NON-FICTION BOOKS FOR YOUNG ADULTS (U.S. CLS. 2, 5, 22, 23, 29, 37, 38 AND 50).

FIRST USE 2-28-2005; IN COMMERCE 2-28-2005.

CLASS 16—(Continued).

2,999,395. THE MARKET SHARE OF MONROE COUNTY INCORPORATED, KEY WEST, FL. SN 78-529,322. FILED P.R. 12-8-2004; AM. S.R. 7-20-2005.

KEY WEST JOURNAL

THE MARK CONSISTS OF STANDARD CHARACTERS WITHOUT CLAIM TO ANY PARTICULAR FONT, STYLE, SIZE, OR COLOR.

NO CLAIM IS MADE TO THE EXCLUSIVE RIGHT TO USE "JOURNAL", APART FROM THE MARK AS SHOWN.

FOR PRINTED MATTER, NAMELY JOURNALS FEATURING INFORMATIONAL ARTICLES, INFORMATION ABOUT SPECIAL EVENTS AND COMMERCIAL ADVERTISEMENTS REGARDING KEY WEST, FLORIDA (U.S. CLS. 2, 5, 22, 23, 29, 37, 38 AND 50).

FIRST USE 1-24-2005; IN COMMERCE 1-24-2005.

CLASS 17—(Continued).

2,999,338. COVERTECH FABRICATING INC., ETOBICOKE ONTARIO M9W 5T8, CANADA. SN 78-263,321. FILED P.R. 6-17-2003; AM. S.R. 7-25-2005.

CONCRETE BARRIER

PRIORITY CLAIMED UNDER SEC. 44(D) ON CANADA APPLICATION NO. 1,162,578, FILED 12-17-2002, REG. NO. 624488, DATED 11-3-2004, EXPIRES 11-3-2019.

FOR FOIL INSULATION FOR CONCRETE, BUILDINGS AND CONSTRUCTION (U.S. CLS. 1, 5, 12, 13, 35 AND 50).

FIRST USE 11-4-1998; IN COMMERCE 11-4-1998.

2,999,398. PONY BOY BRAND, INC., ST. AUGUSTINE, FL. SN 78-535,755. FILED P.R. 12-20-2004; AM. S.R. 7-26-2005.

WOMEN & HORSES

THE MARK CONSISTS OF STANDARD CHARACTERS WITHOUT CLAIM TO ANY PARTICULAR FONT, STYLE, SIZE, OR COLOR.

FOR WOMEN'S LIFESTYLE MAGAZINES AND NEWSLETTERS COVERING ALL ASPECTS OF A HORSEWOMEN'S LIFE (U.S. CLS. 2, 5, 22, 23, 29, 37, 38 AND 50).

FIRST USE 2-1-2004; IN COMMERCE 6-1-2004.

CLASS 19—NON-METALLIC BUILDING MATERIALS

2,999,400. CONTINUOUS COATING CORP., ORANGE, CA. SN 78-975,964. FILED P.R. 2-9-2004; AM. S.R. 2-28-2005.

CLASS 17—RUBBER GOODS

2,999,310. STRONGGO, LLC, TUCSON, AZ. SN 76-582,776. FILED P.R. 3-22-2004; AM. S.R. 6-13-2005.

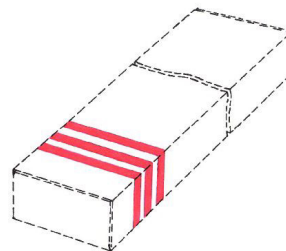
**ROCKSAFE**

FOR POLYESTER BASED SHEETING TO BE USED IN TUNNELING AND MINING (U.S. CLS. 1, 5, 12, 13, 35 AND 50).

FIRST USE 3-15-2005; IN COMMERCE 3-15-2005.

THE COLOR(S) RED IS/ARE CLAIMED AS A FEATURE OF THE MARK.

THE MARK CONSISTS OF THREE PARALLEL TRANSVERSE RED STRIPES APPLIED ADJACENT TO ONE END OF THE ELONGATED PACKAGING FOR THE GOODS.

FOR BUILDING MATERIAL, NAMELY DRYWALL TRIM AND CORNER BEADS, MADE PRIMARILY OF PAPER (U.S. CLS. 1, 12, 33 AND 50).

FIRST USE 8-0-2001; IN COMMERCE 8-0-2001.

CLASS 19—(Continued).

2,999,401. CONTINUOUS COATING CORP., ORANGE, CA. SN 78-975,969. FILED P.R. 3-9-2004; AM. S.R. 2-28-2005.

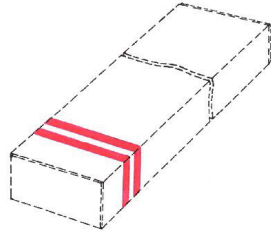

THE COLOR(S) RED IS/ARE CLAIMED AS A FEATURE OF THE MARK.

THE MARK CONSISTS OF TWO NARROW PARALLEL TRANSVERSE RED STRIPES APPLIED ADJACENT ONE END OF THE ELONGATED PACKAGING FOR THE GOODS.

FOR BUILDING MATERIAL, NAMELY DRYWALL TRIM AND CORNER BEADS FOR USE WITH DRYWALL, MADE PRIMARILY OF PAPER (U.S. CLS. 1, 12, 33 AND 50).

FIRST USE 8-0-2001; IN COMMERCE 8-0-2001.

CLASS 20—FURNITURE AND ARTICLES NOT OTHERWISE CLASSIFIED

2,999,359. PRINCE, JEANNETTE, CARDIFF BY THE SEA, CA. SN 78-397,009. FILED P.R. 4-6-2004; AM. S.R. 6-13-2005.

Artworkz

FOR HANGING DISPLAY STANDS AND RACKS INCORPORATING PICTURE FRAMES (U.S. CLS. 2, 13, 22, 25, 32 AND 50).

FIRST USE 5-1-0004; IN COMMERCE 6-17-2004.

CLASS 24—FABRICS

CLASS 24—(Continued).

2,999,290. NAS MANUFACTURING, INC., CLARKSVILLE, GA. SN 76-312,981. FILED P.R. 9-12-2001; AM. S.R. 7-22-2005.

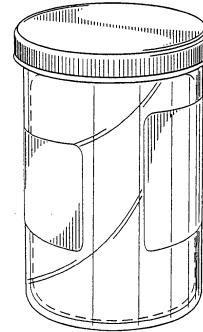

THE ILLUSTRATION OF THE TRADE DRESS INCLUDED SHADING AND PHANTOM LINES TO INDICATE REPRESENTATIVE GOODS STORED WITHIN THE CONTAINER. THE SHADING AND PHANTOM LINES ARE NOT CONSIDERED PARTS OF THE TRADE DRESS.

THE MARK CONSISTS OF A CONTAINER FOR BEDDING PRODUCTS.

FOR BEDDING PRODUCTS; NAMELY PILLOW CASES, PILLOW SHAMS, MATTRESS COVERS, MATTRESS PADS, AND COMFORTERS (U.S. CLS. 42 AND 50).

FIRST USE 10-12-2002; IN COMMERCE 10-12-2002.

2,999,328. NEW CPE, INC., ATLANTA, GA. SN 76-627,623. FILED P.R. 1-11-2005; AM. S.R. 7-8-2005.

“Classic Wool Felt”

NO CLAIM IS MADE TO THE EXCLUSIVE RIGHT TO USE "WOOL FELT", APART FROM THE MARK AS SHOWN.

FOR WOOL FELT (U.S. CLS. 42 AND 50).
FIRST USE 9-1-2003; IN COMMERCE 9-1-2003.

CLASS 25—CLOTHING

2,999,333. CARPENTER, THOMAS, CHESTERFIELD TWP., MI. AND SMITH, EDWARD, CHESTERFIELD TWP., MI. SN 78-153,976. FILED P.R. 8-14-2002; AM. S.R. 6-23-2005.

RESPECT THE HELMET

FOR SPORTS AND ATHLETIC APPAREL, NAMELY T-SHIRTS, TANK TOP SHIRTS, JERSEYS, SPORT SHIRTS, POLO SHIRTS, SWEATSHIRTS, SWEATPANTS, ATHLETIC SHORTS, BOXER SHORTS, JACKETS, CAPS, KNIT HATS, SCARVES, GLOVES, VISORS AND SOCKS (U.S. CLS. 22 AND 39).

FIRST USE 12-19-2003; IN COMMERCE 3-13-2004.

CLASS 25—(Continued).

2,999,340. MARTINET, GARY, ESCONDIDO, CA. SN 78-283,286. FILED P.R. 8-5-2003; AM. S.R. 6-21-2005.

**HUNGRY & OUT OF WORK?
EAT AN
ENVIRONMENTALIST**

FOR CLOTHING, NAMELY TEE SHIRTS, SWEAT-SHIRTS, SWEATPANTS, JACKETS, WIND RESISTANT JACKETS, AND SHORTS (U.S. CLS. 22 AND 39).
FIRST USE 12-31-1982; IN COMMERCE 12-31-1987.

2,999,366. LITTLE EARTH PRODUCTIONS, INC., PITTSBURGH, PA. SN 78-421,650. FILED P.R. 5-19-2004; AM. S.R. 7-7-2005.

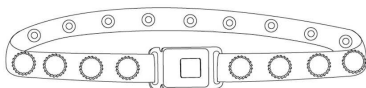

THE MARK CONSISTS OF THE DESIGN OF A BELT INCLUDING BOTTLE CAPS ATTACHED TO THE BELT AND AN AUTOMOTIVE SEAT BELT USED FOR THE BELT BUCKLE.

FOR BELTS (U.S. CLS. 22 AND 39).
FIRST USE 6-1-1993; IN COMMERCE 6-1-1993.

CLASS 28—TOYS AND SPORTING GOODS

2,999,298. VARIFLEX, INC., MOORPARK, CA. SN 76-529,823. FILED P.R. 7-17-2003; AM. S.R. 5-16-2005.

MAPLE

FOR SKATEBOARDS (U.S. CLS. 22, 23, 38 AND 50).
FIRST USE 1-0-1994; IN COMMERCE 1-0-1994.

CLASS 29—(Continued).

2,999,336. MAD MEALS, LLC, MT. KISCO, NY. SN 78-234,925. FILED P.R. 4-7-2003; AM. S.R. 7-1-2004.

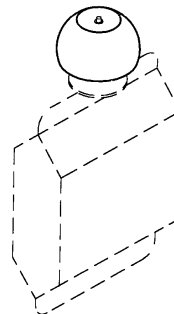

THE MARK CONSISTS OF THE CONFIGURATION OF THE CAP AFFIXED TO THE CONTAINER FOR THE GOODS.

FOR PROCESSED FRUITS (U.S. CL. 46).
FIRST USE 7-0-2001; IN COMMERCE 7-0-2001.

2,999,372. KISSLER, FREDRIC, LOS ANGELES, CA. SN 78-423,205. FILED P.R. 5-21-2004; AM. S.R. 8-1-2005.

HEATZ

THE MARK CONSISTS OF STANDARD CHARACTERS WITHOUT CLAIM TO ANY PARTICULAR FONT, STYLE, SIZE, OR COLOR.

FOR PREPARED, SELF-HEATING ENTREE, CONSISTING PRIMARILY OF MEAT, POULTRY, VEGETABLES OR PASTA (U.S. CL. 46).
FIRST USE 8-12-2004; IN COMMERCE 1-11-2005.

CLASS 29—MEATS AND PROCESSED FOODS**CLASS 30—STAPLE FOODS**

CLASS 30—(Continued).

2,999,299. WILD GOOSE HOLDING CO., INC., WILMINGTON, DE. SN 76-544,727. FILED P.R. 9-15-2003; AM. S.R. 7-25-2005.

HOT- TO-GO BOWLS

THE MARK CONSISTS OF STANDARD CHARACTERS WITHOUT CLAIM TO ANY PARTICULAR FONT, STYLE, SIZE, OR COLOR.

OWNER OF U.S. REG. NO. 2,291,684.

FOR PREPARED MEALS CONSISTING PRIMARILY OF PASTA, RICE AND MASHED POTATOES, BUT ALSO CONTAINING SOME MEAT, CHEESE, VEGETABLES AND SAUCE (U.S. CL. 46).

FIRST USE 6-2-2003; IN COMMERCE 6-2-2003.

2,999,389. CLARK, HARVEY P., BOYLSTON, MA. SN 78-491,634. FILED P.R. 9-29-2004; AM. S.R. 5-20-2005.

ANGUS STEAK SAUCE

THE MARK CONSISTS OF STANDARD CHARACTERS WITHOUT CLAIM TO ANY PARTICULAR FONT, STYLE, SIZE, OR COLOR.

NO CLAIM IS MADE TO THE EXCLUSIVE RIGHT TO USE "STEAK SAUCE", APART FROM THE MARK AS SHOWN.

FOR STEAK SAUCE (U.S. CL. 46).

FIRST USE 1-29-2005; IN COMMERCE 1-29-2005.

CLASS 32—LIGHT BEVERAGES

2,999,288. MORINDA, INC., PROVO, UT. SN 76-070,296. FILED P.R. 6-14-2000; AM. S.R. 5-9-2005.

TAHITIAN NONI

OWNER OF U.S. REG. NOS. 2,174,065, 2,353,364, AND OTHERS.

NO CLAIM IS MADE TO THE EXCLUSIVE RIGHT TO USE "NONI", APART FROM THE MARK AS SHOWN.

THE ENGLISH TRANSLATION OF NONI IS INDIAN MULBERRY.

FOR AERATED WATER, FRUIT JUICE, MINERAL WATER, AERATED FRUIT JUICE, SOFT DRINK COLAS, CONCENTRATED FRUIT JUICE, VEGETABLE JUICE, MIXED FRUIT JUICE, POWDERED FRUIT JUICE, SPORTS DRINK, SYRUPS FOR MAKING FRUIT DRINKS (U.S. CLS. 45, 46 AND 48).

FIRST USE 5-20-1996; IN COMMERCE 5-20-1996.

CLASS 35—(Continued).**SERVICE MARKS****CLASS 35—ADVERTISING AND BUSINESS**

2,999,289. GALLUP, INC., OMAHA, NE. SN 76-188,428. FILED P.R. 1-2-2001; AM. S.R. 8-16-2004.

DEVELOPER

FOR PROVIDING A PERSONAL ANALYSIS OF AN INDIVIDUAL'S INHERENT STRENGTHS OVER AN INTERACTIVE WEBSITE ON A GLOBAL COMPUTER NETWORK (U.S. CLS. 100, 101 AND 102).

FIRST USE 3-17-2000; IN COMMERCE 3-17-2000.

2,999,294. THE OGILVY GROUP, INC., NEW YORK, NY. SN 76-495,342. FILED P.R. 3-7-2003; AM. S.R. 6-20-2005.

360 DEGREE BRAND STEWARDSHIP

OWNER OF U.S. REG. NO. 2,303,886.

NO CLAIM IS MADE TO THE EXCLUSIVE RIGHT TO USE "BRAND", APART FROM THE MARK AS SHOWN.

FOR ADVERTISING AGENCY SERVICES, BUSINESS MARKETING CONSULTING AND MARKET RESEARCH, ALL IN THE FIELDS OF BRANDS AND BRAND BUILDING (U.S. CLS. 100, 101 AND 102).

FIRST USE 0-0-2000; IN COMMERCE 0-0-2000.

2,999,302. HEALTHTRUST PURCHASING GROUP, LP, BRENTWOOD, TN. SN 76-559,198. FILED P.R. 11-12-2003; AM. S.R. 6-29-2005.

SCRUBS

THE MARK CONSISTS OF STANDARD CHARACTERS WITHOUT CLAIM TO ANY PARTICULAR FONT, STYLE, SIZE, OR COLOR.

FOR ADMINISTRATION OF A DISCOUNT PURCHASING PROGRAM OVER A SECURE INTERNET WEBSITE THAT PROVIDES PROGRAM MEMBERS INFORMATION FEATURING THE NAMES OF CONTRACTED VENDORS, THE PRODUCTS AND SERVICES AVAILABLE FOR PURCHASE FROM THE CONTRACTED VENDORS, LISTINGS OF CONTRACTED GOODS AND SERVICES AND DISCOUNTED PRICING AVAILABLE ON CONTRACTED GOODS AND SERVICES; PROVIDING CUSTOMER SERVICE IN THE NATURE OF ASSISTING MEMBERS WITH THE DISCOUNT PURCHASING PROGRAM, NAMELY, DETERMINING THE IDENTITY OF PARTICIPATING VENDORS, CONTRACT LISTINGS, CONTRACT PRICING AND ADDRESSING FREQUENTLY ASKED QUESTIONS (U.S. CLS. 100, 101 AND 102).

FIRST USE 5-25-2001; IN COMMERCE 5-25-2001.

CLASS 35—(Continued).

2,999,314. EZ WEB SHOPPING, INC., PALOS HILLS, IL. SN 76-600,554. FILED P.R. 7-2-2004; AM. S.R. 3-21-2005.

MEDIEVAL WEAPON ART

THE MARK CONSISTS OF STANDARD CHARACTERS WITHOUT CLAIM TO ANY PARTICULAR FONT, STYLE, SIZE, OR COLOR.

FOR CATALOG AND COMPUTERIZED ON-LINE RETAIL STORE SERVICES IN THE FIELD OF REPLICAS OF HISTORICAL AND MYTHOLOGICAL WEAPONS, ARMOR, SHIELDS, CRESTS, CLOTHING, FOOTWEAR, BOTTLES, JEWELRY, BANNERS, PLAQUES, KEYS, DISPLAY STANDS AND HANGERS, CANES, AND HOME AND OFFICE DECOR ACCESSORIES, GLASSWARE, TIME PIECES, BOARD GAMES, STATUETTES, BANNERS, PLACQUES AND DISPOSABLE LIGHTER SLEEVES INCORPORATING SUCH REPLICAS (U.S. CLS. 100, 101 AND 102).

FIRST USE 10-15-2000; IN COMMERCE 10-15-2000.

2,999,316. WSOL, INC., PLANO, TX. SN 76-602,676. FILED P.R. 7-15-2004; AM. S.R. 7-27-2005.

**AGENTS
ON DEMAND**

THE MARK CONSISTS OF STANDARD CHARACTERS WITHOUT CLAIM TO ANY PARTICULAR FONT, STYLE, SIZE, OR COLOR.

NO CLAIM IS MADE TO THE EXCLUSIVE RIGHT TO USE "AGENTS", APART FROM THE MARK AS SHOWN.

FOR BUSINESS SERVICES, NAMELY PROVIDING CALL CENTER SERVICES AND INTERACTIVE VOICE RESPONSE SYSTEM SERVICES TO BUSINESSES (U.S. CLS. 100, 101 AND 102).

FIRST USE 1-1-2002; IN COMMERCE 8-1-2002.

2,999,320. MOORE, EVERTON G., QUEENS VILLAGE, NY. SN 76-608,848. FILED P.R. 8-26-2004; AM. S.R. 6-10-2005.

MARKETING YOUR HOME REALTY

THE MARK CONSISTS OF STANDARD CHARACTERS WITHOUT CLAIM TO ANY PARTICULAR FONT, STYLE, SIZE, OR COLOR.

NO CLAIM IS MADE TO THE EXCLUSIVE RIGHT TO USE "HOME REALTY", APART FROM THE MARK AS SHOWN.

FOR REAL ESTATE MARKETING SERVICES; NAMELY, ON-LINE SERVICES FEATURING TOURS OF RESIDENTIAL AND COMMERCIAL REAL ESTATE (U.S. CLS. 100, 101 AND 102).

FIRST USE 7-5-2004; IN COMMERCE 8-2-2004.

CLASS 35—(Continued).

2,999,324. CRISPINOS HOMEMADE ITALIAN ICES, INC., BAYSIDE, NY. SN 76-618,323. FILED P.R. 10-27-2004; AM. S.R. 7-5-2005.

NEW YORK'S FAMOUS ITALIAN ICES

THE MARK CONSISTS OF STANDARD CHARACTERS WITHOUT CLAIM TO ANY PARTICULAR FONT, STYLE, SIZE, OR COLOR.

FOR RETAIL ICE CREAM, ITALIAN ICE AND GELATO STORE SERVICES (U.S. CLS. 100, 101 AND 102).

FIRST USE 3-0-2000; IN COMMERCE 3-0-2000.

2,999,325. US INTERNATIONAL MEDIA, LLC, LOS ANGELES, CA. SN 76-620,031. FILED P.R. 11-10-2004; AM. S.R. 7-14-2005.

PROMOTION HOUSE

THE MARK CONSISTS OF STANDARD CHARACTERS WITHOUT CLAIM TO ANY PARTICULAR FONT, STYLE, SIZE, OR COLOR.

FOR ADVERTISING AND PROMOTION SERVICES AND RELATED CONSULTING, NAMELY, PROMOTING THE PRODUCTS AND SERVICES OF THIRD PARTIES THROUGH SPONSORING ARRANGEMENTS; AND DISTRIBUTION OF PRINTED MATERIALS AND PROMOTIONAL CONTESTS (U.S. CLS. 100, 101 AND 102).

FIRST USE 12-0-2004; IN COMMERCE 12-0-2004.

2,999,327. SAVANNAH COLLEGE OF ART AND DESIGN, SAVANNAH, GA. SN 76-625,100. FILED P.R. 12-20-2004; AM. S.R. 8-1-2005.

exhibitions

FOR ART GALLERY SERVICES; RETAIL SHOP SERVICES FEATURING ARTWORK, POSTERS, POSTCARDS, BOOKS AND COMIC BOOKS (U.S. CLS. 100, 101 AND 102).

FIRST USE 1-0-2004; IN COMMERCE 1-0-2004.

CLASS 35—(Continued).

2,999,356. MACERICH PARTNERSHIP, L.P., THE, SANTA MONICA, CA. SN 78-378,896. FILED P.R. 3-4-2004; AM. S.R. 7-12-2005.

**SHOPPING IN
AMERICA**

THE MARK CONSISTS OF STANDARD CHARACTERS WITHOUT CLAIM TO ANY PARTICULAR FONT, STYLE, SIZE, OR COLOR.

FOR PROVIDING ADVERTISING AND PUBLICITY SERVICES FOR RETAIL SHOPPING CENTERS AND MALLS; PROVIDING INFORMATION REGARDING DEMOGRAPHICS FOR THE RETAIL SHOPPING CENTER INDUSTRY; CONDUCTING MARKET RESEARCH RELATED TO THE RETAIL SHOPPING CENTER INDUSTRY; CREATING AND UPDATING ADVERTISING MATERIAL FOR RETAIL SHOPPING CENTERS AND MALLS; BUSINESS MARKETING SERVICES FOR RETAIL SHOPPING CENTERS AND MALLS; PROVIDING BUSINESS MARKETING INFORMATION IN THE FIELD OF CONSUMER SHOPPING DEMOGRAPHICS FOR RETAIL SHOPPING CENTERS AND MALLS; PROVIDING BUSINESS MARKETING INFORMATION, NAMELY DISSEMINATION OF MARKET RESEARCH RESULTS TO OTHERS; CONDUCTING BUSINESS RESEARCH IN THE FIELDS OF CONSUMERS AND RETAILERS; CONDUCTING BUSINESS AND MARKET RESEARCH SURVEYS CONCERNING CONSUMERS AND RETAILERS; CONDUCTING MARKETING SURVEYS; BUSINESS RESEARCH SERVICE, NAMELY PREPARING RESEARCH REPORTS FOR OTHERS IN CONNECTION WITH RETAIL SHOPPING CENTER AND MALL SERVICES (U.S. CLS. 100, 101 AND 102).
FIRST USE 12-1-2003; IN COMMERCE 12-1-2003.

CLASS 35—(Continued).

2,999,361. REPUBLICAN STATE LEADERSHIP COMMITTEE, WASHINGTON, DC. SN 78-411,467. FILED P.R. 4-30-2004; AM. S.R. 8-1-2005.

**REPUBLICAN
ATTORNEYS GENERAL
ASSOCIATION**

THE MARK CONSISTS OF STANDARD CHARACTERS WITHOUT CLAIM TO ANY PARTICULAR FONT, STYLE, SIZE, OR COLOR.

NO CLAIM IS MADE TO THE EXCLUSIVE RIGHT TO USE "ASSOCIATION", APART FROM THE MARK AS SHOWN.

FOR POLITICAL ACTION COMMITTEE SERVICES, NAMELY, PROMOTING THE INTERESTS OF REPUBLICAN CANDIDATES FOR STATE ELECTED OFFICE (U.S. CLS. 100, 101 AND 102).

FIRST USE 9-30-2002; IN COMMERCE 9-30-2002.

2,999,369. TWEEN 1, INC., RENO, NV. SN 78-421,997. FILED 5-20-2004.

BETWEEN \$1 AND FIVE

THE MARK CONSISTS OF STANDARD CHARACTERS WITHOUT CLAIM TO ANY PARTICULAR FONT, STYLE, SIZE, OR COLOR.

FOR RETAIL STORE SERVICES FEATURING JEWELRY, COSMETICS, TOYS, GAMES, CANDY AND NOVELTY ITEMS (U.S. CLS. 100, 101 AND 102).

FIRST USE 7-30-2004; IN COMMERCE 7-30-2004.

2,999,370. TWEEN 1, INC., RENO, NV. SN 78-421,999. FILED P.R. 5-20-2004; AM. S.R. 7-18-2005.



FOR RETAIL VARIETY STORE SERVICES (U.S. CLS. 100, 101 AND 102).

FIRST USE 7-30-2004; IN COMMERCE 7-30-2004.

CLASS 35—(Continued).

2,999,392. AMERICAN ASSOCIATION OF CLINICAL ENDOCRINOLOGISTS, INC., JACKSONVILLE, FL. SN 78-519,866. FILED P.R. 11-19-2004; AM. S.R. 7-12-2005.

AAACE ENDOCRINE CAREERS

THE MARK CONSISTS OF STANDARD CHARACTERS WITHOUT CLAIM TO ANY PARTICULAR FONT, STYLE, SIZE, OR COLOR.

OWNER OF U.S. REG. NO. 2,870,331.

NO CLAIM IS MADE TO THE EXCLUSIVE RIGHT TO USE "CAREERS", APART FROM THE MARK AS SHOWN.

FOR ONLINE RECRUITMENT AND CAREER CENTER FOR PHYSICIANS SPECIALIZING IN ENDOCRINOLOGY (U.S. CLS. 100, 101 AND 102).

FIRST USE 11-15-2004; IN COMMERCE 11-15-2004.

2,999,393. EQUINE EVENT, LLC, TIMONIUM, MD. SN 78-523,926. FILED P.R. 11-29-2004; AM. S.R. 7-15-2005.

EQUINE EVENT

THE MARK CONSISTS OF STANDARD CHARACTERS WITHOUT CLAIM TO ANY PARTICULAR FONT, STYLE, SIZE, OR COLOR.

NO CLAIM IS MADE TO THE EXCLUSIVE RIGHT TO USE "EQUINE", APART FROM THE MARK AS SHOWN.

FOR ARRANGING AND CONDUCTING TRADESHOW EXHIBITIONS IN THE FIELD OF HORSES (U.S. CLS. 100, 101 AND 102).

FIRST USE 12-31-2002; IN COMMERCE 1-31-2003.

CLASS 36—INSURANCE AND FINANCIAL

2,999,295. AMERICAN INVESTORS LIFE INSURANCE COMPANY, INC., TOPEKA, KS. SN 76-499,557. FILED P.R. 3-21-2003; AM. S.R. 7-18-2005.

BONUS SELECT

FOR LIFE INSURANCE, ANNUITY UNDERWRITING NAMELY, INDEXED ANNUITY LIFE INSURANCE (U.S. CLS. 100, 101 AND 102).

FIRST USE 5-0-2003; IN COMMERCE 5-0-2003.

CLASS 36—(Continued).

2,999,296. SELECTIVE INSURANCE GROUP, INC., BRANCHVILLE, NJ. SN 76-512,836. FILED P.R. 5-7-2003; AM. S.R. 7-13-2005.

FLOOD ONLINE

THE MARK CONSISTS OF STANDARD CHARACTERS WITHOUT CLAIM TO ANY PARTICULAR FONT, STYLE, SIZE, OR COLOR.

OWNER OF U.S. REG. NO. 2,695,533.

NO CLAIM IS MADE TO THE EXCLUSIVE RIGHT TO USE ONLINE, APART FROM THE MARK AS SHOWN.

FOR PROVIDING AN ONLINE DATABASE ENABLING USERS TO SECURE FLOOD ZONE DETERMINATIONS AND APPLY FOR AND ADMINISTER POLICIES OF FLOOD INSURANCE WRITTEN THROUGH THE NATIONAL FLOOD INSURANCE PROGRAM (U.S. CLS. 100, 101 AND 102).

FIRST USE 1-0-2001; IN COMMERCE 1-0-2001.

2,999,301. ADMAR ENTERPRISES, INC., MERRICK, NY. SN 76-556,193. FILED P.R. 10-16-2003; AM. S.R. 8-19-2004.

ENTERPRISE CHECK CASHFLOW OPTIMIZATION

NO CLAIM IS MADE TO THE EXCLUSIVE RIGHT TO USE ENTERPRISE CHECK CASH FLOW, APART FROM THE MARK AS SHOWN.

FOR CHECK PROCESSING AND CASHING SERVICES, NAMELY, IMMEDIATE CHECK TO CASH CONVERSION (U.S. CLS. 100, 101 AND 102).

FIRST USE 1-3-2003; IN COMMERCE 1-3-2003.

2,999,307. MASSACHUSETTS FINANCIAL SERVICES COMPANY, BOSTON, MA. SN 76-578,192. FILED P.R. 2-26-2004; AM. S.R. 7-25-2005.

DISCIPLINED DIVERSIFICATION

THE MARK CONSISTS OF STANDARD CHARACTERS WITHOUT CLAIM TO ANY PARTICULAR FONT, STYLE, SIZE, OR COLOR.

FOR FINANCIAL SERVICES; NAMELY, FINANCIAL INVESTMENT, FINANCIAL ADVICE, AND THE MANAGEMENT, ADMINISTRATION AND DISTRIBUTION OF MUTUAL FUNDS, VARIABLE ANNUITIES AND OTHER INVESTMENT FUNDS FOR INVESTMENT COMPANIES AND OTHERS (U.S. CLS. 100, 101 AND 102).

FIRST USE 2-0-2003; IN COMMERCE 2-0-2003.

CLASS 36—(Continued).

2,999,313. NEXT ESTATE COMMUNICATIONS, INC., MONROVIA, CA. SN 76-598,194. FILED P.R. 6-18-2004; AM. S.R. 7-18-2005.

UNIVERSAL RELOAD

THE MARK CONSISTS OF STANDARD CHARACTERS WITHOUT CLAIM TO ANY PARTICULAR FONT, STYLE, SIZE, OR COLOR.
FOR DEBIT AND CREDIT CARD SERVICES (U.S. CLS. 100, 101 AND 102).
FIRST USE 6-27-2005; IN COMMERCE 6-27-2005.

2,999,368. DELTA DENTAL PLAN OF MICHIGAN, INC., OKEMOS, MI. SN 78-421,767. FILED P.R. 5-19-2004; AM. S.R. 6-27-2005.

**BENEFIT MANAGER
TOOLKIT**

THE MARK CONSISTS OF STANDARD CHARACTERS WITHOUT CLAIM TO ANY PARTICULAR FONT, STYLE, SIZE, OR COLOR.
NO CLAIM IS MADE TO THE EXCLUSIVE RIGHT TO USE BENEFIT MANAGER, APART FROM THE MARK AS SHOWN.
FOR SERVICES RELATING TO GROUP DENTAL BENEFIT PROGRAMS, NAMELY THE PROCESSING OF DENTAL BENEFITS AND ELIGIBILITY MANAGEMENT ON THE INTERNET (U.S. CLS. 100, 101 AND 102).
FIRST USE 5-1-2003; IN COMMERCE 5-1-2003.

2,999,381. FIRST CASUALTY INSURANCE GROUP, INC., SOUTHERN PINES, NC. SN 78-444,699. FILED P.R. 7-1-2004; AM. S.R. 7-14-2005.

**ASSOCIATED
PETROLEUM INSURERS**

THE MARK CONSISTS OF STANDARD CHARACTERS WITHOUT CLAIM TO ANY PARTICULAR FONT, STYLE, SIZE, OR COLOR.
NO CLAIM IS MADE TO THE EXCLUSIVE RIGHT TO USE "PETROLEUM INSURERS", APART FROM THE MARK AS SHOWN.
FOR INSURANCE AGENCIES FOR THE OIL AND GAS INDUSTRY (U.S. CLS. 100, 101 AND 102).
FIRST USE 5-1-2004; IN COMMERCE 5-1-2004.

CLASS 38—COMMUNICATION**CLASS 38—(Continued).**

2,999,390. THE CHURCH ONLINE, LLC, EAST PITTSBURGH, PA. SN 78-500,710. FILED P.R. 10-15-2004; AM. S.R. 7-5-2005.

The Church Online

THE MARK CONSISTS OF STANDARD CHARACTERS WITHOUT CLAIM TO ANY PARTICULAR FONT, STYLE, SIZE, OR COLOR.
NO CLAIM IS MADE TO THE EXCLUSIVE RIGHT TO USE "ONLINE", APART FROM THE MARK AS SHOWN.
FOR ISP SERVICES, NAMELY, PROVIDING MULTIPLE USE ACCESS TO GLOBAL COMPUTER INFORMATION NETWORKS FOR THE TRANSFER AND DISSEMINATION OF A WIDE RANGE OF INFORMATION (U.S. CLS. 100, 101 AND 104).
FIRST USE 7-1-2004; IN COMMERCE 7-1-2004.

CLASS 39—TRANSPORTATION AND STORAGE

2,999,358. SUPERIOR AIR-GROUND AMBULANCE SERVICE, INC., ELMHURST, IL. SN 78-396,559. FILED P.R. 4-5-2004; AM. S.R. 7-11-2005.

**DALEY'S AMBULANCE
SERVICE**

THE MARK CONSISTS OF STANDARD CHARACTERS WITHOUT CLAIM TO ANY PARTICULAR FONT, STYLE, SIZE, OR COLOR.
NO CLAIM IS MADE TO THE EXCLUSIVE RIGHT TO USE AMBULANCE SERVICE, APART FROM THE MARK AS SHOWN.
FOR AMBULANCE TRANSPORT (U.S. CLS. 100 AND 105).
FIRST USE 12-15-2000; IN COMMERCE 12-15-2000.

CLASS 39—(Continued).

2,999,377. REALLEGAL, LLC, AURORA, CO. SN 78-428,928. FILED P.R. 6-2-2004; AM. S.R. 7-21-2005.

STENOBANK

THE MARK CONSISTS OF STANDARD CHARACTERS WITHOUT CLAIM TO ANY PARTICULAR FONT, STYLE, SIZE, OR COLOR.

FOR ELECTRONIC STORAGE OF STENOGRAPHIC NOTES, TRANSCRIPTS IN VARIOUS FORMS, DICTIONARIES, SPECIALIZED DICTIONARIES, AUDIO AND VIDEO FILES, AND METADATA IN THE FIELDS OF STENOGRAPHY, CAPTIONING, TRANSLATING, AND REPORTING (U.S. CLS. 100 AND 105).

FIRST USE 5-27-2004; IN COMMERCE 6-1-2004.

2,999,380. QUEST DAY OR NIGHT MOVES, INC., NEPTUNE BEACH, FL. SN 78-440,083. FILED P.R. 6-23-2004; AM. S.R. 7-13-2005.

"THE ANYTIME MOVERS"

THE MARK CONSISTS OF STANDARD CHARACTERS WITHOUT CLAIM TO ANY PARTICULAR FONT, STYLE, SIZE, OR COLOR.

NO CLAIM IS MADE TO THE EXCLUSIVE RIGHT TO USE "MOVERS", APART FROM THE MARK AS SHOWN.

FOR COMMERCIAL AND RESIDENTIAL MOVING SERVICES OF FURNITURE, HOUSEHOLD GOODS AND OFFICE GOODS FOR OTHERS; COMMERCIAL AND RESIDENTIAL MOVING VAN SERVICES; COMMERCIAL AND RESIDENTIAL MOVING VAN TRANSPORT SERVICES; COMMERCIAL AND RESIDENTIAL WAREHOUSING SERVICES, NAMELY, STORAGE, PICK-UP, DELIVERY, LOADING, UNLOADING AND PACKING FOR SHIPMENT OF FURNITURE, EQUIPMENT, SUPPLIES, ITEMS, HOUSEHOLD GOODS, OFFICE GOODS, AND FREIGHT FOR OTHERS; PACKAGING ARTICLES OF OTHERS FOR TRANSPORTATION; CARGO LOADING AND UNLOADING FOR OTHERS, NAMELY LOADING AND UNLOADING OF FURNITURE, EQUIPMENT, SUPPLIES, ITEMS AND FREIGHT FOR OTHERS (U.S. CLS. 100 AND 105).

FIRST USE 2-28-2003; IN COMMERCE 2-28-2003.

CLASS 39—(Continued).

2,999,391. GOCAR RENTALS, INC., SAN FRANCISCO, CA. SN 78-506,691. FILED 10-27-2004.

GPS-GUIDED TOURS!

THE MARK CONSISTS OF STANDARD CHARACTERS WITHOUT CLAIM TO ANY PARTICULAR FONT, STYLE, SIZE, OR COLOR.

NO CLAIM IS MADE TO THE EXCLUSIVE RIGHT TO USE "TOURS", APART FROM THE MARK AS SHOWN.

FOR RENTAL OF THREE-WHEELED, COMPUTERIZED VEHICLES ESPECIALLY DESIGNED FOR TOURISTS; ARRANGING EXCURSIONS FOR TOURISTS (U.S. CLS. 100 AND 105).

FIRST USE 4-10-2004; IN COMMERCE 4-10-2004.

CLASS 40—MATERIAL TREATMENT

2,999,297. ANZEN CORPORATION, DENVER, CO. SN 76-521,952. FILED P.R. 6-11-2003; AM. S.R. 7-7-2005.

GREEN OFFICE RECYCLING

NO CLAIM IS MADE TO THE EXCLUSIVE RIGHT TO USE "GREEN" AND "RECYCLING", APART FROM THE MARK AS SHOWN.

FOR RECYCLING OF USED INK-JET AND LASER CARTRIDGES AND CELL PHONES FROM SCHOOLS AND OTHER ORGANIZATIONS (U.S. CLS. 100, 103 AND 106).

FIRST USE 5-1-2002; IN COMMERCE 5-1-2002.

CLASS 41—EDUCATION AND ENTERTAINMENT

2,999,331. VARSITY SPIRIT CORPORATION, MEMPHIS, TN. SN 76-977,618. FILED P.R. 10-3-2003; AM. S.R. 6-10-2005.

THE CHEERLEADING WORLDS

OWNER OF U.S. REG. NO. 2,489,351. FOR CONDUCTING CHEERLEADING COMPETITIONS (U.S. CLS. 100, 101 AND 107).

FIRST USE 4-24-2004; IN COMMERCE 4-24-2004.

CLASS 41—(Continued).

2,999,332. AQUASCAPE DESIGNS, INC., BATAVIA, IL. SN 76-977,662. FILED P.R. 11-24-2003; AM. S.R. 12-29-2004.

PONDS FOR KIDS

THE MARK CONSISTS OF STANDARD CHARACTERS WITHOUT CLAIM TO ANY PARTICULAR FONT, STYLE, SIZE, OR COLOR.

FOR EDUCATIONAL SERVICES NAMELY CONDUCTING PROGRAMS IN THE FIELD OF AQUATIC ECOSYSTEMS AND DISTRIBUTING COURSE MATERIALS IN CONNECTION WITH SUCH PROGRAMS (U.S. CLS. 100, 101 AND 107).

FIRST USE 5-1-2000; IN COMMERCE 5-1-2000.

2,999,335. MCGUIRE-WIEN, MARY, NEW YORK, NY. SN 78-222,913. FILED 3-7-2003.

THE AMERICAN YOGINI

NO CLAIM IS MADE TO THE EXCLUSIVE RIGHT TO USE "YOGINI", APART FROM THE MARK AS SHOWN.

FOR ENTERTAINMENT SERVICES IN THE NATURE OF A TELEVISION SERIES ABOUT YOGA AS A LIFESTYLE (U.S. CLS. 100, 101 AND 107).

FIRST USE 12-31-2004; IN COMMERCE 12-31-2004.

2,999,343. BECKER GALLAGHER LEGAL PUBLISHING INCORPORATED, MAINEVILLE, OH. SN 78-300,939. FILED P.R. 9-16-2003; AM. S.R. 7-20-2005.

FEDERAL PRESS

FOR LEGAL PUBLISHING SERVICES, NAMELY, EDITING AND PRINTING OF LEGAL DOCUMENTS IN PREPARATION FOR FILING IN COURT (U.S. CLS. 100, 101 AND 107).

FIRST USE 7-18-2005; IN COMMERCE 7-18-2005.

CLASS 41—(Continued).

2,999,347. CEO CHALLENGE LLC, BOULDER, CO. SN 78-313,155. FILED P.R. 10-14-2003; AM. S.R. 10-18-2004.

CEO MARATHON CHALLENGE

THE MARK CONSISTS OF STANDARD CHARACTERS WITHOUT CLAIM TO ANY PARTICULAR FONT, STYLE, SIZE, OR COLOR.

NO CLAIM IS MADE TO THE EXCLUSIVE RIGHT TO USE "MARATHON CHALLENGE", APART FROM THE MARK AS SHOWN.

FOR ARRANGING AND CONDUCTING ATHLETIC COMPETITIONS IN THE NATURE OF A CHALLENGE PROGRAM DESIGNED FOR CEOS AND COMPANY PRESIDENTS WHO ARE COMPETING IN A MARATHON (U.S. CLS. 100, 101 AND 107).

FIRST USE 11-12-2003; IN COMMERCE 11-12-2003.

2,999,350. PROFILE MARKETING CONCEPTS, INC., PRINCETON, NJ. SN 78-323,856. FILED P.R. 11-6-2003; AM. S.R. 4-21-2005.

PRACTICE PROFILES

THE MARK CONSISTS OF STANDARD CHARACTERS WITHOUT CLAIM TO ANY PARTICULAR FONT, STYLE, SIZE, OR COLOR.

FOR EDUCATIONAL AND ENTERTAINMENT SERVICES, NAMELY THE PRODUCTION OF TELEVISION PROGRAMS FEATURING INDIVIDUAL PHYSICIANS AND OTHER PROFESSIONALS (U.S. CLS. 100, 101 AND 107).

FIRST USE 8-1-2004; IN COMMERCE 8-1-2004.

CLASS 41—(Continued).

2,999,355. INTEGRITY MEDIA, INC., MOBILE, AL. SN 78-371,124. FILED P.R. 2-20-2004; AM. S.R. 12-2-2004.

CLASS 41—(Continued).

2,999,375. DISCIPLESHIP NETWORK OF AMERICA, SIGNAL MOUNTAIN, TN. SN 78-427,699. FILED P.R. 6-1-2004; AM. S.R. 6-22-2005.

VERTICAL

**Discipleship
Network of
America**

THE MARK CONSISTS OF STANDARD CHARACTERS WITHOUT CLAIM TO ANY PARTICULAR FONT, STYLE, SIZE, OR COLOR.

OWNER OF U.S. REG. NOS. 2,322,532, 2,422,285, AND 2,628,438.

FOR LIVE PERFORMANCES BY A MUSICAL GROUP FEATURING RELIGIOUS AND INSPIRATIONAL MUSIC (U.S. CLS. 100, 101 AND 107).

FIRST USE 9-0-2002; IN COMMERCE 9-0-2002.

THE MARK CONSISTS OF STANDARD CHARACTERS WITHOUT CLAIM TO ANY PARTICULAR FONT, STYLE, SIZE, OR COLOR.

NO CLAIM IS MADE TO THE EXCLUSIVE RIGHT TO USE "NETWORK", APART FROM THE MARK AS SHOWN. FOR RELIGIOUS INSTRUCTION SERVICES (U.S. CLS. 100, 101 AND 107).

FIRST USE 0-0-2001; IN COMMERCE 7-15-2001.

2,999,362. EZENEKWE, FRANKLIN, LOS ANGELES, CA. SN 78-415,190. FILED P.R. 5-7-2004; AM. S.R. 6-11-2005.

2,999,386. BOARD OF REGENTS, THE UNIVERSITY OF TEXAS SYSTEM, AUSTIN, TX. SN 78-469,014. FILED P.R. 8-17-2004; AM. S.R. 6-21-2005.

**AMERICAN FILM
AWARDS**

BRAIN STORIES

THE MARK CONSISTS OF STANDARD CHARACTERS WITHOUT CLAIM TO ANY PARTICULAR FONT, STYLE, SIZE, OR COLOR.

NO CLAIM IS MADE TO THE EXCLUSIVE RIGHT TO USE "FILM AWARDS", APART FROM THE MARK AS SHOWN.

FOR ENTERTAINMENT SERVICES, NAMELY PROVIDING AWARDS TO DEMONSTRATE EXCELLENCE IN THE FIELD OF MOTION PICTURES (U.S. CLS. 100, 101 AND 107).

FIRST USE 4-30-2003; IN COMMERCE 4-30-2003.

THE MARK CONSISTS OF STANDARD CHARACTERS WITHOUT CLAIM TO ANY PARTICULAR FONT, STYLE, SIZE, OR COLOR.

FOR EDUCATION AND ENTERTAINMENT SERVICES, NAMELY, PRODUCTION OF EDUCATIONAL RADIO PROGRAMS (U.S. CLS. 100, 101 AND 107).

FIRST USE 1-28-2005; IN COMMERCE 1-28-2005.

CLASS 41—(Continued).

2,999,387. WLADIMYR, MAYARD, BROOKLYN, NY. SN 78-485,318. FILED P.R. 9-17-2004; AM. S.R. 5-16-2005.

BLACK HOLLYWOOD ENTERTAINMENT

THE MARK CONSISTS OF STANDARD CHARACTERS WITHOUT CLAIM TO ANY PARTICULAR FONT, STYLE, SIZE, OR COLOR.

NO CLAIM IS MADE TO THE EXCLUSIVE RIGHT TO USE "ENTERTAINMENT", APART FROM THE MARK AS SHOWN.

FOR ENTERTAINMENT SERVICES, NAMELY, PROVIDING PRERECORDED MUSIC, INFORMATION IN THE FIELD OF MUSIC, AND COMMENTARY AND ARTICLES ABOUT MUSIC, ALL ON-LINE VIA A GLOBAL COMPUTER NETWORK; ENTERTAINMENT SERVICES, NAMELY, CONDUCTING PARTIES FOR THE PURPOSE OF DATING AND SOCIAL INTRODUCTION FOR ADULTS; ENTERTAINMENT IN THE NATURE OF LIVE VISUAL AND AUDIO PERFORMANCES, NAMELY, MUSICAL BAND, ROCK GROUP, GYMNASTIC, DANCE, AND BALLET PERFORMANCES; COMPOSITION OF MUSIC FOR OTHERS (U.S. CLS. 100, 101 AND 107).

FIRST USE 9-29-2004; IN COMMERCE 9-29-2004.

CLASS 41—(Continued).

2,999,396. BROWN, JOSEPH P, OCALA, FL. SN 78-531,139. FILED P.R. 12-12-2004; AM. S.R. 6-29-2005.

eSecuritySchool

THE MARK CONSISTS OF STANDARD CHARACTERS WITHOUT CLAIM TO ANY PARTICULAR FONT, STYLE, SIZE, OR COLOR.

FOR EDUCATIONAL SERVICES, NAMELY, PROVIDING CLASSES AND LECTURES IN THE FIELD OF SECURITY (U.S. CLS. 100, 101 AND 107).

FIRST USE 11-3-2000; IN COMMERCE 11-3-2000.

2,999,388. DNC PARKS & RESORTS AT KSC, INC., BUFFALO, NY. SN 78-489,344. FILED P.R. 9-24-2004; AM. S.R. 7-8-2005.

CAMP KSC

THE MARK CONSISTS OF STANDARD CHARACTERS WITHOUT CLAIM TO ANY PARTICULAR FONT, STYLE, SIZE, OR COLOR.

NO CLAIM IS MADE TO THE EXCLUSIVE RIGHT TO USE "CAMP", APART FROM THE MARK AS SHOWN.

FOR ASTRONAUT AND SPACE-THEMED CAMPS; GUIDED TOURS OF A SPACE CENTER (U.S. CLS. 100, 101 AND 107).

FIRST USE 6-20-2001; IN COMMERCE 6-20-2001.

2,999,397. ASPIRING YOUNG ARTISTS, SPRING LAKE, NJ. SN 78-532,611. FILED P.R. 12-15-2004; AM. S.R. 7-26-2005.

THE CLAUDE MONET SERIES COLLECTION

THE MARK CONSISTS OF STANDARD CHARACTERS WITHOUT CLAIM TO ANY PARTICULAR FONT, STYLE, SIZE, OR COLOR.

THE NAME CLAUDE MONET DOES NOT IDENTIFY A LIVING INDIVIDUAL.

FOR EDUCATIONAL SERVICES, NAMELY, CONDUCTING CLASSES IN THE FIELD OF THE ART (U.S. CLS. 100, 101 AND 107).

FIRST USE 4-1-2004; IN COMMERCE 5-1-2004.

CLASS 41—(Continued).

2,999,399. AMERICAN ASSOCIATION OF CLINICAL ENDOCRINOLOGISTS, INC., JACKSONVILLE, FL. SN 78-550,600. FILED P.R. 1-20-2005; AM. S.R. 7-12-2005.

**AACE ADVANCES IN
DIAGNOSTIC &
INTERVENTIONAL
ENDOCRINE NECK
ULTRASOUND COURSE**

THE MARK CONSISTS OF STANDARD CHARACTERS WITHOUT CLAIM TO ANY PARTICULAR FONT, STYLE, SIZE, OR COLOR.

OWNER OF U.S. REG. NO. 2,870,331.
NO CLAIM IS MADE TO THE EXCLUSIVE RIGHT TO USE "COURSE", APART FROM THE MARK AS SHOWN.
FOR EDUCATIONAL COURSE ON ADVANCES IN DIAGNOSTIC AND INTERVENTIONAL ENDOCRINE NECK ULTRASOUNDS (U.S. CLS. 100, 101 AND 107).
FIRST USE 11-12-2004; IN COMMERCE 11-12-2004.

CLASS 42—SCIENTIFIC, COMPUTER AND LEGAL SERVICES

2,999,292. JENNINGS RESEARCH AND DEVELOPMENT CORPORATION, ST. JOSEPH, MI. SN 76-358,882. FILED P.R. 1-15-2002; AM. S.R. 7-12-2005.

MEDICAL NET SYSTEMS

NO CLAIM IS MADE TO THE EXCLUSIVE RIGHT TO USE "SYSTEMS", APART FROM THE MARK AS SHOWN.

FOR APPLICATION SERVICE PROVIDER FEATURING SOFTWARE IN THE FIELD OF PATIENT SCHEDULING, HISTORY, AND RECORDS MANAGEMENT (U.S. CLS. 100 AND 101).
FIRST USE 2-1-2003; IN COMMERCE 2-10-2003.

CLASS 42—(Continued).

2,999,306. BEELER GUEST OWENS ARCHITECTS, L. P., DALLAS, TX. SN 76-568,031. FILED P.R. 1-2-2004; AM. S.R. 11-15-2004.

DENSITY BY DESIGN

THE MARK CONSISTS OF STANDARD CHARACTERS WITHOUT CLAIM TO ANY PARTICULAR FONT, STYLE, SIZE, OR COLOR.

FOR ARCHITECTURAL DESIGN (U.S. CLS. 100 AND 101).
FIRST USE 3-1-2003; IN COMMERCE 3-1-2003.

2,999,317. RYAN & COMPANY, INC., DALLAS, TX. AND TECHNOLOGY SOLUTIONS COMPANY, CHICAGO, IL. SN 76-603,600. FILED P.R. 7-23-2004; AM. S.R. 8-2-2005.

**AN ADVANCED U.S. MULTI-STATE
USE TAX DECISION
AUTOMATION SOLUTION**

THE MARK CONSISTS OF STANDARD CHARACTERS WITHOUT CLAIM TO ANY PARTICULAR FONT, STYLE, SIZE, OR COLOR.

NO CLAIM IS MADE TO THE EXCLUSIVE RIGHT TO USE "U.S. MULTI-STATE USE TAX", APART FROM THE MARK AS SHOWN.

FOR CONSULTING SERVICES IN THE FIELD OF INTEGRATION AND IMPLEMENTATION OF TAX SOFTWARE FOR OTHERS (U.S. CLS. 100 AND 101).
FIRST USE 2-20-2004; IN COMMERCE 2-20-2004.

2,999,334. GENERAL MANAGEMENT SYSTEMS, INC., MIAMI BEACH, FL. SN 78-156,560. FILED P.R. 8-21-2002; AM. S.R. 3-3-2004.

ERATEMAKER

FOR PROVIDING TEMPORARY USE OF ONLINE NON-DOWNLOADABLE COMPUTER SOFTWARE FOR MAKING PROPERTY AND CASUALTY INSURANCE RATES (U.S. CLS. 100 AND 101).

FIRST USE 8-6-2002; IN COMMERCE 8-6-2002.

CLASS 42—(Continued).

2,999,357. CERTIFIED ABSTRACT AND SETTLEMENT, INC., EASTON, PA. SN 78-387,672. FILED P.R. 3-19-2004; AM. S.R. 3-25-2005.

**CERTIFIED ABSTRACT
AND SETTLEMENT**

THE MARK CONSISTS OF STANDARD CHARACTERS WITHOUT CLAIM TO ANY PARTICULAR FONT, STYLE, SIZE, OR COLOR.

NO CLAIM IS MADE TO THE EXCLUSIVE RIGHT TO USE "ABSTRACT AND SETTLEMENT", APART FROM THE MARK AS SHOWN.

FOR PROVIDING TITLE SERVICES TO ATTORNEYS, REAL ESTATE PROFESSIONALS, MORTGAGE COMPANIES AND BORROWERS, NAMELY, REVIEWING REAL ESTATE TITLE ABSTRACTS, PROVIDING SETTLEMENT DOCUMENTS, AND COORDINATING THE CLOSING FOR PURCHASING AND RE-FINANCING OF COMMERCIAL AND RESIDENTIAL REAL ESTATE (U.S. CLS. 100 AND 101).

FIRST USE 3-11-2005; IN COMMERCE 3-11-2005.

2,999,385. TRACKER SYSTEMS, INC., SILVERDALE, WA. SN 78-458,824. FILED P.R. 7-29-2004; AM. S.R. 6-29-2005.

TRACKER

THE MARK CONSISTS OF STANDARD CHARACTERS WITHOUT CLAIM TO ANY PARTICULAR FONT, STYLE, SIZE, OR COLOR.

FOR PROVIDING TEMPORARY USE OF ONLINE NON-DOWNLOADABLE SOFTWARE FOR USE IN RECORDING AND UPDATING THE STATUS OF MAINTENANCE AND MANAGEMENT TASKS PERFORMED ON RESIDENTIAL AND COMMERCIAL PROPERTY, BUILDINGS, BUSINESS PREMISES, AND EQUIPMENT (U.S. CLS. 100 AND 101).

FIRST USE 4-21-2004; IN COMMERCE 9-0-2004.

CLASS 43—HOTEL AND RESTAURANT SERVICES

CLASS 43—(Continued).

2,999,322. N Y INNS, NEW YORK, NY. SN 76-611,971. FILED P.R. 9-13-2004; AM. S.R. 7-18-2005.

N Y INNS

THE MARK CONSISTS OF STANDARD CHARACTERS WITHOUT CLAIM TO ANY PARTICULAR FONT, STYLE, SIZE, OR COLOR.

NO CLAIM IS MADE TO THE EXCLUSIVE RIGHT TO USE "INNS", APART FROM THE MARK AS SHOWN.

FOR HOTEL AND MOTEL SERVICES (U.S. CLS. 100 AND 101).

FIRST USE 3-3-2003; IN COMMERCE 3-3-2003.

CLASS 44—MEDICAL, BEAUTY AND AGRICULTURAL SERVICES

2,999,351. TRUESTAR HEALTH, INC., TORONTO M4V 2Y7, CANADA. SN 78-333,654. FILED P.R. 11-26-2003; AM. S.R. 12-19-2004.

FOOD TRAKKER

THE MARK CONSISTS OF STANDARD CHARACTERS WITHOUT CLAIM TO ANY PARTICULAR FONT, STYLE, SIZE, OR COLOR.

FOR PROVIDING INFORMATION IN THE FIELDS OF HEALTH AND NUTRITION VIA THE INTERNET (U.S. CLS. 100 AND 101).

FIRST USE 9-0-2003; IN COMMERCE 9-0-2003.

CLASS 45—PERSONAL SERVICES

2,999,311. INTERMODAL RISK MANAGEMENT, LLC, NEW YORK, NY. SN 76-590,584. FILED P.R. 5-5-2004; AM. S.R. 6-6-2005.

INTERMODAL RISK MANAGEMENT

THE MARK CONSISTS OF STANDARD CHARACTERS WITHOUT CLAIM TO ANY PARTICULAR FONT, STYLE, SIZE, OR COLOR.

FOR CONSULTATION SERVICES IN THE FIELD OF SECURITY FOR CARGO CARRIERS (U.S. CLS. 100 AND 101).

FIRST USE 3-0-2004; IN COMMERCE 3-0-2004.

CLASS 45—(Continued).

2,999,364. IDENTITY THEFT ASSISTANCE CORPORATION,
WASHINGTON, DC. SN 78-417,829. FILED P.R. 5-13-2004;
AM. S.R. 6-15-2005.

**IDENTITY THEFT
ASSISTANCE CENTER**

CLASS 45—(Continued).

THE MARK CONSISTS OF STANDARD CHARACTERS
WITHOUT CLAIM TO ANY PARTICULAR FONT, STYLE,
SIZE, OR COLOR.

FOR PERSONAL ASSISTANCE SERVICES TO VIC-
TIMS OF IDENTITY THEFT, NAMELY, PROVIDING
ADVICE, COUNSEL AND ASSISTANCE TO IDENTITY
THEFT VICTIMS TO REPAIR DAMAGE CAUSED BY
IDENTITY THEFT AND DAMAGE TO CREDIT HIS-
TORY, AND PROVIDING INFORMATION ABOUT IN-
CIDENTS OF IDENTITY THEFT TO CREDIT
REPORTING AGENCIES, CREDITORS, AND GOVERN-
MENT AND REGULATORY AGENCIES (U.S. CLS. 100
AND 101).

FIRST USE 3-23-2004; IN COMMERCE 4-21-2004.

* * * * *

PRIOR UNITED STATES CLASSIFICATION

APPLICATION IN ONE CLASS

CERTIFICATION MARKS

CLASS B—SERVICES

2,999,384. NATIONAL COUNCIL ON FAMILY RELATIONS (NCFR), MINNEAPOLIS, MN. SN 78-454,038. FILED P.R. 7-21-2004; AM. S.R. 7-18-2005.

NO CLAIM IS MADE TO THE EXCLUSIVE RIGHT TO USE "CERTIFIED" AND "EDUCATOR", APART FROM THE MARK AS SHOWN.

THE CERTIFICATION MARK, AS USED BY PERSONS AUTHORIZED BY THE CERTIFIER, CERTIFIES THAT THE GOODS AND/OR SERVICES PROVIDED HAVE MET THE CERTIFICATION QUALIFICATIONS AND REQUIREMENTS ESTABLISHED BY CERTIFER, INCLUDING EXPERIENCE, PORTFOLIO REVIEW, AND CONTINUING EDUCATION, THAT VALIDATE THE INDIVIDUAL'S QUALIFICATIONS, ADVANCED KNOWLEDGE AND PRACTICE.

FOR EDUCATORS IN THE FIELD OF FAMILY LIFE EDUCATION (U.S. CL. B).

FIRST USE 6-1-1984; IN COMMERCE 6-1-1984.

**Certified Family
Life Educator**

THE MARK CONSISTS OF STANDARD CHARACTERS WITHOUT CLAIM TO ANY PARTICULAR FONT, STYLE, SIZE, OR COLOR.

* * * * *

TRADEMARK REGISTRATIONS RENEWED

The designation "U.S. Cl." appearing in this section refers to the U.S. class in effect prior to Sep. 1, 1973 rather than the international class which applies to applications filed on or after that date. For adoption of international classification see notice in the OFFICIAL GAZETTE of Jun. 26, 1973 (911 O.G. TM 210).

50,137.	NICHOLSON. U.S. CL. 23. (INT. CL. 8). REG. 3-6-1906.	780,237.	BEE LINE AND DESIGN. U.S. CL. 23. (INT. CL. 7). REG. 11-17-1964.
102,001.	DOUBLEMINT. U.S. CL. 46. (INT. CL. 30). REG. 1-19-1915.	780,285.	CUBIC. U.S. CL. 26. (INT. CL. 9). REG. 11-17-1964.
103,050.	D AND DESIGN. U.S. CL. 21. (INT. CL. 9). REG. 3-16-1915.	780,286.	MISCELLANEOUS DESIGN. U.S. CL. 26. (INT. CL. 9). REG. 11-17-1964.
169,763.	COPLEY AND DESIGN. U.S. CL. 39. (INT. CLS. 10, 25 AND 26). REG. 7-3-1923.	781,704.	19TH HOLE. U.S. CL. 22. (INT. CL. 28). REG. 12-15-1964.
191,520.	HOMELAWN. U.S. CL. 1. (INT. CL. 31). REG. 11-11-1924.	781,848.	CRISCO. U.S. CL. 46. (INT. CL. 29). REG. 12-15-1964.
197,337.	CRACKER JACK AND DESIGN. U.S. CL. 46. (INT. CL. 30). REG. 4-14-1925.	782,064.	SOILTEST. U.S. CL. 26. (INT. CL. 9). REG. 12-22-1964.
212,919.	MAPLEINE. U.S. CL. 46. (INT. CL. 29). REG. 5-18-1926.	782,228.	FULTON 404. INT. CL. 1. (U.S. CL. 1). REG. 12-29-1964.
304,505.	TOP FLITE. U.S. CL. 46. (INT. CL. 30). REG. 7-11-1933.	783,179.	TOTE. U.S. CL. 23. (INT. CL. 7). REG. 1-12-1965.
321,166.	OXWELD. U.S. CL. 23. (INT. CL. 7). REG. 1-22-1935.	788,085.	TALWIN. U.S. CL. 18. (INT. CL. 5). REG. 4-13-1965.
324,359.	CALVET (STYLIZED). U.S. CL. 47. (INT. CL. 33). REG. 5-14-1935.	788,415.	COLUMBIA (STYLIZED). U.S. CL. 19. (INT. CL. 12). REG. 4-20-1965.
325,152.	CHIVAS REGAL. U.S. CL. 49. (INT. CL. 33). REG. 6-11-1935.	788,416.	COLUMBIA (STYLIZED). U.S. CL. 19. (INT. CL. 12). REG. 4-20-1965.
331,805.	LUBRIPLATE SUPER-LUBRICATION PREVENTS WEAR AND CORROSION AND DESIGN. U.S. CL. 15. (INT. CL. 4). REG. 1-21-1936.	788,893.	PLASTI-TAK (STYLIZED). U.S. CL. 5. (INT. CL. 1). REG. 5-4-1965.
408,208.	JITTERBUG. U.S. CL. 22. (INT. CL. 28). REG. 7-25-1944.	789,632.	MOTOR-ROTOR. U.S. CL. 23. (INT. CL. 7). REG. 5-18-1965.
416,944.	ONEX-SEAL (STYLIZED). U.S. CL. 16. (INT. CL. 2). REG. 10-9-1945.	789,649.	OMNI-FILL. U.S. CL. 23. (INT. CL. 7). REG. 5-18-1965.
592,928.	HAWS. U.S. CL. 13. (INT. CLS. 6, 7, 11, 17, 20 AND 21). REG. 7-27-1954.	790,292.	GRIP-O-MATIC. U.S. CL. 23. (INT. CL. 7). REG. 6-1-1965.
594,785.	TROPHY AND DESIGN. U.S. CL. 16. (INT. CL. 2). REG. 9-7-1954.	790,703.	THERMON AND DESIGN. U.S. CL. 34. (INT. CL. 11). REG. 6-8-1965.
600,245.	TAMAX. U.S. CL. 12. (INT. CL. 19). REG. 1-4-1955.	790,926.	AGIO. U.S. CL. 17. (INT. CL. 34). REG. 6-15-1965.
603,256.	KWIKSET (STYLIZED). U.S. CL. 23. (INT. CL. 8). REG. 3-15-1955.	791,061.	TILE TALK. U.S. CL. 38. (INT. CL. 16). REG. 6-15-1965.
606,714.	HON (STYLIZED). U.S. CL. 32. (INT. CL. 20). REG. 5-31-1955.	791,289.	MERRILL AND DESIGN. U.S. CL. 13. (INT. CL. 6). REG. 6-22-1965.
606,855.	BETTER PACK (STYLIZED). U.S. CL. 2. (INT. CL. 7). REG. 6-7-1955.	791,768.	SENTINEL. U.S. CL. 25. (INT. CL. 6). REG. 6-29-1965.
606,982.	"COMMERCIAL" (STYLIZED). U.S. CL. 23. (INT. CL. 7). REG. 6-7-1955.	792,027.	DOW AND DESIGN. U.S. CLS. 6 AND 15. (INT. CLS. 1 AND 4). REG. 7-6-1965.
607,158.	MICROCUT. U.S. CL. 4. (INT. CL. 3). REG. 6-14-1955.	792,780.	TIOXIDE. U.S. CL. 6. (INT. CL. 1). REG. 7-20-1965.
607,563.	IRON CLAD (STYLIZED). U.S. CL. 16. (INT. CL. 2). REG. 6-21-1955.	793,144.	FUTURE. U.S. CL. 4. (INT. CL. 3). REG. 7-27-1965.
608,117.	B.P.O.E. AND DESIGN. U.S. CL. 100. (INT. CL. 42). REG. 6-28-1955.	793,342.	POROPLATE. U.S. CL. 31. (INT. CL. 11). REG. 7-27-1965.
608,222.	MILEMAKER. U.S. CL. 15. (INT. CL. 4). REG. 7-5-1955.	793,546.	DOWICIL. U.S. CL. 6. (INT. CL. 1). REG. 8-3-1965.
608,233.	HIL-TEX (STYLIZED). U.S. CL. 16. (INT. CL. 2). REG. 7-5-1955.	794,008.	SAFE-FLEX. U.S. CL. 23. (INT. CL. 8). REG. 8-10-1965.
611,277.	PETROTHENE. U.S. CL. 6. (INT. CL. 1). REG. 8-30-1955.	794,980.	GODDARD'S LONG SHINE. U.S. CL. 4. (INT. CL. 3). REG. 8-31-1965.
618,439.	VERV (STYLIZED). U.S. CL. 6. (INT. CL. 1). REG. 1-3-1956.	795,152.	ABEX. U.S. CL. 23. (INT. CL. 7). REG. 8-31-1965.
622,036.	KEEP MOVING (STYLIZED). U.S. CL. 17. (INT. CL. 34). REG. 2-28-1956.	796,160.	M MERRILL AND DESIGN. U.S. CL. 106. (INT. CL. 38). REG. 9-14-1965.
627,123.	SPUD VALLEY (STYLIZED). U.S. CL. 46. (INT. CL. 31). REG. 5-15-1956.	796,887.	MISCELLANEOUS DESIGN. U.S. CL. 52. (INT. CL. 3). REG. 9-28-1965.
743,339.	THUMBELINA. U.S. CL. 22. (INT. CLS. 16, 18, 20, 22, 25 AND 28). REG. 1-8-1963.	797,948.	METHAZATE. U.S. CL. 6. (INT. CL. 1). REG. 10-26-1965.
753,402.	ZENITH. U.S. CL. 44. (INT. CL. 10). REG. 7-23-1963.	799,535.	K AND DESIGN. U.S. CL. 50 ONLY. (INT. CLS. 3, 6, 14, 16, 17, 19, 20, 21, 22, 24, 26, 27 AND 28). REG. 11-30-1965.
773,575.	YUMMIE. U.S. CL. 22. (INT. CLS. 16, 18, 20, 22, 25 AND 28). REG. 7-21-1964.	805,021.	KWELCOF. U.S. CL. 18. (INT. CL. 5). REG. 3-8-1966.
774,476.	SPEECO AND DESIGN. U.S. CL. 23. (INT. CL. 7). REG. 8-4-1964.	805,857.	MACDERMID. U.S. CL. 6. (INT. CL. 1). REG. 3-22-1966.
776,019.	SURE GRIP. U.S. CL. 9. (INT. CL. 13). REG. 9-1-1964.	808,375.	CORTENEMA. U.S. CL. 18. (INT. CL. 5). REG. 5-17-1966.
		995,488.	HOLLAND AMERICA CRUISES. U.S. CL. 105. (INT. CL. 39). REG. 10-8-1974.
		996,144.	KUSHION KRAFT. INT. CL. 16. (U.S. CL. 37). REG. 10-22-1974.
		997,633.	STERNGOLD (STYLIZED). U.S. CL. 44. (INT. CL. 5). REG. 11-5-1974.

- 999,442. GASIL. INT. CL. 1. (U.S. CL. 6). REG. 12-17-1974.
- 999,468. PYROGENT. INT. CL. 1. (U.S. CL. 6). REG. 12-17-1974.
- 999,594. KEMLON. INT. CL. 9. (U.S. CL. 21). REG. 12-17-1974.
- 1,003,076. THE SUPREMES. INT. CL. 41. (U.S. CL. 107). REG. 1-28-1975.
- 1,003,874. AIR TEX (STYLIZED). U.S. CL. 3. (INT. CL. 18). REG. 2-4-1975.
- 1,004,370. PEOPLE YOU CAN COUNT ON... (STYLIZED). INT. CL. 36. (U.S. CL. 102). REG. 2-11-1975.
- 1,006,302. KONI AND DESIGN. INT. CL. 12. (U.S. CLS. 19, 21, 23, 31, 35 AND 44). REG. 3-11-1975.
- 1,008,153. SAAB (STYLIZED). U.S. CL. 26. (INT. CL. 9). REG. 4-1-1975.
- 1,009,269. CONTROL'D. INT. CL. 42. (U.S. CL. 101). REG. 4-22-1975.
- 1,010,038. RELO. INT. CL. 35. (U.S. CL. 101). REG. 5-6-1975.
- 1,010,705. A AND DESIGN. U.S. CL. 23. (INT. CL. 8). REG. 5-13-1975.
- 1,010,815. BERTANI. U.S. CL. 47. (INT. CL. 33). REG. 5-13-1975.
- 1,011,094. KOKUSAI (STYLIZED). INT. CL. 30. (U.S. CL. 46). REG. 5-20-1975.
- 1,011,206. AMERICAN GIFT CORPORATION AG AND DESIGN. U.S. CL. 101. (INT. CL. 42). REG. 5-20-1975.
- 1,011,350. MISCELLANEOUS DESIGN. INT. CL. 5. (U.S. CL. 46). REG. 5-27-1975.
- 1,011,352. AB AND DESIGN. INT. CL. 5. (U.S. CL. 6). REG. 5-27-1975.
- 1,011,873. KREBS. U.S. CL. 23. (INT. CLS. 6, 7, 8, 9, 11, 12, 16, 21 AND 28). REG. 5-27-1975.
- 1,012,065. EAZALL (STYLIZED). INT. CL. 6. (U.S. CL. 14). REG. 6-3-1975.
- 1,012,069. FOLGER ADAM. INT. CL. 6. (U.S. CL. 13). REG. 6-3-1975.
- 1,012,758. LIQUID GOLD (STYLIZED). INT. CL. 3. (U.S. CL. 52). REG. 6-10-1975.
- 1,012,779. ORUDIS. INT. CL. 5. (U.S. CLS. 6, 18, 44, 46, 51 AND 52). REG. 6-10-1975.
- 1,012,922. KOLD-LOK. INT. CL. 16. (U.S. CL. 37). REG. 6-10-1975.
- 1,013,381. SAUDER AND DESIGN. INT. CL. 6. (U.S. CL. 2). REG. 6-17-1975.
- 1,013,560. PROFILE. INT. CL. 18. (U.S. CL. 3). REG. 6-17-1975.
- 1,013,710. SAUDER. INT. CL. 37. (U.S. CL. 103). REG. 6-17-1975.
- 1,013,711. SAUDER AND DESIGN. INT. CL. 37. (U.S. CLS. 100, 103 AND 106). REG. 6-17-1975.
- 1,013,845. BREMNER. U.S. CL. 46. (INT. CL. 30). REG. 6-17-1975.
- 1,014,318. BUTAMER. INT. CL. 42. (U.S. CL. 100). REG. 6-24-1975.
- 1,014,890. KETTLE AND DESIGN. INT. CL. 42. (U.S. CL. 100). REG. 7-1-1975.
- 1,015,381. VO-POP. INT. CL. 29. (U.S. CL. 46). REG. 7-8-1975.
- 1,015,659. GEMINI. INT. CL. 7. (U.S. CL. 4). REG. 7-15-1975.
- 1,015,682. CURTAIN-MINDER. INT. CL. 9. (U.S. CL. 26). REG. 7-15-1975.
- 1,016,220. LEFFINGWELL SINCE 1900 L AND DESIGN. INT. CLS. 1 AND 5. (U.S. CLS. 5, 6, 10, 18, 44, 46, 51 AND 52). REG. 7-22-1975.
- 1,016,576. RICHFIELD AND DESIGN. U.S. CL. 101. (INT. CL. 35). REG. 7-22-1975.
- 1,016,888. SUPER-FLEX. INT. CL. 17. (U.S. CL. 35). REG. 7-29-1975.
- 1,017,042. TWINKLES. INT. CL. 28. (U.S. CL. 50). REG. 7-29-1975.
- 1,017,233. TELCAR. INT. CL. 1. (U.S. CL. 1). REG. 8-5-1975.
- 1,019,369. THE COLLEGE FOR HUMAN SERVICES. INT. CL. 41 ONLY. (U.S. CL. 107). REG. 9-2-1975.
- 1,019,571. BIRELEY'S. INT. CL. 32. (U.S. CL. 45). REG. 9-2-1975.
- 1,021,451. SPIREX. INT. CL. 10. (U.S. CL. 44). REG. 9-30-1975.
- 1,022,307. NATIONAL DAIRY COUNCIL. U.S. CL. 38. (INT. CL. 16). REG. 10-7-1975.
- 1,022,628. ALCOA. INT. CL. 12. (U.S. CL. 19). REG. 10-14-1975.
- 1,023,377. HEARTY BURGUNDY (STYLIZED). INT. CL. 33. (U.S. CL. 47). REG. 10-21-1975.
- 1,023,474. HOLZ HER. U.S. CLS. 13 AND 23. (INT. CLS. 6 AND 7). REG. 10-21-1975.
- 1,026,026. STARRETT MI (STYLIZED). INT. CL. 4. (U.S. CL. 15). REG. 12-2-1975.
- 1,026,753. RAMAL. INT. CL. 19. (U.S. CL. 12). REG. 12-9-1975.
- 1,031,095. IN-N-OUT BURGER. U.S. CLS. 46 AND 100. (INT. CLS. 29, 30 AND 42). REG. 1-20-1976.
- 1,038,428. ISO-TROL. INT. CL. 9. (U.S. CL. 21). REG. 4-27-1976.
- 1,260,208. WW AND DESIGN. INT. CL. 36. (U.S. CL. 102). REG. 12-6-1983.
- 1,271,743. MOELLER. INT. CLS. 16 AND 25. (U.S. CLS. 37, 38 AND 39). REG. 3-27-1984.
- 1,293,688. MISCELLANEOUS DESIGN. INT. CL. 3 ONLY. (U.S. CLS. 1, 4, 6, 50, 51 AND 52). REG. 9-11-1984.
- 1,297,311. ENHANCE. INT. CL. 1. (U.S. CL. 6). REG. 9-25-1984.
- 1,300,324. MISCELLANEOUS DESIGN. INT. CL. 9. (U.S. CLS. 21, 23, 26, 36 AND 38). REG. 10-16-1984.
- 1,300,387. UGX. INT. CL. 9. (U.S. CLS. 21, 23, 26, 36 AND 38). REG. 10-16-1984.
- 1,300,388. SHX. INT. CL. 9. (U.S. CLS. 21, 23, 26, 36 AND 38). REG. 10-16-1984.
- 1,300,390. UMX. INT. CL. 9. (U.S. CLS. 21, 23, 26, 36 AND 38). REG. 10-16-1984.
- 1,301,081. MAGMA-QUARTZ. INT. CL. 1. (U.S. CLS. 1, 5, 6, 10, 26 AND 46). REG. 10-23-1984.
- 1,301,215. DURAVault. INT. CL. 6. (U.S. CLS. 2, 12, 13, 14, 23, 25 AND 50). REG. 10-23-1984.
- 1,301,240. SAMPLMET. INT. CL. 7. (U.S. CLS. 13, 19, 21, 23, 31, 34 AND 35). REG. 10-23-1984.
- 1,301,390. TEGLAR. INT. CL. 9. (U.S. CLS. 21, 23, 26, 36 AND 38). REG. 10-23-1984.
- 1,301,392. UHX II. INT. CL. 9. (U.S. CLS. 21, 23, 26, 36 AND 38). REG. 10-23-1984.
- 1,304,541. TAKE OFF. INT. CL. 3. (U.S. CLS. 29 AND 52). REG. 11-13-1984.
- 1,304,569. LOUIS FERAUD (STYLIZED). INT. CL. 3. (U.S. CL. 51). REG. 11-13-1984.
- 1,304,884. DURA-CUF. INT. CL. 10. (U.S. CL. 44). REG. 11-13-1984.
- 1,305,786. AS AND DESIGN. INT. CL. 9. (U.S. CL. 21). REG. 11-20-1984.
- 1,306,764. AMMONIL. INT. CL. 5. (U.S. CL. 18). REG. 11-27-1984.
- 1,306,941. DALI D'OR. INT. CL. 14. (U.S. CL. 28). REG. 11-27-1984.
- 1,306,972. IRON MAIDEN (STYLIZED). INT. CL. 16. (U.S. CLS. 37 AND 38). REG. 11-27-1984.
- 1,307,146. IRON MAIDEN (STYLIZED). INT. CL. 25. (U.S. CLS. 39 AND 40). REG. 11-27-1984.
- 1,308,370. IRON MAIDEN (STYLIZED). INT. CL. 41. (U.S. CL. 107). REG. 12-4-1984.
- 1,309,328. VALUE GUARD. INT. CL. 36. (U.S. CL. 102). REG. 12-11-1984.
- 1,309,570. BUTCHER'S AND DESIGN. INT. CL. 3. (U.S. CLS. 4, 6 AND 52). REG. 12-18-1984.
- 1,309,805. EPTAWATT. INT. CL. 9. (U.S. CLS. 21 AND 26). REG. 12-18-1984.
- 1,311,070. JAM-STOPPER. INT. CL. 16. (U.S. CL. 23). REG. 12-25-1984.
- 1,311,593. THE EXPLORERS CLUB. INT. CL. 42. (U.S. CL. 100). REG. 12-25-1984.
- 1,312,071. MINI FLEX-VENT. INT. CL. 7. (U.S. CL. 35). REG. 1-1-1985.
- 1,312,946. PATRICE. INT. CL. 3. (U.S. CLS. 51 AND 52). REG. 1-8-1985.
- 1,314,352. JETFLOW. INT. CL. 7. (U.S. CL. 23). REG. 1-15-1985.
- 1,314,585. FARM FORUM. INT. CL. 16. (U.S. CL. 38). REG. 1-15-1985.
- 1,315,193. A.T.R. (STYLIZED). U.S. CL. B. REG. 1-15-1985.
- 1,316,287. TED'S CHARCOAL BROILED HOT DOGS. INT. CL. 42. (U.S. CL. 100). REG. 1-22-1985.
- 1,316,576. EAGLE IRON. INT. CLS. 7 AND 12. (U.S. CLS. 19 AND 21). REG. 1-29-1985.
- 1,317,204. MINUTE MAID. INT. CL. 30. (U.S. CL. 46). REG. 1-29-1985.
- 1,317,412. TED'S CHARCOAL BROILED HOT DOGS AND DESIGN. INT. CL. 42. (U.S. CL. 100). REG. 1-29-1985.
- 1,318,110. VANS AND DESIGN. INT. CL. 31 ONLY. (U.S. CL. 1). REG. 2-5-1985.
- 1,319,330. MAD (STYLIZED). INT. CL. 16. (U.S. CL. 38). REG. 2-12-1985.

- 1,319,439. DYNA WEB. INT. CL. 24. (U.S. CL. 42). REG. 2-12-1985.
- 1,319,653. BETTER CHEDDARS. INT. CL. 30. (U.S. CL. 46). REG. 2-12-1985.
- 1,320,115. LUSTR. INT. CL. 1. (U.S. CLS. 1 AND 6). REG. 2-12-1985.
- 1,321,370. NETTIE'S. INT. CL. 42. (U.S. CLS. 100 AND 103). REG. 2-19-1985.
- 1,322,300. U.S. DIVERS. INT. CL. 28. (U.S. CL. 22). REG. 2-26-1985.
- 1,322,380. SCHWARTZ'S (STYLIZED). INT. CL. 29. (U.S. CL. 46). REG. 2-26-1985.
- 1,323,055. MISCELLANEOUS DESIGN. INT. CL. 10. (U.S. CL. 44). REG. 3-5-1985.
- 1,323,978. NOVAGLOSS. INT. CL. 2. (U.S. CLS. 6 AND 11). REG. 3-12-1985.
- 1,323,979. NOVAVIT. INT. CL. 2. (U.S. CLS. 6 AND 11). REG. 3-12-1985.
- 1,324,345. UHD. INT. CL. 12. (U.S. CLS. 19 AND 31). REG. 3-12-1985.
- 1,325,079. PRONTO. INT. CL. 42. (U.S. CL. 101). REG. 3-12-1985.
- 1,325,227. PRO. INT. CL. 1. (U.S. CLS. 6, 14 AND 16). REG. 3-19-1985.
- 1,325,261. ARMOLOY. INT. CLS. 1 AND 40. (U.S. CLS. 6 AND 106). REG. 3-19-1985.
- 1,325,280. NOVALUX. INT. CL. 2. (U.S. CLS. 6, 11 AND 16). REG. 3-19-1985.
- 1,325,426. NITTANY LIONS. INT. CLS. 6, 12, 14, 16, 20, 21, 24, 25 AND 28 ONLY. (U.S. CLS. 2, 12, 13, 14, 19, 22, 23, 25, 27, 29, 30, 32, 33, 35, 38, 39, 40, 42 AND 50). REG. 3-19-1985.
- 1,326,716. RHEOTHERM. INT. CL. 9. (U.S. CL. 26). REG. 3-26-1985.
- 1,327,833. RUG SHIELD. INT. CL. 3. (U.S. CL. 52). REG. 4-2-1985.
- 1,327,966. CONGESTAC. INT. CL. 5. (U.S. CL. 18). REG. 4-2-1985.
- 1,328,040. TORQUE. INT. CL. 7. (U.S. CL. 23). REG. 4-2-1985.
- 1,328,167. PERMA POWER. INT. CL. 9. (U.S. CL. 21). REG. 4-2-1985.
- 1,328,208. *MEGA AND DESIGN. INT. CL. 9. (U.S. CL. 26). REG. 4-2-1985.
- 1,328,584. THE COLOR CUBICLE. INT. CL. 23. (U.S. CL. 43). REG. 4-2-1985.
- 1,328,781. BLUE BELL SUPREME ICE CREAM BANANA PUDDING HALF GALLON AND DESIGN. INT. CL. 30. (U.S. CL. 46). REG. 4-2-1985.
- 1,329,567. PLUS BUSINESS. INT. CL. 16. (U.S. CL. 38). REG. 4-9-1985.
- 1,329,957. FAUSTINO I. INT. CL. 33. (U.S. CL. 47). REG. 4-9-1985.
- 1,330,569. H.G. LONG. INT. CL. 8. (U.S. CL. 23). REG. 4-16-1985.
- 1,330,583. SHAZAM!. INT. CL. 9. (U.S. CLS. 26 AND 38). REG. 4-16-1985.
- 1,330,800. IZABEL LAM. INT. CL. 14 ONLY. (U.S. CL. 28). REG. 4-16-1985.
- 1,331,479. SPI SUPPLIES (STYLIZED). INT. CL. 1. (U.S. CLS. 5 AND 6). REG. 4-23-1985.
- 1,331,523. RIGIDSEAL. INT. CL. 2. (U.S. CL. 16). REG. 4-23-1985.
- 1,332,083. OB/GYN CLINICAL ALERT. INT. CL. 16. (U.S. CL. 38). REG. 4-23-1985.
- 1,333,469. TIO PEPE'S. INT. CL. 30. (U.S. CL. 46). REG. 4-30-1985.
- 1,333,632. HITCH WORLD AND DESIGN. INT. CLS. 37 AND 42. (U.S. CLS. 101 AND 103). REG. 4-30-1985.
- 1,333,890. MAKROBLEND. INT. CL. 1 ONLY. (U.S. CL. 6). REG. 5-7-1985.
- 1,334,066. TSP. INT. CL. 9 ONLY. (U.S. CL. 38). REG. 5-7-1985.
- 1,334,305. NEOCHROME. INT. CL. 18. (U.S. CL. 1). REG. 5-7-1985.
- 1,334,563. LITTLE CHARLIES. INT. CL. 30. (U.S. CL. 46). REG. 5-7-1985.
- 1,334,619. DIET SPRITE. INT. CL. 32. (U.S. CL. 45). REG. 5-7-1985.
- 1,334,825. CIGNA. INT. CL. 42. (U.S. CL. 100). REG. 5-7-1985.
- 1,334,957. SILCAT. INT. CL. 1. (U.S. CL. 6). REG. 5-14-1985.
- 1,335,494. SEAL & VIEW. INT. CL. 16. (U.S. CL. 37). REG. 5-14-1985.
- 1,335,566. MISCELLANEOUS DESIGN. INT. CL. 20. (U.S. CL. 32). REG. 5-14-1985.
- 1,335,567. GUNLOCKE. INT. CL. 20. (U.S. CL. 32). REG. 5-14-1985.
- 1,335,571. ZIRLON. INT. CL. 20. (U.S. CL. 13). REG. 5-14-1985.
- 1,335,724. FARMSTEAD. INT. CL. 29. (U.S. CL. 46). REG. 5-14-1985.
- 1,335,806. CRYSTAL-FRESH. INT. CL. 32. (U.S. CL. 45). REG. 5-14-1985.
- 1,336,171. PACIFICO AND DESIGN. INT. CL. 32. (U.S. CL. 48). REG. 5-14-1985.
- 1,336,212. BLUE PEARL. INT. CL. 3. (U.S. CL. 51). REG. 5-21-1985.
- 1,336,301. REGINA STEEMER. INT. CL. 7. (U.S. CL. 23). REG. 5-21-1985.
- 1,336,302. REGINA. INT. CL. 7. (U.S. CL. 23). REG. 5-21-1985.
- 1,336,328. IVAN. INT. CL. 8. (U.S. CL. 23). REG. 5-21-1985.
- 1,336,991. BLUE HERON. INT. CL. 29. (U.S. CL. 46). REG. 5-21-1985.
- 1,337,397. THE FELDENKRAIS GUILD. U.S. CL. 200. REG. 5-21-1985.
- 1,337,450. RADICE. INT. CL. 34. (U.S. CL. 8). REG. 5-21-1985.
- 1,337,757. E (STYLIZED). INT. CL. 11. (U.S. CLS. 13 AND 31). REG. 5-28-1985.
- 1,337,904. INFORMATION WEEK (STYLIZED). INT. CL. 16. (U.S. CL. 38). REG. 5-28-1985.
- 1,338,396. M THE MALLORY GROUP AND DESIGN. INT. CL. 39. (U.S. CL. 105). REG. 5-28-1985.
- 1,338,666. VINYL ULTRA GLOSS. INT. CL. 3. (U.S. CL. 52). REG. 6-4-1985.
- 1,338,732. CANCELYZER. INT. CL. 5. (U.S. CL. 6). REG. 6-4-1985.
- 1,339,026. INNOVA. INT. CL. 9. (U.S. CL. 26). REG. 6-4-1985.
- 1,339,045. MINIWIND. INT. CL. 9. (U.S. CLS. 21 AND 38). REG. 6-4-1985.
- 1,339,123. TALINA. INT. CL. 12. (U.S. CL. 19). REG. 6-4-1985.
- 1,339,397. GET THE SENSATION. INT. CL. 30. (U.S. CL. 46). REG. 6-4-1985.
- 1,339,536. D AND DESIGN. INT. CL. 37. (U.S. CL. 103). REG. 6-4-1985.
- 1,339,767. SHAKEY'S PIZZA RESTAURANT AND DESIGN. INT. CL. 42. (U.S. CLS. 100 AND 105). REG. 6-4-1985.
- 1,340,047. DARYL HALL JOHN OATES. INT. CL. 25 ONLY. (U.S. CL. 39). REG. 6-11-1985.
- 1,340,065. ROBOT. INT. CLS. 7 AND 11. (U.S. CLS. 23 AND 31). REG. 6-11-1985.
- 1,340,098. MW AND DESIGN. INT. CL. 7. (U.S. CL. 23). REG. 6-11-1985.
- 1,340,158. MISCELLANEOUS DESIGN. INT. CL. 9. (U.S. CL. 26). REG. 6-11-1985.
- 1,340,362. ULTIMAX. INT. CL. 9. (U.S. CLS. 21 AND 26). REG. 6-11-1985.
- 1,340,430. V-4. INT. CL. 9. (U.S. CL. 23). REG. 6-11-1985.
- 1,340,532. TIOGA AIR HEATERS AND DESIGN. INT. CL. 11. (U.S. CL. 34). REG. 6-11-1985.
- 1,340,537. FRICTION GRIP. INT. CL. 12. (U.S. CLS. 19 AND 35). REG. 6-11-1985.
- 1,340,706. SALVATORE FERRAGAMO (STYLIZED). INT. CLS. 18, 24, 26 AND 34 ONLY. (U.S. CLS. 3, 8, 40 AND 42). REG. 6-11-1985.
- 1,340,805. LUSTREBRUSH. INT. CL. 21. (U.S. CL. 29). REG. 6-11-1985.
- 1,340,859. SALVATORE J CESARANI (STYLIZED). INT. CL. 25. (U.S. CL. 39). REG. 6-11-1985.
- 1,341,107. TROPICAL. INT. CL. 29. (U.S. CL. 46). REG. 6-11-1985.
- 1,341,246. MISCELLANEOUS DESIGN. INT. CL. 30. (U.S. CL. 46). REG. 6-11-1985.
- 1,341,254. URBAN'S SPECIAL. INT. CL. 30. (U.S. CL. 46). REG. 6-11-1985.
- 1,341,367. RIDGE. INT. CL. 33. (U.S. CL. 47). REG. 6-11-1985.
- 1,341,391. DIAL-A-TRUCK AND DESIGN. INT. CL. 35. (U.S. CL. 101). REG. 6-11-1985.
- 1,341,463. THE FACILITATOR. INT. CL. 36. (U.S. CL. 102). REG. 6-11-1985.
- 1,341,531. CPCU AND DESIGN. INT. CL. 41. (U.S. CL. 107). REG. 6-11-1985.
- 1,341,534. RPI AND DESIGN. INT. CL. 41. (U.S. CL. 107). REG. 6-11-1985.
- 1,341,610. BREW THRU. INT. CL. 42. (U.S. CL. 101). REG. 6-11-1985.

- 1,341,658. THE MONKEY BAR A.BAR.WITH.A.TWIST AND DESIGN. INT. CL. 42. (U.S. CL. 100). REG. 6-11-1985.
- 1,341,732. HAPPY STORES. INT. CL. 42. (U.S. CL. 101). REG. 6-11-1985.
- 1,341,783. RISK DISPERSING PORTFOLIO. INT. CL. 36. (U.S. CL. 102). REG. 6-11-1985.
- 1,342,019. GYPLOK. INT. CL. 6. (U.S. CL. 14). REG. 6-18-1985.
- 1,342,172. MISCELLANEOUS DESIGN. INT. CL. 9. (U.S. CL. 26). REG. 6-18-1985.
- 1,342,725. SERIES 2000. INT. CL. 21. (U.S. CL. 2). REG. 6-18-1985.
- 1,342,888. DYNAMO. INT. CL. 28. (U.S. CLS. 22 AND 23). REG. 6-18-1985.
- 1,342,924. BD AND DESIGN. INT. CL. 29. (U.S. CL. 46). REG. 6-18-1985.
- 1,342,962. RICH N' PURE. INT. CL. 29. (U.S. CL. 46). REG. 6-18-1985.
- 1,342,967. SORRELL RIDGE AND DESIGN. INT. CL. 29. (U.S. CL. 46). REG. 6-18-1985.
- 1,343,034. MISCELLANEOUS DESIGN. INT. CL. 30. (U.S. CL. 46). REG. 6-18-1985.
- 1,343,371. FIVE STAR PARKING. INT. CL. 39. (U.S. CL. 105). REG. 6-18-1985.
- 1,343,408. AMERICAN INTERCULTURAL STUDENT EXCHANGE. INT. CL. 41. (U.S. CLS. 100 AND 107). REG. 6-18-1985.
- 1,343,712. ULTRA GLOSS. INT. CL. 3. (U.S. CL. 52). REG. 6-25-1985.
- 1,343,749. ONE MATCH (STYLIZED). INT. CL. 4. (U.S. CL. 15). REG. 6-25-1985.
- 1,343,856. S (STYLIZED). INT. CL. 9. (U.S. CL. 26). REG. 6-25-1985.
- 1,344,013. SUPER 8. INT. CL. 9. (U.S. CL. 23). REG. 6-25-1985.
- 1,344,333. MISCELLANEOUS DESIGN. INT. CL. 16. (U.S. CL. 38). REG. 6-25-1985.
- 1,344,379. THE EXPLORERS JOURNAL. INT. CL. 16. (U.S. CL. 38). REG. 6-25-1985.
- 1,344,538. HIGH SIERRA. INT. CL. 25. (U.S. CL. 39). REG. 6-25-1985.
- 1,344,585. EXPECT THE UNEXPECTED. INT. CL. 25. (U.S. CL. 39). REG. 6-25-1985.
- 1,344,829. GOLDEN FLAKE AND DESIGN. INT. CLS. 29 AND 30. (U.S. CL. 46). REG. 6-25-1985.
- 1,344,904. BIG SHOT AND DESIGN. INT. CL. 32. (U.S. CL. 45). REG. 6-25-1985.
- 1,344,905. LEFFE AND DESIGN. INT. CL. 32. (U.S. CL. 48). REG. 6-25-1985.
- 1,345,116. 5 (STYLIZED). INT. CL. 39. (U.S. CL. 105). REG. 6-25-1985.
- 1,345,606. QUBE. INT. CLS. 7, 9 AND 11. (U.S. CLS. 23, 26 AND 31). REG. 7-2-1985.
- 1,345,703. KJELTEC. INT. CL. 9. (U.S. CL. 26). REG. 7-2-1985.
- 1,345,793. NORTH AND DESIGN. INT. CL. 9. (U.S. CLS. 21, 26, 39 AND 44). REG. 7-2-1985.
- 1,345,856. INFIT. INT. CL. 9. (U.S. CLS. 21, 23, 26, 36 AND 38). REG. 7-2-1985.
- 1,345,857. XEROLYT. INT. CL. 9. (U.S. CLS. 21 AND 26). REG. 7-2-1985.
- 1,346,625. LA PALOMA. INT. CL. 30. (U.S. CL. 46). REG. 7-2-1985.
- 1,346,888. MISCELLANEOUS DESIGN. INT. CL. 42. (U.S. CL. 100). REG. 7-2-1985.
- 1,347,238. HEPKO. INT. CL. 7. (U.S. CL. 23). REG. 7-9-1985.
- 1,347,559. HOT SHOT. INT. CL. 11. (U.S. CL. 21). REG. 7-9-1985.
- 1,347,892. STEP-LOCK. INT. CL. 19. (U.S. CL. 12). REG. 7-9-1985.
- 1,348,464. PEGASYSTEMS. INT. CL. 35. (U.S. CL. 101). REG. 7-9-1985.
- 1,348,651. ARTHUR MURRAY AND DESIGN. INT. CL. 41. (U.S. CL. 107). REG. 7-9-1985.
- 1,349,123. CONTIPLEX. INT. CL. 10. (U.S. CL. 44). REG. 7-16-1985.
- 1,349,320. CHART-BUSTERS. INT. CL. 16. (U.S. CL. 38). REG. 7-16-1985.
- 1,349,999. PUMA. INT. CL. 41. (U.S. CL. 107). REG. 7-16-1985.
- 1,350,002. WORLD CHAMPIONSHIP SLED DOG RACE. INT. CL. 41. (U.S. CL. 107). REG. 7-16-1985.
- 1,350,154. ZIRPROP. INT. CLS. 1, 19 AND 42. (U.S. CLS. 1, 6, 12, 100 AND 103). REG. 7-23-1985.
- 1,350,233. SYNCOPEN. INT. CL. 4. (U.S. CLS. 1, 6 AND 15). REG. 7-23-1985.
- 1,350,239. OMNITASK. INT. CL. 4. (U.S. CL. 15). REG. 7-23-1985.
- 1,350,283. KITZ (STYLIZED). INT. CLS. 6 AND 9. (U.S. CLS. 13, 14, 21 AND 23). REG. 7-23-1985.
- 1,352,062. FIRST INDIANA. INT. CL. 36. (U.S. CL. 102). REG. 7-30-1985.
- 1,352,545. MISCELLANEOUS DESIGN. INT. CL. 9. (U.S. CL. 21). REG. 8-6-1985.
- 1,352,648. ENCORE. INT. CL. 10. (U.S. CL. 44). REG. 8-6-1985.
- 1,352,651. PERCUFIX. INT. CL. 10. (U.S. CL. 44). REG. 8-6-1985.
- 1,352,694. FORT. INT. CL. 12. (U.S. CL. 19). REG. 8-6-1985.
- 1,353,486. AQUA SEAL. INT. CL. 1. (U.S. CL. 6). REG. 8-13-1985.
- 1,354,566. CUVEE WILLIAM DEUTZ (STYLIZED). INT. CL. 33. (U.S. CL. 47). REG. 8-13-1985.
- 1,354,870. DRI-MATIC. INT. CLS. 3 AND 9. (U.S. CLS. 21, 23, 26, 36, 38 AND 52). REG. 8-20-1985.
- 1,354,934. STINGER. INT. CL. 5. (U.S. CL. 6). REG. 8-20-1985.
- 1,354,939. TROPHY. INT. CL. 5. (U.S. CL. 6). REG. 8-20-1985.
- 1,355,378. ALMAG. INT. CL. 19. (U.S. CL. 12). REG. 8-20-1985.
- 1,355,716. BOLLINGER GRANDE ANNEE. INT. CL. 33. (U.S. CL. 47). REG. 8-20-1985.
- 1,355,873. OCC (STYLIZED). U.S. CLS. 200 AND 107. (INT. CL. 41). REG. 8-20-1985.
- 1,356,678. JACK-POST. INT. CL. 20. (U.S. CL. 32). REG. 8-27-1985.
- 1,357,141. HONOR SYSTEM. INT. CL. 36. (U.S. CL. 102). REG. 8-27-1985.
- 1,357,538. JASON. INT. CL. 3. (U.S. CLS. 51 AND 52). REG. 9-3-1985.
- 1,357,591. MAXI-TECH. INT. CL. 5. (U.S. CL. 18). REG. 9-3-1985.
- 1,357,902. FORT AND DESIGN. INT. CL. 12. (U.S. CL. 19). REG. 9-3-1985.
- 1,357,947. I AM AND DESIGN. INT. CL. 14. (U.S. CL. 28). REG. 9-3-1985.
- 1,357,949. AIM AND DESIGN. INT. CL. 14. (U.S. CL. 28). REG. 9-3-1985.
- 1,358,198. ROD SAVER AND DESIGN. INT. CL. 28. (U.S. CL. 22). REG. 9-3-1985.
- 1,358,359. ZACA MESA. INT. CL. 33. (U.S. CL. 47). REG. 9-3-1985.
- 1,358,478. CAMI. INT. CL. 41. (U.S. CLS. 101 AND 107). REG. 9-3-1985.
- 1,358,846. R AND DESIGN. INT. CL. 6. (U.S. CL. 13). REG. 9-10-1985.
- 1,360,063. CITRACAL. INT. CL. 5. (U.S. CL. 18). REG. 9-17-1985.
- 1,361,347. 30 DAY NUTRITION. INT. CL. 5. (U.S. CL. 18). REG. 9-24-1985.
- 1,364,473. AMERON (STYLIZED). INT. CL. 17. (U.S. CLS. 1, 12 AND 35). REG. 10-8-1985.
- 1,364,782. VALLEY FARMS AND DESIGN. INT. CL. 31. (U.S. CL. 46). REG. 10-8-1985.
- 1,365,038. SIGNPLAN. INT. CLS. 37 AND 42. (U.S. CLS. 100 AND 103). REG. 10-8-1985.
- 1,365,085. ADVENTIST INFORMATION MINISTRY. INT. CL. 42. (U.S. CL. 100). REG. 10-8-1985.
- 1,365,425. HORICO AND DESIGN. INT. CL. 10. (U.S. CL. 44). REG. 10-15-1985.
- 1,366,114. UZ. INT. CLS. 1, 3, 4, 6, 7, 8 AND 9. (U.S. CLS. 6, 13, 15, 21, 23, 34 AND 52). REG. 10-22-1985.
- 1,366,969. MISCELLANEOUS DESIGN. INT. CL. 32. (U.S. CL. 48). REG. 10-22-1985.
- 1,367,069. WILDWATER EXPEDITIONS UNLIMITED. INT. CL. 39. (U.S. CL. 105). REG. 10-22-1985.
- 1,370,009. LIPPERT. INT. CL. 11. (U.S. CL. 13). REG. 11-12-1985.
- 1,370,780. EXPRESS. INT. CL. 2. (U.S. CL. 16). REG. 11-19-1985.
- 1,374,979. MISCELLANEOUS DESIGN. INT. CL. 33. (U.S. CL. 47). REG. 12-10-1985.
- 1,375,061. MOST AND DESIGN. INT. CL. 36. (U.S. CL. 102). REG. 12-10-1985.
- 1,375,456. FORT KNOX. INT. CL. 6. (U.S. CL. 25). REG. 12-17-1985.
- 1,375,855. TY-GARD. INT. CL. 17. (U.S. CL. 1). REG. 12-17-1985.
- 1,377,654. GOLDEN TULIP. INT. CL. 42. (U.S. CLS. 100 AND 101). REG. 1-7-1986.
- 1,379,721. PAVIA. INT. CL. 42. (U.S. CL. 100). REG. 1-21-1986.

- 1,380,329. MISCELLANEOUS DESIGN. INT. CL. 15. (U.S. CL. 36). REG. 1-28-1986.
- 1,381,045. DAHLI. INT. CL. 7. (U.S. CL. 23). REG. 2-4-1986.
- 1,382,208. SPOT-SPINNER. INT. CL. 11. (U.S. CL. 13). REG. 2-11-1986.
- 1,384,143. SPINAL-STIM. INT. CL. 10. (U.S. CL. 44). REG. 2-25-1986.
- 1,387,606. OLD SCHOOL. INT. CL. 25. (U.S. CL. 39). REG. 3-25-1986.
- 1,391,170. AGRI-SOUTH. INT. CL. 42. (U.S. CL. 101). REG. 4-22-1986.
- 1,391,824. CAMEL AND DESIGN. INT. CL. 34. (U.S. CL. 17). REG. 4-29-1986.
- 1,392,554. MARCO'S PIZZA. INT. CLS. 30 AND 42. (U.S. CLS. 46 AND 100). REG. 5-6-1986.
- 1,702,330. HIVCARE. INT. CL. 42. (U.S. CL. 100). REG. 7-21-1992.
- 1,789,975. LAURA ASHLEY. INT. CLS. 1, 3, 5, 6, 9, 16, 20, 21, 31, 36 AND 42 ONLY. (U.S. CLS. 1, 2, 4, 5, 6, 11, 12, 13, 14, 18, 21, 23, 26, 29, 30, 32, 33, 37, 38, 40, 44, 46, 50, 51, 52, 100, 101, 102 AND 107). REG. 8-31-1993.
- 1,809,945. QUICKSAVER. INT. CL. 9. (U.S. CL. 21). REG. 12-7-1993.
- 1,821,046. DANCE MAGIC. INT. CL. 9. (U.S. CLS. 21, 23, 26, 36 AND 38). REG. 2-15-1994.
- 1,823,660. ELCA. INT. CL. 10. (U.S. CL. 44). REG. 2-22-1994.
- 1,825,951. LA CUVÉE MYTHIQUE AND DESIGN. INT. CL. 33. (U.S. CL. 47). REG. 3-8-1994.
- 1,828,559. SAFE AUTO INSURANCE. INT. CL. 36. (U.S. CLS. 101 AND 102). REG. 3-29-1994.
- 1,830,106. LOCTITE (STYLIZED). INT. CL. 4. (U.S. CLS. 1, 6 AND 15). REG. 4-12-1994.
- 1,830,972. ENVIRO-PHOS. INT. CL. 1. (U.S. CL. 6). REG. 4-19-1994.
- 1,835,027. 3-D OFFICE. INT. CL. 9. (U.S. CL. 38). REG. 5-3-1994.
- 1,839,040. TAHITI. INT. CL. 25. (U.S. CLS. 22 AND 39). REG. 6-7-1994.
- 1,839,648. SMARTROUTE SYSTEMS. INT. CL. 39. (U.S. CL. 105). REG. 6-14-1994.
- 1,840,415. ANTHONY ROBBINS' POWERTALK. INT. CL. 9. (U.S. CLS. 21, 23, 26, 36 AND 38). REG. 6-21-1994.
- 1,843,246. MANGILAO GOLF CLUB AND DESIGN. INT. CL. 41. (U.S. CLS. 100, 101 AND 107). REG. 7-5-1994.
- 1,845,517. THE BODY YOU DESERVE. INT. CL. 9. (U.S. CLS. 21, 23, 26, 36 AND 38). REG. 7-19-1994.
- 1,848,143. SYNERGY. INT. CL. 9. (U.S. CLS. 21, 23, 26, 36 AND 38). REG. 8-2-1994.
- 1,851,880. DISPENSEJET. INT. CL. 7. (U.S. CL. 23). REG. 8-30-1994.
- 1,854,466. BROWER HOUGHTON, IOWA, U.S.A. AND DESIGN. INT. CLS. 7 AND 11. (U.S. CLS. 23 AND 34). REG. 9-20-1994.
- 1,858,559. BAYLOR. INT. CL. 16. (U.S. CLS. 2, 5, 22, 23, 29, 37, 38 AND 50). REG. 10-18-1994.
- 1,858,817. WORK DOESN'T NEED TO BE A PAIN HUMAN-TECH AND DESIGN. INT. CL. 35. (U.S. CLS. 100, 101 AND 102). REG. 10-18-1994.
- 1,858,917. ARIZONA FALL LEAGUE AND DESIGN. INT. CL. 41. (U.S. CLS. 100, 101 AND 107). REG. 10-18-1994.
- 1,859,068. TERRY TOO SOON. INT. CLS. 16 AND 42. (U.S. CLS. 2, 5, 22, 23, 29, 37, 38, 50, 100 AND 101). REG. 10-18-1994.
- 1,859,080. HAPPY HAND. INT. CL. 3. (U.S. CLS. 1, 4, 6, 50, 51 AND 52). REG. 10-18-1994.
- 1,859,261. ANCIEN. INT. CL. 33. (U.S. CLS. 47 AND 49). REG. 10-18-1994.
- 1,859,541. DISPATCH BUSTER. INT. CL. 9. (U.S. CLS. 21, 23, 26, 36 AND 38). REG. 10-25-1994.
- 1,860,442. ROCKETTES. INT. CL. 28. (U.S. CLS. 22, 23, 38 AND 50). REG. 10-25-1994.
- 1,860,750. MAGNUM. INT. CL. 9. (U.S. CL. 21). REG. 11-1-1994.
- 1,861,408. DAYTONA SPEEDWEAR. INT. CL. 25. (U.S. CL. 39). REG. 11-1-1994.
- 1,861,622. MISCELLANEOUS DESIGN. INT. CL. 7. (U.S. CL. 23). REG. 11-8-1994.
- 1,862,209. COOPERSURGICAL. INT. CLS. 5, 10 AND 11. (U.S. CLS. 18, 31 AND 44). REG. 11-15-1994.
- 1,862,561. FORD. INT. CL. 24. (U.S. CLS. 42 AND 50). REG. 11-15-1994.
- 1,862,698. PSYTE. INT. CL. 35. (U.S. CL. 101). REG. 11-15-1994.
- 1,862,797. STAR CLIPPERS AND DESIGN. INT. CL. 39. (U.S. CL. 105). REG. 11-15-1994.
- 1,863,058. ISOFLEX. INT. CL. 7. (U.S. CLS. 13 AND 23). REG. 11-15-1994.
- 1,863,744. JEAN LOUIS COQUET (STYLIZED). INT. CL. 21. (U.S. CLS. 2, 13, 23, 29, 30, 33, 40 AND 50). REG. 11-22-1994.
- 1,863,842. HINODE CALIFORNIA WHITE. INT. CL. 30. (U.S. CL. 46). REG. 11-22-1994.
- 1,864,011. AMERICANA LEADERSHIP COLLEGE, INC.. INT. CL. 41. (U.S. CL. 107). REG. 11-22-1994.
- 1,864,380. GOLD SEAL. INT. CL. 34. (U.S. CL. 17). REG. 11-22-1994.
- 1,865,150. CYTOPAD. INT. CL. 5. (U.S. CL. 44). REG. 11-29-1994.
- 1,865,407. MISCELLANEOUS DESIGN. INT. CL. 36. (U.S. CL. 102). REG. 11-29-1994.
- 1,865,606. ISIS. INT. CL. 9. (U.S. CL. 38). REG. 12-6-1994.
- 1,866,566. OFFICIAL CENTER OF THE WORLD. INT. CL. 38. (U.S. CL. 104). REG. 12-6-1994.
- 1,866,850. EDNOVATION. INT. CL. 9. (U.S. CL. 38). REG. 12-13-1994.
- 1,866,963. NOSE NEWS . . . IS GOOD NEWS. INT. CL. 16. (U.S. CL. 38). REG. 12-13-1994.
- 1,867,102. EDSEL. INT. CL. 28. (U.S. CL. 22). REG. 12-13-1994.
- 1,867,119. DOMANI. INT. CL. 30. (U.S. CL. 46). REG. 12-13-1994.
- 1,867,774. PICO. INT. CL. 35. (U.S. CL. 101). REG. 12-13-1994.
- 1,867,851. ACOAT SELECTED AND DESIGN. U.S. CL. B. REG. 12-13-1994.
- 1,867,978. DANE. INT. CL. 6. (U.S. CLS. 13 AND 25). REG. 12-20-1994.
- 1,868,060. DYNAMITE. INT. CL. 9. (U.S. CL. 21). REG. 12-20-1994.
- 1,868,540. PREMIERE CHOICE. INT. CL. 35. (U.S. CL. 101). REG. 12-20-1994.
- 1,868,744. LEAN FOR LIFE!. INT. CL. 42. (U.S. CL. 100). REG. 12-20-1994.
- 1,868,840. SWAN. INT. CL. 9. (U.S. CLS. 21, 26 AND 38). REG. 12-20-1994.
- 1,870,720. ARTIE. INT. CL. 30. (U.S. CL. 46). REG. 12-27-1994.
- 1,871,753. TM AND DESIGN. INT. CL. 42. (U.S. CL. 101). REG. 1-3-1995.
- 1,872,159. RAILPLEX AND DESIGN. INT. CL. 2. (U.S. CL. 16). REG. 1-10-1995.
- 1,872,823. NATIONAL PROTECTION INDUSTRIES. INT. CL. 37. (U.S. CLS. 100, 103 AND 106). REG. 1-10-1995.
- 1,873,000. CME. U.S. CL. B. REG. 1-10-1995.
- 1,873,538. DURABLEND. INT. CL. 4. (U.S. CL. 15). REG. 1-17-1995.
- 1,874,207. FORD. INT. CL. 36. (U.S. CL. 102). REG. 1-17-1995.
- 1,874,278. W (STYLIZED). INT. CLS. 41 AND 42. (U.S. CLS. 100 AND 107). REG. 1-17-1995.
- 1,875,206. SPIDER. INT. CL. 16. (U.S. CLS. 22, 37 AND 38). REG. 1-24-1995.
- 1,876,050. SQUEEZE POP SPORTS BOTTLE CANDY. INT. CL. 30. (U.S. CL. 46). REG. 1-24-1995.
- 1,876,337. LA-LED. INT. CL. 6. (U.S. CL. 14). REG. 1-31-1995.
- 1,876,446. ACCUSKI (STYLIZED). INT. CL. 9. (U.S. CL. 21). REG. 1-31-1995.
- 1,876,525. H AND DESIGN. INT. CL. 14. (U.S. CLS. 27 AND 28). REG. 1-31-1995.
- 1,876,690. LILLIAN AUGUST. INT. CL. 24. (U.S. CL. 42). REG. 1-31-1995.
- 1,876,958. MISCELLANEOUS DESIGN. INT. CL. 41. (U.S. CL. 107). REG. 1-31-1995.
- 1,877,314. FLOMAG. INT. CL. 1. (U.S. CL. 6). REG. 2-7-1995.
- 1,877,482. ET. INT. CL. 9. (U.S. CL. 26). REG. 2-7-1995.
- 1,877,727. REBEL ASSAULT. INT. CL. 28. (U.S. CLS. 22 AND 38). REG. 2-7-1995.
- 1,878,037. HEALTH AND SPORT WORKS. INT. CL. 41. (U.S. CLS. 100 AND 107). REG. 2-7-1995.
- 1,878,090. B.B. KING. INT. CL. 42. (U.S. CL. 107). REG. 2-7-1995.
- 1,878,179. ECOTIMBER. INT. CL. 19 ONLY. (U.S. CLS. 1, 12, 33 AND 50). REG. 2-7-1995.
- 1,878,587. TIMIO. INT. CL. 14. (U.S. CL. 28). REG. 2-14-1995.
- 1,879,098. VALTRES. INT. CL. 5. (U.S. CL. 18). REG. 2-14-1995.

- 1,879,105. STAR WARS. INT. CL. 6. (U.S. CLS. 13 AND 50). REG. 2-14-1995.
- 1,879,207. ASSISTED HOUSING MANAGEMENT INSIDER. INT. CL. 16. (U.S. CL. 38). REG. 2-14-1995.
- 1,879,298. JAVA JONES. INT. CL. 30. (U.S. CLS. 46 AND 50). REG. 2-14-1995.
- 1,879,690. FLIP CHART. INT. CL. 16. (U.S. CL. 37). REG. 2-21-1995.
- 1,879,829. WAIKELE. INT. CL. 25. (U.S. CL. 39). REG. 2-21-1995.
- 1,879,946. TAVERN BATTERED. INT. CL. 29. (U.S. CL. 46). REG. 2-21-1995.
- 1,879,998. DELSTAR. INT. CLS. 35 AND 42. (U.S. CLS. 100 AND 101). REG. 2-21-1995.
- 1,880,107. FOCUS. INT. CL. 41. (U.S. CL. 107). REG. 2-21-1995.
- 1,880,227. PLANETARY REACTOR. INT. CL. 9. (U.S. CLS. 21 AND 26). REG. 2-21-1995.
- 1,880,687. YELLOW CAB NEW YORK KOBE AND DESIGN. INT. CL. 25. (U.S. CL. 39). REG. 2-28-1995.
- 1,880,838. PAYWISE. INT. CL. 35. (U.S. CLS. 101 AND 102). REG. 2-28-1995.
- 1,881,349. ENDO TA. INT. CL. 10. (U.S. CL. 44). REG. 2-28-1995.
- 1,881,358. SAFETY 1ST. INT. CL. 10. (U.S. CL. 44). REG. 2-28-1995.
- 1,881,510. GROWING UP WITH VASSARETTE. INT. CL. 25. (U.S. CL. 39). REG. 2-28-1995.
- 1,881,864. TANGENTIAL FOWLER ZALKIN AND DESIGN. INT. CL. 7. (U.S. CL. 23). REG. 3-7-1995.
- 1,882,099. ARISTOCRAT. INT. CL. 15. (U.S. CL. 36). REG. 3-7-1995.
- 1,882,267. COMFORT CENTRAL. INT. CL. 24. (U.S. CL. 42). REG. 3-7-1995.
- 1,882,372. GOURMET TO GO HEARTY HAM 'N CHEESE REDISCOVER AN AMERICAN CLASSIC AND DESIGN. INT. CL. 29. (U.S. CL. 46). REG. 3-7-1995.
- 1,882,646. THE FAR POST AND DESIGN. INT. CL. 42. (U.S. CLS. 100 AND 101). REG. 3-7-1995.
- 1,882,847. HANDSOFF. INT. CL. 9. (U.S. CL. 21). REG. 3-7-1995.
- 1,882,879. TENCAP. INT. CL. 9. (U.S. CLS. 26 AND 38). REG. 3-7-1995.
- 1,883,330. ZIRCON. INT. CLS. 8 AND 9. (U.S. CLS. 21, 23 AND 26). REG. 3-14-1995.
- 1,883,590. O'NEIL DATABASE 15-YEAR PERSPECTIVE. INT. CL. 16. (U.S. CL. 37). REG. 3-14-1995.
- 1,883,591. O'NEIL CANADIAN DATABASE. INT. CL. 16. (U.S. CL. 37). REG. 3-14-1995.
- 1,883,988. MISCELLANEOUS DESIGN. INT. CL. 39. (U.S. CLS. 100 AND 105). REG. 3-14-1995.
- 1,884,244. NEXTEL. INT. CL. 9. (U.S. CL. 21). REG. 3-14-1995.
- 1,884,379. DANA BUCHMAN. INT. CL. 42. (U.S. CL. 101). REG. 3-14-1995.
- 1,884,469. DYNALENE. INT. CL. 1. (U.S. CL. 6). REG. 3-21-1995.
- 1,885,564. TEST 1-2-3. INT. CL. 9. (U.S. CL. 36). REG. 3-21-1995.
- 1,885,597. Q-BIT. INT. CL. 20. (U.S. CLS. 2 AND 50). REG. 3-21-1995.
- 1,886,016. MINI-TORK. INT. CL. 16. (U.S. CL. 37). REG. 3-28-1995.
- 1,886,017. M-TORK. INT. CL. 16. (U.S. CL. 37). REG. 3-28-1995.
- 1,886,386. WTR. INT. CL. 41. (U.S. CL. 107). REG. 3-28-1995.
- 1,886,823. HYPERPRO. INT. CLS. 1 AND 12. (U.S. CLS. 6 AND 19). REG. 4-4-1995.
- 1,886,859. BATES. INT. CL. 3. (U.S. CL. 52). REG. 4-4-1995.
- 1,887,120. TROOPER CONNECTION. INT. CL. 16. (U.S. CL. 37). REG. 4-4-1995.
- 1,887,234. BATES. INT. CL. 25. (U.S. CL. 39). REG. 4-4-1995.
- 1,887,244. MISCELLANEOUS DESIGN. INT. CL. 25. (U.S. CLS. 22 AND 39). REG. 4-4-1995.
- 1,887,886. SUNFIRE. INT. CL. 12. (U.S. CLS. 19 AND 23). REG. 4-4-1995.
- 1,888,197. SU. INT. CLS. 6, 16, 18, 21, 24, 25, 28 AND 41. (U.S. CLS. 2, 3, 13, 22, 27, 28, 39, 41, 42 AND 107). REG. 4-11-1995.
- 1,888,231. GEN400. INT. CL. 9. (U.S. CL. 38). REG. 4-11-1995.
- 1,888,336. MISCELLANEOUS DESIGN. INT. CL. 9. (U.S. CLS. 21, 26 AND 36). REG. 4-11-1995.
- 1,888,621. X-WING. INT. CL. 28. (U.S. CLS. 22 AND 38). REG. 4-11-1995.
- 1,888,916. DAFFODILIANS. INT. CL. 41. (U.S. CLS. 101 AND 107). REG. 4-11-1995.
- 1,889,216. TRANSEND. INT. CL. 10. (U.S. CL. 44). REG. 4-11-1995.
- 1,889,270. VMR. INT. CL. 16. (U.S. CL. 38). REG. 4-11-1995.
- 1,889,615. W WALTER AND DESIGN. INT. CLS. 7 AND 9. (U.S. CLS. 23 AND 26). REG. 4-18-1995.
- 1,889,634. VECTOR. INT. CL. 9. (U.S. CLS. 26 AND 38). REG. 4-18-1995.
- 1,889,686. SCAN AFC SYSTEMS INC AND DESIGN. INT. CL. 9. (U.S. CLS. 21 AND 26). REG. 4-18-1995.
- 1,889,733. ACCUMET. INT. CL. 9. (U.S. CL. 21). REG. 4-18-1995.
- 1,889,797. GRAND PRIX. INT. CL. 12. (U.S. CLS. 19 AND 23). REG. 4-18-1995.
- 1,889,818. LOS ANGELES RAMS. INT. CLS. 16 AND 25. (U.S. CLS. 2, 5, 22, 23, 29, 37, 38, 39 AND 50). REG. 4-18-1995.
- 1,889,895. CONTROL-BLOK. INT. CL. 19. (U.S. CL. 12). REG. 4-18-1995.
- 1,890,148. FIRST NATIONAL BANK OF THE ROCKIES AND DESIGN. INT. CL. 36. (U.S. CL. 102). REG. 4-18-1995.
- 1,890,197. TRUST THE WATER EXPERTS. INT. CLS. 37, 39 AND 42. (U.S. CLS. 100, 101, 103 AND 105). REG. 4-18-1995.
- 1,890,251. COMICVIEW. INT. CL. 41. (U.S. CL. 107). REG. 4-18-1995.
- 1,890,572. GEOSPIRIT. INT. CL. 25. (U.S. CL. 39). REG. 4-18-1995.
- 1,890,993. LASER WAR. INT. CL. 13. (U.S. CL. 9). REG. 4-25-1995.
- 1,891,143. RRL (STYLIZED). INT. CL. 25. (U.S. CL. 39). REG. 4-25-1995.
- 1,891,714. REPLACEMENTS. INT. CL. 16. (U.S. CL. 37). REG. 4-25-1995.
- 1,891,924. MISCELLANEOUS DESIGN. INT. CL. 5. (U.S. CL. 18). REG. 5-2-1995.
- 1,892,018. IE ION ENERGY (STYLIZED). INT. CL. 9. (U.S. CL. 21). REG. 5-2-1995.
- 1,892,111. CANINE GOOD CITIZEN. INT. CL. 16. (U.S. CL. 38). REG. 5-2-1995.
- 1,892,291. TRINKETS AND DESIGN. INT. CL. 30. (U.S. CL. 46). REG. 5-2-1995.
- 1,892,321. RETAIL SERVICES PLUS AND DESIGN. INT. CL. 35. (U.S. CL. 101). REG. 5-2-1995.
- 1,892,408. Q AND DESIGN. INT. CL. 41. (U.S. CL. 107). REG. 5-2-1995.
- 1,892,637. ULTRASTOP. INT. CL. 11. (U.S. CL. 31). REG. 5-2-1995.
- 1,892,675. VERTIKLEAN. INT. CL. 21. (U.S. CL. 29). REG. 5-2-1995.
- 1,892,895. MILPRO. INT. CL. 4. (U.S. CL. 15). REG. 5-9-1995.
- 1,892,945. RIPPER BUCKET. INT. CL. 7. (U.S. CLS. 13, 19, 21, 23, 31, 34 AND 35). REG. 5-9-1995.
- 1,893,041. SAFE-1. INT. CL. 10. (U.S. CL. 44). REG. 5-9-1995.
- 1,893,066. MISTY. INT. CL. 12. (U.S. CL. 19). REG. 5-9-1995.
- 1,893,097. CANINE GOOD CITIZEN AMERICAN KENNEL CLUB INCORPORATED A K C AND DESIGN. INT. CL. 16. (U.S. CL. 38). REG. 5-9-1995.
- 1,893,172. RAZA (STYLIZED). INT. CL. 25. (U.S. CL. 39). REG. 5-9-1995.
- 1,893,240. MON DESIR (STYLIZED). INT. CL. 29. (U.S. CL. 46). REG. 5-9-1995.
- 1,893,322. FLEXIBLE EXCHANGE. INT. CL. 36. (U.S. CL. 102). REG. 5-9-1995.
- 1,893,588. POWERSPEC. INT. CL. 11. (U.S. CL. 21). REG. 5-9-1995.
- 1,893,874. PRIMA (STYLIZED). INT. CL. 2. (U.S. CL. 16). REG. 5-16-1995.
- 1,893,879. EQUATE. INT. CLS. 3 AND 5. (U.S. CLS. 1, 4, 6, 18, 44, 50, 51 AND 52). REG. 5-16-1995.
- 1,893,911. THUNDERBIRD. INT. CL. 6. (U.S. CLS. 13 AND 14). REG. 5-16-1995.
- 1,893,930. AMTECH. INT. CL. 7. (U.S. CL. 23). REG. 5-16-1995.
- 1,893,960. STAK-LITE. INT. CL. 9. (U.S. CL. 26). REG. 5-16-1995.
- 1,894,014. PHYCON. INT. CL. 10. (U.S. CL. 44). REG. 5-16-1995.
- 1,894,106. SAFEMAG (STYLIZED). INT. CL. 17. (U.S. CLS. 1 AND 12). REG. 5-16-1995.
- 1,894,113. KOOL SEAL. INT. CL. 19. (U.S. CL. 12). REG. 5-16-1995.

- 1,894,133. AQUA-SLEEVE. INT. CL. 24. (U.S. CL. 42). REG. 5-16-1995.
- 1,894,136. GORE-TEX AND DESIGN. INT. CL. 24. (U.S. CL. 42). REG. 5-16-1995.
- 1,894,142. TANDEM SPORT. INT. CL. 25. (U.S. CL. 39). REG. 5-16-1995.
- 1,894,146. TRU-WEST. INT. CL. 25. (U.S. CL. 39). REG. 5-16-1995.
- 1,894,180. RAGAMUFFIN TEDDY BEARS. INT. CL. 28. (U.S. CL. 22). REG. 5-16-1995.
- 1,894,208. SUPERCHILL. INT. CL. 29. (U.S. CL. 46). REG. 5-16-1995.
- 1,894,393. GOOD DAY LA. INT. CL. 41. (U.S. CL. 107). REG. 5-16-1995.
- 1,894,457. ISI (STYLIZED). INT. CL. 42. (U.S. CLS. 100 AND 101). REG. 5-16-1995.
- 1,894,458. MISCELLANEOUS DESIGN. INT. CL. 42. (U.S. CLS. 100 AND 101). REG. 5-16-1995.
- 1,894,473. ANOTHER BENEFIT OF HYDRO POWER AND DESIGN. INT. CL. 42. (U.S. CL. 100). REG. 5-16-1995.
- 1,894,507. MEAN BEAVER AND DESIGN. INT. CLS. 25 AND 28. (U.S. CLS. 22 AND 39). REG. 5-16-1995.
- 1,894,513. MISCELLANEOUS DESIGN. INT. CL. 3. (U.S. CL. 4). REG. 5-16-1995.
- 1,894,617. MISCELLANEOUS DESIGN. INT. CL. 16. (U.S. CLS. 2, 5, 22, 23, 29, 37, 38 AND 50). REG. 5-16-1995.
- 1,894,698. AT&T ONENET. INT. CL. 38. (U.S. CL. 104). REG. 5-16-1995.
- 1,894,706. HEAD OVER HEELS AND DESIGN. INT. CL. 41. (U.S. CL. 107). REG. 5-16-1995.
- 1,894,750. 3V. INT. CL. 1. (U.S. CLS. 1, 5, 6, 10, 26 AND 46). REG. 5-23-1995.
- 1,894,764. FANTASTIC COLOR. INT. CL. 3. (U.S. CL. 51). REG. 5-23-1995.
- 1,894,814. MISCELLANEOUS DESIGN. INT. CL. 6. (U.S. CL. 13). REG. 5-23-1995.
- 1,894,817. QUARTZINC. INT. CL. 6. (U.S. CLS. 13 AND 14). REG. 5-23-1995.
- 1,894,828. ZKL AND DESIGN. INT. CL. 7. (U.S. CL. 23). REG. 5-23-1995.
- 1,894,927. ZEON. INT. CL. 9. (U.S. CLS. 21 AND 50). REG. 5-23-1995.
- 1,894,981. BALBOA. INT. CL. 9. (U.S. CLS. 21 AND 26). REG. 5-23-1995.
- 1,895,020. IT'S EASY BEING GREEN. INT. CL. 11. (U.S. CL. 13). REG. 5-23-1995.
- 1,895,157. HERMITEX. INT. CL. 21. (U.S. CL. 29). REG. 5-23-1995.
- 1,895,187. POWER PUMPER. INT. CL. 28. (U.S. CL. 22). REG. 5-23-1995.
- 1,895,205. COMTESSE DU BARRY AND DESIGN. INT. CLS. 29 AND 30 ONLY. (U.S. CL. 46). REG. 5-23-1995.
- 1,895,293. TAARS. INT. CLS. 35 AND 36. (U.S. CLS. 101 AND 102). REG. 5-23-1995.
- 1,895,333. PAYLESS AUTO GLASS AND DESIGN. INT. CL. 37. (U.S. CL. 103). REG. 5-23-1995.
- 1,895,436. FANTASTIC TANS. INT. CL. 42. (U.S. CL. 100). REG. 5-23-1995.
- 1,895,519. HAMMER-CAPSULE. INT. CL. 1. (U.S. CL. 6). REG. 5-23-1995.
- 1,895,620. SPURRIDGE. INT. CL. 25. (U.S. CL. 39). REG. 5-23-1995.
- 1,895,772. NIMUDEN. INT. CL. 1. (U.S. CL. 6). REG. 5-30-1995.
- 1,895,900. TECHNOTRAY. INT. CL. 7. (U.S. CLS. 13, 19, 21, 23, 31, 34 AND 35). REG. 5-30-1995.
- 1,895,907. RAP GATOR. INT. CL. 7. (U.S. CL. 23). REG. 5-30-1995.
- 1,895,976. SESAME STREET. INT. CLS. 9 AND 42. (U.S. CLS. 38, 100 AND 101). REG. 5-30-1995.
- 1,896,048. BEAM BUTLER. INT. CL. 9. (U.S. CLS. 21 AND 23). REG. 5-30-1995.
- 1,896,086. MISCELLANEOUS DESIGN. INT. CLS. 11 AND 17. (U.S. CLS. 1, 12, 26, 34, 35 AND 50). REG. 5-30-1995.
- 1,896,440. AEGIS. INT. CL. 36. (U.S. CLS. 101 AND 102). REG. 5-30-1995.
- 1,896,670. 98% ANGEL AND DESIGN. INT. CL. 42. (U.S. CL. 101). REG. 5-30-1995.
- 1,896,690. ACSM FIT SOCIETY. INT. CL. (U.S. CLS.). U.S. CL. 200. REG. 5-30-1995.
- 1,896,844. MD AND DESIGN. INT. CL. 9. (U.S. CLS. 21, 23, 26, 36 AND 38). REG. 5-30-1995.
- 1,896,871. PROTRAN. INT. CL. 9. (U.S. CLS. 26 AND 31). REG. 5-30-1995.
- 1,896,883. KNOWLEDGE QUEST. INT. CL. 9. (U.S. CLS. 21, 36 AND 38). REG. 5-30-1995.
- 1,896,908. MISCELLANEOUS DESIGN. INT. CL. 11. (U.S. CL. 34). REG. 5-30-1995.
- 1,896,922. LIFE INNOVATIONS. INT. CL. 16. (U.S. CL. 38). REG. 5-30-1995.
- 1,896,971. MERIDIAN COLLECTION. INT. CL. 20. (U.S. CL. 50). REG. 5-30-1995.
- 1,897,111. MISCELLANEOUS DESIGN. INT. CL. 39. (U.S. CL. 103). REG. 5-30-1995.
- 1,897,240. ATLAS WHITE. INT. CL. 2. (U.S. CLS. 6 AND 16). REG. 6-6-1995.
- 1,897,274. UNIPRO. INT. CL. 5. (U.S. CLS. 18 AND 46). REG. 6-6-1995.
- 1,897,275. MISCELLANEOUS DESIGN. INT. CL. 5. (U.S. CLS. 6 AND 18). REG. 6-6-1995.
- 1,897,450. CORBETT. INT. CL. 11. (U.S. CL. 21). REG. 6-6-1995.
- 1,897,535. K KNAACK (STYLIZED). INT. CL. 20. (U.S. CLS. 2 AND 32). REG. 6-6-1995.
- 1,897,553. BEAUTY HANDS. INT. CL. 21. (U.S. CL. 39). REG. 6-6-1995.
- 1,897,577. ARIES AND DESIGN. INT. CL. 25. (U.S. CL. 39). REG. 6-6-1995.
- 1,897,762. ENDOCARE. INT. CL. 37. (U.S. CL. 103). REG. 6-6-1995.
- 1,897,787. FUNNYBONES. INT. CL. 41. (U.S. CLS. 101 AND 107). REG. 6-6-1995.
- 1,897,805. HEALTHY MOMS AND DESIGN. INT. CL. 41. (U.S. CLS. 100 AND 107). REG. 6-6-1995.
- 1,897,848. SIGNATURE CLUB. INT. CL. 42. (U.S. CL. 102). REG. 6-6-1995.
- 1,897,909. MISCELLANEOUS DESIGN. INT. CLS. 11 AND 21. (U.S. CLS. 2, 13, 21, 23, 29, 30, 31, 33, 34, 40 AND 50). REG. 6-6-1995.
- 1,898,020. RATIONAL APEX. INT. CL. 9. (U.S. CL. 38). REG. 6-6-1995.
- 1,898,025. MEDSELECT SYSTEMS. INT. CL. 9. (U.S. CL. 38). REG. 6-6-1995.
- 1,898,086. SHOCKWAVE. INT. CL. 13. (U.S. CLS. 2 AND 9). REG. 6-6-1995.
- 1,898,288. LASALLE BANK. INT. CL. 36. (U.S. CL. 102). REG. 6-6-1995.
- 1,898,356. SEA CLAY. INT. CL. 3. (U.S. CL. 52). REG. 6-6-1995.
- 1,898,365. ADVANCED FIBRE COMMUNICATIONS. INT. CL. 9. (U.S. CLS. 21 AND 26). REG. 6-6-1995.
- 1,898,563. THE SMART NAIL. INT. CL. 6. (U.S. CL. 13). REG. 6-13-1995.
- 1,898,593. JOHNFORD (STYLIZED). INT. CL. 7. (U.S. CL. 23). REG. 6-13-1995.
- 1,898,597. FAST-FEED. INT. CL. 8. (U.S. CL. 23). REG. 6-13-1995.
- 1,898,616. MUREX (STYLIZED). INT. CLS. 9 AND 42. (U.S. CLS. 38, 100 AND 101). REG. 6-13-1995.
- 1,898,620. MAX THE MOOSE. INT. CL. 9. (U.S. CL. 36). REG. 6-13-1995.
- 1,898,732. MISCELLANEOUS DESIGN. INT. CL. 9. (U.S. CLS. 21 AND 26). REG. 6-13-1995.
- 1,898,747. CONFUSABLES. INT. CL. 9. (U.S. CL. 26). REG. 6-13-1995.
- 1,898,799. MISCELLANEOUS DESIGN. INT. CL. 11. (U.S. CL. 34). REG. 6-13-1995.
- 1,898,816. BAYOU CLASSIC (STYLIZED). INT. CL. 11. (U.S. CL. 34). REG. 6-13-1995.
- 1,898,835. MISCELLANEOUS DESIGN. INT. CL. 12. (U.S. CLS. 19 AND 23). REG. 6-13-1995.
- 1,898,840. WHISPER. INT. CL. 13. (U.S. CL. 9). REG. 6-13-1995.
- 1,898,984. WE BRING MORE TO THE TABLE. INT. CL. 21. (U.S. CL. 2). REG. 6-13-1995.
- 1,899,093. LM ANIMAL FARMS AND DESIGN. INT. CL. 31. (U.S. CLS. 1 AND 41). REG. 6-13-1995.
- 1,899,094. L/M ANIMAL FARMS (STYLIZED). INT. CL. 31. (U.S. CLS. 1 AND 46). REG. 6-13-1995.
- 1,899,126. ICA THE INSTITUTE OF CULTURAL AFFAIRS AND DESIGN. INT. CL. 35. (U.S. CL. 101). REG. 6-13-1995.
- 1,899,332. CS CEDARS-SINAI MEDICAL CENTER AND DESIGN. INT. CL. 42. (U.S. CL. 100). REG. 6-13-1995.
- 1,899,342. LOEWS HOTELS AND DESIGN. INT. CL. 42. (U.S. CL. 100). REG. 6-13-1995.

- 1,899,388. WESTIN KIDS CLUB W KC AND DESIGN. INT. CL. 42. (U.S. CL. 100). REG. 6-13-1995.
- 1,899,444. ATLANTIC DOMINION DISTRIBUTORS. INT. CLS. 1 AND 42. (U.S. CLS. 6, 100 AND 101). REG. 6-13-1995.
- 1,899,479. MULTUM. INT. CLS. 9 AND 42. (U.S. CLS. 38, 100 AND 101). REG. 6-13-1995.
- 1,899,507. TEC/SYSTEM. INT. CL. 2. (U.S. CLS. 6, 11 AND 16). REG. 6-13-1995.
- 1,899,570. CERROGROOVE. INT. CL. 6. (U.S. CLS. 2, 12, 13, 14, 23, 25 AND 50). REG. 6-13-1995.
- 1,899,572. DOOR CLUB. INT. CL. 6. (U.S. CL. 13). REG. 6-13-1995.
- 1,899,575. FREELANCE. INT. CL. 7. (U.S. CLS. 13, 19, 21, 23, 31, 34 AND 35). REG. 6-13-1995.
- 1,899,595. GUFU. INT. CL. 9. (U.S. CL. 38). REG. 6-13-1995.
- 1,899,613. PATHFINDER. INT. CL. 9. (U.S. CL. 26). REG. 6-13-1995.
- 1,899,684. MULTIFIX. INT. CL. 9. (U.S. CLS. 21, 23, 26, 36 AND 38). REG. 6-13-1995.
- 1,899,715. OPTITRAN. INT. CL. 9. (U.S. CLS. 26 AND 31). REG. 6-13-1995.
- 1,899,724. SELECTRAC. INT. CL. 9. (U.S. CL. 38). REG. 6-13-1995.
- 1,899,729. MAVERICK. INT. CL. 9. (U.S. CLS. 26 AND 39). REG. 6-13-1995.
- 1,900,126. PLANNED TRADING CYCLE. INT. CL. 39. (U.S. CLS. 100 AND 105). REG. 6-13-1995.
- 1,900,201. CLI. U.S. CL. B. REG. 6-13-1995.
- 1,900,212. CELL OPTIMIZER SYSTEM. INT. CL. 9. (U.S. CL. 26). REG. 6-13-1995.
- 1,900,221. FRANCHISE INC.. INT. CL. 16. (U.S. CL. 38). REG. 6-13-1995.
- 1,900,532. N NEMO AND DESIGN. INT. CLS. 11 AND 20. (U.S. CLS. 21 AND 32). REG. 6-20-1995.
- 1,900,571. LOVING THOUGHTS. INT. CL. 14. (U.S. CL. 28). REG. 6-20-1995.
- 1,900,689. COUNTRYSIDE PLANTERS PLANTER TUBS & FLOWER BOXES AND DESIGN. INT. CL. 21. (U.S. CL. 2). REG. 6-20-1995.
- 1,900,822. CCORE. INT. CL. 35. (U.S. CL. 100). REG. 6-20-1995.
- 1,900,953. THE TECHNOLOGY OF PARTICIPATION (TOP). INT. CL. 41. (U.S. CL. 107). REG. 6-20-1995.
- 1,901,091. TCBY. INT. CL. 30 ONLY. (U.S. CL. 46). REG. 6-20-1995.
- 1,901,107. MAX-AMINE. INT. CL. 1. (U.S. CL. 6). REG. 6-20-1995.
- 1,901,212. OK! AND DESIGN. INT. CL. 16. (U.S. CLS. 37 AND 38). REG. 6-20-1995.
- 1,901,298. BEER IS MY LIFE. INT. CL. 32. (U.S. CLS. 45, 46 AND 48). REG. 6-20-1995.
- 1,901,330. DAYTONA PIT SHOP. INT. CL. 42. (U.S. CLS. 100 AND 101). REG. 6-20-1995.
- 1,901,348. LOFFLER AND DESIGN. INT. CL. 3. (U.S. CL. 52). REG. 6-20-1995.
- 1,901,427. PERFECT 10. INT. CL. 5. (U.S. CL. 18). REG. 6-27-1995.
- 1,901,470. CLM (STYLIZED). INT. CLS. 7 AND 11. (U.S. CLS. 23 AND 34). REG. 6-27-1995.
- 1,901,496. MIDPA. INT. CL. 9. (U.S. CL. 38). REG. 6-27-1995.
- 1,901,517. DALSA. INT. CLS. 9 AND 42. (U.S. CLS. 21, 26 AND 100). REG. 6-27-1995.
- 1,901,768. SUNBRIGHT. INT. CL. 20. (U.S. CL. 50). REG. 6-27-1995.
- 1,901,904. HEAD OF THE CLASS AND DESIGN. INT. CL. 36. (U.S. CL. 102). REG. 6-27-1995.
- 1,901,994. MS. FIGURE. INT. CL. 41. (U.S. CL. 107). REG. 6-27-1995.
- 1,902,362. NUTRIHANCE. INT. CL. 5. (U.S. CLS. 18 AND 46). REG. 7-4-1995.
- 1,902,390. POWERFLEX. INT. CL. 7. (U.S. CLS. 13, 19, 21, 23, 31, 34 AND 35). REG. 7-4-1995.
- 1,902,464. POLYSCORE. INT. CL. 9. (U.S. CL. 38). REG. 7-4-1995.
- 1,902,530. UNITY. INT. CL. 9. (U.S. CL. 38). REG. 7-4-1995.
- 1,902,873. ATEC. INT. CL. 28. (U.S. CLS. 22, 23, 38 AND 50). REG. 7-4-1995.
- 1,903,166. AMERICROWN AND DESIGN. INT. CL. 42. (U.S. CL. 101). REG. 7-4-1995.
- 1,903,200. 98% ANGEL. INT. CL. 42. (U.S. CL. 101). REG. 7-4-1995.
- 1,903,383. FILTERFLEX. INT. CL. 9. (U.S. CLS. 21, 23, 26, 36 AND 38). REG. 7-4-1995.
- 1,903,388. ZFS. INT. CL. 9. (U.S. CLS. 21, 23, 26, 36 AND 38). REG. 7-4-1995.
- 1,903,438. SMARTHEAD. INT. CL. 9. (U.S. CL. 26). REG. 7-4-1995.
- 1,903,946. PERSONNEL POCKET FILE. INT. CL. 16. (U.S. CLS. 2, 5, 22, 23, 29, 37, 38 AND 50). REG. 7-4-1995.
- 1,904,145. POWERPRINT. INT. CL. 9. (U.S. CLS. 26 AND 38). REG. 7-11-1995.
- 1,904,348. REDWOOD. INT. CL. 12. (U.S. CL. 19). REG. 7-11-1995.
- 1,904,460. PARK RIDGE (STYLIZED). INT. CL. 20. (U.S. CL. 32). REG. 7-11-1995.
- 1,904,461. COUNTRY GARDEN AND DESIGN. INT. CL. 20. (U.S. CL. 32). REG. 7-11-1995.
- 1,904,651. AMC. INT. CL. 38. (U.S. CL. 104). REG. 7-11-1995.
- 1,905,110. BURGUNDY CAROUSEL. INT. CL. 31. (U.S. CLS. 1 AND 46). REG. 7-11-1995.
- 1,905,152. GATEWAY CASINO. INT. CL. 41. (U.S. CLS. 100, 101 AND 107). REG. 7-11-1995.
- 1,905,166. SPIRIT OF ST. LOUIS. INT. CL. 41. (U.S. CLS. 100, 101 AND 107). REG. 7-11-1995.
- 1,905,322. CLM. INT. CLS. 7 AND 11. (U.S. CLS. 13, 19, 21, 23, 31, 34 AND 35). REG. 7-18-1995.
- 1,905,323. CONSOLIDATED. INT. CLS. 7 AND 11. (U.S. CLS. 13, 19, 21, 23, 31, 34 AND 35). REG. 7-18-1995.
- 1,905,375. CUT'N PRESS. INT. CL. 9. (U.S. CL. 26). REG. 7-18-1995.
- 1,905,480. HORTICOPIA. INT. CL. 9. (U.S. CL. 38). REG. 7-18-1995.
- 1,905,542. ACCUBAKE. INT. CL. 11. (U.S. CLS. 21, 26 AND 34). REG. 7-18-1995.
- 1,905,615. BAL. INT. CL. 16. (U.S. CL. 38). REG. 7-18-1995.
- 1,905,857. MAXIME TRIJOL. INT. CL. 33. (U.S. CL. 49). REG. 7-18-1995.
- 1,905,967. WE DON'T JUST DO IT FAST, WE DO IT RIGHT. INT. CL. 37. (U.S. CL. 103). REG. 7-18-1995.
- 1,906,037. RESCUE TECHNOLOGY. INT. CL. 41. (U.S. CL. 107). REG. 7-18-1995.
- 1,906,118. HUP! MULTIMEDIA (STYLIZED). INT. CL. 42. (U.S. CLS. 100 AND 101). REG. 7-18-1995.
- 1,906,170. COMMITTED TO LEADERSHIP IN GENETIC SERVICES. INT. CL. 42. (U.S. CL. 100). REG. 7-18-1995.
- 1,906,256. SKINTIMATE. INT. CL. 3. (U.S. CLS. 1, 4, 6, 50, 51 AND 52). REG. 7-18-1995.
- 1,906,415. EFI (STYLIZED). INT. CL. 10. (U.S. CL. 44). REG. 7-18-1995.
- 1,906,980. PRISTERENE. INT. CL. 1. (U.S. CL. 6). REG. 7-25-1995.
- 1,907,083. MECO. INT. CL. 7. (U.S. CL. 23). REG. 7-25-1995.
- 1,907,315. MOVIN' PARTS. INT. CL. 16. (U.S. CL. 38). REG. 7-25-1995.
- 1,907,386. MISCELLANEOUS DESIGN. INT. CL. 21. (U.S. CLS. 2, 13, 23, 29, 30, 33, 40 AND 50). REG. 7-25-1995.
- 1,907,587. GOVCASH. INT. CL. 36. (U.S. CLS. 101 AND 102). REG. 7-25-1995.
- 1,907,639. N W S E ECO-EXPEDITIONS AND DESIGN. INT. CL. 39. (U.S. CL. 105). REG. 7-25-1995.
- 1,907,698. SELF - POWER (STYLIZED). INT. CL. 41. (U.S. CL. 107). REG. 7-25-1995.
- 1,908,000. BALI SHAG (STYLIZED). INT. CL. 34. (U.S. CLS. 2, 8, 9 AND 17). REG. 7-25-1995.
- 1,908,146. HF AND DESIGN. INT. CL. 7. (U.S. CL. 23). REG. 8-1-1995.
- 1,908,839. THE FOX. INT. CL. 38. (U.S. CL. 104). REG. 8-1-1995.
- 1,908,927. SELF AND OTHERS DIMENSION. INT. CL. 41. (U.S. CL. 107). REG. 8-1-1995.
- 1,908,936. GATEWAY TO RICHES. INT. CL. 41. (U.S. CL. 107). REG. 8-1-1995.
- 1,909,492. OAK EXPRESS. INT. CL. 42. (U.S. CL. 101). REG. 8-1-1995.
- 1,909,927. MACE. INT. CL. 13. (U.S. CL. 9). REG. 8-8-1995.
- 1,910,059. OPTICLEAR. INT. CL. 17. (U.S. CLS. 5 AND 35). REG. 8-8-1995.
- 1,910,453. GREAT AMERICAN TRAVELER. INT. CL. 39. (U.S. CL. 105). REG. 8-8-1995.
- 1,910,683. DURATION. INT. CL. 1. (U.S. CLS. 1, 5, 6, 10, 26 AND 46). REG. 8-8-1995.
- 1,910,736. SMART HEAD. INT. CL. 11. (U.S. CL. 21). REG. 8-8-1995.
- 1,911,024. MUSCLE PIG. INT. CL. 5. (U.S. CLS. 18 AND 46). REG. 8-15-1995.

- 1,911,123. SOMME. INT. CL. 7. (U.S. CL. 23). REG. 8-15-1995.
- 1,911,230. SNAP. INT. CL. 10. (U.S. CL. 26). REG. 8-15-1995.
- 1,911,658. CHRISEED. INT. CL. 31. (U.S. CL. 1). REG. 8-15-1995.
- 1,912,004. CHAPEL OF LOVE. INT. CL. 42. (U.S. CLS. 100 AND 101). REG. 8-15-1995.
- 1,912,197. CONFIRM. INT. CL. 5. (U.S. CL. 6). REG. 8-15-1995.
- 1,912,532. DURALITE. INT. CL. 19. (U.S. CLS. 1, 12, 33 AND 50). REG. 8-15-1995.
- 1,912,770. OTTAWA - SENATORS AND DESIGN. INT. CL. 41. (U.S. CLS. 100, 101 AND 107). REG. 8-15-1995.
- 1,914,576. ROLLMAX. INT. CL. 9. (U.S. CLS. 21, 23, 26, 36 AND 38). REG. 8-29-1995.
- 1,914,586. INTERNATIONAL TRADEMARK ASSOCIATION. INT. CLS. 9, 16, 41 AND 42. (U.S. CLS. 21, 36, 37, 38, 100 AND 107). REG. 8-29-1995.
- 1,914,732. DEL-CLAMP. INT. CL. 10. (U.S. CLS. 26 AND 44). REG. 8-29-1995.
- 1,915,557. PURPOSE DIMENSION. INT. CL. 41. (U.S. CL. 107). REG. 8-29-1995.
- 1,916,568. MCILHENNY CO. TABASCO PEPPER SAUCE AND DESIGN. INT. CL. 25. (U.S. CLS. 22 AND 39). REG. 9-5-1995.
- 1,917,629. PARROT BEAK. INT. CL. 7. (U.S. CL. 23). REG. 9-12-1995.
- 1,918,024. TOP OF THE WORLD. INT. CL. 25. (U.S. CL. 39). REG. 9-12-1995.
- 1,918,039. BEER IS MY LIFE. INT. CL. 25. (U.S. CL. 39). REG. 9-12-1995.
- 1,918,233. RURAL ROUTE 1. INT. CL. 30. (U.S. CL. 46). REG. 9-12-1995.
- 1,918,677. ENDEAVOUR. INT. CL. 3. (U.S. CLS. 1, 4, 6, 50, 51 AND 52). REG. 9-12-1995.
- 1,918,764. CLICKSEARCH. INT. CL. 9. (U.S. CLS. 21, 23, 26, 36 AND 38). REG. 9-12-1995.
- 1,918,857. POWERCOMM. INT. CL. 20. (U.S. CLS. 2, 13, 22, 25, 32 AND 50). REG. 9-12-1995.
- 1,920,090. BRAND BANDIT. INT. CL. 35. (U.S. CL. 101). REG. 9-19-1995.
- 1,920,597. TIMERX (STYLIZED). INT. CL. 1. (U.S. CL. 6). REG. 9-19-1995.
- 1,920,714. MEDIA RECORDER. INT. CL. 9. (U.S. CLS. 21, 23, 26, 36 AND 38). REG. 9-19-1995.
- 1,920,782. SONOMA. INT. CL. 9. (U.S. CLS. 21, 23, 26, 36 AND 38). REG. 9-19-1995.
- 1,920,977. AMERISPORT. INT. CL. 27. (U.S. CLS. 19, 20, 37, 42 AND 50). REG. 9-19-1995.
- 1,921,282. BARRON. INT. CL. 20. (U.S. CLS. 2, 13, 22, 25, 32 AND 50). REG. 9-19-1995.
- 1,921,482. ULTRA CLAMP. INT. CL. 6. (U.S. CLS. 2, 12, 13, 14, 23, 25 AND 50). REG. 9-26-1995.
- 1,921,502. SHUTTLELIFT. INT. CL. 7. (U.S. CL. 23). REG. 9-26-1995.
- 1,921,540. MAXIGARD. INT. CL. 9. (U.S. CLS. 21, 23, 26, 36 AND 38). REG. 9-26-1995.
- 1,922,392. PROFORMA. INT. CL. 35. (U.S. CLS. 100, 101 AND 102). REG. 9-26-1995.
- 1,922,889. MISCELLANEOUS DESIGN. INT. CL. 16. (U.S. CLS. 2, 5, 22, 23, 29, 37, 38 AND 50). REG. 9-26-1995.
- 1,923,206. EARTH-SMART. INT. CL. 3. (U.S. CLS. 1, 4, 6, 50, 51 AND 52). REG. 10-3-1995.
- 1,923,422. SELECTING WINNERS. INT. CLS. 9, 16 AND 41. (U.S. CLS. 2, 5, 22, 23, 29, 37, 38, 50 AND 107). REG. 10-3-1995.
- 1,924,101. RCM AND DESIGN. INT. CL. 37. (U.S. CL. 103). REG. 10-3-1995.
- 1,924,607. POKEYTOES. INT. CL. 16. (U.S. CLS. 2, 5, 22, 23, 29, 37, 38 AND 50). REG. 10-3-1995.
- 1,925,513. ENVY. INT. CL. 21. (U.S. CLS. 2 AND 37). REG. 10-10-1995.
- 1,926,329. N NATIONAL SEMICONDUCTOR (STYLIZED). INT. CL. 9. (U.S. CLS. 21, 23, 26, 36 AND 38). REG. 10-10-1995.
- 1,927,302. PHRMA (STYLIZED). INT. CLS. 16 AND 42. (U.S. CLS. 38 AND 100). REG. 10-17-1995.
- 1,928,217. HYDRA FORCE. INT. CL. 7. (U.S. CLS. 13, 19, 21, 23, 31, 34 AND 35). REG. 10-17-1995.
- 1,928,218. ARM ADVANCE SENTRY AND DESIGN. INT. CL. 7. (U.S. CLS. 13, 19, 21, 23, 31, 34 AND 35). REG. 10-17-1995.
- 1,928,930. THE PREMIER NAME IN CASINO ENTERTAINMENT. INT. CL. 41. (U.S. CLS. 100, 101 AND 107). REG. 10-24-1995.
- 1,929,420. MISCELLANEOUS DESIGN. INT. CL. 30. (U.S. CL. 46). REG. 10-24-1995.
- 1,929,542. VIRTUOSO. INT. CL. 9. (U.S. CLS. 21, 23, 26, 36 AND 38). REG. 10-24-1995.
- 1,930,126. PREMIER. INT. CL. 9. (U.S. CLS. 21, 23, 26, 36 AND 38). REG. 10-24-1995.
- 1,930,445. CONSOLIDATED PLASTICS COMPANY, INC. (STYLIZED). INT. CLS. 11, 16, 17 AND 21. (U.S. CLS. 1, 2, 5, 12, 13, 21, 23, 29, 30, 31, 33, 34, 35, 40 AND 50). REG. 10-31-1995.
- 1,930,639. WOODLORE AND DESIGN. INT. CL. 11. (U.S. CL. 34). REG. 10-31-1995.
- 1,930,710. APPLETON MFG. DIV.. INT. CL. 7. (U.S. CL. 23). REG. 10-31-1995.
- 1,930,930. SNAPTRUSS. INT. CL. 6. (U.S. CL. 12). REG. 10-31-1995.
- 1,931,082. POWER CAP. INT. CL. 9. (U.S. CLS. 21, 23, 26, 36 AND 38). REG. 10-31-1995.
- 1,931,623. CARE BAND. INT. CL. 5. (U.S. CLS. 6, 18, 44, 46, 51 AND 52). REG. 10-31-1995.
- 1,931,946. PROJECTWORKS. INT. CL. 9. (U.S. CLS. 21, 23, 26, 36 AND 38). REG. 10-31-1995.
- 1,932,706. SATIN STITCHES AND DESIGN. INT. CL. 25. (U.S. CL. 39). REG. 11-7-1995.
- 1,933,713. PYRAMAT. INT. CL. 19. (U.S. CLS. 1, 12, 33 AND 50). REG. 11-7-1995.
- 1,934,687. NEUROZ (STYLIZED). INT. CL. 1. (U.S. CL. 6). REG. 11-14-1995.
- 1,934,787. SIMATIC. INT. CL. 41. (U.S. CLS. 100, 101 AND 107). REG. 11-14-1995.
- 1,934,806. CHILLI MAN. INT. CL. 29. (U.S. CL. 46). REG. 11-14-1995.
- 1,935,570. THE WORLD OF SWEET VALLEY AND DESIGN. INT. CL. 16. (U.S. CLS. 2, 5, 22, 23, 29, 37, 38 AND 50). REG. 11-14-1995.
- 1,935,655. MACJET. INT. CL. 16. (U.S. CLS. 2, 5, 22, 23, 29, 37, 38 AND 50). REG. 11-14-1995.
- 1,935,726. AIMCO. INT. CL. 36. (U.S. CLS. 100, 101 AND 102). REG. 11-14-1995.
- 1,935,819. GIDDYUP. INT. CL. 9. (U.S. CLS. 21, 23, 26, 36 AND 38). REG. 11-14-1995.
- 1,936,117. PERFECTO'S CAFFE AND DESIGN. INT. CL. 42. (U.S. CLS. 100 AND 101). REG. 11-14-1995.
- 1,937,534. ARTEC COLORIST COLLECTION. INT. CL. 3. (U.S. CLS. 1, 4, 6, 50, 51 AND 52). REG. 11-21-1995.
- 1,937,662. SCOTTLINE. INT. CL. 38. (U.S. CLS. 100, 101 AND 104). REG. 11-28-1995.
- 1,938,146. N NANKANG. INT. CL. 12. (U.S. CLS. 19, 21, 23, 31, 35 AND 44). REG. 11-28-1995.
- 1,938,288. SOLUPOR. INT. CLS. 9, 10, 11 AND 17. (U.S. CLS. 1, 5, 12, 13, 21, 23, 26, 31, 34, 35, 36, 38, 39, 44 AND 50). REG. 11-28-1995.
- 1,938,398. MUSIC GO ROUND AND DESIGN. INT. CLS. 35 AND 42. (U.S. CLS. 100, 101 AND 102). REG. 11-28-1995.
- 1,938,868. DIRTBAG. INT. CL. 11. (U.S. CLS. 13, 21, 23, 31 AND 34). REG. 11-28-1995.
- 1,939,204. MICRO RELEASE. INT. CL. 1. (U.S. CL. 6). REG. 12-5-1995.
- 1,939,811. 22MAG. INT. CL. 9. (U.S. CLS. 21, 23, 26, 36 AND 38). REG. 12-5-1995.
- 1,940,071. SIERRA PACIFIC. INT. CL. 39. (U.S. CLS. 100 AND 105). REG. 12-5-1995.
- 1,940,180. FIT. INT. CL. 16. (U.S. CLS. 2, 5, 22, 23, 29, 37, 38 AND 50). REG. 12-5-1995.
- 1,940,587. MISCELLANEOUS DESIGN. INT. CL. 8. (U.S. CLS. 23, 28 AND 44). REG. 12-12-1995.
- 1,940,588. MISCELLANEOUS DESIGN. INT. CL. 8. (U.S. CLS. 23, 28 AND 44). REG. 12-12-1995.
- 1,940,692. DRYLOK. INT. CLS. 1, 2, 16 AND 19. (U.S. CLS. 1, 2, 5, 6, 10, 11, 12, 16, 22, 23, 26, 29, 33, 37, 38, 46 AND 50). REG. 12-12-1995.
- 1,941,687. RHEOVAC. INT. CL. 9. (U.S. CLS. 21, 23, 26, 36 AND 38). REG. 12-12-1995.
- 1,941,784. INTELLILIGHT. INT. CL. 38. (U.S. CLS. 100, 101 AND 104). REG. 12-12-1995.
- 1,941,786. XELA PACK. INT. CL. 16. (U.S. CLS. 2, 5, 22, 23, 29, 37, 38 AND 50). REG. 12-12-1995.
- 1,942,437. MISCELLANEOUS DESIGN. INT. CL. 9. (U.S. CLS. 21, 23, 26, 36 AND 38). REG. 12-19-1995.
- 1,943,518. SATIN STITCHES. INT. CL. 25. (U.S. CL. 39). REG. 12-26-1995.
- 1,943,970. HELP ALERT. INT. CL. 9. (U.S. CLS. 21, 23, 26, 36 AND 38). REG. 12-26-1995.

- 1,944,546. TROPICANA SEASON'S BEST AND DESIGN. INT. CL. 32. (U.S. CLS. 45, 46 AND 48). REG. 12-26-1995.
- 1,945,545. EVS. INT. CL. 10. (U.S. CLS. 26, 39 AND 44). REG. 1-2-1996.
- 1,946,898. SMART RECOVERY. INT. CL. 42. (U.S. CLS. 100 AND 101). REG. 1-9-1996.
- 1,947,816. GRIT KING. INT. CL. 11. (U.S. CLS. 13, 21, 23, 31 AND 34). REG. 1-16-1996.
- 1,948,463. SCRATCH FREE. INT. CL. 5. (U.S. CLS. 6, 18, 44, 46, 51 AND 52). REG. 1-16-1996.
- 1,948,734. SMITH & HOOK. INT. CL. 33. (U.S. CLS. 47 AND 49). REG. 1-16-1996.
- 1,948,940. SUPER SAVER. INT. CL. 41. (U.S. CLS. 100, 101 AND 107). REG. 1-16-1996.
- 1,949,555. REHABVISIONS. INT. CL. 42. (U.S. CLS. 100 AND 101). REG. 1-16-1996.
- 1,950,993. SMITH & HOOK AND DESIGN. INT. CL. 33. (U.S. CLS. 47 AND 49). REG. 1-23-1996.
- 1,951,931. STEP-N-DROP. INT. CL. 6. (U.S. CLS. 2, 12, 13, 14, 23, 25 AND 50). REG. 1-23-1996.
- 1,955,617. TECHXCHANGE. INT. CL. 35. (U.S. CL. 105). REG. 2-13-1996.
- 1,956,277. AMERIWHITE. INT. CL. 21. (U.S. CLS. 2, 13, 23, 29, 30, 33, 40 AND 50). REG. 2-13-1996.
- 1,956,350. WATERWAY. INT. CLS. 7 AND 11. (U.S. CLS. 13, 19, 21, 23, 31, 34 AND 35). REG. 2-13-1996.
- 1,956,616. W AND DESIGN. INT. CLS. 7 AND 11. (U.S. CLS. 13, 19, 21, 23, 31, 34 AND 35). REG. 2-13-1996.
- 1,958,077. GOOFUS AND GALLANT. INT. CL. 16. (U.S. CLS. 2, 5, 22, 23, 29, 37, 38 AND 50). REG. 2-20-1996.
- 1,958,088. LIFE CENTER. INT. CLS. 41 AND 42. (U.S. CLS. 100, 101 AND 107). REG. 2-20-1996.
- 1,959,026. YES I CAN. INT. CL. 42. (U.S. CLS. 100 AND 101). REG. 2-27-1996.
- 1,959,262. KWALU. INT. CL. 20. (U.S. CLS. 2, 13, 22, 25, 32 AND 50). REG. 2-27-1996.
- 1,960,422. GREENSTONE. INT. CL. 5. (U.S. CLS. 6, 18, 44, 46, 51 AND 52). REG. 3-5-1996.
- 1,962,781. PRIME SOURCE. INT. CL. 3. (U.S. CLS. 1, 4, 6, 50, 51 AND 52). REG. 3-19-1996.
- 1,962,799. LEADING EDGE SAFETY SYSTEMS AND DESIGN. INT. CLS. 9 AND 37. (U.S. CLS. 21, 23, 26, 36, 38 AND 103). REG. 3-19-1996.
- 1,962,997. RED BANK CLOTHING CO.. INT. CL. 25. (U.S. CLS. 22 AND 39). REG. 3-19-1996.
- 1,964,003. SUPER PICKLE. INT. CL. 1. (U.S. CLS. 1, 5, 6, 10, 26 AND 46). REG. 3-26-1996.
- 1,964,069. SYNERGY. INT. CL. 37. (U.S. CLS. 100, 103 AND 106). REG. 3-26-1996.
- 1,964,225. FRIENDS OF THE HALL OF FAME. U.S. CL. 200. REG. 3-26-1996.
- 1,964,518. PONG-MASTER. INT. CL. 28. (U.S. CLS. 22, 23, 38 AND 50). REG. 3-26-1996.
- 1,965,111. RATTLIN' WIGGLER. INT. CL. 28. (U.S. CLS. 22, 23, 38 AND 50). REG. 4-2-1996.
- 1,965,919. FOLD-A-LEAF. INT. CL. 20. (U.S. CLS. 2, 13, 22, 25, 32 AND 50). REG. 4-2-1996.
- 1,966,088. TRADE MARK CG (STYLIZED). INT. CL. 19. (U.S. CL. 12). REG. 4-9-1996.
- 1,966,344. STATSOFT. INT. CL. 9. (U.S. CLS. 21, 23, 26, 36 AND 38). REG. 4-9-1996.
- 1,966,416. CLARISSA. INT. CL. 16. (U.S. CLS. 2, 5, 22, 23, 29, 37, 38 AND 50). REG. 4-9-1996.
- 1,966,650. L'ECOLE NO 41. INT. CL. 33. (U.S. CLS. 47 AND 49). REG. 4-9-1996.
- 1,966,950. FOX LOGISTICS AND DESIGN. INT. CL. 39. (U.S. CLS. 100 AND 105). REG. 4-9-1996.
- 1,970,955. S STERLING PUBLISHING CO., INC. (STYLIZED). INT. CL. 16. (U.S. CLS. 2, 5, 22, 23, 29, 37, 38 AND 50). REG. 4-30-1996.
- 1,972,882. GDM. INT. CL. 11. (U.S. CLS. 13, 21, 23, 31 AND 34). REG. 5-7-1996.
- 1,972,950. DIFIL-G. INT. CL. 5. (U.S. CLS. 6, 18, 44, 46, 51 AND 52). REG. 5-7-1996.
- 1,973,165. MISCELLANEOUS DESIGN. INT. CL. 5. (U.S. CLS. 6, 18, 44, 46, 51 AND 52). REG. 5-7-1996.
- 1,973,456. FALCON. INT. CL. 5. (U.S. CLS. 6, 18, 44, 46, 51 AND 52). REG. 5-7-1996.
- 1,974,010. INFOVISA. INT. CLS. 37 AND 42. (U.S. CLS. 100, 101, 103 AND 106). REG. 5-14-1996.
- 1,974,541. PRO-MASK BLUE. INT. CL. 17. (U.S. CLS. 1, 5, 12, 13, 35 AND 50). REG. 5-21-1996.
- 1,975,051. KEYSTONE AND DESIGN. INT. CL. 16. (U.S. CLS. 2, 5, 22, 23, 29, 37, 38 AND 50). REG. 5-21-1996.
- 1,976,153. THE TORNADO. INT. CL. 28. (U.S. CLS. 22, 23, 38 AND 50). REG. 5-28-1996.
- 1,976,459. THE PIZZA PIPELINE (STYLIZED). INT. CL. 42. (U.S. CLS. 100 AND 101). REG. 5-28-1996.
- 1,976,944. DRIRITE. INT. CL. 37. (U.S. CLS. 100, 103 AND 106). REG. 5-28-1996.
- 1,979,703. WIZARD. INT. CL. 1. (U.S. CLS. 1, 5, 6, 10, 26 AND 46). REG. 6-11-1996.

* * * * *

TRADEMARK REGISTRATIONS CANCELED

The designation "U.S. Cl." appearing in this section refers to the U.S. class in effect prior to Sep. 1, 1973 rather than the international class which applies to applications filed on or after that date. For adoption of international classification see notice in the OFFICIAL GAZETTE of Jun. 26, 1973 (911 O.G. TM 210).

SECTION 7(D)

- 1,807,235. A COURSE IN MIRACLES. INT. CLS. 9, 16 AND 41. REG. 11-30-1993.
2,128,506. ECCO IL PANE. INT. CL. 30. REG. 1-13-1998.
2,213,779. PALAVAC. INT. CLS. 1 AND 10. REG. 12-29-1998.
2,219,360. MESIROW FINANCIAL'S GOES SYSTEM. INT. CL. 36. REG. 1-19-1999.
2,286,995. MYSTIC LOOP. INT. CL. 25. REG. 10-19-1999.
2,288,425. ADVATROL. INT. CL. 5. REG. 10-26-1999.
2,345,879. LITTLE RED CHAIR BOOKS. INT. CL. 16. REG. 4-25-2000.
2,705,405. FLEETWORKS. INT. CLS. 35 AND 36. REG. 4-8-2003.
2,726,250. SBG CHARRETTE. INT. CL. 35. REG. 6-17-2003.
2,791,480. KANGOL AND DESIGN. INT. CL. 25. REG. 12-9-2003.
2,795,470. ARTIVA. INT. CL. 9. REG. 12-16-2003.
2,805,988. OUTFITTER JOURNAL. INT. CL. 16. REG. 1-13-2004.
2,846,597. OPX PARTNERS, LLC AND DESIGN. INT. CL. 42. REG. 5-25-2004.
2,852,326. THE POWER TO CHANGE THE WORLD. INT. CLS. 35, 40 AND 42. REG. 6-15-2004.
2,887,245. SUNBURST CENTER AND DESIGN. INT. CL. 44. REG. 9-21-2004.
2,892,176. NABOR NAPLES AREA BOARD OF REALTORS AND ASSOCIATION OF REAL ESTATE PROFESSIONALS AND DESIGN. INT. CLS. 16, 36, 38, 41 AND 42. REG. 10-12-2004.
2,944,887. DEFINITION. INT. CL. 9. REG. 4-26-2005.
2,947,343. PASHAH.COM AND DESIGN. INT. CL. 3. REG. 5-10-2005.
2,954,213. WORKFORCE AND DESIGN. INT. CL. 25. REG. 5-24-2005.
- 779,539. MARVEL. U.S. CL. 46. REG. 11-3-1964.
779,560. GRAND PRIZE. U.S. CL. 46. REG. 11-3-1964.
779,569. CAL-GROVE. U.S. CL. 46. REG. 11-3-1964.
779,581. GOLDEN LEPRECHAUN LIGHT BEER AND DESIGN. U.S. CL. 48. REG. 11-3-1964.
779,624. SLURRY SEAL AND DESIGN. U.S. CL. 100. REG. 11-3-1964.
779,641. I C AND DESIGN. U.S. CL. 102. REG. 11-3-1964.
779,661. BEEF (STYLIZED). U.S. CL. 38. REG. 11-3-1964.
779,663. GAETANO'S. U.S. CL. 46. REG. 11-3-1964.
779,666. SOMETHING SPECIAL FROM THE WONDERFUL WORLD OF CHOCOLATE. U.S. CL. 46. REG. 11-3-1964.
799,535. K AND DESIGN. U.S. CL. 38, ONLY. REG. 11-30-1965.
997,239. SUMACAL. INT. CL. 5. REG. 11-5-1974.
997,460. GEL-FLO. U.S. CL. 16. REG. 11-5-1974.
997,547. RAYMOND. U.S. CL. 26. REG. 11-5-1974.
997,740. PIP POSTAL INSTANT PRESS AND DESIGN. U.S. CL. 101. REG. 11-5-1974.
1,226,680. ADVANTAGE. INT. CL. 21. REG. 2-8-1983.
1,253,091. YARS' REVENGE. INT. CL. 28. REG. 10-4-1983.
1,270,920. MARSHALL FIELD'S (STYLIZED). INT. CL. 29 ONLY. REG. 3-20-1984.
1,279,509. THERMOLIZER (STYLIZED). INT. CL. 3. REG. 5-29-1984.
1,293,688. MISCELLANEOUS DESIGN. INT. CL. 5 ONLY. REG. 9-11-1984.
1,302,312. S AND DESIGN. INT. CLS. 1, 2, 3, 4 AND 17. REG. 10-30-1984.
1,302,314. DYNALITH. INT. CL. 1. REG. 10-30-1984.
1,302,315. LIGHTEN-UP. INT. CL. 1. REG. 10-30-1984.
1,302,318. COPYCOLOR. INT. CL. 1. REG. 10-30-1984.
1,302,320. MISCELLANEOUS DESIGN. INT. CL. 1. REG. 10-30-1984.
1,302,327. MISCELLANEOUS DESIGN. INT. CLS. 1, 5 AND 42. REG. 10-30-1984.
1,302,331. SURF-COVER. INT. CL. 2. REG. 10-30-1984.
1,302,333. WOODPRESSURE. INT. CL. 2. REG. 10-30-1984.
1,302,338. MISCELLANEOUS DESIGN. INT. CL. 3. REG. 10-30-1984.
1,302,344. COLOR SHEERS. INT. CL. 3. REG. 10-30-1984.
1,302,347. SANS SOUCIS AND DESIGN. INT. CL. 3. REG. 10-30-1984.
1,302,348. SANS SOUCIS AND DESIGN. INT. CL. 3. REG. 10-30-1984.
1,302,349. GUHL AND DESIGN. INT. CL. 3. REG. 10-30-1984.
1,302,350. LAFINE (STYLIZED). INT. CL. 3. REG. 10-30-1984.
1,302,356. GALLOP. INT. CL. 3. REG. 10-30-1984.
1,302,360. AFFINITY. INT. CL. 3. REG. 10-30-1984.
1,302,362. WF AND DESIGN. INT. CL. 4. REG. 10-30-1984.
1,302,363. MAXZOL. INT. CL. 4. REG. 10-30-1984.
1,302,383. WOUND-AID. INT. CL. 5. REG. 10-30-1984.
1,302,387. INSECTAWAY. INT. CLS. 5 AND 7. REG. 10-30-1984.
1,302,393. ABLOY DISKLOCK. INT. CL. 6. REG. 10-30-1984.
1,302,398. WEST CRANE POWER SYSTEMS AND DESIGN. INT. CL. 7. REG. 10-30-1984.
1,302,403. CROSSTALK. INT. CL. 9. REG. 10-30-1984.
1,302,404. THE CROWNSMEN. INT. CLS. 9 AND 41. REG. 10-30-1984.
1,302,416. COTS. INT. CL. 9. REG. 10-30-1984.
1,302,417. BYTEL. INT. CLS. 9 AND 16. REG. 10-30-1984.

SECTION 8

- 191,286. TRUEWORTH. U.S. CL. 46. REG. 11-4-1924.
409,924. GI (STYLIZED). U.S. CL. 21. REG. 10-31-1944.
597,687. SOUTH SHORE AND DESIGN. U.S. CL. 46. REG. 11-2-1954.
779,269. CUPREX. U.S. CL. 6. REG. 11-3-1964.
779,273. FEEDOL. U.S. CL. 6. REG. 11-3-1964.
779,290. VAN-GLO. U.S. CL. 6. REG. 11-3-1964.
779,313. LEAD GASKET. U.S. CL. 13. REG. 11-3-1964.
779,363. DECADERM. U.S. CL. 18. REG. 11-3-1964.
779,384. SERVITA. U.S. CL. 19. REG. 11-3-1964.
779,410. OSBORN AND DESIGN. U.S. CL. 23. REG. 11-3-1964.
779,454. CP. U.S. CL. 31. REG. 11-3-1964.
779,459. VENTROL. U.S. CL. 34. REG. 11-3-1964.
779,464. STRATFORD. U.S. CL. 36. REG. 11-3-1964.
779,472. GOLDEN REY AND DESIGN. U.S. CL. 37. REG. 11-3-1964.
779,491. ROYAL DAN. U.S. CL. 39. REG. 11-3-1964.
779,521. MILLITRIM. U.S. CL. 42. REG. 11-3-1964.

- 1,302,430. WINDSOR TELECOMMUNICATIONS. INT. CL. 9. REG. 10-30-1984.
- 1,302,432. DESIGN LINE. INT. CLS. 9 AND 11. REG. 10-30-1984.
- 1,302,436. ISEGLO (STYLIZED). INT. CL. 9. REG. 10-30-1984.
- 1,302,437. ISECOLOR (STYLIZED). INT. CL. 9. REG. 10-30-1984.
- 1,302,455. PSE. INT. CL. 9. REG. 10-30-1984.
- 1,302,465. K*TEC ELECTRONICS. INT. CL. 9. REG. 10-30-1984.
- 1,302,467. AO AND DESIGN. INT. CL. 9. REG. 10-30-1984.
- 1,302,473. EB. INT. CL. 10. REG. 10-30-1984.
- 1,302,474. MEDI-LOFT. INT. CL. 10. REG. 10-30-1984.
- 1,302,478. NEO-CATH. INT. CL. 10. REG. 10-30-1984.
- 1,302,480. BABYTAINER. INT. CL. 10. REG. 10-30-1984.
- 1,302,483. MHP. INT. CL. 11. REG. 10-30-1984.
- 1,302,484. AUTOPLATE. INT. CL. 11. REG. 10-30-1984.
- 1,302,486. STOWAY. INT. CL. 12. REG. 10-30-1984.
- 1,302,487. DIESEL-AMERICA. INT. CL. 12. REG. 10-30-1984.
- 1,302,489. DIESEL-AMERICA AND DESIGN. INT. CL. 12. REG. 10-30-1984.
- 1,302,490. TUFFSKIRT. INT. CL. 12. REG. 10-30-1984.
- 1,302,491. CHARIOT VANS. INT. CL. 12. REG. 10-30-1984.
- 1,302,493. MISCELLANEOUS DESIGN. INT. CL. 12. REG. 10-30-1984.
- 1,302,495. DYNOUS (STYLIZED). INT. CL. 12. REG. 10-30-1984.
- 1,302,497. DEHANDLERS. INT. CL. 12. REG. 10-30-1984.
- 1,302,498. CADGARD. INT. CL. 12. REG. 10-30-1984.
- 1,302,501. ATKINSON'S TRADING POST. INT. CLS. 14 AND 21. REG. 10-30-1984.
- 1,302,528. BO-X-PACK. INT. CL. 16. REG. 10-30-1984.
- 1,302,530. ROMPER ROOM RR AND DESIGN. INT. CLS. 16 AND 28. REG. 10-30-1984.
- 1,302,543. CHANNELS TO CHILDREN AND DESIGN. INT. CLS. 16 AND 41. REG. 10-30-1984.
- 1,302,545. MISCELLANEOUS DESIGN. INT. CLS. 16 AND 39. REG. 10-30-1984.
- 1,302,554. ON APPROACH AND DESIGN. INT. CL. 16. REG. 10-30-1984.
- 1,302,556. ZIP GUIDE. INT. CL. 16. REG. 10-30-1984.
- 1,302,557. THE COOKING EXPERIENCE. INT. CL. 16. REG. 10-30-1984.
- 1,302,561. TRADECENTER TRENDS. INT. CL. 16. REG. 10-30-1984.
- 1,302,562. WIDGET. INT. CL. 16. REG. 10-30-1984.
- 1,302,583. FASTBALL AND DESIGN. INT. CL. 16. REG. 10-30-1984.
- 1,302,587. GREETING MATS. INT. CL. 16. REG. 10-30-1984.
- 1,302,590. POWER CUTS. INT. CL. 16. REG. 10-30-1984.
- 1,302,593. AVERT. INT. CL. 16. REG. 10-30-1984.
- 1,302,594. COLDGUARD. INT. CL. 16. REG. 10-30-1984.
- 1,302,602. AIR. INT. CL. 16. REG. 10-30-1984.
- 1,302,606. H F D THE WEEKLY HOME FURNISHINGS NEWSPAPER AND DESIGN. INT. CL. 16. REG. 10-30-1984.
- 1,302,612. ACE AND DESIGN. INT. CL. 18. REG. 10-30-1984.
- 1,302,613. FASHION CLUB. INT. CL. 18. REG. 10-30-1984.
- 1,302,620. MISCELLANEOUS DESIGN. INT. CL. 18. REG. 10-30-1984.
- 1,302,621. J. SETH. INT. CLS. 18 AND 25. REG. 10-30-1984.
- 1,302,624. TUFF-STUFF. INT. CL. 18. REG. 10-30-1984.
- 1,302,630. DECK-PAK. INT. CL. 19. REG. 10-30-1984.
- 1,302,631. WEZ. INT. CLS. 20 AND 21. REG. 10-30-1984.
- 1,302,634. TEXTON. INT. CL. 20. REG. 10-30-1984.
- 1,302,635. WESCHO. INT. CL. 20. REG. 10-30-1984.
- 1,302,641. LUXO AND DESIGN. INT. CL. 20. REG. 10-30-1984.
- 1,302,645. NORCROSS AND DESIGN. INT. CL. 20. REG. 10-30-1984.
- 1,302,654. QUEEN ANNE. INT. CL. 21. REG. 10-30-1984.
- 1,302,658. BURVELLE'S EDUCATED CAKE PAN. INT. CL. 21. REG. 10-30-1984.
- 1,302,659. DURA-PRO. INT. CL. 21. REG. 10-30-1984.
- 1,302,669. MIGHTY MUG. INT. CL. 21. REG. 10-30-1984.
- 1,302,677. SPAVILION. INT. CL. 22. REG. 10-30-1984.
- 1,302,679. TYLON. INT. CL. 23. REG. 10-30-1984.
- 1,302,684. VEROPAQUE (STYLIZED). INT. CL. 24. REG. 10-30-1984.
- 1,302,686. CORTLEY. INT. CL. 24. REG. 10-30-1984.
- 1,302,687. CORTLEY DRAPERIES FASHIONED BY CORTLEY AND DESIGN. INT. CL. 24. REG. 10-30-1984.
- 1,302,689. FARIBO AND DESIGN. INT. CL. 24. REG. 10-30-1984.
- 1,302,691. POPUL-7 (STYLIZED). INT. CL. 24. REG. 10-30-1984.
- 1,302,696. TABLE CHARM. INT. CL. 24. REG. 10-30-1984.
- 1,302,700. W.F.M.. INT. CL. 25. REG. 10-30-1984.
- 1,302,702. SCHRADER. INT. CL. 25. REG. 10-30-1984.
- 1,302,712. KRIZIA POI (STYLIZED). INT. CL. 25. REG. 10-30-1984.
- 1,302,713. COLLECTORS SHOP. INT. CL. 25. REG. 10-30-1984.
- 1,302,720. CLARION HILL AND DESIGN. INT. CL. 25. REG. 10-30-1984.
- 1,302,726. COAT WORKS. INT. CL. 25. REG. 10-30-1984.
- 1,302,727. JONATHAN BROMWELL. INT. CL. 25. REG. 10-30-1984.
- 1,302,729. SALSERO AND DESIGN. INT. CL. 25. REG. 10-30-1984.
- 1,302,740. VICTORIA LANE. INT. CL. 25. REG. 10-30-1984.
- 1,302,743. KENAR ENTERPRISES LTD.. INT. CL. 25. REG. 10-30-1984.
- 1,302,744. S AND DESIGN. INT. CL. 25. REG. 10-30-1984.
- 1,302,745. ME & MINE. INT. CL. 25. REG. 10-30-1984.
- 1,302,754. CAPEZIO (STYLIZED). INT. CL. 25. REG. 10-30-1984.
- 1,302,757. SUN RUNNER AND DESIGN. INT. CL. 25. REG. 10-30-1984.
- 1,302,758. TRAVEL-LITE (STYLIZED). INT. CL. 25. REG. 10-30-1984.
- 1,302,761. WEST END. INT. CL. 25. REG. 10-30-1984.
- 1,302,762. WOODSTONE. INT. CL. 25. REG. 10-30-1984.
- 1,302,766. MEGAFLEX. INT. CL. 25. REG. 10-30-1984.
- 1,302,773. SUMMERALLS. INT. CL. 25. REG. 10-30-1984.
- 1,302,776. LIZ SINCLAIR. INT. CL. 25. REG. 10-30-1984.
- 1,302,777. BOSTON TRADERS AND DESIGN. INT. CL. 25. REG. 10-30-1984.
- 1,302,780. EXECUTIVE FOCUS AND DESIGN. INT. CL. 25. REG. 10-30-1984.
- 1,302,781. KAYNEE (STYLIZED). INT. CL. 25. REG. 10-30-1984.
- 1,302,792. TUNETOWN, USA. INT. CL. 28. REG. 10-30-1984.
- 1,302,795. LITE-UP. INT. CL. 28. REG. 10-30-1984.
- 1,302,800. RAFAEL DANIELS. INT. CL. 28. REG. 10-30-1984.
- 1,302,811. COMPUTER COMMAND. INT. CL. 28. REG. 10-30-1984.
- 1,302,817. MONTY AND DESIGN. INT. CL. 28. REG. 10-30-1984.
- 1,302,818. MONTY (STYLIZED). INT. CL. 28. REG. 10-30-1984.
- 1,302,820. SWEET ROSES. INT. CL. 28. REG. 10-30-1984.
- 1,302,824. COLONY 7. INT. CL. 28. REG. 10-30-1984.
- 1,302,825. VECTOR. INT. CL. 28. REG. 10-30-1984.
- 1,302,832. AMERICAN JUNIOR AND DESIGN. INT. CL. 28. REG. 10-30-1984.
- 1,302,834. 10-YARD FIGHT. INT. CL. 28. REG. 10-30-1984.
- 1,302,836. GAMBINA AND DESIGN. INT. CL. 28. REG. 10-30-1984.
- 1,302,837. MARIE LAVEAU. INT. CL. 28. REG. 10-30-1984.
- 1,302,841. COMBAT FORCE. INT. CL. 28. REG. 10-30-1984.
- 1,302,859. BAHL BABY (STYLIZED). INT. CL. 29. REG. 10-30-1984.
- 1,302,860. FENNIMORE CHEESE FENNIMORE CHEESE FENNIMORE CHEESE (STYLIZED). INT. CLS. 29 AND 42. REG. 10-30-1984.
- 1,302,863. NACH-OLE (STYLIZED). INT. CL. 29. REG. 10-30-1984.
- 1,302,872. MISCELLANEOUS DESIGN. INT. CL. 29. REG. 10-30-1984.
- 1,302,873. GREEN COUNTY OF WISCONSIN AND DESIGN. INT. CLS. 29 AND 30. REG. 10-30-1984.
- 1,302,874. GREEN COUNTY. INT. CLS. 29 AND 30. REG. 10-30-1984.

- 1,302,875. FRUIT NUGGETS. INT. CL. 29. REG. 10-30-1984.
 1,302,876. VALMAGE. INT. CL. 29. REG. 10-30-1984.
 1,302,878. HERSHEY MEATS. INT. CL. 29. REG. 10-30-1984.
 1,302,881. CHEF-EASE. INT. CL. 29. REG. 10-30-1984.
 1,302,882. MISCELLANEOUS DESIGN. INT. CL. 29. REG. 10-30-1984.
 1,302,883. ST SUPER TRU AND DESIGN. INT. CL. 29. REG. 10-30-1984.
 1,302,887. NORMEAT. INT. CL. 29. REG. 10-30-1984.
 1,302,890. MISCELLANEOUS DESIGN. INT. CLS. 29, 30 AND 31. REG. 10-30-1984.
 1,302,896. MAGIC VALLEY. INT. CL. 29. REG. 10-30-1984.
 1,302,898. ROAST 82. INT. CL. 29. REG. 10-30-1984.
 1,302,899. ROAST AND DESIGN. INT. CL. 29. REG. 10-30-1984.
 1,302,901. JOUVANCE. INT. CL. 29. REG. 10-30-1984.
 1,302,903. MRS. APPELYARD'S. INT. CLS. 29 AND 30. REG. 10-30-1984.
 1,302,904. MIGHTY CASEY'S. INT. CLS. 29 AND 30. REG. 10-30-1984.
 1,302,905. MIGHTY CASEY'S AND DESIGN. INT. CLS. 29 AND 30. REG. 10-30-1984.
 1,302,906. S&W (STYLIZED). INT. CLS. 29, 30, 31 AND 32. REG. 10-30-1984.
 1,302,914. PARTY PIG. INT. CL. 29. REG. 10-30-1984.
 1,302,915. GRAND ESTATE (STYLIZED). INT. CL. 29. REG. 10-30-1984.
 1,302,925. SUSAN'S SWEET TALK. INT. CL. 30. REG. 10-30-1984.
 1,302,928. TASTEE TATTOOS AND DESIGN. INT. CL. 30. REG. 10-30-1984.
 1,302,937. SPICE MERCHANT. INT. CL. 30. REG. 10-30-1984.
 1,302,941. MANSKE ROLLS. INT. CL. 30. REG. 10-30-1984.
 1,302,942. POPPERS PARTY STOPPERS (STYLIZED). INT. CL. 30. REG. 10-30-1984.
 1,302,943. POPPERS SUPPLY (STYLIZED). INT. CL. 30. REG. 10-30-1984.
 1,302,945. MISCELLANEOUS DESIGN. INT. CL. 30. REG. 10-30-1984.
 1,302,950. MISCELLANEOUS DESIGN. INT. CL. 30. REG. 10-30-1984.
 1,302,959. BRIO. INT. CL. 30. REG. 10-30-1984.
 1,302,960. DON COYOTE AND DESIGN. INT. CL. 30. REG. 10-30-1984.
 1,302,962. MANDARIN CHEF. INT. CL. 30. REG. 10-30-1984.
 1,302,965. ZOORONI. INT. CL. 30. REG. 10-30-1984.
 1,302,967. STACK. INT. CL. 30. REG. 10-30-1984.
 1,302,970. STAR WARS. INT. CL. 30. REG. 10-30-1984.
 1,302,971. WALNUT HILL - 1788. INT. CL. 30. REG. 10-30-1984.
 1,302,972. STEINFELD'S WESTERN ACRES AND DESIGN. INT. CL. 30. REG. 10-30-1984.
 1,302,975. R & R BOURBON STREET. INT. CL. 30. REG. 10-30-1984.
 1,302,978. SPREADIN' HONEY. INT. CL. 30. REG. 10-30-1984.
 1,302,985. ENDOWMENT. INT. CL. 31. REG. 10-30-1984.
 1,302,987. 1ST CHOICE. INT. CL. 31. REG. 10-30-1984.
 1,302,991. PEPSI 100. INT. CL. 32. REG. 10-30-1984.
 1,302,997. BK BOWEY KRIMKO AND DESIGN. INT. CL. 32. REG. 10-30-1984.
 1,302,999. TREEFRESHING. INT. CL. 32. REG. 10-30-1984.
 1,303,007. TURA'. INT. CL. 33. REG. 10-30-1984.
 1,303,015. PICK 'N SAVE. INT. CL. 33. REG. 10-30-1984.
 1,303,017. L&R (STYLIZED). INT. CL. 33. REG. 10-30-1984.
 1,303,018. SILVERSTONE CELLARS (STYLIZED). INT. CL. 33. REG. 10-30-1984.
 1,303,023. PRIVATE STOCK SF&S CABINET SELECTION AND DESIGN. INT. CL. 34. REG. 10-30-1984.
 1,303,030. ASME AND DESIGN. INT. CL. 35. REG. 10-30-1984.
 1,303,037. RATES RAPID ACCESS TARIFF EXPEDITING SERVICE AND DESIGN. INT. CL. 35. REG. 10-30-1984.
 1,303,042. CITIFILE. INT. CL. 35. REG. 10-30-1984.
 1,303,046. ACCELERATOR. INT. CL. 35. REG. 10-30-1984.
 1,303,047. SUPER GROUP. INT. CL. 35. REG. 10-30-1984.
 1,303,048. TACSNET. INT. CL. 35. REG. 10-30-1984.
 1,303,052. CAP. INT. CL. 35. REG. 10-30-1984.
 1,303,064. IRA EXPRESS. INT. CL. 36. REG. 10-30-1984.
 1,303,066. INSURING THE GOOD LIFE. INT. CL. 36. REG. 10-30-1984.
 1,303,069. FEDFACTS. INT. CL. 36. REG. 10-30-1984.
 1,303,078. USF&G CORPORATION. INT. CL. 36. REG. 10-30-1984.
 1,303,082. MISCELLANEOUS DESIGN. INT. CL. 36. REG. 10-30-1984.
 1,303,086. QUANTEX (STYLIZED). INT. CLS. 36 AND 42. REG. 10-30-1984.
 1,303,087. ARIENS POWER CHARGE (STYLIZED). INT. CL. 36. REG. 10-30-1984.
 1,303,088. THE BANK WORTH KNOWING (STYLIZED). INT. CL. 36. REG. 10-30-1984.
 1,303,089. MAQS. INT. CL. 36. REG. 10-30-1984.
 1,303,090. U. S. TIMELINE. INT. CL. 36. REG. 10-30-1984.
 1,303,092. MISCELLANEOUS DESIGN. INT. CL. 36. REG. 10-30-1984.
 1,303,093. STEP 10. INT. CL. 36. REG. 10-30-1984.
 1,303,097. MERCLINE. INT. CL. 36. REG. 10-30-1984.
 1,303,098. PRIME PROTECTION. INT. CL. 36. REG. 10-30-1984.
 1,303,100. BANK ON THE LEADER AND DESIGN. INT. CL. 36. REG. 10-30-1984.
 1,303,103. RELOCATION COUNSELING CENTER AND DESIGN. INT. CL. 36. REG. 10-30-1984.
 1,303,104. AVPAC AND DESIGN. INT. CL. 36. REG. 10-30-1984.
 1,303,105. EXPRESS OFFICE. INT. CL. 36. REG. 10-30-1984.
 1,303,109. RED ALARM AND DESIGN. INT. CL. 37. REG. 10-30-1984.
 1,303,111. MISCELLANEOUS DESIGN. INT. CLS. 37 AND 42. REG. 10-30-1984.
 1,303,112. WE WESTERN ENGINE CO. AND DESIGN. INT. CLS. 37 AND 42. REG. 10-30-1984.
 1,303,122. BUG GOBBLER AND DESIGN. INT. CL. 37. REG. 10-30-1984.
 1,303,125. DDS. INT. CL. 37. REG. 10-30-1984.
 1,303,137. HOLLAND AMERICA AND DESIGN. INT. CL. 39. REG. 10-30-1984.
 1,303,138. THE COMPANY AIRLINE. INT. CL. 39. REG. 10-30-1984.
 1,303,141. AERONAUTICS AND DESIGN. INT. CL. 39. REG. 10-30-1984.
 1,303,143. THE HOLDING COMPANY. INT. CL. 39. REG. 10-30-1984.
 1,303,144. MISCELLANEOUS DESIGN. INT. CL. 39. REG. 10-30-1984.
 1,303,145. SONG OF AMERICA. INT. CL. 39. REG. 10-30-1984.
 1,303,153. GET-UP-AND-GO PASSPORT. INT. CL. 39. REG. 10-30-1984.
 1,303,155. RK SKILLS TRAINING ACHIEVEMENT RECOGNITION STAR AND DESIGN. INT. CL. 41. REG. 10-30-1984.
 1,303,165. CABALLERO CONTROL CORPORATION HOME VIDEO (STYLIZED). INT. CL. 41. REG. 10-30-1984.
 1,303,166. THE RESULT LINE. INT. CL. 41. REG. 10-30-1984.
 1,303,170. AMERICAN COLLEGE OF VETERINARY SURGEONS AND DESIGN. INT. CLS. 41 AND 42. REG. 10-30-1984.
 1,303,173. MISCELLANEOUS DESIGN. INT. CL. 41. REG. 10-30-1984.
 1,303,174. POSITIVICS (STYLIZED). INT. CL. 41. REG. 10-30-1984.
 1,303,182. PLAYORENA. INT. CL. 41. REG. 10-30-1984.
 1,303,189. COLBY COLLEGE WATERVILLE MAINE CHARTERED 1813 AND DESIGN. INT. CL. 41. REG. 10-30-1984.
 1,303,194. INTERMOUNTAIN CONCERTS. INT. CL. 41. REG. 10-30-1984.
 1,303,199. HEALTHSENSE. INT. CL. 41. REG. 10-30-1984.
 1,303,203. PUBLIC PHONE STORES AND DESIGN. INT. CL. 42. REG. 10-30-1984.
 1,303,204. AS YOU LIKE IT. INT. CL. 42. REG. 10-30-1984.

- 1,303,205. LES PRES RESTAURANT CAFE. AND DESIGN. INT. CL. 42. REG. 10-30-1984.
- 1,303,210. THE ROCKER SHOP OF MARIETTA GEORGIA AND DESIGN. INT. CL. 42. REG. 10-30-1984.
- 1,303,214. PRINCE HOTELS. INT. CL. 42. REG. 10-30-1984.
- 1,303,220. SD SOFTWARE DIMENSIONS INC. AND DESIGN. INT. CL. 42. REG. 10-30-1984.
- 1,303,221. PAN AMERICAN OCEAN RESORT HOTEL AND DESIGN. INT. CL. 42. REG. 10-30-1984.
- 1,303,227. TIRES AIN'T PRETTY. INT. CL. 42. REG. 10-30-1984.
- 1,303,231. HOTSITE. INT. CL. 42. REG. 10-30-1984.
- 1,303,234. TERRA-MAR AND DESIGN. INT. CL. 42. REG. 10-30-1984.
- 1,303,235. MIGHTY CASEY'S. INT. CL. 42. REG. 10-30-1984.
- 1,303,239. MISCELLANEOUS DESIGN. INT. CL. 42. REG. 10-30-1984.
- 1,303,245. THE MEDICAL CENTER AND DESIGN. INT. CL. 42. REG. 10-30-1984.
- 1,303,251. KEEPING IN TIME WITH YOU. INT. CL. 42. REG. 10-30-1984.
- 1,303,253. NIBBLE'S CAFE (STYLIZED). INT. CL. 42. REG. 10-30-1984.
- 1,303,256. SAS TELEVISION SERVICES AND DESIGN. INT. CL. 42. REG. 10-30-1984.
- 1,303,258. VELOCITY DRUG AND DESIGN. INT. CL. 42. REG. 10-30-1984.
- 1,303,263. WE AND DESIGN. INT. CL. 42. REG. 10-30-1984.
- 1,303,266. WE PUT YOUR EARS IN GEAR!. INT. CL. 42. REG. 10-30-1984.
- 1,303,267. BOPEEP'S. INT. CL. 42. REG. 10-30-1984.
- 1,303,269. COLUMBIA MEDICAL LABORATORY. INT. CL. 42. REG. 10-30-1984.
- 1,303,270. FAIRFIELD MEDICAL LABORATORY. INT. CL. 42. REG. 10-30-1984.
- 1,303,272. WORDSEED AND DESIGN. INT. CL. 42. REG. 10-30-1984.
- 1,303,273. THE CHAMPION DIFFERENCE. INT. CL. 42. REG. 10-30-1984.
- 1,303,274. KNICKERS AND DESIGN. INT. CL. 42. REG. 10-30-1984.
- 1,303,287. F AND DESIGN. INT. CL. 42. REG. 10-30-1984.
- 1,303,293. WHITE CASTLE AND DESIGN. INT. CL. 42. REG. 10-30-1984.
- 1,303,295. LANCASTER FARMS. INT. CL. 42. REG. 10-30-1984.
- 1,303,296. LF AND DESIGN. INT. CL. 42. REG. 10-30-1984.
- 1,303,298. TGY AND DESIGN. INT. CL. 42. REG. 10-30-1984.
- 1,303,300. PHOTEO. INT. CL. 42. REG. 10-30-1984.
- 1,303,306. M P G (STYLIZED). INT. CL. 42. REG. 10-30-1984.
- 1,303,309. MARIEL. U.S. CL. 200. REG. 10-30-1984.
- 1,318,110. VANS AND DESIGN. INT. CLS. 17 AND 26 ONLY. REG. 2-5-1985.
- 1,325,426. NITTANY LIONS. INT. CLS. 18 AND 34 ONLY. REG. 3-19-1985.
- 1,330,800. IZABEL LAM. INT. CL. 25 ONLY. REG. 4-16-1985.
- 1,334,066. TSP. INT. CL. 16 ONLY. REG. 5-7-1985.
- 1,783,603. LITTLE FALLS. INT. CL. 33. REG. 7-20-1993.
- 1,789,975. LAURA ASHLEY. INT. CLS. 8, 10, 12, 14, 15, 28, 29 AND 30 ONLY. REG. 8-31-1993.
- 1,825,637. ZEBRACLUB. INT. CL. 42. REG. 3-8-1994.
- 1,834,437. FIRECRACKER. INT. CL. 9. REG. 5-3-1994.
- 1,840,989. TODD TIME. INT. CL. 41. REG. 6-21-1994.
- 1,852,407. NATURA GRANITE SERIES. INT. CL. 19. REG. 9-6-1994.
- 1,860,592. PUSHPALENE. INT. CL. 1. REG. 11-1-1994.
- 1,860,594. STYROBLEND. INT. CLS. 1 AND 17. REG. 11-1-1994.
- 1,860,600. VECTOMER. INT. CL. 1. REG. 11-1-1994.
- 1,860,611. CERAM-KOTE 54 AND DESIGN. INT. CL. 2. REG. 11-1-1994.
- 1,860,620. 14-KARAT EXPUNGENT. INT. CL. 3. REG. 11-1-1994.
- 1,860,624. ORAL PURE. INT. CLS. 3, 5, 10 AND 21. REG. 11-1-1994.
- 1,860,628. TRANSTEXAS GAS CORPORATION. INT. CL. 4. REG. 11-1-1994.
- 1,860,629. KEYSTONE AND DESIGN. INT. CL. 4. REG. 11-1-1994.
- 1,860,651. OMC II. INT. CL. 5. REG. 11-1-1994.
- 1,860,655. ALLMETAL. INT. CL. 6. REG. 11-1-1994.
- 1,860,665. MISCELLANEOUS DESIGN. INT. CL. 7. REG. 11-1-1994.
- 1,860,666. MISCELLANEOUS DESIGN. INT. CL. 7. REG. 11-1-1994.
- 1,860,668. MISCELLANEOUS DESIGN. INT. CLS. 7 AND 12. REG. 11-1-1994.
- 1,860,677. CUSHION CUT. INT. CL. 7. REG. 11-1-1994.
- 1,860,692. SOFTPACT (STYLIZED). INT. CL. 9. REG. 11-1-1994.
- 1,860,703. RWT (STYLIZED). INT. CL. 9. REG. 11-1-1994.
- 1,860,717. INSIGHT. INT. CL. 9. REG. 11-1-1994.
- 1,860,734. AZTECH WARE AND DESIGN. INT. CL. 9. REG. 11-1-1994.
- 1,860,735. POSTWATCH. INT. CLS. 9 AND 42. REG. 11-1-1994.
- 1,860,739. RANGER ROO GLOBAL GEOGRAPHIC EXPLORER AND DESIGN. INT. CL. 9. REG. 11-1-1994.
- 1,860,752. NOVAGRAPH. INT. CL. 9. REG. 11-1-1994.
- 1,860,768. LA SONORA MELIYARA (STYLIZED). INT. CL. 9. REG. 11-1-1994.
- 1,860,772. FLEXFILE. INT. CL. 9. REG. 11-1-1994.
- 1,860,776. TIDAL WAVE. INT. CL. 9. REG. 11-1-1994.
- 1,860,777. VERSA-SCREEN. INT. CL. 9. REG. 11-1-1994.
- 1,860,779. DIGIVEC. INT. CL. 9. REG. 11-1-1994.
- 1,860,782. APEQS. INT. CL. 9. REG. 11-1-1994.
- 1,860,784. ACCESS. INT. CL. 9. REG. 11-1-1994.
- 1,860,787. EASE. INT. CL. 9. REG. 11-1-1994.
- 1,860,789. FUGU. INT. CL. 9. REG. 11-1-1994.
- 1,860,792. MIGHTYMINI. INT. CL. 9. REG. 11-1-1994.
- 1,860,795. LASER FLASH. INT. CLS. 9 AND 42. REG. 11-1-1994.
- 1,860,798. TENNA-FLEX. INT. CL. 9. REG. 11-1-1994.
- 1,860,800. ZONEMATE. INT. CLS. 9 AND 11. REG. 11-1-1994.
- 1,860,809. SITESEER. INT. CL. 9. REG. 11-1-1994.
- 1,860,812. VU-POINT. INT. CL. 9. REG. 11-1-1994.
- 1,860,815. FST. INT. CL. 10. REG. 11-1-1994.
- 1,860,844. WORLDWIND (STYLIZED). INT. CL. 11. REG. 11-1-1994.
- 1,860,853. SPACE STATION. INT. CL. 12. REG. 11-1-1994.
- 1,860,856. MOOSEHEAD GRAND PRIX AND DESIGN. INT. CLS. 14, 16, 25 AND 41. REG. 11-1-1994.
- 1,860,875. BY REQUEST. INT. CL. 16. REG. 11-1-1994.
- 1,860,878. THE BEST OF KEY WEST. INT. CL. 16. REG. 11-1-1994.
- 1,860,889. AGELESS IRON. INT. CL. 16. REG. 11-1-1994.
- 1,860,891. PARENT PATH. INT. CLS. 16 AND 42. REG. 11-1-1994.
- 1,860,902. MISCELLANEOUS DESIGN. INT. CL. 16. REG. 11-1-1994.
- 1,860,911. POPEYE. INT. CL. 16. REG. 11-1-1994.
- 1,860,929. AMERICAN HOW-TO. INT. CL. 16. REG. 11-1-1994.
- 1,860,936. AUTO BOOM. INT. CL. 17. REG. 11-1-1994.
- 1,860,967. SUGAR TOWN AND DESIGN. INT. CL. 21. REG. 11-1-1994.
- 1,860,968. PCGS AND DESIGN. INT. CLS. 21 AND 36. REG. 11-1-1994.
- 1,860,970. POWERTYE AND DESIGN. INT. CL. 22. REG. 11-1-1994.
- 1,860,971. QFS. INT. CL. 22. REG. 11-1-1994.
- 1,860,984. LAVA BOOTIES. INT. CL. 25. REG. 11-1-1994.
- 1,860,989. TEASE. INT. CL. 25. REG. 11-1-1994.
- 1,861,000. DUE PER DUE (STYLIZED). INT. CL. 25. REG. 11-1-1994.
- 1,861,002. WHO'S THAT BABY. INT. CL. 25. REG. 11-1-1994.
- 1,861,006. CHADSTON. INT. CL. 25. REG. 11-1-1994.
- 1,861,010. SLAPZ. INT. CL. 25. REG. 11-1-1994.
- 1,861,015. ALPENGRIIP. INT. CL. 25. REG. 11-1-1994.
- 1,861,021. AGAINST GRAVITEE. INT. CL. 25. REG. 11-1-1994.
- 1,861,028. TAGUA INITIATIVE. INT. CLS. 26 AND 42. REG. 11-1-1994.
- 1,861,038. SNOW SKIRT. INT. CL. 28. REG. 11-1-1994.

- 1,861,050. ASCEND. INT. CL. 28. REG. 11-1-1994.
 1,861,051. LIPS. INT. CL. 28. REG. 11-1-1994.
 1,861,057. THE GREEN MOUNTAIN BEARS. INT. CL. 28. REG. 11-1-1994.
 1,861,066. CASINO DE FRANCE. INT. CLS. 29, 30, 32 AND 33. REG. 11-1-1994.
 1,861,075. MISCELLANEOUS DESIGN. INT. CL. 30. REG. 11-1-1994.
 1,861,079. PEPPERHYNDER'S. INT. CL. 30. REG. 11-1-1994.
 1,861,082. LEETOV AND DESIGN. INT. CL. 30. REG. 11-1-1994.
 1,861,086. MISCELLANEOUS DESIGN. INT. CL. 30. REG. 11-1-1994.
 1,861,095. CHATAK. INT. CL. 30. REG. 11-1-1994.
 1,861,096. SELECT SONOMA COUNTY AND DESIGN. INT. CL. 30. REG. 11-1-1994.
 1,861,106. SELECT SONOMA COUNTY AND DESIGN. INT. CL. 31. REG. 11-1-1994.
 1,861,107. SWEDISH KRISTALL. INT. CL. 32. REG. 11-1-1994.
 1,861,110. H2O+ AND DESIGN. INT. CL. 32. REG. 11-1-1994.
 1,861,111. SELECT SONOMA COUNTY AND DESIGN. INT. CLS. 32 AND 33. REG. 11-1-1994.
 1,861,119. MISCELLANEOUS DESIGN. INT. CL. 33. REG. 11-1-1994.
 1,861,140. POWERBIDS. INT. CL. 35. REG. 11-1-1994.
 1,861,141. AAA SHOW YOUR CARD & SAVE AND DESIGN. INT. CL. 35. REG. 11-1-1994.
 1,861,149. AACHIEVERS AND DESIGN. INT. CL. 35. REG. 11-1-1994.
 1,861,163. HITCH YOUR STATION TO A STAR. INT. CL. 35. REG. 11-1-1994.
 1,861,165. CLASSIC CHOICE. INT. CL. 36. REG. 11-1-1994.
 1,861,166. ADVANTAGE TRUST. INT. CL. 36. REG. 11-1-1994.
 1,861,174. MISCELLANEOUS DESIGN. INT. CL. 36. REG. 11-1-1994.
 1,861,186. "SWINGING FOR A CURE" AND DESIGN. INT. CL. 36. REG. 11-1-1994.
 1,861,198. R INTEGRITY RELIABILITY SINCE 1909 AND DESIGN. INT. CLS. 37 AND 42. REG. 11-1-1994.
 1,861,201. WHITTAKER HOMES AND DESIGN. INT. CL. 37. REG. 11-1-1994.
 1,861,203. ACTION PEST CONTROL AND DESIGN. INT. CL. 37. REG. 11-1-1994.
 1,861,208. THE NEW WAY TO BUY USED CARS. INT. CLS. 37 AND 42. REG. 11-1-1994.
 1,861,209. MISCELLANEOUS DESIGN. INT. CL. 37. REG. 11-1-1994.
 1,861,216. BEST OF FLORIDA. INT. CL. 39. REG. 11-1-1994.
 1,861,223. THE FABRIC OF PAPERMAKING. INT. CL. 40. REG. 11-1-1994.
 1,861,241. ST. FRANCIS HEALTH SYSTEM AND DESIGN. INT. CLS. 41 AND 42. REG. 11-1-1994.
 1,861,256. THREE-PERSON TEACHING. INT. CL. 41. REG. 11-1-1994.
 1,861,258. TOPTEC. INT. CL. 41. REG. 11-1-1994.
 1,861,259. IAMS WONDERFUL WORLD OF DOGS. INT. CL. 41. REG. 11-1-1994.
 1,861,267. GLAMOURSHOTS (STYLIZED). INT. CL. 42. REG. 11-1-1994.
 1,861,278. C2I AND DESIGN. INT. CL. 42. REG. 11-1-1994.
 1,861,281. CC AND DESIGN. INT. CL. 42. REG. 11-1-1994.
 1,861,283. NEWS TO PROFIT BY. INT. CL. 42. REG. 11-1-1994.
 1,861,291. THE PRODUCTION ADVANTAGE. INT. CL. 42. REG. 11-1-1994.
 1,861,295. "FRIENDS SERVING FRIENDS". INT. CL. 42. REG. 11-1-1994.
 1,861,299. MISCELLANEOUS DESIGN. INT. CL. 42. REG. 11-1-1994.
 1,861,302. MISCELLANEOUS DESIGN. INT. CL. 42. REG. 11-1-1994.
 1,861,303. LATTE' CHALET ESPRESSO. INT. CL. 42. REG. 11-1-1994.
 1,861,308. JOHNNY APPLESEED RESTAURANTS AND DESIGN. INT. CL. 42. REG. 11-1-1994.
 1,861,313. FINGER RELIEF. INT. CL. 42. REG. 11-1-1994.
 1,861,324. SUPER G AND DESIGN. INT. CLS. 29 AND 30. REG. 11-1-1994.
 1,861,328. THE SAFETY DIRECTOR AND DESIGN. INT. CLS. 3, 5, 10, 41 AND 42. REG. 11-1-1994.
 1,861,334. NEW VISIONS FROM WILD WINGS. INT. CLS. 16 AND 42. REG. 11-1-1994.
 1,861,336. SHOOTERS. INT. CL. 2. REG. 11-1-1994.
 1,861,346. TEPHONIC. INT. CL. 6. REG. 11-1-1994.
 1,861,357. BYTEPORT. INT. CL. 9. REG. 11-1-1994.
 1,861,372. ONE TOUCH. INT. CL. 9. REG. 11-1-1994.
 1,861,375. JBRO. INT. CL. 9. REG. 11-1-1994.
 1,861,384. ECONO CLUB. INT. CL. 12. REG. 11-1-1994.
 1,861,385. ULTRASHIELD. INT. CL. 12. REG. 11-1-1994.
 1,861,393. FLEXPRINT. INT. CL. 16. REG. 11-1-1994.
 1,861,394. DUO-CLICK. INT. CL. 16. REG. 11-1-1994.
 1,861,396. SOUND SURPRISES. INT. CL. 16. REG. 11-1-1994.
 1,861,399. TRAVELER. INT. CL. 16. REG. 11-1-1994.
 1,861,414. RIVER SPORT. INT. CL. 25. REG. 11-1-1994.
 1,861,419. WALL TRACKERS. INT. CL. 28. REG. 11-1-1994.
 1,861,421. PLUSHPUPS. INT. CL. 28. REG. 11-1-1994.
 1,861,426. BAKERY MAGIC. INT. CL. 29. REG. 11-1-1994.
 1,861,429. MISCELLANEOUS DESIGN. INT. CL. 30. REG. 11-1-1994.
 1,861,443. FLOR DE CANA. INT. CL. 33. REG. 11-1-1994.
 1,861,452. RENAISSANCE BANKCARD SERVICES. INT. CL. 36. REG. 11-1-1994.
 1,861,457. HUG-A-BEAR EXPRESS. INT. CL. 39. REG. 11-1-1994.
 1,861,464. ROLLERPLEX. INT. CL. 41. REG. 11-1-1994.
 1,861,465. POPPYDOCS. INT. CL. 42. REG. 11-1-1994.
 1,861,468. THE S. CLAUS COLLECTION. INT. CL. 42. REG. 11-1-1994.
 1,861,469. DREAMSCENE. INT. CL. 42. REG. 11-1-1994.
 1,861,472. TQD. INT. CL. 42. REG. 11-1-1994.
 1,861,479. PDM. INT. CL. 9. REG. 11-1-1994.
 1,861,480. FOUL SHOT. INT. CL. 9. REG. 11-1-1994.
 1,861,482. EL PODER MENTAL. INT. CL. 9. REG. 11-1-1994.
 1,861,490. STEM CELLS. INT. CL. 16. REG. 11-1-1994.
 1,861,502. BUSINESS GEOGRAPHICS. INT. CL. 16. REG. 11-1-1994.
 1,861,512. DO IT YOURSELF IDEAS FOR YOUR HOME AND GARDEN. INT. CL. 16. REG. 11-1-1994.
 1,861,521. MISCELLANEOUS DESIGN. INT. CL. 30. REG. 11-1-1994.
 1,861,524. EDMON'S. INT. CL. 30. REG. 11-1-1994.
 1,861,525. NEVADA (STYLIZED). INT. CL. 32. REG. 11-1-1994.
 1,861,530. SOUTHEAST REGIONAL ACCOUNTING SHOW. INT. CL. 35. REG. 11-1-1994.
 1,861,537. CUBAFAX. INT. CL. 39. REG. 11-1-1994.
 1,861,538. HAVANAFAX. INT. CL. 39. REG. 11-1-1994.
 1,861,539. ENTERTAINMENT DIGITAL NETWORK. INT. CL. 41. REG. 11-1-1994.
 1,861,540. THE ANIMAL CHANNEL. INT. CL. 41. REG. 11-1-1994.
 1,861,541. SOUTHEAST REGIONAL ACCOUNTING SHOW. INT. CL. 41. REG. 11-1-1994.
 1,861,547. THE HIGHEST STANDARDS IN THE SECURITY BUSINESS. INT. CL. 42. REG. 11-1-1994.
 1,878,179. ECOTIMBER. INT. CL. 20 ONLY. REG. 2-7-1995.
 1,901,091. TCBY. INT. CL. 29 ONLY. REG. 6-20-1995.
 1,902,822. DANIEL FIELD. INT. CL. 25. REG. 7-4-1995.
 1,985,063. FALCON. INT. CLS. 7 AND 9. REG. 7-9-1996.
 2,008,487. LYLE/CARLSTROM. INT. CL. 40. REG. 10-15-1996.
 2,021,913. PRIME TIME LIVE. INT. CLS. 41 AND 42. REG. 12-10-1996.
 2,028,854. MINI-TWIN. INT. CL. 16. REG. 1-7-1997.
 2,034,368. AIR APPARENT. INT. CL. 9. REG. 1-28-1997.
 2,035,323. CANCER. INT. CL. 5. REG. 2-4-1997.
 2,038,925. RENOVATION PLUS. INT. CL. 36. REG. 2-18-1997.
 2,040,360. GENERAL ADMISSION. INT. CL. 28. REG. 2-25-1997.
 2,049,425. CLARIS ORGANIZER. INT. CL. 9. REG. 4-1-1997.
 2,052,498. PROFIRE (STYLIZED). INT. CL. 11. REG. 4-15-1997.
 2,055,846. COUPON MASTER AND DESIGN. INT. CL. 9. REG. 4-22-1997.

- 2,070,132. UNSIGNED. INT. CL. 41. REG. 6-10-1997.
 2,074,679. BANANA BITES. INT. CL. 30. REG. 6-24-1997.
 2,081,290. MISCELLANEOUS DESIGN. INT. CL. 42. REG. 7-22-1997.
 2,105,137. SECOND SPIN. INT. CL. 35. REG. 10-14-1997.
 2,107,484. D'ANGELO D'LITES. INT. CL. 42. REG. 10-21-1997.
 2,108,410. SPORTSCHANNEL. INT. CL. 38. REG. 10-28-1997.
 2,110,590. PERMA BRAKE. INT. CL. 12. REG. 11-4-1997.
 2,110,610. SRS INTERNATIONAL. INT. CL. 42. REG. 11-4-1997.
 2,121,293. HUSKY AND DESIGN. INT. CL. 30. REG. 12-16-1997.
 2,130,873. ONKOSERVICES. INT. CL. 42. REG. 1-20-1998.
 2,137,445. H A USA LEATHER AND DESIGN. INT. CL. 25. REG. 2-17-1998.
 2,138,119. ATEL-O-GRAM AND DESIGN. INT. CL. 36. REG. 2-24-1998.
 2,144,562. PHYTO-PLUS. INT. CL. 1. REG. 3-17-1998.
 2,150,467. ALLER-GUARD. INT. CL. 17. REG. 4-14-1998.
 2,150,616. K AND DESIGN. INT. CL. 35. REG. 4-14-1998.
 2,151,888. TOUCH OF ORANGES WOOD CLEANER & RECONDITIONER AND DESIGN. INT. CL. 3. REG. 4-21-1998.
 2,155,765. MONZA (STYLIZED). INT. CL. 12. REG. 5-5-1998.
 2,158,252. LE BEACH CLUB. INT. CL. 39. REG. 5-19-1998.
 2,160,000. EVENTTOOLS. INT. CL. 9. REG. 5-26-1998.
 2,164,698. WINPIPE AND DESIGN. INT. CL. 9. REG. 6-9-1998.
 2,169,164. VFP FIRE SYSTEMS. INT. CLS. 9, 37, 40 AND 42. REG. 6-30-1998.
 2,171,135. NATIONAL KIDNEY CANCER ASSOCIATION AND DESIGN. INT. CLS. 36 AND 42. REG. 7-7-1998.
 2,177,873. ALLSTOKE LUBRICANTS AND DESIGN. INT. CL. 4. REG. 8-4-1998.
 2,200,808. YPPA AND DESIGN. INT. CL. 42. REG. 11-3-1998.
 2,200,813. GABEL AND DESIGN. INT. CLS. 18 AND 28. REG. 11-3-1998.
 2,200,815. 4X4. INT. CL. 4. REG. 11-3-1998.
 2,200,817. QUAKER STATE 4X4. INT. CL. 4. REG. 11-3-1998.
 2,200,818. FAIR PLAY AND DESIGN. INT. CLS. 6, 14, 16, 25, 28 AND 32. REG. 11-3-1998.
 2,200,820. OXFORD HEALTH PLANS HEALTHY MIND HEALTHY BODY AND DESIGN. INT. CL. 16. REG. 11-3-1998.
 2,200,821. TEXAS EMBASSY CANTINA AND DESIGN. INT. CL. 42. REG. 11-3-1998.
 2,200,822. SONDICATOR. INT. CL. 9. REG. 11-3-1998.
 2,200,825. OXFORD ON CALL AND DESIGN. INT. CL. 42. REG. 11-3-1998.
 2,200,826. WATERCOLORS. INT. CL. 25. REG. 11-3-1998.
 2,200,828. PHARMA BOTANIXX. INT. CL. 5. REG. 11-3-1998.
 2,200,829. B BABBITT BASEBALL AND DESIGN. INT. CL. 41. REG. 11-3-1998.
 2,200,830. NUTRAPEX NUTRITON AND DESIGN. INT. CL. 5. REG. 11-3-1998.
 2,200,831. HYPERTAG. INT. CLS. 9, 16, 35 AND 42. REG. 11-3-1998.
 2,200,832. AUTOTEXT. INT. CLS. 9, 16, 35 AND 42. REG. 11-3-1998.
 2,200,835. TELELARM. INT. CL. 9. REG. 11-3-1998.
 2,200,837. INTERNETWORKS. INT. CL. 42. REG. 11-3-1998.
 2,200,838. ANGEL'S ARBOR AND DESIGN. INT. CL. 3. REG. 11-3-1998.
 2,200,839. BEYOND REALITY, INC. FUTURE INCLUDED! AND DESIGN. INT. CL. 42. REG. 11-3-1998.
 2,200,841. THE BOARDROOM. INT. CLS. 25 AND 28. REG. 11-3-1998.
 2,200,843. IMPERIAL CAVIAR COMPANY. INT. CL. 29. REG. 11-3-1998.
 2,200,846. DINO'S PASTA MARKET AND DESIGN. INT. CL. 42. REG. 11-3-1998.
 2,200,847. MGIOT. INT. CL. 25. REG. 11-3-1998.
 2,200,853. ERLI. INT. CLS. 9, 16 AND 42. REG. 11-3-1998.
 2,200,857. MIRASTONE. INT. CL. 42. REG. 11-3-1998.
 2,200,858. MEDIAMATRIX. INT. CL. 9. REG. 11-3-1998.
 2,200,860. NECHO. INT. CLS. 9 AND 42. REG. 11-3-1998.
 2,200,861. LEGEND SERIES. INT. CL. 7. REG. 11-3-1998.
 2,200,863. MAIL & CARE. INT. CL. 10. REG. 11-3-1998.
 2,200,864. LAZI. INT. CLS. 9 AND 25. REG. 11-3-1998.
 2,200,865. SEP SOCIETE EUROPEENNE DE PROPULSION AND DESIGN. INT. CLS. 1, 7, 9, 10, 11, 12, 13, 19, 22, 35, 37, 38, 40, 41 AND 42. REG. 11-3-1998.
 2,200,868. AMERIWEAR. INT. CL. 25. REG. 11-3-1998.
 2,200,869. PDI. INT. CL. 9. REG. 11-3-1998.
 2,200,871. FUKUSUKE. INT. CL. 25. REG. 11-3-1998.
 2,200,872. LOVE LASTS FOREVER (STYLIZED). INT. CL. 35. REG. 11-3-1998.
 2,200,874. CONSULTING PARTNERS. INT. CLS. 41 AND 42. REG. 11-3-1998.
 2,200,875. INTERRAIL. INT. CL. 9. REG. 11-3-1998.
 2,200,876. VENTURETECH. INT. CL. 36. REG. 11-3-1998.
 2,200,880. STRETCHING THE MERIDIANS. INT. CL. 41. REG. 11-3-1998.
 2,200,881. HOLD-IT!. INT. CL. 18. REG. 11-3-1998.
 2,200,884. REHAB 1 2 3. INT. CL. 10. REG. 11-3-1998.
 2,200,885. POWERSCOPE. INT. CL. 9. REG. 11-3-1998.
 2,200,886. SAXON. INT. CL. 10. REG. 11-3-1998.
 2,200,889. M-50. INT. CL. 9. REG. 11-3-1998.
 2,200,894. ENERGY CONNECTION. INT. CLS. 9, 35, 38 AND 42. REG. 11-3-1998.
 2,200,896. K TRON HASLER AND DESIGN. INT. CLS. 7 AND 9. REG. 11-3-1998.
 2,200,899. EYECARE BY THE NUMBERS. INT. CL. 16. REG. 11-3-1998.
 2,200,900. APCOA COMMITTED TO CUSTOMER SATISFACTION PARKING PROPERTY MANAGEMENT & DEVELOPMENT AND DESIGN. INT. CLS. 35, 37 AND 42. REG. 11-3-1998.
 2,200,902. REAL VOLLEYBALL. INT. CL. 25. REG. 11-3-1998.
 2,200,904. RE-CREATE. INT. CL. 30. REG. 11-3-1998.
 2,200,907. BIOSPHERES. INT. CL. 42. REG. 11-3-1998.
 2,200,909. ALWIL. INT. CL. 9. REG. 11-3-1998.
 2,200,910. MANGOGO. INT. CL. 29. REG. 11-3-1998.
 2,200,911. CHABANITO. INT. CL. 29. REG. 11-3-1998.
 2,200,917. TODAY'S BEST AND DESIGN. INT. CL. 31. REG. 11-3-1998.
 2,200,918. ACE. INT. CL. 1. REG. 11-3-1998.
 2,200,920. REDI-INFO. INT. CLS. 35 AND 42. REG. 11-3-1998.
 2,200,921. WEBTRAIN. INT. CL. 9. REG. 11-3-1998.
 2,200,922. "RENTECH BOILERS FOR PEOPLE WHO KNOW AND CARE" (STYLIZED). INT. CL. 11. REG. 11-3-1998.
 2,200,924. GETCENTRIC AND DESIGN. INT. CL. 42. REG. 11-3-1998.
 2,200,925. PURENET (STYLIZED). INT. CLS. 8, 17 AND 20. REG. 11-3-1998.
 2,200,926. TRAINING ON A DISK AND DESIGN. INT. CL. 9. REG. 11-3-1998.
 2,200,929. CARRIDO GOLF FITNESS. INT. CLS. 9 AND 42. REG. 11-3-1998.
 2,200,932. STADIAVISION. INT. CL. 9. REG. 11-3-1998.
 2,200,933. YARDFORMS. INT. CL. 19. REG. 11-3-1998.
 2,200,934. TOTAL COMMUNICATIONS CARD. INT. CL. 36. REG. 11-3-1998.
 2,200,936. CSL (STYLIZED). INT. CL. 1. REG. 11-3-1998.
 2,200,939. OPTILAST. INT. CL. 5. REG. 11-3-1998.
 2,200,941. MISCELLANEOUS DESIGN. INT. CLS. 9, 16, 36, 41 AND 42. REG. 11-3-1998.
 2,200,942. PRECISE PRICE. INT. CLS. 9 AND 39. REG. 11-3-1998.
 2,200,943. CLUB ORGANIC AND DESIGN. INT. CLS. 29 AND 30. REG. 11-3-1998.
 2,200,944. CARTOON SUSHI. INT. CL. 41. REG. 11-3-1998.
 2,200,948. L'OREAL PROFESSIONNEL PARIS AND DESIGN. INT. CLS. 3, 5, 8, 11, 18, 21, 26 AND 42. REG. 11-3-1998.
 2,200,949. PPP. INT. CL. 41. REG. 11-3-1998.
 2,200,951. HELAVA. INT. CLS. 9, 41 AND 42. REG. 11-3-1998.
 2,200,952. OUTPUT TECHNOLOGIES AND DESIGN. INT. CLS. 35, 38 AND 42. REG. 11-3-1998.
 2,200,954. CUSTOMER ACCESS SOLUTIONS. INT. CL. 35. REG. 11-3-1998.

- 2,200,955. ENGINE ENHANCER AND DESIGN. INT. CLS. 1, 7 AND 37. REG. 11-3-1998.
- 2,200,956. SWEET SHOTS. INT. CL. 30. REG. 11-3-1998.
- 2,200,959. SINCOX. INT. CLS. 1 AND 13. REG. 11-3-1998.
- 2,200,960. MISCELLANEOUS DESIGN. INT. CLS. 9 AND 42. REG. 11-3-1998.
- 2,200,962. PANAMA JONES. INT. CL. 34. REG. 11-3-1998.
- 2,200,963. CHARTER BEHAVIORAL HEALTH SYSTEMS. INT. CLS. 35 AND 42. REG. 11-3-1998.
- 2,200,964. OMNIREMOTE. INT. CL. 9. REG. 11-3-1998.
- 2,200,965. TRAVEL WEEKLY ONLINE. INT. CL. 42. REG. 11-3-1998.
- 2,200,968. VIDEOEYE! (STYLIZED). INT. CL. 9. REG. 11-3-1998.
- 2,200,969. 1 UNITED STATES HOLE IN ONE AND DESIGN. INT. CL. 25. REG. 11-3-1998.
- 2,200,970. LANQUEST. INT. CLS. 9 AND 42. REG. 11-3-1998.
- 2,200,971. NTT AND DESIGN. INT. CL. 16. REG. 11-3-1998.
- 2,200,974. SPORTS FANTASTIC (STYLIZED). INT. CL. 35. REG. 11-3-1998.
- 2,200,975. THE VOICE OF MESSAGING. INT. CL. 9. REG. 11-3-1998.
- 2,200,977. THE LEADERSHIP TEMPLATE. INT. CL. 16. REG. 11-3-1998.
- 2,200,979. MISCELLANEOUS DESIGN. INT. CL. 28. REG. 11-3-1998.
- 2,200,980. LABTECHNICS. INT. CL. 9. REG. 11-3-1998.
- 2,200,983. INFINITE ENERGY. INT. CL. 16. REG. 11-3-1998.
- 2,200,987. PALMA. INT. CL. 29. REG. 11-3-1998.
- 2,200,992. MISCELLANEOUS DESIGN. INT. CLS. 35 AND 37. REG. 11-3-1998.
- 2,200,993. WAVI. INT. CL. 6. REG. 11-3-1998.
- 2,200,997. SCAN MOS (STYLIZED). INT. CL. 9. REG. 11-3-1998.
- 2,201,001. W AND DESIGN. INT. CL. 38. REG. 11-3-1998.
- 2,201,002. MISCELLANEOUS DESIGN. INT. CL. 7. REG. 11-3-1998.
- 2,201,004. SEASON. INT. CL. 11. REG. 11-3-1998.
- 2,201,005. MISSION. INT. CL. 8. REG. 11-3-1998.
- 2,201,006. EMTAL AND DESIGN. INT. CL. 9. REG. 11-3-1998.
- 2,201,008. MISCELLANEOUS DESIGN. INT. CL. 35. REG. 11-3-1998.
- 2,201,010. CLICKNET. INT. CL. 9. REG. 11-3-1998.
- 2,201,011. DYNAMIC C EASYSTART. INT. CL. 9. REG. 11-3-1998.
- 2,201,013. GIGARAID. INT. CL. 9. REG. 11-3-1998.
- 2,201,014. POSITIVELY HUMOR. INT. CL. 41. REG. 11-3-1998.
- 2,201,015. APRIORI AND DESIGN. INT. CLS. 14, 18 AND 25. REG. 11-3-1998.
- 2,201,017. JA JACK & AYLIN DESIGNS, INC. AND DESIGN. INT. CL. 14. REG. 11-3-1998.
- 2,201,019. ALMA CHEESE "NIBBLIN' GOOD" AND DESIGN. INT. CL. 29. REG. 11-3-1998.
- 2,201,021. GREENCHEM AND DESIGN. INT. CLS. 12 AND 39. REG. 11-3-1998.
- 2,201,023. SOLUCIONES TAN UNICAS COMO TU. (STYLIZED). INT. CL. 36. REG. 11-3-1998.
- 2,201,024. ARTISTIC ANARCHY. INT. CL. 42. REG. 11-3-1998.
- 2,201,026. COUNTRY HOME LOAN AND DESIGN. INT. CL. 36. REG. 11-3-1998.
- 2,201,029. DAMASCO. INT. CL. 30. REG. 11-3-1998.
- 2,201,030. TEAM AMERICA HUMAN RESOURCES. INT. CL. 35. REG. 11-3-1998.
- 2,201,031. TEAM AMERICA. INT. CL. 35. REG. 11-3-1998.
- 2,201,033. EAGLE NEST INTELLIGENCE. INT. CL. 35. REG. 11-3-1998.
- 2,201,036. RATIONAL DRESS. INT. CL. 18. REG. 11-3-1998.
- 2,201,037. COROLLARY. INT. CL. 9. REG. 11-3-1998.
- 2,201,039. MICRO SPRAY AND DESIGN. INT. CL. 5. REG. 11-3-1998.
- 2,201,045. DIFENE. INT. CL. 5. REG. 11-3-1998.
- 2,201,047. MISCELLANEOUS DESIGN. INT. CL. 38. REG. 11-3-1998.
- 2,201,048. 1-888-ASK-CITI. INT. CL. 36. REG. 11-3-1998.
- 2,201,049. SNIFF FLOWERS NOT DRUGS!. INT. CL. 25. REG. 11-3-1998.
- 2,201,050. "WE COVER THE WORLD" AND DESIGN. INT. CL. 37. REG. 11-3-1998.
- 2,201,053. CHURCH NURSE. INT. CL. 18. REG. 11-3-1998.
- 2,201,057. CONTESSA SILVINI AND DESIGN. INT. CL. 33. REG. 11-3-1998.
- 2,201,058. BAJA BEACH PARTY. INT. CL. 42. REG. 11-3-1998.
- 2,201,062. CLAIMANT EMPLOYMENT SERVICES, INC. "THE MISSING PIECE OF THE PUZZLE" AND DESIGN. INT. CL. 35. REG. 11-3-1998.
- 2,201,063. PRISMACROM. INT. CL. 2. REG. 11-3-1998.
- 2,201,064. THERMOWARE. INT. CL. 9. REG. 11-3-1998.
- 2,201,067. CITRUSNET RIVERSIDE COUNTY CALIFORNIA AND DESIGN. INT. CL. 42. REG. 11-3-1998.
- 2,201,068. ITALSPAWN AND DESIGN. INT. CL. 31. REG. 11-3-1998.
- 2,201,070. SUPRA. INT. CL. 21. REG. 11-3-1998.
- 2,201,071. OPTIMAR. INT. CL. 1. REG. 11-3-1998.
- 2,201,073. HIGH OCTANE SUPER TURBO CHARGED POWER FOOD. INT. CL. 30. REG. 11-3-1998.
- 2,201,074. TAOS: THE DEVELOPER'S WORKBENCH. INT. CL. 9. REG. 11-3-1998.
- 2,201,075. BIDPRO (STYLIZED). INT. CL. 36. REG. 11-3-1998.
- 2,201,079. 549-FLIX. INT. CL. 41. REG. 11-3-1998.
- 2,201,080. MISCELLANEOUS DESIGN. INT. CL. 12. REG. 11-3-1998.
- 2,201,084. MIKE ROFONE. INT. CL. 9. REG. 11-3-1998.
- 2,201,086. POSTERS PLUS AND DESIGN. INT. CL. 35. REG. 11-3-1998.
- 2,201,090. THE NATIONAL THEATRE FOR CHILDREN! AND DESIGN. INT. CL. 41. REG. 11-3-1998.
- 2,201,091. ENTHONE-OMI. INT. CL. 40. REG. 11-3-1998.
- 2,201,092. SCHOKS. INT. CL. 30. REG. 11-3-1998.
- 2,201,095. REALBID. INT. CL. 35. REG. 11-3-1998.
- 2,201,096. FIRON. INT. CL. 17. REG. 11-3-1998.
- 2,201,098. CYTOKINE TOTAL. INT. CL. 1. REG. 11-3-1998.
- 2,201,099. CYBERSLICE. INT. CL. 35. REG. 11-3-1998.
- 2,201,101. 7-50-21-5. INT. CL. 41. REG. 11-3-1998.
- 2,201,104. DIVORCE RECORDS AND DESIGN. INT. CL. 9. REG. 11-3-1998.
- 2,201,108. TRADE SECRET. INT. CLS. 3 AND 21. REG. 11-3-1998.
- 2,201,111. MAGNA PHYSICS. INT. CLS. 7 AND 12. REG. 11-3-1998.
- 2,201,113. BUTTREY FRESH FOODS. INT. CL. 35. REG. 11-3-1998.
- 2,201,116. KOOL GREEN GOLD AND DESIGN. INT. CLS. 16, 18, 20 AND 25. REG. 11-3-1998.
- 2,201,119. TEAM KOOL GREEN. INT. CL. 41. REG. 11-3-1998.
- 2,201,120. EXPRESS FCI AND DESIGN. INT. CL. 41. REG. 11-3-1998.
- 2,201,121. THE WORK THE GREAT UNDOING. INT. CL. 41. REG. 11-3-1998.
- 2,201,125. AUTOTECH AND DESIGN. INT. CL. 12. REG. 11-3-1998.
- 2,201,127. SAFETY RETURNS. INT. CLS. 16 AND 41. REG. 11-3-1998.
- 2,201,128. BELLWETHER GROUP MARKETING BY DESIGN AND DESIGN. INT. CL. 35. REG. 11-3-1998.
- 2,201,129. LASER WORKS. INT. CLS. 16 AND 20. REG. 11-3-1998.
- 2,201,130. BWA. INT. CL. 35. REG. 11-3-1998.
- 2,201,132. GOD GROWS 'EM WE PICK 'EM. INT. CLS. 21 AND 25. REG. 11-3-1998.
- 2,201,133. CYBERSCRAMBLE (STYLIZED). INT. CL. 9. REG. 11-3-1998.
- 2,201,135. PEP PUBLIC ENERGY PARTNERS AND DESIGN. INT. CL. 42. REG. 11-3-1998.
- 2,201,137. ECONOCALL. INT. CLS. 16 AND 36. REG. 11-3-1998.
- 2,201,138. ROAD WARRIOR. INT. CL. 12. REG. 11-3-1998.
- 2,201,139. Q BOX. INT. CL. 9. REG. 11-3-1998.

- 2,201,140. MUGNAINI IMPORTS AND DESIGN. INT. CL. 35. REG. 11-3-1998.
- 2,201,141. NORSOFT. INT. CLS. 37 AND 42. REG. 11-3-1998.
- 2,201,142. CROP V.D.D. AND DESIGN. INT. CL. 31. REG. 11-3-1998.
- 2,201,143. V.D.D. JUNIOR AND DESIGN. INT. CL. 31. REG. 11-3-1998.
- 2,201,146. ISODISC (STYLIZED). INT. CL. 40. REG. 11-3-1998.
- 2,201,148. SL MIRASSOU AND DESIGN. INT. CL. 16. REG. 11-3-1998.
- 2,201,149. FLAMBOYANCE PERFUME GIFT SHOPPES AND DESIGN. INT. CL. 35. REG. 11-3-1998.
- 2,201,150. WINFIELD MEDICAL. INT. CLS. 10 AND 20. REG. 11-3-1998.
- 2,201,154. FOREVER MAXXSEAL. INT. CL. 6. REG. 11-3-1998.
- 2,201,155. EMOTIONAL ERGONOMICS. INT. CL. 41. REG. 11-3-1998.
- 2,201,157. GUARANTEED TO FIT BED GLOVE AND DESIGN. INT. CL. 24. REG. 11-3-1998.
- 2,201,160. TAPSCAN AND DESIGN. INT. CL. 9. REG. 11-3-1998.
- 2,201,161. POORE SIMON'S. INT. CL. 25. REG. 11-3-1998.
- 2,201,162. MISCELLANEOUS DESIGN. INT. CLS. 29 AND 30. REG. 11-3-1998.
- 2,201,163. XL AND DESIGN. INT. CL. 25. REG. 11-3-1998.
- 2,201,164. VST (VISUAL STRUCTURING). INT. CL. 9. REG. 11-3-1998.
- 2,201,165. AREPA ANTIOQUENA DE QUESO AND DESIGN. INT. CL. 30. REG. 11-3-1998.
- 2,201,166. PRELUDE. INT. CL. 40. REG. 11-3-1998.
- 2,201,168. SYSTEMS FOR SUCCESS AND DESIGN. INT. CL. 16. REG. 11-3-1998.
- 2,201,172. MISCELLANEOUS DESIGN. INT. CL. 5. REG. 11-3-1998.
- 2,201,174. MISCELLANEOUS DESIGN. INT. CL. 30. REG. 11-3-1998.
- 2,201,179. CN (STYLIZED). INT. CL. 42. REG. 11-3-1998.
- 2,201,180. MERKSAMER JEWELERS. INT. CL. 35. REG. 11-3-1998.
- 2,201,181. CLINICAL DYNAMICS. INT. CL. 10. REG. 11-3-1998.
- 2,201,182. BLACK HILLS GLOW (STYLIZED). INT. CL. 14. REG. 11-3-1998.
- 2,201,184. FRONTRUNNER. INT. CL. 9. REG. 11-3-1998.
- 2,201,186. WE'RE IN A HURRY TO MAKE YOU HAPPY. INT. CL. 42. REG. 11-3-1998.
- 2,201,187. THE ULTIMATE SALAD KIT. INT. CL. 29. REG. 11-3-1998.
- 2,201,192. INTERMETRICS. INT. CL. 42. REG. 11-3-1998.
- 2,201,193. C-LOC. INT. CLS. 6 AND 9. REG. 11-3-1998.
- 2,201,195. TORNADO ELECTRONIC MESSAGING SYSTEM. INT. CL. 38. REG. 11-3-1998.
- 2,201,197. PRISMALITE. INT. CL. 21. REG. 11-3-1998.
- 2,201,198. SORBCEL. INT. CL. 5. REG. 11-3-1998.
- 2,201,201. SV SHOE VALETS AND DESIGN. INT. CL. 18. REG. 11-3-1998.
- 2,201,203. CAMELOT FROGS. INT. CL. 20. REG. 11-3-1998.
- 2,201,204. LYSOFF. INT. CL. 5. REG. 11-3-1998.
- 2,201,206. DENTAL STAFFING ALTERNATIVES AND DESIGN. INT. CL. 35. REG. 11-3-1998.
- 2,201,208. ANYSOFT AND DESIGN. INT. CL. 9. REG. 11-3-1998.
- 2,201,209. MI-CHI. INT. CLS. 30 AND 32. REG. 11-3-1998.
- 2,201,212. RESONANT NEURO ACCESS. INT. CL. 42. REG. 11-3-1998.
- 2,201,215. FLORIDA CRYSTALS AND DESIGN. INT. CL. 30. REG. 11-3-1998.
- 2,201,217. WDEF 12 LISTENS. INT. CL. 38. REG. 11-3-1998.
- 2,201,222. THE SOURCE AND DESIGN. INT. CL. 16. REG. 11-3-1998.
- 2,201,223. CHIPMASTER. INT. CL. 7. REG. 11-3-1998.
- 2,201,225. THE ROMEO AND JULIET COLLECTION. INT. CL. 14. REG. 11-3-1998.
- 2,201,226. BAY STATERS AND DESIGN. INT. CLS. 25, 35 AND 41. REG. 11-3-1998.
- 2,201,227. SUFFICIENT GROUNDS COFFEEHOUSE. INT. CL. 42. REG. 11-3-1998.
- 2,201,229. MEDCOACH AND DESIGN. INT. CL. 9. REG. 11-3-1998.
- 2,201,230. AU AUREUS RECORDS AND DESIGN. INT. CL. 9. REG. 11-3-1998.
- 2,201,232. PLAISIR DE LA TABLE SAINT LOUIS - HERMES - PUIFORCAT (STYLIZED). INT. CLS. 16, 21, 35, 37, 38, 41 AND 42. REG. 11-3-1998.
- 2,201,233. LOS FANTASMAS DEL CARIBE. INT. CL. 9. REG. 11-3-1998.
- 2,201,236. WHOA 32 LISTENS. INT. CL. 38. REG. 11-3-1998.
- 2,201,237. WTVQ 36 LISTENS. INT. CL. 38. REG. 11-3-1998.
- 2,201,239. VIVACE AND DESIGN. INT. CL. 9. REG. 11-3-1998.
- 2,201,243. SA (STYLIZED). INT. CL. 14. REG. 11-3-1998.
- 2,201,244. MATTHEWS & RYAN MUSICAL PRODUCTS INC AND DESIGN. INT. CL. 35. REG. 11-3-1998.
- 2,201,245. TOOLS FOR TOMORROW (STYLIZED). INT. CL. 41. REG. 11-3-1998.
- 2,201,246. CONSHALLOW. INT. CL. 6. REG. 11-3-1998.
- 2,201,247. GOOD BOOK PROGRAM AND DESIGN. INT. CL. 35. REG. 11-3-1998.
- 2,201,250. MOUNT VERNON. INT. CL. 33. REG. 11-3-1998.
- 2,201,258. ULTRA. INT. CL. 6. REG. 11-3-1998.
- 2,201,263. WEST WINDS (STYLIZED). INT. CL. 6. REG. 11-3-1998.
- 2,201,266. IMAGE PERCUSSION AND DESIGN. INT. CL. 15. REG. 11-3-1998.
- 2,201,267. PMC (STYLIZED). INT. CL. 15. REG. 11-3-1998.
- 2,201,268. SPECTRASAFE (STYLIZED). INT. CL. 9. REG. 11-3-1998.
- 2,201,269. KWIK STAND DISPLAYS. INT. CL. 20. REG. 11-3-1998.
- 2,201,271. MISCELLANEOUS DESIGN. INT. CL. 42. REG. 11-3-1998.
- 2,201,272. KARMA LIGHT. INT. CL. 11. REG. 11-3-1998.
- 2,201,276. DESTINATION: REAL WORLD AND DESIGN. INT. CL. 35. REG. 11-3-1998.
- 2,201,278. MISCELLANEOUS DESIGN. INT. CL. 25. REG. 11-3-1998.
- 2,201,279. MUSEUM STREET PRESS (STYLIZED). INT. CL. 41. REG. 11-3-1998.
- 2,201,280. RED RING. INT. CL. 9. REG. 11-3-1998.
- 2,201,282. SUMMIT CITY SAINTS. INT. CL. 41. REG. 11-3-1998.
- 2,201,283. INDEPENDENCE PASS. INT. CL. 41. REG. 11-3-1998.
- 2,201,285. FOX SPORTS NORTHWEST AND DESIGN. INT. CL. 41. REG. 11-3-1998.
- 2,201,286. FOX SPORTS NORTHWEST AND DESIGN. INT. CL. 38. REG. 11-3-1998.
- 2,201,287. FOX SPORTS PITTSBURGH AND DESIGN. INT. CL. 41. REG. 11-3-1998.
- 2,201,288. FOX SPORTS PITTSBURGH AND DESIGN. INT. CL. 38. REG. 11-3-1998.
- 2,201,289. FOX SPORTS SOUTHWEST AND DESIGN. INT. CL. 41. REG. 11-3-1998.
- 2,201,290. OLIVVI. INT. CL. 25. REG. 11-3-1998.
- 2,201,291. ROBOSHOPPER. INT. CL. 9. REG. 11-3-1998.
- 2,201,292. ISO QUICK AND DESIGN. INT. CL. 41. REG. 11-3-1998.
- 2,201,293. ISOQUICK. INT. CL. 41. REG. 11-3-1998.
- 2,201,294. MARK E. CRUSH CO "YOUR LINK TO EXCELLENT SERVICE" AND DESIGN. INT. CL. 37. REG. 11-3-1998.
- 2,201,296. FIT CLIENT. INT. CL. 9. REG. 11-3-1998.
- 2,201,297. BIOVID (STYLIZED). INT. CL. 9. REG. 11-3-1998.
- 2,201,298. YELLATIME PRODUCTIONS (STYLIZED). INT. CL. 35. REG. 11-3-1998.
- 2,201,300. JKL AND DESIGN. INT. CL. 11. REG. 11-3-1998.
- 2,201,302. PROTECTO-VAN. INT. CL. 12. REG. 11-3-1998.
- 2,201,304. VERIFIED CREDENTIALS INCORPORATED AND DESIGN. INT. CL. 35. REG. 11-3-1998.
- 2,201,305. GASTROLINE. INT. CL. 9. REG. 11-3-1998.
- 2,201,306. POWERLITE. INT. CL. 17. REG. 11-3-1998.
- 2,201,309. IN A WORLD FULL OF DATA, WE PROVIDE INFORMATION. INT. CL. 35. REG. 11-3-1998.

- 2,201,310. OCEAN ESCAPES. INT. CL. 9. REG. 11-3-1998.
 2,201,311. READING PAL. INT. CL. 9. REG. 11-3-1998.
 2,201,313. EPCS. INT. CL. 9. REG. 11-3-1998.
 2,201,315. SWPS. INT. CL. 11. REG. 11-3-1998.
 2,201,318. BRANZI. INT. CL. 14. REG. 11-3-1998.
 2,201,321. B(EE)-ZONE AND DESIGN. INT. CL. 9. REG. 11-3-1998.
 2,201,323. MODEL MASTERS INC. AND DESIGN. INT. CL. 35. REG. 11-3-1998.
 2,201,324. PARTY OF 3 (STYLIZED). INT. CL. 35. REG. 11-3-1998.
 2,201,325. CLASSIDUR. INT. CL. 2. REG. 11-3-1998.
 2,201,326. AMERICANA. INT. CL. 36. REG. 11-3-1998.
 2,201,327. THE WAY MUSIC LOOKS NOW. INT. CL. 41. REG. 11-3-1998.
 2,201,331. PURE APPLE 100% APPLE JUICE AND DESIGN. INT. CL. 32. REG. 11-3-1998.
 2,201,334. PERSONA. INT. CL. 14. REG. 11-3-1998.
 2,201,335. URBAN METAL COLLECTION. INT. CL. 16. REG. 11-3-1998.
 2,201,336. MISCELLANEOUS DESIGN. INT. CL. 36. REG. 11-3-1998.
 2,201,337. TKA (STYLIZED). INT. CL. 14. REG. 11-3-1998.
 2,201,341. SCRA. INT. CLS. 25 AND 41. REG. 11-3-1998.
 2,201,344. GOURMET LUTHERAN COFFEE. INT. CLS. 21 AND 30. REG. 11-3-1998.
 2,201,346. THE VIRTUAL CACTUS. INT. CL. 42. REG. 11-3-1998.
 2,201,347. G&C GALMA & CORDIF JEWELLERS AR AND DESIGN. INT. CL. 14. REG. 11-3-1998.
 2,201,348. WHACK'D AND DESIGN. INT. CL. 25. REG. 11-3-1998.
 2,201,349. OUTDOOR TRAILS AND DESIGN. INT. CL. 25. REG. 11-3-1998.
 2,201,350. TOWTRACK. INT. CL. 9. REG. 11-3-1998.
 2,201,352. RIDD'N ON RECORDS AND DESIGN. INT. CL. 9. REG. 11-3-1998.
 2,201,353. MEGAMORPH (STYLIZED). INT. CL. 42. REG. 11-3-1998.
 2,201,354. MEGAMORPH (STYLIZED). INT. CL. 41. REG. 11-3-1998.
 2,201,355. METARISK AND DESIGN. INT. CL. 42. REG. 11-3-1998.
 2,201,360. LEFRACOR. INT. CL. 5. REG. 11-3-1998.
 2,201,361. AU H2O (STYLIZED). INT. CL. 30. REG. 11-3-1998.
 2,201,364. WORKPORT. INT. CL. 35. REG. 11-3-1998.
 2,201,365. DELICIOUS DELITES AND DESIGN. INT. CL. 30. REG. 11-3-1998.
 2,201,367. A AND DESIGN. INT. CL. 42. REG. 11-3-1998.
 2,201,370. INSTALLMATE. INT. CL. 9. REG. 11-3-1998.
 2,201,372. DON'T BE ALONE, PICK UP THE PHONE. INT. CL. 42. REG. 11-3-1998.
 2,201,374. MISCELLANEOUS DESIGN. INT. CL. 9. REG. 11-3-1998.
 2,201,375. LITESPEC. INT. CL. 9. REG. 11-3-1998.
 2,201,376. PROPLANT AND DESIGN. INT. CL. 5. REG. 11-3-1998.
 2,201,384. MISCELLANEOUS DESIGN. INT. CL. 1. REG. 11-3-1998.
 2,201,385. KRAFTABLES WHERE ART STARTS! AND DESIGN. INT. CLS. 16, 20 AND 25. REG. 11-3-1998.
 2,201,387. RVAMERICA INSURANCE AND DESIGN. INT. CL. 36. REG. 11-3-1998.
 2,201,389. STAY'N SAVE MOTOR INN AND DESIGN. INT. CL. 42. REG. 11-3-1998.
 2,201,395. WAKE UP YOUR FACE. INT. CLS. 35 AND 42. REG. 11-3-1998.
 2,201,397. THINK TIME. INT. CL. 9. REG. 11-3-1998.
 2,201,399. CROCODOC. INT. CL. 9. REG. 11-3-1998.
 2,201,400. CRASH PAD. INT. CL. 20. REG. 11-3-1998.
 2,201,401. WATCH 'N SAVE. INT. CL. 36. REG. 11-3-1998.
 2,201,404. THE ICEBREAKER. INT. CL. 14. REG. 11-3-1998.
 2,201,409. SOLUGUM. INT. CLS. 5 AND 30. REG. 11-3-1998.
 2,201,410. TODAY'S SPORT UTILITY VEHICLE (STYLIZED). INT. CL. 16. REG. 11-3-1998.
 2,201,411. THE ADDRESS IS CBS. WELCOME HOME.. INT. CL. 38. REG. 11-3-1998.
 2,201,412. FOX SPORTS DETROIT AND DESIGN. INT. CL. 41. REG. 11-3-1998.
 2,201,413. FOX SPORTS DETROIT AND DESIGN. INT. CL. 38. REG. 11-3-1998.
 2,201,414. FOX SPORTS NEWS AND DESIGN. INT. CL. 41. REG. 11-3-1998.
 2,201,415. FOX SPORTS NEWS AND DESIGN. INT. CL. 38. REG. 11-3-1998.
 2,201,416. TIARA. INT. CL. 28. REG. 11-3-1998.
 2,201,417. QUICKHEAT. INT. CL. 11. REG. 11-3-1998.
 2,201,422. KOZ. INT. CL. 42. REG. 11-3-1998.
 2,201,423. GRATE WISCONSIN. INT. CL. 29. REG. 11-3-1998.
 2,201,424. C-BOLT. INT. CL. 9. REG. 11-3-1998.
 2,201,431. LENDING PIPELINE. INT. CL. 16. REG. 11-3-1998.
 2,201,432. DUFFER'S DEMISE. INT. CL. 28. REG. 11-3-1998.
 2,201,433. COSBELLE. INT. CL. 3. REG. 11-3-1998.
 2,201,436. ULTIMATE THIGHS. INT. CL. 28. REG. 11-3-1998.
 2,201,437. FARGO. INT. CL. 9. REG. 11-3-1998.
 2,201,441. THE CATALINA COLLECTION. INT. CL. 10. REG. 11-3-1998.
 2,201,442. MX-100. INT. CL. 10. REG. 11-3-1998.
 2,201,446. WWW.BLUECARES.COM. INT. CLS. 36 AND 42. REG. 11-3-1998.
 2,201,448. ZEN GARDEN. INT. CL. 5. REG. 11-3-1998.
 2,201,449. INFLUENCE AND DESIGN. INT. CL. 10. REG. 11-3-1998.
 2,201,453. DREAM DRAW. INT. CLS. 28 AND 36. REG. 11-3-1998.
 2,201,456. IT'S MORE THAN A LOAN... IT'S A WAY OUT.. INT. CL. 36. REG. 11-3-1998.
 2,201,457. MAGAZINE OF THE STARS & STORIES SOAP-OPERA UPDATE AND DESIGN. INT. CL. 16. REG. 11-3-1998.
 2,201,458. FONTGALANT AND DESIGN. INT. CL. 33. REG. 11-3-1998.
 2,201,459. ROYAL FOOD SERVICE INC. AND DESIGN. INT. CL. 35. REG. 11-3-1998.
 2,201,460. JUGGLER THE SEAL. INT. CL. 28. REG. 11-3-1998.
 2,201,463. BERNARD BEAR. INT. CL. 28. REG. 11-3-1998.
 2,201,464. FOX SPORTS SOUTH AND DESIGN. INT. CL. 38. REG. 11-3-1998.
 2,201,466. ARISTIDES' ORIGINAL. INT. CL. 30. REG. 11-3-1998.
 2,201,467. KAVAR (STYLIZED). INT. CL. 29. REG. 11-3-1998.
 2,201,468. CAPACITY. INT. CL. 3. REG. 11-3-1998.
 2,201,469. LFG. INT. CL. 40. REG. 11-3-1998.
 2,201,470. SOS SOCIETY OF OUTDOOR SPORTSMEN AND DESIGN. U.S. CL. 200. REG. 11-3-1998.
 2,201,472. BECAUSE YOUR MEMORIES ARE WORTH IT!. INT. CL. 16. REG. 11-3-1998.
 2,201,476. 800 PROPIO. INT. CL. 38. REG. 11-3-1998.
 2,201,481. FROSTY BERRIES. INT. CL. 3. REG. 11-3-1998.
 2,201,483. GOOB TUBES. INT. CL. 28. REG. 11-3-1998.
 2,201,484. STRETCH GIRAFFE. INT. CL. 28. REG. 11-3-1998.
 2,201,486. SFOGGIO'S AND DESIGN. INT. CL. 30. REG. 11-3-1998.
 2,201,488. GINGER LADY. INT. CL. 33. REG. 11-3-1998.
 2,201,489. ASTRO DELTA MEGAZORD. INT. CL. 28. REG. 11-3-1998.
 2,201,490. 888-BUY-OMNI. INT. CL. 38. REG. 11-3-1998.
 2,201,492. MISCELLANEOUS DESIGN. INT. CL. 41. REG. 11-3-1998.
 2,201,494. 888-OMNI-611. INT. CL. 38. REG. 11-3-1998.
 2,201,495. ZOE THE ZEBRA. INT. CL. 28. REG. 11-3-1998.
 2,201,496. CAPE COD LOBSTER CHOWDER. INT. CL. 29. REG. 11-3-1998.
 2,201,498. DAPPER THE DINOSAUR. INT. CL. 28. REG. 11-3-1998.
 2,201,499. MOZZARELLA THE MOUSE. INT. CL. 28. REG. 11-3-1998.
 2,201,500. APPLIED INGENUITY. INT. CL. 42. REG. 11-3-1998.
 2,201,503. BIO-SORPTION. INT. CL. 40. REG. 11-3-1998.
 2,201,505. AUDIO-VIDEO AND A BOATLOAD OF KNOW-HOW. INT. CL. 35. REG. 11-3-1998.
 2,201,507. KEEPET. INT. CL. 42. REG. 11-3-1998.

- 2,201,509. GREAT TOYS FOR GREAT KIDS. INT. CL. 35. REG. 11-3-1998.
- 2,201,511. DRUNK MONK HEFEWEIZEN. INT. CL. 33. REG. 11-3-1998.
- 2,201,513. GOLD MEDAL FASTPITCH. INT. CL. 41. REG. 11-3-1998.
- 2,201,515. CIELOGRIGIO. INT. CL. 33. REG. 11-3-1998.
- 2,201,517. DR. BEAN'S GOURMET COFFEE. INT. CL. 30. REG. 11-3-1998.
- 2,201,520. TALKSHOP. INT. CL. 41. REG. 11-3-1998.
- 2,201,521. TUNGSTEN FORCE AND DESIGN. INT. CL. 28. REG. 11-3-1998.
- 2,201,522. END ADDRESS BOOK MESS FOREVER!. INT. CL. 16. REG. 11-3-1998.
- 2,201,525. SUNNY ISLE. INT. CL. 32. REG. 11-3-1998.
- 2,201,531. BOYERO. INT. CL. 33. REG. 11-3-1998.
- 2,201,533. MISCELLANEOUS DESIGN. INT. CL. 29. REG. 11-3-1998.
- 2,201,534. ORGALIC. INT. CL. 29. REG. 11-3-1998.
- 2,201,536. OXBOW. INT. CL. 31. REG. 11-3-1998.
- 2,201,545. DAPHNE'S AEGEAN GRILL. INT. CL. 42. REG. 11-3-1998.
- 2,201,546. TOUCH OF FRESHNESS. INT. CL. 31. REG. 11-3-1998.
- 2,201,549. EXPLORER. INT. CL. 24. REG. 11-3-1998.
- 2,201,550. MISCELLANEOUS DESIGN. INT. CL. 14. REG. 11-3-1998.
- 2,201,551. LITE-R-SIDE. INT. CL. 42. REG. 11-3-1998.
- 2,201,556. MISCELLANEOUS DESIGN. INT. CL. 42. REG. 11-3-1998.
- 2,201,559. COFFEA AND DESIGN. INT. CLS. 11, 21, 29 AND 30. REG. 11-3-1998.
- 2,201,561. ANOTHER UNIVERSE. INT. CLS. 9, 14, 16, 20, 25, 28 AND 42. REG. 11-3-1998.
- 2,201,564. EST. 1831 STEWARTS CREAM OF THE BARLEY SCOTCH WHISKY AND DESIGN. INT. CL. 33. REG. 11-3-1998.
- 2,201,565. FUELTEC. INT. CL. 7. REG. 11-3-1998.
- 2,201,566. ULTRALAB AND DESIGN. INT. CL. 9. REG. 11-3-1998.
- 2,201,567. VIBRA-RAM. INT. CL. 9. REG. 11-3-1998.
- 2,201,569. RED EARTH AND DESIGN. INT. CLS. 3, 25 AND 31. REG. 11-3-1998.
- 2,201,572. COLORKEEP. INT. CL. 1. REG. 11-3-1998.
- 2,201,573. MISCELLANEOUS DESIGN. INT. CL. 15. REG. 11-3-1998.
- 2,201,576. AMERICAN SAFEROOM DOORS AND DESIGN. INT. CL. 37. REG. 11-3-1998.
- 2,201,577. DRI-TREDS WATERPROOF AND DESIGN. INT. CL. 25. REG. 11-3-1998.
- 2,201,579. CREATIVE CONCEPTS. INT. CLS. 3, 8, 9, 10, 11, 14, 18, 20, 21 AND 28. REG. 11-3-1998.
- 2,201,580. NETWORKING TRUST CATALYTICA VISION ENTREPRENEURSHIP AND DESIGN. INT. CL. 35. REG. 11-3-1998.
- 2,201,585. MISCELLANEOUS DESIGN. INT. CL. 42. REG. 11-3-1998.
- 2,201,586. TUFF STUFF. INT. CL. 28. REG. 11-3-1998.
- 2,201,591. ELECTRO-SOMPAC. INT. CL. 7. REG. 11-3-1998.
- 2,201,592. IT'S MORPHIN TIME. INT. CL. 41. REG. 11-3-1998.
- 2,201,596. INSTANT INTERNET. INT. CL. 9. REG. 11-3-1998.
- 2,201,597. LIFE'S FINEST. INT. CLS. 5, 29, 30 AND 32. REG. 11-3-1998.
- 2,201,598. GEM-PAK. INT. CL. 20. REG. 11-3-1998.
- 2,201,599. LAMBROS MILONA. INT. CL. 3. REG. 11-3-1998.
- 2,201,600. INTREPID PRESS. INT. CL. 41. REG. 11-3-1998.
- 2,201,604. QUANTUM TRUESTEP AND DESIGN. INT. CL. 10. REG. 11-3-1998.
- 2,201,609. INSIGHT AND DESIGN. INT. CL. 9. REG. 11-3-1998.
- 2,201,611. GORVON. INT. CLS. 24 AND 25. REG. 11-3-1998.
- 2,201,612. ALWAYS FRESH AND HEALTHY. INT. CL. 42. REG. 11-3-1998.
- 2,201,613. S.W.A.T.. INT. CL. 13. REG. 11-3-1998.
- 2,201,614. TABB. INT. CL. 37. REG. 11-3-1998.
- 2,201,617. EDUPLATES AND DESIGN. INT. CL. 16. REG. 11-3-1998.
- 2,201,619. USA AND DESIGN. INT. CL. 35. REG. 11-3-1998.
- 2,201,620. USA (STYLIZED). INT. CL. 16. REG. 11-3-1998.
- 2,201,622. VIACOM. INT. CL. 42. REG. 11-3-1998.
- 2,201,623. FEUX DE SANTAL. INT. CLS. 3, 4, 5 AND 21. REG. 11-3-1998.
- 2,201,624. CROSSWORD CHAMPION. INT. CL. 16. REG. 11-3-1998.
- 2,201,625. ISLANDERS AND DESIGN. INT. CL. 25. REG. 11-3-1998.
- 2,201,626. THERMAL DYNAMICS. INT. CLS. 1, 4 AND 11. REG. 11-3-1998.
- 2,201,628. THOUGHTS HAVE WINGS. INT. CL. 16. REG. 11-3-1998.
- 2,201,632. INNER-CITY GAMES AND DESIGN. INT. CL. 41. REG. 11-3-1998.
- 2,201,635. STERLINGG (STYLIZED). INT. CL. 36. REG. 11-3-1998.
- 2,201,641. NAIL PALETTE. INT. CL. 20. REG. 11-3-1998.
- 2,201,642. VALUDOC. INT. CL. 9. REG. 11-3-1998.
- 2,201,643. SPIRAL. INT. CL. 9. REG. 11-3-1998.
- 2,201,644. MY PLACE. INT. CL. 42. REG. 11-3-1998.
- 2,201,646. CITY COOL. STREET SMART.. INT. CL. 25. REG. 11-3-1998.
- 2,201,647. EFAS. INT. CL. 9. REG. 11-3-1998.
- 2,201,650. FTNY CITY COOL. STREET SMART. AND DESIGN. INT. CL. 25. REG. 11-3-1998.
- 2,201,651. WELL INFORMED. INT. CL. 42. REG. 11-3-1998.
- 2,201,652. VISUAL MIXPALLET. INT. CL. 9. REG. 11-3-1998.
- 2,201,654. DREAMSCAPE. INT. CL. 42. REG. 11-3-1998.
- 2,201,655. GRAMAN (STYLIZED). INT. CL. 28. REG. 11-3-1998.
- 2,201,657. OSTEOPATHIC MEDICINE'S CARING COOPERATIVE AND DESIGN. INT. CL. 41. REG. 11-3-1998.
- 2,201,658. ETE EDUCATION THRU ENTERTAINMENT AND DESIGN. INT. CLS. 9 AND 16. REG. 11-3-1998.
- 2,201,659. BIEX. INT. CL. 10. REG. 11-3-1998.
- 2,201,660. COUNTRY COTTAGE AND DESIGN. INT. CL. 17. REG. 11-3-1998.
- 2,201,661. POWERTEAR. INT. CL. 17. REG. 11-3-1998.
- 2,201,664. BEAR PAW. INT. CL. 13. REG. 11-3-1998.
- 2,201,665. BALPOINT. INT. CL. 13. REG. 11-3-1998.
- 2,201,667. AINLINK. INT. CL. 38. REG. 11-3-1998.
- 2,201,668. FRAN'S HEALTHY HELPINGS. INT. CL. 30. REG. 11-3-1998.
- 2,201,670. THE FANTASTIC VOYAGES OF SINBAD THE SAILOR. INT. CL. 41. REG. 11-3-1998.
- 2,201,672. HTO. INT. CL. 11. REG. 11-3-1998.
- 2,201,676. AHLFLOAT. INT. CL. 11. REG. 11-3-1998.
- 2,201,679. EZ-FIND. INT. CL. 11. REG. 11-3-1998.
- 2,201,680. INTERCHANNEL. INT. CL. 9. REG. 11-3-1998.
- 2,201,681. MOISTURE MAGIC. INT. CL. 3. REG. 11-3-1998.
- 2,201,682. RECIPROCAL FEEDBACK SYSTEM AND DESIGN. INT. CL. 41. REG. 11-3-1998.
- 2,201,683. DELIVERING ON THE PROMISE OF BIOTECHNOLOGY. INT. CL. 42. REG. 11-3-1998.
- 2,201,684. ESSANTE. INT. CL. 5. REG. 11-3-1998.
- 2,201,688. SECUREWAY. INT. CLS. 9 AND 42. REG. 11-3-1998.
- 2,201,693. PLUS ONE. INT. CL. 11. REG. 11-3-1998.
- 2,201,699. ORACLE VIDEO SERVER. INT. CL. 9. REG. 11-3-1998.
- 2,201,704. PREVENTIUM. INT. CL. 5. REG. 11-3-1998.
- 2,201,705. MFX. INT. CL. 9. REG. 11-3-1998.
- 2,201,707. CARDIOCHOICE. INT. CL. 42. REG. 11-3-1998.
- 2,201,708. BANK OF BOSTON OPTIMIZER. INT. CL. 36. REG. 11-3-1998.
- 2,201,712. TROVAC. INT. CL. 9. REG. 11-3-1998.
- 2,201,714. THE DAY THE WALL CAME DOWN. INT. CLS. 9, 16 AND 25. REG. 11-3-1998.
- 2,201,715. RIGHTSTEPS. INT. CL. 35. REG. 11-3-1998.
- 2,201,719. SEMIPOWER. INT. CL. 9. REG. 11-3-1998.
- 2,201,720. PHONE BASIC. INT. CL. 9. REG. 11-3-1998.
- 2,201,724. AI AND DESIGN. INT. CL. 10. REG. 11-3-1998.
- 2,201,725. PARTYTIME STAMPERS. INT. CL. 28. REG. 11-3-1998.

- 2,201,726. BEETLE BATTLE BASE. INT. CL. 28. REG. 11-3-1998.
- 2,201,728. ALIANT COMMUNICATIONS AND DESIGN. INT. CL. 38. REG. 11-3-1998.
- 2,201,730. HIDE-A-HOSE. INT. CL. 9. REG. 11-3-1998.
- 2,201,734. UNLOCK THE DRIVE. INT. CL. 25. REG. 11-3-1998.
- 2,201,735. LEAN TEAM. INT. CL. 41. REG. 11-3-1998.
- 2,201,737. POWERSTORM. INT. CL. 9. REG. 11-3-1998.
- 2,201,740. CYBERTEXT PUBLISHING. INT. CLS. 9 AND 41. REG. 11-3-1998.
- 2,201,741. CONGO VOICE ROUTER. INT. CL. 9. REG. 11-3-1998.
- 2,201,744. BLACK KNIGHT. INT. CL. 25. REG. 11-3-1998.
- 2,201,747. VERYSPECIAL BOUCHEE (STYLIZED). INT. CL. 30. REG. 11-3-1998.
- 2,201,749. 1-800-HIT-LOTTO. INT. CL. 36. REG. 11-3-1998.
- 2,201,750. 1-888-HIT-LOTTO. INT. CL. 36. REG. 11-3-1998.
- 2,201,754. SAVING GRACE. INT. CL. 3. REG. 11-3-1998.
- 2,201,755. STAR DRIVE. INT. CL. 28. REG. 11-3-1998.
- 2,201,756. ALIANT COMMUNICATIONS. INT. CL. 38. REG. 11-3-1998.
- 2,201,757. PERCEPTION A4V. INT. CL. 9. REG. 11-3-1998.
- 2,201,758. YOURNET. INT. CL. 38. REG. 11-3-1998.
- 2,201,759. CHIK'N' SAVORS. INT. CL. 29. REG. 11-3-1998.
- 2,201,760. DON SERRANO GOURMET FOODS AND DESIGN. INT. CL. 29. REG. 11-3-1998.
- 2,201,761. GLOBALUBE AND DESIGN. INT. CLS. 4 AND 7. REG. 11-3-1998.
- 2,201,762. WORLD SERIES. INT. CL. 9. REG. 11-3-1998.
- 2,201,763. TERRAIN. INT. CL. 25. REG. 11-3-1998.
- 2,201,765. OFF RODEO DR. INT. CL. 35. REG. 11-3-1998.
- 2,201,767. MISCELLANEOUS DESIGN. INT. CL. 42. REG. 11-3-1998.
- 2,201,771. SEALANDTECH.COM. INT. CL. 40. REG. 11-3-1998.
- 2,201,772. MACRO. INT. CL. 25. REG. 11-3-1998.
- 2,201,773. TWIN CITIES ONLINE AND DESIGN. INT. CL. 42. REG. 11-3-1998.
- 2,201,775. ANYTIME/ANYWHERE COACHING. INT. CL. 9. REG. 11-3-1998.
- 2,201,776. HIDEROK. INT. CL. 9. REG. 11-3-1998.
- 2,201,777. G-CAP. INT. CL. 9. REG. 11-3-1998.
- 2,201,779. EMBRACER. INT. CL. 10. REG. 11-3-1998.
- 2,201,780. SITESWEEPER. INT. CL. 9. REG. 11-3-1998.
- 2,201,781. SPACE WEB. INT. CL. 9. REG. 11-3-1998.
- 2,201,782. C/C PERFORMANCE PRODUCTS AND DESIGN. INT. CL. 12. REG. 11-3-1998.
- 2,201,783. AT LAST I FOUND MY MARBLES. INT. CL. 21. REG. 11-3-1998.
- 2,201,784. NU-LIFE. INT. CL. 3. REG. 11-3-1998.
- 2,201,785. ROCKDOC. INT. CLS. 9 AND 16. REG. 11-3-1998.
- 2,201,786. ULTRALOC. INT. CL. 7. REG. 11-3-1998.
- 2,201,789. STARFISH. INT. CL. 28. REG. 11-3-1998.
- 2,201,790. TEA BODY'S. INT. CL. 30. REG. 11-3-1998.
- 2,201,794. GOBBLERS. INT. CL. 31. REG. 11-3-1998.
- 2,201,796. BANKNOW. INT. CL. 9. REG. 11-3-1998.
- 2,201,799. TELEMED AND DESIGN. INT. CL. 9. REG. 11-3-1998.
- 2,201,800. BODY VIVE. INT. CL. 3. REG. 11-3-1998.
- 2,201,802. EASYCAT. INT. CL. 9. REG. 11-3-1998.
- 2,201,803. QST. INT. CL. 35. REG. 11-3-1998.
- 2,201,804. RECOVERING THE FUTURE. INT. CL. 42. REG. 11-3-1998.
- 2,201,807. CORECHANGE. INT. CLS. 9 AND 42. REG. 11-3-1998.
- 2,201,810. UNISCAPE. INT. CL. 9. REG. 11-3-1998.
- 2,201,811. BANKBOSTON 1784 AND DESIGN. INT. CL. 36. REG. 11-3-1998.
- 2,201,812. CRYSTALJET. INT. CL. 9. REG. 11-3-1998.
- 2,201,813. SUPERVIEW. INT. CL. 9. REG. 11-3-1998.
- 2,201,816. BLEACH. INT. CLS. 9 AND 41. REG. 11-3-1998.
- 2,201,819. PRAXSYMA. INT. CL. 9. REG. 11-3-1998.
- 2,201,821. KEM BAKE. INT. CL. 2. REG. 11-3-1998.
- 2,201,825. VECTORSTAT. INT. CL. 1. REG. 11-3-1998.
- 2,201,826. BASELINE. INT. CL. 9. REG. 11-3-1998.
- 2,201,828. RHYTHMLINK. INT. CL. 9. REG. 11-3-1998.
- 2,201,832. CNE ENERGY AND DESIGN. INT. CL. 36. REG. 11-3-1998.
- 2,201,835. CAPGUARD. INT. CL. 2. REG. 11-3-1998.
- 2,201,836. ROLLICK. INT. CL. 32. REG. 11-3-1998.
- 2,201,837. SH AND DESIGN. INT. CL. 36. REG. 11-3-1998.
- 2,201,838. MASTERSHELF. INT. CL. 20. REG. 11-3-1998.
- 2,201,839. MYWIL. INT. CL. 16. REG. 11-3-1998.
- 2,201,841. SUNKOSI AND DESIGN. INT. CLS. 9 AND 25. REG. 11-3-1998.
- 2,201,842. SUNKOSI. INT. CLS. 9 AND 25. REG. 11-3-1998.
- 2,201,844. THE MASTER'S PLAN CLUB. INT. CLS. 36 AND 42. REG. 11-3-1998.
- 2,201,846. SUE THE ALLIGATOR. INT. CL. 9. REG. 11-3-1998.
- 2,201,847. AMERINET. INT. CL. 36. REG. 11-3-1998.
- 2,201,848. VUEGO (STYLIZED). INT. CL. 42. REG. 11-3-1998.
- 2,201,851. MISCELLANEOUS DESIGN. INT. CLS. 8 AND 9. REG. 11-3-1998.
- 2,201,852. SALSATILLA. INT. CL. 30. REG. 11-3-1998.
- 2,201,856. AUGUSTA PLANK. INT. CL. 27. REG. 11-3-1998.
- 2,201,857. VILLA ESPANOLA INTERNATIONAL BAKERY. INT. CL. 30. REG. 11-3-1998.
- 2,201,859. LANDSCAPING. INT. CL. 36. REG. 11-3-1998.
- 2,201,863. STATION. INT. CL. 16. REG. 11-3-1998.
- 2,201,864. POSTAL ZONE. INT. CL. 38. REG. 11-3-1998.
- 2,201,868. PUPPY PAIRS. INT. CL. 28. REG. 11-3-1998.
- 2,201,871. FCI AND DESIGN. INT. CL. 35. REG. 11-3-1998.
- 2,201,872. SPECTEX. INT. CL. 17. REG. 11-3-1998.
- 2,201,875. CMI. INT. CLS. 25 AND 28. REG. 11-3-1998.
- 2,201,876. SURFINCHECK. INT. CL. 9. REG. 11-3-1998.
- 2,201,877. BLACK MAGIC. INT. CL. 6. REG. 11-3-1998.
- 2,201,878. CARBO-CAM. INT. CL. 6. REG. 11-3-1998.
- 2,201,879. RATCHAMATIC. INT. CL. 6. REG. 11-3-1998.
- 2,201,880. GARNETT CONSULTING. INT. CL. 35. REG. 11-3-1998.
- 2,201,881. THE ART OF HUMANITY. INT. CL. 36. REG. 11-3-1998.
- 2,201,882. NORTHERN LIGHTS INTERACTIVE. INT. CL. 35. REG. 11-3-1998.
- 2,201,885. N3 (STYLIZED). INT. CL. 9. REG. 11-3-1998.
- 2,201,887. AUTO-CEPTOR. INT. CL. 9. REG. 11-3-1998.
- 2,201,888. LIONEL LEGENDS. INT. CL. 28. REG. 11-3-1998.
- 2,201,890. INLAND. INT. CL. 16. REG. 11-3-1998.
- 2,201,891. GSB GIVE SOMETHING BACK AND DESIGN. INT. CL. 25. REG. 11-3-1998.
- 2,201,894. THE QUALITY CHOICE. INT. CL. 12. REG. 11-3-1998.
- 2,201,896. MS. PASSEMENTERIE. INT. CL. 26. REG. 11-3-1998.
- 2,201,898. THE SCHOOL BOOK. INT. CL. 3. REG. 11-3-1998.
- 2,201,899. RACING RAGS. INT. CL. 25. REG. 11-3-1998.
- 2,201,902. RIGGS & COMPANY. INT. CL. 36. REG. 11-3-1998.
- 2,201,903. RIGGS & CO.. INT. CL. 36. REG. 11-3-1998.
- 2,201,904. MYRTLE. INT. CL. 12. REG. 11-3-1998.
- 2,201,906. CGT. INT. CL. 41. REG. 11-3-1998.
- 2,201,907. EZ-GRIP. INT. CL. 15. REG. 11-3-1998.
- 2,201,909. BITSY BOOP AND DESIGN. INT. CL. 25. REG. 11-3-1998.
- 2,201,911. LIBERTY DREAM. INT. CL. 28. REG. 11-3-1998.
- 2,201,912. SERENADE IN SATIN. INT. CL. 28. REG. 11-3-1998.
- 2,201,914. PARTY PERFECT. INT. CL. 28. REG. 11-3-1998.
- 2,201,915. MARIPOSA. INT. CL. 5. REG. 11-3-1998.
- 2,201,916. FIBERFOUNTAIN. INT. CL. 11. REG. 11-3-1998.
- 2,201,920. SG SOPHIA GERARD AND DESIGN. INT. CL. 3. REG. 11-3-1998.
- 2,201,926. CHELSEA CABELL. INT. CLS. 3, 14, 18, 25, 26 AND 28. REG. 11-3-1998.
- 2,201,928. PERMASEAL. INT. CL. 1. REG. 11-3-1998.
- 2,201,929. MAKING ATM DELIVER TO ITS PROMISE. INT. CL. 9. REG. 11-3-1998.
- 2,201,930. PACKIT!. INT. CL. 16. REG. 11-3-1998.
- 2,201,931. BEST OF ... AND DESIGN. INT. CL. 35. REG. 11-3-1998.
- 2,201,933. E EL PASO ENERGY AND DESIGN. INT. CL. 42. REG. 11-3-1998.
- 2,201,934. EL PASO ENERGY AND DESIGN. INT. CL. 37. REG. 11-3-1998.

- 2,201,937. MONTEREY NATURALS. INT. CL. 3. REG. 11-3-1998.
- 2,201,938. TODAY'S BUSINESSWOMAN. INT. CL. 16. REG. 11-3-1998.
- 2,201,939. XL-LITE. INT. CL. 28. REG. 11-3-1998.
- 2,201,941. THE DUCHESS RING BY CITRA. INT. CL. 14. REG. 11-3-1998.
- 2,201,943. COMPONENTS OF PROFITABILITY. INT. CL. 42. REG. 11-3-1998.
- 2,201,944. EPIC PERENNIALS. INT. CL. 31. REG. 11-3-1998.
- 2,201,946. GHOSTFORMERS. INT. CL. 28. REG. 11-3-1998.
- 2,201,947. JUICE BOUTIQUE AND DESIGN. INT. CLS. 7 AND 11. REG. 11-3-1998.
- 2,201,948. CICALADACON. INT. CL. 28. REG. 11-3-1998.
- 2,201,949. POWERPINCH. INT. CL. 28. REG. 11-3-1998.
- 2,201,950. HERE, THERE AND EVERYWHERE IN BETWEEN. INT. CL. 38. REG. 11-3-1998.
- 2,201,951. TWINTECH. INT. CL. 25. REG. 11-3-1998.
- 2,201,952. ZIPPRIBB'N. INT. CL. 26. REG. 11-3-1998.
- 2,201,957. PBR AND DESIGN. INT. CL. 12. REG. 11-3-1998.
- 2,201,959. GOLFX. INT. CL. 28. REG. 11-3-1998.
- 2,201,960. AIR-B. INT. CL. 12. REG. 11-3-1998.
- 2,201,961. MISTER PAR. INT. CL. 11. REG. 11-3-1998.
- 2,201,964. TRADITIONAL WERTHER'S MILKFULS AND DESIGN. INT. CL. 30. REG. 11-3-1998.
- 2,201,965. SONAI. INT. CL. 9. REG. 11-3-1998.
- 2,201,966. WERTHER'S MILKFULS WERTHER'S TOFFEE WITH-A-RICH-MILK FILLING TRADITIONAL WERTHER'S QUALITY AND DESIGN. INT. CL. 30. REG. 11-3-1998.
- 2,201,967. SPACE COPTER. INT. CL. 28. REG. 11-3-1998.
- 2,201,970. WEATHER BARRIER. INT. CL. 25. REG. 11-3-1998.
- 2,201,971. MIDXTRA. INT. CL. 9. REG. 11-3-1998.
- 2,201,974. GDSL. INT. CL. 9. REG. 11-3-1998.
- 2,201,975. KEYCASH MANAGER. INT. CL. 9. REG. 11-3-1998.
- 2,201,977. ICY-N-CARE. INT. CL. 10. REG. 11-3-1998.
- 2,201,979. AUTOMATIC. INT. CL. 25. REG. 11-3-1998.
- 2,201,982. RED ROCKET. INT. CL. 9. REG. 11-3-1998.
- 2,201,984. PLAN 2000. INT. CL. 9. REG. 11-3-1998.
- 2,201,987. SET 4 LIFE. INT. CL. 20. REG. 11-3-1998.
- 2,201,989. IP* EDI.LINK AND DESIGN. INT. CL. 9. REG. 11-3-1998.
- 2,201,990. IP*NET SUITE AND DESIGN. INT. CL. 9. REG. 11-3-1998.
- 2,201,993. ATHABASKAN HERITAGE COLLECTION. INT. CL. 24. REG. 11-3-1998.
- 2,201,994. WHISTLER. INT. CLS. 6 AND 19. REG. 11-3-1998.
- 2,201,995. PACIFIC HUNTER. INT. CL. 8. REG. 11-3-1998.
- 2,202,000. CRYSTALCAST. INT. CL. 9. REG. 11-3-1998.
- 2,202,002. WOULD YOU?. INT. CL. 25. REG. 11-3-1998.
- 2,202,003. AGEASE. INT. CL. 9. REG. 11-3-1998.
- 2,202,004. RASPBERRY RAGE. INT. CL. 3. REG. 11-3-1998.
- 2,202,007. SUPREME CHOICE. INT. CL. 3. REG. 11-3-1998.
- 2,202,009. NETWORKMCI INFO SOURCE. INT. CL. 38. REG. 11-3-1998.
- 2,202,010. ACCOUNTING UNDER THE HOOD. INT. CL. 9. REG. 11-3-1998.
- 2,202,013. BILL BLASS. INT. CL. 20. REG. 11-3-1998.
- 2,202,014. GENOPEDIGREE. INT. CL. 9. REG. 11-3-1998.
- 2,202,015. CASH THE WALLET COMPANY (STYLIZED). INT. CL. 18. REG. 11-3-1998.
- 2,202,017. MISCELLANEOUS DESIGN. INT. CLS. 3 AND 5. REG. 11-3-1998.
- 2,202,018. UTILISYS AND DESIGN. INT. CLS. 35 AND 38. REG. 11-3-1998.
- 2,202,019. MISCELLANEOUS DESIGN. INT. CL. 35. REG. 11-3-1998.
- 2,202,022. ON THE LAKE. INT. CL. 16. REG. 11-3-1998.
- 2,202,024. REISSWOLF AND DESIGN. INT. CL. 37. REG. 11-3-1998.
- 2,202,025. GREAT GETAWAYS. INT. CL. 28. REG. 11-3-1998.
- 2,202,026. SPORT DREAMS. INT. CL. 20. REG. 11-3-1998.
- 2,202,028. FANCY FISH. INT. CL. 28. REG. 11-3-1998.
- 2,202,031. R-2000 AND DESIGN. INT. CLS. 41 AND 42. REG. 11-3-1998.
- 2,202,032. COLLECT'EMS. INT. CL. 28. REG. 11-3-1998.
- 2,202,033. ECO PULSE AND DESIGN. INT. CL. 9. REG. 11-3-1998.
- 2,202,034. SPORTSTUFF. INT. CL. 9. REG. 11-3-1998.
- 2,202,035. THAT'S BRISK, BABY!. INT. CL. 30. REG. 11-3-1998.
- 2,202,036. ACTIVE LIVING SMART SHOPPING CLUB. INT. CL. 35. REG. 11-3-1998.
- 2,202,038. HOMEOWNER'S CHOICE AND DESIGN. INT. CL. 31. REG. 11-3-1998.
- 2,202,039. ALLEGRO. INT. CL. 12. REG. 11-3-1998.
- 2,202,040. ON THE GO BOOKS BY RICHARD SCARRY. INT. CL. 16. REG. 11-3-1998.
- 2,202,041. PHARMULARY. INT. CL. 42. REG. 11-3-1998.
- 2,202,042. CHANGIN' SEASONS. INT. CL. 28. REG. 11-3-1998.
- 2,202,044. MEMOTHERM. INT. CL. 10. REG. 11-3-1998.
- 2,202,045. RIDE THE WIRE. INT. CL. 38. REG. 11-3-1998.
- 2,202,046. RIGGS & CO. AND DESIGN. INT. CL. 36. REG. 11-3-1998.
- 2,202,047. WET CITY RECORDS. INT. CL. 9. REG. 11-3-1998.
- 2,202,048. AC AND DESIGN. INT. CLS. 3 AND 5. REG. 11-3-1998.
- 2,202,049. MIXABLES. INT. CL. 21. REG. 11-3-1998.
- 2,202,050. ULTRADRIVER. INT. CL. 8. REG. 11-3-1998.
- 2,202,052. INTREPID. INT. CL. 7. REG. 11-3-1998.
- 2,202,055. MAGTECH. INT. CL. 1. REG. 11-3-1998.
- 2,202,056. JOURNEY TO EXCELLENCE. INT. CL. 7. REG. 11-3-1998.
- 2,202,058. UTAH STARZZ AND DESIGN. INT. CL. 28. REG. 11-3-1998.
- 2,202,059. CREATE YOUR OWN SPECIAL EFFECT. INT. CL. 25. REG. 11-3-1998.
- 2,202,063. DOMAIN ENERGY. INT. CL. 42. REG. 11-3-1998.
- 2,202,065. SOLDIERS AT WAR. INT. CL. 9. REG. 11-3-1998.
- 2,202,066. SCANROM. INT. CL. 9. REG. 11-3-1998.
- 2,202,067. BRYAN FAMILY DINNER PIE. INT. CL. 30. REG. 11-3-1998.
- 2,202,068. MASTER TOW. INT. CL. 39. REG. 11-3-1998.
- 2,202,072. BUILDER ZONE. INT. CL. 42. REG. 11-3-1998.
- 2,202,076. KIDS CLUBHOUSE. INT. CL. 28. REG. 11-3-1998.
- 2,202,079. OVERBLOOD. INT. CL. 9. REG. 11-3-1998.
- 2,202,083. WEBRECORD. INT. CL. 9. REG. 11-3-1998.
- 2,202,084. MISCELLANEOUS DESIGN. INT. CL. 42. REG. 11-3-1998.
- 2,202,089. SATIN FACETS. INT. CL. 8. REG. 11-3-1998.
- 2,202,093. THE GREAT TASTING WAY TO MARINATE EVERY DAY!. INT. CL. 30. REG. 11-3-1998.
- 2,202,094. MISCELLANEOUS DESIGN. INT. CLS. 35, 37 AND 42. REG. 11-3-1998.
- 2,202,096. THE SECRETIONS. INT. CL. 41. REG. 11-3-1998.
- 2,202,097. MINTERRIFIC. INT. CL. 30. REG. 11-3-1998.
- 2,202,098. MALT ASSAULT. INT. CL. 30. REG. 11-3-1998.
- 2,202,100. FEDEX CUSTOMER RESOURCE CENTER. INT. CL. 35. REG. 11-3-1998.
- 2,202,101. THE SEATING EDGE. INT. CLS. 10 AND 20. REG. 11-3-1998.
- 2,202,105. IT'S ALL WITHIN YOUR REACH. INT. CL. 36. REG. 11-3-1998.
- 2,202,106. CELACTIV. INT. CL. 1. REG. 11-3-1998.
- 2,202,107. QUILTED MEMORIES. INT. CL. 24. REG. 11-3-1998.
- 2,202,108. DECKLITE. INT. CL. 19. REG. 11-3-1998.
- 2,202,109. A TOUCH OF GOLD. INT. CL. 21. REG. 11-3-1998.
- 2,202,111. MAISONAIRE. INT. CL. 3. REG. 11-3-1998.
- 2,202,112. TOE EZY. INT. CL. 8. REG. 11-3-1998.
- 2,202,113. MISCELLANEOUS DESIGN. INT. CL. 8. REG. 11-3-1998.
- 2,202,114. A CENTURY OF BEAUTIFUL BRIDES. INT. CL. 28. REG. 11-3-1998.
- 2,202,115. FIBERMARK AND DESIGN. INT. CL. 16. REG. 11-3-1998.
- 2,202,116. QUICKPHOTO. INT. CL. 9. REG. 11-3-1998.
- 2,202,117. CLEAN BREEZE. INT. CL. 5. REG. 11-3-1998.
- 2,202,120. CYBER-TALK (STYLIZED). INT. CL. 28. REG. 11-3-1998.
- 2,202,121. THE TWINKLE TOES RECITAL. INT. CL. 28. REG. 11-3-1998.
- 2,202,123. AM HORIZON. INT. CL. 9. REG. 11-3-1998.

- 2,202,124. QUICKCLAIM. INT. CL. 36. REG. 11-3-1998.
 2,202,125. BUSHIDO. INT. CL. 9. REG. 11-3-1998.
 2,202,130. AUTO COUNTRY AND DESIGN. INT. CL. 35. REG. 11-3-1998.
 2,202,132. THE JOURNEY CHRISTIAN BOARD GAME (STYLIZED). INT. CL. 28. REG. 11-3-1998.
 2,202,134. SWEET DREAMS BABY. INT. CL. 28. REG. 11-3-1998.
 2,202,136. KIM-PET. INT. CL. 9. REG. 11-3-1998.
 2,202,142. FROM THE SIDELINES. INT. CL. 35. REG. 11-3-1998.
 2,202,146. GEE-PURRS!. INT. CL. 31. REG. 11-3-1998.
 2,202,152. TOUCHING OUR COMMUNITY. INT. CL. 16. REG. 11-3-1998.
 2,202,153. SORA. INT. CL. 9. REG. 11-3-1998.
 2,202,154. A AND DESIGN. INT. CL. 9. REG. 11-3-1998.
 2,202,155. MEGASUEDE. INT. CL. 24. REG. 11-3-1998.
 2,202,157. CHILD CARE: AMERICA WOULDN'T WORK WITHOUT IT!. INT. CL. 42. REG. 11-3-1998.
 2,202,159. TRIPLE PLAY. INT. CL. 9. REG. 11-3-1998.
 2,202,160. DURALAM. INT. CL. 19. REG. 11-3-1998.
 2,202,161. BIOPUTTY. INT. CL. 1. REG. 11-3-1998.
 2,202,164. STIMULATE. INT. CL. 4. REG. 11-3-1998.
 2,202,174. PASTATHON. INT. CL. 30. REG. 11-3-1998.
 2,202,175. HEALTHRAYS ALLIANCE. INT. CL. 35. REG. 11-3-1998.
 2,202,178. RATIO. INT. CL. 5. REG. 11-3-1998.
 2,202,180. "YOU'VE GOT A LIFE. WE LET YOU LIVE IT. REAL ESTATE IS OUR LIFE.". INT. CL. 42. REG. 11-3-1998.
 2,202,182. PERMANENT MATCH. INT. CL. 34. REG. 11-3-1998.
 2,202,183. EVASORB. INT. CL. 17. REG. 11-3-1998.
 2,202,184. INSUFLOW. INT. CL. 10. REG. 11-3-1998.
 2,202,186. THE COOL SCENT. INT. CL. 3. REG. 11-3-1998.
 2,202,187. THE WARM SCENT. INT. CL. 3. REG. 11-3-1998.
 2,202,188. MISCELLANEOUS DESIGN. INT. CL. 35. REG. 11-3-1998.
 2,202,189. STRONG TOOLS FOR SMART OPERATORS. INT. CL. 21. REG. 11-3-1998.
 2,202,190. GEL-MILLENNIUM. INT. CL. 25. REG. 11-3-1998.
 2,202,192. PHILADELPHIA. INT. CL. 29. REG. 11-3-1998.
 2,202,194. SENSOR-X. INT. CL. 9. REG. 11-3-1998.
 2,202,199. GUIDANCE YOU CAN TRUST. INT. CL. 41. REG. 11-3-1998.
 2,202,200. BARE PLEASURE. INT. CL. 10. REG. 11-3-1998.
 2,202,201. NIGHT HEAT. INT. CL. 10. REG. 11-3-1998.
 2,202,202. MRF-O-MATIC. INT. CL. 9. REG. 11-3-1998.
 2,202,203. MARINADOR. INT. CL. 34. REG. 11-3-1998.
 2,202,204. PLANET FIRE. INT. CL. 28. REG. 11-3-1998.
 2,202,205. TOCCATA. INT. CL. 16. REG. 11-3-1998.
 2,202,206. COSMOPOLITAN BODY BIKE. INT. CL. 28. REG. 11-3-1998.
 2,202,208. THE GOLF CLUB AT BALLANTYNE RESORT. INT. CL. 41. REG. 11-3-1998.
 2,202,209. PRIMESIGHT. INT. CL. 16. REG. 11-3-1998.
 2,202,211. WALDEN POND. INT. CL. 27. REG. 11-3-1998.
 2,202,212. DIAMONDVISION. INT. CL. 7. REG. 11-3-1998.
 2,202,215. MISCELLANEOUS DESIGN. INT. CLS. 41 AND 42. REG. 11-3-1998.
 2,202,216. CORONARY BLOCKBUSTERS RATED (R)EGRESSION OF ATHEROSCLEROTIC PLAQUES FOR MATURE AUDIENCES ONLY. INT. CL. 41. REG. 11-3-1998.
 2,202,217. PRT AND DESIGN. INT. CL. 42. REG. 11-3-1998.
 2,202,218. THE MORTGAGE CENTER AND DESIGN. INT. CL. 36. REG. 11-3-1998.
 2,202,220. VENTURES INITIATIVE AND FOCUS. INT. CL. 16. REG. 11-3-1998.
 2,202,226. TIGHT SQUEEZE. INT. CL. 28. REG. 11-3-1998.
 2,202,227. SNAP N' GROW. INT. CL. 20. REG. 11-3-1998.
 2,202,228. THE AFFORDABLE ALTERNATIVE. INT. CL. 14. REG. 11-3-1998.
 2,202,231. BIG BAD BOW. INT. CL. 28. REG. 11-3-1998.
 2,202,232. SPY WEB. INT. CL. 28. REG. 11-3-1998.
 2,202,233. CAREPAK. INT. CL. 38. REG. 11-3-1998.
 2,202,234. ONE SHOT. INT. CL. 1. REG. 11-3-1998.
 2,202,235. MOUNTAIN TRAILS. INT. CL. 25. REG. 11-3-1998.
 2,202,236. EXPAND-A-BLAST. INT. CL. 28. REG. 11-3-1998.
 2,202,239. HEALTHRAYS ALLIANCE AND DESIGN. INT. CL. 35. REG. 11-3-1998.
 2,202,241. CUSTOM SOLUTIONS. INT. CL. 36. REG. 11-3-1998.
 2,202,244. MELATONIN KL. INT. CL. 5. REG. 11-3-1998.
 2,202,245. BIG STEPS. INT. CL. 25. REG. 11-3-1998.
 2,202,246. DOLPHIN FUN ISLAND. INT. CL. 28. REG. 11-3-1998.
 2,202,254. CHOICES FOR LIVING. INT. CL. 16. REG. 11-3-1998.
 2,202,255. V AND DESIGN. INT. CL. 31. REG. 11-3-1998.
 2,202,257. BOOKCOVERS, ETC.. INT. CL. 16. REG. 11-3-1998.
 2,202,259. SHOETOPIA. INT. CL. 35. REG. 11-3-1998.
 2,202,260. CENTRAL STAR COMMUNICATIONS. INT. CL. 38. REG. 11-3-1998.
 2,202,261. GUARANA GIZER BIOHERBAL. INT. CL. 5. REG. 11-3-1998.
 2,202,262. GERBER HARDWATER FAMILY. INT. CL. 11. REG. 11-3-1998.
 2,202,263. POINTE*ORLANDO AND DESIGN. INT. CL. 25. REG. 11-3-1998.
 2,202,264. COLOUR FLAVOURS AND DESIGN. INT. CL. 21. REG. 11-3-1998.
 2,202,265. LADIES' HOME JOURNAL. INT. CL. 31. REG. 11-3-1998.
 2,202,267. POWDER PLAY. INT. CL. 3. REG. 11-3-1998.
 2,202,270. COMOTION. INT. CL. 28. REG. 11-3-1998.
 2,202,271. HEADS & TAILS. INT. CL. 26. REG. 11-3-1998.
 2,202,272. EZ COMPLY. INT. CL. 36. REG. 11-3-1998.
 2,202,273. DON POMODORO. INT. CL. 30. REG. 11-3-1998.
 2,202,274. SMALL SOLDIERS. INT. CL. 9. REG. 11-3-1998.
 2,202,278. OSTEOSURE. INT. CL. 5. REG. 11-3-1998.
 2,202,279. SKINDULGE. INT. CL. 5. REG. 11-3-1998.
 2,202,282. FIELD SPICE. INT. CL. 31. REG. 11-3-1998.
 2,202,284. AIRMAX. INT. CL. 28. REG. 11-3-1998.
 2,202,285. POWERSOURCE. INT. CL. 28. REG. 11-3-1998.
 2,202,286. SEATHRILLER. INT. CL. 28. REG. 11-3-1998.
 2,202,290. PLASTI-SLAT. INT. CLS. 6 AND 19. REG. 11-3-1998.
 2,202,292. CREDIT REWARDS. INT. CL. 36. REG. 11-3-1998.
 2,202,294. JUICE FIX. INT. CL. 42. REG. 11-3-1998.
 2,202,295. E*STATION AND DESIGN. INT. CL. 36. REG. 11-3-1998.
 2,202,296. PLACE P AND DESIGN. INT. CL. 25. REG. 11-3-1998.
 2,202,297. DR. WACKY'S FUNNY BONES. INT. CL. 16. REG. 11-3-1998.
 2,202,298. METRO BOUND. INT. CL. 16. REG. 11-3-1998.
 2,202,299. FORTIFIED AND DESIGN. INT. CL. 28. REG. 11-3-1998.
 2,202,300. TMB (STYLIZED). INT. CL. 28. REG. 11-3-1998.
 2,202,301. WESTERN EXCLUSIVE. INT. CL. 36. REG. 11-3-1998.
 2,202,302. BUGLE BOY EXCLUSIVE. INT. CL. 25. REG. 11-3-1998.
 2,202,304. MOMMY & ME. INT. CL. 25. REG. 11-3-1998.
 2,202,305. MAXIMEYES. INT. CL. 42. REG. 11-3-1998.
 2,202,308. MINI-CUP. INT. CL. 12. REG. 11-3-1998.
 2,202,311. Q QUAKER STATE RACING AND DESIGN. INT. CLS. 6, 16, 21, 25 AND 28. REG. 11-3-1998.
 2,202,317. DAYLINK. INT. CLS. 10 AND 42. REG. 11-3-1998.
 2,202,320. LAN ENGINEER. INT. CL. 9. REG. 11-3-1998.
 2,202,324. MISCELLANEOUS DESIGN. INT. CL. 11. REG. 11-3-1998.
 2,202,325. THE AUTO SUPERSTORE. INT. CL. 37. REG. 11-3-1998.
 2,202,326. ELECTRONIC TECHNOLOGY CORPORATION. INT. CL. 9. REG. 11-3-1998.
 2,202,327. THE GREAT SHIPS. INT. CLS. 9 AND 41. REG. 11-3-1998.
 2,202,330. GUESS MY SIGN. INT. CL. 25. REG. 11-3-1998.
 2,202,331. ONE FORM SOFTWARE. INT. CL. 9. REG. 11-3-1998.
 2,202,333. SUPER SCENT AIR FRESHENER (STYLIZED). INT. CL. 5. REG. 11-3-1998.

- 2,202,334. LOW PROFILE. INT. CL. 28. REG. 11-3-1998.
 2,202,336. SYNCHRONIZED MRP. INT. CL. 9. REG. 11-3-1998.
 2,202,337. EXPANDABLES AND DESIGN. INT. CLS. 9 AND 18. REG. 11-3-1998.
 2,202,340. SENIORS'. INT. CL. 36. REG. 11-3-1998.
 2,202,341. HYDROXY RELEASE SYSTEM. INT. CL. 3. REG. 11-3-1998.
 2,202,346. METAL MESH. INT. CL. 28. REG. 11-3-1998.
 2,202,347. COLLEGE FOOTBALL 125TH ANNIVERSARY AND DESIGN. INT. CL. 25. REG. 11-3-1998.
 2,202,349. MANHATTAN GARDENS ASSOCIATES. INT. CL. 42. REG. 11-3-1998.
 2,202,351. THE INSULATION PROFESSIONALS (STYLIZED). INT. CL. 37. REG. 11-3-1998.
 2,202,352. KNOW WHAT I'M SAYIN'. INT. CL. 25. REG. 11-3-1998.
 2,202,356. CHRISTIAN COMMUNITY NETWORK. INT. CL. 42. REG. 11-3-1998.
 2,202,357. INSIDERTRADER. INT. CL. 42. REG. 11-3-1998.
 2,202,359. FURNITURE REP'S WAREHOUSE. INT. CL. 35. REG. 11-3-1998.
 2,202,361. ISSUES & ANSWERS IN SALES MANAGEMENT. INT. CL. 16. REG. 11-3-1998.
 2,202,362. CUSTOM QUOTE. INT. CL. 36. REG. 11-3-1998.
 2,202,363. ANTONELLO'S. INT. CL. 42. REG. 11-3-1998.
 2,202,364. ARCHITECTURAL LOC. INT. CL. 6. REG. 11-3-1998.
 2,202,365. LEATHER SHOPPE. INT. CL. 20. REG. 11-3-1998.
 2,202,367. THE BOOKMARK OF SPORTS. INT. CL. 41. REG. 11-3-1998.
 2,202,369. MISCELLANEOUS DESIGN. INT. CL. 9. REG. 11-3-1998.
 2,202,372. REGIONAL NETWORK COMMUNICATIONS, INC.. INT. CLS. 35 AND 42. REG. 11-3-1998.
 2,202,373. INTERNATIONAL HEALTHCARE VIDEO. INT. CL. 9. REG. 11-3-1998.
 2,202,374. LEARN TO SK8TE. INT. CL. 41. REG. 11-3-1998.
 2,202,375. THE MOST FASCINATING WOMEN OF AND DESIGN. INT. CL. 41. REG. 11-3-1998.
 2,202,377. SHOWCASE. INT. CL. 35. REG. 11-3-1998.
 2,202,379. THE CAMBER BAR. INT. CL. 8. REG. 11-3-1998.
 2,202,380. APIACCESS (STYLIZED). INT. CL. 9. REG. 11-3-1998.
 2,202,383. AMERICA'S DIRECT-TO-YOU SEED CORN COMPANY. INT. CL. 31. REG. 11-3-1998.
 2,202,386. CHOICESEAT. INT. CL. 9. REG. 11-3-1998.
 2,202,387. ICE CLEANING SYSTEMS. INT. CL. 37. REG. 11-3-1998.
 2,202,391. MINNESOTA STONE CENTER. INT. CL. 42. REG. 11-3-1998.
 2,202,392. STENGEL'S (STYLIZED). INT. CLS. 29, 30, 32 AND 42. REG. 11-3-1998.
 2,202,394. WARD'S AUTO GROUP. INT. CL. 35. REG. 11-3-1998.
 2,202,395. PHILLIPSON ROD COMPANY. INT. CL. 28. REG. 11-3-1998.
 2,202,398. NEW YORK INSTITUTE OF FINANCE THE WORLD'S LEADING FINANCIAL EDUCATION INSTITUTION.. INT. CL. 41. REG. 11-3-1998.
 2,202,400. OUTDOOR PROJECTS YOU CAN BUILD. INT. CL. 16. REG. 11-3-1998.
 2,202,402. HEMP PAGES. INT. CL. 16. REG. 11-3-1998.
 2,202,407. RETAIL SATURATION. INT. CL. 16. REG. 11-3-1998.
 2,202,410. PACIFIC DESIGN ENGINEERING SHOW. INT. CL. 35. REG. 11-3-1998.
 2,202,411. ATLANTIC DESIGN ENGINEERING SHOW. INT. CL. 35. REG. 11-3-1998.
 2,202,412. BJ WRIGHT'S. INT. CL. 30. REG. 11-3-1998.
 2,202,413. DRTV NEWS. INT. CL. 16. REG. 11-3-1998.
 2,206,184. HEALTHY CRUNCH. INT. CL. 31. REG. 11-24-1998.
 2,213,417. BLOSSOM DEW. INT. CL. 4. REG. 12-22-1998.
 2,216,478. MISCELLANEOUS DESIGN. INT. CLS. 9, 14, 18, 21, 25, 26 AND 42 ONLY. REG. 1-5-1999.
 2,245,382. MAKOLA AND DESIGN. INT. CLS. 3, 18 AND 24 ONLY. REG. 5-18-1999.
 2,257,170. HI-PRO. INT. CL. 18 ONLY. REG. 6-29-1999.
 2,257,662. APRIL BATH & SHOWER. INT. CLS. 8, 18, 20 AND 21 ONLY. REG. 6-29-1999.
 2,296,368. 40-30-30 BALANCE. INT. CL. 30 ONLY. REG. 11-30-1999.
-
- SECTION 18**
- 532,003. CORDON BLEU (STYLIZED). U.S. CL. 46. REG. 10-17-1950.
 660,848. CORDON BLEU. U.S. CL. 46. REG. 4-22-1958.
 1,381,601. PIXIE. INT. CL. 28. REG. 2-4-1986.
 2,081,278. COFFEE EXPRESS AND DESIGN. INT. CL. 30. REG. 7-22-1997.
 2,209,419. ABL. INT. CLS. 16, 25, 28, 35, 36 AND 41. REG. 12-8-1998.
 2,286,608. VENUE. INT. CL. 16. REG. 10-12-1999.
 2,312,281. FAMILY ANTICS. INT. CL. 9. REG. 1-25-2000.
 2,361,940. ECONNECT. INT. CL. 36. REG. 6-27-2000.
 2,414,660. REDEFINING THE DIAMOND EXPERIENCE. INT. CL. 35. REG. 12-19-2000.
 2,437,875. AMERICLEAN. INT. CL. 7. REG. 3-27-2001.
 2,441,709. JAVASPRINGS. INT. CL. 32. REG. 4-10-2001.
 2,526,207. BRILLIANT PRINCESS. INT. CL. 14. REG. 1-1-2002.
 2,567,133. TECHEXPRESS. INT. CL. 42. REG. 5-7-2002.
 2,571,042. C AND DESIGN. INT. CLS. 25 AND 28. REG. 5-21-2002.
 2,583,942. TAX REDUCTION UNIVERSITY. INT. CL. 41. REG. 6-18-2002.
 2,607,521. ULTRACADE. INT. CL. 28. REG. 8-13-2002.
 2,642,912. COMPUTACION SIN BARRERAS. INT. CL. 9. REG. 10-29-2002.
 2,718,270. THE RESORT ROME. INT. CL. 35. REG. 5-20-2003.
 2,724,479. ACTEK HEAVY DUTY. INT. CL. 6. REG. 6-10-2003.
 2,724,737. FROSTY BITES. INT. CL. 30. REG. 6-10-2003.
 2,768,412. MARKETING-RX. INT. CL. 35. REG. 9-23-2003.
 2,826,870. LA FAGIANELLA AND DESIGN. INT. CL. 33. REG. 3-30-2004.
 2,857,927. REAL FOOD. INT. CL. 16. REG. 6-29-2004.
-
- INADVERTENTLY ISSUED REGISTRATION NUMBERS**
- 2,865,353. DTZ. INT. CLS. 35, 36 AND 42. REG. 7-20-2004. RESTORED TO SN 75-853,642.

* * * * *

TRADEMARK REGISTRATIONS AMENDED, CORRECTED, ETC.

The designation "U.S. Cl." appearing in this section refers to the U.S. class in effect prior to Sep. 1, 1973 rather than the international class which applies to applications filed on or after that date. For adoption of international classification see notice in the OFFICIAL GAZETTE of Jun. 26, 1973 (911 O.G. TM 210).

Any change to the registration will be indicated at the bottom of each entry under ELEMENTS AMENDED, CORRECTED OR RESTRICTED. With the exception of changes to the goods and services, additions to the registration will appear in asterisks and deletions of the registration will appear in brackets. Elements which are only changed will be listed with no punctuation. As to the goods/services statement, amendments to the goods/services will appear in asterisks and deletions will appear in brackets. In addition if any change to the goods/services occurs, the element "Goods/Services" will be listed under ELEMENTS AMENDED, CORRECTED OR RESTRICTED.

218,757. REG. 10-5-1926. SERGEANT'S PET CARE PRODUCTS, INC. (NEVADA CORPORATION) 1601 ELM STREET, THIRD FLOOR, DALLAS, TX, 75201, SN 71-230,842. FILED 4-28-1926. PRINCIPAL REGISTER.

FOR COMPUTER PROGRAMS FOR USE IN MEDICAL DIAGNOSIS, TREATMENT, MANAGEMENT AND RECORD-KEEPING.
FIRST USE 12-16-1982; IN COMMERCE 12-16-1982.

SKIP-FLEA

ELEMENTS AMENDED
OWNER ADDRESS
MARK

INT. CL. 3/U.S. CL. 52
FOR DOG SOAP.
FIRST USE 6-0-1919; IN COMMERCE 6-0-1919.

ELEMENTS AMENDED
ASSIGNMENT/NAME CHANGE
MARK

1,004,370. REG. 2-11-1975. MUTUAL OF OMAHA INSURANCE COMPANY (NEBRASKA CORPORATION) MUTUAL OF OMAHA PLAZA, OMAHA, NE, 681751008, SN 73-013,478. FILED 2-14-1974. PRINCIPAL REGISTER.

People you can count on...

1,809,553. REG. 12-7-1993. PANAMERICAN BANK (FLORIDA BANKING ASSOCIATION) 2770 S.W. 27TH AVENUE, COCONUT GROVE, FL, 33133, SN 74-301,294. FILED 8-5-1992. PRINCIPAL REGISTER.

INT. CL. 36/U.S. CL. 102
FOR UNDERWRITING INSURANCE SERVICES.
FIRST USE 12-29-1972; IN COMMERCE 12-29-1972.

ELEMENTS AMENDED
OWNER NAME

PANAMERICAN BANK

1,340,177. REG. 6-11-1985. PKC CORPORATION (DELAWARE CORPORATION) ONE MILLS STREET, BOX A8, BURLINGTON, VT, 05401, SN 73-427,022. FILED 5-23-1983. PRINCIPAL REGISTER.

PROBLEM-KNOWLEDGE COUPLERS

REGISTRATION IS RESTRICTED TO THE AREA COMPRISING THE STATE OF ALABAMA, GEORGIA, LOUISIANA, MISSISSIPPI, NORTH CAROLINA, SOUTH CAROLINA, TENNESSEE, AND VIRGINIA. CONCURRENT USE PROCEEDING NO. 94002037 WITH PAN AMERICAN BANK (CALIFORNIA), SERIAL NO. 76385232.

NO CLAIM IS MADE TO THE EXCLUSIVE RIGHT TO USE "BANK", APART FROM THE MARK AS SHOWN.

INT. CL. 36/U.S. CL. 102
FOR BANKING SERVICES.
FIRST USE 6-15-1992; IN COMMERCE 6-15-1992.

NO CLAIM IS MADE TO THE EXCLUSIVE RIGHT TO USE "COUPLER", APART FROM THE MARK AS SHOWN.
INT. CL. 9/U.S. CL. 38

ELEMENTS AMENDED
CONCURRENT USE STATEMENT

1,981,523. REG. 6-18-1996. RDG CHICAGO TRADEMARK CO. (ILLINOIS CORPORATION) 1840 PICKWICK AVENUE, GLENVIEW, IL, 60025, SN 74-519,543. FILED 5-3-1994. PRINCIPAL REGISTER.

2,262,782. REG. 7-20-1999. SOUTHLAND GROUP ENTERPRISES, INC. (DELAWARE CORPORATION) P.O. BOX 19410, LOUISVILLE, KY, 40259, SN 75-471,702. FILED 4-21-1998. PRINCIPAL REGISTER.

NICK & TONY'S ITALIAN CHOPHOUSE

REGISTRATION IS RESTRICTED TO THE TERRITORY COMPRISING THE STATES OF ALABAMA, ALASKA, ARIZONA, ARKANSAS, COLORADO, DELAWARE, GEORGIA, HAWAII, IDAHO, ILLINOIS, INDIANA, IOWA, KANSAS, KENTUCKY, LOUISIANA, MARYLAND, MICHIGAN, MINNESOTA, MISSISSIPPI, MISSOURI, MONTANA, NEBRASKA, NEVADA, NEW MEXICO, NORTH CAROLINA, NORTH DAKOTA, OHIO, OKLAHOMA, OREGON, PENNSYLVANIA, SOUTH CAROLINA, SOUTH DAKOTA, TENNESSEE, TEXAS, UTAH, VIRGINIA, WASHINGTON, WEST VIRGINIA, WISCONSIN AND WYOMING. CONCURRENT USE PROCEEDING NO. 940002077 WITH BELLA COPPIA, INC., REGISTRATION NO. 2,865,862.

NO CLAIM IS MADE TO THE EXCLUSIVE RIGHT TO USE "ITALIAN CHOPHOUSE", APART FROM THE MARK AS SHOWN.

INT. CL. 42/U.S. CLS. 100 AND 101
FOR RESTAURANT AND TAVERN SERVICES.
FIRST USE 12-1-1994; IN COMMERCE 12-1-1994.

ELEMENTS AMENDED
CONCURRENT USE STATEMENT



REGISTRATION IS RESTRICTED TO THE TERRITORY COMPRISING THE STATES OF ALABAMA, ALASKA, ARIZONA, ARKANSAS, CALIFORNIA, COLORADO, HAWAII, IDAHO, ILLINOIS, INDIANA, IOWA, KANSAS, LOUISIANA, MINNESOTA, MISSISSIPPI, MISSOURI, MONTANA, NEBRASKA, NEVADA, NEW MEXICO, NORTH DAKOTA, OKLAHOMA, OREGON, SOUTH DAKOTA, TEXAS, UTAH, WASHINGTON, WISCONSIN, WYOMING, AS WELL AS KENTUCKY (EXCEPT THE NORTHERN COUNTIES OF BOONE, BRACKEN, CAMPBELL, GALLATIN, GRANT, KENTON, MASON AND PENDLETON), THE WESTERN COUNTIES OF MICHIGAN, SPECIFICALLY, ALGER, ALLEGAN, ANTRIM, BARAGA, BARRY, BENZIE, BERRIEN, BRANCH, CALHOUN, CASS, CHARLEVOIX, CHIPPEWA, CLARE, DELTA, DICKINSON, EATON, EMMET, GOGEBIC, GRAND TRAVERSE, HOUGHTON, IONIA, IRON, ISABELLA, KALAMAZOO, KALKASKA, KENT, KEWEENAW, LAKE, LEELANAU, LUCE, MACKINAC, MANISTEE, MARGUETTE, MASON, MECOSTA, MENOMINEE, MISSAUKEE, MONTCALM, MUSKOGON, NEWAYGO, OCEANA, ONTONAGON, OSCEOLA, OTTAWA, ST. JOSEPH, SCHOOLCRAFT, VAN BUREN, WEXFORD, AND THE WESTERN COUNTIES OF TENNESSEE, SPECIFICALLY, BEDFORD, BENTON, BLEDSOE, CANNON, CARROLL, CHEATHAM, CHESTER, CLAY, COFFEE, CROCKETT, CUMBERLAND, DAVIDSON, DE KALB, DECATUR, DICKSON, DYER, FAYETTE, FENTRESS, FRANKLIN, GIBSON, GILES, GRUNDY, HAMILTON, HARDEMAN, HARDIN, HAYWOOD, HENDERSON, HENRY, HICKMAN, HOUSTON, HUMPHREYS, JACKSON, LAKE, LAUDERDALE, LAWRENCE, LEWIS, LINCOLN, MACON, MADISON, MARION, MARSHALL, MAURY, MCNAIRY, MEGIS, MONTGOMERY, MOORE, OBION, OVERTON, PERRY, PICKETT, PUTNAM, PHEA, ROBERTSON, RUTHERFORD, SEQUATCHIE, SHELBY, SMITH, STEWART, SUMNER, TIPTON, TROUSDALE, VAN BUREN, WARREN, WAYNE, WEAKLEY, WHITE WILLIAMSON, AND WILSON, CONCURRENT USE PROCEEDING NO. 94002070 WITH SOUTHLAND FLOORING SUPPLIES OF CINCINNATI, INC., APPLICATION SERIAL NO. 76458783.

NO CLAIM IS MADE TO THE EXCLUSIVE RIGHT TO USE "FLOORING SUPPLIES", APART FROM THE MARK AS SHOWN.

THE MARK CONSISTS OF, IN PART, THE DESIGN OF A CARPET INSTALLATION TOOL KNOWN AS A KNEE KICKER.

INT. CL. 35/U.S. CLS. 100, 101 AND 102
FOR WHOLESALE DISTRIBUTORSHIPS FEATURING CARPET INSTALLATION MATERIALS.

FIRST USE 8-0-1995; IN COMMERCE 8-0-1995.

2,145,670. REG. 3-24-1998. CLINICAL INNOVATIONS ASSOCIATES, INC. (UTAH CORPORATION) 747 WEST 4170, MURRAY, UT, 84123, SN 75-071,812. FILED 3-13-1996. PRINCIPAL REGISTER.

KOALA

INT. CL. 10/U.S. CLS. 26, 39 AND 44
FOR INTRAUTERINE CATHETER DEVICES.
FIRST USE 5-15-1996; IN COMMERCE 5-15-1996.

ELEMENTS CORRECTED
OWNER NAME

2,201,126. REG. 11-3-1998. AMERICAN DIABETES ASSOCIATION, INC. (OHIO CORPORATION) NATIONAL CENTER, 1660 DUKE STREET, ALEXANDRIA, VA, 22314, SN 75-292,827. FILED 5-15-1997. PRINCIPAL REGISTER.

AMERICAN DIABETES ALERT

OWNER OF U.S. REG. NO. 1,218,650,
AS TO "AMERICAN DIABETES".
INT. CL. 42/U.S. CLS. 100 AND 101
FOR PROMOTING PUBLIC AWARENESS OF THE RISK OF DIABETES.
FIRST USE 3-25-1997; IN COMMERCE 3-24-1997.

ELEMENTS CORRECTED
CITIZENSHIP

ELEMENTS AMENDED
CONCURRENT USE STATEMENT

2,266,804. REG. 8-3-1999. SOUTHLAND GROUP ENTERPRISES, INC. (DELAWARE CORPORATION) P.O. BOX 19410, LOUISVILLE, KY, 40259, SN 75-471,705. FILED 4-21-1998. PRINCIPAL REGISTER.

2,268,755. REG. 8-10-1999. SOUTHLAND GROUP ENTERPRISES, INC. (DELAWARE CORPORATION) P.O. BOX 19410, LOUISVILLE, KY, 40259, SN 75-478,217. FILED 5-1-1998. PRINCIPAL REGISTER.

Southland FLOORING SUPPLIES

Southland

REGISTRATION IS RESTRICTED TO THE TERRITORY COMPRISING THE STATES OF ALABAMA, ALASKA, ARIZONA, ARKANSAS, CALIFORNIA, COLORADO, HAWAII, IDAHO, ILLINOIS, INDIANA, IOWA, KANSAS, LOUISIANA, MINNESOTA, MISSISSIPPI, MISSOURI, MONTANA, NEBRASKA, NEVADA, NEW MEXICO, NORTH DAKOTA, OKLAHOMA, OREGON, SOUTH DAKOTA, TEXAS, UTAH, WASHINGTON, WISCONSIN, WYOMING, AS WELL AS KENTUCKY (EXCEPT THE NORTHERN COUNTIES OF BOONE, BRACKEN, CAMPBELL, GALLATIN, GRANT, KENTON, MASON AND PENDLETON), THE WESTERN COUNTIES OF MICHIGAN, SPECIFICALLY, ALGER, ALLEGAN, ANTRIM, BARAGA, BARRY, BENZIE, BERRIEN, BRANCH, CALHOUN, CASS, CHARLEVOIX, CHIPPEWA, CLARE, DELTA, DICKINSON, EATON, EMMET, GOGEBIC, GRAND TRAVERSE, HOUGHTON, IONIA, IRON, ISABELLA, KALAMAZOO, KALKASKA, KENT, KEWEENAW, LAKE, LEELANAU, LUCE, MACKINAC, MANISTEE, MARGUETTE, MASON, MECOSTA, MENOMINEE, MISSAUKEE, MONTCALM, MUSKEGON, NEWAYGO, OCEANA, ONTONAGON, OSCEOLA, OTTAWA, ST. JOSEPH, SCHOOLCRAFT, VAN BUREN, WEXFORD, AND THE WESTERN COUNTIES OF TENNESSEE, SPECIFICALLY, BEDFORD, BENTON, BLEDSOE, CANNON, CARROLL, CHEATHAM, CHESTER, CLAY, COFFEE, CROCKETT, CUMBERLAND, DAVIDSON, DE KALB, DECATUR, DICKSON, DYER, FAYETTE, FENTRESS, FRANKLIN, GIBSON, GILES, GRUNDY, HAMILTON, HARDEMAN, HARDIN, HAYWOOD, HENDERSON, HENRY, HICKMAN, HOUSTON, HUMPHREYS, JACKSON, LAKE, LAUDERDALE, LAWRENCE, LEWIS, LINCOLN, MACON, MADISON, MARION, MARSHALL, MAURY, MCNAIRY, MEGIS, MONTGOMERY, MOORE, OBION, OVERTON, PERRY, PICKETT, PUTNAM, PHEA, ROBERTSON, RUTHERFORD, SEQUATCHIE, SHELBY, SMITH, STEWART, SUMNER, TIPTON, TROUSDALE, VAN BUREN, WARREN, WAYNE, WEAKLEY, WHITE, WILLIAMSON, AND WILSON, CONCURRENT USE PROCEEDING NO. 94002070 WITH SOUTHLAND FLOORING SUPPLIES OF CINCINNATI, INC., APPLICATION SERIAL NO. 76458783.

NO CLAIM IS MADE TO THE EXCLUSIVE RIGHT TO USE "FLOORING SUPPLIES", APART FROM THE MARK AS SHOWN.

INT. CL. 35/U.S. CLS. 100, 101 AND 102
FOR WHOLESALE DISTRIBUTORSHIPS FEATURING CARPET INSTALLATION MATERIALS.

FIRST USE 8-0-1969; IN COMMERCE 8-0-1969.

ELEMENTS AMENDED
CONCURRENT USE STATEMENT

REGISTRATION IS RESTRICTED TO THE TERRITORY COMPRISING THE STATES OF ALABAMA, ALASKA, ARIZONA, ARKANSAS, CALIFORNIA, COLORADO, HAWAII, IDAHO, ILLINOIS, INDIANA, IOWA, KANSAS, LOUISIANA, MINNESOTA, MISSISSIPPI, MISSOURI, MONTANA, NEBRASKA, NEVADA, NEW MEXICO, NORTH DAKOTA, OKLAHOMA, OREGON, SOUTH DAKOTA, TEXAS, UTAH, WASHINGTON, WISCONSIN, WYOMING, AS WELL AS KENTUCKY (EXCEPT THE NORTHERN COUNTIES OF BOONE, BRACKEN, CAMPBELL, GALLATIN, GRANT, KENTON, MASON AND PENDLETON), THE WESTERN COUNTIES OF MICHIGAN, SPECIFICALLY, ALGER, ALLEGAN, ANTRIM, BARAGA, BARRY, BENZIE, BERRIEN, BRANCH, CALHOUN, CASS, CHARLEVOIX, CHIPPEWAG, CLARE, DELTA, DICKINSON, EATON, EMMET, GOGEBIC, GRAND TRAVERSE, HOUGHTON, IONIA, IRON, ISABELLE, KALAMAZOO, KALKASKA, KENT, KEWEENAW, LAKE, LEELANAU, LUCE, MACKINAC, MANISTEE, MARQUETTE, MASON, MECOSTA, MENOMINEE, MISSAUKEE, MONTCALM, MUSKEGON, NEWAYGO, OCEANA, ONTONAGON, OSCEOLA, OTTAWA, ST. JOSEPH, SCHOOLCRAFT, VAN BUREN, WEXFORD, AND THE WESTERN COUNTIES OF TENNESSEE, SPECIFICALLY, BEDFORD, BENTON, BLEDSOE, CANNON, CARROLL, CHEATHAM, CHESTER, CLAY, COFFEE, CROCKETT, CUMBERLAND, DAVIDSON, DE KALB, DECATUR, DICKSON, DYER, FAYETTE, FENTRESS, FRANKLIN, GIBSON, GILES, GRUNDY, HAMILTON, HARDEMAN, HARDIN, HAYWOOD, HENDERSON, HENRY, HICKMAN, HOUSTON, HUMPHREYS, JACKSON, LAKE, LAUDERDALE, LAWRENCE, LEWIS, LINCOLN, MACON, MADISON, MARION, MARSHALL, MAURY, MCNAIRY, MEGIS, MONTGOMERY, MOORE, OBION, OVERTON, PERRY, PICKETT, PUTNAM, PHEA, ROBERTSON, RUTHERFORD, SEQUATCHIE, SHELBY, SMITH, STEWART, SUMNER, TIPTON, TROUSDALE, VAN BUREN, WARREN, WAYNE, WEAKLEY, WHITE, WILLIAMSON AND WILSON, CONCURRENT USE PROCEEDING NO. 94002070 WITH SOUTHLAND FLOORING SUPPLIES OF CINCINNATI, INC., APPLICATION SERIAL NO. 76458783.

INT. CL. 35/U.S. CLS. 100, 101 AND 102
FOR WHOLESALE DISTRIBUTORSHIPS FEATURING CARPET INSTALLATION MATERIALS.

FIRST USE 8-0-1969; IN COMMERCE 8-0-1969.

ELEMENTS AMENDED
CONCURRENT USE STATEMENT

2,278,973. REG. 9-21-1999. US LACROSSE, INC. (MARYLAND CORPORATION) 113 WEST UNIVERSITY PARKWAY, BALTIMORE, MD, 21210, SN 75-445,726. FILED 3-6-1998. PRINCIPAL REGISTER.

2,526,171. REG. 1-1-2002. CADILLAC COFFEE COMPANY (MICHIGAN CORPORATION) 1801 MICHAEL STREET, MADISON HEIGHTS, MI, 48071, SN 78-017,670. FILED 7-20-2000. PRINCIPAL REGISTER.



OWNER OF U.S. REG. NO. 2,168,700.
NO CLAIM IS MADE TO THE EXCLUSIVE RIGHT TO USE "USLACROSSE", APART FROM THE MARK AS SHOWN.

THE LINING IN THE DRAWING IS A FEATURE OF THE MARK AND DOES NOT REPRESENT COLOR.

INT. CL. 41/U.S. CLS. 100, 101 AND 107

FOR ARRANGING AND CONDUCTING ATHLETIC COMPETITIONS, NAMELY, LACROSSE COMPETITIONS.

FIRST USE 11-1-1997; IN COMMERCE 11-1-1997.

INT. CL. 42/U.S. CLS. 100 AND 101

FOR ASSOCIATION SERVICES, NAMELY, PROMOTING PUBLIC AWARENESS AND INTEREST IN THE SPORT OF LACROSSE.

FIRST USE 10-1-1997; IN COMMERCE 10-1-1997.

ELEMENTS AMENDED
MARK

JAVA MOUNTAIN

REGISTRATION IS RESTRICTED TO THE AREA COMPRISING THE ENTIRE UNITED STATES EXCEPT THE FOLLOWING COUNTIES OF THE STATE OF MICHIGAN: MARQUETTE, SCHOOLCRAFT, LUCE, CHIPPEWA, MACKINAW, ALGER, DELTA, CHEBOYGAN, PRESQUE ISLE, ALPENA, MONTMORENCY, OTSEGO, EMMET, CHARLEVOIX, ANTRIM, LEELANAU, BENZLE, GRAND TRAVERSE, KALKASKA, CRAWFORD, OSCODA, ALCONA, IOSCO, OGENAW, MISSAUKEE, WEXFORD, MANISTEE, MASON, LAKE, OSCEOLA, CLARE, GLADWIN, ARENAC, BAY, MIDLAND, ISABELLA, MECOSTA, NEWAYGO, OCEANA, MUSKEGON, KENT, MONTCALM, GRATIOT, OTTAWA, ALLEGAN, IONIA, VAN BUREN, BERRIEN, CASS AND ROSCOMMON. CONCURRENT USE PROCEEDING NO. 94002074 WITH BLARNEY CASTLE OIL CO., APPLICATION SERIAL NO. 76428251.

NO CLAIM IS MADE TO THE EXCLUSIVE RIGHT TO USE "JAVA", APART FROM THE MARK AS SHOWN.

INT. CL. 30/U.S. CL. 46

FOR COFFEE, COFFEE BEANS, COFFEE-BASED BEVERAGE CONTAINING MILK.

FIRST USE 4-24-2000; IN COMMERCE 2-16-2001.

ELEMENTS AMENDED
CONCURRENT USE STATEMENT

2,320,152. REG. 2-22-2000. WORLD INTER PARTNER LTD. (UNITED KINGDOM COMPANY) OSCAR-ROMERO-ALLEE 15, 53113 BONN, IRELAND., SN 75-397,592. FILED 12-1-1997. PRINCIPAL REGISTER.

2,562,058. REG. 4-16-2002. CLINICAL INNOVATIONS ASSOCIATES, INC. (UTAH CORPORATION) 747 WEST 4170 SOUTH, MURRAY, UT, 84123, SN 78-082,179. FILED 8-31-2001. PRINCIPAL REGISTER.

CAREMED INTERNATIONAL TRAVEL INSURANCE

PRIORITY CLAIMED UNDER SEC. 44(D) ON ERPN CMNTY TM OFC APPLICATION NO. 000587998,, FILED 7-14-1997.

NO CLAIM IS MADE TO THE EXCLUSIVE RIGHT TO USE "INTERNATIONAL TRAVEL INSURANCE", APART FROM THE MARK AS SHOWN.

INT. CL. 36/U.S. CLS. 100, 101 AND 102

FOR INSURANCE ADMINISTRATION IN THE FIELD OF INTERNATIONAL TRAVEL INSURANCE.

FIRST USE 4-16-1996; IN COMMERCE 4-16-1996.

ELEMENTS AMENDED
CITIZENSHIP

OMNICUP

INT. CL. 10/U.S. CLS. 26, 39 AND 44

FOR DISPOSABLE MEDICAL APPARATUS, NAMELY, A VACUUM DELIVERY SYSTEM, COMPRISED OF A HAND HELP PUMP USED TO ASSIST WITH OBSTETRICAL DELIVERIES.

FIRST USE 1-30-1999; IN COMMERCE 1-30-1999.

ELEMENTS CORRECTED
OWNER NAME

2,596,786. REG. 7-23-2002. BAPTIST HEALTHCARE SYSTEM, INC. (KENTUCKY CORPORATION) 4007 KRESGE WAY, LOUISVILLE, KY, 40207, SN 76-005,044. FILED 3-20-2000. PRINCIPAL REGISTER.



REGISTRATION IS RESTRICTED TO THE TERRITORY COMPRISING THE STATE OF KENTUCKY, THE STATE OF TENNESSEE EAST OF THE TENNESSEE RIVER, AND THE TENNESSEE COUNTIES OF LAKE, OBION, WEAKLEY, HENRY, CARROL, GIBSON AND DYER, CONCURRENT USE PROCEEDING NO. 94002080 WITH MISSISSIPPI BAPTIST HEALTH SYSTEM, INC., SERIAL NO 75839627.

OWNER OF U.S. REG. NO. 2,149,896.

NO CLAIM IS MADE TO THE EXCLUSIVE RIGHT TO USE "BAPTIST HEALTHCARE SYSTEM", APART FROM THE MARK AS SHOWN.

INT. CL. 42/U.S. CLS. 100 AND 101
FOR HEALTHCARE SERVICES.
FIRST USE 8-19-1991; IN COMMERCE 8-19-1991.

ELEMENTS AMENDED
CONCURRENT USE STATEMENT

FOR PROVISION OF COMPREHENSIVE HEALTH CARE SERVICES- NAMELY, INPATIENT HOSPITAL SERVICES, OUTPATIENT TREATMENT, NAMELY, REHABILITATIVE THERAPY AND HOME CARE SERVICES, AND HEALTH CARE SERVICES RELATING TO NURSING HOME FACILITIES.

FIRST USE 7-12-1989; IN COMMERCE 7-12-1989.

ELEMENTS AMENDED
CONCURRENT USE STATEMENT

2,615,500. REG. 9-3-2002. CLINICAL INNOVATIONS ASSOCIATES, INC. (UTAH CORPORATION) 747 WEST 4170 SOUTH, MURRAY, UT, 84123, SN 78-069,188. FILED 6-14-2001. PRINCIPAL REGISTER.

KIWI

INT. CL. 10/U.S. CLS. 26, 39 AND 44
FOR DISPOSABLE MEDICAL APPARATUS, NAMELY, A VACUUM DELIVERY SYSTEM, COMPRISED OF A HAND HELD PUMP USED TO ASSIST WITH OBSTETRICAL DELIVERIES.
FIRST USE 1-30-1999; IN COMMERCE 1-30-1999.

ELEMENTS CORRECTED
OWNER NAME



2,635,622. REG. 10-15-2002. BAPTIST HEALTH CARE CORPORATION (FLORIDA CORPORATION) 1717 NORTH E STREET, PENSACOLA, FL, 32501, SN 75-438,325. FILED 2-23-1998. PRINCIPAL REGISTER.



REGISTRATION IS RESTRICTED TO THE TERRITORY COMPRISING THE STATE OF FLORIDA AND THE STATE OF ALABAMA, CONCURRENT USE PROCEEDING NO. 94002080 WITH MISSISSIPPI BAPTIST HEALTH SYSTEM, INC., SERIAL NO. 75839627.

NO CLAIM IS MADE TO THE EXCLUSIVE RIGHT TO USE "BAPTIST HEALTH CARE", APART FROM THE MARK AS SHOWN.

INT. CL. 42/U.S. CLS. 100 AND 101

INT. CL. 10/U.S. CLS. 26, 39 AND 44
FOR MEDICAL DEVICES, NAMELY, OBSTETRICAL AND GYNECOLOGICAL INSTRUMENTS, NAMELY, INTRAUTERINE PRESSURE CATHETERS, VACUUM EXTRACTION DEVICES, AND UTERINE MANIPULATORS.

FIRST USE 1-1-1996; IN COMMERCE 1-1-1996.

ELEMENTS CORRECTED
OWNER NAME

2,763,465. REG. 9-16-2003. PULL-A-PART, LLC (GEORGIA LTD LIAB CO) 888 MARIETTA STREET, N.W., ATLANTA, GA, 30318, SN 76-359,971. FILED 1-9-2002. PRINCIPAL REGISTER.

2,809,131. REG. 1-27-2004. BASEBALL CLUB OF SEATTLE, L.P., THE (WASHINGTON LIMITED PARTNERSHIP) SAFECO FIELD, 1250 FIRST AVENUE SOUTH, SEATTLE, WA, 98134, SN 76-350,133. FILED 12-18-2001. PRINCIPAL REGISTER.



PULL-A-PART

THE STIPPLING IS FOR SHADING PURPOSES ONLY, AND IS NOT INTENDED TO INDICATE COLOR.

THE MARK CONSISTS OF, IN PART, OF THE WORDS, "PULL-A-PART", THE FANCIFUL DESIGN OF A WOMAN HOLDING TOOLS AND VEHICLE PARTS, AND MISCELLANEOUS DESIGN. THE COLOR RED APPEARS ON THE CLOTHING, SHOES, BELT, NECKBAND, HEADBAND, AND LIPS OF THE WOMAN. THE COLOR PINK APPEARS ON THE FACE, HANDS AND LEGS OF THE WOMAN. THE COLOR BEIGE APPEARS ON THE SKIN OF THE WOMAN. THE COLOR BROWN APPEARS ON THE WOMAN'S HAIR. THE COLOR YELLOW APPEARS ON THE WOMAN'S CLOTHING. THE COLOR BLUE APPEARS ON THE TOOLS, AUTOMOBILE PARTS, THE BELT BUCKLE AND SHOES OF THE WOMAN. THE COLOR GREEN APPEARS ON THE WOMAN'S EYES. THE COLOR BLACK APPEARS ON THE TOOLS AND AUTOMOBILE PARTS.

INT. CL. 35/U.S. CLS. 100, 101 AND 102

FOR RETAIL STORE SERVICES AND DISTRIBUTORSHIP IN THE FIELD OF NEW AND USED AUTOMOBILE PARTS.

FIRST USE 1-31-2001; IN COMMERCE 1-31-2001.

INT. CL. 39/U.S. CLS. 100 AND 105

FOR PURCHASING USED AUTOMOBILES, NAMELY, AUTOMOBILE SALVAGE SERVICES.

FIRST USE 1-31-2001; IN COMMERCE 1-31-2001.

ELEMENTS CORRECTED
ASSIGNMENT/NAME CHANGE



2,772,711. REG. 10-7-2003. CLINICAL INNOVATIONS ASSOCIATES, INC. (UTAH CORPORATION) 747 WEST 4170 SOUTH, MURRAY, UT, 84123, SN 78-146,702. FILED 7-23-2002. PRINCIPAL REGISTER.

LATITUDE

INT. CL. 10/U.S. CLS. 26, 39 AND 44

FOR GASTROINTESTINAL PRESSURE CATHETER.
FIRST USE 4-1-2003; IN COMMERCE 6-2-2003.

ELEMENTS CORRECTED
OWNER NAME

INT. CL. 9/U.S. CLS. 21, 23, 26, 36 AND 38

FOR ELECTRICAL AND SCIENTIFIC APPARATUS, NAMELY, ELECTRIC SWITCH PLATE COVERS; SUN [GLASSES,] * GLASSES, * MAGNETS; PROTECTIVE HELMETS; BASEBALL BATTING HELMETS, COMPUTER SOFTWARE, NAMELY, SCREEN SAVERS; VIDEO AND COMPUTER GAME CARTRIDGES, VIDEO AND COMPUTER * GAME DISCS, VIDEO AND COMPUTER GAME CASSETTES, COMPUTER * GAME PROGRAMS, CATCHERS HELMETS, COMPUTER ACCESSORIES, NAMELY MOUSE PADS.

FIRST USE 0-0-1999; IN COMMERCE 0-0-1999.

ELEMENTS CORRECTED
GOODS/SERVICES
GOODS/SERVICES

2,818,800. REG. 3-2-2004. PULL-A-PART, LLC (GEORGIA LTD LIAB CO) 888 MARIETTA STREET, N.W., ATLANTA, GA, 30318, SN 76-359,970. FILED 1-9-2002. PRINCIPAL REGISTER.

2,835,698. REG. 4-27-2004. APPLE COMPUTER, INC. (CALIFORNIA CORPORATION) 1 INFINITE LOOP, CUPERTINO, CA, 95014, SN 75-982,871. FILED 10-18-2001. PRINCIPAL REGISTER.



PULL-A-PART

THE STIPLING ON THE DRAWING IS FOR SHADING PURPOSES ONLY, AND IS NOT INTENDED TO INDICATE COLOR. THE COLOR RED APPEARS ON THE SHOES AND LIPS OF THE WOMAN. THE COLOR YELLOW APPEARS ON THE CLOTHING OF THE WOMAN. THE COLOR PINK APPEARS ON THE SKIN OF THE WOMAN. THE COLOR BROWN APPEARS ON THE WOMAN'S HAIR AND CLOTHING. THE COLOR BLUE APPEARS ON THE TOOLS AND AUTOMOBILE PARTS, AND BUTTONS AND SHOES OF THE WOMAN. THE COLOR SILVER APPEARS ON THE SHOES AND BUTTONS OF THE WOMAN. THE COLOR GREEN APPEARS ON THE TOOLS AND AUTOMOBILE PARTS. THE COLOR BLACK APPEARS ON THE TOOLS AND AUTOMOBILE PARTS.

THE MARK CONSISTS, IN PART, OF THE WORDS, "PULL-A-PART", THE FANCIFUL DESIGN OF A WOMAN HOLDING TOOLS AND VEHICLE PARTS, AND MISCELLANEOUS DESIGN.

INT. CL. 35/U.S. CLS. 100, 101 AND 102
FOR RETAIL STORE SERVICES AND DISTRIBUTORSHIP IN THE FIELD OF NEW AND USED AUTOMOBILE PARTS.

FIRST USE 12-0-2000; IN COMMERCE 12-0-2000.
INT. CL. 39/U.S. CLS. 100 AND 105
FOR PURCHASING USED AUTOMOBILES, NAMELY, AUTOMOBILE SALVAGE SERVICES.
FIRST USE 12-0-2000; IN COMMERCE 12-0-2000.

ELEMENTS CORRECTED
ASSIGNMENT/NAME CHANGE

2,834,936. REG. 4-20-2004. COBRA ELECTRONICS CORPORATION (DELAWARE CORPORATION) 6500 WEST CORTLAND STREET, CHICAGO, IL, 60707, SN 76-263,041. FILED 5-25-2001. PRINCIPAL REGISTER.

HIGHGEAR

OWNER OF U.S. REG. NO. 2,441,636 AND OTHERS.
INT. CL. 9/U.S. CLS. 21, 23, 26, 36 AND 38
FOR TWO-WAY RADIO ACCESSORIES, NAMELY ANTENNAS, ANTENNA MOUNTS, MICROPHONES, SPEAKERS, AND POWER[INVERTS] *INVERTERS*.
FIRST USE 1-0-2000; IN COMMERCE 4-0-2000.

ELEMENTS CORRECTED
GOODS/SERVICES

IPOD

PRIORITY CLAIMED UNDER SEC. 44(D) ON SWITZERLAND APPLICATION NO. 08612/2001, FILED 8-31-2001.
INT. CL. 9/U.S. CLS. 21, 23, 26, 36 AND 38

FOR PORTABLE AND HANDHELD DIGITAL ELECTRONIC DEVICES FOR RECORDING, ORGANIZING, TRANSMITTING, MANIPULATING, AND REVIEWING AUDIO FILES; COMPUTER SOFTWARE FOR USE IN ORGANIZING, TRANSMITTING, MANIPULATING, AND REVIEWING AUDIO FILES ON PORTABLE AND HANDHELD DIGITAL ELECTRONIC DEVICES.
FIRST USE 10-23-2001; IN COMMERCE 10-23-2001.

ELEMENTS CORRECTED
FOREIGN COUNTRY OF ORIGIN
FOREIGN APPLICATION NO.
FOREIGN APPLICATION FILING DATE
PRIORITY CLAIMED STATEMENT

2,868,978. REG. 8-3-2004. UNIRAC, INC. (NEW MEXICO CORPORATION) 3201 UNIVERSITY, S.E., SUITE 110, ALBUQUERQUE, NM, 87106, SN 76-538,802. FILED 8-20-2003. PRINCIPAL REGISTER.

SOLARMOUNT

INT. CL. 6/U.S. CLS. 2, 12, 13, 14, 23, 25 AND 50
FOR MOUNTING BRACKETS MADE OF METAL FOR USE WITH SOLAR [AND WIND] ENERGY EQUIPMENT.
FIRST USE 1-1-2001; IN COMMERCE 1-1-2001.

ELEMENTS CORRECTED
GOODS/SERVICES

2,869,020. REG. 8-3-2004. UNIRAC, INC. (NEW MEXICO CORPORATION) 3201 UNIVERSITY, S.E., SUITE 110, ALBUQUERQUE, NM, 87106, SN 76-541,055. FILED 8-29-2003. PRINCIPAL REGISTER.

SUNFRAME

INT. CL. 6/U.S. CLS. 2, 12, 13, 14, 23, 25 AND 50
FOR MOUNTING BRACKETS MADE OF METAL FOR USE WITH SOLAR [AND WIND] ENERGY EQUIPMENT.
FIRST USE 6-10-2003; IN COMMERCE 6-10-2003.

ELEMENTS CORRECTED
GOODS/SERVICES

2,881,154. REG. 9-7-2004. GREAT LAKES CHAPTER OF THE AMERICAN SOCIETY OF HOME INSPECTORS (ILLINOIS CORPORATION) C/O FERD FLICK, 3771 POWNER ROAD, CINCINNATI, OH, 45248, SN 76-546,556. FILED 5-9-2003. PRINCIPAL REGISTER.

INSPECTOR BY REVIEW

NO CLAIM IS MADE TO THE EXCLUSIVE RIGHT TO USE INSPECTOR, APART FROM THE MARK AS SHOWN.

"THE CERTIFICATION MARK, AS USED BY AUTHORIZED PERSONS, CERTIFIES THAT THE USERS OF THE MARK HAVE MET THE EDUCATION AND/OR EXPERIENCE CRITERIA AS SET FORTH BY THE OWNER OF THE MARK. THE GREAT LAKES CHAPTER OF THE AMERICAN SOCIETY FOR HOME INSPECTORS, INC."

INT. CL. B /U.S. CL. B

FOR HOUSE INSPECTION SERVICES.

FIRST USE 4-9-2003; IN COMMERCE 4-9-2003.

ELEMENTS CORRECTED
CITIZENSHIP
ENTITY

2,890,695. REG. 10-5-2004. NORTECH INVESTMENTS LTD (SEYCHELLES CORPORATION) P.O. BOX W1935, ST. JOHNS, ANTIGUA & BARBUDA,, SN 76-259,238. FILED 5-21-2001. PRINCIPAL REGISTER.



NO CLAIM IS MADE TO THE EXCLUSIVE RIGHT TO USE "RACEBOOK.COM", APART FROM THE MARK AS SHOWN.

INT. CL. 41/U.S. CLS. 100, 101 AND 107

FOR ENTERTAINMENT SERVICES, NAMELY, PROVIDING ONLINE COMPUTER CASINO GAMES WHEREIN THERE ARE NO ACTUAL MONETARY WAGES, CONTESTS AND SWEEPSTAKES ALL VIA A GLOBAL COMPUTER INFORMATION NETWORK.

FIRST USE 2-1-2001; IN COMMERCE 2-1-2001.

ELEMENTS CORRECTED
LINING/STIPPLING STATEMENT

2,894,156. REG. 10-19-2004. INEOS CAPITAL LIMITED (UNITED KINGDOM CORPORATION) 1ST FLOOR OFFICES, QUEENS GATE, 15/17 QUEENS TERRACE, SOUTHAMPTON HAMPSHIRE SO14 3BP, UNITED KINGDOM,, SN 76-401,158. FILED 4-26-2002. PRINCIPAL REGISTER.

INEOS

PRIORITY CLAIMED UNDER SEC. 44(D) ON UNITED KINGDOM APPLICATION NO. 2284144, FILED 10-27-2001, REG. NO. 2284144, DATED 8-29-2003, EXPIRES 10-27-2011.

INT. CL. 1/U.S. CLS. 1

FOR CHEMICALS FOR USE IN THE MANUFACTURE OF A WIDE VARIETY OF GOODS, NAMELY TEXTILES, PLASTICS, SOAPS, CLEANING AGENTS, SURFACTANTS, BLEACH, ALUMINA, PULP, PAPER, FOOD, DRINK, SYNTHETIC RUBBER, PAINTS, VARNISHES, DYESTUFFS, PAINT AND VARNISH REMOVERS, POLYMERS, LUBRICANTS, MASTICS, INDUSTRIAL INTERMEDIATES, PHARMACEUTICALS, COSMETICS, PERFUMES, NON-MEDICATED TOILET PREPARATIONS, AEROSOLS, ASEPTICS, ANTISEPTICS, ANTI-BIOTICS, VITAMINS, BUILDING MATERIALS, DISINFECTANTS, ORGANIC CHEMICALS, SOLVENTS, AGROCHEMICALS, BIOCIDES, PESTICIDES, HERBICIDES, FUNGICIDES, INSECTICIDES, PLANT GROWTH REGULATORS, CHEMICAL ADDITIVES, FLAME RETARDANT ADDITIVES, PLASTICISERS AND EXTENDERS, ELASTOMERS, SEALANTS, CARRIERS, ADHESIVES, DISPERSING AGENTS, OXIDIZING AGENTS, CONTAMINANT REMOVERS, GELATINE AND CASEIN; HYDROFLUOROCARBONS AND BLENDS OF HYDROFLUOROCARBONS FOR USE IN THE MANUFACTURE OF A WIDE VARIETY OF GOODS; HYDROCHLOROFUOROCARBONS; HYDROGEN FLUORIDE AND HYDROFLUORIC ACID FOR USE IN THE MANUFACTURE OF A WIDE VARIETY OF GOODS; TETRA-, PENTA - AND HEXA-FLUOROETHANES FOR USE IN THE MANUFACTURE OF A WIDE VARIETY OF GOODS; DI-, TRI- AND TETRAFLUOROMETHANES FOR USE IN THE MANUFACTURE OF A WIDE VARIETY OF GOODS; [CHLORODIFLUOROMETHANE] * CHLORODIFLUOROMETHANE * FOR USE IN THE MANUFACTURE OF A WIDE VARIETY OF GOODS; [CHLORODIFLUOROETHANE] * CHLORODIFLUOROETHANE * FOR USE IN THE MANUFACTURE OF A WIDE VARIETY OF GOODS; [TRIFLUOROBROMOCHLOROETHANE] * TRIFLUOROBROMOCHLOROETHANE * FOR USE IN THE MANUFACTURE OF A WIDE VARIETY OF GOODS; UNPROCESSED SYNTHETIC AND ARTIFICIAL PLASTICS AND RESINS FOR USE IN THE MANUFACTURE OF PLASTIC ARTICLES, NAMELY PIPES, DUCTS, CONDUITS, TUBING, FOOD AND NON-FOOD PACKAGING AND MEDICAL PRODUCTS, STATIONERY, AUTOMOTIVE TRIMS, TUNNEL LINERS, POOL LINERS, INFLATABLES, BAGS, MEDICAL BAGS, FLOORING, TAPE, HOSES, WIRE AND CABLE SHEATHING, FOOTWEAR, PLUGS, FOOTBALLS, CREDIT CARDS, VENEERS, CONTAINERS, BOTTLES, BLISTER PACKS, TRAY, OFFICE SUPPLIES AND EQUIPMENT, CLADDING, ROLLER BLINDS AND FITTINGS, SYNTHETIC AND ARTIFICIAL PLASTICS FOR USE IN PRINTING AND BUILDING CONSTRUCTION, UNPROCESSED ACRYLATES AND ACRYLIC RESINS FOR USE IN A WIDE VARIETY OF FIELDS; HOMOPOLYMERIC AND CO-POLYMERIC POLYVINYL CHLORIDE PLASTICS AND RESINS FOR USE IN PRODUCING PLASTICS FOR USE IN SILK SCREEN PRINTING, VISCOSITY ADJUSTMENT ADDITIVES, COATING OR IMPREGNATING FABRIC OR PAPER, ANTI-FOAM BUILD-UP SUPPRESSANTS, ANTI-FOAMING AGENTS, BLOWN FILM COATS, ARTIFICIAL LEATHER, SYNTHETIC CLOTH, NAMELY LEATHER CLOTH, FLOORING, WALL COVERINGS, SPORTS MATS, CARPET BACKING, TUBING, SPREAD COATING OF COMPACT THIN COATINGS ON HIGH SPEED REVERSE ROLL AND ROTARY SCREEN COATERS, CHEMICALLY FORMED TEXTURED WALL COVERINGS, ROTATIONAL MOLDINGS, MOLDING OF CROSS-LINKED RIGID PVC FOAM SHEETS OR BOARDS, AUTOMOBILE SEALANT APPLICATIONS APPLIED BY AIRLESS SPRAY OR PLASTICS EXTRUSION, PRINTING INKS, CAP SEALS, AIR FILTER, OIL FILTER, SEALANT AND COATING APPLICATIONS, UNSUPPORTED HIGH EXPANSION AND LOW DENSITY CHEMICAL FOAMS, MECHANICALLY FROTHED FOAMS FOR FLOORING, CHEMICALLY FOAMED AND COMPACT SPIN FILL AND MOLDED CROWN CAP SEALS AND CLOSURES, METAL ADHERENT APPLICATIONS, COMPACT VINYL WALLPAPER BASE, PRODUCTION OF GARMENTS, NAMELY GLOVES AND FOOTWEAR, INDUSTRIAL BELTING, TOYS, DOLLS, PLAY BALLS AND IN THE SURFACE FINISHING OF ARTICLES AND IN MEDICAL PRODUCTS, AQUEOUS DISPERSIONS OF VINYL ACETATE/VINYL ALCOHOL COPOLYMER FOR USE IN THE MANUFACTURE OF A WIDE VARIETY OF GOODS, ETHYLENE OXIDE AND DERIVATIVES THEREOF, NAMELY ETHYLENE GLYCOL, DIETHYLENE GLYCOL, TRIETHYLENE GLYCOL, ETHYLI-

DENE NORBORNENE, ETHANOLAMINES, SPECIALITY AMINES FOR USE IN THE MANUFACTURE OF A WIDE VARIETY OF GOODS; METAL SILICATES, SILICAS, ALUMINOSILICATES, ZEOLITES AND MIXED METAL HYDROXIDES FOR USE IN THE MANUFACTURE OF A WIDE VARIETY OF GOODS; PHENOL FOR USE IN THE MANUFACTURE OF A WIDE VARIETY OF GOODS AND CHEMICALS NAMELY THE MANUFACTURE OF BISPHENOL-A FOR THE MANUFACTURE OF POLYCARBONATE RESIN, THE MANUFACTURE OF PHENOLIC RESINS AND THE PRODUCTION OF CYCLOHEXANONE; ACETONE FOR USE IN THE MANUFACTURE OF A WIDE VARIETY OF GOODS AND CHEMICALS NAMELY MANUFACTURE OF METHYLMETHACRYLATE FOR THE MANUFACTURE OF POLYMETHYLMETHACRYLATE, THE MANUFACTURE OF BISPHENOL-A FOR THE MANUFACTURE OF POLYCARBONATE RESIN AND FOR USE AS A SOLVENT; [ALPHAMETHYL] * ALPHAMETHYL * STYRENE FOR USE IN THE MANUFACTURE OF A WIDE VARIETY OF GOODS AND CHEMICALS NAMELY MODIFIED ABS RESINS, [FAVORS.] * FLAVORS, * FRAGRANCES AND HYDROCARBON RESINS; ACETOPHENONE FOR USE IN THE MANUFACTURE OF A WIDE VARIETY OF GOODS, NAMELY INK PASTES; ANHYDROUS AND LIQUOR CAUSTIC SODA FOR USE IN THE MANUFACTURE OF A WIDE VARIETY OF GOODS; CHLORINE AND CHLOR-CHEMICALS FOR USE IN THE MANUFACTURE OF A WIDE VARIETY OF GOODS; HYDROGEN CHLORIDE AND HYDROCHLORIC ACID FOR USE IN THE MANUFACTURE OF A WIDE VARIETY OF GOODS; SODIUM HYPOCHLORITE FOR USE IN THE MANUFACTURE OF A WIDE VARIETY OF GOODS; CAUSTIC POTASH FOR USE IN THE MANUFACTURE OF A WIDE VARIETY OF GOODS; ETHYLENE DICHLORIDE FOR USE IN THE MANUFACTURE OF A WIDE VARIETY OF GOODS; TRICHLOROETHYLENE FOR USE IN THE MANUFACTURE OF A WIDE VARIETY OF GOODS; PERCHLOROETHYLENE FOR USE IN THE MANUFACTURE OF A WIDE VARIETY OF GOODS; VINYLIDENE CHLORIDE FOR USE IN THE MANUFACTURE OF A WIDE VARIETY OF GOODS; METHYLENE CHLORIDE FOR USE IN THE MANUFACTURE OF A WIDE VARIETY OF GOODS; METHYL CHLORIDE FOR USE IN THE MANUFACTURE OF A WIDE VARIETY OF GOODS; CARBON TETRACHLORIDE FOR USE IN THE MANUFACTURE OF A WIDE VARIETY OF GOODS; CHLOROFORM; CHLORINATED PARAFFINS FOR USE IN THE MANUFACTURE OF A WIDE VARIETY OF GOODS; METAL CHLORIDES FOR USE IN THE MANUFACTURE OF A WIDE VARIETY OF GOODS; CHLORALKALIS FOR USE IN THE MANUFACTURE OF A WIDE VARIETY OF GOODS; CHLORINATED ACIDS FOR USE IN THE MANUFACTURE OF A WIDE VARIETY OF GOODS; SULPHURIC ACID FOR USE IN THE MANUFACTURE OF GOODS; OLEUM; SULPHUR DIOXIDE FOR USE IN THE MANUFACTURE OF A WIDE VARIETY OF GOODS; SULPHUR TRIOXIDE FOR USE IN THE MANUFACTURE OF A WIDE VARIETY OF GOODS; CHLORSULPHONIC ACID FOR USE IN THE MANUFACTURE OF A WIDE VARIETY OF GOODS; BATTERY ACID FOR USE IN THE MANUFACTURE OF BATTERIES; SODIUM [HYDROSULPHIDE] * HYDROSULPHIDE * LIQUOR FOR USE IN THE MANUFACTURE OF A WIDE VARIETY OF GOODS; REFRIGERANTS USED IN COMMERCIAL, INDUSTRIAL, AUTOMOTIVE, TRANSPORT AND DOMESTIC REFRIGERATION AND AIR-CONDITIONING EQUIPMENT; COOLING AGENTS USED IN COMMERCIAL, INDUSTRIAL, AUTOMOTIVE, TRANSPORT AND DOMESTIC REFRIGERATION AND AIR-CONDITIONING EQUIPMENT; SOLVENTS, NAMELY FLUORINATED HYDROCARBONS FOR USE IN A WIDE VARIETY OF FIELDS; AEROSOL PROPELLANTS, BLOWING AGENTS FOR USE IN THE MANUFACTURE OF FOAMED MATERIALS; PLASTIFIERS FOR USE IN THE MANUFACTURE OF A WIDE VARIETY OF GOODS; REFINERY AMINE SYSTEMS COMPRISED OF METHYLDIETHANOLAMINE FOR USE IN GAS TREATING SYSTEMS, NAMELY NATURAL GAS PROCESSING, OIL REFINERIES, AMMONIA PRODUCTION AND OTHER CHEMICAL PROCESSING INDUSTRIES FOR THE REMOVAL OF CARBON DIOXIDE, HYDROGEN SULPHIDE AND OTHER CONTAMINANTS; CHEMICAL TESTING REAGENTS FOR SCIENTIFIC OR RESEARCH USE; EXTRACTION SOLVENTS FOR NATURAL MATERIALS FOR USE IN THE MANUFACTURE OF A WIDE VARIETY OF GOODS; NON-FLAMMABLE

VOLATILE ORGANIC CHEMICAL LIQUIDS FOR USE IN THE MANUFACTURE OF A WIDE VARIETY OF GOODS; HALOGENATED CHEMICALS FOR USE AS CHEMICAL INTERMEDIATES AND MONOMERS IN A WIDE VARIETY OF FIELDS; CHEMICALS USED IN FIRE EXTINGUISHING COMPOSITIONS; CHEMICALS USED AS AEROSOL PROPELLANTS IN SPRAY AND AEROSOL PRODUCTS, FOR RESEARCH, INDUSTRIAL AND CONSUMER APPLICATIONS; CHEMICALS USED AS AEROSOL PROPELLANTS IN MEDICAL AEROSOLS AND INHALERS; CHEMICALS USED AS ANAESTHETICS IN MEDICINAL APPLICATIONS AND AS PROCESSING FLUIDS IN THE ELECTRONIC INDUSTRY; CHEMICALS AND POLYMERS, NAMELY ACRYLATES AND POLYACRYLATES FOR USE IN LIGHTING APPARATUS, LIGHT DIFFUSERS AND GUARD DEVICES FOR LAMPS, APPARATUS FOR WATER SUPPLY AND SANITARY PURPOSES, BATH FITTINGS, BATH TUBS, SHOWER TRAYS, WASH BASINS AND SINKS, SIGNS AND SIGNAGE AND ARCHITECTURAL MATERIALS; POLYMERIC COMPOSITIONS, NAMELY POLYACRYLATE COMPOSITIONS FOR USE IN FLEXIBLE AND RIGID MOLDING PRODUCTS, ADHESIVES AND AS PRIMARY AND SECONDARY SUSPENDING AGENTS, REACTOR BUILD-UP SUPPRESSANTS AND EMULSIFIERS; CHEMICALS FOR USE IN PREPARING POLYESTERS, ANTI-FREEZE COMPOSITIONS, INKS, PAINTS, DETERGENTS, CEMENTS, COSMETICS, COATINGS, ADHESIVES PHARMACEUTICALS, TEXTILES, LUBRICANTS, SYNTHETIC RUBBERS, ROOFING; CHEMICALS FOR USE AS SOLVENTS AND DE-ICERS AND FOR TREATMENT OF HYDROCARBON GASES AND IN THE ELECTRONIC INDUSTRY; CHEMICALS FOR USE IN SOAPS, CLEANING COMPOSITIONS, PAINTS, VARNISHES AND OTHER SURFACE COATINGS; CHEMICALS FOR USE IN THE MANUFACTURE OF PERSONAL CARE PRODUCTS; CHEMICALS FOR USE IN MANUFACTURE OF PAPER; CHEMICALS FOR USE IN BREWING; CHEMICALS FOR USE IN SOIL CONSOLIDATION AND SEWAGE PIPE REPAIR IN CIVIL ENGINEERING; CHEMICALS FOR USE IN THE MANUFACTURE OF ADHESIVE COMPOSITIONS; CHEMICALS FOR USE AS ABSORBENTS AND DESICCANTS AS FILLERS OR ANTI BLOCKING AIDS FOR POLYMERS FOR USE IN THE MANUFACTURE OF A WIDE VARIETY OF GOODS AND AS CATALYSTS OR CATALYST SUPPORTS FOR USE IN THE MANUFACTURE OF A WIDE VARIETY OF GOODS; CHEMICALS FOR USE IN THE MANUFACTURE OF [FAVORS] * FLAVORS * AND FRAGRANCES, PHENOLIC RESINS AND CHEMICAL SYNTHESIS; CHEMICALS FOR USE IN WATER TREATMENT AND PURIFICATION, TEXTILE PROCESSING, PLASTICS AND RUBBER PROCESSING, DRY CLEANING AND BLEACHING COMPOSITIONS, TEMPERING AND SOLDERING PREPARATIONS, REFRIGERANTS, IN PRESERVING FOODSTUFFS AND NUTRITIONAL IMPROVEMENT OF CEREAL GRAIN, IN TANNING SUBSTANCES, IN METAL CLEANING, PICKLING AND DEGREASING, IN PAPER BLEACHING, IN THE PREPARATION OF ORGANIC AND INORGANIC CHEMICALS AND POLYMERS; CHEMICALS FOR USE IN THE MANUFACTURE OF FOOD, DRINK, FERTILIZERS AND PAPER; CHEMICALS FOR USE IN THE ELECTROLYSIS AND ELECTROPLATING, IN BATTERY MANUFACTURE, IN DRYING GASES AND IN HEAT TRANSFER.

FIRST USE 7-1-2001; IN COMMERCE 7-1-2001.

FOR HEAVY DUTY PAINTS AND VARNISHES FOR DOMESTIC OR INDUSTRIAL USE AND FOR INTERIOR OR EXTERIOR USE, NOT INSULATING VARNISHES; LACQUERS IN THE NATURE OF COATINGS; PRESERVATIVES AGAINST RUST AND THE PRESERVATION OF WOOD; COLORANTS AND DYE STUFFS FOR USE IN THE MANUFACTURE OF A WIDE VARIETY OF GOODS, NONE BEING FOR LAUNDRY OR TOILET USE; MORDANTS FOR USE IN THE DYEING INDUSTRY; RAW NATURAL RESINS FOR USE IN THE MANUFACTURE OF PLASTICS; METALSIN FOIL AND POWDER FORM FOR PAINTERS, DECORATORS, PRINTERS AND ARTISTS; STABILIZERS FOR PAINTS; SOLVENTS FOR THINNING PAINTS AND LACQUERS; COATINGS FOR USE IN ELECTROCHEMICAL APPLICATIONS; CONDUCTIVE COATINGS, PRECIOUS METAL ELECTROCATALYTIC COATINGS, COATINGS FOR ANODES AND CATHODES AND METAL COATINGS FOR USE IN ELECTROCHEMISTRY, THE [CHLORALKALI] * CHLORALKALI * INDUSTRY, THE PRODUCTION OF CHLORINE, CAUSTIC SODA AND POTASSIUM HYDROXIDE AND IN THE PRODUCTION OF ENERGY FROM FUEL CELLS.

FIRST USE 7-1-2001; IN COMMERCE 7-1-2001.

INT. CL. 3/U.S. CLS. 1, 4, 6, 50, 51 AND 52

FOR BLEACHING PREPARATIONS AND SUBSTANCES, ALL FOR LAUNDRY USE; CLEANING, POLISHING, ABRASIVE AND SCOURING PREPARATIONS AND SOLVENTS; SOAPS FOR LAUNDRY USE, PERFUMES, ESSENTIAL OILS, COSMETICS, HAIR LOTIONS AND DENTIFRICES; DRY CLEANING PREPARATIONS; PAINT, VARNISH AND STAIN REMOVERS; DISINFECTANTS; SOLVENTS FOR CLEANING TEXTILES, DEGREASING LEATHERS AND SKINS, REMOVING NATURAL OILS, WAXES AND LUBRICANTS FROM TEXTILES, METAL CLEANING AND DEGREASING AND FILM CLEANING NOT USED IN MANUFACTURING PROCESSES AND FOR USE IN DRY CLEANING, LAUNDRY, TANNING, MATERIAL PROCESSING, PRINTING, MINING, OIL DRILLING, INDUSTRIAL PRECISION CLEANING AND ENGINEERING INDUSTRIES.

FIRST USE 7-1-2001; IN COMMERCE 7-1-2001.

INT. CL. 9/U.S. CLS. 21, 23, 26, 36 AND 38

FOR CHEMICAL TEST KITS FOR TESTING SOLVENTS COMPRISING CARRYING CASES, THERMOMETERS, CHEMICAL REAGENTS, TEST TUBES AND GLASS MEASURING BEAKERS; APPARATUS AND INSTRUMENTS, NAMELY ELECTROLYSERS; FUEL CELLS, ELECTRODES, ION EXCHANGE MEMBRANES AND MEMBRANE CELLS ALL FOR USE IN ELECTROCHEMISTRY, THE CHLORALKALI INDUSTRY, THE PRODUCTION OF CHLORINE, CAUSTIC SODA AND POTASSIUM HYDROXIDE, AND THE PRODUCTION OF ENERGY FROM FUEL CELLS; PARTS AND FITTINGS FOR ALL THE AFORESAID GOODS.

FIRST USE 7-1-2001; IN COMMERCE 7-1-2001.

ELEMENTS CORRECTED
GOODS/SERVICES

FOR HEAT TREATMENT OF STEEL AND METALS; COATING OF METALS AND METAL ALLOYS AND CERAMICS IN VACUUM INSTALLATIONS AND PLASMA VACUUM INSTALLATIONS; SURFACE TREATMENT OF METALS, METAL ALLOYS AND CERAMICS; HARDENING OF METALS AND ALLOYS IN A VACUUM; SURFACE TREATMENT OF METALS, METAL ALLOYS AND CERAMICS THROUGH DIFFUSION, IN PARTICULAR NITRATING.

FIRST USE ; IN COMMERCE .

ELEMENTS CORRECTED
CITIZENSHIP

2,909,472. REG. 12-14-2004. STICHT, WALTER (AUSTRIA INDIVIDUAL) KARL-HEINRICH-WAGGERL-STRASSE 8, 4800 ATTNANG-PUCHHEIM, AUSTRIA., SN 76-379,549. FILED 3-7-2002. PRINCIPAL REGISTER.

2,906,207. REG. 11-30-2004. RUBIG GESELLSCHAFT M.B.H. & CO. KG (AUSTRIA JOINT STOCK COMPANY) SCHAFFWIENSTRASSE 56, WELS, AUSTRIA, 4600, SN 78-201,897. FILED 1-10-2003. PRINCIPAL REGISTER.

LT-CI

HELIVAC

PRIORITY CLAIMED UNDER SEC. 44(D) ON REPUBLIC OF KOREA APPLICATION NO. 2002-0020134, FILED 10-7-2002, REG. NO. 0099140, DATED 3-31-2004, EXPIRES 3-31-2014.
INT. CL. 40/U.S. CLS. 100, 103 AND 106

PRIORITY CLAIMED UNDER SEC. 44(D) ON AUSTRIA APPLICATION NO. AM7954/2001, FILED 11-15-2001, REG. NO. 202284, DATED 2-22-2002, EXPIRES 2-28-2013.
INT. CL. 7/U.S. CLS. 13, 19, 21, 23, 31, 34 AND 35

FOR MACHINES AND MACHINE TOOLS, NAMELY, MANUFACTURING MACHINES, ASSEMBLING MACHINES, MANIPULATION MACHINES, JOINING MACHINES, YOKE MACHINES, MACHINE PARTS IN THE NATURE OF WORK FIXTURES AND WORK PIECE CARRIERS, MACHINE PARTS IN THE NATURE OF GRIPPER SYSTEM CONSISTING OF GRAB FINGERS AND SLIDES, DIES FOR USE WITH MACHINE TOOLS, POWER-OPERATED PICK-UP TOOL FOR USE WITH ASSEMBLY AND PROCESSING WORK STATIONS, POWER OPERATED GLUING TOOL FOR USE WITH ASSEMBLY AND PROCESSING WORK STATIONS, ELECTRIC SCREW-DRIVER, DRIFT FOR USE WITH ASSEMBLY AND PROCESSING WORK STATIONS, RIVETING DIE FOR MACHINE TOOLS; MACHINES, NAMELY, CONVEYOR SYSTEMS CONSISTING OF DRIVE CHAIN, WORK PIECE CARRIERS, TWIN-BELTS FOR PRODUCTION PLANTS AND ASSEMBLY PLANTS FOR THE SEMI-AUTOMATED AND FULLY AUTOMATED PRODUCTION OF COMPONENTS, NAMELY, BALL POINT PENS, JOINT HINGE, STEERING ASSEMBLY PARTS, CAMSHAFT ASSEMBLY PARTS, BRAKE ASSEMBLY PARTS, IGNITION COIL ASSEMBLY PARTS, CLUTCH ASSEMBLY PARTS, ANTI BLOCKING SYSTEMS, GEAR ASSEMBLY PARTS, SAFETY BELT ASSEMBLY PARTS, AIR BAG ASSEMBLY PARTS, MOBILE TELEPHONE ASSEMBLY PARTS, SAMPLE CONTAINER, LABORATORY, MEDICINE PLASTIC BOTTLE, PROTECTIVE MOTOR SWITCH, TEMPERATURE SENSOR, TEMPERATURE DIODE, AND REVERSIBLE SWITCH; ASSEMBLY LINES BELTS FOR ASSEMBLING SINGLE PARTS SEQUENTIAL TO A STRUCTURAL COMPONENT; CONVEYOR BELTS; POWER OPERATED CUTTERS AND TRANSFER MECHANISMS THEREFOR FOR INTERCHANGING A SINGLE PART TO ASSEMBLY LINE; MACHINE COMPONENTS, NAMELY, CLAMPING PLATES, TOOL AND WORK PIECE CHANGING DEVICES CONSISTING OF A FASTENER FOR RECEIVING AND POSITIONING THE TOOL OR WORK PIECE AND A LOOSENING TOOL FOR DISENGAGING THE TOOL OR WORK PIECE; POWER OPERATED METAL CUTTING TOOL, NAMELY, CUTTING BLADES AND SAWS; POWER OPERATED PUNCHING TOOLS, NAMELY, DIES AND PICK-UP TOOLS; MACHINE PARTS FOR ASSEMBLY PLANTS, NAMELY, EXTRUDERS, PLASTIFICERS, MOLD INJECTIONS AND EXTRUSION DIES; TORQUE CONVERTERS NOT FOR LAND VEHICLES; LINEAR ACTUATORS; ASSEMBLY ROBOTS; FEED AND UNREELING APPARATUS, NAMELY, MANIPULATION MACHINES, JOINING MACHINES, ROBOT GRIPPERS, CONVEYOR BELTS, CHUTE CONVEYORS, TWIN-BELT CONVEYORS, CONVEYOR, BELT CONVEYOR, RIGIDLY CONCATENATED TRANSPORTATION PLANTS AND LOOSELY CONCATENATED TRANSPORTATION PLANT CONSISTING OF WORKPIECE CARRIERS, PALLET TRAYS, CONVEYOR TRACKS, GRAB HOLDERS, CONVEYING PATHS, AND CONVEYING ROLLERS; ASSEMBLY PARTS UNREELING MACHINES, SPRING UNTANGLING MACHINES, FEED GRIPPER MACHINES, FEED HOPPER MACHINES, MACHINE PARTS, NAMELY, EXTRUSION DIES.

FIRST USE ; IN COMMERCE .

INT. CL. 9/U.S. CLS. 21, 23, 26, 36 AND 38

FOR QUALITY CONTROL MACHINES FOR MONITORING ASSEMBLY AND PROCESSING WORK STATIONS IN THE FIELD OF ASSEMBLY MACHINERY; WELDING TORCH, SCOTCH WELDING TORCH; COMPUTERS; STORED COMPUTER OPERATING PROGRAMS; COMPUTER SOFTWARE FOR RUN-OFF CONTROL OF MACHINES, PROCESS CONTROL, PICTORIALIZATION OF MACHINE DATA, PROCESS DATA, QUALITY DATA, COMPUTER AIDED ENGINEERING, CONSTRUCTION OF PLANS, CONSTRUCTION OF OPERATORS MANUAL, OPTIMIZING OF LOGISTIC RUNNING, SIMULATION OF CONCEPTING AND PLANNING OF MACHINES, SIMULATION FOR PLANNING OF CIRCLE TIME, SIMULATION FOR OPTIMIZING OF WEAR, CONSTRUCTION OF PLANS FOR MAINTENANCE, VISUAL AND ACOUSTIC INFORMATION OF DISTURBANCE INCIDENT SEQUENCE ANALYSES, CONTROLLING OF THE OPERATING STATE AND DATA EXCHANGE BETWEEN A PLURALITY OF MACHINES; DATA EXCHANGE BETWEEN A MACHINE AND THE OPERATOR; COMMUNICATION BETWEEN A MACHINE AND A OPERATING SYSTEM AND A HOST PROCESSOR, COMMUNICATION BETWEEN A MACHINE AND THE AUTOMATED WAREHOUSE MAN-

AGEMENT, INTERCHANGING DATA BETWEEN A HOST-PROCESSOR AND A CLIENT-PROCESSOR BY A DATA NETWORK, THE OUTPUT OF UNIFORM STRUCTURED DATA, COMMUNICATION BETWEEN THE MACHINE AND THE ELECTRONIC MANAGEMENT OF ORDERS; COMPUTER PERIPHERALS; COMPUTER PRINTERS; ELECTRIC MEASURING APPARATUS, NAMELY, CONTROLS USED TO MEASURE PATH OF MACHINES AND MOTORS, FORCE TRANSDUCERS THAT UTILIZE ULTRASONIC OSCILLATIONS TO TEST FOR STRESS AND FATIGUE IN METAL AND METAL STRUCTURES; ELECTRIC CONTROLLER PANELS FOR RECEIVING, PROCESSING, OUTPUTTING OF PROCESS DATA, MACHINE DATA AND OPERATING PARAMETERS, QUALITY DATA, COMMUNICATION BETWEEN OPERATOR AND MACHINE, COMMUNICATION BETWEEN SERVER PROCESSOR AND HOST PROCESSOR, DATA EXCHANGE BETWEEN THE SERVER PROCESSOR AND DATA NETWORK, REAL-TIME OPERATING, STORING DATA, MANAGEMENT OF ASSEMBLING PIECES, MANAGEMENT OF OPERATING PARAMETER, MANAGEMENT OF USER DATA, MANAGEMENT OF MACHINE DATA; ELECTRIC CONTROLLERS, NAMELY, ANALOGUE CONTROL APPARATUS WITH AN INTERFACE, DIGITAL CONTROLLER WITH AN INTERFACE, PROGRAMMABLE LOGIC CONTROLLER WITH AN INTERFACE; ELECTRONIC SYSTEMS, AND APPARATUS AND CONTROL SYSTEMS CONSISTING OF COMPUTER WITH SCREEN AND INPUT TERMINAL, COMPUTER INTERFACE BOARDS, COMPUTER NETWORK HUBS, SWITCHES, AND ROUTERS, DATA STORAGE, COMPUTER OPERATING PROGRAM, DATA PROCESSORS, CONTROL SOFTWARE FOR MONITORING ASSEMBLY AND PROCESSING WORK STATIONS IN THE FIELD OF ASSEMBLY MACHINERY, ELECTRONIC SENSORS FOR ASSEMBLY MACHINERY FOR SENSING WORK OUTPUT AND ASSEMBLY PROCESSES; ELECTRIC OR ELECTRONIC COMPUTER UNITS FOR CONTROLLING AND/OR MANAGING AND/OR MONITORING PRODUCTION PLANTS, AND FOR COMPUTER AIDED DESIGN, AND/OR COMPUTER AIDED MANUFACTURING AND/OR COMPUTER ENGINEERING MANUFACTURING SYSTEMS CONSISTING OF COMPUTER WITH SCREEN AND INPUT TERMINAL, COMPUTER OPERATING SYSTEM, DATA STORAGE, DATA NETWORK, INTERFACE, DATA SOFTWARE FOR USE WITH ASSEMBLING MACHINES, MANIPULATION MACHINES, JOINING MACHINES, MOLDING MACHINES, WELDING MACHINES, QUALITY CONTROL MACHINES, YOKE MACHINES, AUTOMATIC PUNCHING OR CONSEQUENTIAL COSTS CALCULATION, TIME KEEPING, WORK SCHEDULING, ORDER SCHEDULING, ACCEPTANCE OF AN OFFER, ACCEPTANCE OF AN ORDER, ACCEPTANCE OF RECLAMATION, CONSTRUCTION OF DOCUMENTATIONS, REMOTE MAINTENANCE VIA INTERNET, AND CALCULATION OF OUTPUT RATES.

FIRST USE ; IN COMMERCE .

ELEMENTS CORRECTED
FOREIGN REG. EXPIRATION DATE

2,910,748. REG. 12-14-2004. FUJITSU SIEMENS COMPUTERS GMBH (FED REP GERMANY CORPORATION) DOMAGKSTRASSE 28, 80807 MUNICH, FED REP GERMANY., SN 78-291,037. FILED 8-22-2003. PRINCIPAL REGISTER.

FITV

PRIORITY CLAIMED UNDER SEC. 44(D) ON FED REP GERMANY APPLICATION NO. 30312610.809, FILED 3-11-2003, REG. NO. 30312610, DATED 1-16-2004.
INT. CL. 9/U.S. CLS. 21, 23, 26, 36 AND 38

FOR ELECTRICAL APPARATUS FOR RECORDING, EMISSION, TRANSMISSION, RECEPTION, REPRODUCTION AND PROCESSING OF SOUNDS, SIGNALS, CHARACTERS AND/OR IMAGES, ESPECIALLY FOR A MEDIA CENTER BASED ON PC TECHNOLOGY DESIGNED AND OPTIMIZED TO INTERACT WITH DIGITAL TV, VIDEO, AUDIO, INTERNET AND DATA INFORMATION, NAMELY, ADVANCED SETTOPBOX FOR USE AS A DIGITAL TV RECEIVER, TO PROVIDE INTERNET AND MAIL ACCESS, AND TO PLAY DVDS, CDS, MP3 AND VCD; DIGITAL PERSONAL VIDEO RECORDER; RECEIVER FOR VIDEO ON DEMAND SERVICES; ROUTERS AND SERVERS FOR CONNECTING DATA PROCESSING DEVICES; COMMUNICATIONS COMPUTER FOR ENABLING AUDIO-VIDEO COMMUNICATIONS; SOFTWARE FOR OPERATING A MEDIA CENTER BASED ON PC TECHNOLOGY DESIGNED AND OPTIMIZED TO INTERACT WITH DIGITAL TV, VIDEO, AUDIO, INTERNET AND DATA INFORMATION.

FIRST USE ; IN COMMERCE .
INT. CL. 38/U.S. CLS. 100, 101 AND 104

FOR ELECTRONIC, ELECTRIC AND DIGITAL TRANSMISSION OF VOICE, DATA, IMAGES, SIGNALS AND MESSAGES, VIDEO AND AUDIO SEQUENCES.

FIRST USE ; IN COMMERCE .
INT. CL. 42/U.S. CLS. 100 AND 101

FOR CONSULTING SERVICES IN THE FIELD OF DESIGN, SELECTION, IMPLEMENTATION AND USE OF COMPUTER HARDWARE AND SOFTWARE SYSTEMS FOR OTHERS IN THE FIELD OF COMPUTER DATA, COMPUTER INFORMATION AND COMPUTER COMMUNICATIONS ENGINEERING; PLANNING, DEVELOPMENT, PROJECT DESIGN, CONSULTANCY, TESTING, TECHNICAL MONITORING, SYSTEM INTEGRATION AND PRODUCT INTEGRATION FOR OTHERS IN THE FIELD OF COMPUTER DATA, COMPUTER INFORMATION AND COMPUTER COMMUNICATIONS ENGINEERING; DATA CONVERSION OF COMPUTER PROGRAM DATA OR INFORMATION; DEVELOPMENT, INSTALLATION AND RENTING OF DATA PROCESSING PROGRAMS FOR OPERATING A MEDIA CENTER BASED ON PC TECHNOLOGY DESIGNED AND OPTIMISED TO INTERACT WITH DIGITAL TV, VIDEO, AUDIO, INTERNET AND DATA INFORMATION.

FIRST USE ; IN COMMERCE .

ELEMENTS AMENDED
GOODS/SERVICES

2,912,263, REG. 12-21-2004, SGA S.R.L. (ITALY LTD LIAB CO) VIA IBSEN, 24, 39040 CASTELROTTO FRAZ. SIUSI, BOLZANO, ITALY., SN 76-532,004. FILED 7-11-2003. PRINCIPAL REGISTER.



OWNER OF ITALY REG. NO. 00891371, DATED 5-13-2003, EXPIRES 12-12-2012.

NO CLAIM IS MADE TO THE EXCLUSIVE RIGHT TO USE COPPER, APART FROM THE MARK AS SHOWN.

INT. CL. 24/U.S. CLS. 42 AND 50

FOR FABRIC FOR THE MANUFACTURE OF CLOTHING, NAMELY, OVERALLS** TWIN SETS CONSISTING OF SHIRT AND SHORTS, SKIRT AND SHIRTS** SKIRT AND BLAZER OR JACKETS, TROUSERS AND SHIRTS, TROUSERS AND BLAZER OR JACKETS, OUTFITS FOR MEN, NAMELY, TROUSERS, JACKETS, SHIRTS AND PULLOVERS WHICH FIT TOGETHER IN ORDER TO CREATE AN OUTFIT, SUITS CONSISTING OF TROUSERS WITH JACKETS, WOMEN'S CLOTHING, NAMELY, DRESSES, CLOTHING SETS CONSISTING OF DRESSES, SKIRTS, BLOUSES, PANTS AND OTHER CLOTHING ITEMS, NAMELY, PANTS, SHORT PANTS AND BERMUDA PANTS, TAILLEURES CONSISTING OF SKIRTS AND JACKET ENSEMBLES, BLOUSONS, JACKETS, COATS, SHIRTS, DUNGAREES, TROUSERS, PANTS, STRETCH PANTS, BERMUDA SHORTS, SHORTS, SKIRTS, SWEATSHIRTS*, SWEATERS, POLO SHIRTS, T-SHIRTS, WAISTCOATS, VESTS, LEOTARDS AND BOXER SHORTS, KNITWEAR, NAMELY, SHIRTS, PANTS, JACKETS, SPORT JACKETS, T-SHIRTS, SKIRTS, SHORTS, HATS, CAPS, VISORS, BANDANAS, HEADBANDS, NECKBANDS, WRISTBANDS, SCARVES, GLOVES, FOULARD, TIES AND SOCKS; CLOTHS COMPOSED OF COTTON AND COPPER YARNS; SPECIAL KINDS OF FABRICS, NAMELY, COMPOSED OF COTTON AND COPPER YARNS FOR THE PRACTICE OF SPORTS, NAMELY, GOLF AND SKI.

FIRST USE ; IN COMMERCE .

INT. CL. 25/U.S. CLS. 22 AND 39

FOR CLOTHING, NAMELY, OVERALLS, TWIN SETS CONSISTING OF SHIRT AND SHORTS, SKIRT AND SHIRTS, SKIRT AND BLAZER OR JACKETS, TROUSERS AND SHIRTS, TROUSERS AND BLAZER OR JACKETS, OUTFITS FOR MEN, NAMELY, TROUSERS, JACKETS, SHIRTS AND PULLOVERS WHICH FIT TOGETHER IN ORDER TO CREATE AN OUTFIT, SUITS CONSISTING OF TROUSERS WITH JACKETS; WOMEN'S CLOTHING, NAMELY, DRESSES, CLOTHING SETS CONSISTING OF DRESSES, SKIRTS, BLOUSES, PANTS AND OTHER CLOTHING ITEMS, NAMELY, PANTS, SHORT PANTS AND BERMUDA PANTS, TAILLEURES CONSISTING OF SKIRTS AND JACKET ENSEMBLES, BLOUSONS, JACKETS, COATS, SHIRTS, DUNGAREES, TROUSERS, PANTS, STRETCH PANTS, BERMUDA SHORTS, SHORTS, SKIRTS, SWEATSHIRTS, SWEATERS, POLO SHIRTS, T-SHIRTS, WAISTCOATS, VESTS, LEOTARDS AND BOXER SHORTS; KNITWEAR, NAMELY, SHIRTS, PANTS, JACKETS, SPORT JACKETS, T-SHIRTS, SKIRTS, SHORTS, HATS, CAPS, VISORS, BANDANAS, HEADBANDS, NECKBANDS, WRISTBANDS, SCARVES, GLOVES, FOULARD, TIES AND SOCKS.

FIRST USE ; IN COMMERCE .

ELEMENTS CORRECTED
GOODS/SERVICES

2,912,264. REG. 12-21-2004. SGA S.R.L. (ITALY LTD LIAB CO)
VIA IBSEN, 24, 39040 CASTELROTTO FRAZ. SIUSI,
BOLZANO, ITALY., SN 76-532,005. FILED 7-11-2003. PRIN-
CIPAL REGISTER.



OWNER OF ITALY REG. NO. 00790217, DATED 9-20-1999,
EXPIRES 10-30-2007.

THE MARK CONSISTS OF THE WORD PRO IN RED,
THERM IN WHITE, A TRIANGLE IN RED, AN INNER
TRIANGLE IN WHITE, A DESIGN INSIDE BOTH TRIAN-
GLES THAT IS BLUE, AND AN OVERALL BACKGROUND
THAT IS BLUE. COLOR IS CLAIMED AS A FEATURE OF
THE MARK.

INT. CL. 24/U.S. CLS. 42 AND 50

FOR FABRIC FOR THE MANUFACTURE OF CLOTH-
ING, NAMELY, OVERALLS, TWIN SETS CONSISTING
OF SHIRT AND SHORTS, SKIRT AND SHIRTS, SKIRT
AND BLAZER OR JACKETS, TROUSERS AND SHIRTS,
TROUSERS AND BLAZER OR JACKETS, OUTFITS FOR
MEN, NAMELY, TROUSERS, JACKETS, SHIRTS AND
PULLOVERS WHICH FIT TOGETHER IN ORDER TO
CREATE AN OUTFIT, SUITS CONSISTING OF TROU-
SERS WITH JACKETS, WOMEN'S CLOTHING,
NAMELY, DRESSES, CLOTHING SETS CONSISTING
OF DRESSES, SKIRTS, BLOUSES, PANTS AND OTHER
CLOTHING ITEMS, NAMELY, PANTS, SHORT PANTS
AND BERMUDA PANTS, OUTFITS FOR LADIES,
NAMELY, TROUSERS, JACKETS, SHIRTS AND PULL-
OVERS WHICH FIT TOGETHER IN ORDER TO CREATE
AN OUTFIT, TAILLEURES CONSISTING OF SKIRTS
AND JACKET ENSEMBLES, BLOUSONS, JACKETS,
COATS, SHIRTS, DUNGAREES, TROUSERS, PANTS,
STRETCH PANTS, BERMUDA SHORTS, SHORTS,
SKIRTS, SWEATSHIRTS, SWEATERS, POLO SHIRTS, T-
SHIRTS, WAISTCOATS, VESTS, LEOTARDS AND BOX-
ER SHORTS, KNITWEAR, NAMELY, SHIRTS, PANTS,
JACKETS, SPORT JACKETS, T-SHIRTS, SKIRTS,
SHORTS, HATS, CAPS, VISORS, BANDANAS, HEAD-
BANDS, NECKBANDS, WRISTBANDS, SCARVES,
GLOVES, FOULARD, TIES AND SOCKS; CLOTHS COM-
POSED OF POLYESTER AND POLYAMIDE FIBERS;
SPECIAL KINDS OF FABRICS, NAMELY, COMPOSED
OF POLYESTER AND POLYAMIDE FIBERS FOR THE
PRACTICE OF SPORTS, NAMELY, GOLF AND SKI.

FIRST USE ; IN COMMERCE .

INT. CL. 25/U.S. CLS. 22 AND 39

FOR CLOTHING, NAMELY, OVERALLS, TWIN SETS
CONSISTING OF SHIRT AND SHORTS, SKIRT AND
SHIRTS, SKIRT AND BLAZER OR JACKETS, TROU-
SERS AND SHIRTS, TROUSERS AND BLAZER OR
JACKETS*.* OUTFITS FOR MEN, NAMELY, TROU-
SERS, JACKETS, SHIRTS AND PULLOVERS WHICH
FIT TOGETHER IN ORDER TO CREATE AN OUTFIT,
SUITS CONSISTING OF TROUSERS WITH JACKETS;
WOMEN'S CLOTHING, NAMELY, DRESSES, CLOTH-
ING SETS CONSISTING OF DRESSES, SKIRTS,
BLOUSES, PANTS AND OTHER CLOTHING ITEMS,
NAMELY, PANTS, SHORT PANTS AND BERMUDA
PANTS, OUTFITS FOR LADIES, NAMELY, [NAMELY,]
TROUSERS, JACKETS, SHIRTS AND PULLOVERS
WHICH FIT TOGETHER IN ORDER TO CREATE AN
OUTFIT, TAILLEURES CONSISTING OF SKIRTS AND
JACKET ENSEMBLES, BLOUSONS, JACKETS, COATS,
SHIRTS, DUNGAREES, TROUSERS, PANTS, STRETCH
PANTS, BERMUDA SHORTS, SHORTS, SKIRTS, SWEAT-
SHIRTS, SWEATERS, POLO SHIRTS, T-SHIRTS, WAIST-
COATS, VESTS, LEOTARDS AND BOXER SHORTS*.*
KNITWEAR, NAMELY, SHIRTS, PANTS, JACKETS,
SPORT JACKETS, T-SHIRTS, SKIRTS, SHORTS, HATS,
CAPS, VISORS, BANDANAS, HEADBANDS, NECK-
BANDS, WRISTBANDS, SCARVES, GLOVES, FOULARD,
TIES AND SOCKS.

FIRST USE ; IN COMMERCE .

ELEMENTS CORRECTED
GOODS/SERVICES

2,929,201. REG. 3-1-2005. OLYMPUS OPTICAL CO., LTD.
(JAPAN JOINT STOCK COMPANY) 43-2, 2-CHOME HA-
TAGAYA, SHIBUYA-KU, TOKYO, JAPAN., SN 76-293,924.
FILED 8-1-2001. PRINCIPAL REGISTER.

GX

INT. CL. 9/U.S. CLS. 21, 23, 26, 36 AND 38

FOR MICROSCOPES AND PARTS THEREFOR, AC-
CESSORIES FOR MICROSCOPES, NAMELY, TRANS-
MITTED LIGHT ILLUMINATORS, [PHOT-UNITS,]
PHOTO-UNITS, CALIBRATION SCALES, OBSERVA-
TION TUBES, INTERMEDIATE TUBES AND REVOLV-
ING NOSEPIECES.

FIRST USE 10-1-2001; IN COMMERCE 12-14-2001.

ELEMENTS CORRECTED
GOODS/SERVICES

2,934,317. REG. 3-22-2005. INTERNATIONAL MEDICAL
GROUP, INC. (INDIANA CORPORATION) 407 FULTON
STREET, INDIANAPOLIS, IN, 46202, SN 76-483,606. FILED
1-21-2003. PRINCIPAL REGISTER.

YOURSHARE

INT. CL. 35/U.S. CLS. 100, 101 AND 102

FOR CONDUCTING INCENTIVE COMMISSION-
SHARING COMPENSATION PROGRAMS TO INSUR-
ANCE AGENTS, BROKERS AND OTHER INSURANCE
PRODUCERS TO PROMOTE PERFORMANCE IN THE
AREAS OF SALES, MARKETING, PRODUCT LOYALTY,
PROFITABILITY AND [PRODUCTIVELY] * PRODUC-
TIVITY * .

FIRST USE 12-19-2002; IN COMMERCE 12-19-2002.

ELEMENTS CORRECTED
GOODS/SERVICES

2,937,823. REG. 4-5-2005. DARSAWYE PTY LTD. (AUSTRALIA COMPANY) 20 KINGSLEY CLOSE, ROWVILLE, VICTORIA, AUSTRALIA, 3178, SN 78-305,751. FILED 9-26-2003. PRINCIPAL REGISTER.

2,982,646. REG. 8-9-2005. AMERICAN SOCIETY FOR TRAINING & DEVELOPMENT (WISCONSIN NOT-FOR-PROFIT CORPORATION) P.O. BOX 1443, 1640 KING STREET, ALEXANDRIA, VA, 22313, SN 76-561,700. FILED 11-25-2003. PRINCIPAL REGISTER.

RECEPTORASE



PRIORITY CLAIMED UNDER SEC. 44(D) ON AUSTRALIA APPLICATION NO. 966829, FILED 8-20-2003, REG. NO. 966829, DATED 8-20-2003, EXPIRES 8-20-2013.
INT. CL. 5/U.S. CLS. 6, 18, 44, 46, 51 AND 52
FOR PHARMACEUTICAL AND VETERINARY PREPARATIONS FOR THE PREVENTION AND TREATMENT OF DIARRHEA .
FIRST USE ; IN COMMERCE .

NO CLAIM IS MADE TO THE EXCLUSIVE RIGHT TO USE BEST, APART FROM THE MARK AS SHOWN.
INT. CL. 41/U.S. CLS. 100, 101 AND 107
FOR ARRANGING AND CONDUCTING A COMPETITION AND AWARD CEREMONY RECOGNIZING INDIVIDUALS AND ORGANIZATIONS WHOSE OUTSTANDING ACHIEVEMENTS HAVE SIGNIFICANTLY ADVANCED WORKPLACE LEARNING AND PERFORMANCE.
FIRST USE 5-1-2003; IN COMMERCE 5-1-2003.

ELEMENTS CORRECTED
OWNER NAME
OWNER ADDRESS
CITIZENSHIP
ENTITY

ELEMENTS CORRECTED
ENTITY

* * * * *

This page is intentionally blank

INDEX OF REGISTRANTS

SEPT. 20, 2005

(Registered; Renewed; Canceled; Amended, Corrected, etc.; New Certificates; 12c Publications.)

The designation "U.S. Cl." appearing in this section refers to the U.S. class in effect prior to Sep. 1, 1973 rather than the international class which applies to applications filed on or after that date. For adoption of international classification see notice in the OFFICIAL GAZETTE of Jun. 26, 1973 (911 O.G. TM 210).

"REISSWOLF" AKTEN- UND DATENVERNICHTUNG GMBH & CO., 20537 HAMBURG, FED REP GERMANY: 2,202,024, CANC. INT. CL. 37.

A & B ASSOCIATES, INC., ST. LOUIS, MO: 2,996,707, PUB. 6-28-2005. INT. CL. 3.

A & L ENTERTAINMENT LLC, NEW YORK, NY: 2,201,230, CANC. INT. CL. 9.

A TO Z SYSTEMS, INC., BETHESDA, MD, TA AZTECH CORPORATION TO GOMEMBERS.COM, INC., LOMBARD, IL: 1,860,734, CANC. INT. CL. 9.

A. G. EDWARDS & SONS, INC., ST. LOUIS, MO: 2,999,022, INT. CL. 36.

A. H. HOFFMAN, INC., LANDISVILLE, PA: 2,201,660, CANC. INT. CL. 17.

A.F.C. SYSTEMS, INC., TAMPA, FL: 1,889,686, REN. 8-9-05. INT. CL. 9.

A.M.C.C. INTERNATIONAL, INC., WALNUT, CA: 2,997,214, PUB. 6-28-2005. INT. CL. 12.

A.P. PHARMA, INC., REDWOOD CITY, CA: 1,304,541, REN. 8-9-05. INT. CL. 3.

A.P. PRODUCTS LTD., NEW ROCHELLE, NY: 2,202,164, CANC. INT. CL. 4.

A&E TELEVISION NETWORKS, NEW YORK, NY: 2,202,327, CANC. MULTIPLE CLASS, INT. CLS. 9 AND 41. 2,999,152, INT. CL. 41.

AAA WORLD CALLING INC, SCOTTSDALE, AZ: 2,997,048, PUB. 6-28-2005. MULTIPLE CLASS, INT. CLS. 35 AND 42.

AAMP OF FLORIDA, INC., CLEARWATER, FL: 2,998,797, INT. CL. 9.

ABBOTT LABORATORIES, ABBOTT PARK, IL: 2,996,519, PUB. 6-28-2005. MULTIPLE CLASS, INT. CLS. 1, 10 AND 16.

ABBOTT SPECIALTY STAFFING, INC., TUSTIN, CA: 2,998,536, INT. CL. 35.

ABE SCHRADER CORPORATION, NEW YORK, NY: 1,302,702, CANC. INT. CL. 25.

ABKIT INC., NEW YORK, NY: 2,998,664, INT. CL. 5.

ABLOY OY CORPORATION, JOENSUU, FINLAND: 1,302,393, CANC. INT. CL. 6.

ABRAHAM, BENJAMIN, LOS ANGELES, CA, DBA DIAMOND FOODS TO KOSHER PROVISION, INC., VERNON, CA: 1,861,082, CANC. INT. CL. 30.

ABSECON MILLS, INC., COLOGNE, NJ: 2,998,718, INT. CL. 23.

AC ACQUISITION LLC, PEORIA, IL: 2,200,954, CANC. INT. CL. 35.

AC HEALTHCARE SUPPLY, INC., MIAMI, FL: 2,997,392, PUB. 6-28-2005. MULTIPLE CLASS, INT. CLS. 5, 9 AND 10.

ACADEMY BROADWAY CORP., SMITHTOWN, NY: 1,860,971, CANC. INT. CL. 22.

ACCEPTED PRODUCTS, INC., ATLANTA, GA, DBA THE ROCKER SHOP: 1,303,210, CANC. INT. CL. 42.

ACCESS DEVELOPMENT CORPORATION, SALT LAKE CITY, UT, GOLF ACCESS, INC., SALT LAKE CITY, UT: 1,910,453, REN. 8-12-05. INT. CL. 39.

ACCESS, INC., BIRMINGHAM, AL, DBA STUDENT LIFE, INC.: 2,997,273, PUB. 6-28-2005. MULTIPLE CLASS, INT. CLS. 9 AND 41.

ACCOONA CORP., HOBOKEN, NJ: 2,998,271, PUB. 6-28-2005. MULTIPLE CLASS, INT. CLS. 35 AND 42.

ACCUSKI, INC., WINDERMERE, FL: 1,876,446, REN. 8-11-05. INT. CL. 9.

ACE COMPANY LIMITED, CHUO-KU, OSAKA, JAPAN: 1,302,612, CANC. INT. CL. 18.

ACE CONTROLS, INC., FARMINGTON, MI: 2,998,728, INT. CL. 7.

ACE INTERNATIONAL INC., CENTRALIA, WA: 2,200,918, CANC. INT. CL. 1.

ACER PERIPHERALS, INC., TAOYUAN HSIEN, TAIWAN: 2,201,848, CANC. INT. CL. 42.

ACH FOOD COMPANIES, INC., CORDOVA, TN: 2,999,193, INT. CL. 29.

ACHIEVEGLOBAL, INC., TAMPA, FL: 2,998,962, MULTIPLE CLASS, INT. CLS. 9, 16 AND 41.

ACME MANUFACTURING COMPANY, PHILADELPHIA, PA: 779,459, CANC. U.S. CL. 34.

ACME UNITED CORPORATION, FAIRFIELD, CT: 1,010,705, REN. 8-10-05. U.S. CL. 23 (INT. CL. 8).

ACORN CARDIOVASCULAR, INC., ST. PAUL, MN: 2,998,543, INT. CL. 10.

ACOUSTIC ARTISTRY, LLC, BESSEMER, AL: 2,998,269, PUB. 6-28-2005. INT. CL. 9.

ACR, ELECTRONICS, INC., FORT LAUDERDALE, FL: 1,899,613, REN. 8-11-05. INT. CL. 9.

ACREE, DELORES F., ALBUQUERQUE, NM: 2,997,920, PUB. 6-28-2005. INT. CL. 28.

ACTEK ENTERPRISES, INC., SANTA FE SPRINGS, CA: 2,724,479, CANC. INT. CL. 6.

ACTION PEST CONTROL, EVANSVILLE, IN: 1,861,203, CANC. INT. CL. 37.

ACTIVE FEET, INC., SOLANA BEACH, CA: 2,999,183, INT. CL. 35.

ACTIVE VOICE CORPORATION, SEATTLE, WA: 2,201,720, CANC. INT. CL. 9.

ACTIVE WELLNESS, INC., NEW YORK, NY: 2,201,162, CANC. MULTIPLE CLASS, INT. CLS. 29 AND 30.

ADAMS CREATIVE PRODUCTS, INC., PHILADELPHIA, PA: 1,893,874, REN. 8-11-05. INT. CL. 2.

ADAMS EXTRACT & SPICE, LLC, GONZALES, TX: 2,996,551, PUB. 6-28-2005. INT. CL. 30.

ADECCO SA, CHESEREX 1275, SWITZERLAND, ECCO STAFFING SERVICES, INC., NEW YORK, NY: 1,880,838, REN. 8-8-05. INT. CL. 35.

ADEZA BIOMEDICAL CORPORATION, SUNNYVALE, CA: 2,201,659, CANC. INT. CL. 10. 2,999,071, INT. CL. 5.

ADITUS MEDICAL AB, LUND, SWEDEN: 2,996,898, PUB. 6-28-2005. MULTIPLE CLASS, INT. CLS. 9, 10 AND 44.

ADMAR ENTERPRISES, INC., MERRICK, NY: 2,999,301, INT. CL. 36.

- ADOBE SYSTEMS INCORPORATED, SAN JOSE, CA,
ADOBE SYSTEMS INCORPORATED, MOUNTAIN VIEW,
CA:
1,935,819. REN. 8-6-05. INT. CL. 9.
- ADOPTAPLATOON SOLDIER SUPPORT EFFORT, INCORPORATED, LOZANO, TX:
2,997,060, PUB. 6-28-2005. INT. CL. 35.
2,997,061, PUB. 6-28-2005. INT. CL. 35.
- ADOPTIVE FAMILIES TOGETHER, INC., BOSTON, MA:
2,996,346, PUB. 6-28-2005. MULTIPLE CLASS, INT. CLS. 16, 38 AND 41.
- ADVANCE CONCRETE PRODUCTS CO., HIGHLAND, MI:
1,347,892. REN. 8-11-05. INT. CL. 19.
- ADVANCE PARADIGM, INC., IRVING, TX:
2,202,188, CANC. INT. CL. 35.
- ADVANCED BEAUTY SYSTEMS, INC., DALLAS, TX:
2,998,041, PUB. 6-28-2005. INT. CL. 3.
- ADVANCED BIONICS CORPORATION, SYLMAR, CA:
2,998,897, INT. CL. 10.
- ADVANCED CHROMATOGRAPHY TECHNOLOGIES, BRIDGE OF DON, ABERDEEN, UNITED KINGDOM:
2,996,440, PUB. 6-28-2005. MULTIPLE CLASS, INT. CLS. 1 AND 9.
- ADVANCED COMPUTER COMMUNICATIONS, SANTA BARBARA, CA:
2,201,741, CANC. INT. CL. 9.
- ADVANCED FLUID TECHNOLOGIES, INC., WHITEHALL, PA, LOIKITS, DANIEL J., WHITEHALL, PA:
1,884,469. REN. 8-11-05. INT. CL. 1.
- ADVANCED METALFORMING TECHNOLOGIES, INC., OXNARD, CA:
2,997,710, PUB. 6-28-2005. INT. CL. 12.
- ADVANCED NEUROMODULATION SYSTEMS, INC., PLANO, TX:
2,996,852, PUB. 6-28-2005. INT. CL. 10.
- ADVANCED POOL AND SPA PRODUCTS, INC., MONTICELLO, IN:
2,997,640, PUB. 6-28-2005. INT. CL. 1.
- ADVANCED RESEARCH & APPLICATIONS CORP., SUNNYVALE, CA:
2,997,332, PUB. 6-28-2005. INT. CL. 9.
- ADVANCED TECHNOLOGIES DEVELOPMENT CORP., PORTLAND, OR:
2,201,928, CANC. INT. CL. 1.
- ADVANTAGE HOME CARE, INC., FORT WORTH, TX:
2,998,038, PUB. 6-28-2005. INT. CL. 44.
- ADVANTAGE INTERNATIONAL FOODS CORP., WEST CALDWELL, NJ:
2,997,458, PUB. 6-28-2005. INT. CL. 29.
- ADVANTAGEWARE INC., NEW YORK, NY:
2,201,353, CANC. INT. CL. 42.
2,201,354, CANC. INT. CL. 41.
- ADVANTIS TECHNOLOGIES, INC., ALPHARETTA, GA,
APPLIED BIOCHEMISTS, INC., MEQUEN, WI:
1,011,352. REN. 8-11-05. INT. CL. 5.
- ADVANTIS TECHNOLOGIES, INC., ALPHARETTA, GA:
2,998,637, INT. CL. 2.
- ADVISOR TECHNOLOGY SERVICES, LLC, BOSTON, MA:
2,202,123, CANC. INT. CL. 9.
- AEA NETWORK, INC., ALISO VIEJO, CA:
2,998,125, PUB. 6-28-2005. INT. CL. 10.
- AED ENTERPRISES, LLC, CINCINNATI, OH:
2,996,770, PUB. 6-28-2005. MULTIPLE CLASS, INT. CLS. 30 AND 43.
- AEG INTERMAS GMBH, D-60596 FRANKFURT AM MAIN, FED REP GERMANY:
2,200,875, CANC. INT. CL. 9.
- AERO TOYS, INC., RESEDA, CA:
1,302,497, CANC. INT. CL. 12.
- AEROBAT-TERIES, INC., TYLER, TX:
2,999,113, INT. CL. 9.
- AERONAUTICS FORWARDERS, INC., GREAT NECK, NY:
1,303,141, CANC. INT. CL. 39.
- AEROQUIP CORPORATION, MAUMEE, OH:
2,201,258, CANC. INT. CL. 6.
- AEROTEK, INC., HANOVER, MD:
2,996,288, PUB. 6-28-2005. INT. CL. 35.
- AEROVIAS DE MEXICO, S.A. DE C.V., MEXICO, COLONIA CUAUHEMOC, MEXICO:
2,999,075, MULTIPLE CLASS, INT. CLS. 16 AND 39.
- AESCLAP AG & CO. KG, FED REP GERMANY:
2,998,371, PUB. 6-28-2005. INT. CL. 10.
- AETNA INC., BLUE BELL, PA:
2,996,319, PUB. 6-28-2005. INT. CL. 36.
- AFTER-SCHOOL ALL-STARS, LOS ANGELES, CA FROM INNER-CITY GAMES FOUNDATION, SANTA MONICA, CA:
2,998,349, PUB. 6-28-2005. INT. CL. 36.
- AF2 ENTERPRISES, LLC, CHICAGO, IL:
2,996,775, PUB. 6-28-2005. INT. CL. 41.
- AGAINST GRAVITY APPAREL, INC, NEW YORK, NY:
1,861,021, CANC. INT. CL. 25.
- AGATE TECHNOLOGIES, INC., MILPITAS, CA:
2,202,154, CANC. INT. CL. 9.
- AGC, INC., CLEVELAND, OH:
1,861,396, CANC. INT. CL. 16.
2,997,982, PUB. 6-28-2005. INT. CL. 16.
- AGENTS AND CORPORATIONS, INC., WILMINGTON, DE:
2,997,587, PUB. 6-28-2005. INT. CL. 42.
- AGFA-GEVAERT, "NAAMLOZE VENNOOTSCHAP", MORTSEL, BELGIUM:
1,302,318, CANC. INT. CL. 1.
- AGIO SIGARENFABRIEKEN N.V., 5525 AR DUIZEL, NETHERLANDS:
790,926. REN. 8-11-05. U.S. CL. 17 (INT. CL. 34).
- AGIO SIGARENFABRIEKEN N.V., NETHERLANDS:
2,998,364, PUB. 6-28-2005. INT. CL. 34.
2,998,397, PUB. 6-28-2005. INT. CL. 34.
- AGRI-SOUTH, INC., FLORENCE, SC:
1,391,170. REN. 8-10-05. INT. CL. 42.
- AGRISOLUTIONS, INC., BRIGHTON, IL:
2,202,003, CANC. INT. CL. 9.
- AGRIUM INC., CALGARY, ALBERTA T2J 7E8, CANADA, SHERRITT INC., FORT SASKATCHEWAN, ALBERTA, CANADA:
1,910,683. REN. 8-9-05. INT. CL. 1.
- AH AVIATION L.L.C., HEBER CITY, UT:
2,997,368, PUB. 6-28-2005. INT. CL. 37.
- AHOLD RETAIL SERVICES AG, KLOSTERS, SWITZERLAND:
2,998,187, PUB. 6-28-2005. INT. CL. 32.
- AIMWARE, INC., BOSTON, MA:
2,998,888, INT. CL. 9.
- AIPTEK, INC., IRVINE, CA:
2,998,542, INT. CL. 9.
- AIR & ENERGY PRODUCTS, LLC, ACWORTH, GA:
2,997,897, PUB. 6-28-2005. INT. CL. 11.
- AIR PRODUCTS AND CHEMICALS, INC., ALLENTOWN, PA:
2,998,952, INT. CL. 1.
- AIR WAVES, INC., LEWIS CENTER, OH:
2,998,150, PUB. 6-28-2005. INT. CL. 16.
- AIRLINE HYDRAULICS CORPORATION, BENSLEM, PA:
2,996,768, PUB. 6-28-2005. INT. CL. 7.
- AIRPOINTS, INC., LOS ANGELES, CA:
2,997,565, PUB. 6-28-2005. INT. CL. 35.
- AIRWAIR INTERNATIONAL LTD., WOLLASTON, NORTHAMPTONSHIRE, UNITED KINGDOM:
2,998,987, INT. CL. 25.
- AIXTRON AG, AACHEN, FED REP GERMANY, AIXTRON SEMICONDUCTOR TECHNOLOGIES GMBH, D 5100 AACHEN, FED REP GERMANY:
1,880,227. REN. 8-9-05. INT. CL. 9.
- AJINOMOTO U.S.A., INC., NEW YORK, NY:
2,998,843, INT. CL. 31.
- AKRON BOARD OF EDUCATION, AKRON, OH:
2,998,929, INT. CL. 16.
- AKZO NOBEL CHEMICALS B.V., NETHERLANDS:
2,998,396, PUB. 6-28-2005. INT. CL. 2.
- AKZO NOBEL COATINGS INTERNATIONAL B.V., ARNHEM, NETHERLANDS:
1,867,851. REN. 8-9-05. U.S. CL. B.
- ALABAMA BEST PRACTICES CENTER, MONTGOMERY, AL:
2,996,771, PUB. 6-28-2005. INT. CL. 41.

ALABAMA SPACE SCIENCE EXHIBIT COMMISSION, HUNTSVILLE, AL:
2,997,621, PUB. 6-28-2005. INT. CL. 41.

ALADAN CORPORATION, DOTHAN, AL:
2,200,886, CANC. INT. CL. 10.

ALBANY INTERNATIONAL CORP., ALBANY, NY:
1,861,223, CANC. INT. CL. 40.

ALBERTA PIPELINE TECHNOLOGIES, CALGARY, ALBERTA T3G 3Z4, CANADA:
2,164,698, CANC. INT. CL. 9.

ALBUM NETWORK, INC., HOLLYWOOD, CA:
1,302,590, CANC. INT. CL. 16.

ALCAN GLOBAL PHARMACEUTICAL PACKAGING INC., MILLVILLE, NJ, WHEATON HOLDING, INC., WILMINGTON, DE:
1,900,212, REN. 8-10-05. INT. CL. 9.

ALCAN SINGEN GMBH, D-78221 SINGEN/HOHEWIEL, FED REP GERMANY:
2,998,418, PUB. 6-28-2005. MULTIPLE CLASS, INT. CLS. 6, 16 AND 17.

ALCEA (SOCIÉTÉ ANONYME), FRANCE:
2,998,474, PUB. 6-28-2005. MULTIPLE CLASS, INT. CLS. 9 AND 18.

ALCOA INC., PITTSBURGH, PA:
1,022,628, REN. 8-11-05. INT. CL. 12.
1,314,352, REN. 8-6-05. INT. CL. 7.

ALCOA, INC., PITTSBURGH, PA, ALUMINUM COMPANY OF AMERICA, PITTSBURGH, PA:
1,966,088, REN. 8-8-05. INT. CL. 19.

ALCOHOL AND DRUG ABUSE SELF-HELP NETWORK, INC., MENTOR, OH:
1,946,898, REN. 8-11-05. INT. CL. 42.

ALDI INC., BATAVIA, IL:
1,966,416, REN. 8-7-05. INT. CL. 16.

ALEMITE LLC, FORT MILL, SC:
2,998,560, INT. CL. 6.

ALERE MEDICAL INCORPORATED, SAN FRANCISCO, CA:
2,202,317, CANC. MULTIPLE CLASS, INT. CLS. 10 AND 42.

ALEXANDER DORN, AUSTRIA:
2,998,454, PUB. 6-28-2005. MULTIPLE CLASS, INT. CLS. 10 AND 16.

ALEXANDER PRIMAK JEWELRY, INC., NEW YORK, NY:
2,202,228, CANC. INT. CL. 14.

ALF CHRISTIANSON SEED CO., MOUNT VERNON, WA:
1,911,658, REN. 8-9-05. INT. CL. 31.

ALLE INT'L INCORPORATED, NEW YORK, NY TO AMERICAN MERCANTILE GROUP LIMITED, NEW YORK, NY:
1,860,989, CANC. INT. CL. 25.

ALLEN SYSTEMS GROUP, INC., NAPLES, FL:
2,996,310, PUB. 6-28-2005. INT. CL. 9.

ALLIANT ENERGY CORPORATION, MADISON, WI:
2,997,649, PUB. 6-28-2005. INT. CL. 36.

ALLIANT TECHSYSTEMS INC., EDINA, MN:
2,805,988, CANC. INT. CL. 16.

ALLIED BUSINESS INTELLIGENCE, INC., OYSTER BAY, NY:
2,997,146, PUB. 6-28-2005. INT. CL. 35.

ALLIED MARKETING GROUP, INC., DALLAS, TX:
2,996,298, PUB. 6-28-2005. INT. CL. 8.

ALLIED OLD ENGLISH, INC., PORT READING, NJ:
1,342,967, REN. 8-11-05. INT. CL. 29.

ALLIED TIRE SALES, INC., ALTAMONTE SPRINGS, FL:
1,303,227, CANC. INT. CL. 42.

ALLIED WEB, INC., IRVINE, CA:
2,201,965, CANC. INT. CL. 9.

ALLIEDSIGNAL INC., MORRISTOWN, NJ:
1,860,600, CANC. INT. CL. 1.

ALLMETAL, INC., BENSenville, IL:
1,860,655, CANC. INT. CL. 6.

ALLMOTION, INC., SAN JOSE, CA:
2,998,239, PUB. 6-28-2005. INT. CL. 9.

ALLSTATE INVESTMENT MANAGEMENT COMPANY, NORTHBROOK, IL:
1,935,726, REN. 8-11-05. INT. CL. 36.

ALLSTATES TECHNICAL SERVICES, INC., BIRMINGHAM, AL:
2,997,913, PUB. 6-28-2005. INT. CL. 35.

ALLSTOKE, INC., BUCKEYSTOWN, MD:
2,177,873, CANC. INT. CL. 4.

ALLURE LINGERIE INC., NORTH YORK, ONTARIO, CANADA:
2,997,270, PUB. 6-28-2005. INT. CL. 25.

ALMA CHEESE, ALMA, KS:
2,201,019, CANC. INT. CL. 29.

ALMANAUTA, INC., CORAL GABLES, FL:
1,861,482, CANC. INT. CL. 9.

ALPHA AND OMEGA SEMICONDUCTOR LIMITED, HAMILTON HM12, BERMUDA:
2,998,329, PUB. 6-28-2005. INT. CL. 9.

ALPHA AND OMEGA SEMICONDUCTOR LTD., HAMILTON HM12, BERMUDA:
2,998,063, PUB. 6-28-2005. INT. CL. 9.
2,998,173, PUB. 6-28-2005. INT. CL. 9.

ALPHA BAKING CO., INC., CHICAGO, IL:
2,996,902, PUB. 6-28-2005. INT. CL. 30.

ALPHA FOODS COMPANY INC., HOUSTON, TX:
2,997,416, PUB. 6-28-2005. MULTIPLE CLASS, INT. CLS. 29 AND 30.

ALPHA MEDICAL SYSTEMS, INC., NORTH WALES, PA:
2,997,254, PUB. 6-28-2005. INT. CL. 3.

ALSOP, CARLETON SCOTT, SHERMAN OAKS, CA:
2,997,138, PUB. 6-28-2005. INT. CL. 9.

ALTER YOUR LIFE, LLC, CLARKESVILLE, GA:
2,998,685, INT. CL. 16.
2,998,686, INT. CL. 9.

ALTIPARMAK PAZARLAMA KOLLEKTIF; SIRKETI ÖZEN - ÖZGÜR ALTIPARMAK, TURKEY:
2,998,387, PUB. 6-28-2005. INT. CL. 30.
2,998,388, PUB. 6-28-2005. INT. CL. 30.

ALWIL TRADE LTD., 100 00 PRAHA 10, CZECH REPUBLIC:
2,200,909, CANC. INT. CL. 9.

ALWITRA GMBH & CO. KLAUS GOBEL, 54296 TRIER, FED REP GERMANY:
2,996,257, PUB. 6-28-2005. MULTIPLE CLASS, INT. CLS. 1, 6, 17 AND 19.

AMADOR, EDDIE, LOS ANGELES, CA:
2,996,983, PUB. 6-28-2005. INT. CL. 9.

AMANO CORPORATION, KANAGAWA-KEN, JAPAN:
2,996,406, PUB. 6-28-2005. MULTIPLE CLASS, INT. CLS. 7 AND 9.

AMANO ENZYME USA CO., LTD., ELGIN, IL:
2,998,020, PUB. 6-28-2005. INT. CL. 5.

AMC, INC., ATLANTA, GA:
2,996,586, PUB. 6-28-2005. INT. CL. 35.

AMD, LLC., MIAMI, FL:
2,997,436, PUB. 6-28-2005. INT. CL. 3.

AMEI TECHNOLOGIES, INC., WILMINGTON, DE:
1,384,143, REN. 8-11-05. INT. CL. 10.

AMERICA ONLINE, INC., VIENNA, VA:
2,201,644, CANC. INT. CL. 42.

AMERICA'S BODY COMPANY, INC., OAKWOOD VILLAGE, OH:
2,201,302, CANC. INT. CL. 12.

AMERICA'S CHURCH - DAVID ALLBRITTON MINISTRIES, INC., TREASURE ISLAND, FL:
2,997,143, PUB. 6-28-2005. INT. CL. 16.

AMERICAN ACADEMY OF DERMATOLOGY, SCHAUMBURG, IL:
2,997,555, PUB. 6-28-2005. INT. CL. 35.

AMERICAN AIRLINES, INC., FORT WORTH, TX:
1,861,149, CANC. INT. CL. 35.

AMERICAN ANDROID CORP., PRINCETON, NJ:
2,997,728, PUB. 6-28-2005. INT. CL. 9.

AMERICAN ASSOCIATION OF CLINICAL ENDOCRINOLOGISTS, INC., JACKSONVILLE, FL:
2,999,392, INT. CL. 35.
2,999,399, INT. CL. 41.

AMERICAN ASSOCIATION OF STATE TROOPERS, INC., TALLAHASSEE, FL:
1,887,120, REN. 8-6-05. INT. CL. 16.

- AMERICAN AUTOMOBILE ASSOCIATION, INC., HEATHROW, FL:
1,861,141, CANC. INT. CL. 35.
- AMERICAN BASKETBALL LEAGUE, INC., THE, SAN JOSE, CA:
2,209,419, CANC. MULTIPLE CLASS, INT. CLS. 16, 25, 28, 35, 36 AND 41.
- AMERICAN BROADCASTING COMPANIES, INC., NEW YORK, NY:
2,021,913, CANC. MULTIPLE CLASS, INT. CLS. 41 AND 42.
- AMERICAN CITRUS PRODUCTS CORPORATION, MEL-ROSE PARK, IL:
1,302,999, CANC. INT. CL. 32.
- AMERICAN COLLEGE OF SPORTS MEDICINE, INC., INDIANAPOLIS, IN:
1,896,690, REN. 8-11-05. MULTIPLE CLASS, U.S. CL. 200 INT. CL. 16.
- AMERICAN COLLEGE OF VETERINARY OPHTHALMOLOGISTS, INC., MERIDIAN, ID:
2,996,492, PUB. 6-28-2005. U.S. CL. B.
- AMERICAN COLLEGE OF VETERINARY SURGEONS, CHAMPAIGN, IL:
1,303,170, CANC. MULTIPLE CLASS, INT. CLS. 41 AND 42.
- AMERICAN CYANAMID COMPANY, WAYNE, NJ:
1,302,795, CANC. INT. CL. 28.
- AMERICAN DIABETES ASSOCIATION, INC., ALEXANDRIA, VA:
2,201,126, COR. INT. CL. 42.
- AMERICAN EXPRESS COMPANY, NEW YORK, NY:
2,202,241, CANC. INT. CL. 36.
2,999,158, INT. CL. 36.
- AMERICAN GAS FINANCE COMPANY, L.L.C., HERNDON, VA:
2,201,431, CANC. INT. CL. 16.
- AMERICAN GASTROENTEROLOGICAL ASSOCIATION, BETHESDA, MD:
2,996,655, PUB. 6-14-2005. MULTIPLE CLASS, INT. CLS. 16 AND 35.
- AMERICAN GIFT CORPORATION, MIAMI, FL:
1,011,206, REN. 8-9-05. U.S. CL. 101 (INT. CL. 42).
- AMERICAN GILSONITE CO., MENLO PARK, CA:
2,998,140, PUB. 6-28-2005. INT. CL. 19.
- AMERICAN GLASS PRODUCTS COMPANY, KNOXVILLE, TN, AMERICAN GLASS PRODUCTS CO., ROLLA, MO:
1,907,386, REN. 8-12-05. INT. CL. 21.
- AMERICAN HOME FOOD PRODUCTS, INC., NEW YORK, NY:
1,302,965, CANC. INT. CL. 30.
- AMERICAN INGREDIENTS COMPANY, KANSAS CITY, MO, C. J. PATTERSON COMPANY, KANSAS CITY, MO:
618,439, REN. 8-11-05. U.S. CL. 6 (INT. CL. 1).
- AMERICAN INNOVATIONS INC., BUCKINGHAM, PA:
2,201,724, CANC. INT. CL. 10.
- AMERICAN INSTITUTE FOR CHARTERED PROPERTY CASUALTY UNDERWRITERS, MALVERN, PA:
1,341,531, REN. 8-11-05. INT. CL. 41.
- AMERICAN INTERCULTURAL STUDENT EXCHANGE, INC., LAKE VILLAGE, AR:
1,343,408, REN. 8-11-05. INT. CL. 41.
- AMERICAN INTERNATIONAL GROUP, INC., NEW YORK, NY:
2,997,807, PUB. 6-28-2005. INT. CL. 42.
- AMERICAN INVESTORS LIFE INSURANCE COMPANY, INC., TOPEKA, KS:
2,999,295, INT. CL. 36.
- AMERICAN ITALIAN PASTA COMPANY, KANSAS CITY, MO:
2,999,146, INT. CL. 30.
- AMERICAN KENNEL CLUB INCORPORATED, THE, NEW YORK, NY:
1,892,111, REN. 8-9-05. INT. CL. 16.
1,893,097, REN. 8-9-05. INT. CL. 16.
- AMERICAN MAPLE PRODUCTS CORPORATION, NEWPORT, VT:
1,302,903, CANC. MULTIPLE CLASS, INT. CLS. 29 AND 30.
- AMERICAN MEDIA OPERATIONS, INC., BOCA RATON, FL:
2,997,451, PUB. 6-28-2005. INT. CL. 41.
2,997,627, PUB. 6-28-2005. INT. CL. 16.
- AMERICAN MOVIE CLASSICS COMPANY, JERICHO, NY:
1,904,651, REN. 8-11-05. INT. CL. 38.
- AMERICAN MUSSEL HARVESTERS, INC., NORTH KINGSTOWN, RI:
2,997,872, PUB. 6-28-2005. INT. CL. 41.
- AMERICAN OPTICAL CORPORATION, SOUTHBRIDGE, MA:
1,302,467, CANC. INT. CL. 9.
- AMERICAN OSTEOPATHIC ASSOCIATION, CHICAGO, IL:
2,999,234, INT. CL. 16.
- AMERICAN POLYWATER CORPORATION, STILLWATER, MN:
2,998,228, PUB. 6-28-2005. INT. CL. 2.
- AMERICAN PROMOTIONAL EVENTS, INC., FLORENCE, AL, CHINA PYROTECHNICS, INC., FLORENCE, AL:
1,890,993, REN. 8-9-05. INT. CL. 13.
- AMERICAN PROTECTIVE SERVICES, INC., OAKLAND, CA:
1,860,735, CANC. MULTIPLE CLASS, INT. CLS. 9 AND 42.
- AMERICAN SOCIETY FOR MANAGEMENT, INC., HENDERSON, NV:
2,996,441, PUB. 6-28-2005. INT. CL. 35.
- AMERICAN SOCIETY FOR TRAINING & DEVELOPMENT, ALEXANDRIA, VA:
2,982,646, COR. INT. CL. 41.
- AMERICAN SOCIETY OF EMPLOYERS, SOUTHFIELD, MI:
2,996,766, PUB. 6-28-2005. INT. CL. 35.
- AMERICAN SOCIETY OF MECHANICAL ENGINEERS, THE, NEW YORK, NY:
1,303,030, CANC. INT. CL. 35.
- AMERICAN SOCIETY OF SAFETY ENGINEERS, DES PLAINES, IL:
2,999,084, INT. CL. 35.
- AMERICAN SPORTS LICENSING, INC., WILMINGTON, DE:
2,998,604, INT. CL. 35.
- AMERICAN TECTRADE ENTERPRISES INC., SAN LEANDRO, CA:
2,200,830, CANC. INT. CL. 5.
- AMERICAN TORT REFORM ASSOCIATION INCORPORATED, WASHINGTON, DC:
2,998,175, PUB. 6-28-2005. INT. CL. 35.
- AMERICANA BANK, EDINA, MN:
2,201,326, CANC. INT. CL. 36.
- AMERICLEAN, INC., WOOD RIVER, IL:
2,437,875, CANC. INT. CL. 7.
- AMERICROWN SERVICE CORPORATION, DAYTONA BEACH, FL, INTERNATIONAL SPEEDWAY CORPORATION, DAYTONA BEACH, FL:
1,903,166, REN. 8-10-05. INT. CL. 42.
- AMERIGROUP CORPORATION, VIRGINIA BEACH, VA:
2,201,847, CANC. INT. CL. 36.
- AMERISTAR CASINOS, INC., LAS VEGAS, NV:
2,996,508, PUB. 6-28-2005. INT. CL. 35.
2,996,509, PUB. 6-28-2005. INT. CL. 43.
- AMERON, INC., MONTEREY PARK, CA:
1,364,473, REN. 8-8-05. INT. CL. 17.
- AMES TRUE TEMPER PROPERTIES, INC., WILMINGTON, DE:
2,997,658, PUB. 6-28-2005. INT. CL. 8.
- AMEZQUITA, HECTOR A., ORLANDO, FL:
2,997,552, PUB. 6-28-2005. INT. CL. 41.
- AMFM BROADCASTING, INC., SAN ANTONIO, TX, SHAMROCK BROADCASTING, INC., BURBANK, CA:
1,908,839, REN. 8-10-05. INT. CL. 38.
- AMIN, CYRIL, TUSTIN, CA:
2,998,246, PUB. 6-28-2005. INT. CL. 35.
- AMSTAR SUGAR CORPORATION, NEW YORK, PA:
1,302,950, CANC. INT. CL. 30.
- AMSURG, NASHVILLE, TN:
2,996,564, PUB. 6-28-2005. INT. CL. 36.
- AMTROL INC., WEST WARWICK, RI:
2,999,036, INT. CL. 9.

AMUROL PRODUCTS COMPANY, YORKVILLE, IL:
1,876,050, REN. 8-11-05. INT. CL. 30.

ANALOG DEVICES, INC., NORWOOD, MA:
2,999,349, INT. CL. 9.

ANCO INTERNATIONAL CORPORATION:
1,302,901, CANC. INT. CL. 29.

ANDATACO, SAN DIEGO, CA:
2,201,013, CANC. INT. CL. 9.

ANDERSON-MARTIN MACHINE COMPANY, FORT SMITH, AR:
2,998,642, INT. CL. 37.

ANDERSON, CHRISTINE D., FRAZIER PARK, CA:
2,999,032, INT. CL. 41.

ANDIAMO COFFEE, INC., WESTBURY, NY:
2,997,328, PUB. 6-28-2005. MULTIPLE CLASS, INT. CLS. 30 AND 35.

ANDRE, ROB, ROY, UT:
2,998,230, PUB. 6-28-2005. INT. CL. 25.

ANDREW CORPORATION, ORLAND PARK, IL:
1,300,387, REN. 8-11-05. INT. CL. 9.
1,300,388, REN. 8-11-05. INT. CL. 9.
1,300,390, REN. 8-11-05. INT. CL. 9.
1,301,390, REN. 8-11-05. INT. CL. 9.
1,301,392, REN. 8-11-05. INT. CL. 9.
2,999,344, INT. CL. 9.

ANDVENTURE, INC., HARRISBURG, PA:
2,998,617, INT. CL. 35.

ANEXINET, PHILADELPHIA, PA:
2,997,711, PUB. 6-28-2005. INT. CL. 42.

ANGEL SALES, INC., CHICAGO, IL:
2,999,179, INT. CL. 8.

ANGEL'S ARBOR, HERNDON, VA:
2,200,838, CANC. INT. CL. 3.

ANGELSTAR INSPIRED PRODUCTS, INC., MORGAN HILL, CA:
2,998,036, PUB. 6-28-2005. INT. CL. 16.

ANGIOMED GMBH & CO. MEDIZINTECHNIK KG, KARLSRUHE, FED REP GERMANY:
2,202,044, CANC. INT. CL. 10.

ANGLIA COLLEGE ENTERPRISES LIMITED, CHELMSFORD ESSEX CMI ILL, UNITED KINGDOM:
2,201,566, CANC. INT. CL. 9.

ANHEUSER-BUSCH, INCORPORATED, ST. LOUIS, MO:
2,997,835, PUB. 6-28-2005. INT. CL. 25.

ANIDRAL S.R.L., 28100 NOVARA, ITALY:
2,996,444, PUB. 6-28-2005. INT. CL. 5.
2,996,445, PUB. 6-28-2005. INT. CL. 5.

ANIMAL CHANNEL, THE, LOUISA, KY:
1,861,540, CANC. INT. CL. 41.

ANIMAL FEED SUPPLEMENT, INC., BELL FOURCHE, SD:
2,997,632, PUB. 6-28-2005. INT. CL. 5.

ANITA DR. HELBIG GMBH, BRANNENBURG, FED REP GERMANY:
2,997,373, PUB. 6-28-2005. MULTIPLE CLASS, INT. CLS. 10 AND 25.

ANN'S CANDLES, INC., NEWCASTLE, OK:
2,997,258, PUB. 6-28-2005. INT. CL. 4.

ANNE TAINOR, INC., YOUNGSVILLE, NM:
2,996,748, PUB. 6-14-2005. INT. CL. 24.

ANOTO AB, S-223 70 LUND, SWEDEN:
2,996,244, PUB. 6-28-2005. MULTIPLE CLASS, INT. CLS. 9, 16, 38 AND 42.

ANSELL HEALTHCARE PRODUCTS, LLC, RED BANK, NJ, DBA ANSELL HEALTHCARE:
1,352,648, REN. 8-9-05. INT. CL. 10.

ANTARES AUDIO TECHNOLOGIES, SCOTTS VALLEY, CA:
2,996,904, PUB. 6-28-2005. INT. CL. 9.

ANTENNA COMPANY, THE, ORLAND PARK, IL TO ANDREW CORPORATION, ORLAND PARK, IL:
1,860,792, CANC. INT. CL. 9.

ANTHONY TESSELAAR PLANTS PTY LTD., SILVAN, VICTORIA 3795, AUSTRALIA:
2,998,272, PUB. 6-28-2005. INT. CL. 31.

ANTHONY WILLIAMS, INC., MINNEAPOLIS, MN:
2,201,952, CANC. INT. CL. 26.

ANTI SNOR PTY LTD., QUEENSLAND, 4217, AUSTRALIA:
2,998,722, INT. CL. 10.

ANYSOFTLTD., KIRIAT NORDAU, NETANYA, ISRAEL:
2,201,208, CANC. INT. CL. 9.

ANZEN CORPORATION, DENVER, CO:
2,999,297, INT. CL. 40.

APARTMENT AGENCIES LTD., VANCOUVER, BRITISH COLUMBIA, CANADA:
2,997,634, PUB. 6-28-2005. INT. CL. 25.

APC WORKFORCE SOLUTIONS, LLC, ORLANDO, FL, DBA, ZEROCHAOS:
2,998,216, PUB. 6-28-2005. MULTIPLE CLASS, INT. CLS. 35 AND 45.

APCOA, INC., CLEVELAND, OH:
2,200,900, CANC. MULTIPLE CLASS, INT. CLS. 35, 37 AND 42.

APEX FITNESS, INC., SAN RAMON, CA:
2,997,642, PUB. 6-28-2005. INT. CL. 5.

APEX PRODUCTS COMPANY LIMITED, BANGKOK 10500, THAILAND:
2,996,579, PUB. 6-28-2005. MULTIPLE CLASS, INT. CLS. 29 AND 30.

APJET, INC., SANTA FE, NM:
2,998,934, INT. CL. 9.

APOGEE ELECTRONICS CORPORATION, SANTA MONICA, CA:
2,996,890, PUB. 6-28-2005. INT. CL. 9.

APOTHEKER WALTER BOUHON GMBH, D-90427 NÜRNBERG, FED REP GERMANY:
2,998,354, PUB. 6-28-2005. MULTIPLE CLASS, INT. CLS. 3 AND 5.

APPALACHIAN STANDARD FLOORS, INC., CLINTON, SC:
2,996,253, PUB. 6-28-2005. INT. CL. 35.

APPLE COMPUTER, INC., CUPERTINO, CA:
2,200,960, CANC. MULTIPLE CLASS, INT. CLS. 9 AND 42.
2,835,698, COR. INT. CL. 9.
2,997,145, PUB. 6-28-2005. INT. CL. 9.

APPLERA CORPORATION, NORWALK, CT FROM PERKIN-ELMER, THE, ROCKVILLE, MD:
2,998,510, INT. CL. 9.

APPLIED SYSTEMS DEVELOPMENT CORPORATION, GAINESVILLE, GA:
2,998,748, INT. CL. 10.

APPLIED VOICE RECOGNITION, INC., HOUSTON, TX:
2,201,084, CANC. INT. CL. 9.

APTIS HOLDINGS, INC., CHANTILLY, VA:
2,997,846, PUB. 6-28-2005. MULTIPLE CLASS, INT. CLS. 9, 16, 35, 37, 41, 42 AND 45.

APRIORI TEXTILVERTRIEBS GMBH, 48163 MUNSTER, FED REP GERMANY:
2,201,015, CANC. MULTIPLE CLASS, INT. CLS. 14, 18 AND 25.

APRUTINA VINI S.P.A., ROSETO DEGLI ABRUZZI (TERAMO), ITALY:
2,998,731, INT. CL. 33.

APS HEALTHCARE BETHESDA, INC., SILVER SPRING, MD:
2,998,524, MULTIPLE CLASS, INT. CLS. 35 AND 42.
2,998,525, MULTIPLE CLASS, INT. CLS. 35 AND 42.
2,998,526, MULTIPLE CLASS, INT. CLS. 35 AND 42.

AQUA LYTE CORPORATION, JACKSONVILLE, FL TO AQUALYTE, INC., PONTE VEDRA BEACH, FL:
1,861,110, CANC. INT. CL. 32.

AQUAPAC INTERNATIONAL LIMITED, LONDON, UNITED KINGDOM:
2,998,964, INT. CL. 11.

AQUASCAPE DESIGNS, INC., BATAVIA, IL:
2,999,332, INT. CL. 41.

AR-DUE S.P.A., FRAZ. GHIRANO (PN), ITALY:
2,996,496, PUB. 6-28-2005. INT. CL. 20.

ARAMARK EDUCATIONAL RESOURCES, INC., GOLDEN, CO:
2,202,215, CANC. MULTIPLE CLASS, INT. CLS. 41 AND 42.

ARC RISK MANAGEMENT GROUP PLC, WOKINGHAM, UNITED KINGDOM:
2,998,932, INT. CL. 35.

- ARCHDUKE LORENZ D'AUSTRIA ESTE, BRUXELLES, BELGIUM:
2,998,585, INT. CL. 30.
- ARCHER DANIELS MIDLAND COMPANY, DECATUR, IL:
2,998,518, INT. CL. 29.
- ARCHIPELAGO, INC., LOS ANGELES, CA:
2,996,867, PUB. 6-28-2005. INT. CL. 4.
- ARCHITECTURAL GLASS ART, INC., LOUISVILLE, KY:
2,201,197, CANC. INT. CL. 21.
- ARCO INDUSTRIES, LTD., KWAI CHUNG, N.T., KOW-
LOON, HONG KONG:
1,302,841, CANC. INT. CL. 28.
- ARDEN INTERNATIONAL, LLC, LAKEVILLE, MN:
2,999,149, INT. CL. 43.
- ARGO CENTURY, USA, CHARLOTTE, NC:
2,997,916, PUB. 6-28-2005. INT. CL. 28.
- ARGO TURBOSERVE CORPORATION, CARLSTADT, NJ:
2,997,019, PUB. 6-28-2005. INT. CL. 36.
- ARIENS COMPANY, BRILLION, WI:
1,303,087, CANC. INT. CL. 36.
- ARIES SYSTEMS CORPORATION, NORTH ANDOVER, MA:
2,201,305, CANC. INT. CL. 9.
- ARISTOCRAT TECHNOLOGIES AUSTRALIA PTY LTD.,
LANE COVE, 2066, NSW, AUSTRALIA:
2,996,876, PUB. 6-28-2005. INT. CL. 9.
- ARISTOCRAT TECHNOLOGIES AUSTRALIA PTY LTD,
LANE COVE, NEW SOUTH WALES 2066, AUSTRALIA:
2,998,724, INT. CL. 9.
- ARIZONA FALL LEAGUE, INC., THE, NEW YORK, NY:
1,858,917, REN. 8-9-05. INT. CL. 41.
- ARMINIO ENTERPRISES, MONTCHANIN, DE:
2,201,600, CANC. INT. CL. 41.
- ARMINIUS SELECT SERVICES CORPORATION, LAS VE-
GAS, NV:
2,996,282, PUB. 6-28-2005. INT. CL. 28.
- ARMOLYO CORPORATION, THE, DEKALB, IL:
1,325,261, REN. 8-12-05. MULTIPLE CLASS, INT. CLS. 1
AND 40.
- ARMSTEAD, ANTHONY S., CHICAGO, IL:
2,997,496, PUB. 6-28-2005. MULTIPLE CLASS, INT. CLS.
25 AND 41.
- ARMSTRONG GREEN AND EMBREY, MERRIFIELD, VA:
2,997,449, PUB. 6-28-2005. INT. CL. 44.
- ARMSTRONG, ANTHONY, FRANKLIN, TN AND ARM-
STRONG, RANDY, FRANKLIN, TN AND BARNES,
MICHAEL, FRANKLIN, TN AND HENDRIX, ANDREW,
FRANKLIN, TN AND RAUCH, JASEN, FRANKLIN, TN:
2,996,829, PUB. 6-28-2005. INT. CL. 41.
- ARMSTRONG, RODERICK, J, LOS ANGELES, CA:
2,998,144, PUB. 6-28-2005. INT. CL. 25.
- ARMY AND AIR FORCE EXCHANGE SERVICE, DALLAS,
TX:
2,999,078, INT. CL. 24.
- ARNOLD MAGNETIC TECHNOLOGIES CORPORATION,
ROCHESTER, NY:
1,894,106, REN. 8-11-05. INT. CL. 17.
- ARROW EXTERMINATORS, INC., ATLANTA, GA:
2,997,701, PUB. 6-28-2005. INT. CL. 37.
- ARROWHEAD MILLS, INC., HEREFORD, TX:
1,302,890, CANC. MULTIPLE CLASS, INT. CLS. 29, 30
AND 31.
- ARROWHEAD STONE MANUFACTURING, INC., KNOX-
VILLE, TN:
2,997,165, PUB. 6-28-2005. INT. CL. 19.
- ART THERAPY CREDENTIALS BOARD, INC., GREEN-
SBORO, NC:
1,315,193, REN. 8-11-05. U.S. CL. B.
- ARTHREX, INC., NAPLES, FL:
2,998,083, PUB. 6-28-2005. INT. CL. 10.
2,998,084, PUB. 6-28-2005. INT. CL. 10.
- ARTHUR AVENUE ITALIAN DELI, INC., BRONX, NY:
2,998,602, INT. CL. 29.
- ARTHUR MURRAY INTERNATIONAL, INC., CORAL GA-
BLES, FL:
1,348,651, REN. 8-11-05. INT. CL. 41.
- ARTHUR VANMOOR, BOCA RATON, FL:
2,035,323, CANC. INT. CL. 5.
- ARTIN CONCEPT LIMITED, ROAD TOWN, TORTOLA,
BR.VIRGIN ISLANDS:
1,861,419, CANC. INT. CL. 28.
- ARTOGRAPH, INC., PLYMOUTH, MN:
2,999,103, INT. CL. 9.
- ARTS COUNCIL SILICON VALLEY, SAN JOSE, CA:
2,996,478, PUB. 6-28-2005. MULTIPLE CLASS, INT. CLS.
35, 41 AND 42.
- ASAHI GLASS COMPANY, LTD., JAPAN:
2,998,408, PUB. 6-28-2005. MULTIPLE CLASS, INT. CLS. 1
AND 3.
2,998,419, PUB. 6-28-2005. MULTIPLE CLASS, INT. CLS.
16 AND 17.
- ASCI, PARSIPPANY, NJ, AKA ADVANCED SYSTEMS
CONCEPTS:
1,929,542, REN. 8-9-05. INT. CL. 9.
- ASF, LLC, RICHMOND, VA:
2,997,044, PUB. 3-8-2005. INT. CL. 43.
- ASH, GARY W., VALLEY CENTER, CA:
2,997,126, PUB. 6-28-2005. INT. CL. 35.
- ASHLAND LICENSING AND INTELLECTUAL PROPERTY
LLC, DUBLIN, OH, ASHLAND OIL, INC., RUSSELL, KY:
1,873,538, REN. 8-11-05. INT. CL. 4.
- ASHTON-DRAKE GALLERIES, LTD., THE, NILES, IL:
2,202,114, CANC. INT. CL. 28.
2,202,121, CANC. INT. CL. 28.
- ASI SIGN SYSTEMS, INC., DALLAS, TX, ARCHITECTURAL
SIGNING INC., MARINA DEL REY, CA:
1,365,038, REN. 8-9-05. MULTIPLE CLASS, INT. CLS. 37
AND 42.
- ASICS CORPORATION, KOBE 650, JAPAN:
2,202,190, CANC. INT. CL. 25.
- ASM; AUTOMATION SENSORIK MESSTECHNIK GMBH,
FED REP GERMANY:
2,998,389, PUB. 6-28-2005. INT. CL. 9.
- ASO CORPORATION, SARASOTA, FL:
1,931,623, REN. 8-11-05. INT. CL. 5.
- ASPEN SKIING COMPANY, L.L.C., ASPEN, CO:
2,201,283, CANC. INT. CL. 41.
- ASPEX SEMICONDUCTOR LIMITED, BRADFORD, WEST
YORKSHIRE, UNITED KINGDOM:
2,998,298, PUB. 6-28-2005. MULTIPLE CLASS, INT. CLS. 9
AND 42.
- ASPIRING YOUNG ARTISTS, SPRING LAKE, NJ:
2,999,397, INT. CL. 41.
- ASSET MARKETING SYSTEMS, INC., SAN DIEGO, CA:
2,999,337, MULTIPLE CLASS, INT. CLS. 35 AND 36.
- ASSOCIATED ELECTRIC & GAS INSURANCE SERVICES
LIMITED, HAMILTON, BERMUDA:
1,896,440, REN. 8-10-05. INT. CL. 36.
- ASSOCIATED MATERIALS, INC., CUYAHOGA FALLS, OH,
DBA ALSIDE:
2,999,175, INT. CL. 19.
- ASSOCIATES ENGRAVING COMPANY, INC., SPRING-
FIELD, IL:
1,896,971, REN. 8-9-05. INT. CL. 20.
- ASSOCIATION OF WALDORF SCHOOLS OF NORTH
AMERICA, FAIR OAKS, CA:
2,997,399, PUB. 6-28-2005. INT. CL. 41.
- ASSURED GUARANTY LTD., HAMILTON HM 08, BERMU-
DA:
2,998,809, INT. CL. 36.
- ASSURITY FINANCIAL SERVICES, LLC, ENGLEWOOD,
CO:
2,997,466, PUB. 6-28-2005. INT. CL. 36.
- ASTA MEDICA AKTIENGESELLSCHAFT, D-60314 FRANK-
FURT AM MAIN 1, FED REP GERMANY:
2,200,939, CANC. INT. CL. 5.
- ASTHMATX, INC., MOUNTAIN VIEW, CA:
2,999,069, INT. CL. 10.
2,999,346, INT. CL. 10.
- ASTRAZENECA UK LIMITED, LONDON, W1Y 6LN, ENG-
LAND:
2,288,425, CANC. INT. CL. 5.
- AT YOUR SERVICE RESTAURANTS, VIRGINIA BEACH,
VA:
2,997,992, PUB. 6-28-2005. INT. CL. 43.

AT&T CORP., NEW YORK, NY:
1,300,324. REN. 8-11-05. INT. CL. 9.
1,352,545. REN. 8-12-05. INT. CL. 9.

AT&T CORP., NEW YORK, NY, AT&T CORP., NEW YORK, NY:
1,894,698. REN. 8-11-05. INT. CL. 38.

AT&T CORP., NEW YORK, NY:
2,202,105, CANC. INT. CL. 36.
2,998,945, INT. CL. 38.

ATARI, INC., SUNNYVALE, CA TO ATARI INTERACTIVE, INC., BEVERLY, MA:
1,253,091, CANC. INT. CL. 28.

ATECO, AGOURA, CA:
2,996,675, PUB. 6-28-2005. INT. CL. 7.

ATEL CAPITAL GROUP, SAN FRANCISCO, CA TO ATEL CAPITAL GROUP, SAN FRANCISCO, CA:
2,138,119, CANC. INT. CL. 36.

ATHLETIC TRAINING EQUIPMENT COMPANY, INC., SPARKS, NV:
1,902,873. REN. 8-9-05. INT. CL. 28.

ATHLON PHARMACEUTICALS, INC., BIRMINGHAM, AL:
2,998,267, PUB. 6-28-2005. INT. CL. 5.

ATLANTIC BROADBAND FINANCE, LLC, QUINCY, MA:
2,997,251, PUB. 6-28-2005. INT. CL. 38.
2,997,268, PUB. 6-28-2005. INT. CL. 38.

ATLANTIC CONSTRUCTION FABRICS, INC., RICHMOND, VA:
1,938,868. REN. 8-8-05. INT. CL. 11.

ATOFINA, 92800 PUTEAUX, FRANCE:
2,997,122, PUB. 6-28-2005. INT. CL. 1.

ATRONIC INTERNATIONAL GMBH, LUBBECKE, FED REP GERMANY:
2,996,318, PUB. 6-28-2005. INT. CL. 9.
2,998,831, INT. CL. 9.

ATSOCA, INC., JACKSONVILLE, FL:
2,998,858, INT. CL. 29.

ATSUKO ANDO, FRANCE:
2,998,424, PUB. 6-28-2005. INT. CL. 3.

AU OPTRONICS CORP., HSINCHU 300, TAIWAN:
2,997,422, PUB. 6-28-2005. INT. CL. 9.

AUBURN UNIVERSITY, AUBURN, AL:
2,996,591, PUB. 6-28-2005. MULTIPLE CLASS, INT. CLS. 9 AND 41.

AUBURN UNIVERSITY, AUBURN UNIVERSITY, AL:
2,996,714, PUB. 6-28-2005. INT. CL. 39.

AUCTIONDROP, INC., FREMONT, CA:
2,998,894, MULTIPLE CLASS, INT. CLS. 35, 36 AND 39.

AUGUST STORCK KG, 13403 BERLIN, FED REP GERMANY:
2,201,964, CANC. INT. CL. 30.
2,201,966, CANC. INT. CL. 30.

AUTO AUDIO, INC., NEPTUNE, NJ:
1,303,266, CANC. INT. CL. 42.

AUTO TECH INDUSTRY INC., SEMINOLE, FL:
2,200,955, CANC. MULTIPLE CLASS, INT. CLS. 1, 7 AND 37.

AUTOMATED FINANCIAL SYSTEMS, INC., EXTON, PA:
2,997,541, PUB. 6-28-2005. INT. CL. 16.

AUTOMATED SYSTEMS, INC., TAMPA, FL:
2,998,885, INT. CL. 9.

AUTOMATIC PRODUCTIONS INC., NEW YORK, NY:
2,201,327, CANC. INT. CL. 41.

AUTOMATIC SWITCH COMPANY, FLORHAM PARK, NJ:
1,305,786. REN. 8-10-05. INT. CL. 9.

AUTOMATIC SYSTEMS, 1300 WAVRE, BELGIUM:
2,996,315, PUB. 6-28-2005. INT. CL. 9.

AUTOMED TECHNOLOGIES, INC., WILMINGTON, DE, MEDSELECT SYSTEMS, INC., NORTH CANTON, OH:
1,898,025. REN. 8-12-05. INT. CL. 9.
1,899,724. REN. 8-12-05. INT. CL. 9.

AUTOMOTIVE PROFESSIONALS, INC., SCHAUMBURG, IL:
2,997,900, PUB. 6-28-2005. INT. CL. 35.

AUTOTECH USA, PARK CITY, UT:
2,201,125, CANC. INT. CL. 12.

AVALON SUNSPASH LTD., VANCOUVER, BRITISH COLUMBIA, CANADA, DBA CANNABIS CULTURE:
2,997,022, PUB. 6-28-2005. INT. CL. 41.

AVCRAFT AVIATION, L.L.C., LEESBURG, VA:
2,996,532, PUB. 6-28-2005. MULTIPLE CLASS, INT. CLS. 37 AND 40.
2,996,533, PUB. 6-28-2005. MULTIPLE CLASS, INT. CLS. 37 AND 40.

AVEDIS ZILDJIAN CO., NORWELL, MA:
2,999,044, INT. CL. 15.

AVEMCO INSURANCE COMPANY, FREDERICK, MD:
1,302,554, CANC. INT. CL. 16.
1,303,104, CANC. INT. CL. 36.

AVENTIS PHARMA S.A., ANTONY CEDEX, FRANCE, SOCIETE DES USINES CHIMIQUES RHONE POULENC, PARIS 8E, FRANCE:
1,012,779. REN. 8-11-05. INT. CL. 5.

AVERY DENNISON CORPORATION, PASADENA, CA:
2,998,092, PUB. 6-28-2005. INT. CL. 16.
2,998,093, PUB. 6-28-2005. INT. CL. 16.
2,998,097, PUB. 6-28-2005. INT. CL. 17.

AVERY, DONALD RAY, FAYETTEVILLE, NC:
2,996,657, PUB. 6-28-2005. INT. CL. 24.

AVID TECHNOLOGY, INC., TEWKSBURY, MA:
1,920,714. REN. 8-10-05. INT. CL. 9.

AVINODE AB, GOTHEBURG, SWEDEN:
2,998,488, PUB. 6-28-2005. INT. CL. 39.

AVISTAR COMMUNICATIONS CORPORATION, REDWOOD SHORES, CA:
2,997,208, PUB. 6-28-2005. INT. CL. 42.

AVIT SOLUTIONS LIMITED, KWUN TONG, KOWLOON, HONG KONG:
2,201,802, CANC. INT. CL. 9.

AVIVA LIFE INSURANCE COMPANY, QUINCY, MA:
2,997,894, PUB. 6-28-2005. INT. CL. 36.
2,997,956, PUB. 6-28-2005. INT. CL. 36.

AVOCET SPORTS TECHNOLOGY, INC., MENLO PARK, CA:
2,996,581, PUB. 6-28-2005. INT. CL. 12.

AVODAH PUBLISHING, INC., WHITEFISH, MT:
2,999,010, INT. CL. 16.

AVON PRODUCTS, INC., NEW YORK, NY:
2,998,907, INT. CL. 3.
2,998,996, INT. CL. 3.

AWARD SOFTWARE INTERNATIONAL, INC., MOUNTAIN VIEW, CA:
2,202,380, CANC. INT. CL. 9.

AWI LICENSING COMPANY, WILMINGTON, DE:
2,996,800, PUB. 6-28-2005. INT. CL. 17.

AXEL KAUS, FED REP GERMANY:
2,998,361, PUB. 6-28-2005. MULTIPLE CLASS, INT. CLS. 35, 39 AND 43.

AXION CORPORATION, DANBURY, CT:
2,202,019, CANC. INT. CL. 35.

AXIOPE LIMITED, EDINBURGH, UNITED KINGDOM:
2,997,498, PUB. 6-28-2005. INT. CL. 9.

AYURVEDIC CONCEPTS, LTD., HOUSTON, TX, DBA HIMALAYA USA:
2,996,899, PUB. 6-28-2005. INT. CL. 5.

AZTEC FINANCE CORPORATION LIMITED, PORT LOUIS, MAURITIUS:
2,997,867, PUB. 6-28-2005. INT. CL. 3.

AZZOLINI, JOSEPH, ASTORIA, NY:
2,997,605, PUB. 6-28-2005. INT. CL. 25.

B & D MANUFACTURING, INC., SEDALIA, CO:
2,997,529, PUB. 6-28-2005. INT. CL. 12.

B & H MANUFACTURING COMPANY, INC., CERES, CA:
2,998,715, INT. CL. 35.

B & S PLASTICS, INC., OXNARD, CA:
1,956,350. REN. 8-9-05. MULTIPLE CLASS, INT. CLS. 7 AND 11.
1,956,616. REN. 8-9-05. MULTIPLE CLASS, INT. CLS. 7 AND 11.

B. BRAUN MELSUNGEN AG, D-34212 MELSUNGEN, FED REP GERMANY:
1,349,123. REN. 8-11-05. INT. CL. 10.

B. BRAUN MELSUNGEN AKTIENGESELLSCHAFT, D-34212 MELSUNGEN, FED REP GERMANY:
2,998,466, PUB. 6-28-2005. INT. CL. 5.

- B. F. ASCHER & COMPANY, INC., LENEXA, KS, B. F. ASCHER & COMPANY, INC., KANSAS CITY, MO: 805,021. REN. 8-11-05. U.S. CL. 18 (INT. CL. 5).
- B. GOOD LLC, BOSTON, MA: 2,997,167, PUB. 6-28-2005. INT. CL. 43.
- B. J. ALAN COMPANY, INC., YOUNGSTOWN, OH: 1,898,086. REN. 8-12-05. INT. CL. 13.
- B.A.G. CORP., DALLAS, TX: 2,998,747, INT. CL. 22.
- B.E.N. INTERNATIONAL, INC., MIRAMAR, FL: 2,996,716, PUB. 6-28-2005. MULTIPLE CLASS, INT. CLS. 9 AND 41.
- B.F. ASCHER & COMPANY, INC., LENEXA, KS, MENLEY & JAMES LABORATORIES, LTD., PHILADELPHIA, PA: 1,327,966. REN. 8-6-05. INT. CL. 5.
- B.G. YOLLES & COMPANY, HARTFORD, CT: 2,997,930, PUB. 6-28-2005. INT. CL. 36.
- B.J. EQUIPMENT, LTD., COLUMBUS, OH, DBA RENT-A-JOHN: 2,999,195, INT. CL. 44.
- B.V. FABRIEK VAN DIASTATISCHE PRODUCTEN, AK LEIDEN, NETHERLANDS: 1,366,969. REN. 8-11-05. INT. CL. 32.
- B&B ISLAND DISTRIBUTING, LLC, HONOLULU, HI: 2,998,941, MULTIPLE CLASS, INT. CLS. 8, 21 AND 24.
- B-KIN SOFTWARE, S.L., LEIOA (VIZCAYA), SPAIN: 2,998,566, INT. CL. 42.
- BABBITT BASEBALL, INC., BURTONSVILLE, MD: 2,200,829, CANC. INT. CL. 41.
- BABE WINKELMAN PRODUCTIONS, INC., NISSWA, MN: 2,201,470, CANC. U.S. CL. 200.
- BABY'S DREAM FURNITURE, INC., BUENA VISTA, GA: 2,201,987, CANC. INT. CL. 20.
- BACARDI & COMPANY LIMITED, NASSAU, BAHAMAS: 2,997,560, PUB. 6-28-2005. INT. CL. 33.
- BADGER TAG AND LABEL CORPORATION, RANDOM LAKE, WI: 1,303,111, CANC. MULTIPLE CLASS, INT. CLS. 37 AND 42.
- BAEK, JOUNG-HYUN, SEOUL, REPUBLIC OF KOREA: 2,998,969, INT. CL. 35.
- BAER, INC., PHOENIX, AZ: 2,997,918, PUB. 6-28-2005. INT. CL. 12.
- BAHL A. MILK CO., INC., FENNIMORE, WI, DBA FENNIMORE CHEESE: 1,302,859, CANC. INT. CL. 29.
1,302,860, CANC. MULTIPLE CLASS, INT. CLS. 29 AND 42.
- BAICOR, INC., LOGAN, UT: 2,144,562, CANC. INT. CL. 1.
- BAILEY NURSERIES, INC., ST. PAUL, MN: 1,905,110. REN. 8-10-05. INT. CL. 31.
- BAKER COLLEGE, FLINT, MI: 2,997,432, PUB. 6-28-2005. INT. CL. 41.
- BAKER GROUP SOFTWARE SOLUTIONS, INC., THE, OKLAHOMA CITY, OK: 2,996,385, PUB. 6-28-2005. INT. CL. 9.
- BAKER HUGHES INCORPORATED, HOUSTON, TX: 2,201,223, CANC. INT. CL. 7.
- BAKER, STANLEY, LARKSPUR, CA: 2,201,024, CANC. INT. CL. 42.
- BALANCE BAR COMPANY, NORTHFIELD, IL: 2,296,368, CANC. INT. CL. 30.
- BALANCE BAR COMPANY, CARPINTERIA, CA: 2,998,506, INT. CL. 30.
- BALANCE BAR COMPANY, NORTHFIELD, IL: 2,999,244, INT. CL. 29.
- BALBOA INSTRUMENTS, INC., TUSTIN, CA: 1,894,981. REN. 8-9-05. INT. CL. 9.
1,898,732. REN. 8-9-05. INT. CL. 9.
- BALLY GAMING INTERNATIONAL, INC., LAS VEGAS, NV: 1,834,437, CANC. INT. CL. 9.
- BALTIC LINEN COMPANY, INC., VALLEY STREAM, NY: 2,999,214, INT. CL. 24.
- BANC ONE CORPORATION, COLUMBUS, OH: 2,201,023, CANC. INT. CL. 36.
2,201,456, CANC. INT. CL. 36.
- BANCROFT PHARMACEUTICALS, INC., VISTA, CA: 2,998,202, PUB. 6-28-2005. INT. CL. 5.
- BANDAG LICENSING CORPORATION, MUSCATINE, IA: 2,998,206, PUB. 6-28-2005. INT. CL. 7.
- BANE, STEFFANY, NEW CASTLE, DE: 2,996,442, PUB. 6-28-2005. INT. CL. 25.
- BANK ADMINISTRATION INSTITUTE, CHICAGO, IL: 1,905,615. REN. 8-10-05. INT. CL. 16.
- BANK OF AMERICA CORPORATION, CHARLOTTE, NC: 2,201,708, CANC. INT. CL. 36.
- BANK ONE TRUST CO., N.A. TRUSTEE OF THE GENEVIEVE MENGHINI CHARITABLE LEAD TRUST, SPRINGFIELD, IL: 1,325,079. REN. 8-10-05. INT. CL. 42.
- BANKAMERICA CORPORATION, SAN FRANCISCO, CA: 1,303,100, CANC. INT. CL. 36.
- BANKBOSTON CORPORATION, BOSTON, MA: 2,201,811, CANC. INT. CL. 36.
- BAPTIST HEALTH CARE CORPORATION, PENSACOLA, FL: 2,635,622, AM. INT. CL. 42.
- BAPTIST HEALTHCARE SYSTEM, INC., LOUISVILLE, KY: 2,596,786, AM. INT. CL. 42.
- BAPTIST WORLD ALLIANCE, FALLS CHURCH, VA: 2,996,350, PUB. 6-28-2005. INT. CL. 45.
- BARBOUR INTERNATIONAL, INC., BRANDON, MS: 1,898,816. REN. 8-11-05. INT. CL. 11.
- BARCANA, INC., WHITTIER, CA, DBA BARTHELMESS U.S.A.: 2,996,321, PUB. 6-28-2005. INT. CL. 28.
- BARCLAY ENTERPRISES, INC., COLTON, CA: 2,997,406, PUB. 6-28-2005. INT. CL. 37.
- BAREFOOT WEALTH MANAGEMENT, INC., PERRYSBURG, OH: 2,997,299, PUB. 6-28-2005. MULTIPLE CLASS, INT. CLS. 35 AND 36.
- BARNHILL PRODUCTIONS, INC., AUSTIN, TX: 2,997,448, PUB. 6-28-2005. INT. CL. 41.
- BARRINGTON WRIGHT ASSOCIATES, ROCKPORT, MA: 2,201,130, CANC. INT. CL. 35.
- BARRON, MARILYNN, ROCHESTER, NY: 2,201,520, CANC. INT. CL. 41.
- BARRY CALLEBAUT AG, 8008 ZURICH, SWITZERLAND: 2,996,443, PUB. 6-28-2005. INT. CL. 29.
- BARRY GRANT, INC., DAHLONEGA, GA: 2,998,261, PUB. 6-28-2005. INT. CL. 7.
- BARRY SIMON PRODUCTIONS, INC., STUDIO CITY, CA: 2,201,846, CANC. INT. CL. 9.
- BARRY'S CAMERA, INC., DALLAS, TX: 1,303,300, CANC. INT. CL. 42.
- BARTENDERGIRL, INC, HIGHLAND, CA: 2,999,235, INT. CL. 43.
- BASE K USA, INC., CLEVELAND, OH: 2,201,507, CANC. INT. CL. 42.
- BASEBALL CLUB OF SEATTLE, L.P., THE, SEATTLE, WA: 2,809,131, COR. INT. CL. 9.
- BASF AKTIENGESELLSCHAFT, LUDWIGSHAFEN AM RHEIN, FED REP GERMANY: 1,860,594, CANC. MULTIPLE CLASS, INT. CLS. 1 AND 17.
2,201,063, CANC. INT. CL. 2.
- BASF CORPORATION, CLIFTON, NJ: 1,302,331, CANC. INT. CL. 2.
- BASF DRUCKSYSTEME GMBH, STUTTGART, FED REP GERMANY, BASF FARBEN + FASERN AKTIENGESELLSCHAFT, HAMBURG 30, FED REP GERMANY: 1,323,978. REN. 8-11-05. INT. CL. 2.
1,323,979. REN. 8-11-05. INT. CL. 2.
- BASF DURCKSYSTEME GMBH, STUTTGART, FED REP GERMANY, BASF FARBEN + FASERN AKTIENGESELLSCHAFT, HAMBURG 30, FED REP GERMANY: 1,325,280. REN. 8-11-05. INT. CL. 2.
- BASHAS' INC., CHANDLER, AZ: 2,998,765, INT. CL. 32.
- BASIC GRAIN PRODUCTS, INC., COLDWATER, OH: 2,996,695, PUB. 6-28-2005. INT. CL. 29.
- BASIS INTERNATIONAL LTD., ALBUQUERQUE, NM: 2,201,074, CANC. INT. CL. 9.

BASS PRO TRADEMARKS, L.L.C., SPRINGFIELD, MO;
BASS PRO TRADEMARKS, L.P., SPRINGFIELD, MO:
1,976,153. REN. 8-10-05. INT. CL. 28.

BASTAS' INC., BEDFORD HEIGHTS, OH:
2,997,948, PUB. 6-28-2005. INT. CL. 37.

BATES FAMILY, INC., SCHAUMBURG, IL:
2,201,841, CANC. MULTIPLE CLASS, INT. CLS. 9 AND
25.
2,201,842, CANC. MULTIPLE CLASS, INT. CLS. 9 AND
25.

BATH & BODY WORKS, INC., REYNOLDSBURG, OH:
2,999,373, MULTIPLE CLASS, INT. CLS. 3 AND 4.

BATTAT INCORPORATED, PLATTSBURGH, NY:
2,998,171, PUB. 6-28-2005. INT. CL. 28.

BAUER MAGAZINE, L.P., ENGLEWOOD CLIFFS, NJ:
2,201,457, CANC. INT. CL. 16.

BAUGHMAN, JOHN W., GAINESVILLE, VA:
2,202,002, CANC. INT. CL. 25.

BAY CITY MILLING & GROCER CO., BAY CITY, MI:
191,286, CANC. U.S. CL. 46.

BAYER AKTIENGESELLSCHAFT, LEVERKUSEN, FED
REP GERMANY:
1,333,890. REN. 8-9-05. INT. CL. 1.

BAYER CORPORATION, ELKHART, IN:
2,201,204, CANC. INT. CL. 5.

BAYLOR UNIVERSITY, WACO, TX:
1,858,559. REN. 8-9-05. INT. CL. 16.

BC INTERNATIONAL COSMETIC & IMAGE SERVICES,
INC., ORLANDO, FL:
2,997,506, PUB. 6-28-2005. INT. CL. 41.

BE UNLIMITED LTD., MILWAUKEE, WI:
2,996,528, PUB. 6-28-2005. INT. CL. 5.

BEA MAURER, INC., STERLING, VA:
2,201,036, CANC. INT. CL. 18.

BEALE, ALAN J., MILWAUKEE, WI:
2,998,540, INT. CL. 42.

BEAR U.S.A., INC., PALISADES PARK, NJ:
2,997,379, PUB. 6-28-2005. INT. CL. 25.

BEAUTY ELITE GROUP, INC., HOUSTON, TX:
2,997,925, PUB. 6-28-2005. INT. CL. 3.

BECHTEL GROUP, INC., SAN FRANCISCO, CA, BECHTEL
CORPORATION, SAN FRANCISCO, CA:
1,931,946. REN. 8-8-05. INT. CL. 9.

BECKER GALLAGHER LEGAL PUBLISHING INCORPO-
RATED, MAINEVILLE, OH:
2,999,343, INT. CL. 41.

BECKER GROUP, THE, BALTIMORE, MD:
1,861,468, CANC. INT. CL. 42.

BECO CONSTRUCTION, INC., CHESAPEAKE, VA:
2,996,823, PUB. 6-28-2005. INT. CL. 37.

BECTON, DICKINSON AND COMPANY, FRANKLIN
LAKES, NJ:
2,996,913, PUB. 6-28-2005. INT. CL. 10.
2,997,384, PUB. 6-28-2005. INT. CL. 41.

BED BATH & BEYOND PROCUREMENT CO. INC., FARM-
INGDALE, NY:
2,997,277, PUB. 6-28-2005. MULTIPLE CLASS, INT. CLS.
16, 25 AND 35.

BEDROCK FREIGHT BROKERAGE, LP, WAUSAU, WI:
2,996,996, PUB. 6-28-2005. INT. CL. 39.

BEE LINE COMPANY, BETTENDORF, IA:
780,237. REN. 8-12-05. U.S. CL. 23 (INT. CL. 7).

BEE LINE COURIER SERVICES, INC., LOUISVILLE, KY:
2,996,765, PUB. 6-28-2005. INT. CL. 30.

BEE MAID HONEY LIMITED, WINNIPEG, MANITOBA,
CANADA:
2,997,791, PUB. 6-28-2005. INT. CL. 30.

BEECHAM INC., PHILADELPHIA, PA:
1,302,383, CANC. INT. CL. 5.

BEELER GUEST OWENS ARCHITECTS, L. P., DALLAS, TX:
2,999,306, INT. CL. 42.

BEHR PROCESS CORPORATION, SANTA ANA, CA:
2,996,648, PUB. 6-28-2005. MULTIPLE CLASS, INT. CLS.
2, 16 AND 20.
2,997,198, PUB. 6-28-2005. INT. CL. 2.

BEIERSDORF AKTIENGESELLSCHAFT, 20245 HAMBURG,
FED REP GERMANY:
2,998,799, MULTIPLE CLASS, INT. CLS. 3 AND 44.

BEL AIR INDUSTRIES, 69170 TARARE, FRANCE:
2,997,369, PUB. 6-28-2005. MULTIPLE CLASS, INT. CLS.
20 AND 24.

2,998,303, PUB. 6-28-2005. MULTIPLE CLASS, INT. CLS.
20 AND 24.

BEL-AQUA POOL SUPPLY, INC., NEW ROCHELLE, NY:
2,996,658, PUB. 6-28-2005. INT. CL. 35.

BELANGER INDUSTRIAL PRODUCTS, INC., NORTH-
VILLE, MI:
2,997,444, PUB. 6-28-2005. INT. CL. 7.

BELCHER, JOB O. III, ST THOMAS, US VIRGIN ISLANDS:
2,997,430, PUB. 6-28-2005. INT. CL. 25.

BELL, CRAIG RENARD, EL CAJON, CA:
1,887,244. REN. 8-8-05. INT. CL. 25.

BELL, DAVID EUGENE, WASHINGTON DEPOT, CT:
2,201,783, CANC. INT. CL. 21.

BELLE TOUCHE, LLC, SIOUX CITY, IA:
2,996,728, PUB. 6-28-2005. INT. CL. 44.

BELLWETHER GROUP, PHOENIX, AZ:
2,201,128, CANC. INT. CL. 35.

BELZONA MOLECULAR, INC., UNIONDALE, NY:
1,301,081. REN. 8-11-05. INT. CL. 1.

BEMUSIC, INC., NEW YORK, NY:
2,999,206, INT. CL. 35.

BENDER, PAUL A., WESTLAKE VILLAGE, CA, DBA RV
AMERICA INSURANCE MARKETING:
2,201,387, CANC. INT. CL. 36.

BENDIX CORPORATION, THE, DETROIT, MI:
793,342. REN. 8-11-05. U.S. CL. 31 (INT. CL. 11).

BENESOLUTIONS, INC., WASHINGTON, DC FROM BENE-
SOLUTIONS.COM LLC, WASHINGTON, DC:
2,998,830, MULTIPLE CLASS, INT. CLS. 35 AND 36.

BENETTON GROUP S.P.A., TREVISO, ITALY:
2,996,252, PUB. 6-28-2005. MULTIPLE CLASS, INT. CLS.
18, 25 AND 28.

BENEVOLENT AND PROTECTIVE ORDER OF ELKS OF
THE UNITED STATES OF AMERICA, CHICAGO, IL:
608,117. REN. 8-11-05. U.S. CL. 100 (INT. CL. 42).

BENJAMIN FRANKLIN LITERARY & MEDICAL SOCIETY,
INC., THE, INDIANAPOLIS, IN:
1,924,607. REN. 8-11-05. INT. CL. 16.

BENJAMIN, MILTON R., VERO BEACH, FL:
2,997,645, PUB. 6-28-2005. INT. CL. 39.

BENNETT BROTHERS, INC., CHICAGO, IL:
2,998,949, INT. CL. 35.

BENNETT, SUSAN A., SANTA BARBARA, CA:
2,997,928, PUB. 6-28-2005. INT. CL. 43.

BENTLEY PRICE ASSOCIATES, INC., SANTA YNEZ, CA:
2,996,644, PUB. 6-28-2005. INT. CL. 35.

BENTLEY SYSTEMS INCORPORATED, EXTON, PA:
2,200,885, CANC. INT. CL. 9.

BERGIN FINANCIAL INC., SOUTHFIELD, MI, DBA PER-
FECT MORTGAGE, INC.:
2,996,762, PUB. 6-28-2005. INT. CL. 36.

BERKLEY GIRL, LLC, NEW YORK, NY:
2,996,884, PUB. 6-28-2005. MULTIPLE CLASS, INT. CLS.
25 AND 35.

BERKLINE CORPORATION, THE, MORRISTOWN, TN:
2,202,365, CANC. INT. CL. 20.

BERLIN PACKAGING, LLC, CHICAGO, IL:
2,997,873, PUB. 6-28-2005. MULTIPLE CLASS, INT. CLS.
6, 16 AND 21.

BERNARD HODES GROUP INC., NEW YORK, NY:
2,996,334, PUB. 6-28-2005. INT. CL. 35.

BERNARDS, TERESA, NAPA, CA, DBA ANCIEN WINES:
1,859,261. REN. 8-9-05. INT. CL. 33.

BERNINI, INC., LOS ANGELES, CA:
2,201,765, CANC. INT. CL. 35.

BERNSTEIN, STANLEY K., TORONTO, ONTARIO, CANA-
DA:
2,997,661, PUB. 6-28-2005. INT. CL. 5.

BERRY, BRIAN D, PLEASANT VALLEY, NY AND VIG-
NOGNA, JAMES R, HOPWELL JUNCTION, NY:
2,997,132, PUB. 6-28-2005. INT. CL. 41.

BERRY, DONALD P., SR., DEBARY, FL:
2,996,465, PUB. 6-28-2005. INT. CL. 21.

BERRYHILL, JENNIFER C., BROOMFIELD, CO:
2,997,215, PUB. 6-28-2005. INT. CL. 25.

- BERTHOLON-ROWLAND, INC., PHILADELPHIA, PA, DBA
USI COLBURN INSURANCE SERVICE:
2,996,951, PUB. 6-28-2005. INT. CL. 42.
- BEST ADDRESS REAL ESTATE, LLC, WASHINGTON, DC:
2,998,078, PUB. 6-28-2005. INT. CL. 36.
- BEST EQUIPMENT INTERNATIONAL, INC., CAMDEN, NJ:
2,996,366, PUB. 6-28-2005. MULTIPLE CLASS, INT. CLS.
18, 25 AND 28.
- BEST OF KEY WEST INC., KEY WEST, FL TO FLORIDA
KEYS MARKETING ASSOCIATES, INC., KEY WEST, FL:
1,860,878, CANC. INT. CL. 16.
- BETHEL DELIVERANCE OUTREACH MINISTRIES, FT.
WASHINGTON, MD:
2,996,417, PUB. 6-28-2005. INT. CL. 45.
- BETHUNE-COOKMAN COLLEGE, INC., DAYTONA
BEACH, FL:
2,997,255, PUB. 6-28-2005. INT. CL. 41.
- BETTER PACKAGES, INC, SHELTON, CT, BETTER
PACKAGES, INCORPORATED, SHELTON, CT:
606,855. REN. 8-11-05. U.S. CL. 2 (INT. CL. 7).
- BETZ LABORATORIES, INC., TREVOSE, PA:
1,302,327, CANC. MULTIPLE CLASS, INT. CLS. 1, 5 AND
42.
- BEYOND REALITY, INC., SCOTTSDALE, AZ:
2,200,839, CANC. INT. CL. 42.
- BHS CORRUGATED; MASCHINEN- UND ANLAGENBAU
GMBH, FED REP GERMANY:
2,998,432, PUB. 6-28-2005. INT. CL. 7.
- BI PROPERTIES I INC., GREENSBORO, NC:
2,996,386, PUB. 6-28-2005. INT. CL. 27.
- BIA CORDON BLEU, INC., SOUTH SAN FRANCISCO, CA:
2,998,967, INT. CL. 21.
- BICKFORD'S AUSTRALIA PTY. LTD., NORTH PLYMPTON,
AUSTRALIA:
2,996,269, PUB. 6-28-2005. INT. CL. 32.
- BIG BANG SOFTWARE, INC., HARLEYSVILLE, PA:
2,201,370, CANC. INT. CL. 9.
- BIG ENTERTAINMENT, INC., BOCA RATON, FL:
2,201,585, CANC. INT. CL. 42.
- BIG HAMMER, LLC, WAUKESHA, WI:
2,997,286, PUB. 6-28-2005. INT. CL. 9.
- BIG SHOT BEVERAGES, INC., WINNSBORO, LA, JEFFERSON
BOTTLING COMPANY, METAIRIE, LA:
1,344,904. REN. 8-11-05. INT. CL. 32.
- BIG SUR WATERBEDS, INC., LAKEWOOD, CO:
1,909,492. REN. 8-11-05. INT. CL. 42.
- BILL BLASS, LTD., NEW YORK, NY:
2,202,013, CANC. INT. CL. 20.
- BILL SUYEYASU WHOLESALE FLORIST, INC., FREMONT,
CA, DBA FRESH FLORAL BOUQUET CO.:
2,201,546, CANC. INT. CL. 31.
- BIO-NUTRA TECHNOLOGIES, LLC, VENICE, FL:
2,998,320, PUB. 6-28-2005. INT. CL. 5.
- BIO-RAD, 92430 MARNES LA COQUETTE, FRANCE:
2,997,000, PUB. 6-28-2005. MULTIPLE CLASS, INT. CLS. 9
AND 10.
- BIOCEPT, INC., SAN DIEGO, CA:
2,999,101, INT. CL. 9.
- BIOCHEMIX, INC., AUSTIN, TX:
2,201,704, CANC. INT. CL. 5.
- BIOFARMA, 92200 NEUILLY-SUR-SEINE, FRANCE:
2,996,562, PUB. 6-28-2005. INT. CL. 5.
2,997,123, PUB. 6-28-2005. INT. CL. 5.
- BIOGAIA AB, SE-443 39 LERUM, SWEDEN:
2,996,422, PUB. 3-8-2005. MULTIPLE CLASS, INT. CLS. 5,
29, 30 AND 32.
- BIOGEN IDEC MA INC., CAMBRIDGE, MA:
2,201,683, CANC. INT. CL. 42.
- BIOLAB SERVICES, INC., WILMINGTON, DE:
2,999,140, INT. CL. 1.
- BIOMAX INFORMATICS AG, 82152 MARTINSRIED, FED
REP GERMANY:
2,998,839, MULTIPLE CLASS, INT. CLS. 9 AND 42.
- BIOMEDICAL DIAGNOSTICS SA, CROISSY BEAUBOURG,
FRANCE:
2,996,469, PUB. 6-28-2005. INT. CL. 9.
- BIOPHARM AUSTRALIA PTY LIMITED, AUSTRALIA:
2,998,490, PUB. 6-28-2005. INT. CL. 5.
- BIOPHARMACEUTICALS, L.L.C., WESTWOOD, NJ:
2,997,922, PUB. 6-28-2005. INT. CL. 3.
- BIOPRODUCTS, INC., FAIRLAWN, OH:
2,996,526, PUB. 6-28-2005. INT. CL. 35.
- BIOQUELL UK LIMITED, ANDOVER, HAMPSHIRE, UNITED
KINGDOM:
2,997,027, PUB. 6-28-2005. MULTIPLE CLASS, INT. CLS.
37 AND 40.
- BIOSAN LABORATORIES, INC., DERRY, NH:
2,998,151, PUB. 6-28-2005. INT. CL. 5.
- BIOSPHERES, INC., LIBERTY, MO:
2,200,907, CANC. INT. CL. 42.
- BIOWHITTAKER TECHNOLOGIES, INC., WALKERSVILLE,
MD, MALLINCKRODT, INC., ST. LOUIS, MO:
999,468. REN. 8-12-05. INT. CL. 1.
- BIRTH TO THREE, EUGENE, OR:
2,998,631, INT. CL. 16.
- BISSELL HOTELS, INC., CHARLOTTE, NC:
2,202,208, CANC. INT. CL. 41.
- BISSON, JOHN A. BURLINGTON, VT:
2,996,892, PUB. 6-28-2005. INT. CL. 9.
- BJ GLOBAL DIRECT, INC., IRVINE, CA:
2,996,919, PUB. 1-4-2005. MULTIPLE CLASS, INT. CLS. 8,
9 AND 21.
- BJ WRIGHT'S, L.L.C., PROVO, UT:
2,202,412, CANC. INT. CL. 30.
- BLACK & DECKER CORPORATION, THE, TOWSON, MD:
1,867,978. REN. 8-10-05. INT. CL. 6.
- BLACK BOX CORPORATION, PITTSBURGH, PA, DBA
WIDGET WORLD:
1,302,562, CANC. INT. CL. 16.
- BLACK ENTERTAINMENT TELEVISION, INC., WASHINGTON,
DC:
1,890,251. REN. 8-9-05. INT. CL. 41.
2,998,333, PUB. 6-28-2005. INT. CL. 41.
- BLACK, GENE, BENICIA, CA:
2,997,190, PUB. 6-28-2005. INT. CL. 35.
- BLACKHAT, INC., SEATTLE, WA:
2,998,847, INT. CL. 25.
- BLACKROCK CAPITAL CORPORATION, LAS VEGAS, NV:
2,998,866, INT. CL. 36.
- BLACKWELL, DAVE, FORT WAYNE, IN AND DRUHOT,
GLEN, FORT WAYNE, IN AND GLASSCOCK, BOB, FORT
WAYNE, IN AND KANTZ, GARY, FORT WAYNE, IN
AND MAYHALL, DALE, FORT WAYNE, IN AND MEREDITH,
SHANE, FORT WAYNE, IN AND REECE, GARY, FORT WAYNE,
IN:
2,201,282, CANC. INT. CL. 41.
- BLACKWELL, DEVAN M., MAYS LANDING, NJ:
2,998,292, PUB. 6-28-2005. INT. CL. 16.
- BLACKWELL, SANDRA, LAKE RIDGE, VA:
2,997,340, PUB. 6-28-2005. INT. CL. 30.
- BLANCHE, FRANCES, BROOKLYN, NY:
2,998,219, PUB. 6-28-2005. INT. CL. 9.
- BLANKEBAER/BOWEYKRIMKO CORPORATION, FENTON,
MO:
1,302,997, CANC. INT. CL. 32.
- BLEACH, BRENTWOOD, TN:
2,201,816, CANC. MULTIPLE CLASS, INT. CLS. 9 AND
41.
- BLENDEX COMPANY, LOUISVILLE, KY:
1,302,971, CANC. INT. CL. 30.
- BLESOFF, MARC, OAK PARK, IL:
2,201,513, CANC. INT. CL. 41.
- BLIMPIE INTERNATIONAL, INC., ATLANTA, GA:
2,997,499, PUB. 6-28-2005. INT. CL. 30.
- BLISTEX INC., OAK BROOK, IL:
2,998,981, INT. CL. 5.
- BLOCK, MARY, GOLDEN, CO:
2,997,278, PUB. 6-28-2005. INT. CL. 18.
- BLUE BELL CREAMERIES L.P., BRENHAM, TX:
1,328,781. REN. 8-11-05. INT. CL. 30.
- BLUE CROSS AND BLUE SHIELD ASSOCIATION, CHICAGO,
IL:
2,201,446, CANC. MULTIPLE CLASS, INT. CLS. 36 AND
42.

- BLUE CROSS AND BLUE SHIELD OF VERMONT, MONTPELIER, VT:
2,997,700, PUB. 6-28-2005. MULTIPLE CLASS, INT. CLS. 35 AND 36.
- BLUE DIGITAL CORP, MIAMI, FL:
2,997,780, PUB. 6-28-2005. INT. CL. 40.
- BLUE HERON FRENCH CHEESE CO., TILLAMOOK, OR:
1,336,991. REN. 8-11-05. INT. CL. 29.
- BLUE ISLAND PROPERTY HOLDINGS, LLC, MILLERSVILLE, MD:
2,996,779, PUB. 6-28-2005. INT. CL. 43.
- BLUE MOON SOFTWARE, INC., LEBANON, NJ:
2,200,921, CANC. INT. CL. 9.
- BLUE ORCHID GROUP LLC, SANTA MONICA, CA:
2,996,595, PUB. 6-28-2005. INT. CL. 36.
- BLUE STAR LIMITED, MUMBAI 400 020, INDIA:
2,996,275, PUB. 6-28-2005. INT. CL. 42.
2,996,276, PUB. 6-28-2005. INT. CL. 42.
- BLUEDOT VIRTUAL EVENT ORGANIZATION, INC., PALO ALTO, CA:
2,160,000, CANC. INT. CL. 9.
- BLUM, INC., LAFAYETTE, CA:
2,201,272, CANC. INT. CL. 11.
- BLUMENTHAL LANSING COMPANY, CARLSTADT, NJ:
2,999,180, INT. CL. 16.
- BLYDENSTEIN-WILLINK NV, 7500 AA ENSCHEDE, NETHERLANDS:
1,302,684, CANC. INT. CL. 24.
- BLÜCHER METAL APS, DENMARK:
2,998,402, PUB. 6-28-2005. MULTIPLE CLASS, INT. CLS. 6, 11 AND 19.
- BNA COMMUNICATIONS, INC., ROCKVILLE, MD:
2,200,926, CANC. INT. CL. 9.
- BOARD OF REGENTS, THE UNIVERSITY OF TEXAS SYSTEM, AUSTIN, TX:
2,999,386, INT. CL. 41.
- BOARDROOM SOFTWARE, INC., CARROLLTON, TX:
2,999,376, INT. CL. 9.
- BOARDROOM, INC., STAMFORD, CT:
2,997,667, PUB. 6-28-2005. INT. CL. 16.
- BOATSTOCK.COM, LLC, TOMS RIVER, NJ:
2,996,427, PUB. 6-28-2005. INT. CL. 42.
- BOBMAC, LLC, LAS VEGAS, NV:
2,996,674, PUB. 6-14-2005. INT. CL. 9.
- BOC GROUP, INC., THE, MURRAY HILL, NEW PROVIDENCE, NJ:
2,201,268, CANC. INT. CL. 9.
- BODEGAS FAUSTINO MARTINEZ, S.A., OYON, SPAIN:
1,329,957. REN. 8-10-05. INT. CL. 33.
- BODY-SOLID, INC., FOREST PARK, IL:
2,998,938, INT. CL. 28.
- BOEHRINGER INGELHEIM INTERNATIONAL GMBH, D-55216 INGELHEIM AM RHEIN, FED REP GERMANY:
2,201,360, CANC. INT. CL. 5.
- BOEHRINGER INGELHEIM PHARMA GMBH & CO. KG, FED REP GERMANY:
2,998,420, PUB. 6-28-2005. INT. CL. 10.
2,998,425, PUB. 6-28-2005. INT. CL. 5.
- BOEHRINGER INGELHEIM VETMEDICA GMBH, INGELHEIM AM RHEIN, FED REP GERMANY:
2,996,967, PUB. 6-28-2005. INT. CL. 5.
- BOEHRINGER INGELHEIM VETMEDICA GMBH, FED REP GERMANY:
2,998,485, PUB. 6-28-2005. INT. CL. 5.
- BOEING MANAGEMENT COMPANY, SEAL BEACH, CA:
2,998,942, INT. CL. 37.
- BOHLER-UDDEHOLM PRECISION STRIP AKTIEBOLAG, S-684 28 MUNKFORS, SWEDEN:
2,998,972, MULTIPLE CLASS, INT. CLS. 6 AND 7.
- BOHN, HOLLY A., NEWBURY PARK, CA:
2,998,001, PUB. 6-28-2005. INT. CL. 16.
- BOILER SUPPLY COMPANY, INC., NASHVILLE, TN:
2,996,606, PUB. 6-28-2005. MULTIPLE CLASS, INT. CLS. 35 AND 37.
- BOLAND, WILLIAM M., NEW YORK, NY:
2,997,102, PUB. 6-28-2005. INT. CL. 44.
- BOLD DISTRIBUTION, INC., CAPE CORAL, FL:
2,571,042, CANC. MULTIPLE CLASS, INT. CLS. 25 AND 28.
- BOLESKY/NOLTE INTENTION, INC., BUCKLEY, WA, DBA SOMA INSTITUTE OF NEUROMUSCULAR INTEGRATION:
2,998,627, INT. CL. 41.
- BOLTARON PERFORMANCE PRODUCTS, LLC, NEWCOMERSTOWN, OH:
2,998,559, INT. CL. 17.
- BOMAG GMBH, HELLERWALD, BOPPARD D-56154, FED REP GERMANY:
2,996,379, PUB. 6-28-2005. MULTIPLE CLASS, INT. CLS. 7 AND 9.
- BOMGAARS, JOEL, RIDGELAND, MS:
2,999,354, INT. CL. 9.
- BONK DESIGNS, INC, VENICE, CA:
2,997,327, PUB. 6-28-2005. INT. CL. 10.
- BONOBO'S LLC, FORTH WORTH, TX:
2,996,957, PUB. 6-28-2005. MULTIPLE CLASS, INT. CLS. 29 AND 31.
- BOOSWEET ENTERPRISES, LLC, RIALTO, CA:
2,997,981, PUB. 6-28-2005. MULTIPLE CLASS, INT. CLS. 9 AND 25.
- BOOTS COMPANY USA HOLDINGS INC., THE, WILMINGTON, DE:
2,998,882, INT. CL. 3.
2,999,274, INT. CL. 3.
- BORAL LIFETILE INC., NEWPORT BEACH, CA:
2,202,108, CANC. INT. CL. 19.
- BORJA, CARL, OAKLAND, CA:
2,996,357, PUB. 6-28-2005. INT. CL. 25.
- BORLAND SOFTWARE CORPORATION, SCOTTS VALLEY, CA FROM INPRISE CORPORATION, SCOTTS VALLEY, CA:
2,996,254, PUB. 6-28-2005. INT. CL. 9.
- BOROFF, ROBERT, LITHIA, FL:
2,996,939, PUB. 6-28-2005. INT. CL. 35.
- BOSTON SCIENTIFIC CORPORATION, NATICK, MA, MEDI-TECH, INCORPORATED, WATERTOWN, MA:
1,352,651. REN. 8-9-05. INT. CL. 10.
- BOSTON SCIENTIFIC SCIMED, INC., MAPLE GROVE, MN:
1,889,216. REN. 8-9-05. INT. CL. 10.
- BOSTON TRADING LTD., INC., LYNN, MA:
1,302,777, CANC. INT. CL. 25.
- BOUCHAIB CHAKIR, FED REP GERMANY:
2,998,359, PUB. 6-28-2005. INT. CL. 9.
- BOUTIQUE INDUSTRIES, INC., NEW YORK, NY:
1,302,758, CANC. INT. CL. 25.
- BOW RIVER CAPITAL PARTNERS, DENVER, CO:
2,997,321, PUB. 6-28-2005. INT. CL. 36.
- BOWATER INCORPORATED, GREENVILLE, SC:
2,998,005, PUB. 6-28-2005. INT. CL. 16.
- BOWERS, J. MICHAEL, PLANO, TX:
2,998,532, INT. CL. 32.
- BOWIE ENTERPRISES, FRESNO, CA:
2,996,813, PUB. 6-28-2005. INT. CL. 37.
- BOWTIE, INC., IRVINE, CA:
2,997,035, PUB. 6-28-2005. INT. CL. 41.
- BOYD GAMING CORPORATION, LAS VEGAS, NV:
2,998,178, PUB. 6-28-2005. INT. CL. 25.
- BRADCAL, INC., CERRITOS, CA:
2,997,295, PUB. 6-28-2005. INT. CL. 25.
- BRADFORD, JAMES L., COLUMBUS, OH:
2,441,709, CANC. INT. CL. 32.
- BRADSHAW INTERNATIONAL, INC., RANCHO CUCAMONGA, CA:
2,999,039, INT. CL. 21.
- BRAINSTORM DESIGN, INC., INDIANAPOLIS, IN, DBA BRAINSTORM:
2,997,037, PUB. 6-28-2005. INT. CL. 35.
- BRAKEBUSH BROTHERS, INC., WESTFIELD, WI:
2,201,759, CANC. INT. CL. 29.
- BRAKEFIELD, H. CHRISTOPHER, BIRMINGHAM, AL:
2,999,107, INT. CL. 42.
- BRANASH ENTERPRISES, INCORPORATED, KITTY HAWK, NC, BREW THRU, INC., KILL DEVIL HILLS, NC:
1,341,610. REN. 8-10-05. INT. CL. 42.

- BRANDESS-KALT-AETNA GROUP, INC., VERNON HILLS, IL:
2,996,344, PUB. 5-3-2005. MULTIPLE CLASS, INT. CLS. 2, 3 AND 16.
- BRANSON ULTRASONICS CORPORATION, DANBURY, CT:
1,893,930. REN. 8-11-05. INT. CL. 7.
- BRASSERIE DU CARDINAL FRIBOURG S.A., FRIBOURG, SWITZERLAND:
1,302,528, CANC. INT. CL. 16.
- BRAUN GMBH, KRONBERG IM TAUNUS D-61476, FED REP GERMANY:
2,999,342, INT. CL. 10.
- BRAVO DEVELOPMENT, INC., CHAGRIN FALLS, OH:
2,996,778, PUB. 6-28-2005. INT. CL. 43.
- BRAVO FABRICS INTERNATIONAL, LLC, NEW YORK, NY:
2,998,954, INT. CL. 24.
- BRECK'S LLC, GUILFORD, IN:
2,997,104, PUB. 3-8-2005. INT. CL. 31.
- BREMBO INTERNATIONAL S.A., LUXEMBOURG:
2,998,581, MULTIPLE CLASS, INT. CLS. 1, 14, 18, 25 AND 28.
- BREWING NORTHWEST, LTD., CORVALLIS, OR, DBA OREGON TRAIL BREWERY:
2,997,976, PUB. 6-28-2005. INT. CL. 32.
- BRICO S.R.L., 28040 DORMELLETO (NO), ITALY:
2,201,321, CANC. INT. CL. 9.
- BRIGGS & MORGAN, PROFESSIONAL ASSOCIATION, MINNEAPOLIS, MN:
2,997,602, PUB. 6-28-2005. INT. CL. 42.
- BRIGGS MEDICAL SERVICE COMPANY, WEST DES MOINES, IA, DBA BRIGGS CORPORATION:
2,997,108, PUB. 6-28-2005. INT. CL. 44.
- BRIGHAM YOUNG UNIVERSITY, PROVO, UT:
2,997,543, PUB. 6-28-2005. INT. CL. 16.
- BRIGHT OF AMERICA, LLC, SUMMERSVILLE, WV:
1,302,587, CANC. INT. CL. 16.
- BRILEY MANUFACTURING CO, HOUSTON, TX:
2,996,637, PUB. 6-28-2005. MULTIPLE CLASS, INT. CLS. 13, 37 AND 40.
- BRINE, INC., MILFORD, MA:
2,998,335, PUB. 6-28-2005. MULTIPLE CLASS, INT. CLS. 9, 18, 25 AND 28.
- BRINKER INTERNATIONAL HOLDINGS, L.P., DALLAS, TX:
2,997,750, PUB. 6-28-2005. INT. CL. 43.
- BRINO-HOLDING AG, SWITZERLAND:
2,998,457, PUB. 6-28-2005. MULTIPLE CLASS, INT. CLS. 29 AND 33.
- BROOKHOUSE, DAVID, ALMA, MI:
2,997,882, PUB. 6-28-2005. INT. CL. 42.
- BROOKS MANUFACTURING COMPANY, CINCINNATI, OH, BROOKS MANUFACTURING COMPANY, CINCINNATI, OH:
788,893. REN. 8-10-05. U.S. CL. 5 (INT. CL. 1).
- BROOKSTONE PURCHASING, INC., NASHUA, NH:
2,998,250, PUB. 6-28-2005. INT. CL. 6.
- BROOKWOOD HEALTH SERVICES, INC., BIRMINGHAM, AL:
2,201,707, CANC. INT. CL. 42.
- BROWAR NAMYSLOW SP.Z O.O., NAMYSLOW, POLAND:
2,997,391, PUB. 6-28-2005. INT. CL. 32.
- BROWN & WILLIAMSON TOBACCO CORPORATION, LOUISVILLE, KY:
2,201,116, CANC. MULTIPLE CLASS, INT. CLS. 16, 18, 20 AND 25.
2,201,119, CANC. INT. CL. 41.
- BROWN GROUP, INC., ST. LOUIS, MO:
2,202,059, CANC. INT. CL. 25.
- BROWN, JANICE, SAN DIEGO, CA:
2,997,899, PUB. 6-28-2005. INT. CL. 42.
- BROWN, JOSEPH P, OCALA, FL:
2,999,396, INT. CL. 41.
- BROWN, SHARP AND STEELY, CINCINNATI, OH, DBA CROWNSMEN QUARTET:
1,302,404, CANC. MULTIPLE CLASS, INT. CLS. 9 AND 41.
- BROWNING, MORGAN, UT:
2,998,114, PUB. 6-28-2005. INT. CL. 6.
- BRUCE A. CARTER, KISSIMMEE, FL:
2,996,909, PUB. 6-28-2005. INT. CL. 35.
- BRUCE FOODS CORPORATION, NEW IBERIA, LA:
1,302,863, CANC. INT. CL. 29.
- BRUNER, E. JOHN, WINFRED, SD:
2,996,311, PUB. 6-28-2005. INT. CL. 29.
- BRUNO SAINT HILAIRE, FRANCE:
2,998,414, PUB. 6-28-2005. MULTIPLE CLASS, INT. CLS. 3, 18 AND 25.
- BRUNO SANTERRE, INC., QUEBEC, CANADA:
2,998,521, INT. CL. 11.
- BRUNSWICK BOWLING & BILLIARDS CORPORATION, LAKE FOREST, IL:
2,998,513, INT. CL. 28.
- BSH BOSCH AND SIEMENS HAUSGERATE GMBH, MUNICH, FED REP GERMANY:
2,997,575, PUB. 6-28-2005. INT. CL. 7.
- BSH BOSCH UND SIEMENS HAUSGERATE GMBH, MUNICH, FED REP GERMANY:
2,997,504, PUB. 6-28-2005. MULTIPLE CLASS, INT. CLS. 7, 9 AND 11.
2,997,505, PUB. 6-28-2005. MULTIPLE CLASS, INT. CLS. 7, 9 AND 11.
- BSM DEVELOPPEMENT, 75007 PARIS, FRANCE:
2,996,448, PUB. 6-28-2005. INT. CL. 19.
- BUDD COMPANY, THE, TROY, MI:
1,302,498, CANC. INT. CL. 12.
- BUEHLER LTD., LAKE BLUFF, IL:
2,998,973, INT. CL. 7.
- BUEHLER, LTD., LAKE BLUFF, IL:
607,158. REN. 8-9-05. U.S. CL. 4 (INT. CL. 3).
1,301,240. REN. 8-11-05. INT. CL. 7.
- BUFFETS, INC., EAGAN, MN:
2,997,774, PUB. 6-28-2005. INT. CL. 43.
- BUFFETT, JIMMY, KEY WEST, FL:
2,216,478, CANC. MULTIPLE CLASS, INT. CLS. 9, 14, 18, 21, 25, 26 AND 42.
- BUFORD, DELORES, CLEVELAND, OH:
2,201,053, CANC. INT. CL. 18.
- BUGLE BOY INDUSTRIES, INC., SIMI VALLEY, CA:
2,201,772, CANC. INT. CL. 25.
2,202,302, CANC. INT. CL. 25.
- BUILDING RESOURCES, INC., DES PLAINES, IL, DBA B.R.C. HEATING/COOLING:
2,996,622, PUB. 6-28-2005. MULTIPLE CLASS, INT. CLS. 37 AND 42.
- BUM & ROH, INC., CARSON, CA:
2,996,907, PUB. 6-28-2005. MULTIPLE CLASS, INT. CLS. 7 AND 12.
- BUNDESDRUCKEREI GMBH, D-10958 BERLIN, FED REP GERMANY:
2,996,885, PUB. 6-28-2005. MULTIPLE CLASS, INT. CLS. 1, 9, 17, 40, 42 AND 45.
- BUNTEMEYER, PETE W., SAN DIEGO, CA:
2,997,495, PUB. 6-28-2005. INT. CL. 25.
- BUNYAN INDUSTRIES, L.L.C., WEST JORDAN, UT:
2,996,602, PUB. 6-28-2005. INT. CL. 7.
2,996,603, PUB. 6-28-2005. INT. CL. 7.
- BUNZL DISTRIBUTION USA, INC., ST. LOUIS, MO:
1,925,513. REN. 8-12-05. INT. CL. 21.
1,962,781. REN. 8-12-05. INT. CL. 3.
- BURANDT, JASON T., PHOENIX, AZ AND BURANDT, CHARLOTTE L., PHOENIX, AZ:
2,997,837, PUB. 6-28-2005. INT. CL. 9.
- BURLINGTON COAT FACTORY WAREHOUSE CORPORATION, BURLINGTON, NJ:
2,999,009, INT. CL. 35.
- BURNING PLANET, INC., LONG BEACH, CA:
2,996,811, PUB. 6-28-2005. INT. CL. 18.
- BURNS BROS., INC., PORTLAND, OR:
2,201,614, CANC. INT. CL. 37.
- BURNS LONDON LTD., OTTERSHAW, SURREY, UNITED KINGDOM:
2,998,007, PUB. 6-28-2005. INT. CL. 15.
- BURVELLE ENTERPRISES, CITRUS HEIGHTS, CA:
1,302,658, CANC. INT. CL. 21.

BURZYNSKI, STANISLAW R., HOUSTON, TX:
2,999,213, INT. CL. 5.

BUSCH ENTERTAINMENT CORPORATION, ST. LOUIS, MO:
2,998,243, PUB. 6-28-2005. INT. CL. 41.

BUSHNELL PERFORMANCE OPTICS, OVERLAND PARK, KS, TASCO SALES, INC., MIAMI, FL:
1,920,782, REN. 8-11-05. INT. CL. 9.

BUSINESS ADVANTAGE, INC., LA CONNER, WA:
2,201,168, CANC. INT. CL. 16.

BUSINESS APPLICATIONS PERFORMANCE CORPORATION, BURLINGAME, CA:
2,997,725, PUB. 6-28-2005. INT. CL. 9.

BUSINESS TO BUSINESS SOLUTIONS, LLC, RICHMOND, VA:
2,996,245, PUB. 6-28-2005. MULTIPLE CLASS, INT. CLS. 16, 41 AND 42.

BUTTERS, MARY JANE, MOSCOW, ID:
2,997,063, PUB. 6-28-2005. INT. CL. 16.

BUTTONS, ETC., INC., HICKSVILLE, NY:
2,997,087, PUB. 6-28-2005. INT. CL. 23.

BUTTREY FOOD AND DRUG COMPANY, GREAT FALLS, MT:
2,201,113, CANC. INT. CL. 35.

BYRNE, ROBIN, DARLINGTON, UNITED KINGDOM:
2,997,355, PUB. 6-28-2005. MULTIPLE CLASS, INT. CLS. 16 AND 41.

BYTEL CORPORATION, BERKELEY, CA:
1,302,417, CANC. MULTIPLE CLASS, INT. CLS. 9 AND 16.

BÖE, HANS PETER, D-46049 OBERHAUSEN, FED REP GERMANY:
2,998,495, PUB. 6-28-2005. MULTIPLE CLASS, INT. CLS. 1 AND 19.

C & Y ENTERPRISES, INC., ALHAMBRA, CA:
2,202,048, CANC. MULTIPLE CLASS, INT. CLS. 3 AND 5.

C. H. GUENTHER & SON, INC., SAN ANTONIO, TX, DBA PIONEER FLOUR MILLS:
1,341,246, REN. 8-10-05. INT. CL. 30.
1,343,034, REN. 8-10-05. INT. CL. 30.
1,346,625, REN. 8-10-05. INT. CL. 30.

C. R. BARD, INC., MURRAY HILL, NJ:
2,996,992, PUB. 6-28-2005. INT. CL. 10.

C. STUART PTY. LTD., CHELTENHAM, VICTORIA, AUSTRALIA:
2,996,955, PUB. 6-28-2005. MULTIPLE CLASS, INT. CLS. 24 AND 25.

C. UYEMURA & CO., LTD., OSAKA-SHI, OSAKA, JAPAN:
1,895,772, REN. 8-10-05. INT. CL. 1.

C. V. GAMBINA, INC., NEW ORLEANS, LA:
1,302,836, CANC. INT. CL. 28.
1,302,837, CANC. INT. CL. 28.

C.A.O. INTERNATIONAL, INC., NASHVILLE, TN:
2,999,191, INT. CL. 34.

C.E.I.A. - COSTRUZIONI ELETTRONICHE; INDUSTRIALI AUTOMATISMI - S.P.A., ITALY:
2,998,428, PUB. 6-28-2005. INT. CL. 9.

C&S BEARINGS, INC., SOUTH EL MONTE, CA:
2,998,158, PUB. 6-28-2005. INT. CL. 7.

C/HCA, INC., NASHVILLE, TN:
2,997,115, PUB. 6-28-2005. INT. CL. 44.
2,998,042, PUB. 6-28-2005. INT. CL. 44.
2,998,052, PUB. 6-28-2005. INT. CL. 44.
2,998,053, PUB. 6-28-2005. INT. CL. 44.

CABALLERO CONTROL CORPORATION LIMITED, INC., CANOGA PARK, CA:
1,303,165, CANC. INT. CL. 41.

CABOODLES, LLC, MEMPHIS, TN:
2,998,605, INT. CL. 3.

CABOS ENTERPRISES, INC., ENCINO, CA:
2,999,112, INT. CL. 43.

CACHE CREEK CASINO RESORT, BROOKS, CA:
2,997,222, PUB. 6-28-2005. INT. CL. 43.
2,997,244, PUB. 6-28-2005. INT. CL. 41.

CADBURY BEVERAGES DELAWARE INC, RYE BROOK, NY, PETER PAUL CADBURY, INC., NAUGATUCK, CT:
1,339,397, REN. 8-11-05. INT. CL. 30.

CADESTANSA, LLC, SAN RAFAEL, CA:
2,996,432, PUB. 6-28-2005. INT. CL. 9.

CADILLAC COFFEE COMPANY, MADISON HEIGHTS, MI:
2,526,171, AM. INT. CL. 30.

CAESARS WORLD, INC., LAS VAGAS, NV:
2,999,188, INT. CL. 43.

CAFE DAMASCO S.A., CURITIBA, PARANA, BRAZIL:
2,201,029, CANC. INT. CL. 30.

CAFFE BRASS MONKEY, LOS ANGELES, CA:
2,996,612, PUB. 6-28-2005. INT. CL. 43.

CALCOMP TECHNOLOGY, INC., ANAHEIM, CA:
2,201,812, CANC. INT. CL. 9.

CALGON CARBON CORPORATION, PITTSBURGH, PA:
2,998,607, INT. CL. 11.

CALICO BRANDS, INC., ONTARIO, CA:
2,998,199, PUB. 6-28-2005. INT. CL. 34.
2,998,201, PUB. 6-28-2005. INT. CL. 34.

CALIFORNIA ASSOCIATION OF REALTORS, LOS ANGELES, CA:
2,202,180, CANC. INT. CL. 42.

CALIFORNIA BLENDING CORP., EL MONTE, CA:
1,302,937, CANC. INT. CL. 30.

CALIFORNIA EXOTIC NOVELTIES, INC., CHINO, CA:
2,201,441, CANC. INT. CL. 10.
2,201,442, CANC. INT. CL. 10.

CALIFORNIA FRAGRANCE COMPANY, INC., HUNTINGTON STATION, NY:
2,998,322, PUB. 6-28-2005. INT. CL. 3.

CALIFORNIA STORMWATER QUALITY ASSOCIATION, MENLO PARK, CA:
2,996,858, PUB. 6-28-2005. INT. CL. 41.

CALPIS CO., LTD., TOKYO, JAPAN:
2,997,129, PUB. 6-28-2005. INT. CL. 32.

CALTUS HOLDINGS LLC, LOS ANGELES, CA:
2,998,575, INT. CL. 36.

CALVET, BORDEAUX (GIRONDE), FRANCE, J. CALVET & CIE, S.A.R.L., BORDEAUX, FRANCE:
324,359, REN. 8-10-05. U.S. CL. 47 (INT. CL. 33).

CALZATURIFICIO F.LLI CAPONI S.R.L., ITALY:
2,998,413, PUB. 6-28-2005. INT. CL. 25.

CALZATURIFICIO ROBERTO DEL CARLO S.R.L., ITALY:
2,998,469, PUB. 6-28-2005. MULTIPLE CLASS, INT. CLS. 18 AND 25.

CAMBRIDGE DIAGNOSTIC PRODUCTS, INC., FORT LAUDERDALE, FL:
2,999,174, INT. CL. 3.

CAMBRIDGE SCIENTIFIC ABSTRACTS, BETHESDA, MD:
2,996,391, PUB. 6-28-2005. MULTIPLE CLASS, INT. CLS. 16 AND 42.

CAMM, JOHN T., SOUTH BURLINGTON, VT:
1,861,291, CANC. INT. CL. 42.

CAMOMILE LABORATORIES, INC., FAIR HAVEN, NJ:
2,998,061, PUB. 6-28-2005. INT. CL. 3.
2,998,064, PUB. 6-28-2005. INT. CL. 3.

CAMP GOOD DAYS AND SPECIAL TIMES, INC., MENDON, NY:
2,998,132, PUB. 6-28-2005. INT. CL. 36.

CAMPBELL, DOROTHY C., SHARON, MA:
1,907,698, REN. 8-10-05. INT. CL. 41.

CANBURY HOMES, INC., SANFORD, ME:
2,996,846, PUB. 6-28-2005. INT. CL. 37.

CANDLE BEE FARM, LLC, FISHERVILLE, KY:
2,997,723, PUB. 6-28-2005. INT. CL. 4.
2,997,724, PUB. 6-28-2005. INT. CL. 4.

CANDLE CORPORATION OF AMERICA, DES PLAINES, IL:
2,997,540, PUB. 6-28-2005. INT. CL. 4.

CANNED INTERACTIVE, INC., HOLLYWOOD, CA:
2,997,437, PUB. 6-28-2005. MULTIPLE CLASS, INT. CLS. 35, 41 AND 42.

CANON COMMUNICATIONS LLC, SANTA MONICA, CA:
2,202,410, CANC. INT. CL. 35.
2,202,411, CANC. INT. CL. 35.

CANON KABUSHIKI KAISHA, SHIMOMARUKO, OHTAKU, TOKYO, JAPAN:
2,202,083, CANC. INT. CL. 9.

CANTAR/POLYAIR INC., TORONTO, ONTARIO, CANADA:
2,996,978, PUB. 6-28-2005. INT. CL. 6.

- CANTRELL, KRISTA, CAVE CREEK, AZ:
2,996,938, PUB. 6-28-2005. INT. CL. 41.
- CANTRELL, OSSIOLA A, LOS ANGELES, CA:
2,997,666, PUB. 6-28-2005. INT. CL. 25.
- CANTU DE MEXICO, S.A. DE C.V., 11520 MEXICO, D.F., MEXICO:
2,201,318, CANC. INT. CL. 14.
- CAPEWELL COMPONENTS COMPANY, LLC, CROMWELL, CT:
2,996,756, PUB. 6-28-2005. INT. CL. 8.
- CAPITAL CITIES MEDIA, INC., NEW YORK, NY:
1,302,606, CANC. INT. CL. 16.
- CAPITAL SPORTS & ENTERTAINMENT INC., KANATA, ONTARIO, CANADA, OTTAWA SENATORS HOCKEY CLUB LIMITED PARTNERSHIP, NEPEAN, ONTARIO, CANADA:
1,912,770, REN. 8-10-05. INT. CL. 41.
- CAPO, INC., ORMOND BEACH, FL:
2,997,959, PUB. 6-28-2005. INT. CL. 9.
- CAPSTAR BROADCASTING PARTNERS, INC., AUSTIN, TX:
2,202,260, CANC. INT. CL. 38.
- CAPTIVE-AIRE SYSTEMS, INC., YOUNGSVILLE, NC:
2,996,730, PUB. 6-28-2005. INT. CL. 11.
- CARACAS PAPER COMPANY, S.A., MARACAY, EDO. ARAGUA, VENEZUELA:
2,998,548, INT. CL. 16.
- CARAWORKS, INC., PEORIA, IL:
2,996,621, PUB. 6-28-2005. INT. CL. 42.
- CARDEN TRAN, NEW YORK, NY:
2,999,014, INT. CL. 25.
- CARDIAC PACEMAKERS, INC., ST. PAUL, MN:
2,998,755, INT. CL. 10.
- CARDINAL BUSINESS MEDIA, INC., FORT WASHINGTON, PA:
2,200,899, CANC. INT. CL. 16.
- CARDINAL HEALTH TECHNOLOGIES, LLC, LAS VEGAS, NV:
2,999,133, INT. CL. 35.
- CARE ENVIRONMENTAL CORP., LANDING, NJ:
1,861,281, CANC. INT. CL. 42.
- CAREMARK INTERNATIONAL INC., NORTHBROOK, IL:
2,996,952, PUB. 6-28-2005. INT. CL. 35.
- CARETRUST NETWORKS, FOLSOM, CA:
2,999,129, INT. CL. 35.
- CARGILL, INCORPORATED, MINNETONKA, MN:
1,341,254, REN. 8-11-05. INT. CL. 30.
- CARGNELLI, ILARIA, 248 - 35031 ABANO TERME (PADOVA), ITALY:
2,245,382, CANC. MULTIPLE CLASS, INT. CLS. 3, 18 AND 24.
- CARHARTT, INC., DEARBORN, MI:
2,999,170, INT. CL. 25.
2,999,215, INT. CL. 25.
- CARISBROOK INDUSTRIES, INC., NEW YORK, NY:
1,302,679, CANC. INT. CL. 23.
- CARL BUDDIG AND COMPANY, HOMEWOOD, IL:
2,998,828, INT. CL. 29.
- CARLISLE INTANGIBLE COMPANY, SYRACUSE, NY:
2,996,514, PUB. 6-28-2005. INT. CL. 12.
- CARMAX BUSINESS SERVICES, LLC, GLEN ALLEN, VA:
2,202,325, CANC. INT. CL. 37.
- CARNEY-NEUHAUS, INC., MIAMI BEACH, FL:
2,201,179, CANC. INT. CL. 42.
- CAROL GOLLOB FOUNDATION FOR BREAST CANCER RESEARCH, THE, WINNETKA, IL:
1,861,186, CANC. INT. CL. 36.
- CAROLINA HERRERA, LTD., NEW YORK, NY:
2,998,695, INT. CL. 14.
- CARPEDIEM MANAGEMENT COMPANY, NEW ALBANY, OH:
2,998,741, INT. CL. 43.
- CARPENTER, THOMAS, CHESTERFIELD TWP., MI AND SMITH, EDWARD, CHESTERFIELD TWP, MI:
2,999,333, INT. CL. 25.
- CARR, H. THOMAS, JOHNSON CITY, TN:
2,998,819, INT. CL. 43.
- CARRIDO, JOHN, NEWPORT BEACH, CA, DBA CARRIDO GOLF FITNESS:
2,200,929, CANC. MULTIPLE CLASS, INT. CLS. 9 AND 42.
- CARRIER CORPORATION, FARMINGTON, CT:
2,997,557, PUB. 6-28-2005. INT. CL. 35.
- CARRIFF CORPORATION INC., MIDLAND, NC:
1,894,133, REN. 8-11-05. INT. CL. 24.
- CARRILLO, ROBERT G., ANAHEIM, CA:
1,860,970, CANC. INT. CL. 22.
- CARSON, STEVE, VANCOUVER, WA:
2,201,350, CANC. INT. CL. 9.
- CARSTAR FRANCHISE SYSTEMS, INC., OVERLAND PARK, KS:
2,997,840, PUB. 6-28-2005. INT. CL. 37.
- CARTER, DELUCA, FARRELL & SCHMIDT, LLP, MELVILLE, NY:
2,996,559, PUB. 6-28-2005. INT. CL. 42.
2,996,560, PUB. 6-28-2005. INT. CL. 42.
2,996,561, PUB. 6-28-2005. INT. CL. 42.
- CARTER, FRANKLIN, FT. COLLINS, CO:
2,201,943, CANC. INT. CL. 42.
- CARTÉGRAPH SYSTEMS, INC., DUBUQUE, IA:
2,997,812, PUB. 6-28-2005. INT. CL. 9.
- CARUS PUBLISHING COMPANY, PERU, IL:
1,875,206, REN. 8-10-05. INT. CL. 16.
- CASA BELLA DESIGN CENTER, LLC, NAPERVILLE, IL:
2,999,047, INT. CL. 37.
- CASEY'S FRANCHISING SYSTEM L.L.C., OMAHA, NE:
2,200,974, CANC. INT. CL. 35.
- CASINO GUICHARD PERRACHON & CIE, 42008 ST.ETIENNE, FRANCE:
1,861,066, CANC. MULTIPLE CLASS, INT. CLS. 29, 30, 32 AND 33.
- CASTELLA IMPORTS, INC., FARMINGDALE, NY:
2,996,363, PUB. 6-28-2005. INT. CL. 35.
2,996,900, PUB. 6-28-2005. INT. CL. 35.
- CASTER, FRANCE:
2,998,369, PUB. 6-28-2005. INT. CL. 3.
- CASTLE BANCGROUP INC., DEKALB, IL:
2,202,218, CANC. INT. CL. 36.
- CASTLE ROCK INDUSTRIES, INC., ENGLEWOOD, CO:
1,354,870, REN. 8-8-05. MULTIPLE CLASS, INT. CLS. 3 AND 9.
- CATALOGOS ESTRATEGICOS, S.A. DE C.V., GUADALAJARA JALISCO, Z.C., MEXICO:
2,996,546, PUB. 6-28-2005. MULTIPLE CLASS, INT. CLS. 16, 35 AND 42.
- CATERINA, PATRICIA ANN, SO. EDINA, MN:
1,343,712, REN. 8-8-05. INT. CL. 3.
- CATERPILLAR INC., PEORIA, IL:
2,998,993, INT. CL. 7.
- CAUSEFFECTS, INC., DALLAS, TX:
2,996,727, PUB. 6-28-2005. INT. CL. 35.
- CAV. G. B. BERTANI S.R.L., GREZZANA (VERONA), ITALY, CAV. G. B. BERTANI, VERNONA, ITALY:
1,010,815, REN. 8-9-05. U.S. CL. 47 (INT. CL. 33).
- CBI LABORATORIES, INC., CARROLLTON, TX:
2,202,111, CANC. INT. CL. 3.
- CBITE, INC., CHANTILLY, VA:
2,997,960, PUB. 6-28-2005. INT. CL. 5.
2,997,966, PUB. 6-28-2005. INT. CL. 5.
- CBS BROADCASTING INC., NEW YORK, NY:
2,998,975, INT. CL. 28.
2,998,976, INT. CL. 14.
2,998,977, INT. CL. 9.
- CBS INC., NEW YORK, NY:
2,201,411, CANC. INT. CL. 38.
- CBS, INC, JACKSONVILLE, FL, DBA MOTO IMPORTS:
2,997,583, PUB. 6-28-2005. INT. CL. 25.
- CDOMARKETING, ALMA, WI:
2,996,692, PUB. 6-28-2005. INT. CL. 35.
- CEACO, INC., WATERTOWN, MA:
2,996,839, PUB. 6-28-2005. INT. CL. 28.
2,996,840, PUB. 6-28-2005. INT. CL. 28.
- CEDARS-SINAI MEDICAL CENTER, LOS ANGELES, CA:
1,899,332, REN. 8-9-05. INT. CL. 42.

- CELANESE INTERNATIONAL CORPORATION, DALLAS, TX:
2,202,106, CANC. INT. CL. 1.
- CELESTIAL SEASONINGS, INC., BOULDER, CO:
1,302,945, CANC. INT. CL. 30.
- CELINE, FRANCE:
2,998,437, PUB. 6-28-2005. INT. CL. 3.
- CELL SIGNALING TECHNOLOGY, INC., BEVERLY, MA:
2,998,813, INT. CL. 1.
- CELLECTRICON AB, GOTHENBURG, SWEDEN:
2,996,954, PUB. 6-28-2005. MULTIPLE CLASS, INT. CLS. 9, 35 AND 42.
- CELTRA, INC., PORTLAND, OR:
2,996,805, PUB. 6-28-2005. INT. CL. 44.
2,996,806, PUB. 6-28-2005. INT. CL. 44.
- CENCOURSE, MIAMI, FL:
2,997,765, PUB. 6-28-2005. INT. CL. 38.
- CENTER FOR HEALTHCARE INDUSTRY PERFORMANCE STUDIES, COLUMBUS, OH TO INGENIX, INC., EDEN PRAIRIE, MN:
1,860,787, CANC. INT. CL. 9.
- CENTER OF THE WORLD, INC., FELICITY, CA:
1,866,566, REN. 8-11-05. INT. CL. 38.
- CENTER PARCS EUROPE N.V., ROTTERDAM, NETHERLANDS FROM CENTER PARCS N.V., 3063 ED ROTTERDAM, NETHERLANDS:
2,996,256, PUB. 6-28-2005. MULTIPLE CLASS, INT. CLS. 39, 41 AND 42.
- CENTER PARCS N.V.:
See— CENTER PARCS EUROPE N.V.
- CENTEX CORPORATION, DALLAS, TX:
2,998,222, PUB. 6-28-2005. INT. CL. 36.
- CENTRAL AMERICAN PRODUCE, INC., POMPANO BEACH, FL:
2,996,832, PUB. 6-28-2005. INT. CL. 31.
- CENTRAL REFRIGERATED SERVICE, INC., WEST VALLEY CITY, UT:
2,997,156, PUB. 6-28-2005. INT. CL. 39.
- CENTRAL SOYA OF KANSAS CITY, INC., NORTH KANSAS CITY, MO:
779,539, CANC. U.S. CL. 46.
- CENTURION TECHNOLOGIES, INC., FENTON, MO:
2,998,659, INT. CL. 9.
- CENTURY BATHWORKS, INC, WEST PATERSON, NJ:
2,996,376, PUB. 6-28-2005. INT. CL. 11.
- CEO CHALLENGE LLC, BOULDER, CO:
2,999,347, INT. CL. 41.
- CEONEX, INC., NORTH ADAMS, MA:
2,997,776, PUB. 6-28-2005. INT. CL. 42.
- CEQUENT TOWING PRODUCTS, INC., PLYMOUTH, MI:
2,996,240, PUB. 6-28-2005. INT. CL. 12.
- CEREXAGRI, INC., PHILADELPHIA, PA, PENNWALT CORPORATION, PHILADELPHIA, PA:
1,320,115, REN. 8-6-05. INT. CL. 1.
- CERNER MULTUM, INC, DENVER, CO, MULTUM INFORMATION SERVICES, INC., DENVER, CO:
1,899,479, REN. 8-10-05. MULTIPLE CLASS, INT. CLS. 9 AND 42.
- CERTIFIED ABSTRACT AND SETTLEMENT, INC., EASTON, PA:
2,999,357, INT. CL. 42.
- CERTIFIED GROCERS OF CALIFORNIA, LTD., COMMERCE, CA:
2,201,937, CANC. INT. CL. 3.
- CERVECERIA DEL PACIFICO, S.A. DE C.V., COLONIA CHAPULTEPEC POLANCO, MEXICO:
1,336,171, REN. 8-10-05. INT. CL. 32.
- CESARANI, SALVATORE J., BROOKLYN, NY:
1,340,859, REN. 8-10-05. INT. CL. 25.
- CESSNA AIRCRAFT COMPANY, THE, WICHITA, KS:
1,303,138, CANC. INT. CL. 39.
- CETE SOFTWARE IP, LLC, BETHESDA, MD:
2,997,242, PUB. 6-28-2005. INT. CL. 9.
- CGE ENTERPRISES, LLC, WESTON, VT:
2,999,253, INT. CL. 21.
- CHAMPAGNE DEUTZ, 51106 AY, FRANCE, MAISON DEUTZ & GELDERMANN, AY, FRANCE:
1,354,566, REN. 8-10-05. INT. CL. 33.
- CHAMPION INTERNATIONAL CORPORATION, STAMFORD, CT:
1,303,273, CANC. INT. CL. 42.
- CHAMPION MANAGEMENT SYSTEMS, INC., BUIES CREEK, NC:
1,303,199, CANC. INT. CL. 41.
- CHANNELS TO CHILDREN, COLORADO SPRINGS, CO:
1,302,543, CANC. MULTIPLE CLASS, INT. CLS. 16 AND 41.
- CHANRICK, INC., MADISON, VA:
2,996,838, PUB. 6-28-2005. INT. CL. 44.
- CHARAPP & WEISS, LLP, WASHINGTON, DC:
2,997,677, PUB. 6-28-2005. MULTIPLE CLASS, INT. CLS. 16 AND 42.
- CHARIOT VANS, INC., ELKHART, IN:
1,302,491, CANC. INT. CL. 12.
- CHARLES KOMAR & SONS, INC., NEW YORK, NY:
2,999,006, INT. CL. 25.
- CHATMAN, PATRICIA RENEE, COLUMBUS, OH:
2,998,029, PUB. 6-28-2005. INT. CL. 41.
- CHEAP THRILLS, LLC., NEW YORK, NY:
2,996,676, PUB. 6-28-2005. INT. CL. 35.
- CHEAP TICKETS, INC., PARSIPPANY, NJ:
2,997,308, PUB. 6-28-2005. MULTIPLE CLASS, INT. CLS. 16, 35, 39 AND 43.
- CHEM PRUF DOOR CO., LTD., BROWNSVILLE, TX:
2,996,545, PUB. 6-28-2005. INT. CL. 19.
- CHEMGLASS, INC., VINELAND, NJ:
2,996,866, PUB. 6-28-2005. INT. CL. 9.
- CHEN HSIANG FOODS INDUSTRIAL CO., LTD., CHIA-YI HSIEN, TAIWAN:
2,998,963, MULTIPLE CLASS, INT. CLS. 29 AND 30.
- CHEN, GUOLIN, LOS ANGELES, CA:
2,998,281, PUB. 6-28-2005. INT. CL. 25.
- CHERUB TECHNOLOGY CO., LTD., SHENZHEN, CHINA:
2,999,200, INT. CL. 15.
- CHESAPEAKE CORPORATION, RICHMOND, VA:
2,997,860, PUB. 6-28-2005. MULTIPLE CLASS, INT. CLS. 40 AND 42.
- CHESAPEAKE WALLCOVERINGS CORPORATION, UPPER MARLBORO, MD:
2,202,211, CANC. INT. CL. 27.
- CHIBA PUBLICATIONS, INC., NEW YORK, NY:
2,997,766, PUB. 6-28-2005. INT. CL. 16.
- CHICAGO BOARD OPTIONS EXCHANGE, INC., CHICAGO, IL:
1,893,322, REN. 8-9-05. INT. CL. 36.
- CHICAGO COSMETOLOGISTS ASSOCIATION, INC., CHICAGO, IL:
2,999,318, MULTIPLE CLASS, INT. CLS. 35 AND 41.
- CHICAGO MERCANTILE EXCHANGE, CHICAGO, IL:
1,303,097, CANC. INT. CL. 36.
- CHILD EVANGELISM FELLOWSHIP INCORPORATED, WARRENTON, MO:
2,996,461, PUB. 6-28-2005. INT. CL. 45.
- CHILDREN'S PLACE RETAIL STORES, INC., THE, WEST CALDWELL, NJ:
2,202,296, CANC. INT. CL. 25.
- CHILI RECORDS, INC., SAN ANTONIO, TX:
2,997,890, PUB. 6-28-2005. INT. CL. 41.
- CHIMAC-AGRIPHAR, 4102 OUGREE, BELGIUM:
2,201,376, CANC. INT. CL. 5.
- CHINET COMPANY, THE, WATERVILLE, ME:
2,202,189, CANC. INT. CL. 21.
- CHIQUITA BRANDS, INC., CINCINNATI, OH:
1,861,521, CANC. INT. CL. 30.
- CHIVAS BROTHERS (AMERICAS) LIMITED, PASLEY, RENFREWSHIRE, UNITED KINGDOM, CHIVAS BROTHERS, ABERDEEN, SCOTLAND:
325,152, REN. 8-11-05. U.S. CL. 49 (INT. CL. 33).
- CHOATE, JOHN, STAMFORD, CT, DBA IRVAN MORITZKY AND DBA RCCTB CORP.:
1,861,313, CANC. INT. CL. 42.
- CHOICE INVESTMENT MANAGEMENT, LLC, GREENWOOD VILLAGE, CO:
2,996,702, PUB. 6-28-2005. INT. CL. 36.
- CHOO CHOO JOHNNY'S, INC., FRANKFORT, IL:
2,996,827, PUB. 6-28-2005. INT. CL. 43.

- CHOONG, YEN WEI, SANTA CRUZ, CA:
2,201,448, CANC. INT. CL. 5.
- CHOU, BELLE, UNION CITY, CA:
2,998,999, MULTIPLE CLASS, INT. CLS. 9 AND 10.
- CHRIS MADDEN INC., PORT CHESTER, NY:
2,997,219, PUB. 6-28-2005. INT. CL. 42.
2,999,161, INT. CL. 11.
2,999,162, INT. CL. 16.
2,999,163, INT. CL. 24.
2,999,164, INT. CL. 26.
- CHRIST INSPIRED, INC., FORT WORTH, TX:
2,997,601, PUB. 6-28-2005. INT. CL. 16.
- CHRISTENSEN, DANIEL L., MINNEAPOLIS, MN:
2,200,933, CANC. INT. CL. 19.
- CHRISTIAN-GOLDSCHMIEDE AG, SWITZERLAND:
2,998,382, PUB. 6-28-2005. INT. CL. 14.
- CHRISTIE DIGITAL SYSTEMS USA, INC., CYPRESS, CA:
1,339,045. REN. 8-11-05. INT. CL. 9.
- CHRISTINA AMERICA INC., MONTREAL, QUEBEC, CANADA:
2,997,324, PUB. 6-28-2005. INT. CL. 25.
- CHRIVIA, WESLEY B., BAY CITY, MI:
2,996,818, PUB. 6-28-2005. MULTIPLE CLASS, INT. CLS. 25 AND 28.
- CH2M HILL, INC., ENGLEWOOD, CO:
2,998,896, INT. CL. 35.
- CIELO S.P.A., I-36050 MONTORSO, ITALY:
2,201,515, CANC. INT. CL. 33.
- CIGAR SAVOR ENTERPRISES LLC, SEYMOUR, CT:
2,202,182, CANC. INT. CL. 34.
- CIGAR SAVOR ENTERPRISES LLC, WOODBRIDGE, CT:
2,202,234, CANC. INT. CL. 1.
- CIGNA INTELLECTUAL PROPERTY, INC., WILMINGTON, DE:
1,334,825. REN. 8-8-05. INT. CL. 42.
- CILCORP INC., PEORIA, IL:
2,201,803, CANC. INT. CL. 35.
- CINEA, INC., RESTON, VA:
2,997,905, PUB. 6-28-2005. MULTIPLE CLASS, INT. CLS. 9 AND 42.
- CINTAS FIRST AID HOLDINGS CORP., SPARKS, NV:
1,861,328, CANC. MULTIPLE CLASS, INT. CLS. 3, 5, 10, 41 AND 42.
- CIRCLE ATHLETICS, INC., PLAINFIELD, IL:
2,998,994, MULTIPLE CLASS, INT. CLS. 25 AND 28.
2,999,020, MULTIPLE CLASS, INT. CLS. 25 AND 28.
- CIRCUIT CITY STORES WEST COAST, INC., WALNUT, CA TO CARMAX BUSINESS SERVICES, LLC, GLEN ALLEN, VA:
1,861,208, CANC. MULTIPLE CLASS, INT. CLS. 37 AND 42.
- CITICORP, NEW YORK, NY:
1,303,042, CANC. INT. CL. 35.
2,201,048, CANC. INT. CL. 36.
- CITIES INSPECTION SERVICE, INCORPORATED, BURNSVILLE, MN:
1,861,209, CANC. INT. CL. 37.
- CITPRO CORPORATION, CORAL SPRINGS, FL:
2,997,199, PUB. 6-28-2005. INT. CL. 41.
- CITRA TRADING CORPORATION, NEW YORK, NY:
2,201,941, CANC. INT. CL. 14.
- CITRUSNET, INC., RIVERSIDE, CA:
2,201,067, CANC. INT. CL. 42.
- CITY NATIONAL BANK, BEVERLY HILLS, CA:
2,996,242, PUB. 6-28-2005. INT. CL. 36.
- CITY OF ATLANTA BUREAU OF CULTURAL AFFAIRS, ATLANTA, GA:
2,996,668, PUB. 6-28-2005. MULTIPLE CLASS, INT. CLS. 16, 25 AND 41.
- CITY OF PHILADELPHIA, THE, PHILADELPHIA, PA, DBA TRUSTEE OF THE WILLS EYE HOSPITAL TRUST, AN UNINCORPORATED NON-PROFIT TRUST OF PENNSYLVANIA:
1,874,278. REN. 8-6-05. MULTIPLE CLASS, INT. CLS. 41 AND 42.
- CITY OF ST. CLOUD, MINNESOTA, ST. CLOUD, MN:
2,996,836, PUB. 6-28-2005. INT. CL. 35.
- CITY OF TACOMA, STATE OF WASHINGTON, TACOMA, WA:
1,303,173, CANC. INT. CL. 41.
- CK FRANCHISE SYSTEMS, INC., LOS ANGELES, CA:
2,997,513, PUB. 6-28-2005. INT. CL. 43.
- CLAIMANT EMPLOYMENT SERVICES, INC., LAKE MARY, FL:
2,201,062, CANC. INT. CL. 35.
- CLAM INDUSTRIES, INC., LAKELAND, FL:
1,861,622. REN. 8-9-05. INT. CL. 7.
- CLAMP SWING PRICING CO., OAKLAND, CA:
2,999,251, INT. CL. 20.
- CLANTON, JOHN W., BRYAN, TX:
2,997,184, PUB. 6-28-2005. MULTIPLE CLASS, INT. CLS. 35 AND 37.
- CLARIS CORPORATION, SANTA CLARA, CA:
2,049,425, CANC. INT. CL. 9.
- CLARITUS, INC., SIOUX FALLS, SD:
2,997,028, PUB. 6-28-2005. MULTIPLE CLASS, INT. CLS. 35 AND 42.
- CLARK, HARVEY P., BOYLSTON, MA:
2,999,389, INT. CL. 30.
- CLARK, MICHAEL E., TINLEY PARK, IL:
2,997,647, PUB. 6-28-2005. INT. CL. 43.
- CLASS 1, INC., OCALA, FL:
2,997,200, PUB. 6-28-2005. INT. CL. 9.
- CLAUSEN COMPANY, THE, FORDS, NJ:
1,302,315, CANC. INT. CL. 1.
- CLAYTON I.D.S., INC., COLUMBUS, OH:
2,997,137, PUB. 6-28-2005. INT. CL. 9.
- CLEAR DIRECTIONS, INC., UKIAH, CA:
2,999,118, MULTIPLE CLASS, INT. CLS. 41 AND 45.
- CLEMENT COMMUNICATIONS, INCORPORATED, CONCORDVILLE, PA:
2,202,361, CANC. INT. CL. 16.
- CLEVELAND MACHINE CONTROLS, INC., CLEVELAND, OH TO CLEVELAND MOTION CONTROLS, INC., CLEVELAND, OH:
1,860,779, CANC. INT. CL. 9.
- CLIFF COOK GOLF CO., INC., AMARILLO, TX:
2,201,875, CANC. MULTIPLE CLASS, INT. CLS. 25 AND 28.
- CLIFFMART, LLC, LOS ANGELES, CA, DBA TRIPLE PLAY SYSTEMS:
2,202,159, CANC. INT. CL. 9.
- CLIMATE TECHNOLOGIES PTY LTD, SOUTH AUSTRALIA, AUSTRALIA:
2,999,033, INT. CL. 11.
- CLINICAL DYNAMICS CORPORATION, WALLINGFORD, CT:
2,201,181, CANC. INT. CL. 10.
- CLINICAL INNOVATIONS ASSOCIATES, INC., MURRAY, UT:
2,145,670, COR. INT. CL. 10.
2,562,058, COR. INT. CL. 10.
2,615,500, COR. INT. CL. 10.
2,752,902, COR. INT. CL. 10.
2,772,711, COR. INT. CL. 10.
- CLOG MASTER OF SWEDEN, INC., LOS ANGELES, CA:
2,997,767, PUB. 6-28-2005. INT. CL. 25.
- CLOUDEIGHT INTERNET LLC, HASTINGS, MI:
2,997,687, PUB. 6-28-2005. INT. CL. 9.
- CLUETT PEABODY RESOURCES CORPORATION, NEW YORK, NY:
2,999,224, INT. CL. 25.
- CMP MEDIA LLC, MANHASSET, NY:
1,337,904. REN. 8-11-05. INT. CL. 16.
2,997,878, PUB. 6-28-2005. INT. CL. 42.
2,997,879, PUB. 6-28-2005. INT. CL. 42.
2,998,180, PUB. 6-28-2005. INT. CL. 42.
2,998,181, PUB. 6-28-2005. INT. CL. 42.
2,998,182, PUB. 6-28-2005. INT. CL. 42.
2,998,183, PUB. 6-28-2005. INT. CL. 42.
2,998,184, PUB. 6-28-2005. INT. CL. 42.
2,998,185, PUB. 6-28-2005. INT. CL. 42.
- CNA FINANCIAL CORPORATION, CHICAGO, IL, DBA CNA:
1,303,093, CANC. INT. CL. 36.

- CNE ENERGY SERVICES GROUP, INC., BRIDGEPORT, CT:
2,201,832, CANC. INT. CL. 36.
- CNF INC., PALO ALTO, CA:
2,996,412, PUB. 6-28-2005. MULTIPLE CLASS, INT. CLS.
16, 35 AND 39.
- CNH AMERICA LLC, RACINE, WI, INTERNATIONAL
HARVESTER COMPANY, CHICAGO, IL:
1,314,585, REN. 8-9-05. INT. CL. 16.
- COALITION OF ENTREPRENEURIAL ORGANIZATIONS,
INC., GLENS FALLS, NY:
2,202,007, CANC. INT. CL. 3.
- COAST TO COAST TELECOMMUNICATIONS, INC.,
CLARKSTON, MI:
2,201,047, CANC. INT. CL. 38.
- COAXIS, INC., HUNT VALLEY, MD:
2,997,016, PUB. 6-28-2005. INT. CL. 9.
- COBBLESTONE AUTO SPA & MARKET I, L.L.C., SCOTTSDALE, AZ:
2,997,996, PUB. 6-28-2005. INT. CL. 35.
- COBRA ELECTRONICS CORPORATION, CHICAGO, IL:
2,834,936, COR. INT. CL. 9.
- COCA-COLA COMPANY; THE, ATLANTA, GA:
1,317,204, REN. 8-6-05. INT. CL. 30.
1,334,619, REN. 8-9-05. INT. CL. 32.
- COCOS INTERNATIONAL TRADING INC, LOS ANGELES,
CA:
2,998,820, INT. CL. 18.
- CODA MUSIC TECHNOLOGY, INC., EDEN PRAIRIE, MN:
2,201,239, CANC. INT. CL. 9.
- COFFEA S.A., 1009 PULLY, SWITZERLAND:
2,201,559, CANC. MULTIPLE CLASS, INT. CLS. 11, 21, 29
AND 30.
- COGEN, S.A., BOSQUET 8, B-1400 NIVELLES, BELGIUM:
2,200,831, CANC. MULTIPLE CLASS, INT. CLS. 9, 16, 35
AND 42.
- COGEN, S.A., B-1400, NIVELLES, BELGIUM:
2,200,832, CANC. MULTIPLE CLASS, INT. CLS. 9, 16, 35
AND 42.
- COHEN, ROBERT M. JR., BRANFORD, CT:
2,201,517, CANC. INT. CL. 30.
- COHERENT, INC., SANTA CLARA, CA:
1,339,026, REN. 8-9-05. INT. CL. 9.
- COHN, SALOMON, SAN FRANCISCO, CA:
2,998,640, INT. CL. 10.
- COLART FINE ART & GRAPHICS LIMITED, MIDDLESEX,
HA3 5RH, UNITED KINGDOM:
2,996,229, PUB. 6-28-2005. INT. CL. 16.
- COLBY COLLEGE, WATERVILLE, ME:
1,303,189, CANC. INT. CL. 41.
- COLEGROVE, JAMES W., FORT WORTH, TX:
2,997,446, PUB. 6-28-2005. MULTIPLE CLASS, INT. CLS. 9
AND 41.
- COLITA BEVERAGE CORP., HOWARD BEACH, NY:
2,201,525, CANC. INT. CL. 32.
- COLL, FRANCISCO, WASHINGTON, DC:
1,864,011, REN. 8-10-05. INT. CL. 41.
- COLLABORACT CONSULTING, LLC, MINNEAPOLIS, MN:
2,997,822, PUB. 6-28-2005. INT. CL. 35.
- COLLEGE ENTRANCE EXAMINATION BOARD, NEW
YORK, NY:
1,303,052, CANC. INT. CL. 35.
- COLLISION SERVICES, INC., HUDSON, IA:
2,997,297, PUB. 6-28-2005. MULTIPLE CLASS, INT. CLS.
37, 41 AND 42.
- COLOPLAST A/S, DENMARK:
2,998,430, PUB. 6-28-2005. INT. CL. 10.
- COLOR-BOX, LLC, ATLANTA, GA:
2,997,216, PUB. 6-28-2005. MULTIPLE CLASS, INT. CLS.
16 AND 40.
- COLORADO BOARDROOM, INC., LAKEWOOD, CO:
2,200,841, CANC. MULTIPLE CLASS, INT. CLS. 25 AND
28.
- COLORADO SPECIAL EVENTS, INC., LAKEWOOD, CO:
2,997,482, PUB. 6-28-2005. INT. CL. 44.
- COLORBLIND S.A., CH1753 MATRAN, SWITZERLAND:
2,998,362, PUB. 6-28-2005. INT. CL. 25.
- COLOTEX INDUSTRIAL CO., LTD., TAIPEI, TAIWAN:
2,996,483, PUB. 6-28-2005. INT. CL. 25.
- COLSON CASTER CORPORATION, CHICAGO, IL:
779,384, CANC. U.S. CL. 19.
- COLUMBIA ARTISTS MANAGEMENT INC., NEW YORK,
NY:
1,358,478, REN. 8-8-05. INT. CL. 41.
- COLUMBIA INSURANCE COMPANY, OMAHA, NE:
607,563, REN. 8-11-05. U.S. CL. 16 (INT. CL. 2).
- COLUMBUS REGIONAL HEALTHCARE SYSTEM, INC.,
COLUMBUS, GA:
1,303,245, CANC. INT. CL. 42.
- COMMAND PACKAGING, LOS ANGELES, CA:
2,999,379, INT. CL. 16.
- COMMAND SYSTEMS, INC., FAMINGTON, CT:
2,201,424, CANC. INT. CL. 9.
- COMMERCE BANCORP, INC., CHERRY HILL, NJ:
2,996,378, PUB. 6-28-2005. INT. CL. 41.
- COMMERCIAL RISK PARTNERS LIMITED, HAMILTON
HM BX, BERMUDA:
1,865,407, REN. 8-10-05. INT. CL. 36.
- COMMODITY NEWS SERVICES, INC., NEW YORK, NY:
1,302,561, CANC. INT. CL. 16.
- COMMSCO HOLDING SA LUXEMBOURG, PRINCE HENRI
1724, LUXEMBOURG:
2,996,271, PUB. 6-28-2005. MULTIPLE CLASS, INT. CLS.
9, 35, 38 AND 42.
- COMMUNICATION CONCEPTS, INC., HUNTINGTON
BEACH, CA, DBA ILLUSTRATED GRAPHIC COMMU-
NICATIONS:
2,201,410, CANC. INT. CL. 16.
- COMMUNICATION MACHINERY CORPORATION, SAN-
TA BARBARA, CA:
2,997,089, PUB. 6-28-2005. INT. CL. 9.
- COMMUNITY CLUB AWARDS, INC., WESTPORT, CT:
1,861,163, CANC. INT. CL. 35.
- COMMUNITY DENTAL SERVICES, INC., SANTA ANA, CA,
DBA SMILECARE DENTAL GROUP:
2,996,841, PUB. 6-28-2005. INT. CL. 44.
2,996,842, PUB. 6-28-2005. INT. CL. 36.
- COMMVAULT SYSTEMS, INC., OCEANPORT, NJ:
2,999,321, INT. CL. 9.
- COMPAGNIE LAITIERE EUROPEENNE, CONDE-SUR-
VIRE, FRANCE:
2,996,958, PUB. 6-28-2005. INT. CL. 29.
- COMPANIA CERILLERA LA CENTRAL, S.A. DE C.V., COL-
ATLAMP, MEXICO:
2,997,091, PUB. 6-28-2005. INT. CL. 34.
- COMPANIA LICORERA DE CENTROAMERICA, S.A., MIA-
MI, FL:
1,861,443, CANC. INT. CL. 33.
- COMPASS GROUP USA, INC., CHARLOTTE, NC:
2,998,341, PUB. 6-28-2005. MULTIPLE CLASS, INT. CLS.
35 AND 42.
- COMPASS POINT BOOKS, INC., MINNEAPOLIS, MN:
2,997,738, PUB. 6-28-2005. INT. CL. 16.
- COMPASS PUBLISHING BV, 3062 MA ROTTERDAM,
NETHERLANDS:
2,996,280, PUB. 3-29-2005. MULTIPLE CLASS, INT. CLS.
35 AND 42.
- COMPETITION SPORTS CORP., FARMINGDALE, NY:
2,997,579, PUB. 6-28-2005. INT. CL. 28.
- COMPETITIVE INTELLIGENCE & CONSULTING LIM-
ITED, LONDON, UNITED KINGDOM:
2,997,154, PUB. 6-28-2005. INT. CL. 35.
- COMPLITIME SA, SWITZERLAND:
2,998,464, PUB. 6-28-2005. INT. CL. 14.
- COMPUSOURCE, CARY, NC:
1,303,231, CANC. INT. CL. 42.
- COMPUTER CURRICULUM CORPORATION, SUNNY-
VALE, CA:
2,201,310, CANC. INT. CL. 9.
2,201,311, CANC. INT. CL. 9.
- COMPUTER SCIENCES CORPORATION, EL SEGUNDO,
CA:
1,303,048, CANC. INT. CL. 35.
- COMPUTERIZED SECURITY SYSTEMS, INC., TROY, MI:
2,999,065, INT. CL. 9.
- COMTESSE DU BARRY, 32200 GIMONT, FRANCE:
1,895,205, REN. 8-12-05. MULTIPLE CLASS, INT. CLS. 29

- AND 30.
 COMUNIDAD HUEVO, S.A. DE C.V., MEXICO, D.F., MEXICO:
 2,998,290, PUB. 6-28-2005. INT. CL. 25.
 COMUNIDAD HUEVO, S.A. DE C.V., COLONIA DEL VALLE, MEXICO:
 2,998,347, PUB. 6-28-2005. INT. CL. 16.
 COMWELD GROUP PTY LTD., PRESTON, VICTORIA, AUSTRALIA:
 2,201,776, CANC. INT. CL. 9.
 CONAGRA BRANDS, INC., OMAHA, NE:
 2,202,254, CANC. INT. CL. 16.
 2,996,772, PUB. 6-28-2005. INT. CL. 30.
 CONAIR CORPORATION, EDISON, NJ:
 1,302,432, CANC. MULTIPLE CLASS, INT. CLS. 9 AND 11.
 CONAIR CORPORATION, STAMFORD, CT:
 2,999,121, INT. CL. 21.
 CONCEPT MARKETING GROUP, INC., O'FALLON, MO:
 2,202,026, CANC. INT. CL. 20.
 CONCORD MUSIC GROUP, INC., BERKELEY, CA:
 2,996,468, PUB. 6-28-2005. INT. CL. 9.
 CONDITIONOMICS, LLC, PITTSBURGH, PA:
 2,997,969, PUB. 6-28-2005. INT. CL. 36.
 CONE, RICHARD R., KING'S MOUNTAIN, NC:
 2,202,112, CANC. INT. CL. 8.
 2,202,113, CANC. INT. CL. 8.
 CONGOLEUM CORPORATION, MERCERVILLE, NJ:
 2,998,926, INT. CL. 1.
 CONGRESS FINANCIAL CORPORATION (FLORIDA), AS AGENT, FORT LAUDERDALE, FL:
 1,302,621, CANC. MULTIPLE CLASS, INT. CLS. 18 AND 25.
 1,302,744, CANC. INT. CL. 25.
 CONGRESS FINANCIAL CORPORATION, (FLORIDA), AS AGENT, MIAMI, FL:
 1,302,925, CANC. INT. CL. 30.
 CONGRESSIONAL BLACK CAUCUS FOUNDATION, INC., WASHINGTON, DC:
 2,997,030, PUB. 6-28-2005. MULTIPLE CLASS, INT. CLS. 36 AND 41.
 CONN-SELMER, INC., ELKHART, IN:
 1,882,099, REN. 8-10-05. INT. CL. 15.
 CONNECTABLES, L.L.C., WAUKEGAN, IL:
 2,997,385, PUB. 3-8-2005. INT. CL. 9.
 CONNECTIX CORPORATION, SAN MATEO, CA:
 2,312,281, CANC. INT. CL. 9.
 CONNETICS CORPORATION, PALO ALTO, CA:
 2,998,123, PUB. 6-28-2005. INT. CL. 5.
 CONSERVATION INTERNATIONAL FOUNDATION, WASHINGTON, DC:
 1,861,028, CANC. MULTIPLE CLASS, INT. CLS. 26 AND 42.
 CONSITEX S.A., 6850 MENDRISIO, SWITZERLAND:
 2,201,951, CANC. INT. CL. 25.
 CONSOLIDATED ENGINEERING CO, INC., KENNESAW, GA. CONSOLIDATED ENGINEERING CO, INC., KENNESAW, GA:
 1,896,908, REN. 8-9-05. INT. CL. 11.
 CONSOLIDATED PLASTICS COMPANY, INC., TWINSBURG, OH:
 1,930,445, REN. 8-9-05. MULTIPLE CLASS, INT. CLS. 11, 16, 17 AND 21.
 CONSORCIO COMEX, S.A. DE C.V., MEXICO, D.F., MEXICO:
 2,998,960, INT. CL. 2.
 CONSULTING PARTNERS, INC., DALLAS, TX:
 2,200,874, CANC. MULTIPLE CLASS, INT. CLS. 41 AND 42.
 CONSUMER RELATIONS, INC., MONSEY, NY:
 2,997,262, PUB. 6-28-2005. INT. CL. 35.
 CONSUMERVOTED.ORG, LLC, ATLANTA, GA:
 2,997,431, PUB. 6-28-2005. U.S. CL. 200.
 CONTEC, INC., SPARTABURGH, SC:
 1,892,675, REN. 8-10-05. INT. CL. 21.
 CONTEMPRADANCE THEATRE, INC., WAYNE, PA:
 2,996,565, PUB. 6-28-2005. INT. CL. 41.
 CONTENTSCAN, LLC, SAN DIEGO, CA:
 2,998,601, MULTIPLE CLASS, INT. CLS. 9, 35, 38, 41, 42 AND 44.
 CONTINENTAL AKTIENGESELLSCHAFT, 30165 HANNOVER, FED REP GERMANY:
 2,996,822, PUB. 6-28-2005. INT. CL. 12.
 CONTINENTAL AKTIENGESELLSCHAFT, FED REP GERMANY:
 2,998,404, PUB. 6-28-2005. INT. CL. 12.
 CONTINUOUS COATING CORP., ORANGE, CA:
 2,999,400, INT. CL. 19.
 2,999,401, INT. CL. 19.
 CONTRACTORSHEAVEN.COM, LOUISVILLE, KY:
 1,895,907, REN. 8-9-05. INT. CL. 7.
 CONTROL INSTRUMENTS, INC., SMYRNA, GA:
 1,861,278, CANC. INT. CL. 42.
 CONTROL'D ENGINEERING SUPPLY CO., INC., GLEN ELLYN, IL:
 1,009,269, REN. 8-11-05. INT. CL. 42.
 CONTURA SA, SWITZERLAND:
 2,998,438, PUB. 6-28-2005. MULTIPLE CLASS, INT. CLS. 5 AND 10.
 CONWAY/MILLIKEN & ASSOCIATES, INC., CHICAGO, IL:
 1,303,046, CANC. INT. CL. 35.
 CONWAY/MILLIKEN ASSOCIATES, INC., CHICAGO, IL:
 1,303,047, CANC. INT. CL. 35.
 COOGI PARTNERS, LLC, LAKE SUCCESS, NY:
 2,996,871, PUB. 6-28-2005. INT. CL. 25.
 COOK, DAVID W., DENVER, CO:
 2,201,349, CANC. INT. CL. 25.
 COOKIE TRAIL CONNECTION, MANSFIELD CENTER, CT:
 2,999,126, INT. CL. 35.
 COOPER BRANDS, INC., HOUSTON, TX, NICHOLSON FILE COMPANY, PROVIDENCE, RI:
 50,137, REN. 8-11-05. U.S. CL. 23 (INT. CL. 8).
 COOPERSTOWN PROPERTIES, L.L.C., SALISBURY, NC:
 2,996,945, PUB. 6-28-2005. INT. CL. 41.
 COOPERSURGICAL, INC., PLEASANTON, CA:
 1,862,209, REN. 8-10-05. MULTIPLE CLASS, INT. CLS. 5, 10 AND 11.
 COORS GLOBAL PROPERTIES, INC., LAKEWOOD, CO:
 2,997,442, PUB. 6-28-2005. INT. CL. 32.
 COPELAND CORPORATION, SIDNEY, OH:
 2,998,159, PUB. 6-28-2005. INT. CL. 37.
 COPERNICUS BUSINESS SYSTEMS, LLC, SMYRNA, GA:
 2,998,200, PUB. 6-28-2005. INT. CL. 9.
 COPPER MOUNTAIN NETWORKS, INC., SAN DIEGO, CA:
 2,201,982, CANC. INT. CL. 9.
 CORBETT LIGHTING, INC., CITY OF INDUSTRY, CA:
 1,897,450, REN. 8-10-05. INT. CL. 11.
 CORDON BLEU INTERNATIONAL LTD., VILLE D'ANJOU, QUEBEC, CANADA:
 532,003, CANC. U.S. CL. 46.
 CORDON BLEU INTERNATIONAL, LTD., ANJOU QUEBEC HIJ 2P8, CANADA:
 660,848, CANC. U.S. CL. 46.
 CORE COMMUNITIES, LLC, PORT ST. LUCIE, FL:
 2,999,160, INT. CL. 41.
 CORECHANGE, INC., BOSTON, MA:
 2,201,807, CANC. MULTIPLE CLASS, INT. CLS. 9 AND 42.
 COREMATRIX SYSTEMS LLC, RED BANK, NJ:
 2,996,347, PUB. 6-28-2005. INT. CL. 42.
 CORESLAB HOLDINGS U.S., INC., CEDAR PARK, TX:
 2,997,279, PUB. 6-28-2005. INT. CL. 37.
 CORNERSTONE SENSORS, INC., VISTA, CA:
 2,997,936, PUB. 6-28-2005. INT. CL. 9.
 CORNERSTONE SYSTEMS, INC., IRVINE, CA:
 2,997,314, PUB. 6-28-2005. INT. CL. 9.
 2,997,315, PUB. 6-28-2005. INT. CL. 9.
 COROLLARY, INC., IRVINE, CA:
 2,201,037, CANC. INT. CL. 9.
 CORONEOS, DIANNE, STANWOOD, WA:
 1,861,006, CANC. INT. CL. 25.
 CORPORATE EXPRESS, INC., BROOMFIELD, CO:
 2,997,651, PUB. 6-28-2005. INT. CL. 35.

- CORPORATE MENTORING SOLUTIONS, INC., SAANICHTON, BRITISH COLUMBIA, CANADA:
2,998,890, INT. CL. 41.
- CORREDOIRA, CARLOS A., FORT MYERS, FL AND SAPP, STEVEN D., FORT MYERS, FL:
2,998,649, INT. CL. 45.
- CORRINGTON'S ALASKAN IVORY LTD., SKAGWAY, AK:
2,998,913, INT. CL. 21.
- COSMETIQUE SANS SOUCIS GMBH, BADEN-BADEN, FED REP GERMANY:
1,302,347, CANC. INT. CL. 3.
1,302,348, CANC. INT. CL. 3.
- COSMICHROME, INC., BROOKPARK, OH:
2,997,073, PUB. 6-28-2005. MULTIPLE CLASS, INT. CLS. 2 AND 7.
- COSTA COLOR MERCHANDISING INC., GOULDS, FL:
2,997,034, PUB. 6-28-2005. INT. CL. 44.
- COSTAR REALTY INFORMATION, INC., BETHESDA, MD:
2,996,462, PUB. 6-28-2005. INT. CL. 36.
- COTTA TRANSMISSION COMPANY, LLC, BELOIT, WI:
2,997,946, PUB. 6-28-2005. MULTIPLE CLASS, INT. CLS. 7 AND 12.
- COTTAGE CHIC, INC., PINEHURST, NC:
2,997,754, PUB. 6-28-2005. INT. CL. 35.
- COTTAGE GREEN, LLC, FT. LAUDERDALE, FL:
2,997,759, PUB. 6-28-2005. INT. CL. 21.
- COTTRELL, LTD., ENGLEWOOD, CO TO COTTRELL INTERNATIONAL, LLC., ENGLEWOOD, CO, DBA COTTRELL, LTD.:
1,860,651, CANC. INT. CL. 5.
- COUCH/BRAUNSDORF AFFINITY, INC., LIBERTY CORNER, NJ:
2,997,414, PUB. 6-28-2005. INT. CL. 9.
- COUNCIL OF INSURANCE AGENTS & BROKERS, THE, WASHINGTON, DC:
2,998,701, MULTIPLE CLASS, INT. CLS. 16 AND 41.
- COUNTRY INNS & SUITES BY CARLSON, INC., MINNEAPOLIS, MN:
2,999,171, INT. CL. 43.
- COUNTRYSIDE FRAGRANCES, INC., SEATTLE, WA:
2,201,481, CANC. INT. CL. 3.
- COURTROOM TELEVISION NETWORK LLC, NEW YORK, NY:
2,998,085, PUB. 6-28-2005. INT. CL. 41.
- COVENTRY CONNECTIONS, INC., OTTAWA, ONTARIO, CANADA:
2,996,370, PUB. 6-28-2005. INT. CL. 9.
- COVERTECH FABRICATING INC., ETOBICOKE ONTARIO M9W 5T8, CANADA:
2,999,338, INT. CL. 17.
- COVEY LEADERSHIP CENTER, PROVO, UT TO FRANKLIN COVEY CO., SALT LAKE CITY,, UT:
1,861,256, CANC. INT. CL. 41.
- COX COMMUNICATIONS, INC., ATLANTA, GA:
2,996,701, PUB. 6-28-2005. INT. CL. 41.
- COZMOFON INC., TORONTO, CANADA:
2,997,794, PUB. 6-28-2005. INT. CL. 36.
- CPI COMPANIES, INC., BROOKFIELD, WI:
2,999,049, INT. CL. 41.
- CRA INTERNATIONAL, CO., MIAMI, FL:
2,998,651, INT. CL. 3.
- CRABTREE & EVELYN, LTD., WOODSTOCK, CT:
2,998,931, MULTIPLE CLASS, INT. CLS. 20, 21, 24 AND 35.
- CRACK TEAM USA, INC., ST. LOUIS, MO:
2,997,744, PUB. 6-28-2005. INT. CL. 37.
- CRAIG ZABLOCKI, INDIANAPOLIS, IN:
2,201,014, CANC. INT. CL. 41.
- CRANE & CO., INC., DALTON, MA:
2,999,230, INT. CL. 17.
2,999,231, INT. CL. 17.
- CREAMERY HOLLOW USA, INC., PRESTON, ID:
2,201,533, CANC. INT. CL. 29.
- CREATING CHARACTER LLC, SAGINAW, MI:
2,996,807, PUB. 6-28-2005. INT. CL. 41.
2,996,808, PUB. 6-28-2005. INT. CL. 41.
- CREATIVE BEAUTY CONCEPTS, LTD., SKOKIE, IL:
2,998,273, PUB. 6-28-2005. INT. CL. 9.
- CREATIVE EDUCATIONAL CONCEPTS, INC., LEXINGTON, KY:
2,998,906, INT. CL. 41.
- CREDIT UNION CAREERS, INC., TALLAHASSEE, FL:
2,998,584, INT. CL. 35.
- CRIS CONF S.P.A., FIDENZA (PARMA, ITALY):
2,996,395, PUB. 6-28-2005. MULTIPLE CLASS, INT. CLS. 18 AND 25.
- CRISPINOS HOMEMADE ITALIAN ICES, INC., BAYSIDE, NY:
2,999,324, INT. CL. 35.
- CRK, INC., HONOLULU, HI, DBA RUSS K MAKAHA:
2,997,427, PUB. 6-28-2005. MULTIPLE CLASS, INT. CLS. 25 AND 28.
- CROCODILE ENTERPRISES, INC., PASADENA, CA:
2,201,556, CANC. INT. CL. 42.
- CROSS MATCH TECHNOLOGIES, INC., PALM BEACH GARDENS, FL:
2,999,176, INT. CL. 9.
- CROWN PRINCE, INC., FRANKLIN, WI:
2,998,995, INT. CL. 25.
- CRUPAIN, DANIEL, NEW YORK, NY:
2,998,867, INT. CL. 42.
- CRYSTAL SEA RECORDS, INC., HAMPSTEAD, NC:
2,996,569, PUB. 6-28-2005. INT. CL. 9.
- CSL LIMITED, PARKVILLE, VICTORIA 3052, AUSTRALIA:
2,200,936, CANC. INT. CL. 1.
- CST INDUSTRIES, INC., KANSAS CITY, KS, A.O. SMITH HARVESTORE PRODUCTS, INC., DEKALB, IL:
1,928,217, REN. 8-11-05. INT. CL. 7.
1,928,218, REN. 8-11-05. INT. CL. 7.
- CUBIC CORPORATION, SAN DIEGO, CA:
780,285, REN. 8-9-05. U.S. CL. 26 (INT. CL. 9).
780,286, REN. 8-9-05. U.S. CL. 26 (INT. CL. 9).
- CULLIGAN INTERNATIONAL COMPANY, NORTHBROOK, IL:
1,890,197, REN. 8-9-05. MULTIPLE CLASS, INT. CLS. 37, 39 AND 42.
- CULLINAN ANSTALT, VADUZ, LIECHTENSTEIN:
2,996,925, PUB. 6-28-2005. INT. CL. 14.
- CURE SOURCE, INC., CHARLESTON, SC:
2,997,889, PUB. 6-28-2005. INT. CL. 44.
2,997,912, PUB. 6-28-2005. INT. CL. 44.
- CURRY, CHRISTOPHER, STUDIO CITY, CA:
2,997,577, PUB. 6-28-2005. MULTIPLE CLASS, INT. CLS. 25 AND 42.
- CUSHION CUT, INC., TORRANCE, CA TO BOART LONG-YEAR COMPANY, SALT LAKE CITY, UT:
1,860,677, CANC. INT. CL. 7.
- CUSHMAN WINERY CORPORATION, LOS ANGELES, CA, ZACA MESA WINERY, LOS OLIVOS, CALIFORNIA, CA:
1,358,359, REN. 8-11-05. INT. CL. 33.
- CUSTOM BUILT PUBLISHING LLC, MINNEAPOLIS, MN:
2,999,371, INT. CL. 16.
- CUSTOMFLIX LABS, INC., LOS GATOS, CA:
2,996,895, PUB. 6-28-2005. INT. CL. 35.
- CUTS FITNESS FOR MEN, CLARK, NJ:
2,996,543, PUB. 6-28-2005. INT. CL. 41.
- CYBERDUCTIONS, INC., NORWELL, MA:
2,999,041, INT. CL. 45.
- CYBERNET WORLD BUSINESS, INC., GLENDALE, CA:
2,996,250, PUB. 3-8-2005. INT. CL. 36.
- CYBERSLICE, INC., SEATTLE, WA:
2,201,099, CANC. INT. CL. 35.
- CYBERTEXT PUBLISHING, INC., BLOOMINGTON, IN:
2,201,740, CANC. MULTIPLE CLASS, INT. CLS. 9 AND 41.
- CYBERZONE INTERACTIVE ENTERTAINMENT INC., LA MESA, CA:
2,996,946, PUB. 6-28-2005. INT. CL. 42.
- CYBEX INTERNATIONAL, INC., MEDWAY, MA:
2,997,223, PUB. 6-28-2005. INT. CL. 36.
- CYCLE GROUP, LTD., MIGDAL HAEMEK, ISRAEL:
2,998,161, PUB. 6-28-2005. INT. CL. 31.
- CYGNUS SOFTWARE LTD., TEL AVIV, ISRAEL:
2,997,109, PUB. 6-28-2005. INT. CL. 35.
- CYI, INC., CHATSWORTH, CA:
2,996,642, PUB. 6-28-2005. INT. CL. 28.

- CYPRESS COVE AT HEALTHPARK FLORIDA, INC, FORT MYERS, FL:
2,997,891, PUB. 6-28-2005. INT. CL. 41.
- CYPRUS GROUP, INC., THE, SPOKANE, WA:
2,201,397, CANC. INT. CL. 9.
- D & D GOLD PRODUCT CORPORATION, SANTA ANA, CA:
2,997,452, PUB. 6-28-2005. INT. CL. 30.
2,997,453, PUB. 6-28-2005. INT. CL. 30.
- D.L. MAHER COMPANY, NORTH READING, MA:
2,201,222, CANC. INT. CL. 16.
- D.O.C OPTICS CORPORATION, SOUTHFIELD, MI:
2,201,395, CANC. MULTIPLE CLASS, INT. CLS. 35 AND 42.
- D'ACCORD, INC., MIAMI, FL:
2,998,270, PUB. 6-28-2005. INT. CL. 25.
- D'ANGELO'S SANDWICH SHOPS, INC., WICHITA, KS:
2,107,484, CANC. INT. CL. 42.
- D'ARBELLES, RODOLFO, IV, HIGH SPRINGS, FL AND D'ARBELLES, MARYANN, HIGH SPRINGS, FL:
2,201,839, CANC. INT. CL. 16.
- DADE BEHRING INC., DEERFIELD, IL:
2,997,461, PUB. 6-28-2005. INT. CL. 9.
- DAEWOOK TECH CO., LTD, YONGIN-SI, REPUBLIC OF KOREA:
2,997,593, PUB. 6-28-2005. INT. CL. 21.
- DAH LIH MACHINERY INDUSTRY CO., LTD., TAIWAN, CHINA:
1,381,045, REN. 8-7-05. INT. CL. 7.
- DAIICHI PHARMACEUTICAL CO., LTD., JAPAN:
2,998,501, PUB. 6-28-2005. INT. CL. 5.
- DAIMLERCHRYSLER CORPORATION, AUBURN HILLS, MI:
2,999,082, INT. CL. 12.
2,999,131, INT. CL. 4.
2,999,134, INT. CL. 35.
- DAIRY FARMERS OF AMERICA, INC., KANSAS CITY, MO:
2,996,503, PUB. 6-28-2005. INT. CL. 29.
- DAIWA SEIKO, INC., HIGASHIKURUME-CITY, TOKYO, JAPAN:
2,202,346, CANC. INT. CL. 28.
- DAKOTA BANKSHARES, INC., FARGO, ND:
1,303,092, CANC. INT. CL. 36.
- DALLAS COWBOYS FOOTBALL CLUB, LTD., IRVING, TX:
2,996,639, PUB. 6-28-2005. MULTIPLE CLASS, INT. CLS. 4, 16, 18, 20 AND 24.
- DALSA INC., WATERLOO, ONTARIO, CANADA:
1,901,517, REN. 8-10-05. MULTIPLE CLASS, INT. CLS. 9 AND 42.
- DALTAM S.N.C. DI PEDROLI IRMA & C., MATTARELLO-TRENTO, ITALY:
2,998,663, INT. CL. 30.
- DAN RIVER INC., DANVILLE, VA:
779,491, CANC. U.S. CL. 39.
- DAN-DEE INTERNATIONAL LIMITED, JERSEY CITY, NJ:
1,894,180, REN. 8-8-05. INT. CL. 28.
- DAN' L WEBSTER/HEARTH' N KETTLE MANAGEMENT GROUP, HYANNIS, MA:
2,201,496, CANC. INT. CL. 29.
- DANCE PAWS, LLC, CAMBRIDGE, MA:
2,998,215, PUB. 6-28-2005. INT. CL. 25.
- DANNEMANN AG, SWITZERLAND:
2,998,357, PUB. 5-3-2005. MULTIPLE CLASS, INT. CLS. 3, 33 AND 34.
- DARE FOODS LIMITED, KITCHENER, ONTARIO, CANADA:
2,997,467, PUB. 6-28-2005. INT. CL. 30.
- DARE TO BE FIT, INC, BEVERLY HILLS, CA:
2,998,699, INT. CL. 41.
- DARLING PRODUCTS, INC., PENNGROVE, CA:
2,201,647, CANC. INT. CL. 9.
- DART CONTAINER CORPORATION, MASON, MI:
1,302,654, CANC. INT. CL. 21.
- DAS DISTRIBUTORS, INC., PALMYRA, PA:
1,859,541, REN. 8-9-05. INT. CL. 9.
- DATA GROUP SELECT, LLC, OAKLAND, NJ:
2,996,660, PUB. 6-28-2005. INT. CL. 35.
- DATA NET CORPORATION, MIRAMAR, FL:
1,860,772, CANC. INT. CL. 9.
- DATA-GRATER FANCHISES, INC., CAMBRIDGE, MA:
1,303,125, CANC. INT. CL. 37.
- DATABASE MARKETING GROUP, INC., SANTA ANA, CA, BRAND BANDIT, INC., SANTA ANA, CA:
1,920,090, REN. 8-11-05. INT. CL. 35.
- DATAVIZ, INC., MILFORD, CT:
2,996,755, PUB. 6-28-2005. INT. CL. 9.
- DAUM COMMUNICATIONS CORP., SEOUL, REPUBLIC OF KOREA:
2,997,100, PUB. 6-28-2005. INT. CL. 38.
- DAVCO MANUFACTURING LTD., GRANDE PRAIRIE, CANADA:
2,997,052, PUB. 6-28-2005. INT. CL. 7.
- DAVE'S LURES, LLC, NORMAN, OK:
2,998,264, PUB. 6-28-2005. INT. CL. 28.
2,998,265, PUB. 6-28-2005. INT. CL. 28.
- DAVID LIVINGSTONE MISSIONARY FOUNDATION, INC., MORGANTOWN, WV:
2,997,359, PUB. 6-28-2005. INT. CL. 43.
- DAVID OPPENHEIMER AND ASSOCIATES PARTNERSHIP, COQUITLAM BRITISH COLUMBIA, CANADA:
2,999,339, MULTIPLE CLASS, INT. CLS. 31 AND 35.
- DAVIDGE, MATTHEW, LOS ANGELES, CA:
2,997,253, PUB. 6-28-2005. INT. CL. 25.
- DAVIES, GARTH W., LUXEMBURG, WI AND PERONTO, ALVIN L., LUXEMBURG, WI:
2,998,600, INT. CL. 28.
- DAYS MEDICAL AIDS LIMITED, BRIDGEND, UNITED KINGDOM:
2,996,979, PUB. 6-28-2005. MULTIPLE CLASS, INT. CLS. 10 AND 12.
- DC COMICS, NEW YORK, NY:
2,998,011, PUB. 6-28-2005. INT. CL. 41.
2,998,012, PUB. 6-28-2005. INT. CL. 9.
2,998,021, PUB. 6-28-2005. INT. CL. 25.
2,998,022, PUB. 6-28-2005. INT. CL. 28.
- DE GIORGIO, JOSE, MIAMI, FL:
2,642,912, CANC. INT. CL. 9.
- DEALERSHIP CONSULTING SERVICES, INC., RANCHO SANTA MARGARITA, CA:
2,997,411, PUB. 6-28-2005. INT. CL. 35.
- DEAN INTELLECTUAL PROPERTY SERVICES, L.P, DALLAS, TX:
1,342,962, REN. 8-11-05. INT. CL. 29.
- DEAN MARKLEY STRINGS, INC., SANTA CLARA, CA:
2,997,231, PUB. 6-28-2005. INT. CL. 3.
- DEAN SPECIALTY INTELLECTUAL PROPERTY SERVICES, L.P., DALLAS, TX:
1,322,380, REN. 8-6-05. INT. CL. 29.
- DECKY COMPANY, INC., COMPTON, CA:
2,999,079, INT. CL. 35.
- DECLEATER, INC., LAYTON, UT:
2,997,477, PUB. 6-28-2005. INT. CL. 28.
- DECONNA ICE CREAM, ORANGE LAKE, FL:
2,121,293, CANC. INT. CL. 30.
- DEDDENS, STEPHEN G., HOUSTON, TX:
1,861,140, CANC. INT. CL. 35.
- DEDO WEIGERT FILM GMBH, MUNICH, FED REP GERMANY:
2,996,969, PUB. 6-28-2005. MULTIPLE CLASS, INT. CLS. 9 AND 11.
- DEERE & COMPANY, MOLINE, IL:
2,997,174, PUB. 6-28-2005. INT. CL. 16.
- DEL MONTE CORPORATION, PITTSBURGH, PA:
2,997,884, PUB. 6-28-2005. INT. CL. 29.
- DELAWARE CAPITAL FORMATION, INC., WILMINGTON, DE:
2,997,603, PUB. 6-28-2005. INT. CL. 7.
- DELAWARE VALLEY CHILD CARE COUNCIL, PHILADELPHIA, PA:
2,202,157, CANC. INT. CL. 42.
- DELICIAS ANDINAS, CORONA, NY:
2,201,165, CANC. INT. CL. 30.
- DELTA CARBONA, L.P., FAIRFIELD, NJ:
2,997,580, PUB. 6-28-2005. INT. CL. 1.

- DELTA CONNECTION ACADEMY, INC., SANFORD, FL:
2,996,710, PUB. 6-28-2005. INT. CL. 41.
- DELTA CORPORATE IDENTITY, INC., ATLANTA, GA:
2,999,167, INT. CL. 43.
- DELTA DENTAL PLAN OF MICHIGAN, INC., OKEMOS, MI:
2,999,368, INT. CL. 36.
- DELUXE CRAFT MANUFACTURING CO., CHICAGO, IL:
2,201,472, CANC. INT. CL. 16.
- DEMPSIE, HERBERT, EAST FREEDOM, PA, DBA HD MERCHANT SERVICES:
2,996,635, PUB. 6-28-2005. INT. CL. 36.
- DENDRITIC NANOTECHNOLOGIES LIMITED, VICTORIA 3181, AUSTRALIA:
2,996,290, PUB. 6-28-2005. MULTIPLE CLASS, INT. CLS. 1, 5 AND 42.
- DENEE FLORAL LIMITED, NIAGARA-ON-THE-LAKE, ONTARIO, CANADA:
2,201,944, CANC. INT. CL. 31.
- DENNIS GARBERG & ASSOCIATES, INC., OVERLAND PARK, KS:
2,997,903, PUB. 6-28-2005. MULTIPLE CLASS, INT. CLS. 16 AND 35.
- DENTAL EXCELLANCE, TERRYVILLE, CT:
2,997,247, PUB. 6-28-2005. INT. CL. 21.
- DENTAL SPA, PACIFIC PALISADES, CA:
2,998,351, PUB. 6-28-2005. MULTIPLE CLASS, INT. CLS. 3 AND 44.
- DENTISTS MANAGEMENT CORPORATION, PORTLAND, OR:
2,997,576, PUB. 6-28-2005. INT. CL. 9.
- DEPARTMENT OF THE ARMY, ARLINGTON, VA:
2,998,635, INT. CL. 14.
- DEPP, ROBERT EARL, PITTSBURGH, PA:
2,200,847, CANC. INT. CL. 25.
- DEPUY, INC., WARSAW, IN:
2,997,240, PUB. 6-28-2005. INT. CL. 10.
2,998,197, PUB. 6-28-2005. INT. CL. 10.
- DER TEELADEN GEBR. GSCHWENDNER GMBH, 53340 MECKENHEIM, FED REP GERMANY:
1,861,524, CANC. INT. CL. 30.
- DERMAVIVE INC., LAKE OSWEGO, OR:
2,996,963, PUB. 3-8-2005. INT. CL. 5.
- DEROYAL TEXTILES, INC., POWELL, TN, HERMITAGE INDUSTRIES, INC., CAMDEN, SC:
1,895,157, REN. 8-9-05. INT. CL. 21.
- DERVAES, A. RENE, JR., PALM BEACH, FL AND DERVAES, ROBERT S., PALM BEACH, FL AND FINFROCK, DALE B., PALM BEACH, FL:
2,202,340, CANC. INT. CL. 36.
- DES ANGES, LLC, LAS VEGAS, NV:
2,998,141, PUB. 6-28-2005. INT. CL. 33.
- DESERT MOON CAFE FRANCHISE CORPORATION, OSISING, NY:
2,997,183, PUB. 6-28-2005. INT. CL. 43.
- DESIGN FORCE, INC., MARLTON, NJ:
2,997,304, PUB. 6-28-2005. INT. CL. 42.
- DESIGN IN MOTION, INC., LAUREL, MD:
2,997,433, PUB. 6-28-2005. INT. CL. 25.
- DESIGNS APPAREL, INC., CANTON, MA:
2,997,388, PUB. 6-28-2005. INT. CL. 25.
2,997,389, PUB. 6-28-2005. INT. CL. 25.
- DESIGNWARE, INC., MERIDEN, CT:
1,835,027, REN. 8-11-05. INT. CL. 9.
- DESTINATION LANA'I, LANA'I CITY, HI:
2,997,586, PUB. 6-28-2005. INT. CL. 35.
- DEUTSCHE TELEKOM AG, 53113 BONN, FED REP GERMANY:
2,996,314, PUB. 6-28-2005. MULTIPLE CLASS, INT. CLS. 9, 16, 35, 36, 38, 41 AND 42.
- DEUTSCHE TELEKOM AG, BONN, FED REP GERMANY:
2,997,463, PUB. 6-28-2005. INT. CL. 16.
2,997,490, PUB. 6-28-2005. INT. CL. 42.
2,998,174, PUB. 6-28-2005. INT. CL. 9.
- DEZENHALL RESOURCES, INC., WASHINGTON, DC:
2,997,205, PUB. 6-28-2005. INT. CL. 35.
- DFA, LLC, NEW YORK, NY:
2,997,650, PUB. 6-28-2005. INT. CL. 41.
- DIAGEO NORTH AMERICA, INC., NORWALK, CT:
2,998,294, PUB. 6-28-2005. INT. CL. 41.
- DIAMONDREVIEW.COM, INC., LOS ALTOS, CA:
2,996,910, PUB. 6-28-2005. MULTIPLE CLASS, INT. CLS. 35 AND 42.
- DIASCIENCE CORP., NEW YORK, NY:
2,996,413, PUB. 6-28-2005. INT. CL. 14.
- DIASCIENCE CORP., NEW YORK, NY, DBA YEHUDA DIAMOND CO.:
2,996,414, PUB. 6-28-2005. INT. CL. 14.
- DIASCIENCE CORP., NEW YORK, NY:
2,996,415, PUB. 6-28-2005. INT. CL. 14.
- DIDAX INC., CHANTILLY, VA:
2,202,356, CANC. INT. CL. 42.
- DIDELOW, PATRICIA, WOODLAND HILLS, CA:
1,783,603, CANC. INT. CL. 33.
- DIGITAL COMMUNICATIONS ASSOCIATES, INC., ALPHARETTA, GA:
1,302,403, CANC. INT. CL. 9.
- DIGITAL EQUIPMENT CORPORATION, MAYNARD, MA:
2,201,737, CANC. INT. CL. 9.
- DIGITAL PROCESSING SYSTEMS, INC., FLORENCE, KY:
2,201,757, CANC. INT. CL. 9.
- DINING CONCEPTS, LTD., DES PLAINES, IL:
1,303,274, CANC. INT. CL. 42.
- DIOMED DEVELOPMENTS LIMITED, HERTFORDSHIRE, UNITED KINGDOM:
2,996,905, PUB. 6-28-2005. INT. CL. 5.
- DIPO, SOCIETE ANONYME, 34830 CLAPIERS, FRANCE:
2,998,568, INT. CL. 9.
- DIRAIMONDO, LOUIS, MIAMI, FL:
2,998,337, PUB. 6-28-2005. INT. CL. 12.
- DISCERNA LIMITED, CAMBRIDGE, UNITED KINGDOM FROM KS BIOMEDIX HOLDINGS PLC, ESHER, SURREY, UNITED KINGDOM:
2,996,887, PUB. 6-28-2005. MULTIPLE CLASS, INT. CLS. 5, 10 AND 42.
- DISCIPLESHIP NETWORK OF AMERICA, SIGNAL MOUNTAIN, TN:
2,999,375, INT. CL. 41.
- DISCOUNT SPECIALTY CHEMICALS, INCORPORATED, CULVER CITY, CA:
1,860,620, CANC. INT. CL. 3.
- DISTRIBUTION SCIENCES, INC., DES PLAINES, IL:
1,302,556, CANC. INT. CL. 16.
- DIVA LIMOUSINE LTD., LOS ANGELES, CA:
2,996,709, PUB. 6-28-2005. INT. CL. 39.
- DIVERSEY WYANDOTTE CORPORATION, WYANDOTTE, MI:
779,290, CANC. U.S. CL. 6.
1,302,356, CANC. INT. CL. 3.
- DIVINE DIMENSIONS INC., MIAMI, FL:
2,997,656, PUB. 6-28-2005. INT. CL. 24.
- DJL, CHICAGO, IL:
2,997,032, PUB. 6-28-2005. INT. CL. 9.
- DME CORPORATION, FORT LAUDERDALE, FL:
1,868,840, REN. 8-11-05. INT. CL. 9.
- DMI FRANCHISE, INC., FORT MYERS, FL:
2,996,382, PUB. 6-28-2005. INT. CL. 41.
- DMW, INC., OKLAHOMA CITY, OK:
2,996,763, PUB. 6-28-2005. INT. CL. 2.
- DNC PARKS & RESORTS AT KSC, INC., BUFFALO, NY:
2,999,388, INT. CL. 41.
- DOC GREEN'S GOURMET SALADS, INC., ATLANTA, GA:
2,999,088, INT. CL. 43.
- DODSON, BETTY, BALLWIN, MO:
2,998,082, PUB. 6-28-2005. INT. CL. 18.
- DOG TRAINING IN YOUR HOME, MATTHEWS, NC:
2,997,025, PUB. 6-28-2005. INT. CL. 41.
- DOLLAR LOAN CENTER, LLC, LAS VEGAS, NV:
2,997,839, PUB. 6-28-2005. INT. CL. 36.
- DOLLAR THRIFTY AUTOMOTIVE GROUP, INC., TULSA, OK:
2,998,789, MULTIPLE CLASS, INT. CLS. 35 AND 39.
- DOLLAR TREE STORES, INC., NORFOLK, VA:
2,257,662, CANC. MULTIPLE CLASS, INT. CLS. 8, 18, 20 AND 21.

- DOMAIN ENERGY CORPORATION, HOUSTON, TX:
2,202,063, CANC. INT. CL. 42.
- DOMENESHOP AS, NORWAY:
2,998,497, PUB. 6-28-2005. MULTIPLE CLASS, INT. CLS. 35, 38 AND 42.
- DONALD A. GARDNER, INC., GREENVILLE, SC:
2,997,261, PUB. 6-28-2005. INT. CL. 42.
- DONOHUE DIGITAL LLC, CASTLE ROCK, CO:
2,998,072, PUB. 6-28-2005. INT. CL. 9.
- DONRUSS PLAYOFF, L.P., ARLINGTON, TX:
2,996,868, PUB. 6-28-2005. INT. CL. 16.
- DORF, ROBERT E. SARASOTA, FL:
2,997,614, PUB. 6-28-2005. INT. CL. 9.
- DORMAN-ROTH FOODS, INC., MOONACHIE, NJ:
1,302,876, CANC. INT. CL. 29.
1,302,915, CANC. INT. CL. 29.
- DORNIER MEDTECH AMERICA, INC., KENNESAW, GA:
2,998,527, INT. CL. 10.
- DOROSHIN, VITALY, PODOLSK, RUSSIAN FED. AND BOLGOV, MIKHAIL, BALASHIHA, RUSSIAN FED. AND SHAFIKOVA, LAISAN, LYTKARINO, RUSSIAN FED.:
2,997,289, PUB. 6-28-2005. INT. CL. 9.
- DOS BONITAS, LLC, MILWAUKEE, WI:
2,997,847, PUB. 6-28-2005. INT. CL. 43.
- DOSKOCIL MANUFACTURING COMPANY, INC., ARLINGTON, TX:
2,201,400, CANC. INT. CL. 20.
2,996,681, PUB. 6-28-2005. INT. CL. 28.
- DOUBLE K INDUSTRIES, INC., NORTHRIDGE, CA:
2,201,681, CANC. INT. CL. 3.
- DOUBLETREE, INC., PHOENIX, AZ:
1,303,267, CANC. INT. CL. 42.
- DOUGHERTY, MARY ANN, VALENCIA, PA AND MOLETZ, FIORE, VALENCIA, PA:
2,998,667, INT. CL. 37.
- DOVER WELDING & MACHINE, INC., DOVER, FL:
2,999,291, INT. CL. 12.
- DOVETAIL BUSINESS SOLUTIONS, INC., HIGHLANDS RANCH, CO:
2,996,491, PUB. 6-28-2005. INT. CL. 42.
- DOW AGROSCIENCES LLC, INDIANAPOLIS, IN, DOW CHEMICAL COMPANY, THE, MIDLAND, MI:
1,354,934, REN. 8-11-05. INT. CL. 5.
- DOW AGROSCIENCES LLC, INDIANAPOLIS, IN, STAUFFER CHEMICAL COMPANY, WESTPORT, CT:
1,354,939, REN. 8-11-05. INT. CL. 5.
- DOW AGROSCIENCES LLC, INDIANAPOLIS, IN:
1,912,197, REN. 8-9-05. INT. CL. 5.
2,998,910, INT. CL. 5.
- DOW CHEMICAL COMPANY, THE, MIDLAND, MI:
792,027, REN. 8-11-05. MULTIPLE CLASS, U.S. CLS. 6 (INT. CL. 1) AND 15 (INT. CL. 4).
793,546, REN. 8-11-05. U.S. CL. 6 (INT. CL. 1).
- DOW JONES & COMPANY, INC., NEW YORK, NY:
1,861,283, CANC. INT. CL. 42.
- DOWNSTREAM TECHNOLOGIES, LLC, BOLTON, MA:
2,999,308, INT. CL. 9.
- DOYON FOUNDATION, FAIRBANKS, AK:
2,201,993, CANC. INT. CL. 24.
- DR. GERGELY & CO., A-1053 VIENNA, AUSTRIA:
2,201,409, CANC. MULTIPLE CLASS, INT. CLS. 5 AND 30.
- DR. JOANNE WHITE CONSULTING SERVICES, LLC, CHERRY HILL, NJ:
2,996,814, PUB. 6-28-2005. INT. CL. 41.
- DR. SUWELACK SKIN & HEALTH CARE AG, FED REP GERMANY:
2,998,433, PUB. 6-28-2005. MULTIPLE CLASS, INT. CLS. 1 AND 3.
- DRAFT WORLDWIDE, INC, CHICAGO, IL:
2,998,668, INT. CL. 35.
2,998,669, INT. CL. 35.
- DREAM HOME TOUR, LLC, EDMOND, OK:
2,997,353, PUB. 6-28-2005. INT. CL. 35.
- DREAMQUEST EVENTS, LLC, WESTFIELD, IN:
2,997,367, PUB. 6-28-2005. INT. CL. 41.
- DREAMSCENE, INC., PALM SPRINGS, CA:
1,861,469, CANC. INT. CL. 42.
- DREISON INTERNATIONAL, INC., CLEVELAND, OH:
2,997,984, PUB. 6-28-2005. INT. CL. 11.
- DRESS FOR SUCCESS WORLDWIDE INC., NEW YORK, NY:
2,998,234, PUB. 6-28-2005. INT. CL. 45.
- DRIGGS FARMS OF INDIANA, INC., DECATUR, IN:
2,999,265, INT. CL. 30.
- DRINKS AMERICAS, INC., WILTON, CT:
2,997,116, PUB. 6-28-2005. INT. CL. 33.
- DRIRITE OF CENTRAL FLORIDA, INC., WINTER GARDEN, FL, DRIRITE, INC., WINTER GARDEN, FL:
1,976,944, REN. 8-11-05. INT. CL. 37.
- DRUGTECH CORPORATION, WILMINGTON, DE, KV PHARMACEUTICAL COMPANY, ST. LOUIS, MO:
1,939,204, REN. 8-6-05. INT. CL. 1.
- DRURY PROPERTIES, INC., SPRINGFIELD, MO:
2,999,165, INT. CL. 43.
- DRURY UNIVERSITY, SPRINGFIELD, MO:
2,996,914, PUB. 6-28-2005. MULTIPLE CLASS, INT. CLS. 16, 25 AND 41.
- DS WATERS OF AMERICA, LP, ATLANTA, GA:
1,335,806, REN. 8-10-05. INT. CL. 32.
- DSM IP ASSETS B.V., HEERLEN, NETHERLANDS:
2,201,071, CANC. INT. CL. 1.
- DSM SOLUTCH B.V., NETHERLANDS, DSM KUNSTSTOFFEN B.V., 6135 KR SITTARD, NETHERLANDS:
1,938,288, REN. 8-10-05. MULTIPLE CLASS, INT. CLS. 9, 10, 11 AND 17.
- DTZ HOLDINGS PLC, LONDON, UNITED KINGDOM:
2,865,353, CANC. IIRN. RESTORED TO S.N. 75-853,642.
- DUANE READE INTERNATIONAL, INC., NEW YORK, NY:
2,997,779, PUB. 6-28-2005. INT. CL. 35.
- DULLIN S.A., B.P. 2132 VILLEURBANNE CEDEX 69603, FRANCE:
2,202,336, CANC. INT. CL. 9.
- DUNDEE BANCORP INC., TORONTO, ONTRARIO M5H 4A9, CANADA:
2,997,280, PUB. 6-28-2005. INT. CL. 36.
- DUO TANG, INC., PAW, MI:
1,861,394, CANC. INT. CL. 16.
- DURLACHER & COMPANY, INCORPORATED, NEW YORK, NY:
1,302,776, CANC. INT. CL. 25.
- DURR INDUSTRIES, INC., PLYMOUTH, MI:
2,201,672, CANC. INT. CL. 11.
- DUTY FREE EXPRESS, INC., MIAMI, FL, DBA COSBELLE INTERNATIONAL:
2,201,433, CANC. INT. CL. 3.
- DVR CONNECTION, INC., MOORE, OK:
2,997,300, PUB. 6-28-2005. INT. CL. 9.
- DX/DY VOICE PROCESSING, INC., SPOKANE, WA:
2,996,590, PUB. 6-28-2005. INT. CL. 38.
- DYNACRAFT BSC, INC., SAN RAFAEL, CA:
1,893,066, REN. 8-11-05. INT. CL. 12.
- DYNAMIC INDUSTRIAL GROUP, INC., CRYSTAL LAKE, IL:
2,996,821, PUB. 6-28-2005. INT. CL. 4.
- DYNAMIT NOBEL GMBH EXPLOSIVSTOFF-UND SYSTEMTECHNIK, 53840 TROISDORF, FED REP GERMANY:
2,200,959, CANC. MULTIPLE CLASS, INT. CLS. 1 AND 13.
- DYNAPOWERNAMICS INC., ST. LOUIS, MO:
2,999,148, INT. CL. 7.
- DYNAWAVE INCORPORATED, HAVERHILL, MA:
1,868,060, REN. 8-6-05. INT. CL. 9.
- DYNEX TECHNOLOGIES, INC., CHANTILLY, VA:
2,201,705, CANC. INT. CL. 9.
- E P ENTERPRISES, LLC, GREENFIELD, WI:
2,999,222, INT. CL. 20.
- E R CLASSIC PRODUCTIONS, INC., NEW YORK, NY:
2,996,859, PUB. 6-28-2005. INT. CL. 41.
- E. & J. GALLO WINERY, MODESTO, CA, DBA GALLO VINEYARDS:
1,023,377, REN. 8-11-05. INT. CL. 33.

- E. I. DU PONT DE NEMOURS AND COMPANY, WILMINGTON, DE:
2,997,964, PUB. 6-28-2005. INT. CL. 9.
2,998,143, PUB. 6-28-2005. INT. CL. 1.
- E. LAND WORLD LTD., SEOUL, REPUBLIC OF KOREA:
2,998,700, INT. CL. 25.
- E.B. HARRIS INC., WARRENTON, NC:
2,998,147, PUB. 6-28-2005. INT. CL. 35.
- E.C. PUBLICATIONS, INC., NEW YORK, NY:
1,319,330. REN. 8-6-05. INT. CL. 16.
1,344,333. REN. 8-6-05. INT. CL. 16.
- E.R. SQUIBB & SONS LLC, PRINCETON, NJ:
2,998,193, PUB. 6-28-2005. INT. CL. 3.
- E.S. ORIGINALS, INC., NEW YORK, NY:
1,861,414, CANC. INT. CL. 25.
- E+E ELEKTRONIK GES.M.B.H., ENGERWITZDORF, AUSTRIA:
2,997,303, PUB. 6-28-2005. INT. CL. 9.
- E*TRADE SECURITIES, INC., PALO ALTO, CA:
2,202,295, CANC. INT. CL. 36.
- E-Z LEGAL FORMS, INC., DEERFIELD BEACH, FL:
2,202,331, CANC. INT. CL. 9.
- EAGLENEST INTELLIGENCE INC., SAN MARCOS, TX:
2,201,033, CANC. INT. CL. 35.
- EARLEX LIMITED, SURREY, UNITED KINGDOM:
2,997,363, PUB. 6-28-2005. INT. CL. 7.
- EARTH & OCEAN SPORTS, INC., REDMOND, WA:
1,861,010, CANC. INT. CL. 25.
- EARTHRIGHTS INTERNATIONAL, WASHINGTON, DC:
2,997,096, PUB. 6-28-2005. INT. CL. 41.
- EASTERN AIR LINES, INC., MIAMI, FL:
1,303,153, CANC. INT. CL. 39.
- EASTERN ALLOYS, INC., MAYBROOK, NY:
1,012,065. REN. 8-10-05. INT. CL. 6.
- EASTMAN KODAK COMPANY, ROCHESTER, NY:
2,999,060, INT. CL. 5.
- EASTSIDE STAPLE & NAIL, INC., BELLEVUE, WA:
2,996,989, PUB. 6-28-2005. INT. CL. 6.
- EASYBOOKER.COM, LLC, CHAMPAIGN, IL:
2,997,712, PUB. 6-28-2005. INT. CL. 42.
- EAZ-LIFT SPRING CORPORATION, SUN VALLEY, CA:
2,998,736, INT. CL. 12.
- EBAC LIMITED, CO. DURHAM DL14 9AL, UNITED KINGDOM:
2,998,770, INT. CL. 11.
- EBSCO INDUSTRIES, INC., BIRMINGHAM, AL, ARBOGAST, FRED, AKRON, OH:
408,208. REN. 8-8-05. U.S. CL. 22 (INT. CL. 28).
- EBSCO INDUSTRIES, INC., BIRMINGHAM, AL:
2,997,488, PUB. 6-28-2005. INT. CL. 41.
- EB5 CORPORATION, PORTLAND, OR:
2,997,337, PUB. 6-28-2005. INT. CL. 3.
- ECCO IL PANE BAKERY INC., VANCOUVER, BRITISH COLUMBIA, CANADA:
2,128,506, CANC. INT. CL. 30.
- ECKSTEIN BROS., INC., HAWTHORNE, CA:
1,302,473, CANC. INT. CL. 10.
- ECLECTIC ETC., INC., WILLOW GROVE, PA:
2,996,736, PUB. 6-28-2005. INT. CL. 14.
- ECOLAB INC., ST. PAUL, MN:
2,997,396, PUB. 6-28-2005. INT. CL. 1.
2,997,730, PUB. 6-28-2005. INT. CL. 2.
- ECOLOGICAL TECHNOLOGIES, LLC, DELRAY, FL:
2,998,676, INT. CL. 4.
- ECONOMIC DEVELOPMENT BOARD, SINGAPORE, SINGAPORE:
2,996,990, PUB. 6-28-2005. MULTIPLE CLASS, INT. CLS. 35 AND 41.
- EDGE CRAFT CORPORATION, AVONDALE, PA:
2,997,101, PUB. 6-28-2005. INT. CL. 7.
- EDIAL, INC., WALTHAM, MA:
2,996,304, PUB. 6-28-2005. INT. CL. 9.
- EDNOVATION, INC., FOREST HILLS, NY:
1,866,850. REN. 8-8-05. INT. CL. 9.
- EDUCATION THRU ENTERTAINMENT, INC., TEMECULA, CA:
2,201,658, CANC. MULTIPLE CLASS, INT. CLS. 9 AND 16.
- EDUCATIONAL FOUNDATION OF THE NATIONAL RESTAURANT ASSOCIATION, THE, CHICAGO, IL:
2,201,127, CANC. MULTIPLE CLASS, INT. CLS. 16 AND 41.
- EDWARDS LIFESCIENCES CORPORATION, IRVINE, CA:
2,998,958, INT. CL. 10.
- EEG SPECTRUM INTERNATIONAL, INC., CANOGA PARK, CA:
2,998,833, INT. CL. 41.
- EGS GAUGING, INC., BILLERICA, MA:
2,998,592, MULTIPLE CLASS, INT. CLS. 7, 9 AND 42.
- EICHROM TECHNOLOGIES, INC., DARIEN, IL:
2,997,527, PUB. 6-28-2005. INT. CL. 9.
- EIDOS INTERACTIVE LIMITED, WIMBLEDON, LONDON, UNITED KINGDOM:
2,997,348, PUB. 6-28-2005. INT. CL. 9.
- EIDOS INTERACTIVE LIMITED, LONDON, UNITED KINGDOM:
2,997,558, PUB. 6-28-2005. INT. CL. 9.
- EK KNIVES, LLC, SPRINGFIELD, IL:
1,330,569. REN. 8-8-05. INT. CL. 8.
- EL PASO ENERGY CORPORATION, EL PASO, TX:
2,201,933, CANC. INT. CL. 42.
2,201,934, CANC. INT. CL. 37.
- EL TORITO RESTAURANTS, INC., IRVINE, CA:
2,201,058, CANC. INT. CL. 42.
- ELB DESIGNS, DALLAS, TX:
2,997,523, PUB. 6-28-2005. INT. CL. 25.
- ELECTROLUX HOME CARE PRODUCTS LTD., CLEVELAND, OH:
1,896,048. REN. 8-9-05. INT. CL. 9.
- ELECTRONIC CONTROLS DESIGN, INC., MILWAUKIE, OR:
2,999,229, INT. CL. 9.
- ELECTRONIC INTELLECT, LLC, PITTSBURGH, PA:
2,999,081, INT. CL. 42.
- ELECTRONIC SIGN CORPORATION, STOCKTON, CA:
2,200,932, CANC. INT. CL. 9.
- ELECTRONIC TECHNOLOGY CORPORATION, AMES, IA:
2,202,326, CANC. INT. CL. 9.
- ELECTRONICS FOR IMAGING, INC., FOSTER CITY, CA:
2,998,574, MULTIPLE CLASS, INT. CLS. 41 AND 42.
- ELENA YOUNG AND NANCY A. LORENZ PARTNERSHIP, THE, YELM, WA:
2,997,333, PUB. 6-28-2005. INT. CL. 38.
- ELENI'S NYC, INC., NEW YORK, NY:
2,996,421, PUB. 6-28-2005. INT. CL. 30.
- ELEPHANT & CASTLE GROUP, INC., VANCOUVER, BRITISH COLUMBIA, CANADA:
2,998,293, PUB. 6-28-2005. INT. CL. 43.
- ELF LUBRICANTS NORTH AMERICA, INC., LINDEN, NJ:
1,860,629, CANC. INT. CL. 4.
- ELIXIR TECHNOLOGIES CORPORATION, VENTURA, CA:
2,201,399, CANC. INT. CL. 9.
- ELKAY MANUFACTURING COMPANY, OAK BROOK, IL:
1,337,757. REN. 8-11-05. INT. CL. 11.
- ELO TOUCHSYSTEMS, INC., MENLO PARK, CA:
2,997,423, PUB. 6-28-2005. INT. CL. 9.
- ELVIS PRESLEY ENTERPRISES, INC., MEMPHIS, TN:
2,997,346, PUB. 6-28-2005. INT. CL. 16.
- EMAMI LIMITED, KOLKATA, INDIA:
2,997,093, PUB. 6-28-2005. INT. CL. 3.
- EMBIENCE, INC., SAN DIEGO, CA:
2,997,380, PUB. 6-28-2005. MULTIPLE CLASS, INT. CLS. 9 AND 42.
- EMCA INC., GAINESVILLE, VA:
2,201,561, CANC. MULTIPLE CLASS, INT. CLS. 9, 14, 16, 20, 25, 28 AND 42.
- EMCO ENTERPRISES, INC., DES MOINES, IA, DBA EMCO SPECIALTIES, INC.:
2,201,154, CANC. INT. CL. 6.
- EMERSON ELECTRIC CO., ST. LOUIS, MO:
1,328,040. REN. 8-11-05. INT. CL. 7.
- EMILIO PUCCI S.R.L., FIRENZE, ITALY:
2,996,557, PUB. 6-28-2005. MULTIPLE CLASS, INT. CLS. 3, 18 AND 25.

- EMMIS TELEVISION BROADCASTING, L.P., INDIANAPOLIS, IN:
2,998,046, PUB. 6-28-2005. INT. CL. 41.
- EMPIRE BRANDS, INC., NEW YORK, NY:
2,996,920, PUB. 6-28-2005. INT. CL. 35.
- EMPLOYEE MANAGED CARE CORPORATION, BELLEVUE, WA:
2,201,651, CANC. INT. CL. 42.
- EMPTY TOMB, INC., CHAMPAIGN, IL:
2,998,240, PUB. 6-28-2005. INT. CL. 36.
2,998,348, PUB. 6-28-2005. INT. CL. 36.
- EMTAL CORPORATION, TALLAHASSEE, FL:
2,201,006, CANC. INT. CL. 9.
- EMULATION TECHNOLOGY, INC., SANTA CLARA, CA:
1,877,482, REN. 8-8-05. INT. CL. 9.
- ENDOCARE, INC., IRVINE, CA, NORTH AMERICAN MEDICAL, INC., GREENSBORO, NC:
1,897,762, REN. 8-10-05. INT. CL. 37.
- ENDURA PRODUCTS, INC., COLFAX, NC:
2,997,237, PUB. 6-28-2005. INT. CL. 36.
- ENERFLEX SYSTEMS LTD., CALGARY, CANADA:
2,999,092, MULTIPLE CLASS, INT. CLS. 7 AND 40.
- ENGICON INTERNATIONAL, INC., HOUSTON, TX:
2,201,246, CANC. INT. CL. 6.
- ENHANCED MANAGEMENT SERVICES, INC., DANVILLE, PA:
2,997,809, PUB. 6-28-2005. INT. CL. 35.
- ENTEK IRD INTERNATIONAL CORPORATION, CINCINNATI, OH:
2,201,826, CANC. INT. CL. 9.
- ENTERPRISE IG, SAN FRANCISCO, CA:
2,726,250, CANC. INT. CL. 35.
- ENTERTAINMENT DIGITAL NETWORK, INC., SAN FRANCISCO, CA:
1,861,539, CANC. INT. CL. 41.
- ENTHONE-OMI INC., WARREN, MI:
2,201,091, CANC. INT. CL. 40.
- ENVIRONMENTAL CHOICES, INC., CHARLOTTE, NC:
2,997,276, PUB. 6-28-2005. MULTIPLE CLASS, INT. CLS. 1 AND 3.
- ENVIRONMENTAL INSECT CONTROL SYSTEMS, INC., HOUSTON, TX:
1,302,387, CANC. MULTIPLE CLASS, INT. CLS. 5 AND 7.
- EPHRATAH SAFETY SYSTEMS INC., ST. JOHNSVILLE, NY:
1,860,798, CANC. INT. CL. 9.
- EPICON, INC., WALTHAM, MA:
2,201,296, CANC. INT. CL. 9.
- EPIGRAPHICS SOFTWARE, INC., HILLSIDE, IL:
2,996,389, PUB. 6-28-2005. INT. CL. 9.
- EPIPADY 2000 L.L.C., HATZOR HAGLILIT, ISRAEL:
2,998,644, INT. CL. 8.
- EPNER, PAUL, RAMONA, CA:
2,999,219, INT. CL. 25.
- EQUALS 4 INC., NEW YORK, NY:
1,861,000, CANC. INT. CL. 25.
- EQUINE EVENT, LLC, TIMONIUM, MD:
2,999,393, INT. CL. 35.
- EQUIP FOR INDEPENDENCE, INC., WHITE PLAINS, NY:
1,906,415, REN. 8-10-05. INT. CL. 10.
- EQUIPMENT SYSTEMS & DEVICES, INC., FT. WASHINGTON, PA:
1,340,430, REN. 8-10-05. INT. CL. 9.
1,344,013, REN. 8-11-05. INT. CL. 9.
- EQUISTAR CHEMICALS, LP, HOUSTON, TX, NATIONAL PETRO-CHEMICALS CORPORATION, NEW YORK, NY:
611,277, REN. 8-9-05. U.S. CL. 6 (INT. CL. 1).
- EQUITY INDUSTRIES CORP., VIRGINIA BEACH, VA:
2,998,569, INT. CL. 14.
- EQUITY RECORDS, INC., NASHVILLE, TN:
2,999,023, INT. CL. 9.
2,999,024, INT. CL. 41.
- ERB INDUSTRIES, INC., WOODSTOCK, GA:
1,899,729, REN. 8-9-05. INT. CL. 9.
- ERBES, MICHAEL R., BELMONT, CA:
2,201,064, CANC. INT. CL. 9.
- ERGONOMIC DENTAL TECHNOLOGIES, INC., SAN FRANCISCO, CA:
2,999,142, INT. CL. 21.
- ERICO INTERNATIONAL CORPORATION, SOLON, OH:
2,996,631, PUB. 6-28-2005. INT. CL. 9.
- ERIELLE, INC., DOWNERS GROVE, IL:
2,201,404, CANC. INT. CL. 14.
- ERNST MUHLBAUER GMBH & CO KG, NORDERFRIEDRICHSKOOG, FED REP GERMANY, STERNDEUT CORP., MOUNT VERNON, NY:
997,633, REN. 8-6-05. U.S. CL. 44 (INT. CL. 5).
- ERNST, ALAN C, PERRYSBURG, OH:
2,997,441, PUB. 6-28-2005. INT. CL. 9.
- ERSKINE COLLEGE, DUE WEST, SC:
2,997,265, PUB. 6-28-2005. MULTIPLE CLASS, INT. CLS. 41 AND 43.
- ESAB AB, S-402 77 GOTEBOG, SWEDEN, OXWELD ACETYLENE COMPANY, NEW YORK, NY:
321,166, REN. 8-6-05. U.S. CL. 23 (INT. CL. 7).
- ESALEN INSTITUTE, BIG SUR, CA:
2,999,119, INT. CL. 9.
- ESCADA AG, D-85609 ASCHHEIM, FED REP GERMANY:
2,998,461, PUB. 6-28-2005. INT. CL. 12.
- ESCORT INC., WEST CHESTER, OH:
2,996,737, PUB. 6-28-2005. INT. CL. 35.
- ESPORTIA INTERNATIONAL, INC., DUARTE, CA:
2,996,819, PUB. 6-28-2005. INT. CL. 25.
2,996,843, PUB. 6-28-2005. INT. CL. 25.
- ESSANTE CORPORATION, DRAPER, UT:
2,201,684, CANC. INT. CL. 5.
- ESSENTIAL LIVING FOODS, INC., SAN LUIS OBISPO, CA:
2,999,116, INT. CL. 5.
- ESSENTIAL MEDICAL SUPPLY, INC., WINTER PARK, FL:
2,999,249, INT. CL. 10.
- ESSICK, INC., WINSTON-SALEM, NC:
2,997,929, PUB. 6-28-2005. INT. CL. 22.
- ESSIG, JOHN R., NAPLES, FL:
2,997,443, PUB. 6-28-2005. INT. CL. 43.
- ESTEE LAUDER INC., NEW YORK, NY:
2,202,267, CANC. INT. CL. 3.
- ETABLISSEMENTS COQUET, SAINT LEONARD DE NOBLAT, FRANCE:
1,863,744, REN. 8-11-05. INT. CL. 21.
- ETABLISSEMENTS MAXIME TRIJOL, 17520 SAINT-MARTIAL-SUR-NE, FRANCE:
1,905,857, REN. 8-11-05. INT. CL. 33.
- ETALK CORPORATION, IRVING, TX:
2,996,650, PUB. 6-28-2005. INT. CL. 9.
- EURO COFFEE, A PARTNERSHIP, LOS ANGELES, CA:
2,997,786, PUB. 6-28-2005. INT. CL. 30.
- EUROPA DIAMOND SYNDICATE, INC., NEW YORK, NY:
2,526,207, CANC. INT. CL. 14.
- EUROWALLS, LLC, LOCKPORT, NY:
2,998,751, INT. CL. 20.
- EVANS AND DAVIS, ORLANDO, FL:
2,997,163, PUB. 6-28-2005. INT. CL. 25.
- EVERGLADES DIRECT, INC., NORTH MANKATO, MN, ONE WRITE SYSTEMS, INC., SUNRISE, FL, DBA G. NEIL COMPANIES:
1,903,946, REN. 8-10-05. INT. CL. 16.
- EVERTEK COMPUTER CORPORATION, OCEANSIDE, CA:
2,997,805, PUB. 6-28-2005. INT. CL. 35.
- EVERTSEN, EIMERD, SAN FRANCISCO, CA:
2,996,640, PUB. 6-28-2005. INT. CL. 39.
- EVERYDAY SOLUTIONS, LLC, SHAWNEE, KS:
2,996,810, PUB. 6-28-2005. INT. CL. 20.
- EVSEV TECH CORP., SHIJR CITY, TAIPEI HSIEN, TAIWAN:
2,996,516, PUB. 6-28-2005. INT. CL. 9.
- EXCLAIMER LTD, HAMPSHIRE, UNITED KINGDOM:
2,997,803, PUB. 6-28-2005. INT. CL. 9.
- EXECUTIVE MACHINES, INC., BROOKLYN, NY:
2,996,641, PUB. 6-28-2005. INT. CL. 16.
- EXECUTIVE PRESENTATION L.L.C., SEATTLE, WA:
2,997,814, PUB. 6-28-2005. INT. CL. 35.
- EXEL OY, FINLAND:
2,998,455, PUB. 6-28-2005. MULTIPLE CLASS, INT. CLS. 25, 28 AND 41.

- EXHART ENVIRONMENTAL SYSTEMS, INC., CHATSWORTH, CA:
2,998,827, INT. CL. 11.
- EXLINE, INC., SALINA, KS:
2,996,784, PUB. 6-28-2005. INT. CL. 40.
- EXPERIENCE HENDRIX, L.L.C., SEATTLE, WA:
2,997,675, PUB. 6-28-2005. INT. CL. 9.
2,997,676, PUB. 6-28-2005. INT. CL. 41.
2,998,058, PUB. 6-28-2005. INT. CL. 41.
2,998,059, PUB. 6-28-2005. INT. CL. 41.
- EXPETEC CORPORATION, ABERDEEN, SD:
2,997,171, PUB. 6-28-2005. INT. CL. 36.
- EXPLORERS CLUB; THE, NEW YORK, NY:
1,311,593, REN. 8-12-05. INT. CL. 42.
- EXPLORERS CLUB, THE, NEW YORK, NY:
1,344,379, REN. 8-12-05. INT. CL. 16.
- EXPORSEVILLA, S.A., DOS HERMANAS (SEVILLA), SPAIN:
2,997,196, PUB. 6-28-2005. INT. CL. 29.
- EXPRESS CHEMICAL FINANCE, LLC, SAN ANTONIO, TX, WELL-FLOW TECHNOLOGIES, INC., HOUSTON, TX:
1,964,003, REN. 8-11-05. INT. CL. 1.
- EXTENDAY IP LIMITED, KUMEU, NEW ZEALAND:
2,997,459, PUB. 6-28-2005. INT. CL. 31.
- EXTREME TEAM INC., ENCINITAS, CA:
2,997,568, PUB. 5-3-2005. MULTIPLE CLASS, INT. CLS. 25 AND 28.
- EYE TO EYE COMMUNICATIONS, INC., SCOTTSDALE, AZ:
2,201,492, CANC. INT. CL. 41.
- EYEON SOFTWARE INC., TORONTO, ONTARIO, CANADA:
2,997,157, PUB. 6-28-2005. INT. CL. 9.
- EZ WEB SHOPPING, INC., PALOS HILLS, IL:
2,999,314, INT. CL. 35.
- EZ-TEK INDUSTRIES, INC., DEER PARK, NY:
2,998,567, INT. CL. 9.
- EZENEKWE, FRANKLIN, LOS ANGELES, CA:
2,999,362, INT. CL. 41.
- EZRAD.COM, INC., BALDWINVILLE, NY:
2,998,130, PUB. 6-28-2005. INT. CL. 9.
- F. KORBEL & BROS., GUEREVILLE, CA:
2,996,869, PUB. 6-28-2005. INT. CL. 33.
- F. W. WOOLWORTH CO., NEW YORK, NY:
1,302,967, CANC. INT. CL. 30.
- FABER CASTELL AG, STEIN 90546, FED REP GERMANY:
1,922,889, REN. 8-11-05. INT. CL. 16.
- FABRICANT DE POELES INTERNATIONAL INC., QUEBEC, QUEBEC, CANADA:
2,996,394, PUB. 6-28-2005. INT. CL. 11.
- FACE & BODY, INC., PORTLAND, OR:
2,999,247, INT. CL. 5.
- FACE AND BODY PROFESSIONALS, INC., NOVATO, CA:
2,997,021, PUB. 1-4-2005. INT. CL. 5.
- FAIRCHILD CONVAC GMBH, D-71665 VAIHINGEN/ENZ, FED REP GERMANY:
1,985,063, CANC. MULTIPLE CLASS, INT. CLS. 7 AND 9.
- FAIRFIELD OPTIMIST CLUB, FAIRFIELD, OH:
2,996,632, PUB. 6-28-2005. INT. CL. 41.
- FAIRHEAD, ANTHONY J., CINCINNATI, OH, DBA RUSHMORE LEADERSHIP:
2,200,977, CANC. INT. CL. 16.
- FAIRWAY IMPORT EXPORT, INC., RANCHO DOMINGUEZ, CA:
1,945,545, REN. 8-11-05. INT. CL. 10.
- FALA DIRECT MARKETING, INC., MELVILLE, NY:
2,997,895, PUB. 6-28-2005. MULTIPLE CLASS, INT. CLS. 35 AND 40.
- FALCON PHARMACEUTICALS, LTD, FORT WORTH, TX, ALCON LABORATORIES, INC., FORT WORTH, TX:
1,973,456, REN. 8-11-05. INT. CL. 5.
- FALCONWOOD CORPORATION, THE, NEW YORK, NY, MOCATTA CORPORATION, THE, NEW YORK, NY:
1,341,783, REN. 8-11-05. INT. CL. 36.
- FAMILY HISTORY DVD, L.L.C., ADDISON, TX:
2,999,309, INT. CL. 16.
- FAMOUS DISTRIBUTORS, INC, DENVER, CO:
2,105,137, CANC. INT. CL. 35.
- FANIMATION DESIGN & MANUFACTURING, INC., LEBANON, IN:
2,998,692, INT. CL. 7.
- FANTASTIC SAMS FRANCHISE CORPORATION, BEVERLY, MA, FANTASTIC SAM'S INTERNATIONAL, INC., MEMPHIS, TN:
1,894,764, REN. 8-12-05. INT. CL. 3.
1,895,436, REN. 8-12-05. INT. CL. 42.
- FANUC LTD., YAMANASHI, JAPAN:
2,997,319, PUB. 6-28-2005. INT. CL. 7.
- FAR POST SOCCER SUPPLY COMPANY, THE, PORTLAND, OR:
1,882,646, REN. 8-10-05. INT. CL. 42.
- FARAJ, ZAHER, RIDGEFIELD, NJ:
2,997,777, PUB. 6-28-2005. INT. CL. 43.
- FARIBAUT FOODS ILLINOIS, INC., MINNEAPOLIS, MN:
1,934,806, REN. 8-11-05. INT. CL. 29.
- FARIBAUT WOOLEN MILL COMPANY, FARIBAUT, MN:
1,302,689, CANC. INT. CL. 24.
- FARM CREDIT SERVICES OF THE MIDLANDS, FLCA, OMAHA, NE:
2,201,026, CANC. INT. CL. 36.
- FARMER'S DINER, LLC, WASHINGTON, VT:
2,997,885, PUB. 6-28-2005. MULTIPLE CLASS, INT. CLS. 29 AND 43.
- FARMERS' RICE COOPERATIVE, SACRAMENTO, CA:
2,996,618, PUB. 6-28-2005. INT. CL. 30.
- FARMRX, LLC, JACKSON, MN:
2,997,177, PUB. 6-28-2005. INT. CL. 42.
- FARRELL, JENNIFER, BOYNTON BEACH, FL:
2,997,188, PUB. 6-28-2005. INT. CL. 42.
- FASTEMS OY AB, 33840 TAMPERE, FINLAND:
2,998,729, MULTIPLE CLASS, INT. CLS. 7, 9 AND 37.
- FAUCETDIRECT, INC., CHICO, CA:
2,998,249, PUB. 6-28-2005. INT. CL. 35.
- FEDERAL EXPRESS CORPORATION, MEMPHIS, TN:
2,202,100, CANC. INT. CL. 35.
- FEDERAL NATIONAL MORTGAGE ASSOCIATION, WASHINGTON, DC, DBA FANNIE MAE:
2,997,951, PUB. 6-28-2005. INT. CL. 35.
- FEDERAL RESERVE BANKS, CHICAGO, IL:
2,996,667, PUB. 6-28-2005. INT. CL. 36.
- FEDERATED DEPARTMENT STORES, INC., CINCINNATI, OH:
2,201,926, CANC. MULTIPLE CLASS, INT. CLS. 3, 14, 18, 25, 26 AND 28.
- FEDERATED MUTUAL INSURANCE COMPANY, OWATONNA, MN:
2,997,739, PUB. 6-28-2005. INT. CL. 36.
- FELDENKRAIS GUILD OF NORTH AMERICA, PORTLAND, OR:
1,337,397, REN. 8-10-05. U.S. CL. 200.
- FELIX, NICK, OKLAHOMA CITY, OK, DANCE MAGIC, INC., OKLAHOMA CITY, OK:
1,821,046, REN. 8-9-05. INT. CL. 9.
- FELLOWSHIP TECHNOLOGIES, LP, IRVING, TX:
2,996,739, PUB. 6-28-2005. INT. CL. 9.
- FER FAHRZEUGELEKTRIK GMBH, EISENACH, FED REP GERMANY:
2,997,241, PUB. 6-28-2005. INT. CL. 11.
- FERAUD & CIE, PARIS, FRANCE:
1,304,569, REN. 8-10-05. INT. CL. 3.
- FERGUSON, RICHARD LAWRENCE, HOLLYWOOD, CA:
2,201,104, CANC. INT. CL. 9.
- FF TRADEMARK, LLC, NEW YORK, NY:
2,998,988, INT. CL. 3.
- FIAT AUTO S.P.A., CORSO G. AGNELLI 200, ITALY:
2,201,080, CANC. INT. CL. 12.
- FIATGEOTECH TECNOLOGIE PER LA TERRA S.P.A., 41100 MODENA, ITALY, DBA FIATGEOTECH S.P.A. TO NEW HOLLAND ITALIA S.P.A., MODENA, ITALY:
1,860,668, CANC. MULTIPLE CLASS, INT. CLS. 7 AND 12.
- FIBER BOND CORPORATION, MICHIGAN CITY, IN:
1,892,637, REN. 8-10-05. INT. CL. 11.

- FIBERMARK, INC., BRATTLEBORO, VT:
2,202,115, CANC. INT. CL. 16.
2,998,087, PUB. 6-28-2005. INT. CL. 16.
- FIBERSTARS, INC., FREMONT, CA:
2,201,916, CANC. INT. CL. 11.
- FIELDCOMMS INTERNATIONAL LTD., KENILWORTH,
WARWICKSHIRE CV8 1HE, UNITED KINGDOM:
2,201,871, CANC. INT. CL. 35.
- FIERCE AMERICAN PRODUCTS, LLC, ASPEN, CO:
2,998,225, PUB. 6-28-2005. INT. CL. 30.
- FIERCEMARKETS, INC., WASHINGTON, DC:
2,996,506, PUB. 6-28-2005. INT. CL. 42.
- FILI ENTERPRISES INCORPORATED, SAN DIEGO, CA:
2,201,545, CANC. INT. CL. 42.
- FILLMORE INDUSTRIAL COOPERATIVE, INC., FILL-
MORE, UT:
2,201,959, CANC. INT. CL. 28.
- FIN CONTROL SYSTEMS PTY. LIMITED, MONA VALE,
NEW SOUTH WALES, AUSTRALIA:
2,997,117, PUB. 6-28-2005. INT. CL. 25.
2,997,118, PUB. 6-28-2005. INT. CL. 28.
- FINANCIAL TECHNOLOGIES LLC, EDWARDSVILLE, IL:
2,997,684, PUB. 6-28-2005. INT. CL. 36.
- FIND MY SPECIALIST, INC., ARTESIA, CA:
2,997,191, PUB. 6-28-2005. INT. CL. 42.
- FIND/SVP, INC., NEW YORK, NY:
2,996,918, PUB. 6-28-2005. INT. CL. 35.
- FINE SCIENCE TOOLS (USA), INC., FOSTER CITY, CA:
1,860,815, CANC. INT. CL. 10.
- FINETRE CORPORATION, HERNDON, VA:
2,998,726, MULTIPLE CLASS, INT. CLS. 36 AND 41.
- FINJAN SOFTWARE LTD., NETANYA SOUTH, 42504,
ISRAEL:
2,201,876, CANC. INT. CL. 9.
- FIORE, JOSEPH F. JR., LEBANON, PA:
2,998,189, PUB. 6-28-2005. INT. CL. 21.
- FIRE BASE EAGLE, ALTOONA, PA:
2,997,769, PUB. 6-28-2005. INT. CL. 36.
- FIRE ETC., EDMONTON ALBERTA, CANADA:
2,996,317, PUB. 6-28-2005. MULTIPLE CLASS, INT. CLS.
9, 16 AND 41.
- FIRE SAFETY INTERNATIONAL, INC., BEREHA, OH:
2,997,090, PUB. 6-28-2005. INT. CL. 9.
- FIREBAUGH, DOUGLAS, BIRMINGHAM, MI AND AN-
DROS, JODI M., BIRMINGHAM, MI:
2,996,430, PUB. 6-28-2005. MULTIPLE CLASS, INT. CLS. 9
AND 16.
- FIREKING INTERNATIONAL, INC., NEW ALBANY, IN:
1,301,215, REN. 8-11-05. INT. CL. 6.
- FIRES OF TRADITION INC., MIAMI BEACH, FL:
2,996,536, PUB. 6-28-2005. MULTIPLE CLASS, INT. CLS.
11 AND 19.
- FIRM GROUP CO., LTD., LADKRABANG, BANGKOK 1050,
THAILAND:
2,201,004, CANC. INT. CL. 11.
- FIRMENICH SA, SWITZERLAND:
2,998,453, PUB. 6-28-2005. MULTIPLE CLASS, INT. CLS. 1
AND 3.
- FIRST CASUALTY INSURANCE GROUP, INC., SOUTHERN
PINES, NC:
2,999,381, INT. CL. 36.
- FIRST HORIZON NATIONAL CORPORATION, MEMPHIS,
TN:
2,999,018, INT. CL. 36.
- FIRST INDIANA CORPORATION, INDIANAPOLIS, IN,
FIRST INDIANA FEDERAL SAVINGS BANK, INDIANA-
POLIS, IN:
1,352,062, REN. 8-9-05. INT. CL. 36.
- FIRST MAGNUS FINANCIAL CORPORATION, TUCSON,
AZ:
2,996,313, PUB. 6-28-2005. INT. CL. 36.
- FIRST MARYLAND BANCORP, BALTIMORE, MD:
1,303,088, CANC. INT. CL. 36.
- FIRST NATIONAL BANK OF THE ROCKIES, MEEKER, CO:
1,890,148, REN. 8-9-05. INT. CL. 36.
- FIRST NONPROFIT MUTUAL HOLDING COMPANY, CHI-
CAGO, IL:
2,999,204, INT. CL. 35.
- FIRSTLOGIC, INC., LACROSSE, WI:
2,999,238, INT. CL. 9.
2,999,242, INT. CL. 9.
- FISCAL PLANNING SERVICES, INC., WASHINGTON, DC:
1,303,069, CANC. INT. CL. 36.
- FISCHER, ROBERT E., HUNTINGTON, WV:
2,996,653, PUB. 6-28-2005. INT. CL. 16.
- FISHER SCIENTIFIC COMPANY L.L.C., HAMPTON, MA:
1,889,733, REN. 8-9-05. INT. CL. 9.
- FISHKING PROCESSORS, INC., LOS ANGELES, CA:
1,879,946, REN. 8-8-05. INT. CL. 29.
- FISHPOND, LLC, SILVERTHORNE, CO:
2,996,826, PUB. 6-28-2005. INT. CL. 25.
- FISKE BROTHERS REFINING CO., NEWARK, NJ:
331,805, REN. 8-6-05. U.S. CL. 15 (INT. CL. 4).
- FITZSIMMONS, KELLY E., CHICAGO, IL:
2,998,102, PUB. 6-28-2005. INT. CL. 37.
- FIVE STAR PARKING, LOS ANGELES, CA:
1,343,371, REN. 8-12-05. INT. CL. 39.
1,345,116, REN. 8-12-05. INT. CL. 39.
- FKI LOGISTEX INTEGRATION INC., LOUISVILLE, KY:
2,997,149, PUB. 6-28-2005. MULTIPLE CLASS, INT. CLS.
39 AND 45.
- FLAT EARTH PRODUCTIONS, INC., BURBANK, CA:
2,996,232, PUB. 6-28-2005. INT. CL. 41.
- FLEETWOOD ENTERPRISES, INC., RIVERSIDE, CA:
2,996,481, PUB. 6-28-2005. INT. CL. 20.
2,997,830, PUB. 6-28-2005. INT. CL. 12.
2,997,831, PUB. 6-28-2005. INT. CL. 12.
2,997,832, PUB. 6-28-2005. INT. CL. 12.
- FLETCHER, HAROLD H., OAKLAND PARK, FL:
2,997,438, PUB. 6-28-2005. INT. CL. 37.
- FLEXOVIT USA, INC., ANGOLA, NY:
2,997,531, PUB. 6-28-2005. INT. CL. 7.
2,997,977, PUB. 6-28-2005. INT. CL. 7.
- FLINT HILLS RESOURCES, LLC, WICHITA, KS:
2,998,054, PUB. 6-28-2005. INT. CL. 4.
2,999,139, INT. CL. 4.
- FLOCAST, LLC, DOLGEVILLE, NY, DBA BERGERON
HEALTH CARE:
2,997,192, PUB. 6-28-2005. INT. CL. 10.
- FLOOR COVERING ASSOCIATES, INC., SHOREWOOD, IL:
2,996,482, PUB. 6-28-2005. MULTIPLE CLASS, INT. CLS.
37 AND 42.
- FLOORBOTICS, INC., AUSTIN, TX:
2,996,971, PUB. 6-28-2005. MULTIPLE CLASS, INT. CLS. 7
AND 9.
- FLOORCOVERINGS INTERNATIONAL, LTD., FOREST
PARK, GA:
2,996,863, PUB. 6-28-2005. MULTIPLE CLASS, INT. CLS.
37 AND 42.
- FLORES; EDDIE, BROOKLYN, NY:
1,302,729, CANC. INT. CL. 25.
- FLORIDA AUTOMOTIVE DISTRIBUTING, INC., ST. PE-
TERSBERG, FL:
2,997,967, PUB. 6-28-2005. INT. CL. 37.
- FLORIDA CRYSTALS, INC., PALM BEACH, FL:
2,201,215, CANC. INT. CL. 30.
- FLORIDA DEPARTMENT OF EDUCATION, TALLAHAS-
SEE, FL:
2,996,522, PUB. 6-28-2005. INT. CL. 41.
- FLORIDA INSTITUTE OF CERTIFIED PUBLIC ACCOUN-
TANTS, TALLAHASSEE, FL:
1,861,530, CANC. INT. CL. 35.
1,861,541, CANC. INT. CL. 41.
- FLORIDA INTERNATIONAL UNIVERSITY, MIAMI, FL:
2,201,278, CANC. INT. CL. 25.
- FLORIDA SURETY BONDS, INC., ALTAMONTE SPRINGS,
FL:
2,996,966, PUB. 6-28-2005. INT. CL. 36.
- FLORIDA TILE INDUSTRIES, INC., LAKELAND, FL:
1,852,407, CANC. INT. CL. 19.
- FLORSHEIM GROUP INC., CHICAGO, IL:
2,201,577, CANC. INT. CL. 25.
- FLYNN, JOEL, VANCOUVER, CANADA, DBA VERGE
ENTERTAINMENT:
2,996,230, PUB. 6-28-2005. INT. CL. 41.

- FNC, INC., OXFORD, MS:
2,997,731, PUB. 6-28-2005. INT. CL. 9.
- FOAM ENTERPRISES, LLC, MOUNT OLIVE, NJ:
2,997,187, PUB. 6-28-2005. INT. CL. 17.
- FOCUS ON THE FAMILY, COLORADO SPRINGS, CO:
2,997,861, PUB. 6-28-2005. INT. CL. 16.
- FOCUS RECEIVABLES MANAGEMENT, L.L.C., ATLANTA, GA:
2,996,669, PUB. 6-28-2005. INT. CL. 36.
- FOMO PRODUCTS, INC., NORTON, OH:
2,997,497, PUB. 6-28-2005. INT. CL. 35.
- FONAWIN CORPORATION, NEW YORK, NY:
1,303,166, CANC. INT. CL. 41.
- FONBELLE AMERICAS, CORAL GABLES, FL:
2,997,121, PUB. 3-8-2005. INT. CL. 33.
- FONIX CORPORATION, SANDY, UT:
2,998,139, PUB. 6-28-2005. INT. CL. 9.
- FONTANESI, JAMES, CLINTON TOWNSHIP, MI TO AMERICAN HEALTHWAYS, INC., NASHVILLE, TN:
2,130,873, CANC. INT. CL. 42.
- FOOD FOR LIFE GLOBAL, POTOMAC, MD:
2,999,196, INT. CL. 43.
- FOODS, INC., SARASOTA, FL:
597,687, CANC. U.S. CL. 46.
- FORD MOTOR COMPANY, DEARBORN, MI:
1,862,561, REN. 8-11-05. INT. CL. 24.
1,867,102, REN. 8-9-05. INT. CL. 28.
1,874,207, REN. 8-11-05. INT. CL. 36.
1,893,911, REN. 8-11-05. INT. CL. 6.
2,201,549, CANC. INT. CL. 24.
2,201,550, CANC. INT. CL. 14.
2,998,848, INT. CL. 12.
- FORD, MARTIN ROBERT, SUNNYVALE, CA, DBA "SOLUTIONSOFT":
2,201,291, CANC. INT. CL. 9.
- FORDHAM LABS LLC, PLANTATION, FL:
2,998,166, PUB. 6-28-2005. INT. CL. 5.
- FOREIGN CANDY COMPANY, INC., THE HULL, IA:
2,998,172, PUB. 6-28-2005. INT. CL. 30.
- FORMANEK CUSTOM DESIGNS AND DISTRIBUTING L.L.C., LINDSAY, NE:
2,998,345, PUB. 6-28-2005. INT. CL. 6.
- FORMULAWERKS, INC., KENOSHA, WI:
2,997,207, PUB. 6-28-2005. INT. CL. 25.
- FORREST & COMPANY LIMITED, TORONTO, ONTARIO, CANADA:
2,200,949, CANC. INT. CL. 41.
- FORT HILL COMPANY, MONTCHANIN, DE:
2,997,746, PUB. 6-28-2005. INT. CL. 35.
- FORT HOWARD CORPORATION, GREEN BAY, WI:
2,028,854, CANC. INT. CL. 16.
- FORT JAMES OPERATING COMPANY, ATLANTA, GA, CROWN ZELLERBACH CORPORATION, SAN FRANCISCO, CA:
1,342,725, REN. 8-11-05. INT. CL. 21.
- FORT KNOX SECURITY PRODUCTS, INC., OREM, UT, FORT KNOX SECURITY PRODUCTS, INC., OREM, UT:
1,375,456, REN. 8-11-05. INT. CL. 6.
- FORT KRUIWAGENS B.V., 4004 JV TIEL, NETHERLANDS:
1,352,694, REN. 8-8-05. INT. CL. 12.
- FOSECO INTERNATIONAL LIMITED, BIRMINGHAM, ENGLAND:
779,269, CANC. U.S. CL. 6.
779,273, CANC. U.S. CL. 6.
- FOSS ANALYTICAL AB, 263 21 HOGANAS, SWEDEN:
1,345,703, REN. 8-11-05. INT. CL. 9.
- FOSSIL, INC., RICHARDSON, TX:
2,996,864, PUB. 6-28-2005. INT. CL. 14.
- FOUNDATION FOR INNER PEACE, GLEN ELLEN, CA TO FOUNDATION FOR A COURSE IN MIRACLES, TEMECULA, CA:
1,807,235, CANC. MULTIPLE CLASS, INT. CLS. 9, 16 AND 41.
- FOUNDATION FOR SARCOIDOSIS RESEARCH, CHICAGO, IL:
2,996,802, PUB. 6-28-2005. INT. CL. 36.
- FOUNDATIONS, INC., MOORESTOWN, NJ:
2,998,781, INT. CL. 41.
- FOWLER PRODUCTS COMPANY, LLC, ATHENS, GA:
1,881,864, REN. 8-10-05. INT. CL. 7.
- FOX TELEVISION STATIONS, INC., LOS ANGELES, CA:
1,894,393, REN. 8-9-05. INT. CL. 41.
- FOX, AMY E, WILLIAMSBURG, VA:
2,997,150, PUB. 6-28-2005. INT. CL. 25.
- FPI FIREPLACE PRODUCTS INTERNATIONAL, LTD., DELTA, BRITISH COLUMBIA, CANADA:
2,997,007, PUB. 6-28-2005. INT. CL. 11.
- FRAN'S HEALTHY HELPINGS, INC., BURLINGAME, CA:
2,201,668, CANC. INT. CL. 30.
- FRANK BRUNCKHORST CO., L.L.C., BROOKLYN, NY:
2,999,177, INT. CL. 29.
- FRANK W. KERR & COMPANY, NOVI, MI:
1,892,321, REN. 8-10-05. INT. CL. 35.
- FRANK, GILBERT A., SAN DIEGO, CA:
2,200,962, CANC. INT. CL. 34.
- FRANK'S SEPTIC SERVICE, INC., VACAVILLE, CA:
2,998,844, INT. CL. 40.
- FRANKIE AVALON PRODUCTS, INC., WESTLAKE VILLAGE, CA:
1,861,051, CANC. INT. CL. 28.
- FRANKLIN ELECTRONIC PUBLISHERS, INCORPORATED, BURLINGTON, NJ:
1,898,747, REN. 8-11-05. INT. CL. 9.
- FRATELLI BRANCA DISTILLERIE S.R.L., MILANO, ITALY:
2,996,976, PUB. 6-28-2005. MULTIPLE CLASS, INT. CLS. 32 AND 33.
- FRED MEYER JEWELERS, INC., PORTLAND, OR:
2,201,180, CANC. INT. CL. 35.
- FREDERIC FEKKAI & CO., LLC, NEW YORK, NY:
2,999,365, INT. CL. 3.
- FREDERICK ATKINS, INC., NEW YORK, NY:
2,201,579, CANC. MULTIPLE CLASS, INT. CLS. 3, 8, 9, 10, 11, 14, 18, 20, 21 AND 28.
- FREDERICK GOLDMAN, INC., NEW YORK, NY:
2,998,670, INT. CL. 14.
- FREDERICKS, ELLEN, WARREN, NJ AND PROFESSIONAL COACHING AND TRAINING, INC., EDISON, NJ:
2,997,047, PUB. 6-28-2005. MULTIPLE CLASS, INT. CLS. 16 AND 41.
- FREECOM, INC., BIG SPRING, TX:
1,860,611, CANC. INT. CL. 2.
- FREESCALE SEMICONDUCTOR, INC., AUSTIN, TX:
2,997,722, PUB. 6-28-2005. INT. CL. 41.
- FRESENIUS MEDICAL CARE DEUTSCHLAND GMBH, BAD HOMBURG, FED REP GERMANY:
2,998,398, PUB. 6-28-2005. INT. CL. 10.
- FRESENIUS MEDICAL CARE; DEUTSCHLAND GMBH, FED REP GERMANY:
2,998,486, PUB. 6-28-2005. INT. CL. 10.
- FRESENIUS USA, INC., LEXINGTON, MA:
1,911,230, REN. 8-12-05. INT. CL. 10.
1,914,732, REN. 8-12-05. INT. CL. 10.
- FRESH PRODUCE SPORTSWEAR, INC., BOULDER, CO:
2,997,397, PUB. 6-28-2005. INT. CL. 25.
- FRESHWATER FISH MARKETING CORPORATION, WINNIPEG, MANITOBA R2C 3L4, CANADA:
1,894,208, REN. 8-8-05. INT. CL. 29.
- FRIDAY MORNING QUARTERBACK ALBUM REPORT, INC., CHERRY HILL, NJ:
1,349,320, REN. 8-11-05. INT. CL. 16.
- FRIEDLAND, AMANDA, LOS ANGELES, CA, DBA AMANDAFREESTYLE:
2,996,988, PUB. 6-28-2005. INT. CL. 25.
- FRIENDLY ICE CREAM CORPORATION, WILBRAHAM, MA:
2,998,509, INT. CL. 30.
- FRIENDS OF THE COLORADO CENTER FOR HUMAN NUTRITION, LAKEWOOD, CO:
2,996,326, PUB. 6-28-2005. INT. CL. 44.
2,996,327, PUB. 6-28-2005. INT. CL. 41.
- FRIGOSCANDIA FOOD PROCESS SYSTEMS AKTIEBOLAG, HELSINGBORG, SWEDEN:
1,302,484, CANC. INT. CL. 11.

- FRINGE BENEFITS MANAGEMENT COMPANY, TALLAHASSEE, FL:
2,202,272, CANC. INT. CL. 36.
- FRITO-LAY NORTH AMERICA, INC., PLANO, TX, CRACKER JACK CO., THE, CHICAGO, IL:
197,337. REN. 8-10-05. U.S. CL. 46 (INT. CL. 30).
- FROM YOU FLOWERS, LLC, OLD SAYBROOK, CT:
2,996,659, PUB. 6-28-2005. INT. CL. 38.
- FRONTIER FERTILIZER & CHEMICAL COMPANY, JOHNSTOWN, CO:
2,998,571, INT. CL. 1.
- FROSTY BITES DISTRIBUTION, LLC, MIAMI, FL:
2,724,737, CANC. INT. CL. 30.
- FROZEN POND INVESTMENTS, LLC, RICHMOND, VA:
2,202,374, CANC. INT. CL. 41.
- FSI INTERNATIONAL, INC., CHASKA, MN:
2,998,609, INT. CL. 7.
- FTLC-LLC, PERU, IN:
2,998,629, INT. CL. 16.
- FUELTEC, INC., HUTCHINSON, KS:
2,201,565, CANC. INT. CL. 7.
- FUGU LTD., BELLEVUE, WA TO FUGU LTD., BELLEVUE, WA:
1,860,789, CANC. INT. CL. 9.
- FUJI CHEMICAL INDUSTRY CO., LTD., TOYAMA-KEN, JAPAN:
2,996,429, PUB. 6-28-2005. MULTIPLE CLASS, INT. CLS. 5 AND 29.
- FUJI SYSTEMS CORPORATION, BUNKYO-KU, TOKYO, JAPAN:
1,894,014. REN. 8-6-05. INT. CL. 10.
- FUJISANKEI COMMUNICATIONS INTERNATIONAL, INC., NEW YORK, NY:
2,201,120, CANC. INT. CL. 41.
- FUJITSU NETWORK COMMUNICATIONS, INC., RICHARDSON, TX AND FUJITSU LIMITED, KANAGAWA-KEN 11-88, JAPAN:
2,201,929, CANC. INT. CL. 9.
- FUJITSU SIEMENS COMPUTERS GMBH, 80807 MUNICH, FED REP GERMANY:
2,910,748, AM. MULTIPLE CLASS, INT. CLS. 9, 38 AND 42.
- FUJITSU SOFTWARE CORPORATION, SAN JOSE, CA:
2,201,654, CANC. INT. CL. 42.
- FUKUSUKE KABUSHIKI KAISHA, TOKYO, JAPAN:
2,200,871, CANC. INT. CL. 25.
- FULD, JOHN W., WINTER GARDEN, FL:
2,997,569, PUB. 6-28-2005. INT. CL. 41.
- FULL SAIL, INC., WINTER PARK, FL:
2,996,883, PUB. 6-28-2005. MULTIPLE CLASS, INT. CLS. 9, 16, 25 AND 41.
- FULLER BRUSH COMPANY, INC., THE, GREAT BEND, KS, FULLER BRUSH COMPANY, THE, NORTH KANSAS CITY, MO:
1,340,805. REN. 8-10-05. INT. CL. 21.
- FUNDACION POR EL FUTURO, SPAIN:
2,998,435, PUB. 6-28-2005. MULTIPLE CLASS, INT. CLS. 35 AND 41.
- FUNDAMENTAL VALUES, LLC, CIBOLO, TX:
2,997,994, PUB. 6-28-2005. INT. CL. 41.
- FURUYA, MITSUMASA, EDOGAWA-KU, TOKYO, 132, JAPAN AND SHIRAI, TAKAMASA, DOVE CANYON, CA:
2,201,977, CANC. INT. CL. 10.
- FUTURE DONTICS, INC., LOS ANGELES, CA:
2,997,926, PUB. 6-28-2005. INT. CL. 35.
- G. ROCCISANO & SONS PTY LTD, AUSTRALIA:
2,998,498, PUB. 6-28-2005. INT. CL. 33.
- G. A. WOODLAND, INC., BROCKTON, MA:
2,998,131, PUB. 6-28-2005. INT. CL. 37.
- G. B. MANASEK INC, NORWICH, VT:
2,201,279, CANC. INT. CL. 41.
- G. E. MASSENEZ, 67220 VILLE, FRANCE:
2,201,488, CANC. INT. CL. 33.
- G. WILLIKERS, INC., SARASOTA, FL:
2,202,203, CANC. INT. CL. 34.
- G.L.B., FRANCE:
2,998,372, PUB. 6-28-2005. INT. CL. 3.
- G.M. GABEL ENTERPRISES WINDSOR INC., TECUMSEH, ONTARIO, CANADA:
2,200,813, CANC. MULTIPLE CLASS, INT. CLS. 18 AND 28.
- GA MODEFINE S.A., SWITZERLAND:
2,998,352, PUB. 6-28-2005. MULTIPLE CLASS, INT. CLS. 18, 25 AND 35.
- GABRIELLO, ANDREA, ANDOVER, MA AND GABRIELLO, MAX, ANDOVER, MA, DBA PERFECTO'S CAFFE:
1,936,117. REN. 8-9-05. INT. CL. 42.
- GAETANO'S INC., KANSAS CITY, MO:
779,663, CANC. U.S. CL. 46.
- GALAXY POWER INC, VALLEY FORGE, PA. INTEGRATED CIRCUIT SYSTEMS, INC., VALLEY FORGE, PA:
1,809,945. REN. 8-10-05. INT. CL. 9.
- GALLAGHER LIMITED, SURREY KT13 OQU, UNITED KINGDOM:
2,997,492, PUB. 6-28-2005. INT. CL. 34.
- GALLERY ONE, LTD., COMPANY, MENTOR, OH:
2,997,518, PUB. 6-28-2005. INT. CL. 35.
- GALLET GROUP AG (GALLET GROUP SA); (GALLET GROUP LTD) (GALLET GROUP INC), SWITZERLAND:
2,998,373, PUB. 6-28-2005. INT. CL. 14.
- GALLUP, INC., OMAHA, NE:
2,999,289, INT. CL. 35.
- GALMA & CORDIF S.P.A., I-52100 AREZZO, ITALY:
2,201,347, CANC. INT. CL. 14.
- GAMBLIN ARTISTS COLORS CO., PORTLAND, OR:
2,997,256, PUB. 6-28-2005. INT. CL. 2.
- GAME SHOW NETWORK, LLC, SANTA MONICA, CA:
2,999,068, INT. CL. 41.
- GAMELAB LLC, NEW YORK, NY:
2,997,828, PUB. 6-28-2005. INT. CL. 28.
- GAP (APPAREL), LLC, SAN FRANCISCO, CA:
2,998,065, PUB. 6-28-2005. INT. CL. 25.
- GARDENS OF TAXCO, INC., WEST HOLLYWOOD, CA:
2,998,916, INT. CL. 30.
- GARDNER, MERLE F., MEMPHIS, TN:
2,998,275, PUB. 6-28-2005. INT. CL. 9.
- GARDNER, WALTON A., MEMPHIS, TN:
2,201,206, CANC. INT. CL. 35.
- GARY'S LEATHER CREATIONS, INC., VERNON, CA:
2,202,337, CANC. MULTIPLE CLASS, INT. CLS. 9 AND 18.
- GASTAFSON LLC, PLANO, TX, KALO, INC., OVERLAND PARK, KS, DBA KALO AGRICULTURAL CHEMICALS, INC.:
1,297,311. REN. 8-11-05. INT. CL. 1.
- GAUSPOHL, CHRISTOPHER M., CHICAGO, IL:
2,997,072, PUB. 6-28-2005. INT. CL. 35.
- GAYLORD ENTERTAINMENT COMPANY, NASHVILLE, TN:
2,997,210, PUB. 6-28-2005. INT. CL. 25.
2,997,211, PUB. 6-28-2005. INT. CL. 28.
2,997,213, PUB. 6-28-2005. INT. CL. 16.
- GAYNOR MINDEN, INC., NEW YORK, NY:
2,997,679, PUB. 6-28-2005. INT. CL. 25.
- GC GROUP, LTD., FRAMINGHAM, MA:
2,201,880, CANC. INT. CL. 35.
- GDE SYSTEMS, INC., SAN DIEGO, CA:
2,200,951, CANC. MULTIPLE CLASS, INT. CLS. 9, 41 AND 42.
- GE BETZ, INC., TREVOSE, PA, BETZ PROCESS CHEMICALS, INC., THE WOODLANDS, TX:
1,901,107. REN. 8-11-05. INT. CL. 1.
- GE MEDICAL SYSTEMS INFORMATION TECHNOLOGIES, INC., MILWAUKEE, WI:
1,304,884. REN. 8-9-05. INT. CL. 10.
- GE OSMONICS, INC., MINNETONKA, MN:
2,997,294, PUB. 6-28-2005. INT. CL. 9.
- GEAC ENTERPRISE SOLUTIONS, INC., SOUTHBOROUGH, MA:
2,200,941, CANC. MULTIPLE CLASS, INT. CLS. 9, 16, 36, 41 AND 42.
- GELMEDIC HOLDING APS, 2970 HORSHOLM, DENMARK:
2,996,247, PUB. 6-28-2005. INT. CL. 5.

- GEN 400 LIMITED, TEDDINGTON, MIDDLESEX, UNITED KINGDOM, GEN400, MIDDLESEX, TW11 9AJ, UNITED KINGDOM:
1,888,231. REN. 8-9-05. INT. CL. 9.
- GEN-X SPORTS SARL, CH-1630, BULLE, SWITZERLAND:
2,998,619. INT. CL. 28.
- GENCACHE LLC, IRVINE, CA:
2,999,252. INT. CL. 9.
- GENERAL ALUMINUM COMPANY OF TEXAS, LP, CARROLLTON, TX:
2,996,604. PUB. 6-28-2005. MULTIPLE CLASS, INT. CLS. 6 AND 19.
- GENERAL BINDING CORPORATION, NORTHBROOK, IL:
1,311,070. REN. 8-9-05. INT. CL. 16.
- GENERAL CHURCH OF THE NEW JERUSALEM, BRYN ATHYN, PA:
2,996,922. PUB. 6-28-2005. MULTIPLE CLASS, INT. CLS. 35, 41 AND 45.
- GENERAL CONFERENCE CORPORATION OF SEVENTH-DAY, WASHINGTON, DC:
1,365,085. REN. 8-8-05. INT. CL. 42.
- GENERAL ELECTRIC COMPANY, FAIRFIELD, CT, LIQUID NITROGEN PROCESSING CORPORATION, MALVERN, PA:
782,228. REN. 8-12-05. U.S. CL. 1 (INT. CL. 1).
- GENERAL ELECTRIC COMPANY, FAIRFIELD, CT, UNION CARBIDE CORPORATION, DANBURY, CT:
1,334,957. REN. 8-10-05. INT. CL. 1.
- GENERAL ELECTRIC COMPANY, SCHENECTADY, NY:
2,996,474. PUB. 6-28-2005. INT. CL. 36.
2,998,908. INT. CL. 36.
2,998,909. INT. CL. 9.
2,998,912. INT. CL. 9.
- GENERAL INDUSTRIES, THE, ELYRIA, OH:
409,924. CANC. U.S. CL. 21.
- GENERAL MANAGEMENT SYSTEMS, INC., MIAMI BEACH, FL:
2,999,334. INT. CL. 42.
- GENERAL MILLS, INC., MINNEAPOLIS, MN:
1,929,420. REN. 8-9-05. INT. CL. 30.
- GENERAL MOTORS CORPORATION, DETROIT, MI:
1,887,886. REN. 8-11-05. INT. CL. 12.
1,889,797. REN. 8-9-05. INT. CL. 12.
1,898,835. REN. 8-9-05. INT. CL. 12.
1,907,315. REN. 8-10-05. INT. CL. 16.
2,997,036. PUB. 6-28-2005. INT. CL. 28.
- GENERAL NUTRITION INVESTMENT COMPANY, PITTSBURGH, PA:
2,202,178. CANC. INT. CL. 5.
2,202,278. CANC. INT. CL. 5.
- GENERAL PENCIL COMPANY, INC., JERSEY CITY, NJ:
2,996,505. PUB. 6-28-2005. INT. CL. 16.
- GENERAL RE CORPORATION, STAMFORD, CT:
2,996,470. PUB. 6-28-2005. INT. CL. 16.
- GENERALE BISCUIT, 91200 ATHIS-MONS, FRANCE:
2,201,092. CANC. INT. CL. 30.
- GENERALE BISCUIT, F-91200 ATHIS-MONS, FRANCE:
2,998,383. PUB. 6-28-2005. MULTIPLE CLASS, INT. CLS. 5, 29 AND 30.
- GENERATION CHESS, LLC, NEW YORK, NY:
2,997,418. PUB. 6-28-2005. MULTIPLE CLASS, INT. CLS. 35 AND 41.
- GENERATION THREE REALTY HOLDINGS, LLC, SKOKIE, IL:
779,666. CANC. U.S. CL. 46.
- GENESIS DIRECT, INC., FORT LEE, NJ:
2,202,142. CANC. INT. CL. 35.
- GENESIS HEALTHCARE, INC., GREENFIELD, WI:
2,201,642. CANC. INT. CL. 9.
- GENESPAN CORPORATION, REDMOND, WA:
2,201,825. CANC. INT. CL. 1.
- GENEVA MEDIA, LLC, REDWOOD CITY, CA:
2,997,298. PUB. 6-28-2005. MULTIPLE CLASS, INT. CLS. 35 AND 42.
- GENIX INTERNATIONAL CORPORATION, OAKVILLE, ONTARIO, CANADA:
2,997,870. PUB. 6-28-2005. INT. CL. 16.
- GENLYTE GROUP, INC., THE, SECAUCUS, NJ TO GENLYTE THOMAS GROUP LLC, LOUISVILLE, KY:
1,860,800. CANC. MULTIPLE CLASS, INT. CLS. 9 AND 11.
- GENLYTE THOMAS GROUP LLC, LOUISVILLE, KY, GENLYTE GROUP INCORPORATED, THE, SECAUCUS, NJ:
1,893,588. REN. 8-9-05. INT. CL. 11.
- GENMAR INDUSTRIES, INC., MINNEAPOLIS, MN:
2,998,237. PUB. 6-28-2005. INT. CL. 39.
- GENOME INTERNATIONAL CORPORATION, MADISON, WI:
2,996,744. PUB. 6-28-2005. INT. CL. 42.
- GENZYME CORPORATION, CAMBRIDGE, MA, GENETRIX, INC., SCOTTSDALE, AZ:
1,906,170. REN. 8-9-05. INT. CL. 42.
- GEODE CAPITAL MANAGEMENT, LLC, BOSTON, MA:
2,997,931. PUB. 6-28-2005. INT. CL. 36.
- GEOMEMBRANE SERVICES INC., KEWADIN, MI:
2,201,050. CANC. INT. CL. 37.
- GEORGE KELK CORPORATION, TORONTO, ONTARIO, CANADA, GEORGE KELK LIMITED, DON MILLS, ONTARIO, M3B 2T5, CANADA:
1,914,576. REN. 8-12-05. INT. CL. 9.
- GEORGE ZAWACKI ENTERPRISES, LLC, ARLINGTON HEIGHTS, IL:
2,996,723. PUB. 6-28-2005. INT. CL. 41.
- GEORGIA BIOMEDICAL, INC., MACON, GA:
2,202,184. CANC. INT. CL. 10.
- GEORGIA-PACIFIC CORPORATION, ATLANTA, GA:
2,998,911. INT. CL. 35.
- GEORGIEV, PLAMEN ZHELIAZKOV, NASHVILLE, TN:
2,998,675. INT. CL. 25.
- GERBER PLUMBING FIXTURES CORP., CHICAGO, IL:
2,202,262. CANC. INT. CL. 11.
- GERBER PRODUCTS COMPANY, FREMONT, MI:
1,011,350. REN. 8-10-05. INT. CL. 5.
- GERBIG SNELL/WEISHEIMER ADVERTISING, LLC, WESTERVILLE, OH:
2,997,802. PUB. 6-28-2005. INT. CL. 35.
- GETCENTRIC, INC., BEDFORD, TX:
2,200,924. CANC. INT. CL. 42.
- GETRONICS INTELLECTUAL PROPERTY B.V., 1043 AJ AMSTERDAM, NETHERLANDS:
2,996,284. PUB. 6-28-2005. MULTIPLE CLASS, INT. CLS. 9, 35 AND 42.
2,996,285. PUB. 6-28-2005. MULTIPLE CLASS, INT. CLS. 9, 35 AND 42.
- GFD FABRICS, INC., GREENSBORO, NC:
2,202,155. CANC. INT. CL. 24.
- GFY BEVERAGES COMPANY, NEW YORK, NY:
2,999,286. INT. CL. 25.
- GGB ENTERPRISES, INC., SAN GABRIEL, CA:
2,996,303. PUB. 6-28-2005. INT. CL. 30.
- GHEENT MANUFACTURING, INC., LEBANON, OH:
2,996,722. PUB. 6-28-2005. INT. CL. 16.
- GIANCI, ANN, CHARLESTOWN, MA:
2,201,628. CANC. INT. CL. 16.
- GIANT FOOD INC., LANDOVER, MD:
1,861,324. CANC. MULTIPLE CLASS, INT. CLS. 29 AND 30.
- GIBSON OVERSEAS, INC., ALHAMBRA, CA:
2,202,264. CANC. INT. CL. 21.
- GIBSON WINE COMPANY, ELK GROVE, CA:
1,303,018. CANC. INT. CL. 33.
- GIFT CERTIFICATE CENTER, INC., THE, MINNEAPOLIS, MN:
1,868,540. REN. 8-8-05. INT. CL. 35.
- GIGAVAC LLC, CARPINTERIA, CA:
2,997,797. PUB. 6-28-2005. INT. CL. 9.
- GILBERT ADVANCED ASSET MANAGEMENT, INC., JOHNSON CITY, TN:
2,996,576. PUB. 6-28-2005. INT. CL. 36.
- GILREATH, KIM L., BELTSVILLE, MD:
2,997,567. PUB. 6-28-2005. INT. CL. 4.
- GINTER, GARY, CHICAGO, IL:
2,201,580. CANC. INT. CL. 35.
- GIOVANNI'S PIZZA, INC., ASHLAND, KY:
2,997,652. PUB. 6-28-2005. INT. CL. 43.

- GIRLS WHEREVER, KNOXVILLE, TN:
2,999,115, INT. CL. 25.
- GIS WORLD, INC., FORT COLLINS, CO TO MCA COMMUNICATIONS, LLC, PALM SPRINGS, CA:
1,861,502, CANC. INT. CL. 16.
- GIUSTI, JAY R, CHICAGO, IL, DBA BY ACCLAMATION:
2,201,184, CANC. INT. CL. 9.
- GIVAUDAN SA, SWITZERLAND:
2,998,412, PUB. 6-28-2005. INT. CL. 1.
- GLADSON & ASSOCIATES, INC., LISLE, IL, DBA GLADSON INTERACTIVE SERVICES:
2,996,558, PUB. 6-28-2005. INT. CL. 35.
- GLAMOUR SHOTS LICENSING, INC., OKLAHOMA CITY, OK, DBA GLAMOUR SHOTS:
1,861,267, CANC. INT. CL. 42.
- GLASSCO, JOHN M., EPHRATA, WA:
2,996,994, PUB. 6-28-2005. INT. CL. 9.
- GLAXO WELLCOME INC., RESEARCH TRIANGLE PARK, NC:
2,201,767, CANC. INT. CL. 42.
- GLEN ELLYN INDUSTRIES, LLC, GLEN ELLYN, IL:
2,998,673, INT. CL. 16.
- GLENDALE INTERNATIONAL CORP., OAKVILLE, ONTARIO, CANADA:
2,997,405, PUB. 6-28-2005. INT. CL. 12.
- GLIDDEN COMPANY, THE, CLEVELAND, OH:
997,460, CANC. U.S. CL. 16.
- GLOBAL BEARINGS, INC., TULSA, OK:
2,997,604, PUB. 6-28-2005. INT. CL. 7.
- GLOBAL HOME LOANS AND FINANCE INC., MELVILLE, NY:
2,996,265, PUB. 6-28-2005. INT. CL. 36.
- GLOBALUBE GESELLSCHAFT FUR SCHMIERSTOFF-GEBER MBH, DEUTSCHLAND, 27572 BREMERHAVE, FED REP GERMANY:
2,201,761, CANC. MULTIPLE CLASS, INT. CLS. 4 AND 7.
- GLOBE MANUFACTURING COMPANY, PITTSFIELD, NH:
2,997,112, PUB. 6-28-2005. INT. CL. 9.
- GLOBEOP FINANCIAL SERVICES, LLC, HARRISON, NY:
2,997,819, PUB. 6-28-2005. MULTIPLE CLASS, INT. CLS. 35, 36 AND 42.
- GLORIA ELECTRONICS PTE, LTD., SINGAPORE:
2,201,777, CANC. INT. CL. 9.
- GMB, INC., KING, NC:
1,391,824, REN. 8-11-05. INT. CL. 34.
- GMH ASSOCIATES, INC., NEWTOWN SQUARE, PA:
2,996,835, PUB. 6-28-2005. MULTIPLE CLASS, INT. CLS. 36 AND 37.
- GMR PROTECTION RESOURCES, INC., ROCKWALL, TX:
2,998,925, MULTIPLE CLASS, INT. CLS. 41, 42 AND 45.
- GN RESOUND A/S, DENMARK:
2,998,434, PUB. 6-28-2005. INT. CL. 10.
- GO AMERICA TOURS, INC., NEW YORK, NY TO LTU TOURISTIK GMBH, DUESSELDORF, FED REP GERMANY:
1,861,216, CANC. INT. CL. 39.
- GOCAR RENTALS, INC., SAN FRANCISCO, CA:
2,999,391, INT. CL. 39.
- GODIGITAL TELECOMMUNICATIONS, INC., FREMONT, CA:
2,201,974, CANC. INT. CL. 9.
- GOEINS WILLIAMS ASSOCIATES INC., WILMINGTON, DE:
2,998,706, INT. CL. 16.
- GOEMAR INTERNATIONAL CORPORATION, ATLANTA, GA:
1,302,338, CANC. INT. CL. 3.
- GOER MANUFACTURING COMPANY, INC., NORTH CHARLESTON, SC:
2,202,290, CANC. MULTIPLE CLASS, INT. CLS. 6 AND 19.
- GOLD RIVER MILLS, LLC, WOODLAND, CA:
1,011,094, REN. 8-10-05. INT. CL. 30.
1,863,842, REN. 8-6-05. INT. CL. 30.
- GOLDEN FLAKE SNACK FOODS, INC., BIRMINGHAM, AL:
1,344,829, REN. 8-12-05. MULTIPLE CLASS, INT. CLS. 29 AND 30.
- GOLDEN FUTURE WEDDING BAND, INC., HACKENSACK, NJ:
2,996,416, PUB. 6-28-2005. INT. CL. 40.
- GOLDEN HOUR DATA SYSTEMS, INC., SOLANA BEACH, CA:
2,997,202, PUB. 6-28-2005. MULTIPLE CLASS, INT. CLS. 35 AND 42.
- GOLDEN SOFTWARE, INC., GOLDEN, CO:
2,999,250, INT. CL. 9.
- GOLDEN SUN, INC., SANTA CLARITA, CA:
2,996,463, PUB. 5-3-2005. INT. CL. 3.
- GOLDEN TULIP INTERNATIONAL B.V., 1211 EM HILVERSUM, NETHERLANDS:
1,377,654, REN. 8-12-05. INT. CL. 42.
- GOLDEN WINDOWS LIMITED, KITCHENER, ONTARIO, CANADA:
2,997,141, PUB. 6-28-2005. INT. CL. 19.
- GOLDMAN, STEVEN A., BEACHWOOD, OH:
2,998,019, PUB. 6-28-2005. INT. CL. 44.
- GOLDWATER'S FOODS OF ARIZONA, SCOTTSDALE, AZ:
2,201,361, CANC. INT. CL. 30.
- GOLF GIFTS AND GALLERY, INC., POWERS LAKE, WI, BRANDELL PRODUCTS CORPORATION, CHICAGO, IL:
781,704, REN. 8-12-05. U.S. CL. 22 (INT. CL. 28).
- GOLF GIFTS, INC., PITTSBURGH, PA:
2,201,432, CANC. INT. CL. 28.
- GOLF MEDIA, INC., CHETEK, WI:
2,996,495, PUB. 6-28-2005. INT. CL. 43.
- GOOD NEWS PUBLISHERS, WHEATON, IL:
2,997,914, PUB. 6-28-2005. INT. CL. 16.
- GOOD SOURCE SOLUTIONS, INC, SAN DIEGO, CA:
2,997,342, PUB. 6-28-2005. INT. CL. 35.
- GOODALL RUBBER COMPANY, ASTON, PA:
1,861,472, CANC. INT. CL. 42.
- GOODMN MEDIA GROUP, INC., NEW YORK, NY, GCR PUBLISHING GROUP, INC., NEW YORK, NY:
1,940,180, REN. 8-11-05. INT. CL. 16.
- GOODNIGHT STUDIO, LTD., SANTA FE, NM:
2,201,714, CANC. MULTIPLE CLASS, INT. CLS. 9, 16 AND 25.
- GOODSPORTS FOR LIFE, INC., LAGUNA BEACH, CA:
2,996,291, PUB. 6-28-2005. INT. CL. 16.
- GORDON GROUP HOLDINGS, LLC, GREENWICH, CT:
2,996,767, PUB. 6-28-2005. MULTIPLE CLASS, INT. CLS. 36 AND 37.
- GOTTESMAN DIAMOND CORP., CHICAGO, IL:
2,414,660, CANC. INT. CL. 35.
- GOULD, MITCHELL SANTINE, PORTLAND, OR:
2,997,468, PUB. 6-28-2005. INT. CL. 41.
- GOURMET KITCHENS, INC., CHICAGO, IL:
2,997,934, PUB. 6-28-2005. INT. CL. 43.
- GRACIE, RORION, TORRANCE, CA:
2,997,282, PUB. 6-28-2005. INT. CL. 25.
- GRAF WOLF DEVELOPMENT, INC., FREDERICK, MD:
2,998,869, INT. CL. 43.
- GRAHAM RICHARD A, AMHERST, OH:
2,996,950, PUB. 6-28-2005. INT. CL. 25.
- GRAMAN USA, INC., FOUNTAIN VALLEY, CA:
2,201,655, CANC. INT. CL. 28.
- GRAND HALL ENTERPRISE CO., LTD., TAIPEI, TAIWAN:
2,996,438, PUB. 6-28-2005. INT. CL. 11.
- GRANDE CHEESE COMPANY, BROWNSVILLE, WI:
2,997,507, PUB. 6-28-2005. MULTIPLE CLASS, INT. CLS. 35 AND 42.
2,999,263, INT. CL. 29.
- GRANDMA EMILIE BROWN, INC., DEFIANCE, OH TO INTERSTATE BAKERIES CORPORATION, KANSAS CITY, MO:
1,861,429, CANC. INT. CL. 30.
- GRANGE MUTUAL CASUALTY COMPANY, COLUMBUS, OH:
2,996,833, PUB. 6-28-2005. INT. CL. 36.
2,996,834, PUB. 6-28-2005. INT. CL. 36.
2,996,880, PUB. 6-28-2005. INT. CL. 42.
2,996,881, PUB. 6-28-2005. INT. CL. 42.
2,996,882, PUB. 6-28-2005. INT. CL. 42.
- GRANNY'S BAKERY, LLC, SCOTTSDALE, AZ:
2,997,740, PUB. 6-28-2005. INT. CL. 30.

- GRAPE TECHNOLOGY GROUP, INC., WILMINGTON, DE:
2,996,479, PUB. 6-28-2005. INT. CL. 35.
- GRAPHIC IMPRESSIONS, INC., COLUMBIA, MD:
2,201,086, CANC. INT. CL. 35.
- GRAPHIC PACKAGING INTERNATIONAL, INC., MAR-
IETTA, GA, BROWN COMPANY, PASADENA, DE:
1,012,922, REN. 8-10-05. INT. CL. 16.
- GRASSROOTS COMMUNICATIONS, INC., PALM DESERT,
CA:
2,998,921, INT. CL. 38.
- GRATEFUL DEAD PRODUCTIONS, NOVATO, CA:
2,997,910, PUB. 6-28-2005. MULTIPLE CLASS, INT. CLS.
9, 16, 25 AND 41.
2,998,339, PUB. 6-28-2005. MULTIPLE CLASS, INT. CLS.
14, 16, 21 AND 25.
- GRAYBEAL JACKSON HALEY LLP, BELLEVUE, WA:
2,997,077, PUB. 6-28-2005. INT. CL. 42.
- GRAYSON FAIRBANKS, INC., ROCHESTER, NY:
2,997,761, PUB. 6-28-2005. INT. CL. 3.
- GREAT DANE LIMITED PARTNERSHIP, SAVANNAH, GA:
2,201,138, CANC. INT. CL. 12.
- GREAT EXPECTATIONS LICENSOR, L.L.C., HOUSTON,
TX:
1,346,888, REN. 8-9-05. INT. CL. 42.
- GREAT GO CYCLES INC., TAICHUNG HSIEN, TAIWAN:
2,996,796, PUB. 6-28-2005. INT. CL. 12.
- GREAT LAKES BUSINESS FORMS, INC., GRAND RAPIDS,
MI TO HARLAND FINANCIAL SOLUTIONS, INC., PORT-
LAND, OR:
1,860,795, CANC. MULTIPLE CLASS, INT. CLS. 9 AND
42.
- GREAT LAKES CHAPTER OF THE AMERICAN SOCIETY
OF HOME INSPECTORS, CINCINNATI, OH:
2,881,154, COR. U.S. CL. B.
- GREATER ANCHORAGE, INC., ANCHORAGE, AK:
1,350,002, REN. 8-11-05. INT. CL. 41.
- GREATER AUSTIN CHAMBER OF COMMERCE, AUSTIN,
TX:
2,997,637, PUB. 6-28-2005. INT. CL. 35.
- GREEN, NATHANIEL E., LOUISVILLE, KY:
1,892,408, REN. 8-10-05. INT. CL. 41.
- GREENE PLASTICS CORPORATION, HOPE VALLEY, RI:
2,996,548, PUB. 6-28-2005. INT. CL. 28.
- GREENE, LEONARD M., KINGS PARK, NY:
2,999,323, INT. CL. 2.
- GREENE, RAY, ST AUGUSTINE, FL:
2,996,694, PUB. 6-28-2005. INT. CL. 30.
- GREENSTONE LTD., PORTAGE, MI:
1,960,422, REN. 8-10-05. INT. CL. 5.
- GREENVILLE HOSPITAL SYSTEM, GREENVILLE, SC:
1,958,088, REN. 8-8-05. MULTIPLE CLASS, INT. CLS. 41
AND 42.
- GREENWICH TRANSPORTATION UNDERWRITERS, INC.,
NASHVILLE, TN:
2,996,513, PUB. 6-28-2005. INT. CL. 9.
- GRINNELL, E. TRACY, BROOKLYN, NY:
2,996,862, PUB. 6-28-2005. INT. CL. 16.
- GROK, INC., NEVADA CITY, CA:
2,999,026, INT. CL. 9.
- GRONDIN, MARK, GREENWOOD, IN, DBA JOYFUL
HEART MUSIC:
1,898,620, REN. 8-10-05. INT. CL. 9.
- GROOVE LABS LLC, AUSTIN, TX:
2,997,785, PUB. 6-28-2005. INT. CL. 41.
- GROSSBERG, JEFFREY, A., CHICAGO, IL:
2,997,727, PUB. 6-28-2005. INT. CL. 41.
- GROUPE LACASSE LLC, HOLLAND, MI:
2,998,944, INT. CL. 20.
- GROVER PRODUCTS COMPANY, LOS ANGELES, CA:
2,996,746, PUB. 6-28-2005. INT. CL. 12.
- GROW COMPANY, INC., RIDGEFIELD, NJ:
2,996,754, PUB. 6-28-2005. INT. CL. 5.
- GROWING COMPANY SOLUTIONS, NORTH POTOMAC,
MD:
2,997,733, PUB. 6-28-2005. INT. CL. 35.
- GRUBB MANAGEMENT, INC., CARY, NC:
2,201,635, CANC. INT. CL. 36.
- GRUNDL ENTERPRISES INC., FRISCO, TX:
2,998,002, PUB. 6-28-2005. INT. CL. 9.
- GRUNER + JAHR PRINTING AND PUBLISHING CO.,
NEW YORK, NY, GOLDHIRSH GROUP, INC., BOSTON,
MA:
1,900,221, REN. 8-10-05. INT. CL. 16.
- GRUPO BIMBO, S.A. DE C.V., MEXICO CITY, MEXICO:
2,999,037, INT. CL. 30.
- GRUPPO COOPERATIVO VINI-SOC. COOP. A.R.L., VERO-
NA, ITALY:
1,303,007, CANC. INT. CL. 33.
- GRUPPO II GIOIELLO LIMITED, NEW YORK, NY:
2,996,467, PUB. 6-28-2005. INT. CL. 14.
- GSI-ERLI, 94227 CHARENTON-LE-PONT CEDEX, FRANCE:
2,200,853, CANC. MULTIPLE CLASS, INT. CLS. 9, 16
AND 42.
- GSLE SUBCO L.L.C., CHARLOTTE, NC:
789,632, REN. 8-9-05. U.S. CL. 23 (INT. CL. 7).
790,292, REN. 8-9-05. U.S. CL. 23 (INT. CL. 7).
- GTE INTELLIGENT NETWORK SERVICES INCORPO-
RATED, IRVING, TX:
2,201,667, CANC. INT. CL. 38.
- GTM PAYROLL SERVICES, INC., CLIFTON PARK, NY:
2,996,515, PUB. 6-28-2005. INT. CL. 43.
2,996,627, PUB. 6-28-2005. INT. CL. 36.
2,996,628, PUB. 6-28-2005. INT. CL. 36.
- GUANTES VITEX S.A. DE C.V., C.P. 03020, MEXICO:
1,897,553, REN. 8-11-05. INT. CL. 21.
- GUARANTEED WATT SAVER SYSTEMS - WEST, INC.,
OKLAHOMA CITY, OK:
2,997,099, PUB. 6-28-2005. INT. CL. 41.
- GUARDIAN MOVING AND STORAGE, INC., INDIANAPOLIS,
IN:
2,996,689, PUB. 6-28-2005. INT. CL. 39.
- GUARDSMARK, INC., MEMPHIS, TN:
1,861,547, CANC. INT. CL. 42.
- GUESS?, INC., LOS ANGELES, CA:
2,202,330, CANC. INT. CL. 25.
- GUEST, PAMELA YVONNE, BALTIMORE, MD:
2,998,027, PUB. 6-28-2005. INT. CL. 16.
- GUITAR CENTER, INC., WESTLAKE VILLAGE, CA:
2,996,547, PUB. 6-28-2005. MULTIPLE CLASS, INT. CLS.
15, 16 AND 20.
- GUNLOCKE COMPANY, THE, WAYLAND, NY, GUN-
LOCKE COMPANY; THE, WAYLAND, NY:
1,335,566, REN. 8-10-05. INT. CL. 20.
- GUNLOCKE COMPANY, THE, WAYLAND, NY, GUN-
LOCKE COMPANY, THE, WAYLAND, NY:
1,335,567, REN. 8-12-05. INT. CL. 20.
- GUNN, JUDY, ALBUQUERQUE, NM:
2,202,107, CANC. INT. CL. 24.
- GUNTHER SCHLINK GMBH, BAD KREUZNACH, FED
REP GERMANY:
2,999,054, INT. CL. 33.
- GUSTAFSON, TIMI (IRIS), NAPA, CA:
2,998,340, PUB. 6-28-2005. INT. CL. 41.
- GUTMANN CUTLERY, INC., BELLINGHAM, WA:
2,201,995, CANC. INT. CL. 8.
- GUYNES DESIGN, PHOENIX, AZ:
2,200,884, CANC. INT. CL. 10.
- H SQUARED CORP., ATLANTA, GA:
2,997,169, PUB. 6-28-2005. MULTIPLE CLASS, INT. CLS.
37 AND 41.
- H.H. BROWN SHOE COMPANY, INC., GREENWICH, CT:
2,201,744, CANC. INT. CL. 25.
- H.O.B. JEWELRY COMPANY, NEW YORK, NY:
2,997,932, PUB. 6-28-2005. INT. CL. 14.
- H-D MICHIGAN, INC., ANN ARBOR, MI, HARLEY-DA-
VIDSON MOTOR CO. INC., MILWAUKEE, WI:
1,316,576, REN. 8-8-05. MULTIPLE CLASS, INT. CLS. 7
AND 12.
- HACO AG, SWITZERLAND:
2,998,411, PUB. 6-28-2005. INT. CL. 30.
- HADAR FOUNDATION, THE, NEW YORK, NY:
2,201,881, CANC. INT. CL. 36.
- HAEGER INDUSTRIES, INC., DUNDEE, IL:
2,996,828, PUB. 6-28-2005. INT. CL. 11.

- HAENIMTOYS CO., LTD., BUSAN, REPUBLIC OF KOREA:
2,998,591, INT. CL. 12.
- HAG ASA, 0369 OSLO, NORWAY:
2,996,323, PUB. 6-28-2005. INT. CL. 20.
- HAGELE, JAMES, NEVADA CITY, CA:
2,998,980, INT. CL. 10.
- HAGEMEYER NORTH AMERICA, INC., ALPHARETTA, GA:
2,998,646, INT. CL. 21.
- HAGNER, LARRY, ANDOVER, MN:
2,996,365, PUB. 6-28-2005. MULTIPLE CLASS, INT. CLS. 9 AND 41.
- HAK-DONG KIM, SEOUL, REPUBLIC OF KOREA:
2,996,984, PUB. 6-28-2005. INT. CL. 18.
- HALBERT, HARGROVE/RUSSELL LLC, LONG BEACH, CA:
2,998,998, INT. CL. 36.
- HALL, BRONWYN H., BERKELEY, CA, DBA TSP INTERNATIONAL:
1,334,066, REN. 8-11-05. INT. CL. 9.
1,334,066, CANC. INT. CL. 16.
- HALL, SANDRA, PORT CHARLOTTE, FL:
2,998,682, INT. CL. 30.
- HAMEL MANUFACTURING COMPANY, INC., WATERLOO, NE:
2,997,944, PUB. 6-28-2005. INT. CL. 35.
- HAMILTON BEACH/PROCTOR-SILEX, INC., GLEN ALLEN, VA:
2,998,787, INT. CL. 11.
- HAMILTON COLLECTION, THE, JACKSONVILLE, FL:
2,201,203, CANC. INT. CL. 20.
- HAMILTON NEW MEDIA, ENGLEWOOD, FL:
2,997,519, PUB. 6-28-2005. INT. CL. 9.
- HAMMOND, GERARD JOHN, BRODHEADSVILLE, PA:
2,201,049, CANC. INT. CL. 25.
- HANA COBI CO., LTD., INCHEON, REPUBLIC OF KOREA:
2,999,086, INT. CL. 21.
- HAND PICKED SELECTIONS, INC., WARRENTON, VA:
2,997,864, PUB. 6-28-2005. INT. CL. 33.
- HANDELSGESELLSCHAFT HEINRICH HEINE GMBH, 22179 HAMBURG, FED REP GERMANY:
2,996,476, PUB. 6-28-2005. MULTIPLE CLASS, INT. CLS. 8, 14, 18, 20, 21, 24 AND 25.
- HANDELSKWEKERIJ EXCEPTIO B.V., NETHERLANDS:
2,998,379, PUB. 6-28-2005. MULTIPLE CLASS, INT. CLS. 31 AND 44.
- HANKOOK TIRE CO., LTD., SEOUL, REPUBLIC OF KOREA:
2,998,561, INT. CL. 12.
2,999,124, INT. CL. 12.
- HANLEY-WOOD, LLC, WASHINGTON, DC:
2,997,953, PUB. 6-28-2005. INT. CL. 35.
2,997,957, PUB. 6-28-2005. INT. CL. 35.
- HANNA-BARBERA PRODUCTIONS, INC., SHERMAN OAKS, CA:
2,998,576, INT. CL. 16.
- HANNAFIN, GERALD, NEW PORT RICHEY, FL:
2,997,686, PUB. 6-28-2005. INT. CL. 1.
- HANNOUSH JEWELERS, WEST SPRINGFIELD, MA:
1,876,525, REN. 8-10-05. INT. CL. 14.
- HANS SCHWARZKOPF & HENKEL GMBH & CO. KG, FED REP GERMANY:
2,998,386, PUB. 6-28-2005. MULTIPLE CLASS, INT. CLS. 3, 41 AND 44.
- HANSGROHE AG, D-77761 SCHILTACH, FED REP GERMANY:
2,996,993, PUB. 6-28-2005. MULTIPLE CLASS, INT. CLS. 6, 11, 17 AND 19.
2,997,004, PUB. 3-8-2005. MULTIPLE CLASS, INT. CLS. 6, 11 AND 17.
2,997,005, PUB. 3-8-2005. MULTIPLE CLASS, INT. CLS. 6, 11 AND 17.
2,997,006, PUB. 3-8-2005. MULTIPLE CLASS, INT. CLS. 6, 11 AND 17.
- HANSON, AYLIN AKER, NEWPORT BEACH, CA:
2,201,017, CANC. INT. CL. 14.
- HANSON, MICHAEL F., SMYRNA, GA:
2,997,259, PUB. 6-28-2005. INT. CL. 35.
- HANWOONG COATECH CO., LTD., ANSAN CITY, KYUNG KI DO, REPUBLIC OF KOREA:
2,996,529, PUB. 6-28-2005. INT. CL. 3.
- HAPROFF, BRAD, IRVINE, CA:
2,996,623, PUB. 6-28-2005. INT. CL. 25.
- HARBIN BREWING CO., LTD., CHINA:
2,998,444, PUB. 6-28-2005. INT. CL. 32.
- HARBOR SWEETS, INC., SALEM, MA:
2,200,956, CANC. INT. CL. 30.
- HARDY WINE COMPANY LIMITED, REYNELLA, SOUTH AUSTRALIA, AUSTRALIA:
2,998,549, INT. CL. 33.
- HARDY WINE COMPANY LIMITED, REYNELLA, AUSTRALIA:
2,999,135, INT. CL. 33.
- HARIMA CHEMICALS, INC., OSAKA 541, JAPAN:
1,934,687, REN. 8-8-05. INT. CL. 1.
- HARITOS, SERGIO, TARPON SPRINGS, FL:
2,998,145, PUB. 6-28-2005. INT. CL. 41.
- HARKEN, INC., PEWAUKEE, WI:
2,201,877, CANC. INT. CL. 6.
2,201,878, CANC. INT. CL. 6.
2,201,879, CANC. INT. CL. 6.
- HARLEQUIN ENTERPRISES LIMITED, DON MILLS, ONTARIO M3B 3K9, CANADA:
1,860,875, CANC. INT. CL. 16.
- HAROLD'S STORES, INC., NORMAN, OK:
1,387,606, REN. 8-10-05. INT. CL. 25.
- HARPER, CLETE D., BAKERSFIELD, CA:
2,997,915, PUB. 6-28-2005. INT. CL. 33.
- HARRAH'S LICENSE COMPANY, LLC, LAS VEGAS, NV, HARRAH'S CLUB, RENO, NV:
1,928,930, REN. 8-8-05. INT. CL. 41.
- HARRINGTON INSTITUTE OF INTERIOR DESIGN, INC., CHICAGO, IL:
2,996,434, PUB. 6-28-2005. INT. CL. 41.
- HARRINGTON, TODD, HARTFORD, CT:
2,996,424, PUB. 6-28-2005. INT. CL. 44.
- HARRIS CORPORATION, MELBOURNE, FL:
2,999,029, INT. CL. 9.
- HARRIS FINANCIAL GROUP, INC., AMARILLO, TX:
2,996,352, PUB. 8-10-2004. INT. CL. 36.
- HARRIS, NEAL C., BARRINGTON, IL:
2,997,403, PUB. 6-28-2005. INT. CL. 20.
- HARRISON, SCOTT, BAKERSFIELD, CA:
2,998,872, INT. CL. 31.
- HARRY'S GARDEN CENTER, INC., FARMINGTON HILLS, MI:
2,997,257, PUB. 6-28-2005. INT. CL. 35.
- HARSCO CORPORATION, WORMLEYSBURG, PA:
2,201,835, CANC. INT. CL. 2.
- HARTFORD COURANT COMPANY, THE, HARTFORD, CT:
2,201,079, CANC. INT. CL. 41.
- HARTMANN, JENNIFER L, BELLEVUE, WA:
2,999,102, INT. CL. 16.
- HARTWELL, JOHN E., MIRAMAR, FL:
2,998,033, PUB. 6-28-2005. INT. CL. 12.
- HARTZ MOUNTAIN CORPORATION, THE, SECAUCUS, NJ, HARTZ MOUNTAIN PRODUCTS CORP., NEW YORK, NY:
773,575, REN. 8-12-05. U.S. CL. 22 (INT. CLS. 16, 18, 20, 22, 25 AND 28).
- HARTZ MOUNTAIN CORPORATION, THE, SECAUCUS, NJ, L/M ANIMAL FARMS, INC., PLEASANT PLAIN, OH:
1,899,093, REN. 8-9-05. INT. CL. 31.
1,899,094, REN. 8-11-05. INT. CL. 31.
- HARVEY CRANE, INC., DAYTONA BEACH, FL:
2,998,804, INT. CL. 42.
2,998,806, INT. CL. 42.
- HARVEY, TOMMY, TITUSVILLE, FL:
2,997,147, PUB. 6-28-2005. INT. CL. 25.
- HASBRO INC., PAWTUCKET, RI:
1,302,530, CANC. MULTIPLE CLASS, INT. CLS. 16 AND 28.

- HASBRO, INC., PAWTUCKET, RI:
2,201,948, CANC. INT. CL. 28.
2,201,949, CANC. INT. CL. 28.
2,202,231, CANC. INT. CL. 28.
2,202,232, CANC. INT. CL. 28.
2,202,236, CANC. INT. CL. 28.
2,996,500, PUB. 6-28-2005. INT. CL. 28.
2,998,606, INT. CL. 28.
2,998,727, INT. CL. 28.
2,998,790, INT. CL. 28.
2,998,801, INT. CL. 28.
- HASTINGS MANUFACTURING COMPANY, HASTINGS, MI:
1,312,071, REN. 8-10-05. INT. CL. 7.
- HASUNJUNG GENERAL FOOD CO., LTD, ANSUNG-KUN, REPUBLIC OF KOREA:
2,997,239, PUB. 6-28-2005. INT. CL. 29.
- HATTERAS HAMMOCKS, INC., GREENVILLE, NC:
2,998,757, INT. CL. 22.
- HAUPTMAN, O'BRIEN, WOLF & LATHROP, P.C., OMAHA, NE:
2,996,607, PUB. 6-28-2005. INT. CL. 42.
2,996,608, PUB. 6-28-2005. INT. CL. 42.
- HAWKEYE HOME INSPECTIONS, INC., PARKLAND, FL:
2,998,597, INT. CL. 42.
- HAWKEYE STEEL PRODUCTS INC., HOUGHTON, IA:
1,854,466, REN. 8-8-05. MULTIPLE CLASS, INT. CLS. 7 AND 11.
- HAWORTH LTD., CALGARY, CANADA, DBA SMED INTERNATIONAL:
2,997,088, PUB. 6-28-2005. INT. CL. 20.
- HAWS DRINKING FAUCET COMPANY, SPARKS, NV, HAWS DRINKING FAUCET COMPANY, BERKELEY, CA:
592,928, REN. 8-12-05. U.S. CL. 13 (INT. CLS. 6, 7, 11, 17, 20 AND 21).
- HEAD SPORTS, INC., BOULDER, CO:
1,302,825, CANC. INT. CL. 28.
- HEADSPROUT, INC., SEATTLE, WA:
2,998,528, MULTIPLE CLASS, INT. CLS. 9, 16 AND 41.
- HEALTH DIALOG SERVICES CORPORATION, BOSTON, MA:
2,996,504, PUB. 6-28-2005. INT. CL. 44.
- HEALTH WORKS, INC., DAVIDSON, NC:
1,878,037, REN. 8-8-05. INT. CL. 41.
- HEALTHATION, LLC, DARIEN, IL:
2,996,693, PUB. 6-28-2005. INT. CL. 9.
- HEALTHMATE PRODUCTS, INC., EVANSTON, IL:
2,997,347, PUB. 6-28-2005. INT. CL. 5.
- HEALTHTRUST PURCHASING GROUP, LP, BRENTWOOD, TN:
2,999,302, INT. CL. 35.
- HEALY MEDIA, INC., CHULA VISTA, CA:
2,999,043, INT. CL. 16.
- HEARST BUSINESS PUBLISHING, INC., NEW YORK, NY:
2,996,555, PUB. 6-28-2005. INT. CL. 37.
2,996,556, PUB. 6-28-2005. INT. CL. 9.
- HEARST COMMUNICATIONS, INC., NEW YORK, NY:
2,202,206, CANC. INT. CL. 28.
- HEARST CORPORATION, THE, NEW YORK, NY TO HEARST HOLDINGS, INC., NEW YORK, NY:
1,860,911, CANC. INT. CL. 16.
- HEARST CORPORATION, THE, HOUSTON, TX:
2,202,152, CANC. INT. CL. 16.
- HEARST HOLDINGS, INC., NEW YORK, NY:
2,201,909, CANC. INT. CL. 25.
- HEARTLAND DESIGN ASSOCIATES, LLC, BROOKFIELD, WI:
2,998,146, PUB. 6-28-2005. INT. CL. 31.
- HEARTLAND FIELDS, LLC, WEST DES MOINES, IA:
2,996,464, PUB. 6-28-2005. INT. CL. 29.
- HEARTS ON FIRE COMPANY, BOSTON, MA:
2,999,072, INT. CL. 14.
2,999,169, INT. CL. 14.
- HEARTS ON FIRE COMPANY, LLC, BOSTON, MA:
2,998,665, INT. CL. 14.
- HEATCRAFT INC., GRENADA, MS:
2,201,693, CANC. INT. CL. 11.
- HEATH WINES PTY LTD, BOWDEN, SOUTH AUSTRALIA, 5007, AUSTRALIA:
2,997,824, PUB. 6-28-2005. INT. CL. 33.
- HEINEKEN ITALIA S.P.A., 11020 POLLEIN (AO), ITALY:
2,998,918, INT. CL. 32.
- HELADOS MI CANITA, INC., HIALEAH, FL:
2,996,956, PUB. 6-28-2005. INT. CL. 30.
- HELMERS PUBLISHING, INC., PETERBOROUGH, NH:
2,997,834, PUB. 6-28-2005. INT. CL. 16.
- HELMS BRISCOE PERFORMANCE GROUP, INC., SCOTTSDALE, AZ:
2,996,731, PUB. 6-28-2005. INT. CL. 41.
- HEMOCELLULAR THERAPEUTICS, INC., CHAPEL HILL, NC:
2,998,111, PUB. 6-28-2005. INT. CL. 5.
- HENDERSON AND CO., MARYVILLE, TN:
2,997,644, PUB. 6-28-2005. INT. CL. 36.
- HENKEL CONSUMER ADHESIVES, INC., AVON, OH:
1,894,617, REN. 8-10-05. INT. CL. 16.
- HENKEL CORPORATION, GULPH MILLS, PA:
1,830,106, REN. 8-11-05. INT. CL. 4.
- HENKEL KGAA, DUESSELDORF, FED REP GERMANY:
2,996,908, PUB. 3-8-2005. MULTIPLE CLASS, INT. CLS. 3 AND 5.
- HENRI WINTERMANS CIGARS B.V., NL-5521 CB EERSEL, NETHERLANDS:
2,998,481, PUB. 6-28-2005. INT. CL. 34.
- HENRIQUES, SEAN PAUL, NEW YORK, NY:
2,996,974, PUB. 6-28-2005. INT. CL. 41.
- HENRY DONEGER ASSOCIATES, INC., NEW YORK, NY:
1,302,726, CANC. INT. CL. 25.
1,302,727, CANC. INT. CL. 25.
- HENRY, STEVEN C., GENEVA, IL:
2,998,842, MULTIPLE CLASS, INT. CLS. 9, 35 AND 42.
- HEPCO SLIDE SYSTEMS LIMITED, GREENFORD, MIDDLESEX, ENGLAND:
1,347,238, REN. 8-10-05. INT. CL. 7.
- HER MAJESTY THE QUEEN IN RIGHT OF CANADA AS REPRESENTED BY THE MINISTER OF NATURAL RESOURCES, OTTAWA, ONTARIO K1A 0G1, CANADA:
2,202,031, CANC. MULTIPLE CLASS, INT. CLS. 41 AND 42.
- HERAEUS KULZER GMBH, HANAU D-63450, FED REP GERMANY, HERAEUS KULZER GMBH, 63450 HANAU, FED REP GERMANY:
1,895,900, REN. 8-9-05. INT. CL. 7.
- HERAEUS KULZER GMBH, 63450 HANAU, FED REP GERMANY:
2,213,779, CANC. MULTIPLE CLASS, INT. CLS. 1 AND 10.
- HERBERT, JOSEPH E., HOUSTON, TX:
2,201,891, CANC. INT. CL. 25.
- HERBKO INTERNATIONAL, INC., HALLANDALE, FL:
2,201,624, CANC. INT. CL. 16.
- HERCO INC., HERSHEY, PA:
1,302,878, CANC. INT. CL. 29.
- HERE & THERE, LLC, NEW YORK, NY:
1,328,584, REN. 8-11-05. INT. CL. 23.
- HERMES INTERNATIONAL, 75008 PARIS, FRANCE:
2,201,232, CANC. MULTIPLE CLASS, INT. CLS. 16, 21, 35, 37, 38, 41 AND 42.
- HESTER INDUSTRIES, INC., MOOREFIELD, WV:
1,302,914, CANC. INT. CL. 29.
- HEWLETT-PACKARD DEVELOPMENT COMPANY, L.P., HOUSTON, TX:
2,997,720, PUB. 6-28-2005. INT. CL. 9.
2,998,350, PUB. 6-28-2005. INT. CL. 9.
- HHU, INC., CRESWELL, OR:
2,997,515, PUB. 6-28-2005. INT. CL. 12.
- HI-STOR TECHNOLOGIES SA, FRANCE:
2,998,492, PUB. 6-28-2005. MULTIPLE CLASS, INT. CLS. 9 AND 42.
- HI-TECH INSTRUMENTS, INC., SUGAR LAND, TX:
2,997,938, PUB. 6-28-2005. INT. CL. 9.
- HI-TOUCH IMAGING TECHNOLOGIES, PAN CHIAO CITY, TAIWAN:
2,997,413, PUB. 6-28-2005. INT. CL. 1.

- HIBISCUS CHILDREN'S CENTER, JENSEN BEACH, FL:
2,998,754, INT. CL. 44.
- HIDDEN COVE HAIR DESIGN & SALES INC., APPLE VALLEY, MN:
2,998,121, PUB. 6-28-2005. INT. CL. 3.
- HIGGINS SLACKS CO., INC., LINEVILLE, AL:
1,302,766, CANC. INT. CL. 25.
- HIGH REACH COMPANY LLC, SANFORD, FL:
2,997,185, PUB. 6-28-2005. MULTIPLE CLASS, INT. CLS. 7, 35 AND 37.
2,997,186, PUB. 6-28-2005. MULTIPLE CLASS, INT. CLS. 7, 35 AND 37.
- HIGH SIERRA SPORT COMPANY, VERNON HILLS, IL:
2,201,970, CANC. INT. CL. 25.
- HIGH TENSILE WIRELOC MFG., INC., CANTON, TX:
2,997,068, PUB. 6-28-2005. INT. CL. 6.
- HIGHLIGHTS FOR CHILDREN, INC., COLUMBUS, OH:
1,958,077, REN. 8-11-05. INT. CL. 16.
- HILL-ROM SERVICES, INC., BATESVILLE, IN:
2,999,004, INT. CL. 20.
- HILLEL SEGAL, INC., BOULDER, CO:
2,158,252, CANC. INT. CL. 39.
- HILLERICH & BRADSBY CO., LOUISVILLE, KY:
2,999,155, INT. CL. 25.
- HILLYARD ENTERPRISES, INC., ST. JOSEPH, MO:
416,944, REN. 8-11-05. U.S. CL. 16 (INT. CL. 2).
- HILLYARD ENTERPRISES, INC., ST. JOSEPH, MO, HILLYARD CHEMICAL COMPANY, ST. JOSEPH, MO:
594,785, REN. 8-11-05. U.S. CL. 16 (INT. CL. 2).
- HILLYARD ENTERPRISES, INC., ST. JOSEPH, MO:
608,233, REN. 8-12-05. U.S. CL. 16 (INT. CL. 2).
1,918,677, REN. 8-10-05. INT. CL. 3.
- HILTON HOSPITALITY, INC., BEVERLY HILLS, CA:
1,379,721, REN. 8-9-05. INT. CL. 42.
- HINO JIDOSHA KOGYO KABUSHIKI KAISHA, HINO-SHI, TOKYO, JAPAN, TA HINO MOTORS, LTD.:
2,201,894, CANC. INT. CL. 12.
- HIP HOP CANDYSHOP, LLC, WEST CHESTER, PA:
2,998,152, PUB. 6-28-2005. INT. CL. 30.
- HIPPLE CANCER RESEARCH CENTER, DAYTON, OH, DBA ALPHAMED PRESS TO ALPHAMED COMPANY, INC., THE, DAYTON, OH:
1,861,490, CANC. INT. CL. 16.
- HIRT, JOSEPH B., SAN GABRIEL, CA:
2,996,518, PUB. 6-28-2005. INT. CL. 41.
- HISTORYBAG LLC, INDEPENDENCE, MO:
2,996,690, PUB. 6-28-2005. INT. CL. 16.
- HIX CORPORATION, PITTSBURG, KS:
2,997,782, PUB. 6-28-2005. INT. CL. 16.
- HM MANE SOLUTIONS, LLC, WESTON, CT:
2,999,287, INT. CL. 3.
- HMD SEAL/LESS PUMPS LTD, EASTBOURNE, EAST SUSSEX, BN22 9AN, UNITED KINGDOM:
1,860,717, CANC. INT. CL. 9.
- HNI TECHNOLOGIES INC., MUSCATINE, IA, HOME-ONIZE CO., THE, MUSCATINE, IA:
606,714, REN. 8-11-05. U.S. CL. 32 (INT. CL. 20).
- HOBBES COMPUTER NETWORK ACCESSORIES CORP., MONROVIA, CA:
2,996,390, PUB. 6-28-2005. INT. CL. 9.
- HODGMAN, INC., MONTGOMERY, IL:
2,996,287, PUB. 6-28-2005. INT. CL. 25.
- HOH GYMNASTICS, INC., BIRMINGHAM, AL, HEAD OVER HEELS, INC., BIRMINGHAM, AL:
1,894,706, REN. 8-9-05. INT. CL. 41.
- HOLA, S.A., SPAIN:
2,998,415, PUB. 6-28-2005. INT. CL. 16.
- HOLBROOK MFG., INC., WHEELING, IL:
2,996,549, PUB. 6-28-2005. INT. CL. 6.
- HOLDEN CORPORATION, HOFFMAN ESTATES, IL:
2,201,775, CANC. INT. CL. 9.
- HOLDING COMPANY, THE, BRYN MAWR, PA:
1,303,143, CANC. INT. CL. 39.
1,303,144, CANC. INT. CL. 39.
- HOLIDAY INNS, INC., MEMPHIS, TN:
1,303,239, CANC. INT. CL. 42.
- HOLJERON CORPORATION, WILSONVILLE, OR:
2,997,066, PUB. 6-28-2005. INT. CL. 9.
- HOLLAND AMERICA LINE USA, INC., SEATTLE, WA, HOLLAND AMERICA CRUISES, N.V., NEW YORK, NY:
995,488, REN. 8-8-05. U.S. CL. 105 (INT. CL. 39).
- HOLLAND USA, INC., NORTH MANKATO, MN:
2,999,218, INT. CL. 16.
- HOLLANDER HOME FASHIONS CORP., BOCA RATON, FL:
2,201,157, CANC. INT. CL. 24.
- HOLLYWOOD COLLECTORS SHOW, INC., SPRING HILL, FL:
2,997,095, PUB. 6-28-2005. INT. CL. 35.
- HOME DISCOVERE REAL ESTATE SERVICES CORPORATION, TAMPA, FL:
2,996,656, PUB. 6-28-2005. INT. CL. 36.
- HOMEGOODS, INC., FRAMINGHAM, MA:
2,998,948, MULTIPLE CLASS, INT. CLS. 8, 21 AND 24.
- HOMEGROWN KIDS, INC., MANHATTAN BEACH, CA:
2,999,094, INT. CL. 28.
- HOMER LAUGHLIN CHINA COMPANY, THE, NEWELL, WV:
1,956,277, REN. 8-8-05. INT. CL. 21.
- HOMER T. HAYWARD LUMBER COMPANY, INC., MONTEREY, CA:
1,878,179, REN. 8-8-05. INT. CL. 19.
1,878,179, CANC. INT. CL. 20.
- HONEYWELL CONSUMER PRODUCTS, INC., SOUTHBOROUGH, MA:
2,202,324, CANC. INT. CL. 11.
- HOOP STARS, NFP, RIVER FOREST, IL:
2,996,399, PUB. 6-28-2005. INT. CL. 41.
2,996,400, PUB. 6-28-2005. INT. CL. 41.
- HOPE ACRES FARM, LLC, BROGUE, PA:
2,999,048, MULTIPLE CLASS, INT. CLS. 29 AND 30.
- HOPF, RINGLEB & CO. GMBH & CIE., BERLIN, FED REP GERMANY:
1,365,425, REN. 8-11-05. INT. CL. 10.
- HORN ABBOT LTD., TORONTO, ONTARIO, CANADA:
2,996,961, PUB. 6-28-2005. INT. CL. 41.
- HORTICOPIA, INC., PURCELLVILLE, VA, DESOPS, LTD., PURCELLVILLE, VA:
1,905,480, REN. 8-12-05. INT. CL. 9.
- HORTICULTURAL RESEARCH INSTITUTE ENDOWMENT FUND INC., THE, WASHINGTON, DC:
1,302,985, CANC. INT. CL. 31.
- HOSPIRA, INC., LAKE FOREST, IL:
788,085, REN. 8-10-05. U.S. CL. 18 (INT. CL. 5).
- HOSS'S ENTERPRISES, INC., WILMINGTON, DE:
2,996,502, PUB. 6-28-2005. INT. CL. 43.
- HOSTWAY CORPORATION, CHICAGO, IL:
2,997,713, PUB. 6-28-2005. INT. CL. 42.
- HOT 'N SPICEY, INC., WORTHINGTON, OH:
1,882,372, REN. 8-9-05. INT. CL. 29.
- HOT RODS - MOTORCYCLE & AUTO PARTS CORPORATION, URBANDALE, IA:
2,996,661, PUB. 6-28-2005. INT. CL. 7.
- HOTELS.COM, L.P., DALLAS, TX:
2,997,636, PUB. 6-28-2005. MULTIPLE CLASS, INT. CLS. 39 AND 43.
- HOUSE OF BLUES BRANDS CORP, HOLLYWOOD, CA:
2,997,172, PUB. 6-28-2005. INT. CL. 15.
- HOUSE OF WINDSOR, INC., YOE, PA:
1,303,023, CANC. INT. CL. 34.
- HOUSEVALUES, INC., REDMOND, WA:
2,996,982, PUB. 6-28-2005. INT. CL. 35.
- HOUSING MADE SIMPLE INC., FAIRFAX, VA:
2,038,925, CANC. INT. CL. 36.
- HP INTELLECTUAL CORP., WILMINGTON, DE:
2,997,266, PUB. 6-28-2005. INT. CL. 9.
- HREVENTS LLC, LITTLE FALLS, NJ:
2,996,286, PUB. 6-28-2005. INT. CL. 35.
- HRGURU.BIZ CORPORATION, DALLAS, TX:
2,997,002, PUB. 6-28-2005. MULTIPLE CLASS, INT. CLS. 35 AND 41.
- HSI SERVICE CORP., NEWARK, DE:
2,999,143, INT. CL. 35.
- HUBBARDTON FORGE CORPORATION, CASTLETON, VT:
2,997,716, PUB. 6-28-2005. MULTIPLE CLASS, INT. CLS. 11 AND 21.

HUDSON OPTICAL CORPORATION, BOHEMIA, NY:
2,201,437, CANC. INT. CL. 9.

HUDSON SOLID SURFACES INTERNATIONAL, LLC, CA-TOOSA, OK:
2,999,073, INT. CL. 17.

HUGGINS, KENNETH P., CONWAY, SC:
2,997,501, PUB. 6-28-2005. INT. CL. 41.

HUGHES, THOMAS S., RANCHO PALOS VERDES, CA:
2,361,940, CANC. INT. CL. 36.

HUKI CORPORATION, COCOA, FL:
2,996,921, PUB. 6-28-2005. INT. CL. 28.

HUMANICARE INTERNATIONAL, INC., EAST BRUNSWICK, NJ:
2,997,400, PUB. 6-28-2005. INT. CL. 5.

HUMANTECH INC, ANN ARBOR, MI:
1,858,817. REN. 8-11-05. INT. CL. 35.

HUMANUS BIOBOTANICA ALIMENTOS, COSMETICOS E BEBIDAS ESPECIAIS, LTDA., 1222, PARANAGUA-PR, BRAZIL:
2,202,261, CANC. INT. CL. 5.

HUNT MIDWEST ENTERPRISES, INC., KANSAS CITY, MO:
2,996,672, PUB. 6-28-2005. MULTIPLE CLASS, INT. CLS. 36 AND 37.

HUNTER FAN COMPANY, MEMPHIS, TN:
1,861,372, CANC. INT. CL. 9.

HUNTER-DENVER, INC., DENTON, TX:
2,997,606, PUB. 6-28-2005. INT. CL. 43.

HUNTER-MCMAIN, INC., HOUSTON, TX:
2,997,988, PUB. 6-28-2005. INT. CL. 35.

HUP! MULTIMEDIA, INC., SEATTLE, WA:
1,906,118. REN. 8-11-05. INT. CL. 42.

HUPPIN'S HI-FI, PHOTO AND VIDEO, INC., SPOKANE, WA:
2,997,383, PUB. 6-28-2005. INT. CL. 35.

HURCO COMPANIES, INC., INDIANAPOLIS, IN, HURCO MANUFACTURING COMPANY, INC., INDIANAPOLIS, IN:
1,340,362. REN. 8-9-05. INT. CL. 9.

HURST, LARRY, PEACHTREE CITY, GA:
2,999,352, INT. CL. 6.

HUTCHINSON, S.A., 75384 PARIS CEDEX 08, FRANCE:
1,896,086. REN. 8-11-05. MULTIPLE CLASS, INT. CLS. 11 AND 17.

HUXHOLD, JAMES B., INDIANAPOLIS, IN:
2,998,837, MULTIPLE CLASS, INT. CLS. 16 AND 28.

HUYCK LICENSCO, INC., WILMINGTON, DE:
2,201,786, CANC. INT. CL. 7.

HWE, INC., NORTH HOLLYWOOD, CA:
2,202,101, CANC. MULTIPLE CLASS, INT. CLS. 10 AND 20.

HYDRAFORCE, INC., LINCOLNSHIRE, IL:
1,908,146. REN. 8-9-05. INT. CL. 7.

HYDRO INTERNATIONAL PLC, CLEVEDON, AVON BS21 7RD, UNITED KINGDOM, HYDRO INTERNATIONAL LIMITED, CLEVEDON, AVON BS21 7NE, UNITED KINGDOM:
1,947,816. REN. 8-9-05. INT. CL. 11.

HYPERWARE, INC., SAN JOSE, CA:
2,607,521, CANC. INT. CL. 28.

HÜLLER HILLE GMBH, D-71636 LUDWIGSBURG, FED REP GERMANY:
2,998,449, PUB. 6-28-2005. INT. CL. 7.

I DIG PIG, LLC, DURHAM, NC:
2,997,752, PUB. 6-28-2005. INT. CL. 43.

I SEE ME! INC., DEEPHAVEN, MN:
2,998,254, PUB. 6-28-2005. INT. CL. 16.

I.M. RECORDS INC., LOS ANGELES, CA:
2,997,698, PUB. 6-28-2005. INT. CL. 9.

I.M.C. INTERNATIONAL MANUFACTURING; COMPANY S.R.L., ITALY:
2,998,503, PUB. 6-28-2005. INT. CL. 25.

I.V. CORP., CHICAGO, IL, DBA I.V. DESIGNS:
2,996,688, PUB. 6-28-2005. INT. CL. 14.

IAMS COMPANY, THE, CINNCINNATI, OH:
1,861,259, CANC. INT. CL. 41.

IBA INC., MILLBURY, MA:
2,997,471, PUB. 6-28-2005. MULTIPLE CLASS, INT. CLS. 3 AND 5.

2,997,472, PUB. 6-28-2005. MULTIPLE CLASS, INT. CLS. 7, 11 AND 16.

IBAK HELMUT HUNGER GMBH & CO KG, D-24148 KIEL, FED REP GERMANY:
2,998,922, INT. CL. 9.

IBEX OUTDOOR CLOTHING, LLC, WOODSTOCK, VT:
2,997,345, PUB. 6-28-2005. INT. CL. 25.

ICE CREAM SPECIALTIES, INC., CARLINVILLE, IL:
2,998,223, PUB. 6-28-2005. INT. CL. 30.

ICEBERG ENTERPRISES, LLC, GLENDALE HEIGHTS, IL:
2,998,623, INT. CL. 20.

ICEOPLEX, SANTA MONICA, CA:
1,861,464, CANC. INT. CL. 41.

ICOM INCORPORATED, OSAKA-SHI, OSAKA, JAPAN:
2,998,745, INT. CL. 9.

ICONIC MANUFACTURING COMPANY LLC, LUMMI ISLAND, WA:
2,998,884, INT. CL. 9.

IDATECH, LLC, BEND, OR:
2,998,784, MULTIPLE CLASS, INT. CLS. 9 AND 11.

IDEA NUOVA, NEW YORK, NY:
2,201,463, CANC. INT. CL. 28.
2,201,484, CANC. INT. CL. 28.
2,201,495, CANC. INT. CL. 28.
2,201,498, CANC. INT. CL. 28.
2,201,499, CANC. INT. CL. 28.

IDEA NUOVA, NEW YORK, NY:
2,201,460, CANC. INT. CL. 28.

IDEASTREAM CONSUMER PRODUCTS LLC, PARMA, OH:
2,999,278, INT. CL. 16.

IDEMITSU KOSAN CO., LTD., CHIYODA-KU, TOKYO 100-8321, JAPAN:
2,998,445, PUB. 6-28-2005. INT. CL. 4.

IDENTITY THEFT ASSISTANCE CORPORATION, WASHINGTON, DC:
2,999,364, INT. CL. 45.

IFM ELECTRONIC GMBH, D-45127 ESSEN, FED REP GERMANY:
2,996,407, PUB. 6-28-2005. MULTIPLE CLASS, INT. CLS. 9 AND 42.

IGD SYSTEMS, LLC, PITTSBURGH, PA:
2,997,566, PUB. 6-28-2005. INT. CL. 35.

IGOR S.R.L., ITALY:
2,998,442, PUB. 6-28-2005. INT. CL. 29.

IGROK TRADING INTERNATIONAL, LLC, WOODLAND HILLS, CA:
2,997,245, PUB. 6-28-2005. INT. CL. 36.

IGT, RENO, NV:
1,860,776, CANC. INT. CL. 9.
2,997,581, PUB. 6-28-2005. INT. CL. 9.
2,997,665, PUB. 6-28-2005. INT. CL. 9.
2,997,694, PUB. 6-28-2005. INT. CL. 9.
2,998,870, INT. CL. 9.
2,999,220, INT. CL. 9.

IIVUS MARKETING, INC., COTTONWOOD, CA:
2,151,888, CANC. INT. CL. 3.

IIL CORPORATION, PORTLAND, OR TO HOUSEHOLD INTERNATIONAL, INC., PROSPECT HEIGHTS, IL:
1,861,452, CANC. INT. CL. 36.

IKEGOSHI AKIHIRO, JAPAN:
2,998,375, PUB. 6-28-2005. INT. CL. 42.
2,998,381, PUB. 6-28-2005. INT. CL. 42.

IL MARCHESE COCCAPANI S.P.A., 290 I-41019 SOLIERA (MO), ITALY:
2,998,416, PUB. 6-28-2005. INT. CL. 25.

ILINK TECHNOLOGIES CORPORATION, VANCOUVER, BRITISH COLUMBIA, CANADA:
2,998,712, MULTIPLE CLASS, INT. CLS. 9 AND 42.

ILIUM SOFTWARE, INC., ANN ARBOR, MI:
2,997,859, PUB. 6-28-2005. INT. CL. 9.

ILLINOIS TOOL WORKS INC., GLENVIEW, IL:
2,997,783, PUB. 6-28-2005. INT. CL. 6.

ILLUMINATING CONCEPTS, LTD., FARMINGTON HILLS, MI:
1,910,736. REN. 8-12-05. INT. CL. 11.

ILSA SRL, ITALY:
2,998,472, PUB. 6-28-2005. INT. CL. 21.

- IMAGE HUNTER PUBLISHING, INC., MCLEAN, VA:
2,998,533, INT. CL. 41.
2,998,534, MULTIPLE CLASS, INT. CLS. 16 AND 35.
- IMAGE IMPRINTING, INC., NEW CARROLLTON, MD:
2,202,271, CANC. INT. CL. 26.
- IMAGE PRODUCTS GROUP, LLC, SOUTH HADLEY, MA:
2,996,339, PUB. 6-28-2005. INT. CL. 17.
- IMCOF CORPORATION, JOHNSTOWN, NY:
2,996,266, PUB. 6-28-2005. INT. CL. 30.
- IMERICA LIFE AND HEALTH INSURANCE COMPANY,
TAMPA, FL:
2,997,735, PUB. 6-28-2005. INT. CL. 36.
- IMMOBILIENGESELLSCHAFT HELMUT FISCHER GMBH
& CO. KG, SINDELINGEN, FED REP GERMANY:
2,997,001, PUB. 3-8-2005. INT. CL. 9.
- IMMUCOR INTELLECTUAL PROPERTIES, INC., NOR-
CROSS, GA:
2,997,633, PUB. 6-28-2005. INT. CL. 5.
- IMMUNE MODULATION MAXIMUM CORP., NEW YORK,
NY:
2,202,279, CANC. INT. CL. 5.
- IMOVE, INC., PORTLAND, OR:
2,998,937, INT. CL. 9.
- IMPACT TECHNOLOGIES GROUP, INC., CHARLOTTE,
NC:
2,998,653, INT. CL. 9.
- IMPERIAL CASUALTY AND INDEMNITY COMPANY,
OMAHA, NE:
779,641, CANC. U.S. CL. 102.
- IMPERIAL CAVIAR COMPANY, SAN FRANCISCO, CA:
2,200,843, CANC. INT. CL. 29.
- IMPERVA, INC., FOSTER CITY, CA:
2,997,291, PUB. 6-28-2005. INT. CL. 42.
- IMPREST PTY LTD, NEW SOUTH WALES 2480, AUSTRA-
LIA:
2,996,611, PUB. 6-28-2005. INT. CL. 28.
- IMS TRADING, LLC, STUDIO CITY, CA:
2,998,734, INT. CL. 5.
- IM2 LTD., CHANNEL ISLANDS, UNITED KINGDOM:
2,998,128, PUB. 6-28-2005. INT. CL. 9.
- IN MOCEAN GROUP, L.L.C., NEW YORK, NY:
1,839,040, REN. 8-10-05. INT. CL. 25.
- IN NEW YORK, LLC, AUGUSTA, GA:
2,999,330, MULTIPLE CLASS, INT. CLS. 41 AND 43.
- IN-N-OUT BURGERS, IRVINE, CA:
1,031,095, REN. 8-11-05. MULTIPLE CLASS, U.S. CLS. 46
(INT. CLS. 29 AND 30) AND 100 (INT. CL. 42).
- INBEV S.A., 1000 BRUSSELS, BELGIUM, BRASSERIE ST.
GUIBERT, 5870 MONT-SAINT-GUIBERT, BELGIUM,
DBA BROUWERIJ ST. GUIBERT:
1,344,905, REN. 8-10-05. INT. CL. 32.
- INDEPENDENCE BLUE CROSS, PHILADELPHIA, PA:
2,996,501, PUB. 6-28-2005. MULTIPLE CLASS, INT. CLS.
16 AND 44.
- INDEPENDENT ANALYTICS & RESEARCH, LLC, WEST
CHESTER, PA:
2,997,217, PUB. 6-28-2005. INT. CL. 36.
- INDEPENDENT BANKERS' BANK OF FLORIDA, LAKE
MARY, FL:
1,907,587, REN. 8-6-05. INT. CL. 36.
- INDEX POWERED FINANCIAL SERVICES, LLC, DENVER,
CO:
2,999,087, INT. CL. 36.
- INDIAN TRADING POST, INC., SCOTTSDALE, AZ:
1,302,501, CANC. MULTIPLE CLASS, INT. CLS. 14 AND
21.
- INDIANA HARBOR BELT RAILROAD COMPANY, HAM-
MOND, IN:
2,996,717, PUB. 6-7-2005. INT. CL. 39.
- INDIANA TICKET COMPANY, INC., MUNCIE, IN:
2,999,212, INT. CL. 16.
- INDUSTRIAL COATINGS GROUP, INC., CHICAGO, IL:
2,201,872, CANC. INT. CL. 17.
- INDUSTRIAS VANYPLAS S.A., BOGOTA, COLOMBIA:
2,997,017, PUB. 6-28-2005. MULTIPLE CLASS, INT. CLS.
20 AND 21.
- INEOS CAPITAL LIMITED, SOUTHAMPTON HAMPSHIRE
SO14 3BP, UNITED KINGDOM:
2,894,156, COR. MULTIPLE CLASS, INT. CLS. 1, 2, 3
AND 9.
- INEOS SILICAS NETHERLANDS B.V., EIJSDEN, NETHER-
LANDS:
999,442, REN. 8-12-05. INT. CL. 1.
- INFINITY BROADCASTING CORPORATION, NEW YORK,
NY:
2,998,300, PUB. 6-28-2005. INT. CL. 41.
- INFLUENCE INC., SAN FRANCISCO, CA:
2,201,449, CANC. INT. CL. 10.
- INFOCUS CORPORATION, WILSONVILLE, OR:
2,998,986, INT. CL. 9.
- INFONE LLC, BEAVERTON, OR:
2,997,179, PUB. 6-28-2005. INT. CL. 35.
2,997,180, PUB. 6-28-2005. INT. CL. 45.
- INFORELIANCE CORPORATION, FAIRFAX, VA:
2,996,792, PUB. 6-28-2005. INT. CL. 35.
2,996,793, PUB. 6-28-2005. INT. CL. 35.
- INFORMATION & COMPUTING SERVICES, INC., JACK-
SONVILLE, FL:
2,997,097, PUB. 6-28-2005. INT. CL. 9.
- INFORMATION TECHNOLOGY GROUP, MALVERNE, NY:
2,997,556, PUB. 6-28-2005. INT. CL. 42.
- INFOUSA, OMAHA, NE:
2,996,411, PUB. 6-28-2005. INT. CL. 35.
- INFOVISA, INC., CORNELIUS, NC:
1,974,010, REN. 8-9-05. MULTIPLE CLASS, INT. CLS. 37
AND 42.
- INFRINGEMENT SOLUTIONS, INC., GREENVILLE, SC:
2,998,902, INT. CL. 35.
- ING. CASTALDI ILLUMINAZIONE S.R.L., TREZZANO SUL
NAVIGLIO (MILANO), ITALY:
2,996,942, PUB. 6-28-2005. INT. CL. 11.
- INGENIOUS DESIGNS LLC, ST. PETERSBURG, FL:
2,999,001, INT. CL. 8.
- INGENIOUS DESIGNS, LLC, ST. PETERSBURG, FL, COP-
QUIN MURPHY INC., PORT JEFFERSON, NY:
1,891,714, REN. 8-9-05. INT. CL. 16.
- INJEBRECK LIMITED, DOUGLAS, ISLE OF MAN, GREAT
BRITAIN:
2,200,821, CANC. INT. CL. 42.
- INLAND PAPERBOARD AND PACKAGING, INC., INDIA-
NAPOLIS, IN:
2,201,890, CANC. INT. CL. 16.
- INNER CITY BROADCASTING CORPORATION, NEW
YORK, NY:
2,996,261, PUB. 6-28-2005. MULTIPLE CLASS, INT. CLS.
38 AND 41.
- INNER-CITY GAMES FOUNDATION, SANTA MONICA,
CA:
2,201,632, CANC. INT. CL. 41.
- INNER-CITY GAMES FOUNDATION:
See— AFTERSCHOOL ALL-STARS.
- INNOVATIVE TECHNOLOGIES GROUP PLC, WINSFORD,
CHESHIRE CW7 3PD, UNITED KINGDOM:
2,201,198, CANC. INT. CL. 5.
- INOX VITI SNC DI CATTINORI E & B., 24064 GRUMELLO
DEL MONTE (BG), ITALY:
2,200,993, CANC. INT. CL. 6.
- INPRISE CORPORATION:
See— BORLAND SOFTWARE CORPORATION.
- INSIGHT DIRECT, INC., TEMPE, AZ:
2,201,609, CANC. INT. CL. 9.
- INSITEC, INC., SAN RAMON, CA:
2,201,313, CANC. INT. CL. 9.
- INSL-X PRODUCTS CORPORATION, STONY POINT, NY:
2,998,735, INT. CL. 2.
- INSTITUT CURIE, FRANCE:
2,998,355, PUB. 6-28-2005. MULTIPLE CLASS, INT. CLS.
14, 25 AND 36.
- INSTITUTE OF CULTURAL AFFAIRS, CHICAGO, IL:
1,899,126, REN. 8-9-05. INT. CL. 35.
- INSTITUTE OF CULTURAL AFFAIRS, THE, CHICAGO, IL:
1,900,953, REN. 8-9-05. INT. CL. 41.
- INSULPRO AMERICA, INC., SEATTLE, WA:
2,202,351, CANC. INT. CL. 37.

- INTAPOL INDUSTRIES, INC., JERSEY CITY, NJ:
2,996,597, PUB. 6-28-2005. INT. CL. 25.
- INTEC INTERACTIVE II, LLC, MIAMI, FL:
2,996,392, PUB. 6-28-2005. INT. CL. 9.
- INTEGRA FINANCIAL CORPORATION, PITTSBURGH, PA
TO NATIONAL CITY CORPORATION, CLEVELAND, OH:
1,861,165, CANC. INT. CL. 36.
- INTEGRATED ANIMAL PRODUCTION PTY LTD, TOO-
WOOMBA, AUSTRALIA:
2,996,911, PUB. 6-28-2005. INT. CL. 35.
- INTEGRATED DOCUMENT TECHNOLOGIES, INC., ITAS-
CA, IL:
2,997,309, PUB. 6-28-2005. MULTIPLE CLASS, INT. CLS.
35 AND 42.
- INTEGRATED SYSTEMS ENGINEERING, INC., LOGAN,
UT:
1,302,436, CANC. INT. CL. 9.
1,302,437, CANC. INT. CL. 9.
- INTEGRITY MEDIA, INC., MOBILE, AL:
2,999,181, INT. CL. 16.
2,999,355, INT. CL. 41.
2,999,360, MULTIPLE CLASS, INT. CLS. 35, 41 AND 45.
- INTEK, INC., WESTERVILLE, OH:
1,326,716, REN. 8-6-05. INT. CL. 9.
1,941,687, REN. 8-10-05. INT. CL. 9.
- INTELICOAT CORPORATION, MONTICELLO, IN:
2,202,383, CANC. INT. CL. 31.
- INTERACTIX CORPORATION, CHICAGO, IL:
2,998,557, INT. CL. 9.
- INTERCONNECT SERVICES GROUP, LLC, WAYNE, NJ:
2,200,934, CANC. INT. CL. 36.
- INTERGEN COMPANY L.P., PURCHASE, NY:
2,201,098, CANC. INT. CL. 1.
- INTERLOCK STRUCTURES INTERNATIONAL, INC., MIN-
NEAPOLIS, MN:
1,930,930, REN. 8-9-05. INT. CL. 6.
- INTERMODAL RISK MANAGEMENT, LLC, NEW YORK,
NY:
2,999,311, INT. CL. 45.
- INTERNATIONAL BUSINESS MACHINES CORPORATION,
ARMONK, NY, RATIONAL, SANTA CLARA, CA:
1,898,020, REN. 8-11-05. INT. CL. 9.
- INTERNATIONAL BUSINESS MACHINES CORPORATION,
ARMONK, NY:
2,201,688, CANC. MULTIPLE CLASS, INT. CLS. 9 AND
42.
- INTERNATIONAL BUSINESS MACHINES CORPORATION,
ARMONK, NY, AKA IBM CORPORATION:
2,996,703, PUB. 6-28-2005. INT. CL. 42.
- INTERNATIONAL BUSINESS MACHINES CORPORATION,
ARMONK, NY:
2,999,348, MULTIPLE CLASS, INT. CLS. 16, 38 AND 41.
- INTERNATIONAL ELECTRONICS, INC., CANTON, MA:
2,999,012, INT. CL. 9.
2,999,013, INT. CL. 9.
- INTERNATIONAL MEDICAL GROUP, INC., INDIANAPOLIS,
IN:
2,934,317, COR. INT. CL. 35.
- INTERNATIONAL RESEARCH AND DEVELOPMENT
CORP., MATTAWAN, MI:
1,302,344, CANC. INT. CL. 3.
- INTERNATIONAL RESEARCH ASSOCIATION, LLC, CAM-
BRIDGE, MA:
2,998,951, U.S. CL. B.
- INTERNATIONAL SPECIAL EVENTS SOCIETY, INC., CHI-
CAGO, IL:
2,997,825, PUB. 6-28-2005. U.S. CL. B.
- INTERNATIONAL SPEEDWAY INC., DAYTONA BEACH,
FL:
1,861,408, REN. 8-12-05. INT. CL. 25.
- INTERNATIONAL SPEEDWAY, INC., RENO, NV, INTER-
NATIONAL SPEEDWAY CORPORATION, DAYTONA
BEACH, FL:
1,901,330, REN. 8-9-05. INT. CL. 42.
- INTERNATIONAL SPORTS PROPERTIES, INC., WINSTON-
SALEM, NC:
2,997,757, PUB. 6-28-2005. MULTIPLE CLASS, INT. CLS.
35 AND 41.
- INTERNATIONAL TRADEMARK ASSOCIATION, INC.,
NEW YORK, NY, INTERNATIONAL TRADEMARK AS-
SOCIATION, INC., NEW YORK, NY:
1,914,586, REN. 8-8-05. MULTIPLE CLASS, INT. CLS. 9,
16, 41 AND 42.
- INTERNET WORLD BROADCASTING CORPORATION,
EVERETT, WA:
2,201,864, CANC. INT. CL. 38.
2,202,072, CANC. INT. CL. 42.
- INTERNETWORKS CORPORATION, NEW YORK, NY:
2,200,837, CANC. INT. CL. 42.
- INTERSIL AMERICAS INC., MILPITAS, CA:
2,998,656, INT. CL. 9.
- INTERVET INTERNATIONAL BV, NL-5831 AN BOXMEER,
NETHERLANDS:
2,998,450, PUB. 6-28-2005. INT. CL. 5.
- INTRADO INC., LONGMONT, CO:
2,999,166, INT. CL. 38.
- INTRANET, INC., NEWTON, MA:
2,081,290, CANC. INT. CL. 42.
- INTUIT INC., MOUNTAIN VIEW, CA:
2,201,796, CANC. INT. CL. 9.
- INUNITY CORPORATION:
See—NEW RIVER, INC.
- INVESTIGATION SPECIALISTS, INC., WINTER PARK, FL:
1,894,457, REN. 8-9-05. INT. CL. 42.
1,894,458, REN. 8-9-05. INT. CL. 42.
- INVISIBLE FENCE, INC., GARRETT, IN, INVISIBLE FENCE
COMPANY, INC., MALVERN, PA:
1,931,082, REN. 8-11-05. INT. CL. 9.
- INVISTA NORTH AMERICA S. A R.L., CHARLOTTE, NC:
2,998,062, PUB. 6-28-2005. INT. CL. 1.
- IOWA LOTTERY, DES MOINES, IA:
2,201,453, CANC. MULTIPLE CLASS, INT. CLS. 28 AND
36.
- IPFLEX INC., TOKYO 150-0021, JAPAN:
2,998,616, INT. CL. 9.
- IPG TECHNOLOGIES INC., COLUMBIA, SC:
1,974,541, REN. 8-11-05. INT. CL. 17.
- IPNET SOLUTIONS INC., NEWPORT BEACH, CA:
2,201,989, CANC. INT. CL. 9.
2,201,990, CANC. INT. CL. 9.
- IProspect.COM, INC., WATERTOWN, MA:
2,997,896, PUB. 6-28-2005. INT. CL. 42.
- IRA EXPRESS, LOS ANGELES, CA:
1,303,064, CANC. INT. CL. 36.
- IREM CORPORATION, MATSUBARA-SHI, OSAKA-FU, JA-
PAN:
1,302,834, CANC. INT. CL. 28.
- IRON AGE CORPORATION, PITTSBURGH, PA:
2,998,039, PUB. 6-28-2005. INT. CL. 25.
- IRON MAIDEN HOLDINGS LIMITED, LONDON, ENG-
LAND:
1,306,972, REN. 8-11-05. INT. CL. 16.
1,307,146, REN. 8-11-05. INT. CL. 25.
1,308,370, REN. 8-11-05. INT. CL. 41.
- IRON MOUNTAIN INCORPORATED, BOSTON, MA:
2,997,574, PUB. 6-28-2005. INT. CL. 42.
- IRONCLAD PERFORMANCE WEAR CORP., LOS AN-
GELES, CA:
2,954,213, CANC. INT. CL. 25.
- IRVING TANNING COMPANY, HARTLAND, ME:
1,302,624, CANC. INT. CL. 18.
- ISFCE CORP., KEY LARGO, FL:
2,997,697, PUB. 6-28-2005. INT. CL. 41.
- ISI BRANDS, INC., GRAND RAPIDS, MI:
2,997,924, PUB. 6-28-2005. INT. CL. 5.
- ISL PROPERTIES LTD., 6060 SARNEN, SWITZERLAND:
2,200,818, CANC. MULTIPLE CLASS, INT. CLS. 6, 14, 16,
25, 28 AND 32.
- ISLAND HONEY LLC, HONOLULU, HI:
2,997,804, PUB. 6-28-2005. INT. CL. 30.
- ISO PROPERTIES, INC., WILMINGTON, DE:
2,998,220, PUB. 6-28-2005. INT. CL. 36.
- ISOCHEM CORPORATION, WEST LINN, OR:
2,998,991, INT. CL. 5.
- ISORAY MEDICAL, INC., RICHLAND, WA:
2,999,205, INT. CL. 5.

- ISOTEC, INC., HUNTINGTON BEACH, CA:
2,997,120, PUB. 6-28-2005. INT. CL. 35.
- ISUPPORTLEARNING COM LLC, OLATHE, KS:
2,997,269, PUB. 6-28-2005. INT. CL. 9.
- ITA PARTNERS LLC, PHILADELPHIA, PA:
2,997,709, PUB. 6-28-2005. MULTIPLE CLASS, INT. CLS. 44 AND 45.
- ITALEE OPTICS, INC., LOS ANGELES, CA:
2,997,045, PUB. 6-28-2005. INT. CL. 9.
- ITALSPAWN S.A.S. DI SARTOR VALENTINO & C. (TREVISO), ITALY:
2,201,068, CANC. INT. CL. 31.
- ITAP SPA, ITALY:
2,998,496, PUB. 6-28-2005. MULTIPLE CLASS, INT. CLS. 6 AND 19.
- ITEMS INTERNATIONAL, INC., ALTOONA, PA:
2,201,763, CANC. INT. CL. 25.
- ITOCHU CORPORATION, OSAKA-SHI, OSAKA, JAPAN:
2,998,832, MULTIPLE CLASS, INT. CLS. 10 AND 20.
- IVFONLINE.COM, LLC, GUILFORD, CT:
2,996,361, PUB. 6-28-2005. INT. CL. 35.
- IVIS TECHNOLOGIES, INC., PHOENIX, AZ:
2,999,258, INT. CL. 9.
- IVIVITY INC., NORCROSS, GA:
2,998,850, INT. CL. 9.
- IZOR ENTERPRISES, INC., CHULA VISTA, CA:
2,998,003, PUB. 6-28-2005. INT. CL. 43.
- I2 TECHNOLOGIES, INC., IRVING, TX:
2,201,828, CANC. INT. CL. 9.
- J & J SNACK FOOD CORP., PENNSAUKEN, NJ:
1,333,469, REN. 8-10-05. INT. CL. 30.
- J. C. PENNEY PRIVATE BRANDS, INC., PLANO, TX:
2,997,874, PUB. 6-28-2005. INT. CL. 25.
- J. KINDERMAN & SONS, INC., PHILADELPHIA, PA:
2,997,749, PUB. 6-28-2005. INT. CL. 11.
- J. M. SMUCKER COMPANY, THE, ORRVILLE, OH:
1,302,978, CANC. INT. CL. 30.
- J.D. COGGINS SM LLC, INDEPENDENCE, OH:
2,998,208, PUB. 6-28-2005. INT. CL. 43.
- J.M. CORPORATION, EDISON, NJ:
2,996,307, PUB. 6-28-2005. INT. CL. 36.
- J&J SNACK FOODS CORPORATION, PENNSAUKEN, NJ:
1,870,720, REN. 8-11-05. INT. CL. 30.
- J-WALKER STUDIO, INC., BRADENTON, FL:
2,996,740, PUB. 6-28-2005. INT. CL. 16.
- JABRO BATTERIES, INC., LISLE, IL:
1,861,375, CANC. INT. CL. 9.
- JAC JACOBSEN A/S, MANGLERUD, NORWAY:
1,302,641, CANC. INT. CL. 20.
- JACK-POST CORPORATION, BUCHANAN, MI:
1,356,678, REN. 8-11-05. INT. CL. 20.
1,904,460, REN. 8-9-05. INT. CL. 20.
1,904,461, REN. 8-9-05. INT. CL. 20.
- JACOBS MANUFACTURING COMPANY, INC., THE, BLOOMFIELD, CT:
1,860,666, CANC. INT. CL. 7.
- JACOBS, ERIC, VIENNA, VA:
2,997,991, PUB. 6-28-2005. INT. CL. 3.
- JAFER LIMITED, HAMILTON, BERMUDA:
2,998,961, INT. CL. 3.
2,998,997, INT. CL. 4.
- JAFFE, MAX, DALLAS, TX:
2,998,895, MULTIPLE CLASS, INT. CLS. 36 AND 41.
- JAIME MASCARO, S.A., MENORCA, ISLAS BALEARES, SPAIN:
2,996,342, PUB. 6-28-2005. INT. CL. 25.
- JAM DEVELOPERS INC, REDMOND, WA:
2,996,375, PUB. 6-28-2005. INT. CL. 42.
- JAMBA JUICE COMPANY, SAN FRANCISCO, CA:
2,997,335, PUB. 6-28-2005. INT. CL. 32.
- JAMES FRANK JAROLIMEK, ESTES PARK, CO:
2,998,959, INT. CL. 41.
- JAMES RIVER CONSULTING LLC, FAIRFAX, VA:
2,997,672, PUB. 6-28-2005. INT. CL. 42.
- JANCU, ROBERT, FOREST HILLS, NY AND MCCONVILLE, DAN, FOREST HILLS, NY:
2,997,419, PUB. 6-28-2005. INT. CL. 42.
- JANE & COMPANY, LLC, BALTIMORE, MD:
2,998,336, PUB. 6-28-2005. INT. CL. 3.
- JANELCO GLOBAL, INC., PEARL RIVER, LA:
2,081,278, CANC. INT. CL. 30.
- JANSPORT APPAREL CORP., WILMINGTON, DE:
2,997,678, PUB. 6-28-2005. MULTIPLE CLASS, INT. CLS. 18 AND 25.
- JAQUET S.A.; MANUFACTURE D'HORLOGERIE COMPLIQUÉE, SWITZERLAND:
2,998,471, PUB. 6-28-2005. INT. CL. 14.
- JAQUEZ, RAMON E., BRENTWOOD, NY:
2,999,319, INT. CL. 5.
- JARECKA, CARUSHKA H., VALLEY VILLAGE, CA:
1,344,585, REN. 8-11-05. INT. CL. 25.
- JASON NATURAL PRODUCTS, INC., CULVER CITY, CA:
1,357,538, REN. 8-9-05. INT. CL. 3.
- JAVA JONES, INC., DALLAS, TX:
1,879,298, REN. 8-11-05. INT. CL. 30.
- JAZZ AT LINCOLN CENTER, INC., NEW YORK, NY:
2,999,256, INT. CL. 41.
- JB RESEARCH, INC., BELLFLOWER, CA:
2,201,779, CANC. INT. CL. 10.
- JBS INDUSTRIES, INC., PAWLEY'S ISLAND, SC:
2,997,623, PUB. 6-28-2005. INT. CL. 5.
- JCW ENTERPRISES, INC., NEW YORK, NY:
2,996,917, PUB. 6-28-2005. INT. CL. 41.
- JEFFERSON INSTITUTE FOR LIFELONG LEARNING, CHARLOTTESVILLE, VA:
2,997,660, PUB. 6-28-2005. INT. CL. 41.
- JELLY BELLY CANDY COMPANY, FAIRFIELD, CA:
2,999,257, INT. CL. 30.
- JENNINGS RESEARCH AND DEVELOPMENT CORPORATION, ST. JOSEPH, MI:
2,999,292, INT. CL. 42.
- JFYNETWORKS, BOSTON, MA:
2,996,520, PUB. 6-28-2005. INT. CL. 35.
- JHOON RHEE INTERNATIONAL, FALLS CHURCH, VA:
2,996,798, PUB. 6-28-2005. INT. CL. 41.
- JIM BEAM BRANDS CO., DEERFIELD, IL:
2,201,250, CANC. INT. CL. 33.
- JIMLAR CORPORATION, GREAT NECK, NY:
2,998,603, INT. CL. 3.
- JIMONI INC., ROCHESTER, MN, DBA TRUCKIN' AMERICA:
2,997,539, PUB. 6-28-2005. INT. CL. 35.
- JINBEI AUTOMOTIVE COMPANY LIMITED, CHINA:
2,998,494, PUB. 6-28-2005. INT. CL. 12.
- JKL COMPONENTS CORPORATION, PACOIMA, CA:
2,201,300, CANC. INT. CL. 11.
- JMS MARKETING, INC., BROOKLYN, NY:
2,998,030, PUB. 6-28-2005. INT. CL. 16.
- JO TO GO AMERICA, INC., GREEN BAY, WI:
2,999,182, INT. CL. 43.
- JOHN E. HARTWELL, MIRAMAR, FL:
2,110,590, CANC. INT. CL. 12.
- JOHN L. SCOTT, INC., BELLEVUE, WA:
1,937,662, REN. 8-12-05. INT. CL. 38.
- JOHN SNELL & ASSOCIATES, INC., MONTPELIER, VT:
2,996,837, PUB. 6-28-2005. INT. CL. 41.
- JOHNNY APPLESEED RESTAURANTS, INC., RICHMOND, VA:
1,861,308, CANC. INT. CL. 42.
- JOHNS HOPKINS UNIVERSITY, THE, LAUREL, MD:
1,902,464, REN. 8-6-05. INT. CL. 9.
- JOHNSON & JOHNSON, NEW BRUNSWICK, NJ:
1,293,688, CANC. INT. CL. 5.
1,293,688, REN. 8-9-05. INT. CL. 3.
1,302,360, CANC. INT. CL. 3.
2,202,341, CANC. INT. CL. 3.
2,998,010, PUB. 6-28-2005. INT. CL. 3.
2,998,515, INT. CL. 1.
2,998,570, INT. CL. 9.
2,998,713, INT. CL. 21.
- JOHNSON, DAVID, HAMDEN, CT, DBA WISTFUL VISTA TELEPHONE CO.:
2,996,733, PUB. 6-28-2005. INT. CL. 37.
2,996,734, PUB. 6-28-2005. INT. CL. 35.
2,996,735, PUB. 6-28-2005. INT. CL. 9.

- JONDY CHEMICALS, INC., SOMERSET, KY:
2,996,673, PUB. 6-28-2005. INT. CL. 24.
- JONES SODA CO. (USA) INC., SEATTLE, WA:
2,996,249, PUB. 3-2-2004. INT. CL. 32.
- JONES STUDIO LIMITED, STATEN ISLAND, NY:
2,996,239, PUB. 6-28-2005. INT. CL. 42.
- JONES, BRIGHT INTERNATIONAL, INC., THE WOODLANDS, TX:
2,201,192, CANC. INT. CL. 42.
- JONES, J. D., WINTERSVILLE, OH, DBA SSK INDUSTRIES:
1,898,840. REN. 8-10-05. INT. CL. 13.
- JONES, ROBERT, DALLAS, TX:
2,998,710, INT. CL. 16.
2,998,711, INT. CL. 44.
- JOOP! GMBH, HAMBURG, FED REP GERMANY:
2,997,510, PUB. 6-28-2005. MULTIPLE CLASS, INT. CLS. 3, 9, 14, 18 AND 25.
- JOSEPH, TERESA, BROOKLYN, NY:
2,998,779, INT. CL. 14.
- JOSEPH'S CAFE, INC., LOS ANGELES, CA:
2,998,018, PUB. 6-28-2005. INT. CL. 43.
- JOSEPHS, IRA, MARINA DEL REY, CA:
2,202,352, CANC. INT. CL. 25.
- JOSLYN CLARK CONTROLS, INC., LANCASTER, DE:
1,893,960. REN. 8-11-05. INT. CL. 9.
- JOSS VISION CARE LTD., WINNIPEG, MANITOBA, CANADA:
2,997,484, PUB. 6-28-2005. INT. CL. 35.
- JOURNAL OF COMMERCE, INC., NEW YORK, NY:
1,303,037, CANC. INT. CL. 35.
- JR GOLD DESIGN, INC., NEW YORK, NY:
2,996,804, PUB. 6-28-2005. INT. CL. 14.
- JRC INDUSTRIES, INC., SANTA FE SPRINGS, CA:
2,997,176, PUB. 6-28-2005. INT. CL. 35.
- JUDGE MARKETING, INC., INDIANAPOLIS, IN:
2,201,335, CANC. INT. CL. 16.
- JUICING FOR JOCKS, LLC, CHICAGO, IL:
2,998,650, MULTIPLE CLASS, INT. CLS. 35 AND 41.
- JUNE BUG ENTERPRISES, INC., BEVERLY HILLS, CA:
2,997,398, PUB. 6-28-2005. INT. CL. 25.
- JUNE TAILOR, INC., RICHFIELD, WI:
1,905,375. REN. 8-10-05. INT. CL. 9.
- JURA ELEKTROAPPARATE AG, NIEDERBUCHSITEN, SWITZERLAND:
2,996,431, PUB. 6-28-2005. INT. CL. 11.
- JURY VERDICT REVIEW PUBLICATIONS, INC., SPRINGFIELD, NJ:
2,996,683, PUB. 6-28-2005. INT. CL. 16.
2,996,684, PUB. 6-28-2005. INT. CL. 16.
2,996,685, PUB. 6-28-2005. INT. CL. 16.
- JUST RIGHT, LLC, GREER, SC:
2,996,847, PUB. 6-28-2005. INT. CL. 35.
- JUST SAY ROCK, INC., DOVER, NH:
2,997,626, PUB. 6-28-2005. INT. CL. 25.
- JUST THE BASICS, INC., EDGEWOOD, KY:
2,997,898, PUB. 6-28-2005. INT. CL. 35.
- J2 PRODUCTIONS, INC., LOS ANGELES, CA:
2,998,680, MULTIPLE CLASS, INT. CLS. 31 AND 41.
- K & S HAWAIIAN CREATIONS, INCORPORATED, HONOLULU, HI, DBA HONOLULU COOKIE COMPANY:
2,996,860, PUB. 6-28-2005. INT. CL. 35.
- K AND S DISTRIBUTING CO., INC., PORTLAND, OR:
1,302,333, CANC. INT. CL. 2.
- K. HANSOTIA & CO., INC., MIAMI, FL:
2,998,658, INT. CL. 34.
- K-FOUR, INC., ROCKVILLE, MD:
2,998,562, INT. CL. 42.
- K-SWISS INC., WESTLAKE VILLAGE, CA:
2,996,552, PUB. 6-28-2005. INT. CL. 25.
- K-TRON TECHNOLOGIES, INC., WILMINGTON, DE:
2,200,896, CANC. MULTIPLE CLASS, INT. CLS. 7 AND 9.
- KABA ILCO, INC., MONTREAL, QUEBEC, CANADA:
2,998,057, PUB. 6-28-2005. INT. CL. 9.
- KABUSHIKI KAISHA CRIMSON, NARA-CITY, JAPAN, DBA CRIMSON, INC.:
2,201,904, CANC. INT. CL. 12.
- KABUSHIKI KAISHA KITZ, CHIBA-SHI, CHIBA-KEN, JAPAN, DBA KITZ CORPORATION:
1,350,283. REN. 8-11-05. MULTIPLE CLASS, INT. CLS. 6 AND 9.
- KABUSHIKI KAISHA SEGA, TOKYO 144-8531, JAPAN, DBA SEGA CORPORATION:
2,998,586, MULTIPLE CLASS, INT. CLS. 9 AND 42.
- KABUSHIKI KAISHA SONY COMPUTER ENTERTAINMENT, MINATO-KU, TOKYO, JAPAN, TA SONY COMPUTER ENTERTAINMENT INC.:
2,996,241, PUB. 6-28-2005. INT. CL. 3.
- KABUSHIKI KAISHA YAKULT HONSHA, TOKYO, JAPAN:
2,996,636, PUB. 6-28-2005. MULTIPLE CLASS, INT. CLS. 30 AND 32.
- KADENA SYSTEMS, INC., SAN JOSE, CA:
2,999,137, INT. CL. 9.
- KAHLO JEEP EAGLE, INC., NOBLESVILLE, IN:
2,997,734, PUB. 6-28-2005. INT. CL. 35.
- KAHN.KAHN, INC., BURLINGAME, CA:
2,997,811, PUB. 6-28-2005. INT. CL. 21.
- KAI CONVENI GLOBAL INC., VILLE ST-LAURENT, QUEBEC H4S 1N5, CANADA:
2,996,263, PUB. 6-28-2005. INT. CL. 30.
- KALIMAR INC., CHESTERFIELD, MO:
2,201,813, CANC. INT. CL. 9.
- KALLMAN RESEARCH CORP., WHITESTONE, NY:
2,200,881, CANC. INT. CL. 18.
- KALLOY INDUSTRIAL CO., LTD., TAICHUNG HSIEN, TAIWAN:
2,996,633, PUB. 6-28-2005. INT. CL. 12.
- KAMAN MUSIC CORPORATION, BLOOMFIELD, CT:
2,201,907, CANC. INT. CL. 15.
- KAMTECH, INC., GLENS FALLS, NY:
2,201,676, CANC. INT. CL. 11.
- KANE, MARI, FORESTVILLE, CA:
2,202,402, CANC. INT. CL. 16.
- KANEBO KABUSHIKI KAISHA (KANEBO, LTD.), SUMIDA-KU, TOKYO, JAPAN:
1,302,691, CANC. INT. CL. 24.
- KANG, CHING-KWEI, THE WOODLANDS, TX:
2,998,051, PUB. 6-28-2005. INT. CL. 5.
- KANG'S DISTRIBUTION, INC., CERRITOS, CA:
2,996,794, PUB. 6-28-2005. INT. CL. 36.
- KANGOL LIMITED, CLEATOR, UNITED KINGDOM:
2,791,480, CANC. INT. CL. 25.
- KANSAS CITY POWER & LIGHT COMPANY, KANSAS CITY, MO:
1,883,988. REN. 8-11-05. INT. CL. 39.
- KAO KABUSHIKI KAISHA, CHUO-KU, TOKYO, JAPAN, ATA KAO CORPORATION:
1,302,349, CANC. INT. CL. 3.
- KAO KABUSHIKI KAISHA, TOKYO, JAPAN:
1,302,350, CANC. INT. CL. 3.
- KAO KABUSHIKI KAISHA, CHUO-KU, TOKYO, JAPAN, TA KAO CORPORATION:
2,998,045, PUB. 6-28-2005. INT. CL. 3.
- KARL LOFFLER GMBH & CO.KG, 50735 KOLN, FED REP GERMANY:
1,901,348. REN. 8-11-05. INT. CL. 3.
- KARL STORZ GMBH & CO. KG, D-78532 TUTTLINGEN, FED REP GERMANY:
2,996,308, PUB. 6-28-2005. INT. CL. 16.
- KARL STORZ GMBH & CO. KG, D-78532 TUTTLINGEN, FED REP GERMANY FROM KARL STORZ GMBH, & CO, D-7B532 TUTTLINGEN, FED REP GERMANY:
2,996,237, PUB. 6-28-2005. MULTIPLE CLASS, INT. CLS. 9 AND 10.
- KARL STORZ GMBH, & CO:
See—KARL STORZ GMBH & CO. KG.
- KARMAN, INC., AURORA, CO:
1,895,620. REN. 8-10-05. INT. CL. 25.
- KARMAN, INC., DENVER, CO:
2,202,235, CANC. INT. CL. 25.
- KARMA2GO.COM, LLC, SAN FRANCISCO, CA:
1,899,595. REN. 8-10-05. INT. CL. 9.
- KARPOWICH, JOHN W, LOS ANGELES, CA:
2,996,926, PUB. 6-28-2005. INT. CL. 12.

- KARSTEN MANUFACTURING CORPORATION, PHOENIX, AZ:
2,998,878, INT. CL. 21.
- KASSBOHRER GELANDEFAHRZEUG AG, LAUPHEIM, FED REP GERMANY:
2,998,875, INT. CL. 7.
- KASSIR IMPORT-EXPORT CO., INC., COMMERCE, CA:
2,997,789, PUB. 6-28-2005. INT. CL. 34.
- KATANALI, LLC, LONGVIEW, TX:
2,997,018, PUB. 6-28-2005. INT. CL. 25.
- KATOS, ARISTIDES, ERIE, PA:
2,201,466, CANC. INT. CL. 30.
- KAUFMANN, KENNETH W., YONKERS, NY:
2,996,711, PUB. 6-28-2005. INT. CL. 40.
- KAYNEE COMPANY, THE, NEW YORK, NY:
1,302,781, CANC. INT. CL. 25.
- KB HOLDINGS, LLC, LAS VEGAS, NV:
2,998,915, INT. CL. 28.
- KDP, INC., LAWRENCE, MA:
2,998,043, PUB. 6-28-2005. INT. CL. 3.
- KEEFER, BRYAN R., MOUNTAIN VIEW, CA AND NYHAN, BRENDAN, DURHAM, NC AND FRITZ, BENJAMIN, LOS ANGELES, CA:
2,997,020, PUB. 6-28-2005. INT. CL. 35.
- KEENAN, ELYSE, M., CENTEREACH, NY:
2,998,081, PUB. 6-28-2005. INT. CL. 41.
- KEGAN, DANIEL L., CHICAGO, IL:
2,996,235, PUB. 6-28-2005. MULTIPLE CLASS, INT. CLS. 35 AND 41.
- KEILHACK, HANS KRISTOPHER, CHARLOTTE, NC:
2,998,000, PUB. 6-28-2005. INT. CL. 12.
- KEL-KOTE, INC., BERKELEY, CA:
2,997,079, PUB. 6-28-2005. INT. CL. 2.
- KELKAR, RUCHA, ALISO VIEJO, CA:
2,997,502, PUB. 6-28-2005. INT. CL. 5.
- KELLER INTERNATIONAL PUBLISHING CORPORATION, GREAT NECK, NY:
1,302,602, CANC. INT. CL. 16.
- KELLER INTERNATIONAL PUBLISHING LLC, GREAT NECK, NY:
2,997,135, PUB. 6-28-2005. INT. CL. 16.
- KELLEY, KEVIN W., SAN RAFAEL, CA:
2,998,537, INT. CL. 41.
- KELLOGG BROWN & ROOT, INC., HOUSTON, TX:
2,997,435, PUB. 6-28-2005. MULTIPLE CLASS, INT. CLS. 35, 37 AND 42.
- KELVIN CHEN INTERNATIONAL LLC, CITY OF INDUSTRY, CA:
2,997,607, PUB. 6-28-2005. INT. CL. 6.
- KEMLON PRODUCTS AND DEVELOPMENT COMPANY, PEARLAND, TX:
999,594, REN. 8-12-05. INT. CL. 9.
- KEMPS LLC, MINNEAPOLIS, MN:
2,998,226, PUB. 6-28-2005. INT. CL. 30.
- KEN YING ENTERPRISE CO., LTD., NIEO SUNG HSIANG, TAIWAN:
2,996,348, PUB. 6-28-2005. INT. CL. 7.
- KENAR ENTERPRISES, LTD., NEW YORK, NY:
1,302,743, CANC. INT. CL. 25.
- KENIG, URI, ENCINO, CA:
2,998,236, PUB. 6-28-2005. INT. CL. 44.
- KENNETH NATHAN OATMAN, BOULDER, CO:
2,857,927, CANC. INT. CL. 16.
- KENT ELECTRONICS CORPORATION, HOUSTON, TX:
1,302,465, CANC. INT. CL. 9.
- KERN SCHOOLS FEDERAL CREDIT UNION, BAKERSFIELD, CA:
1,303,082, CANC. INT. CL. 36.
- KERR, CRISTIE, CORAL GABLES, FL:
2,999,178, INT. CL. 36.
- KESSLER PRODUCTS, LTD., YOUNGSTOWN, OH:
2,150,467, CANC. INT. CL. 17.
- KESZI, JULIUS E, HOCKESSIN, DE:
2,996,408, PUB. 6-28-2005. INT. CL. 42.
- KETTENBACH GMBH & CO. KG, ESCHENBURG, FED REP GERMANY:
2,998,887, INT. CL. 5.
- KETTLE RESTAURANTS, INC., GARLAND, TX, HLH ENTERPRISES, INC., HOUSTON, TX:
1,014,890, REN. 8-11-05. INT. CL. 42.
- KEVIN KENNEDY AND ASSOCIATES, INDIANAPOLIS, IN:
2,996,437, PUB. 6-28-2005. INT. CL. 42.
- KEY WHOLESALER GROUP ASSOCIATION, INDEPENDENCE, MO:
2,997,524, PUB. 6-28-2005. INT. CL. 35.
- KEYCORP, CLEVELAND, OH:
2,201,975, CANC. INT. CL. 9.
- KEYMRO, BOULOGNE-BILLANCOURT, FRANCE:
2,996,933, PUB. 6-28-2005. MULTIPLE CLASS, INT. CLS. 35, 36, 38 AND 42.
- KEYNAMICS LLC, LAKEWAY, TX:
2,999,378, INT. CL. 9.
- KIDDE CONSUMER DURABLES CORP., BRONX, NY:
1,226,680, CANC. INT. CL. 21.
- KIDPOWER, INC., BRENTWOOD, TN:
2,201,483, CANC. INT. CL. 28.
- KIDS CARE INC., VIENNA, VA:
2,998,955, INT. CL. 3.
- KILLER BEAZ, INC., MOBILE, AL:
2,996,585, PUB. 6-28-2005. INT. CL. 9.
- KIMBALL HILL, INC., ROLLING MEADOWS, IL:
2,996,743, PUB. 6-28-2005. INT. CL. 37.
- KIMBER IP, LLC, YONKERS, NY:
2,999,315, INT. CL. 13.
- KIMBERLI J. BRYAN, PINE, CO:
2,997,013, PUB. 6-28-2005. MULTIPLE CLASS, INT. CLS. 14 AND 28.
- KIMBERLY-CLARK CORPORATION, NEENAH, WI:
1,302,593, CANC. INT. CL. 16.
1,302,594, CANC. INT. CL. 16.
- KIMBERLY-CLARK WORLDWIDE, INC., NEENAH, WI:
2,998,274, PUB. 6-28-2005. MULTIPLE CLASS, INT. CLS. 3, 16, 21 AND 24.
- KIMBLE GLASS, INC., VINELAND, NJ:
2,202,136, CANC. INT. CL. 9.
- KIMPTON HOTEL & RESTAURANT GROUP, LLC, SAN FRANCISCO, CA:
2,998,015, PUB. 6-28-2005. INT. CL. 43.
2,998,016, PUB. 6-28-2005. INT. CL. 43.
- KIN PRODUCTS, INC., CINCINNATI, OH:
2,997,629, PUB. 6-28-2005. INT. CL. 20.
- KING EDWARDTECHNOLOGY, INC., WILMINGTON, DE, M. TRELLES & CO., NEW ORLEANS 6, LA:
622,036, REN. 8-8-05. U.S. CL. 17 (INT. CL. 34).
- KING TECHNOLOGY OF MISSOURI, INC., ST. CHARLES, MO:
2,996,698, PUB. 6-28-2005. INT. CL. 17.
- KINGMAN INDUSTRIES, INC., ANAHEIM, CA:
1,302,928, CANC. INT. CL. 30.
- KINGS SUPERMARKETS, INC., WEST CALDWELL, NJ:
1,897,848, REN. 8-9-05. INT. CL. 42.
- KINGSID VENTURES, LTD., LAS VEGAS, NV:
1,878,090, REN. 8-8-05. INT. CL. 42.
- KINSHIP, INC., MINNEAPOLIS, MN:
2,998,167, PUB. 6-28-2005. INT. CL. 41.
2,998,168, PUB. 6-28-2005. INT. CL. 41.
- KISSLER, FREDRIC, LOS ANGELES, CA:
2,999,372, INT. CL. 29.
- KITTRICH CORPORATION, LA MIRADA, CA:
2,998,073, PUB. 6-28-2005. INT. CL. 16.
- KIWANIS INTERNATIONAL, INC., INDIANAPOLIS, IN:
799,535, CANC. U.S. CL. 38.
799,535, REN. 8-12-05. U.S. CL. 50 (INT. CLS. 3, 6, 14, 16, 17, 19, 20, 21, 22, 24, 26, 27 AND 28).
- KIWI EUROPEAN HOLDINGS B.V., UTRECHT 3532 AD, NETHERLANDS:
2,998,079, PUB. 6-28-2005. INT. CL. 3.
- KLAWHORN INDUSTRIES, INC., WADSWORTH, OH:
2,997,250, PUB. 6-28-2005. INT. CL. 8.
- KLC LAND COMPANY, LLC, HONOLULU, HI:
1,879,829, REN. 8-8-05. INT. CL. 25.
- KLEIN, ELLIOT, NEW YORK, NY:
2,999,259, INT. CL. 39.
- KLEIN'S NATURALS, LTD., BROOKLYN, NY:
2,996,302, PUB. 6-28-2005. MULTIPLE CLASS, INT. CLS.

- 29 AND 31.
 KLINGE PHARMA GMBH, 81673 MUNCHEN, FED REP GERMANY:
 2,201,045, CANC. INT. CL. 5.
 KLUGE ESTATE WINERY AND VINEYARD, L.L.C., CHARLOTTESVILLE, VA:
 2,996,539, PUB. 6-28-2005. INT. CL. 33.
 2,996,540, PUB. 6-28-2005. INT. CL. 33.
 2,996,541, PUB. 6-28-2005. INT. CL. 33.
 2,996,542, PUB. 6-28-2005. MULTIPLE CLASS, INT. CLS. 29 AND 30.
 KLÜBER LUBRICATION MÜNCHEN KG, FED REP GERMANY:
 2,998,399, PUB. 6-28-2005. INT. CL. 4.
 KMART PROPERTIES, INC., TROY, MI:
 1,860,624, CANC. MULTIPLE CLASS, INT. CLS. 3, 5, 10 AND 21.
 KNAACK MANUFACTURING COMPANY, CRYSTAL LAKE, IL, KNAACK MANUFACTURING COMPANY, CRYSTAL LAKE, IL:
 1,897,535, REN. 8-11-05. INT. CL. 20.
 KNIGHT IMAGES, INC., ORLANDO, FL:
 2,997,008, PUB. 6-28-2005. INT. CL. 35.
 KOENIG & BAUER AKTIENGESELLSCHAFT, FED REP GERMANY:
 2,998,484, PUB. 6-28-2005. MULTIPLE CLASS, INT. CLS. 7, 9 AND 37.
 KOHLER & CAMPBELL, INC., GRANITE FALLS, NC:
 779,464, CANC. U.S. CL. 36.
 KOHN; RONALD T., RAPID CITY, SD, DBA INTERMOUNTAIN CONCERTS:
 1,303,194, CANC. INT. CL. 41.
 KOLINAS, TINA M., LAS VEGAS, NV:
 2,997,764, PUB. 6-28-2005. INT. CL. 8.
 KOLKA EQUIPMENT, L.L.C., W. BLOOMFIELD, MI:
 2,201,436, CANC. INT. CL. 28.
 KOLON FASHION CORPORATION, KWACHEON-CITY, REPUBLIC OF KOREA:
 2,998,547, INT. CL. 25.
 KONAMI CORPORATION, TOKYO, JAPAN:
 2,998,556, INT. CL. 28.
 KONI BV, OUD-BEYERLAND, NETHERLANDS, KONI B.V., OUD-BEIJERLAND, NETHERLANDS:
 1,006,302, REN. 8-10-05. INT. CL. 12.
 KONICA MINOLTA BUSINESS SOLUTIONS U.S.A., INC., WINDSOR, CT:
 2,996,246, PUB. 6-28-2005. INT. CL. 9.
 KONIG MOTORING ACCESSORIES, PLAINVIEW, NY:
 2,996,615, PUB. 6-28-2005. MULTIPLE CLASS, INT. CLS. 7 AND 12.
 KONINKLIJKE PHILIPS ELECTRONICS N.V., NETHERLANDS:
 2,998,370, PUB. 6-28-2005. INT. CL. 9.
 2,998,377, PUB. 6-28-2005. MULTIPLE CLASS, INT. CLS. 9 AND 42.
 KOOKOGHEY, KEVIN S., FRANKLIN, TN:
 2,997,638, PUB. 6-28-2005. INT. CL. 16.
 KORNBLATT, STEVEN, NEW YORK, NY:
 2,201,915, CANC. INT. CL. 5.
 KORNY, BARBARA, HOLLAND, MA AND KORNY, RAYMOND, HOLLAND, MA:
 2,996,686, PUB. 6-28-2005. INT. CL. 43.
 KORS, MARLAR, SAVAGE & ASSOCIATES, INC., HOUSTON, TX:
 2,998,276, PUB. 6-28-2005. INT. CL. 35.
 KOSLOW ENTERPRISES, INC, URBANDEALE, IA, DBA PIQUES DIETS AND DESSERTS:
 2,996,699, PUB. 6-28-2005. MULTIPLE CLASS, INT. CLS. 41, 43 AND 44.
 KOSMA-KARE CANADA INC., LONGUEUIL, QUEBEC J4G 1R7, CANADA:
 2,996,369, PUB. 6-28-2005. INT. CL. 5.
 KOVAR'S INC., CARMICHAEL, CA:
 2,998,610, INT. CL. 9.
 KOWA AMERICAN CORP., NEW YORK, NY:
 1,880,687, REN. 8-11-05. INT. CL. 25.
 KOZ INC., DURHAM, NC:
 2,201,422, CANC. INT. CL. 42.
 KRADJIAN IMPORTING COMPANY, INC., GLENDALE, CA:
 2,201,467, CANC. INT. CL. 29.
 KRAFT FOODS FEDERAL CREDIT UNION, PURCHASE, NY:
 2,996,809, PUB. 6-28-2005. INT. CL. 36.
 KRAFT FOODS HOLDINGS, INC., NORTHFIELD, IL, NABISCO BRANDS, INC., PARSIPPANY, NJ:
 1,319,653, REN. 8-9-05. INT. CL. 30.
 KRAFT FOODS HOLDINGS, INC., NORTHFIELD, IL:
 2,999,114, INT. CL. 30.
 KRAFT FOODS, INC., NORTHFIELD, IL:
 2,202,192, CANC. INT. CL. 29.
 KREBS INTERNATIONAL, TUCSON, AZ:
 1,011,873, REN. 8-10-05. U.S. CL. 23 (INT. CLS. 6, 7, 8, 9, 11, 12, 16, 21 AND 28).
 KREICK, CHRISTINA, PISCATAWAY, NJ:
 2,999,240, INT. CL. 24.
 KREUZER, TANYA, MESA, AZ:
 2,998,971, INT. CL. 25.
 KRISTALL BEVERAGE INC., LEXINGTON, MA:
 1,861,107, CANC. INT. CL. 32.
 KRIZIA S.P.A., MILANO, ITALY:
 1,302,712, CANC. INT. CL. 25.
 KRUEGER INTERNATIONAL, INC., GREEN BAY, WI:
 1,918,857, REN. 8-10-05. INT. CL. 20.
 1,921,282, REN. 8-11-05. INT. CL. 20.
 2,998,826, INT. CL. 20.
 KS BIOMEDIX HOLDINGS PLC:
See—DISCERNA LIMITED.
 KSE MEDIA VENTURES, LLC, DENVER, CO:
 2,996,624, PUB. 6-28-2005. MULTIPLE CLASS, INT. CLS. 38 AND 41.
 KUAMP, INC., MASPETH, NY:
 2,997,107, PUB. 6-28-2005. INT. CL. 41.
 KUIL NOORDELOOS B.V., 4225 PA NOORDELOOS, NETHERLANDS:
 1,886,823, REN. 8-10-05. MULTIPLE CLASS, INT. CLS. 1 AND 12.
 KUNDE ENTERPRISES, INC., KENWOOD, CA:
 2,998,782, INT. CL. 33.
 KUNGSORS PLAST AB, KUNGSOR, SWEDEN:
 2,997,547, PUB. 6-28-2005. MULTIPLE CLASS, INT. CLS. 17 AND 19.
 KUONI REISEN AG, 8005 ZÜRICH, SWITZERLAND:
 2,996,273, PUB. 6-28-2005. INT. CL. 39.
 KWALU INC., RIGELAND, SC:
 1,959,262, REN. 8-8-05. INT. CL. 20.
 KWIK PRODUCTS, INC., PHOENIX, AZ:
 2,998,777, INT. CL. 7.
 KWIK STAND DISPLAYS, INC., BRAINERD, MN:
 2,201,269, CANC. INT. CL. 20.
 KYE SYSTEMS CORP., SAN CHUNG, TAIPEI HSIEN, TAIWAN:
 2,202,116, CANC. INT. CL. 9.
 KYOCERA MITA CORPORATION, OSAKA, JAPAN:
 2,997,220, PUB. 6-28-2005. INT. CL. 9.
 KYOSHO CORPORATION, TOKYO 102-0093, JAPAN:
 2,996,449, PUB. 6-28-2005. INT. CL. 28.
 L. S. STARRETT COMPANY, THE, ATHOL, MA:
 794,008, REN. 8-10-05. U.S. CL. 23 (INT. CL. 8).
 1,026,026, REN. 8-10-05. INT. CL. 4.
 L.C. LICENSING, INC., NEW YORK, NY:
 1,884,379, REN. 8-9-05. INT. CL. 42.
 2,998,829, INT. CL. 9.
 2,999,285, INT. CL. 25.
 L.F.P., INC., BEVERLY HILLS, CA:
 2,998,177, PUB. 6-28-2005. INT. CL. 16.
 L.N. GORDON DESIGNS, INC., HOUSTON, TX:
 2,201,611, CANC. MULTIPLE CLASS, INT. CLS. 24 AND 25.
 L-7 DESIGNS, INC., DALLAS, TX:
 1,840,989, CANC. INT. CL. 41.
 L'OREAL, 75008 PARIS, FRANCE:
 2,200,948, CANC. MULTIPLE CLASS, INT. CLS. 3, 5, 8, 11,

- 18, 21, 26 AND 42.
2,201,800, CANC. INT. CL. 3.
2,202,186, CANC. INT. CL. 3.
2,202,187, CANC. INT. CL. 3.
- L'OREAL USA CREATIVE, INC., NEW YORK, NY:
1,937,534, REN. 8-10-05. INT. CL. 3.
2,997,820, PUB. 6-28-2005. INT. CL. 3.
2,999,260, INT. CL. 3.
- LA AUTENTICA FOODS, INC., HIALEAH, FL:
2,201,852, CANC. INT. CL. 30.
- LA CUCINA ITALIANA S.R.L., 43031 BAGANZOLA, PARMA, ITALY:
2,201,096, CANC. INT. CL. 17.
- LA JOLLA HOLDING GROUP, L.L.C., LA JOLLA, CA:
2,996,231, PUB. 6-28-2005. INT. CL. 39.
- LA MAISON DU KELSCH SARL, MOLSHEIM, FRANCE:
2,998,149, PUB. 6-28-2005. INT. CL. 18.
- LA ROGGIA S.R.L., 20146 MILANO, ITALY:
2,996,393, PUB. 6-28-2005. INT. CL. 14.
- LA TABACALERA, C. POR A., SANTO DOMINGO, DOMINICAN REP:
2,998,928, INT. CL. 34.
- LABORATORIOS RUBIÓ, S.A., SPAIN:
2,998,463, PUB. 6-28-2005. INT. CL. 5.
2,998,475, PUB. 6-28-2005. INT. CL. 5.
- LACHACZ, FRANK ANTHONY, ROBERTSDALE, AL:
2,997,285, PUB. 6-28-2005. INT. CL. 16.
- LADYBERG S.P.A., 24050 GRASSBBIO (BERGAMO), ITALY:
2,996,497, PUB. 6-28-2005. INT. CL. 25.
- LAFARGE NORTH AMERICA INC., HERNDON, VA:
2,998,625, INT. CL. 19.
- LAFEFER, TED, BATAVIA, IL:
2,998,133, PUB. 6-28-2005. INT. CL. 31.
- LAING, WILLIAM H., JR., KEITHVILLE, LA, DBA C/C PERFORMANCE PRODUCTS:
2,201,782, CANC. INT. CL. 12.
- LAMINA CERAMICS, INC., WESTHAMPTON, NJ:
2,997,743, PUB. 6-28-2005. INT. CL. 9.
- LAN AIRLINES S.A., SANTIAGO, CHILE:
2,997,197, PUB. 6-28-2005. INT. CL. 39.
- LAN UTILITIES, L.L.C., PLEASANT GROVE, UT:
2,202,320, CANC. INT. CL. 9.
- LANARD TOYS LIMITED, HONG KONG SAR, HONG KONG:
2,998,794, INT. CL. 28.
- LANCASTER ARCHERY SUPPLY, INC., LANCASTER, PA:
2,997,584, PUB. 6-28-2005. INT. CL. 35.
- LANCASTER FARMS, INC., SUFFOLK, VA:
1,303,295, CANC. INT. CL. 42.
1,303,296, CANC. INT. CL. 42.
- LANCE MFG. LLC, CHARLOTTE, NC:
2,999,053, INT. CL. 30.
- LANCE-LARKIN, LLC, PORTLAND, OR:
2,997,526, PUB. 6-28-2005. INT. CL. 6.
- LAND O'LAKES, INC., ARDEN HILLS, MN:
1,302,320, CANC. INT. CL. 1.
- LANDEC AG, INC., MONTICELLO, IN:
2,998,555, INT. CL. 31.
- LANDERWOOD CORPORATION, CHARLOTTE, NC:
2,998,231, PUB. 6-28-2005. INT. CL. 25.
- LANG & REED LLC, ST. HELENA, CA:
2,997,535, PUB. 6-28-2005. INT. CL. 33.
- LANGE EYE CARE & ASSOCIATES, P.A., OCALA, FL:
2,997,790, PUB. 6-28-2005. INT. CL. 35.
- LANGFORD TOOL & DRILL CO., MINNEAPOLIS, MN:
1,860,665, CANC. INT. CL. 7.
- LANQUEST GROUP, FREMONT, CA:
2,200,970, CANC. MULTIPLE CLASS, INT. CLS. 9 AND 42.
- LARI, DAVID B., BALTIMORE, MD:
2,997,338, PUB. 6-28-2005. MULTIPLE CLASS, INT. CLS. 25 AND 28.
- LAROSA'S, INC., CINCINNATI, OH:
2,996,745, PUB. 6-28-2005. INT. CL. 36.
- LARSEN, JOHN M., TIGARD, OR:
2,996,475, PUB. 6-28-2005. INT. CL. 35.
- LASALLE BANK CORPORATION, CHICAGO, IL:
1,898,288, REN. 8-11-05. INT. CL. 36.
- LASALLE STEEL COMPANY, HAMMOND, IN:
1,876,337, REN. 8-10-05. INT. CL. 6.
- LASER WORKS, INC., BRADENTON, FL:
2,201,129, CANC. MULTIPLE CLASS, INT. CLS. 16 AND 20.
- LASERSOFT IMAGING USA, LONGBOAT KEY, FL:
2,997,033, PUB. 6-28-2005. INT. CL. 42.
- LASERTRON, INC., AMHERST, NY:
2,998,319, PUB. 6-28-2005. INT. CL. 28.
- LASSEN WINDOW FASHIONS INC, ANAHEIM, CA:
2,996,335, PUB. 6-14-2005. INT. CL. 35.
- LATTE' CHALET ESPRESSO INC., SAGLE, ID:
1,861,303, CANC. INT. CL. 42.
- LAURA ASHLEY LIMITED, FULHAM, LONDON SW6 2QA, ENGLAND, LAURA ASHLEY MANUFACTURING B.V., 33/37, HELMOND, NETHERLANDS:
1,789,975, REN. 8-8-05. MULTIPLE CLASS, INT. CLS. 1, 3, 5, 6, 9, 16, 20, 21, 31, 36 AND 42.
- LAURA ASHLEY MANUFACTURING B.V., 33/37, HELMOND, NETHERLANDS TO LAURA ASHLEY LIMITED, FULHAM, LONDON SW6 2QA, ENGLAND:
1,789,975, CANC. MULTIPLE CLASS, INT. CLS. 8, 10, 12, 14, 15, 28, 29 AND 30.
- LAURICE EL BADRY RAHME LTD., NEW YORK, NY, DBA LAURICE & CO.:
2,998,759, INT. CL. 3.
- LAW BULLETIN PUBLISHING COMPANY, CHICAGO, IL:
2,997,927, PUB. 6-28-2005. INT. CL. 41.
- LAWRENCE EQUIPMENT, SOUTH EL MONTE, CA:
2,200,861, CANC. INT. CL. 7.
- LAWRENCE; NICHOL, BERKELEY, CA:
1,303,109, CANC. INT. CL. 37.
- LAWSON COMPANY, THE, CUYAHOGA FALLS, OH:
1,302,669, CANC. INT. CL. 21.
- LAZARIDES, JIM CHRISTOPHER, MANLY NSW 2095, AUSTRALIA:
2,200,864, CANC. MULTIPLE CLASS, INT. CLS. 9 AND 25.
- LD1, LLC, WASHINGTON, DC, DBA EYEBAR:
2,997,801, PUB. 6-28-2005. INT. CL. 43.
- LE DEKOR, INC., SANTA FE SPRINGS, CA:
2,999,034, INT. CL. 3.
- LE MYSTERE GROUP LLC, NEW YORK, NY:
2,998,091, PUB. 6-28-2005. INT. CL. 25.
- LEADING EDGE MARKETING INC., NASSAU, BAHAMAS:
2,997,973, PUB. 6-28-2005. INT. CL. 5.
- LEADING EDGE SAFETY SYSTEMS, INC., DEEP RIVER, CT:
1,962,799, REN. 8-11-05. MULTIPLE CLASS, INT. CLS. 9 AND 37.
- LEARNING APPLICATIONS, INC., WINTER PARK, FL:
2,200,858, CANC. INT. CL. 9.
- LEARNING CURVE TOYS, L.L.C., CHICAGO, IL:
2,201,967, CANC. INT. CL. 28.
- LEATHER FACTORY, INC., THE, FORT WORTH, TX:
1,336,328, REN. 8-10-05. INT. CL. 8.
- LECON TECHNISCHE KONSTRUKTIONEN UND -DESIGN GES.M.B.H., VIENNA, AUSTRIA:
2,996,243, PUB. 6-28-2005. MULTIPLE CLASS, INT. CLS. 3, 6, 8, 9, 14, 16, 18, 21, 24, 28, 29, 30, 32, 33, 34, 41 AND 43.
- LEE, CALVIN SPENCER, LOS ANGELES, CA, DBA LINE ONE LABORATORIES:
2,202,200, CANC. INT. CL. 10.
2,202,201, CANC. INT. CL. 10.
- LEE, HAROLD D, MORTLAKE, AUSTRALIA:
2,997,024, PUB. 6-28-2005. INT. CL. 24.
- LEESFIELD, LEIGHTON, RUBIO, MAHFOOD & BOYERS, P.A., MIAMI, FL:
2,996,638, PUB. 6-28-2005. INT. CL. 42.
- LEGACY GOLF, INC., PALM BEACH, FL:
2,200,969, CANC. INT. CL. 25.
- LEGALAUTHORITY.COM, LOS ANGELES, CA:
2,997,493, PUB. 6-28-2005. INT. CL. 35.
- LEHMAN BROTHERS INC., NEW YORK, NY:
2,997,168, PUB. 6-28-2005. INT. CL. 16.
- LEISUREMAX, INC., PALM DESERT, CA:
2,998,120, PUB. 6-28-2005. INT. CL. 35.

- LEKAS, ERIK, IRVINE, CA AND LEKAS, MARK, IRVINE, CA AND MILLER, TIM, IRVINE, CA:
2,997,287, PUB. 6-28-2005. INT. CL. 41.
- LENCO INDUSTRIES, INC., PITTSFIELD, MA:
2,998,737, INT. CL. 12.
- LEO BURNETT WORLDWIDE, INC., CHICAGO, IL:
2,996,255, PUB. 6-28-2005. INT. CL. 35.
- LEON, AARON, PARAMOUNT, CA:
2,998,115, PUB. 6-28-2005. INT. CL. 35.
- LEON'S FURNITURE LIMITED, WESTON, ONTARIO, CANADA:
2,996,349, PUB. 6-28-2005. INT. CL. 35.
- LEONARD, STREET AND DEINARD PROFESSIONAL ASSOCIATION, MINNEAPOLIS, MN:
2,997,288, PUB. 6-28-2005. INT. CL. 42.
- LES CAVES DE LANDIRAS-LOUIS ESCHENAUER, LANDIRAS, FRANCE:
2,996,975, PUB. 6-28-2005. INT. CL. 33.
- LES PRODUITS MOULES SYNERTECH INC./SYNERTECH MOULDED PRODUCTS INC., CITY OF CANDIAC, QUEBEC, CANADA:
1,912,532. REN. 8-11-05. INT. CL. 19.
- LET US, INC., ADA, MI:
2,998,108, PUB. 6-28-2005. INT. CL. 37.
- LETTUCE ENTERTAIN YOU ENTERPRISES, INC., CHICAGO, IL:
2,998,207, PUB. 6-28-2005. INT. CL. 41.
- LEVA QUELL LEVITATIONS-UND KOLLOIDALTECHNOLOGIE AG, 9690 SCHWARMSTEDT, FED REP GERMANY:
2,996,387, PUB. 6-28-2005. MULTIPLE CLASS, INT. CLS. 11, 32 AND 44.
- LEVINE, HOWARD L., LYNDHURST, OH:
1,866,963. REN. 8-8-05. INT. CL. 16.
- LEVITATOR, INC., CHESTERFIELD, MO:
2,997,692, PUB. 6-28-2005. MULTIPLE CLASS, INT. CLS. 37 AND 42.
2,997,693, PUB. 6-28-2005. MULTIPLE CLASS, INT. CLS. 37 AND 42.
- LEVITON MANUFACTURING CO., INC., LITTLE NECK, NY:
2,996,477, PUB. 6-28-2005. INT. CL. 9.
2,998,514, INT. CL. 9.
- LEWIS, BRIAN CHARLES, VENTURA, CA:
2,999,002, INT. CL. 37.
- LEWIS, CARROLL W. JR., WICHITA, KS:
2,202,132, CANC. INT. CL. 28.
- LEWIS, RIK E., LAS VEGAS, NV:
2,997,125, PUB. 6-28-2005. INT. CL. 9.
- LEWTAN TECHNOLOGIES, INC., WALTHAM, MA:
2,201,164, CANC. INT. CL. 9.
- LG CORP., SEOUL, REPUBLIC OF KOREA:
2,996,977, PUB. 6-28-2005. INT. CL. 2.
- LI-COR, INC., LINCOLN, NE:
2,999,035, INT. CL. 9.
- LIA, DON, HUNTINGTON, NY:
2,997,533, PUB. 6-28-2005. INT. CL. 35.
- LIAISON COUNCIL ON CERTIFICATION FOR THE SURGICAL TECHNOLOGIST, COLORADO SPRINGS, CO:
2,996,322, PUB. 6-28-2005. MULTIPLE CLASS, INT. CLS. 16 AND 42.
- LIBBY'S LITE-R-SIDE CAFE, INC., OKEMOS, MI:
2,201,551, CANC. INT. CL. 42.
- LIBERTECH, INC., DURHAM, NC:
2,201,780, CANC. INT. CL. 9.
- LIBERTY BRANDS LLC, MELVILLE, NY:
2,999,141, INT. CL. 34.
- LIBERTY GLOVE, INC., CITY OF INDUSTRY, CA:
2,999,185, INT. CL. 9.
2,999,186, INT. CL. 9.
- LIBERTY MUTUAL INSURANCE COMPANY, BOSTON, MA:
2,996,916, PUB. 6-28-2005. INT. CL. 36.
- LIBRA ADVISORS LLC, NEW YORK, NY:
2,996,293, PUB. 6-28-2005. INT. CL. 36.
2,996,294, PUB. 6-28-2005. INT. CL. 36.
- LIDL STIFTUNG & CO. KG, D-74167 NECKARSULM, FED REP GERMANY:
2,996,259, PUB. 6-28-2005. MULTIPLE CLASS, INT. CLS. 29, 30, 31 AND 32.
- LIDL STIFTUNG & CO. KG, FED REP GERMANY:
2,998,353, PUB. 6-28-2005. INT. CL. 29.
- LIFE CAPTURED CORPORATION, FORT LAUDERDALE, FL:
2,997,236, PUB. 6-28-2005. INT. CL. 16.
- LIFE INNOVATIONS, INC., ROSEVILLE, MN, LIFE INNOVATIONS, INC., ROSEVILLE, MN:
1,896,922. REN. 8-10-05. INT. CL. 16.
- LIFELINE INTERNATIONAL, INC., FORT WAYNE, IN:
2,998,638, INT. CL. 9.
- LIFELINE NUTRACEUTICALS, INC., ENGLEWOOD, CO:
2,999,080, INT. CL. 5.
- LIFELINK FOUNDATION, INC., TAMPA, FL:
2,998,811, INT. CL. 5.
- LIFESYSTEMS, SAN JOSE, CA:
2,998,904, INT. CL. 16.
- LIFTOMATIC MATERIAL HANDLING, INC., BUFFALO GROVE, IL:
1,917,629. REN. 8-10-05. INT. CL. 7.
- LIGHT WAVE, LTD., RENO, NV:
2,998,841, INT. CL. 28.
- LIGHTSPEED HOBBIES, INC., VALPARAISO, IN:
2,996,851, PUB. 6-28-2005. INT. CL. 35.
- LIGHTSPEED SEMICONDUCTOR CORP., SANTA CLARA, CA:
2,998,280, PUB. 6-28-2005. INT. CL. 9.
- LILLIAN AUGUST DESIGNS, INC., SOUTH NORWALK, CT:
1,876,690. REN. 8-6-05. INT. CL. 24.
- LILLIAN VERNON CORPORATION, NEW ROCHELLE, NY, LILLIAN VERNON CORPORATION, MOUNT VERNON, NY:
1,017,042. REN. 8-11-05. INT. CL. 28.
- LINCOLN GLOBAL, INC, MONTEREY PARK, CA, LINCOLN ELECTRIC COMPANY, THE, CLEVELAND, OH:
1,860,750. REN. 8-9-05. INT. CL. 9.
- LINCOLN TELECOMMUNICATIONS COMPANY, LINCOLN, NE:
2,201,728, CANC. INT. CL. 38.
2,201,756, CANC. INT. CL. 38.
- LINDEN CORPORATION, WILMINGTON, DE:
2,202,117, CANC. INT. CL. 5.
- LINDLEY, GINGER, SAN DIEGO, CA AND AGUILAR, JD, SAN DIEGO, CA:
2,201,979, CANC. INT. CL. 25.
- LINDNER, DELORES P., STONE LAKE, WI:
2,998,188, PUB. 6-28-2005. INT. CL. 28.
2,998,190, PUB. 6-28-2005. INT. CL. 16.
- LINDORA, INC., COSTA MESA, CA:
1,868,744. REN. 8-10-05. INT. CL. 42.
- LINKING HUMAN SYSTEMS, LLC, BOULDER, CO:
2,997,031, PUB. 6-28-2005. INT. CL. 44.
- LINVATEC CORPORATION, LARGO, FL:
1,903,438. REN. 8-9-05. INT. CL. 9.
- LINZER PRODUCTS CORP., WYANDANCH, NY:
2,997,148, PUB. 6-28-2005. INT. CL. 16.
- LIONEL L.L.C., CHESTERFIELD, MI:
2,201,888, CANC. INT. CL. 28.
- LIPHA, LYONNAISE, INDUSTRIELLE PHARMACEUTIQUE, 69008 LYON, FRANCE:
2,201,172, CANC. INT. CL. 5.
- LIPPERT CORPORATION, MENOMONEE FALLS, WI:
1,370,009. REN. 8-10-05. INT. CL. 11.
- LIPTON INVESTMENTS, INC., WILMINGTON, DE:
2,202,035, CANC. INT. CL. 30.
- LIQUID CONTROLS, L.L.C., LAKE BLUFF, IL:
2,200,889, CANC. INT. CL. 9.
- LIQUID FERTILISER PTY LTD ACN 105 456 148, LOGAN-HOLME, QUEENSLAND, AUSTRALIA, TA AGRICHEM:
2,997,173, PUB. 6-28-2005. INT. CL. 1.
- LIQUID LIVING LLC, SOLON, OH:
2,997,434, PUB. 6-28-2005. INT. CL. 41.

- LISA FRANK, INC., TUCSON, AZ:
2,996,934, PUB. 6-28-2005. INT. CL. 3.
2,999,040, INT. CL. 26.
- LITESPEC OPTICAL FIBER L.L.C., RESEARCH TRIANGLE PARK, NC:
2,201,374, CANC. INT. CL. 9.
2,201,375, CANC. INT. CL. 9.
- LITTLE EARTH PRODUCTIONS, INC., PITTSBURGH, PA:
2,999,366, INT. CL. 25.
- LITTLE HORSE ENTERPRISES, INC., FORT COLLINS, CO:
2,997,318, PUB. 6-28-2005. INT. CL. 16.
- LITTLE SCOOPS, INC., BLAUVELT, NY:
2,997,201, PUB. 6-28-2005. INT. CL. 43.
- LITZ, JOHN, CHICAGO, IL:
2,998,160, PUB. 6-28-2005. INT. CL. 25.
- LIU, JULIE T., ARCADIA, CA:
2,997,046, PUB. 6-28-2005. INT. CL. 16.
- LOANSTAR FUNDING GROUP, INC., BRYAN, TX:
2,998,595, INT. CL. 36.
2,999,216, INT. CL. 36.
- LOCKHEED MARTIN CORPORATION, BETHESDA, MD:
2,998,876, INT. CL. 9.
- LOEW'S HOTELS, INC., NEW YORK, NY:
1,899,342, REN. 8-11-05. INT. CL. 42.
- LOFTS SEED COMPANY, INC., LAS VEGAS, NV:
2,202,038, CANC. INT. CL. 31.
- LOGSDON, PETER, CHICAGO, IL:
2,202,373, CANC. INT. CL. 9.
- LOLLICUP USA, INC., BALDWIN PARK, CA:
2,996,297, PUB. 6-28-2005. MULTIPLE CLASS, INT. CLS. 29, 30 AND 32.
- LOLLY TOGS, LTD., NEW YORK, NY:
2,201,646, CANC. INT. CL. 25.
2,201,650, CANC. INT. CL. 25.
- LOMBARDI, ETHEL M., LOCKPORT, IL:
1,303,309, CANC. U.S. CL. 200.
- LONDON CUPPA, LIMITED, THE, COWLEY, UXBRIDGE, UNITED KINGDOM:
2,997,366, PUB. 6-28-2005. INT. CL. 30.
- LONE STAR STEAKHOUSE & SALOON, INC., WICHITA, KS:
2,997,691, PUB. 6-28-2005. INT. CL. 43.
- LONG & FOSTER REAL ESTATE, INC., FAIRFAX, VA:
1,303,103, CANC. INT. CL. 36.
- LOPEZ, RENEE (IRENE) GAMBLE, MEMPHIS, TN:
1,303,174, CANC. INT. CL. 41.
- LOS ANGELES BIOMEDICAL RESEARCH INSTITUTE AT HARBOR-UCLA MEDICAL CENTER, TORRANCE, CA:
2,997,478, PUB. 6-28-2005. MULTIPLE CLASS, INT. CLS. 36, 41, 42 AND 44.
- LOS FANTASMAS DEL CARIBE, VAN NUYS, CA:
2,201,233, CANC. INT. CL. 9.
- LOUISVILLE LADDER GROUP LLC, LOUISVILLE, KY:
2,999,063, INT. CL. 20.
- LOVE AND LOGIC INSTITUTE, INC., GOLDEN, CO:
2,996,870, PUB. 6-28-2005. MULTIPLE CLASS, INT. CLS. 9, 16 AND 41.
- LOVE MY WORLD, INC., MADISON, CT:
2,998,520, INT. CL. 42.
- LOVE THE BEER, INC., SILVER SPRING, MD:
2,996,947, PUB. 6-28-2005. INT. CL. 43.
- LOVELY SKIN, INC., OMAHA, NE:
2,998,098, PUB. 6-28-2005. INT. CL. 3.
- LOWDEN SCHOOLHOUSE CORPORATION, LOWDEN, WA:
1,966,650, REN. 8-11-05. INT. CL. 33.
- LOWRY FOOD CO., THE, DALLAS, TX:
2,201,486, CANC. INT. CL. 30.
- LP VENTURES, LLC, REDWOOD CITY, CA:
2,998,017, PUB. 6-28-2005. INT. CL. 35.
- LUBECKI TECHNICAL HOLDINGS INC., GRANBY, QUEBEC, CANADA:
2,997,131, PUB. 6-28-2005. INT. CL. 11.
- LUBOW, MIKE, RIVERWOODS, IL:
2,997,671, PUB. 6-28-2005. INT. CL. 16.
- LUCAS INNOVATION, INC., TORTOLA, BR. VIRGIN ISLANDS:
2,998,117, PUB. 6-28-2005. INT. CL. 11.
- LUCASFILM ENTERTAINMENT COMPANY LTD., NICASIO, CA, LUCASARTS ENTERTAINMENT COMPANY, SAN RAFAEL, CA:
1,877,727, REN. 8-8-05. INT. CL. 28.
- LUCASFILM ENTERTAINMENT COMPANY LTD., NICASIO, CA, LUCASFILM LTD., SAN RAFAEL, CA:
1,888,621, REN. 8-9-05. INT. CL. 28.
- LUCASFILM LTD., SAN RAFAEL, CA:
1,302,970, CANC. INT. CL. 30.
- LUCASFILM LTD., NICASIO, CA:
1,879,105, REN. 8-10-05. INT. CL. 6.
- LUCENT DIAMONDS, INC., LAKEWOOD, CO:
2,996,991, PUB. 6-28-2005. INT. CL. 14.
- LUCKY STRIKE BAIT WORKS, LTD., PETERBOROUGH, ONTARIO, CANADA:
1,965,111, REN. 8-11-05. INT. CL. 28.
- LUEVANOS, LUPE, FONTANA, CA:
2,997,080, PUB. 6-28-2005. INT. CL. 36.
- LUI, JOSEPH, STOW, OH, DBA HON DING INTERNATIONAL:
1,861,086, CANC. INT. CL. 30.
- LUMERA CORPORATION, BOTHELL, WA:
2,997,415, PUB. 6-28-2005. INT. CL. 9.
- LUMLEY, BRIAN, CHELSTON TORQUAY TQ2 6RZ, ENGLAND:
2,996,777, PUB. 6-28-2005. INT. CL. 16.
- LUMMI COMMERCIAL COMPANY, FERNDALE, WA:
2,996,931, PUB. 6-28-2005. INT. CL. 41.
- LUNA MUSIC CORPORATION, LOS ANGELES, CA:
1,860,768, CANC. INT. CL. 9.
- LUSH ADVERTISING, INC., MIAMI, FL:
2,998,245, PUB. 6-28-2005. INT. CL. 35.
- LUSH CANDLES, INC., DALLAS, TX:
2,998,544, INT. CL. 4.
- LUSTRELAB LXR, INCORPORATED, GREENVILLE, SC:
2,996,362, PUB. 6-28-2005. INT. CL. 3.
- LUVOGT, TRACY, SUNNYVALE, CA:
2,997,401, PUB. 6-28-2005. INT. CL. 35.
- LUXURY APPAREL GROUP, L.L.C., BRISTOL, TN:
2,997,249, PUB. 6-28-2005. INT. CL. 25.
- LUXURYHUT IMPORTS INC. / LES IMPORTATIONS LUXURYHUT INC., MONTREAL, PROVINCE OF QUEBEC, CANADA:
2,998,671, INT. CL. 35.
- LW SCIENTIFIC, INC., TUCKER, GA:
2,201,297, CANC. INT. CL. 9.
- LYLE/CARLSTROM ASSOCIATES, INC., SOMERVILLE, NJ:
2,008,487, CANC. INT. CL. 40.
- LYMAN PRODUCTS CORPORATION, MIDDLETOWN, CT, FIREARM ACCESSORIES, INC., LOS ANGELES, CA, DBA THE MERSHON CO., INC.:
776,019, REN. 8-12-05. U.S. CL. 9 (INT. CL. 13).
- LYRICK CORPORATION, ALLEN, TX:
2,345,879, CANC. INT. CL. 16.
- M.I.T. FINANCIAL GROUP, INC., NORTHBROOK, IL, DBA GENERAL LEARNING CORPORATION:
2,996,953, PUB. 6-28-2005. INT. CL. 16.
- M&B COOL SNACKS, LLC, LOS ANGELES, CA TO WELL'S DAIRY, INC., LE MARS, IA:
2,074,679, CANC. INT. CL. 30.
- MAACO ENTERPRISES, INC., KING OF PRUSSIA, PA:
2,997,464, PUB. 6-28-2005. INT. CL. 35.
- MACDERMID ACUMEN, INC., WATERBURY, CT:
805,857, REN. 8-11-05. U.S. CL. 6 (INT. CL. 1).
- MACE TRADEMARK CORP., BENNINGTON, VT, MACE SECURITY INTERNATIONAL, INC., BENNINGTON, VT:
1,909,927, REN. 8-10-05. INT. CL. 13.
- MACERICH PARTNERSHIP, L.P., THE, SANTA MONICA, CA:
2,999,356, INT. CL. 35.
- MACHEREY, NAGEL & CO. HANDELSGESELLSCHAFT, DUEREN, FED REP GERMANY:
2,999,268, INT. CL. 1.
- MACKAY; WADE FINDLAY, AUSTIN, TX, DBA WFM SPORTS:
1,302,700, CANC. INT. CL. 25.

- MACKELLAR, DUNCAN LIVINGSTONE, ARGYLL, PA37 IQS, SCOTLAND:
2,996,337, PUB. 6-28-2005. MULTIPLE CLASS, INT. CLS. 32 AND 33.
- MACKOUL & ASSOCIATES, INC., LYNBROOK, NY:
2,201,336, CANC. INT. CL. 36.
- MACMILLAN BLOEDEL LIMITED, VANCOUVER, BRITISH COLUMBIA, CANADA:
2,202,160, CANC. INT. CL. 19.
- MACY, JOHN M., MCMINNVILLE, OR, DBA MACY'S OF OREGON AND MACY, CAROL ANN, MCMINNVILLE, OR, DBA MACY'S OF OREGON:
1,302,832, CANC. INT. CL. 28.
- MAD DOC SOFTWARE, LLC, LAWERANCE, MA:
2,999,000, MULTIPLE CLASS, INT. CLS. 9 AND 42.
- MAD MEALS, LLC, MT. KISCO, NY:
2,999,336, INT. CL. 29.
- MADISON CHEMICAL INDUSTRIES INC., MILTON, ONTARIO L9T 3Y5, CANADA:
2,998,773, INT. CL. 2.
- MAG INSTRUMENT, INC., ONTARIO, CA:
2,999,097, MULTIPLE CLASS, INT. CLS. 9 AND 11.
- MAGELLAN HEALTH SERVICES, INC., ATLANTA, GA:
2,200,963, CANC. MULTIPLE CLASS, INT. CLS. 35 AND 42.
- MAGNETIC SEPARATION SYSTEMS, INC., NASHVILLE, TN:
2,202,202, CANC. INT. CL. 9.
- MAGUS MANAGEMENT CORPORATION, NEW YORK, NY:
2,997,243, PUB. 6-28-2005. INT. CL. 9.
- MAINEBIZ PUBLICATIONS, INC., PORTLAND, ME:
2,997,784, PUB. 6-28-2005. INT. CL. 16.
- MAJESTIC COMMUNITIES, INC., SAN DIEGO, CA:
2,996,999, PUB. 6-28-2005. MULTIPLE CLASS, INT. CLS. 36 AND 37.
- MAJOR, DAVID C., NEW YORK, NY AND MAJOR, JOHN S., NEW YORK, NY:
2,202,349, CANC. INT. CL. 42.
- MAJORPOWER CORPORATION, CHAMPLAIN, NY:
2,997,164, PUB. 6-28-2005. INT. CL. 9.
- MAKEMUSIC! INC., EDEN PRAIRIE, MN:
2,997,296, PUB. 6-28-2005. INT. CL. 9.
- MAKING DOUGH BY CHANCE, L.L.C., LAPORTE, IN:
2,998,730, INT. CL. 43.
- MALANDRINO, QUIRINO, NEW YORK, NY:
2,998,044, PUB. 6-28-2005. INT. CL. 35.
2,998,048, PUB. 6-28-2005. INT. CL. 35.
- MALLESONS STEPHEN JAQUES, NEW SOUTH WALES 2000, AUSTRALIA:
2,998,611, MULTIPLE CLASS, INT. CLS. 35, 36, 41 AND 42.
- MALLESONS STEPHEN JAQUES, PARTNERSHIP, THE, NEW SOUTH WALES 2000, AUSTRALIA:
2,998,612, MULTIPLE CLASS, INT. CLS. 35, 36, 41 AND 42.
- MALLOVE, EUGENE F., CONCORD, NH, DBA INFINITE ENERGY MAGAZINE:
2,200,983, CANC. INT. CL. 16.
- MALONEY, MATTHEW M., CHICAGO, IL:
2,998,028, PUB. 6-28-2005. INT. CL. 35.
- MANA ENTERPRISES, INC., MARION, IA:
2,202,379, CANC. INT. CL. 8.
- MANARA MINISTRIES, ARLINGTON, VA:
2,997,407, PUB. 6-28-2005. INT. CL. 36.
- MANCO, INC., AVON, OH:
2,202,257, CANC. INT. CL. 16.
- MANDARIN SOY SAUCE, INC., MIDDLETOWN, NY:
1,302,962, CANC. INT. CL. 30.
- MANGIAMO FRANCHISE CORPORATION, JACKSON, MI:
2,202,363, CANC. INT. CL. 42.
- MANHATTAN GROUP, LLC, MINNEAPOLIS, MN:
2,201,509, CANC. INT. CL. 35.
- MANHEIM AUCTIONS, INC., ATLANTA, GA:
2,996,780, PUB. 6-28-2005. INT. CL. 37.
- MANISOPRA MANAGEMENT CORPORAT, NEW YORK, NY:
2,998,714, INT. CL. 16.
- MANNINGTON MILLS, INC., SALEM, NJ:
2,998,821, INT. CL. 27.
- MANUFACTURERS LIFE INSURANCE COMPANY, THE, TORONTO, ONTARIO, CANADA:
2,996,912, PUB. 6-28-2005. MULTIPLE CLASS, INT. CLS. 36 AND 41.
- MAPINFO CANADA, INC., TORONTO, CANADA, BLACKBURN/POLK MARKETING SERVICES, TORONTO, ONTARIO, CANADA:
1,862,698, REN. 8-10-05. INT. CL. 35.
- MARATHON ASHLAND PETROLEUM LLC, FINDLAY, OH, OHIO OIL COMPANY, THE, FINDLAY, OH:
608,222, REN. 8-10-05. U.S. CL. 15 (INT. CL. 4).
- MARATHON MORTGAGE COMPANY, INC., HOPKINTON, MA:
2,998,155, PUB. 6-28-2005. INT. CL. 36.
- MARCHEL, WOJCIECH, GARFIELD, NJ:
2,997,362, PUB. 6-28-2005. INT. CL. 16.
- MARCHEX, INC., SEATTLE, WA:
2,999,093, MULTIPLE CLASS, INT. CLS. 35 AND 42.
- MARCO'S FRANCHISING, LLC, TOLEDO, OH:
1,392,554, REN. 8-11-05. MULTIPLE CLASS, INT. CLS. 30 AND 42.
- MARCOS LARRAÑAGA Y CIA, S.A., SPAIN:
2,998,421, PUB. 6-28-2005. INT. CL. 21.
- MARES, FRANCISCO JAVIER CANALES, LEÓN, GUANAJUATO, MEXICO:
2,996,584, PUB. 6-28-2005. INT. CL. 25.
- MARIKA GROUP, INC., THE, SAN DIEGO, CA:
2,998,838, MULTIPLE CLASS, INT. CLS. 35, 41 AND 42.
- MARIN MOUNTAIN BIKES, INC., NAVATO, CA:
1,904,348, REN. 8-10-05. INT. CL. 12.
- MARINE & PETROLEUM MFG., INC., HOUSTON, TX TO JAMCO PRODUCTS LLC, CHARLOTTE, NC:
1,861,346, CANC. INT. CL. 6.
- MARIO RUSSO, INC., BOSTON, MA:
2,996,571, PUB. 6-28-2005. INT. CL. 3.
- MARITIME TELECOMMUNICATIONS NETWORK, INC., MIRAMAR, FL:
2,998,213, PUB. 6-28-2005. INT. CL. 9.
- MARK E. CRUSH CO., INC., LOUISVILLE, KY:
2,201,294, CANC. INT. CL. 37.
- MARKET DAY CORPORATION, ITASCA, IL:
2,997,465, PUB. 6-28-2005. INT. CL. 35.
- MARKETRX INC., BRIDGEWATER, NJ:
2,997,857, PUB. 6-28-2005. INT. CL. 35.
- MARKETSOURCE CORPORATION, CRANBURY, NJ:
2,201,276, CANC. INT. CL. 35.
- MARKITECTURE LLC, NORWALK, CT:
2,768,412, CANC. INT. CL. 35.
- MARKSTEIN, BERNARD M., III, PHOENIXVILLE, PA, DBA MARKSTEIN ADVISORS:
2,201,309, CANC. INT. CL. 35.
- MARMON METALS COMPANIES LLC, CHICAGO, IL:
1,899,570, REN. 8-9-05. INT. CL. 6.
- MARRIOTT INTERNATIONAL, INC., BETHESDA, MD:
2,997,886, PUB. 6-28-2005. INT. CL. 43.
2,998,891, INT. CL. 43.
- MARS, INCORPORATED, MC LEAN, VA:
2,202,255, CANC. INT. CL. 31.
- MARSHALL, FELICITY RUTH, MARLBOROUGH, NEW ZEALAND:
2,997,124, PUB. 6-28-2005. MULTIPLE CLASS, INT. CLS. 25 AND 44.
- MARTHA CLARA VINEYRADS, RIVERHEAD, NY:
2,998,212, PUB. 6-28-2005. INT. CL. 33.
- MARTIN AUDIO LIMITED, HIGH WYCOMBE, BUCKS. HP12 3SL, ENGLAND:
2,996,328, PUB. 6-28-2005. MULTIPLE CLASS, INT. CLS. 9, 16 AND 42.
- MARTIN MARIETTA MAGNESIA SPECIALITIES, LLC, RALEIGH, NC:
1,877,314, REN. 8-8-05. INT. CL. 1.
- MARTIN RESORTS, INC., SAN LUIS OBISPO, CA:
2,996,605, PUB. 6-28-2005. INT. CL. 43.
- MARTIN, DAVID L., WOODLAND HILLS, CA:
2,997,390, PUB. 6-28-2005. INT. CL. 25.

- MARTINET, GARY, ESCONDIDO, CA:
2,999,340, INT. CL. 25.
- MARVIN LUMBER AND CEDAR COMPANY, WARROAD, MN:
2,999,173, INT. CL. 6.
- MARY MEYER CORPORATION, TOWNSEND, VT:
1,861,057, CANC. INT. CL. 28.
- MASCHIO, VALERIE, WILLOWBROOK, IL:
2,996,598, PUB. 6-28-2005. INT. CL. 26.
- MASCIARELLI, NICOLA, WEYMOUTH, MA:
2,996,510, PUB. 6-28-2005. INT. CL. 33.
- MASCO CORPORATION, TAYLOR, MI:
2,998,874, INT. CL. 6.
- MASON ENGINEERING AND DESIGNING CORPORATION, WOOD DALE, IL, AKA MASON ENGINEERING:
1,338,732. REN. 8-11-05. INT. CL. 5.
- MASSACHUSETTS FINANCIAL SERVICES COMPANY, BOSTON, MA:
2,999,307, INT. CL. 36.
- MASSACHUSETTS YOUTH SOCCER ASSOCIATION, AC-TON, MA:
2,201,226, CANC. MULTIPLE CLASS, INT. CLS. 25, 35 AND 41.
- MASTER CUTLERY, INC., SECAUCUS, NJ:
2,997,617, PUB. 6-28-2005. INT. CL. 8.
- MASTER'S PLAN FINANCIAL SERVICES, INC., THE, BOOTHWYN, PA:
2,201,844, CANC. MULTIPLE CLASS, INT. CLS. 36 AND 42.
- MASTERCARD INTERNATIONAL INCORPORATED, PURCHASE, NY:
2,997,071, PUB. 6-28-2005. MULTIPLE CLASS, INT. CLS. 38 AND 42.
- MATCON TRADING CORP., MIAMI, FL:
2,998,775, INT. CL. 19.
- MATERIAUX A BAS PRIX LTEE/ BARGAIN BUILDING MATERIALS LTD., QUEBEC GOL 2J0, CANADA:
2,996,457, PUB. 6-14-2005. INT. CL. 19.
- MATHIESEN, LLC, OSCEOLA, WI:
2,997,064, PUB. 6-28-2005. INT. CL. 6.
- MATHIOS REFRACTORIES S.A., RENIS 18233, GREECE:
2,998,760, INT. CL. 19.
- MATRIX GROUP LIMITED, INC., SAFETY HARBOR, FL:
2,996,368, PUB. 6-28-2005. MULTIPLE CLASS, INT. CLS. 16 AND 35.
- MATSUSHITA ELECTRIC INDUSTRIAL CO., LTD., OSAKA-FU, JAPAN:
2,998,836, INT. CL. 9.
- MATTEL INC., EL SEGUNDO, CA:
2,202,025, CANC. INT. CL. 28.
- MATTEL, INC., EL SEGUNDO, CA:
743,339. REN. 8-9-05. U.S. CL. 22 (INT. CLS. 16, 18, 20, 22, 25 AND 28).
- MATTEL, INC., HAWTHORNE, CA:
1,302,820, CANC. INT. CL. 28.
- MATTEL, INC., EL SEGUNDO, CA:
2,201,725, CANC. INT. CL. 28.
2,201,868, CANC. INT. CL. 28.
2,201,911, CANC. INT. CL. 28.
2,201,912, CANC. INT. CL. 28.
2,201,914, CANC. INT. CL. 28.
2,202,042, CANC. INT. CL. 28.
2,202,246, CANC. INT. CL. 28.
2,999,015, INT. CL. 28.
2,999,016, INT. CL. 28.
- MATTHEWS & RYAN MUSICAL PRODUCTS, INC., BROOKLYN, NY:
2,201,244, CANC. INT. CL. 35.
- MATTHEWS, ROBERT C., ORANGE, CA:
2,998,024, PUB. 6-28-2005. INT. CL. 9.
- MATTHIESSEN, JAMES M., SEATTLE, WA:
2,202,047, CANC. INT. CL. 9.
- MATURE ADVANTAGE CORPORATION, NEW YORK, NY:
2,998,805, INT. CL. 16.
- MAURICE CORPORATION, PORTSMOUTH, NH, DBA POORE SIMON'S:
2,201,161, CANC. INT. CL. 25.
- MAVI S.R.L., 43100 PARMA PR, ITALY:
2,996,550, PUB. 6-28-2005. INT. CL. 25.
- MAX-CELL U.S.A., L.L.C., BROOKLYN, NY:
2,996,535, PUB. 6-28-2005. INT. CL. 5.
- MAXIMA TECHNOLOGIES & SYSTEMS, INC., LANCASTER, PA:
2,997,871, PUB. 6-28-2005. INT. CL. 9.
2,997,983, PUB. 6-28-2005. INT. CL. 25.
- MAXTEK GO-GO CO., LTD., SHINDIAN CITY, TAIPEI HSIEN, TAIWAN:
2,998,767, INT. CL. 9.
2,998,768, INT. CL. 9.
- MAXWELL LABORATORIES, INC., SAN DIEGO, CA:
1,860,812, CANC. INT. CL. 9.
- MAXXAR CORPORATION, THE, WIXOM, MI, VYSION, INC., LIVONIA, MI:
1,889,634. REN. 8-9-05. INT. CL. 9.
- MAY DEPARTMENT STORES COMPANY, THE, ST. LOUIS, MO:
2,202,109, CANC. INT. CL. 21.
- MAY, EDWARD, J., MIDDLE VILLAGE, NY:
2,999,194, INT. CL. 41.
- MAYAKA INTERNATIONAL INC., MONTREAL, QUEBEC, CANADA:
2,996,973, PUB. 6-28-2005. INT. CL. 30.
- MAYER/BERKSHIRE CORPORATION, WAYNE, NJ:
2,997,887, PUB. 6-28-2005. INT. CL. 25.
- MAYFLOWER TRANSIT, INC., CARMEL, IN:
2,200,942, CANC. MULTIPLE CLASS, INT. CLS. 9 AND 39.
- MAYWAY CORP., OAKLAND, CA:
1,861,075, CANC. INT. CL. 30.
- MCALPINE, DAVID B, FORT WORTH, TX:
2,998,879, INT. CL. 30.
- MCCALL & SMITH B.V., 25, 5021 AT TILBURG, NETHERLANDS:
2,200,863, CANC. INT. CL. 10.
- MCCAULEY BROTHERS, INC., VERSAILLES, KY:
2,999,122, INT. CL. 9.
- MCCORMICK & COMPANY, INCORPORATED, SPARKS, MD:
212,919. REN. 8-9-05. U.S. CL. 46 (INT. CL. 29).
- MCDAVID ELKINS, ELIZABETH, ATLANTA, GA:
2,999,199, INT. CL. 41.
- MCDERMOTT, SAMANTHA, LAGUNA BEACH, CA:
2,998,209, PUB. 6-28-2005. INT. CL. 18.
- MCDONALD'S CORPORATION, OAK BROOK, IL:
2,201,186, CANC. INT. CL. 42.
2,999,077, INT. CL. 41.
- MCGUIGAN SIMEON WINES LIMITED, CESSNOCK, AUSTRALIA:
2,998,861, INT. CL. 33.
- MCGUIRE-WIEN, MARY, NEW YORK, NY:
2,999,335, INT. CL. 41.
- MCI COMMUNICATIONS CORPORATION, WASHINGTON, DC:
2,202,009, CANC. INT. CL. 38.
2,202,045, CANC. INT. CL. 38.
- MCILHENNY COMPANY, AVERY ISLAND, LA:
1,916,568. REN. 8-12-05. INT. CL. 25.
- MCKENNEY, MICHELLE W., SAN DIEGO, CA:
2,997,998, PUB. 6-28-2005. INT. CL. 3.
- MCKESSON AUTOMATION INC., PITTSBURGH, PA:
2,997,038, PUB. 6-28-2005. INT. CL. 9.
- MCLAUGHLIN GORMLEY KING COMPANY, MINNEAPOLIS, MN:
2,997,317, PUB. 6-28-2005. INT. CL. 5.
- MCLAUGHLIN, WARD & CO., SPRING ARBOR, MI:
1,340,098. REN. 8-11-05. INT. CL. 7.
- MCLEER, MICHAEL, BROOKLYN, NY:
2,997,339, PUB. 6-28-2005. INT. CL. 41.
- MCLEODUSA INCORPORATED, CEDAR RAPIDS, IA:
2,997,596, PUB. 6-28-2005. INT. CL. 38.
2,997,597, PUB. 6-28-2005. INT. CL. 38.
- MCMAHAN, JEFFERY A., PIQUA, OH:
2,998,851, INT. CL. 12.

MDC VACUUM PRODUCTS CORPORATION, HAYWARD, CA:
2,201,193, CANC. MULTIPLE CLASS, INT. CLS. 6 AND 9.

MEADWESTVACO CORPORATION, STAMFORD, CT:
2,996,485, PUB. 6-28-2005. INT. CL. 41.
2,996,486, PUB. 6-28-2005. INT. CL. 41.
2,996,487, PUB. 6-28-2005. INT. CL. 41.
2,996,488, PUB. 6-28-2005. INT. CL. 41.

MEAN BEAVER MANUFACTURING COMPANY, TULSA, OK, MEAN BEAVER MANUFACTURING COMPANY, TULSA, OK:
1,894,507. REN. 8-9-05. MULTIPLE CLASS, INT. CLS. 25 AND 28.

MECO CORPORATION, GREENEVILLE, TN:
2,998,721, INT. CL. 11.

MED-EL ELEKTRO-MEDIZINISCHE GERATE GMBH, A-6020 INNSBRUCK, AUSTRIA:
2,998,940, INT. CL. 9.

MEDECO SECURITY LOCKS, INC., SALEM, VA:
2,998,720, INT. CL. 6.

MEDERER GMBH, FED REP GERMANY:
2,998,479, PUB. 6-28-2005. INT. CL. 30.

MEDIA GENERAL BROADCASTING OF MONTGOMERY, INC., RICHMOND, VA:
2,201,236, CANC. INT. CL. 38.

MEDIA GENERAL BROADCASTING, INC., RICHMOND, VA:
2,201,217, CANC. INT. CL. 38.
2,201,237, CANC. INT. CL. 38.

MEDIACORP WORLDWIDE, L.L.C., OVERLAND PARK, KS:
2,996,729, PUB. 6-28-2005. INT. CL. 21.

MEDIALOGIC S.P.A, ROME, ITALY:
2,997,402, PUB. 6-28-2005. MULTIPLE CLASS, INT. CLS. 9, 38 AND 42.

MEDICAL DISPOSABLES COMPANY, INC., MARIETTA, GA:
1,302,474, CANC. INT. CL. 10.

MEDICAL PROPERTIES TRUST, BIRMINGHAM, AL:
2,997,483, PUB. 6-28-2005. MULTIPLE CLASS, INT. CLS. 36 AND 37.

MEDICAL WORLD BUSINESS PRESS, INC., JAMESBURG, NJ:
2,997,152, PUB. 6-28-2005. MULTIPLE CLASS, INT. CLS. 9 AND 16.

MEDICAL WORLD COMMUNICATIONS, INC., JAMESBURG, NJ:
2,997,561, PUB. 6-28-2005. INT. CL. 16.

MEDIMETRIX GROUP, INC., CLEVELAND, OH TO MEDIMETRIX GROUP, INC., CLEVELAND, OH:
1,860,891, CANC. MULTIPLE CLASS, INT. CLS. 16 AND 42.

MEDIMPACT HEALTHCARE SYSTEMS, INC., SAN DIEGO, CA:
2,998,723, MULTIPLE CLASS, INT. CLS. 36 AND 42.

MEDLEY, MARK, GLENDORA, CA:
2,202,270, CANC. INT. CL. 28.

MEDSPRING GROUP, INC., BOUNTIFUL, UT:
2,998,137, PUB. 6-28-2005. INT. CL. 5.

MEDTRONIC, INC., MINNEAPOLIS, MN:
2,999,248, INT. CL. 41.

MEDTURN, WESTFIELD, IN:
2,998,099, PUB. 6-28-2005. INT. CL. 35.

MEDUSA FILM S.P.A., ROME, ITALY:
2,996,274, PUB. 6-28-2005. MULTIPLE CLASS, INT. CLS. 16, 35 AND 38.

MEEKS, JOSEPH A., CORONA, CA AND MEEKS, MARY GROSSMAN, CORONA, CA:
2,997,322, PUB. 6-28-2005. INT. CL. 3.

MEETEXPO, INC, SAN JOSE, CA:
2,998,037, PUB. 6-28-2005. INT. CL. 42.

MEETING PROFESSIONALS INTERNATIONAL, DALLAS, TX:
2,998,248, PUB. 6-28-2005. INT. CL. 35.

MEIJER, INC., GRAND RAPIDS, MI:
2,998,750, INT. CL. 35.

MEL BERNIE AND COMPANY, INC., BURBANK, CA:
2,998,295, PUB. 6-28-2005. INT. CL. 14.

MELKONYAN, OGANES, HOLLYWOOD, CA:
2,998,739, INT. CL. 30.

MELONHEAD CORPORATION, THORNHILL, ONTARIO L4J 4P8, CANADA:
2,996,466, PUB. 6-28-2005. INT. CL. 3.

MEMBERS CHOICE CREDIT UNION, HOUSTON, TX:
2,996,262, PUB. 8-27-2002. INT. CL. 36.

MEMPHIS COMPRESS & STORAGE COMPANY, MEMPHIS, TN, DBA THE MALLORY GROUP:
1,338,396, REN. 8-9-05. INT. CL. 39.

MENOW, STEVEN, YARDLEY, PA:
2,998,719, INT. CL. 42.

MERAK SRL, 70017 PUTIGNANO (BA), ITALY:
2,996,236, PUB. 6-28-2005. INT. CL. 33.

MERCER VALVE COMPANY, INC., OKLAHOMA CITY, OK:
2,996,649, PUB. 6-28-2005. INT. CL. 37.

MERCHANT MEDIA, LLC, NATICK, MA:
2,998,342, PUB. 6-28-2005. INT. CL. 20.

MERCK & CO., INC., RAHWAY, NJ:
779,363, CANC. U.S. CL. 18.

MERCK & CO., INC., WHITEHOUSE STATION, NJ:
1,973,165, REN. 8-11-05. INT. CL. 5.

MERCK KGAA, FED REP GERMANY:
2,998,367, PUB. 6-28-2005. INT. CL. 1.

MERCK; KOMMANDITGESELLSCHAFT AUF AKTIEN, D-64293 DARMSTADT, FED REP GERMANY:
2,998,385, PUB. 6-28-2005. INT. CL. 1.

MEREDITH CORPORATION, DES MOINES, IA:
1,860,889, CANC. INT. CL. 16.
1,861,512, CANC. INT. CL. 16.
2,202,265, CANC. INT. CL. 31.
2,202,375, CANC. INT. CL. 41.
2,202,400, CANC. INT. CL. 16.
2,999,138, INT. CL. 16.

MERIAL LIMITED, DULUTH, GA:
2,201,712, CANC. INT. CL. 9.

MERKATUM CORPORATION, MIAMI, FL:
2,997,703, PUB. 6-28-2005. INT. CL. 9.

MERRILL LYNCH & CO., INC., NEW YORK, NY:
2,996,489, PUB. 6-28-2005. INT. CL. 36.

MERRILL MANUFACTURING CORPORATION, MERRILL, WI:
791,289, REN. 8-9-05. U.S. CL. 13 (INT. CL. 6).
796,160, REN. 8-9-05. U.S. CL. 106 (INT. CL. 38).

MERRIMACK PHARMACEUTICALS, INC., CAMBRIDGE, MA:
2,998,835, INT. CL. 5.

MERTEN, WILLIAM, CHICAGO, IL AND BOHN, STEVE, BARTLETT, IL:
2,201,734, CANC. INT. CL. 25.

MERVYN'S BRANDS, LLC, HAYWARD, CA:
1,344,538, REN. 8-8-05. INT. CL. 25.

MESIROW FINANCIAL HOLDINGS, INC., CHICAGO, IL:
2,219,360, CANC. INT. CL. 36.

MESSE DÜSSELDORF GMBH, FED REP GERMANY:
2,998,427, PUB. 6-28-2005. MULTIPLE CLASS, INT. CLS. 16, 35 AND 41.

MESSINA ELECTRONIQUE INC., BLAINVILLE, QUEBEC J7C 5E2, CANADA:
2,202,369, CANC. INT. CL. 9.

MESTRA AG, SWITZERLAND:
2,998,436, PUB. 6-28-2005. MULTIPLE CLASS, INT. CLS. 9, 37, 39 AND 42.

METAALWARENFABRIEK "HET FORT" B.V., HARDINXVELD-GIESSENDAM, NETHERLANDS:
1,357,902, REN. 8-8-05. INT. CL. 12.

METAGENICS, INC., SAN CLEMENTE, CA:
1,897,274, REN. 8-10-05. INT. CL. 5.

METARISK L.L.C., WASHINGTON, DC:
2,201,355, CANC. INT. CL. 42.

METCALF, LISA MORONEY, YUBA CITY, CA:
2,997,588, PUB. 6-28-2005. INT. CL. 44.
2,997,589, PUB. 6-28-2005. INT. CL. 44.

METPATH INC., TETERBORO, NJ:
1,303,269, CANC. INT. CL. 42.
1,303,270, CANC. INT. CL. 42.

- METRO CREATIVE GRAPHICS, INC., NEW YORK, NY;
METRO ASSOCIATED SERVICES, INC., NEW YORK, NY:
1,329,567. REN. 8-10-05. INT. CL. 16.
- METRO INDUSTRIES, INC., WILKES BARRE, PA:
2,996,270. PUB. 6-28-2005. INT. CL. 20.
- METROPOLIS PUBLICATIONS, INC., LOS ANGELES, CA:
2,201,863. CANC. INT. CL. 16.
- METROPOLITAN COLLEGE OF NEW YORK, NEW YORK,
NY, COLLEGE FOR HUMAN SERVICES, THE, NEW
YORK, NY:
1,019,369. REN. 8-10-05. INT. CL. 41.
- METROPOLITAN COLLEGE OF NEW YORK, NEW YORK,
NY:
1,908,927. REN. 8-10-05. INT. CL. 41.
1,915,557. REN. 8-10-05. INT. CL. 41.
- METROPOLITAN PSYCHIATRIC GROUP, BETHESDA, MD:
1,303,306. CANC. INT. CL. 42.
- METROPOLITAN TRANSPORTATION AUTHORITY, NEW
YORK, NY:
2,996,527. PUB. 6-28-2005. INT. CL. 41.
- METTLER -TOLEDO GMBH, 8606 GREIFENSEE, SWITZER-
LAND, DR. W. INGOLD AG (DR. W. INGOLD SA) (DR. W.
INGOLD LTD.), URDORF, ZURICH, SWITZERLAND:
1,345,856. REN. 8-12-05. INT. CL. 9.
- METTLER -TOLEDO GMBH, 8606 GREIFENSEE, SWITZER-
LAND, DR. W. INGOLD AG (DR. W. INGOLD SA) (DR. W.
INGOLD LTD.), ZURICH, SWITZERLAND:
1,345,857. REN. 8-12-05. INT. CL. 9.
- MEXICAN FINE ARTS CENTER MUSEUM, CHICAGO, IL:
2,996,616. PUB. 6-28-2005. INT. CL. 41.
- MFA INCORPORATED, COLUMBIA, MO:
1,911,024. REN. 8-10-05. INT. CL. 5.
- MG TAYLOR CORPORATION, LOUISVILLE, KY:
2,997,947. PUB. 6-28-2005. MULTIPLE CLASS, INT. CLS.
35 AND 41.
- MIB SERVICES, INC., LAWRENCEVILLE, NJ:
2,201,364. CANC. INT. CL. 35.
- MICHAEL D JONES, OREGON CITY, OR, HART ENTER-
PRISES, INC., VANCOUVER, WA:
1,895,187. REN. 8-10-05. INT. CL. 28.
- MICHAEL G. KESSLER & ASSOCIATES, LTD., NEW YORK,
NY:
2,998,107. PUB. 6-28-2005. INT. CL. 35.
- MICHAELS OF OREGON CO., OREGON CITY, OR:
2,997,904. PUB. 6-28-2005. INT. CL. 13.
2,997,906. PUB. 6-28-2005. INT. CL. 9.
2,998,066. PUB. 6-28-2005. INT. CL. 16.
2,998,067. PUB. 6-28-2005. INT. CL. 13.
- MICHAELS, PHYLLIS, FORT LEE, NJ:
2,997,572. PUB. 6-28-2005. INT. CL. 4.
- MICHIGAN TUBE SWAGERS AND FABRICATORS, INC.,
TEMPERANCE, MI:
1,965,919. REN. 8-11-05. INT. CL. 20.
- MICRO-LABORATORIES, INC., JOHNSTON, RI:
2,201,039. CANC. INT. CL. 5.
- MICRODYNAMICS, INC., DALLAS, TX TO GERBER GAR-
MENT TECHNOLOGY, INC., TOLLAND, CT:
1,861,479. CANC. INT. CL. 9.
- MICROLEAGUE MULTIMEDIA, INC., NEWARK, DE:
2,040,360. CANC. INT. CL. 28.
- MICROSMARTS LLC, OLYMPIA FIELDS, IL:
2,999,326. INT. CL. 9.
- MICROSOFT CORPORATION, REDMOND, WA:
2,201,271. CANC. INT. CL. 42.
2,999,281. INT. CL. 9.
2,999,282. MULTIPLE CLASS, INT. CLS. 38, 42 AND 45.
2,999,283. MULTIPLE CLASS, INT. CLS. 38, 42 AND 45.
- MID-AMERICAN NATIONAL BANK AND TRUST COM-
PANY, TOLEDO, OH:
2,201,401. CANC. INT. CL. 36.
- MID-STATES ASPHALT AND CAN'T STRIP, INC., TUSCA-
LOOSA, AL:
2,996,490. PUB. 6-28-2005. INT. CL. 22.
- MID-USA CYCLE PARTS, INC., ST. LOUIS, MO:
2,997,544. PUB. 6-28-2005. INT. CL. 12.
- MIDDENDORF ENTERPRISES, INC., PHILADELPHIA, PA:
1,302,745. CANC. INT. CL. 25.
- MIDI MUSIC CENTER, INC., LAGRANGE PARK, IL, DBA
LOWREY ORGAN COMPANY:
2,998,814. INT. CL. 15.
- MIDWEST BRAKE BOND COMPANY, WARREN, MI:
2,201,591. CANC. INT. CL. 7.
- MIDWEST BUS REBUILDERS CORP., OWOSSO, MI:
1,302,490. CANC. INT. CL. 12.
- MIDWEST MOTORCYCLE SUPPLY DISTRIBUTORS
CORP., ARNOLD, MO:
2,998,071. PUB. 6-28-2005. INT. CL. 12.
- MIGHTY CASEY'S INC., AUSTELL, GA:
1,303,235. CANC. INT. CL. 42.
- MIGHTY CASEY'S, INC., AUSTELL, GA:
1,302,904. CANC. MULTIPLE CLASS, INT. CLS. 29 AND
30.
1,302,905. CANC. MULTIPLE CLASS, INT. CLS. 29 AND
30.
- MILACRON INDUSTRIAL PRODUCTS INC., LIVONIA, MI,
CINCINNATI MILACRON INC., CINCINNATI, OH:
1,892,895. REN. 8-8-05. INT. CL. 4.
- MILANIAN, CYRUS, POMPAÑO BEACH, FL:
2,718,270. CANC. INT. CL. 35.
- MILBANK, TWEED, HADLEY & MCCLOY, NEW YORK,
NY:
1,895,293. REN. 8-11-05. MULTIPLE CLASS, INT. CLS. 35
AND 36.
- MILL HOLLOW CORPORATION, NEW YORK, NY:
2,202,413. CANC. INT. CL. 16.
- MILLENIUM GLOBAL MARKETPLACE, INC., WILMING-
TON, DE:
2,996,924. PUB. 6-28-2005. INT. CL. 9.
2,998,049. PUB. 6-28-2005. INT. CL. 9.
- MILLENNIUM MARKETING GROUP, LLC, HOUSTON, TX:
2,997,081. PUB. 6-28-2005. INT. CL. 36.
2,997,181. PUB. 6-28-2005. MULTIPLE CLASS, INT. CLS.
36 AND 41.
- MILLENNIUM RECORDS, LLC, INDIANAPOLIS, IN:
2,998,694. INT. CL. 9.
- MILLER DE MEXICO, S.A. DE C.V., EDO. DE MEXICO, C.P.
53560, MEXICO:
2,202,052. CANC. INT. CL. 7.
- MILLER, CRAIG, MINEOLA, NY:
2,997,439. PUB. 6-28-2005. INT. CL. 35.
- MILLER, RITA M., STORY, WY:
2,998,026. PUB. 6-28-2005. INT. CL. 16.
- MILLERSVILLE UNIVERSITY OF PENNSYLVANIA OF
THE STATE SYSTEM OF HIGHER EDUCATION, MILL-
ERSVILLE, PA:
2,997,381. PUB. 6-28-2005. MULTIPLE CLASS, INT. CLS.
25 AND 41.
- MILLIKEN & COMPANY, NEW YORK, NY:
779,521. CANC. U.S. CL. 42.
- MILNE, INC., PORTLAND, OR:
2,998,109. PUB. 6-28-2005. MULTIPLE CLASS, INT. CLS.
30, 39 AND 43.
- MILO'S WHOLE WORLD GOURMET, LLC, ATHENS, OH:
2,997,290. PUB. 6-28-2005. INT. CL. 30.
- MILONA LAMBROS FASHIONS LTD., NEW YORK, NY:
2,201,599. CANC. INT. CL. 3.
- MILT WRIGHT & ASSOCIATES, INC., CHATSWORTH, CA:
2,201,155. CANC. INT. CL. 41.
- MIMVISTA CORP., CLEVELAND, OH:
2,997,445. PUB. 6-28-2005. INT. CL. 9.
- MINDER RESEARCH CORPORATION, BRAMPTON, ON-
TARIO, CANADA:
2,996,619. PUB. 6-28-2005. INT. CL. 9.
- MINE SAFETY APPLIANCES COMPANY, PITTSBURGH,
PA:
1,848,143. REN. 8-10-05. INT. CL. 9.
- MINI-CUP RACING, INC., CHARLOTTE, NC:
2,202,308. CANC. INT. CL. 12.
- MININNI, DARLENE M., NORTHRIDGE, CA:
2,997,514. PUB. 6-28-2005. INT. CL. 41.
- MINKA LIGHTING, INC., CORONA, CA:
2,996,831. PUB. 6-28-2005. INT. CL. 11.
- MINNESOTA DEPARTMENT OF HEALTH, ST. PAUL, MN:
2,997,655. PUB. 6-28-2005. MULTIPLE CLASS, INT. CLS.
16 AND 41.

MINNESOTA MUTUAL LIFE INSURANCE COMPANY, THE, ST. PAUL, MN:
2,202,362, CANC. INT. CL. 36.

MINNETONKA BRANDS, INC., EDEN PRAIRIE, MN:
2,202,004, CANC. INT. CL. 3.

MINNTECH CORPORATION, MINNEAPOLIS, MN:
1,302,478, CANC. INT. CL. 10.

MIRASSOU, SHARON, SAN JOSE, CA, DBA S L MIRASSOU:
2,201,148, CANC. INT. CL. 16.

MISS ASIAN PAGEANT, SAN FRANCISCO, CA:
2,997,657, PUB. 6-28-2005. INT. CL. 41.

MISSION IMPRINTABLES, INC., SAN DIEGO, CA:
2,998,297, PUB. 6-28-2005. INT. CL. 35.

MISSION KNIVES & TOOLS, INC., SAN JUAN CAPISTRANO, CA:
2,201,005, CANC. INT. CL. 8.

MISSION PHARMACAL COMPANY, SAN ANTONIO, TX:
1,360,063, REN. 8-11-05. INT. CL. 5.

MISSISSIPPI AUTHORITY FOR ETV (MAET), JACKSON, MS:
1,897,787, REN. 8-11-05. INT. CL. 41.

MISSLER, CHARLES W., COEUR D'ALENE, ID:
2,998,968, MULTIPLE CLASS, INT. CLS. 16 AND 41.

MISSOURI PATIENT CARE REVIEW FOUNDATION, COLOMBIA, MO:
2,996,753, PUB. 6-28-2005. INT. CL. 35.

MISTER DRIPPER, LLC, ROCHESTER, MI:
2,202,033, CANC. INT. CL. 9.

MITSUBISHI ELECTRIC CORPORATION, TOKYO, JAPAN:
2,997,553, PUB. 6-28-2005. INT. CL. 9.

MITSUBISHI MATERIALS CORPORATION, TOKYO 100, JAPAN:
2,998,530, INT. CL. 7.

MITSUBISHI TOKYO WEALTH MANAGEMENT SECURITIES, LTD., TOKYO, JAPAN:
2,997,074, PUB. 6-28-2005. INT. CL. 36.

MIXED NUTS LLC, OLD HICKORY, TN:
2,201,385, CANC. MULTIPLE CLASS, INT. CLS. 16, 20 AND 25.

MOCATTA CORPORATION, THE, NEW YORK, NY:
1,303,089, CANC. INT. CL. 36.

MODEL MASTERS, INC., NEW ORLEANS, LA:
2,201,323, CANC. INT. CL. 35.

MODERN ENGINEERING, INC., ROCHESTER HILLS, MI:
2,998,331, PUB. 6-28-2005. MULTIPLE CLASS, INT. CLS. 9, 35 AND 42.

MODERN HOME PRODUCTS CORP., ANTIOCH, IL:
1,302,483, CANC. INT. CL. 11.

MODERN SHIRT INDUSTRIES 2001 INC., MONTREAL, QUEBEC H3B 2N2, CANADA:
2,286,995, CANC. INT. CL. 25.

MODERN TECHNOLOGIES CORPORATION, DAYTON, OH:
2,202,000, CANC. INT. CL. 9.

MOE'S SOUTHWEST GRILL, LLC, ATLANTA, GA:
2,997,175, PUB. 6-28-2005. INT. CL. 43.

MOGILNICKI, MILOSZ, CHICAGO, IL:
2,996,305, PUB. 6-28-2005. INT. CL. 25.

MOLECULAR PROBES, INC., EUGENE, OR:
2,996,610, PUB. 6-28-2005. INT. CL. 1.

MOMMY & ME ENTERPRISES, INC., PLANTATION, FL:
2,202,304, CANC. INT. CL. 25.

MOMSWIN, INC., LEAVENWORTH, KS:
2,997,770, PUB. 6-28-2005. INT. CL. 35.

MONARCH COMPUTER SYSTEMS, INC., TUCKER, GA:
2,997,850, PUB. 6-28-2005. INT. CL. 9.

MONARCH LUGGAGE COMPANY, BROOKLYN, NY:
1,302,613, CANC. INT. CL. 18.

MONARCH RUBBER COMPANY, BALTIMORE, MD:
2,202,183, CANC. INT. CL. 17.

MONDO-TRONICS, INC., SAN RAFAEL, CA:
2,997,771, PUB. 6-28-2005. INT. CL. 6.

MONKEY BAR, INC., THE, BOSTON, MA:
1,341,658, REN. 8-11-05. INT. CL. 42.

MONSANTO COMPANY, ST. LOUIS, MO:
2,201,804, CANC. INT. CL. 42.

MONSANTO TECHNOLOGY LLC, SAINT LOUIS, MO:
2,997,742, PUB. 6-28-2005. INT. CL. 31.

MONTALYO, ROBERTO, LANSING, MI, URN COMPANY, LANSING, MI:
1,893,172, REN. 8-11-05. INT. CL. 25.

MONZA POWER BOATS CORP., MIAMI, FL:
2,155,765, CANC. INT. CL. 12.

MOONEY AIRCRAFT CORPORATION, KERRVILLE, TX:
2,202,039, CANC. INT. CL. 12.

MOORE BUSINESS FORMS, INC., GRAND ISLAND, NY TO MOORE NORTH AMERICA, INC., GRAND ISLAND, NY:
1,861,399, CANC. INT. CL. 16.

MOORE, EVERTON G., QUEENS VILLAGE, NY:
2,999,320, INT. CL. 35.

MOORE, MARK, TALLAHASSEE, FL:
2,998,742, INT. CL. 21.

MOOSEHEAD BREWERIES LIMITED, SAINT JOHN, NEW BRUNSWICK, CANADA:
1,860,856, CANC. MULTIPLE CLASS, INT. CLS. 14, 16, 25 AND 41.

MOOY, JOHN D., DES MOINES, IA:
2,201,101, CANC. INT. CL. 41.

MORELAND, JONATHAN G., NEW YORK, NY:
2,202,357, CANC. INT. CL. 42.

MORELATO S.R.L., ITALY:
2,998,487, PUB. 6-28-2005. INT. CL. 20.

MORGAN ADHESIVE COMPANY, STOW, OH:
1,935,655, REN. 8-7-05. INT. CL. 16.

MORGAN ADHESIVES COMPANY, STOW, OH:
1,910,059, REN. 8-7-05. INT. CL. 17.

MORGAN CITY CORPORATION, LOS ANGELES, CA:
1,302,740, CANC. INT. CL. 25.

MORGAN, DELBERT, BLAINE, TN:
2,997,393, PUB. 6-28-2005. INT. CL. 35.

MORINDA, INC., PROVO, UT:
2,999,288, INT. CL. 32.

MORNINGSTAR FELLOWSHIP CHURCH, WILKESBORO, NC:
2,999,144, INT. CL. 32.

MORRIS MATERIALS HANDLING LTD., LOUGHBOROUGH LE11 1RL, LEICESTERSHIRE, UNITED KINGDOM:
2,998,587, INT. CL. 7.

MORRIS PUBLISHING GROUP, LLC, AUGUSTA, GA:
2,996,324, PUB. 6-28-2005. MULTIPLE CLASS, INT. CLS. 16 AND 41.

MORRIS, MARK, CHICAGO, IL:
2,998,162, PUB. 6-28-2005. INT. CL. 44.

MORSE AUTOMOTIVE CORPORATION, CHICAGO, IL:
1,340,537, REN. 8-9-05. INT. CL. 12.

MORSE, CHARLES T., JR. CLU, BUCHANAN, MI:
2,998,080, PUB. 6-28-2005. INT. CL. 36.

MORTON INTERNATIONAL, INC., CHICAGO, IL:
1,302,314, CANC. INT. CL. 1.
2,202,055, CANC. INT. CL. 1.
2,998,266, PUB. 6-28-2005. INT. CL. 1.

MOSER, MARY FAITH, ROSWELL, GA:
2,998,112, PUB. 6-28-2005. INT. CL. 41.

MOTIONPOINT CORPORATION, COCONUT CREEK, FL:
2,997,537, PUB. 6-28-2005. INT. CL. 42.
2,997,538, PUB. 6-28-2005. INT. CL. 42.

MOTO-MAPS, MERRIMACK, NH:
2,997,753, PUB. 6-28-2005. INT. CL. 16.

MOTOMAN, INC., WEST CARROLLTON, OH:
2,201,652, CANC. INT. CL. 9.
2,996,812, PUB. 6-28-2005. INT. CL. 9.

MOTOROLA, INC., SCHAUMBURG, IL:
2,034,368, CANC. INT. CL. 9.

MOUNT UNION COLLEGE, ALLIANCE, OH:
2,996,356, PUB. 6-28-2005. INT. CL. 41.

MOUNT WASHINGTON OBSERVATORY, NORTH CONWAY, NH:
2,996,609, PUB. 6-28-2005. INT. CL. 41.

MOVES, A DANCE AND FITNESS STUDIO, INC., WEST CHICAGO, IL:
2,997,534, PUB. 6-28-2005. INT. CL. 41.

MOVO MEDIA, INC., LOS ANGELES, CA:
2,201,372, CANC. INT. CL. 42.

MOYERS, GAYLE, AUSTIN, TX:
2,997,521, PUB. 6-28-2005. INT. CL. 41.

- MOYNAHAN, MICHAEL B., BURBANK, CA:
2,997,736, PUB. 6-28-2005. INT. CL. 41.
- MP GLOBAL PRODUCTS, LLC, NORFOLK, NE:
2,998,772, INT. CL. 19.
- MPS MARKETING CO., INC., ENGLEWOOD, NJ:
2,202,273, CANC. INT. CL. 30.
- MPW INDUSTRIAL SERVICES, INC., HEBRON, OH:
2,997,849, PUB. 6-28-2005. MULTIPLE CLASS, INT. CLS. 37 AND 40.
- MR OSCAR ALEXANDER VOKES, CHELTENHAM, GLOUCESTERSHIRE GL52 2QS, UNITED KINGDOM:
2,998,384, PUB. 6-28-2005. INT. CL. 25.
- MR. AQUARIUM, L.P., LUBBOCK, TX:
2,997,409, PUB. 6-28-2005. INT. CL. 35.
- MRS. GROSSMAN'S PAPER COMPANY, PETALUMA, CA:
2,999,305, INT. CL. 16.
- MS MIKROFILM OPTICAL DISC GMBH, 42329 WUPPERTAL, FED REP GERMANY:
2,200,997, CANC. INT. CL. 9.
- MT&B CORPORATION, BELLE MEAD, NJ:
1,861,421, CANC. INT. CL. 28.
- MUG WORLD INC., GAINESVILLE, TX:
2,998,056, PUB. 6-28-2005. INT. CL. 21.
- MUGNAINI IMPORTS, L.L.C., WATSONVILLE, CA:
2,201,140, CANC. INT. CL. 35.
- MULKERIN, MICHAEL J., AVONDALE, AZ AND CARROLL, DANIEL, AVONDALE, AZ:
2,201,346, CANC. INT. CL. 42.
- MULTIBRANDS INTERNATIONAL LTD, UNITED KINGDOM:
2,998,478, PUB. 6-28-2005. INT. CL. 16.
- MULTIMEDIA GAMES, INC., AUSTIN, TX AND EMT WORLDWIDE, INC., MOORPARK, CA:
2,999,159, INT. CL. 9.
- MULTISORB TECHNOLOGIES, INC., BUFFALO, NY:
2,997,562, PUB. 6-28-2005. INT. CL. 17.
- MULTNOMAH PUBLISHERS, INC., SISTERS, OR:
2,999,275, INT. CL. 9.
- MURAKAMI WOLF SWENSON, INC., BURBANK, CA, DBA FRED WOLF FILMS:
2,201,670, CANC. INT. CL. 41.
- MUREX S.A.S., PARIS, FRANCE:
1,898,616, REN. 8-11-05. MULTIPLE CLASS, INT. CLS. 9 AND 42.
- MURPHY SWITCH OF CALIFORNIA, INC., PALMDALE, CA:
2,997,554, PUB. 6-28-2005. INT. CL. 9.
- MURPHY, LAURA VALENTINI, HAPEVILLE, GA:
2,997,921, PUB. 6-28-2005. INT. CL. 43.
- MURRELL COMPANY, THE, SPRING, TX:
2,201,201, CANC. INT. CL. 18.
- MUSE NETWORK, LLC, NEW CANAAN, CT:
2,998,774, INT. CL. 35.
- MUSICARES FOUNDATION, INC., SANTA MONICA, CA:
2,996,309, PUB. 6-28-2005. MULTIPLE CLASS, INT. CLS. 43 AND 44.
- MUTUAL OF OMAHA INSURANCE COMPANY, OMAHA, NE:
1,004,370, AM. INT. CL. 36.
1,004,370, REN. 8-9-05. INT. CL. 36.
- MWC, INC., FOLSOM, CA:
1,303,258, CANC. INT. CL. 42.
- MWH SOFT, INC., PASADENA, CA:
2,998,785, INT. CL. 9.
2,998,786, INT. CL. 9.
- MX IMAGE, LLC, SACRAMENTO, CA:
2,997,010, PUB. 6-28-2005. INT. CL. 20.
- MYCA GROUP, INC., CINCINNATI, OH AND LEADINGEDGE MANAGEMENT SERVICES, DETROIT, MI:
2,201,292, CANC. INT. CL. 41.
- MYCA GROUP, INC., CINCINNATI, OH AND LEADING EDGE MANAGEMENT SERVICES, INCORPORATED, DETROIT, MI:
2,201,293, CANC. INT. CL. 41.
- MYERCHIN ENTERPRISES INC., BELLEVUE, WA:
2,996,980, PUB. 6-28-2005. INT. CL. 4.
- MYJEWISHLEARNING, INC., ROCKVILLE, MD:
2,997,085, PUB. 6-28-2005. INT. CL. 45.
- MYSTIC SEAPORT MUSEUM, INC., MYSTIC, CT:
2,998,511, MULTIPLE CLASS, INT. CLS. 39 AND 41.
- MÜNCH MOTORRAD TECHNIK (MMT) GMBH, FED REP GERMANY:
2,998,482, PUB. 6-28-2005. MULTIPLE CLASS, INT. CLS. 7, 9, 11 AND 12.
- N Y INNS, NEW YORK, NY:
2,999,322, INT. CL. 43.
- N.I.F. GROUP, INC., MANHASSET, NY:
2,998,196, PUB. 6-28-2005. INT. CL. 36.
- NABBA USA, INC., BRONX, NY:
1,901,994, REN. 8-11-05. INT. CL. 41.
- NAKAWATASE, HAYATO, DIAMOND BAR, CA AND HANAOKA, MINORU, DIAMOND BAR, CA AND ROSINGANA, JOHN, DIAMOND BAR, CA:
2,201,534, CANC. INT. CL. 29.
- NALCO COMPANY, NAPERVILLE, IL:
2,996,671, PUB. 6-28-2005. INT. CL. 1.
- NAN SHAN INTERNATIONAL CO., LTD., TAIPEI, TAIWAN:
2,998,802, INT. CL. 11.
- NANJING HONGBAOLI CO. LTD., NANJING, CHINA:
2,996,997, PUB. 6-28-2005. INT. CL. 1.
- NANKANG RUBBER TIRE CORP., LTD., TAIPEI, TAIWAN, NANKANG RUBBER CORP. LTD., TAIPEI, TAIWAN:
1,938,146, REN. 8-8-05. INT. CL. 12.
- NANOINK, INC., CHICAGO, IL:
2,998,572, MULTIPLE CLASS, INT. CLS. 1, 9, 41 AND 42.
- NANOPHASE TECHNOLOGIES CORPORATION, ROMEOVILLE, IL:
2,998,522, MULTIPLE CLASS, INT. CLS. 1 AND 6.
- NAPCO, INC., KEARNEY, MO:
2,997,354, PUB. 6-28-2005. INT. CL. 19.
- NAPLES AREA BOARD OF REALTORS AND ASSOCIATION OF REAL ESTATE PROFESSIONALS, INC., NAPLES, FL:
2,892,176, CANC. MULTIPLE CLASS, INT. CLS. 16, 36, 38, 41 AND 42.
- NAS MANUFACTURING, INC., CLARKSVILLE, GA:
2,999,290, INT. CL. 24.
- NASSER, DAVID, LONG BEACH, CA:
2,202,294, CANC. INT. CL. 42.
- NATIONAL AGRICULTURE COOPERATIVE FEDERATION (NACF), SEOUL 100-707, REPUBLIC OF KOREA:
2,201,331, CANC. INT. CL. 32.
- NATIONAL ASSEMBLY OF HEALTH & HUMAN SERVICE ORGANIZATIONS, WASHINGTON, DC:
2,998,654, MULTIPLE CLASS, INT. CLS. 16, 41 AND 42.
- NATIONAL ASSOCIATION FOR HOME CARE & HOSPICE, WASHINGTON, DC:
2,996,758, PUB. 6-28-2005. INT. CL. 41.
- NATIONAL ASSOCIATION FOR STOCK CAR AUTO RACING, INC., DAYTONA BEACH, FL:
2,998,338, PUB. 6-28-2005. INT. CL. 16.
- NATIONAL ASSOCIATION OF COLLEGE AND UNIVERSITY BUSINESS OFFICERS, WASHINGTON, DC:
2,997,816, PUB. 6-28-2005. INT. CL. 16.
- NATIONAL ASSOCIATION OF COLLEGIATE DIRECTORS OF ATHLETICS, WESTLAKE, OH:
2,202,347, CANC. INT. CL. 25.
- NATIONAL ASSOCIATION OF LEGAL INVESTIGATORS INC, GRAND BLANC, MI:
1,900,201, REN. 8-11-05. U.S. CL. B.
- NATIONAL BANK OF CANADA, AS COLLATERAL AGENT, MONTREAL, QUEBEC, CANADA:
2,150,616, CANC. INT. CL. 35.
- NATIONAL BASEBALL HALL OF FAME AND MUSEUM, INC., COOPERSTOWN, NY:
1,964,225, REN. 8-9-05. U.S. CL. 200.
- NATIONAL BOARD OF CHIROPRACTIC EXAMINERS, GREELEY, CO:
2,997,408, PUB. 6-28-2005. INT. CL. 41.
2,997,668, PUB. 6-28-2005. INT. CL. 41.
- NATIONAL CITY CORPORATION, CLEVELAND, OH:
2,202,292, CANC. INT. CL. 36.
2,996,741, PUB. 6-28-2005. INT. CL. 36.
2,996,742, PUB. 6-28-2005. INT. CL. 36.

- NATIONAL COUNCIL ON FAMILY RELATIONS (NCFR), MINNEAPOLIS, MN:
2,999,384, U.S. CL. B.
- NATIONAL DAIRY COUNCIL, ROSEMONT, IL:
1,022,307, REN. 8-11-05. U.S. CL. 38 (INT. CL. 16).
- NATIONAL EVALUATION SYSTEMS, INC., HADLEY, MA:
2,996,795, PUB. 6-28-2005. INT. CL. 41.
- NATIONAL FEDERATION OF COFFEE GROWERS OF COLOMBIA, SANTAFE DE BOGOTA, COLOMBIA:
2,998,743, INT. CL. 30.
- NATIONAL FEDERATION OF REPUBLICAN WOMEN, ALEXANDRIA, VA:
2,996,577, PUB. 6-28-2005. MULTIPLE CLASS, INT. CLS. 35 AND 41.
- NATIONAL GEOSPATIAL-INTELLIGENCE AGENCY, BETHESDA, MD:
2,996,664, PUB. 6-28-2005. MULTIPLE CLASS, INT. CLS. 9 AND 39.
- NATIONAL HOSPICE AND PALLIATIVE CARE ORGANIZATION, ALEXANDRIA, VA:
2,998,923, INT. CL. 35.
- NATIONAL HYDROPOWER ASSOCIATION, WASHINGTON, DC:
1,894,473, REN. 8-9-05. INT. CL. 42.
- NATIONAL KIDNEY CANCER ASSOCIATION, EVANSTON, IL:
2,171,135, CANC. MULTIPLE CLASS, INT. CLS. 36 AND 42.
- NATIONAL LIBRARY OF MEDICINE, THE, BETHESDA, MD:
2,997,224, PUB. 6-28-2005. MULTIPLE CLASS, INT. CLS. 16, 36, 41, 42 AND 44.
- NATIONAL MARINE MANUFACTURERS ASSOCIATION, INC., CHICAGO, IL:
2,997,613, PUB. 6-28-2005. INT. CL. 41.
- NATIONAL POOLS CORPORATION, SAN FRANCISCO, CA:
2,201,749, CANC. INT. CL. 36.
2,201,750, CANC. INT. CL. 36.
- NATIONAL PROTECTION INDUSTRIES, INC., SAN DIEGO, CA:
1,872,823, REN. 8-6-05. INT. CL. 37.
- NATIONAL PUBLISHING COMPANY, PHILADELPHIA, PA, SUNDAY SCHOOL BOARD OF THE SOUTHERN BAPTIST CONVENTION, NASHVILLE, TN:
1,975,051, REN. 8-11-05. INT. CL. 16.
- NATIONAL SEMICONDUCTOR CORPORATION, SANTA CLARA, CA:
1,926,329, REN. 8-9-05. INT. CL. 9.
- NATIONAL SOCCER HALL OF FAME, ONEONTA, NY:
2,996,404, PUB. 6-28-2005. INT. CL. 41.
2,996,405, PUB. 6-28-2005. INT. CL. 16.
- NATURA WORLD, INC., CAMBRIDGE, ONTARIO, CANADA:
2,998,953, MULTIPLE CLASS, INT. CLS. 20 AND 24.
- NATURAL BODY INTERNATIONAL, INC., ATLANTA, GA:
2,997,371, PUB. 6-28-2005. INT. CL. 44.
- NATURAL ORGANICS INC., MELVILLE, NY:
2,996,817, PUB. 6-28-2005. INT. CL. 5.
2,998,795, INT. CL. 5.
- NATURAL SELECTION FOODS, SAN JUAN BAUTISTA, CA:
2,201,187, CANC. INT. CL. 29.
- NATURE BRIGHT COMPANY, IRVINE, CA:
2,997,489, PUB. 6-28-2005. INT. CL. 11.
- NATURE'S SUNSHINE PRODUCTS, INC., PROVO, UT:
2,999,198, INT. CL. 5.
- NAUTILUS OFFSHORE COMPANY, INC., THE WOODLANDS, TX:
2,998,579, MULTIPLE CLASS, INT. CLS. 37 AND 42.
- NAVESINK CONSULTING GROUP, LITTLE SILVER, NJ:
2,998,824, INT. CL. 42.
- NAVIGANT CONSULTING, INC., CHICAGO, IL:
2,997,140, PUB. 6-28-2005. MULTIPLE CLASS, INT. CLS. 35, 36 AND 42.
- NCI BUILDING SYSTEMS, L.P., HOUSTON, TX:
2,202,364, CANC. INT. CL. 6.
- NEAT SOLUTIONS, INC, HUNTERSVILLE, NC:
2,996,279, PUB. 6-28-2005. INT. CL. 24.
- NEBRASKA IRRIGATION INC., COLUMBUS, NE:
2,996,725, PUB. 6-28-2005. INT. CL. 11.
- NECHO SYSTEMS CORP., MISSISSAUGA, ONTARIO, CANADA:
2,200,860, CANC. MULTIPLE CLASS, INT. CLS. 9 AND 42.
- NEDBOY, ROBIN L, NEW YORK, NY:
2,997,372, PUB. 5-10-2005. INT. CL. 3.
- NEIL PRYDE LIMITED, TUEN MUN, HONG KONG:
2,996,484, PUB. 6-28-2005. INT. CL. 28.
- NEIMAN MARCUS GROUP, INC., THE, DALLAS, TX:
2,997,522, PUB. 6-28-2005. INT. CL. 35.
- NELSON AND SONS, INC., UKIAH, CA, DBA NELSON FAMILY VINEYARDS:
2,998,165, PUB. 6-28-2005. INT. CL. 33.
- NELSON INDUSTRIES, INC., STOUGHTON, WI:
779,454, CANC. U.S. CL. 31.
- NELSON WHITE SYSTEMS, INC., BALTIMORE, MD:
2,997,612, PUB. 6-28-2005. MULTIPLE CLASS, INT. CLS. 37 AND 42.
- NELSON, LEIGH, JERSEY CITY, NJ AND LEWIS, MATHEW, JERSEY CITY, NJ AND SANDERLIN, MARK, JERSEY CITY, NJ AND FANOUS, SHERIF, JERSEY CITY, NJ:
2,997,979, PUB. 6-28-2005. INT. CL. 41.
- NEMO S.P.A., ROVELLASCA (COMO), ITALY:
1,900,532, REN. 8-9-05. MULTIPLE CLASS, INT. CLS. 11 AND 20.
- NEON G.D. INC., SAN GABRIEL, CA:
2,996,460, PUB. 6-28-2005. MULTIPLE CLASS, INT. CLS. 11, 12, 27 AND 35.
- NEOTECH PRODUCTS, INC., CHATSWORTH, CA:
2,998,104, PUB. 6-28-2005. INT. CL. 10.
- NEPTUNE PROPERTIES, LP, TYLER, TX:
2,998,074, PUB. 6-28-2005. INT. CL. 37.
- NETACQUIRE CORPORATION, KIRKLAND, WA:
2,996,888, PUB. 6-28-2005. INT. CL. 9.
- NETHERLANDS ANTILLES CORPORATION, WEST SEATTLE, WA:
1,303,137, CANC. INT. CL. 39.
- NETTERFIELD; TERRY ALLEN, TOLEDO, OH:
1,303,253, CANC. INT. CL. 42.
- NETTIE'S FLOWER GARDEN, INC., ST. LOUIS, MO:
1,321,370, REN. 8-6-05. INT. CL. 42.
- NETTLETON SHOES, INC., CORAL GABLES, FL:
2,997,378, PUB. 6-28-2005. INT. CL. 25.
- NEW BALANCE ATHLETIC SHOE, INC., BOSTON, MA:
2,998,634, INT. CL. 25.
- NEW CPE, INC., ATLANTA, GA:
2,999,328, INT. CL. 24.
- NEW ENGLAND AUDIO CO., INC., CANTON, MA:
2,201,505, CANC. INT. CL. 35.
- NEW FRONTIER ELECTRONICS, INC., PIPERSVILLE, PA:
1,885,564, REN. 8-12-05. INT. CL. 9.
- NEW IDEAS INTERNATIONAL, INC., THOMASVILLE, GA:
2,202,333, CANC. INT. CL. 5.
- NEW JERSEY PRIMARY CARE ASSOCIATION, INC., PRINCETON JUNCTION, NJ:
2,997,970, PUB. 6-28-2005. INT. CL. 44.
- NEW ORLEANS COFFEE WORKS, LLC, KENNER, LA:
2,997,559, PUB. 6-28-2005. INT. CL. 30.
- NEW PRODUCT DESIGNS, LLC, SKOKIE, IL:
2,997,404, PUB. 6-28-2005. INT. CL. 16.
- NEW YORK DOG SPA & HOTEL, INC., NEW YORK, NY:
2,999,070, MULTIPLE CLASS, INT. CLS. 35 AND 44.
- NEW YORK INSTITUTE OF FINANCE, INC., NEW YORK, NY:
2,202,398, CANC. INT. CL. 41.
- NEW YORK ISLANDERS HOCKEY CLUB, L.P., UNIONDALE, NY:
2,201,625, CANC. INT. CL. 25.
- NEW YORK LIFE INSURANCE COMPANY, NEW YORK, NY:
1,341,463, REN. 8-11-05. INT. CL. 36.
- NEW YORK STATE ASSOCIATION FOR RETARDED CHILDREN, AMSTERDAM, NY, DBA LIBERTY ENTERPRISES:
1,302,881, CANC. INT. CL. 29.

- NEWBLOCK CORPORATION, ONTARIO, CANADA:
1,889,895. REN. 8-9-05. INT. CL. 19.
- NEWELL OPERATING COMPANY, FREEPORT, IL, LOU-
VERDRAPE, INC., SANTA MONICA, CA:
1,335,571. REN. 8-11-05. INT. CL. 20.
- NEWELL OPERATING COMPANY, FREEPORT, IL:
2,997,945. PUB. 6-28-2005. INT. CL. 6.
- NEWFREY LLC, NEWARK, DE, KWIKSET LOCKS, INC.,
ANAHEIM, CA:
603,256. REN. 8-8-05. U.S. CL. 23 (INT. CL. 8).
- NEWFREY LLC, NEWARK, DE:
1,894,814. REN. 8-9-05. INT. CL. 6.
- NEWGARDEN, JOSEPH E., JR., GALLATIN, TN:
1,964,518. REN. 8-11-05. INT. CL. 28.
- NEWMILK COMPANY, INC., STOCKTON, CA:
2,998,004. PUB. 6-28-2005. INT. CL. 5.
- NEWRIVER, INC., ANDOVER, MA FROM INUNITY COR-
PORATION, WATERTOWN, MA:
2,996,238. PUB. 6-28-2005. MULTIPLE CLASS, INT. CLS.
36 AND 38.
- NEWS AMERICA FSI, INC., NEW YORK, NY:
2,202,407. CANC. INT. CL. 16.
- NEWS AMERICA MARKETING PROPERTIES, INC., CHI-
CAGO, IL:
2,997,875. PUB. 6-28-2005. INT. CL. 35.
- NEWS GROUP NEWSPAPERS LIMITED, LONDON, E1 9BD,
UNITED KINGDOM:
2,996,258. PUB. 10-29-2002. MULTIPLE CLASS, INT. CLS.
9, 16, 35, 41 AND 42.
- NEXGEN LENDING, INC., LAKEWOOD, CO:
2,996,927. PUB. 6-28-2005. INT. CL. 9.
2,996,928. PUB. 6-28-2005. INT. CL. 9.
- NEXT ESTATE COMMUNICATIONS, INC., MONROVIA,
CA:
2,999,313. INT. CL. 36.
- NEXT LEVEL COMMUNICATIONS, ROHNERT PARK, CA:
2,201,885. CANC. INT. CL. 9.
- NEXTEL COMMUNICATIONS, INC., RESTON, VA, FLEET
CALL, INC., RUTHERFORD, NJ:
1,884,244. REN. 8-8-05. INT. CL. 9.
- NGL CLEANING TECHNOLOGY S.A., SWITZERLAND:
2,998,356. PUB. 6-28-2005. MULTIPLE CLASS, INT. CLS. 1
AND 3.
- NIAGARA CONSERVATION CORP., CEDAR KNOLLS, NJ:
1,895,020. REN. 8-10-05. INT. CL. 11.
- NIC INC, JERSEY CITY, NJ:
2,997,310. PUB. 6-28-2005. INT. CL. 14.
- NICO INNOVATIONS INC., POUGHQUAG, NY:
2,997,395. PUB. 6-28-2005. INT. CL. 6.
- NIKKO AMERICA, INC., PLANO, TX:
2,201,789. CANC. INT. CL. 28.
- NINGXIA NATIONAL CHEMICALS GROUP COMPANY,
LTD., SHIZUIZHAN CITY, NINGXIA, CHINA:
2,201,384. CANC. INT. CL. 1.
- NINTENDO CO., LTD., MINAMI-KU, KYOTO, JAPAN:
2,996,267. PUB. 6-28-2005. INT. CL. 16.
- NIPPON DENKI KABUSHIKI KAISHA, TOKYO, JAPAN,
DBA NEC CORPORATION:
2,201,680. CANC. INT. CL. 9.
- NIPPON DENSHIN DENWA KABUSHIKI KAISHA, TOKYO,
JAPAN, DBA NIPPON TELEGRAPH AND TELEPHONE
CORPORATION:
2,200,971. CANC. INT. CL. 16.
- NIPPON SEIKO KABUSHIKI KAISHA, TOKYO, JAPAN,
DBA NSK LTD.:
2,996,325. PUB. 6-28-2005. INT. CL. 4.
- NISSAN JIDOSHA KABUSHIKI, TOKYO, JAPAN, TA NIS-
SAN MOTOR CO., LTD.:
2,998,886. INT. CL. 18.
- NISSUN CAP, CHINO, CA:
2,996,601. PUB. 6-28-2005. MULTIPLE CLASS, INT. CLS.
9, 18, 25 AND 28.
- NITTO ELECTRIC WORKS, LTD., AICHI, JAPAN:
2,996,354. PUB. 6-28-2005. INT. CL. 11.
- NIXON, INC., ENCINITAS, CA:
2,997,793. PUB. 6-28-2005. MULTIPLE CLASS, INT. CLS.
14 AND 25.
- NO FEAR, INC., CARLSBAD, CA:
2,999,104. INT. CL. 12.
- NOAHS ARK ANIMAL WORKSHOP, CRESTWOOD, IL:
2,999,211. INT. CL. 41.
- NOBLE FIBER TECHNOLOGIES, INC., CLARK SUMMIT, PA:
2,998,546. MULTIPLE CLASS, INT. CLS. 11, 14, 20, 21, 25
AND 26.
- NOBLE GRACE LLC, NEW YORK, NY:
2,997,051. PUB. 6-28-2005. INT. CL. 38.
- NOF CORPORATION, TOKYO, JAPAN:
2,996,359. PUB. 6-28-2005. MULTIPLE CLASS, INT. CLS. 1
AND 5.
- NOF CORPORATION, SHIBUYA-KU, TOKYO, JAPAN:
2,996,781. PUB. 6-28-2005. INT. CL. 1.
- NOKIA CORPORATION, FINLAND:
2,998,500. PUB. 6-28-2005. MULTIPLE CLASS, INT. CLS.
9, 28 AND 41.
- NORBROOK LABORATORIES LIMITED, UNITED KING-
DOM:
2,998,365. PUB. 6-28-2005. INT. CL. 5.
- NORCO INDUSTRIES, INC., COMPTON, CA:
2,997,508. PUB. 6-28-2005. INT. CL. 7.
- NORCROSS INDUSTRIES, INC., WEST PALM BEACH, FL:
1,302,645. CANC. INT. CL. 20.
- NORDIC TRADING CO. INC., NEW YORK, NY:
2,201,334. CANC. INT. CL. 14.
- NORDSON CORPORATION, WESTLAKE, OH:
1,851,880. REN. 8-11-05. INT. CL. 7.
1,860,777. CANC. INT. CL. 9.
- NORDSTROM, INC., SEATTLE, WA:
1,302,713. CANC. INT. CL. 25.
- NORMARK CORPORATION, MINNETONKA, MN:
2,998,286. PUB. 6-28-2005. INT. CL. 8.
2,998,287. PUB. 6-28-2005. INT. CL. 9.
2,998,288. PUB. 6-28-2005. INT. CL. 28.
- NORSIG & ASSOCIATES, INC., DALLAS, TX:
2,201,859. CANC. INT. CL. 36.
- NORSOFT, INC., CAMP HILL, PA:
2,201,141. CANC. MULTIPLE CLASS, INT. CLS. 37 AND
42.
- NORTECH INVESTMENTS LTD, ST. JOHNS, ANTIGUA &
BARBUDA:
2,890,695. COR. INT. CL. 41.
- NORTH AMERICAN ENCLOSURES, INC., CENTRAL ISLIP,
NY:
2,998,539. INT. CL. 20.
- NORTH AMERICAN MEDICAL CORPORATION, ATLAN-
TA, GA:
2,997,417. PUB. 6-28-2005. INT. CL. 10.
- NORTH AMERICAN OUTDOOR GROUP, INC., MINNE-
TONKA, MN:
1,860,929. CANC. INT. CL. 16.
- NORTH AMERICAN REFRACTORIES COMPANY, MOON
TOWNSHIP, PA, CHAS. TAYLOR'S SONS COMPANY,
THE, CINCINNATI, OH:
600,245. REN. 8-11-05. U.S. CL. 12 (INT. CL. 19).
- NORTH AMERICAN REFRACTORIES COMPANY, MOON
TOWNSHIP, PA, ELTRA CORPORATION, TOLEDO, OH:
1,026,753. REN. 8-11-05. INT. CL. 19.
- NORTH CAROLINA STATE UNIVERSITY, RALEIGH, NC:
2,996,425. PUB. 6-28-2005. MULTIPLE CLASS, INT. CLS.
6, 14, 16, 21, 25 AND 41.
- NORTH SAFETY PRODUCTS INC., CRANSTON, RI:
1,345,793. REN. 8-11-05. INT. CL. 9.
- NORTHEAST OHIO LONG TERM CARE ALLIANCE,
BROADVIEW HEIGHTS, OH:
2,202,175. CANC. INT. CL. 35.
2,202,239. CANC. INT. CL. 35.
- NORTHERN & SHELL TITLES LIMITED, LONDON, UNI-
TED KINGDOM, OK MAGAZINES LIMITED, MILLHAR-
BOUR, LONDON E14, ENGLAND:
1,901,212. REN. 8-10-05. INT. CL. 16.
- NORTHWEST DENTAL ASSOCIATES, TUSTIN, CA:
2,998,229. PUB. 6-28-2005. INT. CL. 44.
- NORTHWESTERN MEMORIAL HEALTHCARE, CHICAGO,
IL:
2,996,573. PUB. 6-28-2005. INT. CL. 36.

NORWOOD OPERATING COMPANY, INDIANAPOLIS, IN,
DBA NORWOOD PROMOTIONAL PRODUCTS, AIRLINE
TEXTILE MFG. CO., DES MOINES, IA:
1,003,874. REN. 8-8-05. U.S. CL. 3 (INT. CL. 18).

NOTH'N TO IT, INC., BERLIN, MD:
2,997,494, PUB. 6-28-2005. INT. CL. 40.

NOTHING BUT HEALTH LLC, TEMPE, AZ:
2,998,614, INT. CL. 5.

NOTHING TO IT!!!, RENO, NV:
2,998,628, INT. CL. 16.

NOVAGRAPH, INCORPORATED, RICHARDSON, TX:
1,860,752, CANC. INT. CL. 9.

NOVARTIS AG, BASEL, SWITZERLAND:
2,997,235, PUB. 6-28-2005. INT. CL. 5.
2,998,169, PUB. 6-28-2005. INT. CL. 5.
2,998,259, PUB. 6-28-2005. INT. CL. 5.
2,998,260, PUB. 6-28-2005. INT. CL. 5.

NOVARTIS AG, SWITZERLAND:
2,998,441, PUB. 6-28-2005. INT. CL. 5.
2,998,460, PUB. 6-28-2005. INT. CL. 5.
2,998,473, PUB. 6-28-2005. INT. CL. 5.

NOVARTIS AG, BASEL, SWITZERLAND:
2,998,978, INT. CL. 5.
2,999,019, INT. CL. 5.

NOVASTAR FINANCIAL, INC., KANSAS CITY, MO:
2,996,371, PUB. 6-28-2005. INT. CL. 36.

NOVELTY MANUFACTURING COMPANY, LANCASTER,
PA:
1,900,689. REN. 8-11-05. INT. CL. 21.

NOVOZYMES A/S, DENMARK:
2,998,446, PUB. 6-28-2005. INT. CL. 1.

NOVOZYMES A/S, BAGSVAERD, DENMARK:
2,998,615, INT. CL. 1.

NU SQUARE CORP., MONTEREY PARK, CA:
2,997,128, PUB. 6-28-2005. INT. CL. 43.

NU-KOTE INTERNATIONAL, INC., ROCHESTER, NY:
2,201,784, CANC. INT. CL. 3.

NUHERBS, INC., OAKLAND, CA:
2,997,530, PUB. 6-28-2005. MULTIPLE CLASS, INT. CLS. 5
AND 31.

NULL, MILDRED, GLASGOW, KY:
2,998,205, PUB. 6-28-2005. INT. CL. 16.

NUTRAMAX PRODUCTS, INC., GLOUCESTER, MA:
2,201,070, CANC. INT. CL. 21.

NUTRI/SYSTEM IPHC, INC., WILMINGTON, DE, NUTRI/
SYSTEM L.P., HORSHAM, PA:
1,902,362. REN. 8-10-05. INT. CL. 5.

NUTRITION HEADQUARTERS (DE), INC., BOHEMIA, NY:
2,201,597, CANC. MULTIPLE CLASS, INT. CLS. 5, 29, 30
AND 32.

NVIDIA CORPORATION, SANTA CLARA, CA:
2,999,017, INT. CL. 9.

NYCHARITIES.ORG, NEW YORK, NY:
2,997,625, PUB. 6-28-2005. INT. CL. 36.

O.C. LOCAL, INC., READING, PA:
2,996,507, PUB. 6-28-2005. INT. CL. 43.

O.C. SEACRETS, OCEAN CITY, MD:
2,999,329, MULTIPLE CLASS, INT. CLS. 21 AND 33.

O'NEAL, SONIA, ROAD TOWN, TORTOLA, BR.VIRGIN
ISLANDS:
2,201,149, CANC. INT. CL. 35.

O'NEILL, JOHN, OVERLAND PARK, KS, DBA J. B. MAN-
UFACTURING COMPANY:
1,358,198. REN. 8-11-05. INT. CL. 28.

O'RITE TECHNOLOGY CO., LTD., JHONGHE CITY, TAI-
WAN, TAIWAN:
2,997,516, PUB. 6-28-2005. INT. CL. 9.

O'SULLIVAN CORPORATION, WINCHESTER, VA TO
POLYONE CORPORATION, AVON LAKE, OH:
1,861,385, CANC. INT. CL. 12.

OAKMONT COUNTRY CLUB, OAKMONT, PA:
1,355,873. REN. 8-9-05. MULTIPLE CLASS, U.S. CL. 200
INT. CL. 41.

OAKVILLE HILLS CELLAR, INC., OAKDALE, CA:
1,861,119, CANC. INT. CL. 33.

OBJECTSPACE, INC., DALLAS, TX:
2,201,500, CANC. INT. CL. 42.

OCTEL COMMUNICATIONS CORPORATION, MILPITAS,
CA:
2,200,975, CANC. INT. CL. 9.

OCUSOFT, INC., RICHMOND, TX:
2,998,554, INT. CL. 5.
2,998,563, INT. CL. 5.

ODEN, SAMUEL L., LOS ANGELES, CA, DBA RIDD'N ON
RECORDS:
2,201,352, CANC. INT. CL. 9.

ODWALLA, INC., HALF MOON BAY, CA:
2,998,075, PUB. 6-28-2005. INT. CL. 32.

OFFICE AND PROFESSIONAL EMPLOYEES INTERNA-
TIONAL UNION, NEW YORK, NY:
2,997,525, PUB. 6-28-2005. INT. CL. 35.

OHAUS CORPORATION, PINE BROOK, NJ, OHAUS SCALE
CORPORATOIN, FLORHAM PARK, NJ:
1,340,158. REN. 8-11-05. INT. CL. 9.

OHIO CASUALTY INSURANCE COMPANY, THE, HAMIL-
TON, OH:
2,201,837, CANC. INT. CL. 36.

OHIO HICKORY HARVEST BRAND PRODUCTS, INC.,
AKRON, OH:
1,302,882, CANC. INT. CL. 29.

OIL STOP, INC., HARVEY, LA:
1,860,936, CANC. INT. CL. 17.

OLD BRIDGE CELLARS, NAPA, CA:
2,998,660, INT. CL. 33.

OLD DOMINION TOBACCO COMPANY, INC., VIRGINIA
BEACH, VA:
1,899,444. REN. 8-11-05. MULTIPLE CLASS, INT. CLS. 1
AND 42.

OLD FASHIONED NATURAL PRODUCTS, INC., SANTA
ANA, CA, DBA 30 DAY NUTRITION:
1,361,347. REN. 8-11-05. INT. CL. 5.

OLIGOS ETC. INC., WILSONVILLE, OR:
2,997,162, PUB. 6-28-2005. INT. CL. 5.

OLIN CORPORATION, NORWALK, CT:
2,202,282, CANC. INT. CL. 31.

OLIVE TREE MEDIA, L.L.C., HOUSTON, TX:
2,998,899, INT. CL. 9.
2,998,900, INT. CL. 9.

OLIVVI, LTD., RICHMOND, VA:
2,201,290, CANC. INT. CL. 25.

OLMSTEAD, JOSEPH DAVID, BOZEMAN, MT:
1,860,739, CANC. INT. CL. 9.

OLYMPUS OPTICAL CO., LTD., TOKYO, JAPAN:
2,929,201, COR. INT. CL. 9.

OM ORGANICS, BOULDER, CO:
2,997,009, PUB. 6-28-2005. INT. CL. 5.

OMEGA ENGINEERING, INC., STAMFORD, CT:
1,328,208. REN. 8-8-05. INT. CL. 9.

OMEGA IP CO., WATERLOO, IA:
2,997,041, PUB. 6-28-2005. INT. CL. 20.

OMEGA SA (OMEGA AG) (OMEGA LTD.), CH-2502 BIEL/
BIENNE, SWITZERLAND:
2,998,393, PUB. 6-28-2005. INT. CL. 14.

OMNIPOINT CORPORATION, BETHESDA, MD:
2,201,490, CANC. INT. CL. 38.
2,201,494, CANC. INT. CL. 38.

OMNISTOR ACCESSORIES N.V., BELGIUM:
2,998,423, PUB. 6-28-2005. MULTIPLE CLASS, INT. CLS.
6, 12, 18 AND 22.

OMTOOL, LTD., SALEM, NH:
2,998,687, INT. CL. 9.

ON THE LAKE INC., HOLLISTER, MO:
2,202,022, CANC. INT. CL. 16.

ONE MARKET RESTAURANT PARTNERS L.P., SAN
FRANCISCO, CA:
2,996,932, PUB. 6-28-2005. INT. CL. 43.

ONE MIND, LLC, SCHWENKSVILLE, PA:
2,996,696, PUB. 6-28-2005. INT. CL. 35.

ONFIBER COMMUNICATIONS, INC., ENGLEWOOD, CO:
2,998,538, INT. CL. 38.

ONTARIO SYSTEMS CORPORATION, MUNCIE, IN:
2,795,470, CANC. INT. CL. 9.

OPENING OF THE HEART, BAINBRIDGE ISLAND, WA:
2,997,695, PUB. 6-28-2005. MULTIPLE CLASS, INT. CLS.
35 AND 41.

- OPERATION HOMECOMING USA, BRANSON, MO:
2,998,116, PUB. 6-28-2005. INT. CL. 36.
- OPTCAPITAL, LLC, CHARLOTTE, NC:
2,996,972, PUB. 6-28-2005. INT. CL. 36.
- OPTERNITY STORAGE, INC., CAMBRIDGE, MA:
2,997,360, PUB. 6-28-2005. INT. CL. 39.
- OPTICAL CONNECTION, INC., SAN JOSE, CA:
2,944,887, CANC. INT. CL. 9.
- OPTIMA BUS CORPORATION, VALLEY CENTER, KS:
2,997,153, PUB. 6-28-2005. INT. CL. 12.
- OPTION CARE, INC., BANNOCKBURN, IL:
2,201,367, CANC. INT. CL. 42.
- OPTIONS UNIVERSITY LLC, BOCA RATON, FL:
2,997,350, PUB. 6-28-2005. INT. CL. 9.
- OPUS ONE, OAKVILLE, CA:
1,374,979. REN. 8-10-05. INT. CL. 33.
- OPUS SOLUTIONS, LLC, BEAVERTON, OR:
2,997,796, PUB. 6-28-2005. INT. CL. 35.
- OPX PARTNERS, LLC, NOBLESVILLE, IN:
2,846,597, CANC. INT. CL. 42.
- ORACLE CORPORATION, REDWOOD SHORES, CA:
2,201,699, CANC. INT. CL. 9.
- ORACLE INTERNATIONAL CORPORATION, REDWOOD CITY, CA:
2,997,144, PUB. 6-28-2005. MULTIPLE CLASS, INT. CLS. 9, 16, 41 AND 42.
- ORAK, ZEKI, SAN FRANCISCO, CA:
2,999,226, INT. CL. 9.
- ORANGE GLO INTERNATIONAL, INC., GREENWOOD VILLAGE, CO:
2,998,119, PUB. 6-28-2005. INT. CL. 3.
- ORBIT PRODUCTIONS LLC, MODESTO, CA:
2,997,582, PUB. 6-28-2005. INT. CL. 41.
- ORBITAL DATA CORPORATION, SAN MATEO, CA:
2,998,334, PUB. 6-28-2005. INT. CL. 9.
- ORGANIZATION FOR UNDERSTANDING CLUSTER HEADACHES, GLADEWATER, TX:
2,997,696, PUB. 6-28-2005. INT. CL. 35.
- ORIENT POWER HOLDINGS LIMITED, KOWLOON, HONG KONG:
2,998,846, INT. CL. 9.
- ORIGINAL HONEY BAKED HAM CO. OF GEORGIA, INC., THE, NORCROSS, GA:
2,996,538, PUB. 6-28-2005. MULTIPLE CLASS, INT. CLS. 35 AND 41.
- ORION LASERS, INC., WILMINGTON, DE:
2,998,060, PUB. 6-28-2005. INT. CL. 10.
- OROC, INC., BAY VILLAGE, OH:
2,997,818, PUB. 6-28-2005. MULTIPLE CLASS, INT. CLS. 25 AND 36.
- ORTHO MATTRESS INC., CERRITOS, CA:
2,997,470, PUB. 6-28-2005. INT. CL. 20.
- ORTIZ, LEROY, SANTA FE, NM:
2,997,040, PUB. 6-28-2005. INT. CL. 41.
- OSBORN MANUFACTURING CORPORATION, THE, CLEVELAND, OH:
779,410, CANC. U.S. CL. 23.
- OSBORNE, CARL ANDREW, ROSEVILLE, MN:
2,202,391, CANC. INT. CL. 42.
- OSPRAIE MANAGEMENT, LLC, NEW YORK, NY:
2,997,799, PUB. 6-28-2005. INT. CL. 36.
- OSRAM GESELLSCHAFT MIT BESCHRÄNKTER HAF-TUNG, MÜNCHEN D-81543, FED REP GERMANY:
2,998,380, PUB. 6-28-2005. INT. CL. 11.
- OSRAM SYLVANIA INC., DANVERS, MA:
2,997,763, PUB. 6-28-2005. INT. CL. 11.
- OTIS ELEVATOR COMPANY, FARMINGTON, CT:
1,882,847. REN. 8-9-05. INT. CL. 9.
- OTSEGO SKI CLUB - HIDDEN VALLEY, INC., GAYLORD, MI:
2,998,235, PUB. 6-28-2005. INT. CL. 41.
- OTSUKA PHARMACEUTICAL CO., LTD., CHIYODA-KU, TOKYO, JAPAN:
2,996,665, PUB. 6-28-2005. INT. CL. 32.
- OUATTARA, AYESHA, NEW YORK, NY:
2,997,833, PUB. 6-28-2005. INT. CL. 18.
- OUT OF THE BOX PUBLISHING, INC., MADISON, WI:
2,997,760, PUB. 6-28-2005. INT. CL. 28.
- OUTDOOR OPTICS, INC., MEMPHIS, TN, DBA OLYMPIC OPTICAL CO.:
2,997,382, PUB. 6-28-2005. INT. CL. 9.
- OUTDOOR RESEARCH INC, SEATTLE, WA:
1,861,015, CANC. INT. CL. 25.
- OUTLOOK MEDIA INCORPORATED, COLUMBUS, OH:
2,997,204, PUB. 6-28-2005. INT. CL. 41.
- OUTOKUMPU OYJ, FIN02200 ESPOO, FINLAND:
2,998,447, PUB. 6-28-2005. MULTIPLE CLASS, INT. CLS. 37 AND 42.
- OUTPUT TECHNOLOGIES, INC., KANSAS CITY, MO:
2,200,952, CANC. MULTIPLE CLASS, INT. CLS. 35, 38 AND 42.
- OVER THE RAINBOW, LTD., DES MOINES, IA:
1,302,620, CANC. INT. CL. 18.
- OWENS-CORNING FIBERGLAS TECHNOLOGY INC., SUMMIT, IL:
2,998,856, INT. CL. 7.
- OWENS-ILLINOIS CLOSURE INC., TOLEDO, OH:
2,997,827, PUB. 6-28-2005. INT. CL. 20.
- OWENS, CHARLES DANIEL, CHARLOTTE, NC:
2,998,095, PUB. 6-28-2005. INT. CL. 41.
- OWBOW ENTERPRISES, INC., MURDOCK, NE:
2,201,536, CANC. INT. CL. 31.
- OXFORD HEALTH PLANS LLC, TRUMBULL, CT:
2,200,820, CANC. INT. CL. 16.
2,200,825, CANC. INT. CL. 42.
- OZ E TRADING POST PTY LTD, AUSTRALIA:
2,998,378, PUB. 6-28-2005. INT. CL. 25.
- OZERKOVSKY, ALEJANDRO PODOSWA, COLONIA CON-DESA, D.F., MEXICO:
2,999,207, INT. CL. 21.
- P. MICHAEL, SHIRLEY, SUMMIT, NJ:
1,339,536. REN. 8-12-05. INT. CL. 37.
- P. T. DJARUM, JAKARTA, INDONESIA:
1,864,380. REN. 8-9-05. INT. CL. 34.
- P.C. RICHARD & SON LONG ISLAND CORPORATION, FARMINDALE, NY:
1,861,198, CANC. MULTIPLE CLASS, INT. CLS. 37 AND 42.
- PACE INTERNATIONAL, LLC, SEATTLE, WA, THOMP-SON-HAYWARD CHEMICAL COMPANY, KANSAS CITY, KS:
1,016,220. REN. 8-9-05. MULTIPLE CLASS, INT. CLS. 1 AND 5.
- PACIFIC COAST FEATHER CO., SEATTLE, WA:
2,996,789, PUB. 6-28-2005. INT. CL. 20.
- PACIFIC COAST FEATHER COMPANY, SEATTLE, WA:
1,882,267. REN. 8-9-05. INT. CL. 24.
2,996,662, PUB. 3-8-2005. INT. CL. 20.
- PACIFIC INSTITUTE FOR COMMUNITY ORGANIZA-TIONS, OAKLAND, CA:
2,997,748, PUB. 6-28-2005. INT. CL. 41.
- PACIFIC OPTICAL, ORANGE, CA:
2,202,153, CANC. INT. CL. 9.
- PACIFIC PACKAGING CONCEPTS, INC., CARSON, CA, DBA FRESH START VITAMINS CO. AND DBA C & A ENTERPRISES, INC.:
2,996,512, PUB. 6-28-2005. INT. CL. 5.
- PACIFIC SUNWEAR OF CALIFORNIA, ANAHEIM, CA:
2,998,305, PUB. 6-28-2005. INT. CL. 25.
- PACIFIC YURTS, INC., COTTAGE GROVE, OR:
1,302,677, CANC. INT. CL. 22.
- PACIFICA DATA SERVICES, INC., LAGUNA BEACH, CA:
1,896,883. REN. 8-11-05. INT. CL. 9.
- PACT INFORMATIONSTECHNOLOGIE GMBH, MUENCH-EN, 80807, FED REP GERMANY:
2,996,301, PUB. 6-28-2005. MULTIPLE CLASS, INT. CLS. 9, 38 AND 42.
- PACTIV CORPORATION, LAKE FOREST, IL:
2,998,936, INT. CL. 8.
- PADDINGTON & COMPANY, HERTFORDSHIRE, UNITED KINGDOM:
2,997,536, PUB. 6-28-2005. INT. CL. 9.
- PADDOCK LABORATORIES, INC., MINNEAPOLIS, MN:
2,998,191, PUB. 6-28-2005. INT. CL. 5.
- PADRES L.P., SAN DIEGO, CA:
2,998,508, INT. CL. 25.

- PAGES BOOK FAIRS, INC., ST. PETERSBURG, FL:
2,201,247, CANC. INT. CL. 35.
- PAI, NARENDRA M., LEWISTOWN, PA:
2,202,216, CANC. INT. CL. 41.
- PAL PUBLICATIONS, INC., POTTSTOWN, PA:
2,997,503, PUB. 6-28-2005. INT. CL. 16.
- PALM BEACH YACHT CENTER, HYPOLUXO, FL:
2,996,494, PUB. 6-28-2005. MULTIPLE CLASS, INT. CLS. 37 AND 39.
- PALMETTO STATE TRANSPORTATION CO., INC., GREENVILLE, SC:
2,997,274, PUB. 6-28-2005. INT. CL. 39.
- PALTRONICS, INC., LAS VEGAS, NV:
2,998,674, INT. CL. 9.
- PAN AMERICAN HOTEL, INC., ST. PAUL, MN:
1,303,221, CANC. INT. CL. 42.
- PANACEA SOLUTIONS, INC., BERNARDSVILLE, NJ:
2,996,960, PUB. 6-28-2005. INT. CL. 9.
- PANAMERICAN BANK, COCONUT GROVE, FL:
1,809,553, AM. INT. CL. 36.
- PANDA LUGGAGE & HANDBAG (U.S.A.), INC., AVEN-
TURA, FL:
2,996,752, PUB. 6-28-2005. INT. CL. 18.
- PANDEMIC STUDIOS, LLC, LOS ANGELES, CA:
2,997,323, PUB. 6-28-2005. INT. CL. 42.
- PANDUIT CORP., TINLEY PARK, IL:
2,998,564, INT. CL. 9.
2,998,565, INT. CL. 9.
- PANLINE U.S.A., INC., ENGLEWOOD, NJ:
2,202,028, CANC. INT. CL. 28.
- PANPALS, INC., SALT LAKE CITY, UT:
2,997,978, PUB. 6-28-2005. INT. CL. 21.
- PANTEK, INC., CLEVELAND, OH:
2,998,289, PUB. 6-28-2005. INT. CL. 42.
- PANTHEON FLOOR SOLUTIONS, DALLAS, TX:
2,998,198, PUB. 6-28-2005. INT. CL. 19.
- PAOLO TESTI, ITALY AND LUIGI SPAGGIARI, ITALY:
2,998,462, PUB. 6-28-2005. INT. CL. 3.
- PAPEMAN, PHILIP LEO, CHICO, CA:
2,997,670, PUB. 6-28-2005. MULTIPLE CLASS, INT. CLS. 16 AND 25.
- PAPPAS, PETER, WOBURN, MA:
2,997,394, PUB. 6-28-2005. INT. CL. 11.
- PAR-WAY GROUP, COSTA MESA, CA:
1,861,426, CANC. INT. CL. 29.
- PARADATA SYSTEMS INC., WHISTLER, BRITISH COLUM-
BIA, CANADA:
2,996,682, PUB. 6-28-2005. INT. CL. 40.
- PARADISE CREEK INVESTMENTS 71 (PTY) LIMITED,
PIETERMARITZBURG, SOUTH AFRICA:
2,997,326, PUB. 6-28-2005. INT. CL. 25.
- PARADISE FARM ORGANICS, INC., MOSCOW, ID:
2,997,054, PUB. 6-28-2005. INT. CL. 29.
- PARAGON VISION SCIENCES, INC., MESA, AZ:
2,202,305, CANC. INT. CL. 42.
- PARAMOUNT PARKS INC., CHARLOTTE, NC:
2,996,423, PUB. 6-28-2005. INT. CL. 41.
- PARAMOUNT PICTURES CORPORATION, LOS ANGELES,
CA:
2,202,040, CANC. INT. CL. 16.
- PARCELL, KEVIN J., ST AUGUSTINE, FL:
2,997,838, PUB. 6-28-2005. INT. CL. 44.
- PARIS ACCESSORIES, INC., NEW YORK, NY:
2,998,633, MULTIPLE CLASS, INT. CLS. 13 AND 25.
- PARK LANE CONSERVATORIES LTD., POYNTON, CHE-
SHIRE SK1 21YL, UNITED KINGDOM:
2,998,678, MULTIPLE CLASS, INT. CLS. 6 AND 19.
- PARKER INTAGIBLES LLC, CLEVELAND OH 441244141,
OH, AMERICAN BRAKE SHOE COMPANY, NEW YORK,
NY:
795,152, REN. 8-11-05. U.S. CL. 23 (INT. CL. 7).
- PARKER INTANGIBLES LLC, CLEVELAND, OH, COM-
MERCIAL SHEARING AND STAMPING COMPANY,
THE, YOUNGSTOWN, OH:
606,982, REN. 8-11-05. U.S. CL. 23 (INT. CL. 7).
- PARKER INTANGIBLES LLC, CLEVELAND, OH, DAYCO
CORPORATION, DAYTON, OH:
1,016,888, REN. 8-11-05. INT. CL. 17.
- PARKER INTANGIBLES LLC, CLEVELAND, OH:
1,324,345, REN. 8-8-05. INT. CL. 12.
- PARKER INTANGIBLES LLC, CLEVELAND, OH, WATTS
FLUIDAIR INC., KITTERY, ME:
1,345,606, REN. 8-11-05. MULTIPLE CLASS, INT. CLS. 7,
9 AND 11.
- PARMALAT FOOD INC., ETOBICOKE ONTARIO, CANA-
DA, BROOKE BOND INC., KIRKLAND, QUEBEC, CANA-
DA:
1,342,924, REN. 8-11-05. INT. CL. 29.
- PARSONS, DAVID A., INCLINE VILLAGE, NV:
2,201,961, CANC. INT. CL. 11.
- PARTNERS IN CHANGE, INC., MCMURRAY, PA:
2,996,452, PUB. 6-28-2005. INT. CL. 35.
- PARTY OF 3, GREENWICH, CT:
2,201,324, CANC. INT. CL. 35.
- PASCAL, FRANCINE, NEW YORK, NY:
1,935,570, REN. 8-10-05. INT. CL. 16.
- PASSANG, TENZIN, BOULDER, CO:
2,996,587, PUB. 6-28-2005. INT. CL. 35.
- PASSCHENDAELE RIDGE PTY LTD, AUSTRALIA:
2,998,360, PUB. 6-28-2005. INT. CL. 33.
- PASTA-THON, INC., MUTTONTOWN, NY:
2,202,174, CANC. INT. CL. 30.
- PASTER BROTHERS CONSTRUCTION, WESTLAKE VIL-
LAGE, CA:
2,201,576, CANC. INT. CL. 37.
- PASTIFICIO ARTIGIANO CAV. GIUSEPPE COCCO S.N.C.,
FARA S. MARTINO (CH), ITALY:
2,998,516, MULTIPLE CLASS, INT. CLS. 29 AND 30.
- PATENT INFORMATION USERS GROUP, INC., SOUTH-
FIELD, MI:
2,997,517, PUB. 6-28-2005. INT. CL. 35.
- PATEREKAS, ANDREW, D, MOUNT JOY, PA:
2,997,424, PUB. 6-28-2005. INT. CL. 9.
- PATIENT CARE TECHNOLOGY SYSTEMS, LLC., ALISO
VIEJO, CA:
2,998,186, PUB. 6-28-2005. INT. CL. 9.
- PATRICE COSMETICS, INC., TOLEDO, OH:
1,312,946, REN. 8-9-05. INT. CL. 3.
- PATRIOT HEALTH INC., PLAINVIEW, NY:
2,999,151, INT. CL. 35.
- PAUL REED SMITH GUITARS, LIMITED PARTNERSHIP,
STEVENSVILLE, MD, SMITH, PAUL REED, ANNAPOLIS,
MD:
1,380,329, REN. 8-11-05. INT. CL. 15.
- PAUL, ALISA VINCENT, COUNCIL GROVE, KS:
2,997,475, PUB. 6-28-2005. INT. CL. 25.
- PAULSEN, LEIGH A., MANCHESTER, NH:
2,998,864, MULTIPLE CLASS, INT. CLS. 19 AND 40.
- PAULY, PETER, BERNKASTEL-KUES, FED REP GER-
MANY:
2,997,076, PUB. 6-28-2005. INT. CL. 33.
- PAVES' PROFESSIONAL, INC., HARVEY, ILLINOIS, CA:
2,996,962, PUB. 6-28-2005. INT. CL. 3.
- PAYROLL USA, INC., NAGS HEAD, NC:
2,996,678, PUB. 6-28-2005. INT. CL. 35.
- PBR AUTOMOTIVE PTY. LTD., EAST BENTLEIGH, VIC-
TORIA, AUSTRALIA:
2,201,957, CANC. INT. CL. 12.
- PC PITSTOP L.L.C., DAKOTA DUNES, SD:
2,567,133, CANC. INT. CL. 42.
- PDK LABS, INC., HAUPPAUGE, NY:
2,999,246, INT. CL. 5.
- PEACHTREE SOFTWARE, INC., NORCROSS, GA TO
PEACHTREE SOFTWARE, INC., NORCROSS, GA:
2,202,010, CANC. INT. CL. 9.
- PEAK BODY SYSTEMS, INC., BOULDER, CO:
2,997,341, PUB. 6-28-2005. INT. CL. 28.
- PEARISON, INC., CYNTHIANA, IN:
2,997,456, PUB. 6-28-2005. INT. CL. 25.
- PEARLMAN, DANIEL ALEXANDER, PEMBROKE PINES,
FL:
2,997,851, PUB. 6-28-2005. INT. CL. 35.
- PEARSON EDUCATION, INC., UPPER SADDLE RIVER, NJ:
2,996,353, PUB. 6-28-2005. INT. CL. 21.

- PEARSON, KENT D., ANTELOPE, CA AND PEARSON, MELANIE A., ANTELOPE, CA:
2,999,127, INT. CL. 28.
- PECO CORPORATION, AUBURN HILLS, MI:
2,997,053, PUB. 6-28-2005. INT. CL. 7.
- PECO ENERGY COMPANY, PHILADELPHIA, PA, PECO ENERGY COMPANY, PHILADELPHIA, PA:
1,897,111. REN. 8-10-05. INT. CL. 39.
- PEERLESS IMPORTED RUGS, CHICAGO, IL:
1,327,833. REN. 8-11-05. INT. CL. 3.
- PEGASYSTEMS INC., CAMBRIDGE, MA:
1,348,464. REN. 8-11-05. INT. CL. 35.
- PELC, GENE, SETAGAYA-KU, TOKYO 158, JAPAN:
2,202,125, CANC. INT. CL. 9.
- PELICAN ENTERPRISES, INC., TOPEKA, KS:
1,303,204, CANC. INT. CL. 42.
- PENCO PRODUCTS, INC., OAKS, PA:
2,998,749, INT. CL. 20.
- PENDER NURSERY, INC., GARNER, NC:
2,997,551, PUB. 6-28-2005. INT. CL. 35.
- PENGUIN GROUP (USA) INC., NEW YORK, NY FROM PENGUIN PUTNAM INC., NEW YORK, NY:
2,998,613, MULTIPLE CLASS, INT. CLS. 9 AND 16.
- PENN CAPITAL, INC., ANNAPOLIS, MD:
2,998,641, INT. CL. 36.
- PENNSYLVANIA FASHIONS, INC., WARRENDALE, PA:
1,302,720, CANC. INT. CL. 25.
- PENNSYLVANIA STATE UNIVERSITY; THE, UNIVERSITY PARK, PA:
1,325,426. REN. 8-10-05. MULTIPLE CLASS, INT. CLS. 6, 12, 14, 16, 20, 21, 24, 25 AND 28.
1,325,426, CANC. MULTIPLE CLASS, INT. CLS. 18 AND 34.
- PENNZOIL PRODUCTS COMPANY, HOUSTON, TX:
1,302,363, CANC. INT. CL. 4.
- PENTECH INTERNATIONAL INC., LANGHORNE, PA:
1,302,583, CANC. INT. CL. 16.
- PENWEST PHARMACEUTICALS CO., DANBURY, CT, EDWARD MENDELL CO., INC., PATTERSON, NY:
1,920,597. REN. 8-10-05. INT. CL. 1.
- PEOPLE FOR THE AMERICAN WAY FOUNDATION, DISTRICT OF COLUMBIA, DC:
2,997,232, PUB. 6-28-2005. INT. CL. 35.
- PEPSICO, INC.:
1,302,991, CANC. INT. CL. 32.
- PERCEPTRON, INC., PLYMOUTH, MI:
1,342,172. REN. 8-10-05. INT. CL. 9.
- PERFECT FIT INDUSTRIES, INC., MONROE, NC:
1,302,686, CANC. INT. CL. 24.
1,302,687, CANC. INT. CL. 24.
- PERFETTI VAN MELLE S.P.A., 20020 MILAN, ITALY:
2,996,299, PUB. 6-28-2005. INT. CL. 30.
- PERFORMANCE PRODUCTS, LLC, OAKDALE, CA:
2,998,588, INT. CL. 4.
- PERFORMANCE TECHNOLOGY, INC., SAN ANTONIO, TX:
2,201,596, CANC. INT. CL. 9.
- PERKIN-ELMER CORPORATION, THE, FOSTER CITY, CA:
2,202,014, CANC. INT. CL. 9.
- PERLMAN, MELISSA, PHOENIX, AZ:
2,998,893, INT. CL. 41.
- PERMAR SYSTEMS, INC., WOLCOTT, NY, DBA ELECTRO-MARK CO.:
1,901,768. REN. 8-10-05. INT. CL. 20.
- PERMAR SYSTEMS, INC., WOLCOTT, NY:
2,997,619, PUB. 6-28-2005. INT. CL. 20.
- PERRIN MANUFACTURING COMPANY, CITY OF INDUSTRY, CA:
2,996,646, PUB. 6-28-2005. INT. CL. 12.
- PEST DESIGN AB, STOCKHOLM, SWEDEN:
2,997,275, PUB. 6-28-2005. MULTIPLE CLASS, INT. CLS. 35, 41 AND 45.
- PETER STOKKEBYE TOBAKSFABRIK A/S, 5610 ASSENS, DENMARK, ORLIK TOBACCO COMPANY A/S, 5610 ASSENS, DENMARK:
1,908,000. REN. 8-6-05. INT. CL. 34.
- PHARMABOTANIXX, INC., IRVINE, CA:
2,200,828, CANC. INT. CL. 5.
- PHARMACEUTICAL RESEARCH AND MANUFACTURERS OF AMERICA, WASHINGTON, DC, PHARMACEUTICAL RESEARCH AND MANUFACTURERS OF AMERICA, WASHINGTON, DC:
1,927,302. REN. 8-11-05. MULTIPLE CLASS, INT. CLS. 16 AND 42.
- PHARMANEX, LLC., PROVO, UT:
2,998,877, INT. CL. 5.
- PHARMICA SCIENCES, INC., NORTH MIAMI BEACH, FL:
2,996,383, PUB. 6-28-2005. INT. CL. 5.
- PHILIPP, TIMOTHY, P., BRIDGETON, MO:
2,999,277, INT. CL. 5.
- PHILOSOPHY, INC., PHOENIX, AZ:
2,201,754, CANC. INT. CL. 3.
2,201,898, CANC. INT. CL. 3.
- PHOENIX INTANGIBLES HOLDING COMPANY, GREENVILLE, DE:
2,998,823, INT. CL. 35.
- PHOENIX TECHNOLOGIES LTD., MILPITAS, CA:
2,998,662, INT. CL. 42.
- PHOTODEX CORPORATION, AUSTIN, TX, RAXSOFT, INC., LIVERMORE, CA, DBA PHOTODEX:
1,918,764. REN. 8-9-05. INT. CL. 9.
- PHUONG DONG GARMENT COMPANY, HO CHI MINH CITY, VIETNAM:
2,996,915, PUB. 6-28-2005. INT. CL. 25.
- PHYSICAL PLANNING TECHNOLOGIES INC., MARKHAM, ONTARIO, CANADA:
2,996,891, PUB. 6-28-2005. MULTIPLE CLASS, INT. CLS. 9 AND 42.
- PHYSICIANS MUTUAL INSURANCE COMPANY, OMAHA, NE:
2,202,124, CANC. INT. CL. 36.
- PICK UP STICKS JEWELRY COMPANY, LLC, CLOVIS, NM:
2,998,725, INT. CL. 14.
- PIEH, AMY LYNNE, CAMP VERDE, AZ:
2,998,860, INT. CL. 8.
- PIERRET JOHAN MARIA ALFONS;; PIERRET KAREL LYDIA WILLEM, BELGIUM:
2,998,459, PUB. 6-28-2005. INT. CL. 18.
- PILARCZYK, ARCHBISHOP OF CINCINNATI, TRUSTEE FOR THE CATHOLIC ARCHDIOCESE OF CINCINNATI; DANIEL E., CINCINNATI, OH:
1,271,743. REN. 8-10-05. MULTIPLE CLASS, INT. CLS. 16 AND 25.
- PINK SUGAR, LLC, PLANO, TX:
2,996,593, PUB. 6-28-2005. INT. CL. 25.
- PINNACLE CONSORTIUM, INC., ADA, MI:
2,201,531, CANC. INT. CL. 33.
- PINPOINT SOFTWARE CORPORATION, SAN JOSE, CA:
2,201,010, CANC. INT. CL. 9.
- PINTAIL TECHNOLOGIES, INC., PLANO, TX:
2,998,088, PUB. 6-28-2005. INT. CL. 9.
- PIO CESARE S.R.L., 12051 ALBA (CUNEO), ITALY:
2,996,666, PUB. 6-28-2005. INT. CL. 33.
- PIONEER LABORATORIES, INC., MARQUETTE, MI:
2,997,549, PUB. 6-28-2005. INT. CL. 10.
2,997,594, PUB. 6-28-2005. INT. CL. 10.
- PIPE 'N HEADS, INC., PLANO, TX TO JENCO WHOLESALE NURSERIES, INC., CARROLLTON, TX:
1,861,295, CANC. INT. CL. 42.
- PIRANHA PRODUCTIONS, INC., WEATHERFORD, TX:
1,886,386. REN. 8-11-05. INT. CL. 41.
- PIRELLI DEUTSCHLAND AG, D-64747 BREUBERG, FED REP GERMANY:
2,998,391, PUB. 6-28-2005. INT. CL. 12.
- PIRRONE, DOUGLAS, HUNTINGTON, NY:
2,997,469, PUB. 6-28-2005. INT. CL. 35.
- PISTACHIO TREE RANCH, ALAMOGORDO, NM:
2,996,472, PUB. 6-28-2005. INT. CL. 33.
- PIX AKTIEBOLAG, GAVLE 1, SWEDEN:
1,302,959, CANC. INT. CL. 30.
- PIXEL TRANSLATIONS, INC., CUPERTINO, CA:
1,865,606. REN. 8-11-05. INT. CL. 9.
- PIXOLOGIC, INC., LOS ANGELES, CA:
2,999,184, INT. CL. 9.
- PIZZA PIPELINE, INC., SPOKANE, WA:
1,976,459. REN. 8-10-05. INT. CL. 42.

PIZZA SCHMIZZA, INC., HILLSBORO, OR:
2,997,528, PUB. 6-28-2005. INT. CL. 43.

PKC CORPORATION, BURLINGTON, VT:
1,340,177, AM. INT. CL. 9.

PLACER SIERRA BANCSHARES, SACRAMENTO, CA:
2,999,209, INT. CL. 36.
2,999,210, INT. CL. 36.

PLAN 2000 SOFTWARE LLC, DENVER, CO:
2,201,984, CANC. INT. CL. 9.

PLANET CASH LLC, ST. LOUIS, MO:
2,997,578, PUB. 6-28-2005. MULTIPLE CLASS, INT. CLS.
35, 36 AND 39.

PLANETWIDE GAMES, INC., COSTA MESA, CA:
2,998,241, PUB. 6-28-2005. INT. CL. 41.

PLANT RESEARCH INTERNATIONAL B.V., 6708 AA WAGENINGEN, NETHERLANDS:
2,998,889, MULTIPLE CLASS, INT. CLS. 1, 5 AND 42.

PLANTATION PRODUCTS, INC., NORTON, MA, NORTH-UP KING & CO., MINNEAPOLIS, MN:
191,520, REN. 8-11-05. U.S. CL. 1 (INT. CL. 31).

PLANTING IMPOSSIBLE GARDENS, NORTH BAY VILLAGE, FL:
2,070,132, CANC. INT. CL. 41.

PLASMACUTE AS, 5008 BERGEN, NORWAY:
2,996,338, PUB. 6-28-2005. MULTIPLE CLASS, INT. CLS.
10, 42 AND 44.

PLASTIC SUPPLIERS, INC., COLUMBUS, OH:
2,997,225, PUB. 6-28-2005. INT. CL. 17.

PLASTIPAK PACKAGING, INC., PLYMOUTH, MI:
2,201,598, CANC. INT. CL. 20.

PLATT, STUART C, LOUISVILLE, KY:
2,998,203, PUB. 6-28-2005. INT. CL. 3.

PLATYPUS WEAR, INC., SAN DIEGO, CA:
2,998,553, INT. CL. 41.

PLAY-TECH, INC., NEW YORK, NY:
2,202,284, CANC. INT. CL. 28.
2,202,285, CANC. INT. CL. 28.
2,202,286, CANC. INT. CL. 28.

PLAYMATES HOLDINGS LIMITED, KOWLOON, HONG KONG:
1,381,601, CANC. INT. CL. 28.

PLAYMATES TOYS INC., COSTA MESA, CA:
2,202,134, CANC. INT. CL. 28.

PLAYORENA, INC., MELVILLE, NY:
1,303,182, CANC. INT. CL. 41.

PLAYSKOOL BABY, INC., PAWTUCKET, RI:
1,302,480, CANC. INT. CL. 10.

POBRAN, DAVID H., SAN MARCOS, CA:
2,998,296, PUB. 6-28-2005. MULTIPLE CLASS, INT. CLS.
10 AND 28.

POINTE ORLANDO DEVELOPMENT COMPANY, EDMONTON, ALBERTA, CANADA:
2,202,263, CANC. INT. CL. 25.

POLK MILLER PRODUCTS CORPORATION, RICHMOND, VA TO SERGEANT'S PET CARE PRODUCTS, INC., DALLAS, TX:
218,757, AM. U.S. CL. 52.

POLY-TUFF SYSTEMS INTERNATIONAL CORPORATION, LAS VAGAS, NV:
2,998,306, PUB. 6-28-2005. INT. CL. 2.

POLYMER DYNAMICS TECHNOLOGY INC, ALLENTOWN, PA:
2,997,029, PUB. 6-14-2005. INT. CL. 25.

POLYMERIC SYSTEMS, INC., PHOENIXVILLE, PA:
2,997,858, PUB. 6-28-2005. INT. CL. 17.

POMPANETTE, LLC, CHARLESTOWN, NH:
1,302,486, CANC. INT. CL. 12.

PONTICELLI, ROBERT, J., CAMARILLO, CA:
2,998,857, MULTIPLE CLASS, INT. CLS. 9 AND 11.

PONY BOY BRAND, INC., ST. AUGUSTINE, FL:
2,999,398, INT. CL. 16.

POP-A-SHOT, INC., SALINA, KS:
1,861,480, CANC. INT. CL. 9.

POPPERS SUPPLY CO., PORTLAND, OR:
1,302,942, CANC. INT. CL. 30.
1,302,943, CANC. INT. CL. 30.

PORTLAND GENERAL ELECTRIC COMPANY, PORTLAND, OR:
2,996,582, PUB. 6-28-2005. U.S. CL. A.

POSADAS DE MEXICO, S.A. DE C.V., MEXICO CITY, MEXICO:
2,996,511, PUB. 6-28-2005. INT. CL. 43.

POSITIVE ALTERNATIVE RADIO, INC., BLACKSBURG, VA:
2,996,844, PUB. 6-28-2005. INT. CL. 38.

POSTAL INSTANT PRESS, INC., AGOURA HILLS, CA:
997,740, CANC. U.S. CL. 101.

POW WOW INC., NEW YORK, NY:
2,998,301, PUB. 6-28-2005. INT. CL. 25.

POWELL ELECTRICAL SYSTEMS, INC., HOUSTON, TX:
1,038,428, REN. 8-12-05. INT. CL. 9.
2,998,752, INT. CL. 9.

POWER FINANCIAL GROUP, INC., WILMINGTON, DE:
2,996,824, PUB. 6-28-2005. INT. CL. 36.

POWER TOOL HOLDERS INCORPORATED, WILMINGTON, DE:
2,202,056, CANC. INT. CL. 7.

POWERCELL ENERGY PRODUCTS, INC., SOUTHAMPTON, PA:
2,997,062, PUB. 6-28-2005. INT. CL. 9.

POWERCOLD CORPORATION, LA VERNIA, TX:
2,998,769, INT. CL. 11.

POWERS PRODUCTS III, L.L.C., NEW ROCHELLE, NY, RAWLPLUG COMPANY, INC., THE, NEW ROCHELLE, NY:
1,895,519, REN. 8-9-05. INT. CL. 1.

POWERSURGE TECHNOLOGIES, INC., CEDAR FALLS, IA:
2,997,267, PUB. 5-3-2005. MULTIPLE CLASS, INT. CLS. 38
AND 42.

PRAECIS PHARMACEUTICALS, INC., WALHAM, MA:
2,996,450, PUB. 6-28-2005. INT. CL. 5.

PRAIRIE MOUNTAIN, LOCKWOOD, MO:
2,998,758, INT. CL. 25.

PRECIOUS MOMENTS, INC., ST. CHARLES, IL:
1,860,967, CANC. INT. CL. 21.

PRECIOUS PREEMIES, INC., CHICAGO, IL:
2,997,357, PUB. 6-28-2005. INT. CL. 25.

PRECISION DEVICES, INC., MIDDLETON, WI:
2,200,869, CANC. INT. CL. 9.

PRECISION TECHNOLOGY LLC, MEMPHIS, TN:
2,996,388, PUB. 6-28-2005. INT. CL. 2.

PRELUDE PLASTIC PRODUCTS CORP., WINDSOR, ONTARIO N9J 3E5, CANADA:
2,201,166, CANC. INT. CL. 40.

PREMIER CHEMICALS, LLC, KING OF PRUSSIA, PA:
1,830,972, REN. 8-11-05. INT. CL. 1.

PREMIERE LOCK COMPANY LLC, TULSA, OK:
2,997,699, PUB. 6-28-2005. MULTIPLE CLASS, INT. CLS. 6
AND 21.

PREMIUM WATERS, INC., MINNEAPOLIS, MN:
2,997,450, PUB. 6-28-2005. INT. CL. 40.

PREPARED FOODS, INC., EL PASO, TX:
1,302,898, CANC. INT. CL. 29.
1,302,899, CANC. INT. CL. 29.

PRESCOTT, CORRIE D., APO, AE:
2,996,761, PUB. 6-28-2005. INT. CL. 16.

PRESENCIA HILATURAS, S. A., 46600 ALCIRA (VALENCIA), SPAIN:
2,996,312, PUB. 6-28-2005. INT. CL. 23.

PRESIDENT RIVERBOAT CASINO-MISSOURI, INC., ST. LOUIS, MO, PRESIDENT RIVERBOAT CASINOS, INC., DAVENPORT, IA:
1,905,152, REN. 8-11-05. INT. CL. 41.
1,905,166, REN. 8-11-05. INT. CL. 41.

PRESIDENT RIVERBOAT CASINO-MISSOURI, INC., ST. LOUIS, MO, PRESIDENT CASINOS, INC., DAVENPORT, IA:
1,908,936, REN. 8-11-05. INT. CL. 41.

PRICEWATERHOUSECOOPERS LLP, LONDON WC2N 6RH, ENGLAND:
2,996,345, PUB. 6-28-2005. MULTIPLE CLASS, INT. CLS.
35 AND 36.

PRIDE MOBILITY PRODUCTS CORPORATION, EXETER, PA:
2,996,410, PUB. 6-28-2005. INT. CL. 9.

- PRIMAGEN HOLDING B.V., 1105 BA AMSTERDAM, NETHERLANDS:
2,996,941, PUB. 6-28-2005. MULTIPLE CLASS, INT. CLS. 1 AND 5.
- PRIME NOVELTY, L.L.C., PORT NECHES, TX:
2,998,693, INT. CL. 28.
- PRIMESIGHT, SAN FRANCISCO, CA:
2,202,209, CANC. INT. CL. 16.
- PRIMESTAR REALTY, LLC., MESA, AZ:
2,999,243, INT. CL. 36.
- PRINCE HOTELS, INC., SHIBUYA-KU TOKYO, JAPAN:
1,303,214, CANC. INT. CL. 42.
- PRINCE, JEANNETTE, CARDIFF BY THE SEA, CA:
2,999,359, INT. CL. 20.
- PRINCETON ENTERPRISES LTD, LLC, NEWBURY, OH:
2,997,320, PUB. 6-28-2005. INT. CL. 35.
- PRINTABLE TECHNOLOGIES, INC., SOLANA BEACH, CA:
2,997,083, PUB. 6-28-2005. INT. CL. 41.
- PRIVATEBANCORP, INC., CHICAGO, IL:
2,997,630, PUB. 6-28-2005. INT. CL. 36.
2,997,631, PUB. 6-28-2005. INT. CL. 36.
- PRL USA HOLDINGS, INC., WILMINGTON, DE, POLO RALPH LAUREN, L.P., NEW YORK, NY:
1,891,143, REN. 8-11-05. INT. CL. 25.
- PRO-TECH ARMORED PRODUCTS OF MASSACHUSETTS, INC., JACKSONVILLE BEACH, FL:
2,999,353, INT. CL. 6.
- PROBIND, INC., BEVERLY, MA:
2,997,462, PUB. 6-28-2005. INT. CL. 7.
- PROCESADORA PALMA S.A. DE C.V., MONTERREY N.L. C.P. 64988, MEXICO:
2,200,910, CANC. INT. CL. 29.
2,200,911, CANC. INT. CL. 29.
2,200,987, CANC. INT. CL. 29.
- PROCESS CONTROL SYSTEMS, INC., CHASKA, MN:
1,921,540, REN. 8-11-05. INT. CL. 9.
- PROCOVAL USA, LLC, WESTON, FL:
2,999,003, INT. CL. 25.
- PROCTOR, PATRICK E., BARSTOW, CA:
2,997,773, PUB. 6-28-2005. INT. CL. 9.
- PRODUCTIVE SOLUTIONS INC, NEENAH, WI, MENASHA CORPORATION, NEENAH, WI:
1,930,710, REN. 8-12-05. INT. CL. 7.
- PROFESSIONAL ASSOCIATION OF VOLLEYBALL OFFICIALS, OXFORD, KS:
2,996,929, PUB. 6-28-2005. INT. CL. 25.
- PROFESSIONAL COIN GRADING SERVICE, INC., NEWPORT BEACH, CA TO COLLECTORS UNIVERSE, INC., NEWPORT BEACH, CA:
1,860,968, CANC. MULTIPLE CLASS, INT. CLS. 21 AND 36.
- PROFESSIONAL LACROSSE PLAYERS' ASSOCIATION, NEWPORT, RI:
2,996,652, PUB. 6-28-2005. INT. CL. 25.
- PROFILE MARKETING CONCEPTS, INC., PRINCETON, NJ:
2,999,350, INT. CL. 41.
- PROFILE RESPIRATORY SYSTEMS LIMITED, WEST SUSSEX, UNITED KINGDOM:
2,998,519, INT. CL. 10.
- PROFITPOINT, INC., FRANKLIN, TN:
2,996,854, PUB. 6-28-2005. INT. CL. 36.
2,996,855, PUB. 6-28-2005. INT. CL. 36.
- PROFORMA, INC., CLEVELAND, OH:
1,922,392, REN. 8-10-05. INT. CL. 35.
- PROGENESIS, INC., JEFFERSON CITY, MO:
2,998,512, INT. CL. 42.
- PROGRESSIVE CASUALTY INSURANCE COMPANY, MAYFIELD VILLAGE, OH:
2,997,823, PUB. 6-28-2005. INT. CL. 36.
2,997,826, PUB. 6-28-2005. INT. CL. 36.
- PROGRESSIVE POWER YOGA, INC., WOODLAND HILLS, CA:
2,996,721, PUB. 6-28-2005. MULTIPLE CLASS, INT. CLS. 9, 35 AND 41.
- PROGRESSIVE TOOL & INDUSTRIES COMPANY, SOUTHFIELD, MI:
1,867,774, REN. 8-9-05. INT. CL. 35.
- PROJECT STRATEGIX, LLC, ROSLYN, NY:
2,997,741, PUB. 6-28-2005. INT. CL. 41.
- PROMARK BRANDS INC., MERIDIAN, ID, FOOD SERVICE PRODUCTS COMPANY, OAKLAND, CA:
1,867,119, REN. 8-12-05. INT. CL. 30.
- PROMARK INTERNATIONAL, INC., BOISE, ID:
2,206,184, CANC. INT. CL. 31.
- PROMEGA CORPORATION, MADISON, WI:
1,979,703, REN. 8-11-05. INT. CL. 1.
- PROMO INK, NEW YORK, NY:
2,999,203, INT. CL. 35.
- PROMORADI/O, INC., LAS VEGAS, NV:
2,201,133, CANC. INT. CL. 9.
- PROMOS TECHNOLOGIES INC., HSINCHU, TAIWAN:
2,997,130, PUB. 6-28-2005. INT. CL. 9.
- PROTEC MICROSYSTEMS INC., POINTE CLAIRE, PROVINCE OF QUEBEC, CANADA:
1,861,357, CANC. INT. CL. 9.
- PROTECH CHIMIE LTEE/PROTECH CHEMICALS LTD., SAINT LAURENT, QUEBEC, CANADA:
2,997,781, PUB. 6-28-2005. INT. CL. 2.
- PROTECTIVE COATINGS TECHNOLOGIES INC, MENO-MONIE, WI:
2,998,282, PUB. 6-28-2005. INT. CL. 40.
2,998,283, PUB. 6-28-2005. INT. CL. 40.
- PROTECTIVE STRUCTURES, LTD., ROSWELL, GA:
2,999,266, INT. CL. 19.
- PROVEN WINNERS NORTH AMERICA LLC, CAMPBELL, CA:
2,996,568, PUB. 6-28-2005. INT. CL. 21.
- PROVENIO SOFTWARE CORPORATION, TORONTO, ONTARIO, CANADA:
2,997,917, PUB. 6-28-2005. INT. CL. 9.
- PROXIMO RESTAURANTS LLC, WASHINGTON, DC:
2,998,210, PUB. 6-28-2005. INT. CL. 43.
- PRT GROUP INC., NEW YORK, NY:
2,202,217, CANC. INT. CL. 42.
- PRUDENTIAL INSURANCE COMPANY OF AMERICA, THE, NEWARK, NJ:
1,861,174, CANC. INT. CL. 36.
- PRYM-DRITZ CORPORATION, SPARTANBURG, SC:
2,998,717, MULTIPLE CLASS, INT. CLS. 8, 9 AND 26.
- PSE, INC., BELLEVILLE, MI:
1,302,455, CANC. INT. CL. 9.
- PSS WORLD MEDICAL, INC., JACKSONVILLE, FL:
2,997,937, PUB. 6-28-2005. INT. CL. 35.
- PUBLIC ENERGY PARTNERS, ATLANTA, GA:
2,201,135, CANC. INT. CL. 42.
- PUBLISHERS WEST, INC., SCOTTSDALE, AZ:
2,201,938, CANC. INT. CL. 16.
- PULL-A-PART, INC., NORCROSS, GA:
2,763,465, COR. MULTIPLE CLASS, INT. CLS. 35 AND 39.
2,818,800, COR. MULTIPLE CLASS, INT. CLS. 35 AND 39.
- PUNCH FITNESS, INC., MIAMI BEACH, FL:
2,999,227, INT. CL. 28.
2,999,228, INT. CL. 28.
- PURE & SIMPLE CLOTHING INC., MONTREAL, QUEBEC H2N 2J9, CANADA:
2,996,634, PUB. 6-28-2005. INT. CL. 25.
- PURINA MILLS, LLC, ST. LOUIS, MO, RALSTON PURINA COMPANY, ST. LOUIS, MO:
1,357,591, REN. 8-11-05. INT. CL. 5.
- PURPLE BOOK, LLC, THE, BEVERLY HILLS, CA:
2,998,531, INT. CL. 35.
- PURSELL TECHNOLOGIES, INC., SYLACAUGA, AL:
2,996,289, PUB. 6-28-2005. MULTIPLE CLASS, INT. CLS. 1 AND 40.
- PUSHPA AMERICA CORPORATION, TORRANCE, CA:
1,860,592, CANC. INT. CL. 1.
- PUTNAM COMPANY, INC., WALWORTH, WI:
1,861,038, CANC. INT. CL. 28.
- PUYALLUP VALLEY DAFFODIL FESTIVAL, TACOMA, WA:
1,888,916, REN. 8-6-05. INT. CL. 41.

PYRAMID DIGITAL SOLUTIONS, INC., BIRMINGHAM, AL:
2,200,964, CANC. INT. CL. 9.

QLOGIC CORPORATION, ALISO VIEJO, CA:
2,999,038, INT. CL. 9.

QRS, INC., KNOXVILLE, TN:
2,996,233, PUB. 6-28-2005. INT. CL. 9.

QUAKER STATE CORPORATION, OIL CITY, PA:
2,200,815, CANC. INT. CL. 4.

QUAKER STATE CORPORATION, IRVING, TX:
2,200,817, CANC. INT. CL. 4.

QUAKER STATE CORPORATION, IRVING, TX:
2,202,311, CANC. MULTIPLE CLASS, INT. CLS. 6, 16, 21, 25 AND 28.

QUALCOMM INCORPORATED, SAN DIEGO, CA:
2,998,328, PUB. 6-28-2005. INT. CL. 35.

QUALITY LIVING INC., OMAHA, NE:
2,996,726, PUB. 6-28-2005. INT. CL. 44.

QUALLO, DENNIS E., BKLYN, NY:
2,997,182, PUB. 6-28-2005. INT. CL. 41.

QUANTEX CORPORATION, ISELIN, NJ:
1,303,086, CANC. MULTIPLE CLASS, INT. CLS. 36 AND 42.

QUANTOMIX LTD., NES ZIONA 70400, ISRAEL:
2,997,078, PUB. 6-28-2005. INT. CL. 9.

QUEST DAY OR NIGHT MOVES, INC., NEPTUNE BEACH, FL:
2,999,380, INT. CL. 39.

QUILL, JAMES, BEVERLY HILLS, CA:
2,997,662, PUB. 6-28-2005. INT. CL. 41.

QUINNCORP PTY LTD, KILKENNY 5 009, STATE OF SOUTH AUSTRALIA, AUSTRALIA:
2,200,980, CANC. INT. CL. 9.

QVC, INC., WEST CHESTER, PA:
2,999,055, MULTIPLE CLASS, INT. CLS. 7, 8, 11 AND 21.

Q1 SOLUTIONS, THOUSAND OAKS, CA:
2,997,718, PUB. 6-28-2005. INT. CL. 9.

R & M GOLF COMPANY, ORLANDO, FL, DBA TRIUMPH GOLF COMPANY TO LASALLE NATIONAL BANK, CHICAGO, IL:
1,861,050, CANC. INT. CL. 28.

R & R BOURBON STREET, INC., SAN LUIS OBISPO, CA:
1,302,975, CANC. INT. CL. 30.

R. J. GROUX CORPORATION, SANTA ANA, CA:
2,201,209, CANC. MULTIPLE CLASS, INT. CLS. 30 AND 32.

R. J. WALLACE & ASSOC., INC., TWIN LAKES, CO:
1,966,950, REN. 8-8-05. INT. CL. 39.

R.L. DRAKE COMPANY, FRANKLIN, OH:
2,996,788, PUB. 6-28-2005. INT. CL. 9.

R.V. INDUSTRIES, INC., DORAVILLE, GA:
1,341,107, REN. 8-11-05. INT. CL. 29.

R-OBJECTS INC., SUNNYVALE, CA:
2,997,110, PUB. 6-28-2005. INT. CL. 9.

R/D TECH INC., QUEBEC (QUEBEC), CANADA:
2,996,329, PUB. 6-28-2005. INT. CL. 9.

RADIANT INTERACTIVE, INC., SAN FRANCISCO, CA:
2,997,203, PUB. 6-28-2005. INT. CL. 41.

RADICA GAMES LTD., HAMILTON HM11, BERMUDA:
2,996,599, PUB. 6-28-2005. INT. CL. 28.

RADICAL MOODSWINGER MUSIC, VENICE, CA, DBA CRYPTOGRAMOPHONE:
2,998,255, PUB. 6-28-2005. INT. CL. 9.

RADICE MARZIO E GIANLUCA S.N.C., CUCCIAGO, ITALY:
1,337,450, REN. 8-10-05. INT. CL. 34.

RADIO CITY TRADEMARK, LLC, NEW YORK, NY, ROCKEFELLER GROUP, INC., NEW YORK, NY:
1,860,442, REN. 8-9-05. INT. CL. 28.

RAGLAND, CARY, FORT WORTH, TX:
2,997,643, PUB. 6-28-2005. INT. CL. 41.

RAHIMI, AFSHIN DAVID, LOS ANGELES, CA:
2,998,179, PUB. 6-28-2005. INT. CL. 44.

RAINOSEK; GILBERT D., SAN MARCOS, TX, DBA GIL'S BROILER:
1,302,941, CANC. INT. CL. 30.

RAISIN SOCIAL LIMITED, GODSTONE, SURREY, UNITED KINGDOM:
2,996,903, PUB. 6-28-2005. MULTIPLE CLASS, INT. CLS. 33 AND 35.

RAJAGOPAL, PADMANABHAHPOTTI, MYLAPORE, CHENNAI, INDIA:
2,997,065, PUB. 6-28-2005. INT. CL. 43.

RAJOTTE; JACQUES R., HOOD RIVER, OR:
1,342,019, REN. 8-10-05. INT. CL. 6.

RALEY'S TM, INC., WEST SACRAMENTO, CA:
2,997,810, PUB. 6-28-2005. INT. CL. 35.

RALPH KORTE, INC., HIGHLAND, IL:
1,303,155, CANC. INT. CL. 41.

RALPHS GROCERY COMPANY, LOS ANGELES, CA:
2,055,846, CANC. INT. CL. 9.

RALSTON PURINA COMPANY, ST. LOUIS, MO:
2,201,794, CANC. INT. CL. 31.

RAM SYSTEMS, INC., LACROSSE, WI:
2,996,330, PUB. 6-28-2005. INT. CL. 42.

RAMIREZ, RICARDO, LOS ANGELES, CA:
2,998,069, PUB. 6-28-2005. INT. CL. 25.

RAMPONA, DOUGLAS M., VIRGINIA BEACH, VA:
2,997,653, PUB. 6-28-2005. INT. CL. 44.

RAPID DISPLAYS, INC., CHICAGO, IL:
2,202,297, CANC. INT. CL. 16.

RAPPAPORT, ALEXANDER, SAN FRANCISCO, CA:
2,999,267, INT. CL. 9.

RASMUSSEN, MICHELLE D., TEMECULA, CA:
2,997,546, PUB. 6-28-2005. INT. CL. 36.

RAVIZZA MAURO, ITALY:
2,998,458, PUB. 6-28-2005. MULTIPLE CLASS, INT. CLS. 18 AND 25.

RAYMOND ENGINEERING INC., MIDDLETOWN, CT:
997,547, CANC. U.S. CL. 26.

RAYNOR MARKETING LTD., WEST HEMPSTEAD, NY, DBA THE RAYNOR GROUP:
2,997,949, PUB. 6-28-2005. INT. CL. 20.

RC IMPORT-EXPORT GMBH, 90571 SCHWAIG B. NURNBERG, FED REP GERMANY:
2,826,870, CANC. INT. CL. 33.

RC IMPORTS, SAN JOSE, CA:
2,996,592, PUB. 6-14-2005. INT. CL. 28.

RDG CHICAGO TRADEMARK CO., GLENVIEW, IL:
1,981,523, AM. INT. CL. 42.

REACH MEDIA, INC., DALLAS, TX:
2,999,383, MULTIPLE CLASS, INT. CLS. 35, 36, 38, 41, 44 AND 45.

REAL DIGITAL MEDIA, LLC, SARASOTA, FL:
2,996,760, PUB. 6-28-2005. INT. CL. 9.

REAL MARKET EXPERTS FRANCHISE, INC., THE, SCOTTSDALE, AZ:
2,999,120, INT. CL. 35.

REALBID, LLC, LARKSPUR, CA:
2,201,095, CANC. INT. CL. 35.

REALLEGAL, LLC, AURORA, CO:
2,999,377, INT. CL. 39.

REALLY USEFUL GROUP LIMITED, THE, LONDON, WC2H 9NS, UNITED KINGDOM:
2,201,573, CANC. INT. CL. 15.

REALPAGE, INC., CARROLLTON, TX:
2,997,070, PUB. 6-28-2005. MULTIPLE CLASS, INT. CLS. 35 AND 38.

REALTYTEAM.COM, INC, BRADENTON, FL:
2,997,086, PUB. 6-28-2005. INT. CL. 36.

RECKITT & COLMAN INC., MONTVALE, NJ:
2,202,093, CANC. INT. CL. 30.

RECKITT BENCKISER INC., PARSIPPANY, NJ:
2,997,491, PUB. 6-28-2005. INT. CL. 5.

2,999,074, MULTIPLE CLASS, INT. CLS. 3, 5 AND 11.

RECREATIONAL WATER TECHNOLOGIES, LLC, WEST PALM BEACH, FL:
2,998,346, PUB. 6-28-2005. INT. CL. 1.

RED EARTH LICENSING LIMITED, TORTOLA, BR. VIRGIN ISLANDS:
2,201,569, CANC. MULTIPLE CLASS, INT. CLS. 3, 25 AND 31.

RED SPADE, CHICAGO, IL:
2,998,263, PUB. 6-28-2005. INT. CL. 35.

- REDBURN PARTNERS LLP, LONDON, UNITED KINGDOM:
2,998,390, PUB. 6-28-2005. INT. CL. 36.
- REDCATS USA, L.P., INDIANAPOLIS, IN:
2,998,863, MULTIPLE CLASS, INT. CLS. 25 AND 35.
- REDCLIFFE LIMITED, BRISLINGTON, BRISTOL BS4 5PS, UNITED KINGDOM:
2,996,251, PUB. 6-28-2005. MULTIPLE CLASS, INT. CLS. 6, 9 AND 20.
- REDI2 TECHNOLOGIES, INC., OAKLAND, CA:
2,997,745, PUB. 6-28-2005. INT. CL. 9.
- REDLIGHT BEER LIMITED, UNITED KINGDOM:
2,998,477, PUB. 6-28-2005. INT. CL. 32.
- REED PUBLISHING (NEDERLAND) B.V., 1061 AG, AMSTERDAM, NETHERLANDS:
2,200,965, CANC. INT. CL. 42.
- REED, DONALD K., SR., NEW HYDE PARK, NY:
2,997,618, PUB. 6-28-2005. INT. CL. 41.
- REFLECTIONS INTERACTIVE LIMITED, NEWCASTLE UPON TYNE NE1 2AZ, UNITED KINGDOM:
2,999,363, INT. CL. 9.
- REFRATECHNIK HOLDING GMBH, 85737 ADALPEROSTRASSE, FED REP GERMANY:
1,355,378, REN. 8-11-05. INT. CL. 19.
- REGAL CINEMEDIA CORPORATION, ENGLEWOOD, CO:
2,998,582, MULTIPLE CLASS, INT. CLS. 35, 41 AND 43.
- REGAL-BELOIT CORPORATION, BELOIT, WI:
2,998,965, INT. CL. 7.
- REGENAT USA HOLDING CORP., GREENWICH, CT:
2,998,639, MULTIPLE CLASS, INT. CLS. 37 AND 40.
- REGIONAL CLAIM SERVICES, INC., PEOTONE, IL:
2,201,075, CANC. INT. CL. 36.
- REGIONAL NETWORK COMMUNICATIONS, INC., BETHLEHEM, PA:
2,202,372, CANC. MULTIPLE CLASS, INT. CLS. 35 AND 42.
- REHABVISIONS, INC., OMAHA, NE:
1,949,555, REN. 8-12-05. INT. CL. 42.
- REICH SPEZIALMASCHINEN GMBH, D-72622 NURTINGEN, FED REP GERMANY, REICH, KARL M., NURTINGEN, FED REP GERMANY:
1,023,474, REN. 8-11-05. MULTIPLE CLASS, U.S. CLS. 13 (INT. CL. 6) AND 23 (INT. CL. 7).
- REINHART FOODSERVICE, L.L.C., LA CROSSE, WI:
2,998,845, INT. CL. 29.
- REITER'S BEER DISTRIBUTORS, BROOKLYN, NY:
779,581, CANC. U.S. CL. 48.
- REIZ, IRA, SILVER SPRING, MD:
2,996,572, PUB. 6-28-2005. INT. CL. 10.
- RELIANCE ROLOCATIN SERVICES, INC., CHICAGO, IL:
1,010,038, REN. 8-11-05. INT. CL. 35.
- REMAX VOGUE REALTY, INC., HOLLAND, MI:
2,999,096, INT. CL. 41.
- REMINGTON STOP SMOKING CENTER, LLC., ALPHARETTA, GA, DBA ANNE PENMAN LASER THERAPY:
2,998,761, INT. CL. 44.
- REMOTE ACCESS TECHNOLOGY, RODEO, CA:
2,997,226, PUB. 6-28-2005. INT. CL. 42.
- REMY INC., ANDERSON, IN:
2,998,703, INT. CL. 7.
2,998,704, INT. CL. 7.
2,998,705, INT. CL. 7.
- RENFRO SAVANNAH DEVELOPMENT, LLC, COLUMBUS, IN:
2,997,961, PUB. 6-28-2005. INT. CL. 37.
- RENNIE, PETER CAMPBELL, SOUTH MELBOURNE VICTORIA 3205, AUSTRALIA:
2,201,682, CANC. INT. CL. 41.
- RENSSELAER POLYTECHNIC INSTITUTE, TROY, NY, DBA RPI:
1,341,534, REN. 8-10-05. INT. CL. 41.
- RENTECH BOILER SYSTEMS, INC., ABILENE, TX:
2,200,922, CANC. INT. CL. 11.
- REPUBLIC SHEET METAL AND MANUFACTURING CO., INC., DALLAS, TX, DBA REPUBLIC SALES & MANUFACTURING:
2,996,738, PUB. 6-28-2005. INT. CL. 7.
- REPUBLICAN STATE LEADERSHIP COMMITTEE, WASHINGTON, DC:
2,999,361, INT. CL. 35.
- RESCO PRODUCTS, INC., PITTSBURGH, PA:
2,997,772, PUB. 6-28-2005. INT. CL. 19.
- RESCUE TECHNOLOGY INC., LARCHMONT, NY:
1,906,037, REN. 8-10-05. INT. CL. 41.
- RESOLUTION HEALTH, INC., SAN JOSE, CA:
2,997,447, PUB. 6-28-2005. INT. CL. 44.
- RESORTQUEST INTERNATIONAL, INC., DESTIN, FL:
2,998,014, PUB. 6-28-2005. INT. CL. 35.
2,998,070, PUB. 6-28-2005. INT. CL. 42.
2,998,321, PUB. 6-28-2005. INT. CL. 36.
- RESOURCE RX, INC., WASHINGTON, DC:
2,201,008, CANC. INT. CL. 35.
- RESPONSE DESIGN CORPORATION, OCEAN CITY, NJ:
1,900,822, REN. 8-9-05. INT. CL. 35.
- RESTAURANTS LES PRES (CANADA) LTEE, CHOMEDEY, LAVAL, PROVINCE OF QUEBEC, CANADA:
1,303,205, CANC. INT. CL. 42.
- RESTORE MEDIA LLC, WASHINGTON, DC:
2,999,233, INT. CL. 16.
- RESULTANT CONSULTING GROUP, LLC, KIRKLAND, WA:
2,998,253, PUB. 6-28-2005. INT. CL. 35.
- RETAIL BRAND ALLIANCE, INC., ENFIELD, CT:
1,302,754, CANC. INT. CL. 25.
- RETAIL FORWARD, INC., COLUMBUS, OH:
2,997,876, PUB. 6-28-2005. INT. CL. 35.
- REVIVE PARTNERS, LLC, LAS VEGAS, NV:
2,998,163, PUB. 6-28-2005. INT. CL. 9.
- REVLON CONSUMER PRODUCTS CORPORATION, NEW YORK, NY:
2,996,894, PUB. 6-28-2005. INT. CL. 3.
- REX MEDICAL, L.P., RADNOR, PA:
2,998,529, INT. CL. 10.
- REXUS CORP., CITY OF INDUSTRY, CA:
2,996,872, PUB. 6-28-2005. INT. CL. 9.
- REYNOLDS AND REYNOLDS HOLDINGS, INC., KETTERING, OH, HALF-A-CAR COMPANY, WYNNEWOOD, PA:
1,900,126, REN. 8-11-05. INT. CL. 39.
- REYNOLDS AND REYNOLDS HOLDINGS, INC., KETTERING, OH:
2,997,228, PUB. 6-28-2005. INT. CL. 42.
2,997,229, PUB. 6-28-2005. INT. CL. 9.
- REZAC, DARCY E., VANCOUVER, BRITISH COLUMBIA, CANADA:
2,996,331, PUB. 6-28-2005. MULTIPLE CLASS, INT. CLS. 9, 16, 35 AND 41.
2,996,332, PUB. 6-28-2005. MULTIPLE CLASS, INT. CLS. 9, 16, 35 AND 41.
- RF TECHNOLOGIES, INC., BROOKFIELD, WI:
1,943,970, REN. 8-9-05. INT. CL. 9.
- RFR MANAGEMENT LLC, NEW YORK, NY:
2,998,744, INT. CL. 25.
2,998,834, MULTIPLE CLASS, INT. CLS. 20 AND 24.
- RICE, JOHN T., RALEIGH, NC:
2,998,541, INT. CL. 42.
- RICH PRODUCTS CORPORATION, BUFFALO, NY:
2,999,254, INT. CL. 30.
- RICH. HENGSTENBERG GMBH & CO. KG, FED REP GERMANY:
2,998,422, PUB. 6-28-2005. INT. CL. 29.
- RICH, JEFFREY S., NEW YORK, NY:
2,202,161, CANC. INT. CL. 1.
- RICHARDS DISTRIBUTING, INC., MELBOURNE, FL:
2,996,750, PUB. 6-28-2005. INT. CL. 3.
- RICHARDSON, HAMISH, BURBANK, CA AND RICHARDSON, ANGUS, BURBANK, CA:
2,996,409, PUB. 6-28-2005. INT. CL. 41.
- RICHEMONT INTERNATIONAL SA, CH-1752 VILLARSUR-GLÜNE, SWITZERLAND:
2,998,448, PUB. 6-28-2005. INT. CL. 14.
- RICHEMONT INTERNATIONAL SA, SWITZERLAND:
2,998,470, PUB. 6-28-2005. INT. CL. 14.
- RICHFIELD TRAILER SUPPLY & DISTRIBUTORS, INC., FLINT, MI:
1,016,576, REN. 8-10-05. U.S. CL. 101 (INT. CL. 35).

- RICHMOND GOLF CORP., RANCHO SANTA FE, CA:
2,997,659, PUB. 6-28-2005. INT. CL. 28.
- RICK'S RODS, DENVER, CO:
2,202,395, CANC. INT. CL. 28.
- RIDCO, INC., RAPID CITY, SD:
2,201,182, CANC. INT. CL. 14.
- RIDGE VINEYARDS, INC., CUPERTINO, CA:
1,341,367, REN. 8-9-05. INT. CL. 33.
- RIGAKU INDUSTRIAL CORPORATION, OSAKA 569-1146, JAPAN:
2,998,822, INT. CL. 9.
- RIGGS NATIONAL CORPORATION, WASHINGTON, DC:
2,201,902, CANC. INT. CL. 36.
2,201,903, CANC. INT. CL. 36.
2,202,046, CANC. INT. CL. 36.
- RIGHTCHOICE MANAGED CARE, INC., ST. LOUIS, MO, DBA BLUE CROSS/BLUE SHIELD OF MISSOURI:
2,201,715, CANC. INT. CL. 35.
- RING'S STUDIO GUN RENTAL, INC., MELBOURNE, FL, DBA RING'S MANUFACTURING:
2,997,178, PUB. 6-28-2005. INT. CL. 13.
- RINGERS RESOURCE, INC., MOORPARK, CA:
2,996,373, PUB. 6-28-2005. INT. CL. 25.
2,996,374, PUB. 6-28-2005. INT. CL. 9.
- RIPPLES TRADING CO., LTD., WOODRIDGE, NY:
2,201,760, CANC. INT. CL. 29.
- RITAM INTERNATIONAL LTD., FAIRFIELD, IA:
1,302,817, CANC. INT. CL. 28.
1,302,818, CANC. INT. CL. 28.
- RITTAL GMBH & CO., 35745 HERBORN, FED REP GERMANY:
2,998,862, MULTIPLE CLASS, INT. CLS. 6 AND 9.
- RIVERDEEP INTERACTIVE LEARNING LIMITED, DUBLIN 2, IRELAND:
2,998,655, INT. CL. 16.
- RIVERHILLSOFT INC., FUKUOKA-SHI, FUKUOKA 810, JAPAN:
2,202,079, CANC. INT. CL. 9.
- RIVERLINK, INC., RED WING, MN:
2,996,647, PUB. 6-28-2005. INT. CL. 9.
- RIVERMINE SOFTWARE, INC., FAIRFAX, VA:
2,999,111, MULTIPLE CLASS, INT. CLS. 9 AND 42.
- RIVERTOWN TRADING COMPANY, ST. PAUL, MN:
2,201,344, CANC. MULTIPLE CLASS, INT. CLS. 21 AND 30.
- RLC, LLC, TULSA, OK:
2,997,233, PUB. 6-28-2005. MULTIPLE CLASS, INT. CLS. 9 AND 16.
- RLIS, INC., SAN ANTONIO, TX:
2,201,799, CANC. INT. CL. 9.
- ROADWAY PACKAGE SYSTEM, INC., PITTSBURGH, PA TO FEDEX GROUND PACKAGE SYSTEM, INC., MOON TOWNSHIP, PA:
1,860,784, CANC. INT. CL. 9.
- ROARK, JOYCE A., AVILA BEACH, CA:
1,900,571, REN. 8-10-05. INT. CL. 14.
- ROB GOLDMAN, INC., HUNTINGTON, NY:
2,997,756, PUB. 6-28-2005. INT. CL. 41.
- ROBBINS RESEARCH INTERNATIONAL, INC., SAN DIEGO, CA, ROBBINS, ANTHONY J., SAN DIEGO, CA:
1,845,517, REN. 8-10-05. INT. CL. 9.
- ROBBINS-GIOIA, LLC, ALEXANDRIA, VA:
2,999,304, INT. CL. 16.
- ROBERT A. CLAIR COMPANY, INC., NEW YORK, NY:
1,302,757, CANC. INT. CL. 25.
- ROBERTS IRRIGATION PRODUCTS, INC., SAN MARCOS, CA:
1,382,208, REN. 8-10-05. INT. CL. 11.
- ROBERTS, LINDA, NASHVILLE, TN:
2,997,425, PUB. 6-28-2005. INT. CL. 43.
- ROBIN AGENCY, INC., THE, OKLAHOMA CITY, OK, DBA REDI-INFO INFORMATION SERVICE:
2,200,920, CANC. MULTIPLE CLASS, INT. CLS. 35 AND 42.
- ROBINSON, BYRON M SR., SOPERTON, GA AND HARPER, TALLY S, SOPERTON, GA:
2,999,046, INT. CL. 35.
- ROBLES, CARLOS ALBERTO, LOS ANGELES, CA:
2,999,221, INT. CL. 25.
- ROBOT PUMPS B.V., 2404 CC ALPHEN A/D RIJN, NETHERLANDS:
1,340,065, REN. 8-9-05. MULTIPLE CLASS, INT. CLS. 7 AND 11.
- ROCHE THERAPEUTICS INC., NUTLEY, NJ:
2,997,808, PUB. 6-28-2005. INT. CL. 44.
- ROCKFORD CORPORATION, TEMPE, AZ:
2,997,358, PUB. 6-28-2005. INT. CL. 9.
- ROCKLAND INDUSTRIES, INC., BALTIMORE, MD:
2,998,006, PUB. 6-28-2005. INT. CL. 24.
- ROCKLER COMPANIES, INC., MEDIA, MN:
2,999,341, MULTIPLE CLASS, INT. CLS. 35 AND 41.
- ROCKMOUNT RANCH WEAR MANUFACTURING COMPANY, DENVER, CO:
1,894,146, REN. 8-12-05. INT. CL. 25.
- RODALE INC., EMMAUS, PA:
2,997,600, PUB. 6-28-2005. MULTIPLE CLASS, INT. CLS. 16 AND 41.
2,997,681, PUB. 6-28-2005. INT. CL. 16.
- RODLU INC, HENDERSON, NV:
2,997,598, PUB. 6-28-2005. INT. CL. 43.
- ROGERS BLUE JAYS BASEBALL PARTNERSHIP, TORONTO, ONTARIO, CANADA:
2,999,027, INT. CL. 41.
2,999,028, INT. CL. 41.
- ROGERS BLUE JAYS BASEBALL PARTNERSHIP, TORONTO, CANADA:
2,999,030, INT. CL. 41.
- ROHM AND HAAS COMPANY, PHILADELPHIAPENN, PA:
1,325,227, REN. 8-11-05. INT. CL. 1.
- ROLAND CORPORATION, OSAKA 530-0002, JAPAN:
2,996,704, PUB. 6-28-2005. INT. CL. 9.
- ROLLE, BYRON KATIE, BARSTOW, CA:
2,201,121, CANC. INT. CL. 41.
- ROMINE-KANTOR, MARIA B., ST. CHARLES, MO:
2,997,954, PUB. 6-28-2005. INT. CL. 41.
- RON BARTKOWSKI & ASSOCIATES, INC., WHEATON, IL:
2,202,359, CANC. INT. CL. 35.
- RONCO INVENTIONS, LLC, CHATSWORTH, CA:
2,998,504, INT. CL. 9.
- ROPINTASSCO 5, LLC, DULUTH, GA:
2,200,822, CANC. INT. CL. 9.
- ROSCO INC., JAMAICA, NY:
2,999,061, INT. CL. 12.
2,999,062, INT. CL. 12.
- ROSCO MACHINERY CO., INC., LOS ANGELES, CA:
1,901,470, REN. 8-9-05. MULTIPLE CLASS, INT. CLS. 7 AND 11.
1,905,322, REN. 8-10-05. MULTIPLE CLASS, INT. CLS. 7 AND 11.
1,905,323, REN. 8-10-05. MULTIPLE CLASS, INT. CLS. 7 AND 11.
- ROSE ART INDUSTRIES, INC., LIVINGSTON, NJ:
2,999,095, INT. CL. 16.
- ROSEN & ROSEN INDUSTRIES, INC., SAN CLEMENTE, CA:
1,302,800, CANC. INT. CL. 28.
- ROSENBERG, CABLE, CHANDLER, AZ:
2,996,381, PUB. 6-28-2005. INT. CL. 41.
- ROSENBERG, STEPHEN MARK, WARNER ROBINS, GA:
2,997,474, PUB. 6-28-2005. INT. CL. 36.
- ROSEVILLE TELEPHONE COMPANY, ROSEVILLE, CA:
2,202,233, CANC. INT. CL. 38.
- ROSEVINE ENTERPRISES, LLC, MARIETTA, GA:
2,996,687, PUB. 6-28-2005. INT. CL. 40.
- ROSS, CELESTINE, BRONX, NY:
2,997,429, PUB. 6-28-2005. INT. CL. 41.
- ROSSEAU INC., KITCHENER, ONTARIO N2C 4G4, CANADA:
1,013,845, REN. 8-11-05. U.S. CL. 46 (INT. CL. 30).
- ROTECH HEALTHCARE INC., ORLANDO, FL:
2,999,261, INT. CL. 44.
- ROTOR CLIP COMPANY, INC., SOMERSET, NJ:
1,358,846, REN. 8-9-05. INT. CL. 6.
- ROTTER, MARTIN J., GLENSIDE, PA:
1,898,563, REN. 8-10-05. INT. CL. 6.

- ROUNDTOP MACHINERY INDUSTRIES CO., LTD., TAI-CHUNG, TAIWAN:
1,898,593. REN. 8-9-05. INT. CL. 7.
- ROUNDY'S, INC., MILWAUKEE, WI:
1,303,015, CANC. INT. CL. 33.
- ROUST TRADING LIMITED, HAMILTON, BERMUDA:
2,998,580, INT. CL. 33.
- ROVCAI, INC., FRESNO, CA:
2,201,679, CANC. INT. CL. 11.
- ROVVINS RESEARCH INTERNATIONAL, INC., SAN DIEGO, CA:
1,840,415. REN. 8-10-05. INT. CL. 9.
- ROWE ENTERPRISES, INC., TUCSON, AZ:
2,997,234, PUB. 6-28-2005. INT. CL. 35.
- ROY L. ESKOW, D.D.S., P.A., BETHESDA, MD, DBA BETHESDA DENTAL IMPLANT CENTER:
2,996,447, PUB. 6-28-2005. INT. CL. 44.
- ROYAL APPLIANCE MFG. CO., CLEVELAND, OH:
2,201,730, CANC. INT. CL. 9.
- ROYAL BODYCARE, INC., IRVING, TX:
2,998,970, INT. CL. 5.
- ROYAL CARIBBEAN CRUISE LINE, INC., MIAMI, FL:
1,303,145, CANC. INT. CL. 39.
- ROYAL FOOD SERVICE CO., INC., FOREST PARK, GA:
2,201,459, CANC. INT. CL. 35.
- ROYAL OAK SALES, INC., ROSWELL, GA, RUTLAND FIRE CLAY COMPANY, RUTLAND, VT:
1,343,749. REN. 8-10-05. INT. CL. 4.
- ROYAL TOBACCO, INC., ARCADIA, CA:
2,996,720, PUB. 6-28-2005. INT. CL. 34.
- RREEF AMERICA L.L.C., CHICAGO, IL:
2,997,564, PUB. 6-28-2005. MULTIPLE CLASS, INT. CLS. 35, 36, 37 AND 42.
- RSC THE QUALITY MEASUREMENT COMPANY, EVANSVILLE, IN:
2,999,153, INT. CL. 35.
- RSR INFORMATION TECHNOLOGY, INC., ST. LOUIS, MO, DBA HEALTHTECH SOLUTIONS:
2,202,041, CANC. INT. CL. 42.
- RUBBER CITY MACHINERY CORP., AKRON, OH:
1,924,101. REN. 8-10-05. INT. CL. 37.
- RUBBERMAID COMMERCIAL PRODUCTS LLC, FREEPORT, IL:
2,998,105, PUB. 6-28-2005. INT. CL. 21.
2,998,892, INT. CL. 12.
- RUBBERMAID COMMERCIAL PRODUCTS LLC, FREEPORT, IL:
2,998,086, PUB. 6-28-2005. INT. CL. 6.
- RUBBERMAID INCORPORATED, WOOSTER, OH:
1,302,659, CANC. INT. CL. 21.
- RUBICOR MEDICAL, INC. REDWOOD CITY, CA:
2,997,615, PUB. 6-28-2005. INT. CL. 10.
- RUBIG GESELLSCHAFT M.B.H. & CO. KG, WELS, AUSTRIA:
2,906,207, COR. INT. CL. 40.
- RUCKUS NETWORK, INC., BOSTON, MA:
2,997,166, PUB. 6-28-2005. INT. CL. 41.
- RUFIN COSMETIC GMBH, FED REP GERMANY:
2,998,363, PUB. 6-28-2005. INT. CL. 3.
- RUGGIERO, CHRISTIAN, NEW YORK, NY AND JASPER, GERMANY, NEW YORK, NY:
2,998,974, INT. CL. 41.
- RURAL ROUTE 1, INC., LIVINGSTON, WI, TRELAY FARMS, INC., LIVINGSTON, WI:
1,918,233. REN. 8-10-05. INT. CL. 30.
- RUSSELL ASSET MANAGEMENT, INC., WILMINGTON, DE:
2,201,586, CANC. INT. CL. 28.
- RUSSELL, GARY F., MYSTIC, CT, LOVE, EVALYN SUE, SCOTSDALE, AZ:
1,880,107. REN. 8-11-05. INT. CL. 41.
- RUSSO, ROBERT M., TAMPA, FL:
2,201,348, CANC. INT. CL. 25.
- RWL CORPORATION, HICKORY, NC, DBA DELSTAR:
1,879,998. REN. 8-6-05. MULTIPLE CLASS, INT. CLS. 35 AND 42.
- RWT CORPORATION, MOUNT PROSPECT, IL:
1,860,703, CANC. INT. CL. 9.
- RYAN & COMPANY, INC., DALLAS, TX AND TECHNOLOGY SOLUTIONS COMPANY, CHICAGO, IL:
2,999,317, INT. CL. 42.
- RYAN, JUDITH BEATTIE, NEW LONDON, OH:
2,201,617, CANC. INT. CL. 16.
- RYOSAN COMPANY LIMITED, CHIYODA-KU, TOKYO, JAPAN:
2,996,574, PUB. 6-28-2005. INT. CL. 9.
- R82 A/S, DENMARK:
2,998,410, PUB. 6-28-2005. MULTIPLE CLASS, INT. CLS. 10 AND 12.
- S B ICE, LLC, MIAMI BEACH, FL:
2,996,566, PUB. 6-28-2005. MULTIPLE CLASS, INT. CLS. 41 AND 43.
- S. B. RESTAURANT CO., GOLETA, CA:
2,997,209, PUB. 6-28-2005. INT. CL. 43.
- S. C. JOHNSON & SON, INC., RACINE, WI:
793,144. REN. 8-10-05. U.S. CL. 4 (INT. CL. 3).
796,887. REN. 8-10-05. U.S. CL. 52 (INT. CL. 3).
- S. C. JOHNSON & SON, INC., RACINE, WI, DOWBRANDS INC., INDIANAPOLIS, IN:
1,897,275. REN. 8-9-05. INT. CL. 5.
- S. C. JOHNSON & SON, INC., RACINE, WI:
1,906,256. REN. 8-10-05. INT. CL. 3.
- S. C. JOHNSON HOME STORAGE, INC., RACINE, WI:
2,999,276, INT. CL. 16.
- S. E. RYKOFF & CO., LOS ANGELES, CA:
779,472, CANC. U.S. CL. 37.
- S. SMITH & SON PTY LTD., AUSTRALIA:
2,998,452, PUB. 6-28-2005. INT. CL. 33.
- S.A. TWINTEC INTERNATIONAL, L-8821 KOETSCHETTE, LUXEMBOURG:
2,997,344, PUB. 6-28-2005. MULTIPLE CLASS, INT. CLS. 6, 19 AND 27.
- S.C. JOHNSON & SON, INC., RACINE, WI:
794,980. REN. 8-10-05. U.S. CL. 4 (INT. CL. 3).
- S.C. ROMAQUA GROUP S.A., ROMANIA:
2,998,426, PUB. 6-28-2005. MULTIPLE CLASS, INT. CLS. 5, 32 AND 35.
- S.E.G., INC., COLUMBUS, GA:
2,202,299, CANC. INT. CL. 28.
2,202,300, CANC. INT. CL. 28.
- S&L SOLUTIONS LLC, LATROBE, WESTMORELAND COUNTY, PA:
2,996,706, PUB. 6-28-2005. INT. CL. 35.
- S&S BRANDS, INC., WILMINGTON, DE:
2,999,245, MULTIPLE CLASS, INT. CLS. 3, 5, 10 AND 16.
- S&W FINE FOODS, INC., SAN MATEO, CA:
1,302,906, CANC. MULTIPLE CLASS, INT. CLS. 29, 30, 31 AND 32.
- SAAB AUTOMOBILE AB, TROLLHATTAN, SWEDEN:
1,008,153. REN. 8-9-05. U.S. CL. 26 (INT. CL. 9).
- SABAN ENTERTAINMENT, INC., LOS ANGELES, CA:
2,201,489, CANC. INT. CL. 28.
2,201,592, CANC. INT. CL. 41.
2,201,726, CANC. INT. CL. 28.
- SABIAN LTD., MEDUCTIC, NEW BRUNSWICK, CANADA:
2,997,365, PUB. 6-28-2005. INT. CL. 15.
- SABMILLER FINANCE B.V., NETHERLANDS:
2,998,392, PUB. 6-28-2005. INT. CL. 32.
2,998,400, PUB. 6-28-2005. INT. CL. 32.
- SACHTLER CORPORATION OF AMERICA, HAUPPAUGE, NY:
1,343,856. REN. 8-11-05. INT. CL. 9.
- SAEILO ENTERPRISES, INC., PEARL RIVER, NY:
2,996,537, PUB. 6-28-2005. INT. CL. 28.
- SAES GETTERS S.P.A., ITALY:
2,998,480, PUB. 6-28-2005. MULTIPLE CLASS, INT. CLS. 6 AND 9.
- SAFE AUTO INSURANCE COMPANY, COLUMBUS, OH, SAFE AUTO INSURANCE AGENCY, INC., COLUMBUS, OH:
1,828,559. REN. 8-10-05. INT. CL. 36.
- SAFETY MANAGEMENT SOLUTIONS, CHICAGO, IL:
2,999,157, INT. CL. 41.
- SAFETY 1ST MEDICAL, INC., SANTA ANA, CA:
1,881,358. REN. 8-8-05. INT. CL. 10.

- SAFETY 1ST MEDICAL, INC., LAGUNA NIGUEL, CA:
1,893,041. REN. 8-8-05. INT. CL. 10.
- SAIIA CONSTRUCTION, LLC, BIRMINGHAM, AL:
2,997,260. PUB. 6-28-2005. INT. CL. 37.
2,997,364. PUB. 6-28-2005. INT. CL. 37.
- SAINT FRANCIS MEMORIAL HOSPITAL, SAN FRANCISCO, CA:
1,702,330. REN. 8-10-05. INT. CL. 42.
- SAINT GERMAIN FOUNDATION, SCHAUMBURG, IL,
SAINT GERMAIN PRESS, INC., SCHAUMBURG, IL:
1,357,947. REN. 8-11-05. INT. CL. 14.
1,357,949. REN. 8-11-05. INT. CL. 14.
- SAINT-GOBAIN ABRASIVES LIMITED, STAFFORDSHIRE
ST16 1EA, ENGLAND:
2,996,439. PUB. 6-28-2005. INT. CL. 7.
- SAINT-GOBAIN ABRASIVES, INC., WORCESTER, MA:
1,015,659. REN. 8-10-05. INT. CL. 7.
1,902,390. REN. 8-9-05. INT. CL. 7.
- SALES AND MARKETING EXECUTIVES-INTERNATIONAL, INC., SUMAS, WA:
1,873,000. REN. 8-11-05. U.S. CL. B.
- SALESFORCE.COM, INC., SAN FRANCISCO, CA:
2,998,330. PUB. 6-28-2005. INT. CL. 42.
- SALESPRO TECHNOLOGIES, INC., ERIE, PA:
2,996,306. PUB. 6-28-2005. INT. CL. 9.
- SALISBURY, CLYDE E., CARLISLE, PA:
2,999,239. INT. CL. 22.
- SALK INSTITUTE FOR BIOLOGICAL STUDIES, THE, LA
JOLLA, CA:
2,200,857. CANC. INT. CL. 42.
- SALLIE MAE, INC., RESTON, VA:
2,997,349. PUB. 6-28-2005. INT. CL. 36.
- SALOMON S.A., FRANCE:
2,998,465. PUB. 6-28-2005. MULTIPLE CLASS, INT. CLS.
25, 28 AND 35.
- SALVATORE FERRAGAMO ITALIA S.P.A., FLORENCE,
ITALY, SALVATORE FERRAGAMO S.P.A., FLORENCE,
ITALY:
1,340,706. REN. 8-8-05. MULTIPLE CLASS, INT. CLS. 18,
24, 26 AND 34.
- SAMBAND OF ICELAND CORPORATION, NEWPORT
NEWS, VA:
2,996,783. PUB. 6-28-2005. INT. CL. 29.
- SAMSON DISTRIBUTING INC., WELLINGTON, FL:
2,998,032. PUB. 6-28-2005. INT. CL. 5.
2,998,034. PUB. 6-28-2005. INT. CL. 5.
- SAMSONITE CORPORATION, DENVER, CO:
1,013,560. REN. 8-10-05. INT. CL. 18.
- SAMSUNG ELECTRONICS CO., LTD., SUWON-CITY,
KYUNGKI-DO, REPUBLIC OF KOREA:
2,997,026. PUB. 6-28-2005. INT. CL. 7.
- SAMUELS, ROCHELLE, WILMINGTON, DE:
2,997,737. PUB. 6-28-2005. INT. CL. 41.
- SANDIA MEDICAL INSTRUMENTS, INC., ALBUQUERQUE,
NM:
2,200,992. CANC. MULTIPLE CLASS, INT. CLS. 35 AND
37.
- SANDY DENNIS INCORPORATED, VALLEY STREAM, NY:
2,999,156. INT. CL. 45.
- SANFORD, L.P., FREEPORT, IL, SANFORD CORPORATION,
BELLWOOD, IL:
1,879,690. REN. 8-8-05. INT. CL. 16.
- SANOCHEMIA DIAGNOSTICS DEUTSCHLAND GMBH,
NEUSS, FED REP GERMANY:
2,997,050. PUB. 6-28-2005. INT. CL. 5.
- SANTORO, LUCIO AND SANTORO, MEERA, LONDON,
UNITED KINGDOM:
2,997,481. PUB. 6-28-2005. INT. CL. 24.
2,998,284. PUB. 6-28-2005. INT. CL. 24.
2,998,285. PUB. 6-28-2005. INT. CL. 28.
- SANYO NORTH AMERICA CORPORATION, CHATSWORTH,
CA:
2,999,192. INT. CL. 9.
- SAPPHIRE AUDIO, LLC, BOSTON, MA:
2,996,948. PUB. 6-28-2005. INT. CL. 9.
- SARA LEE FOODS, INC., CINCINNATI, OH:
2,202,067. CANC. INT. CL. 30.
2,997,836. PUB. 6-28-2005. INT. CL. 29.
- SARAMAR CORPORATION, DOVER, DE:
1,302,773. CANC. INT. CL. 25.
- SARAMAR L.L.C., CHICAGO, IL:
2,213,417. CANC. INT. CL. 4.
- SAS INSTITUTE INC., CARY, NC:
1,303,256. CANC. INT. CL. 42.
- SATIN STITCHES, LTD., COON RAPIDS, MN:
1,932,706. REN. 8-9-05. INT. CL. 25.
1,943,518. REN. 8-9-05. INT. CL. 25.
- SAUBERMAN, HERMINA, PASO ROBLES, CA:
2,998,127. PUB. 6-28-2005. INT. CL. 28.
- SAUDER CUSTOM FABRICATION, INC., EMPORIA, KS,
SAUDER INDUSTRIES, INC., EMPORIA, KS:
1,013,381. REN. 8-11-05. INT. CL. 6.
1,013,710. REN. 8-11-05. INT. CL. 37.
1,013,711. REN. 8-11-05. INT. CL. 37.
- SAVACOR, INC., LOS ANGELES, CA:
2,998,632. INT. CL. 44.
- SAVANNAH COLLEGE OF ART AND DESIGN, SAVANNAH,
GA:
2,999,327. INT. CL. 35.
- SAVE NOW DISCOUNT PHARMACY, INC., SNOHOMISH,
WA:
2,998,796. INT. CL. 35.
- SAZERAC COMPANY, INC., NEW ORLEANS, LA:
2,997,888. PUB. 6-28-2005. INT. CL. 33.
- SBLI USA MUTUAL LIFE INSURANCE COMPANY, INC.,
NEW YORK, NY:
2,996,861. PUB. 6-28-2005. INT. CL. 36.
- SCA HYGIENE PRODUCTS AB, SE-405 03 GOTEBOG,
SWEDEN, MOLNLYCKE AB, S-405 03 GOTEBOG, SWEDEN:
1,886,016. REN. 8-11-05. INT. CL. 16.
- SCA HYGIENE PRODUCTS AB, SE-405 03 GOTEBOG,
SWEDEN, MOLNLYCKE AB, SWEDEN:
1,886,017. REN. 8-11-05. INT. CL. 16.
- SCADUTO, DEAN, RIVER VALE, NJ:
2,200,846. CANC. INT. CL. 42.
- SCALAMANDRE SILKS, INC., LONG ISLAND CITY, NY:
2,201,896. CANC. INT. CL. 26.
- SCCI MARKETING INC., WANTAGH, NY:
2,996,848. PUB. 6-28-2005. INT. CL. 40.
- SCENTESSENCE, INC., PORT CLINTON, OH:
2,998,090. PUB. 6-28-2005. INT. CL. 3.
- SCHAFFNER EMV AG (SCHAFFNER EMV SA); (SCHAFFNER
EMV LTD.), SWITZERLAND:
2,998,443. PUB. 6-28-2005. MULTIPLE CLASS, INT. CLS. 9
AND 42.
- SCHIED VINEYARDS AND MANAGEMENT CO., MARINA
DEL REY, CA:
2,201,132. CANC. MULTIPLE CLASS, INT. CLS. 21 AND
25.
- SCHELLING, CHRISTIANNE, THREE RIVERS, CA:
2,997,136. PUB. 6-28-2005. MULTIPLE CLASS, INT. CLS. 3
AND 5.
- SCHEMALOGIC, INC., REDMOND, WA:
2,997,343. PUB. 6-28-2005. MULTIPLE CLASS, INT. CLS. 9
AND 42.
- SCHLEICHER & SCHUELL, INC., KEENE, NH:
1,896,871. REN. 8-9-05. INT. CL. 9.
1,899,715. REN. 8-9-05. INT. CL. 9.
- SCHLOSSBERG, GERALD, INDIANAPOLIS, IN:
2,202,387. CANC. INT. CL. 37.
- SCHLUMBERGER TECHNOLOGY CORPORATION, HOUSTON,
TX:
2,201,567. CANC. INT. CL. 9.
- SCHLUMBERGER TECHNOLOGY CORPORATION, SUGAR
LAND, TX:
2,999,300. MULTIPLE CLASS, INT. CLS. 9 AND 42.
- SCHNEIDER; JEAN PAUL, VADUZ, LIECHTENSTEIN:
1,306,941. REN. 8-11-05. INT. CL. 14.
- SCHOOLSPPRING, INC., BURLINGTON, VT:
2,998,103. PUB. 6-28-2005. INT. CL. 35.
2,998,106. PUB. 6-28-2005. INT. CL. 35.
- SCHRAMM, JACOB W., HINSDALE, IL:
2,997,486. PUB. 6-28-2005. INT. CL. 41.
- SCHRAMM, WALTER, 31029 VITTORIO VENETO, ITALY:
2,201,931. CANC. INT. CL. 35.

- SCHRATTER FOODS INCORPORATED, FAIRFIELD, NJ,
CHURNY COMPANY, INC., NORTHBROOK, IL:
1,893,240. REN. 8-11-05. INT. CL. 29.
- SCHROEDER, STEVAN E., SUGAR LAND, TX:
2,997,302, PUB. 6-28-2005. MULTIPLE CLASS, INT. CLS. 9
AND 41.
- SCHWAN'S IP, LLC, MARSHALL, MN:
1,334,563. REN. 8-11-05. INT. CL. 30.
- SCHWANENGEL, ULRICH, MUNCHEN, FED REP GER-
MANY:
2,996,343, PUB. 10-21-2003. INT. CL. 42.
- SCHWARZ PHARMA AG, FED REP GERMANY:
2,998,429, PUB. 6-28-2005. INT. CL. 5.
- SCHWEPPE'S INTERNATIONAL LIMITED, UNITED KING-
DOM:
2,998,405, PUB. 6-28-2005. MULTIPLE CLASS, INT. CLS.
5, 32 AND 33.
- SCICAN, DIVISION OF LUX & ZWINGENBERGER LTD.,
TORONTO, ONTARIO M3B 3P9, CANADA:
2,996,525, PUB. 6-28-2005. INT. CL. 11.
- SCIENTIFIC MANUFACTURING COMPANIES, INC., EAST
ORANGE, NJ:
2,201,572, CANC. INT. CL. 1.
- SCOOTALONGS, INC., BAILEYS CROSSROADS, VA:
2,996,937, PUB. 6-28-2005. INT. CL. 12.
- SCOPINICH, FRED JR., EAST QUOQUE, NY:
788,415. REN. 8-11-05. U.S. CL. 19 (INT. CL. 12).
- SCOPINICH, FRED JR., EAST QUOQUE, NY, HAMPTRONS
SHIPYARDS, INC., THE, EAST QUOQUE, NY:
788,416. REN. 8-11-05. U.S. CL. 19 (INT. CL. 12).
- SCORPION SPORTS, INC., COTO DE CAZA, CA:
2,999,083, INT. CL. 9.
- SCOTT CAMERON GOLF DESIGN, INC., CARLSBAD, CA:
2,997,919, PUB. 6-28-2005. INT. CL. 28.
- SCOTT'S LIQUID GOLD, INC., DENVER, CO:
1,012,758. REN. 8-9-05. INT. CL. 3.
- SCOTTSDALE CONVENTION AND VISITORS BUREAU,
INC., SCOTTSDALE, AZ:
2,998,593, INT. CL. 35.
2,998,594, INT. CL. 35.
- SCRANTON LACE COMPANY, SCRANTON, PA:
1,302,696, CANC. INT. CL. 24.
- SEA HARVEST CORPORATION LIMITED, CAPE TOWN,
WESTERN CAPE, SOUTH AFRICA:
2,996,930, PUB. 6-28-2005. INT. CL. 29.
- SEALAND TECHNOLOGY, INC., BIG PRAIRIE, OH:
2,201,771, CANC. INT. CL. 40.
- SEALED AIR CORPORATION, SADDLE BROOK, NJ, JIFFY
MANUFACTURING COMPANY, HILLSIDE, NJ:
996,144. REN. 8-11-05. INT. CL. 16.
- SEARS BRANDS, LLC, HOFFMAN ESTATES, IL:
2,996,264, PUB. 6-28-2005. INT. CL. 3.
2,998,302, PUB. 6-28-2005. INT. CL. 35.
- SEARS, BARRY D., DANVERS, MA:
2,997,305, PUB. 6-28-2005. INT. CL. 29.
- SEARS, ROEBUCK AND CO., HOFFMAN ESTATES, IL:
2,201,417, CANC. INT. CL. 11.
- SECRECTIONS, THE, GENEVA, NY:
2,202,096, CANC. INT. CL. 41.
- SECURITY PACIFIC HOME LOANS, INC., PASADENA, CA:
2,996,691, PUB. 6-28-2005. INT. CL. 36.
- SECURITY WORLD INTERNATIONAL, INC., SHARON, PA:
2,201,613, CANC. INT. CL. 13.
- SEE IT SO L.L.C., AUSTIN, TX:
2,998,688, INT. CL. 16.
2,998,689, INT. CL. 16.
- SEIGLER MOUNTAIN GROUP, INC., THE, FAIRFAX, CA
TO BAY LOGICS, INC., SAN DIEGO, CA:
1,860,809, CANC. INT. CL. 9.
- SELECT ORIGINS, INC., WESTHAMPTON BEACH, NY:
1,302,557, CANC. INT. CL. 16.
- SELECTED CHEMICAL PRODUCTS COMPANY, WAUKE-
GAN, IL:
2,996,801, PUB. 6-28-2005. INT. CL. 3.
- SELECTIVE INSURANCE GROUP, INC., BRANCHVILLE,
NJ:
2,999,296, INT. CL. 36.
- SEMIPOWER SYSTEMS, INC., SAN JOSE, CA:
2,201,719, CANC. INT. CL. 9.
- SEMROCK, INC., ROCHESTER, NY:
2,997,877, PUB. 6-28-2005. INT. CL. 9.
- SENARIO LLC, WOODSTOCK, IL:
2,997,599, PUB. 6-28-2005. INT. CL. 9.
- SEND-A-STORK, LAKE OSWEGO, OR:
1,302,545, CANC. MULTIPLE CLASS, INT. CLS. 16 AND
39.
- SENKIR, DAMIEN JP, WENATCHEE, WA:
2,137,445, CANC. INT. CL. 25.
- SENSIENT COLORS INC., MILWAUKEE, WI:
1,897,240. REN. 8-12-05. INT. CL. 2.
- SENTAGE CORPORATION, MINNEAPOLIS, MN:
2,201,469, CANC. INT. CL. 40.
- SEOUL NASSAU (UK) LTD, WEST SUSSEX RH19 1YH,
UNITED KINGDOM:
2,996,433, PUB. 6-28-2005. MULTIPLE CLASS, INT. CLS.
19, 27 AND 28.
- SERENGETI EYEWEAR, INC., SARASOTA, FL:
2,202,194, CANC. INT. CL. 9.
- SERVICE MERCHANDISE COMPANY, INC., BRENT-
WOOD, TN:
2,202,049, CANC. INT. CL. 21.
- SESAME WORKSHOP, NEW YORK, NY, CHILDREN'S
TELEVISION WORKSHOP, NEW YORK, NY:
1,895,976. REN. 8-9-05. MULTIPLE CLASS, INT. CLS. 9
AND 42.
- SEVEN SEAS, INC., WINSTON-SALEM, NC:
2,999,076, INT. CL. 12.
- SEYMOUR OF SYCAMORE INC., SYCAMORE, IL:
1,302,312, CANC. MULTIPLE CLASS, INT. CLS. 1, 2, 3, 4
AND 17.
- SEZ AG, AUSTRIA:
2,998,440, PUB. 6-28-2005. INT. CL. 7.
- SF INVESTMENTS, INC., WILMINGTON, DE:
1,335,724. REN. 8-10-05. INT. CL. 29.
- SFC DELI, INC., LONG BEACH, NY, DBA ZAMBONI'S:
2,996,874, PUB. 6-28-2005. INT. CL. 43.
- SGA S.R.L., BOLZANO, ITALY:
2,912,263, COR. MULTIPLE CLASS, INT. CLS. 24 AND
25.
2,912,264, COR. MULTIPLE CLASS, INT. CLS. 24 AND
25.
- SGL TECHNIC, INC., VALENCIA, CA:
1,331,523. REN. 8-8-05. INT. CL. 2.
- SHABBY CHIC, INC., LOS ANGELES, CA:
2,998,803, MULTIPLE CLASS, INT. CLS. 11, 16, 18, 20, 21,
24, 25 AND 27.
- SHADES OF THE FUTURE, INC., BEAVERTON, OR:
2,996,700, PUB. 6-28-2005. INT. CL. 20.
- SHAKY'S RESTAURANTS FRANCHISING COMPANY,
LLC, ALHAMBRA, CA:
1,339,767. REN. 8-11-05. INT. CL. 42.
- SHAKOPEE MDEWAKANTON SIOUX COMMUNITY,
PRIOR LAKE, MN:
2,998,124, PUB. 6-28-2005. MULTIPLE CLASS, INT. CLS.
39, 41 AND 43.
- SHAMIS, BARRY, MERCER ISLAND, WA, DBA EFFEC-
TIVE SELECTION SYSTEMS:
1,923,422. REN. 8-10-05. MULTIPLE CLASS, INT. CLS. 9,
16 AND 41.
- SHANGHAI RUNDAN TRADING CO., LTD., CHINA:
2,998,467, PUB. 6-28-2005. INT. CL. 25.
2,998,468, PUB. 6-28-2005. INT. CL. 25.
- SHANGHAI TOHKIN BEVERAGE COMPANY LIMITED,
JIADING DISRICT; SHANGHAI 201812, CHINA:
2,998,491, PUB. 6-28-2005. INT. CL. 32.
- SHAR PRODUCTS COMPANY, ANN ARBOR, MI:
2,997,155, PUB. 6-28-2005. MULTIPLE CLASS, INT. CLS.
15, 35 AND 37.
- SHARGAA, JILL R., ORLANDO, FL:
2,998,025, PUB. 6-28-2005. INT. CL. 41.
- SHARON, RICHARD A, FORT WORTH, TX, SHARON,
FRIEDA C., FORT WORTH, TX:
1,901,496. REN. 8-9-05. INT. CL. 9.
- SHARPE & OSBURN, ORANGE, CA:
2,997,056, PUB. 1-4-2005. INT. CL. 25.

- SHARPLESS, S. ROBERT, DEVON, PA:
2,996,384, PUB. 6-28-2005. INT. CL. 11.
- SHAW MUDGE & COMPANY, SHELTON, CT:
2,998,966, INT. CL. 1.
- SHAW, JAMES G., BEND, OR, DBA SHAW RESOURCES:
2,997,862, PUB. 6-28-2005. INT. CL. 9.
- SHAZAM! COMPUTER SYSTEMS, INC., SUFFIELD, CT,
SHAZAM! MICRO-SYSTEMS, INC., NEW ORLEANS, LA:
1,330,583. REN. 8-8-05. INT. CL. 9.
- SHEAKLEY RESOLUTION SYSTEMS, L.L.C., CINCINNATI,
OH:
2,998,709, MULTIPLE CLASS, INT. CLS. 35 AND 36.
- SHELL TRADEMARK MANAGEMENT B.V., THE HAGUE,
NETHERLANDS:
2,997,151, PUB. 6-28-2005. MULTIPLE CLASS, INT. CLS.
37 AND 42.
2,997,281, PUB. 6-28-2005. MULTIPLE CLASS, INT. CLS.
37, 41 AND 42.
2,997,440, PUB. 6-28-2005. INT. CL. 37.
- SHENICK SOFTWARE SYSTEMS INC., BURLINGAME, CA:
2,999,264, INT. CL. 9.
- SHENZHEN HYT SCIENCE & TECHNOLOGY CO., LTD,
SHENZHEN, CHINA:
2,998,242, PUB. 6-28-2005. INT. CL. 9.
- SHENZHEN TAITAI PHARMACEUTICAL INDUSTRY
COMPANY LIMITED, SHENZHEN, GUANGDONG PRO-
VINCE, CHINA:
2,998,979, INT. CL. 5.
- SHERILL, INC., GREENSBORO, NC:
2,997,059, PUB. 6-28-2005. INT. CL. 8.
- SHERWIN-WILLIAMS COMPANY, THE, CLEVELAND, OH:
2,201,821, CANC. INT. CL. 2.
- SHERWOOD MEDICAL COMPANY, ST. LOUIS, MO:
997,239, CANC. INT. CL. 5.
- SHERWOOD SERVICES AG, SCHAFFHAUSEN, SWITZER-
LAND:
2,999,232, INT. CL. 5.
- SHERWOOD-DROLET CORPORATION LTD., SHER-
BROOKE, QUEBEC, CANADA:
2,201,939, CANC. INT. CL. 28.
- SHIFFERAW, TESSEMA DOSHO, ALBANY, CA:
2,997,962, PUB. 6-28-2005. INT. CL. 28.
2,998,327, PUB. 6-28-2005. MULTIPLE CLASS, INT. CLS.
25 AND 28.
- SHIMAMURA, SEIICHIRO, TOKYO, JAPAN:
2,998,702, INT. CL. 25.
- SHIMANO INC., SAKAI, OSAKA, JAPAN:
2,997,868, PUB. 6-28-2005. INT. CL. 28.
2,997,869, PUB. 6-28-2005. INT. CL. 28.
- SHISEIDO CO., LTD., TOKYO, JAPAN:
1,279,509, CANC. INT. CL. 3.
- SHISEIDO COMPANY, LTD., TOKYO, JAPAN:
2,998,956, INT. CL. 3.
- SHMYR, MERVYN, EDMONTON, ALBERTA, CANADA:
1,859,080. REN. 8-9-05. INT. CL. 3.
- SHORE HEALTH SYSTEM, INC., EASTON, MD:
2,996,234, PUB. 6-28-2005. INT. CL. 42.
- SHOWCASE ENTERPRISES, INC., MINNEAPOLIS, MN:
2,997,082, PUB. 6-28-2005. MULTIPLE CLASS, INT. CLS.
25 AND 41.
- SHOWROOM SOLUTIONS, INC., LAKEWOOD, CO:
2,997,161, PUB. 6-28-2005. INT. CL. 9.
- SHUTTLELIFT, INC., STURGEON BAY, WI:
1,921,502. REN. 8-10-05. INT. CL. 7.
- SI CORPORATION, CHICKAMAUGA, GA, SYNTHETIC
INDUSTRIES, INC., CHICKAMAUGA, GA:
1,933,713. REN. 8-8-05. INT. CL. 19.
- SI-PHARM LTD, WINDSOR, ONTARIO, CANADA:
2,201,836, CANC. INT. CL. 32.
- SICHUAN YIBIN WULIANGYE GROUP CO., LTD.; (SI-
CHUANGSHENG YIBIN; WULIANGYE JITUAN YOUX-
IAN GONGSI), CHINA:
2,998,366, PUB. 6-28-2005. INT. CL. 33.
- SIDEOUT SPORT, INC., MONROVIA, CA:
2,200,902, CANC. INT. CL. 25.
- SIDNEY FRANK IMPORTING CO., INC., NEW ROCHELLE,
NY:
2,999,241, INT. CL. 33.
- SIEI PETERLONGO S.P.A., MILAN, ITALY:
1,860,692, CANC. INT. CL. 9.
- SIEMENS AKTIENGESELLSCHAFT, MUNICH, FED REP
GERMANY:
1,934,787. REN. 8-9-05. INT. CL. 41.
2,997,012, PUB. 6-28-2005. INT. CL. 9.
- SIERRA PACIFIC RESOURCES, RENO, NV:
1,940,071. REN. 8-11-05. INT. CL. 39.
- SIGMA ALPHA LAMBDA, INC., ATLANTA, GA:
2,996,454, PUB. 3-8-2005. INT. CL. 41.
- SIGMA ELECTRIC MANUFACTURING CORPORATION,
GARNER, NC:
2,999,236, INT. CL. 11.
- SIGMA-INTERNET, INC., DIAMOND BAR, CA:
2,996,596, PUB. 6-28-2005. MULTIPLE CLASS, INT. CLS.
35, 37 AND 42.
- SIGNATORY PAINTING CONTRACTORS ORGANIZA-
TION, INC., ALOHA, OR:
2,996,355, PUB. 6-28-2005. INT. CL. 35.
- SIGNATURE BRANDS, LLC, OCALA, FL:
2,998,214, PUB. 6-28-2005. MULTIPLE CLASS, INT. CLS.
29 AND 30.
- SIGNATURE PARTNERS, INC., CELINA, OH:
2,996,613, PUB. 6-28-2005. INT. CL. 6.
- SIGNONE CLIPSIN USA, L.L.C., CAPE GIRARDEAU, MO:
2,996,367, PUB. 6-28-2005. INT. CL. 6.
- SILBER, ROGER, SAN DIEGO, CA:
2,999,042, INT. CL. 28.
- SILIPOS INC., NEW YORK, NY:
2,998,982, INT. CL. 10.
- SILVER, DAVID, SOUTH HACKENSACK, NJ:
2,997,974, PUB. 6-28-2005. INT. CL. 41.
- SILVEX ALTRA LTD., 1504 SOFIA, BULGARIA:
2,201,057, CANC. INT. CL. 33.
- SIMCRO TECH LIMITED, HAMILTON, NEW ZEALAND:
2,998,903, INT. CL. 10.
- SIMDESK TECHNOLOGIES, INC., HOUSTON, TX:
2,997,732, PUB. 6-28-2005. MULTIPLE CLASS, INT. CLS. 9
AND 42.
- SIMMONS OUTDOOR CORPORATION, IRVINE, CA:
1,939,811. REN. 8-11-05. INT. CL. 9.
- SIMMONS, AISHAH SHAHIDAH, PHILADELPHIA, PA:
2,997,669, PUB. 6-28-2005. INT. CL. 41.
- SIMON & SCHUSTER, INC., NEW YORK, NY:
2,999,374, INT. CL. 16.
- SIMOUN-TRADING E MARKETING LDA, MADEIRA,
PORTUGAL:
1,890,572. REN. 8-9-05. INT. CL. 25.
- SINCLAIR PHARMACEUTICALS LIMITED, UNITED
KINGDOM:
2,998,489, PUB. 6-28-2005. INT. CL. 5.
- SINGER & HAMILTON, FRANCE:
2,998,406, PUB. 6-28-2005. INT. CL. 35.
- SINGLE SERVE TEA CORP., WOODMERE, NY:
2,997,792, PUB. 6-28-2005. INT. CL. 30.
- SINGLENTRY SYSTEMS CORP, SPRINGFIELD, VA:
2,997,616, PUB. 6-28-2005. INT. CL. 9.
- SISTER GIRL ENTERPRISES, INC., ENCINO, CA:
2,996,719, PUB. 6-28-2005. INT. CL. 41.
- SKANSKA AB, SWEDEN:
2,998,358, PUB. 6-28-2005. MULTIPLE CLASS, INT. CLS.
19, 36 AND 37.
- SKATING ASSOCIATION FOR THE BLIND AND HANDI-
CAPPED, INC., WEST SENECA, NY:
2,997,990, PUB. 6-28-2005. INT. CL. 41.
- SKIPPACK CREEK CORPORATION, WILMINGTON, DE:
2,997,821, PUB. 6-28-2005. INT. CL. 29.
- SKIVA INTERNATIONAL, INC., BROOKLYN, NY:
1,861,002, CANC. INT. CL. 25.
- SKOOG, WAYNE ANTHONY, HOUSTON, TX:
2,996,757, PUB. 6-28-2005. INT. CL. 44.
- SKYLINE COMMERCIAL REAL ESTATE, LLC, CONSHO-
HOCKEN, PA:
2,998,652, INT. CL. 36.
- SLAGTERISELSKABET ROYAL DANE - QUALITY A/S, DK-
7400 HERNING, DOMINICA:
1,302,887, CANC. INT. CL. 29.

- SLEEP COUNTRY USA, INC., KENT, WA:
2,999,132, INT. CL. 35.
- SLEEP SOLUTIONS, INC., PALO ALTO, CA:
2,998,589, INT. CL. 9.
- SLEEPTECH LLC, KINNELON, NJ:
2,996,764, PUB. 6-28-2005. INT. CL. 20.
- SLOAN, SALLY, WINFIELD, WV:
2,201,365, CANC. INT. CL. 30.
- SLR, SCOTTSDALE, AZ:
2,997,955, PUB. 6-28-2005. INT. CL. 19.
- SLURRY SEAL, INC., WACO, TX:
779,624, CANC. U.S. CL. 100.
- SMALL CHANGE ORIGINAL THEATRE, INC., MINNEAPOLIS, MN:
2,201,090, CANC. INT. CL. 41.
- SMART BUSINESS NETWORK, INC., WESTLAKE, OH:
2,998,898, INT. CL. 16.
- SMART CARPET, INCORPORATED, PT. PLEASANT, NJ:
2,998,142, PUB. 6-28-2005. INT. CL. 27.
- SMART GIRL INVESTMENTS, LLC, GLENDALE, OH:
2,996,712, PUB. 6-28-2005. INT. CL. 3.
2,996,713, PUB. 6-28-2005. INT. CL. 28.
- SMART PARTS, INC., LOYALHANNA, PA:
2,996,614, PUB. 6-28-2005. MULTIPLE CLASS, INT. CLS. 25 AND 41.
- SMARTROUTE SYSTEMS, INC., NEW YORK, NY:
1,839,648, REN. 8-11-05. INT. CL. 39.
- SMC-HEC CORP., WEST COVINA, CA:
2,997,721, PUB. 6-28-2005. MULTIPLE CLASS, INT. CLS. 7 AND 8.
- SMEAD MANUFACTURING COMPANY, HASTINGS, MN:
1,335,494, REN. 8-11-05. INT. CL. 16.
- SMITH & HOOK WINERY, SOLEDAD, CA:
1,948,734, REN. 8-8-05. INT. CL. 33.
1,950,993, REN. 8-8-05. INT. CL. 33.
- SMITH INDUSTRIES, INC., MONTGOMERY, AL, DBA JAY R. SMITH MFG. CO.:
2,201,887, CANC. INT. CL. 9.
- SMITH, ANDERSON, BLOUNT, DORSETT, MITCHELL & JERNIGAN, L.L.P., RALEIGH, NC:
2,996,553, PUB. 6-28-2005. INT. CL. 42.
2,996,554, PUB. 6-28-2005. INT. CL. 42.
- SMITH, JEFFREY A., ALPHARETTA, GA:
2,996,897, PUB. 6-28-2005. INT. CL. 6.
- SMITH, MICHAEL R., MEDFORD, OR:
2,998,268, PUB. 6-28-2005. INT. CL. 5.
- SMITH, NORMAN, JAMES, SANTA ROSA, CA:
2,997,361, PUB. 6-28-2005. INT. CL. 42.
- SMITHKLINE BEECHAM CORPORATION, PHILADELPHIA, PA, BURROUGHS WELLCOME CO., RESEARCH TRIANGLE PARK, NC:
1,879,098, REN. 8-8-05. INT. CL. 5.
- SMITHKLINE BEECHAM CORPORATION, PHILADELPHIA, PA:
2,201,657, CANC. INT. CL. 41.
- SMITHKLINE BEECHAM P.L.C., BRENTFORD, MIDDLESEX, UNITED KINGDOM:
2,997,856, PUB. 6-28-2005. INT. CL. 5.
- SMOKIN GOURMET, WASHOUGAL, WA:
2,996,747, PUB. 6-28-2005. INT. CL. 29.
- SMOOCH, INC., ENCINO, CA:
2,997,680, PUB. 6-28-2005. MULTIPLE CLASS, INT. CLS. 25 AND 41.
2,997,688, PUB. 6-28-2005. MULTIPLE CLASS, INT. CLS. 25 AND 41.
2,997,689, PUB. 6-28-2005. MULTIPLE CLASS, INT. CLS. 25 AND 41.
2,997,907, PUB. 6-28-2005. MULTIPLE CLASS, INT. CLS. 25 AND 41.
2,997,908, PUB. 6-28-2005. MULTIPLE CLASS, INT. CLS. 25 AND 41.
2,997,909, PUB. 6-28-2005. MULTIPLE CLASS, INT. CLS. 25 AND 41.
2,998,307, PUB. 6-28-2005. MULTIPLE CLASS, INT. CLS. 25 AND 41.
2,998,308, PUB. 6-28-2005. MULTIPLE CLASS, INT. CLS. 25 AND 41.
2,998,309, PUB. 6-28-2005. MULTIPLE CLASS, INT. CLS. 25 AND 41.
- 2,998,310, PUB. 6-28-2005. MULTIPLE CLASS, INT. CLS. 25 AND 41.
- 2,998,311, PUB. 6-28-2005. MULTIPLE CLASS, INT. CLS. 25 AND 41.
- 2,998,312, PUB. 6-28-2005. MULTIPLE CLASS, INT. CLS. 25 AND 41.
- 2,998,313, PUB. 6-28-2005. MULTIPLE CLASS, INT. CLS. 25 AND 41.
- 2,998,314, PUB. 6-28-2005. MULTIPLE CLASS, INT. CLS. 25 AND 41.
- 2,998,315, PUB. 6-28-2005. MULTIPLE CLASS, INT. CLS. 25 AND 41.
- 2,998,316, PUB. 6-28-2005. MULTIPLE CLASS, INT. CLS. 25 AND 41.
- 2,998,317, PUB. 6-28-2005. MULTIPLE CLASS, INT. CLS. 25 AND 41.
- 2,998,318, PUB. 6-28-2005. MULTIPLE CLASS, INT. CLS. 25 AND 41.
- 2,998,323, PUB. 6-28-2005. MULTIPLE CLASS, INT. CLS. 25 AND 41.
- 2,998,324, PUB. 6-28-2005. MULTIPLE CLASS, INT. CLS. 25 AND 41.
- 2,998,325, PUB. 6-28-2005. MULTIPLE CLASS, INT. CLS. 25 AND 41.
- SMOOTH INDUSTRIES, INC., NEW YORK, NY:
1,902,822, CANC. INT. CL. 25.
- SMS DEMAG AG, FED REP GERMANY:
2,998,395, PUB. 6-28-2005. MULTIPLE CLASS, INT. CLS. 9 AND 42.
- SMS MEER GMBH, MONCHENGLADBACH, FED REP GERMANY:
2,998,068, PUB. 6-28-2005. INT. CL. 7.
- SMUCKER FRUIT PROCESSING COMPANY, SALINAS, CA:
781,848, REN. 8-12-05. U.S. CL. 46 (INT. CL. 29).
- SNA HOLDINGS INC., WILMINGTON, DE, DETROIT FUSE & MANUFACTURING COMPANY, WILMINGTON, DE:
103,050, REN. 8-12-05. U.S. CL. 21 (INT. CL. 9).
- SNAP TV, INC., SANTA MONICA, CA:
2,999,284, MULTIPLE CLASS, INT. CLS. 9 AND 42.
- SNAP-ON INCORPORATED, PLEASANT PRAIRIE, WI, SNAP-ON INCORPORATED, KENOSHA, WI:
1,940,587, REN. 8-9-05. INT. CL. 8.
1,940,588, REN. 8-9-05. INT. CL. 8.
- SNELL & WILCOX LIMITED, TWICKENHAM, MIDDLESEX TW1 1RQ, ENGLAND:
2,996,418, PUB. 3-8-2005. INT. CL. 9.
- SNO-WAY INTERNATIONAL, INC., HARTFORD, WI:
1,302,398, CANC. INT. CL. 7.
- SNYDER, DAVID W., LEAD, SD:
2,996,480, PUB. 6-28-2005. INT. CL. 16.
- SOCIEDAD AGRICOLA DON MANUEL, SANTIAGO, CHILE:
2,997,284, PUB. 6-28-2005. INT. CL. 33.
- SOCIETA ESERCIZIO CANTIERI S.P.A., 00186 ROMA, ITALY:
2,201,021, CANC. MULTIPLE CLASS, INT. CLS. 12 AND 39.
- SOCIETE BOLLINGER & CO., AY, FRANCE:
1,355,716, REN. 8-11-05. INT. CL. 33.
- SOCIETE DE DISTRIBUTION DE DIDONNE, 17120 SEMUSAC, FRANCE:
2,201,458, CANC. INT. CL. 33.
- SOCIETE DES PRODUITS NESTLE S.A., 1800 VEVEY, SWITZERLAND:
2,997,230, PUB. 6-28-2005. INT. CL. 30.
- SOCIETE DIAGNOSTICA-STAGO, FRANCE:
2,998,483, PUB. 6-28-2005. INT. CL. 10.
- SOCIETE EUROPEENNE DE PROPULSION - S.E.P., 92150 SURESNES, FRANCE:
2,200,865, CANC. MULTIPLE CLASS, INT. CLS. 1, 7, 9, 10, 11, 12, 13, 19, 22, 35, 37, 38, 40, 41 AND 42.
- SOCIETE EUROPEENNE DES PRODUITS REFRACTAIRES, 92 COURBEVOIE, FRANCE:
1,350,154, REN. 8-11-05. MULTIPLE CLASS, INT. CLS. 1, 19 AND 42.

- SOCIETY OF AUTOMOTIVE ENGINEERS, INC., WARREN-DALE, PA:
1,861,258, CANC. INT. CL. 41.
- SOCIETYWEST LLC, LOS ANGELES, CA:
2,997,292, PUB. 6-28-2005. MULTIPLE CLASS, INT. CLS. 41 AND 45.
- SOEKORO, INC., LONG ISLAND CITY, NY:
2,947,343, CANC. INT. CL. 3.
- SOFT-WORLD INTERNATIONAL CORPORATION, KAOHSIUNG, TAIWAN:
2,998,818, INT. CL. 9.
- SOFTWARE DIMENSIONS, INC., HACKENSACK, NJ:
1,303,220, CANC. INT. CL. 42.
- SOFTWARE IMAGING LIMITED, VANCOUVER, BRITISH COLUMBIA, GDT SOFTWARES INC., BURNABY, BRITISH COLUMBIA, CANADA:
1,904,145, REN. 8-10-05. INT. CL. 9.
- SOFTWARE OPTIONS, INC., ENGLEWOOD CLIFFS, NJ:
1,302,416, CANC. INT. CL. 9.
- SOFTWARE SERVICES GROUP, OMAHA, NE:
2,201,146, CANC. INT. CL. 40.
- SOILTEST, INC., EVANSTON, IL:
782,064, REN. 8-12-05. U.S. CL. 26 (INT. CL. 9).
- SOLARFLARE COMMUNICATIONS, INC., IRVINE, CA:
2,996,679, PUB. 6-28-2005. INT. CL. 9.
- SOLARSUN, INC., SETAUKET, NY:
2,996,705, PUB. 6-28-2005. INT. CL. 1.
- SOLESSE HOLDINGS, INC., PLEASANTON, CA:
2,202,017, CANC. MULTIPLE CLASS, INT. CLS. 3 AND 5.
- SOLVAY PHARMA PROPERTIES, INC., BAUDETTE, MN:
808,375, REN. 8-11-05. U.S. CL. 18 (INT. CL. 5).
- SOMA BEVERAGE COMPANY, LLC, SAN FRANCISCO, CA:
2,997,272, PUB. 6-28-2005. INT. CL. 32.
- SOMMETRADE, S.L., VIZCAYA, SPAIN, AGENCIA DE RELACIONES INTERNACIONALES, S.L., LAS ARENAS VIZCAYA, SPAIN:
1,911,123, REN. 8-10-05. INT. CL. 7.
- SON INTEGRATION, INC., CORONA, CA:
2,998,157, PUB. 6-28-2005. INT. CL. 42.
- SONAR AUTO PARTS CO., LTD., PANCHIAO, TAIPEI, TAIWAN:
2,998,740, INT. CL. 11.
- SONASOFT, INC., SAN JOSE, CA:
2,996,428, PUB. 6-28-2005. MULTIPLE CLASS, INT. CLS. 9 AND 42.
- SONOMA COUNTY AGRICULTURAL MARKETING PROGRAM, SANTA ROSA, CA TO SELECT SONOMA COUNTY, ROHNERT PARK, CA:
1,861,096, CANC. INT. CL. 30.
- SONOMA COUNTY AGRICULTURAL MARKETING PROGRAM, SANTA ROSA, CA:
1,861,106, CANC. INT. CL. 31.
- SONOMA COUNTY AGRICULTURAL MARKETING PROGRAM, SANTA ROSA, CA TO SELECT SONOMA COUNTY, ROHNERT PARK, CA:
1,861,111, CANC. MULTIPLE CLASS, INT. CLS. 32 AND 33.
- SONY COMPUTER ENTERTAINMENT EUROPE LIMITED, LONDON, UNITED KINGDOM:
2,998,920, INT. CL. 9.
- SONY CORPORATION, TOKYO 141, JAPAN:
1,892,018, REN. 8-9-05. INT. CL. 9.
- SONY CORPORATION, SHINAGAWA-KU, TOKYO 141, JAPAN:
1,896,844, REN. 8-9-05. INT. CL. 9.
- SORBOTHANE, INC., KENT, OH:
2,998,221, PUB. 6-28-2005. INT. CL. 25.
- SOUND ENHANCEMENTS, INC., CARY, IL:
2,998,204, PUB. 6-28-2005. INT. CL. 9.
- SOUND INTERNATIONAL, INCORPORATED, SEATTLE, WA:
2,996,732, PUB. 6-28-2005. INT. CL. 11.
- SOUND TREK DISTRIBUTORS, TAMPA, FL:
2,201,266, CANC. INT. CL. 15.
2,201,267, CANC. INT. CL. 15.
- SOUNDEXCHANGE, INC., WASHINGTON, DC:
2,999,089, INT. CL. 36.
- SOURCEONE, INC., LINCOLN, NE:
2,998,211, PUB. 6-28-2005. INT. CL. 7.
- SOUTH PUGET SOUND COMMUNITY COLLEGE, OLYMPIA, WA:
2,999,367, MULTIPLE CLASS, INT. CLS. 16, 25 AND 41.
- SOUTH WATER MARKET, INC., CHICAGO, IL:
2,996,981, PUB. 6-28-2005. INT. CL. 35.
- SOUTHEASTERN DENTAL RESEARCH CORPORATION, BATON ROUGE, LA:
2,998,217, PUB. 6-28-2005. INT. CL. 3.
- SOUTHERN FOLGER DETENTION EQUIPMENT COMPANY, GREELEY, CO, TELKEE, INC., JOLIET, IL:
1,012,069, REN. 8-12-05. INT. CL. 6.
- SOUTHERN FOLGER DETENTION EQUIPMENT COMPANY, GREELEY, CO:
2,997,935, PUB. 6-28-2005. INT. CL. 9.
- SOUTHERN FOODS GROUP L.P., DALLAS, TX:
2,202,097, CANC. INT. CL. 30.
2,202,098, CANC. INT. CL. 30.
- SOUTHERN IONICS INCORPORATED, WEST POINT, MS:
2,996,873, PUB. 6-28-2005. INT. CL. 1.
- SOUTHLAND GROUP ENTERPRISES, INC., LOUISVILLE, KY:
2,262,782, AM. INT. CL. 35.
2,266,804, AM. INT. CL. 35.
2,268,755, AM. INT. CL. 35.
- SOUTHWEST APPAREL, INC., PARADISE VALLEY, AZ:
2,200,868, CANC. INT. CL. 25.
- SOUTHWEST BUSINESS CORPORATION, SAN ANTONIO, TX:
2,996,567, PUB. 3-8-2005. MULTIPLE CLASS, INT. CLS. 35 AND 36.
- SOY INC., GIBSON, IA:
2,998,138, PUB. 6-28-2005. INT. CL. 5.
- SOY VAY ENTERPRISES, INC., FELTON, CA:
2,999,223, INT. CL. 30.
- SPACE SAVER CORPORATION, FORT ATKINSON, WI:
1,903,388, REN. 8-11-05. INT. CL. 9.
- SPANGLER CANDY COMPANY, BRYAN, OH:
2,201,174, CANC. INT. CL. 30.
- SPANGLER, AMY, ATLANTA, GA:
2,999,108, MULTIPLE CLASS, INT. CLS. 9 AND 16.
2,999,109, MULTIPLE CLASS, INT. CLS. 9 AND 16.
- SPANISH BROADCASTING SYSTEM, INC., COCONUT GROVE, FL:
2,996,697, PUB. 6-28-2005. INT. CL. 41.
- SPARE KEY, SOUTH ST. PAUL, MN:
2,996,459, PUB. 6-28-2005. INT. CL. 36.
- SPARLING, JOSEPH J., CHAPEL HILL, NC:
2,999,145, MULTIPLE CLASS, INT. CLS. 16 AND 41.
- SPC RESOURCES INC., HARTSVILLE, SC:
2,998,620, INT. CL. 19.
- SPECIALIZED EQUIPMENT (AUSTRALIA) PY LTD, VICTORIA 3812, AUSTRIA:
1,899,575, REN. 8-11-05. INT. CL. 7.
- SPECIALTY CERAMICS, INC., COLUMBIANA, OH:
1,930,639, REN. 8-11-05. INT. CL. 11.
- SPECIALTY FILAMENTS, INC., BURLINGTON, VT:
2,201,306, CANC. INT. CL. 17.
- SPECTRANETICS CORPORATION, THE, COLORADO SPRINGS, CO:
1,823,660, REN. 8-11-05. INT. CL. 10.
- SPEECO INCORPORATED, GOLDEN, CO, SMITH, RAWLEN T., GOLDEN, CO, DBA SPECIAL PRODUCTS COMPANY:
774,476, REN. 8-6-05. U.S. CL. 23 (INT. CL. 7).
- SPICER, AMILIA K, STUDIO CITY, CA:
2,997,768, PUB. 6-28-2005. INT. CL. 9.
- SPIRAL HOLDING, INC., GUERNSEY (CI) GY14BZ, UNITED KINGDOM:
2,201,643, CANC. INT. CL. 9.
- SPORT ELLE, INC., NEW YORK, NY:
2,998,708, INT. CL. 25.
- SPORTS BAR, LLC, O'FALLON, IL:
2,997,690, PUB. 6-28-2005. INT. CL. 43.
- SPORTS IDENTITY, INC., BOSTON, MA:
2,998,636, INT. CL. 35.

- SPORTSCHANNEL VENTURES, INC., WOODBURY, NY:
2,108,410, CANC. INT. CL. 38.
- SPORTY K9, LTD., NEW YORK, NY:
2,998,657, INT. CL. 31.
- SPRAYING SYSTEMS CO., WHEATON, IL:
2,999,130, INT. CL. 7.
- SPRING MEADOW NURSERY, INC., GRAND HAVEN, MI:
2,999,208, INT. CL. 31.
- SPRINT CAR RACING ASSOCIATION, DOWNEY, CA:
2,201,341, CANC. MULTIPLE CLASS, INT. CLS. 25 AND 41.
- SPRINT COMMUNICATIONS COMPANY L.P., KANSAS CITY, MO:
2,201,476, CANC. INT. CL. 38.
- SPRINT COMMUNICATIONS COMPANY L.P., OVERLAND PARK, KS:
2,999,237, INT. CL. 38.
- SPURLIN INDUSTRIES, INC., PALMETTO, GA:
1,898,799, REN. 8-6-05, INT. CL. 11.
- SRS INTERNATIONAL CORPORATION, WASHINGTON, DC:
2,110,610, CANC. INT. CL. 42.
- ST. FRANCIS HEALTH SYSTEM, PITTSBURGH, PA:
1,861,241, CANC. MULTIPLE CLASS, INT. CLS. 41 AND 42.
- ST. JOHN HEALTH, WARREN, MI:
2,997,654, PUB. 6-28-2005, INT. CL. 44.
- ST. JOHNS, COLLIN, TARZANA, CA:
2,201,073, CANC. INT. CL. 30.
- ST. LOUIS HEART INSTITUTE CARDIOTHORACIC SURGEONS, INC., BRIDGETON, MO:
1,861,299, CANC. INT. CL. 42.
- ST. LOUIS MUSIC, INC., ST. LOUIS, MO:
2,997,351, PUB. 6-28-2005, INT. CL. 15.
- ST. LOUIS RAMS PARTNERSHIP, ST. LOUIS, MO, LOS ANGELES RAMS FOOTBALL COMPANY, ANAHEIM, CA:
1,889,818, REN. 8-9-05, MULTIPLE CLASS, INT. CLS. 16 AND 25.
- ST. NORBERT COLLEGE, INC., DE PERE, WI:
2,997,410, PUB. 6-28-2005, INT. CL. 41.
- STAINLESS INCORPORATED, DEERFIELD BEACH, FL:
2,202,076, CANC. INT. CL. 28.
- STAIR-PAK PRODUCTS COMPANY, INC., UNION, NJ:
1,302,630, CANC. INT. CL. 19.
- STAMPEDE TECHNOLOGIES, INC., DAYTON, OH:
2,996,830, PUB. 6-28-2005, INT. CL. 9.
- STANDARD LIFE INVESTMENTS LIMITED, EDINBURGH, EH2 2LL, UNITED KINGDOM:
2,998,590, INT. CL. 36.
- STANLEY WORKS, THE, NEW BRITAIN, CT:
2,201,851, CANC. MULTIPLE CLASS, INT. CLS. 8 AND 9.
- STANWOOD ELECTRONICS CORPORATION, COLUMBIA, MD:
1,303,203, CANC. INT. CL. 42.
- STAPLOE LIMITED, IPSWICH, SUFFOLK IP3 8SG, UNITED KINGDOM:
2,999,293, INT. CL. 9.
- STAR BRIDGE SYSTEMS, INC., MIDVALE, UT:
2,996,580, PUB. 6-28-2005, INT. CL. 9.
- STAR CLIPPERS, LTD., CORAL GABLES, FL, STAR CLIPPERS, INCORPORATED, COCONUT GROVE, FL:
1,862,797, REN. 8-11-05, INT. CL. 39.
- STAR NETWORKS, INC., MAITLAND, FL:
1,357,141, REN. 8-11-05, INT. CL. 36.
- STAR NETWORKS, INC., MAITLAND, FL, EFT GROUP, INC., RESTON, VA:
1,375,061, REN. 8-11-05, INT. CL. 36.
- STAR NURSERY, INC., HENDERSON, NV:
2,998,672, INT. CL. 1.
- STAR PRIMAS, INC., SAN JOSE, CA:
2,201,641, CANC. INT. CL. 20.
- STAR TRIBUNE COMPANY, THE, MINNEAPOLIS, MN:
2,201,773, CANC. INT. CL. 42.
- STAR-BRITE DISTRIBUTING, INC., FORT LAUDERDALE, FL:
2,998,808, INT. CL. 3.
- STARCRAFT AUTOMOTIVE CORPORATION, GOSHEN, IN TO STARCRAFT CORPORATION, GOSHEN, IN:
1,860,853, CANC. INT. CL. 12.
- STARE DECISIS, LLC, GLENDALE, CO:
2,997,940, PUB. 6-28-2005, INT. CL. 9.
- STARK CARPET CORP., NEW YORK, NY:
2,998,224, PUB. 6-28-2005, INT. CL. 27.
- 2,998,227, PUB. 6-28-2005, INT. CL. 27.
- STARKING TECHNOLOGY CORP., JHONGHE CITY, TAIWAN:
2,997,352, PUB. 6-28-2005, INT. CL. 9.
- STARR WESTERN WEAR, INC., EL PASO, TX:
2,996,865, PUB. 6-28-2005, MULTIPLE CLASS, INT. CLS. 25 AND 35.
- START TO FINISH FITNESS, LLC, CLEVELAND HEIGHTS, OH:
2,997,775, PUB. 6-28-2005, MULTIPLE CLASS, INT. CLS. 41 AND 44.
- STARZ ENTERTAINMENT GROUP LLC, ENGLEWOOD, CO:
2,997,608, PUB. 6-28-2005, INT. CL. 41.
- 2,997,610, PUB. 6-28-2005, INT. CL. 41.
- STATE INDUSTRIAL PRODUCTS CORPORATION, CLEVELAND, OH:
1,366,114, REN. 8-9-05, MULTIPLE CLASS, INT. CLS. 1, 3, 4, 6, 7, 8 AND 9.
- STATE STREET BARBERS, LLC, CHICAGO, IL:
2,998,990, INT. CL. 44.
- STATSOFT INC, TULSA, OK:
1,966,344, REN. 8-9-05, INT. CL. 9.
- STATSOFT, INC., TULSA, OK:
1,942,437, REN. 8-9-05, INT. CL. 9.
- STAY'N SAVE MOTOR INN SERVICES INC., VICTORIA, BRITISH COLUMBIA, CANADA:
2,201,389, CANC. INT. CL. 42.
- STEIBLI, MANFRED G., CORNVILLE, AZ AND STEIBLI, MARY B., CORNVILLE, AZ:
2,997,092, PUB. 6-28-2005, MULTIPLE CLASS, INT. CLS. 37 AND 40.
- STEIN MART BUYING CORP., JACKSONVILLE, FL:
2,998,622, INT. CL. 35.
- STEINFELD'S PRODUCTS COMPANY, PORTLAND, OR, AKA STEINFELD'S PRODUCTS CO.:
1,302,972, CANC. INT. CL. 30.
- STELLA INDUSTRIES LLC, SPRINGFIELD, VA:
2,996,986, PUB. 6-28-2005, INT. CL. 3.
- STEMCOR USA, INC., NEW YORK, NY:
2,997,500, PUB. 6-28-2005, MULTIPLE CLASS, INT. CLS. 35, 36 AND 39.
- STENGEL, HANS, 8834 SCHINDELLEGI, SWITZERLAND AND STENGEL, HELENE, 8834 SCHINDELLEGI, SWITZERLAND:
2,202,392, CANC. MULTIPLE CLASS, INT. CLS. 29, 30, 32 AND 42.
- STEPHKA'S COLLECTION LLC, SAN FRANCISCO, CA:
2,996,645, PUB. 1-4-2005, INT. CL. 3.
- STERLING PUBLISHING CO., INC., NEW YORK, NY:
1,970,955, REN. 8-11-05, INT. CL. 16.
- STEWART & SON OF DUNDEE LIMITED, DUNDEE DD4 7 RE, SCOTLAND:
2,201,564, CANC. INT. CL. 33.
- STEWART ELECTRONICS CORPORATION, RANCHO CORDOVA, CA:
2,201,762, CANC. INT. CL. 9.
- STEWART-JACKSON PHARMACAL, INC., MEMPHIS, TN, MED-DERM PHARMACEUTICALS, INC., GRAY, TN, DBA MED-DERM, INC.:
1,972,950, REN. 8-11-05, INT. CL. 5.
- STICHT, WALTER, 4800 ATTNANG-PUCHHEIM, AUSTRIA:
2,909,472, COR. MULTIPLE CLASS, INT. CLS. 7 AND 9.
- STILA COSMETICS, INC., LOS ANGELES, CA:
2,999,067, INT. CL. 3.
- STM WIRELESS, INC., IRVINE, CA:
2,201,781, CANC. INT. CL. 9.
- STMICROELECTRONICS NV, 1228 GENEVE, SWITZERLAND:
2,996,316, PUB. 6-28-2005, INT. CL. 9.

- STMICROELECTRONICS S.R.L., AGRATE BRIANZA, ITALY:
1,309,805. REN. 8-12-05. INT. CL. 9.
- STORANDT PANN MARGOLIS & PARTNERS, LA GRANGE, IL:
2,999,128. INT. CL. 44.
- STRATA-TAC, INC., BATAVIA, IL:
2,997,055. PUB. 6-28-2005. INT. CL. 16.
- STRATEGIC FINANCIAL COMMUNICATIONS CORP., NEW YORK, NY:
2,201,522. CANC. INT. CL. 16.
- STRATEGIC SIMULATIONS, INC., NOVATO, CA:
2,202,065. CANC. INT. CL. 9.
- STRATEGICELEVATION, LLC, PALATINE, IL:
2,998,573. INT. CL. 35.
- STRATHMORE PRODUCTS, INC., SYRACUSE, NY:
1,872,159. REN. 8-11-05. INT. CL. 2.
- STRATMAR SYSTEMS, INC., PORT CHESTER, NY:
2,202,036. CANC. INT. CL. 35.
- STRAUSS, KAREN, TOMS RIVER, NJ:
2,996,630. PUB. 6-28-2005. INT. CL. 26.
- STREAMLINE SHIPPERS ASSOCIATION, INC., CITY OF COMMERCE, CA:
2,997,067. PUB. 6-14-2005. INT. CL. 39.
- STREETCARS, INC., IRVING, TX:
2,998,677. INT. CL. 25.
- STRESSGEN BIOTECHNOLOGIES CORPORATION, VICTORIA BRITISH COLUMBIA, CANADA:
2,999,273. INT. CL. 5.
- STRINGER'S, LLC, TEMECULA, CA:
2,997,356. PUB. 6-28-2005. INT. CL. 39.
- STRONG, DARYL M., TEMPE, AZ, STRONG, DARYL M., TEMPE, AZ:
1,878,587. REN. 8-10-05. INT. CL. 14.
- STRONGGO, LLC, TUCSON, AZ:
2,999,310. INT. CL. 17.
- STRUCTURE PROBE, INC., WEST CHESTER, PA:
1,331,479. REN. 8-11-05. INT. CL. 1.
- STRYKER CORPORATION, KALAMAZOO, MI:
2,997,454. PUB. 6-28-2005. INT. CL. 10.
- STUDENTCITY.COM, INC., PEABODY, MA:
2,997,702. PUB. 6-28-2005. MULTIPLE CLASS, INT. CLS. 39 AND 42.
- STUDIO RTA, INC., PICO RIVERA, CA:
2,996,782. PUB. 6-28-2005. INT. CL. 20.
- STUDIO 42, INC., NEW YORK, NY:
2,998,134. PUB. 6-28-2005. INT. CL. 36.
- STUF PRODUCTS LLC, PASADENA, CA:
2,997,751. PUB. 6-28-2005. INT. CL. 3.
- STUNARD APPRAISAL RESEARCH COUNSELORS, LTD., CHICAGO, IL:
2,996,296. PUB. 6-28-2005. MULTIPLE CLASS, INT. CLS. 36 AND 42.
- STYLING TECHNOLOGY CORP, DUNCANVILLE, TX:
2,201,468. CANC. INT. CL. 3.
- SUB-ZERO FREEZER COMPANY, INC., MADISON, WI:
2,997,015. PUB. 6-28-2005. MULTIPLE CLASS, INT. CLS. 35 AND 41.
- SUCCESS DNA, INC, MINDEN, NV:
2,998,927. MULTIPLE CLASS, INT. CLS. 16 AND 35.
- SUFFICIENT GROUNDS COFFEEHOUSE, INC., LITTLE ROCK, AR:
2,201,227. CANC. INT. CL. 42.
- SUGIURA, JOE J., HOLLISTER, CA, DBA HOLLISTER FARMS:
2,200,917. CANC. INT. CL. 31.
- SUMMER CLASSICS, INC., MONTEVALLO, AL:
2,997,195. PUB. 6-28-2005. MULTIPLE CLASS, INT. CLS. 6, 8, 11, 20 AND 21.
- SUMMERS-PERRY, BROOKE, HOUSTON, TX AND HOLBROOK, SARAH, CYPRESS, TX:
2,999,150. INT. CL. 42.
- SUMMIT BREWING COMPANY, ST. PAUL, MN:
1,901,298. REN. 8-10-05. INT. CL. 32.
1,918,039. REN. 8-10-05. INT. CL. 25.
- SUMNER MANUFACTURING CO., INC., HOUSTON, TX:
1,921,482. REN. 8-9-05. INT. CL. 6.
- SUN-DIAMOND GROWERS OF CALIFORNIA, STOCKTON, CA:
1,302,875. CANC. INT. CL. 29.
- SUNART LIMITED, TSIMSHATSUI, KOWLOON, HONG KONG:
2,201,243. CANC. INT. CL. 14.
- SUNBEAM PRODUCTS, INC., BOCA RATON, FL, SUNBEAM CORPORATION, CHICAGO, IL:
1,347,559. REN. 8-11-05. INT. CL. 11.
- SUNBEAM PRODUCTS, INC., BOCA RATON, FL, SUNBEAM CORPORATION, FT. LAUDERDALE, FL:
1,898,597. REN. 8-11-05. INT. CL. 8.
- SUNBRIDGE, INC., ALBUQUERQUE, NM:
2,202,084. CANC. INT. CL. 42.
- SUNDARAM MULTI PAP LIMITED, MUMBAI MAHARASHTRA, INDIA:
2,998,257. PUB. 6-28-2005. INT. CL. 16.
- SUNKIST GROWERS, INC., LOS ANGELES, CA:
779,569. CANC. U.S. CL. 46.
- SUNLIKE JUICE LTD., SCARBOROUGH, ONTARIO, CANADA:
1,861,525. CANC. INT. CL. 32.
- SUNPENTOWN INTERNATIONAL INC., CITY OF INDUSTRY, CA:
2,996,943. PUB. 6-28-2005. MULTIPLE CLASS, INT. CLS. 11, 20 AND 21.
- SUNRISE SENIOR LIVING, INC., MCLEAN, VA:
2,998,746. INT. CL. 36.
- SUNROAD INTERNATIONAL, INC., CITY OF INDUSTRY, CA:
1,897,577. REN. 8-6-05. INT. CL. 25.
- SUPER RADIATOR COILS LIMITED PARTNERSHIP, CHASKA, MN:
2,998,873. INT. CL. 11.
- SUPERFASTCARZ INC., CHEYENNE, WY:
2,997,758. PUB. 6-28-2005. INT. CL. 35.
- SUPERIOR AIR-GROUND AMBULANCE SERVICE, INC., ELMHURST, IL:
2,999,358. INT. CL. 39.
- SUPERIOR TOY & MANUFACTURING CO., INC., CHICAGO, IL:
1,302,792. CANC. INT. CL. 28.
- SUPERVALU INC., EDEN PRAIRIE, MN:
2,996,944. PUB. 6-28-2005. INT. CL. 35.
- SUPREME TOYS (HONG KONG) LIMITED, TSIMSHATSUI, KOWLOON, HONG KONG:
2,202,120. CANC. INT. CL. 28.
- SURRY LICENSING LLC, KEENE, NH:
1,302,883. CANC. INT. CL. 29.
1,303,287. CANC. INT. CL. 42.
- SUSIDKO, LYNN DRENNON, MORGAN HILL, CA:
2,997,170. PUB. 6-28-2005. INT. CL. 25.
- SUTTON, JAMES A., JR., STATESVILLE, NC:
1,015,682. REN. 8-10-05. INT. CL. 9.
- SUZUKI TECHNO AMERICA, INC., CHERRY HILL, NJ:
2,998,698. INT. CL. 9.
- SW-SOFT HOLDINGS, LTD., HERNDON, VA:
2,997,987. PUB. 6-28-2005. INT. CL. 9.
- SWC DISTRIBUTORS, INC., WINDSOR, CO:
2,996,790. PUB. 6-28-2005. INT. CL. 21.
- SWEARWEAR, LLC, WESTFIELD, NJ:
2,997,330. PUB. 6-28-2005. INT. CL. 25.
- SWEET & SASSY, INC., SOUTHLAKE, TX:
2,996,797. PUB. 6-28-2005. INT. CL. 41.
- SWEETAPPLE, MATTHEW, JOHN, WELWYN, UNITED KINGDOM:
2,998,880. MULTIPLE CLASS, INT. CLS. 28 AND 36.
- SWIMC, INC., WILMINGTON, DE, SPRAYON PRODUCTS, INC., BEDFORD HEIGHTS, OH:
789,649. REN. 8-9-05. U.S. CL. 23 (INT. CL. 7).
- SWIMC, INC., WILMINGTON, DE, WESTERN STATES LACQUER CORPORATION OF TEXAS, GRAND PRAIRIE, TX, DBA WESTERN SPECIALTY COATINGS COMPANY:
1,370,780. REN. 8-9-05. INT. CL. 2.
- SWIMC, INC., WILMINGTON, DE:
1,894,113. REN. 8-11-05. INT. CL. 19.

- SWIMC, INC., WILMINGTON, DE, SHERWIN-WILLIAMS COMPANY, THE, CLEVELAND, OH:
1,899,507, REN. 8-9-05. INT. CL. 2.
- SWING PAINTS LTD, MONTREAL, QUEBEC, CANADA:
2,997,377, PUB. 6-28-2005. MULTIPLE CLASS, INT. CLS. 2 AND 3.
- SWINGSCOPE INC., TORONTO, ONTARIO, CANADA:
2,998,683, INT. CL. 28.
- SWISS COLONY, INC., THE, MONROE, WI:
1,302,873, CANC. MULTIPLE CLASS, INT. CLS. 29 AND 30.
1,302,874, CANC. MULTIPLE CLASS, INT. CLS. 29 AND 30.
- SWISS VALLEY FARMS CO., DAVENPORT, IA:
2,998,135, PUB. 6-28-2005. MULTIPLE CLASS, INT. CLS. 29 AND 32.
- SWISS-AMERICAN IMPORTING CO., ST. LOUIS, MO:
1,302,960, CANC. INT. CL. 30.
- SYDA FOUNDATION, SOUTH FALLSBURG, NY, SIDDHA INTERNATIONAL IMPORT & EXPORT, INC., GAINESVILLE, FL:
1,336,212, REN. 8-11-05. INT. CL. 3.
- SYMATEC SF CORPORATION, CUPERTINO, CA:
2,996,248, PUB. 3-20-2001. MULTIPLE CLASS, INT. CLS. 38 AND 42.
- SYNAPSE FITNESS, INC., ALISO VIEJO, CA:
2,998,865, INT. CL. 28.
- SYNCO CHEMICAL CORPORATION, BOHEMIA, NY:
1,350,233, REN. 8-10-05. INT. CL. 4.
- SYNDIX, INC., NEW SYMRNA BEACH, FL:
2,997,057, PUB. 6-28-2005. INT. CL. 18.
- SYNERGETICS, INC., DALLAS, TX:
1,302,493, CANC. INT. CL. 12.
- SYNERGY SERVICES INCORPORATION, GREENVILLE, SC:
1,964,069, REN. 8-7-05. INT. CL. 37.
- SYNGENTA PARTICIPATIONS AG, GREENSBORO, NC, SANDOZ AG (SANDOZ LTD., SANDOZ S.A.), BASLE, SWITZERLAND:
1,885,597, REN. 8-11-05. INT. CL. 20.
- SYNGENTA PARTICIPATIONS AG, BASEL, SWITZERLAND:
2,998,855, INT. CL. 31.
- SYNTHETIC ENVIRONMENTS, INC., MCLEAN, VA:
2,998,840, INT. CL. 9.
- SYRACUSE UNIVERSITY, SYRACUSE, NY:
1,888,197, REN. 8-10-05. MULTIPLE CLASS, INT. CLS. 6, 16, 18, 21, 24, 25, 28 AND 41.
- SYRATECH CORPORATION, EAST BOSTON, MA:
2,202,089, CANC. INT. CL. 8.
- SYSCO CORPORATION, HOUSTON, TX:
2,997,479, PUB. 6-28-2005. INT. CL. 30.
- SYSTEMAX INC., PORT WASHINGTON, NY:
2,997,550, PUB. 6-28-2005. INT. CL. 35.
- SYSTEMS DESIGN AND TECHNOLOGY LLC, WELLESLEY, MA:
2,996,995, PUB. 6-28-2005. INT. CL. 9.
- SZCZEPANSKI, ZYGMUNT, SAN CLEMENTE, CA:
2,997,865, PUB. 6-28-2005. INT. CL. 39.
- T. G. & Y. STORES CO., OKLAHOMA CITY, OK:
1,303,298, CANC. INT. CL. 42.
- T.F. WILCOX, INC., WEST ST PAUL, MN, DBA CHAPEL OF LOVE WEDDING CHAPELS:
1,912,004, REN. 8-11-05. INT. CL. 42.
- T.G. MANUFACTURING, INC., HAMMONTON, NJ:
2,996,791, PUB. 6-28-2005. INT. CL. 12.
- T.K. ANDERSON JEWELRY, LTD., ATHENS, GA:
2,201,337, CANC. INT. CL. 14.
- T.M. SCHULTZ TRAILER SALES, INC., BRANDON, SD:
2,999,147, INT. CL. 35.
- T.O. CATTLE COMPANY, SAN JUAN BAUTISTA, CA:
2,997,747, PUB. 6-28-2005. INT. CL. 29.
- T-REX PRODUCTS, INC., CHULA VISTA, CA:
2,996,570, PUB. 6-28-2005. MULTIPLE CLASS, INT. CLS. 20, 21 AND 31.
- T-SHIRT CELLAR, INC., PANAMA CITY BEACH, FL:
2,996,401, PUB. 6-28-2005. MULTIPLE CLASS, INT. CLS. 16 AND 35.
- TA HSING ELECTRIC WIRE & CABLE CO., LTD., TAIPEI, TAIWAN:
2,997,376, PUB. 6-28-2005. INT. CL. 35.
- TAB COMPUTER SYSTEMS, INC., SOUTH WINDSOR, CT:
2,999,100, MULTIPLE CLASS, INT. CLS. 9 AND 42.
- TACTICAL LINK, LLC, BELLEVUE, WA:
2,997,800, PUB. 6-28-2005. INT. CL. 13.
- TAITO AMERICA CORPORATION, WHEELING, IL:
1,302,824, CANC. INT. CL. 28.
- TAIWAN FU HSING INDUSTRIAL CO., LTD., KAOHSIUNG HSIEN, TAIWAN:
2,999,007, MULTIPLE CLASS, INT. CLS. 6 AND 7.
2,999,008, INT. CL. 9.
- TAIWAN SALT COMPANY, TAINAN CITY, TAIWAN:
2,999,091, INT. CL. 3.
- TAJ GIFTS & JEWELRY, INC., HOUSTON, TX, DBA IMPORT WORLD:
2,997,571, PUB. 6-28-2005. INT. CL. 14.
- TAKARA CO., LTD., TOKYO, JAPAN:
2,998,946, MULTIPLE CLASS, INT. CLS. 9 AND 28.
- TAKARA U.S.A. CORPORATION, NEW YORK, NY:
2,202,226, CANC. INT. CL. 28.
- TAKEDA PHARMACEUTICALS NORTH AMERICA, INC., LINCOLNSHIRE, IL:
2,997,042, PUB. 6-28-2005. INT. CL. 42.
- TALENT RETRIEVER, LLC, WOBURN, MA:
2,996,803, PUB. 6-28-2005. INT. CL. 35.
- TAMROCK OY, 33310 TAMPERE, FINLAND:
2,201,785, CANC. MULTIPLE CLASS, INT. CLS. 9 AND 16.
- TAMURA CORPORATION, TOKYO, JAPAN:
2,998,621, INT. CL. 1.
- TANG, YI, PLANO, TX:
2,997,094, PUB. 6-28-2005. INT. CL. 42.
- TANIMURA & ANTLE, INC., SALINAS, CA:
2,998,643, MULTIPLE CLASS, INT. CLS. 29, 31 AND 35.
- TAP PHARMACEUTICAL PRODUCTS INC., LAKE FOREST, IL:
2,997,798, PUB. 6-28-2005. INT. CL. 44.
- TAP PHARMACEUTICALS PRODUCTS, INC, LAKE FOREST, IL:
1,859,068, REN. 8-9-05. MULTIPLE CLASS, INT. CLS. 16 AND 42.
- TAPCO INTERNATIONAL CORPORATION, WIXOM, MI:
2,998,277, PUB. 6-28-2005. INT. CL. 8.
- TAPSCAN, INC., BIRMINGHAM, AL:
2,201,160, CANC. INT. CL. 9.
- TARKETT INC., FARNHAM, QC, CANADA:
1,920,977, REN. 8-12-05. INT. CL. 27.
- TARKETT INC., FARNHAM, QUEBEC:
2,201,856, CANC. INT. CL. 27.
- TASH SHOE COMPANY, CINCINNATI, OH:
2,202,259, CANC. INT. CL. 35.
- TAX ANALYSTS, ARLINGTON, VA:
2,997,194, PUB. 6-28-2005. INT. CL. 41.
- TAXISURE EXCHANGE, MANALAPAN, NJ:
2,997,866, PUB. 6-28-2005. INT. CL. 36.
- TAYLOR, WILLIAM J., CORNELIUS, NC:
2,201,899, CANC. INT. CL. 25.
- TC LICENSE, LTD, HUMMELSTOWN, PA:
1,341,391, REN. 8-11-05. INT. CL. 35.
- TCBY SYSTEMS, LLC, SALT LAKE CITY, UT:
1,901,091, REN. 8-6-05. INT. CL. 30.
1,901,091, CANC. INT. CL. 29.
- TCI PRODUCTS, INC., ST. LOUIS, MO:
2,996,965, PUB. 6-28-2005. MULTIPLE CLASS, INT. CLS. 2, 6, 16, 17 AND 21.
- TDC TOTALLØSNINGER A/S, DK-0900 COPENHAGEN C, DENMARK:
2,998,368, PUB. 6-28-2005. INT. CL. 38.
- TEA BODY'S, INC., TURLOCK, CA:
2,201,790, CANC. INT. CL. 30.
- TEAL, DARIN, KEIZER, OR:
2,997,426, PUB. 6-28-2005. INT. CL. 30.
- TEALIGHTFUL TREASURES, INC., ROCHESTER, NY:
2,997,206, PUB. 6-28-2005. INT. CL. 30.
- TEAM AIR EXPRESS, INC., WINNSBORO, TX:
2,996,670, PUB. 6-28-2005. INT. CL. 35.

- TEAM AMERICA CORPORATION, WORTHINGTON, OH:
2,201,030, CANC. INT. CL. 35.
2,201,031, CANC. INT. CL. 35.
- TEAM 02 INVESTMENTS, LLC, COLORADO SPRINGS, CO:
2,998,771, MULTIPLE CLASS, INT. CLS. 25, 41 AND 43.
- TECH INCORPORATED, LENEXA, KS:
2,997,334, PUB. 6-28-2005. MULTIPLE CLASS, INT. CLS.
4, 7, 8 AND 12.
- TECHLINE USA, LLC, MADISON, WI:
2,999,064, INT. CL. 20.
- TECHNOLOGIES AZUR INC., MONTREAL, QUEBEC, CA-
NADA:
2,996,940, PUB. 6-28-2005. INT. CL. 9.
- TECHTRONIC APPLIANCES HOLDINGS COMPANY LIM-
ITED, HAMILTON, HM 11, BERMUDA, NEW REGINA
CORPORATION, RAHWAY, NJ:
1,336,301. REN. 8-12-05. INT. CL. 7.
- TECHTRONIC APPLIANCES HOLDINGS COMPANY LIM-
ITED, HAMILTON, BERMUDA, NEW REGINA COR-
PORATION, RAHWAY, NJ:
1,336,302. REN. 8-12-05. INT. CL. 7.
- TED'S JUMBO RED HOTS, INC., AMHERST, NY:
1,316,287. REN. 8-10-05. INT. CL. 42.
1,317,412. REN. 8-10-05. INT. CL. 42.
- TEDDY BEAR HOUSE INC., THE, EDMONTON, ALBERTA,
CANADA TO AMBER HOLDINGS INC., CALGARY,
ALBERTA, CANADA:
1,861,457, CANC. INT. CL. 39.
- TEEL PLASTICS, INC., BARABOO, WI:
2,202,227, CANC. INT. CL. 20.
- TEHCURB LLC, HOUSTON, TX:
2,998,031, PUB. 6-28-2005. INT. CL. 41.
- TEIJIN KABUSHIKI KAISHA (TEIJIN LIMITED), OSAKA,
JAPAN:
2,999,187, INT. CL. 17.
- TEKNOR APEX COMPANY, PAWTUCKET, RI, B. F. GOOD-
RICH COMPANY, THE, AKRON, OH:
1,017,233. REN. 8-10-05. INT. CL. 1.
- TEKTRO TECHNOLOGY CORPORATION, CHANG-HUA
HSIEN, TAIWAN:
2,997,590, PUB. 6-28-2005. INT. CL. 12.
2,997,591, PUB. 6-28-2005. INT. CL. 12.
- TELE-RILEVAMENTO-EUROPA - T.R.E. S.R.L., 32, I-20133
MILANO, ITALY:
2,996,397, PUB. 6-28-2005. MULTIPLE CLASS, INT. CLS.
9, 42 AND 45.
- TELEGRAPH PUBLISHING COMPANY, HUDSON, NH:
2,997,863, PUB. 6-28-2005. INT. CL. 16.
- TELENOR SATELLITE SERVICES, INC., ROCKVILLE, MD:
2,996,773, PUB. 6-28-2005. INT. CL. 38.
- TELEPHONE ELECTRONICS CORPORATION, JACKSON,
MS:
2,999,031, INT. CL. 38.
- TELIA AB, S-123 86 FARSTA, SWEDEN:
2,200,835, CANC. INT. CL. 9.
- TELLABS PETALUMA, INC., PETALUMA, CA, ADVANCED
FIBRE COMMUNICATIONS, PETALUMA, CA:
1,898,365. REN. 8-10-05. INT. CL. 9.
- TELTRUST, INC., SALT LAKE CITY, UT:
2,201,137, CANC. MULTIPLE CLASS, INT. CLS. 16 AND
36.
- TEMBOARD INC., MONTREAL, QUEBEC, CANADA TO
TEMBEC INDUSTRIES INC., MONTREAL, QUEBEC,
CANADA:
1,861,393, CANC. INT. CL. 16.
- TEN CAP INC., MINNETONKA, MN:
1,882,879. REN. 8-8-05. INT. CL. 9.
- TENET HEALTHCARE CORPORATION, DALLAS, TX:
2,997,663, PUB. 6-28-2005. INT. CL. 44.
2,998,009, PUB. 6-28-2005. INT. CL. 44.
- TERAGREN LLC, BAINBRIDGE ISLAND, WA:
2,999,066, INT. CL. 19.
- TERALINK COMMUNICATIONS, INC., YUSEONG-GU,
DAEJEON, REPUBLIC OF KOREA:
2,999,345, INT. CL. 9.
- TERASEN INC., VANCOUVER, BRITISH COLUMBIA, CA-
NADA:
2,996,268, PUB. 6-28-2005. INT. CL. 35.
- TERI & YAKI CHICKEN HOUSE #2, INC., PASADENA, CA:
2,997,311, PUB. 6-28-2005. INT. CL. 43.
- TERME DI SATURNIA S.R.L., ITALY:
2,998,451, PUB. 6-28-2005. MULTIPLE CLASS, INT. CLS.
3, 41 AND 42.
- TERMINIX INTERNATIONAL COMPANY, L.P., MEMPHIS,
TN:
1,303,122, CANC. INT. CL. 37.
- TERRA-MAR RESOURCE INFORMATION SERVICES,
INC., MOUNTAIN VIEW, CA:
1,303,234, CANC. INT. CL. 42.
- TERRALIFT INTERNATIONAL, LTD., STOCKBRIDGE,
MA:
2,201,002, CANC. INT. CL. 7.
- TESA TAPE INC., CHARLOTTE, NC:
2,201,661, CANC. INT. CL. 17.
- TESSENDERLO KERLEY, INC., PHOENIX, AZ:
2,997,933, PUB. 6-28-2005. INT. CL. 1.
- TETT, DAVID, HEALDSBURG, CA, DBA BUSHTRACKS
AFRICAN EXPEDITIONS, INC.:
2,997,883, PUB. 6-28-2005. INT. CL. 39.
- TEXAS AND SOUTHWESTERN CATTLE RAISERS ASSO-
CIATION, FORT WORTH, TX:
2,996,473, PUB. 6-28-2005. INT. CL. 41.
- TEXAS DAIRY QUEEN OPERATORS' COUNCIL, BED-
FORD, TX:
2,998,788, INT. CL. 30.
- TEXAS IDEAGROUP, INC., DALLAS, TX:
2,996,620, PUB. 6-28-2005. INT. CL. 44.
- TEXAS INDEPENDENT PRODUCERS & ROYALTY OWN-
ERS ASSOCIATION, AUSTIN, TX:
2,200,894, CANC. MULTIPLE CLASS, INT. CLS. 9, 35, 38
AND 42.
- TEXAS MUTUAL INSURANCE COMPANY, AUSTIN, TX:
2,997,843, PUB. 6-28-2005. INT. CL. 36.
- TEXAS UTILITIES COMMUNICATIONS, INC., DALLAS,
TX:
2,201,950, CANC. INT. CL. 38.
- TEXTON DISTRIBUTING COMPANY, INC., GARLAND,
TX:
1,302,634, CANC. INT. CL. 20.
- TEXTRON FINANCIAL CORPORATION, LAKE OSWEGO,
OR:
2,997,133, PUB. 6-28-2005. INT. CL. 37.
- TH CORPORATION, BARRIGADA, GUAM, DBA MANGI-
LAO GOLF CLUB:
1,843,246. REN. 8-11-05. INT. CL. 41.
- THALER EVENT GBR, FED REP GERMANY:
2,998,376, PUB. 6-28-2005. INT. CL. 25.
- THALES GEOSOLUTIONS GROUP LIMITED, BERKSHIRE
RG-12 IRG, ENGLAND, RACAL SURVEY LIMITED,
BRACKNELL, BERKSHIRE RG12 IRG, ENGLAND:
1,899,684. REN. 8-9-05. INT. CL. 9.
- THAYER DENTAL LABORATORY, INC., MECHANICS-
BURG, PA:
2,998,170, PUB. 6-28-2005. INT. CL. 10.
- THE AVICON GROUP, INC., WALTHAM, MA:
2,997,943, PUB. 6-28-2005. INT. CL. 35.
- THE BELL GROUP, ALBUQUERQUE, NM:
2,996,380, PUB. 6-28-2005. INT. CL. 7.
- THE BIGIO GROUP LLC, NEW YORK, NY:
2,998,156, PUB. 6-28-2005. MULTIPLE CLASS, INT. CLS.
18 AND 25.
- THE BLACK DOG TAVERN COMPANY, INC., BOSTON,
MA:
2,998,256, PUB. 6-28-2005. INT. CL. 35.
- THE BRAINY BABY COMPANY LLC, ALPHARETTA, GA:
2,996,964, PUB. 6-28-2005. INT. CL. 9.
- THE BREAD GARDEN LIMITED, FEDERAL WAY, WA:
2,997,817, PUB. 6-28-2005. INT. CL. 30.
- THE BRONSKILL GROUP, INC., TORONTO, ONTARIO,
CANADA:
2,996,272, PUB. 6-28-2005. INT. CL. 9.
- THE BUTCHER COMPANY, MARLBOROUGH, MA,
BUTCHER POLISH CO.; THE, MARLBOROUGH, MA:
1,309,570. REN. 8-10-05. INT. CL. 3.
- THE CANNON CORPORATION, GRAND ISLAND, NY:
2,996,377, PUB. 6-28-2005. INT. CL. 42.

- THE CHAUNCEY GROUP INTERNATIONAL LTD., PRINCETON, NJ:
2,998,154, PUB. 6-28-2005. MULTIPLE CLASS, INT. CLS. 16 AND 42.
- THE CHRISTIAN NETWORK, INC., CLEARWATER, FL:
2,996,816, PUB. 6-28-2005. INT. CL. 38.
- THE CHURCH ONLINE, LLC, EAST PITTSBURGH, PA:
2,999,390, INT. CL. 38.
- THE CLUB AT SPANISH PEAKS, LLC, BIG SKY, MT:
2,996,589, PUB. 6-28-2005. MULTIPLE CLASS, INT. CLS. 36, 37 AND 41.
- THE COCA-COLA COMPANY, ATLANTA, GA:
2,997,881, PUB. 6-28-2005. INT. CL. 36.
- THE CONSULTANT COMPANY, STONE MOUNTAIN, GA:
2,998,852, MULTIPLE CLASS, INT. CLS. 9 AND 41.
- THE CORPORATE EXECUTIVE BOARD COMPANY, WASHINGTON, DC:
2,997,685, PUB. 6-28-2005. INT. CL. 16.
- THE COURAGE TO SPEAK FOUNDATION, INC., NORWALK, CT:
2,996,426, PUB. 6-28-2005. INT. CL. 41.
- THE CROSS COUNTRY GROUP, LLC, BOSTON, MA:
2,997,014, PUB. 6-28-2005. INT. CL. 37.
- THE DERING CORPORATION, LANCASTER, PA:
2,996,853, PUB. 6-28-2005. INT. CL. 9.
- THE DUART GROUP LTD, NEW HOPE, PA:
1,860,782, CANC. INT. CL. 9.
- THE FIELD GENERALS, LLC, ATLANTA, GA:
2,998,645, INT. CL. 36.
- THE FOREIGN CANDY COMPANY, INC., HULL, IA:
2,998,233, PUB. 6-28-2005. INT. CL. 30.
- THE FOREST HIGHLANDS ASSOCIATION, FLAGSTAFF, AZ:
2,998,780, INT. CL. 36.
- THE FRANTZ GROUP, INC., GRAFTON, WI:
2,996,625, PUB. 6-28-2005. INT. CL. 35.
2,996,626, PUB. 6-28-2005. INT. CL. 35.
- THE GOOD HOME CO., INC., NEW YORK, NY:
2,998,252, PUB. 6-28-2005. INT. CL. 3.
- THE GOODYEAR TIRE & RUBBER COMPANY, AKRON, OH:
2,998,110, PUB. 6-28-2005. INT. CL. 35.
2,998,192, PUB. 6-28-2005. INT. CL. 12.
2,998,238, PUB. 6-28-2005. INT. CL. 12.
- THE GREAT AMERICAN BAGEL ENTERPRISES, INC., WESTMONT, IL:
2,998,810, INT. CL. 43.
- THE GREAT AMERICAN WATERFALL COMPANY, SPRING HILL, FL:
2,999,059, INT. CL. 11.
- THE HAROLD E. LEMAY MUSEUM, TACOMA, WA:
2,997,283, PUB. 6-28-2005. INT. CL. 41.
- THE HAYS GROUP INC., MINNEAPOLIS, MN:
2,997,480, PUB. 6-28-2005. INT. CL. 36.
- THE INNOVATION GROUPS, INC., TAMPA, FL:
2,997,570, PUB. 6-28-2005. INT. CL. 41.
- THE INSERT SHIRT COMPANY, LLC, PITTSBURGH, PA:
169,763, REN. 8-12-05. U.S. CL. 39 (INT. CLS. 10, 25 AND 26).
- THE INSTITUTE OF ELECTRICAL AND ELECTRONICS ENGINEERS, INC., PISCATAWAY, NJ:
2,998,304, PUB. 6-28-2005. INT. CL. 41.
- THE KAPLAN CONSULTING GROUP, WALNUT CREEK, CA:
2,999,057, INT. CL. 42.
- THE KROGER CO. OF MICHIGAN, LIVONIA, MI:
2,998,817, MULTIPLE CLASS, INT. CLS. 11, 15, 20, 21 AND 28.
- THE LIFESKILLS COMPANY, CUMMING, GA:
2,996,260, PUB. 6-28-2005. INT. CL. 42.
- THE LLOYD GROUP, INC., NEW YORK, NY:
2,999,056, MULTIPLE CLASS, INT. CLS. 37, 38 AND 42.
- THE LUBRIZOL CORPORATION, WICKLIFFE, OH:
2,998,247, PUB. 6-28-2005. INT. CL. 1.
- THE LUDLOW COMPANY LP, PORTSMOUTH, NH:
1,323,055, REN. 8-9-05. INT. CL. 10.
- THE MAHER TEAM, LLC, LEAWOOD, KS:
2,997,986, PUB. 6-28-2005. INT. CL. 36.
- THE MARCUS CORPORATION, MILWAUKEE, WI, MARCUS THEATRES CORPORATION, MILWAUKEE, WI:
1,948,940, REN. 8-10-05. INT. CL. 41.
- THE MARKET SHARE OF MONROE COUNTY INCORPORATED, KEY WEST, FL:
2,999,382, INT. CL. 16.
2,999,394, INT. CL. 9.
2,999,395, INT. CL. 16.
- THE MAY DEPARTMENT STORES COMPANY, ST. LOUIS, MO:
1,270,920, CANC. INT. CL. 29.
- THE MCPHERSON COMPANIES, INC., BIRMINGHAM, AL:
2,997,160, PUB. 6-28-2005. INT. CL. 4.
- THE MIAMI PRODUCTS & CHEMICAL COMPANY, DAYTON, OH:
2,996,724, PUB. 6-28-2005. INT. CL. 5.
- THE MIBRO GROUP, L.C., BUFFALO, NY:
2,996,320, PUB. 6-28-2005. INT. CL. 20.
- THE NATIONAL COMPANY FOR FOODS N.F.C., BEKAA, LEBANON:
2,996,651, PUB. 6-28-2005. INT. CL. 29.
- THE NATIONAL OSTEOPOROSIS FOUNDATION, WASHINGTON, DC, DC:
2,999,269, INT. CL. 35.
- THE NOBLE COMPANY, GRAND HAVEN, MI:
2,996,849, PUB. 6-28-2005. INT. CL. 1.
- THE OGILVY GROUP, INC., NEW YORK, NY:
2,999,294, INT. CL. 35.
- THE ORIGINAL MIRACLE MATT, CHATSWORTH, CA:
2,996,341, PUB. 6-28-2005. INT. CL. 20.
- THE OXFORD TOY COMPANY LIMITED, WALLINGFORD, OXON, UNITED KINGDOM:
2,998,096, PUB. 6-28-2005. INT. CL. 28.
- THE PENN TRAFFIC COMPANY, SYRACUSE, NY:
2,996,879, PUB. 6-28-2005. INT. CL. 29.
- THE PEP BOYS MANNY, MOE & JACK OF CALIFORNIA, PHILADELPHIA, PA:
2,998,825, INT. CL. 32.
- THE PERISHABLES GROUP, INC., CHICAGO, IL:
2,996,825, PUB. 6-28-2005. INT. CL. 35.
- THE PILLSBURY COMPANY, MINNEAPOLIS, MN:
2,998,136, PUB. 6-28-2005. INT. CL. 30.
- THE PLASTIC LUMBER COMPANY, INC., AKRON, OH:
2,998,883, INT. CL. 19.
- THE PRESIDENT'S COUNCIL, LLC, CLEVELAND, OH:
2,998,679, INT. CL. 35.
- THE PROCTER & GAMBLE COMPANY, CINCINNATI, OH:
2,998,040, PUB. 6-28-2005. INT. CL. 3.
2,999,255, INT. CL. 3.
- THE RITZ-CARLTON HOTEL COMPANY, L.L.C., BETHESDA, MD:
2,997,985, PUB. 6-28-2005. INT. CL. 43.
- THE RIVER CITY GROUP, LLC, ST. CHARLES, MO:
2,996,575, PUB. 6-28-2005. INT. CL. 41.
- THE SALVATION ARMY, USA EASTERN TERRITORY, WEST NYACK, NY:
2,996,420, PUB. 6-28-2005. INT. CL. 16.
- THE SKOLL COMMUNITY FUND, SAN JOSE, CA:
2,998,917, INT. CL. 38.
- THE SPRING AIR COMPANY, ELK GROVE VILLAGE, IL:
2,998,935, INT. CL. 20.
- THE ST. PAUL TRAVELERS COMPANIES, INC., SAINT PAUL, MN:
1,303,078, CANC. INT. CL. 36.
- THE TAN FACTORY, LLC, LAS VEGAS, NV:
2,998,218, PUB. 6-28-2005. INT. CL. 44.
- THE TERRAPIN COMPANIES, SANTA BARBARA, CA:
2,997,127, PUB. 6-28-2005. INT. CL. 3.
- THE TJX COMPANIES, INC., FRAMINGHAM, MA:
2,999,005, MULTIPLE CLASS, INT. CLS. 8 AND 21.
2,999,190, INT. CL. 25.
- THE TOMATO HEAD, INC., KNOXVILLE, TN:
2,997,880, PUB. 6-28-2005. INT. CL. 43.
- THE TRUSTEE OF THE MICHAELS TRUST, AS PATRICA J. MICHAELS, A U. S. CITIZEN., SANTA MONICA, CA:
2,200,872, CANC. INT. CL. 35.

- THE TRUSTEES OF THE HOPKINS TRUST DATED FEBRUARY 9, 2001, A CALIFORNIA TRUST, THE TRUSTEES COMPRISING VINCENT R. HOPKINS AND DANETTE L. HOPKINS, BOTH U.S. CITIZENS., CAMARILLO, CA:
2,998,577, INT. CL. 41.
2,998,578, INT. CL. 41.
- THE WESTERN AND SOUTHERN LIFE INSURANCE COMPANY, CINCINNATI, OH:
2,998,815, INT. CL. 36.
- THE WINE EXPERT PTY LTD, SYDNEY 2000, NEW SOUTH WALES, AUSTRALIA:
2,997,387, PUB. 6-28-2005. MULTIPLE CLASS, INT. CLS. 35 AND 42.
- THE YANKEE CANDLE COMPANY, INC., SOUTH DEERFIELD, MA:
2,998,343, PUB. 6-28-2005. INT. CL. 11.
2,998,344, PUB. 6-28-2005. INT. CL. 5.
2,998,930, INT. CL. 11.
- THE 1031 EXCHANGE EXPERTS, LLC, GREENWOOD VILLAGE, CO:
2,997,648, PUB. 6-28-2005. INT. CL. 42.
- THE, SIN KWANG, CHATSWORTH, CA:
2,997,293, PUB. 6-28-2005. INT. CL. 41.
- THERMO ELECTRON OY, VANTAA, FINLAND:
2,996,889, PUB. 6-28-2005. MULTIPLE CLASS, INT. CLS. 9 AND 10.
- THERMOFLOW, INC, SUDBURY, MA:
2,996,970, PUB. 6-28-2005. MULTIPLE CLASS, INT. CLS. 9 AND 42.
- THERMON MANUFACTURING COMPANY, SAN MARCOS, TX, THERMON MANUFACTURING COMPANY, SAN MARCOS, TX:
790,703. REN. 8-10-05. U.S. CL. 34 (INT. CL. 11).
- THERMOS L.L.C, ROLLING MEADOWS, IL:
1,897,909. REN. 8-11-05. MULTIPLE CLASS, INT. CLS. 11 AND 21.
- THERRES, GREGORY A., TOWSON, MD AND CAPOZZOLI, DAVID, ABINGDON, MD:
2,997,421, PUB. 6-28-2005. MULTIPLE CLASS, INT. CLS. 9 AND 25.
- THESSALONIA, DEPRINCE, FLUSHING QUEENS, NY:
2,997,595, PUB. 6-28-2005. INT. CL. 41.
- THETORN AB, HELSINGBORG, SWEDEN:
1,349,999. REN. 8-10-05. INT. CL. 41.
- THIERRY MUGLER PARFUMS S.A.S., NEUILLY-SUR-SEINE, FRANCE:
2,996,949, PUB. 6-28-2005. INT. CL. 3.
- THMX HOLDINGS, LLC, ONTARIO, CA:
2,201,626, CANC. MULTIPLE CLASS, INT. CLS. 1, 4 AND 11.
- THOMAS CONVEYER COMPANY, FORT WORTH, TX, HOOVER BALL AND BEARING COMPANY, SALINE, MI:
783,179. REN. 8-8-05. U.S. CL. 23 (INT. CL. 7).
- THOMAS HASTINGS CO., LLC, HINGHAM, MA:
2,996,936, PUB. 6-28-2005. INT. CL. 37.
- THOMAS NELSON, INC., NASHVILLE, TN:
2,202,205, CANC. INT. CL. 16.
- THOMAS SCIENTIFIC INC., PHILADELPHIA, PA:
2,996,360, PUB. 6-28-2005. MULTIPLE CLASS, INT. CLS. 9 AND 16.
2,996,419, PUB. 6-28-2005. INT. CL. 38.
2,996,600, PUB. 6-28-2005. INT. CL. 42.
- THOMAS, KIM, WEST MONROE, LA:
2,997,893, PUB. 6-28-2005. INT. CL. 28.
- THOMAS, ROBERT, THE DALLES, OR:
2,202,130, CANC. INT. CL. 35.
- THOMPSON, JAMES L., ST. THOMAS, US VIRGIN ISLANDS AND LOCKER, MATTHEW, WANAQUE, NJ:
2,999,025, INT. CL. 11.
- THOMSON CONSUMER ELECTRONICS, INC., INDIANAPOLIS, IN:
2,202,034, CANC. INT. CL. 9.
- THOMSON HEALTHCARE INC., MONTVALE, NJ, INTERNATIONAL THOMSON MEDICAL INFORMATION INC., PHILADELPHIA, PA:
1,332,083. REN. 8-11-05. INT. CL. 16.
- THOMSON LEARNING INC., STAMFORD, CT:
2,202,199, CANC. INT. CL. 41.
- THOR TECH, INC., SAGINAW, MI:
2,998,753, INT. CL. 38.
- THORNTONS INC., LOUISVILLE, KY:
2,705,405, CANC. MULTIPLE CLASS, INT. CLS. 35 AND 36.
- THORO'BRED RACING PLATE COMPANY, INC., ANAHEIM, CA:
1,901,427. REN. 8-9-05. INT. CL. 5.
- THREE FLOYDS BREWING, L.L.C., HAMMOND, IN:
2,201,511, CANC. INT. CL. 33.
- THREE RIVERS CENTER FOR INDEPENDENT LIVING, PITTSBURGH, PA:
1,860,902, CANC. INT. CL. 16.
- THREE 43 MAIN LTD., CARBONDALE, CO:
2,997,993, PUB. 6-28-2005. INT. CL. 43.
- TIFFIN COMPANY, L.L.C., THE, HAUPPAGE, NY:
1,903,383. REN. 8-12-05. INT. CL. 9.
- TIFFIN METAL PRODUCTS CO., TIFFIN, OH, J. AUSTIN SMITH & SON, LOUDONVILLE, OH, DBA SENTINEL LOCKERS:
791,768. REN. 8-11-05. U.S. CL. 25 (INT. CL. 6).
- TIFFIN METAL PRODUCTS CO., TIFFIN, OH:
2,996,300, PUB. 6-28-2005. INT. CL. 20.
- TILLIT GROUP, LLC, PRINCETON, NJ:
2,997,901, PUB. 6-28-2005. INT. CL. 36.
- TILLOTTS PHARMA AG, ZIEFEN, SWITZERLAND:
2,997,003, PUB. 6-28-2005. MULTIPLE CLASS, INT. CLS. 1 AND 5.
- TIM JANIS ENSEMBLE, INC., NEW YORK, NY:
2,998,118, PUB. 6-28-2005. INT. CL. 9.
- TIME INC., NEW YORK, NY:
2,997,509, PUB. 6-28-2005. INT. CL. 41.
- TIME MAX S.A., SWITZERLAND:
2,998,403, PUB. 6-28-2005. INT. CL. 14.
- TIME WARNER ENTERTAINMENT CO., L.P., MILILANI, HI, DBA OCEANIC TIME WARNER CABLE:
2,997,111, PUB. 6-28-2005. MULTIPLE CLASS, INT. CLS. 25 AND 41.
- TIMES MIRROR MAGAZINES, INC., NEW YORK, NY:
2,202,367, CANC. INT. CL. 41.
- TINDALL ASSOCIATES, INC., ORLAND PARK, IL:
2,996,453, PUB. 6-28-2005. INT. CL. 9.
- TIOGA, INC., MINNEAPOLIS, MN, W.F.J., INC., MINNEAPOLIS, MN:
1,340,532. REN. 8-10-05. INT. CL. 11.
- TIOXIDE UK LIMITED, BILLINGHAM, DURHAM, ENGLAND:
792,780. REN. 8-8-05. U.S. CL. 6 (INT. CL. 1).
- TIRE MART, INC., ST. LOUIS, MO:
1,871,753. REN. 8-10-05. INT. CL. 42.
- TISHCON CORP., WESTBURY, NY:
2,998,816, INT. CL. 5.
- TITUS GROUP, INC., THE, MILWAUKEE, WI:
2,996,629, PUB. 6-28-2005. INT. CL. 35.
- TIVO INC., ALVISO, CA:
2,996,654, PUB. 6-28-2005. INT. CL. 41.
- TJM DESIGN CORPORATION, TOKYO, JAPAN:
2,997,039, PUB. 6-28-2005. INT. CL. 9.
- TKL RESEARCH INC., PARAMUS, NJ:
2,999,098, INT. CL. 35.
- TM INDUSTRIAL SUPPLY, INC., ERIE, PA:
2,201,315, CANC. INT. CL. 11.
- TME CO., INC., NEW MILFORD, CT:
2,996,544, PUB. 6-28-2005. INT. CL. 14.
- TMI INCORPORATED, PITTSBURGH, PA:
2,996,493, PUB. 6-28-2005. INT. CL. 19.
- TN TECHNOLOGIES INC., WESTPORT, CT:
2,201,882, CANC. INT. CL. 35.
- TODAY'S WINDOW FASHIONS, FRAZIER PARK, CA:
2,998,630, INT. CL. 35.
- TODDLETAILS, LLC, ROSWELL, GA:
2,998,035, PUB. 6-28-2005. INT. CL. 35.
- TOGUN, ADEWALE A, DOUGLASVILLE, GA:
2,999,271, INT. CL. 9.
- TOKHEIM HOLDING B.V., AD BLADEL, NETHERLANDS:
1,930,126. REN. 8-10-05. INT. CL. 9.
- TOMAN, ROBERT NORRIS, CLACKAMAS, OR:
2,997,852, PUB. 6-28-2005. INT. CL. 28.

- TOMNIK FOOD SERVICES, INC., NANUET, NY:
2,997,682, PUB. 6-28-2005. INT. CL. 43.
- TOMPKINS; DOUGLAS L., EL PASO, TX:
1,339,123. REN. 8-11-05. INT. CL. 12.
- TOOL CRIB, INC., KNOXVILLE, TN:
2,997,620, PUB. 6-28-2005. MULTIPLE CLASS, INT. CLS.
35 AND 42.
- TOOLBOX PRODUCTIONS INC., KINGSTON, NY:
2,996,358, PUB. 6-28-2005. INT. CL. 9.
- TOOLOVATION, LLC, BEACHWOOD, OH:
2,998,551, INT. CL. 7.
- TOP OF THE WORLD CORPORATION, NORMAN, OK:
1,918,024. REN. 8-9-05. INT. CL. 25.
- TOP RISE COMPANY, INC., YORBA LINDA, CA:
2,997,609, PUB. 6-28-2005. INT. CL. 29.
- TOPCO ASSOCIATES, INC., SKOKIE, IL:
2,998,507, MULTIPLE CLASS, INT. CLS. 29, 30 AND 32.
2,998,618, MULTIPLE CLASS, INT. CLS. 29 AND 30.
- TOPPS COMPANY, INC., THE, NEW YORK, NY:
2,202,032, CANC. INT. CL. 28.
- TORNADO, INC., MANHATTAN BEACH, CA:
2,201,195, CANC. INT. CL. 38.
- TOTAL DOCUMENT SOLUTIONS, INC., RESTON, VA:
2,996,523, PUB. 6-28-2005. INT. CL. 41.
2,996,524, PUB. 6-28-2005. INT. CL. 35.
- TOTAL TEAM SOLUTIONS, ORLANDO, FL:
2,998,989, INT. CL. 9.
- TOTAL TRAVEL & TICKETS, INC., FORT LAUDERDALE,
FL:
2,997,729, PUB. 6-28-2005. INT. CL. 35.
- TOTALLY YOU, INC., MELBOURNE, FL:
1,898,356. REN. 8-10-05. INT. CL. 3.
- TOTALVID, INC., NORFOLK, VA:
2,998,738, MULTIPLE CLASS, INT. CLS. 35 AND 38.
- TOTES ISOTONER CORPORATION, LOVELAND, OH:
2,200,826, CANC. INT. CL. 25.
- TOUR ADVANCE INTERNATIONAL, INC., SAN DIEGO,
CA:
2,201,521, CANC. INT. CL. 28.
- TOWNE PROPERTIES, INC., CINCINNATI, OH:
2,997,139, PUB. 6-28-2005. MULTIPLE CLASS, INT. CLS.
35, 36 AND 37.
- TOYO RUBBER INDUSTRY CO., LTD., THE, NISHI-KU,
OSAKA, JAPAN:
1,302,495, CANC. INT. CL. 12.
- TRACK CORP., SPRING LAKE, MI:
2,997,098, PUB. 6-28-2005. INT. CL. 40.
- TRACKER MARINE, L.L.C., SPRINGFIELD, MO:
2,997,476, PUB. 6-28-2005. INT. CL. 12.
- TRACKER SYSTEMS, INC., SILVERDALE, WA:
2,999,385, INT. CL. 42.
- TRAD GANG, LLC, RESACA, GA:
2,996,759, PUB. 6-28-2005. INT. CL. 41.
- TRADE SECRET, INC., MINNEAPOLIS, MN:
2,201,108, CANC. MULTIPLE CLASS, INT. CLS. 3 AND
21.
- TRADER PUBLISHING COMPANY, NORFOLK, VA:
2,996,521, PUB. 6-28-2005. INT. CL. 35.
- TRAFFIX DEVICES, SAN CLEMENTE, CA:
1,951,931. REN. 8-11-05. INT. CL. 6.
- TRAININGPASS SALES CORP., BUCKFIELD, ME:
2,997,664, PUB. 6-28-2005. INT. CL. 41.
- TRAN, JACQUELYN, HUNTINGTON BEACH, CA:
2,997,520, PUB. 6-28-2005. INT. CL. 35.
- TRANS WORLD INTERNATIONAL, INC., CLEVELAND,
OH:
2,998,089, PUB. 6-28-2005. INT. CL. 41.
- TRANSAMERICA LIFE INSURANCE COMPANY, CEDAR
RAPIDS, IA:
2,997,968, PUB. 6-28-2005. INT. CL. 36.
- TRANSAMERICAN AUTO PARTS CO., INC., COMPTON,
CA:
2,996,336, PUB. 6-28-2005. INT. CL. 35.
- TRANSAMERICAN NATURAL GAS CORPORATION,
HOUSTON, TX TO TRANSTEXAS GAS CORPORATION,
HOUSTON, TX:
1,860,628, CANC. INT. CL. 4.
- TRANSCONEX, INC., RENTON, WA:
2,997,325, PUB. 6-28-2005. INT. CL. 39.
- TRANSGROUP EXPRESS, INC., SEATTLE, WA, DBA
TRANSGROUP WORLDWIDE LOGISTICS:
2,996,663, PUB. 6-28-2005. INT. CL. 35.
2,996,875, PUB. 6-28-2005. INT. CL. 39.
- TRAPPERS TURN, INC., WISCONSIN DELLS, WI:
2,996,278, PUB. 6-28-2005. INT. CL. 43.
- TRAVEL DYNAMICS, INC., SCOTTSDALE, AZ:
2,583,942, CANC. INT. CL. 41.
- TRAVEL PROFESSIONALS INTERNATIONAL, INC.,
LOUISVILLE, KY:
2,286,608, CANC. INT. CL. 16.
- TRAVELERS INDEMNITY COMPANY, THE, HARTFORD,
CT:
1,303,098, CANC. INT. CL. 36.
- TRAVELOCK LLC, NEW YORK, NY:
2,201,930, CANC. INT. CL. 16.
- TRECO HOLDINGS, INC., VANCOUVER, BRITISH CO-
LUMBIA:
2,998,853, MULTIPLE CLASS, INT. CLS. 36 AND 37.
- TREK BICYCLE CORPORATION, WATERLOO, WI:
2,997,159, PUB. 6-28-2005. INT. CL. 12.
- TRENDMASTERS, INC., ST. LOUIS, MO:
2,201,946, CANC. INT. CL. 28.
2,202,204, CANC. INT. CL. 28.
- TREVER WEIPPER JEANSWEAR S.P.A., ITALY:
2,998,502, PUB. 6-28-2005. MULTIPLE CLASS, INT. CLS.
18 AND 25.
- TRIAD TRAILERS, INC., NEW MILFORD, CT:
2,998,278, PUB. 6-28-2005. INT. CL. 12.
2,998,279, PUB. 6-28-2005. INT. CL. 12.
- TRIARCO INDUSTRIES, INC., WAYNE, NJ:
2,998,624, INT. CL. 5.
2,999,168, INT. CL. 5.
- TRICOM USA, INC., JERSEY CITY, NJ:
2,202,298, CANC. INT. CL. 16.
- TRIDELTA INDUSTRIES, INC., MENTOR, OH:
2,201,111, CANC. MULTIPLE CLASS, INT. CLS. 7 AND
12.
- TRIEXE MANAGEMENT GROUP INC., FONTHILL, ON-
TARIO, CANADA:
2,996,815, PUB. 6-28-2005. INT. CL. 27.
- TRIMFOOT CO., FARMINGTON, MO:
2,202,245, CANC. INT. CL. 25.
- TRINITY SPECIALTY COMPOUNDING, INC., NORWALK,
CT:
2,996,617, PUB. 6-28-2005. INT. CL. 1.
- TRIPOS, INC., ST. LOUIS, MO, TRIPOS ASSOCIATES, INC.,
ST. LOUIS, MO:
1,902,530. REN. 8-10-05. INT. CL. 9.
- TRITON INCORPORATED, ATLANTA, GA:
1,341,732. REN. 8-11-05. INT. CL. 42.
- TROJAN TECHNOLOGIES INC., LONDON, ONTARIO,
CANADA:
2,996,583, PUB. 6-28-2005. INT. CL. 42.
- TRONDAK, INC., MONROE, LA, TRONDAK LTD., SEAT-
TLE, WA:
1,353,486. REN. 8-10-05. INT. CL. 1.
- TROPHY BONDED BULLETS, INC., HOUSTON, TX:
2,201,664, CANC. INT. CL. 13.
2,201,665, CANC. INT. CL. 13.
- TROPICANA PRODUCTS, INC., BRADENTON, FL:
1,944,546. REN. 8-10-05. INT. CL. 32.
- TRS FIBER OPTICS SYSTEMS, INC., STERLING HEIGHTS,
MI, AKA TRS FIELDBUS SYSTEMS, INC.:
2,201,280, CANC. INT. CL. 9.
- TRS QUALITY, INC., FORT WORTH, TX:
2,999,052, INT. CL. 9.
- TRUE MANUFACTURING COMPANY, INC., O'FALLON,
MO:
1,972,882. REN. 8-9-05. INT. CL. 11.
- TRUE TEMPER SPORTS, INC., MEMPHIS, TN:
2,997,316, PUB. 6-28-2005. INT. CL. 12.
- TRUESTAR HEALTH, INC., TORONTO M4V 2Y7, CANADA:
2,999,351, INT. CL. 44.
- TRUFFA SEED CO., INC., WALDEN, NY:
1,364,782. REN. 8-10-05. INT. CL. 31.

- TRUMETA CORPORATION, CAMARILLO, CA:
2,996,588, PUB. 6-28-2005. INT. CL. 40.
- TRUMPF GMBH + CO. KG, FED REP GERMANY:
2,998,499, PUB. 6-28-2005. INT. CL. 9.
- TRUSERV CORPORATION, CHICAGO, IL:
2,201,245, CANC. INT. CL. 41.
- TRUST MANAGEMENT GROUP, INC., ORLANDO, FL:
2,997,755, PUB. 6-28-2005. INT. CL. 36.
- TRUSTED STRATEGIES LLC, PLEASANTON, CA:
2,997,487, PUB. 6-28-2005. INT. CL. 35.
- TRUVATIV INTERNATIONAL CO. LTD., TA LI CITY, TAIWANG HSIEN, TAIWAN:
2,997,997, PUB. 6-28-2005. INT. CL. 12.
2,997,999, PUB. 6-28-2005. INT. CL. 12.
2,998,232, PUB. 6-28-2005. INT. CL. 12.
- TRUVATIV INTERNATIONAL CO., LTD., TA LI CITY, TAIWAN:
2,997,815, PUB. 6-28-2005. INT. CL. 12.
- TSAI, SHU CHI, TAICHUNG HSIEN, TAIWAN:
2,996,643, PUB. 6-28-2005. INT. CL. 15.
- TSR, INC., LAKE GENEVA, WI:
2,201,755, CANC. INT. CL. 28.
- TTI, INC., FORT WORTH, TX:
2,997,923, PUB. 6-28-2005. INT. CL. 35.
- TUBEDEPOT, LLC, MEMPHIS, TN:
2,998,291, PUB. 6-28-2005. INT. CL. 35.
- TUHABONYE, GILBERT, AUSTIN, TX:
2,997,301, PUB. 6-28-2005. INT. CL. 41.
- TUMI, INC., SOUTH PLAINFIELD, NJ:
2,998,914, INT. CL. 18.
- TURBO POWER, INC., FLUSHING, NY:
2,998,924, INT. CL. 11.
- TURNKEY CONSULTANTS, LTD., NEW YORK, NY:
1,962,997, REN. 8-9-05. INT. CL. 25.
- TUTORIALS FOR EXCELLENCE, INC., HOUSTON, TX:
2,996,856, PUB. 6-28-2005. INT. CL. 41.
- TV AZTECA, S.A. DE C.V., MEXICO, MEXICO:
2,998,535, MULTIPLE CLASS, INT. CLS. 16, 38 AND 41.
- TV ONE, LLC, SILVER SPRING, MD:
2,998,957, INT. CL. 41.
- TVHOST, L.L.C., CHARLESTON, SC:
2,996,968, PUB. 6-28-2005. INT. CL. 35.
- TWEDE, EVAN, SANDY, UT:
2,997,386, PUB. 6-28-2005. INT. CL. 14.
- TWEEN 1, INC., RENO, NV:
2,999,369, INT. CL. 35.
2,999,370, INT. CL. 35.
- TWELVE INCH LP, INC., EAST WINDSOR, NJ:
2,998,696, MULTIPLE CLASS, INT. CLS. 25 AND 35.
2,998,697, MULTIPLE CLASS, INT. CLS. 25 AND 35.
- TWENTIETH CENTURY FOX FILM CORPORATION, LOS ANGELES, CA:
2,201,285, CANC. INT. CL. 41.
2,201,286, CANC. INT. CL. 38.
2,201,287, CANC. INT. CL. 41.
2,201,288, CANC. INT. CL. 38.
2,201,289, CANC. INT. CL. 41.
2,201,412, CANC. INT. CL. 41.
2,201,413, CANC. INT. CL. 38.
2,201,414, CANC. INT. CL. 41.
2,201,415, CANC. INT. CL. 38.
2,201,464, CANC. INT. CL. 38.
- TWIN SISTERS IP, LLC, AKRON, OH:
2,997,375, PUB. 6-28-2005. MULTIPLE CLASS, INT. CLS. 9 AND 16.
- TWO PEAS IN A BUCKET, INC., MIDDLETON, WI:
2,996,708, PUB. 6-28-2005. MULTIPLE CLASS, INT. CLS. 35 AND 38.
- TWO'S COMPANY, INC., MOUNT VERNON, NY:
2,998,756, INT. CL. 21.
- TYCO VALVES & CONTROLS LP, HOUSTON, TX, CROSBY VALVE & GAGE COMPANY, WRENTHAM, MA:
1,863,058, REN. 8-12-05. INT. CL. 7.
- TYGAR MANUFACTURING, INC., CANTON, GA:
2,998,244, PUB. 6-28-2005. INT. CL. 7.
- TYLER CANDLE COMPANY, L.L.C., TYLER, TX:
2,997,844, PUB. 6-28-2005. INT. CL. 4.
2,997,845, PUB. 6-28-2005. INT. CL. 4.
2,997,848, PUB. 6-28-2005. INT. CL. 4.
- TYSON FOODS, INC., SPRINGDALE, AR:
1,302,872, CANC. INT. CL. 29.
2,997,246, PUB. 6-28-2005. INT. CL. 43.
- TZIVOS HASHEM, BROOKLYN, NY, DBA HACHAI HOT-ZAOS SEFORIM/PUBLISHING:
2,996,857, PUB. 6-28-2005. INT. CL. 16.
- U. S. BANCORP, PORTLAND, OR:
1,303,090, CANC. INT. CL. 36.
- U. S. REPEATING ARMS COMPANY, MORGAN, UT:
2,998,101, PUB. 6-28-2005. INT. CL. 13.
2,998,113, PUB. 6-28-2005. INT. CL. 13.
- U.S. CHEMICAL STORAGE, LLC, BOONE, NC:
2,997,511, PUB. 6-28-2005. INT. CL. 6.
- U.S. DEPARTMENT OF VETERANS AFFAIRS, AUSTIN, TX:
2,997,455, PUB. 6-28-2005. INT. CL. 35.
- U.S. DIVERS CO., INC., VISTA, CA, U.S.D. CORP., SANTA ANA, CA:
1,322,300, REN. 8-9-05. INT. CL. 28.
- U.S. EAGLE SPORTS CO., INC., MARIETTA, GA:
2,200,979, CANC. INT. CL. 28.
- U.S. MILLS, INC., NEEDHAM, MA:
2,999,225, INT. CL. 30.
- U.S. TECHNOLOGY CORPORATION, CANTON, OH:
2,998,707, INT. CL. 19.
- U-HAUL INTERNATIONAL, INC., PHOENIX, AZ:
1,333,632, REN. 8-10-05. MULTIPLE CLASS, INT. CLS. 37 AND 42.
2,996,499, PUB. 6-28-2005. INT. CL. 12.
- UBICOM, INC., MOUNTAIN VIEW, CA:
2,997,972, PUB. 6-28-2005. INT. CL. 9.
- UBS AG, ZURICH, SWITZERLAND:
2,996,435, PUB. 6-28-2005. MULTIPLE CLASS, INT. CLS. 35 AND 36.
- UCB, S.A., BRUSSELS, BELGIUM:
2,998,583, INT. CL. 44.
- UGINE & ALZ FRANCE, FRANCE:
2,998,456, PUB. 6-28-2005. MULTIPLE CLASS, INT. CLS. 6 AND 40.
- ULDO-BACKMITTEL GMBH, FED REP GERMANY:
2,998,493, PUB. 6-28-2005. MULTIPLE CLASS, INT. CLS. 30, 35 AND 43.
- ULTIMA ELECTRONICS CORP., CHUNG-HO CITY, TAIPEI, R.O.C., TAIWAN:
2,202,066, CANC. INT. CL. 9.
- ULTIMATE COMMUNICATIONS, INC., HOUSTON, TX:
2,997,980, PUB. 6-28-2005. INT. CL. 16.
- ULTIMATE OUTDOOR SOLUTIONS INC., RANGER, GA:
2,997,628, PUB. 6-28-2005. INT. CL. 3.
- ULTRAGLOZZ CO I/S, NAERUM, DENMARK, GLOSSIT MANUFACTURING CO., INC., CITY OF INDUSTRY, CA:
1,338,666, REN. 8-8-05. INT. CL. 3.
- UMG RECORDINGS, INC., SANTA MONICA, CA, MOUNTAIN RECORD CORPORATION, DETROIT, MI:
1,003,076, REN. 8-11-05. INT. CL. 41.
- UMICORE, 1000 BRUSSELS, BELGIUM:
2,996,277, PUB. 4-19-2005. MULTIPLE CLASS, INT. CLS. 1, 2, 6, 9, 14, 40 AND 42.
- UMICORE FRANCE, BAGNOLET, FRANCE:
1,894,817, REN. 8-10-05. INT. CL. 6.
- UMT HOLDINGS, L.P., DALLAS, TX:
2,997,787, PUB. 6-28-2005. INT. CL. 36.
- UNA MAS RESTAURANTS, INC., MOUNTAIN VIEW, CA:
2,201,612, CANC. INT. CL. 42.
- UNCLE ED'S OIL SHOPPE INC., BATTLE CREEK, MI:
1,905,967, REN. 8-10-05. INT. CL. 37.
- UNDERGROUND MESSENGER, INC., SPRINGFIELD, TN:
2,997,374, PUB. 6-28-2005. INT. CL. 35.
- UNFAIR ADVANTAGE, INC., PACIFICA, CA:
2,997,049, PUB. 6-28-2005. INT. CL. 35.
- UNICAM INCORPORATED, EMERSON, NJ:
2,997,193, PUB. 3-1-2005. INT. CL. 12.
- UNICHEMA CHEMIE B.V., 2802 BE GOUDA, NETHERLANDS:
1,906,980, REN. 8-11-05. INT. CL. 1.

- UNIDELTA S.P.A., ITALY:
2,998,431, PUB. 6-28-2005. INT. CL. 17.
- UNIDINE CORPORATION, BOSTON, MA:
2,996,715, PUB. 6-28-2005. INT. CL. 43.
- UNIGROUP, INC., FENTON, MO:
2,997,548, PUB. 6-28-2005. INT. CL. 39.
- UNIMAX TOYS, LTD., HARBOR CITY, TSIMSHATSUI KOWLOON, HONG KONG:
2,201,416, CANC. INT. CL. 28.
- UNIRAC, INC., ALBUQUERQUE, NM:
2,868,978, COR. INT. CL. 6.
2,869,020, COR. INT. CL. 6.
- UNIROYAL CHEMICAL COMPANY, INC., MIDDLEBURY, CT, UNITED STATES RUBBER COMPANY, NEW YORK, NY:
797,948. REN. 8-9-05. U.S. CL. 6 (INT. CL. 1).
- UNIROYAL ENGINEERED PRODUCTS, LLC, SARASOTA, FL, UNIROYAL, INC., NEW YORK, NY:
1,334,305. REN. 8-9-05. INT. CL. 18.
- UNISCAPE INCORPORATED, REDWOOD CITY, CA:
2,201,810, CANC. INT. CL. 9.
- UNITE-IT PARTNERS NETWORK, L.L.C., GAITHERSBURG, MD:
2,996,799, PUB. 6-28-2005. INT. CL. 42.
- UNITED AGRI PRODUCTS, INC., GREELEY, CO:
2,998,690, MULTIPLE CLASS, INT. CLS. 1, 5 AND 31.
- UNITED BANK & TRUST COMPANY, HAMPTON, IA:
2,997,142, PUB. 6-28-2005. INT. CL. 36.
- UNITED CANCER FRONT, INC., BEVERLY HILLS, CA:
2,998,608, MULTIPLE CLASS, INT. CLS. 36, 42 AND 44.
- UNITED DISTILLERS MANUFACTURING, INC., LOUISVILLE, KY:
2,997,971, PUB. 6-28-2005. INT. CL. 33.
- UNITED GILSONITE LABORATORIES, SCRANTON, PA:
1,940,692. REN. 8-10-05. MULTIPLE CLASS, INT. CLS. 1, 2, 16 AND 19.
- UNITED LABORATORIES, INC., ST. CHARLES, IL:
1,923,206. REN. 8-8-05. INT. CL. 3.
- UNITED RECOVERY SYSTEMS INC., MIAMI, FL:
2,997,542, PUB. 6-28-2005. INT. CL. 41.
- UNITED REFRACTORIES CO., MCMURRAY, PA:
2,996,530, PUB. 6-28-2005. INT. CL. 19.
2,996,531, PUB. 6-28-2005. INT. CL. 19.
- UNITED SOLAR SYSTEMS CORP., TROY, MI:
2,852,326, CANC. MULTIPLE CLASS, INT. CLS. 35, 40 AND 42.
- UNITED STATES CERAMIC TILE COMPANY, EAST SPARTA, OH:
791,061. REN. 8-12-05. U.S. CL. 38 (INT. CL. 16).
- UNITED STATES NAVY, NAVAL SEA SYSTEMS COMMAND, WASHINGTON, DC:
2,997,043, PUB. 6-28-2005. MULTIPLE CLASS, INT. CLS. 16, 41 AND 42.
- UNITED STATES PHARMACOPEIAL CONVENTION, INC., THE, ROCKVILLE, MD:
2,201,229, CANC. INT. CL. 9.
- UNITED STATES POSTAL SERVICE, WASHINGTON, DC:
2,996,877, PUB. 6-28-2005. INT. CL. 45.
2,996,878, PUB. 6-28-2005. INT. CL. 25.
- UNITED STATES SHOE CORPORATION, THE, CINCINNATI, OH:
1,302,780, CANC. INT. CL. 25.
- UNITED STATES SURGICAL CORPORATION, NORWALK, CT:
1,881,349. REN. 8-8-05. INT. CL. 10.
- UNITED STATES TENNIS ASSOCIATION INCORPORATED, WHITE PLAINS, NY:
2,997,221, PUB. 6-28-2005. INT. CL. 41.
- UNITED STATES VOLLEYBALL ASSOCIATION, COLORADO SPRINGS, CO:
2,998,076, PUB. 6-28-2005. INT. CL. 41.
2,998,077, PUB. 6-28-2005. INT. CL. 41.
- UNIVERSAL CITY STUDIOS LLLP, UNIVERSAL CITY, CA:
2,998,800, INT. CL. 41.
- UNIVERSAL CITY STUDIOS, INC., UNIVERSAL CITY, CA:
2,202,274, CANC. INT. CL. 9.
- UNIVERSAL DISPLAY CORPORATION, EWING, NJ:
2,998,983, INT. CL. 9.
2,998,984, INT. CL. 9.
2,998,985, INT. CL. 9.
- UNIVERSAL FOODS & MERCHANDISE CO., TORONTO, ONTARIO M6J 2Y7, CANADA TO LATCHMAN, ROBERT, BAYONNE, NJ:
1,861,095, CANC. INT. CL. 30.
- UNIVERSAL FROZEN FOODS CO., WALLA WALLA, WA:
1,302,896, CANC. INT. CL. 29.
- UNIVERSAL HOSPITAL SERVICES, INC., BLOOMINGTON, MN:
2,997,683, PUB. 6-28-2005. INT. CL. 35.
2,997,705, PUB. 6-28-2005. MULTIPLE CLASS, INT. CLS. 35 AND 44.
2,997,706, PUB. 6-28-2005. MULTIPLE CLASS, INT. CLS. 35 AND 44.
2,997,707, PUB. 6-28-2005. MULTIPLE CLASS, INT. CLS. 35 AND 44.
- UNIVERSAL INTERACTIVE, INC., LOS ANGELES, CA:
2,997,313, PUB. 6-28-2005. INT. CL. 41.
- UNIVERSITY OF CENTRAL FLORIDA, ORLANDO, FL:
2,997,023, PUB. 6-28-2005. MULTIPLE CLASS, INT. CLS. 16, 25, 41 AND 42.
- UNIVERSITY OF HAWAII, HONOLULU, HI:
2,997,795, PUB. 6-28-2005. INT. CL. 25.
- UNIVERSITY OF NOTRE DAME DU LAC, NOTRE DAME, IN:
2,996,446, PUB. 6-28-2005. INT. CL. 41.
- UNIVERSITY TECHNOLOGIES INTERNATIONAL INC., CALGARY, ALBERTA, CANADA:
2,997,264, PUB. 6-28-2005. INT. CL. 9.
- UNIWORLD GROUP, INC., NEW YORK, NY:
2,997,119, PUB. 6-28-2005. INT. CL. 35.
- UOP LLC, DES PLAINS, IL, UNIVERSAL OIL PRODUCTS COMPANY, DES PLAINES, IL:
1,014,318. REN. 8-12-05. INT. CL. 42.
- UPONOR INNOVATION AB, SE-51381 FRISTAD, SWEDEN:
2,996,351, PUB. 6-28-2005. INT. CL. 17.
- UPSHER-SMITH LABORATORIES, INC., MAPLE GROVE, MN:
2,998,626, INT. CL. 5.
- UPSIDE PUBLISHING COMPANY, THE, SAN MATEO, CA:
2,202,377, CANC. INT. CL. 35.
- URBAN MINISTRIES, INC., CALUMET CITY, IL:
2,997,952, PUB. 6-28-2005. MULTIPLE CLASS, INT. CLS. 9, 16 AND 35.
2,997,963, PUB. 6-28-2005. INT. CL. 9.
2,997,965, PUB. 6-28-2005. INT. CL. 9.
- US INTERNATIONAL MEDIA, LLC, LOS ANGELES, CA:
2,999,325, INT. CL. 35.
- US LACROSSE, INC., BALTIMORE, MD:
2,278,973, AM. MULTIPLE CLASS, INT. CLS. 41 AND 42.
- US TOO INTERNATIONAL, INC., DOWNERS GROVE, IL:
2,998,766, MULTIPLE CLASS, INT. CLS. 9, 16 AND 41.
- USA BASKETBALL, COLORADO SPRINGS, CO:
2,201,619, CANC. INT. CL. 35.
2,201,620, CANC. INT. CL. 16.
- USA DIRECT, INC, YORK, PA:
2,996,998, PUB. 6-28-2005. MULTIPLE CLASS, INT. CLS. 35 AND 42.
- USA MILLENNIUM, L.P., BEAUMONT, TX:
2,998,881, INT. CL. 34.
- USA SECURITY SERVICES, INC., HACKENSACK, NJ:
2,996,471, PUB. 6-28-2005. MULTIPLE CLASS, INT. CLS. 37 AND 45.
- USANA, INC., SALT LAKE CITY, UT:
2,201,735, CANC. INT. CL. 41.
2,202,244, CANC. INT. CL. 5.
- USE IT AGAIN COMPUTERS, INC., SANDY, UT:
2,201,819, CANC. INT. CL. 9.
- USER CENTRIC, INC., OAKBROOK TERRACE, IL:
2,997,331, PUB. 6-28-2005. INT. CL. 42.
- USGI MEDICAL, INC., SAN CLEMENTE, CA:
2,999,262, INT. CL. 10.

UTICA MUTUAL INSURANCE COMPANY, NEW HARTFORD, NY, DBA UTICA NATIONAL INSURANCE GROUP:
1,901,904. REN. 8-9-05. INT. CL. 36.

UTILISYS CORPORATION, SAN DIEGO, CA:
2,202,018. CANC. MULTIPLE CLASS, INT. CLS. 35 AND 38.

UTR, INC., ENGLEWOOD CLIFFS, NJ:
2,997,271. PUB. 6-28-2005. INT. CL. 9.

UV SALES, INC., ROCKLEIGH, NJ:
2,998,262. PUB. 6-28-2005. INT. CL. 35.

V&S VIN & SPRIT AKTIEBOLAG, SWEDEN:
2,996,340. PUB. 6-28-2005. INT. CL. 33.

V&V SUPREMO FOODS, INC., CHICAGO, IL:
2,996,850. PUB. 6-28-2005. INT. CL. 29.

V-DAY, SAN FRANCISCO, CA:
2,997,189. PUB. 6-28-2005. MULTIPLE CLASS, INT. CLS. 35, 36 AND 41.

V-FLUENCE INTERACTIVE PUBLIC RELATIONS, INC., SAN DIEGO, CA:
2,997,058. PUB. 6-28-2005. INT. CL. 16.

V-SIM INCORPORATED, ROCHESTER, MI:
2,998,008. PUB. 6-28-2005. INT. CL. 9.

VAERELANDT-ICON PRODUCTS LLC, NEW YORK, NY:
2,998,716. INT. CL. 3.

VALCO ENGINEERS LLC, MCDONALD, PA:
2,998,684. INT. CL. 42.

VALENITE, LLC, MADISON HEIGHTS, MI:
2,998,647. INT. CL. 7.

VALIANT VINEYARDS, INC., VERMILLION, SD:
2,997,939. PUB. 6-28-2005. INT. CL. 33.

VALLE DE LA PUERTA S.A., LA RIOJA, ARGENTINA:
2,998,859. INT. CL. 33.

VALLEY FRUIT & VEGETABLE COMPANY, INC., PHARR, TX, DBA VALLEY FRUIT & VEGETABLE CO.:
779,560. CANC. U.S. CL. 46.

VALLEY NATIONAL CORPORATION, PHOENIX, AZ TO BANK ONE CORPORATION, CHICAGO, IL:
1,861,166. CANC. INT. CL. 36.

VALLEY-DYNAMO, L.P., LAKE FOREST, IL:
1,342,888. REN. 8-11-05. INT. CL. 28.

VALLEYCREST COMPANIES, CALABASAS, CA:
2,997,238. PUB. 6-28-2005. INT. CL. 44.

VALUE LINE, INC., NEW YORK, NY:
1,309,328. REN. 8-10-05. INT. CL. 36.

VALUECURVE TECHNOLOGIES, INC., NEW RIVER, AZ:
2,996,985. PUB. 6-28-2005. MULTIPLE CLASS, INT. CLS. 35 AND 42.

VALX, LLC, LAKEWOOD, CO:
2,998,849. INT. CL. 36.

VAN DEN BERG MANAGEMENT, INC., AUSTIN, TX:
2,996,333. PUB. 6-28-2005. INT. CL. 36.

VAN DIJK ESPANA, S.A., 46021 VALENCIA, SPAIN:
2,201,142. CANC. INT. CL. 31.
2,201,143. CANC. INT. CL. 31.

VAN ROMER, LESLIE, SEQUIM, WA:
2,997,592. PUB. 6-28-2005. INT. CL. 41.

VANDERWEIL FACILITY ADVISORS, INC., BOSTON, MA:
2,996,820. PUB. 6-28-2005. INT. CL. 42.
2,996,845. PUB. 6-28-2005. INT. CL. 9.

VANITY FAIR, INC., WILMINGTON, DE, V.F. CORPORATION, WYOMISSING, PA:
1,881,510. REN. 8-6-05. INT. CL. 25.

VANS INC., ALSIP, IL:
1,318,110. REN. 8-9-05. INT. CL. 31.
1,318,110. CANC. MULTIPLE CLASS, INT. CLS. 17 AND 26.

VANTAGE TECHNOLOGIES, INC., BOSTON, MA:
2,998,550. INT. CL. 9.

VARIFLEX, INC., MOORPARK, CA:
2,999,298. INT. CL. 28.

VARSITY SPIRIT CORPORATION, MEMPHIS, TN:
2,999,331. INT. CL. 41.

VASCULAR AND COSMETIC SPECIALISTS, P.C., ATLANTA, GA:
2,997,715. PUB. 6-28-2005. INT. CL. 44.

VASSAR COLLEGE, POUGHKEEPSIE, NY:
2,996,458. PUB. 6-28-2005. MULTIPLE CLASS, INT. CLS. 25 AND 41.

VAUGHAN, SARABETH, LAFAYETTE, IN:
2,999,312. INT. CL. 14.

VCAMPUS CORPORATION, RESTON, VA:
2,996,751. PUB. 6-28-2005. INT. CL. 41.

VEDALAB, FRANCE:
2,998,407. PUB. 6-28-2005. INT. CL. 5.

VEE-TECH, P.C., CARY, NC:
2,201,503. CANC. INT. CL. 40.

VELASTAR, LLC, ADDISON, TX:
2,999,270. INT. CL. 9.

VELENO, JOHN M., ST. PETERSBURG, FL:
2,996,283. PUB. 6-28-2005. INT. CL. 15.

VENDOME GROUP LLC, NEW YORK, NY:
1,879,207. REN. 8-11-05. INT. CL. 16.

VENETIAN CASINO RESORT, LLC, LAS VEGAS, NV:
2,999,279. INT. CL. 43.
2,999,280. INT. CL. 41.

VENTURA FOODS, LLC, BREA, CA, VEGETABLE OIL PRODUCTS COMPANY, INC., LOS ANGELES, CA, DBA WILSEY FOODS, INC.:
1,015,381. REN. 8-11-05. INT. CL. 29.

VENTURA FOODS, LLC, BREA, CA:
2,999,051. INT. CL. 41.

VENTURES IN EDUCATION, INC., NEW YORK, NY:
2,202,220. CANC. INT. CL. 16.

VENTURETECH, INC., RESTON, VA:
2,200,876. CANC. INT. CL. 36.

VENVEST, INC., ST. LOUIS, MO:
2,998,691. INT. CL. 37.
2,998,783. INT. CL. 35.

VERA BRADLEY DESIGNS, INC., FORT WAYNE, IN:
2,999,011. INT. CL. 27.

VERCILLO, ANTHONY M., LAS VEGAS, NV:
2,997,532. PUB. 6-28-2005. INT. CL. 41.

VERIDIAN HOMES, LLC, MADISON, WI:
2,999,021. INT. CL. 37.

VERIFIED CREDENTIALS, INC., LAKEVILLE, MN:
2,201,304. CANC. INT. CL. 35.

VERIFIED PERSON, NEW YORK, NY:
2,997,902. PUB. 6-28-2005. INT. CL. 45.

VERIZON SERVICES CORP., ARLINGTON, VA:
1,941,784. REN. 8-6-05. INT. CL. 38.

VERMILLION, L.L.C., CHICAGO, IL:
2,999,058. INT. CL. 43.

VERNIS CLAESSENS S.A., 1020 RENENS, SWITZERLAND:
2,201,325. CANC. INT. CL. 2.

VERSATRANS SOLUTIONS, INC., LATHAM, NY:
2,997,958. PUB. 6-28-2005. INT. CL. 9.

VERY HEALTHY ENTERPRISES, INC., INGLEWOOD, CA:
1,948,463. REN. 8-8-05. INT. CL. 5.

VERYSPECIAL CHOCOLATS, AZUSA, CA:
2,201,747. CANC. INT. CL. 30.

VESSA LIMITED, SOUTHAMPTON, SU15 2UF, ENGLAND:
2,201,604. CANC. INT. CL. 10.

VESTURE CORPORATION, ASHEBORO, NC:
1,860,984. CANC. INT. CL. 25.

VETERINARY ENTERPRISES, INC., MOUNTAIN VIEW, OK:
2,996,677. PUB. 6-28-2005. INT. CL. 5.

VFP FIRE SYSTEMS, SAINT PAUL, MN:
2,169,164. CANC. MULTIPLE CLASS, INT. CLS. 9, 37, 40 AND 42.

VIÑEDOS DE PÁGANOS, S.L., SPAIN:
2,998,394. PUB. 6-28-2005. INT. CL. 33.

VIACOM INTERNATIONAL INC., NEW YORK, NY:
2,200,944. CANC. INT. CL. 41.
2,201,622. CANC. INT. CL. 42.
2,998,919. INT. CL. 16.
2,998,939. INT. CL. 16.
2,998,992. INT. CL. 16.

VIALOGY CORP., ALTADENA, CA:
2,999,099. MULTIPLE CLASS, INT. CLS. 9 AND 42.

VICKERY, MAUREEN M., HOUSTON, TX:
2,998,933. INT. CL. 41.

VICTORY MEDIA, INC., SEWICKLEY, PA:
2,996,451. PUB. 6-28-2005. INT. CL. 35.

- VIDEO UPDATE, INC., ST. PAUL, MN:
1,303,251, CANC. INT. CL. 42.
- VIFOR FRANCE SA, F-92300 LEVALLOIS PERRET,
FRANCE:
2,998,374, PUB. 6-28-2005. INT. CL. 5.
- VIGNERONS DE LA MEDITERRANEE, 11100 NARBONNE,
FRANCE, SICA VIGNERONS DE LA MEDITERRANEE,
11100 NARBONNE, FRANCE:
1,825,951, REN. 8-10-05. INT. CL. 33.
- VIGNOLO FARMS, SHAFTER, CA, MENDELSON-ZELLER
CO., SAN FRANCISCO, CA:
627,123, REN. 8-9-05. U.S. CL. 46 (INT. CL. 31).
- VILLA ESPANOLA BAKERY, INCORPORATED, MIAMI,
FL:
2,201,857, CANC. INT. CL. 30.
- VIN CONSEIL, S.A.R.L., FLAYOSC, FRANCE:
1,303,017, CANC. INT. CL. 33.
- VINICON, INC., SAN RAFAEL, CA:
2,999,123, INT. CL. 33.
- VINOS DEL SUR S.A., SANTIAGO, CHILE:
2,997,989, PUB. 6-28-2005. INT. CL. 33.
- VINPROM PESHTERA, 4000 PLOVDIV, BULGARIA:
2,996,364, PUB. 6-28-2005. INT. CL. 33.
- VINTAGE CAPITAL LLC, GREENWICH, CT:
2,996,436, PUB. 6-28-2005. INT. CL. 33.
- VIRBAC AH, INC., FORT WORTH, TX:
1,306,764, REN. 8-11-05. INT. CL. 5.
2,997,158, PUB. 6-28-2005. INT. CL. 5.
- VIRGINIA DARE EXTRACT CO., INC., BROOKLYN, NY:
2,997,854, PUB. 6-28-2005. INT. CL. 30.
2,997,855, PUB. 6-28-2005. INT. CL. 30.
2,998,194, PUB. 6-28-2005. INT. CL. 30.
2,998,195, PUB. 6-28-2005. INT. CL. 30.
- VIRGO PACIFIC LTD., TORTOLA, BR. VIRGIN ISLANDS:
2,997,673, PUB. 6-28-2005. INT. CL. 35.
2,997,674, PUB. 6-28-2005. INT. CL. 35.
- VISIONART'S, S.L., GIRONA, SPAIN:
2,997,545, PUB. 6-28-2005. INT. CL. 10.
- VISIONOPS, HIGHLANDS RANCH, CO:
2,999,045, INT. CL. 41.
- VISTAR INSURANCE SERVICES, CARPENTERSVILLE, IL:
2,996,295, PUB. 5-3-2005. INT. CL. 36.
- VITA POWER LIMITED, WANGANUI, NEW ZEALAND:
2,998,764, INT. CL. 5.
- VITA-PAKT CITRUS PRODUCTS CO., COVINA, CA:
1,019,571, REN. 8-12-05. INT. CL. 32.
- VITAL BIOTECH (HONG KONG) LIMITED, WANCHAI,
HONG KONG:
2,937,823, COR. INT. CL. 5.
- VITALI CORP., BROOKLYN, NY:
2,996,935, PUB. 6-28-2005. INT. CL. 25.
- VITAMIN WORLD, INC., BOHEMIA, NY:
2,997,995, PUB. 6-28-2005. INT. CL. 5.
- VITAPHARM INTERNATIONAL INC., JERSEY CITY, NJ:
2,996,517, PUB. 6-28-2005. INT. CL. 5.
- VITIV, INC., BURDETT, NY:
2,996,594, PUB. 6-28-2005. INT. CL. 3.
- VIVOMETRICS, INC., VENTURA, CA:
2,999,105, MULTIPLE CLASS, INT. CLS. 10 AND 44.
- VK CORPORATION, PYONGTAEK-CITY, KYONGGI-DO,
REPUBLIC OF KOREA:
2,998,905, INT. CL. 9.
- VMR INTERNATIONAL, INC., GRAFTON, MA:
1,889,270, REN. 8-9-05. INT. CL. 16.
- VNU BUSINESS MEDIA, INC., NEW YORK, NY:
2,997,512, PUB. 6-28-2005. INT. CL. 41.
- VOCO GMBH, CUXHAVEN, FED REP GERMANY:
2,997,829, PUB. 6-28-2005. INT. CL. 5.
- VOIGHT ENTERPRISES, INC., LIVONIA, MI:
2,998,778, INT. CL. 41.
- VOLKSWAGEN AG, FED REP GERMANY:
2,998,409, PUB. 6-28-2005. MULTIPLE CLASS, INT. CLS.
12, 35 AND 37.
- VOLLEYBALL CONNECTION, INC., LOUISVILLE, KY:
1,894,142, REN. 8-11-05. INT. CL. 25.
- VONAGE HOLDING CORP., EDISON, NJ:
2,999,303, INT. CL. 9.
- VORTECH ENGINEERING, INC., CHANNEL ISLANDS, CA:
2,997,218, PUB. 6-28-2005. MULTIPLE CLASS, INT. CLS. 7
AND 11.
- VORTECHNICS, INC., SCARBOROUGH, ME:
2,997,806, PUB. 6-28-2005. INT. CL. 11.
- VOSLAUER HEILQUELLEN VERWERTUNG AKTIENGE-
SELLSCHAFT, PAITZRIEGELGASSE 2, AUSTRIA:
2,998,517, INT. CL. 32.
- VOTYPKA, EDWARD A., CHAGRIN FALLS, OH:
2,999,106, INT. CL. 20.
- VOYENCE, INC., RICHARDSON, TX:
2,996,923, PUB. 6-28-2005. MULTIPLE CLASS, INT. CLS. 9
AND 42.
- VRVV, INC., HOUSTON, TX:
2,997,252, PUB. 6-28-2005. INT. CL. 25.
- VT HALTER MARINE, INC, GULFPORT, MS:
2,997,306, PUB. 6-28-2005. INT. CL. 12.
- VTH SEASON, CHENNEGY, FRANCE:
2,997,714, PUB. 6-28-2005. INT. CL. 41.
- VYVX, INC., TULSA, OK:
2,202,386, CANC. INT. CL. 9.
- W. H. MAZE COMPANY, PERU, IL:
779,313, CANC. U.S. CL. 13.
- W. L. GORE & ASSOCIATES, INC., NEWARK, DE:
1,894,136, REN. 8-10-05. INT. CL. 24.
- W. R. GRACE & CO.-CONN., COLUMBIA, MD:
2,996,396, PUB. 6-28-2005. MULTIPLE CLASS, INT. CLS.
8, 11, 18, 21, 25 AND 28.
- W. W. DISTRIBUTORS, INC., RICHMOND, VA:
2,996,749, PUB. 6-28-2005. INT. CL. 32.
- W.C. BRADLEY COMPANY, COLUMBUS, GA:
2,201,838, CANC. INT. CL. 20.
- W.M. BARR & CO., INC., MEMPHIS, TN:
1,861,336, CANC. INT. CL. 2.
- W.M.S. TRADE GROUP INTERNATIONAL, INC., HAWLEY,
PA:
2,201,920, CANC. INT. CL. 3.
- W.W. GRAINGER, INC., LAKE FOREST, IL:
2,998,326, PUB. 6-28-2005. MULTIPLE CLASS, INT. CLS.
16 AND 35.
- WABTEC HOLDING CORPORATION, WILMERDING, PA:
2,997,428, PUB. 6-28-2005. INT. CL. 12.
2,998,176, PUB. 6-28-2005. INT. CL. 9.
- WAGH, ASHER, BROOKLYN, NY:
2,998,793, INT. CL. 3.
- WAGNER, TERRY LYNN, SARASOTA, FL:
2,200,880, CANC. INT. CL. 41.
- WAGT TELEVISION, INC., AUGUSTA, GA:
2,998,947, INT. CL. 41.
- WAITEX INTERNATIONAL CO. LTD., NEW YORK, NY:
2,997,635, PUB. 6-28-2005. MULTIPLE CLASS, INT. CLS.
35, 39 AND 42.
- WAL-MART STORES, INC., BENTONVILLE, AR:
1,893,879, REN. 8-11-05. MULTIPLE CLASS, INT. CLS. 3
AND 5.
2,998,648, INT. CL. 14.
2,998,732, INT. CL. 20.
2,998,733, INT. CL. 20.
- WALDEMAR LINK GMBH & CO. KG, FED REP GER-
MANY:
2,998,417, PUB. 6-28-2005. MULTIPLE CLASS, INT. CLS. 6
AND 10.
- WALDRIP WRECKER SERVICE, INC., MONTGOMERY,
AL:
2,202,068, CANC. INT. CL. 39.
- WALGREEN CO., DEERFIELD, IL:
2,998,798, INT. CL. 5.
- WALL, DAROLD E., STANLEY, WI:
1,861,079, CANC. INT. CL. 30.
- WALLS, TIMOTHY ROBERT, WEST BADEN SPRINGS, IN:
2,999,090, INT. CL. 25.
- WALNUT INDUSTRIES, INC., BENSALEM, PA:
1,375,855, REN. 8-9-05. INT. CL. 17.
- WALTER AKTIENGESELLSCHAFT, D-72072 TUBINGEN,
FED REP GERMANY:
1,889,615, REN. 8-9-05. MULTIPLE CLASS, INT. CLS. 7
AND 9.

- WARD, CURTIS, STATEN ISLAND, NY:
2,202,394, CANC. INT. CL. 35.
- WARD, KATHLEEN, RANCHO CUCAMONGA, CA:
1,861,465, CANC. INT. CL. 42.
- WARNACO SWIMWEAR PRODUCTS INC., LOS ANGELES, CA:
1,861,302, CANC. INT. CL. 42.
- WARNER BROS. ENTERTAINMENT INC., BURBANK, CA:
1,888,336, REN. 8-10-05. INT. CL. 9.
- WASHINGTON MUTUAL, INC., SEATTLE, WA:
2,998,505, INT. CL. 36.
- WATER GREMLIN COMPANY, WHITE BEAR LAKE, MN:
2,202,334, CANC. INT. CL. 28.
- WATER PURE, INC., PORT WASHINGTON, NY, DBA PURITY PRODUCTS:
2,996,398, PUB. 6-28-2005. INT. CL. 5.
- WATERBURY COMPANIES, INC., WATERBURY, CT:
1,860,844, CANC. INT. CL. 11.
- WATERFALL INDUSTRIES, INC., SANFORD, FL:
2,996,563, PUB. 6-28-2005. INT. CL. 35.
- WATERFRONT TRAVEL SERVICE, INC., BOSTON, MA:
2,999,117, INT. CL. 39.
- WATKINS, SHEILA S., VIDALIA, GA, HEALTHY MOMS, LLC, BETHESDA, MD:
1,897,805, REN. 8-12-05. INT. CL. 41.
- WATSON PHARMACEUTICALS, INC., CORONA, CA:
2,998,666, INT. CL. 5.
- WATTS REGULATOR CO., NORTH ANDOVER, MA:
2,996,402, PUB. 6-28-2005. INT. CL. 11.
2,996,403, PUB. 6-28-2005. INT. CL. 11.
- WAVEPHORE, INC., PHOENIX, AZ:
2,201,001, CANC. INT. CL. 38.
- WAX, INC., NEW YORK, NY:
2,999,154, INT. CL. 25.
- WAYS, DAVID E., BRADENTON, FL:
2,997,646, PUB. 6-28-2005. MULTIPLE CLASS, INT. CLS. 22 AND 25.
- WE S.N.C., I-20129 MILANO, ITALY:
2,998,401, PUB. 6-28-2005. INT. CL. 25.
- WEAVER, CHARLES T., COSTA MESA, CA:
2,997,412, PUB. 6-28-2005. INT. CL. 44.
- WEB DYNAMICS, INC., FLANDERS, NJ:
1,319,439, REN. 8-6-05. INT. CL. 24.
- WEB ORIGINATIONS LLC, BEVERLY HILLS, MI:
2,998,013, PUB. 6-28-2005. INT. CL. 35.
- WEBATTACK INC., MARATHON, FL:
2,997,622, PUB. 6-28-2005. INT. CL. 42.
- WEBB COMPANY, THE, SAINT PAUL, MN:
779,661, CANC. U.S. CL. 38.
- WEBER-ARIES, INC., NEW YORK, NY:
2,997,717, PUB. 6-28-2005. INT. CL. 25.
2,997,719, PUB. 6-28-2005. INT. CL. 25.
- WEBMEDX, INC., PITTSBURGH, PA:
2,996,456, PUB. 5-3-2005. INT. CL. 42.
- WEBPOWER, INC., LAKE WORTH, FL:
2,996,987, PUB. 6-28-2005. MULTIPLE CLASS, INT. CLS. 35 AND 42.
- WEC COMPANY, OREGON, IL, WAIN-ROY, INC., HUBBARDSTON, MA:
1,892,945, REN. 8-10-05. INT. CL. 7.
- WEGENER COMMUNICATIONS, INC., DULUTH, GA:
2,998,047, PUB. 6-28-2005. MULTIPLE CLASS, INT. CLS. 9 AND 35.
2,998,050, PUB. 6-28-2005. INT. CL. 9.
- WEIDER NUTRITION INTERNATIONAL, INC., SALT LAKE CITY, UT:
2,200,904, CANC. INT. CL. 30.
- WEIDER PUBLICATIONS, LLC, BOCA RATON, FL:
2,997,457, PUB. 6-28-2005. INT. CL. 41.
- WEINSTEIN MANAGEMENT CO., INC., GLEN ALLEN, VA:
2,997,370, PUB. 6-28-2005. INT. CL. 36.
- WEINSTEIN, STEVEN P., CENTENNIAL, CO:
2,998,055, PUB. 6-28-2005. INT. CL. 16.
- WEISER CHAMBER OF COMMERCE, WEISER, ID:
2,997,011, PUB. 6-28-2005. INT. CL. 41.
- WEITZBERG CONSULTING, INC., COSTA MESA, CA:
2,996,578, PUB. 6-28-2005. INT. CL. 41.
- WELCOME HOME AMERICA, INC., HOLLY SPRINGS, GA:
2,998,164, PUB. 6-28-2005. INT. CL. 16.
- WELCOMEMAT SERVICES, INC., CHARLOTTE, NC:
2,997,084, PUB. 6-28-2005. INT. CL. 35.
- WELL TRAVELED IMPORTS, INC., AMELIA ISLAND, FL:
2,997,485, PUB. 6-28-2005. INT. CL. 20.
- WELLNESS ENTERPRISES, GAINESVILLE, FL:
2,997,134, PUB. 6-28-2005. INT. CL. 1.
- WELLORIA, TARZANA, CA:
2,997,307, PUB. 6-28-2005. INT. CL. 41.
- WELLS FARGO & COMPANY, SAN FRANCISCO, CA:
1,303,105, CANC. INT. CL. 36.
- WELLS FARGO & COMPANY, MINNEAPOLIS, MN:
2,998,599, INT. CL. 36.
- WELLS DAIRY, INC., LE MARS, IA:
2,999,272, INT. CL. 30.
- WEMCO, INC., NEW ORLEANS, LA:
1,302,761, CANC. INT. CL. 25.
1,302,762, CANC. INT. CL. 25.
- WESCON PRODUCTS COMPANY, WICHITA, KS:
2,202,050, CANC. INT. CL. 8.
- WESCOR, INC., LOGAN, UT:
1,865,150, REN. 8-10-05. INT. CL. 5.
- WESHO AKTIENGESELLSCHAFT, HAGEN, FED REP GER-MANY:
1,302,635, CANC. INT. CL. 20.
- WEST JET CORPORATION, BOISE, ID:
2,200,968, CANC. INT. CL. 9.
- WESTCOAST HOTELS, INC., SPOKANE, WA:
2,997,841, PUB. 6-28-2005. INT. CL. 37.
2,997,842, PUB. 6-28-2005. INT. CL. 43.
- WESTED, SAN FRANCISCO, CA:
2,998,126, PUB. 6-28-2005. MULTIPLE CLASS, INT. CLS. 16 AND 41.
- WESTERN ENGINE CO., ADDISON, IL:
1,303,112, CANC. MULTIPLE CLASS, INT. CLS. 37 AND 42.
- WESTERN FAMILY FOODS, INC., PORTLAND, OR:
1,302,362, CANC. INT. CL. 4.
- WESTERN FINANCIAL BANK, F.S.B., IRVINE, CA:
2,202,301, CANC. INT. CL. 36.
- WESTERN LITHO PLATE & SUPPLY CO., ST. LOUIS, MO, DBA WESTERN LITHOTECH:
2,202,212, CANC. INT. CL. 7.
- WESTERN WORLD INSURANCE COMPANY, FRANKLIN LAKES, NJ, WESTERN WORLD INSURANCE COMPANY, INC., RAMSEY, NJ:
1,260,208, REN. 8-9-05. INT. CL. 36.
- WESTERN/SCOTT FETZER COMPANY, WESTLAKE, OH:
2,201,263, CANC. INT. CL. 6.
- WESTIN LICENSE COMPANY, WHITE PLAINS, NY, WESTIN HOTEL COMPANY, SEATTLE, WA:
1,899,388, REN. 8-11-05. INT. CL. 42.
- WESTMORELAND, PAUL T., TUJUNGA, CA:
2,999,110, INT. CL. 14.
- WESTWOOD HOLDINGS GROUP, INC., DALLAS, TX:
2,997,788, PUB. 6-28-2005. INT. CL. 36.
- WEZ KUNSTSTOFFWERK AG, OBERENTFELDEN, SWITZERLAND:
1,302,631, CANC. MULTIPLE CLASS, INT. CLS. 20 AND 21.
- WHAM-O, INC., SAN FRANCISCO, CA:
2,996,886, PUB. 6-28-2005. INT. CL. 28.
- WHEREHOUSE ENTERTAINMENT, INC., TORRENCE, CA:
1,303,263, CANC. INT. CL. 42.
- WHIRLPOOL PROPERTIES, INC., ST. JOSEPH, MI, FLYNN BURNER CORPORATION, NEW ROCHELLE, NY:
1,905,542, REN. 8-6-05. INT. CL. 11.
- WHIRLWIND MUSIC DISTRIBUTORS, INC., ROCHESTER, NY:
2,201,139, CANC. INT. CL. 9.
- WHISTLER CORPORATION OF MASSACHUSETTS, CHELMSFORD, MA:
2,201,994, CANC. MULTIPLE CLASS, INT. CLS. 6 AND 19.
- WHITE CAP INDUSTRIES II, INC., COSTA MESA, CA:
2,997,227, PUB. 6-28-2005. INT. CL. 16.

- WHITE CASTLE SYSTEM, INC., COLUMBUS, OH:
1,303,293, CANC. INT. CL. 42.
- WHITEHILL ORAL TECHNOLOGIES, INC., STAFFORD, TX:
2,999,050, INT. CL. 21.
- WHITESSELL, WENDY S., BROOKLYN, NY:
2,997,704, PUB. 6-28-2005. INT. CL. 16.
- WHITMORE MANUFACTURING COMPANY, THE, ROCKWALL, TX:
1,350,239, REN. 8-11-05. INT. CL. 4.
- WHITTAKER CONSTRUCTION, INCORPORATED, ST. PETERS, MO:
1,861,201, CANC. INT. CL. 37.
- WHITTMANHART, INC., CHICAGO, IL:
2,998,681, MULTIPLE CLASS, INT. CLS. 35 AND 42.
- WHOLE OATS ENTERPRISES, SADDLE RIVER, NJ:
1,340,047, REN. 8-10-05. INT. CL. 25.
- WHOLESALE INDUSTRIES, INC., LYNDBURST, NJ:
1,302,487, CANC. INT. CL. 12.
1,302,489, CANC. INT. CL. 12.
- WIBERG CORPORATION, OAKVILLE, ONTARIO, CANADA:
2,998,598, INT. CL. 30.
- WICO DISTRIBUTION CORP., NILES, IL:
1,302,811, CANC. INT. CL. 28.
- WIDE EYE PRODUCTIONS, WINSTON SALEM, NC:
2,997,975, PUB. 6-28-2005. INT. CL. 41.
- WIFIWAVE, INC., RENO, NV:
2,998,299, PUB. 6-28-2005. INT. CL. 9.
- WILCOX, ARIEL, DIXMONT, ME:
2,201,212, CANC. INT. CL. 42.
- WILD GOOSE HOLDING CO., INC., WILMINGTON, DE:
2,999,299, INT. CL. 30.
- WILD WINGS, LLC, LAKE CITY, MN:
1,861,334, CANC. MULTIPLE CLASS, INT. CLS. 16 AND 42.
- WILDWATER EXPEDITION UNLIMITED, INC., LANSING, WV, WILDWATER EXPEDITIONS UNLIMITED, INC., THURMOND, WV:
1,367,069, REN. 8-10-05. INT. CL. 39.
- WILKINS-ROGERS, INCORPORATED, ELLICOTT CITY, MD, WILKINS-ROGERS MILLING CO., INC., WASHINGTON, DC:
304,505, REN. 8-8-05. U.S. CL. 46 (INT. CL. 30).
- WILLIAM O'NEIL + CO. INCORPORATED, LOS ANGELES, CA:
1,883,590, REN. 8-8-05. INT. CL. 16.
1,883,591, REN. 8-8-05. INT. CL. 16.
- WILLIAMS HEALTHCARE SYSTEMS, ELGIN, IL:
753,402, REN. 8-12-05. U.S. CL. 44 (INT. CL. 10).
- WILLIAMS MAIN STREET ASSOCIATION, INC., WILLIAMS, AZ:
2,996,455, PUB. 6-28-2005. INT. CL. 35.
- WILLIAMS; ROBERT H., WENDEL, PA:
1,303,272, CANC. INT. CL. 42.
- WILLIAMS, MARK LONDON, NORTH HOLLYWOOD, CA:
2,998,122, PUB. 6-28-2005. INT. CL. 41.
- WILLIAMS, NATHANIEL, HOMEWOOD, IL:
2,997,942, PUB. 6-28-2005. INT. CL. 16.
- WILLIAMS, PAUL E., MOBILE, AL:
2,997,778, PUB. 6-28-2005. INT. CL. 29.
- WILLIAMS, SCOTT, LA CANADA, CA:
2,996,774, PUB. 6-28-2005. INT. CL. 19.
- WILLIS ELECTRIC CO., LTD., SEC. 4, HSIN-CHU, TAIWAN:
2,997,069, PUB. 6-28-2005. INT. CL. 11.
- WILSON-COOK MEDICAL INC., WINSTON-SALEM, NC:
2,998,545, INT. CL. 10.
- WIMMER'S MEAT PRODUCTS, INC., WEST POINT, NE:
2,997,336, PUB. 6-28-2005. INT. CL. 29.
- WINDOW ROCK ENTERPRISES, INC., YORBA LINDA, CA:
2,997,105, PUB. 6-28-2005. INT. CL. 5.
- WINDSOR INDUSTRIES, INC., MELVILLE, NY:
1,302,430, CANC. INT. CL. 9.
- WINDY HILL PET FOOD COMPANY, INC., BRENTWOOD, TN:
2,202,146, CANC. INT. CL. 31.
- WINFIELD CONSUMER PRODUCTS, INC., WINFIELD, KS:
2,998,148, PUB. 6-28-2005. INT. CL. 6.
- WINFIELD MEDICAL, SAN DIEGO, CA:
2,201,150, CANC. MULTIPLE CLASS, INT. CLS. 10 AND 20.
- WINMARK CONCEPTS INC., WASHINGTON, DC:
2,998,791, INT. CL. 10.
- WINMARK CORPORATION, MINNEAPOLIS, MN:
1,938,398, REN. 8-10-05. MULTIPLE CLASS, INT. CLS. 35 AND 42.
- WINNEBAGO INDUSTRIES, INC., FOREST CITY, IA:
2,998,807, INT. CL. 12.
- WINNER INTERNATIONAL ROYALTY LLC, SHARON, PA, WINNER, JAMES E., JR., SHARON, PA:
1,899,572, REN. 8-9-05. INT. CL. 6.
- WINNER, JAMES E., JR., SHARON, PA TO WINNER INTERNATIONAL ROYALTY LLC, SHARON, PA:
1,861,384, CANC. INT. CL. 12.
- WINTER, ROBERT, DANA POINT, CA, DBA CREATIVE ARTS - MINI FINS:
2,202,015, CANC. INT. CL. 18.
- WINTOP INTERNATIONAL INDUSTRIAL CO., LTD, WENZHOU CITY, ZHEJIANG PROVINCE, CHINA:
2,996,959, PUB. 6-28-2005. INT. CL. 9.
- WINTRUST FINANCIAL CORPORATION, LAKE FOREST, IL:
2,996,680, PUB. 6-28-2005. INT. CL. 36.
- WIRELESS ACCESSORIES, LLC, PALM BAY, FL:
2,996,896, PUB. 6-28-2005. MULTIPLE CLASS, INT. CLS. 9 AND 35.
- WIREMOLD COMPANY, THE, WEST HARTFORD, CT:
1,328,167, REN. 8-10-05. INT. CL. 9.
- WISCON CORPORATION, LAKE FOREST, IL:
2,201,423, CANC. INT. CL. 29.
- WISCONSIN CHEESEMAN INC., THE, SUN PRAIRIE, WI, MILLE LACS M.P. CO., INC., SUN PRAIRIE, WI:
1,892,291, REN. 8-9-05. INT. CL. 30.
- WISCONSIN ENERGY CORPORATION, MILWAUKEE, WI:
2,202,094, CANC. MULTIPLE CLASS, INT. CLS. 35, 37 AND 42.
- WISE KOSHER NATURAL POULTRY, INC., BROOKLYN, NY:
2,997,563, PUB. 6-28-2005. INT. CL. 29.
- WISE LEASING COMPANY, LLC, VISALIA, CA:
2,996,534, PUB. 6-28-2005. INT. CL. 37.
- WISNIEWSKI, JOHN A., SOUTH GLASTONBURY, CT:
1,895,333, REN. 8-9-05. INT. CL. 37.
- WIVA VERPAKKINGEN B.V., 4903 RH OOSTERHOUT, NETHERLANDS:
2,200,925, CANC. MULTIPLE CLASS, INT. CLS. 8, 17 AND 20.
- WIZARD STUDIOS INTERNATIONAL, INC., SEMINOLE, FL:
2,996,372, PUB. 6-28-2005. INT. CL. 35.
- WLADIMYR, MAYARD, BROOKLYN, NY:
2,999,387, INT. CL. 41.
- WM. H. LEAHY ASSOCIATES, INC., DEERFIELD, IL:
2,201,947, CANC. MULTIPLE CLASS, INT. CLS. 7 AND 11.
- WM. WRIGLEY JR. COMPANY, CHICAGO, IL:
102,001, REN. 8-11-05. U.S. CL. 46 (INT. CL. 30).
- WMS GAMING INC., WAUKEGAN, IL:
2,999,172, INT. CL. 9.
2,999,189, INT. CL. 9.
2,999,201, INT. CL. 9.
2,999,202, INT. CL. 9.
2,999,217, INT. CL. 9.
- WNA COMET EAST, INC., CHELMSFORD, MA, COMET PRODUCTS, INC., CHELMSFORD, MA:
1,898,984, REN. 8-11-05. INT. CL. 21.
- WNBA ENTERPRISES, LLC, SECAUCUS, NJ:
2,202,058, CANC. INT. CL. 28.
2,998,950, INT. CL. 28.
- WOLBER, 02205 SOISSONS CEDEX, FRANCE:
2,201,960, CANC. INT. CL. 12.
- WOLF, JOHN, ITHACA, NY:
2,997,853, PUB. 6-28-2005. INT. CL. 42.
- WOLF, ROGER P., BUTLER, PA:
2,997,103, PUB. 6-28-2005. INT. CL. 16.

WOLFF OLINS LIMITED, LONDON, N1 9RL, UNITED KINGDOM:
2,998,523, INT. CL. 16.

WOLPER SUBSCRIPTION SERVICES, INC., EASTON, PA:
2,997,611, PUB. 6-28-2005. INT. CL. 35.

WOLVERINE WORLD WIDE, INC., ROCKFORD, MI:
1,886,859, REN. 8-6-05. INT. CL. 3.
1,887,234, REN. 8-6-05. INT. CL. 25.
1,894,513, REN. 8-9-05. INT. CL. 3.
2,996,292, PUB. 6-28-2005. INT. CL. 25.

WOMEN OF TOMORROW MENTOR AND SCHOLARSHIP PROGRAM, INC., MIAMI BEACH, FL:
2,997,263, PUB. 6-28-2005. MULTIPLE CLASS, INT. CLS. 18, 25, 35, 36 AND 41.

WOMEN'S HEALTH CONNECTION, INC., MADISON, WI, GENESIS SYSTEMS CORPORATION, MADISON, WI, DBA WOMEN'S HEALTH CONNECTION:
1,876,958, REN. 8-12-05. INT. CL. 41.

WOOD BRIDGE MUSIC SHOP, INC., CLARKSVILLE, MD:
2,997,473, PUB. 6-28-2005. INT. CL. 15.

WOOD SALES, INC., DALTON, GA:
2,997,420, PUB. 6-28-2005. INT. CL. 11.

WOOD, JODY MARQUEZ, HUNTINGTON BEACH, CA:
2,997,892, PUB. 6-28-2005. INT. CL. 16.

WOODEX BEARING COMPANY, INC., GEORGETOWN, ME:
1,907,083, REN. 8-10-05. INT. CL. 7.

WOODMEN INSURANCE AGENCY, INC., OMAHA, NE:
2,998,776, INT. CL. 36.

WOODSTOCK PERCUSSION, INC., SHOKON, NY:
2,998,792, MULTIPLE CLASS, INT. CLS. 6, 19 AND 21.

WOODSTONE CREDIT UNION, FEDERAL WAY, WA:
2,998,153, PUB. 6-28-2005. INT. CL. 36.

WORLD ASSOCIATES, INC., DENVER, CO:
2,201,906, CANC. INT. CL. 41.

WORLD ENTERTAINMENT, INC., PHILADELPHIA, PA:
2,997,941, PUB. 6-28-2005. INT. CL. 41.

WORLD INTER PARTNER LTD., 53113 BONN, IRELAND:
2,320,152, AM. INT. CL. 36.

WORLD LEAGUE LICENSING, L.L.C., WILMINGTON, DE:
2,996,785, PUB. 6-28-2005. INT. CL. 41.
2,996,786, PUB. 6-28-2005. INT. CL. 41.
2,996,787, PUB. 6-28-2005. INT. CL. 41.

WORLD RICHMAN CORPORATION, ELK GROVE VILLAGE, IL:
2,257,170, CANC. INT. CL. 18.

WORLD TRIATHLON CORPORATION, TARPON SPRINGS, FL:
2,998,100, PUB. 6-28-2005. INT. CL. 25.

WORLD WOODS CORPORATION, BROOKSVILLE, FL:
2,997,762, PUB. 6-28-2005. INT. CL. 41.

WORLDSPAN, L.P., ATLANTA, GA:
1,955,617, REN. 8-12-05. INT. CL. 35.

WORLDVIEW ACADEMY INCORPORATED, NEW BRAUNFELS, TX:
2,997,106, PUB. 6-28-2005. INT. CL. 41.

WORLDWIDE CREATIONS, L.L.C., CLIO, MI:
2,996,718, PUB. 6-28-2005. INT. CL. 19.

WRANGLER APPAREL CORP., WILMINGTON, DE:
2,998,129, PUB. 6-28-2005. INT. CL. 25.
2,998,258, PUB. 6-28-2005. INT. CL. 25.
2,998,332, PUB. 6-28-2005. INT. CL. 25.

WRIGHT, MARK, PITTSBURG, CA:
2,999,125, INT. CL. 18.

WSOL, INC., PLANO, TX:
2,999,316, INT. CL. 35.

WYETG, MADISON, NJ:
1,891,924, REN. 8-9-05. INT. CL. 5.

WYETH, MADISON, NJ:
2,998,943, INT. CL. 9.

WYNN RESORTS HOLDINGS, LLC, LAS VEGAS, NV:
2,998,762, INT. CL. 41.
2,998,763, INT. CL. 43.

XCELERON LIMITED, YORK, UNITED KINGDOM:
2,996,893, PUB. 6-28-2005. MULTIPLE CLASS, INT. CLS. 42 AND 44.

XELA PACK, INC., BRIDGEWATER, MI:
1,941,786, REN. 8-8-05. INT. CL. 16.

XEROX CORPORATION, STAMFORD, CT:
2,998,596, INT. CL. 35.

XIONETIC TECHNOLOGIES, INC., BOZEMAN, MT:
2,998,023, PUB. 6-28-2005. MULTIPLE CLASS, INT. CLS. 9 AND 42.

XL FLIES, BILLINGS, MT:
2,201,163, CANC. INT. CL. 25.

XM SATELLITE RADIO INC., WASHINGTON, DC:
2,998,812, INT. CL. 41.

XTEE ENTERPRISES, INC., ENCINITAS, CA:
2,997,639, PUB. 6-28-2005. INT. CL. 25.

YALE ROBBINS INC., NEW YORK, NY:
2,997,641, PUB. 6-28-2005. INT. CL. 41.

YAMAHA CORPORATION, SHIZUOKA, JAPAN:
2,201,971, CANC. INT. CL. 9.

YANKEE CANDLE COMPANY, INC., THE, SOUTH DEERFIELD, MA:
2,998,552, INT. CL. 3.

YEAGER, LISA C., MISSOULA, MT:
2,998,854, INT. CL. 5.

YEIDID INTERNATIONAL INC., NEW YORK, NY:
2,997,813, PUB. 6-28-2005. INT. CL. 14.

YELLATIME PRODUCTIONS, INC., SAN MATEO, CA:
2,201,298, CANC. INT. CL. 35.

YELLOW PAGES PUBLISHERS ASSOCIATION, TROY, MI, DBA YPPA:
2,200,808, CANC. INT. CL. 42.

YELLOW ROSE FINANCIAL CORPORATION, NORTH PLATTE, NE:
1,861,537, CANC. INT. CL. 39.
1,861,538, CANC. INT. CL. 39.

YES I CAN DME, INC., CATHEDRAL CITY, CA, JACKMAN, LOIS, CATHEDRAL CITY, CA:
1,959,026, REN. 8-9-05. INT. CL. 42.

YO LATINO, INC., ORLANDO, FL:
2,999,085, INT. CL. 25.

YOKOGAWA CORPORATION OF AMERICA, NEWNAN, GA:
2,999,136, INT. CL. 9.

YORKE, JENNIFER J., SOUTH HADLEY, MA:
2,887,245, CANC. INT. CL. 44.

YOUNG AGAIN PRODUCTS, INC., WILMINGTON, NC:
2,997,573, PUB. 6-28-2005. INT. CL. 5.
2,997,911, PUB. 6-28-2005. INT. CL. 5.

YOUNG DENTAL MANUFACTURING I, LLC, EARTH CITY, MO, DENTICATOR COMPANY, INC., THE, SAN FRANCISCO, CA:
1,021,451, REN. 8-11-05. INT. CL. 10.

YOUNG, WAYNE, OREM, UT:
2,996,776, PUB. 6-28-2005. INT. CL. 44.

YOURNET, INC., MERRIAM, KS:
2,201,758, CANC. INT. CL. 38.

YOYAMART INC., NEW YORK, NY:
2,997,460, PUB. 6-28-2005. MULTIPLE CLASS, INT. CLS. 2, 25 AND 35.

YVES SAINT LAURENT PARFUMS S.A., 92521 NEILLY CEDEX, FRANCE:
2,201,623, CANC. MULTIPLE CLASS, INT. CLS. 3, 4, 5 AND 21.

YX PROPERTIES, LLC, OMAHA, NE:
2,996,906, PUB. 6-28-2005. MULTIPLE CLASS, INT. CLS. 35 AND 39.

Z-WORLD, INC., DAVIS, CA:
2,201,011, CANC. INT. CL. 9.

ZAIS; BERNARD H., COLCHESTER, VT, DBA THE ZAIS GROUP:
1,303,066, CANC. INT. CL. 36.

ZALE DELAWARE, INC., IRVING, TX:
2,201,225, CANC. INT. CL. 14.

ZAPPOS.COM, INC., LAS VEGAS, NV:
2,998,094, PUB. 6-28-2005. INT. CL. 35.

ZARTIC, INC., ROME, GA:
2,996,498, PUB. 6-28-2005. INT. CL. 29.

ZEBRACLUB, INC., SEATTLE, WA TO INTERNATIONAL NEWS, INC., KENT, WA:
1,825,637, CANC. INT. CL. 42.

ZEGRAHM EXPEDITIONS, INC., SEATTLE, WA:
1,907,639, REN. 8-10-05. INT. CL. 39.

- ZELLWEGER ANALYTICS LIMITED, DORSET, UNITED KINGDOM:
2,997,113, PUB. 6-28-2005. INT. CL. 9.
2,997,114, PUB. 6-28-2005. INT. CL. 9.
- ZELLWOOD FARMS, INC., ZELLWOOD, FL:
1,302,987, CANC. INT. CL. 31.
- ZEMMOUR ERIC, FRANCE:
2,998,476, PUB. 6-28-2005. MULTIPLE CLASS, INT. CLS. 3, 16, 26, 41, 42 AND 44.
- ZENASIS TECHNOLOGIES, INC., CAMPBELL, CA:
2,998,868, INT. CL. 9.
- ZEON CORPORATION, LOUISVILLE, CO, DATA DISPLAY CORPORATION, LOUISVILLE, CO, DBA NEON GLASSWORKS:
1,894,927. REN. 8-11-05. INT. CL. 9.
- ZERO SURGE INC., FRENCHTOWN, NJ:
2,997,212, PUB. 6-28-2005. INT. CL. 9.
- ZESTRON CORPORATION, ASHBURN, VA:
2,996,769, PUB. 6-28-2005. INT. CL. 3.
- ZHOU, LIFENG, ENGLEWOOD CLIFFS, NJ:
2,997,624, PUB. 6-28-2005. INT. CL. 7.
- ZIA MIA'S CUCINA ITALIANA, INC., FRESNO, CA:
2,997,585, PUB. 6-28-2005. INT. CL. 43.
- ZIMMERMAN-GALE, TONYA, LEWES, DE:
2,998,661, INT. CL. 3.
- ZIRCON CORPORATION, CAMPBELL, CA:
1,883,330. REN. 8-11-05. MULTIPLE CLASS, INT. CLS. 8 AND 9.
- ZISMAN, DAVID, MIAMI, FL:
2,052,498, CANC. INT. CL. 11.
- ZKL, A.S., 628 00 BRNO-LISEN, CZECH REPUBLIC:
1,894,828. REN. 8-12-05. INT. CL. 7.
- ZONARE MEDICAL SYSTEMS, INC., MOUTAIN VIEW, CA:
2,998,871, INT. CL. 10.
- ZOOZMANIA INC., AVALON, CA:
2,997,708, PUB. 6-28-2005. INT. CL. 35.
- ZUCCOLO ROCHET & CIE.; SOCIÉTÉ ANONYME, FRANCE:
2,998,439, PUB. 6-28-2005. INT. CL. 14.
- ZURN INDUSTRIES, INC., ERIE, PA:
2,998,901, INT. CL. 11.
- ZYLISS USA CORPORATION, FOOTHILL RANCH, NY:
2,997,312, PUB. 6-28-2005. INT. CL. 21.
- 0-IN DESIGN AUTOMATION, INC., SAN JOSE, CA:
2,997,075, PUB. 6-28-2005. INT. CL. 9.
- IVISION SOFTWARE, INC., LOVELAND, CO:
2,996,281, PUB. 6-28-2005. INT. CL. 9.
- 101COMMUNICATIONS LLC, CHATSWORTH, CA:
2,998,251, PUB. 6-28-2005. INT. CL. 41.
- 1688, INC., BROOKLYN, NY:
1,330,800. REN. 8-11-05. INT. CL. 14.
1,330,800, CANC. INT. CL. 25.
- 2SOURCE MANUFACTURING, INC., MISSISSAUGA, CANADA:
2,999,197, INT. CL. 40.
- 24 HOUR FITNESS USA, INC., SAN RAMON, CA:
2,997,726, PUB. 6-28-2005. INT. CL. 41.
- 2827841 CANADA INC., MONTREAL, PROVINCE OF QUEBEC, CANADA:
2,200,943, CANC. MULTIPLE CLASS, INT. CLS. 29 AND 30.
- 3 MUSES, LLC, STUDIO CITY, CA:
2,996,901, PUB. 6-28-2005. INT. CL. 28.
- 3IS, INC., NOVI, MI:
2,997,329, PUB. 6-28-2005. INT. CL. 42.
- 3V INC., WEEHAWKEN, NJ:
1,894,750. REN. 8-10-05. INT. CL. 1.
- 4-U NUTRACEUTICALS, LLC, PHOENIX, AZ:
2,997,950, PUB. 6-28-2005. INT. CL. 5.
- 7-ELEVEN, INC., DALLAS, TX:
2,997,248, PUB. 6-28-2005. INT. CL. 32.
2,998,558, INT. CL. 4.
- 98% ANGEL, INC., MALIBU, CA:
1,896,670. REN. 8-11-05. INT. CL. 42.
1,903,200. REN. 8-11-05. INT. CL. 42.

* * * * *